

# RADIO & ELECTRONICS CONSTRUCTOR

NOVEMBER 1975

30p

## POWER SUPPLY FOR OP-AMPS

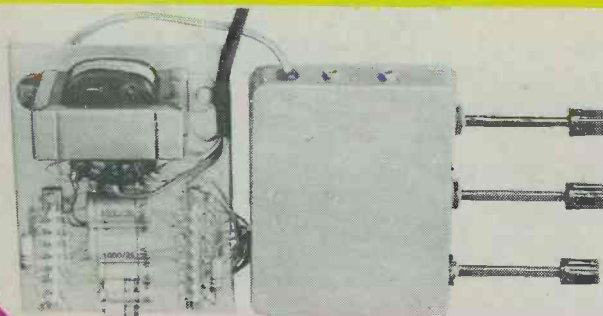
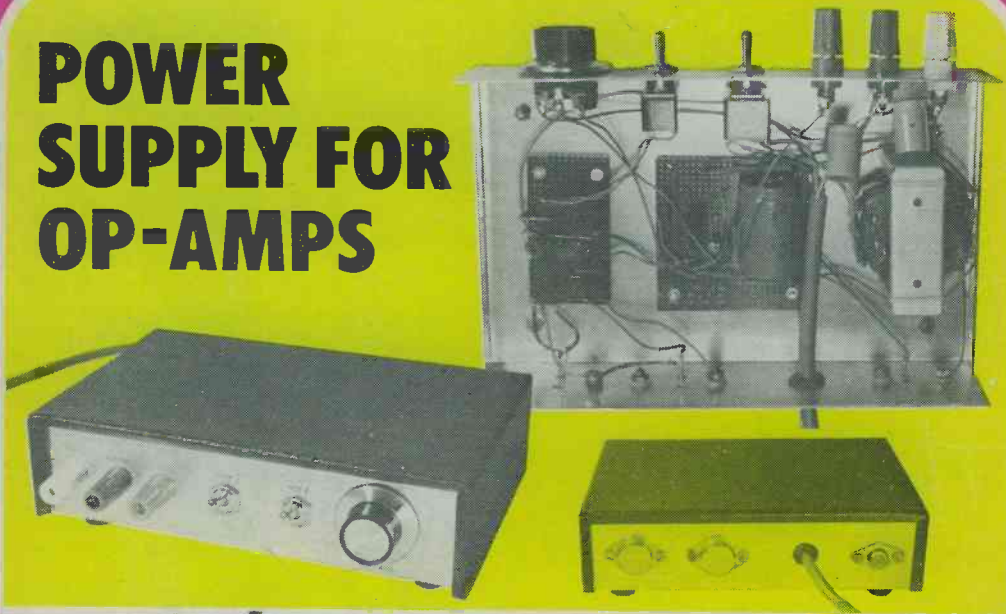

## 6/12 AMPLIFIER

6 WATT CONTINUOUS  
12 WATT PEAK

**ALSO  
FEATURED**

**SUBSTITUTING BY SILICON RECTIFIERS  
NEW TRANSISTORISED OSCILLOSCOPE — Conclusion**



**1** Household contents and personal possessions up to £600



**2** All Risks cover on personal belongings up to £60.



**3** Personal accident insurance (road, rail and sea risks) - £3 per week



**4** Loss of cash up to £20.

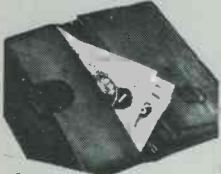

**5** Household removal cover up to £600.



**6** All Risks cover on sports equipment up to £30.



**7** Personal liability cover for the family up to £20,000.



**8** Cover on Radio, Television etc. for damage in the home up to £60

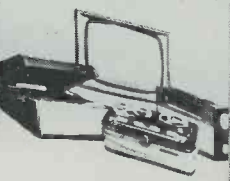

**9** Holiday deposits cover up to £20.

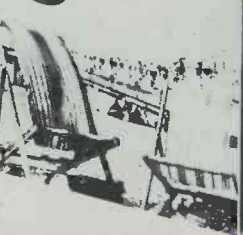

**9**  
Policies  
in ONE

**Each £3 unit of Home Unit Insurance gives you protection up to the limit shown**

This is the simplified insurance you have been waiting for. Not just cover on the contents of your home but a package of personal protection you and your family need. And it's how we save you so much money: just ONE policy to issue instead of nine!  
You can build up to the cover you need by additional units

(or 1/4 units after the first) up to a maximum of five. So simple. So easy. Apply to your Broker, Agent or local office of a General Accident company.  
The Home Unit Policy can replace your existing insurances And remember - as you buy more possessions just add more Home Units at any time. *Quote Ref. 20/9468*

**THE GENERAL ACCIDENT FIRE & LIFE ASSURANCE CORPORATION LTD**

Metropolitan House, 35 Victoria Avenue,  
Southend-on-Sea, Essex, SS2 6BT

Please send me further particulars of the Home Unit Insurance.

Name.....

Address.....

It pays to be protected by a **General Accident** company

20/9468

# RADIO & ELECTRONICS CONSTRUCTOR

NOVEMBER, 1975  
Volume 29 No. 4

Published Monthly (1st of Month)  
First Published 1947

*Incorporating The Radio Amateur*

Editorial and Advertising Offices  
57 MAIDA VALE LONDON W9 1SN

Telephone  
01-286 6141

Telegrams  
Databux, London

© Data Publications Ltd., 1975. Contents may only be reproduced after obtaining prior permission from the Editor. Short abstracts or references are allowable provided acknowledgement of source is given.

Annual Subscription: £4.00 (U.S.A. and Canada \$10.00) including postage. Remittances should be made payable to "Data Publications Ltd". Overseas readers please pay by cheque or International Money Order.

*Technical Queries.* We regret that we are unable to answer queries other than those arising from articles appearing in this magazine nor can we advise on modifications to equipment described. We regret that such queries cannot be answered over the telephone; they must be submitted in writing and accompanied by a stamped addressed envelope for reply.

*Correspondence* should be addressed to the Editor, Advertising Manager, Subscription Manager or the Publishers as appropriate.

*Opinions* expressed by contributors are not necessarily those of the Editor or proprietors.

*Production.*—Web Offset.

## CONTENTS

THE 6/12 AMPLIFIER — Part 1 by J. T. Neill	206
NEWS AND COMMENT	212
MULTI-WAY LATCH CIRCUITS (Suggested Circuit 300) by G. A. French	214
SUBSTITUTING BY SILICON RECTIFIERS by F. G. Rayer	217
SCHMITT RELAY FLASHER by J. R. Davies	220
ADDED AMBIENCE by R. N. Soar	223
POWER SUPPLY FOR OP-AMPS by A. P. Roberts	224
NEW TRANSISTORISED OSCILLOSCOPE Part 3 (Conclusion) by R. A. Penfold	229
WIDE RANGE METRONOME by M. G. Robertson	233
ELECTRONIC ODDITIES by R. River	235
SHORT WAVE NEWS — For DX Listeners by Frank A. Baldwin	236
NEW PRODUCTS	238
CATALOGUE	238
THE SN76023N POWER AMPLIFIER by P. R. Arthur	239
IN YOUR WORKSHOP — TV Line and Vertical Blanking Circuits	243
ELECTRONICS DATA — No. 4 (For the Beginner — Switches)	iii

Published in Great Britain by the Proprietors and Publishers, Data Publications Ltd, 57 Maida Vale, London W9 1SN

The *Radio & Electronics Constructor* is printed by Swale Press Ltd.

DECEMBER ISSUE WILL BE  
PUBLISHED ON 1st DECEMBER

# BI-PAK

VISIT OUR COMPONENT SHOP 18 BALDOK ST., WARE, Herts. (A10)  
Open Mon-Thurs 9.15-6 pm, Sat 9.15-5.30 pm. Late Night Shopping until 7 Fri. Tel: 61593

## SEMICONDUCTORS

### COMPONENTS

**CARBON RESISTOR PAKS**  
These Paks contain a range of Carbon Resistors, assorted into the following groups:

R1. 50 Mixed  
100 ohms-820 ohms  $\frac{1}{2}$  W. 0.60

R2. 60 Mixed  
1K ohms-8.2K ohms  $\frac{1}{2}$  W. 0.60

R3. 50 Mixed  
10K ohms-82K ohms  $\frac{1}{2}$  W. 0.60

R4. 50 Mixed  
100K ohms-820K ohms  $\frac{1}{2}$  W. 0.60

R5. 30 Mixed  
100 ohms-820 ohms  $\frac{1}{2}$  W. 0.60

R6. 30 Mixed  
1K ohms-8.2K ohms  $\frac{1}{2}$  W. 0.60

R7. 30 Mixed  
10K ohms-82K ohms  $\frac{1}{2}$  W. 0.60

R8. 30 Mixed  
100K ohms-820K ohms  $\frac{1}{2}$  W. 0.60

These are unreplicable prices

**LOW COST CAPACITORS**

500 uF 50V Elect. 0.09 each  
.01 uF 400 V 0.03 each

**REPANCO CHOKES & COILS**  
**RF Chokes**  
CH1 2.5mH 0.27 CH2 5.0mH 0.28  
CH3 7.5mH 0.29 CH4 10mH 0.31  
CH5 1.5mH 0.26

**Coils**  
DRK1 Crystal set 0.29  
DRR2 Dual range 0.42

**CARBON POTENTIOMETERS**  
Log and Lin  
4.7K, 10K, 22K, 47K, 100K, 220K, 470K, 1M, 2M.

VC1 Single Less Switch 0.14  
VC2 Single D.P. Switch 9.26  
VC3 Tandem Less Switch 0.43  
VC4 1K Lin Less Switch 0.14  
VC5 100K Log anti-Log 0.43

**HORIZONTAL CARBON PRESETS**  
0.1 Watt 0.06 each  
100, 220, 470, 1K, 2.2K, 4.7K, 10K, 22K, 47K, 100K, 220K, 470K, 1M, 2M, 4.7M.

**REPANCO TRANSFORMERS**  
240V. Primary. Secondary voltages available from selected tappings  
4v, 7v, 8v, 10v, 40v, 50v and 25v-0.25v.

Type	Amps	Price	P & P
MT50/1	1	£1.79	45p
MT50/1	1	£2.24	48p
MT50/2	2	£3.06	60p

**COIL FORMERS & CORES**  
NORMAN 1" Cores & Formers 7p  
1" Cores & Formers 9p

**SWITCHES**  
DP/DT Toggle 28p  
SP/ST Toggle 22p

**FUSES**  
1 $\frac{1}{2}$ " and 20mm, 100mA, 200mA, 250mA, 500mA, 1A, 1.5A, 2A  
**QUICK BLOW** \*5p each  
Anti-Surge 20mm only \*8p each

**VEROBOARDS**  
VB1 containing approx. 50 sq.ins. various sizes all 0.1 matrix. \*60p  
VB2 containing approx. 50 sq.ins. various sizes all 0.15 matrix. \*60p

**DECON-DALO 33PC MARKER**  
Etch resistant printed circuit marker pen. Full instructions supplied with each pen \*92p

**BATTERY HOLDERS**  
Takes 6 H.F. 7s \*31p each terminal clip and lead

**CABLES** Per Metre

CP 1 Single lapped screen \*8p  
CP 2 Twin Common Screen \*11p  
CP 3 Stereo Screened \*12p  
CP 4 Four Core Common Screen \*21p  
CP 5 Four Core individually screened \*28p  
CP 6 Microphone Fully Braided Cable \*11p  
CP 7 Three Core Mains Cable \*11p  
CP 8 Twin Oval Mains Cable\* 8p  
CP 9 Speaker Cable \*6p  
CP10 Low Loss Co-Axial \*14p

### INSTRUMENT CASES



(In 2 sections, Black Vinyl covered top and sides and bezel)  
No. Length Width Height Price  
BV1 6" x 5 $\frac{1}{2}$ " x 3" \*£1.25  
BV2 11" x 6" x 3" \*£1.62  
BV3 6" x 4 $\frac{1}{2}$ " x 1 $\frac{1}{2}$ " \*92p  
BV4 9" x 5 $\frac{1}{2}$ " x 2 $\frac{1}{2}$ " \*£1.39

### ALUMINIUM BOXES

No. Length Width Height Price  
BA1 5 $\frac{1}{2}$ " x 2 $\frac{1}{2}$ " x 1 $\frac{1}{2}$ " \*45p  
BA2 4" x 4" x 1 $\frac{1}{2}$ " \*45p  
BA3 4" x 2 $\frac{1}{2}$ " x 1 $\frac{1}{2}$ " \*45p  
BA4 5 $\frac{1}{2}$ " x 4" x 1 $\frac{1}{2}$ " \*54p  
BA5 4" x 2 $\frac{1}{2}$ " x 2" \*45p  
BA6 3" x 2" x 1" \*39p  
BA7 7" x 5" x 2 $\frac{1}{2}$ " \*79p  
BA8 8" x 6" x 3" \*£1.02  
BA9 6" x 4" x 2" \*65p

(Each complete with  $\frac{1}{2}$ " deep lid and screws)  
Please add 20p p & p for each box

### COMPONENT PAKS

Pak No. Qty. Description Price  
C 1 200 Resistors mixed values approx. count by weight 60p  
C 2 150 Capacitors mixed values approx. count by weight 60p  
C 3 50 Precision Resistors mixed values 60p  
C 4 75 4 width Resistors mixed preferred values 60p  
C 5 5 Pieces assorted Ferrite Rods 60p  
C 6 2 Jack Gangs, MW/LWVHF 60p  
C 7 1 Pak Wire 50 metres assorted colours \*60p  
C 8 10 Reed Switches \*60p  
C 9 3 Micro Switches \*60p  
C10 15 Assorted Pots & Pre-sets 60p  
C11 5 Jack Sockets 3 x 3.5m. 2 x standard Switch Type 60p  
C12 30 Paper Condensers preferred types mixed values 60p  
C13 20 Electrolytics Trans. types 60p  
C14 1 Pack assorted Hardware Nuts/Bolts, Grommets etc. \*60p  
C15 5 Mains Slide Switches, 2 Amp/ 60p  
C16 20 Assorted Tag Strips and Panels \*60p  
C17 10 Assorted Control Knobs 60p  
C18 4 Rotsy Wave Change Switches 60p  
C19 2 Relays 6-24v Operating 60p  
C20 Sheets Copper Laminate approx. 200 sq.ins. \*60p  
Please add 20p p & p on all component paks, plus a further 10p on pack nos. C1, C2, C19 & C20.

### AVDEL BOND

**SOLVE THOSE STICKY PROBLEMS!**

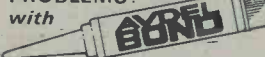

**CYANOACRYLATE C2 ADHESIVE**  
The wonder bond which works in seconds—bond plastic, rubber transistors, components permanently, immediately!

**OUR PRICE ONLY 60p for 2gm phial**

### BI-HI-FI ACCESSORIES

Ref.	Price
B Stylus and turntable cleaning kit *31p	
J Tape head cleaning kit *68p	
P Hi-Fi cleaner *30p	
9 Wire stripper/Cutter *94p	
31 Cassette head cleaner *58p	
32 Tape editing kit *£1.64	
32A Stylus balance *£1.24	
36A Record stylus cleaning kit *32p	
42 De Luxe Groov-Kleen *£1.84	
43 Record care kit *£2.68	
45 Auto changer groove cleaner *98p	
46 Spirit level *68p	
56 Hi-Fi stereo hints & tips *38p	
60 Chrome finish as above *£1.72	

### ANTEX EQUIPMENT

**SOLDERING IRONS**  
X25. 25 watt \*£2.45  
Model G. 18 watt \*£2.70  
CCN 240. 15 watt \*£2.90  
SK2. Soldering Kit \*£3.90

**BITS AND ELEMENTS**  
102 for model CN240 \*42p  
104 for model CCN240 \*42p  
106 for model CCN240 \*42p  
1100 for model CCN240 \*42p  
1101 for model CCN240 \*42p  
1102 for model CCN240 \*42p  
1020 for model G240 \*42p  
1021 for model G240 \*42p  
1022 for model G240 \*42p  
50 for model X25 \*44p  
51 for model X25 \*44p  
52 for model X25 \*44p

**ELEMENTS**  
Model ECN 240 \*£1.10  
Model EG 240 \*£1.35  
Model EGN 240 \*£1.55  
Model EX 25 \*£1.20

**SOLDERING IRON STAND**  
ST3 Suitable for all models \*£1.10  
Antex heat shunt \*10p

### PLUGS

PS	Price
PS 1 D.I.N. 2 Pin (Speaker)	10p
PS 2 D.I.N. 3 Pin	11p
PS 3 D.I.N. 4 Pin	14p
PS 4 D.I.N. 5 Pin 180°	15p
PS 5 D.I.N. 5 Pin 240°	15p
PS 6 D.I.N. 6 Pin	16p
PS 7 D.I.N. 7 Pin	17p
PS 8 Jack 2.5mm Screened	17p
PS 9 Jack 3.5mm Plastic	11p
PS 10 Jack 3.5mm Screened	14p
PS 11 Jack 3" Plastic	14p
PS 12 Jack 1" Screened	20p
PS 13 Jack Stereo Screened	33p
PS 14 Phono	9p
PS 15 Car Aerial	14p
PS 16 Co-Axial	14p

### INLINE SOCKETS

PS	Price
PS 21 D.I.N. 2 Pin (Speaker)	13p
PS 22 D.I.N. 3 Pin	19p
PS 23 D.I.N. 5 Pin 180°	19p
PS 24 D.I.N. 5 Pin 240°	19p
PS 25 Jack 2.5mm Plastic	15p
PS 26 Jack 3.5mm Plastic	15p
PS 27 Jack 1" Plastic	28p
PS 28 Jack 1" Screened	28p
PS 29 Jack Stereo Plastic	35p
PS 30 Jack Stereo Screened	35p
PS 31 Phono Screened	17p
PS 32 Car Aerial	20p
PS 33 Co-Axial	20p

### SOCKETS

PS	Price
PS 35 D.I.N. 2 Pin (Speaker)	7p
PS 36 D.I.N. 3 Pin	9p
PS 37 D.I.N. 5 Pin 180°	9p
PS 38 D.I.N. 5 Pin 240°	10p
PS 39 Jack 2.5mm Switched	11p
PS 40 Jack 3.5mm Switched	11p
PS 41 Jack 1" Switched	19p
PS 42 Jack Stereo Switched	28p
PS 43 Phono Single	7p
PS 44 Phono Double	9p
PS 46 Co-Axial Surface	9p
PS 47 Co-Axial Flush	19p

### P.C.B. KITS & PENS

**PROFESSIONAL D.I.Y. PRINTED CIRCUIT KIT**  
Containing 6 sheets of 6" x 4" single sided laminate, a generous supply of etching powder, etching dish, etchant measure, tweezers, etch resistant marking pen, high quality pump drill with spares, cutting knife with spare blades, 6" metal ruler, plus full easy to follow instructions. \*£7.80 per kit  
Spare container of etchant for above \*60p  
PCB Pens 2 x Quality marker pens specifically designed for drawing fine line etch resistant circuits on copper laminate. Complete with full instructions \*£1.53 per pair

### LOW-NOISE CASSETTES

C60 \*33p; C90 \*44p; C120 \*56p

### AUDIO LEADS

S221	Price
5 pin DIN plug to 2 phono plugs length 1.5m	£1.08
S222 5 pin DIN plug to 5 pin DIN socket length 1.5m	68p
S237 5 pin DIN plug to 5 pin DIN plug mirror image length 1.5m	£1.20
S238 2 pin DIN plug to 2 pin DIN socket length 5m	68p
S258 5 pin DIN plug to 3 pin DIN plug 1 & 4 and 3 & 5 length 1.5m	£1.00

S270	Price
2 pin DIN plug to 2 pin DIN socket length 10m	80p
S271 5 pin DIN plug to 2 phono plugs connected to pins 3 & 5 length 1.5m	70p
S275 5 pin DIN plug to 2 phono sockets connected to pins 3 & 5 length 23cm.	68p
S318 5 pin DIN socket to 2 phono plugs connected to pins 3 & 5 length 23cm.	68p
S404 Coiled stereo headphones extension cord extends to 7m	£1.40
S217 3 pin DIN plug to 3 pin DIN plug length 1.5m	80p
S219 5 pin DIN plug to 5 pin DIN plug length 1.5m	80p
S474 3.5mm Jack to 3.5mm Jack length 1.5m	80p
S600 5 pin DIN plug to 3.5mm Jack connected to pins 3 & 5 length 1.5m	80p
S700 5 pin DIN plug to 3.5 jack connected to pins 1 & 4 length 1.5m	80p

### CROSSOVER NETWORK

K4007 1/P Impedance 8 ohms. (2-way) Insertion Loss 3dB.  
Crossover Frequency 3 KHz. PRICE £1.12

### H/PHONE JUNCTION BOX

H1012 Enables change-over from (3-way stereo) loudspeaker to head phone listening. Also has a centre position for both outputs PRICE £1.75

### A.L. PRICES EXCLUDE V.A.T.

Please add V.A.T. at 25% all items except \* ADD 8%  
NO V.A.T.  
GIRO NUMBER 388-7006

### HANDBOOKS

**Transistor Data Book - DTE 1**  
227 Pages packed with information on European Transistors. Full specification including outlines. Price \*£2.95 each

**Transistor Equivalents Book - BPE 75**  
256 Pages of cross references and equivalents for European, American and Japanese Transistors. This is the most comprehensive equivalents book no the market today and has an introduction in 13 languages. Price \*£2.68 each

**DIODE EQUIVALENTS BOOK DE 74**  
144 Pages of cross references and equivalents for European, American and Japanese Diodes, Zeners, Thyristors, Triacs, Diacs and L.E.D.'s. Price \*£1.98 each

**MULLARD DATA BOOK 1974/75 - MDB 74**  
The latest edition of this popular handbook contains information on Semiconductors, Integrated Circuits, Television Picture Tubes, Valves, Capacitors and Resistors. Included in the 161 informative pages are 21 pages on Semiconductor Comparables. Price \*£20.40 each

**TTL DATA BOOK - DIC 75**  
Now complete Data book of 74 series TTL (7400-7413). Covering 13 main manufacturers in the U.S.A. and Europe, this book gives full data as well as equivalents. Price \*£3.74

**THE WORLD'S BROADCASTING STATIONS - WBS 75**  
An up to the minute guide for those interested in DX-ing. Contains all the world's broadcast stations on SW, MW and LW, as well as European FM/TV stations. Price \*£3.56  
A full range of technical books available on request.

# PO BOX 6 WARE HERTS

**AL 60**

50w. PEAK (25w. R.M.S.)

**ONLY £3.95**

- Max Heat Sink temp. 90°C.
- Frequency Response 20Hz to 100K Hz
- Distortion better than 0.1 at 1KHz.
- Supply voltage 15-50 volts.
- Thermal Feedback.
- Latest Design Improvements.
- Load - 3, 4, 5 or 16 ohms.
- Signal to noise ratio 80dB.
- Overall size 63mm x 105mm x 13mm.

Especially designed to a strict specification. Only the finest components have been used and the latest solid state circuitry incorporated in this powerful little amplifier which should satisfy the most critical A. F. enthusiast.

## STABILISED POWER MODULE SPM80

SPM80 is especially designed to power 2 of the AL60 Amplifiers, up to 15 watt (r.m.s.) per channel simultaneously. This module embodies the latest components and circuit techniques incorporating complete short circuit protection. With the addition of the Mains Transformer BMT80, the unit will provide outputs of up to 1.5 amps at 35 volts. Size: 63mm x 105mm x 30mm.

These units enable you to build Audio Systems of the highest quality at a hitherto unobtainable price. Also ideal for many other applications including: Disco Systems, Public Address Intercom Units, etc. Handbook available # 10p

TRANSFORMER BMT80 £2.60

**PRICE £3.00**

## STEREO PRE-AMPLIFIER TYPE PA100

Built to a specification and NOT a price, and yet still the greatest value on the market, the PA100 stereo pre-amplifier has been conceived from the latest circuit techniques.

Designed for use with the AL50 power amplifier system, this quality made unit incorporates no less than eight silicon planar transistors, two of these are specially selected low noise NPN devices for use in the input stages.

Three switched stereo inputs, and rumble and scratch filters are features of the PA100 which also has a STEREO/MONO switch, volume, balance and continuously variable bass and treble controls.

**PRICE £13.20**

**MK 60 AUDIO KIT** Comprising: 2 x AL60, 1 x SPM80, 1 x BTM80, 1 x PA100, 1 front panel, 1 kit of parts to include on-off switch, neon indicator, stereo headphone sockets plus instruction booklets.

COMPLETE PRICE: £27.55 plus 45p postage

**TEAK 60 AUDIO KIT** Comprising: Teak veneered cabinet size 16½" x 11½" x 3", other parts include aluminium chassis, heatsink and front panel bracket, plus back panel and appropriate sockets etc.

KIT PRICE: £9.20 plus 45p postage.

stage and packaging overseas and extra for airmail. Minimum order 75p.

## STEREO 30 COMPLETE AUDIO CHASSIS

7+7 WATTS R.M.S.

The Stereo 30 comprises a complete stereo pre-amplifier, power amplifiers and power supply. This, with only the addition of a transformer or overwind, will produce a high quality audio unit suitable for use with a wide range of inputs, i.e. high quality ceramic pickup, stereo tuner, stereo tape desk, etc.

Simple to install, capable of producing really first class results, this unit is supplied with full instructions, black front panel, knobs, mains switch, fuse and fuse holder and universal mounting bracket, enabling it to be installed in a record plinth, cabinets of your own construction or the cabinet available.

Ideal for the beginner or advanced constructor who requires Hi-Fi performance with a minimum of installation difficulty. Can be installed in 30 mins.

PRICE **£15.75** P & P 45p

TRANSFORMER **£2.45** P & P 45p TEAK CASE **£3.65** P & P 45p

## AL10/AL20/AL30

The AL10, AL20 and AL30 units are similar in their appearance and in their general specification. However, careful selection of the plastic power devices has resulted in a range of output powers from 3 to 10 watts R.M.S. The versatility of their design makes them ideal for use in record players, tape recorders, stereo amplifiers and cassette and cartridge tape players in the car and at home.

AL10 £2.30 AL20 £2.65 AL30 £2.95

### M.P.A. 30

Enjoy the quality of a magnetic cartridge with your existing ceramic equipment using the new Bi-Pak M.P.A. 30 which is a high quality pre-amplifier enabling magnetic cartridges to be used where facilities exist for the use of ceramic cartridges only.

Used in the construction are 4 low noise, high gain, silicon transistors. It is provided with a standard DIN input socket for ease of connection.

Supplied with full, easy to follow instructions. Price £2.65

### STORAGE/CARRY CASES\*

#### RECORD CASES

7 in. E.P. 18½ in. x 7 in. x 8 in.  
(50 records) \*£2.48  
12 in. L.P. 13½ in. x 7½ in. x 12½ in.  
(50 records) \*£3.30

#### CASSETTE CASES

Holds 15. 10 in. x 3½ in. x 5 in. Lock and handle. \*£1.50

#### 8-Track CARTRIDGE CASES

Holds 14. 13 in. x 5 in. x 6 in. Lock and handle. \*£2.20  
Holds 24. 13½ in. x 8 in. x 5½ in. Lock and handle. \*£3.20

### CARTRIDGES

#### ACOS

GP91-1SC 200mV at 1.2cms/sec £1.11  
GP93-1 280mV at 1cm/sec £1.43  
GP96-1 100mV at 1 cm/sec £2.31

#### TTC

J-2005 Crystal/Hi Output 97p  
J-2010C Crystal/Hi Output Compatible £1.11  
J-2006S Stereo/Hi Output £1.52  
J-2105 Ceramic/Med Output £1.81

J-2203 Magnetic 5mV/5cm/sec. including stylus £4.78  
J-2203S Replacement stylus for above £2.88

AT-55 Audio-technica magnetic cartridge 4mV/5cm/sec. £3.06

### DYNAMIC MICROPHONES

TYPE B1223 200 ohms impedance. Complete with stand, on/off switch and 2.5mm and 3.5mm plugs. Suitable for cassette tape recorders. PRICE £1.67

**JUST OUT!**  
**STEREO FM TUNER**

**WRITE NOW FOR FULL DETAILS**

**SATISFACTION GUARANTEED OR YOUR MONEY RETURNED**

# RADIO & ELECTRONICS

Pricelist free with sae.  
Product info folder 40p

## CONSTRUCTED.

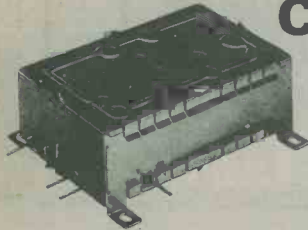

EF5600: Varicap FM tunerhead, AFC/AGC/MOSFET input. £10.00.

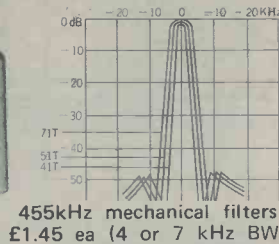

CFS  
10.7MHz



ceramic FM IF filter 40p.



s18 VHF coils POA

Ambit is the wireless specialist. We supply tuners, tunerheads, components, modules and accessories specifically to provide a 'one stop' wireless constructor's source.

Here's a brief selection from our full range of ICs, components & modules:  
AM radio system:

EC720 varicap tuned MW radio tuner with ceramic IF filter, and IC signal processing system. . . . kit £8.00.

Three gang tuning diode MVAM1 : £2.75 each. 2 gang MVAM2: £1.05.

FM radio System:

Larsholt 7252 tuner set. An electronically tuned 88-108 MHz receiver module. 1uV for 26dB S/N, mute, AFC, AGC, 'scan and hold', meter outputs for signal strength, tuning & frequency indication. Built and tested for £24.00.

Tuning Accessories:

WS150 150mm WW slider pot for direct scale readout. . . . £3.00

9932 6 button preset pot. bank for preset station selection. . . £3.40

Meters (illuminated) for frequency, sig. strength, tuning. . . £2.50 each

Selection of 78 series voltage regulators for total stability, see lists.

**AMBIT INTERNATIONAL** 37 High Street, Brentwood, Essex.

All prices quoted exclude VAT. Postage 20p per order. Min CWO £2. Min. invoice £7.50.

## At Home Soldering?

You should be — with the LITESOLD CONQUEROR

A superbly handling lightweight iron, fully insulated and earthed for safety. Bits are interchangeable, non-seize, and are available in 16 different shapes and sizes, from 1/16" up to 1/4", in copper and long-life types. (Standard fitting, 1/8" copper single chisel shape). Covers a range of work often needing several different irons.

A special spring stand gives safe, easy location of the iron and spare bits. The heavy heat-resistant base is complete with non-slip pads and bit cleaning sponge.

Send cheque/PO direct, or ask for leaflet.



Conqueror Iron Only £3.35  
Iron & Spring Stand £5.66  
Iron, Stand & set of  
4 spare copper bits £7.30  
(Prices include 8% VAT  
and p. & p.)

**LIGHT SOLDERING DEVELOPMENTS LTD**

97-99, Gloucester Road, Croydon, CRO 2DN. 01-689 0574

LS/M



**"I MADE IT MYSELF"**

*Imagine the thrill you'll feel! Imagine how impressed people will be when they're hearing a programme on a modern radio you made yourself.*

**Now! Learn the secrets of radio and electronics by building your own modern transistor radio!**

Practical lessons teach you sooner than you would dream possible.

What a wonderful way to learn – and pave the way to a new, better-paid career! No dreary ploughing through page after page of dull facts and figures. With this fascinating Technatron Course, you learn by building!

You build a modern Transistor Radio... a Burglar Alarm. You learn Radio and Electronics by doing actual projects you enjoy – making things with your own hands that you'll be proud to own! No wonder it's so fast and easy to learn this way. Because learning becomes a hobby! And what a profitable hobby. Because opportunities in the field of Radio and Electronics are growing faster than they can find people to fill the jobs!

No soldering – yet you learn faster than you ever dreamed possible. Yes! Faster than you can imagine, you pick up the technical know how you need. Specially prepared step-by-step lessons show you how to read circuits – assemble components – build things – experiment. You enjoy every minute of it!

You get everything you need. Tools. Components. Even a versatile Multimeter that we teach you how to use. All included in the course. **AT NO EXTRA CHARGE!** And this is a course anyone can afford. (You can even pay for it by easy instalments).

So fast, so easy, this personalised course will teach you even if you don't know a thing today!

No matter how little you know now, no matter what your background or education, we'll teach you. Step by step, in simple easy-to-understand language, you pick up the secrets of radio and electronics.

You become a man who makes things, not just another of the millions who don't understand. And you could pave the way to a great new career, to add to the thrill and pride you receive when you look at what you have achieved. Within weeks you could hold in your hand your own transistor radio. And after the course you can go on to acquire highpowered technical qualifications, because our famous courses go right up to City & Guilds levels.

Send now for **FREE** 76 page book – see how easy it is – read what others say!

Find out more now! This is the gateway to a thrilling new career, or a wonderful hobby you'll enjoy for years. Send the coupon now. There's no obligation.

**BUILD YOURSELF  
A 25W AMP  
FOR ONLY**

**£29-95  
+ 4-05 VAT**

**COMPLETE  
KIT SUPPLIED**

GENUINE  
BIG-SOUND  
VALUE!

DORAM, ONE OF BRITAIN'S LEADING MAIL-ORDER DISTRIBUTORS OF AUDIO ACCESSORIES AND COMPONENTS BRINGS YOU THE 'INTERNATIONAL 25' - A 25W STEREO AMP - THAT YOU CAN BUILD YOURSELF! THIS 'REAL VALUE FOR MONEY' KIT IS SUPPLIED WITH CLEAR ASSEMBLY INSTRUCTIONS AND RELIABLE COMPONENTS TO GIVE YOU A BIG SOUND TO BE PROUD OF.



**FEATURES**

- ★ TRIPLE OP-AMP PRE-AMPLIFIER
- ★ POWER 'DARLINGTONS' IN OUTPUT STAGE
- ★ 25W R.M.S. PER CHANNEL INTO 8 OHMS
- ★ MODERN, ELEGANT STYLING

MANY MORE INTERESTING AUDIO KITS AND COMPONENTS LISTED IN DORAM'S CATALOGUE - PRICED AT ONLY 60p.

**DORAM**  
*The doorway to amateur electronics*

P.O. Box TR8, Leeds LS12 2UF Tel: Leeds (0532) 34222  
An Electrocomponents Group Company

**POST TODAY FOR FREE BOOK**

To: ALDERMASTON COLLEGE  
DEPT. CRE 11, READING RG7 4PF **CRE 11**

Also at our London Advisory Office, 4 Fore Street Avenue, Moorgate, London, EC2Y 5EJ Tel: 01-628 2721  
Yes, I'd like to know more about your course. Please send me free details—plus your big, 76-page book that tells about all your courses.

NAME .....

ADDRESS .....

POSTCODE .....



**HOME OF BRITISH INSTITUTE OF ENGINEERING TECHNOLOGY**

# COMPONENTS

HOBBYIST - PROFESSIONAL - DOMESTIC - SURPLUS - INDUSTRIAL  
 JUST A FEW OF OUR BARGAINS ARE LISTED BELOW - SEND STAMPED  
 ADDRESSED ENVELOPE FOR A QUOTE ON OTHER REQUIREMENTS.  
 PAY US A VISIT. OVER 90% OF STOCK BELOW QUANTITY  
 WHOLESALE PRICE. RETURN POSTAL SERVICE UNLESS CHEQUE.

Goods sent at customer's risk, unless sufficient payment for insurance  
 included (2p per £1 Min 5p) U.K. only.

JAP 4 gang min. sealed tuning condensers New 25p  
 Ex-eqpt. 2 or 4 gang 15p

VALVE BASES	
Printed circuit B9A - B7G	2p
Chassis B7 - B9G - B7G	4p
Shrouded chassis B7G - B9A	6p
B8A - B9A chassis - B12A tube	6p

TO3 or TO66	
Mica Washer	2p
18 volt 4 amp charger, bridge rectifier 50p	
GC10/4B	£3.00

**ELECTROLYTICS MFD/VOLT. Many others**  
 in stock 70- 200- 300- 450-  
 Up to 10V 25V 50V 75V 100V 250V 350V 500V  
 MFD

Speaker, 6" x 4", 5 ohm, ideal for car radio etc. £1  
**TAG STRIP - 6 way 3p**  
 9 way 5p Single 1p

**Telescopic aerial**  
 Closed 9½", open 38½"  
 Fitted right angle TV  
 plug, 50p

10	4p	5p	6p	8p	8p	12p	16p	20p
25	4p	5p	6p	8p	8p	15p	18p	20p
50	4p	5p	6p	9p	13p	18p	25p	—
100	5p	6p	10p	12p	19p	20p	—	—
250	9p	10p	11p	17p	28p	—	85p	£1
500	10p	11p	17p	24p	45p	—	—	—
1000	13p	17p	40p	75p	—	£1.50	—	—
2000	23p	37p	45p	—	—	—	—	—

1½ glass fuses— 250 m/a or 3 amp (box of 12) 18p  
 3" tape spools 8p 1 Terryclips chrome finish 4p  
 Brand new Boxed 6K7G 25p 1.5m, log edge pot 8p  
 PVC or metal clip on M.E.S. bulb holder 5p  
 Geared Knob, Inner to Outer Ratio 8:1 60p  
 Bulgin, 5mm Jack plug and switched socket (pair) 30p  
 12 volt solenoid and plunger 30p  
 250 RPM 50 c/s locked frequency miniature mains motor 50p  
 200 OHM coil, 2¼" long, hollow centre 10p  
 Belling Lee white plastic surface coax outlet Box 30p  
 R.S. 12 way standard plug and shell 20p

As total number of values are too numerous to list,  
 use this price guide to work out cost of your  
 actual value requirements, i.e. 2MFD, 30V would  
 be 5p, or 330MFD, 50V would be 14p, etc. etc.  
 8/20, 10/20, 12/20 Tubular tantalum 15p each  
 16-32/275, 32-32/275, 100-100/150, 100-  
 100/275 50-50/300 20p each  
 50/50-385 30p  
 12,000/12, 32-32-50/300, 700/200 100-100-  
 100-150-150/320 50p each  
 20-20-20/350 40p each

SWITCHES		
Pole	Way	Type
4	2	Sub. Min. Slide
6	2	Slide
4	2	Lever Slide
2	2	Slide
1	3	+ off Sub. min. edge
1	3	13 amp small rotary
2	2	Locking with 2 to 3 keys
£1.50		
2	1	2 Amp 250V A.C. rotary
Wafer Rotary, all types 24p		
S.P.S.T. 10 amp 240v. white rocker switch with neon. 1" square flush panel fitting 30p		

RESISTORS	
¼ ¼ watt	1p
1 watt	2p
Up to 5 watt wire	10p
10 watt wire	
wound	12p
15 watt	14p

**INDICATORS**  
 Bulgin D676 red, takes M.E.S. bulb 20p  
 12 volt red, small pushfit 20p  
 Mains neon, red, pushfit 20p

**1½ METER AUDIO LEAD**  
 5 pin din plug 180° both ends 80p  
 3 pin din to open end, 1½yd twin screened  
 lead 35p

Philips transformer,  
 safety fused. In 200-  
 220-240v. Out 240v  
 60ma +6.3v 1a approx  
 2" x 2½" x 2½" £1.50

**CAPACITOR GUIDE - maximum 500V**  
 Up to .01 ceramic 2p. Up to .01 poly 3p.  
 Up to 1000PF silver mica 5p. 1,200PF up to .01  
 silver mica 10p. .013 up to .25 poly etc. 4p.  
 .27 up to .68 poly etc. 6p  
 Over 500 volt order from above guide and few  
 others listed below.  
 6p. .1/600: 10p. .01/1000, 1/350, 8/20, .1/900,  
 .22/900, 4/16. .25/250 AC (600VDC) .1/1500  
 40p. 5/150, 9/275AC, 10/150, 15/150, 40/150.

**COMPUTER AND AUDIO BOARDS**  
 VARYING PANELS WITH ZENER, GOLD BOND,  
 SILICON, GERMANIUM, LOW AND HIGH POWER  
 TRANSISTORS AND DIODES, HI STAB RESISTORS,  
 CAPACITORS, ELECTROLYTICS, TRIMPOTS, POT  
 CORES, CHOKES ETC.

POTS	
Log or Lin carbon	13p
Switched	25p
Dual Pots	38p
Dual & switch	50p
Lin wirewound	25p
Slider Pot	25p
Dual Slider	35p

**TRIMMERS, 20p each**  
 100PF Ceramic, 30PF Beehive, 12PF PTFE  
 2500PF 750 volt, 33PF MIN. AIR SPACED  
 5PF, MIN. AIR SPACED, 50PF CERAMIC.

3lb for 85p + 75p post and packing  
 7lb for £1.75 + £1 post and packing

THERMISTORS	
VA1008, VA1034,	} 10p
VA1039, VA1040,	
VA1055, VA1066,	} 15p
VA1082, VA1100	
VA1077,	}
VA1005, VA1026	

**CONNECTOR STRIP**  
 Belling Lee L1469, 4 way polythene. 3p each  
 Strong grey plastic box same design as die cast  
 all 4¾" x 2¾" x 1½" 40p  
 1" or 1½" or 2" CAN CLIPS 2p

Skeleton Presets	Clear Plastic Boxes
Slider, horizontal or vertical standard or submin. 5p	For component storage or projects, sliding lid. 1½" x 1" 10p

**MAINS DROPPERS**  
 36+79 ohm 15p  
 66+66+158 ohm, 66+66+137 ohm  
 17+14+6 ohm, 266+14+193 ohm 20p  
 50+40+1k5 ohm }  
 285+575+148+35 ohm } 30p  
 25+35+97+59+30 ohm }

**KNOBES**  
 SILVER METAL PUSH ON WITH POINTER, OR  
 WHITE PLASTIC, GRUB SCREW WITH POINTER AND  
 SILVER CENTRE 8p EACH.  
 1" DIAM. WITH 1½" SKIRT SPUN ALUMINIUM  
 GRUB SCREW FIXING, ½" 30p EACH.

**RELAYS**  
 12 volt S.P.C.O octal  
 mercury wetted high  
 speed 75p  
 P.O. 3000 type, 1,000  
 OHM coil, 4 pole c/o  
 60p  
 Mains or 12v d.p.c.o.  
 heavy duty octal 60p

5½" x 2¾" Speaker, ex-equipment 3 ohm 30p  
 2 Amp Suppression Choke 5p  
 3 x 2½ x 1½" } PAXOLINE 2p  
 4½ x 1½ x 1½" } 2 for 1p  
 220K & 100 ohm 3 watt resistors 4p  
**VALVE RETAINER CLIP, adjustable** 2p

**ZM1162A INDICATOR TUBE**  
 0-9 Inline End View. Rectangular Envelope 170V  
 2.5M/A £1.50

Boxed GEC KT88  
 valve £2

**OUTPUT TRANSFORMERS**  
 Sub-miniature Transistor Type 25p  
 Valve type, centre tapped or straight 40p

**RESETTABLE COUNTER**  
 English Numbering Machines LTD.  
 MODEL 4436-159-989  
 6-14 volt, 6 digit, illuminated, fully enclosed. £2.50  
 Ferric Chloride, Anhydrous mil. spec. 1lb. bag 50p

12 volt 250M/A or 6 volt ½A  
 Transformers £1  
 Whiteley Stentorian 3 ohm constant impedance  
 volume control way below trade at 80p  
 Drive Cord 1p per yd.

## THE RADIO SHACK

161 ST. JOHNS HILL, BATTERSEA, LONDON S.W.11  
 Open 10 a.m. till 7 p.m. Monday to Saturday - Also Sunday afternoons

Terms: Payment with order Telephone: 01-223 5016



**SEMICONDUCTORS**

Full spec. marked by Mullard, etc. Many other types in stock

AC107 .. 12p	BC179B .. 11p	BF180/1/2/3 .. 20p
AC128 .. 5p	BC184C .. 9p	BF184/5 .. 15p
AC176 .. 10p	BC186/7 .. 13p	BF194/5/6/7 .. 5p
ACY28 .. 18p	BC213L/214B .. 9p	BF194A/195C/200 .. 12p
AD149 .. 40p	BC261B .. 10p	BF258/262/263 .. 24p
AD161/2 matched pr. 69p	BC327 .. 12p	BF336 .. 25p
AF116 .. 12p	BC328 .. 10p	BFS28 Dual Mosfet .. 92p
AF124/6/7 .. 20p	BC337/8 .. 12p	BFW10/11 F.E.T. .. 26p
AF139/178/180/181 .. 30p	BC547/558A .. 7p	BFW30 .. £1.35
AF239 .. 20p	BC548 .. 9p	BFW57/58 .. 20p
ASY27/73 .. 25p	BCX32/36 .. 12p	BFX12 .. 20p
BC107A or B .. 9p	BCY40 .. 60p	BFX29/30/84/88 .. 16p
BC107/8/9 .. 7p	BCY70/1/2 .. 9p	BFX89 .. 30p
BC108A/B/109B/C .. 10p	BD112/3/5/6 .. 40p	BFY50/1/2 .. 12p
BC147/8/9 .. 6p	BD131/2/3/5 .. 30p	BFY90 .. 50p
BC147A/B .. 8p	BD201/2/3/4 .. £1.00	BR101 .. 30p
BC148A/B, 9B/C/S .. 8p	BD232/4/5 .. 46p	BR139 } Programmable Unj Junction
BC157/8/9 .. 6p	BDX77 .. £1.40	BRY56 .. 34p
BC158A/B .. 11p	BF115 .. 12p	BSV64 .. 40p
BC159B/C, 157A .. 11p	BF167/173 .. 15p	BSV79/80 F.E.T.s .. £1
BC178A/B .. 12p	BF178/9 .. 20p	BSV81 Mosfet .. 90p

**BRIDGE RECTIFIERS**

Amp	Volt		Amp	Volt	
1/2	1,600	BYX10	30p		LT120 type
1	140	OSHO1-200	30p		EC433
1.4	42	BY164	28p		Texas
			5	400	75p

**RECTIFIERS**

Amp	Volt		
IN4004	1	400	4p
IN4005	1	600	
IN4006	1	800	
IN4007	1	1,000	
BY103	1	1,500	15p
SR100	1.5	100	7p
SR400	1.5	400	8p
REC53A	1.5	1,250	14p
LT102	2	30	10p
BYX38-600	2.5	600	40p
BYX38-300R	2.5	300	36p
BYX38-900	2.5	900	45p
BYX38-1200	2.5	1,200	50p
BYX49-600	2.5	600	34p
BYX49-300	2.5	300	26p
BYX49-900	2.5	900	40p
BYX49-1200	2.5	1,200	52p
BYX48-300	6	300	40p
BYX48-600	6	600	50p
BYX48-900	6	900	60p
BYX48-1200	6	1,200	80p
BYX72-150R	10	150	35p
BYX72-300R	10	300	45p
BYX72-500R	10	500	55p
BYX42-300	10	300	30p
BYX42-600	10	600	65p
BYX42-900	10	900	80p
BYX42-1200	10	1,200	95p
BYX46-300*	15	300	£1.00
BYX46-400*	15	400	£1.50
BYX46-500*	15	500	£1.75
BYX46-600*	15	600	£2.00
BYX20-200	25	200	60p
BYX52-300	40	300	£1.75
BYX52-1200	40	1,200	£2.50

\*Avalanche type

Amp	Volt	TRIACS	
6	400	Plastic	74p
25	900	BTX94-900	£4.00
25	1200	BTX94-1200	£6.00
12-0-12 50M/A Min. Txmfr.			90p
Pair of LA2407 Ferroxc cores with adjuster			25p
Chrome Car Radio fascia			15p
Rubber Car Radio gasket			5p
DLI Pal Delayline			50p
Relay socket			10p
Take miniature 2PCO relay			
B7G or B9A valve can			2p
0-30, or 0-15, black pvc, 360° dial, silver digits, self adhesive, 4 1/2" dia.			10p

**OPTO ELECTRONICS**

BPX40	65p	Photo transistor	
BPX42	£1.00	BPX29	£1.00
BPY10	£1.00	OC P71	30p
(VOLIAC)		BIG L.E.D. 0.2"	
BPY68	£1.00	2v 50m/A max.	
BPY69		RED	14p
BPY77		ORANGE	16p
		GREEN	
		YELLOW	

**PHOTO SILICON CONTROLLED SWITCH** BPX66 PNP 10 amp £1.00

3" red 7 segment L.E.D. 14 D.I.L. 0-9 + D.P. display 1.9v, 10m/a segment 65p

CQY11B L.E.D. Infra red transmitter £1 One fifth of trade

Wire ended glass neons 5p

Plastic, Transistor or Diode Holder 1p  
Transistor or Diode Pad 1p  
Holders or pads 50pper100

Philips Iron Thermostat .. 15p  
Bulgin 2-pin flat plug and socket 10p  
McMurdo PP108 8 way edge plug 10p

**TO3 HEATSINK**

Euroelec HP1 TO3B individual 'curly' pcover transistor type. Ready drilled 20p

Tested unmarked, or marked ample lead ex new equipment

ACY17-20	8p	OC71/2	5p
ASX20	8p	OC200-5	10p
ASZ21	15p	TIC44	24p
BC186	11p	2G240	2-50
BCY30-34	10p	2G302	6p
BCY70/1/2	8p	2G401	10p
BF115	10p	2N711	25p
BY127	7p	2N2926	7p
BZY88 series	5p	2N598/9	6p
HG1005	2p	2N1091	8p
HG5009	2p	2N1302	8p
HG5079	2p	2N1907	2-50
L78/9	2p	Germ. diode	1p
M3	10p	GET120 (AC128 in 1" sq. heat sink)	20p
OA81	2p	OA47	2p
OA47	2p	OA200-2	3p
OC23	20p	OC23	20p

BSX20/21	13p
BSY40	28p
BU105-01	93p
CV7042 (OC41 OC44, ASY63)	7p
GET111	40p
OC35	32 1/2p
ON222	30p
TIP30	52p
TIP3055	50p
TIS88A FET	23p
ZTX300	8p
ZTX341	15p
2N393/MA393	30p
2N706	8p
2N929	14p
2N987	35p
2N1507/2219	17p
2N2401/2412/2483	25p
2N2904/5/6/7	13p
2N2907A	15p
2N3053	13p
2N3054/3055(or equiv)	35p
2N3133	18p
2N3704	10p
2N4037	35p
2N5036	60p
2SA141/2/360	31p
2SB135/6/457	20p
40250	60p

**OTHER DIODES**

IN916	6p
IN4148	2.5p
BA145/148	12p
Centercel	10p
BZY61	10p
BB103/110 Varicap	18p
BA182	18p
OA5/7/10	10p
BZY88 Up to 33 volt	26p
BZX61 11 volt	16p
BR100 Diac	19p

**INTEGRATED CIRCUITS**

741 8 pin d.i.l. op. Amp	24p
TAD100 AMRF	£1.00
CA3001 R. F. Amp	£1.00
TAA300 1wt Amp	£1.25
NE555v Timer	44p
TAA550 Y or G	31p
TAA263 Amp	65p
7400/2/10/20/30	13p
7404	14p
7414	45p
7438/74/86	27p
7483	80p
LM300, 2-20 volt	50p
74154	£1.44

**THYRISTORS**

Amp	Volt		
1	240	BTX18-200	50p
1	400	BTX18-300	65p
1	240	BTX30-200	40p
6.5	500	BT102-500R	75p
15	500	BT107	£1.00
6.5	500	BT101-500R	90p
6.5	500	BT109-500R	75p
20	600	BTW92-600RM	£3.00
15	800	BTX95-800R Pulse Modulated	£8.00
30	1000	28T10 (Less Nut)	£3.00

**SOLDER**

Multicore - 2 1/2p foot

ENAM. COPPER WIRE SWG. PER YD.  
20-24 2p  
26-42 1p

**GARRARD**

GCS23T or GP93/1 Crystal Stereo Cart-ridge £1.00

**HANDLES**

Rigid light blue nylon 6 1/2" with secret fitting screws 5p

14 D.I.L. socket, gold plated contacts, NOT cheap type 13p

Miniature Axial Lead Ferrite Choke formers 2p

**DEE PLUG**

McMurdo DA15P 15 way chassis plug 10p

Fairway 18009 Coax. socket 3p

**TIE CLIPS**

Nylon self locking 7" or 3 1/2" 2p

**CINCH 150**

12 way edge socket 10p

1lb Mixed nuts, bolts, washers etc. 35p

SMALL ORDERS, ENCLOSE SUITABLE STAMPED ADDRESSED ENVELOPE  
LARGE ORDERS, ADD SUFFICIENT FOR POSTAGE, INSURANCE, ETC.  
TOTAL GOODS PLUS CARRIAGE. ADD V.A.T.

**MAIL ORDER CUSTOMERS ONLY ADD 8% V.A.T.**

Have you seen  
this years most important  
component catalogue yet?

**HENRY'S 1975  
CATALOGUE  
IS NOW AVAILABLE**



Don't buy another electronic component until you've consulted the Henry's 1975 issue! It's packed with more items than ever before—over 5000 in all, making the Henry's range of electronic components the largest in the UK for the home constructor.

There are literally dozens of new lines and new ranges to get excited about! And many components are selling at reduced prices. Get your copy soon, and start reading these 200 pages of vital statistics about electronic components. If you don't, you'll miss out on a lot of kits, projects and test gear, apart from all the other products.

**ONLY 50p** Complete with  
+20p p & p FREE 50p  
Discount Voucher! FREE to Educational  
Establishments when ordered  
on official headed notepaper.

Get your copy NOW - send remittance of 70p (cheque or P.O.).

MIDLANDS NEW ELECTRONICS STORE  
OPEN: 34/36 UPPER PARLIAMENT  
STREET, NOTTINGHAM. TEL: (0802) 42688.  
LONDON: 231 TOTTENHAM COURT RD.  
W1. (LOWER SALES FLOOR) 01-580 3459

**HENRY'S**  
RADIO

**ELECTRONIC FOOTBALL & TENNIS  
WITH THE FABULOUS**

**VIDEO SPORT  
ON YOUR OWN TV**

Play three exciting electronic ball games FOOTBALL, TENNIS, HOLE IN THE WALL or your own TV! Just plug Video Sport into the aerial socket of Your TV and away you go. Completely safe for you, your children and your TV. Mains operated.



**OUR INCREDIBLE PRICE  
£29.50 inc VAT**  
DEMONSTRATIONS NOW IN ALL CENTRES!

**SPECIAL OFFER  
GARRARD CT48 STEREO CASSETTE  
TRANSPORT MECHANISM**

Features:  
★ Stereo Heads ★ Pause Control  
★ Built In Motor Stabiliser ★ 12v DC Operation.  
★ Auto Stop Eject.

Robust, precision engineered mechanism based on the "STAR" patented design. Ideal for use in Car stereo cassette players, Hi-Fi stereo cassette recorders, industrial and many other applications. Suitable for the "PW" Ascot Stereo Cassette Deck.



**£13.50 incl. VAT\* P. & P. 35p**

**AM/FM MODULES LP1179 LP1171**

Combined AM/FM tuner modules, together with a small number of R + C's Ferrite Aerial, make up a sensitive FM/MW/LW tuner. 6 Volts supply, supplied with data and circuit sheets.

LP1171 combined IF strip £4.60  
LP1179 FM front end and AM gang £4.60.  
£8.62 the pair.  
Suitable Ferrite aerial 87p.



ALL HENRY'S PRICES INCLUDE VAT

Electronic Centres  
404-406 Electronic Components & Equipment 01 402 8381  
354 PA-Disco-Lighting High power Sound 01 402-5854  
303 Special offers and bargains store  
All mail to 303 Edgware Road London W2 1BW

Hi-Frond  
Electronics  
Centres Open  
9 am - 6 pm

Prices correct at time of preparation. Subject to change without notice. E & D E

**NOW AVAILABLE . . .**



Comprising  
768 pages  
inc. index

AUGUST 1974  
to JULY 1975

**LATEST BOUND  
VOLUME No. 28**

of  
**"Radio & Electronics  
Constructor"**

**FOR YOUR LIBRARY**

**PRICE £2.75 P&P 65p**

BOUND VOLUME No. 25 (August 1971 to July 1972)

PRICE £2.00 p. & p. 65p

BOUND VOLUME No. 27 (August 1973 to July 1974)

PRICE £2.40 p. & p. 65p

Limited number of these volumes still available

We regret all other volumes are now completely sold out.  
Available only from

**DATA PUBLICATIONS LTD., 57 MAIDA VALE, LONDON, W9 1SN**

# BI-PRE-PAK

Bargains in Semi-Conductors, components, modules & equipment.

## Bargains from our FREE Catalogue

20 large pages, filled with real bargains in transistors, I.C.s, components, equipment, etc. Send large S.A.E. with 7p stamp for your FREE copy of 6th Edition by return. Meanwhile, for prompt delivery order from this month's ad. NOW.

### TRANSISTOR PACKS ALL 60p each TESTED AND GUARANTEED

B79	4	IN4007 Sil. Rec. diodes, 1,000PIV 1 amp. plastic	H39	6	Integrated circuits 4 gates BMC 962, 2 flip flops BMC 945
B81	10	Reed Switches, 1" long 1/2" dia. High-speed P.O. type	H41	2	BD131/BD132 Complementary Plastic Transistors
H36	100	Mixed Diodes, Germ. Gold bonded, etc. Marked and Unmarked	H65	4	40361 Type NPN Sil. Transistors TO-5 can comp. to H66
H38	30	Short lead Transistors, NPN Silicon Planar types	H66	4	40362 Type PNP Sil. Transistors TO-5 can comp. to H65

### UNMARKED & UNTESTED

B1	50	Germanium Transistors PNP, AF and RF	H20	20	BY126/7 Type Silicon Rectifiers 1 amp. plastic. Mixed volts
B66	150	Germanium Diodes Min. glass type	H34	15	Power Transistors, PNP, Germ. NPN Silicon TO-3 Can
B84	100	Silicon Diodes DO-7 glass equiv. to OA200, OA202	H67	10	3819N Channel FET's plastic case type
B86	100	Dil. Diodes sub. min. IN914 and IN916 types			

### SILICON POWER TRANSISTORS—

40 WATT ●	Type	Gain	VCE	NPN	Price
	40N1	15	15	NPN	20p
	40N2	40	40	NPN	30p
	40P1	15	15	PNP	20p
	40P2	40	40	PNP	30p
30 WATT ●					
	30N1	15	15	NPN	25p
	30N2	40	40	NPN	35p
	30P1	15	15	PNP	25p
	30P2	40	40	PNP	35p

### NEW X-HATCH GENERATOR Mk. 2



Essential for Colour T.V. alignment of 4 patterns. Featuring plug in IC's and a more sensitive sync. pick-up circuit. The case is virtually unbreakable—ideal for the engineer's toolbox—only measures 3" x 5 1/2" x 3". Operates from 3 U2 type batteries (extra).

P & P add 50p kit or complete **£7.93** Complete kit **£9.93** Ready built unit only

### OVER 1,000,000 TRANSISTORS IN STOCK!

#### CAPACITOR DISCHARGE IGNITION UNITS

Transistorised. Simple to Fit. Improves performance, cuts fuel costs  
P & P add 27p **£7.50**

MNFRS. AM/FM CHASSIS To clear, NO instructions or tuning drives, useful for experimenters. Not too difficult to get working. Make good portables  
EACH **£1**

#### SUNDRY

Metrication Pocket Charts 12p. 8 assorted relays £1.00 (8%). Rev. counter device (for cars) £1.00. U.H.F./TV Tuner Units. 625 lines. Rotary Tuning £2.50. L.M.380 Audio I.C. £1.00 and technical books of all kinds.

### TERMS OF BUSINESS

V.A.T. Prices shown do NOT include V.A.T. Please add 25% to total value of your order, except for items marked with a ●, or (8%) for which the V.A.T. rate is 8%. No V.A.T. on overseas orders.

POSTAGE Except where stated, add 25p for postage & packing in U.K. Overseas—add £1. any difference being charged or refunded.

PAYMENT Cash with order, Cheque or money order. Minimum value—£1. You can also pay by ACCESS.

IMPORTANT—Every effort is made to ensure accuracy of prices and description at time of preparing this advertisement and going to press. Prices are subject to alteration without notice.

## XMAS OFFER!

Batt/Mains Stereo F.M. Tuner/Amp

TO SHOW YOU A SAVING OF **£12**

if you buy all 4 units together for £18. Bought singly you save 33 1/3 off regular price of each unit

1

#### F.M. TUNER FROM END

Ganged tuning; A.F.C. facility. Reduction-gear drive, 88—108 MHZ. Usual price inc. VAT £8.01 —

**£5.34**

2

#### I. F. BOARD

Using I.C. Designed for use with above front-end. Usual price inc. VAT £6.76 —

**£4.50**

3

#### STEREO DECOVER, USING I.C.

Designed for use with above modules, can also be used with other mono F.M. tuners. Ready aligned. (L.E.D. for stereo beacon available at 20p) Usual price inc. VAT £7.22 —

**£4.82**

4

#### 5 + 5 watt MUSIC POWER I.C. AMP

Useful stereo power amplifier with good performance, at economy price. Usual price inc. VAT £8.01 —

**£5.34**

TOTAL VALUE AT REGULAR ADVERTISED PRICE **£30.00**

- ★ Prices include VAT and postage and packing in U.K.
- ★ Total Value **£30** — You pay **£18.00**
- ★ Satisfaction guaranteed
- ★ Order now — delivery by return

### SS.300 POWER SUPPLY STABILIZER

Delivers 12 to 50 volts, variable by its fixed pre-set pot. By substituting a remote-control potentiometer, a voltmeter and milliammeter may be incorporated to permit workbench and experimental applications. Protected against shorting. Easily connected. Ensures better performances wherever its use is indicated **£3.25**

TO BI-PRE-PAK, 224-226 WEST RD., WESTCLIFF-ON-SEA, ESSEX

Please send .....

for which I enclose ..... inc. V.A.T.

Name .....

Address .....

REC 12

## BI-PRE-PAK LTD

222 224 WEST ROAD, WESTCLIFF-ON-SEA, ESSEX SSO 9DF.

TELEPHONE: SOUTHEND (0702) 46344.

WRITE ORDER SEPARATELY AND ATTACH COUPON IF REQUIRED



# WILMSLOW AUDIO

## THE Firm for speakers!

### SPEAKERS

Baker Group 25, 3, 8 or 15 ohm £8.64  
 Baker Group 35, 3, 8 or 15 ohm £10.25  
 Baker Group 50/12, 8 or 15 ohm £14.00  
 Baker Deluxe 12", 8 or 15 ohm £13.75  
 Baker Major 3, 8 or 15 ohm £11.87  
 Baker Superb 8 or 15 ohm £18.12  
 Baker Regent 8 or 15 ohm £10.00  
 Baker Auditorium 12" £16.25  
 Celestion PST8 (for Unilex) £3.75  
 Celestion G12H 8 or 15 ohm £15.95  
 Celestion G12M 8 or 15 ohm £12.95  
 Celestion G15C 8 or 15 ohm £26.95  
 Celestion G18C 8 or 15 ohm £34.50  
 Celestion MH1000 8 or 15 ohm £13.50  
 EMI 13 x 8, 150 d/cone, 8 ohm £2.94  
 EMI 13 x 8 type 350, 8 or 15 ohm £9.56  
 EMI 13 x 8.25 watt bass £9.00  
 EMI 5" 14A/730 mid-range 8 ohm £3.50  
 EMI 6 1/2" 93850 4 or 8 ohm £2.90  
 EMI 8 x 5, cer. mag. 8 ohm £1.87  
 EMI 8 x 5, 10 watt, d/c roll/s 8 ohm £3.44  
 EMI 10 x 6 93870 8 ohm £2.67  
 EMI 2 1/2" tweeter 8 ohm .77  
 Elac 9 x 5, 59RM109 15 ohm, 59RM114 8 ohm £3.44  
 Elac 6 1/2" d/cone, roll surr. 8 ohm £4.06  
 Elac 6 1/2" d/cone 8 ohm £3.12  
 Elac TW4 4" tweeter £1.75  
 Elac 10" 10RM239 d/c 8 ohm £3.12  
 Elac 8" 3 ohm £2.87  
 Eagle Crossover 3, 8 or 16 ohm £1.75  
 Eagle CT5 cone tweeter 8 ohm £2.06  
 Eagle CT10 tweeter 8 or 16 ohm £3.00  
 Eagle DT33 dome tweeter 8 ohm £6.31  
 Eagle FF5 3 way crossover £3.62  
 Eagle SN75 crossover with tw. contro £4.69  
 Eagle FF28 multicell, horn £9.00  
 Eagle HT15 horn tw. 16 ohm £4.40  
 Eagle HT21 horn tw. 8 ohm £6.81  
 Eagle MHT10 horn tw. 8 ohm £4.44  
 Eagle FR4 4" full range £6.12  
 Eagle FR65 6 1/2" full range £9.62  
 Eagle FR8 8" full range £12.31  
 Fane Pop 15 watt 12" £5.25  
 Fane Pop 25T 30 watt 12" £7.50  
 Fane Pop 20 watt 12" £12.00  
 Fane Pop 55 12" 60 watt £13.95  
 Fane Pop 60 watt 15" £14.75  
 Fane Pop 100 watt 18" £25.95

### SPEAKERS

Fane Crescendo 12A 8 or 15 ohm £34.50  
 Fane Crescendo 12B 8 or 15 ohm £36.50  
 Fane Crescendo 15, 8 or 15 ohm £47.50  
 Fane Crescendo 18, 8 or 15 ohm £62.95  
 Fane 910 horn £14.95  
 Fane 920 horn £33.95  
 Fane 152/12a 15" 15 ohm £16.00  
 Fane 801T 8" d/cone roll surr. £8.50  
 Fane 808T 8" d/cone" £3.95  
 Fane 807T 8" d/cone roll surr. £5.75  
 Goodmans 8P 8 or 15 ohm £5.50  
 Goodmans 10P 8 or 15 ohm £5.80  
 Goodmans 12P 8 or 15 ohm £13.95  
 Goodmans 12P-D 8 or 15 ohm £16.95  
 Goodmans 12P-G 8 or 15 ohm £15.95  
 Goodman 12AX 100 watt 8 or 15 ohm £36.50  
 Goodmans 15AX 100 watt 8 or 15 ohm £40.25  
 Goodmans 15P 8 or 15 ohm £21.00  
 Goodmans 18P 8 or 15 ohm £36.00  
 Goodmans Hifax 750 £16.00  
 Goodmans Axent 100 tweeter & crossover £8.44  
 Goodmans Audiom 100, 8 or 15 ohm £13.90  
 Goodmans Axiom 401, 8 or 15 ohm £20.00  
 Goodmans Twinaxiom 8" 8 or 15 ohm £10.14  
 Goodmans Twinaxiom 10" 8 or 15 ohm £10.75  
 Gauss 12" full range 8 ohm £73.00  
 Gauss 12" Bass 8 ohm £73.00  
 Gauss 15" full range 8 ohm £83.00  
 Gauss 15" Bass 8 ohm £83.00  
 Gauss 18" full range 8 ohm £110.00  
 Gauss 18" Bass 8 ohm £110.00  
 All the above Gauss (American) speakers are fitted with 4 1/2" voice coils and can handle 200 watts RMS.  
 Kef T27 £6.06  
 Kef T15 £6.94  
 Kef B110 £8.37  
 Kef B200 £9.50  
 Kef B139 £6.94  
 Kef DN8 £2.31  
 Kef DN12 £5.99  
 Kef DN13 £4.50  
 Richard Allan CG8T 8" d/c roll surr. 8 ohms £7.50  
 STC 4001G super tweeter £6.56  
 2 1/2" 64 ohm, 70mm 8 ohm, 70mm 80 ohm .77  
 2 1/2" 75 ohm .55  
 7" x 4" 3, 8 or 15 ohm £1.63  
 8" x 5" 3, 8 or 15 ohm £1.75  
 10" x 6" 6, 8 or 15 ohm £2.69

### SPEAKER KITS (Carr. 75p each. £1.50 pair)

Baker Major Module 3, 8 or 15 ohm each £13.44  
 Goodmans Mezzo Twinkit pair £47.19  
 Goodmans DIN 20 4 ohm each £14.75  
 Helme XLK25 pair £25.44  
 Helme XLK30 pair £17.19  
 Helme XLK50 pair £46.25  
 Kefkit 1 pair £48.44  
 Kefkit 3 each £42.50  
 Peerless 3-15 (3 sp. system) each £17.19  
 Peerless 20/2 each £17.44  
 Peerless 30/2 each £24.38  
 Peerless 20/3 each £26.56  
 Peerless 50/4 each £40.50  
 Richard Allan Twinkit each £10.95  
 Richard Allan Triple 8 each £16.50  
 Richard Allan Triple each £23.95  
 Richard Allan Super Triple each £28.75  
 Wharfedale Linton 2 kit pair £23.12  
 Wharfedale Glendale 3 kit pair £40.62  
 Wharfedale Dovedale 3 kit pair £63.12

### PA/DISCO AMPLIFIERS (Carr. and ins. £1)

Baker Major 100 watt £57.25  
 Linear 30/40 £30.00  
 Linear 40/60 £35.00  
 Linear 80/100 £58.95  
 Linear 100 watt slave £44.00  
 Eagle PRO A120, 120 watts RMS £135.00  
 Eagle PRO A65, 65 watts RMS £108.00  
 Eagle PRO A35, 35 watts RMS £82.00  
 Eagles TPA40 mains/12v mobile £50.00  
 Eagle HHS 36 watts. mobile 12v. £37.50  
 Eagle TPA20 paging amplifier £45.50  
 Eagle RA859 Reverb (p. & p. £1.50) £19.75  
 Eagle RA856 Reverb (p. & p. £1.50) £12.50

### MICROPHONES (p. & p. 50p)

Shure 515 SB Low Impedance £17.31  
 Shure 515 SA High Impedance £18.25  
 Shure 545 Dual Impedance £34.69  
 Shure 588 SB Low Impedance £23.12  
 Shure 588 SA High Impedance £23.75

Prices correct at 25.9.75

FREE with loudspeaker orders over £7 - "HiFi Loudspeaker Enclosures" book

All items guaranteed new and perfect

Prompt despatch

Carriage: 50p per speaker 12" and up 75p each, 30p per tweeter, crossover or 2 1/2" 70mm speaker kits 80p each (£1.60 pair)

Including VAT — 25% on Hi-Fi 8% on PRO and PA

Send stamp for free booklet "Choosing a speaker"

Big discounts on Grundig, ITT, Koyo, etc. Send stamp for list

# WILMSLOW AUDIO

DEPT RC

LOUDSPEAKERS: SWAN WORKS BANK SQUARE, WILMSLOW, CHESHIRE

AMPLIFIERS, RADIO ETC. 10 SWAN ST., WILMSLOW, CHESHIRE

## The Ultimate Radio!

### GRUNDIG SATELLIT 2000

You've got your yacht, private aircraft, Rolls Comiche? — then all you need for a full set of status symbols is this latest model Grundig Satellit, Germany's top radio! Radio performance, appearance and sound quality are all superb. VHF/FM, MW, LW 10SW bands plus bandspread, 27 transistors and 22 diodes, Battery/Mains (110/240v.), 2 speakers, 57" telescopic aerial.

Our Price £149.95 inc. VAT, carr. & ins.

Big discounts on Grundig, ITT, Koyo, etc. Send stamp for list.

WILMSLOW AUDIO, 10 SWAN STREET, WILMSLOW, CHESHIRE

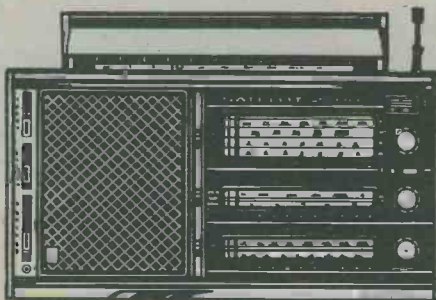

# BI-PAK



## BARGAIN BUNDLES

Send to: BI-PAK SEMICONDUCTORS,  
DEPT. R.C. P.O. BOX 6, WARE, HERTS.

Bi-Pak bring you, for 2 months only a fantastic inflation beating offer designed to help you, the customer. With every Pak comes a useful FREE GIFT. In addition to this, our star attraction is the D.I.Y. Printed Circuit Kit. With every kit sold during this offer comes a voucher to the value of £1.50 to be spent on any item from our Retail Catalogue.

**I.C. BUNDLE**  
2 x 7400    2 x 7474  
2 x 74121    2 x 74141  
2 x 741

**PLUS FREE**  
2 x BPS8 and 2 x BPS16  
I.C. Sockets

**ALL FOR ONLY**  
**£1.50**  
**OFFER WORTH £3.27**

**PRINTED CIRCUIT KIT.** Containing 6 sheets of 6" x 4" single sided laminate, a generous supply of etchant powder, etching dish, etchant measure, tweezers, etch resistant marking pen, high quality pump drill with spares, cutting knife with spare blades, 6" metal ruler, plus full easy-to-follow instructions. **£7.80**

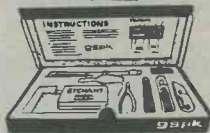

**3 for the PRICE of 2**

Buy 2 x C60 cassettes for 72p per pr. GET 1 x C60 absolutely FREE. Buy 2 x C90 cassettes for 96p per pr. GET 1 x C90 absolutely FREE.

**DIODE + RECTIFIER BUNDLE**  
20 GERM G.P. DIODES DIRECT REPLACEMENTS FOR (OA81-85, OA91-95)

2 x BY100    4 x 1N4004    4 x 1.5A 400V  
4 x 1N4001    4 x 1.5A 50V    4 x 1N4148

**PLUS FREE BOOK**  
No. BP9 "38 PRACTICAL TESTED DIODE CIRCUITS FOR THE HOME CONSTRUCTOR"  
**ALL FOR ONLY £1.50**    **OFFER WORTH £3.00**

**TRANSISTOR BUNDLE**

2 x BC108C    2 x BC178  
2 x OC71    2 x BC107  
2 x BF115    2 x BC109  
2 x 2N3819    2 x BFX84  
2 x 2N3646    2 x BFX29

**PLUS FREE**  
ONE SHEET OF VEROBOARD

**ALL FOR ONLY**  
**£1.50**  
**OFFER WORTH £3.00**

**S.C.R. BUNDLE**

2 x 6A 100V    2 x 1A 400V  
2 x 1A 50V    2 x 3A 50V  
2 x 5A 400V **plus FREE**  
2 METRES OF 18SWG MULTI-CORE SOLDER **ALL FOR ONLY**  
**£1.50**  
**OFFER WORTH £3.00**

**CAPACITOR + RESISTOR BUNDLE**

100 1/4W Resistors in assorted values ranging from 100 ohm to 1M ohm.  
50 C280 Capacitors in assorted values ranging from .01uF to 2.2uF

**PLUS FREE**  
COLOUR CODE CHARTS  
**ALL FOR ONLY**  
**£1.50**  
**OFFER WORTH £3.00**

**WATCH THIS SPACE FOR THE GREAT BI-PAK CHRISTMAS COMPETITION WITH A FIRST PRIZE OF A COLOUR T.V. PLUS 52 OTHER PRIZES**



# CHINAGLIA

**PROFESSIONAL QUALITY TEST EQUIPMENT**

## THE MINOR

**33 RANGES**  
**20kΩ/V d.c.**  
**4kΩ/V a.c.**

WITH

- ROBUST CLASS 1.5 PRECISION MOVEMENT
- ACCURACY 2.5% D.C. AND 3.5% A.C.
- 12 MONTH GUARANTEE
- SELF-POWERED AND POCKET-SIZED
- OPTIONAL 30KV.D.C. PROBE

**PRICE £19.00 Inc. VAT (P. & P. 80p)**  
**PROBE £9.50**

For details of this and the many other exciting instruments in the Chinaglia range, including multimeters, component measuring, automotive and electronic instruments please write or telephone:

**CHINAGLIA**  
**(U.K.) LTD.** 19 Mulberry Walk, London  
SW3 6DZ Tel: 01-352 1897



TRADE ENQUIRIES WELCOMED

you must have a soldering iron -

so choose **SOLON**

and be sure of years of reliable service

Available in 15watt, 25watt and 35watt sizes, and specifically designed for radio and electrical work, Solon is the obvious choice of radio and hi-fi enthusiasts.

Solon irons are moderately priced, robustly constructed and with all parts replaceable.

Ask for details of the complete range of Solon soldering irons from your dealer or direct from -

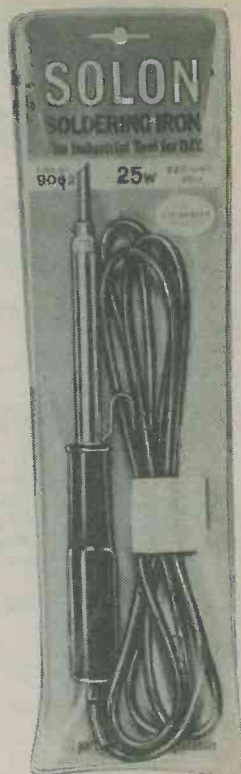

Accessories Department

**GEC-HENLEY LTD**

GRAVESEND KENT

Obtainable from Halfords, Currys, most radio and electrical retailers, ironmongers, etc.

## 1. Understand electronics.

Step by step, we take you through all the fundamentals of electronics and show you how easily the subject can be mastered using our unique Lerna-Kit course.

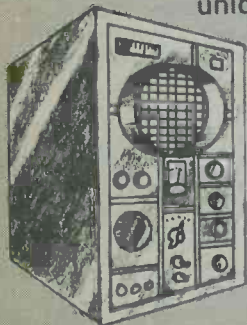

- (1) Build an oscilloscope.
- (2) Read, draw and understand circuit diagrams.
- (3) Carry out over 40 experiments on basic electronic circuits and see how they work.

## 2. Become a radio amateur.

Learn how to become a radio-amateur in contact with the whole world. We give skilled preparation for the G.P.O. licence.

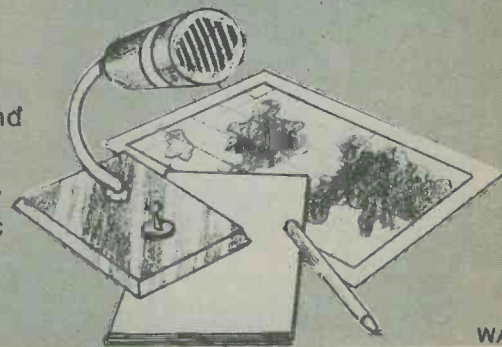

WAA

**Free!**

Brochure, without obligation to:  
**BRITISH NATIONAL RADIO & ELECTRONICS SCHOOL, Dept REL 115**  
P.O. Box 156, Jersey, Channel Islands.

NAME \_\_\_\_\_

ADDRESS \_\_\_\_\_

Block caps please

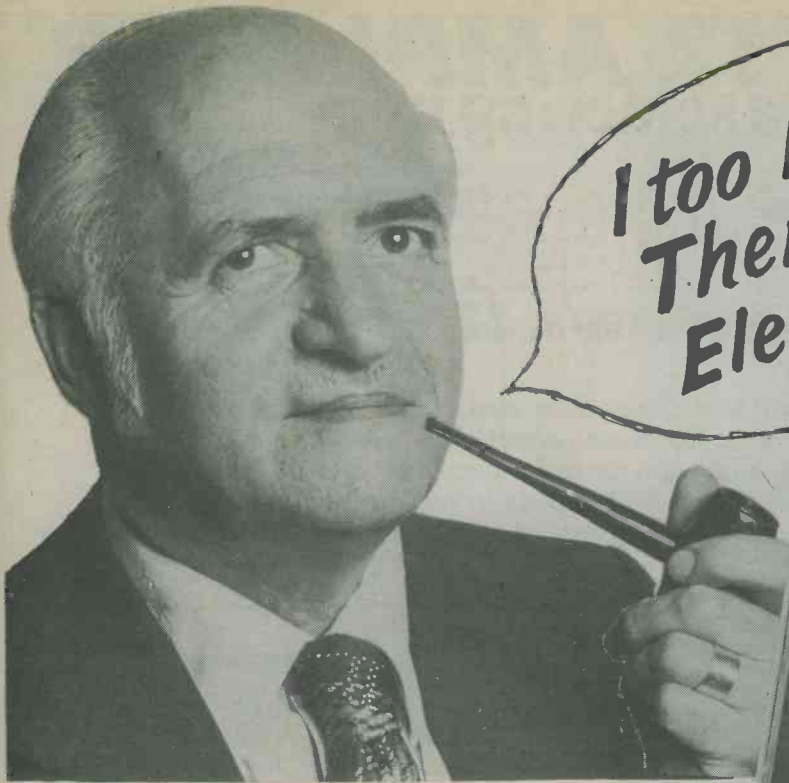

I too have a  
Theme on  
Electronics



As you may already know, the front cover of the Home Radio Components catalogue features a colour picture of the striking modern sculpture "Theme on Electronics" by the late Dame Barbara Hepworth. The original sculpture, incidentally, was commissioned in 1957 by Mullards for their Electronics Centre showroom.

If you asked me for *my* theme on electronics I'd say that experience has taught me that the simplest and most satisfactory way of getting electronic components is to buy them from Home Radio Components — either over the counter at their shop in Mitcham or by Mail Order. Ninety-nine times out of a hundred they can supply just what you want immediately from stock — at very keen prices too. If you're likely to require bits and pieces fairly regularly it will be worth your while to make use of their Credit Account Service. This is a fairly new service provided by Home Radio Components, but they tell me that already about a thousand customers are using it. That doesn't surprise me. I for one have found that it saves me time and money in several ways. No space to give details here, but full information and an application form are given in the catalogue. Whether or not you use the Credit Account Service

you'll certainly need the catalogue, and at £1.30 (85p plus 45p post & packing) it's a real bumper bargain. Its 240 pages list about 6000 components with nearly 2000 illustrations. What's more the catalogue contains Vouchers worth 70 pence when used against orders, so you can soon recover a good slice of your investment.

Send the coupon below with your cheque or P.O. for £1.30, and before long you too will be harping on the same theme on electronics!

Today's finest Components  
Catalogue **85p** plus 45p POST & PACKING

**POST THIS COUPON**  
with cheque or PO for £1.30

The price of £1.30 applies to customers in the U.K. and to BFPO addresses.

Please write your Name and Address in block capitals

NAME .....

ADDRESS .....



HOME RADIO (Components) LTD., Dept. RC  
234-240 London Road, Mitcham, Surrey CR4 3HD

Regd. No. 912966, London

**HOME RADIO (Components) LTD. Dept. RC, 234-240 London Road, Mitcham, CR4 3HD. Phone: 01-648 8422**

# THE 6/12 AMPLIFIER

## Part 1

by J. T. Neill

## 6 watt continuous, 12 watt peak

Incorporating some very neat circuit techniques, this a.f. amplifier also features small size and compact layout. Circuit operation is described this month, and details of construction will appear in next month's concluding article.

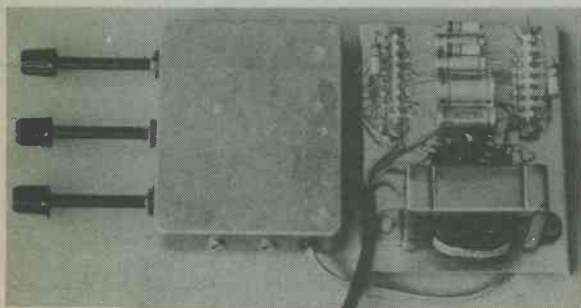

The amplifier coupled to the associated power supply unit

The dramatic rise in popularity of audio reproduction has led to the publication of a number of high quality designs. The author has had the opportunity to listen to several of these, and they all represent a high level of fidelity. However, what has been apparent, in the author's view, is that the number of features provided and power levels available have increased the cost of such equipment to the point where a constructor requiring a moderate power output at reasonable quality has no modern design to follow.

Accordingly, the amplifier presented here has been designed to fill that requirement. Only a mono version is described; such a limitation is not considered to be a serious drawback for the programme sources envisaged, namely reproduction of "pop" records from a ceramic pick-up and from the output of a medium quality cassette recorder. A radio tuner is also a very suitable signal source.

The specification appears in the accompanying table and it is from the output quoted there that the amplifier derives its name.

### MAXIMUM POWER

The maximum power that can be delivered to a load of  $8\Omega$  with the suggested power supply and output transistors is 12 watts; any attempt to drive the amplifier harder results in clipping of the output.

### Specification

Output power	6/12 watts (see text)
Frequency response	45Hz to 25kHz at -3dB
Input for full output	30mV peak at $2.2M\Omega$ (ceramic p.u.)
	250mV peak at $115k\Omega$ (cassette)
Tone control range	+12dB at 100Hz +12dB, -16dB at 10kHz
Signal/noise ratio at full gain	56dB
Power supply (output stage)	+22V at 600mA
Size (excluding power supply)	$4\frac{1}{2} \times 4\frac{1}{2} \times 1\frac{1}{2}$ in.

However, with the heat sink arrangements provided the output transistors will overheat after about 30 seconds at full output with sine wave drive, and the maximum continuous rating is therefore 6 watts. Sufficiently large heat sinks would enable the continuous rating to be raised to the 12 watt level, but would considerably increase the size of the complete amplifier.

It is appreciated that some readers, and especially those without the appropriate test equipment, would feel uncertain about building an amplifier in which it is possible for the output transistors to overheat under certain signal input conditions. Such readers can ensure that the output transistors will not overheat at any input level by the simple process of connecting the amplifier output to a  $15\Omega$  speaker instead of to an  $8\Omega$  speaker. The maximum output power with a  $15\Omega$  speaker will be restricted to some 4 watts but, bearing in mind the small size of the amplifier, this still represents a very attractive option.

The upper limit to the frequency response is set to allow full benefit to be made of any signal source. The lower limit has been deliberately made slightly higher than is sometimes the case in order to reduce the effects of very low frequency rumble that could otherwise arise from the use of one of the cheaper turntables. The response below 40Hz falls off at about 12dB per octave, as determined by the values of coupling capacitors employed at each stage.



## AMPLIFIER CIRCUIT

A block diagram of the "6/12" appears in Fig. 1, while Fig. 2 gives the complete circuit diagram excluding the power supply, of which more later.

A choice of inputs is provided, these being 250mV at 115k $\Omega$  input impedance, and 30mV at 2.2M $\Omega$ . Switching between them is carried out automatically by the insertion of the appropriate jack plugs.

Amplifier A1 is built around a type 748 integrated circuit, the overall stage gain being about 30 times with the output in phase with the input. Following the volume control is a further 748 i.c. feeding a power

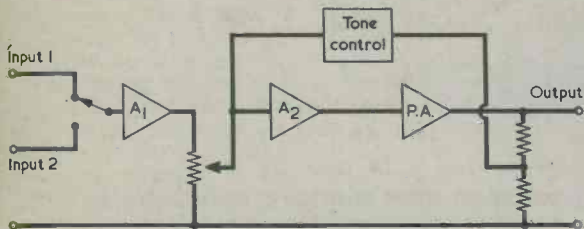
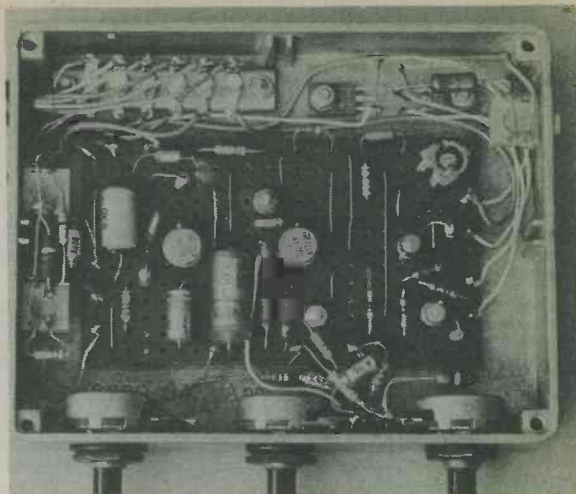

Fig. 1 Block diagram illustrating the amplifier stage line-up



Apart from the power supply, all the amplifier components are enclosed in a neat small die-cast box

## COMPONENTS

### Resistors

(All fixed values  $\frac{1}{4}$  watt 10% unless otherwise stated)

- R1 100k $\Omega$
- R2 15k $\Omega$
- R3 2.2M $\Omega$
- R4 47k $\Omega$
- R5 1.5k $\Omega$
- R6 47k $\Omega$
- R7 1k $\Omega$
- R8 3.3k $\Omega$
- R9 3.3k $\Omega$
- R10 4.7k $\Omega$
- R11 22k $\Omega$
- R12 22k $\Omega$
- R13 180 $\Omega$
- R14 470 $\Omega$
- R15 47 $\Omega$
- R16 180 $\Omega$
- R17 470 $\Omega$
- R18 47 $\Omega$
- R19 1.5k $\Omega$
- R20 100 $\Omega$
- R21 1 $\Omega$  3 watt wire-wound
- R22 & R23 1.5k $\Omega$   $\frac{1}{4}$  watt
- R24 & R25 1.5k $\Omega$   $\frac{1}{4}$  watt
- VR1 10k $\Omega$  potentiometer, log
- VR2 47k $\Omega$  or 50k $\Omega$  potentiometer, linear
- VR3 47k $\Omega$  or 50k $\Omega$  potentiometer, linear
- VR4 500 $\Omega$  pre-set potentiometer, miniature skeleton, horizontal mounting

### Capacitors

- C1 6,800pF polystyrene
- C2 47 $\mu$ F or 50 $\mu$ F electrolytic, 6 V. Wkg.
- C3 10pF polystyrene
- C4 10pF polystyrene
- C5 0.33 $\mu$ F polyester
- C6 0.1 $\mu$ F polyester

- C7 6,800pF polystyrene
- C8 6,800pF polystyrene
- C9 10pF polystyrene
- C10 22 $\mu$ F or 20 $\mu$ F electrolytic, 16 V. Wkg.
- C11 1,000 $\mu$ F electrolytic, 35 V. Wkg.
- C12 470 $\mu$ F or 500 $\mu$ F electrolytic, 16 V. Wkg.
- C13 1,000 $\mu$ F electrolytic, 35 V. Wkg.
- C14 470 $\mu$ F or 500 $\mu$ F electrolytic, 16 V. Wkg.

### Transformer

- T1 Mains transformer, secondary 20-12-0-12-20V at 0.7A (R.S. Components)

### Semiconductors

- IC1 748 in TO99 encapsulation
- IC2 748 in TO99 encapsulation
- TR1 BC108
- TR2 BD132 with insulating washer
- TR3 BCY71
- TR4 BD131 with insulating washer
- D1 1N914
- D2 OA47
- D3-D6 silicon bridge rectifier, 100V 2A

### Sockets

- J1 3.5mm. jack socket, insulated
- J2 3.5mm. jack socket, insulated, with break contact
- J3 3.5mm. jack socket, insulated

### Miscellaneous

- Die-cast box, 4 $\frac{1}{4}$  x 3 $\frac{1}{4}$  x 1 $\frac{1}{2}$ in. (I21 x 95 x 29mm.) (S.T.C.)
- 3 knobs
- Veroboard, 0.15in. pitch, 23 holes x 13 strips
- Veropins for 0.15in. Veroboard
- Aluminium for power supply chassis
- 1-off 6-way tagstrip
- 2-off 8-way tagstrips
- 2-off 6BA nylon nuts.

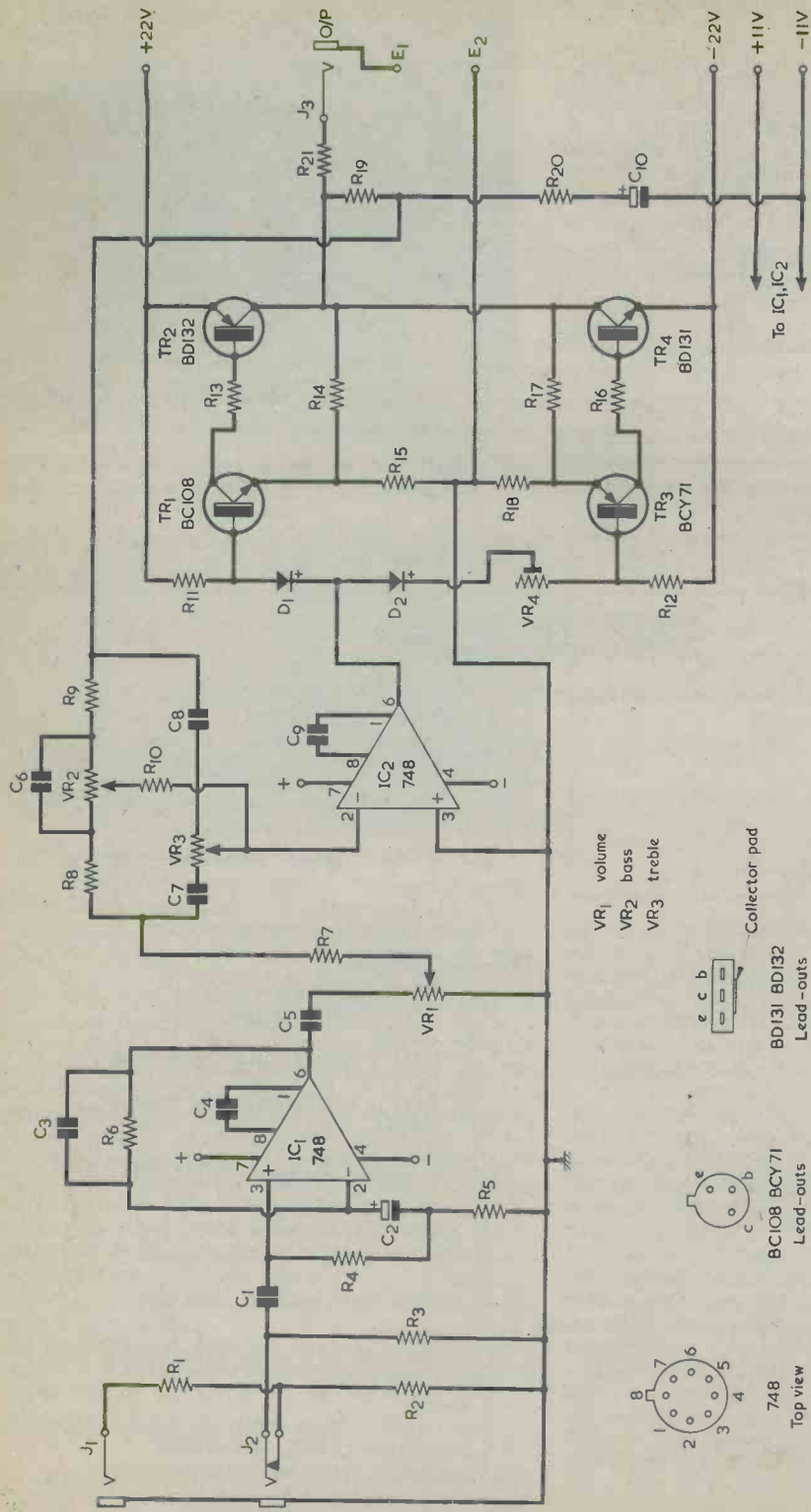

Fig. 2. Complete circuit of the "6/12" amplifier

- VR1 volume
- VR2 bass
- VR3 treble
- Collector pad
- BD131 BD132  
Lead-outs
- BC108 BCY71  
Lead-outs
- 748  
Top view

amplifier using discrete transistors, giving together a voltage gain at 1kHz of 16 times and a phase inversion. Thus the whole amplifier is phase inverting, so reducing the chance of unwanted positive feedback leading to instability, and enabling it to be constructed as a very compact unit as can be seen from the specification and photographs.

Wide range tone controls giving both bass and top boost and cut are, unusually, arranged to function over the entire stage following the volume control. They thereby eliminate the need for a separate tone control stage and further contribute to the compactness of the design.

Signals fed to the high level input J1 in Fig. 2 are reduced in level by the potential divider R1, R2, before being applied to IC1. The insertion of a jack plug into the high impedance input J2 switches out R2, leaving only R3 as load for the signal. IC1 is arranged to have an extremely high value of input impedance, obtained by the bootstrapping of R4. This arises from the action of the large value capacitor C2, which has its upper plate connected to the inverting input of the integrated circuit amplifier; since the negative feedback around that amplifier tends to keep the difference between its inputs very small, almost the same signal appears at both ends of R4. Consequently, there is very little signal current in R4 and it appears to have a very much larger value than its actual physical resistance. With C2 at 50 $\mu$ F, R4 appears to be greater than 2M $\Omega$  at all frequencies above 40Hz, and accordingly the input impedance at J2 is substantially set by R3.

The value of R3 is 2.2M $\Omega$ , so giving a good low frequency response when a ceramic pick-up is connected to J2. A substantially lower value for R3 would cause unwanted attenuation of bass frequencies, since the signal from a ceramic pick-up is effectively fed in series with a capacitance of about 800pF.

The overall gain of IC1 is determined by the ratio of R6 to R5, so that with maximum permitted signal at either input there is about 900mV at the top of the volume control, VR1. Compensation capacitor C4 sets the open loop gain-frequency characteristic to give the appropriate response.

## TONE CONTROL

The second i.c. amplifier and the output stage proper have overall negative feedback applied. A Baxendall type tone control network is included in this feedback loop and gives bass and top boost and cut in the usual way. Fig. 3 shows the frequency responses available. What is not so usual, however, is that the feedback is obtained from a tap in a potential divider across the amplifier output, giving a voltage gain with the tone controls in mid-position of some 16 times between volume control and loudspeaker. This gain is required to rise to 64 times with either tone control at maximum boost, and to assist in ensuring that sufficient gain is available the output stage transistors are given a voltage gain of 11 times. Fig. 4, which is a simplified circuit, makes clear how this is done.

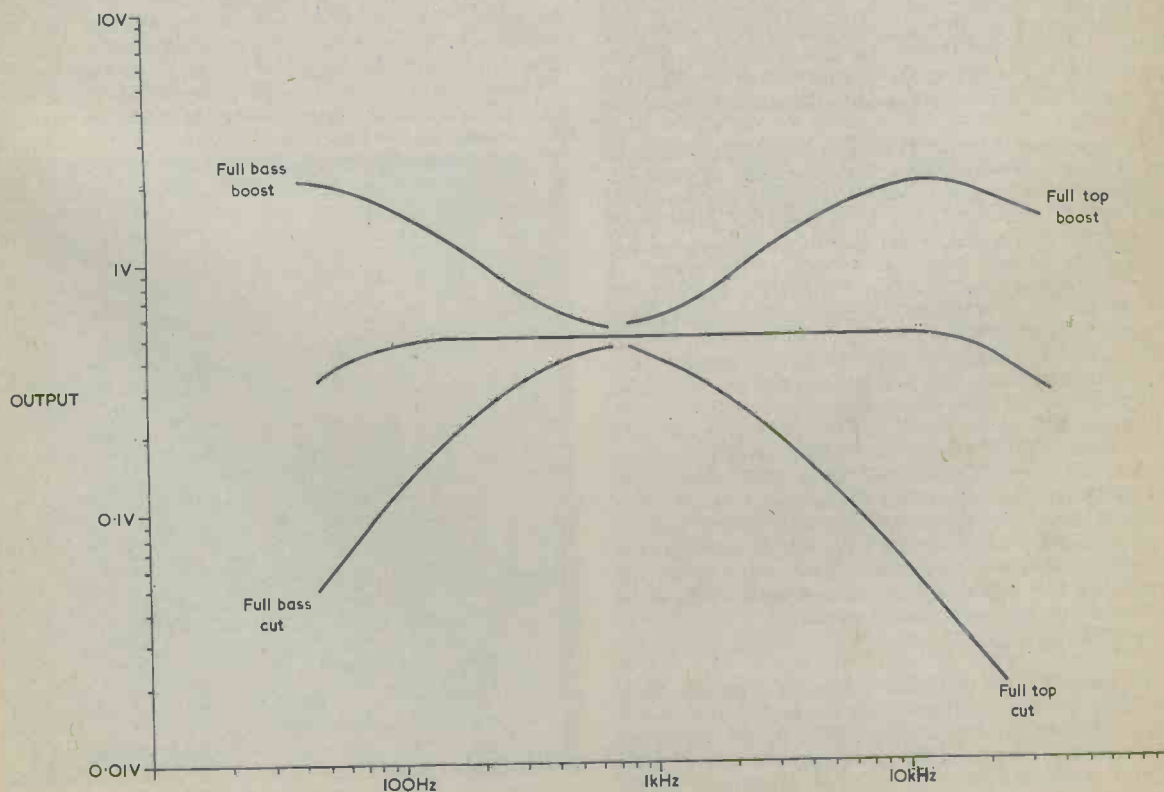
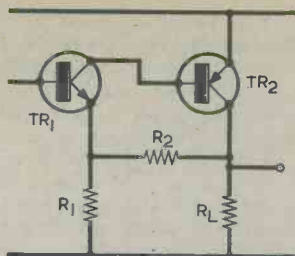

Fig. 3. Frequency response curves for the amplifier

**Fig. 4. Simplified diagram illustrating the operation of the output stage**



Transistor TR1 in Fig. 4 has a load resistor R1 in its emitter circuit, and under normal emitter follower action the signal voltage present at the emitter is of the same magnitude and phase as that at the base. However, the collector current of TR1 is modulated by the signal and as this current is the base current of TR2, a further amplified version of the input appears at TR2 collector; since the signal has undergone two stages of amplification, each with a phase reversal, it is now in phase again with the input. Its magnitude is determined by the relative values of R1 and R2. If they are equal, then obviously the signal at TR2 collector is twice that at TR1 emitter, that is, twice the input signal. A similar reasoning will show that the corresponding gain of the circuit in Fig. 2 is 11 times.

Thus we have a stage with a voltage gain and, since the transistor used for TR2 is usually a high power type, a high output power is available at a low impedance due to the large amount of negative feedback present within the stage itself.

In the "6/12" amplifier two such stages, each the complement of the other, are used in push-pull, with a voltage gain in each of 11, as determined by the relative values of R14 and R15, and R17 and R18. Resistors R13 and R16 limit the dissipation in the stage (and so therefore, the output power) by limiting the maximum drive to each output transistor base to a safe level.

Voltage gain is incorporated in the output stage, in the manner just described, for a number of reasons.

Besides ensuring that sufficient gain is present at the "boost" settings of the tone controls, the output stage gain also enables the amplifier output voltage swing to be larger than that present at the output of IC2. The supply rail voltages for the i.c. are only 11 volts or so, which restricts the maximum output swing to some 18 volts. This is less than that required for full power output. Voltage gain in the output stage makes up for this situation and permits the full swing of load voltage to be the 28 volts required.

Lastly, the 748 i.c. has a limitation known as "slew rate". Basically, although IC2 has a level frequency response at small signal levels up to well above that required here, the faster rate of change of voltage called for at the higher signal voltages at high frequencies is not within its capabilities. Once again, voltage gain in the output stage compensates for this deficiency, by permitting the signal voltage delivered by IC2 to be less than would otherwise be required.

## OUTPUT BIAS

The output stage transistors require to be biased so that they draw a small standing current under quiescent conditions, and this is best done by arranging for the bases of TR1 and TR3 to be respectively a small amount positive and negative with respect to earth. Two forward biased diodes, D1 and D2, are used to provide most of this difference voltage, with a small

pre-set variable resistor VR4 in series to enable fine adjustments to be made to compensate for component tolerances.

The voltage across D1, D2 and VR4 is substantially constant with variations in power supply voltage due to the almost constant voltage drop across each diode. However, temperature changes are also corrected; for example, a rise which could cause an increase in output stage current reduces the diode voltages and so tends to reduce the standing current. Thus temperature variations resulting from both environmental changes and local heating due to increased dissipation in the output transistors are reduced in effect. Note, however, that the latter compensation can only be present if the diodes are mounted close to the output transistors so that they are affected by any temperature rise in them.

One diode, D1, is a silicon type, the other is germanium. It was found during development of the circuit that the use of two silicon diodes gave too large a standing voltage between TR1 base and TR3 base, while two germanium diodes gave a voltage that was too small. This arises, of course, from the property of a conducting silicon diode to have 0.7 volt or so developed across it, the corresponding figure for a germanium diode being only about 0.4 volt. A compromise seemed in order, even though it is a little unusual. It is worth noting that other amplifier designs frequently call for more complicated arrangements involving an extra transistor used as a voltage multiplier.

The degree of overall negative feedback from output to volume control slider is set, as mentioned earlier, by the ratio of R19 and R20 — at audio frequencies, that is. At very low frequencies the impedance of C10 becomes large compared to R19 so that the degree of negative feedback is thereby increased; for d.c. this increase is such that the overall gain of IC2 and the output stage is unity, so that the d.c. voltage at the junction of TR2 and TR4 collectors is the same as that at the volume control slider, i.e. it is zero with respect to earth. Consequently, the loudspeaker can be connected directly between the output collector junction and the earth line, so eliminating an expensive high value capacitor and contributing to the small size of the unit.

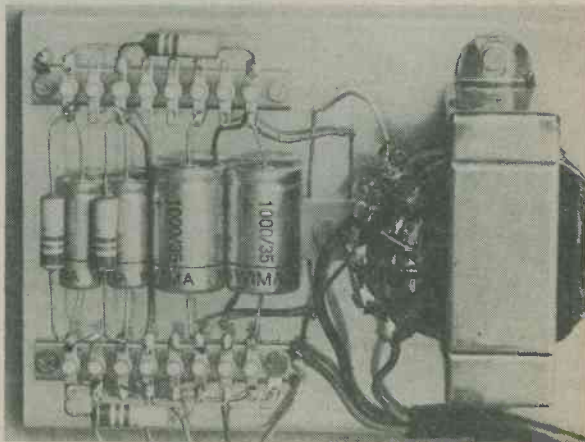

**A close-up view of the power supply components**

The negative side of electrolytic capacitor C10 is returned to the negative 11 volt supply rail, and not to the earth line. This method of connection ensures that C10 remains properly polarised, with its upper end at earth potential.

A 1Ω resistor R21 is used in series with the loudspeaker to reduce a little the large currents that could otherwise flow should a short-circuit appear at the output. The power loss due to R21 is negligible.

## OUTPUT POWER

The output transistors used are types BD131 and BD132, a complementary n.p.n.-p.n.p. pair in plastic encapsulation. Although they are each rated at 15 watts maximum (some references state 11 watts) this does not mean that 30 watts can be drawn from the amplifier described here. A primary objection to this is a phenomenon known as secondary breakdown.

A curve showing the current-voltage limits that have to be observed in order to prevent such breakdown is given in Fig. 5 (extracted from Mullard data). It will be seen that at a rail voltage of 22 volts, as provided in the power supply of the "6/12" amplifier, the maximum collector current permitted is 0.6 amp. Resistors R13 and R16 have been chosen so that the greatest mean current through each of the output transistors is 0.6 amp when signal clipping starts. With two transistors in push-pull, 12 watts can be driven into 8Ω and this is the peak rating of the amplifier.

Further limitations arise due to thermal considerations. The heat sinking provided in this design is capable of maintaining a suitable junction temperature only if the average output power over some minutes is limited to 6 watts into 8Ω and this is therefore the maximum mean output of the amplifier. As was stated earlier, the risk of over-heating is obviated if the amplifier feeds into a 15Ω loudspeaker.

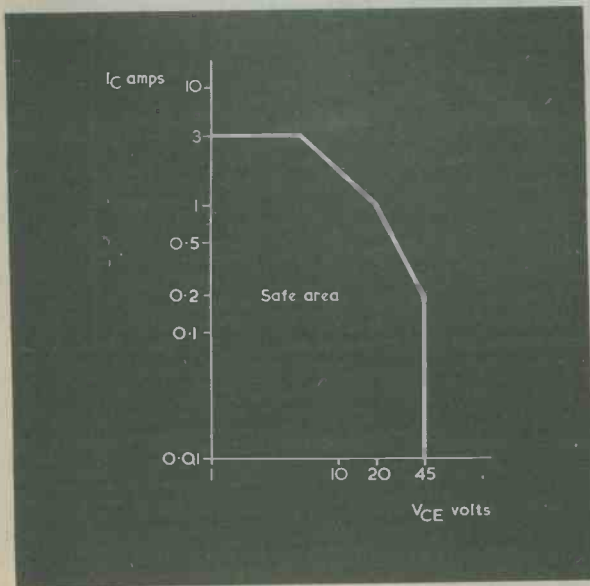

Fig. 5. Secondary breakdown curves for the BD131 and BD132

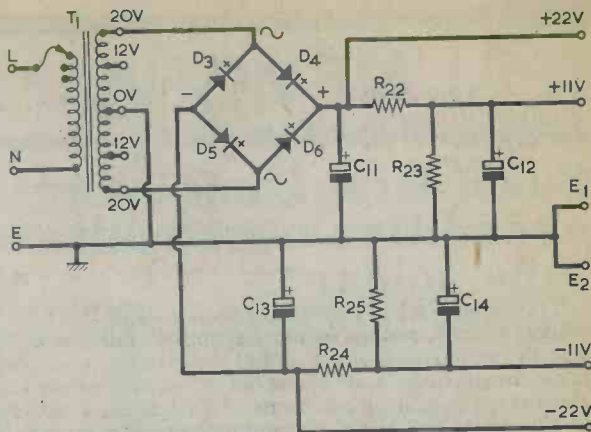

Fig. 6. The power supply. No connections are made to the 12 volt taps in the transformer secondary

## POWER SUPPLY

The power supply for the "6/12" is required to offer outputs of 22 volts positive and negative at 600mA and 11 volts positive and negative for the two integrated circuits.

These outputs are easily achieved with the circuit of Fig. 6. The combination of a transformer with a 20-0-20 volt secondary and a bridge rectifier in the configuration shown gives a dual output of about ±30 volts off load, falling to ±22 volts when the amplifier is delivering its full output of 12 watts. The two 748 i.c.'s require lower rail voltages and these are most easily provided by means of two potential dividers. The extra expense of a regulated supply using zener diodes is hard to justify in view of the excellent rejection of supply rail changes by the 748's.

This completes the description of the circuit of the "6/12" amplifier and its power supply, and constructional details will be given in next month's concluding article. The full Components List appears in this issue. The two 748's employed are in the round TO99 (sometimes referred to as TO5) encapsulation and these are available from several retailers. An S.T.C. die-cast box was employed for the prototype amplifier, and this is listed by Home Radio. The three jack sockets have an insulated construction, i.e. both their contacts are insulated from chassis. The two output transistors require an insulating mica washer, which is normally supplied with them. The polystyrene capacitors shown in the Components List are available from Doram Electronics or Electrovalue. The tagstrips employed in the prototype can be seen in the accompanying photographs. The 6-way tagstrip is fitted in the amplifier. It should have all tags insulated from chassis and should not be longer than about 2½ in. The two 8-way tagstrips are in the power supply and are not critical with respect to length, although the use of small tagstrips is preferable. The silicon bridge rectifier employed for D3 to D6 may have a voltage or current rating in excess of those stated. Readers having any other queries concerning components should find that these are cleared up in next month's article.

(To be concluded)

## Successful Himalayan expedition uses multicore tape solder

News recently reached Multicore Solders Limited of Maylands Avenue, Hemel Hempstead, Herts., from their Polish Distributor who reported that during 1974 a Polish mountaineering expedition conquered the highest unclimbed peak in the Himalayas — the Kangbachen Peak (7902 metres). Five Polish mountaineers placed a Polish and Nepalese flag on the peak which had defied all previous expeditions.

The secretary of the expedition, the first one on the peak, was an electrical engineer and physicist, Dr. Eng. Wojciech Branski. Dr. Branski was responsible for servicing and maintaining all the electrical and electronic equipment. He told Muticore's Polish Distributor:

"Well before the start of the expedition I was concerned about equipment failure as one cannot carry both solder and soldering iron due to weight and space restrictions. The answer to this problem came from Multicore Solders. Specially prepared Tape Solder wound round wire terminals soldered quickly when heated by the flame of a match. Ersin Multicore Flux Cored Tape Solder can be used anywhere and at any height, as I have proved on several occasions in the mountains. Ersin Multicore Tape Solder should be an essential part of any mountaineers equipment."

Dr. Branski also stated that he used Multicore Tape Solder both at home and on his car.

Ersin Multicore match melting Tape Solder has been on the market for many years now and has useful and varied applications, besides the ones described above. For industrial uses it is available in many shapes and forms, according to specific requirements. It is also sold in shops in a convenient pack of pre-cut pieces.



*The photograph shows members of the Polish expedition in the Himalayas, who successfully repaired their electronic equipment with Ersin Multicore Tape Solder.*

## CCTV EQUIPMENT PROBLEM SOLVED WITH SPEEDFRAME

The photographic unit of the GKN Group Technological Centre provides a comprehensive photographic service to meet the requirements of both internal departments and external sectors of the Group.

One of the services run by the unit is a closed circuit television facility which is used for the recording and analysis of industrial processes, work study techniques and training courses.

The CCTV equipment comprises cameras, a video tape recorder, monitors, switching unit and various ancillary components. All of these parts need to be wired up and positioned correctly for monitoring. This had become a lengthy and inconvenient procedure, since each piece of equipment had to be stored, transported, and set up separately before each video tape session.

Dexion Speedframe proved to be an ideal solution to the problem. A framework of 1" Speedframe measuring 3' x 2' x 2' was constructed to form a purpose built mobile control console for housing all the equipment. The console framework was then fitted with 4" diameter castors and plywood shelves to form a trolley. The top shelf of the trolley is removable so that the unit can be carried easily in an estate car.

Once reassembled and loaded, the trolley becomes a rigid and practical support facility which can transport the equipment quickly and easily from one location to another.



# COMMENT

## Fire-damaged PCBs cleaned up

Following a serious fire in the computer centre of a Dutch electronics factory over 1000 contaminated PCB assemblies were successfully cleaned to new condition in 'Arklone' solvent at the ICI Technical Service laboratory at Runcorn.

Many of the computer boards still had flux residues adhering to them, dating from their original manufacture, which had to be removed with 'Arklone' K before final cleaning could commence. The remaining fire contamination, consisting mainly of water staining, was removed by 'Arklone' W and rinsing in 'Arklone' P.

Subsequent inspection and testing by the electronics manufacturer has shown that the boards are all usable with the exception of a mere dozen which suffered mechanical damage to cheap and easily replaceable diodes.

The efficiency of 'Arklone' solvents in removing contamination from PCBs and assemblies was clearly demonstrated in this rigorous and unusual exercise.

Further details of the range of 'Arklone' solvents are available from Department P, ICI Mond Division, PO Box 13, The Heath, Runcorn, Cheshire WA7 4QF.

## Post Office charges

The recent severe increase in Post Office charges has made life more difficult for most publishers as they are, unavoidably, substantial users of Post Office services.

Solely due to the increase in postal rates, we regret that it has become necessary to increase our annual subscription rate to £4.50 per annum, as from 1st November.

It is perhaps worth mentioning, that our subscription rate is less than the full cover price of the magazine plus postage, by nearly 50p, and of course subscribers are insulated against any further price rises for 12 months.

## Independent Television in Outer Hebrides

About 17,000 inhabitants of the Isle of Lewis in the Outer Hebrides in Scotland are to be given a choice of television programmes for the first time — and they will be in colour.

To date, the only television service available in the Western Isles has been the black-and-white VHF 405-line service of BBC-1. But the opening of a new high-power UHF 625-line transmitting station by the Independent Broadcasting Authority at Eitshal in early 1976, will bring the programmes of Grampian Television in both monochrome and colour.

The optimum route for the ITV programme signals has been achieved by a co-operative effort between the IBA and the BBC and necessitates the use of an SHF (Super High Frequency) link, over a hundred miles in length.

## Unusual stand at Audio Fair

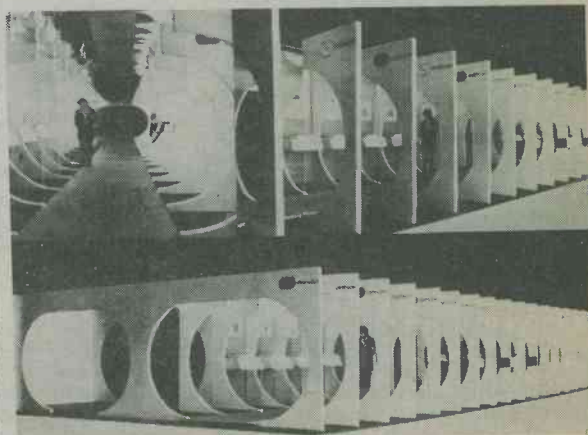

Strathearn Audio's unusual stand in the main hall at this year's Audio Fair. Picture shows the stand which was of unusual and eye-catching design. A special area was set aside for the reception of dealers to provide a forum for discussion. The rest of the stand was devoted to the general public, there were two large areas — one for giving short formal demonstrations of Strathearn products, and another, which ran the entire length of the stand, was a "hands-on-products" area to enable the public to try out of the various turntables for themselves.

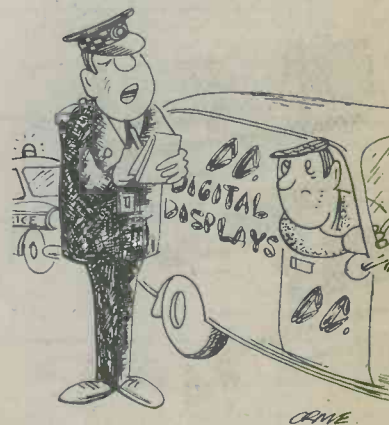

"I suppose in your line of business you'd describe that sign you gave me as a double digit display?"

# MULTI-WAY LATCH CIRCUITS

By G. A. French

In the author's article, "Touch Button Circuits", which appeared in the January 1975 issue of this journal, simple bistable circuits were described which require two transistors and a few other components only. These circuits all took advantage of the fact that the collector of a bottomed silicon transistor has a potential which is approximately 0.2 volt above emitter potential, whilst the base potential under these circumstances is about 0.6 volt above emitter potential.

## BASIC CIRCUIT

The basic bistable, with typical resistor values, is illustrated in Fig. 1. In this circuit both transistors are

silicon planar types. One transistor is always turned on and one transistor is always turned off.

Let us assume that it is TR1 which is turned on. Its collector is then about 0.2 volt positive of the negative supply rail, whereupon the base of TR2 is held at this potential by way of R2, and TR2 is in consequence cut off. The fact that TR2 is cut off allows base current to flow to TR1 via R4 and R3, maintaining TR1 in the turned on condition. If push-button switch S2 is pressed the circuit remains in this state. This is because TR2 is already cut off, and connecting its emitter to its base merely maintains it in the same condition.

If, on the other hand, S1 is pressed the circuit changes state dramatically. Pressing S1 causes TR1 to turn off, whereupon it draws no collector current via R1. A bias current flows into the base of TR2 via R1 and R2, causing this transistor to turn on and its collector voltage to drop to about 0.2 volt above the negative supply rail. When S1 is released the potential at TR1 base is now equal to that at TR2 collector and TR1 remains cut off.

Thus, pressing S1 has caused TR1 to cut off and TR2 to turn on. If S2 is pressed the circuit reverts to its original state.

The author felt that it would be of interest to see whether this mode of operation could be applied to latching circuits having more than two stable states. If a bias rail is provided which is negative of the lower rail in Fig. 1, it becomes possible to set up a network in which only one of quite a large number of transistors is held on at any time, but this does not take advantage of the simple and inherent latching action provided by the fact that the collector potential of a turned on silicon transistor is lower than its base potential. If it is accepted that a multi-way network allows only one of a number of transistors to be turned off at any time, then relatively simple multi-way latching circuits can be assembled which work from the disparity between collector and base voltages, and which require two supply rails only. With reasonably careful control of resistor values it should be possible to incorporate ten or more transistors in a circuit of this nature but the author considered that four transistors represented a reasonable practical maximum. With more than four transistors circuit operation, although still quite simple and reliable, would require rather a large number of inter-coupling resistors between the transistors.

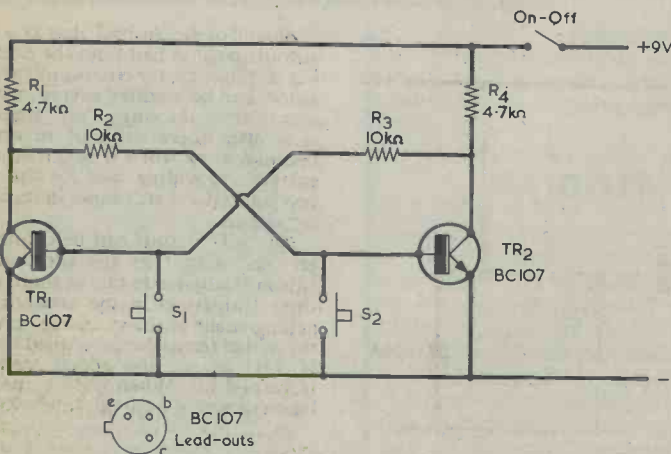

Fig. 1. A latching circuit in which one transistor is always on and one is always off. The circuit changes state when the appropriate push-button switch is pressed



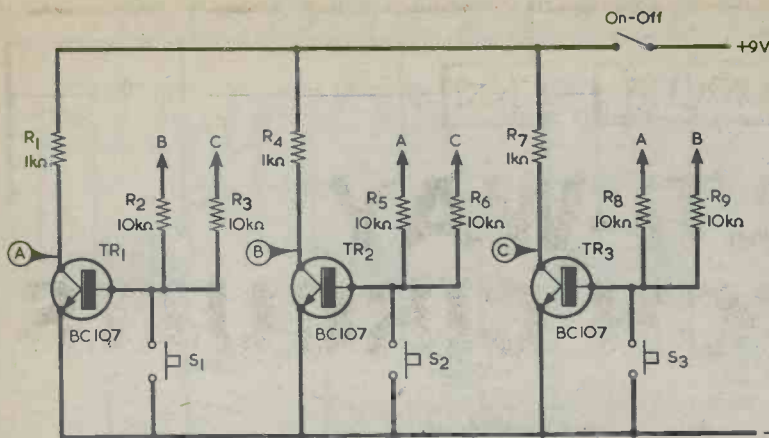

Fig. 2. The circuit can be adapted to take in three transistors. Here, one transistor is always off and two are always on

### THREE-TRANSISTOR CIRCUIT

Fig. 2 shows a latching circuit incorporating three transistors and having three stable states. To simplify circuit presentation the three transistor collectors have been designated A, B and C, and the upper ends of the base bias resistors connect to these collectors as indicated. Thus, the upper end of R2 connects to the collector of TR2 and the upper end of R3 connects to the collector of TR3.

In this circuit one transistor is always off and two transistors are always on. Let us say that it is TR2 and TR3 that are turned on. A potential approximately 0.2 volt positive of the negative rail is then applied to the upper end of R2 and a similar potential to the upper end of R3. These potentials, applied to the base of TR1, maintain TR1 in the off state. A bias current flows via R1 and R5 to the base of TR2, turning this transistor on. R6 couples the base of TR2 to the collector of TR3 but since the voltage across this resistor is only about 0.4 volt (the difference between 0.6 volt at TR2 base and 0.2 volt at TR3 collector) the current which flows through it is much smaller than that in R1 and R5. The latter current predominates, ensuring that TR2 is hard on. A similar situation exists in the base circuit of TR3. A relatively high bias current flows via R1 and R8 to TR3 base and a much smaller current, from TR3 base to TR2 collector, flows via R9. The bias current in R1 and R8 is much the greater of the two and, like TR2, transistor TR3 turns hard on. The circuit is, therefore, stable, with TR1 cut off and TR2 and TR3 on.

If, now, push-button switch S2 is pressed, TR2 turns off. Its collector voltage rises and a base bias current becomes available to TR1 via R4 and R2, and to TR3 via R4 and R9. When S2 is released TR2 remains cut off and the circuit is in the second of its three

stable states, with TR2 off and TR1 and TR3 on. Pressing S3 brings the circuit to its third stable state, in which TR3 is off and TR1 and TR2 are on.

To sum up, any of the three transistors can be caused to turn off, and stay off, by pressing the appropriate switch.

When the supply is switched on, any one of the three transistors may assume the turned off condition, although in practice this will most probably be the transistor with the lowest gain. If it is desired that a specific transistor be reliably in the off condition after switch-on, a capacitor may be added between its base and the negative supply rail. Fig. 3 shows the capacitor coupled to TR1 base. It delays the rise in base voltage in this

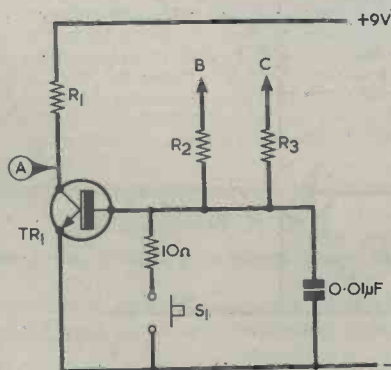

Fig. 3. Adding a capacitor at the base of one transistor ensures that this transistor is off at switch-on

transistor when the supply is applied and so ensures that this transistor is the one which is turned off. The presence of the capacitor does not upset subsequent operation of the circuit. When the supply is switched on sharply by the on-off switch shown in Fig. 2, it is found that a value of  $0.01\mu\text{F}$  is quite adequate for the capacitor. If the rise in supply voltage is more gradual, as occurs when a mains supply unit is switched on at its mains input, a higher value is required in the capacitor, and this has to be found by experiment.

Fig. 3 also shows a  $10\Omega$  resistor inserted in series with S1. This resistor is included to limit capacitor discharge current when S1 is pressed. Considering the capacitance and voltages involved the inclusion of the  $10\Omega$  resistor is rather a pedantic design point, and it could be omitted if desired. If, however, the use of a mains supply necessitates increasing the capacitor value to  $0.1\mu\text{F}$  or more, it would be preferable to retain the  $10\Omega$  resistor.

### OBTAINING OUTPUTS

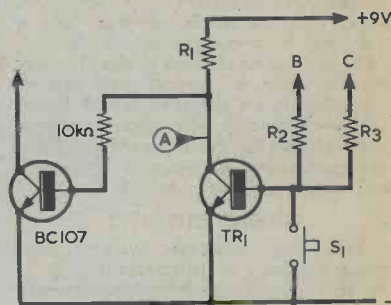

Fig. 4. One method of taking an output from one of the transistors

Should it be desired that two "on" outputs be obtained from the circuit of Fig. 2, the collector circuits of the transistors can be modified accordingly. An output from the single "off" transistor is a little more difficult to arrange because, even when it is turned off, a current (providing bias for the other two transistors) still flows in its collector circuit.

An "off" output can be changed to an "on" output by the addition of a silicon transistor to one or more of the three transistors in the network. The arrangement is shown in Fig. 4, where the added transistor is coupled to TR1. If TR1 is on, the added transistor is turned off. When TR1 turns off a base current of approximately  $0.65\text{mA}$  is available for the added transistor, which can then pass a collector current equal to  $0.65\text{mA}$  multiplied by its current gain. The collector load for the added transistor can be returned to the 9 volt positive rail or to any other positive supply point of suitable voltage level.

An "off" output may be obtained by inserting the base-emitter junction of an added silicon transistor between the emitter of one of the network transistors and the negative rail. Fig. 5 shows two silicon transistors added in this way to TR1 and TR2. Each of the added transistors is off when the transistor connecting to it is off, and is hard on when the transistor connecting to it is on. The added transistors cause the emitters of TR1 and TR2 to be effectively 0.6 volt above the negative supply rail. To maintain balance and ensure reliable operation, the emitter of TR3 has also to be 0.6 volt above the negative supply rail, and this is achieved by inserting a forward biased silicon diode between the emitter and the rail. Alternatively, the base-emitter junction of a third added transistor could be inserted in the emitter circuit of TR3. The capacitor circuit of Fig. 3 works equally well with this version of the circuit.

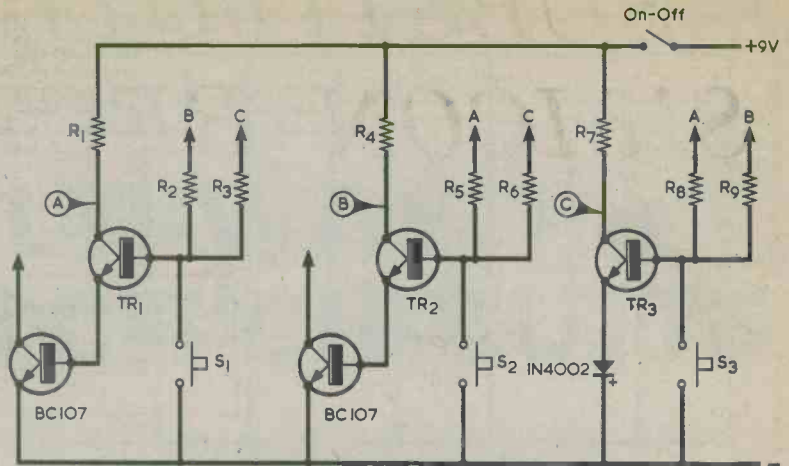

Fig. 5. An alternative output circuit

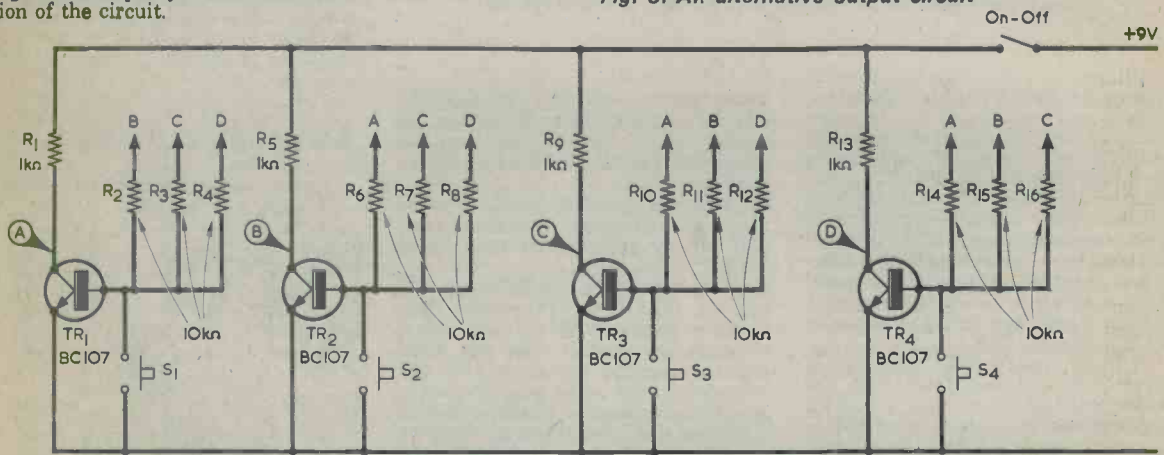

Fig. 6. The basic circuit expanded to incorporate four transistors. This network has four stable states

#### FOUR STATE VERSION

The latching network can be expanded to include four transistors, and a practical working circuit is given in Fig. 6. In this arrangement one transistor is always off and three transistors are always on. Any transistor can be set to the off state by pressing the switch connected to its base and emitter. The capacitor circuit of Fig. 3 functions satisfactorily with this

arrangement, as also do the output circuits illustrated in Figs. 4 and 5.

There is little reason to doubt that more than four transistors could be employed in a multi-way latching circuit employing the basic principles of the three and four transistor networks. However, the circuit complexity increases with each transistor that is added and the four transistor circuit of Fig. 6 is, perhaps, the maximum that is worth assembling with discrete com-

ponents.

The principles employed in the circuits are of a general nature and the experienced experimenter will be able to incorporate them in any specific applications he has in mind. All the resistors in the circuits can be  $\frac{1}{4}$  watt 5 or 10% types. The author used BC107's throughout, but any similar small silicon planar n.p.n. transistors having a current gain of 100 or more should be equally satisfactory. ■

## BACK NUMBERS

For the benefit of new readers we would draw attention to our back number service.

We retain past issues for a period of two years and we can, occasionally, supply copies more than two years old. The cost is the cover price stated on the issue, plus 11p postage.

Before undertaking any constructional project described in a back issue, it must be borne in mind that components readily available at the time of publication may no longer be so.

We regret that we are unable to supply photo copies of articles where an issue is not available. Libraries and members of local radio clubs can often be very helpful where an issue is not available for sale.

# SUBSTITUTING BY SILICON RECTIFIERS

by F. G. Rayer

Silicon rectifiers offer an economic alternative to valve h.t. rectifiers, and they may be instrumental in prolonging the useful life of earlier equipment.

Silicon rectifiers are compact and inexpensive and they offer an admirable substitute or replacement for most valve rectifiers. They can usually be fitted to replace expensive or difficult to obtain valve rectifiers in transmitting equipment, or in the older audio amplifiers and radio receivers.

Fig. 1 shows a typical half-wave rectifier circuit with a reservoir capacitor and smoothing choke. A resistor is frequently employed instead of the choke. The valve rectifier only conducts on the half-cycles when its anode is positive; electrons then flow from the heated cathode (or the heater itself with directly heated valves) towards the anode. In consequence, a positive rectified voltage is available at the rectifier cathode.

A silicon rectifier carries out the same function as the valve rectifier, but is much smaller and requires no heater. Also, it has a very low resistance when it conducts, which means that the rectified voltage it produces is higher. When replacing a valve by a silicon rectifier it is usually necessary to insert a series resistor so that the rectified voltage does not become too high and to keep charging current surges in the reservoir capacitor to a low level.

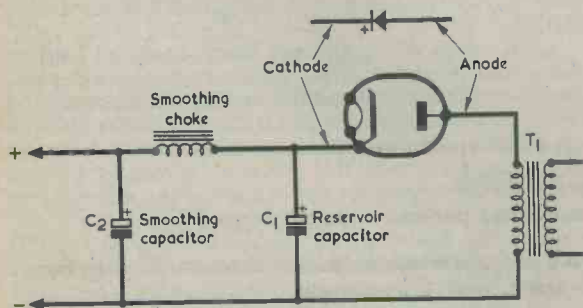

Fig. 1. A typical half-wave valve rectifier circuit supplied by the secondary of mains transformer T1. The symbol for a silicon rectifier appears above the valve rectifier



A valve rectifier and the plug-in rectifier unit which replaces it

A silicon rectifier symbol is drawn above the valve rectifier symbol in Fig. 1, and its anode and cathode are identified. These correspond to the anode and cathode of the valve rectifier.

The polarity of a silicon rectifier is most frequently indicated by a coloured band on its body near the cathode end. Sometimes the cathode end is indicated by a tapering of the body. If any doubt exists about the polarity of a silicon rectifier, connect one end to the transformer secondary, leave the other end free and check polarity with a testmeter switched to a

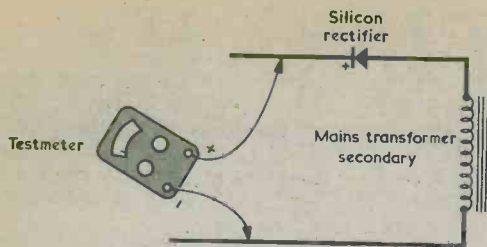

Fig. 2. If any doubt exists, the polarity of a silicon rectifier can be confirmed with a testmeter before connecting the rectifier fully into circuit. The testmeter is set to a suitable volts range

suitable volts range. See Fig. 2. The testmeter needle will give a forward reading if its positive test clip connects to the rectifier cathode. A silicon rectifier connected wrong way round will almost certainly break down reservoir and smoothing capacitors and can cause considerable damage.

## RECTIFIER RATINGS

Silicon rectifiers must have ratings adequate for the voltages and currents which appear in the circuits in which they are fitted. Fortunately, silicon rectifiers with adequate ratings for most circuits are readily available.

**Peak Inverse Voltage.** This is the peak voltage which is applied across the rectifier when it is not conducting. In Fig. 1, suppose that the secondary voltage of the mains transformer, T1, is rated at 300 volts. This is the r.m.s. rating as would be indicated, for instance, by a testmeter switched to an a.c. volts range. The peak voltage is approximately 1.4 times this figure, or 420 volts. If no load current were drawn from reservoir capacitor C1 this could charge up to the peak voltage, with the terminal connected to the rectifier cathode positive. On half-cycles when the upper end of the transformer secondary is negative the total possible peak inverse voltage applied to the rectifier will consist of the 420 volts in the transformer secondary plus the 420 volts in C1, or 840 volts. So the peak inverse voltage rating of a silicon rectifier used in the circuit of Fig. 1 must be greater than 840 volts.

In circuits of the type shown in Fig. 1 the peak inverse voltage rating of the rectifier must, therefore, be greater than 2.8 times the r.m.s. value of the applied alternating voltage. In the full-wave rectifier circuit of Fig. 3 an r.m.s. voltage of 250 volts is applied to each

rectifier, so that these must both have a peak inverse voltage rating of greater than 2.8 times 250 volts, or 700 volts.

In circuits such as Fig. 1 and Fig. 3, rectifiers with a peak inverse voltage rating of 800 volts are suitable for applied alternating voltages up to 250 volts r.m.s., and a peak inverse voltage rating of 1,000 volts for applied alternating voltages up to 350 volts r.m.s.

For very high voltages, two or more rectifiers can be connected in series, as is shown later.

**Rectified current.** Most valve rectifiers have maximum current ratings in the range of 100 to 250mA. Silicon rectifiers rated at 1 amp are readily available, and so it is normally an easy matter to obtain silicon rectifiers of adequate current rating.

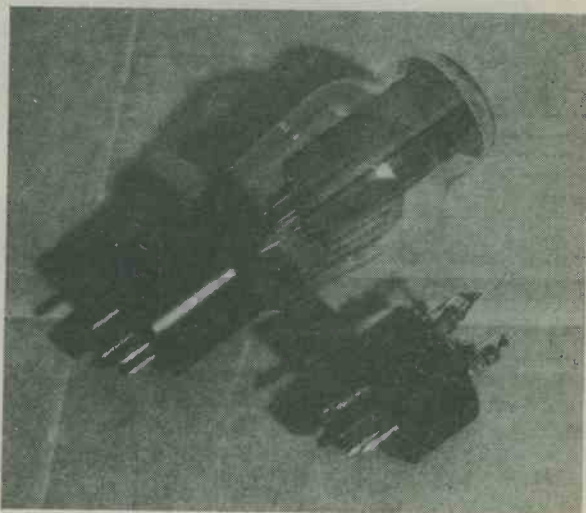

Another rectifier and its substitution plug-in unit

## HEATER CIRCUIT

Many full-wave valve rectifiers have 5 volt 2 amp or 3 amp heaters, these including the 5R4GY, 5U4G, 5V4G, 5Y3GT and similar types. Others, such as the 6X4 and 6X5GT, have 6.3 volt 0.6 amp heaters. These heaters are normally fed from a 5 volt or 6.3 volt mains transformer secondary. Substitution by silicon rectifiers will merely mean that the load on the transformer is reduced. No compensation for this is needed.

Some items of equipment have the valve heaters connected in series. To take an example, a typical rectifier intended for series heater operation is the 35Z4GT, which has a 35 volt 0.15 amp heater. If such a rectifier is removed, a resistor of suitable value must be connected across the valveholder heater pins to maintain the circuit for the heaters of the other valves in the equipment.

Since the heater of the 35Z4GT drops 35 volts at 0.15 amp, the required resistance is 35 divided by 0.15, or 233Ω. The wattage dissipated by the resistor will be 35 times 0.15, or 5.25 watts, and so the resistor should have a wattage rating of 6 watts or more. It will be difficult to obtain a resistor of 233Ω, but one at the nearest preferred value of 240Ω would be adequate. The equipment may have an adjustable dropper resistor in series with the heater chain. In this in-

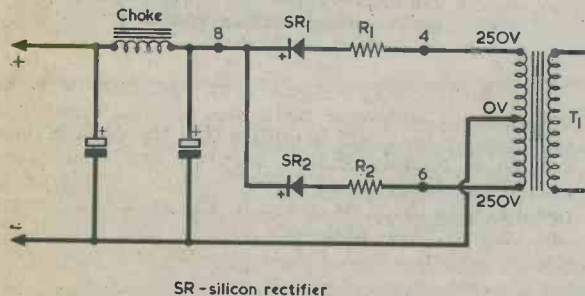

Fig. 3. A silicon rectifier circuit replacing a full-wave valve rectifier

stance, other more readily obtainable resistors such as 200  $\Omega$  or 220  $\Omega$  could be used and the dropper readjusted to provide the small extra resistance required. The resistor will run warm and should be clear of other items and have adequate air cooling.

With the 35Z4GT, the heater pins are 2 and 7. It may be convenient to pass the resistor leads through sockets 2 and 7 of the valveholder and solder them to the two valveholder tags. The resistor will then be positioned above the valveholder. Alternatively, it may be possible to include the resistor in a plug-in unit such as that illustrated in Fig. 4.

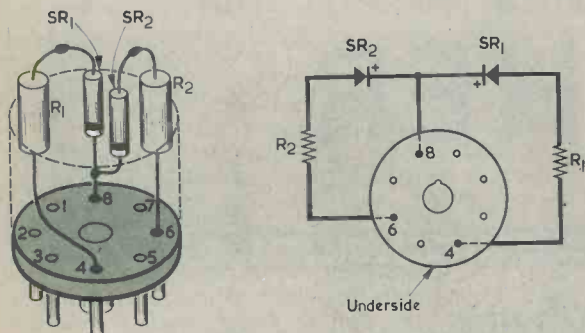

Fig. 4. The silicon rectifiers and series resistors of Fig. 3 can be wired up on an octal valve base to form a plug-in replacement unit

## FULL-WAVE CIRCUIT

Full-wave rectification is common in a.c. equipment, and Fig. 3 shows two silicon rectifiers replacing a valve of the 5R4GY, 5U4G and similar types. The points numbered 4 and 6 correspond to the valve anode pins and that marked 8 to the cathode. (The 5R4GY and 5U4G are directly heated rectifiers and point 8 corresponds, in practice, to one end of the heater).

Due to the low forward (i.e. conducting) resistance of the silicon rectifiers, resistors R1 and R2 are added. For most receivers, small amplifiers and similar units, R1 and R2 can be 100  $\Omega$  1 watt. The resistors help to ensure that the rectified voltage provided by the silicon rectifiers is not excessively increased over that provided by the valve rectifier they replace. They also reduce peak currents.

If there is no reservoir capacitor and the rectified voltage is fed to a smoothing choke on its own, R1 and R2 can often be omitted. They may be added if subsequent checks show that the rectified voltage is too high.

## PLUG-IN REPLACEMENT

A convenient method of fitting the silicon rectifiers consists of wiring them to a plug which can be fitted to the rectifier valveholder in place of the valve. Octal plugs are available, but a suitable plug can also be obtained from an unwanted octal valve. Other, obsolete, valve bases may be similarly obtained.

First wrap the valve in a good thickness of newspaper or rags and break away the glass. Carefully remove all the glass from the base and clean out the

required pins by applying a soldering iron to the tip and pushing a wire through.

The rectifiers and series resistors can then be soldered to the valve base pins, as in Fig. 4. This will make a direct plug-in replacement for the valve rectifier. The resistors can be 100  $\Omega$  1 watt, as already discussed, and the rectifiers may have a peak inverse voltage rating of 800 or 1,000 volts to suit the alternating voltage applied to them.

## SAFETY

A plug-in unit like that of Fig. 4 may only be used when equipment is fully enclosed, so that h.t. and other high voltage circuit points cannot be accidentally touched. For the same reason, silicon rectifiers and resistors must not be mounted above the chassis in equipment which is not fully enclosed.

With home-built equipment, or equipment having valves exposed on the top of the chassis, the silicon rectifiers and series resistors must be fitted underneath so as not to leave exposed h.t. or other dangerous circuit points.

## HIGHER VOLTAGES

When the applied alternating voltage is above 350 volts r.m.s. it is usually convenient to employ inexpensive wire-ended rectifiers with a peak inverse voltage rating of 1,000 volts in series. A suitable type is the 1N4007. Two such rectifiers in series will be suitable for alternating voltages up to 700 volts r.m.s.

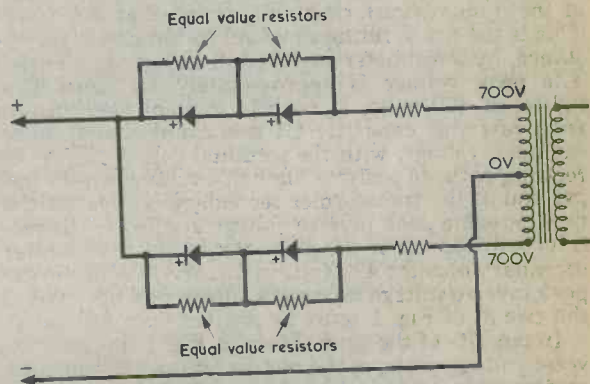

Fig. 5. When rectifiers are connected in series, equal value resistors are placed in parallel to ensure that each rectifier has the same peak inverse voltage applied across it

For a full-wave circuit four rectifiers will be necessary. The reverse resistance of silicon rectifiers is extremely high and to ensure that the peak inverse voltage is equally shared between two series connected rectifiers, equal value resistors are placed in parallel with them, as in Fig. 5. The actual values are not very critical, and each resistor can be, for instance, 220k  $\Omega$  1 watt. Where the alternating voltage is close to the limiting level of 700 volts r.m.s. for two series connected rectifiers, the resistors should have a tolerance on value of 5%. Fig. 5 also shows the two series resistors which carry out the same function as R1 and R2 of Fig. 3.

# SCHMITT RELAY FLASHER

by J. R. Davies

An unusual astable circuit in which a relay carried out an active function.

Despite its usefulness, the Schmitt trigger does not find many applications in home constructor projects. In the design to be described in this short article a Schmitt trigger is employed in company with a relay to form a continually running astable oscillator. The relay energises and releases at a frequency dependent upon the value of a single capacitor, and one of its contact sets may be used to allow a lamp to flash on and off or perform any similar function. The length of the switching cycle may be varied from the fastest frequency at which the relay can operate to periods in excess of 30 seconds. The circuit has the advantage that frequency can be changed by altering the value of one capacitor.

## SCHMITT TRIGGER

The circuit of the astable appears in Fig. 1, in which TR1 and TR2 appear in the Schmitt trigger configuration. The relay coil is represented by a rectangle alongside which is the identification letter "A" over the figure "2". This indicates that the coil is part of relay "A", and that it has two contact sets. These are shown elsewhere in the diagram, as A1 and A2, and are illustrated in the de-energised condition. Thus, contact set A1 is normally closed and contact set A2 is normally open.

On application of the 12 volt supply, capacitor C1 is discharged and the base of TR1 is held at the same potential as the negative rail, whereupon this transistor is cut off. At the same time the supply voltage appears across the series combination of the relay coil, R4 and R5, causing a positive voltage to be applied to the base of TR2. Making the initial assumptions that the relay coil has a negligibly low resistance in comparison with R4 and R5 and that base current in TR2 is very small, the base of TR2 is held positive of the

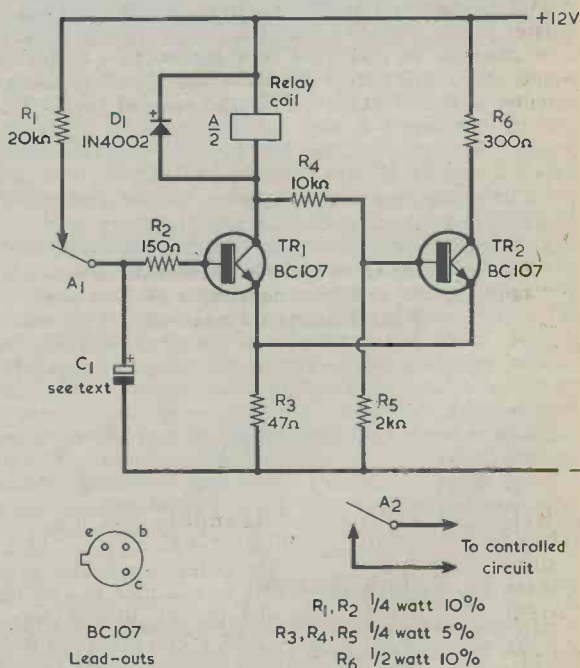

Fig. 1. The circuit of the Schmitt-relay astable. The circuit oscillates at a frequency which is controlled by the value of C1

negative rail by 2 volts. TR2 is in consequence fully conductive and a potential 0.6 volt lower appears at its emitter, giving a voltage of 1.4 volts across R3. This resistor limits TR2 emitter current to 30mA. The current of 30mA flows also through R6, with the result that this resistor drops 9 volts. Thus, the dissipation in TR2 is the remaining 1.6 volts multiplied by 30mA, i.e. 48mw. The only function of R6 is to ensure that dissipation in TR2 is maintained at a low level.

After switch-on, C1 commences to charge via relay contact set A1 and resistor R1. When the voltage across its plates reaches 2 volts, a forward bias of 0.6 volt appears across the base-emitter junction of TR1 and this transistor commences to pass emitter and collector current. As the voltage across C1 continues to increase the emitter of TR1 raises the voltage across R3 above its previous 1.4 volt level. At the same time the increasing collector current passing through the relay coil causes TR1 collector voltage, and hence that at the base of TR2, to fall. TR2 emitter is therefore being taken positive whilst its base is being taken negative. The emitter current TR2 passes through R3 reduces, whereupon the voltage on TR1 emitter goes negative, giving further forward bias for TR1. The effect between the two transistors is cumulative and the overall result is that TR1 is rapidly turned hard on and TR2 is rapidly turned off; the changeover having been triggered when the base of TR1 was taken positive to the level where this transistor commences to turn on. Since TR1 is now conductive the potential at TR2 base is just slightly positive of that on the negative rail.

### CAPACITOR DISCHARGE

The changeover causes relay contact set A1 to open, and C1 next commences to discharge via R2, the base-emitter junction of TR1 and R3. As C1 discharges the base current in TR1 reduces whereupon, after a period, this transistor passes a significantly lower collector and emitter current. Because of this, TR1

mechanism is possible when C1 discharges, the effect being that the relay coil current reduces to a level which causes the relay to release, whereupon contact set A1 closes and the capacitor commences to charge once more. However, the circuit will not continue to run under these conditions with many practical relays, because there would be a tendency to reach a condition of equilibrium in which contact set A1 opens and closes over a very small traverse of the relay armature. For positive relay operation it is necessary that the Schmitt trigger changeover occurs both at the end of the discharge period and at the end of the charge period. It will be noted that it is required of the relay that it remain energised at a coil voltage which is significantly lower than that at which it operates. This raises little difficulty because the release voltage of an energised relay, whose armature is held against the relay core, is normally considerably lower than its energising voltage.

Diode D1 is merely the usual protective diode which is connected across any relay coil driven by a transistor, and it prevents the appearance of a high back-e.m.f. across the coil when the relay releases.

The frequency of oscillation is controlled by the value of C1, which can range from less than 100  $\mu\text{F}$  to greater than 2,500  $\mu\text{F}$ . At 2,500  $\mu\text{F}$  the length of a complete cycle (with R2 at 150  $\Omega$ ) is approximately 30 seconds, and lower values of capacitance give proportionately shorter cycle periods. Thus, with C1 at 250  $\mu\text{F}$  the length of a cycle is approximately 3 seconds. The time, during the cycle, when the relay is energised can be altered by varying the value of R2, and this can range from zero (in which case the positive terminal of C1 connects directly to the base of TR1) to some 10k  $\Omega$ . The relay remains energised for a longer period as the value of R2 is increased. If desired, different frequencies can be selected by switching different capacitors into the C1 position, as indicated in Fig. 2. The electrolytic capacitor or capacitors employed for C1 should have a working

Fig. 2. If desired, alternative frequencies can be selected by switching capacitors of different values into the C1 position

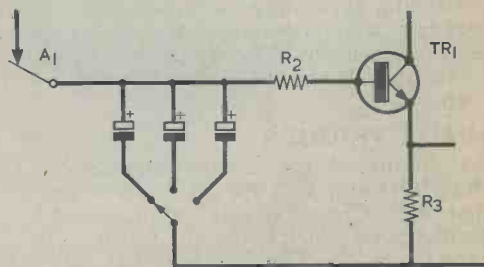

collector goes positive and TR1 emitter goes negative. When the voltage at TR1 collector is about 6 to 7 volts positive of the negative rail the potentials at the base and emitter of TR2 allow TR2 to commence passing current and the reverse changeover takes place, resulting in TR2 turning fully on and TR1 becoming cut off. The relay de-energises, contact set A1 closes and C1 commences to charge once more. Regular cycles then proceed, with C1 charging until TR1 turns on and energises the relay, followed by periods during which C1 discharges until TR1 is cut off again and the relay releases.

At first sight it might appear that an alternative

voltage of 6 volts or more.

The relay can be any type with the requisite contact sets, a coil resistance between 500  $\Omega$  and 1k  $\Omega$ , and an energising voltage of 9 volts or less and a release voltage of 5 volts or less. The author employed a P.O.3000 relay with a 500  $\Omega$  coil in the prototype circuit. During the explanation of operation given earlier it was assumed that the relay coil resistance was negligibly low in comparison with R4 and R5. In practice, the coil resistance causes the voltage at TR2 base, and the current passed by this transistor, to be a little lower than the figures quoted. ■



A new range of plastic cases, attractively finished in light grey ABS with aluminium front and rear panels. Provision is made for both vertical and horizontal mounting of circuit boards.

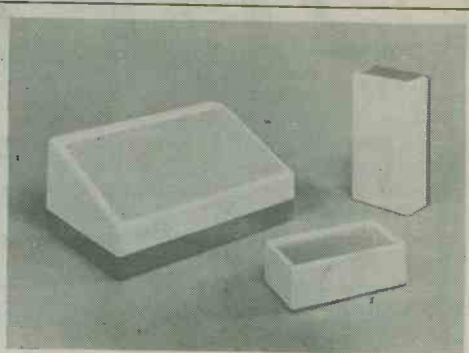

These boxes have proved popular in industry, and are now available to the home constructor. High quality mouldings give projects the "professional" touch.

## VERO FOR THE HOME CONSTRUCTOR

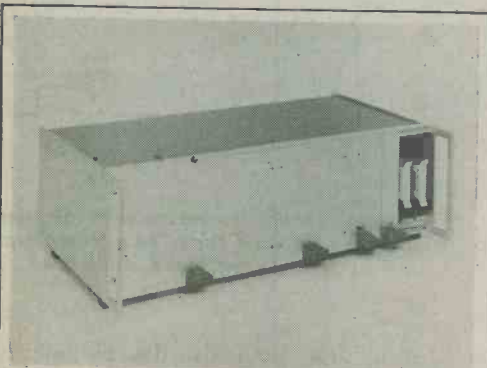

For the more advanced project, this Card Frame/Case accepts plug-in modules and boards. Finished in natural anodised aluminium with light blue PVC coated covers.

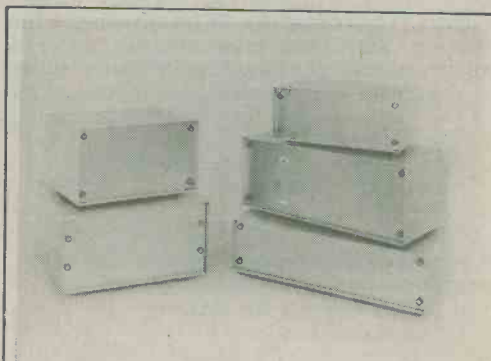

A further new Case range. PVC-clad steel, "knockdown" form, modern styling, five sizes.

**vero**

VERO ELECTRONICS LIMITED, INDUSTRIAL ESTATE, CHANDLER'S FORD, HAMPSHIRE, SO5 3ZR  
Telephone Chandler's Ford 2952      Cables Veroelec Southampton      Telex 47551



# ADDED AMBIENCE

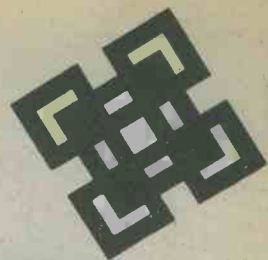

By R. N. Soar

A simple means of obtaining "all round" sound with a stereo system.

This is a simple add-on circuit which, when used with a small stereo system and two extra speakers, will give ambience effects from stereo recordings. The stereo amplifier should have a common chassis connection for both its existing speakers, as will normally be the case. The two extra speakers should have the same impedance as the existing speakers.

## SPEAKER PHASING

As the diagram shows, the circuit depends on correct speaker phasing. Basically the circuit adds the two rear speakers across the non-earthly terminals of the existing speakers. The  $25\Omega$  potentiometer enables the rear volume to be controlled. This potentiometer must be wire-wound, and the one used by the author had a rating of 3 watts. The switch is a toggle type which disconnects the rear speakers to give normal stereo reproduction. If a stereo record is played through the system and the switch is closed, the rear speakers produce a surprisingly spacious effect.

It is very important that the speakers be correctly phased. One way of finding the connections for correct phasing is to use a stereo test record which has phasing tests on it. First ensure that the two existing front speakers are in phase and then designate the terminal of each which connects to chassis as "negative" and that which connects to the non-earthly amplifier outputs as "positive".

Disconnect one of the front speakers and replace it with one of the additional speakers and find, with the aid of the test record, which method of connection produces correct phasing. Designate the speaker terminals as "negative" and "positive" accordingly, and then repeat the process with the second additional speaker. Switch the amplifier off whilst changing speaker connections and take great care not to accidentally short-circuit the output as the output circuit could then be damaged. Finally, reconnect the original front speaker.

An alternative method of speaker phasing consists of temporarily connecting a 1.5 volt cell to each speaker and checking whether the cone moves forward or backward. The terminals of all speakers

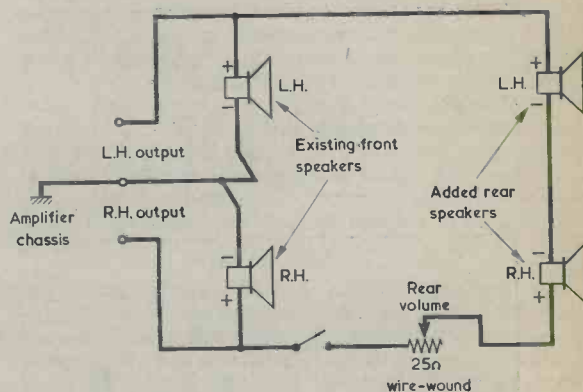

Two rear speakers, connected with the phasing shown here, may be added to a stereo system to produce enhanced ambience

may then be designated with the cell polarity which gives the same direction of cone movement.

The additional rear speakers are connected up as shown in the diagram. Note that the junction of the two rear speakers is *not* connected to chassis.

It is not necessary that all four speakers should be identical, but the two rear speakers should be a pair. If these are small they could be wall mounted; this improves the effect.

The switch and wire-wound potentiometer can be fitted in a small control box with output jack sockets for the two rear speakers. If the box is made of metal the sockets will need to be insulated types.

In use the circuit gives apparent "four channel" sound, and offers an improvement with most recordings. Sometimes, the effects can be startling. Sounds appear which are not noticed when a record is played in the normal stereo mode and the improvement in reproduction is quite dramatic.

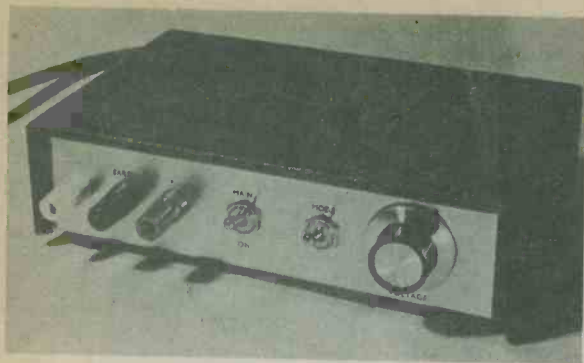

# POWER FOR OP

Integrated circuit operational amplifiers are now being used in an increasing number of applications in the field of amateur electronics, and they are amongst the most versatile active devices available today. The only problem that they are likely to cause is the provision of a suitable power source for testing a prototype design incorporating operational amplifiers, or when experimenting with operational amplifiers.

The problem lies in the fact that, when used as d.c. amplifiers, operational amplifiers require two supply voltages, one positive of earth and the other negative of earth. Most operational amplifiers require equal positive and negative supply voltages but a few types, such as the 710 voltage comparator, require a positive supply having a potential double that of the negative supply.

Few ordinary mains power supply units are equipped to provide these voltages and it is often inconvenient to use batteries, which are in any case expensive in the long term. The mains operated power supply described here has been specifically designed for use with operational amplifier i.c.'s, and it has output voltages which are both positive and negative of earth. In one mode of operation the positive and negative voltages are equal and are continuously variable from some 5 to 16 volts. In an alternative mode of operation the positive voltage is double the negative voltage; in this instance the positive voltage is continuously variable from approximately  $6\frac{1}{2}$  to  $21\frac{1}{2}$  volts with the negative voltage being continuously variable from about  $3\frac{1}{2}$  to  $10\frac{1}{2}$  volts.

The maximum output current is 100mA, although this can be increased somewhat if required by altering the value of one resistor. Output current limiting is employed to protect the unit against accidental short-circuits.

## VOLTAGE REGULATOR

The circuit diagram of the power supply unit appears in Fig. 1. The alternating voltage from the secondary of T1 is given full-wave rectification by the bridge rectifier formed by D1 to D4, the output of this being applied to reservoir capacitor C1. Regulation and further smoothing of the supply is then provided by IC1, which is a 723C voltage regulator. This has a rather complex internal circuit and the way in which it functions can perhaps be best understood by ex-

Using an ingenious voltage splitting technique, the power unit provides continuously variable positive and negative voltages for the supply of operational amplifier circuits. Further features include voltage stabilization and overload current limiting.

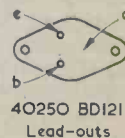
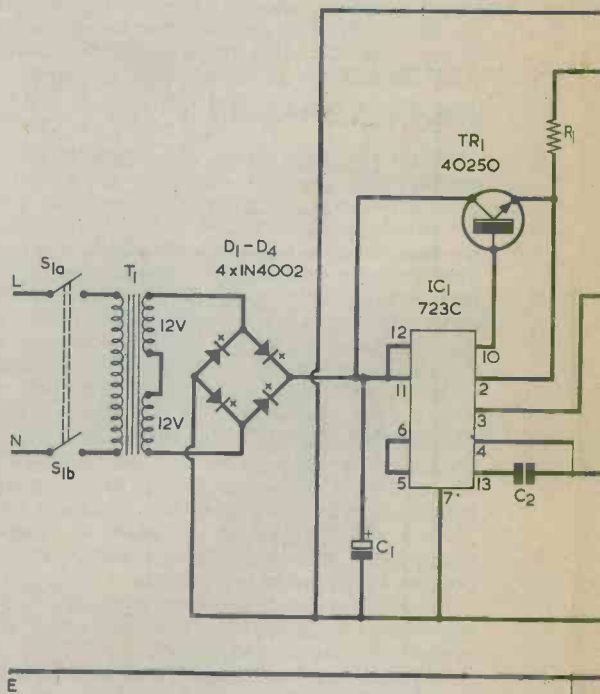

Fig. 1. The circuit of the power supply. This provides both positive and negative voltages.

# POWER SUPPLY FOR OP-AMPS

Using an ingenious voltage splitting technique, this power unit provides continuously variable positive and negative voltages for the supply of all standard operational amplifier circuits. Further features are voltage stabilization and overload current limiting.

By A. P. Roberts

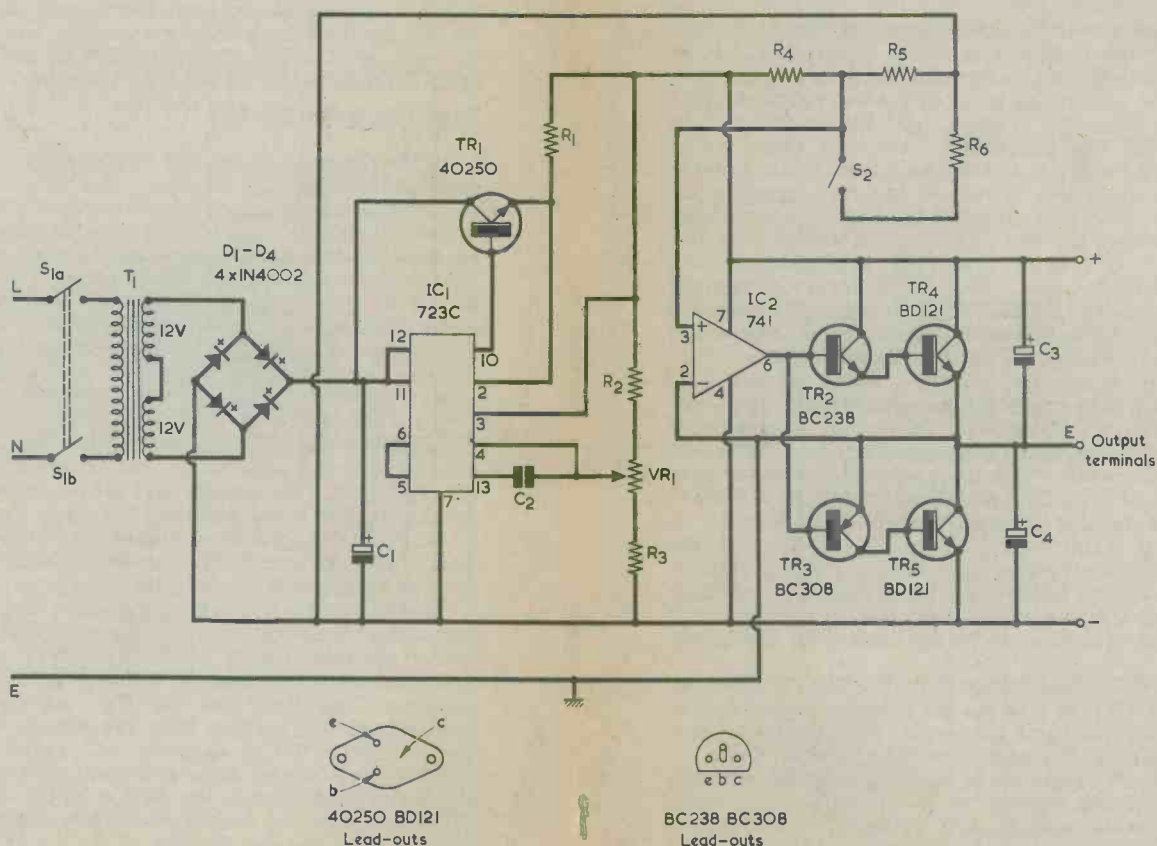
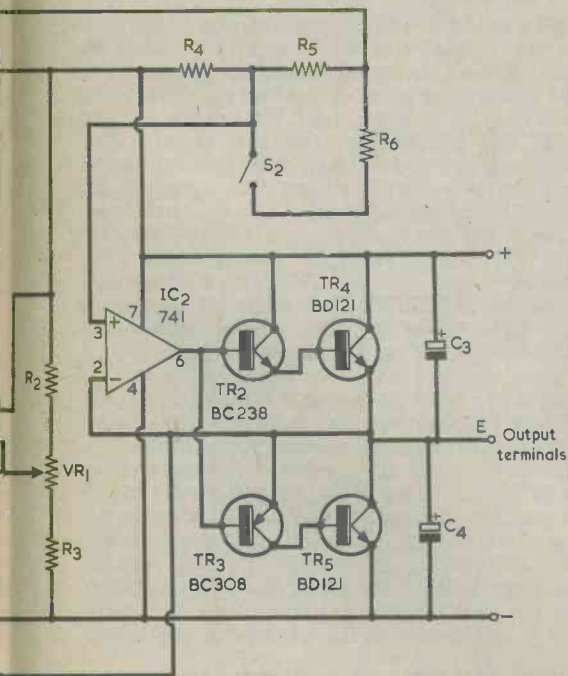

Fig. 1. The circuit of the power supply. This provides continuously variable output voltages which are both positive and negative of earth

# SUPPLY -AMPS

technique, this  
positive and  
all standard  
features are  
limiting.

By A. P. Roberts



BC238 BC308  
Lead-outs

continuously variable output voltages which are  
negative of earth

NOVEMBER 1975

## COMPONENTS

### Resistors

(All fixed values  $\frac{1}{2}$  or  $\frac{1}{4}$  watt)

R1 6.8 $\Omega$  5% (see text)

R2 12k $\Omega$  2%

R3 10k $\Omega$  2%

R4 20k $\Omega$  1% or 2%

R5 20k $\Omega$  1% or 2%

R6 20k $\Omega$  1% or 2%

VR1 25k $\Omega$  potentiometer, linear

### Capacitors

C1 1,000 $\mu$ F electrolytic, 50 V. Wkg.

C2 120pF polystyrene or silvered mica

C3 100 $\mu$ F electrolytic, 25 V. Wkg.

C4 100 $\mu$ F electrolytic, 25 V. Wkg.

### Transformer

T1 Mains transformer, secondary 24 V at 500mA  
(see text)

### Semiconductors

IC1 723C (see text)

IC2 741 (see text)

TR1 40250

TR2 BC238

TR3 BC308

TR4 BD121

TR5 BD121

D1-D4 1N4002

### Switches

S1(a) (b) d.p.s.t. toggle

S2 s.p.s.t. toggle

### Miscellaneous

Instrument case (see text)

3 insulated terminals

Control knob

2 insulating kits (for TR1 and TR4)

Veroboard, 0.1in. matrix

Vero pins, as required

Mains lead

Grommet

4 rubber feet

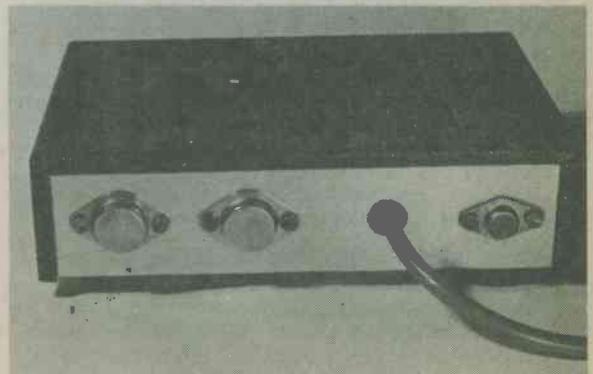

The three power transistors are fitted to the  
rear panel of the power supply case

225

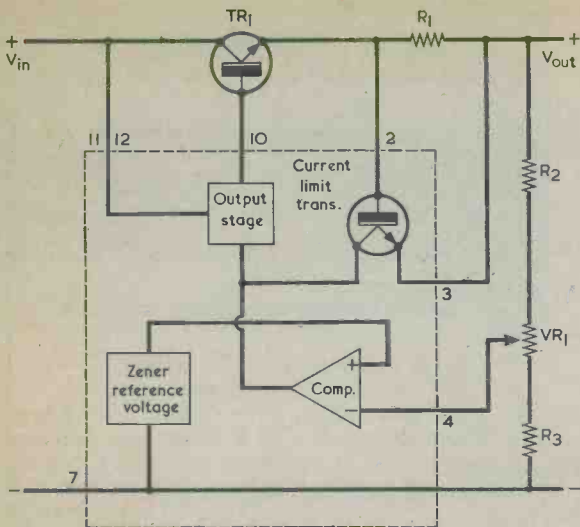

Fig. 2. Simplified diagram illustrating the operation of the 723C voltage regulator

aming the simplified block diagram which is given in Fig. 2.

As will be seen from this, an internal zener reference source couples to the non-inverting input of a comparator. The output of this comparator feeds the output stage, which consists of a Darlington pair emitter follower. The Darlington pair provide a very low output impedance, enabling the i.c. to handle output currents up to 150mA. Although this output current range is sufficient for the present power supply unit design, the i.c. will suffer excessive dissipation at the relatively high output voltages employed. In consequence, the i.c. output is coupled to the external discrete emitter follower, TR1.

If the presence of R1 is temporarily ignored, the inverting input of the comparator connects to the potential divider across the output which is given by R2, VR1 and R3. When the inverting input of the comparator is negative of the non-inverting input its output swings high. If, on the other hand, the inverting input is positive of the non-inverting input the comparator output swings low. The gain of the comparator is extremely high, and only a very small voltage difference is required at its inputs to produce the full, or the minimum, output level.

A negative feedback loop is, as a result, set up via the output of the comparator and the potential divider, and this will stabilize the circuit so as to provide the same voltage at the two comparator inputs. The zener reference source produces approximately 7 volts and so if, for instance, the slider of VR1 taps off exactly half the output voltage with respect to the negative rail then the output will be 14 volts.

Other settings of VRI will provide different output voltages, and with the values specified for the potential divider these range from a little less than 10 to slightly more than 32 volts. Apart from enabling the output voltage to be controlled, the negative feedback loop also provides stabilization despite fluctuations in mains voltage and variations in input voltage due to different loadings on the mains transformer. Such stabilization must obviously exist since the output

voltage is dependent upon the zener reference voltage and the resistance values in the potential divider, and not upon the input voltage. The only proviso here, of course, is that the input voltage must be at least a volt or so higher than any required output voltage.

## CURRENT LIMITING

R1 and a transistor inside the 723C provide current limiting. This works by virtue of the fact that a silicon transistor starts to become significantly conductive when a voltage of 0.66 volt forward biases its base-emitter junction. Once this voltage has been reached only a small increase is required to take the transistor into saturation.

For the sake of explanation let us assume that R1 has a value of  $6.6\Omega$  (actually, it has the nearest preferred value of  $6.8\Omega$ ). An output current of up to 100mA can flow before the voltage across R1 is sufficiently high to cause the transistor to conduct. If this current is exceeded the transistor conducts heavily and current from the comparator output is conducted to the negative rail via the transistor and the output load. The current drawn from the comparator output reduces the voltage at this point, and the output voltage drops to a level which causes no more than 100mA to flow in R1. If the output is short-circuited the current will still be limited to 100mA and the output voltage will be virtually zero.

## SUPPLY SPLITTER

Returning to the circuit diagram of Fig. 1, the output from the regulator is fed to a circuit which, in effect, splits it into two separate supplies connected in series, the connecting point of the two supplies being earthed. When S2 is open, half the output voltage appears at the junction of the two equal value resistors R4 and R5, and this half-voltage is applied to the non-inverting input of the 741 operational amplifier, IC2. The output of this i.c. is coupled to the input bases of the two transistor pairs TR2-TR4 and TR3-TR5. TR2 and TR4 form a Darlington pair emitter follower, and TR3 and TR5 form a compound common emitter amplifier. Both pairs of transistors have unity voltage gain and a low output impedance. The common output of the two transistor pairs is connected back to the inverting input of the 741, whereupon the i.c. and the transistors make up a composite voltage follower with the output voltage being the same as that at the non-inverting input of the 741. Due to forward voltage drop across the emitter-base junctions of TR2, TR3 and TR4, the output of the 741 can shift positive or negative by a small amount on either side of the output voltage, but this has no effect on overall circuit performance due to the high gain inside the voltage follower feedback loop. The common output of the two transistor pairs forms the earth point and is connected to the chassis of the power supply.

When the output voltage from the 723C is varied by means of VR1, so also are the voltages at the positive and negative output terminals, with the earth terminal being at the central voltage between them.

Closing S2 causes R5 to be shunted by R6, with the result that the voltage at the junction of R4 and R5 is one-third of the output voltage. In consequence the voltage between the positive output terminal and earth then becomes twice that between earth and the negative output terminal, as is required by the 710 and similar devices.

Switch S1(a) (b) is the on-off switch for the power

supply unit, and C2 is coupled to IC1 to prevent instability. The two electrolytic capacitors, C3 and C4, were added across the output terminals after a little experience had been gained with the supply unit, and they prevent the appearance of a very small ripple voltage which can occasionally appear with some loads. It should be noted that they will allow a momentary discharge current to flow in the load before the current limiting action comes into operation if the output is suddenly short-circuited.

### CONSTRUCTION

The power supply unit is assembled in a ready-made instrument case measuring 8 by 5½ by 2in. One piece of the case consists of an aluminium front, base and rear panel, whilst the other is a black vinyl covered steel top and sides. The drilling for the front panel controls and terminals is shown in Fig. 3. The layout of the mains transformer and component panels on the base can be seen from the photograph of the interior. Layout is not at all critical and there is plenty of space. C3 and C4 are soldered directly to the output terminals.

At the rear panel are required holes for TR1, the mains lead grommet, TR4 and TR5, in that order. The rear panel functions as a heat sink for the transistors and TR1 is to the left, behind the mains transformer. Both TR1 and TR4 need to be insulated from the rear panel, and are fitted with mica washers and

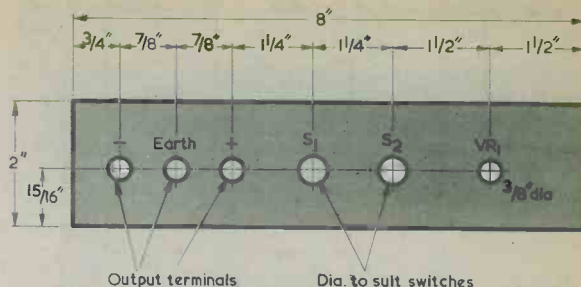

Fig. 3. Drilling details for the front panel

insulating bushes. TR5 is bolted direct to the rear panel. The connection to TR5 collector also provides the chassis connection to the power supply circuit. When, later, the mains lead is fitted, its live and neutral leads will connect to S1(a) (b), and its earth lead to the earth output terminal.

Four rubber feet are fitted at the corners of the base, and suitable holes should be drilled for these.

### COMPONENT PANELS

The smaller components are assembled on two pieces of 0.1in. matrix Veroboard, details of which are given in Figs. 4 and 5. It should be possible to cut the two panels from a longer piece 2½in. wide, using a

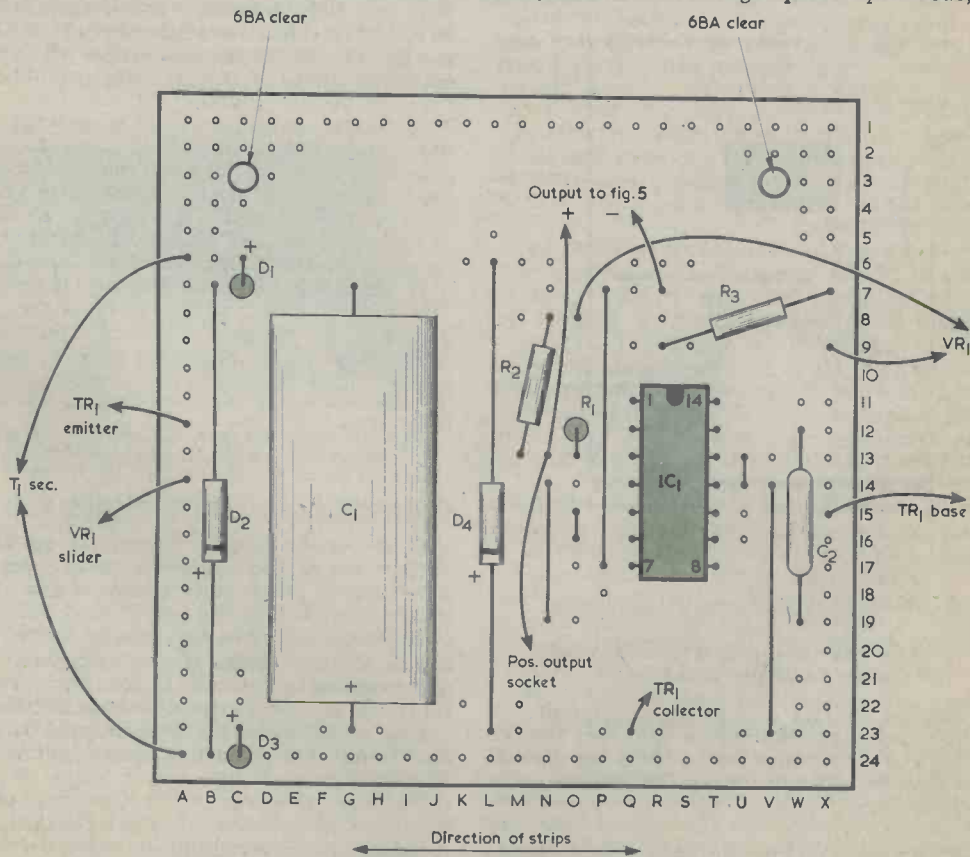

Cut strips at: S11, S12, S13, S14, S15, S16 and S17

Fig. 4. Wiring and layout of the components on the voltage regulator board

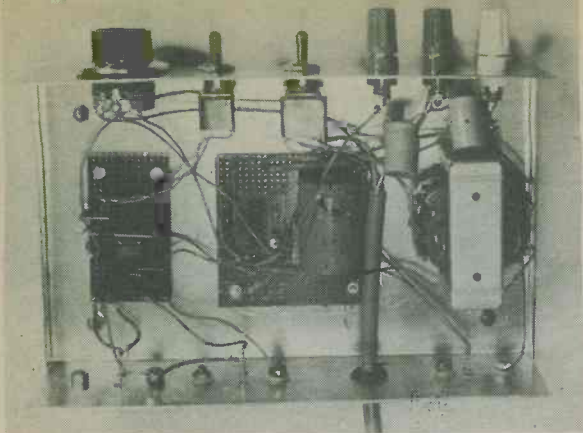

The layout on the chassis is simple and uncluttered. Capacitors C3 and C4 can be seen connected directly to the output terminals

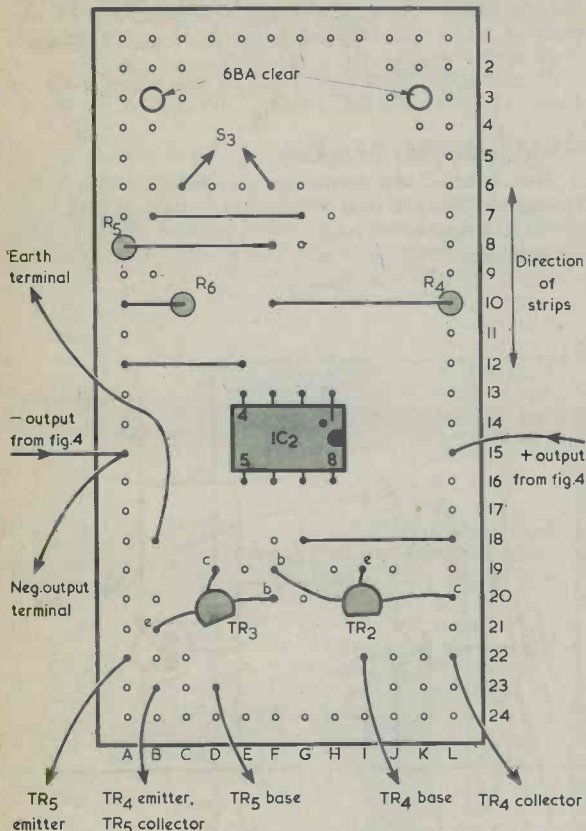

Cut strips at + A5, B5, C5, J5, K5, L5, E14, F14, G14 and H14

Fig. 5. How the components on the supply splitter board are wired up

small hacksaw. The larger panel carries the rectifier, smoothing and regulator circuitry, whilst the smaller has the supply splitter components assembled on it.

Two mounting holes are drilled 6BA clear in each panel with a No. 31 twist drill. The cabinet base may then be marked out and the corresponding 6BA clear holes drilled in it. Next, the copper strips are cut at the points specified in the diagrams.

Link wires, rectifiers, resistors and capacitors are

next soldered into position on the panels. A number of connections are made from each panel to external components, such as transistors, etc. Vero terminal pins should be inserted at the appropriate points in the panels and soldered in position. Finally, the two integrated circuits are fitted and their pins soldered.

The two panels are then mounted on the cabinet base, each with two 6BA bolts 1 in. long. Extra nuts are fitted between the panel undersides and the base, so that they are spaced off adequately. The interconnecting leads between the component panels and external parts may then be fitted. Also, the mains input wiring up to T1 primary can be completed.

If desired, the front panel can have transfers taken from 'Panel Signs' Set No. 4 affixed at the controls and terminals. A dial calibrated in terms of output voltage may be fitted behind the control knob for VR1, although this was not done with the prototype. Instead, a multimeter is connected to its output when required to monitor the output voltage.

### COMPONENTS

As already mentioned, the prototype is housed in a cabinet measuring 8 by 5½ by 2 in. This is the Instrument Case type BV1, available from Bi-Pak. The integrated circuit type 723C should be obtained in the 14 pin dual-in-line package and the 741 in the 8 pin d.i.l. package.

Mains transformer T1 may be any component offering 24 volts at 500mA or more and which is less than 2 in. high. A suitable transformer is the Douglas MT213CT, which is available from Home Radio. This has two 12 volt 500mA secondaries which may be connected in series to give 24 volts at 500mA.

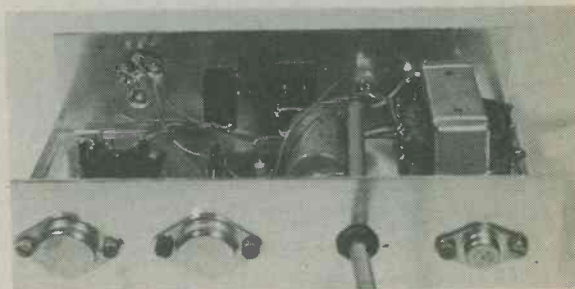

A view from the rear. C3 and C4 were not fitted when this particular photograph was taken

### INCREASED OUTPUT CURRENT

If a higher output current is required before limiting takes place, the value of R1 can be reduced accordingly. There is, of course, a restriction to the output current that can be obtained before the mains transformer becomes too heavily loaded to produce the minimum voltage of about 33 volts which is required across C1. If there is insufficient voltage across C1 it will not then be possible to obtain the maximum output voltage from the power supply. In general, the maximum limiting current level is of the order of 150 to 200mA.

The new value required in R1 may be calculated by dividing 0.66 by the limiting current in amps. Thus, if it is decided to have a limiting current level of 120mA, or 0.12 amp, the value of R1 should be reduced to 5.5Ω. The nearest preferred value of 5.6Ω could be used in practice.

# NEW TRANSISTORISED OSCILLOSCOPE

Part 3 By R. A. Penfold

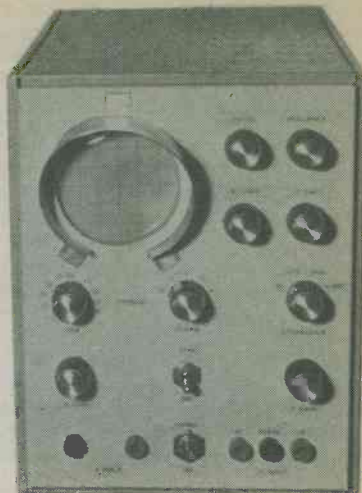

In this concluding article, the assembly of the flyback blanking amplifier is described. Also dealt with are frequency compensation in both X and Y amplifiers, and the frequency calibration of the oscilloscope timebase.

In last month's issue nearly all the constructional work for the oscilloscope was described, the only component panel not discussed being that for the flyback blanking amplifier. This will be dealt with next.

## FLYBACK BLANKING

During the period when the spot is deflected back from right to left across the screen, having completed a sweep, a flyback line can be traced out. At low frequencies this will be very faint, but at higher frequencies the flyback time grows longer in comparison with the sweep time, and a quite bright flyback line can in consequence result. This gives a somewhat confusing trace, and so it is customary to cut off the c.r.t. electron beam during the flyback period, and thus remove the line.

The circuit of the flyback blanking amplifier is shown in Fig. 15. The pulse obtained from the NE555V during flyback is negative-going, and this is applied via C21 to the base of TR15. TR15 functions as a phase inverter, causing a positive-going pulse to be applied to the base of TR16. TR16 again inverts the phase and a high amplitude negative-going pulse is thus applied to the grid of the c.r.t., cutting off the beam during flyback.

The amplitude of the negative-going pulse from the NE555V is greater than the maximum reverse base-emitter voltage rating of the 2N708 employed for TR15. In consequence it is possible for charge and discharge currents to flow in C21. No harm to the NE555V or the 2N708 has been detected in practice with the circuit arrangement used, and dissipation will be very small as the negative-going pulses are extremely brief. The effect of a resistor in series with the

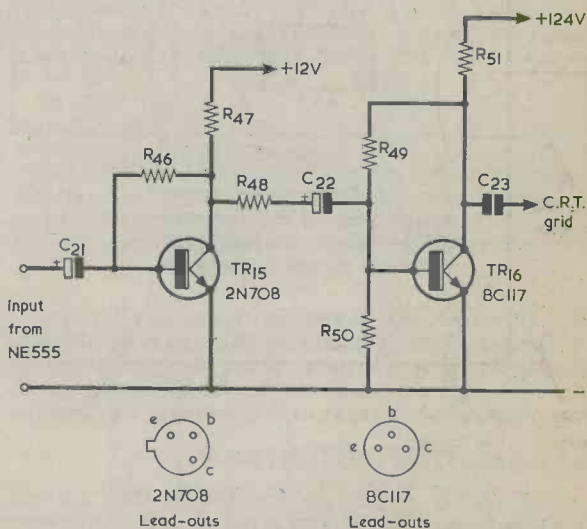
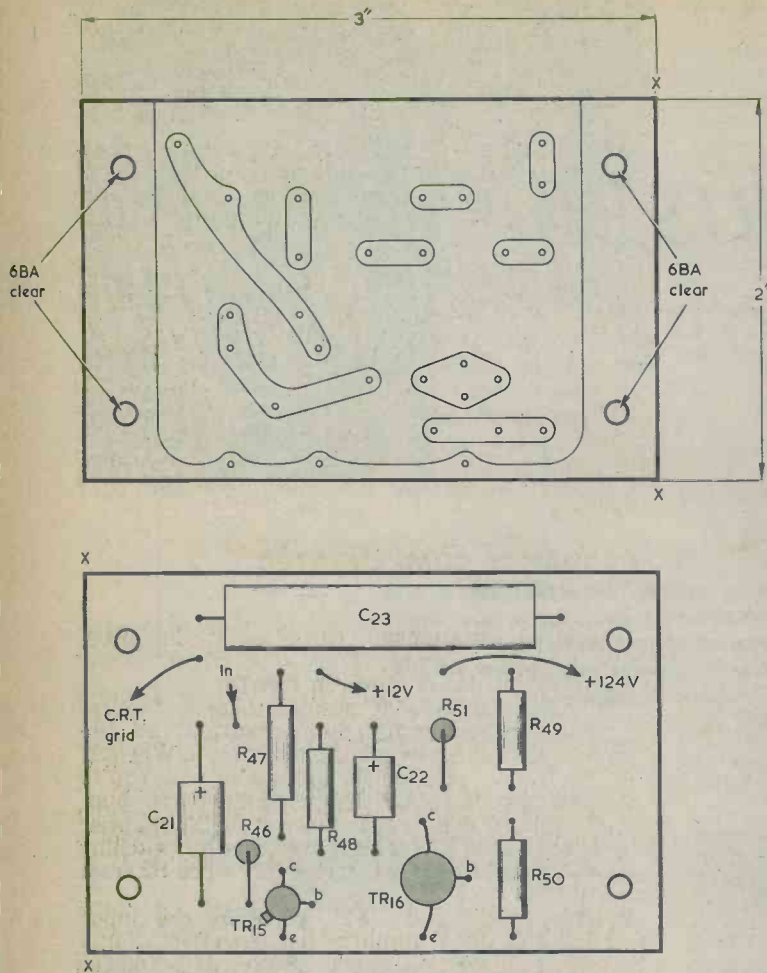

Fig. 15. The flyback blanking amplifier applies a large negative-going pulse to the c.r.t. grid

base of TR15 has been checked but this slightly reduced the effectiveness of the flyback blanking; since the circuit functions satisfactorily in practice without the resistor it has not been incorporated.

The flyback blanking circuit is constructed on a printed circuit board which measures 3 by 2in. The etching details of this board are reproduced full size in





**Fig. 16.** The printed circuit board assembly for the flyback blanking amplifier is relatively simple to make up



The flyback blanking amplifier board is fitted to the rear panel of the case, above the 12 volt supply board

Fig. 16, which also shows the component layout.

The completed printed circuit board is mounted on the inside of the rear panel of the case, just above the 12 volt supply board. It can be clearly seen in the accompanying photograph of the prototype oscilloscope.

### ASTIGMATISM ADJUSTMENT

The correct setting for the astigmatism control, VR8, is found by trial and error. Couple a sinewave signal to the a.c. Y input, then adjust the timebase controls and the X and Y gain controls to obtain a trace of several cycles which fills the screen.

Next try various settings of the astigmatism control, readjusting the focus control for each new setting. The final setting of the astigmatism control is that which gives the best defined trace at all areas of the screen.

### C8 AND C10

The values quoted for the frequency compensating capacitors, C8 in the X amplifier and C10 in the Y amplifier, are those which were found to give op-

timum results in the prototype oscilloscope. While these values should give adequate results with other units, ideally the values should be selected to suit the individual oscilloscope.

To find the correct value for C8, switch the timebase to about its highest frequency and connect a signal generator to the Y input to obtain a waveform on the screen. If C8 has near enough the correct value there should be no trace of the flyback signal, and the sweep trace should be as bright at the left hand side of the screen as it is at the right hand side. If the flyback signal leaves a trace towards the left hand side of the screen, then C8 must be increased in value. If the trace of the waveform decreases in brightness towards the left hand side of the screen, then the value of C8 is a little too high. The correct value is found by trial and error, and is one which eliminates the flyback trace but does not affect the trace of the waveform.

In order to find the correct value for C10 it is necessary to inject an audio square wave, say at a frequency of about 400 to 1,000Hz, into the Y input with S2 in the "XI,000" position. This should give a

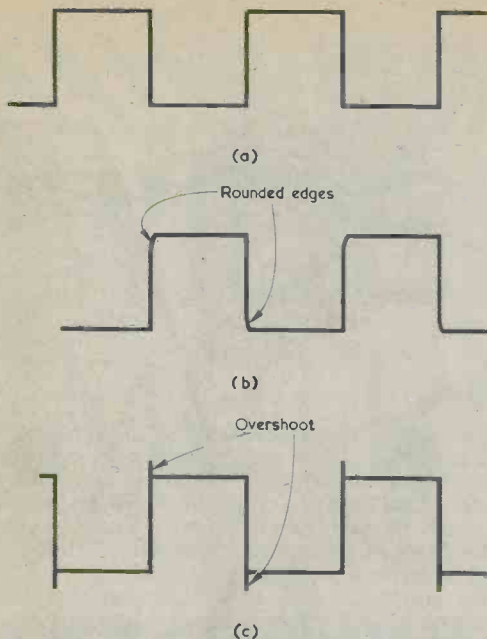

**Fig. 17(a).** The Y amplifier frequency response may be checked by applying a square wave to the input  
**(b).** Poor high frequency response will result in rounding of the leading edges of the waveform  
**(c).** Excessive high frequency response will produce overshoot

trace which is similar to that shown in Fig. 17(a). However, if C10 has too low a value a trace with rounded leading edges, like that shown in Fig. 17(b), will be obtained. It will then be necessary to try a slightly higher value for C10.

If, on the other hand, C10 is too high in value the trace will look more like Fig. 17(c), with overshoot lines being produced on the leading edges of the waveform. A lower value for C10 must then be tried, the correct value being found empirically.

### TIMEBASE CALIBRATION

It is a useful feature to have a scale around the control knob of the timebase fine frequency control which is calibrated in terms of timebase frequency. If a calibrated signal generator is available it can be set to a frequency of 50Hz and connected to the Y input. Set the timebase range switch to position 2 (50 to 700Hz) and adjust VR5 towards the low frequency end of its range.

Switch off the sync at S4 and adjust VR5 to give one complete cycle on the screen. With a single cycle on the screen the timebase and signal generator are running at the same frequency. The scale of VR5 is marked "5" at this point. By using the same process at other signal generator frequencies up to 700Hz (at which point the scale is marked "70") a complete scale can be marked around the knob of VR5.

If an accurately calibrated signal generator is not available the 50Hz mains can be used as a frequency standard. Set the Y attenuator and fine gain controls for maximum sensitivity, and connect a short lead,

say about 12 to 18in. long, to one of the Y inputs. With the timebase switch set to position 2, the sync turned off and VR5 adjusted towards the minimum frequency end of the range, it should be possible to obtain a display of a single cycle. The timebase is then running at 50Hz, the Y input consisting of random pick-up from the local mains wiring.

VR5 should now be advanced until a stable trace is obtained consisting of two lines. Each of these is one half cycle and the timebase frequency is then 100Hz (2 x 50Hz): If VR5 is further advanced until a stable trace is again obtained there will be three lines displayed on the screen, each being one third of a cycle long. This indicates a timebase frequency of 150Hz (3 x 50Hz). This procedure can be repeated with four and five lines, and so on, to identify timebase frequencies of 200Hz, 250Hz, and further multiples of 50Hz.

It is possible to use the oscilloscope for approximate frequency measurement by employing this procedure in reverse. If, for instance, the timebase frequency is 600Hz and there are five complete cycles displayed on the screen, then the input frequency is 600 times 5, or 3,000Hz.

### FREQUENCY COMPENSATED ATTENUATOR

If required, the attenuator can be modified to incorporate frequency compensation. The circuit of the modified attenuator is shown in Fig. 18.

With S2 in the "X1,000" position there is of course no need for frequency compensation, as the attenuator is in effect switched out of circuit. When S2 is in the "X100" position the attenuator will tend to reduce the upper frequency response due to the shunting effect of the input capacitance of the Y amplifier on resistors R21 to R24. This is overcome by switching a low value capacitor, C24, across R20 when S2 is set to "X100."

In the "X10" and "X1" positions the input capacitance of the Y amplifier has less effect as it is shunting a lower resistance. Stray capacitances around R20 and R21 then have the most pronounced effect, causing an increase in the frequency response at high frequencies. TC1 is used to shunt R22, R23 and R24, and so counteract these stray capacitances.

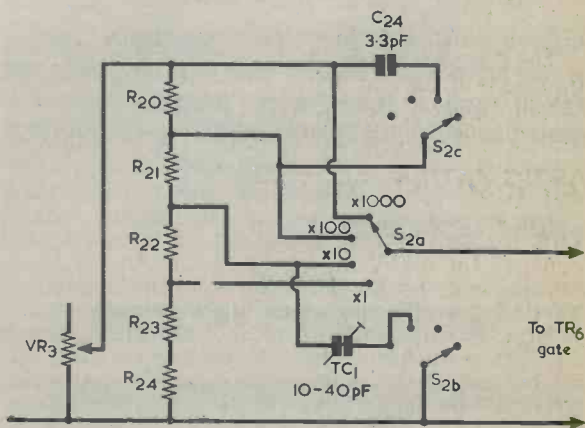

**Fig. 18.** Modifying the Y input attenuator to give frequency compensation

Fig. 19. The modified wiring at the attenuator switch

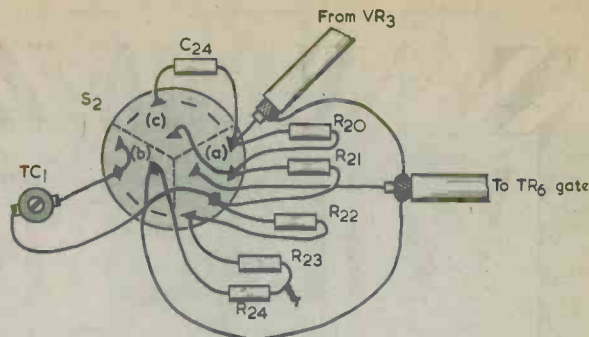

### SENSITIVITY

The additional two components are mounted on S2, and the wiring of the modified attenuator assembly is shown in Fig. 19. For ease of presentation the components and wiring in Fig. 19 are shown spread out, but in practice all wiring here must be kept short.

Note that the value of C24 might need to be altered to suit individual oscilloscopes. If necessary, the correct value can be found by trial and error using the same procedure as was employed to find the value of C10 in the Y amplifier. The correct capacitance for TC1 is found in the same way.

The two additional capacitors are not included in the Components List which accompanied Part 1 of this series.

It is of course necessary to know the sensitivity of the Y amplifier if the oscilloscope is to be used to measure signal amplitudes. A suitable a.c. calibrator is not described here as a number of designs have been published in the recent past. These include "Oscilloscope Calibration Generator" by P. R. Arthur, which was published in the March 1975 issue of this journal, and "Oscilloscope Amplitude Calibrator" by A. Foord which appeared in the December 1974 issue.

Since the oscilloscope is d.c. coupled it is not even essential to use an a.c. calibrator, as a d.c. voltage of known value can be employed instead.

(Concluded)

## IN NEXT MONTH'S ISSUE

# WEIN BRIDGE AUDIO SIGNAL GENERATOR

Offering a continuously variable range from 7.5Hz to 75KHz, this mains powered audio signal generator employs an ingenious method of automatic gain control for its op-amp sine wave oscillator. A second op-amp provides an alternative square wave output.

**PLUS  
MANY OTHER ARTICLES**

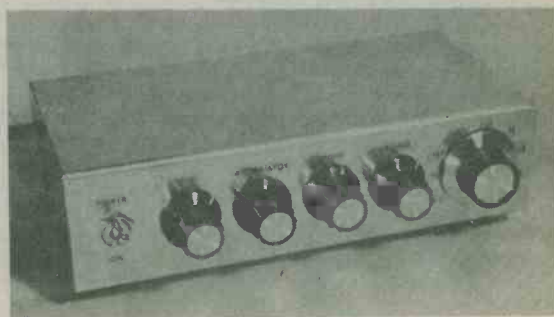

**PRICE 30p**

**RADIO & ELECTRONICS  
CONSTRUCTOR**

**ON SALE 1st DECEMBER**

RADIO & ELECTRONICS CONSTRUCTOR

# WIDE RANGE METRONOME

By M. G. Robertson

This simple design, which incorporates a 555 timer i.c., produces audible tone bursts of controllable length over a wide range of frequencies.

Electronic metronomes have been described in the past in the home constructor electronic press, but these have almost invariably produced audible outputs in the form of regularly spaced "clicks". A typical instance is given when the "clicks" are discharge pulses from a unijunction transistor oscillator. The audible energy in such pulses is low, even when some form of amplification is provided to increase their current amplitude.

The present design employs an alternative approach, and it produces short bursts of an audio tone instead of single d.c. pulses. These bursts have a much higher energy level and can be more readily heard against ambient noise levels. At its lowest frequency the prototype circuit produced 1 burst every 8 seconds, whilst its highest frequency was well in excess of 3 bursts per second. The length of each burst is controllable.

## 555 TIMER

The circuit of the metronome can be seen in the accompanying diagram. This employs an NE555V timer i.c., or equivalent, in conjunction with a simple multivibrator incorporating TR1 and TR2. The multivibrator is turned on periodically by the NE555V, and it then oscillates at approximately 400Hz.

The NE555V operates in a standard astable circuit, with its pin 2 (trigger) and pin 6 (threshold) connected

together. Under these conditions, capacitor C1 charges via VR1, R1, VR2 and R2 until the voltage across it reaches two-thirds of the supply potential. The internal circuitry of the i.c. then changes state, and pin 7 falls to very nearly the same potential as the negative rail. C1 next discharges via VR2 and R2 until the voltage across it is one-third of the supply potential. At this voltage, the internal circuitry of the i.c. reverts to its previous state, and the capacitor commences to charge once more. Since the capacitor discharge path is by way of VR2 and R2 only, whereas the charge path is by way of VR1 and R1 as well as VR2 and R2 the discharge period is shorter than the charge period. In the present design the multivibrator is turned on during the discharge period.

The output of the NE555V at pin 3 goes low (i.e. negative) during the discharge period and is high during the charge period. Thus, during the charge period the lower ends of R3, R4 and R5 in the multivibrator are at a potential which is very close to the positive rail and the multivibrator cannot operate. During the discharge period the lower ends of these resistors are taken nearly to the negative rail, whereupon the multivibrator is able to oscillate in normal fashion.

The collector of TR2 is coupled via C4 and R7 to the primary of output transformer T1, the secondary of

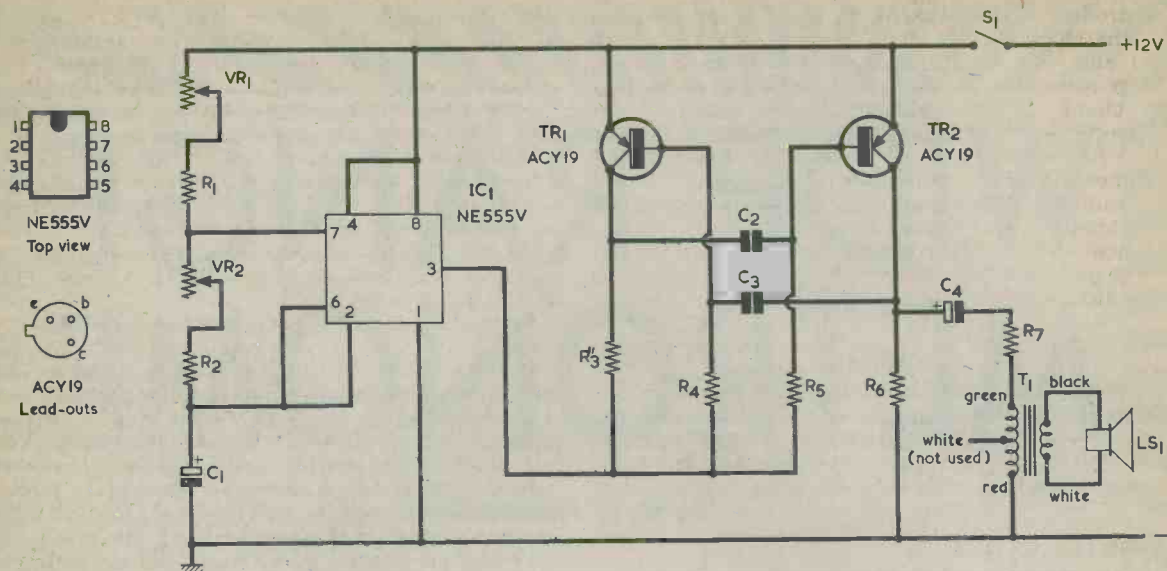

The circuit of the wide range metronome. The multivibrator is turned on and off successively by the NE555V timer

which connects to the loudspeaker. In consequence, the loudspeaker reproduces the multivibrator tone during the discharge period for C1, and the bursts of tone from the loudspeaker constitute the metronome output. Capacitor C4 in the primary circuit of T1 is a d.c. blocking component. R7 is included to prevent the inductance in T1 primary from upsetting multivibrator operation. Without R7 the multivibrator frequency tends to vary and is not fully controlled by the multivibrator timing components.

TR1 and TR2 are germanium rather than silicon transistors. This is because silicon transistors have low reverse base-emitter voltage ratings which would be exceeded during multivibrator operation. The transistors specified for TR1 and TR2 have a maximum reverse base-emitter voltage rating of 12 volts, which just satisfies present circuit requirements.

### TIMING PERIODS

The length of the timing periods can be calculated with the aid of several simple equations. It is helpful first to find the discharge period, this being approximately equal, in seconds, to 0.7 times the product of the capacitance (C1) and the resistance in the discharge path (VR2 and R2). When VR2 is set to insert minimum resistance the discharge path is given by R2 on its own, at 2.2k  $\Omega$ . The corresponding time is about 15.5 milliseconds. With VR2 set to insert maximum resistance the discharge resistance is 12.2k  $\Omega$  and the discharge time then calculates as 85 milliseconds. In consequence, the tone burst produced during the discharge of C1 can be varied, by means of VR2, from 14.5 to 85 milliseconds.

## COMPONENTS

### Resistors

(All fixed values  $\frac{1}{4}$  watt 10%)

- R1 10k  $\Omega$
- R2 2.2k  $\Omega$
- R3 2.7k  $\Omega$
- R4 22k  $\Omega$
- R5 22k  $\Omega$
- R6 2.7k  $\Omega$
- R7 470  $\Omega$
- VR1 1M  $\Omega$  potentiometer, log
- VR2 10k  $\Omega$  potentiometer, linear

### Capacitors

- C1 10 $\mu$ F electrolytic, 12 V. Wkg.
- C2 0.1 $\mu$ F plastic foil
- C3 0.1 $\mu$ F plastic foil
- C4 4 $\mu$ F electrolytic, 12 V. Wkg.

### Transformer

- T1 Output transformer type LT700 (Eagle)

### Semiconductors

- IC1 NE555V, or equivalent
- TR1 ACY19
- TR2 ACY19

### Speaker

- LS1 3 $\Omega$  moving coil

### Switch

- S1 s.p.s.t. toggle

The charge time is approximately equal to 0.7 times the product of the capacitance and the resistance in the charge path (VR1, R1, VR2 and R2). With both VR1 and VR2 set to minimum resistance the total charge resistance is given by R1 and R2 in series, and the charge period calculates, once more, at 85 milliseconds. If VR2 is set to maximum resistance and VR1 to minimum resistance, the charge period becomes 155 milliseconds. When VR1 and VR2 insert maximum resistance into circuit the charge period is a little higher than 7 seconds.

Since none of the resistors in the discharge and charge paths is a close tolerance component, and since in particular C1 will have a wide tolerance on value, practical versions of the circuit can be expected to offer discharge and charge periods which vary quite considerably from the calculated values. As already mentioned, the lowest frequency obtained with the prototype was 1 tone burst every 8 seconds, whilst the highest frequency was well in excess of 3 bursts per second. Results with the prototype agreed, in consequence, quite well with the calculated figures.

### CONSTRUCTION

There are few constructional problems as the circuit is very simple and layout is not at all critical. VR1, VR2 and the on-off switch are mounted on the front panel of the unit, as also may be the loudspeaker. VR1 is specified as a log component, since a log track enables adjustment at the higher

frequency end to be "opened out" as the potentiometer spindle is rotated. The potentiometer is wired up such that the resistance it inserts into circuit increases as its spindle is turned clockwise. This causes frequency to decrease with clockwise rotation. VR2 is wired up in a similar manner, to ensure that both controls operate in the same sense.

With regard to the other components, C1 should be a good quality modern electrolytic capacitor. No connection is made to pin 5 of the NE555V. The batteries can be any combination which makes up the 12 volts required. Current consumption is reasonably low, being 5.5 to 6mA between bursts, rising to about 10mA when a burst is produced.

After the unit has been completed, a little experience will soon provide familiarity with the controls. VR2 varies the length of each burst while VR1 controls the time between bursts. At frequencies close to the high end of the range the controls become interdependent, and it will be found that adjusting VR2 for a shorter pulse will also reduce the period between pulses. This is not a disadvantage and it merely necessitates first setting up VR2 for the desired burst length and then adjusting VR1 for frequency. If, however, it is desired to calibrate VR1 accurately in terms of frequency it would be better to make VR2 a pre-set potentiometer which is mounted inside the unit. It may be set up for any burst length favoured by the constructor and then left alone. After this, VR1 can be calibrated by checking burst frequency against a watch fitted with a second sweep hand. ■

---

# ELECTRONIC ODDITIES

An off-beat glance at the electronic scene.

by R. River

When capacitors have a holiday do they go to the C-side Faraday?

In 1875 Alexander Graham Bell invented the telephone; this was a failure until 1876 when he invented the other telephone.

Barkhausen is German for dog-kennel.

Guide to metrication:

10 hertz = 5 bicycles per second

10 millipedes = 1 centipede

10 decimals = 1 mal

10<sup>12</sup> pins = 1 terrapin

Millicent = Hector

Centigram = unit for weighing rose petals.

Transistors? They're as easy as EBC.

Dud f.e.t.'s — money down the drain.

What sort of mathematics do trees do?  
Logs and twig.

A meter takes a sample  
And shows if the current is ample.  
It also shows up faults  
By measuring the volts.

Why does an American tube have a plate?  
For the 'eather!

Use of stone — Stone Age.  
Use of iron — Iron Age.  
Use of electricity — Volt Age.

Soot all over the bench! It came out of the sweep generator.

Cat's whiskers — are they made of mumetal?

Guide to technical terms:  
Portable — it has a handle on it  
Hi-Fi/Stereo — it has 2 loudspeakers.

I don't like your explanation about how transistors work. It's full of holes.

Cheap alternative to the videocassette recorder — wait 3 months then turn the set on again.

# SHORT WAVE NEWS

## FOR DX LISTENERS



Times = GMT

Frequencies = kHz

By Frank A. Baldwin

It is at this time of the year that many Dxers set their receiver dials on the appropriate frequencies, at the times most likely to produce results, in the quest for Dx from the East and Far East. The reception and identification of some of these signals probably represents the greatest challenge of all to the short wave Dxer. As an aid to the comparative newcomer, some of these transmission times and frequencies are mentioned here.

As an introduction to Far East listening, Radio Singapore will probably prove to be the easiest to receive. Listen on **5010** or **5052** around 1530 or from 2230. Then there is Kuching, Sarawak on **4950** with schedule is from 2230 to 1630.

Malaysia would be next and a watch should be kept on **4985** at 1530 for the time-check and newscast in English from Penang. The afternoon transmission closes at 1630 and the late night session commences at 2230. Then there is Kuching, Sarawak on **4950** which programmes in both English and Chinese and is scheduled on the air from 2200 to 0100 and from 0800 to 1600; listen therefore from around 1530 and from 2200 onwards.

Signals from Kathmandu, Nepal, will certainly interest the Dxer. Although located nearer to the UK than the above mentioned transmitters, reception of signals from Nepal will provide a sense of satisfaction to the newcomer. Listen from around 1530 and from 0020 for programmes in the Home Service scheduled from 0020 to 0350 and from 1150 to 1720, also in parallel on **3425**.

Next month, more transmissions from the East and Far East will be brought to the attention of readers interested in broadcast band Dx.

### CURRENT SCHEDULES

#### ● LEBANON

"The Overseas Service of Radio Lebanon", Beirut, broadcasts to Europe and Africa in English from 1830 to 1900 on **11795**. The English transmission directed to North and Central America is from 0230 to 0300 on **9675**.

#### ● VATICAN CITY

"Vatican Radio" presents a service in English to the U.K. from 1450 to 1505 on **7160**, **9625** and on **11825**; from 2030 to 2045 on **6190**, **7250** and on **9645**.

#### ● SAUDI ARABIA

The "Broadcasting Service of the Kingdom of

Saudi Arabia", Riyadh, operates a Home Service entirely in Arabic from 0300 to 2300 as follows — from 0300 to 2300 on **6000**, **7220**, **9720** and on **11950**; from 1600 to 2300 on **6130**; **1545** to 2300 on **7110**; from 0500 to 0830 on **7285**; from 0830 to 1600 on **9605**; from 1900 to 2300 on **9730**; from 0500 to 0800 on **9770**; from 1530 to 1900 on **11780**; from 0500 to 1545 on **11890**; from 0800 to 1530 on **15205** and from 0500 to 1530 on **15275**.

#### ● SUDAN

"Radio Omdurman" has a Home Service in Arabic from 0400 to 2200 on **7200**, **9508** and on **11835**, this programme also being on **4994** and **6150** except for the period 1300 to 1500 when these two channels carry the Southern Provinces programme in Arabic, English and vernaculars.

#### ● FRANCE

"Radio France", Paris, radiates a "France Inter" service, in French, from 1800 to 2100 on **3965** and from 0700 to 2100 on **6175**.

#### ● ISRAEL

The evening programme in English directed to Western Europe is on the air from 2000 to 2055 on **7395**, **9815** and **11642**. Lower powered transmitters will be on **9495** and **12025**, the programme also being beamed to Africa on **9009**.

Other programmes in English are from 0500 to 0515 to Western Europe on **5900**, **7395** and **9009**; from 1200 to 1230 to Western Europe on **12025** and **15100**. Additional frequencies (low powered) for the 0500 transmission will be **11642**, **12025** and **15405**, those for the 1200 transmission being **15405**, **17685** and **17815**.

#### ● YEMEN ARAB REPUBLIC

"Radio San'a" may be heard by listening to the Domestic Service, in Arabic, from 0300 to 0700, from 1100 to 2015 on **5805** and **7300**; from 2015 to 2200 on **7300** only.

#### ● NORTH KOREA

"Radio Pyongyang" directs an External Service transmission to Europe in English from 2000 to 2200 on **3890**, **6565** and **9420**. The Domestic Service in Korean is on **2850** from 2000 to 1800; **3015** from

1500 to 1800; **4270** from 1100 to 1800; **6290** from 2000 to 0830; **6600** from 2000 to 0830 and from 1500 to 1800 and on **11350** from 2000 to 1050.

#### ● SOUTH KOREA

"Radio Korea", Seoul, has an English and General Service directed to Europe from 0630 to 0700 and from 1900 to 1930 on **9640** and **15335**.

#### ● PHILIPPINES

From Manila, broadcasts in English directed to Asia are made from 1000 to 1200 and from 2200 to 2400 on **6170**.

#### ● INDIA

AIR Delhi on **3905** at 1929, closing announcements by YL in Arabic, off at 1930 without National Anthem. This is the Foreign Service which operates from 1445 to 1545 in Pushtu, from 1615 to 1715 in Farsi (Persian), from 1730 to 1930 in Arabic and from 2245 to 0115 in English. The Home Service on this channel operates from 0130 to 0335 and from 1130 to 1445.

#### ● MALTA

Radio Mediteranee on **9755** at 2053 with identification "Malta Calling", followed by pop records, local news, tourist and export news items.

#### ● AUSTRALIA

ABC Brisbane on **4920** at 1910, programme of pop records with announcements in English. Schedule of this one is from 1900 (Sundays 1930) to 1402 and the power is 10kW.

#### ● INDONESIA

Jakarta on a measured **4804.5** at 2200, OM with newscast in Malindo. RRI (Radio Republik Indonesia) Jakarta, listed on **4805**, radiates the "Programme Nasional" from 2200 to 0100 and from 1000 to 1600, power is 20kW.

#### ● MALAYSIA

Kuala Lumpur on **4845** at 2205, Indian-type music, YL and OM in duet. This is the Radio Malaysia Tamil Service which operates Monday to Friday from 2130 to 0130 and from 0545 to 1530; Saturdays from 2130 to 0330 and from 0545 to 1530 and on Sundays from 2130 to 1530, power is 50kW.

#### ● CHINA

Radio Peking on **3450** at 2119, military music, announcements by OM in Standard Chinese. This is the Home Service 1 having a schedule from 2000 to 2200, also in parallel on **4905**.

Radio Peking on **4250** at 2125, Chinese music, YL with song in Standard Chinese in the Home Service 2 programme. Schedule is from 2100 to 2240 and from 1330 to 1600.

Radio Peking on **6225** at 2035, local music, songs by YL chorus. This is the Home Service 1 having a schedule from 2000 to 0100 and from 1100 to 1735. These transmissions are also carried in parallel on **4800**, **5860**, **5880**, **6750** and on **7095**.

PLA (People's Liberation Army) Fukien on **3400** at 2126, YL with talk, military music. This transmitter operates a service to the offshore islands, the schedule being from 2005 to 0155 and from 1000 to 2000.

#### ● HONDURAS

Voz Evangelica, Tegucigalpa, on **4820** at 0339, light music and songs, OM with announcements in English. Schedule of Voz Evangelica is from 1000 to 0430 the English programmes being from 1500 to 1600 and from 0300 to 0430.

#### ● DOMINICAN REPUBLIC

Radio Norte, Santiago, on a measured **4807.5**, Latin American music, OM with local pops. This transmitter commenced operations last year and is listed as having a 24 hour schedule on a nominal **4805** but is sometimes reported closing at 0400!

#### ● ECUADOR

Sistema de Em. Atalaya, Guayaquil, on **4790** at 0349, OM with sports commentary then into a discussion with a YL, several mentions of Guayaquil. Schedule is from 1100 to 1330 and from 0100 to 0500 and the power is 10kW but beware, this one (like that above) exhibits those charming traits often displayed by Latin American stations, wandering (from **4790** to **4795**) and closing anytime (between 0405 and 0615).

Radio Nacional Espejo, Quito, on a measured **4670** at 0404, Latin American music, songs in Spanish, OM announcer. With a 24 hour schedule, this one can wander and is often reported operating on **4678** or **4679**.

Emisora Gran Colombia, Quito, on **4910** at 0410, light music programme, songs in Spanish. Schedule is from 1100 to 1500 and from 2200 to 0500 and the power is 5kW but — here we go again — the frequency is known to vary from that quoted to **4912** and has been reported operating as late as 0540.

#### ● COLOMBIA

Radio Surcolombiana, Neiva, on **5010** at 0423, OM with sports commentary in Spanish. This one has a 24 hour schedule and the power is 2.5kW.

#### ● PERU

Radio Andina, Huancayo, on **4996** at 0420, guitar music, OM with frequent local announcements. This one is easy to identify, the announcements are obviously made in an empty room, the echo-effect is not electronic! The nominal frequency of this one is **4995** and the schedule is from 1100 to 0600 but it has been reported when closing at 0545 and as late as 0900.

#### ● BRAZIL

Radio Brasil Central, Goiania, on **4985** at 0415, OM with announcements, local music, several mentions of Brazil. Schedule is from 0800 to 0500 and the power is 5kW. Formerly on **4995**, this transmitter, like most Brazilians on the Tropical Bands changed channel on May 1st in a major revision of frequency allocations.

#### ● ZAIRE

Kinshasha on **4880** at 1848, OM in vernacular, local orchestra with local pops. Kinshasha has a 24-hour schedule and the power is 10kW.

#### ● MALAWI

Blantyre on **3380** at 2035, Euro-style pop music records, announcements in English. The evening schedule is from 1700 to 2210 and the power is 100kW.



# New Products

## NiCd CHARGER RANGE

A new, bigger range of Nickel Cadmium modular chargers is available ex-stock from Electroplan, the Royston based distributor of electronic instruments and accessories.

Manufactured by Crowborough Electronics, the new charger units provide true constant current operation and are intended for recharging NiCd cells. Output currents range from 10mA to 400mA and up to 10 cells may be charged simultaneously in series. Each charger incorporates a neon "power-on" indicator and the higher current modules are fused.

Two case sizes are available depending on power output, each with a dual tap mains transformer enabling 240V or 110V operation. Mounting is by two 4BA tapped holes.

Prices range from £9.00 + VAT for a 10mA 1-10 cell

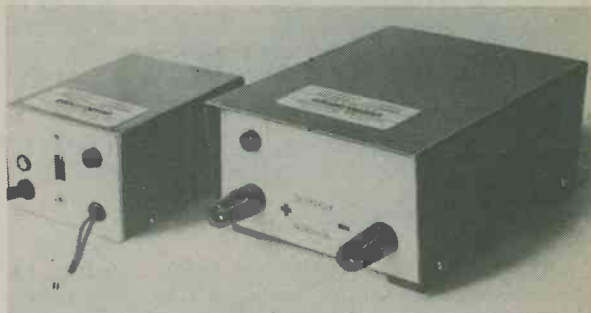

charger up to £12.25 + VAT for the 400mA 7-10 cell charger.

Further details from:— Electroplan Limited, P.O. Box 19, Orchard Road, Royston, Herts. SG8 5HH.

## TRANSISTOR TESTER

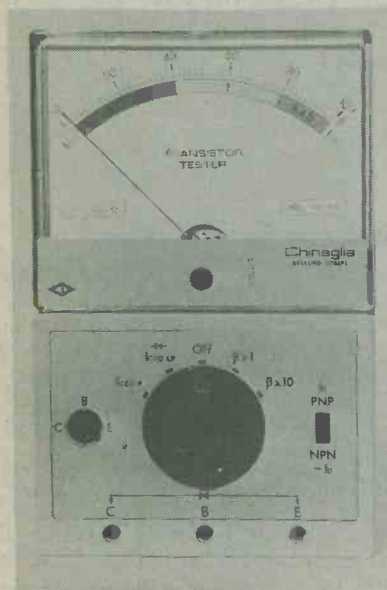

This simple-to-use special purpose instrument has been added to the Chinaglia range of professional equipment specifically to meet the need for fast device testing, both in and out of circuit.

Not only will the new instrument cope with the normal n.p.n./p.n.p. germanium/silicon variations, but it can deal with both low signal and power devices in addition to carrying-out in-circuit tests at reduced accuracy.

Constructed to the usual high Chinaglia standard, the transistor tester has a tough ABS plastic case and an easy-to-read scaling which both indicates device state in a "Good" — ? — "Bad" colour indication and shows leakage and B to ample accuracy. The basic movement is a class 1.5, 1mA, 50Ω unit with core magnet and sprung bearing jewels.

Range switching is simple, with a slide switch for p.n.p./n.p.n. selection and a rotary switch for other functions. A small signal device socket is mounted on the instrument face in conjunction with sockets for test leads supplied for connection to external circuits and devices.

Power is supplied by internal batteries.

Price, complete of carrying case and leads, £25.70 VAT incl.

For further information please contact Chinaglia (U.K.) Ltd, 19 Mulberry Walk, SW3 6DZ.

# CATALOGUE

Doram Electronics Limited have now issued Edition 2 of their component catalogue. Priced at 60p (including postage), this supersedes the first Doram catalogue. It has 100 pages and includes a new 16-page data section giving design information on components, both active and passive, as well as describing a 10 watt stereo tuner-amplifier incorporating the Mullard LP1186, LP1185, LP1400, LP1184/2 and LP1173 modules. Also included for the purchase price of the catalogue is a free up-date product and price information service.

Of particular interest to radio and hi-fi enthusiasts will be the inclusion of a new turntable kit and record deck, a full range of quality blank cassettes, magnetic cartridges, speakers and speaker cabinets, microphones, earphones, quartz crystals, variable capacitors, radio and audio modules, and a full range of pick-up styli.

The new Doram catalogue is available by return of post from Doram Electronics Ltd., P.O. Box TR8, Wellington Road Industrial Estate, Wellington Bridge, Leeds LS12 2UF.

# THE SN76023N POWER AMPLIFIER

By P. R. Arthur

The Texas Instruments SN76023N is an integrated circuit a.f. power amplifier which is particularly useful for home constructor applications. This article describes a basic amplifier incorporating the i.c. and shows how it may be employed as a replacement for the Sinclair Super IC-12 in earlier designs.

Despite the availability of specialist integrated circuits for virtually every purpose these days, it is still probably true to say that audio i.c.'s hold the greatest interest for the amateur electronics enthusiast. One of the most versatile of the audio i.c.'s currently available is the Texas Instruments SN76023N. This is typically capable of an output power of 5 watts r.m.s. into an  $8\ \Omega$  load when using a 24 volt supply. It will work satisfactorily with supply voltages as low as 8 volts, although with reduced maximum output power and performance. Higher impedance loads can also be used if less power is required, but loads lower than  $8\ \Omega$  must not be employed. The maximum permissible supply voltage is 28 volts.

The SN76023N contains an integral pre-amplifier which enables a high input impedance and sensitivity to be obtained if required. Noise and distortion are both low, with distortion being typically less than 1% provided the output power does not exceed a certain level for a given load impedance and supply voltage. For an  $8\ \Omega$  load this is 3.3 watts at 20 volts rising to more than 6 watts at 28 volts. The noise level is approximately -70dB.

The device is contained in a standard 16 pin d.i.l. package, except that the two centre pins of each row are missing and are replaced by heat tabs. The SN76023N has these coupled to an extruded aluminium heat sink. There is another version, the SN76023ND, which has the heat tabs only. These tabs are intended to be soldered to an area of the copper on the printed circuit board, which then acts as a heat sink. The minimum load impedance for the SN76023ND is  $15\ \Omega$ , and minimum output power into this impedance at 24 volts supply is 3 watts.

## SIMPLE AMPLIFIER

Fig. 1 shows the circuit diagram of a simple a.f. amplifier incorporating the SN76023N. This was primarily designed as a replacement amplifier for the Sinclair Super IC-12 units employed in the "Four Channel Synthesiser" and "Mains Table Radio" articles which appeared respectively in the April and May 1975 issues of this journal. The IC-12 has now been discontinued.

The SN76023N is very nearly a direct equivalent to the IC-12, but it does not have quite such a stringent specification, and it is not supplied with a matching printed circuit board. It is similar to operational amplifiers in many ways and has both an inverting input (pin 16) and a non-inverting input (pin 1). It is intended for single supply operation, however, and has a Class AB power output stage.

Feedback from the output to the inverting input is provided via R5. At d.c. R5 provides virtually 100% negative feedback over the amplifier, and this helps to give a stable biasing system. In order to provide a useful voltage gain at a.f. some of the feedback must be decoupled; this is carried out by C4, with R4 limiting its effect so that quite a large level of feedback remains. This, of course, has the benefits of reducing noise and distortion.

The values given to R4 and R5 determine the closed loop voltage gain of the amplifier, and the voltage gain is approximately equal to  $(R4 + R5)$  divided by R4. The gain of the circuit can thus be altered by altering the values of these resistors. With R4 maintained at  $100\ \Omega$ , it is probably best, in the interests of good stability, to keep R5 within the range of  $10k\ \Omega$  to

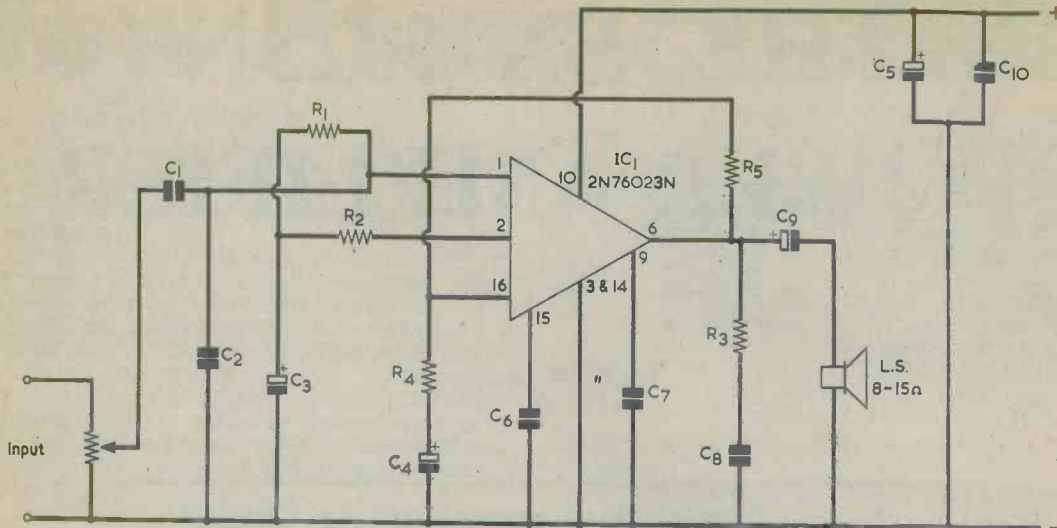

Fig. 1. The circuit of a simple amplifier incorporating the SN76023N

100k  $\Omega$ , which gives a range of approximate voltage gains of 100 to 1,000 times (40 to 60dB).

Biasing for the non-inverting input of the i.c. is provided by R1 and R2 from an internal potential divider circuit in the device. C3 removes any mains hum or other noise which may be present on the supply lines, and ensures that this does not find its way to the non-inverting input where it would be amplified

and fed to the speaker. R1 determines the input impedance of the circuit, and the input impedance can be regarded as being approximately equal to the value of this resistor. R1 can have any value up to 1M  $\Omega$ . The input signal is coupled to pin 1 via C1, which provides d.c. blocking.

C6 and C7 are required to prevent instability. R3 and C8 compensate for the fact that the speaker impedance rises with frequency. C2 reduces the input impedance at high frequencies and so also helps to give good stability. With low values of R1, say up to 10k  $\Omega$ , this capacitor will probably be unnecessary. C9 couples the signal from the output of the i.c. to the speaker, and provides d.c. blocking. C5 and C10 are

## COMPONENTS

### Resistors

(All  $\frac{1}{4}$  watt 10%)

R1 100k  $\Omega$  (see text)

R2 100k  $\Omega$

R3 18  $\Omega$

R4 100  $\Omega$

R5 22k  $\Omega$  (see text)

### Capacitors

C1 0.1  $\mu$ F, type C280 (Mullard — see text)

C2 270pF ceramic plate

C3 4  $\mu$ F electrolytic, 16 V. Wkg.

C4 100  $\mu$ F electrolytic, 16 V. Wkg.

C5 100  $\mu$ F electrolytic, 30 V. Wkg.

C6 1,500pF disc ceramic, or paper or plastic foil.

C7 1,000pF disc ceramic

C8 0.01  $\mu$ F disc ceramic, or type C280 (Mullard)

C9 500-1,000  $\mu$ F electrolytic, 16 V. Wkg.

C10 0.068  $\mu$ F, type C280 (Mullard)

### Integrated Circuit

IC1 SN76023N (or SN76023ND)

### Miscellaneous

8-15  $\Omega$  speaker (see text)

0.1in. Veroboard

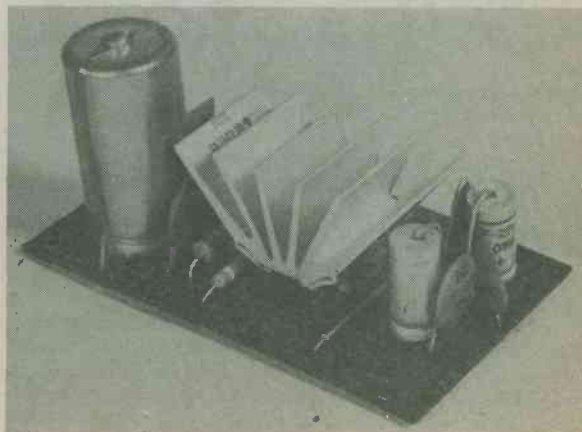

An amplifier assembled to the layout of Fig. 2

bypass capacitors, and it is important that C10 be connected physically close to the i.c. Otherwise, high frequency instability may result, particularly if long supply leads are employed.

The component values given in the Components List are suitable if the amplifier is used in the Synthesiser circuit. If the amplifier is employed in the Mains Table Radio circuit, R1 should be 27k  $\Omega$  and R5 47k  $\Omega$ . C1 is 0.22  $\mu$ F in the Mains Table Radio version. In the Mains Table Radio circuit the amplifier follows a ZN414, whereupon the r.m.s. input signal voltage is of the order of 30mV.

The amplifier of Fig. 1 can, of course, be used for applications other than in these two circuits, bearing in mind the notes just given concerning the values of R5 and R1. No value is given for the input volume control shown in Fig. 1. The value is not critical and, in general, it should be lower than R1.

The output capacitor, C9, is specified in the Components List as 500-1,000 $\mu$ f. Any value in this range will be satisfactory, although a slightly improved bass response will be given by a capacitor at or near 1,000 $\mu$ F. The speaker employed should be capable of handling the output power given by the i.c.

## CONSTRUCTION

A suitable layout for the amplifier on Veroboard of 0.1in. matrix is shown in Fig. 2. The Veroboard should be cut out to the correct size and the copper strips cut at the points indicated. Two 6BA clear holes for mounting purposes are also drilled out.

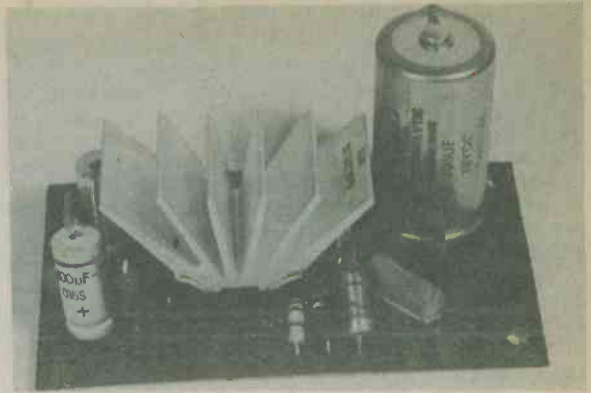

The amplifier board seen from the other side

If the version of the i.c. having the integral heat sink is employed, then it is probably best to mount the i.c. first and then fit the other components around it. Mount those closer to the i.c. before fitting those that are situated further away.

When using the version of the i.c. that so does not have the heat sink, it is best to leave the mounting of

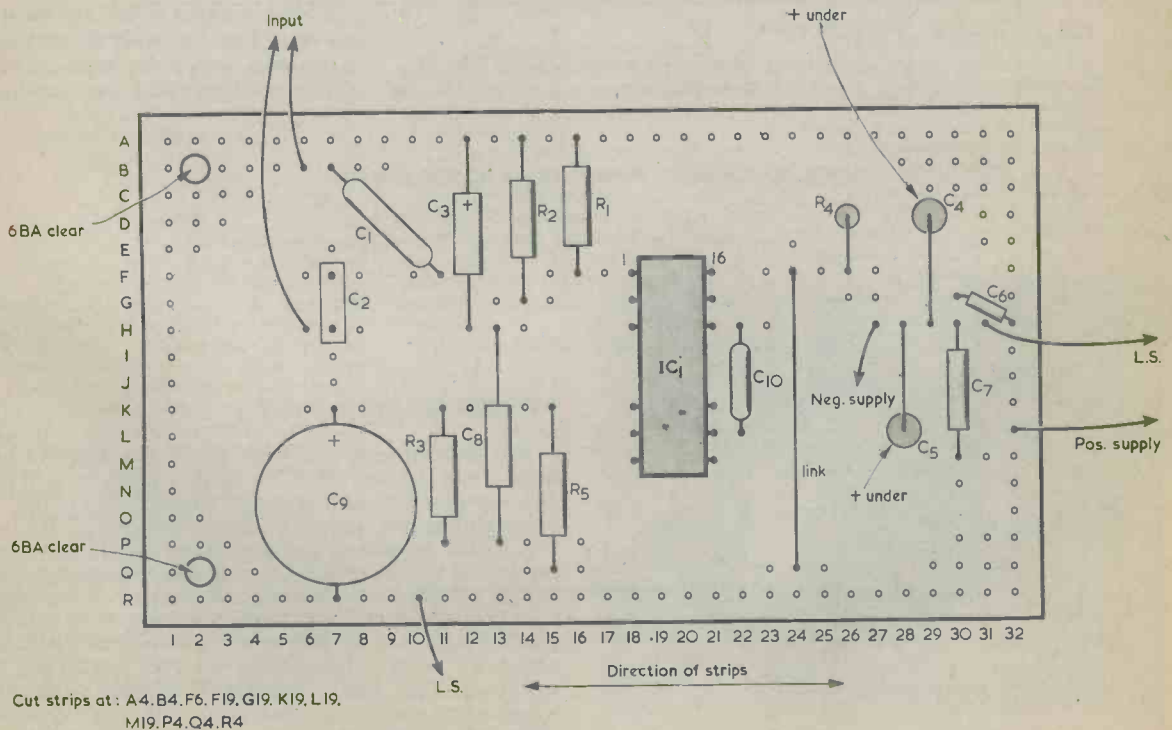

Fig. 2. Amplifier layout on a Veroboard panel with components uppermost

the i.c. until last. The tabs of the device are carefully bent up through about 150°. Two rectangles of copper laminate board are soldered to the tabs in order to provide the necessary heat radiation. These heat fins should have an area of about 3.5cm. by 4.5cm., or more if sufficient space is available. Remember that this version of the i.c. should not have a speaker load impedance of less than 15Ω.

An amplifier using this type of heat sink is shown in the accompanying photographs. It is assembled on a Veroboard layout slightly different from that of Fig. 2.

The pins of the i.c. without the integral heat sink can be identified with the aid of the usual cut-out in the top of the case between pins 1 and 16. With the other version of the i.c., pin 1 is the pin near the Texas Instruments trade mark after the SN76023N type number. If in any doubt about the identification of the pins, pins 3 and 14 of the device connect to the heat sink and can be located with the aid of an ohmmeter.



A similar amplifier incorporating the SN76023ND

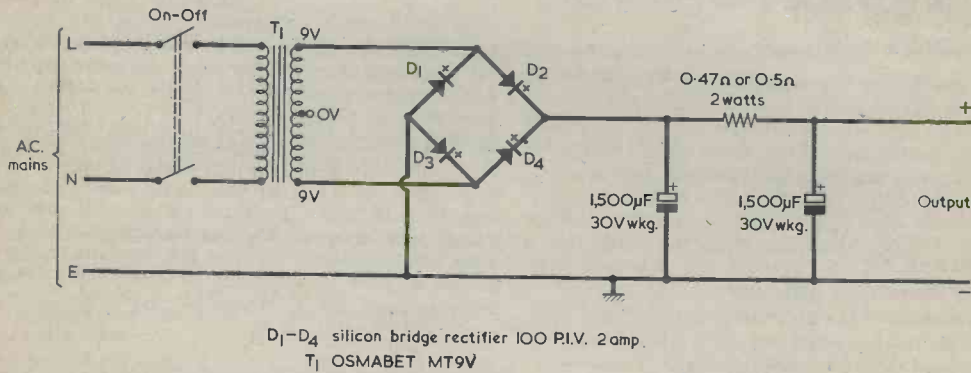
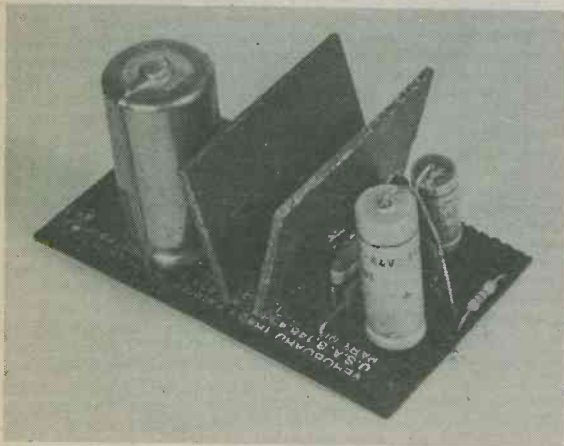

Fig. 3. A suitable power supply for the amplifier



Another view of the SN76023ND amplifier. The radiating fins are rectangles of copper laminate

## POWER SUPPLY UNIT

For constructors who wish to use the amplifier of Figs. 1 and 2 as an amplifier in its own right, and not as a replacement for the earlier articles, the circuit of a suitable power supply is illustrated in Fig. 3.

A highly smoothed and stabilized supply is not essential for the SN76023N, and the simple unregulated supply circuit shown is quite satisfactory. It is important that the maximum supply voltage does not exceed 28 volts, and for this reason a transformer offering about 18 volts r.m.s. under no-load conditions is specified. This has a 9-0-9 volt 1 amp secondary whose outer ends are connected to a silicon bridge rectifier. No connection is made to the secondary centre-tap. The smoothing circuit consists of the two electrolytic capacitors and the smoothing resistor shown.

# In your work-shop

This month we find Smithy's assistant, Dick, wrestling with the complexities of TV line and vertical blanking circuits. However, he is given a little aid by the Serviceman and is eventually able to trace and clear quite an unusual television snag.

"Ah, that should fix it!"

With a grunt of satisfaction Dick replaced his soldering iron on its rest and carefully examined the connections to the  $1k\Omega$  resistor he had just soldered to the printed circuit board of the 12 inch monochrome TV on his bench. The two solder joints at the resistor lead-outs were, as was always the case with Dick, immaculately finished. As Dick himself admitted, he might not be too clued up on technical details but when it came to soldering he was a real past master.

Dick switched on the receiver and waited expectantly. It had been quite an interesting piece of troubleshooting: the collector feed resistor for the first i.f. transistor had gone high in value, a fact that had been readily revealed by voltage checks around the transistor and its immediate components. Dick had now replaced that resistor.

## LINE BLANKING

After a short while the picture tube came to life and Dick was delighted to see that this depicted a bright, well

focused scene of good resolution. As he watched cheerfully, he saw three masked Mexicans traverse the little screen on horseback as they converged on the friendly neighbourhood bank. He advanced the volume control. The sound quality was good, too, with the clatter of horses' hooves being backed by a 50-piece orchestra softly playing music to raid banks by.

The scene changed to the interior of the bank, and the screen went darker. Dick leaned forward to look more closely and then suddenly gave a frown. Approximately a third of the way from the left of the picture was a vertical line, about a quarter of an inch wide, which was noticeably brighter than the rest of the scene. The line jiggled slightly to left and right in an irritating fashion. The picture changed to the brighter scene outside the bank and the vertical line disappeared. Then the picture returned to the bank interior and the line came back again. As he watched, Dick noticed also a series of vertical striations to the left of the line.

Visited by a subconscious inspiration, Dick reached for the brightness control and turned it to a higher level. The jittering vertical line now became visible both on the indoor and the outdoor scenes. Dick returned the brightness control to its proper setting and scowled at the receiver. The Mexicans had now entered the bank and the resultant unbroken dark scene continually revealed the vertical line with all its annoying tremor.

"Hey, Smithy."

The Serviceman, completely absorbed in the chassis of another television set on his own bench, gave no indication that he had been called.

"Hey, Smithy!"

There was still no response.

"Hey," roared Dick, "Smithy!"

Smithy looked up absently, as though in response to some mild stimulus, then returned to his television set. But his concentration had patently been broken because, after a moment, he turned round to face his assistant.

"Is," he asked vaguely, "something

wrong over there?"

"Blow me," snorted Dick. "I've been calling you for ages."

"Have you?" replied Smithy in the satisfied tone of one for whom a minor problem has been solved. "Then that explains the noises I thought I heard."

"Well, before you go back into your coma," said Dick quickly, "can you have a quick look at this TV set I've got here?"

Sighing, Smithy rose from his stool and walked over to examine the picture displayed by the television receiver. The masked Mexicans were now emptying the bank strong-room, in the murky shadows of which clearly trembled the vertical line.

"What's probably happened here," remarked Smithy, "is that the line blanking circuit has gone duff. Is this vertical line the fault that the set came in with?"

"No," replied Dick, "the main fault was very weak signal I've cleared that, and now I find I've got this darned wagging line. It only shows up on dark scenes."

"I should guess that that line was there for quite some time before the major fault occurred," surmised Smithy. "The set-owner probably put up with it or didn't even think it was a fault. Anyway, now you've repaired the major snag you might as well clear up this minor one. If you get the service manual out I'll show you where the line blanking circuit is."

"I've got the manual out already," responded Dick. "Here it is, and here's the circuit of the set."

"Dear me," said Smithy, impressed. "It must have been a tricky snag for you to consult the manual. Well, let's have a look at it. Ah yes, here's the bit which gives you line blanking."

Smithy pointed to a section of the receiver circuit. (Fig. 1.)

"Is that it?" said Dick uncertainly, as he gazed at the circuit area indicated by Smithy. "What exactly is it supposed to do?"

"It's supposed to cut off the picture tube during line flyback. Which reminds me that it may also be called a line flyback suppression circuit."

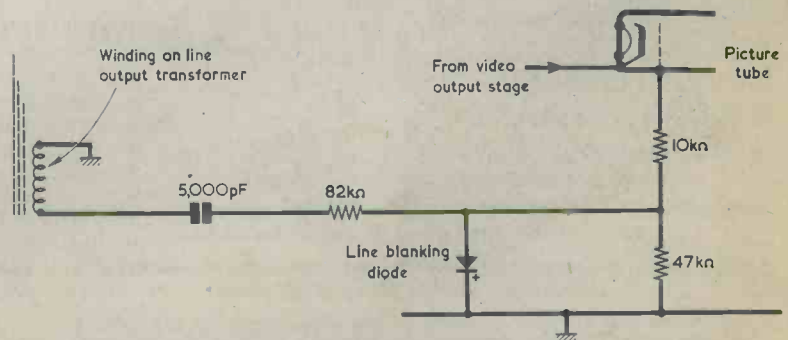

Fig. 1. A typical line blanking circuit, as encountered in monochrome television receivers. Component values are representative of current design practice

## SYNC PULSE OVERSHOOT

"I don't quite understand this," said Dick. "Why, for a start, do you have to cut off the tube during line flyback? The signal is at black level or lower than black level during the flyback period in any case."

"The signal may be," retorted Smithy, "but not so far as the picture tube is concerned. Now let me ask you a question for a change. What happens to the signal when you come to the end of a line of picture information?"

"Well," said Dick, "the signal amplitude goes down to black level for a short period and then goes down further to sync level to give the start of the line sync pulse. After that it returns to black level and, a little later, the next line of picture information starts." (Fig. 2(a).)

"Fair enough for now," commended Smithy. "The bit before the sync pulse is known as the front porch and the bit after the sync pulse is called the back porch. Also, in the 625 line system, the black and the blanking levels are both the same. Now, in a perfectly ordered world, the picture tube would be set up such that black level would always coincide with the tube being just cut off." (Fig. 2(b).)

"I suppose," put in Dick, "that you would obtain this condition by adjusting the brightness control correctly."

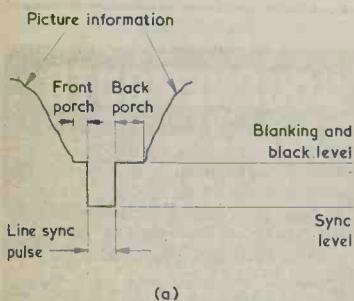

(a)

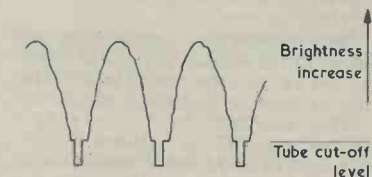

(b)

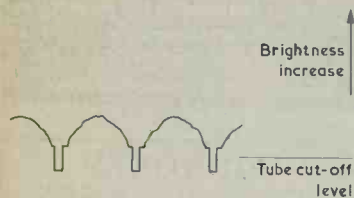

(c)

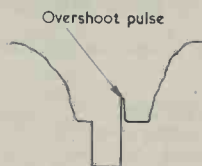

(d)

Fig. 2(a). The line sync pulse in the 625 line system. The colour burst on the back porch is not included here

(b). Ideally, the signal presented to the picture tube should have its black level just at tube cut-off level

(c). When there is a.c. coupling of the video signal to the tube, a reduction in the overall picture brightness causes the blanking level to rise above tube cut-off level

(d). The line sync pulse can produce a visible effect on the screen if there is overshoot after its trailing edge

"You could do," replied Smithy, "but the brightness control would need to be set up more carefully than most viewers would do, and you'd also have to have full d.c. coupling of the signal all the way from the video detector to the picture tube. But these monochrome 625 line sets don't have d.c. coupling. They have an a.c. coupling to the tube, which means that the average voltage at the tube modulating electrode, which is normally the cathode, varies according to the overall brightness of the scene being transmitted. If, with bright pictures, the average voltage is such that black level corresponds to the tube being just cut off, dark pictures will cause the black level to come well within the range of signal voltages that give visible effects on the screen." (Fig. 2(c).)

"That's exactly what happened with this set," said Dick excitedly. "The vertical line wasn't visible with a bright scene, but it showed up quite clearly on the dark scenes. Now, let's think a minute."

His brow furrowed in concentration.

"At the end of the line," he went on slowly, "we get the front porch and then the start of the line sync pulse. Now, if there was direct line sync in the set the start of the sync pulse would actually initiate the flyback, and so the pulse start couldn't have any visible effect during flyback. Present day sets

have flywheel sync but, even so, the start of the line sync pulse will still occur approximately at the same time as the start of line flyback."

"So?"

"So," continued Dick, "the thing which causes this waggly line to appear must be the end of the sync pulse, when it goes up from sync level to black level."

"You're very nearly there," commented Smithy. "If the sync pulses were perfectly shaped the end of each pulse would still, however, have little visible effect on the tube screen, even when the tube screen isn't cut off at black level. This is because the spot on the screen is travelling extremely quickly to the left during flyback and the end of the pulse would have a gradual effect. If, on the other hand, something in the system between the transmitter camera and the receiver picture tube caused a sharp overshoot to appear at the end of the line sync pulse, then the result on the screen would be quite noticeable. What's causing that line on the screen of your set is a sharp overshoot pulse at the end of the line sync pulse. This overshoot pulse is very short in duration, much shorter in fact than the flyback period, and so it causes the screen to go a little brighter each time it appears. Since the overshoot pulse appears during every line flyback period, and at about the same time in the period, it builds up a vertical line on the screen." (Fig. 2(d).)

"Well," remarked Dick, "that explains the presence of the line. Why does it waggle to left and right?"

"Partly because of slight discrepancies between the width of successive sync pulses," replied Smithy, "and partly because of slight differences in flyback initiation in the receiver line timebase. These wouldn't have any effect if the spot was travelling across the tube screen at the relatively slow scan speed, but they become noticeable at the very much higher flyback speed. Another thing we haven't even mentioned yet is the fact that present-day transmissions carry colour burst signals on the back porch. These will follow your overshoot pulse and will be causing those vertical striations you can see. So, apart from guarding against the overshoot effect, line blanking is necessary to remove any visible effects due to colour bursts."

"I can see the situation now," replied Dick. "How about looking at the line blanking circuit in this particular set?"

## SHUNT DIODE

"We'll do that right now," stated Smithy. "If you look at that circuit I indicated, you'll see that a winding on the line output transformer couples to a 5,000pF capacitor and an 82kΩ resistor. The winding is connected so that there is a line output waveform with negative-going flyback pulses at its non-earthly end. This waveform is

## Your Local Supplier

LONDON

### THE MODERN BOOK CO.

Largest selection of English & American radio and technical books in the country.

19-21 PRAED STREET,  
LONDON, W2 1NP  
Tel: 01-723 4185/2926

## ST. HELEN'S RADIO

HI-FI Equipment  
Tape Recorders  
Radio Receivers  
Television  
SPECIALISTS IN RADIO  
& ELECTRONIC TEXTBOOKS  
ST. HELENS GARDENS  
LONDON, W.10  
Tel: 01-969 3657

HAMPSHIRE

## BOURNEMOUTH

LARGEST HI-FI AND  
RADIO COMPONENT  
STORE IN THE SOUTH

FORRESTERS NATIONAL  
RADIO SUPPLIES LTD.  
70-72 Holdenhurst Road  
Bournemouth  
Telephone 25232  
Closed all day Wednesday

SURREY

## WITWORTH TRANSFORMERS

TV Line out-put transformers  
Manufacturers of the largest range in the country. All makes supplied.

Modern  
BAIRD, BUSH, GEC, PHILIPS  
Replacement types ex-stock.  
For "By-return" service, contact  
London 01-948 3702

Tidman Mail Order Ltd., Dept. R.C.  
236 Sandycombe Road,  
Richmond, Surrey TW9 2EQ  
Callers welcome.

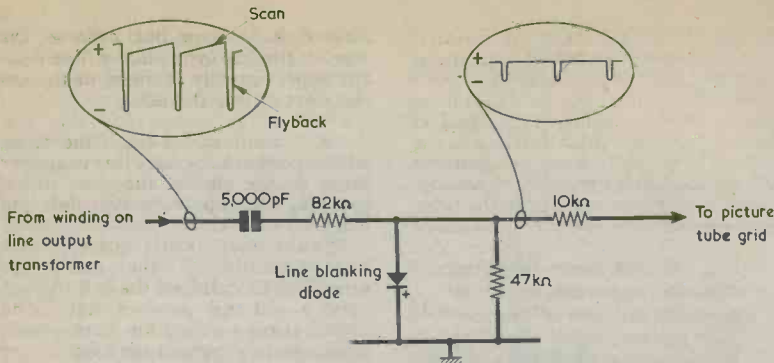

Fig. 3. The waveform from the line output transformer winding in Fig. 1 is changed to a series of negative-going pulses for application to the picture tube grid. These pulses have a lower amplitude than those at the transformer winding because of potential dividing action in the 82kΩ and 47kΩ resistors

applied to the 5,000pF capacitor and 82kΩ resistor, after which it arrives at the line blanking diode. The 5,000pF capacitor offers a much higher impedance to the slow scan sections of the waveform than it does to the considerably quicker flyback pulses, with the result that the waveform appearing at the diode consists of negative-going flyback pulses with flat parts in between." (Fig. 3).

"I suppose," remarked Dick, "that these flat parts will be around chassis potential."

"They will be," agreed Smithy. "The diode prevents the waveform going positive of chassis by more than its forward voltage, with the result that the 5,000pF capacitor takes up a charge which keeps the flat parts of the waveform at this voltage level. So we've now got some nice regular negative-going pulses appearing during line flyback, and these are applied to the grid of the tube via the 10kΩ series resistor. As a result the tube is neatly cut off during the line flyback."

"What's the 10kΩ resistor for?"

"It's to limit current in the event of an internal flash-over to the grid," explained Smithy. "It has nothing to do

with the line blanking operation."

"Fair enough," remarked Dick. "This line blanking business doesn't seem to be so complicated after all."

"It's dead easy," replied Smithy. "In fact, the provision of line flyback blanking is often carried out by circuits that are even simpler than the one we've just considered. Hang on a jiff and I'll show you."

Smithy walked over to the filing cabinet and selected two service manuals.

"Here we are," he said, returning to Dick's bench. "I'll show you another line blanking circuit. Take a look at this."

Smithy opened one of the manuals and pointed at its circuit. (Fig. 4).

"Blimey," remarked Dick. "This one's a piece of cake. All you've got here is a winding on the line output transformer coupling to the grid of the tube by way of a 200kΩ resistor and a 5,000pF capacitor. Hullo, there's a 47kΩ resistor and a 0.05μF capacitor coupling from the vertical output stage, too."

"That's to give vertical blanking, or vertical flyback suppression," explained Smithy.

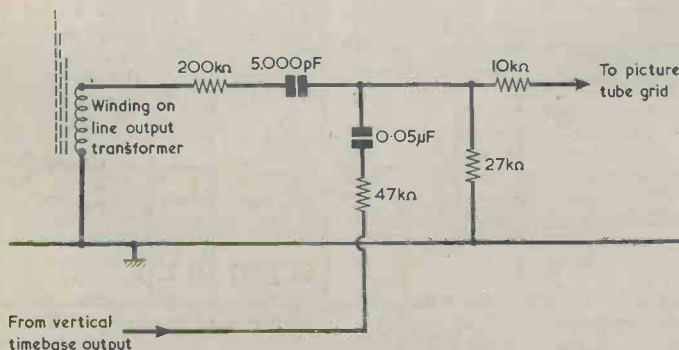

Fig. 4. A simple circuit which gives both line and vertical flyback suppression. The waveforms from the line output transformer winding and the vertical timebase output stage have negative-going flyback pulses. Component values are representative



## Your Local Supplier

SUSSEX

### JEFFRIES

For your new television set  
tape recorder, transistor radio  
and hi-fi equipment

PHILIPS, ULTRA, INVICTA  
DANSETTE, MASTERADIO, PERDIO,  
MARCONI, PHILCO FIDELITY

6A Albert Parade  
Victoria Drive,  
EASTBOURNE SUSSEX

EIRE

### PEATS for PARTS ELECTRONIC COMPONENTS RADIO & TELEVISION

For the convenience of Irish  
enthusiasts we supply  
Radio & Electronics  
Constructor  
Data Books and  
Panel Signs Transfers  
Also a postal service

Wm. B. PEAT & Co. Ltd.  
28 PARNELL STREET  
DUBLIN 1

### RADIO & ELECTRONICS CONSTRUCTOR

ANNUAL  
SUBSCRIPTIONS  
to this magazine  
may be obtained  
through your  
newsagent  
or direct from the  
publishers  
ONLY £4.50  
per year, post free

Please send remittance with name  
and address and commencing issue  
required to:

DATA PUBLICATIONS LTD  
57 Malda Vale London W9 1SN

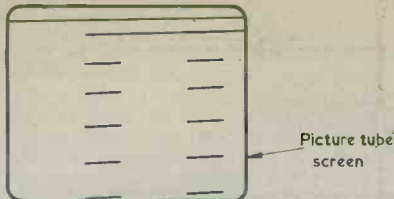

Fig. 5. Without vertical flyback suppression it is possible for part of the vertical synchronising signal to produce sloping lines on the picture tube screen similar to those shown here

"Gosh," exclaimed Dick, "do you have to cut off the tube during vertical flyback as well?"

"Oh, definitely," said Smyth. "It's just as important to have vertical flyback blanking as it is to have line blanking. The vertical flyback is relatively quite slow, and if the tube happens to give a response at blanking level, the frame sync pulse waveform produces a number of sloping lines as the spot moves upwards." (Fig. 5).

"I hadn't realised that," stated Dick. "Let's have a look at another blanking circuit."

"Right you are," said Smyth cheerfully. "Here's an unusual one which employs a separate transistor as a blanking amplifier."

Smyth put another circuit in front of his assistant. (Fig. 6).

"It looks," remarked Dick, "as though this provides both line and frame blanking."

"It does," confirmed Smyth. "The collector of the line output transistor couples to the base of the blanking amplifier by way of the 1.5MΩ resistor. The line output transistor collector goes positive during line flyback and so it turns on the blanking amplifier

and produces a negative pulse at the blanking amplifier collector. The multivibrator in the vertical timebase couples to the blanking amplifier base via the 47kΩ resistor, and this also turns on the blanking amplifier during vertical flyback. So there are negative-going pulses at the collector of the blanking amplifier during both the line and the vertical flyback periods. These are applied via a 10μF capacitor to a shunt rectifier which acts in the same way as the shunt diode in the set you've got on your bench. The negative-going pulses are then passed to the grid of the picture tube."

### VIDEO AMPLIFIER

"These blanking circuits seem pretty obvious, once you've sorted them out," remarked Dick.

"Most of them are simple enough," responded Smyth. "Sometimes, you find that the blanking is achieved by way of the video amplifier. A typical example consists of injecting positive-going frame flyback pulses to the emitter of the video output transistor. These cause the collector to go positive, too, whereupon the cathode, and not the grid, of the picture tube is driven positive during the flyback period. Driving the tube cathode positive is, of course, the same as driving the tube grid negative." (Fig. 7).

"Blimey, Smyth," said Dick appreciatively, "you've certainly given me some real gen on this blanking business."

"Think nothing of it," remarked Smyth carelessly. "Anyway, I want to get back to my own TV now."

Left to himself, Dick turned on the television receiver once more. The vertical line was still present. Also, the three Mexicans had progressed quite some way through their story, and were now quarrelling savagely over the loot. Dick switched the set off and pulled his testmeter towards him.

He pondered for a moment. Since the picture tube was working satisfac-

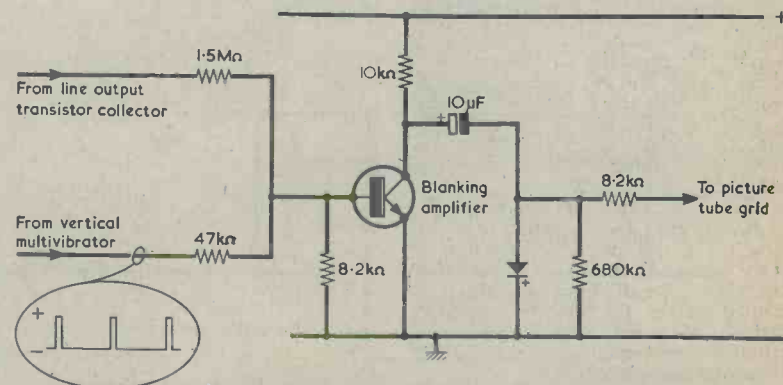

Fig. 6. Here, a blanking amplifier transistor has positive-going flyback pulses from both the line and vertical timebases. These are inverted and applied to the picture tube grid. (This circuit is incorporated in the I.T.T. Television Chassis type VC300).

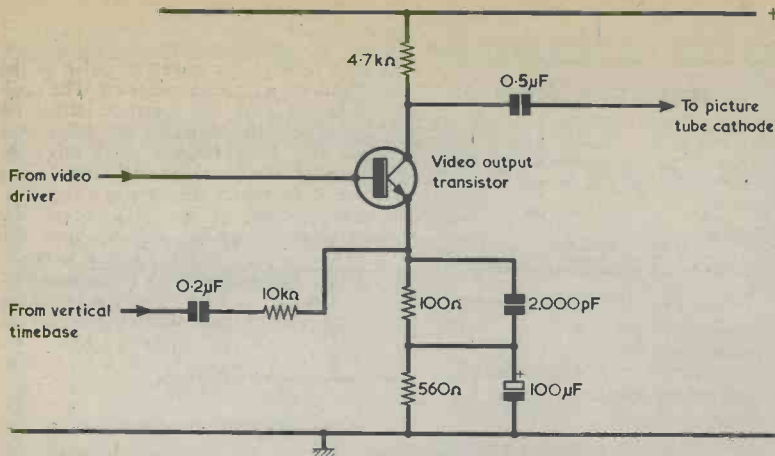

Fig. 7. Simplified circuit, again with representative component values, illustrating how vertical blanking can be obtained by applying positive flyback pulses to the emitter of the video output transistor

tory apart from the vertical line and its attendant striations, it was fairly certain that its grid was coupling to chassis via the 10kΩ resistor and the 47kΩ resistor across the blanking diode. So these components should not be faulty. The blanking diode could have become short-circuit, but this seemed less likely than a fault in a resistor or capacitor. It occurred to him that the line output transformer winding might have become open-circuit.

Dick quickly put this frightening thought to the back of his mind and considered more cheerful probabilities. There were two components left: the 5,000pF capacitor and the 82kΩ resistor. One of these could be open-circuit.

He pulled his testmeter towards him, selected an ohms range and zeroed the meter. Consulting the service manual, he located the 82kΩ resistor on the board and connected the testmeter prods across it. The testmeter read approximately 82kΩ (Fig. 8(a).)

No luck so far.

Dick next selected a 5,000pF capacitor from a box of spares on his bench and temporarily soldered it across the capacitor in the receiver. (Fig. 8(b).) He switched it on and waited impatiently for the picture tube to warm up. The screen flickered into life, to reveal one of the Mexicans bashing the living daylights out of the other two.

The vertical line had disappeared.

Jubilantly, Dick turned up the brightness, and the picture was now as it should be. All that could be seen was the successive piling of two Mexican bodies on the floor as the argumentative one successfully pursued the ritualistic movements of karate, kung fu and plain skullduggery.

Dick happily switched off the receiver, removed the existing 5,000pF capacitor, fitted a new one and then switched the set on again. He looked anxiously to see if the vertical line reappeared, but it continued to be ab-

sent.

"Hey, Smythy."

No reply.

"Hey, Smythy!"

Still no reply.

"Hey, Smythy!"

At last, the Serviceman turned round.

"You were calling?"

"Ye gods," said Dick irritably, "I could have been lying here on the floor electrocuted and screaming my head off for all the attention you'd pay."

"Well, what's your problem now?"

"I've got no problem," replied Dick, allowing his annoyance to die down. "It's just that you were right about that line blanking circuit being faulty. The 5,000pF coupling capacitor to the line blanking diode had gone open."

"Good, good," responded Smythy.

"It's nice to have snags like that which are easy to diagnose. These single-standard 625 line black and white TV's are probably the simplest jobs we handle nowadays, because they offer fault symptoms which are almost straight out of the text-book."

#### ANOTHER LINE

With which words, Smythy returned to his bench and his own television receiver. Dick quickly put the printed circuit board of his receiver back in position, screwed on the cabinet back, gave the set a final check on all the local channels, then carried it triumphantly to the "Repaired" rack. He turned to the "For Repair" rack and examined its contents. There seemed to be nothing else but TV sets today. Dubiously, he selected a rather battered dual-standard monochrome model, then returned with it to his bench and connected it to the mains and to the u.h.f. and v.h.f. aerials.

He switched it on, selected 625 lines, and waited for it to warm up. The set was dead. Experimentally, he turned over to 405 lines, to be immediately rewarded with both a picture and sound. And, although he now had fewer lines to occupy, there was the single victorious Mexican riding off

## GAREX

Modulation transformers	
Valve type 747, for 30W Tx	£2.60
Transistor type, p/p NKT404 to QV03-20a (or QV03-10), with driver transformer to match - special offer - the two	£1.45
Audio transformers - driver and output (2W) p/p NKT404 to 3Ω	the two 70p
NKT404	17p each, 4 for 60p
Mains transformer (multitap primary) 250-0-250V 200mA, 6-3V 5A, 5V 2A, fully shrouded, (suitable for 30W Tx - matching style to mod. transf.)	£5.70
H.T. chokes 5H 80mA, 1.8H 125mA	£1.10
Inverter Transformer Input 12V DC, output 170/380V 180mA	£2.05
Relays GPO type 2400, 12V coil, 8A contacts, 4PCO or 2P make	any 4 for £1.00
Neons min. wire end,	10 for 55p, 100 for £4.50
Slide Switches (new) min. DPDT	13p
	2P3W 20p
PL259 UHF Plug	45p; Reducer 15p
BNC Free (cable mtg.) Socket "50Ω" 15p	12 for £1.30
Connection data supplied with transformers. Components are ex-equipment, in good condition, your satisfaction guaranteed.	
Prices inclusive of UK Post, Packing and VAT at 25%	
Mail order only	Sole address:
<b>GAREX ELECTRONICS</b>	
7 NORVIC ROAD, MARSWORTH,	
TRING, HERTS HP23 4LS	
Cheddington (STD 0296) 668684	

**the audio amateur?**

What a trip old Richard's Rhine journey could have become had he built his own mixers, 900 watt amps, octave equalizers, 24 inch woofers, electronic crossovers, and home brew electrostats. Zounds what sounds!

Ask our Rhine maidens for details.

**theAudio Amateur** Yellow Oak Cottage  
Tillington nr. Hereford  
HR48LQ

Send now for a free prospectus.

Craig Stark of STEREO REVIEW says:  
"Top quality, only U.S. publication devoted to the serious audiophile constructor."

Name .....

Address .....

R

# BOOKS

## ON ELECTRONICS

**Electronics ..... £1.65**

—An elementary introduction for beginners (31 Units). The eagerly awaited step by step explanation for those meeting with the subject for the first time.

**Towers International Transistor Selector**  
Just Published ..... **£3.40**

**Mathematics for Telecommunications**  
by Spooner and Grinstead  
Chief Examiner for City and Guilds.  
Based on the C & G Syllabus, equally valuable for National Certificate.  
In 2 vols. Vol.1 **£1.70**, Vol.2 **£2.20**.

**Mullard Publications**

**Data Book 1974/75 55p**

**Integrated Circuits ..... 55p**

**Thyristors ..... 70p**

**Magnetic Core Memories ..... 55p**

**Simple Transistor Measurements ..... 40p**

**Simple Valve Measurements ..... 40p**

**A Simple Closed Circuit Television Camera ..... £1.00**

(Prices include postage and packing)

**SELRAY BOOK COMPANY**

**60 HAYES HILL  
HAYES, BROMLEY  
BR2 7HP**

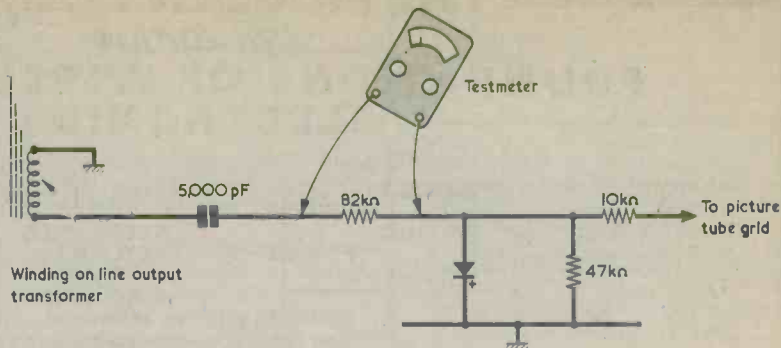

(a)

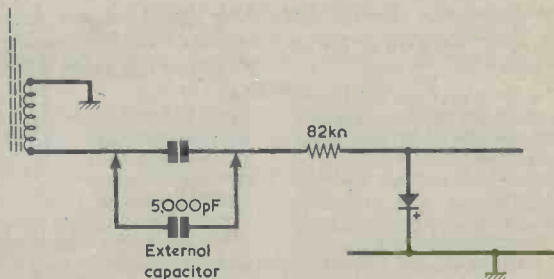

(b)

**Fig. 8(a):** Dick initially checked the resistance of the 82kΩ resistor in the line blanking circuit of his receiver

**(b).** He next bridged the capacitor in the circuit with an external 5,000pF capacitor

with the swag that he had wrested from his two partners in crime.

Just as the television scene flashed to the ambush awaiting the Mexican, a vertical line of bright individual circles appeared on the screen, about a third of the way from the left.

As Dick watched incredulously, the line jiggled uncertainly from side to side and then moved slowly to the right. It disappeared, and then reappeared at the left. Dick decided to waste no time on intermediate approaches.

"Hey, Smithy!"

"Dear, oh dear," came Smithy's voice from the other side of the workshop. "What on earth are you yelling about now?"

"I've got another vertical line," wailed Dick. "Only this time it's made up of flashes and it's moving all over the picture."

Smithy walked over, glanced quickly at Dick's receiver then returned to his own bench. There was the click of a switch and the vertical line on Dick's receiver disappeared.

"Blimey," said Dick, startled, "what did you do then?"

"I turned off the TV on my bench," replied Smithy. "It's another dual-standard job, and I also had it running on 405 lines, but tuned to a different channel."

"Then what caused the vertical line?"

"There must be a spot of e.h.t. cor-

ona in the line output stage of my set which appears during line flyback. Your set was picking it up, and since the corona appeared after each transmitted line it showed up as a vertical line of flashes."

"But why did the line keep moving sideways?"

"Because, my lad, the line frequencies in the two sets weren't exactly identical, and the position of the line on your screen varied according to the phase difference between them."

"Well, blow me, that's something to be thankful for. Still, it's the first time you've cleared a picture snag on my bench by turning off a set on yours!"

"Servicing," said Smithy philosophically, "is full of these little surprises. That's what keeps us on our toes."

With which little homily Smithy returned to his work, leaving Dick to determine why the set he'd selected didn't work on 625 lines. But, before switching back to the defunct u.h.f. channel, Dick allowed the Mexican on the screen to play out his last part. Riddled with bullets, the bank raider writhed into his final death-throes, surrounded by the sheriff, his deputies, the bank manager, the bank teller, the two other Mexicans and the bank manager's daughter (we missed the earlier bits where she appeared).

Which drives home yet a further homily. Crime, conducted carelessly, does not pay. ■

# THE MODERN BOOK CO

NEW EDITION

## FOUNDATIONS OF WIRELESS AND ELECTRONICS

By M. G. Scroggie

Price £4.25

### PRINCIPLES OF TRANSISTOR CIRCUITS

by S. W. Amos PRICE £3.50

SOLID STATE HOBBY CIRCUITS  
by RCA PRICE £1.30

ELEMENTARY TELECOMMUNICATION  
PRACTICE

by J. R. G. Smith PRICE £1.55

ABC OF HI-FI  
by J. Earl PRICE £4.15

THE OSCILLOSCOPE  
by G. Zwick PRICE £2.05

PRINCIPLES OF TELEVISION RECEPTION  
by W. Wharton PRICE £1.95

ELECTRONICS UNRAVELLED  
by J. Kyle PRICE £2.20

RADIO CONSTRUCTION FOR AMATEURS  
by R. H. Warring PRICE £2.70

RADIO COMMUNICATION  
by J. M. Reyner PRICE £5.55

RADIO SERVICING POCKET BOOK  
by V. Capel PRICE £2.20

### BEGINNER'S GUIDE TO ELECTRONICS

by T. L. Squires PRICE £2.20

PRINCIPLES OF PAL COLOUR T.V. & RELATED  
SYSTEMS

by H. V. Slms PRICE £1.80

RADIO TECHNICIAN'S BENCH MANUAL  
by H. W. Hellyer PRICE £3.45

PRACTICAL INTEGRATED CIRCUITS  
by A. J. McEvoy PRICE £1.30

ELECTRONICS SELF-TAUGHT ...  
WITH EXPERIMENTS & PROJECTS

by J. Ashe PRICE £2.15

UNDERSTANDING IC OPERATIONAL  
AMPLIFIERS

by R. Melen PRICE £2.35

110 SEMICONDUCTOR PROJECTS FOR THE  
HOME CONSTRUCTOR

by R. M. Marston PRICE £2.00

IMPROVING YOUR HI-FI  
by J. Earl PRICE £3.30

ALL PRICES INCLUDE POSTAGE

We have the Finest Selection of English and American Radio Books in the Country

19-21 PRAED STREET (Dept RC) LONDON W2 1NP

Telephone 01-723 4185



Associates Ltd

# indicator lamps and light sources

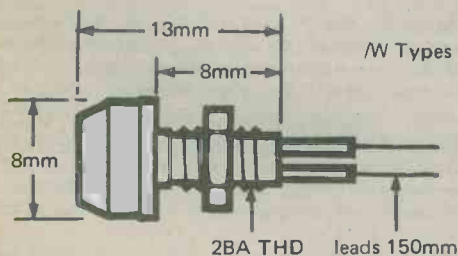

W Types

Filament



LED's R/G/Y



Neon

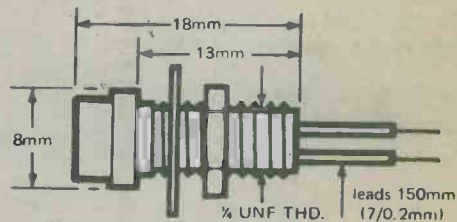

1/4 UNF THD.

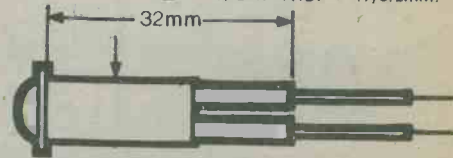
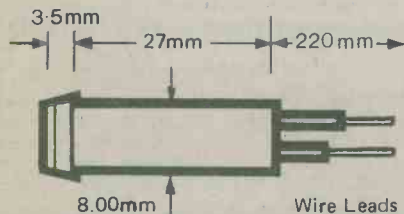

- \* For industrial use in instruments on circuit boards.
- \* For domestic use as indicators on washing machines, amplifiers, door bells.
- \* Long life, high reliability \* Low current drain \* Small size

J·H·ASSOCIATES LIMITED · SILVER STREET · STANSTED

# TV

## FAULT FINDING MANUAL for 405/625 LINES



90p

P. & P. 17p

## REVISED & ENLARGED

EDITED BY J. R. DAVIES

132 pages

Over 100 illustrations, including 60 photographs of a television screen after the appropriate faults have been deliberately introduced.

Comprehensive Fault Finding Guide cross-referenced to methods of fault rectification described at greater length in the text.

# UNDERSTANDING TELEVISION



by  
J. R. DAVIES

Over 500 pages  
300 diagrams

£3.25

P. & P. 50p

UNDERSTANDING TELEVISION deals with:

- Principles of 405 line reception
- Principles of 625 line reception
- Nature of the television signal
- Receiver tuner units
- A.F. and video amplifiers
- Deflector coil assemblies
- Automatic gain and contrast control
- Receiver aerials
- The cathode ray tube
- Receiver i.f. amplifiers
- Vertical and horizontal timebases
- Synchronising
- Power supply circuits
- Colour television
- **COLOUR TELEVISION** – 80 page section deals comprehensively with this subject

The reader is required to have only a basic knowledge of elementary radio principles. The treatment is non-mathematical throughout, and there is no necessity for any previous experience in television whatsoever. At the same time UNDERSTANDING TELEVISION is of equal value to the established engineer because of the very extensive range it covers and the factual information it provides.

To Data Publications Ltd., 57 Maida Vale, London, W9 1SN

Please supply the 4th revised edition of TV FAULT FINDING, Data Book No. 5.....

Please supply UNDERSTANDING TELEVISION, Data Book No. 17.....

I enclose cheque/crossed postal order for.....(Tick which book is required)

NAME.....

ADDRESS.....

(BLOCK LETTERS PLEASE)

# SMALL ADVERTISEMENTS

Rate: 5p per word. Minimum charge 75p  
Box No. 10p extra.

Advertisements must be prepaid and all copy must be received by the 4th of the month for insertion in the following month's issue. The Publishers cannot be held liable in any way for printing errors or omissions, nor can they accept responsibility for the *bona fides* of Advertisers. (Replies to Box Numbers should be addressed to: Box No. —, *Radio and Electronics Constructor*, 57 Maida Vale, London, W9 1SN.

**AERIAL BOOSTERS.** Improve weak radio and television reception. Price £3.20. P. & P. 20p. S.A.E. for leaflets. **BARGAIN PACK POLYESTER (C280) CAPACITORS.** 250V/W and 400V/W. Very good mixed selection from 0.01uF to 2.2uF. Price 100 £1, P. & P. 15p. (Our choice). **VALVE BARGAINS,** 10p each, P. & P. 10p. ECC82, ECL80, EF80/183/184, PC86/88, PCF80/802, PCL82/84, PCL85/805, PL36/504, 30PL14, PY33/81/800. **COLOUR VALVES,** 12p each, P & P. 10p. PL508, PL509, PY500A. Lancashire Mail Order (R), 6 William Street, Stubbins, Ramsbottom, Bury, Lancs.

**TREASURE HUNTERS!** Construct highest performance electronic metal detector for under £2. Equals models costing up to £50. For simple illustrated plans send £1. Colin Lucas, 241 Uppminster Road South, Rainham, Essex.

**SERVICE SHEETS** for Radios/TV's etc. 50p and s.a.e. Catalogue 20p and s.a.e. Hamilton Radio, 47 Bohemia Road, St. Leonards-on-Sea, Sussex.

**TO CLEAR BOOKSHELVES:** *Handbook of Satellites and Space Vehicles* by R. Haviland, £3. *Medical Radiation Biology* by F. Ellinger, £3. *Space* by Patrick Moore, £2. *Rocketry and Space Exploration* by Haley, £2. *Health Physics* by Rees, £3. Box No. G274.

**FOR SALE:** Solartron CD513.2 oscilloscope, v.g.c., £25. Cossor WM8 working 'scope, £20. Cossor WM16 oscilloscope, working, £30. Various 'scopes for sale from £6. Wanted: Avometers irrespective of condition, good prices paid. 'Q' Services Electronic Camberley Ltd., 29 Lawford Crescent, Yateley, Camberley, Surrey. Telephone: 0252-871048.

**BUILD THE MULLARD C.C. TV CAMERA.** Complete kits now available from Crofton Electronics. Send large s.a.e. for details to:- 124 Colne Road, Twickenham, Middlesex, TW2 6QS. Telephone: 01-898 1569.

**VALVES,** Radio, TV, Transmitting, Industrial. 1930 to 1975. 2200 types in stock. Many obsolete. List 20p. Quotations s.a.e. Postal export service. We wish to buy all types of valves. Wholesalers, dealers, etc., stocks purchased. Cox Radio (Sussex) Ltd., The Parade, East Wittering, Sussex. Telephone: West Wittering 2023.

**FOR SALE:** Complete Widescreen film outfit. 9.5mm camera and projector with widescreen lens, screen, film, etc. Would exchange for other photo or radio gear or w.h.y.? S.A.E. for details to Box No. G276.

**RADIO. LEARN FROM THE BEGINNING.** 16 vintage circuit diagrams, receivers and transmitters with notes, £1.00. Allister, 58 Wavell Road, Maidenhead, SL6 5AD.

(Continued on page 253)

## BENTLEY ACOUSTIC CORPORATION LTD.

All prices inclusive of V.A.T. at 25%

The Old Police Station, Gloucester Road, LITTLEHAMPTON Sussex. PHONE 6743

OB2	.45	10P14	2.34	E180F	1.17	EH90	.44	PCL82	.45	UM80	.60
1A7GT	.60	12A6	.75	BA30	.40	EL32	.60	PCL83	.50	UY41	.50
3V4	.82	12AC6	.90	ABC80		EL34	1.00	PCL84	.50	UY85	.50
3U4G	.50	12AD6	.90	ECC2	.45	EL41	.60	PCL505	.70	X41	1.00
5Y3GT	.55	12AE6	.90	EAC91	.65	EL84	.36	PCL86	.55	X66	1.46
5Z4G	.55	12AT6	.47	EAF42	.88	EL506	1.20	PFL200	.82	X76M	.88
6J0L2	.80	12AU6	.53	EAF801	.80	EM80	.53	PL36	.70	Z759	5.85
6AR6	.80	12AV6	.59	EB91	.23	EM81	.76	PL81	.53	AC165	.33
6AQ5	.53	12BA6	.53	EBCA1	.88	EM83	.64	PL82	.43	AD140	.47
6AT6	.53	12BE6	.59	EBCA1	.45	EM84	.47	PL83	.50	AD149	.64
6AU6	.40	12BH7	.59	EBF80	.40	EM87	1.10	PL84	.45	AD151	.59
6AV6	.53	12BY7	.85	EBF83	.50	EY51	.30	PL504	.82	AD162	.59
6BA6	.41	12K5	1.17	EBF89	.40	BY87/6	.40	PL508	1.10	AF114	.33
6BE6	.41	19AQ5	.65	ECC2	.55	EY88	.60	PL509	1.65	AF121	.39
6BH6	.75	20P4	1.17	ECC33	2.00	EZ40	.55	PY33/2	.50	AF121	.39
6BJ6	.64	30C15	.80	ECC35	2.00	EZ41	.55	PY81	.40	AF126	.23
6BQ7A	.64	30C17	.85	ECC40	1.20	EZ80	.55	PY82	.40	BC107	.16
6BR7	1.20	30F5	.75	ECC81	.40	EZ81	.35	PY83	.45	BC108	.16
6BR8	1.25	30FL1	1.10	ECC82	.39	GY501	.82	PY88	.47	BC109	.16
6BW6	1.00	30FL2	1.10	ECC83	.39	GZ32	.59	PY500	1.11	BC113	.33
6BW7	.65	30FL14	.82	ECC84	.40	GZ34	.60	PY800	.45	BC118	.29
6CZ6	.57	30L15	.82	ECC85	.47	KTW61		PY801	.45	BCZ11	.45
6C4	.47	30L17	.76	ECC88	.55		1.76	PZ30	.50	BF158	.29
6C6	.47	30P12	.80	ECC807		KTW62		QQV0310		BF159	.33
6C9	2.00	30P19	.88		1.41		1.76		2.10	BF163	.26
6CL6	.76	30PL1	1.00	ECF80	.50	KTW63		R19	.75	BF180	.39
6CU5	.88	30PL2	.80	ECF82	.50		1.17	U25	.70	BY100	.23
6E5	1.17	30PL131.20		ECF86	.88	KT66	2.93	U26	.65	BY126	2.0
6F1	.80	30PL141.29		ECF804		PABC80		U91	.50	BY127	.23
6F6G	.60	35L6GT	.88		2.63	PC86	.45	U801	.80	OA91	.12
6F18	.64	35M4	.80	ECH35	1.60	PC88	.70	UABC8		OA95	.12
6F23	.80	35Z4GT	.82	ECH42	.80	PC88	.70	UC23	.49	OC21	.49
6F28	.78	50B5	1.00	ECH81	.40	PC97	.42	UAF42	.75	OC24	.49
6H6GT	.29	50C5	.70	ECH83	.52	PC900	.30	UBC41	.60	OC25	.49
6J5GT	.53	50L6GT	.53	ECH86	.40	PC84	.40	UBC1	.60	OC44	.13
6J6	.35		1.00	ECL80	.50	PC85	.30	UBF80	.47	OC45	.14
6K7G	.35	85A2	.75	ECL82	.45	PC88	.65	UBF89	.47	OC46	.20
8K8G	.53	80T	1.17	ECL83	.82	PC89	.50	UC92	.60	OC70	.16
6L6GT	.68	5763	1.76	ECL86	.47	PC8189	.60	UCC94	.90	OC71	.14
6O7G	.50	ATP4	.50	EF22	1.00	PCF80	.47	UC85	.53	OC72	.14
6Q7GT	.60	AZ31	.60	EF40	.88	PCF82	.50	UC90	.90	OC74	.29
6S7G	.52	DAF91	.40	EF41	.82	PCF84	.70	UCF42	.88	OC75	.14
6S17	.64	DAF96	.60	EF80	.30	PCF86	.50	UC81	.47	OC78	.20
6V6G	.30	DF91	.30	EF83	1.45	PCF200		UCL82	.45	OC78D	.20
6W6GT	.53	DF96	.65	EF85	.40	PCF201	1.00	UCL83	.64	OC81	.14
6X4	.47	DK91	.50	EF86	.50	PCF201		UF41	.82	OC81D	.14
6X5GT	.50	DK92	1.15	EF89	.35	PCF801	1.05	UF42	.82	OC82	.14
7B6	.88	DK96	.70	EF91	.50	PCF801	.65	UF80	.41	OC82D	.14
7Y4	.80	DL92	.47	EF92	.60	PCF802	.50	UF85	.52	OC83	.26
9D7	.70	DL96	.64	EF98	.95	PCF805	.85	UF89	.47	OC84	.31
10F1	.88	DY87/6	.41	EF183	.40	PCF806	.60	UL41	.75	OC202	.55
10F18	.60	DY802	.47	EF184	.40	PCR2001.00		UL84	.49	OC205	.55
10P13	.88	E88CC	1.20								

All goods are unused and boxed, and subject to the standard 90-day guarantee. Terms of business: Cash or cheque with order only. Despatch charges:—Orders below £10, add 25p extra per order. Orders over £10 post free. Same day despatch. Terms of business available on request. Any parcel insured against damage in transit for only 3p extra per parcel. Please enclose S.A.E. with any enquiries. Many other types in stock.

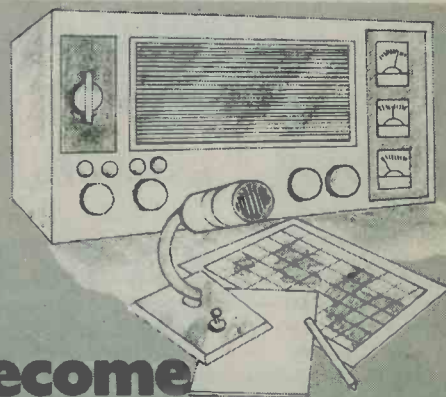

## Become a radio amateur.

Learn how to become a radio-amateur in contact with the whole world. We give skilled preparation for the G.P.O. licence.

Free!

Brochure, without obligation to:

BRITISH NATIONAL RADIO & ELECTRONICS SCHOOL, Dept

P.O.Box 156, Jersey, Channel Islands.

NAME \_\_\_\_\_

ADDRESS \_\_\_\_\_

REB 115

(Block caps please)

# NEW STYLE SELF-BINDER

## for "Radio & Electronics Constructor"

The "CORDEX" Patent Self-Binding Case will keep your issues in mint condition. Copies can be inserted or removed with the greatest of ease. Rich maroon finish, gold lettering on spine.

Specially constructed Binding Cords are made from Super Linen of great strength, very hard twisted and twice doubled. They are attached to strong RUSTLESS Springs under tension, and the method adopted ensures PERMANENT RESILIENCE of the Cords. Any slack that may develop is immediately compensated for and the Cords will always remain taut and strong. It is impossible to overstretch the springs, as a safety check device is fitted to each.

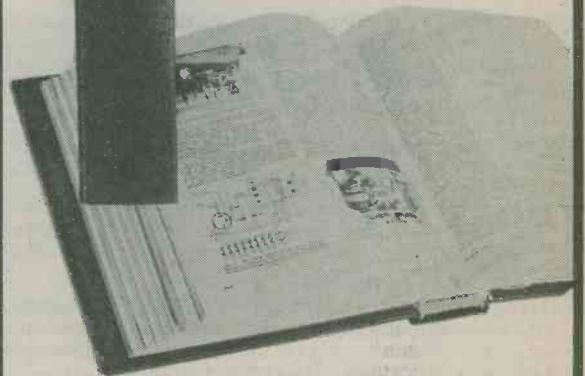

PRICE **£1.00** P. & P. 25p  
including V.A.T.  
Available only from:—

**Data Publications Ltd.**  
57 Maida Vale London W9 1SN

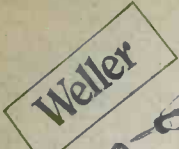

SP15D (15W)  
£2-52 + VAT (20p)

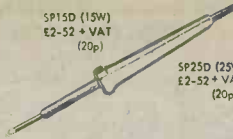

SP25D (25W)  
£2-52 + VAT (20p)

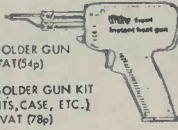

EXPERT SOLDER GUN  
E6-80 + VAT(54p)

EXPERT SOLDER GUN KIT  
(SPARE BITS, CASE, ETC.)  
£9-80 + VAT (70p)

SPARE BITS  
PAIR. 26p + VAT(2p)

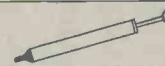

SOLDER SUCKERS STANDARD MODEL E4-50 + VAT (34p)  
SKIRTED MODEL E4-95 + VAT (40p)

---

SERVISOL PRODUCTS.

Super Servisol	65p	+ VAT	5p
Silicone Grease	60p	+ VAT	5p
Foam Cleanser	60p	+ VAT	5p
Plastic Seal	55p	+ VAT	4p
Aero Klene	50p	+ VAT	4p
Freeze-It 6oz standard	50p	+ VAT	4p
Anti-Static Spray Mist	50p	+ VAT	4p
Saloo-Mop	65p	+ VAT	5p
Servisol standard 11n	65p	Zero	—
Supa Freeze-It 8oz 11n	65p	+ VAT	5p

SIDE CUTTERS  
HIGH QUALITY  
"CRESCENT"  
MADE IN USA.  
£5-45 + VAT(44p)



MINIATURE PLIERS  
HIGH QUALITY  
"CRESCENT"  
MADE IN USA  
£4-35 + VAT (35p)



---

SPECIAL OFFER - MIXED BAGS - CAPACITORS 50p, RESISTORS 50p

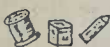

MULTICORE SOLDER  
Size 5 SAVBIT 18swg in alloy dispenser 32p + VAT (3p)  
Size C1SAV18 SAVBIT 18swg 56p + VAT (4p)  
Size 12 SAVBIT 18swg on plastic reel £1.80 + VAT (15p)

**B. BAMBER ELECTRONICS (DEPT REC.)**  
5 STATION ROAD LITTLEPORT CAMBS. CB6 1QE TEL: ELY (0353) 860185 (2 lines)

TERMS OF BUSINESS: CASH WITH ORDER MINIMUM ORDER OF £10. ALL PRICES NOW INCLUDE POST & PACKING (UK ONLY) EXPORT ENQUIRIES WELCOME

CALLERS WELCOME TUESDAY-SATURDAY PLEASE ORDER THROUGH RETAILERS NEAREST TO YOU WITH ALL ENQUIRIES PLEASE ADD VAT AS SHOWN

# REVOR OPTICAL & TECHNICAL

12/13 HENRIETTA ST.,  
LONDON W.C.2  
Tel. 01-836 4536

**£6.00**  
**POST FREE**

**4"** dia. lens

**FLEXIBLE  
MAGNIFIER**

WITH CAST IRON BASE,  
PRECISION GROUND AND  
POLISHED LENS, CHROME PLATED  
FRAME AND FLEXIBLE TUBE.  
IDEAL FOR HOBBIES, AND  
DETAILED WORK WHICH REQUIRES  
BOTH HANDS FREE.

S.A.E. FOR CATALOGUE

(Subject to price ruling at the time of issue)



## SMALL ADVERTISEMENTS

(Continued from page 251)

**UNIQUE VHF KITS, 80-180MHz.** Receiver, tuner converter. World wide sales. Send £5 or s.a.e. for literature. Johnsons Radio (C), Worcester, WR1 3QQ.

**FOR SALE:** 2m converter, mains operated. 24-26MHz. £8. Box No. G278.

**WINDMILL HEATING SYSTEMS,** vertical generators, professional drawings, books, constructional articles, plans, obtainable library, 90 references, bibliography, £2 plus s.a.e. As above solar bibliography £2 plus s.a.e. Stuart & Stuart Engineering, Loversall, Nr. Doncaster, Yorks, DN11 9DG.

**GRIMSBY ELECTRONICS FOR COMPONENTS.** Relays, sirens, surplus equipment, etc. Sample pak 25p. List No. 10 8p. 95 Lambert Road, Grimsby, Humberside.

**FOR SALE:** Polarised relays. Suitable for RTTY terminal units, etc. £1.00 each. Box No. G281.

**BURGLAR/FIRE ALARMS.** Emergency lighting. Professional and D.I.Y. equipment. Catalogue 25p. Castle Alarms, Box W06, Windsor, Berks.

**MENTAL DEVELOPMENT COURSES.** Towards a greater state of memory. Price 8 gns. Dynamic Thinking. A postal course to double your thinking and reading speed. 4 gns. Mitchell, 29 Walton Road, Thorpe Bay, Essex.

**WANTED TO PURCHASE:** All early books on radio, preferably before 1925. Box No. 282.

**KITS CONSTRUCTED.** Send details for quote. Competitive prices. John Robinson, 5 Norfolk Place, Leeds 7, Yorks.

**MAKE A CHEAP STEREO AMP.** from surplus components. Send 20p and s.a.e. for details to: 19 Reginald Road, Eastney, Portsmouth, Hampshire.

**TO CLEAR:** Xtals 2306, 2381, 2009KHz, 3/4" pin spacing, £1 each. Sigma type 72AOZ, 160TG-TCP, polarised relays, octal base, £2 24V d.c. miniature model motor 2" x 1 1/4" diam, 1/8" shaft, £1. Cold cathode tube GC10B, £1. 1 1/2" c.r.t. VLS492AG.F, £2. R.E.P. 3-reed tuned relay, £2. Miniature R.E.P. R/C relay, £1. 2 1/2" mic. insert 25p. Radiospares miniature output for personal receiver, 50p. Transformer 3.2 ohm/600 ohm £1. Ditto 3000 ohm/600 ohm, £1. Telford Communications 2M bandpass aerial filter, £3. TC7 Bandsearcher, £3. 7X electric torch map magnifier, £1. Box No. G283.

**FOR SALE:** Assorted transistors, untested, ample leads, 100 for £1.25. Ex-new electrolytics 100 for £1.25. Resistors 500 for £1.00. Computer panels, 3lbs. 85p, 50p. P. & P. Post on others 30p s.a.e. for list. Robert Broadbent, 24 Flaxton Street, Leeds, 11, West Yorks.

**WANTED:** "Everyday Electronics", January 1975. Whole issue or copy of articles. Price ? John Hunt, 251 West Bruceton, Pittsburgh, PA 15236, U.S.A.

**FOR SALE:** Personal portable receiver chassis, contains speaker, transistors, I.F.'s, etc. £2. Box No. G288.

(Continued on page 254)

## PRECISION

### POLYCARBONATE CAPACITORS

ALL HIGH STABILITY - EXTREMELY LOW LEAKAGE

440V AC (+-10%)	63V DC Range	+1%	+2%	+5%
0.1µF (1 x 1)	51p	0.47µF	67p	50p
0.22µF (1 x 1)	64p	1.0µF	82p	52p
0.25µF (1 x 1)	67p	2.2µF	96p	61p
0.47µF (1 x 1)	80p	4.7µF	£1.62	£1.13
0.5µF (1 x 1)	87p	6.8µF	£1.86	£1.38
0.68µF (1 x 1)	93p	10.0µF	£2.40	£1.95
1.0µF (2" x 1)	£1.03	15.0µF	£3.22	£2.79
2.0µF (2" x 1)	£1.44	22.0µF	£4.28	£3.68

**TANTALUM BEAD CAPACITORS** - Values available: 0.1, 0.22, 0.47, 1.0, 2.2, 4.7, 6.8µF at 15V/25V or 35V; 10.0µF at 16V/20V or 25V; 22.0µF at 6V/10V or 16V; 33.0µF at 6V or 10V; 47.0µF at 3V or 6V; 100.0µF at 3V. ALL AT 10p EACH; 10 for 95p; 50 for £4.00.

### TRANSISTORS:

BC107/B/9	9p	BC183/183L	11p	BF194	12p	BFY51	20p
BC114	12p	BC184/184L	12p	BF196	13p	BFY52	20p
BC147/B/9	10p	BC212/212L	14p	BF197	13p	OC71	12p
BC153/7/8	12p	BC547	12p	AF178	30p	2N3055	50p
BC182/182L	11p	BC558A	12p	BFY50	20p	2N3702/4	11p

1N914 6p; 8 for 45p; 18 for 90p. 1N916 8p; 6 for 45p; 14 for 90p. 1S44 5p; 11 for 59p; 24 for £1.00. 1N4148 5p; 6 for 27p; 12 for 48p.

**LOW PRICE ZENER DIODES:** 400mW; Tol. +-5% at 5mA. Values available: 3V; 3.6V; 4.7V; 5.1V; 5.6V; 6.2V; 6.8V; 7.5V; 8.2V; 9.1V; 10V; 11V; 12V; 13V; 13.5V; 15V; 16V; 18V; 20V; 22V; 24V; 27V; 30V. All at 7p each; 5 for 33p; 10 for 65p. SPECIAL: 100 Zeners for £6.00.

**RESISTORS:** High stability low noise carbon film 5%. 1/2 W at 40°C; 1/4 W at 70°C. E12 series only - from 2.2Ω to 2.2MΩ ALL AT 1p EACH; 8p for 10 of any one value; 70p for 100 of any one value. SPECIAL PACK: 10 of each value 2.2Ω to 2.2MΩ (730 resistors) £5.00.

**SILICON PLASTIC RECTIFIERS** - 1.5 Amp - Brand new wire ended D027: 100 P.I.V. - 7p (4/26p); 400 P.I.V. - 8p (4/30p).

**BRIDGE RECTIFIERS:** 2 1/2 Amp. 200V - 40p; 350V - 45p; 600V - 55p.

**SUBMINIATURE VERTICAL PRESETS** - 0.1W only: ALL AT 5p each; 50Ω, 100Ω, 220Ω, 470Ω, 680Ω 1K, 2.2K, 4.7K, 6.8K, 10K, 15K, 22K, 47K, 100K, 250K, 680K, 1M, 2.5M, & 5M.

**PLEASE ADD 25% V.A.T. TO ORDERS.** PLEASE ADD 15p POST AND PACKING ON ALL ORDERS BELOW £5.00. Send S.A.E. for lists of additional ex-stock items. Wholesale price lists available to bona-fide companies. ALL EXPORT ORDERS ADD COST OF SEA/AIRMAIL.

## MARCO TRADING

Dept. C6, The Old School, Edstaston, NR. WEM, Salop.  
Tel: WHIXALL (Salop) 4645 (STD 094872) (Proprs: Minicost Trading Ltd.)

## ENGINEERS

# FREE



## YOURSELF FOR A BETTER JOB WITH MORE PAY!

Do you want promotion, a better job, higher pay? 'New Opportunities' shows you how to get them through our low-cost home study course. There are no books to buy and you can pay-as-you-learn.

This helpful guide to success should be read by every ambitious engineer. Send for this helpful 76 page FREE book now. No obligation and nobody will call on you. It could be the best thing you ever did.

**POST NOW**

**CUT OUT THIS COUPON**

**CHOOSE A BRAND NEW FUTURE HERE!**

Tick or state subject of interest. Post to the address below.

Prac. Radio & Electronics (with kit)	<input type="checkbox"/>	Motor Mechanics	<input type="checkbox"/>	Inst. Eng. & Techn.	<input type="checkbox"/>
Electronic Eng. Cert.	<input type="checkbox"/>	C & G Motor V Mechs	<input type="checkbox"/>	Maintenance Eng.	<input type="checkbox"/>
Gen. Elec. Eng. Cert.	<input type="checkbox"/>	Gen. Auto Eng.	<input type="checkbox"/>	Welding	<input type="checkbox"/>
C & G. Elect. Install.	<input type="checkbox"/>	A.M.I.M.I.	<input type="checkbox"/>	Computer Prog.	<input type="checkbox"/>
Elect. Install & Work	<input type="checkbox"/>	Air Regn. Brd. Certs.	<input type="checkbox"/>	Inst. of Cost - Management Accts.	<input type="checkbox"/>
C & G Elect. Techn.	<input type="checkbox"/>	M.A.A./I.M.I. Dip.	<input type="checkbox"/>	Gen. Draughtamp.	<input type="checkbox"/>
Colour TV Servicing	<input type="checkbox"/>	Heat, Ventilating & Air Conditioning	<input type="checkbox"/>	Elec. Draughtamp.	<input type="checkbox"/>
C & G Telecoms. Technician's Cert.	<input type="checkbox"/>	Architectural Draughtmanship & Design	<input type="checkbox"/>		
C & G Radio, TV & Electronics Mech. Cert.	<input type="checkbox"/>	L.I.O.B.	<input type="checkbox"/>		
Radio & TV Eng. Course	<input type="checkbox"/>	Carpentry & Joinery	<input type="checkbox"/>		
Radio Serv. & Rep.	<input type="checkbox"/>	Plumbing Tech.	<input type="checkbox"/>		
Radio Amateur's Exam	<input type="checkbox"/>	General Building	<input type="checkbox"/>		
		Paints & Decs.	<input type="checkbox"/>		
		A.M.S.E. (Mech.)	<input type="checkbox"/>		
		General Mech. Eng.	<input type="checkbox"/>		

**GCE 58 'O' and 'A' level subjects - over 10,000 group passes**

Coaching for many major examinations

To ALDERMASTON COLLEGE, Dept. TRE11, READING RG7 4PF  
Also at our London Advisory Office, 4 Fore Street Avenue, Moorgate, London, EC2Y 5EJ Tel: 01-828 2721 **TRE11**

NAME (Block Capitals Please).....  
ADDRESS.....  
POSTCODE..... other subjects..... Age.....

Accredited by C.A.C.C. Member of A.B.C.C.

HOME OF BRITISH INSTITUTE OF ENGINEERING TECHNOLOGY



**ENGINEERS**

**FREE**

**YOURSELF FOR A BETTER JOB WITH MORE PAY!**

Do you want promotion, a better job, higher pay? "New Opportunities" shows you how to get them through our low-cost home study course. There are no books to buy and you can pay-as-you-learn.

This helpful guide to success should be read by every ambitious engineer. Send for this helpful 76 page FREE book now. No obligation and nobody will call on you. It could be the best thing you ever did.



**POST NOW**

**CUT OUT THIS COUPON**  
**CHOOSE A BRAND NEW FUTURE HERE!**

Tick or state subject of interest. Post to the address below.

- |  |   |  |
|--|---|--|
| Build-As-You-Learn <input type="checkbox"/>                                | Electronic Engineering <input type="checkbox"/>                   | Transistor Technology <input type="checkbox"/>                             |
| <b>PRACTICAL RADIO AND ELECTRONICS</b> (with kit) <input type="checkbox"/> | Computer Electronics <input type="checkbox"/>                     | <b>CITY &amp; GUILDS</b> Installations and Wiring <input type="checkbox"/> |
| Electrical Engineering <input type="checkbox"/>                            | Computer Programming <input type="checkbox"/>                     | <b>CITY &amp; GUILDS</b> Electrical Technicians <input type="checkbox"/>   |
| Electrical Installations and Wiring <input type="checkbox"/>               | Colour TV Servicing <input type="checkbox"/>                      | <b>CITY &amp; GUILDS</b> Telecommunications <input type="checkbox"/>       |
| Electrical Draughtsmanship <input type="checkbox"/>                        | C & G Radio, TV and Electronic Mechanics <input type="checkbox"/> | Radio Amateurs' Exam etc. etc. <input type="checkbox"/>                    |
| Electrical Mathematics <input type="checkbox"/>                            | General Radio and TV Engineering <input type="checkbox"/>         | <b>G.C.E. 58 'O' &amp; 'A' LEVELS</b>                                      |
|  | Radio Servicing, Maintenance and Repairs <input type="checkbox"/> | Coaching for many major examinations                                       |

**TO ALDERMASTON COLLEGE, Dept. ERE 11, READING RG7 4PF**  
Also at our London Advisory Office, 4 Fore Street  
Avenue, Moorgate, London, EC2Y 5EJ Tel: 01-628 2721 **ERE 11**

NAME (Block Capitals Please) .....  
ADDRESS .....  
POSTCODE .....  
Other subjects' ..... Age .....  
Accredited by C.A.C.C. Member of A.B.C.C.

**HOME OF BRITISH INSTITUTE OF ENGINEERING TECHNOLOGY**

**SMALL ADVERTISEMENTS**

(Continued from page 253)

**JOIN THE INTERNATIONAL S.W. LEAGUE.** Free services to members including Q.S.L. Bureau, Amateur and Broadcast Translation, Technical and Identification Dept. — both Broadcast and Fixed Stations, DX Certificates, contests and activities for the SWL and transmitting members. Monthly magazine, *Monitor*, containing articles of general interest to Broadcast and Amateur SWLs, Transmitter Section and League affairs, etc. League supplies such as badges, headed notepaper and envelopes, QSL cards, etc., are available at reasonable cost. Send for League particulars. Membership including monthly magazines, etc., £3.75 per annum. (U.K. and British Commonwealth), overseas \$10.00 or £4.00. Secretary ISWL, 1 Grove Road, Lydney, Glos., GL15 5JE.

**POSTAL ADVERTISING?** This is the Holborn Service. Mailing lists, addressing, enclosing, wrapping, facsimile letters, automatic typing, copy service, campaign planning, design and artwork, printing and stationery. Please ask for price list. — The Holborn Direct Mail Company Capacity House, 2-6 Rothsay Street, Tower Bridge Road, London, S.E.1. Telephone: 01-407 1495.

**WANTED URGENTLY** suitable complete working amplifier assembly for "Collaro Studio" 2-track T-deck. All letters answered. Box No. G291.

**THE RADIO AMATEUR INVALID & BEDFAST CLUB** is a well established Society providing facilities for the physically handicapped to enjoy the hobby of Amateur Radio. Please become a supporter of this worthy cause. Details from the Hon. Secretary, Mrs. Rita Shepherd, 59 Paintain Road, Loughborough, Leics., LE11 3LZ.

**RECITALS OF RECORDED MUSIC.** The second Saturday evening of each winter month. Next recital: November 8th, 1975, 8 p.m. at Woodford Green United Free Church, Woodford Green, Essex. Bus routes 20, 20A, 179 & 275 — alight at "The Castle" stop. Programme includes works by Vivaldi, Bruch, Shostakovich and Barber.

**FOR SALE:** Manufacturers' reject walkie-talkies £20.00, working £30.00 (licence required). Miniature f.m. transmitter with microphone £5.50 (licence required). Miniature 12VZP.C.O. relay 30p. IN4007 10p, ZN3819 15p. 10A scr's 50p. XN3 ex-eqpt. 75p. 3015F Minitron £1. 1N914/6 diodes unmarked, 50-50p. 1lb. ferric chloride 75p. 20 mixed crystals £1.10. P.C. pens 75p. TO3 sockets 15p. 100 Unmarked BZY88 50p. 50 unmarked ZW zeners 50p. 100 3-5-7-10W resistors £1. Switch cleaner 50p. 1/8th in. dia. steel wire rope, 100 ft. 75p. S.A.E. for sample. Used cassettes 75p. 10-£1.75. Non-working 19" colour televisions £35. 8 No. 625 mercury cells in case 10p. Stereo cassette mechanism £15. Ni-cad battery chargers 50p. Tachometer motors (needs voltmeter to act as tachometer) £1.50. Unused surplus Avomitor, leather case, £8. Self-sealing plastic bags, mixed sizes, 100-75p. Stereo cassette mechanism £12.50. 4mm plugs and sockets 15p. Box No. G292.

**FREQUENCY LIST TRANSFERS.** We have a limited supply of sheets of Dial Frequency Transfers in black. Short Wave frequencies 1.8Mc/s to 32Mc/s and 144Mc/s and 146Mc/s. Includes amateur band marker frequencies at 100kc/s points and other short wave frequencies from 2 to 32 Mc/s at every 500Kc/s points. Each frequency is repeated. Two sheets for 5p., five sheets for 10p., postage 6p. Data Publications Ltd., 57 Maida Vale, London, W9 1SN.

(Continued on page 255)

**VALVE BARGAINS**

Any 5 60p, 10 90p, 50 £4.00, 100 £7.50. Your choice from the following list:  
ECC82, ECL80, EB91, EF80, EF183, EF184, PC86, PC88, PC97, PC900, PCC84, PCC89, PCC189, PCF80, PCF802, PCF805, PCL82, PCL84, PCL85, PCL805, PCL86, PFL200, PL36, PL504, PY33, PY81, PY800, PY88, EH90, 30FL1, 30FL2, 30PL14.  
Colour Valves 30p each  
PL508, PL509, PY500/A.  
Press 4 Button UHF Tuners £2.50

**AERIAL BOOSTERS**

We make three types of Aerial Boosters all for set top fitting, with Co-ax Plugs and Sockets.  
**B11** — For Stereo and Standard VHF Radio.  
**B12** — For the older VHF Television, please state BBC1 and ITV Channels.  
**B45** — For mono or colour this covers the complete UHF band.  
All Boosters are complete with Battery and take only minutes to fit.  
**Price £3.90 each**

**BARGAIN PACKS**

All Components in the Bargain Packs are unused and marked.  
Pack 1 — Polyester (C280) Axial Leads Capacitors — 250V/W & 400V/W, very good mixed selection from 0.01uF to 2.2uF Price 100 £1.25, 1000 £10 (our choice).  
Pack 2 — Transistors — any 10 90p, any 100 £8 (your choice). AC128 — AC176 — BC113 — BC115 — BC135 — BC153 — BC171 — BC172.  
Pack 3 — 15 Mixed Plugs. mixed selection of co-ax, din 2-3-5 pins, jack standard — 3.5mm-2.5mm. Price £1.25.  
Prices include VAT P&P under £1/10p, £1 to £3/15p, above £3/20p. Overseas at cost. Money back guarantee on all orders.

**ELECTRONIC MAIL ORDER LTD., 62A BRIDGE ST., RAMSBOTTOM, BURY, LANCs. Tel. Rams. 3036**

## SMALL ADVERTISEMENTS

(Continued from page 254)

**FOR SALE:** Light diodes (produce up to 1mA from light) 10p. 25 unmarked BC107/8/9 50p. 25 unmarked 2W zeners 50p. 50 unmarked BZY88 50p. 25 3-5-7W resistors 50p. 0.5V 60mA silicon solar cells £2.00. Box No. G293.

**SELLING:** Lafayette HE-30 general coverage receiver, £30. P.O. relays 150  $\Omega$  22p each. Carriage extra. Box No. G294.

**FOR SALE:** Dual trace oscilloscope Marconi TF1331 DC-15MHz, 14 x 11 x 23, in DP. Original price £395. Sale price £125 with manual and probes. Ring: 01-444-8216 evenings or write: Box No. G295.

## PERSONAL

**JANE SCOTT FOR GENUINE FRIENDS.** Introductions to opposite sex with sincerity and thoughtfulness. Details free. Stamp to: Jane Scott, 3/Con North St. Quadrant, Brighton, Sussex, BN1 3GJ.

**ESSEX GARDENERS.** Buy your Bedding and rock plants, shrubs, etc., also cacti from May's Nurseries, 608 Rayleigh Road, Hutton, Brentwood, Essex. Callers only. Monday to Saturday.

**IF YOU HAVE ENJOYED A HOLIDAY** on the Norfolk Broads, why not help to preserve these beautiful waterways. Join the Broads Society and play your part in determining Broadlands future. Further details from: - The Hon. Membership Secretary, The Broads Society, "Icknield," Hilly Plantation, Thorpe St. Andrew, Norwich, NOR 85S.

**YOUNG MAN DISABLED** needs work at home. Electronic/wire assembly. Would collect and deliver. Mr. B. Grimes, Llainwen, Glanrhyd, Cardigan, Wales, SA43 3PE.

**SPONSORS** required for exciting scientific project. Norwich Astronomical Society are building a 30" telescope to be housed in a 20' dome of novel design. All labour being given by volunteers. Already supported by Industry and Commerce in Norfolk. Recreational. Educational. You can be involved. Write to: NAS Secretary. The Manse, Back Lane, Wymondham, Norfolk.

FINE COPPER BRAID — FOR FLEXIBLE CONNECTIONS AND — DON'T ALL RUSH — BUT SOME OF OUR CUSTOMERS HAVE ACTUALLY BEEN KNOWN TO USE THIS FOR DESOLDERING — IT'S CERTAINLY CHEAP ENOUGH!

5 yds. 1/16" Tinned Copper Braid (Pack W45)	30p
10 yds. 1/32" Plain Copper Braid (Pack W44)	30p
10yds. 1/32" Rolled Flat (Pack W44A)	30p

ALL ABOVE INCLUDE VAT & POSTAGE THIS MONTH  
TERMS CHEQUE OR P.O. WITH ORDER (CROSSED)  
\*Op stamp for list or free with order if requested. Mail order only.  
ATLANTA E.S.P. LTD. (R & E.C.)

10 DRYDEN CHAMBERS, 119 OXFORD STREET, LONDON W1R 1PA

**THE SPACE-AGE GADGET FOR THE ELECTRONICS ENGINEER**  
**LITROBE — BENDS LIGHT ROUND CORNERS**

Throw light on those dark, inaccessible corners. Find that dropped part, see that connection clearly. Liteprobe is fast, accurate — and flexible!

Small hand torch with extension lead of glass fibres protected by plastic sleeve. High concentration of light at tip. No external bulb. Requires two HP7 batteries. Money refunded in seven days if not completely satisfied

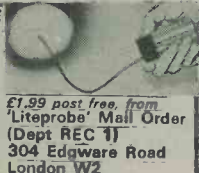

£1.99 post free, from  
"Liteprobe" Mail Order  
(Dept REC 1)  
304 Edgware Road  
London W2

## ESSENTIAL BOOKS!

**POWER SUPPLIES FOR ELECTRONIC EQUIPMENT.** J. R. Nowicki. Published recently in 2 vols. A full treatment of all power supplies is given. Includes rectification, inverters, transverters, silicon diodes and other electronic devices. With full circuit diagrams and component values. Originally published at £4.50 per volume. Bargain price £4 for the 2 volumes incl. postage.

**THE MOBILE RADIOTELEPHONE EQUIPMENT HANDBOOK.** Gives circuits, data and illustrations plus some valuable modification details for COMMERCIAL RADIOTELEPHONE equipment. Price of this edition including postage £6.25.  
**HOW TO MAKE WALKIE-TALKIES FOR LICENSED OPERATION.** 40p, p.p. 15p.

**HOW TO MAKE 2M & 4M CONVERTORS FOR AMATEUR USE.** Fully comprehensive. Contains circuits layouts, component lists, diagrams and full instructional notes. Price 60p, p.p. 15p.

**THE GOVERNMENT SURPLUS WIRELESS EQUIPMENT HANDBOOK.** Gives circuits, data and illustrations plus valuable information for British/USA receivers, transmitters, trans/receivers. £4 including postage.

**DIRECTORY OF GOVERNMENT SURPLUS WIRELESS EQUIPMENT DEALERS!** Gives details of surplus wireless equipment stores and dealers including addresses plus equipment and spares that they are likely to have available. A valuable book only 50p, p.p. 15p.

**GETTING THE BEST FROM YOUR COLOUR TV.** R. Maude. Essential advice for colour TV engineers and owners. Could save you pounds. 50p, p.p. 15p.

**THE THEORY OF GUIDED ELECTROMAGNETIC WAVES.** The most comprehensive book yet written about waveguides, transmission lines, cavity resonators. Over 500 pages. Ideal for anyone interested in Radar and UHF. Published at £11.50. Special offer £4.50 p.p. 50p.

**INTERNATIONAL DICTIONARY OF SEMICONDUCTORS.** A 2-volume electronics dictionary published at £16 available at less than half price. In 7 languages it proves an invaluable addition to any collection of electronics reference books. Contained are 1373 pages packed with information. In leather styled finish. Only £6.50, p.p. 50p.

**THE RADIO CONTROL MANUAL.** Contains numerous plans, photographs and instructions. A large format hardback book published at £1.25. Bargain price 60p, p.p. 20p.

**THE THEORY AND DESIGN OF MAGNETIC AMPLIFIERS.** 487 pages. Published at £1.75. Bargain price 75p, p.p. 25p.

**WORKED EXAMPLES IN ALTERNATING CURRENT.** A must for the student, technician and electrical engineer. Contains numerous examples and how they were arrived at. Published at £1.25. Bargain price 60p, p.p. 20p.

**THE BARGAIN BOOK GAZETTE.** Contains thousands of interesting new and out of print books at bargain prices. Subjects include all types of hobbies, collecting, 1001 interests. Published regularly and sent free on request.

Dept. R. C. GERALD MYERS (Publisher & Bookseller), 138 Cardigan Rd., Headingley, Leeds 6, Yorks. (Callers Welcome).

## CLEARANCE BARGAINS

**SPECIAL OFFER** — Metallised Polyester Capacitors by Erie, Mullard, etc. Values include .01/160V, .01/250V, .015/160V, .022/160V .033/160V, .047/160V, .068/160V, .1/160-250V, .22/160V, etc. This is a bargain not to be missed, 100 for £2.00.

**ASSORTED CAPACITORS,** Silver Mica, Tubular and Disc Ceramics, Polystyrene. Tremendously good selection 300 for £1.70.

**MULLARD FERRITE CORES** LA3 54p, LA4 81p, LA2100 54p.  
OUT OF SPEC. 2N 3055 5 for £1.08

**CERAMIC FORMERS** L23mm Diam. 13mm Bore 1 end 8mm other end 4mm 100 for £1.88.

**ROTARY SWITCHES** very good quality 1P x 18 way x 3 banks 65p

Please note all prices include Postage and V.A.T.

MAIL ORDER ONLY  
**XEROZA RADIO**  
1, EAST STREET,  
BISHOPSTAWTON,  
DEVON

## MORSE MADE BY THE RHYTHM METHOD!

**FACT NOT FICTION.** If you start RIGHT you will be reading amateur and commercial Morse within a month. (Normal progress to be expected.)

Using scientifically prepared 3-speed records you automatically learn to recognise the code RHYTHM without translating. You can't help it. It's as easy as learning a tune. 18-W.P.M. in 4 weeks guaranteed. For Complete Course 3 Records & Books send £4.95 including P.P.I. etc. (overseas surface mail £1 extra.)

For further details of course Ring 01-660 2896 or send large S.A.E. for explanatory booklet to:—S. BENNETT, G3HSC (Box 38) 45 GREEN LANE, PURLEY, SURREY

# PLAIN-BACKED NEW STYLE SELF-BINDERS

The "CORDEX" Patent Self-Binding Case will keep your copies in mint condition. Issues can be inserted or removed with the greatest of ease. Specially constructed Binding cords are made from Super Linen of great strength, very hard twisted and twice doubled. They are attached to strong RUSTLESS Springs under tension, and the method adopted ensures PERMANENT RESILIENCE of the Cords. Any slack that may develop is immediately compensated for, and the Cords will always remain taut and strong. It is impossible to overstretch the springs, as a safety check device is fitted to each.

for your other magazines  
(max. format 7½" x 9½")



PRICE **95p** P. & P. 25p

including V.A.T.

Available only from:—

COLOURS: MAROON OR GREEN

(If choice not stated, colour available will be sent)

**Data Publications Ltd. 57 Maida Vale London W9 1SN**

## DATA BOOK SERIES

- DB5 TV FAULT FINDING**  
132 pages. Price 90p, P. & P. 17p
- DB6 RADIO AMATEUR OPERATOR'S HANDBOOK**  
88 pages. Price 70p, P. & P. 12p
- DB16 RADIO CONTROL FOR MODELS**  
Now out of print
- DB17 UNDERSTANDING TELEVISION**  
504 pages. Price £3.25, P. & P. 50p
- DB18 AUDIO AMPLIFIERS**  
128 pages. Price 53p, P. & P. 14p
- DB19 SIMPLE SHORT WAVE RECEIVERS**  
140 pages. Price 80p, P. & P. 17p

I enclose Postal Order/Cheque for..... in payment for.....

NAME .....

ADDRESS .....

..... (BLOCK LETTERS PLEASE)

*Postal Orders should be crossed and made payable to Data Publications Ltd.  
Overseas customers please pay by International Money Order.  
All publications are obtainable through your local bookseller.  
Data Publications Ltd., 57 Maida Vale, London W9 1SN*

**PLEASE MENTION THIS MAGAZINE WHEN WRITING TO ADVERTISERS**