

THE

RADIO CONSTRUCTOR

Vol. 21 No. 8

MARCH 1968
3/-

RADIO · TELEVISION · ELECTRONICS · AUDIO

A DATA PUBLICATION

Crystal Controlled F.M. Receiver

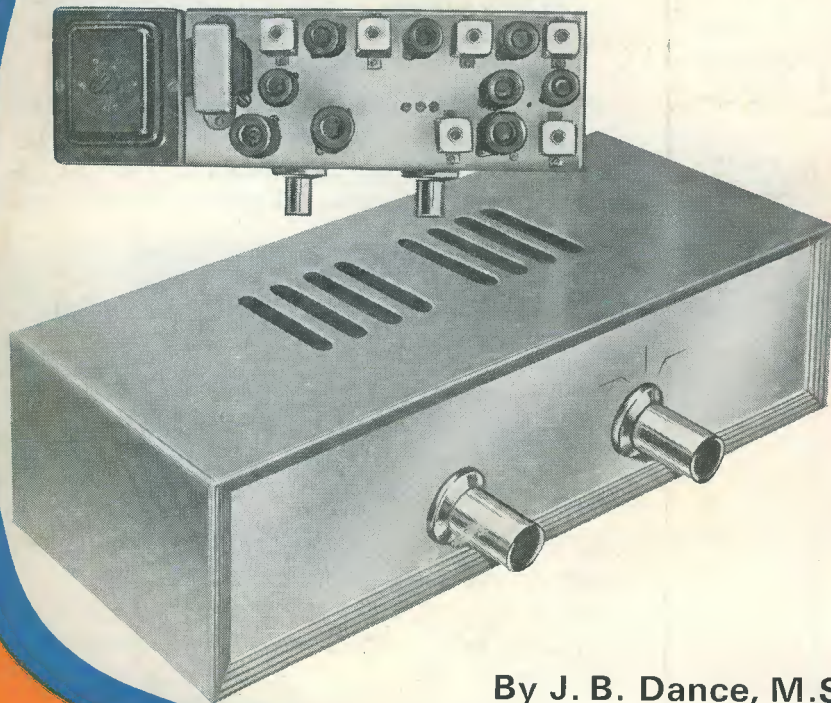

FREE
INSIDE
Two
Detachable
Data
Sheets

By J. B. Dance, M.Sc.

Also featured

Rowing Stroke
Rating Meter

★

Versatile
Signal Generator

★

Car Aerial
Booster

Scottish Insurance Corporation Ltd

66-67 CORNHILL · LONDON · EC3



TELEVISION SETS, RECEIVERS AND TRANSMITTERS

Television Sets, Receivers and Short Wave Transmitters are expensive to acquire and you no doubt highly prize your installation. Apart from the value of your Set, you might be held responsible should injury be caused by a fault in the Set, or injury or damage by your Aerial collapsing.

A "Scottish" special policy for Television Sets, Receivers and Short Wave Transmitters provides the following cover:

- (a) Loss or damage to installation (including in the case of Television Sets the Cathode Ray Tube) by Fire, Explosion, Lightning, Theft or Accidental External Means at any private dwelling-house.
- (b) (i) Legal Liability for bodily injury to Third Parties or damage to their property arising out of the breakage or collapse of the Aerial Fittings or Mast, or through any defect in the Set. Indemnity £10,000 any one accident.
- (ii) Damage to your property or that of your landlord arising out of the breakage or collapse of the Aerial Fittings or Mast, but not exceeding £500.

The cost of Cover (a) is 5/- a year for Sets worth £50 or less, and for Sets valued at more than £50 the cost is in proportion. Cover (b) (i) and (ii) costs only 2/6 a year if taken with Cover (a), or 5/- if taken alone.

Why not BE PRUDENT AND INSURE your installation—it is well worth while AT THE VERY LOW COST INVOLVED. If you write to the Corporation's Office a proposal will be submitted for completion.

Write for full details, quoting reference 5304, to:—

THE MANAGER
SCOTTISH INSURANCE CORPORATION LTD.,
66-67 CORNHILL, LONDON E.C.3

FREE TO AMBITIOUS ENGINEERS

—THE LATEST EDITION OF ENGINEERING OPPORTUNITIES

Have you sent for your copy?

ENGINEERING OPPORTUNITIES is a highly informative 132-page guide to the best paid engineering posts. It tells you how you can quickly prepare at home for a recognised engineering qualification and outlines a wonderful range of modern Home Study Courses in all branches of Engineering. This unique book also gives full details of the Practical Radio & Electronic Courses, administered by our Specialist Electronics Training Division—explains the benefits of our Appointments Dept. and shows you how to qualify for five years promotion in one year.

SATISFACTION OR REFUND OF FEE

Whatever your age or experience you cannot afford to miss reading this famous book. If you are earning less than £30 a week send for your copy of "ENGINEERING OPPORTUNITIES" today—FREE.

WHICH IS YOUR PET SUBJECT

RADIO
TELEVISION
ELECTRONICS
MECHANICAL
CIVIL
PRODUCTION
AUTOMOBILE
AERONAUTICAL
PLASTICS
BUILDING
DRAUGHTSMANSHIP
B.SC.
CITY & GUILDS
GENERAL CERTIFICATE OF EDUCATION
ETC., ETC.

PRACTICAL EQUIPMENT

Basic Practice and Theoretical Courses for beginners in Radio T.V. Electronics Etc. A.M.I.E.R.E. City & Guilds
Radio Amateur's Exam. R.T.E.B. Certificate. P.M.G. Certificate. Practical Radio, Radio & Television Servicing
Practical Electronics
Electronics
Engineering
Automation

INCLUDING TOOLS!

The specialist Electronics Division of B.I.E.T.

NOW offers you a real laboratory training at home with practical equipment.

Ask for details.



POST COUPON NOW!

■ Please send me your FREE 132-page "ENGINEERING OPPORTUNITIES" (Write if you prefer not to cut page)

■ NAME

■ ADDRESS

■ SUBJECT OR EXAM THAT INTERESTS ME 409B

BRITISH INSTITUTE OF ENGINEERING TECHNOLOGY

(Dept. 409B), Aldermaston Court, Aldermaston, Berkshire

THE B.I.E.T. IS THE LEADING INSTITUTE OF ITS KIND IN THE WORLD

Fast Mail Order for the Amateur Radio Enthusiast!

AERIAL EQUIPMENT

TWIN FEEDER. 300 ohm twin ribbon feeder similar K25, 8d. per yard. 75 ohm twin feeder, 6d. per yard. Post on above feeders and cable, 2/- any length.

COPPER WIRE. 14G, H/D. 140 ft., 30/-; 70ft., 16/-. Post and packing 3/3. Lengths are only approx. Actually sold by weight.

FEEDER SPREADERS. 6" Ceramic type F.S., 10d. each. Postage 2/6 up to 12.

CERAMIC CENTRE PIECE for dipoles, Type AT, 1/6 each. P. & P. 1/-.

2 METRE BEAM, 5 ELEMENT W.S. YAGI. Complete in box with 1" to 2 1/2" masthead bracket. Price 56/-. P. & P. 4/-.

SUPER AERAXIAL. 70/80 ohm coax. 300 watt very low loss, 2/3 per yard. 50 ohm 300 watt, 2/6 per yard. P. & P. 2/6.

TOUGH POLYTHENE LINE, type ML1 (100lb.), 2d. per yd. or 12/6 per 100 yds. Type ML2 (220lb.), 4d. per yd. or 25/- per 100 yds., ML4 (400lb.), 6d. per yd. ideal for Guys, L.W. Supports, Halyards, etc. Postage 1/6 on all line.

MIDLAND AGENTS FOR

EDDYSTONE

Receivers & Components

TRIO

Transmitters, Receivers and Sundry Equipment by

- KW ELECTRONICS
- HALSON
- T.W. ELECTRONICS
- CODAR RADIO
- PARTRIDGE (Joystick)

NEW BOXED VALVES

3/6 each, 4 for 10/- P. & P. 2/-.

TYPES

6N7GT	6SF7	6AB7	6SH7	KT41
6AC7	6F7	6SK7	956	Z21
U.10	MSP4	6G6G	IUS	Z22

ABSORPTION WAVEMETERS, 3.00 to 35.00 Mc/s in 3 Switched Bands. 3.5, 7, 14, 21 and 28 Mc/s. Ham Bands marked on scale. Complete with indicator bulb. A MUST for any Ham Shack. ONLY 25/- EACH. P. & P. 1/6.

SHORT WAVE KIT, 1 valve only, 45/-, Phones, Ant. and Batteries 40/- extra if required. Ideal for junior operator.

VARIABLE CONDENSERS. All brass with ceramic end plates and ball race bearings. 50pF, 5/9; 100, 6/6; 160, 7/6; 240, 8/6. Extension for ganging. P. & P. 2/-.

SEALED RELAYS, 12v. 105Ω Coil Type A. 4 Pole, C.O. 15/- Type B.2 Pole, C.O. + 2 Pole Norm. on, 12/6. P. & P. 1/6.



The Widest Range in the Midlands

- ★ HIRE PURCHASE
- ★ PART EXCHANGE

Chas. H. YOUNG Ltd.

At your service G2AK, G3LAY, G3VVF

Please print your address. No. C.O.D. under £1.

'phone 021-236 1635

170-172 Corporation Street,
Birmingham 4

BUY A LOW-PRICED HI-FI SYSTEM A "Package Deal" saves you money



**GARRARD
PLAYER
SP-25**

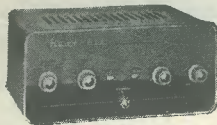

**S-33H
STEREO
AMP**

A basic system can consist of a suitable Record player unit such as the Garrard SP-25 with Deram cartridge, a Stereo Amplifier, Model S-33H and two SSU-1 Loudspeaker systems. Supplied as kits for a total cost of less than **£58**. FM Radio may be added at low cost at a later date. Our Technical Dept. will be pleased to advise on this or any other combination of Heathkit Hi-Fi Models.

NEW! PORTABLE STEREO RECORD PLAYER, SRP-1 Kit £27.15.0

Ready-to-Use price on request



Automatic playing of 16, 33, 45 and 78 rpm records. All transistor—cool instant operation. Dual LP/78 stylus. Plays mono or stereo records. Suitcase portability. Detachable speaker enclosure for best stereo effect. Two 8in x 5in. special loudspeakers. For 220-250V a.c. mains operation. Overall cabinet size 15 $\frac{1}{2}$ x 3 $\frac{1}{2}$ x 10 $\frac{1}{2}$ in.

Compact, economical stereo and mono record playing for the whole Family—plays anything from the Beatles to Bartok. All solid-state circuitry gives room filling volume.



ENJOY YOURSELF AND SAVE MONEY HEATHKIT for Britain Best in Electronic kits

INSTRUMENTS

3" LOW-PRICED SERVICE OSCILLOSCOPE. Model OS-2. Compact size 5" x 7 $\frac{1}{2}$ " x 12" deep. Wt. only 9 $\frac{1}{2}$ lb. "Y" bandwidth 2 c/s-3 Mc/s \pm 3dB. Sensitivity 100mV/cm. T/B 20 c/s-200 kc/s in four ranges, fitted mu-metal CRT Shield. Modern functional styling.

Kit **£23.18.0** Ready-to-Use **£31.18.0**

5" GEN-PURPOSE OSCILLOSCOPE. Model 10-12U. An outstanding model with professional specification and styling. "Y" bandwidth 3 c/s-4.5 Mc/s \pm 3dB. T/B 10 c/s-500 kc/s.

Kit **£35.17.6** Ready-to-Use **£45.15.0**

DE LUXE LARGE-SCALE VALVE VOLT-METER. Model IM-13U. Circuit and specification based on the well-known model V-7A but with many worth-while refinements. 6" Ernest Turner meter. Unique gimbal bracket allows operation of instrument in many positions. Modern styling. Kit **£18.18.0** Ready-to-Use **£26.18.0**

AUDIO SIGNAL GENERATOR. Model AG-9U. 10 c/s to 100 kc/s, switch selected. Distortion less than 0.1%, 10V sine wave output metered in volts and dB's.

Kit **£23.15.0** Ready-to-Use **£31.15.0**

VALVE VOLTMETER. Model V-7A. 7 voltage ranges d.c. volts to 1,500. A.c. to 1,500 r.m.s. and 4,000 peak to peak. Resistance 0.1 Ω to 1,000M Ω with internal battery. D.c. input resistance 11M Ω . dB measurement, has centre-zero scale. Complete with test prods, leads and standardising battery.

Kit **£13.18.6** Ready-to-Use **£19.18.6**

MULTIMETER. Model MM-1U. Ranges 0-1.5V to 1,500V a.c. and d.c.; 150 μ A to 15A d.c.; 0.2 Ω to 20M Ω . 4 $\frac{1}{2}$ " 50 μ A meter. Kit **£12.18.0** Ready-to-Use **£18.11.6**

R.F. SIGNAL GENERATOR. Model RF-1U. Up to 100 Mc/s fundamental and 200 Mc/s on harmonics. Up to 100mV output. Kit **£13.18.0** Rdy-to-Use **£20.8.0**

SINE/SQUARE WAVE GENERATOR. Model IG-82U. Freq. range 20 c/s-1 Mc/s in 5 bands less than 0.5% sine wave dist. less than 0.15 μ sec. sq. wave rise time.

Kit **£25.15.0** Rdy-to-Use **£37.15.0**



OS-2

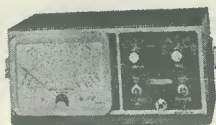

IM-13U



V-7A



RF-1U

Complete your motoring pleasure with this outstanding CAR RADIO, Model CR-1



Will give you superb LW and MW entertainment wherever you drive. Tastefully styled to harmonise with any car colour scheme. Available for your convenience in two separate parts, RF Amp. Kit **£1.13.6** incl. P.T. IF/AF Amp. Kit **£11.3.6**

Total Price Kit (excl. Loudspeaker) **£12.17.0** incl. P.T. 8" x 5" Loudspeaker **£1.16.1** incl. P.T.

TRANSISTOR RADIOS

"OXFORD" LUXURY PORTABLE. Model UXR-2. Specially designed for use as a domestic, car or personal portable receiver. Many features, including solid leather case. Kit **£14.18.0** incl. P.T.

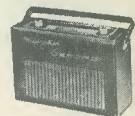

UXR-2

TRANSISTOR PORTABLE. Model UXR-1. Pre-aligned I.F. transformers, printed circuit. Covers L.W. and M.W. Has 7" x 4" loudspeaker. Real hide case. Kit **£12.11.0** incl. P.T.



UXR-1

JUNIOR EXPERIMENTAL WORKSHOP Model EW-1. More than a toy! Will make over 20 exciting electronic devices, incl: Radios, Burglar Alarms, etc. 72 page Manual. The ideal present! Kit **£7.13.6** incl. P.T.

STEREO TRANSISTOR FM TUNER

(Mono version also available)
14 transistor, 5 diode circuit. Tuning range 88-108 Mc/s. Designed to match the AA-22U Amplifier. Available in separate units, can be built for a total price. TFM-IS Kit (Stereo) **£24.18.0** incl. P.T. TFM-IM Kit (Mono) **£20.19.0** incl. P.T. Cabinet extra **£2.5.0**.



FM Tuner

SEE HOW EASY-IT-IS TO BUILD ANY HEATHKIT MODEL YOURSELF

Full details of manual only purchase scheme in latest catalogue. Remember all Heathkit models are fully guaranteed.

VISIT THE HEATHKIT CENTRES

GLOUCESTER Bristol Road Tel. 29451

LONDON 233 Tottenham Ct. Rd. Tel. 01-636 7349

BIRMINGHAM 17-18 St. Martin Hse, Bull Ring Tel. 021-643 4386

NEW! STEREO AMPLIFIER, TSA-12

12 x 12 watts output.

Kit £30.10.0 less cabinet

Ready-to-Use £42.10.0

Cabinet £2.5.0 extra

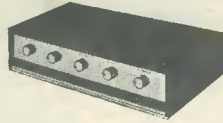

FOR THIS SPECIFICATION

- 17 transistors, 6 diode circuit • \pm 1dB, 16 to 50,000 c/s at 12 watts per channel into 8 ohms • Output suitable for 8 or 15 ohm loudspeakers • 3 stereo inputs for Gram, Radio and Aux. • Modern low silhouette styling
- Attractive aluminium, golden anodised front panel • Handsome assembled and finished walnut veneered cabinet available • Matches Heathkit models TFM-1 and AFM-2 transistor tuners.

Full range power . . . over extremely wide frequency range. Special transformerless output circuitry. Adequately heat-sinked power transistors for cool operation—long life. 6 position source switch.

FULL SPECIFICATION SHEET AVAILABLE

NEW! STEREO TAPE RECORDER, STR-1



Fully portable—own speakers

Kit £45.18.0

Ready-to-Use £59.15.0

FOR THIS SPECIFICATION

- $\frac{1}{2}$ track stereo or mono record and playback at $7\frac{1}{2}$, $3\frac{3}{4}$ and $1\frac{1}{2}$ ips • Sound-on-sound and sound-with-sound capabilities • Stereo record, stereo playback, mono record and playback on either channel • 18 transistor circuit for cool, instant and dependable operation
- Moving coil record level indicator • Digital counter with thumbwheel zero reset • Stereo microphone and auxiliary inputs and controls, speaker/headphone and external amplifier outputs . . . front panel mounted for easy access • Push-button controls for operational modes • Built-in stereo power amplifier giving 4 watts rms per channel • Two high efficiency 8" x 5" speakers • Operates on 230V a.c. supply.

Versatile recording facilities. So easy to build—so easy to use.

FULL SPECIFICATION SHEET AVAILABLE

See HEATHKIT at the IDEAL HOME LONDON, March 5-30th 1968 Stand 201



Low-priced STEREO FM RADIO

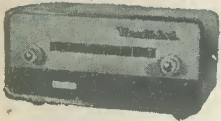

FM
TUNER
FM-4U

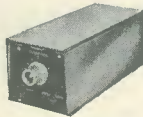

STEREO
DECODER
SD-1

HI-FI FM TUNER. Model FM-4U. Available in two units. R.F. tuning unit (£2.15.0 incl. P.T.) with I.F. output of 10.7 Mc/s, and I.F. amplifier unit, with power supply and valves (£13.13.0). May be used free standing or in a cabinet. Total Kit £16.8.0 (Stereo decoder available, as extra.) Ready-to-Use price on request

STEREO DECODER. Model SD-1. Converts FM Mono receivers to stereo at low-cost. Styled to match Heathkit models FM-4U and AFM-1 Tuners. Kit £8.10.0 Ready-to-use £12.5.0



SSU-1

SPEAKER SYSTEMS

HI-FI SPEAKER SYSTEM, Model SSU-1
Ducted-port bass reflex cabinet in the white: Two speakers, vertical or horizontal models with legs. KIT £12.12.0, without legs, KIT £11.17.6 incl. PT.

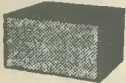

AVON MINI SPEAKER SYSTEM

6 $\frac{1}{2}$ " Bass, 3 $\frac{1}{2}$ " Treble speakers and crossover unit. Kit £4.18.0 incl. PT. Beautiful. Walnut veneered fully-finished cabinet, £8.18.0, Total price Kit £13.16.0 incl. PT.

"AMATEUR" EQUIPMENT

THE "MOHICAN" GENERAL COVERAGE RECEIVER. Model GC-1U. With 4 piezo-electric transistors, variable tuned B.F.O. and Zener diode stabiliser, this is an excellent fully transistorised general purpose receiver for Amateur and Short wave listeners. Printed circuits, telescopic aerial, tuning meter and large slide-rule dial. Kit £37.17.6 Ready-to-Use £45.17.6

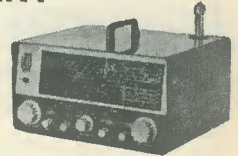

GC-1U

AMATEUR BANDS RECEIVER. Model RA-1. To cover all the Amateur Bands from 160-10 metres. Many special features, including: half-lattice crystal filter; 8 valves; signal strength "S" meter; tuned R.F. Amp. stage. Kit £39.6.6 Ready-to-Use £52.10.0

160-10M TRANSMITTER. Model DX-100U. Careful design has achieved high performance and stability. Completely self-contained. Kit £81.10.0 Ready-to-Use £106.15.0



RG-1

COMMUNICATIONS TYPE RECEIVER. Model RG-1. A high performance, low cost receiver for the discriminating listener. Frequency coverage: 600 kc/s-1.5 Mc/s and 1.7 Mc/s-32 Mc/s. Kit £39.16.0 Ready-to-Use £53.0.0

Low-cost 3 + 3W Transistor Stereo Amplifier, TS-23



Incorporating all the essential features for good quality sound reproduction from record, radio and other sources. 16 Transistor, 4 diode circuit. Good frequency response 6 position selector switch. Modern slim line styling.

Kit (less cabinet) £17.15.0

Kit (with handsome finished cabinet) £18.19.0



Send for this
Catalogue . . .

. . . it's FREE!

36 pages packed with Britain's largest selection of electronic Kits. Mail coupon or write:

**DAYSTROM LTD., Dept. RC-3
GLOUCESTER. Tel. 29451.**

To DAYSTROM LTD., GLOUCESTER

Please send me FREE BRITISH CATALOGUE

Please send me details of models

NAME _____

ADDRESS _____

RC-3



A NO-COMPROMISE HIGH-FIDELITY LOUDSPEAKER

Listen to a Q.14. Hear it in your own home. It is the result of long and thorough investigation into speaker design in order to produce one which would outperform anything within pounds of its price. How far we have succeeded can be seen from the independently taken test report which compares excellently with loudspeakers over four times the price. The Sinclair Q.14 is uncommonly versatile, too. It can serve as a free-standing unit for bookshelf, etc., as a corner radiator, or be flush mounted in a multi-unit assembly. Power handling capacity is in excess of 14 Watts with remarkably smooth response between 60 and 16,000 c/s. Size $9\frac{3}{4}$ " square x $4\frac{3}{4}$ " deep. In black matt finish with solid aluminium bar embellishment and detachable plinth base.

SINCLAIR
Q.14
£6.19.6

TRY IT IN YOUR OWN HOME—MONEY (INC. POSTAGE) REFUNDED IF NOT SATISFIED

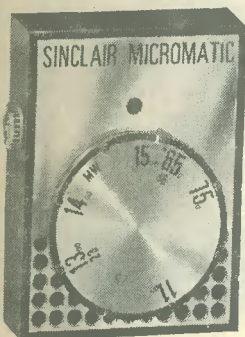

SINCLAIR MICROMATIC PRICE REDUCED

With sales and export orders for the Sinclair Micromatic breaking all records, we have changed over to new production methods to meet the ever-increasing demand for the world's smallest radio set. This has enabled us to effect dramatic economies in production costs. At the same time, we have appreciably improved the set's quality by supplying a magnetic earpiece with it, and what was superb performance before, now sounds better than ever. At the new prices, everyone is going to want the Micromatic. Order yours now for prompt delivery.

Kit complete with magnetic earpiece, solder and instructions, originally 59/6, now

49'6

Post Paid

Ready built with magnetic earpiece, originally 79/6 now

59'6

Post Paid

2 Mercury Cell long life batteries for either of above, each, 2/9d.

- $14\frac{1}{5} \times 13\frac{1}{10} \times 1\frac{1}{2}$ "
- Plays anywhere
- M.W., A.G.C. and Bandpass
- Kit or Built

SINCLAIR Z.12 12 WATT INTEGRATED HI-FI AMPLIFIER AND PRE-AMP

- Size $3" \times 1\frac{3}{8}" \times 1\frac{1}{2}"$.
- 8 special HF transistors.
- Ultra-linear class B output and generous neg. feedback.
- Response—15 to 50,000 c/s ± 1 dB.
- Output suitable for 3, 7.5 and 15 ohm loads. Two 3 ohm speakers may be used in parallel.
- Input—2mV into 2K ohms.
- Signal to noise ratio—better than 60dB.

USE IT FOR HI-FI, RADIO, MUSICAL INSTRUMENTS, INTERCOM, P.A., etc.



SINCLAIR RADIONICS LIMITED
22 NEWMARKET RD., CAMBRIDGE
Telephone OCA3 52996

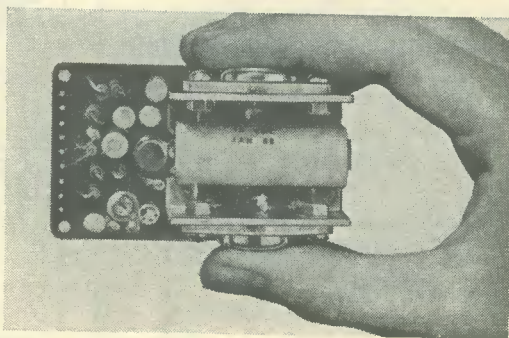

SINCLAIR STEREO 25
Pre-amp/Control Unit for two Z.12s in stereo, built.
£9.19.6

SINCLAIR PZ.4
Stabilised Heavy Duty Mains Power Unit. Delivers 18V. d.c. at 1.5 amp.
99/6

Ready built, tested & guaranteed with Z.12 manual

89'6

- 12 watt RMS continuous sine wave
- Ideal for battery operation

GUARANTEE If you are not completely satisfied when you receive your purchase from us, your money will be refunded at once, in full and without question.

SINCLAIR RADIONICS LTD., 22 NEWMARKET ROAD, CAMBRIDGE

Please send _____

NAME _____

ADDRESS _____

for which I enclose cash/cheque/money order

value £ _____ s _____ d _____

RC3

BOUND VOLUME No. 20
of "The Radio Constructor"
FOR YOUR LIBRARY

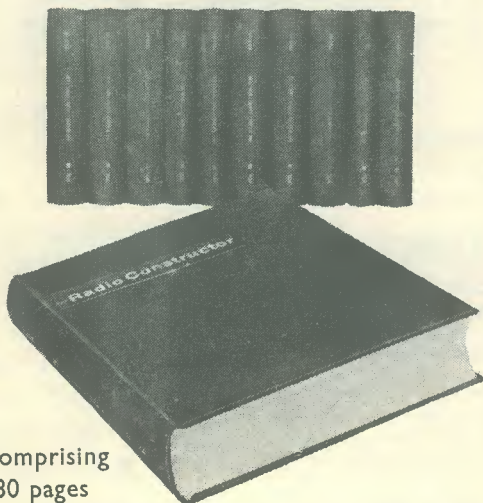

Comprising
780 pages
plus index

Volume 20 August 1966 to July 1967

PRICE 32/6 Postage 4/6

Special discount of 10/- for regular readers

Where the 12 monthly issues making up the volume are returned, the price is only 22/6 plus 4/6 postage

BOUND VOLUME No. 19
August 1965 to July 1966
*Limited number still available
same prices as above*

Available only from:—

Data Publications Ltd.

57 Maida Vale London W9

Radio Control . . .

a complete

**TRANSMITTER
and RECEIVER**

for the home constructor

- THE R-M "SINGLET"
SINGLE CHANNEL TRANSISTOR
TRANSMITTER AND RECEIVER
—CIRCUITS AND BUILDING
INSTRUCTIONS PUBLISHED IN

**"RADIO
MODELLER"**

★ *Special offer—*

*For only 2/6d you get a copy of the
January issue containing the RE-
CEIVER article PLUS FREE REPRINT
of the article on building the TRANS-
MITTER*

Just send 2/6 P.O. to:—

**RADIO
MODELLER**

*"the magazine
for the
practical
enthusiast"*

64 WELLINGTON ROAD, HAMPTON HILL, MIDDX.

- OTHER ELECTRONIC constructional features—

ADD-ON PULSER (December 1966)
COMBINATION CODER (January 1967)
PULSE RECEIVER (June 1967)

the above issues are still available, 2/6 each post free.

THE MODERN BOOK CO

Colour Television: Pal System. By G. N. Patchett. 40s. Postage 1s.

Aerial Handbook. By G. A. Briggs with R. S. Roberts. 15s. Postage 1s.

Tape Recording for the Hobbyist. By A. Zucker-
man. 26s. Postage 1s.

Everyman's Wireless Book. Pub: Newnes. 21s.
Postage 1s.

Basic Theory & Application of Transistors.
By U.S. Dept. of Army. 12s. Postage 1s.

TV Servicing Made Easy. By W. Lemons. 24s.
Postage 1s.

Mullard Data Book 1968. 3s. 6d. Postage 6d.

TV Fault Finding 405/625 Lines. A Data Pub.
8s. 6d. Postage 6d.

Radio Valve Date 8th Ed. Compiled by "WW".
9s. 6d. Postage 1s.

World Radio TV Handbook. 1968. 42s. Postage 1s.

Outline of Radio & Television. By J. P. Hawker.
30s. Postage 2d. 6s.

Hi Fi Yearbook. 1967/8. 15s. Postage 1s.

Practical Wireless Service Manual. By H. W.
Hellyer. 25s. Postage 1s.

Electronic Novelty Designs. By I. J. Kampel.
8s. 6d. Postage 6d.

Transistors for Technical Colleges. By L.
Barnes. 25s. Postage 1s.

Inter: GEC Transistor Manual. 7th ed. 21s.
Postage 2s.

Tape Recorder Servicing Mechanics. By H.
Schroder. 30s. Postage 1s.

Television Servicing H'book. By G. J. King.
35s. Postage 1s.

We have the Finest Selection of English and American Radio Books in the Country

19-21 PRAED STREET (Dept RC) LONDON W2

Telephone PADdington 4185

PRE-PAK

SEMICONDUCTORS

DISTRIBUTED EXCLUSIVELY BY

BI-PRE-PAK LTD., DEPT. E.
222-224 WEST ROAD, WESTCLIFF-ON-SEA, ESSEX
PHONE: SOUTHEND (0702) 46344

**NEW FROM THE U.S.A.
"TEXAS" Integrated Circuits**

SN7360	Quadruple 2 Input Nand/Nor Gate	19/6
SN7430	8 Input positive Nand Gate	21/6
SN7302	Dual J-K Flip-Flop with pre-set	35/-
F.E.T'S.	Field Effect Transistors	
2N3822	'N' Channel 4-lead	15/-

No.		PRICE
A1.	6—Silicon rectifiers BY100 type	20/-
A3.	20—Mixed marked and tested trans.	20/-
A9.	1—2N 174 real power trans. 80V 150W	20/-
A15.	2—Power Comp. Pair. AD161/2	20/-
B1.	50—Unmarked untested, trans., new	10/-
B2.	4—Solar cells, inc. Book of Instruc- tions	10/-
B3.	4—OA5 gold bonded, diodes Mul- lard	10/-
B5.	7—Matched set, OC44, 45/81D/81 + diode	10/-
B6.	15—Red spot AF. trans. or white spot RF	10/-
B8.	2—Power trans. OC26/35 type	10/-
B9.	1—Light sensitive cell, ORP12 type	9/-
B10.	10—50V trans. germ. PNP latest type	10/-
B44.	1—Tunnel diode, AEY11, 1050 Mc/s	10/-
B21.	2—Sil. recs. 10 amp., 50-100 PIV	10/-
B42.	5—Switching trans. TK22C STC	10/-
C2.	1—Uni junction, 2N2160 or 2N2646	15/-
C4.	2—RF power trans., OC22 and BUY11	15/-
C31.	4—Sil. recs. 800 PIV $\frac{1}{2}$ amp. top hat	15/-
C32.	2—Power trans. TK400A/NKT404 VCB64 IC 8 amp.	15/-
D18.	1—ORP60 type light sensitive cell	5/-

BRAND NEW

SAVE £'s

WE TELL YOU

DON'T TAKE

CHANCES ON

UNKNOWN

LOTS

UNTESTED
TRANSISTORS

★ TEST THEM
YOURSELVES

★ WHAT TYPES
THEY ARE

TRANSISTORS	PRICE
25 BSY95A NPN Silicon	TRANSISTORS 10/-
10 1000 PIV 1 amp. Min. Silicon	DIODES 10/-
25 BSY26-27 NPN Silicon	TRANSISTORS 10/-
10 10 Watt Silicon All Voltages	ZENERS 10/-
25 2N1131-32 PNP Silicon	TRANSISTORS 10/-
AC107	6/-
AC126	2/6
AC128	2/6
AC127	3/-
ACY17	5/-
AF114	4/-
AF115	3/-
AF116	3/-
AF117	4/-
AF118	3/6
AF119	3/6
BCZ11	7/6
BF50	15/-
BSY25	10/-
BSY26	5/-
BSY27	5/-
BSY28	5/-
BSY29	5/-
BSY95A	5/-
OC41	2/6
OC44	1/11
OC45	1/9
OC71	2/6
OC72	2/6
OC73	5/-
OC81	2/6
OC81D	2/6
OC83	4/-
OC139	2/6
OC140	5/-

RECTIFIERS	TRANSISTORS	DIODES	ZENERS
10 4 amp. Stud. Silicon	TRANSISTORS 10/-		
25 BC107-8-9 NPN Silicon	TRANSISTORS 10/-		
40 IN914-6 Sub. Min. Silicon	DIODES 10/-		
50 Min. Germ. High Quality	DIODES 10/-		
25 2N706 A NPN Silicon	TRANSISTORS 10/-		
OC170	2/6	2S303	2/6
OC171	4/-	POWER TRANSISTORS	
OC200	5/-	OC20	10/-
OC201	8/-	OC23	10/-
2G301	2/6	OC25	8/-
2G303	2/6	OC26	5/-
2N697	5/-	OC28	7/6
2N706	5/-	OC35	5/-
2N711	10/-	OC36	7/6
2N1302	4/-	DIODES	
2N1303	4/-	AA42	2/-
2N1304	5/-	OA9	2/-
2N1305	5/-	OA10	2/-
2N1306	6/-	OA70	1/9
2N1307	6/-	OA79	1/9
2N1308	8/-	OA81	1/9
2N1309	8/-	OA182	2/-

FREE ★ ★
Packs of your own
choice to the value
of 10/- with all
orders over £4.

SEND FOR OUR FREE LISTS AND CAT-
ALOGUE OF ALL OUR PRODUCTS. CHECK
YOUR OWN EQUIVALENTS WITH OUR
FREE SUBSTITUTION CHART.

NO CONNECTION WITH ANY OTHER FIRM
MINIMUM ORDER 10/- CASH WITH ORDER
PLEASE. Add 1/- post and packing per order.
OVERSEAS ADD EXTRA FOR AIRMAIL.

Great News ★
We now give a
written guarantee
with all our semi-
conductors.

Read any good books lately?

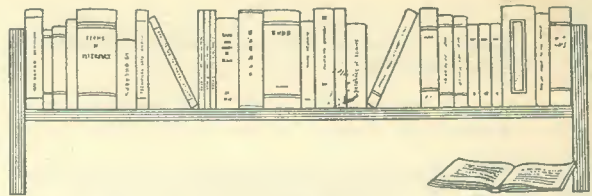

Many people find our Components Catalogue invaluable, especially when searching for rare and difficult items. We wonder however if they realise that in the latest edition, the Book Section alone lists over 200 titles, covering all aspects of Electronics, T.V., Radio and Hi-Fi, each with a brief description of the contents.

Set out below are just a few. If you are interested in the complete list we suggest you send for our catalogue, price 7/6 plus 2/- p.p. Every catalogue contains 5 Vouchers, each worth 1/- if used as directed. Send the coupon with your cheque or P.O. for 9/6.

1. AUDIO, HI-FI AND TAPE RECORDING

Title	Author	Publisher	Pages
A.F. amplification One of a set of four Philips paperback covering the syllabus of the former "From the electron to the superhet." Covers A.F. and R.F. amplification, detection and servicing notes.	E. J. Black	Iliffe	90
Audio quality A Philips paperback dealing with the problems of Hi-Fi. The sort of book which can be read without causing mental indigestion.	G. Slot	Iliffe	167
Cabinet handbook A short introduction to woodworking, also a few cabinet designs and instructions for fixing the well-known "Tygan" covering material.	G. A. Briggs	Wharfedale	112
Hi-Fi amplifier circuits An extended version of the well-known Mullard "Circuits for audio amplifiers." It gives the single ECL86 3-W amplifier, 10-W amplifier using two ECL86, 20-W using two pairs of EL84, A 10-W single-ended push-pull, plus most of the original circuits.	E. Rodenhuis	Philips Technical Library	125
Loudspeakers Widely recognised as the bible of loudspeakers, their design, development and applications. Warmly recommended to anyone interested in this subject.	G. A. Briggs	Wharfedale	336
Magnetic recording handbook Deals with the early developments of recording, the basic requirements of a tape recorder and a long chapter on commercial equipment.	R. E. B. Hickman	Newnes	192
Questions and answers on audio A neat little book covering all aspects of audio from stereo reproduction, amplifiers and loudspeakers to loudspeaker enclosures.	C. Brown	Newnes	104
Records and gramophone equip. A "How it works" book covering design and construction of amplifiers, pickups, loudspeakers, autochangers, etc.	E. N. Bradley	Price	124
Your book of tape recording Young person's guide to the tape recorder and its applications, dealing with taping as a hobby, and a glimpse into its possible future.	K. Peters	Faber	87

2. ELECTRICITY

Title	Author	Publisher	Pages
Basic electricity This book employs the well-known picture book method—is really a companion book to <i>Basic electronics</i> , most strongly recommended. Also available in five separate volumes.		Technical Press	570
Beginners guide to automobile electrical equipment Covers generation of power, control equipment, distribution, ignition, battery, lights, fuel pumps, etc.	J. H. M. Sykes	Newnes	174
Notes for radio mechanics Employs the well-known picture book method and explains the fundamentals of electricity as well as components, with the minimum of maths. Strongly recommended.		H.M.S.O.	197

3. ELECTRONIC MUSICAL INSTRUMENTS

Title	Author	Publisher	Pages
Transistor electronic organs for the constructor A 100% practical book covering oscillators, swell registers, percussion and reverberation circuits.	Douglas/Astley	Pitman	76

4. ELECTRONICS

Title	Author	Publisher	Pages
Basic electronics Impossible to recommend too highly. From it the beginner can acquire a sound knowledge in a most enjoyable manner since everything is explained by means of pictures.		Technical Press	625
Electronics for young experimenters A very unusual book containing 71 experiments in electronics, the parts for which are simple and inexpensive, mostly handmade.	W. E. Pearce	Bell	160
Practical robot circuits An introduction to electronic sensory systems, including a design for a robot dog which comes when whistled.	A. H. Bruinsma	Philips Technical Library	125
Your book of electronics A good book for the beginner, covers the simple theory of the valve, transistor, telstar, electron-microphone, radar, etc.	T. L. Squires	Faber	74

5. RADIO

Title	Author	Publisher	Pages
Foundations of wireless The latest edition of this famous textbook, now with chapters on transistors. Nearly a quarter of a million copies have been sold.	M. G. Scroggie	Iliffe	388
Outline of radio and television A very comprehensive book, readable, practical and right up-to-date. Even includes details on decoders and a brief mention of the P.A.L. system of colour T.V.	J. P. Hawker	Newnes	400
Radio circuits, a step by step survey A survey of valve and transistor circuits, both A.M. and F.M., from the fundamentals to the complex, including some fold-out circuits. Its aim is to teach the reading of circuit diagrams.	Miller/Spreadbury	Iliffe	228
Radio receiver servicing Highly recommended for its down-to-earth approach to radio servicing and the way it presents old "dodges" and new techniques.	J. T. Frye	Foulsham/Sams	222
Radio servicing Covers latest valve and transistor circuits. Each chapter concludes with exercises. Recommended for the beginner who has grasped basic circuits.	L. Butterworth	E.U.P.	218
Radio, television, electrical repairs Thirty chapters covering mains, battery and car radios, valve and transistor TV, record players, Hi-Fi equipment, tape recorders, domestic appliances and wiring.	R. C. Norris	Odhams	576
Short wave amateur radio Guide to amateur radio for the beginner, covering receivers, aerials, transmitters and test equipment. Four fold-out sections give details of construction for T.R.F. and superhet receivers, and a transmitter.	J. Schaap (PAOHH)	Philips Technical Library	158
Short wave listening A Philips paperback. Covering propagation of radio waves, construction of aerials, choice of receiver and rules for reporting long distance signals.	J. Vastenhouid	Iliffe	107
Technical topics for the radio amateur A collection of articles which appeared under "Technical topics" in the R.S.G.B. Bulletin. A mine of information for anyone who can construct units from basic information. Strongly recommended.	P. Hawker	R.S.G.B.	100

6. SEMICONDUCTORS

Title	Author	Publisher	Pages
Principles of transistor circuits Third edition of what is probably the best book on transistors and their use in common circuits. There is some mathematics but this is unavoidable. Strongly recommended.	S. W. Amos	Iliffe	294
Servicing transistor radios and printed circuits A book which should appeal to the amateur and apprentice, covers the theory of transistor circuits found in radios.	L. C. Lane	Iliffe	263
Transistor pocket book An up-to-date, readable book covering theory of semiconductor devices. Then audio amplifiers, oscillators, receivers, switches, D.C. amplifiers, power supplies, etc.	R. G. Hibberd	Newnes	304

7. TELEVISION

Title	Author	Publisher	Pages
PAL colour television The most up-to-date and authoritative book on this subject. Published April 1967. With fold-out diagrams of complete receivers. For the service engineer.		Mullard	94
Understanding television A readable book taking us up to the latest developments in colour T.V. All fundamental circuits discussed in detail with some illustrations of possible faults.	J. R. Davies	Data	504

8. TEST EQUIPMENT

Title	Author	Publisher	Pages
Oscilloscope measuring technique A huge book! In 3 parts: Part One, the oscilloscope itself covering the operation of the tube, the power supply, timebase units of all types, amplifiers, measuring techniques in every detail; Part Three covers 29 practical applications, from studying fluorescent lamps, television to examining camera shutters. The last word on the oscilloscope.		Philips Technical Library	620
Practical oscilloscope handbook As the title indicates this is a most practical book. An unusual feature is the chapter on photographing the screen.	R. P. Turner	Iliffe	179

Please write your Name and Address in block capitals

Name

Address

Home Radio (Mitcham) Ltd., Dept. RC, 187 London Rd., Mitcham, CR4 2YQ

THE Radio Constructor



Incorporating THE RADIO AMATEUR

MARCH 1968

Vol. 21 No. 8

Published Monthly (1st of Month)
First Published 1947

Editorial and Advertising Offices
57 MAIDA VALE LONDON W9

Telephone Telegrams
CUNningham 6141 Databux, London

© Data Publications Ltd., 1968. Contents may only be reproduced after obtaining prior permission from the Editor. Short abstracts or references are allowable provided acknowledgement of source is given.

Annual Subscription 42s. (U.S.A. and Canada \$5) including postage. Remittances should be made payable to "Data Publications Ltd". Overseas readers please pay by cheque or International Money Order.

Queries. We regret that we are unable to answer queries other than those arising from articles appearing in this magazine nor can we advise on modifications to equipment described. Queries should be submitted in writing and accompanied by a stamped addressed envelope for reply.

Correspondence should be addressed to the Editor, Advertising Manager, Subscription Manager or the Publishers as appropriate.

Opinions expressed by contributors are not necessarily those of the Editor or proprietors.

Production.—Letterpress/contact litho.

Published in Great Britain by the Proprietors and Publishers
Data Publications Ltd. 57 Maida Vale London W9
Produced by Quicks the Printers,
Clacton-on-Sea, England

Rowing Stroke Rating Meter	458
<i>by D. M. P. Freeman</i>	
Car Aerial Booster Circuit	461
(Suggested Circuit No. 208)	
<i>by G. A. French</i>	
Can Anyone Help?	463
News and Comment	464
Super-Efficient Mains Filter Unit	466
<i>by A. Irwin</i>	
Versatile Signal Generator	468
<i>by S. J. Kearley</i>	
Transistor Circuits for Improving Relay Sensitivity	472
<i>by B. T. Hathaway</i>	
Radio Constructors Data Sheet No. 3	473
(Frequency/Wavelength Conversion Chart)	
Trade Review	474
Sinclair "Neoteric 60" Stereo Amplifier	
Trade Review	481
Heathkit Portable Stereo Tape Recorder Model STR-1	
Crystal Controlled F. M. Receiver, Part 1	482
<i>by J. B. Dance, M.Sc.</i>	
Radio Constructors Data Sheet No. 4	491
(International Morse Code and N.A.T.O. Services Telephony Code)	
Recent Publications	493
Gas Filled Detectors for Nuclear Radiation	494
<i>by M. J. Darby</i>	
The "Secret Voter"	498
<i>by R. Miller</i>	
Understanding Radio	500
(Negative Feedback)	
<i>by W. G. Morley</i>	
In Your Workshop	503
Radio Topics	508
<i>by Recorder</i>	

MARCH 1968

457

Rowing Stroke Rating Meter

by

D. M. P. FREEMAN

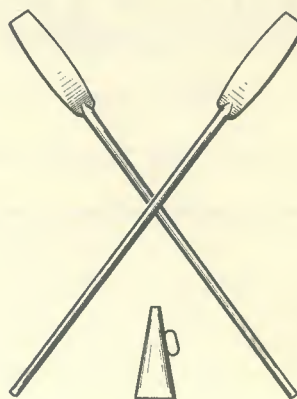

The primary function of this pulse rating meter is to indicate directly, on a $50\mu\text{A}$ meter, rowing stroke frequency up to 50 strokes a minute. However, the basic operating principle may be readily adapted for the direct frequency measurement of other slow pulse trains

THERE ARE A NUMBER OF APPLICATIONS IN WHICH an inexpensive slow speed pulse frequency meter may usefully be brought into service. The author's own need for such an instrument arose when he was asked to provide for a rowing eight an instrument that would indicate, in a similar manner to the rev. counter on a car, the rate at which the oarsmen are taking strokes. The rating, up to 50 strokes per minute, is read directly off a $50\mu\text{A}$ meter mounted in the unit. This can be fitted to the boat, and thus the need for continual stop-watch readings to be taken to determine the rate of striking of the crew is removed.

Obtaining The Pulses

In order to operate the pulse frequency meter a series of pulses is required whose frequency is proportional to the rate at which the oarsmen are taking strokes. This means that a pulse must be produced each time the oarsmen take a stroke or, alternatively, two evenly spaced pulses produced for each stroke taken. In a racing eight the oarsmen

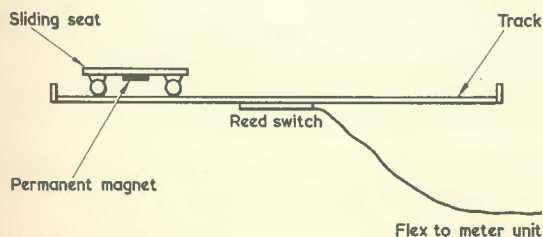

Fig. 1. How the reed-switch and magnet are fitted to the oarsman's seat and track

usually sit on sliding seats, and in the course of a stroke they move their seats up and down the slide once, the displacement of the seat from one end of the slide to the other usually being about 18in. The easiest way to obtain the required pulse series is to arrange that a switch operates every time one of the oarsmen passes over the mid-point of his slide; in this way two pulses are obtained for each stroke taken.

The switching arrangement could not, incidentally, employ a micro-switch as this would offer distraction to the oarsman when passing over the mid-point of his slide. The problem is, however, very easily overcome by the use of a reed-switch mounted at the slide mid-point, with a permanent magnet mounted on the underside of the sliding seat, as shown in Fig. 1. Each time the oarsman passes over the mid-point of his slide the magnetic field from the magnet on his seat becomes sufficiently strong around the reed-switch for the latter to operate. The reed-switch may thus be used to convert a direct current into a pulse series, and so a system is obtained in which we have the required series of pulses without any mechanical contact with the oarsman or his oar or seat.

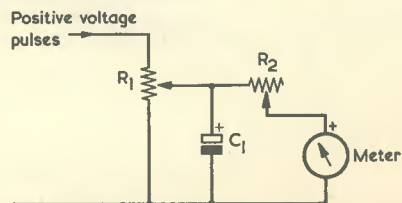

Fig. 2. A circuit illustrating basic pulse frequency meter principles

COMPONENTS

(Fig. 3)

For frequency range 40–140 pulses per minute.

Resistors

- R_1 47 Ω 20% $\frac{1}{4}$ watt
 R_2 5k Ω miniature preset potentiometer

Capacitors

- C_1 8 μ F electrolytic, 15V wkg.
 C_2 32 μ F—2,000 μ F (see text) electrolytic, 15V wkg.

Meter

- M_1 50 μ A meter

Reed-Switch

- RS_1 Changeover, Radiospares 13-RSR (or similar)

Switch

- S_1 s.p.s.t. on-off

Miscellaneous

- 9-volt battery
 Magnet (Radiospares "Long" type or similar)
 N.B. Radiospares components may only be purchased through retailers

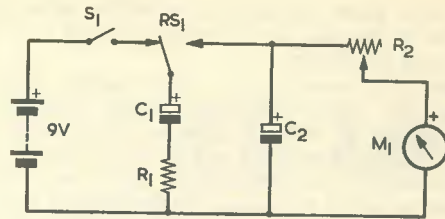

Fig. 3. A practical circuit which overcomes the limitations inherent in Fig. 2.

The Pulse Frequency Meter

Let us now consider the pulse frequency meter itself. The problem is to convert a pulse series into a steady direct current proportional to the frequency of the pulses, the current being used to deflect a moving coil meter. One basic way in which it might appear that this could be done is by use of the circuit shown in Fig. 2. Here the pulses are used to charge a capacitor C_1 which is simultaneously discharging through the meter M_1 . After about three strokes have been taken a point is reached where the gain of charge to C_1 from the pulses is equal to the loss of charge through the meter M_1 , and so a fairly steady meter reading is obtained. The unit may be calibrated by means of R_1 and R_2 , the values of which, in conjunction with the capacitance of C_1 , determine the maximum working frequency of the unit. This is the frequency above which further increases of frequency cease to increase the meter current.

If the meter is to have a linear calibration which indicates directly the frequency of the pulses, or the rating of the oarsmen, the circuit of Fig. 2 is not practicable and suffers from two main limitations. The first is that the voltage pulses must all be at the same potential and, second and more serious, the pulses must all be of a constant duration with only the time gaps varying to change the frequency. The second of these limitations makes the circuit of Fig. 2 unsuitable for most requirements, and certainly unsuitable for a rating meter where the duration of each pulse varies with frequency. If, when the oarsman is taking 20 strokes per minute, the reed-switch is surrounded by a sufficiently strong magnetic field to close for t seconds per

COMPONENTS

(Fig. 4)

Resistors

- R_1 220k Ω 20% $\frac{1}{4}$ watt
 R_2 5k Ω miniature preset potentiometer

Capacitors

- C_1 8 μ F electrolytic, 15V wkg.
 C_2 32 μ F—2,000 μ F (see text) electrolytic, 15V wkg.

Semiconductors

- TR_1 OC71 (see text)
 D_1 OA81

Meter

- M_1 50 μ A meter

Reed-Switch

- RS_1 Single throw normally-open, Radiospares 6-RSR (or similar)

Switch

- S_1 s.p.s.t. on-off

Miscellaneous

- 9-volt battery
 Magnet (Radiospares "Long" type or similar)

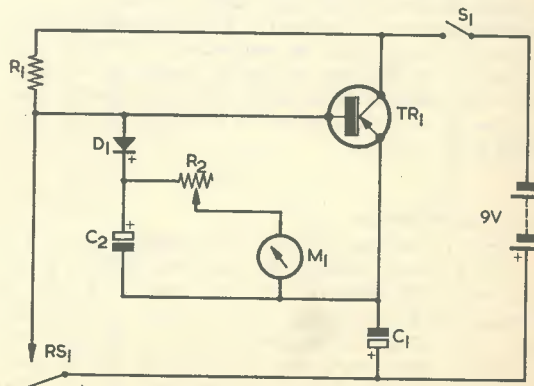

Fig. 4. A transistorised version of Fig. 3. This requires a single-throw reed-switch only.

pulse, then when the oarsman is taking 40 strokes per minute the reed-switch will be closed for only $t/2$ seconds per pulse.

There is, fortunately, a fairly simple way of making the pulse frequency meter suitable to accept pulses of varying duration. This is shown in Fig. 3. When the reed-switch RS_1 is not in the magnetic field, C_1 is connected to the battery. When the reed-switch is activated, by the magnet passing over it, C_1 is disconnected from the battery and connected to C_2 . This means that C_1 loses some of its charge to C_2 as the voltages across the two capacitors equalise. When the reed-switch emerges from the magnetic field, C_1 is disconnected from C_2 and recharged to battery potential. As the charge on C_2 builds up, so the size of the charge given to it by C_1 each time they are connected together decreases, with the result that when about four strokes have been taken the charge imparted to C_2 from C_1 at each pulse just balances out the charge which C_2 loses through the meter. This means that a fairly steady meter reading is obtained, the meter current being directly proportional to the frequency of the pulses within the working frequency limits of the unit. Furthermore, the meter current bears no relation to the duration of the pulses, as long as the pulse duration is of sufficient length for the voltages on C_1 and C_2 to equalise, and the space duration long enough for C_1 to recharge to battery potential.

R_1 , in Fig. 3, is merely a limiting resistor which keeps the initial current flow from the battery to C_1 , and the initial current flow from C_1 to C_2 , below the maximum figure specified by the manufacturer of the reed-switch. When the system reaches equilibrium there is no voltage drop across R_1 and it has no effect on pulse frequency measurements.

The working frequency limits of the unit depend upon the values of C_1 and C_2 , whose charge times at the selected supply voltage must be taken into account, and upon the total resistance of R_2 and the meter M_1 . The main design point is that C_1 should normally be considerably smaller than C_2 , otherwise C_2 will simply be charged up to battery potential after a few strokes regardless of frequency. Suitable component values for the frequency range 40–140 pulses per minute are C_1 $8\mu\text{F}$, C_2 $32\mu\text{F}$, total resistance of R_2 and meter M_1 variable between some $1.5\text{k}\Omega$ and $4\text{k}\Omega$, and battery voltage 9. Given suitable capacitor values for the required frequency range, the unit may be calibrated by varying the resistance of R_2 , or in certain cases by putting a variable resistor in parallel with the meter. Some further notes concerning the value of C_2 are given later in this article.

Transistor Version

The unit shown in Fig. 3 is suitable for use as a rating meter. Owing to the cost of changeover reed-switches, however, it was decided to take the design one stage further and produce an alternative unit which could be used with a single throw normally-open reed-switch, available at a much lower price. This may be done with the aid of a transistor, employing the circuit shown in Fig. 4. In this diagram, the reed-switch RS_1 is normally open, thus the base of the transistor TR_1 is suitably

biased via R_1 to allow a current to flow in the collector-emitter circuit. This current flows through C_1 , thus charging it to battery potential. The negative plates of C_1 and C_2 are connected together. The positive plate of C_2 is connected through D_1 to the base of TR_1 , and as long as RS_1 is open the base of TR_1 is negative with respect to the emitter and so no current can flow through D_1 and C_2 . However, when RS_1 closes the base of TR_1 is brought down to the positive supply line, so the emitter-collector resistance of TR_1 increases and C_1 is effectively disconnected from the battery. Also, the positive plates of C_1 and C_2 are now coupled together via RS_1 and D_1 , which allow a charge to flow from C_1 to C_2 . When RS_1 opens again C_1 and C_2 are disconnected, and C_1 is recharged through TR_1 . Thus the circuit of Fig. 4 is effectively the same as that of Fig. 3, but it dispenses with the changeover reed-switch. A good OC71 is suggested for TR_1 . (Alternatively, a more modern transistor, such as the ACY19, could be used—Editor.) Over the frequency range 40–140 pulses per minute R_1 may be $220\text{k}\Omega$. At higher frequencies the bias current may need to be increased (i.e. R_1 decreased) owing to the shorter charge time available. It is important that D_1 has a reverse resistance of at least $3.5\text{M}\Omega$. Most OA81's fulfil this requirement, but it is worth checking.

Steady Meter Readings

If steadier meter readings, for ratings of below 30 strokes per minute, were required, it was found necessary to increase the value of C_2 above $32\mu\text{F}$. A compromise has to be arrived at here, because increasing C_2 has the secondary effect of increasing the time taken before the meter deflection reaches its final value, and the constructor may have to experimentally find the value of C_2 which best meets his particular requirements. It depends upon the use to which the pulse frequency meter is to be put whether it is preferable to have a rock-steady reading with a comparatively long time lag before the meter reading reaches its true value, or to have very little time lag but a flickering meter reading. With C_2 at $2,000\mu\text{F}$ the first of these situations occurs, with an initial time lag of about 12 pulses, while with C_2 at $32\mu\text{F}$ we get the second. The optimum solution for any particular case will probably be between these values.

The construction of the rating meter (using either the Fig. 3 or Fig. 4 circuit) presents few problems, since everything except the reed-switch and the meter may be mounted on a chip of Veroboard. In the author's installation, the reed-switch was mounted in a Perspex housing at the mid-point of the slide, and connected by a short length of flex to a Perspex box which contains the meter and the chip of Veroboard. The box is mounted in such a position that the oarsman can read the meter. The meter should be completely enclosed by the box as otherwise water tends to penetrate around the zero-adjusting screw.

The writer feels that it is fair to say that this unit is a very useful accessory to any rowing eight, having an accuracy very much better than to the nearest stroke per minute. Its low cost compares extremely well with that of previously available devices fulfilling the same function.



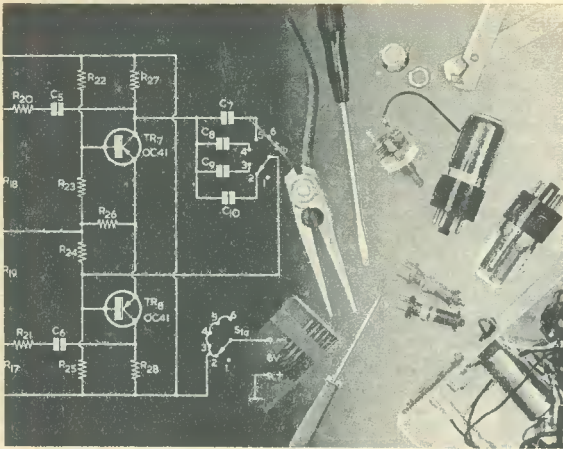

SUGGESTED CIRCUIT No. 208

Car Aerial Booster Circuit

by G. A. FRENCH

IT IS, OF COURSE, A COMMON practice nowadays to operate portable medium and long wave transistor radio receivers whilst travelling in cars. Due to the screening given by the car bodywork the transistor receivers cannot, however, provide as good a performance as they do in the open, whereupon it is usual to fit a small external aerial to the car, this being coupled to a "car aerial" socket provided in the receiver.

For a number of reasons, the results given by the combination of portable receiver and external car aerial are still not always satisfactory and this month's "Suggested Circuit" is for a simple signal booster which can remedy this state of affairs. Before proceeding further it must be pointed out that, due to variations between different transistor portable receivers and between different car aerial installations, it is impossible to *guarantee* that the circuit to be described will be effective in all instances. It is necessary for the constructor to initially assemble the booster in temporary form to see if it provides a worthwhile improvement with his particular receiver and aerial installation before making it up in permanent form. Fortunately, the temporary hook-up need only consist basically of two resistors, a capacitor and a p.n.p. transistor having at least a useful gain over medium and long wave frequencies, and most constructors should have these components already on hand as spares for routine or experimental work.

The writer bench-tested the prototype circuit with a conventional medium and long wave receiver under conditions simulating those occurring in a car, and found that a very marked boost was given at all points of the long wave band,

and at wavelengths greater than 350 metres on the medium wave band. At wavelengths lower than about 300 metres on the medium wave band the circuit offered no improvement in signal strength, and its introduction caused a significant loss in signal strength at wavelengths lower than 250 metres. Because of this last effect, the booster is provided with a switch which takes it out of circuit when receiving stations at these wavelengths. It is possible that, by the addition of tuned filters, etc., the unit would be capable of giving a useful signal boost over all the medium wave band, but it was felt that this would be adding unwelcome complications to what is intended to be a very simple and inexpensive circuit. Incidentally, it is usually found that the combination of car aerial and portable transistor receiver offers best results at the shorter wavelengths on the medium wave band in any case, whereupon there is less necessity for a booster circuit at these frequencies. The circuit described here provides signal boosting at the frequencies where boosting is needed most.

Receiver Input Circuit

The majority of transistor medium and long wave receivers employ a car aerial input circuit of the type shown in Fig. 1. A coaxial socket at the receiver is connected to a small coupling coil fitted to its ferrite rod aerial, whereupon signals from the car aerial are inductively coupled to the input tuned circuits, which are also fitted on the ferrite rod. It is intended that the car aerial be coupled to the socket via low-capacitance screened cable, the braiding of which connects to the car metalwork at some convenient point. The booster unit described

in this article is designed for use with a receiver aerial input circuit of this nature.

The method of car aerial coupling illustrated in Fig. 1 suffers from the disadvantage that the aerial is not adequately matched to the receiver at all the frequencies it is intended to receive. A car aerial consists basically of a thin metal rod or tube which may vary in length from about 3 to 10ft only. Such an aerial possesses little inductance or capacitance to earth and, for best performance at medium and long wave frequencies, should be coupled to an input circuit offering a high impedance. At the same time, the impedance presented by the aerial coupling coil inside the receiver offers an impedance which varies at different reception frequencies and which, over much of the frequency range to be covered, may well be considerably lower than the optimum impedance required by the aerial. Looking upon the coupling coil as a primary and the subsequent tuned coil on the ferrite rod as a secondary, it is fairly safe to assume that the

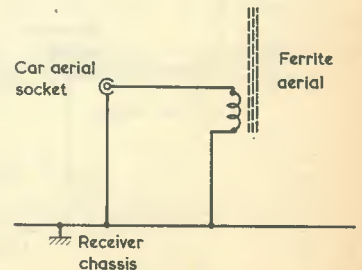

Fig. 1. The car aerial input circuit which is fitted to most medium and long wave transistor portable receivers

reflected impedance offered by the aerial coupling coil in the average transistor portable will be greatest at the high frequency (short wavelength) end of the medium wave band, where tuned circuit Q is at its greatest. This point is partly borne out in practice by the fact that a combination of transistor portable and car aerial usually offers best performance at the high frequency end of the medium wave band; although it must, of course, be remembered that the portable receiver will already be at its most efficient at the higher medium wave frequencies.

Booster Circuit

Fig. 2 shows the booster circuit in the form it takes up if installed inside the cabinet of a transistor portable receiver having a positive chassis line. The additional components required inside the cabinet are TR₁, R₁, R₂, C₁ and S₁.

When S₁ is set to Out, section S_{1(b)} disconnects the negative supply from the booster circuitry, whilst S_{1(a)} connects the centre contact of the car aerial socket to the coupling winding on the receiver ferrite rod aerial. Under these circumstances the aerial input circuit is the same as in Fig. 1, with the exception that the booster components are now connected to the centre contact of the aerial socket. These components are inactive and, provided they are mounted fairly close to the aerial socket, will have no effect on receiver performance, which will be the same as for Fig. 1.

If S₁ is set to the In position, switch section S_{1(b)} applies the negative supply to the collector of TR₁ and to R₁. R₁ has a value which causes TR₁ to pass a collector current of about 1mA and this

value will lie, typically, between 220kΩ and 680kΩ. At the same time, S_{1(a)} applies the centre contact of the aerial socket to the base of TR₁ by way of C₁. The emitter circuit of TR₁ is completed to chassis via the coupling winding on the receiver ferrite aerial rod. TR₁ now functions as an emitter-follower, and offers an impedance at its base which is considerably higher than the impedance at its emitter. Thus, at reception frequencies where, for greatest signal strength, the car aerial has to work into an impedance higher than that presented by the receiver coupling coil, TR₁ provides that higher impedance.

Capacitor C₁ is included in the circuit merely to prevent the base of TR₁ being connected directly to the car aerial. At d.c. TR₁ base has a high input resistance to earth, and the transistor could be damaged by any potential which might accidentally appear on the car aerial. This risk is obviated by the inclusion of C₁. R₂ is added as a further precaution and prevents the formation of a static potential on the aerial. Should the aerial be short-circuited to earth whilst carrying a static potential, a voltage spike could be passed to TR₁ base.

The negative supply switched by S_{1(b)} may be obtained from the receiver. A suitable point would be at the bypassed negative supply for the receiver mixer-oscillator, and it is doubtful whether any instability would occur as a result of this connection. Should such instability appear, a 0.1μF capacitor should be added between the arm of S_{1(b)} and the positive supply line, and a 560Ω decoupling resistor inserted in series with the negative supply to S_{1(b)}. If the instability occurs on

long waves, a 5μF electrolytic capacitor may provide a better bypass than the 0.1μF capacitor. The writer found no necessity for any of these additional decoupling components during his experiments with the prototype circuit.

The transistor shown in Fig. 1 is an OC171, the writer finding by experiment that this provided a high level of signal boost. Similarly good results were given with an OC170, which has the same lead-out layout as the OC171. With both these transistors, the shield lead-out was left unconnected. An OC44 gave useful results but these were not quite as good as with the OC170 and OC171. Working from these facts it can be assumed that any p.n.p. transistor capable of operation up to the higher medium wave frequencies may be employed in the booster circuit, but that it is preferable to use one having a response which extends well above such frequencies. The OC170 is, incidentally, intended for use as a 10.7 Mc/s i.f. amplifier, and the OC171 as an r.f. amplifier at Band II.

R₁ should be selected such that the transistor passes about 1mA collector current. A suitable starting value is 470kΩ.

Results With The Prototype

The circuit of Fig. 2 was checked on the bench with a conventional medium and long wave superhet portable under conditions which simulated operation in a car. The chassis of the receiver was connected to earth and an aerial consisting of 3ft of wire connected to the centre contact of the car aerial socket. A voltmeter connected across the receiver volume control track, which formed the diode load, offered a rough visual estimate of signal strength, it being remembered that the readings given by strong signals would suffer masking due to a.g.c.

Since the receiver was not screened, as would occur in a car, it had initially been intended to rotate it to the position which gave minimum pick-up on its ferrite aerial when evaluating the effect of the booster with a particular signal. However, it was found possible to work with signals which, with the booster switched out, offered negligible deflection in the diode load voltmeter regardless of the orientation of the receiver. The tests were carried out in the evening, when plenty of medium and long wave signals could be received.

At wavelengths from approximately 300 to 250 metres the booster offered no improvement to signal strength. At wavelengths below 250 metres, switching in the booster caused a reduction in signal strength. This was probably due to the fact that switching in the booster lowered

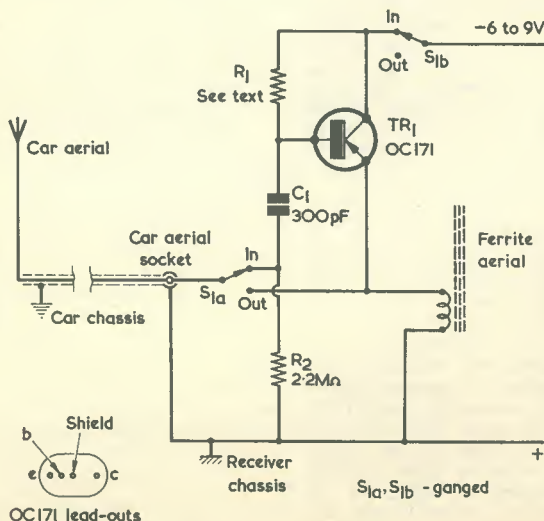

Fig. 2. The booster circuit, in the form it takes up when installed at the receiver

the impedance applied to the coupling coil in the receiver and thereby damped the medium wave aerial tuned circuit. At wavelengths higher than 300 metres, switching in the booster caused an improvement in signal strength, the degree of improvement increasing as wavelength increased up to 350 metres. At 350 metres and above, the booster was very effective and was able to raise weak signals clean out of the background noise. Whereas such signals previously caused virtually no deflection of the voltmeter across the diode load, the voltmeter reading rose to about one-quarter of that for a local station when the booster was switched in. With stronger signals, the initial deflection of the meter was increased by some 3 to 5 times by switching in the booster.

This same improvement in reception was given by the booster circuit at all points over the long wave band.

Judging from these results it may be stated that the booster circuit gives a very useful increase in signal strength at wavelengths where the impedance offered by the coupling coil in the receiver is too low for the car aerial. In use, it may then be switched in at such wavelengths, it being left out of circuit at the wavelengths where its impedance step-up is not required.

As was stated at the beginning of this article, the performance obtained by the author cannot be guaranteed for all receivers or car aerial installations. The constructor must first check experimentally that the booster is of advantage for his own particular installation before

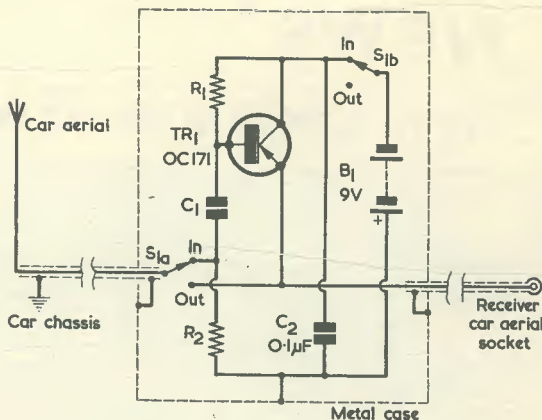

Fig. 3. Making up the booster circuit as an external unit

making it up into permanent form. The circuit can be tested without S_{1a} , if desired, although inclusion of this switch makes it easier to evaluate results.

Wiring, for both the temporary and permanent versions, should be kept reasonably short, and all the components may be conveniently mounted on a 5-way tagstrip with some of the component leads anchored to the switch tags. The switch may be a d.p.d.t toggle or slide type. All the booster components should be mounted near the car aerial socket.

Separate Unit

Some readers may prefer to build

the booster as a separate unit, rather than install it in the receiver cabinet. The circuit in Fig. 3 will meet this requirement. This is basically the same as Fig. 2, except that a 9 volt battery and a $0.1\mu\text{F}$ bypass capacitor are now added. The unit of Fig. 3 has one screened lead-out passing to the car aerial, and another passing to the receiver.

As with Fig. 2, it must again be emphasised that the circuit of Fig. 3 should be checked out experimentally in the particular installation in which it is to be used before building it up into permanent form.



CAN ANYONE HELP ?

Requests for information are inserted in this feature free of charge, subject to space being available. Users of this service undertake to acknowledge all letters, etc., received and to reimburse all reasonable expenses incurred by correspondents. Circuits, manuals, service sheets, etc., lent by readers must be returned in good condition within a reasonable period of time

R1155 Receiver.—D. R. Collin, 90 London Road, Shrewsbury, Shropshire—requires last i.f.t.

1392 Receiver.—G. Rentmore, Royal Holloway College, Alderhurst, Bakeham Lane, Englefield Green, Surrey—loan of circuit diagram and any other information.

Correspondent Required.—D. Hagan, 4 Priors Croft, London E.17—would like to correspond with any reader of his own age, 15, interested in semiconductor circuits and amateur radio in general.

Monitor Unit Type GRD/AN.—R. G. Hayward, Sunnyfields, Lighthouse Road, St. Margaret's Bay, Nr. Dover, Kent—loan or purchase of manual covering this and the following equipments—junction box GRD6; control unit type 568/GRD; control unit type 567/GRD; comparator unit type 23/GRD; and aerial system type 449/GRD.

R216 VHF Receiver.—D. A. Vink, 7 Hayes Garden, Hayes, Bromley, Kent—manual, handbook, circuit diagram or any other information, loan or purchase.

Simpson Tube Tester.—J. Kennedy, 1 Barff Road, Salford 5—chart manual required for this tester—type No: I-177-B.

BC433 Receiver.—D. Lee, 74 Hopkinson Road, Sheepridge, Huddersfield, Yorks—manual or circuit diagram for this receiver and also for BC733 receiver, R101A receiver, CRV-46151 receiver and indicator unit type 266.

Test Set 219.—R. Booth, 11 Almerly Terrace, Bootham, York—circuit diagram or any information—also for valve tester model 314 made by Radio City Products, New York.

NEWS . . . AND .

NEW LANGUAGE TEACHING SYSTEM

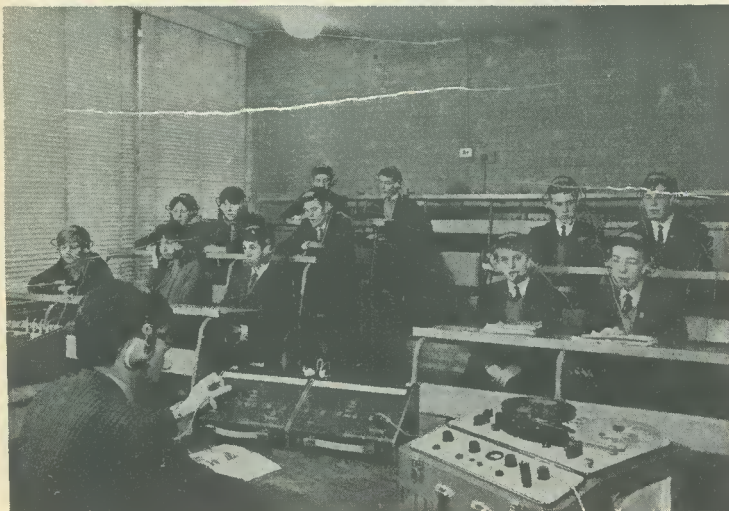

Interlog, the new language teaching system from the Education Technology Service of S. G. Brown Ltd., a Hawker Siddeley Company, being used by pupils of Hatfield Grammar School

A new concept in language teaching has been developed by the Education Technology Service of S. G. Brown Ltd. Known as 'Interlog', this inexpensive and extremely flexible system has been designed in conjunction with the teaching profession to meet the widest range of demands in the field of language instruction.

Simple, inexpensive and flexible—it provides the teacher with the means of matching tuition to individual pupil's needs.

The basic Interlog system comprises a desk console, 12 $\frac{3}{4}$ x 9 x 6 $\frac{1}{2}$ in, for the teacher, a group junction box, 20 x 8 x 12in and a case of six headsets. Any number of units can be inter-linked to cater for larger classes.

The lesson input can be provided by tape or record. The equipment gives the teacher the facility for two-way conversation with one or more students, confidential monitoring of individual students, and recording answers for examination purposes.

Interlog is portable, weighing only 30 lbs complete, and operates from ordinary mains output supply.

TOO LOW A MEMBERSHIP?

From time to time, various scraps of information come our way, the nature of which gives us cause to think! Recently for instance, we heard it said that only approximately half the radio amateurs with transmitting licences in this country were members of the R.S.G.B. We are not in a position to confirm or deny the accuracy of this statement, but the fact that it was made by a person who would be likely to know the true state of affairs in this country, assures us of one thing, and that is that the proportion of transmitting amateurs who are members of the R.S.G.B., is far, far, too low. Considering all that the R.S.G.B. do, and have done in the past, for the hobby of amateur radio, not only in this country but in the international sphere as well, one would have thought that at least 90% of the licenced amateurs in this country could have seen their way to supporting the Society. In fact, it is difficult to see why 100% don't join! The privilege of using sections of the radio frequency spectrum was not given to the amateur radio transmitting licensee as a birthright. It had to be fought for, and once obtained, it has to be continuously preserved. Those wishing to use the radio spectrum are scrabbling over one another to grab whatever is going and the amateur only holds his allocations by constant vigilance and the organisation which correlates this activity is the R.S.G.B. This vigilance has to be applied not only at home, but in the international sphere as well, and here the R.S.G.B. has diligently fought for the radio amateur's cause.

The Society has, through its publications, kept the radio amateur abreast of technical developments and has set a high standard in this respect making available to the amateur much knowledge which would otherwise be available only to the professional. The encouragement of exhibitions, contests and trophies has given the competitively minded targets to aim for and for those who find the social aspects of the hobby of major interest, the R.S.G.B. has encouraged and provided opportunities in this direction. From ensuring our survival at one extreme to providing the frills of the hobby at the other, the R.S.G.B. has served every participant of Amateur Radio in the country.

It is a trend of the times, that a large number of our leisure activities are in danger of being taken from us if we don't fight for them. Be it walking in the countryside; sailing in the coastal waters of these islands; motoring; flying or what have you, someone will have good reasons for stopping you doing it—usually in the name of 'progress or development'—which mostly means 'in the interests of commercialism'. So beware; support the organisations which fight for your liberty. And in the case of Amateur Radio, this is the Radio Society of Great Britain.

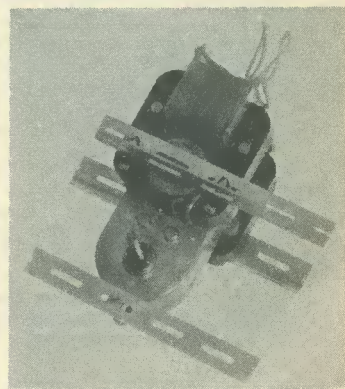

Model and Prototype Systems Limited have introduced a new light duty, reversible, geared electric motor unit which is primarily for use with the Proto system for building mechanical and structural models, but which is expected to have a wider application.

A pair of skeleton shaded pole motors have a common input shaft to the gearbox and by simply switching from one to the other, the direction of rotation of the output shaft is reversed without complex wiring and switching arrangements. The unit bears the reference G.M.R.R. 230/250V. a.c. 128 r.p.m. 12lb/in torque.

The illustration above shows the unit mounted on the Miniature Plotted Angle which is a feature of Proto.

COMMENT

NEW HEATHKIT TRANSISTOR 12 + 12 WATT STEREO AMPLIFIER

This new stereo amplifier by Daystrom combines outstanding Hi-fi performance with low cost.

With 17 transistors and a 6 diode circuit it gives 12 watts r.m.s. per channel into 8 ohms over an extremely wide frequency range of 16 to 50,000 c/s.

A 6-position source switch easily handles records, radio or auxiliary inputs—stereo or mono.

As our illustration shows, this stereo amplifier has an attractive low silhouette styling and is available as a kit for £30 10s. 0d. or factory assembled for £42 10s. 0d.

Write to Daystrom Ltd., Gloucester, mentioning this magazine, for a free catalogue of the complete British Heathkit range.

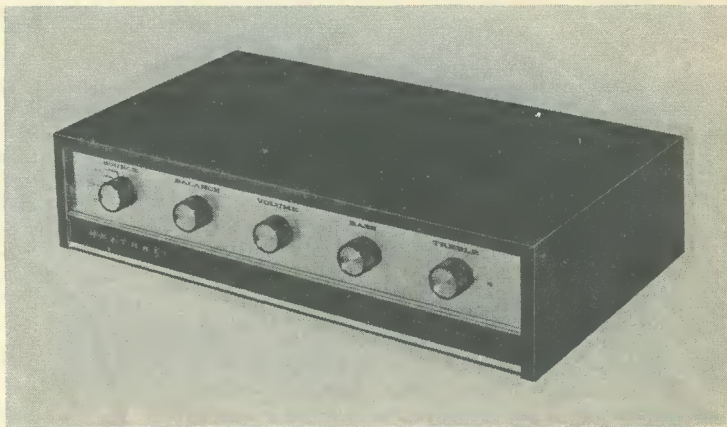

THE COMPUTER AGE

From their beginnings as fast calculating machines for use by scientists and engineers, computers have invaded every aspect of industrial, commercial and professional life. The rapid development of computer circuits and mechanisms (their hardware) will continue, and will be matched by advances in methods of programming (their software).

Great increases can be expected in the simultaneous use of a single computer by a large number of users employing it from remote points, each for their different purposes.

The exploitation of large systems of computers linked by telecommunication channels to each other, to their users, and to data banks, will bring about a revolution in our methods of gathering, analysing and distributing information of all kinds. Our ability to plan wisely and to cope with the tremendous amount of detailed analysis and design needed to bring such a system into being will determine how fast we can advance into the computer age, before whose threshold we now stand.

These observations are from a lecture entitled "The Computer Age" given to members of The Institution of Electrical and Electronic Engineers by F. J. M. Laver, B.Sc., F.I.E.E., Head of Computers Division, Ministry of Technology.

RADIO NEW YORK WORLDWIDE NOW BROADCASTS EXPANDED VERSION OF DXing Worldwide

Unique . . . different . . . these are some of the ways people are describing DXing Worldwide, Radio New York Worldwide's (WNYW) special programme for the individual interested in almost any phase of communications.

Expanded, by popular demand, to a full half-hour, DXing Worldwide is broadcast every Saturday at 17.30 GMT (12.30 p.m. EST) on 21.525, 17.845, 17.760 & 21.465 Mc/s and on Sunday at 19.30 GMT (2.30 p.m. EST) on 15.440, 17.760 & 21.525 Mc/s over the five 50/100 kilowatt transmitters of Radio New York Worldwide, the only commercial independent radio station broadcasting internationally from the United States.

Reaching the United Kingdom, Western Europe, the Americas and Africa, DXing Worldwide is the international voice of the Radio New York Worldwide Listeners Club which now has more than 3900 members in over 86 countries throughout the world. All Club members receive a monthly magazine filled with communications features, listening tips and advance Radio New York programme information.

Further details may be obtained from Radio New York Worldwide Listeners Club, 485 Madison Avenue, New York 10002, U.S.A., mentioning *The Radio Constructor*.

THE BRITISH AMATEUR ELECTRONICS CLUB

The Chairman of the above club, in writing to thank us for the information we gave on their aims and achievements in our January issue, informs us that, as a result of our write-up, they have enrolled members from among our readership.

For those who are interested in applying for membership, write to the new Honorary Secretary, J. H. Hooper of 5 Cwrt-y-Vil Road, Penarth, Glamorgan.

BACK TO WINDING COILS AFTER 50 YEARS

A Hertfordshire firm was recently asked to recondition an aircraft component made 50 years ago, but there was a snag, after such a long time there were no records regarding its specification.

Then someone called to mind that a retired aircraft worker, Mrs. Doris Whyte of Watford had, as a girl of 13 years of age, learned the art of winding coils for aircraft engine magnetos.

When asked, Mrs. Whyte immediately remembered that there were 8,700 turns in the Vickers Vimy aircraft magneto coil. She spent six days at Messrs. Rotax of Hemel Hempstead winding coils. They are wanted for a replica of a Vickers Vimy aircraft which is to fly the Atlantic next year to celebrate the first crossing by Alcock and Brown in 1919.

The above information is based on a report which appeared in the *Daily Mail*.

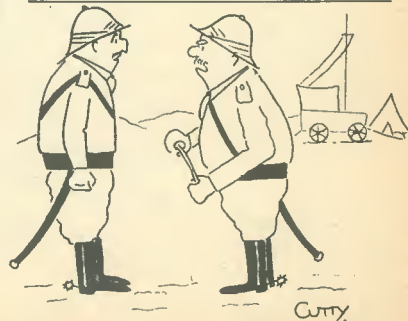

"Dammit Carruthers, this wireless nonsense will never replace a native runner with a cleft stick."

SUPER-EFFICIENT MAINS FILTER UNIT

by A. IRWIN

Offering an insertion loss of 80dB from 1 Mc/s to 20 Mc/s, and better than 45dB from 200 kc/s to 100 Mc/s (measured at 75Ω source impedance) this rugged mains filter unit can be readily constructed by any enthusiast with simple metal-working facilities. The filter unit is intended for a standard a.c. mains supply and can pass currents up to 15 amps.

A GENERAL PURPOSE MAINS FILTER UNIT OFFERING a high level of attenuation over long waves, medium waves and Band I TV is a useful item of equipment in any workshop or laboratory, but it has to be carefully designed if it is to offer maximum attenuation.

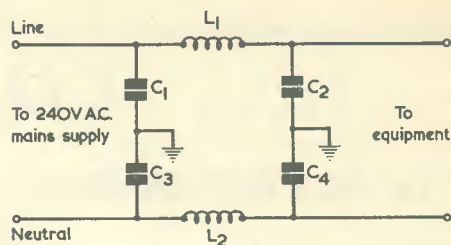

Fig. 1. The circuit of the filter unit

To obtain an overall attenuation of at least 40dB two pi filters are required, as shown in Fig. 1. One filter is in the line lead and the other in the neutral lead. The filter unit to be described employs the circuit of Fig. 1 with all components mounted in an earthed metal case, and it is suitable for a.c. mains supplies from 200 to 250 volts, with currents up to 15 amps.

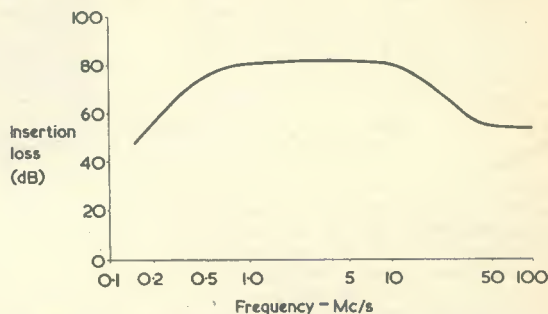

Fig. 2. The insertion loss from 120 kc/s to 100 Mc/s, as measured with the prototype under the conditions described in the text

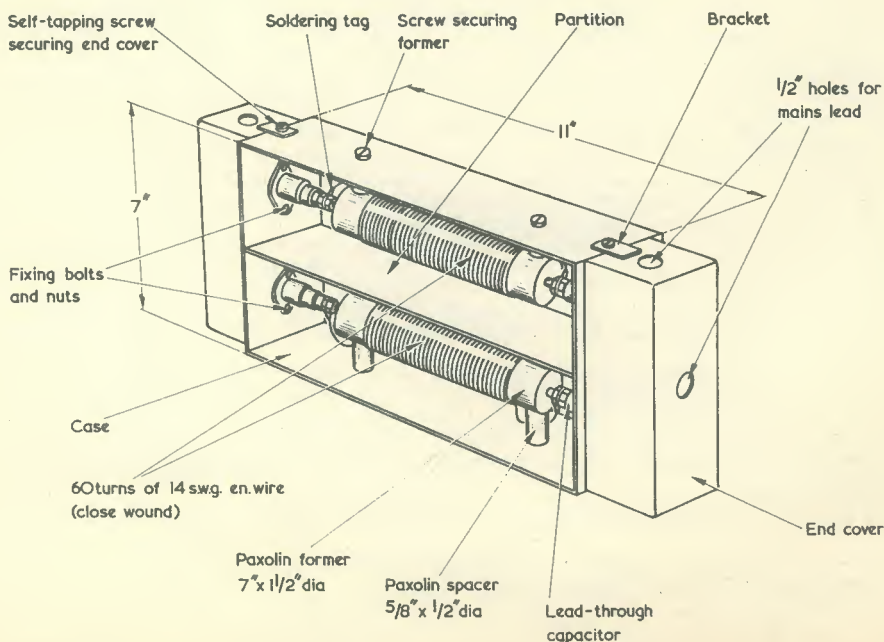

Fig. 3. The assembled filter unit with lid removed

Component Details

Coils L_1 and L_2 have an inductance of $30\mu\text{H}$ and each consists of 60 turns of 14 s.w.g. enamelled wire close-wound on a Paxolin former with an outside diameter of $1\frac{1}{2}$ in. The winding length is 5 in and the writer employed formers having a length of 7 in. If difficulty in obtaining such formers is experienced, suitable alternatives are the 6 in by $1\frac{1}{2}$ in diameter Paxolin formers available from Home Radio (Mitcham) Ltd. under Cat. No. ZA25. (These appear in the Home Radio catalogue as "Lantex tubing".) The shorter 6 in formers still allow $\frac{1}{2}$ in to project at either end of the winding and this is adequate for mounting purposes.

Capacitors C_1 to C_4 are lead-through types having an extremely low inductance, with the result that self-resonance occurs at much higher frequencies than those with which we are concerned here. Each

capacitor has a metal rod passing through its centre, this providing one of its terminals. The current flows through this central rod and leads can be connected to it by means of the nuts provided at each end. A "rolled" type of capacitor is wound round this rod, one set of foil ends connecting to the rod and the other to the surrounding metal case. A mounting flange is integral with the case, and has two holes in it for mounting purposes. It is this method of construction which enables the capacitors to exhibit their very low inductance.

The capacitors are described as Filter Suppressor, type SBC.2, $0.1\mu\text{F}$, 250 volt 20 amp maximum, and are manufactured by Dubilier. They may be ordered from Dubilier Condenser Co. (1925) Ltd., Ducon Works, Victoria Road, North Acton, London W.3, whereupon arrangements will be made for them to be supplied via a local Dubilier distributor.*

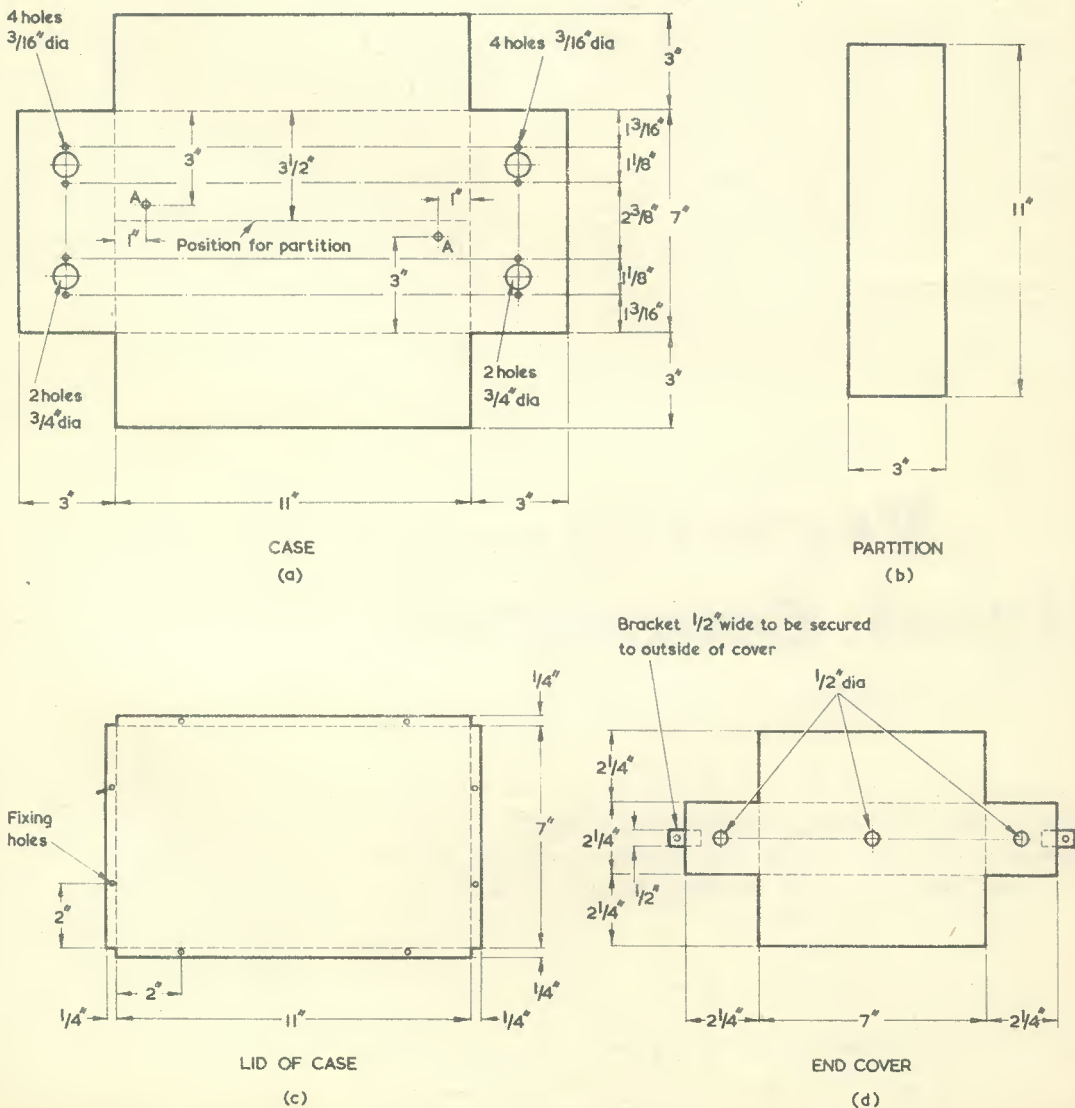

Fig. 4. Dimensions of the case, partition, lid and end covers used in the filter unit. Material is 18 s.w.g. tinplate for all parts

Performance

The curve of Fig. 2 shows the insertion loss given by the filter unit over the frequencies 120 kc/s to 100 Mc/s. As may be seen, the insertion loss is about 45dB at 200 kc/s, rising to 80dB at 1 Mc/s. It then remains constant at 80dB up to 20 Mc/s, after which it drops gradually to 50dB at 100 Mc/s. The curve was taken under laboratory conditions using a signal generator with an output impedance of 75Ω coupled to the input of the filter unit, and a measuring set having an input impedance of 75Ω connected to the filter unit output.

Construction

The completed filter unit, with lid removed, is illustrated in Fig. 3, and it will be seen that construction is quite simple and straightforward. Each former is secured at its ends by a suitable bolt and nut, employing $\frac{3}{8}$ in insulated spacers at each mounting position. A metal centre partition appears between the two filters, and two end covers provide access for the input and output mains leads. An earth connection at each end may be obtained from one of the inside capacitor mounting bolts.

Details of the metalwork are given in Fig. 4, the material being 18 s.w.g. tinsplate for all parts. The case, before bending, is illustrated in Fig. 4 (a). Not shown in this diagram are the coil mounting holes required on each long edge. These should be drilled to hold the coils centrally and their positions depend upon the length of the coil formers used.

*Due to possible changes in price, the cost of the Filter Suppressors (which may be a little expensive by home-constructor standards) cannot, unfortunately be specified in this article. Readers are advised to obtain a quotation from Dubilier Condenser Co. before ordering or obtaining any of the other components required for the filter unit. — Editor.

The four sides are bent up, towards the reader, and the four corners may be soldered. Small angle brackets can be fitted internally at the corners for added strength, if desired, care being taken to ensure that they do not interfere with parts added later. The two holes marked "A" are for fixing screws for the complete unit, and may have a diameter suitable for the mounting screws it is intended to use.

The centre partition is shown in Fig. 4 (b) this being soldered in position centrally across the case.

The case lid appears in Fig. 4 (c), and it should be noted that the 7in and 11in dimensions do not take into account the thickness of the case material. When completed, with the $\frac{1}{2}$ in sides bent up, the lid should fit snugly on the case. The fixing holes are clearance size for small self-tapping screws.

One of the two end covers appears in Fig. 4 (d). Two small brackets are fixed to this to enable it to be secured to the main case by means of small self-tapping screws. These brackets have clearance holes for the self-tapping screws.

Tap size holes are next marked out on the case, to correspond with the mounting holes in the lid and end-piece brackets whilst these parts are held in position. After these holes have been drilled, self-tapping screws can be used to secure the lid and end-pieces in place.

When the metalwork has been completed the case and end-pieces should be cleaned out and the coils and capacitors fitted. It is important that the flanges of the lead-through capacitors be mounted squarely and secured tightly on clean metal so as to make good contact. If, for instance, it is desired to paint the case, this should be done afterwards.

The filter unit is now complete and ready for use.



Versatile Signal Generator

by S. J. KEARLEY

Employing two low-cost transistors and readily available components, this unit offers test signals from 150 kc/s to 30 Mc/s. The output can be switched to r.f., modulated r.f., or a.f.

THE SIGNAL GENERATOR DESCRIBED here was designed chiefly for testing and aligning transistor receivers. It is extremely cheap to construct, and should not cost more than about £2, even if all the components are purchased new.

The instrument is transistorised, so it possesses the further advantages of portability, cool running, and independence of mains supplies (and trailing mains leads).

R.F. signals may be obtained, at low impedance, unmodulated or

modulated with 400 c/s. The frequency coverage is from 150 kc/s to 30 Mc/s on fundamentals in 5 switched ranges. Provision is made for switching in external coils. The 400 c/s tone can be obtained separately for audio testing purposes.

The Circuit

The circuit is shown in Fig. 1. The a.f. oscillator, TR_2 employs a simple feedback circuit incorporating T_1 , a transformer type LT44. Different transformers from the LT44 may also be satisfactory, but adjustments to C_5 will probably be necessary to bring the frequency to 400 c/s. If using a different transformer, the connections to one winding may have to be reversed before the circuit oscillates. The a.f. output is taken from TR_2 emitter.

The r.f. oscillator, TR_1 , uses a Colpitts circuit, which has the advantage of not requiring taps in the coils or feedback windings. This simplifies switching, and makes coil winding much easier. VC_1 is an ordinary 500+500pF tuning capacitor, the two sections being connected

COMPONENTS

Resistors

(All fixed values $\frac{1}{4}$ watt 10%)

- R₁ 2.2k Ω
- R₂ 470k Ω
- R₃ 120 Ω
- R₄ 330 Ω
- R₅ 47k Ω
- R₆ 10k Ω
- R₇ 1k Ω
- VR₁ 1k Ω potentiometer, carbon linear

Capacitors

- C₁ 0.01 μ F ceramic
- C₂ 500pF silver-mica
- C₃ 0.04 μ F ceramic
- C₄ 2 μ F electrolytic, 12V wkg.
- C₅ 0.01 μ F paper
- C₆ 0.1 μ F paper, 500V wkg.
- VC₁ 500+500pF variable 2-gang

Inductors

- L₁ See text
- L₂-L₅ See Table. Home-wound on 4 formers $\frac{7}{8}$ x $\frac{1}{4}$ in dia, Cat. No. CR4 (Home Radio) with 3 dust cores, Cat. No. CR5 (Home Radio)

- T₁ Transformer type LT44 (Henry's Radio)

Transistors

- TR₁ NKT676
- TR₂ OC71

Switches

- S₁ 1 pole 6 way, rotary
- S_{2(a)} (b) 2 pole 3 way, rotary
- S₃ s.p.s.t., toggle

Battery

- B₁ 9-volt battery, PP6 (Ever Ready) or as required

Miscellaneous

- 2 insulated terminals
- 1 coaxial socket
- 12-way group-board
- Knobs and scale cursor, etc.
- Epicyclic slow motion drive with flange, Cat. No. 4511/F (Jackson Bros.)

in series by way of the metal frame, which connects to chassis. R₂ provides base bias and the collector supply is via R₁. Since the base end of whichever coil is selected by S₁ is fairly heavily damped by the low input impedance of the transistor, R₁ is connected to this end. If it were connected to the collector end, the tuned circuit would be so heavily damped that it would oscillate feebly or not at all.

The output is taken from the emitter of TR₁. It will be found that adjustment of the output VR₁ has very little effect on the frequency of oscillation, even if there is a short-circuit across the output

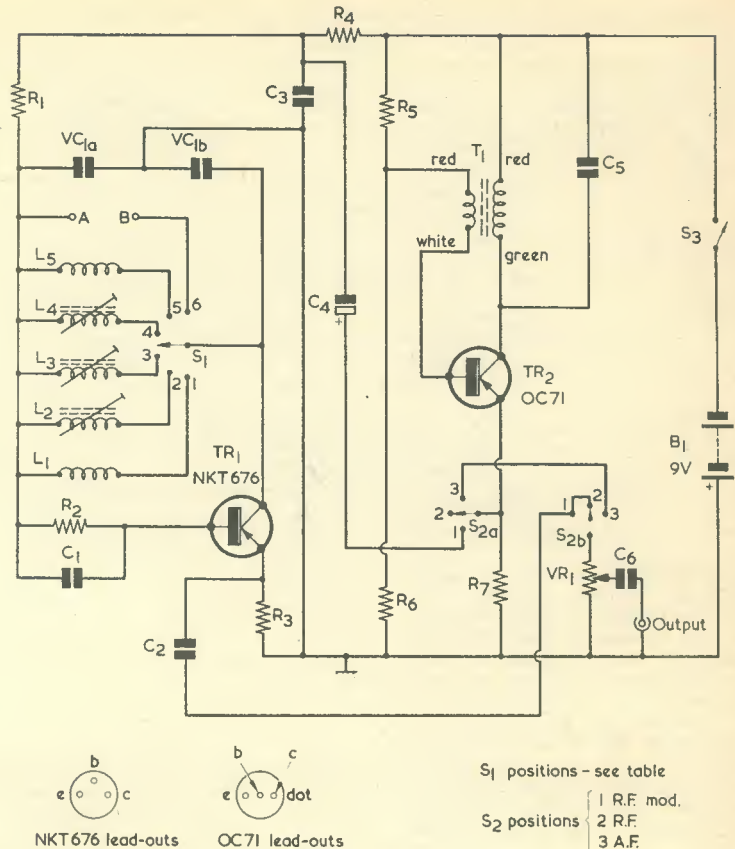

Fig. 1. The circuit of the signal generator. A feature of the design is the simple coil switching arrangement

socket. Modulation, when required, is applied by setting S_{2(a)} to position 1, thus feeding the output of the a.f. oscillator across R₄.

As well as simplifying construction, the use of capacitive feedback in the r.f. oscillator circuit has additional advantage over the more usual inductive feedback. As the frequency of oscillation increases, the current gain of TR₁ decreases. Since the feedback is capacitive, it becomes increased at higher frequencies, and compensates for the reduced gain of the transistor. Furthermore, when VC₁ is at maximum capacitance, the increased feedback through it counteracts the reduced Q of the tuned circuit. The result is that r.f. oscillations are maintained reasonably constant up to at least 30 Mc/s.

TR₁ must be a high gain r.f. transistor with a cut-off frequency of not less than 30 Mc/s. If the gain is on the low side, oscillation may not be obtained throughout the lowest frequency band. The author used an NKT676. The transistor employed in the TR₂ position is not critical, and the OC71 specified represents an inexpensive choice. Surplus transis-

tors of the "Red Spot" variety and similar types should also function satisfactorily.

The output capacitor, C₆, has a working voltage of 500. Thus, the output of the unit may be applied to any points in equipment under test across which d.c. potentials up to 500 volts may appear, without risk of breakdown in the capacitor.

The Coils

All the coils with the exception of L₁ are home-wound on standard polystyrene formers having a diameter of $\frac{1}{4}$ in and a length of $\frac{3}{8}$ in. Details of the windings used for the prototype are given in the Table. Dust cores are fitted to the formers where indicated. L₁ is a long wave aerial coil with the two windings connected in series. The author used a rather nondescript coil salvaged from an old mains receiver but a Wearite PA1 coil or similar would be suitable. It should be noted that the normal long wave aerial coil (for valve receivers) has a coupling winding with more inductance than the tuned winding, as opposed to an r.f. coupling coil in which the coup-

TABLE			
S ₁ position	Coil selected	Winding details	Frequency coverage
1	L ₁	See text.	150—350 kc/s
2	L ₂	200 turns, 30 s.w.g. enamelled s.s.c. Pile wound. Dust core.	330 kc/s—1.4 Mc/s
3	L ₃	85 turns, 30 s.w.g. enamelled s.s.c. Pile wound. Dust core.	1.2—3.8 Mc/s
4	L ₄	25 turns, 30 s.w.g. enamelled s.s.c. Close wound. Dust core.	3.5—11 Mc/s
5	L ₅	13 turns, 22 s.w.g. enamelled. Close wound. No core.	10—30 Mc/s
6		External coil	

ling winding has less inductance than the tuned winding. A long wave aerial coil, whose coupling winding has more inductance than the tuned winding, is the type required here. It is important to connect the two windings in phase—the correct mode of connection is, of course, that which gives the lower frequency output.

An external coil is switched into circuit on position 6 of S₁, and details concerning this are given later in this article.

Construction

Most of the components were assembled on a 12-way group-board, as shown in Fig. 2. The transistors should be soldered in last, preferably using a heat shunt. Care must be taken to connect T₁ as shown. Wiring to the variable capacitor, the coils and S₁ must be kept as short and rigid as possible. Connections external to the group-board should

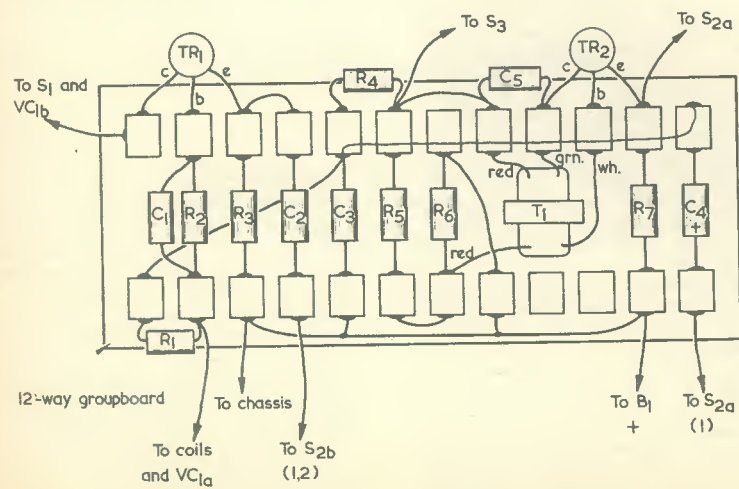

Fig. 2. The components mounted on the 12-way group-board

be checked from the circuit diagram in Fig. 1.

The generator is housed in a metal or foil-lined box, with the metal connected to the positive supply line. This prevents unwanted radiation. The size of the case depends chiefly on the type of dial used for VC₁. The author's instrument has a 4in diameter dial, and is housed in a box measuring 7 x 4½ x 2½in. The front panel layout is shown in Fig. 3. The tuning capacitor is driven by way of an epicyclic slow motion drive having a flange to which a home-made cursor can be fitted.

Calibration

Calibration is carried out with the generator in its case, as the proximity of earthed metal will modify both the inductance of the coils and the stray capacitances. The generator dial is initially marked 0—180°, using a

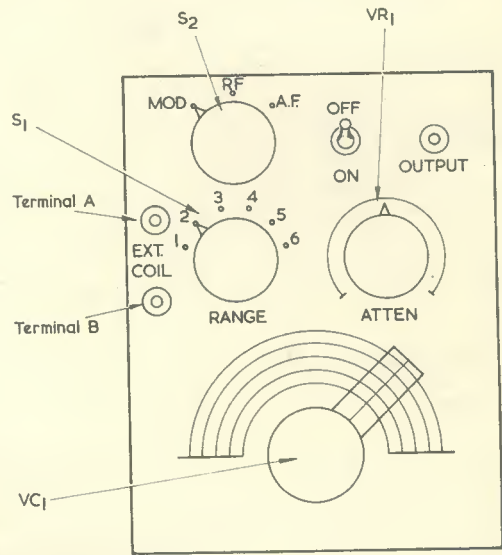

Fig. 3. A suitable front panel layout

protractor. An all-band receiver is necessary and, preferably, an accurately calibrated signal generator.

If a standard signal generator is available it is set to 150 kc/s, loosely coupled to the receiver, and the receiver tuned until the carrier is picked up (as a steady hiss). The uncalibrated generator, with the modulation off, is tuned until a whistle is heard. By careful tuning, the frequency of the whistle may be reduced to "zero beat". The dial reading in degrees is noted. The procedure is repeated for other spot frequencies up to 30 Mc/s. The two generators must be tuned "in step" as this prevents spurious signals due to harmonics, images, etc., from spoiling results. The dust cores of

L₂, L₃ and L₄ are adjusted to give a small overlap between each range, and then sealed with wax. A graph of frequency against angular rotation is drawn for each range. If a smooth curve does not join all the points, the calibration for that range must be carefully re-checked.

Calibration may also be carried out using the 200 kc/s Light Programme signal as a standard. This procedure is more difficult and less accurate. The generator is tuned to "zero beat" with the 200 kc/s signal, and the reading of the dial noted. The receiver is next tuned to around 500 metres where the third harmonic (600 kc/s) of the generator will be picked up. The generator is tuned down in frequency until a signal is again received, this time on the fourth harmonic of 150 kc/s, and the generator dial reading once more noted. The generator is tuned up in frequency until the second harmonic of 300 kc/s is picked up, and the dial reading again noted. It is important to note, here, that

signals around 230 kc/s may break through if the receiver has the normal 465 kc/s i.f. A signal due to i.f. breakthrough may be recognised in that it does not disappear when the receiver tuning is altered.

The generator is next tuned back to 200 kc/s and the third harmonic, again picked up on 600 kc/s. The generator is now tuned until its fundamental is on 600 kcs, and the dial reading noted. The generator is returned to 200 kc/s, its fourth harmonic tuned in on 800 kc/s and the procedure repeated. Ranges 1, 2 and 3 can thus be calibrated at 200 kc/s intervals.

Ranges 4 and 5 are calibrated at 1 Mc/s intervals. The procedure is the same as before, but the generator is returned to 1 Mc/s each time. Modulation will be needed unless the receiver has a signal strength indicator or a b.f.o. Image signals will be a problem—most receivers will pick up a spurious signal about 900 kc/s above the wanted one. This effect is minimised by reducing the

coupling between the generator and the receiver.

When the graphs have been drawn and checked, the generator scale may be directly calibrated from them. The time spent doing this will be amply repaid later by the time saved in not having to hunt for the calibration charts every time the generator is used.

When the switch is in position 6, an external coil may be connected across terminals A and B. This facility is useful when matching coils. The first coil is put into circuit, and VC₁ is adjusted until a signal is picked up at a convenient frequency on a receiver. The first coil is removed and the second put into circuit. By adjustment of the core or the number of turns, the inductance of this second coil is altered until the signal is picked up once more. The two coils then have the same inductance.



1968 MULLARD DATA BOOK

Full Coverage of Entertainment Products

The 1968 edition of the Mullard Data Book has been published.

For the first time it embraces the complete ranges of the company's valves, tubes, semiconductors and components for entertainment applications.

One of the features of the latest edition of this well-known reference work is the use of different coloured paper for each of the four main product sections. Buff is used for semiconductors, blue for valves, pink for picture tubes and green for components.

All four sections cover data and the type nomenclature system. In addition, comparables are listed in the semiconductor section, equivalents and earlier types in the valve section and replacements in the picture tube section. The book opens with a list of symbols and abbreviations.

The handy pocket size and durable cover have been retained.

The usual free distribution has been made to the trade. However, in view of the breadth of information the book contains and because of the higher production costs involved, it has been decided to make a charge for additional copies.

It has also been decided to make the book available, for the first time, through dealers, to interested persons, such as electronics enthusiasts outside the trade, at a recommended price of 3s. 6d. a copy.

RADIO AND TELEVISION SERVICING

The 1968 Edition, is the latest edition of this famous series of annual volumes. It provides Circuits, Diagrams and Repair Data for all the popular 1967/68 makes of Televisions (including colour TV), Radios, Tape Recorders and Record Players. Formerly published by Newnes it is now available from Buckingham Press Ltd., Mail Books Dept., 4 Fitzroy Square, London W.1. (Price is 80/-).

TRANSISTOR CIRCUITS FOR IMPROVING RELAY SENSITIVITY

by B. T. HATHAWAY

Our contributor presents a number of practical circuits which afford a very considerable increase in relay energising sensitivity. It should be mentioned that these circuits are intended for the somewhat more experienced constructor who is familiar with relays and relay operation, and who will understand the basic principles involved.

RELAYS ARE WIDELY USED IN ELECTRONIC circuitry, and the amateur enthusiast finds a vast range of types, all with different characteristics, available on the market. In spite of this, it often happens that some special job crops up in which a relay with an exceptionally high degree of sensitivity in terms of operating current or voltage is required, but that a suitable type is either simply not available or proves to be prohibitively expensive.

The simple answer to this problem is to employ special transistor circuitry which will modify the characteristics of a low-cost existing relay to suit the particular characteristics that the constructor has in mind, and with this end in view this article presents a total of six different transistor circuits for increasing the sensitivities of normal relays.

Thus, using one of these circuits, it is possible to take a conventional 700 Ω , 9 volt relay (for example), which requires a normal operating current of 13mA, and make it operate from 200 μ A at 10 volts. Alter-

natively, using a different circuit, it can be made to operate from as little as 20 μ A at 10.5 volts. A third possibility, given by yet another circuit, allows the same relay to operate from 100 μ A with an input voltage of 300mV only. Each circuit is extremely versatile and may be used with a large number of basic relay types, so that the reader should find that at least one or other of these circuits will suit any particular application that he may have in mind.

Circuit No. 1

This circuit (shown in Fig. 1 (a)) is designed to give a large increase in the current sensitivity of an existing relay, but no improvement in the voltage sensitivity.

From Fig. 1 (a) it can be seen that TR₁ is wired as an emitter follower with RLA as its emitter load. The transistor base is clamped to the negative supply line by R₁ and the input signal is applied to this base via R₂ and D₁. In this circuit virtually no output voltage appears across RLA until the input voltage exceeds about 1.5 volts (the combined forward "knee voltages" of D₁ and TR₁ emitter-base junction) after which the emitter then "follows" any increase in input voltage above this level. Thus, under actual operating conditions, the voltage across RLA equals V_{in} minus 1.5V, so that if we use a relay that normally turns on at 8.5 volts and off at 5 volts, it will in fact turn on at 10 volts and off at 6.5 volts when used with this circuit. Note that, although the circuit has the disadvantage of increasing the operating voltage of the relay, it has the advantage of slightly reducing the on/off voltage ratio.

The primary aim of the circuit is to reduce the "trigger" current required to operate the relay, and

(continued on page 475)

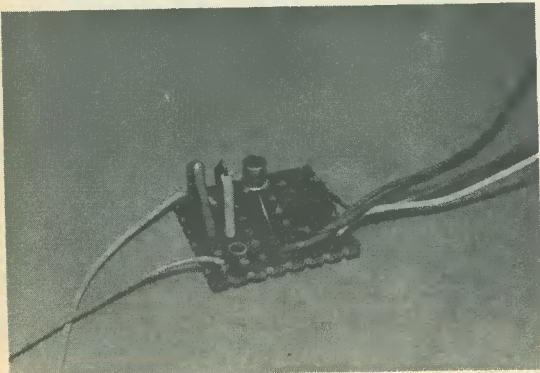

The simple assembly given in the circuit of Fig. 1

RADIO CONSTRUCTORS DATA SHEET

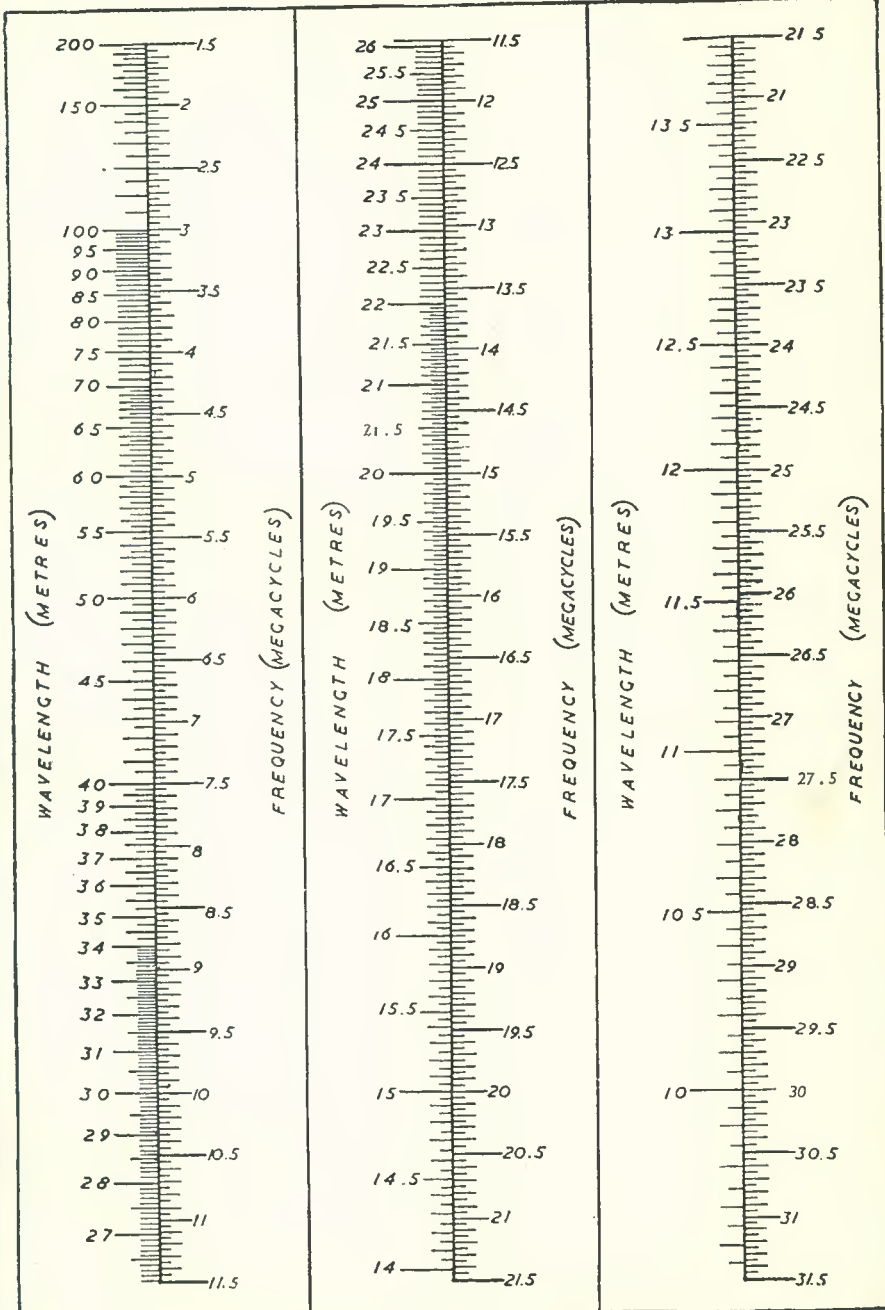

FREQUENCY/WAVELENGTH CONVERSION CHART

RG/DS/3

CUT ALONG THIS LINE

TRADE REVIEW . . .

SINCLAIR "NEOTERIC 60" STEREO AMPLIFIER

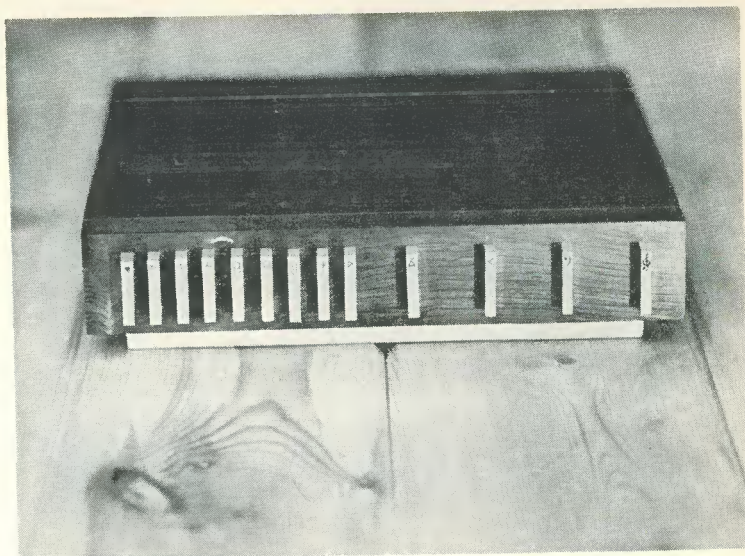

Sinclair Radionics of Cambridge, England have entered the luxury high fidelity field with the announcement of their "Neoteric" range of components. The first production product, called the "Neoteric 60", is a 60 watt (30 watts per channel) integrated stereo amplifier of advanced design and specification, selling at 55 guineas.

Boasting an ultra-low level of distortion at all powers and frequencies, the amplifier delivers a minimum of 30 watts (r.m.s.) continuous sine wave, and 60 watts music power into 8Ω . At 10 watts per channel and 1 kc/s into 15Ω , the total harmonic distortion is 0.05% only. Distortion is 0.1% at 15 watts per channel into 8Ω .

Internally many innovations are incorporated in the "Neoteric 60". The pre-amplifier is designed around five silicon planar transistors per channel, thereby providing a great capacity against overload (approximately 100:1). User convenience is further assured by adjustable sensitivities on three of the five input pairs. The power amplifier employs pure complementary symmetry in the output stages and offers complete stability on all types of loads, including electrostatic loudspeakers. As the unit's entire case is thermally coupled to the modular sub-assemblies, this considerable heat-sinking area ensures a large margin of power capability. The power supply itself, "trips" in less than one-thousandth of a second should the outputs be short-circuited.

Measuring $2\frac{1}{8}$ high, $8\frac{1}{2}$ wide, and $9\frac{1}{4}$ in deep, the "Neoteric 60" claims a new world standard in size to power ratio. It weighs 6 pounds, 8 ounces. The finish is consistent with the sophisticated electronic specifications since the entire case is hand crafted, much of it from solid materials such as the rosewood front panel, and the aluminium and brass control knobs which are engraved with identification symbols. The case itself is hand rubbed and stove enamelled over steel. All external connections are located unobtrusively at the rear, facing downwards, and the earphone socket is concealed behind a sliding magnetic thumb plate.

The "Neoteric 60" is fully guaranteed by the makers, Sinclair Radionics Limited, 22, Newmarket Road, Cambridge.

Full trade discounts are available to bona fide dealers.

TRANSISTOR CIRCUITS FOR IMPROVING RELAY SENSITIVITY

(continued from page 472)

this is achieved by normal transistor action, the precise degree of increase in sensitivity depending on the current gain of the particular transistor used. In the general case, a Sinclair ST140 transistor will result in an increase in current sensitivity of about 30 times, while a Sinclair ST141 will result in an increase of about 60 times. Thus, if a relay requires a normal operating current of 13mA, an operating current of only about 200 μ A will be required when it is used in Fig. 1 (a) with an ST141 transistor.

With this particular circuit the input voltage to the transistor must be connected with the polarity shown. D₁ functions as a safety diode to ensure that TR₁ will not be damaged in the event of the input signal being applied with incorrect polarity.

R₂ is used as a base-current limiting resistor, and

has a normal value of 1k Ω . However, the value of this resistor can, if required, be increased to raise, by voltage divider action, the effective operating voltage of the relay, thereby enabling (for example) a 9 volt relay to operate at an input potential of 20 volts.

The precise value of R₂ must be found by trial and error in such cases, but as a general guide for relays with energising currents of the order of 13mA, it can be said that R₂ should be given a value of 2k Ω per surplus volt when ST140 transistors are used, and 3.5k Ω per surplus volt when ST141 transistors are used. Thus, if a normal 9 volt relay is required to operate at 20 volts in an ST141 circuit, 1.5 of the surplus volts will be lost by "knee voltage" in D₁ and TR₁, whilst the remaining 9.5 volts can be lost in R₂ which, at 3.5 k Ω per surplus volt, will require a value of about 33k Ω .

RLA may be any relay providing it requires a basic operating current of less than 200mA and an operating voltage of less than about 18 volts. The positive supply line of the circuit should have a potential equal to the relay operating voltage plus

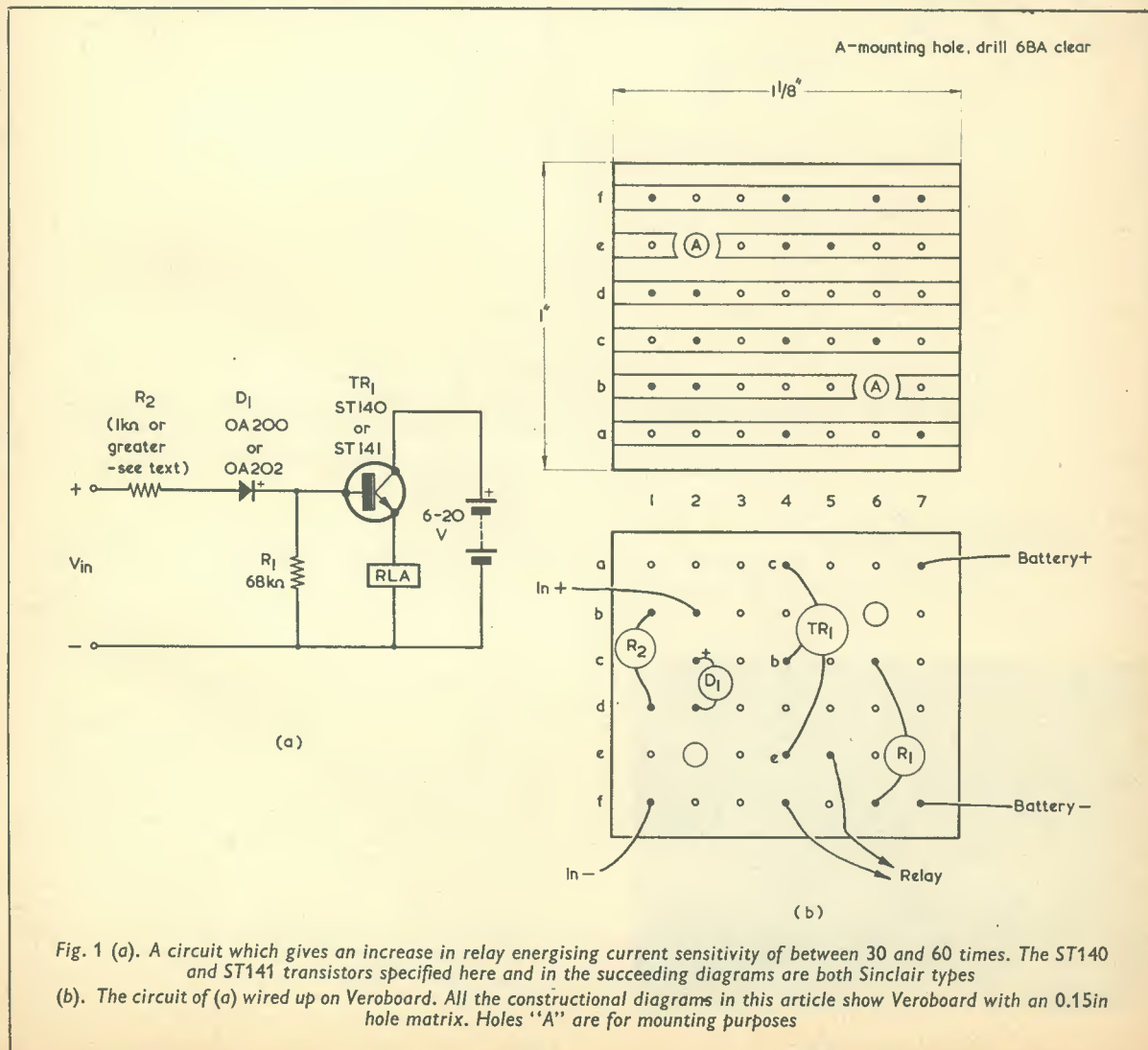

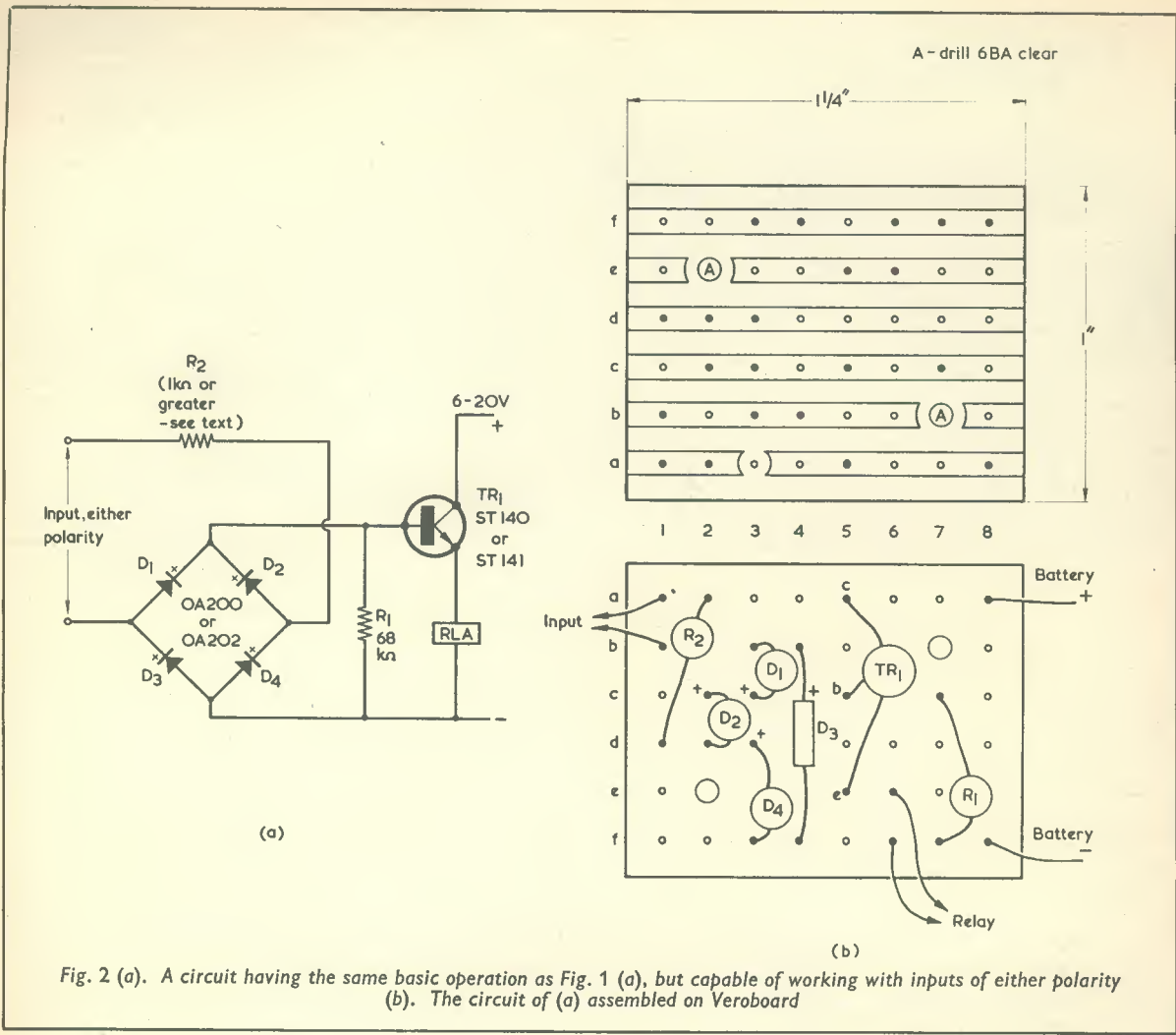

some 2 to 4 volts, i.e., if a 9 volt relay is used, a 12 volt supply should be employed.

The basic amplifier circuit may be wired up on a small piece of Veroboard, complete with mounting holes, and suitable constructional details are shown in Fig. 1 (b).

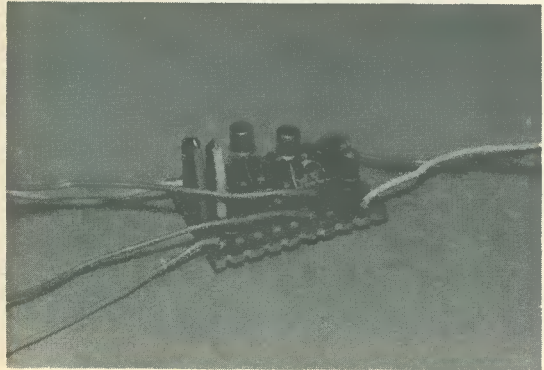

Fig. 2 completely wired up

Circuit No. 2

When discussing the circuit of Fig. 1 (a) it was pointed out that the input potential must be connected with the polarity shown if the circuit is to operate correctly. A normal relay will, however, operate with either polarity of supply voltage, and there may be some applications in which similar action is required in a transistor-relay circuit. In such cases, the circuit of Fig. 2 (a) may be used.

This circuit is similar to that already discussed with the exception that the input signal is converted in the bridge rectifier given by D₁ to D₄, so that a unidirectional output signal is fed to TR₁ base irrespective of the polarity of the input voltage at the actual input terminals, and the circuit will operate satisfactorily with any polarity of input. When using this circuit it is important to note that either the input terminals or the circuit itself must be "floating", i.e., the input terminals must not share a common "ground" line with the circuit.

A "knee voltage" of about 2 volts is obtained with this circuit, so that a relay that will normally switch on at 8.5 volts and off at 5 volts will in fact operate at 10.5 volts and switch off at 7 volts when used in

Fig. 2 (a). Other factors, such as trigger current, the value of R_2 , the value of supply potential, etc., are the same as was described for Circuit No. 1.

Constructional details for Circuit No. 2 are shown in Fig. 2 (b).

Circuit No. 3

In this circuit (shown in Fig. 3 (a)) TR_1 and TR_2 are wired as a "Super-Alpha Pair", and can be regarded as a single transistor having an exceptionally high value of current gain. Thus, this circuit can be seen to be similar to that of Fig. 1 (a), but with a far greater current gain.

In this case, an overall current gain of about 600 times is available, so that a relay which would normally require an energising current of 13mA can be operated by a mere $20\mu A$ or so. The circuit has a "knee voltage" of about 2 volts.

The effective operating voltage of the relay can be increased by suitable choice of the value of R_2 working on the rough basis of $33k\Omega$ per surplus volt for a 13mA relay.

The range of values for relay types and the supply

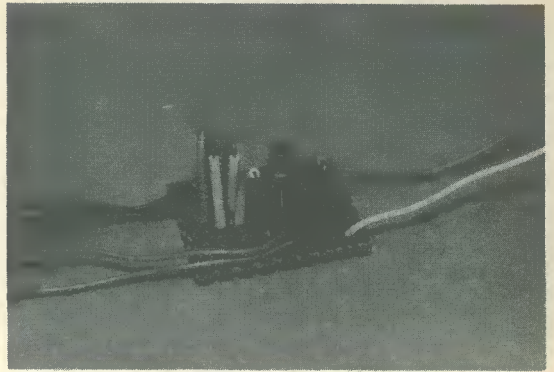

The circuit of Fig. 3, fully assembled

line voltages are the same as was discussed for Circuit No. 1.

As in the case of Circuit No. 1, the input voltages to this circuit must be connected with the polarity shown. Full constructional details of the circuit are shown in Fig. 3 (b).

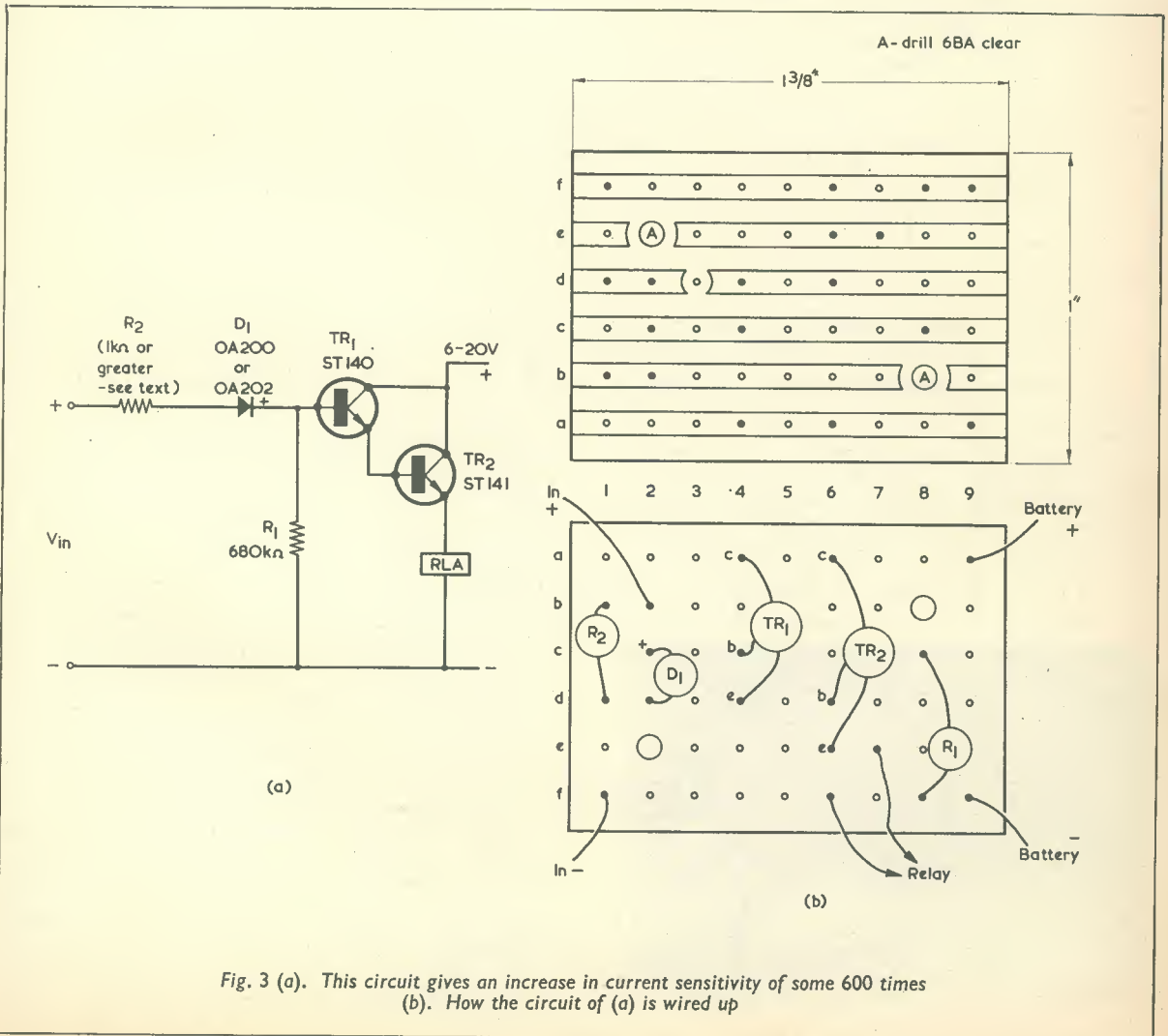

Fig. 3 (a). This circuit gives an increase in current sensitivity of some 600 times (b). How the circuit of (a) is wired up

A - drill 6BA clear

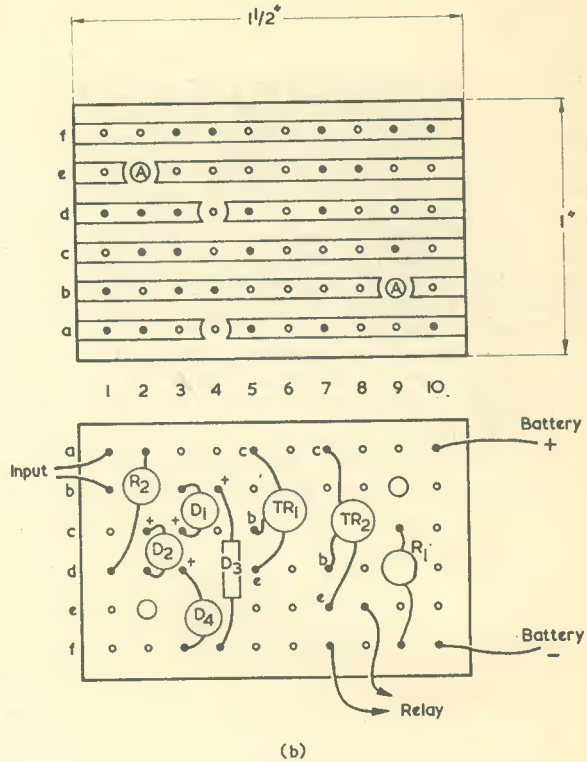
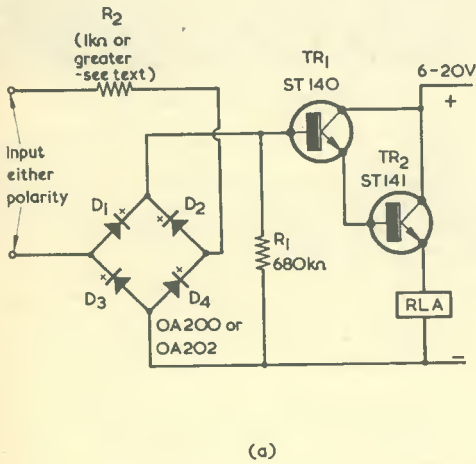
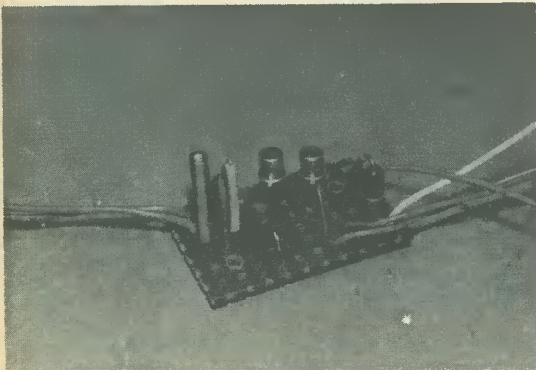

Fig. 4 (a). Offering the same increase in current sensitivity as Fig. 3 (a), this circuit accepts inputs of either polarity
(b). A practical assembly for the circuit of (a)

Circuit No. 4

This circuit is illustrated in Fig. 4 (a), and is virtually the same as that of Fig. 3 (a), with the exception that the bridge rectifier given by D₁ to D₄ enables the circuit to work from either polarity of input signal. Either the input terminals or the actual circuit must be "floating" in this case, however, and the "knee voltage" of the circuit is about 2.5 volts.



Completed version of the circuit of Fig. 4

Details of current sensitivity, the selection of value for R₂, etc., are the same as already described for Circuit No. 3.

Constructional details of Circuit No. 4 are shown in Fig. 4 (b).

Circuit No. 5

This circuit (Fig. 5 (a)) is designed to increase both the voltage and current sensitivity of an existing relay, and to reduce the on/off voltage ratio of the relay at the same time. Using a 700 ohm relay with a normal on voltage of 8.5 volts and an off voltage of 5 volts, the circuit modifies the characteristics so that the relay switches on at 300mV and off at 250mV, the on current being about 90μA. In practice these characteristics are largely independent of the resistance of the relay coil.

Referring to Fig. 5 (a), TR₁ is wired as a common emitter amplifier with collector load R₂. R₁ is connected between TR₁ base and the positive supply line so that the transistor is biased hard on in the absence of an input signal, whereupon almost the full supply voltage is dropped across R₂, causing TR₁ collector to be near zero potential with respect to the negative supply line. TR₂ is wired as an emitter follower, with emitter load RLA, and with its base direct coupled to TR₁ collector. When no input

voltage is applied, TR₂ is normally cut off and no current flows in RLA.

If an input signal is now connected to TR₁ base, via R₃, D₁ and D₂, with the polarity shown, the base current of TR₁ will be reduced until, finally, the transistor becomes cut off. Under this condition no voltage will be dropped across R₂, and TR₁ collector will be at the positive supply potential, driving TR₂ hard on and operating the relay.

Diodes D₁ and D₂ prevent an incorrectly connected input signal damaging the circuit, while R₃ limits the input current to a safe value. It is important to note that the specified silicon diodes must be used in this circuit, for the following reason.

If the base of TR₁ is short-circuited to the negative supply line, zero base current will flow in this transistor and the relay will operate in the manner outlined above. A similar action will be obtained even if the base is connected to the negative supply line via a resistance with a value of several thousand ohms, and it can be seen that (unless suitable precautions are taken) this action might be obtained simply by short-circuiting the input terminals of the circuit together or by connecting an input of zero volts from a low impedance source. Now, under normal operating conditions TR₁ has a "knee voltage" of between 600mV and 800mV on its base, and the only way of ensuring that the transistor will not switch off when the input terminals are short-

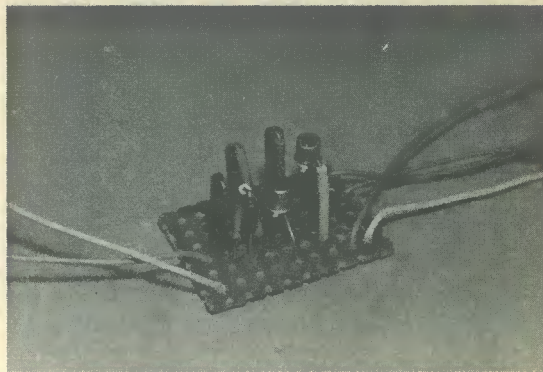

The amplifier of Fig. 5

circuited together is to wire a device in series with the input base lead which has a "knee voltage" greater than that of the transistor. This high "knee voltage" is obtained here by using the two silicon diodes shown in Fig. 5 (a). It must be emphasised that the high "knee voltage" could not be obtained with germanium diodes, since the "knee voltage" of a germanium diode is much lower than that of a silicon type.

When R₃ is given a value of 1kΩ, the relay will

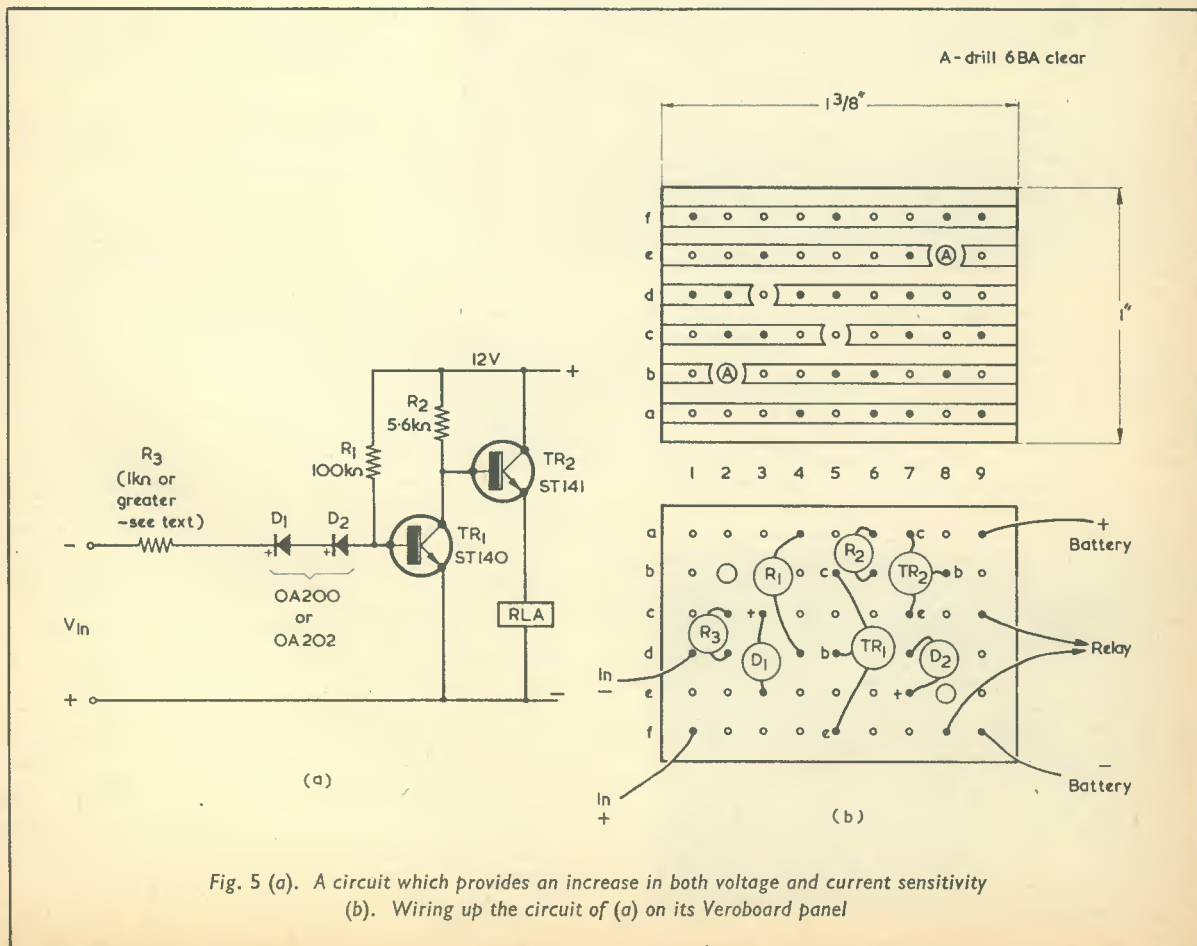

Fig. 5 (a). A circuit which provides an increase in both voltage and current sensitivity
(b). Wiring up the circuit of (a) on its Veroboard panel

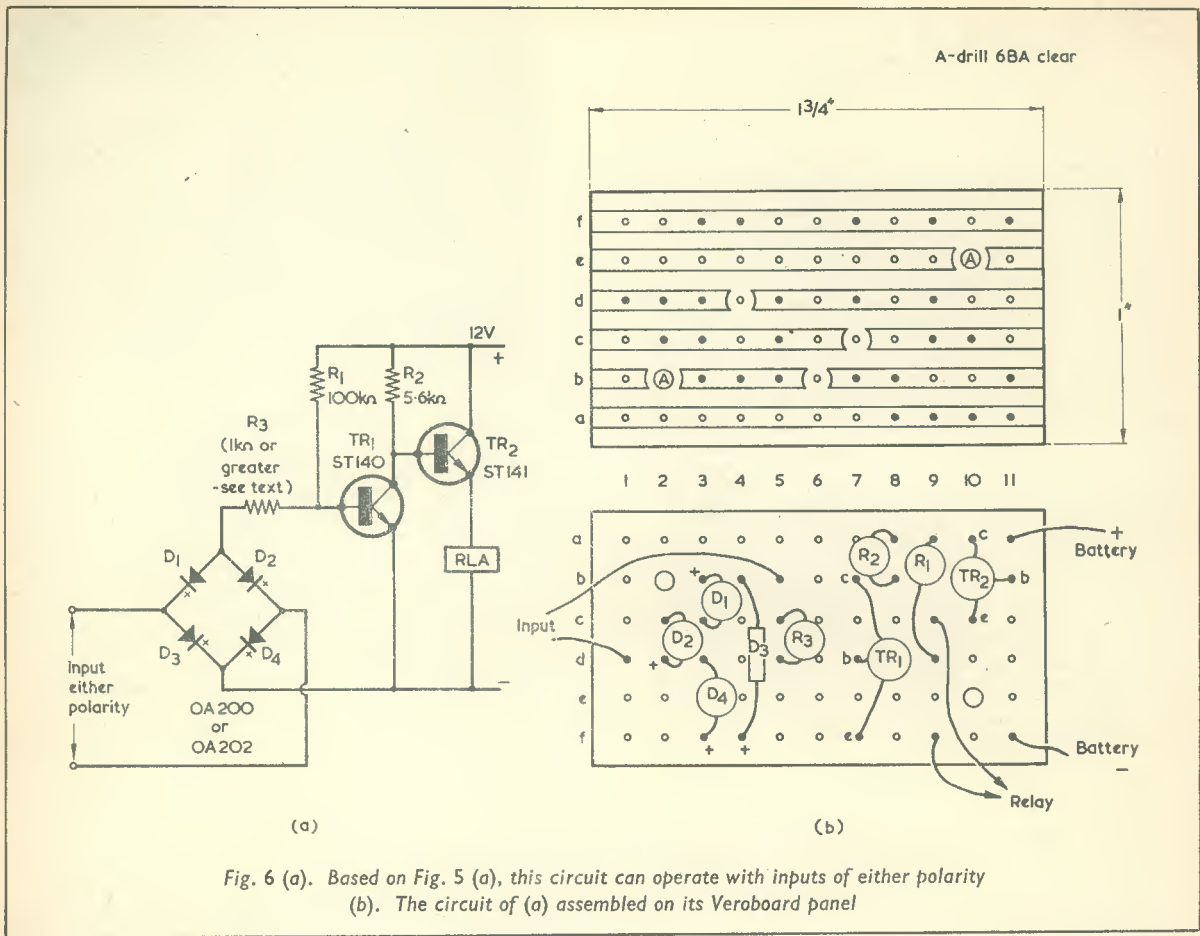
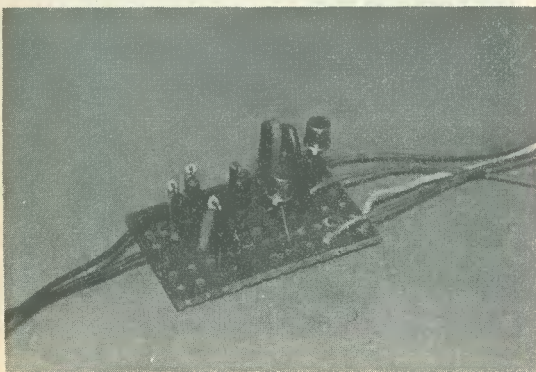

Fig. 6 (a). Based on Fig. 5 (a), this circuit can operate with inputs of either polarity (b). The circuit of (a) assembled on its Veroboard panel

operate with an input voltage of about 300mV. If required, the operating voltage can be increased by increasing the value of R_3 on the rough basis of 10kΩ per volt for a relay of the type discussed previously.

Using the component values and supply rail potential shown, the circuit is suitable for use with relays having coil resistances of 60Ω or greater, and operating voltages of 10 volts or less. If relays other than these types are to be used, the component values of the circuit will have to be changed, using the following procedure.



The circuit of Fig. 6 in its assembled form

Remove R_1 and TR_1 from the circuit and connect RLA in place. Connect the supply, with a value equal to the relay operating voltage plus 2 to 4 volts (up to a maximum of 20 volts), to the circuit, and check that RLA operates. If RLA does not operate, reduce the value of R_2 until it does, but do not reduce the value to less than 220Ω. Connect TR_1 and R_1 in circuit, and adjust the value of TR_1 until no more than 0.5 volt is developed across RLA. Now connect an input voltage to the unit and check that the relay operates with an input voltage of a few hundred millivolts. If satisfactory, the design is complete. It should be noted that the circuit must not be employed with relays that require operating currents of greater than 200mA.

Constructional details of Circuit No. 5 are shown in Fig. 5 (b).

Circuit No. 6

This, the final circuit in this series, is shown in Fig. 6 (a) and is similar to that of Fig. 5 (a), with the exception that the bridge rectifier given by D_1 to D_4 enables the circuit to operate from an input signal of either polarity. Either the input terminals or the actual circuit must be "floating" in this case, however, and an operating voltage of 450mV or greater is needed.

The circuit can be made to operate at voltages greater than 450mV, if required, by increasing the

value of R_3 on the basis of $10k\Omega$ per surplus volt as previously discussed. All other points concerning types of relay and circuit modifications are as described for Circuit No. 5 and silicon diodes must be used in the D_1 to D_4 positions.

Editor's Note—

In the circuits described in this article the relay coil is presented, in each diagram, as a rectangle having the legend "RLA". Relay contacts are not shown.

Each circuit incorporates one or more silicon diodes type OA200 or OA202 in series with the input, and it should be remembered that the OA200 has a peak inverse voltage rating of 50 volts, and the OA202 a peak inverse voltage rating of 150 volts.

The author employs the term "knee voltage" to define the voltage at which a silicon diode, or the base-emitter junction of a silicon transistor, commences to pass forward current. When several of these devices are in series, the total "knee voltage" is equal to the sum of the individual "knee voltages".

If the relay is employed in an application in which it may de-energise quickly due to the sudden cessation of energising current or voltage, it would be desirable to connect a diode (such as the OA81) across the relay coil to prevent the appearance of a high back-e.m.f. which might damage the controlling transistor. The diode should be connected so that it is non-conductive when the relay is energised. In all the circuits given here, the anode ("negative end") of such a diode would connect to the negative supply line. *

TRADE REVIEW . . .

HEATHKIT PORTABLE STEREO TAPE RECORDER MODEL STR-1



This new kit, recently released by Daystrom, provides complete recording and playback facilities in one compact cabinet. Special features of this unit include $\frac{1}{2}$ track stereo or mono record and playback at $7\frac{1}{2}$, $3\frac{3}{4}$ and $1\frac{7}{8}$ i.p.s.; sound-on-sound and sound-with-sound capabilities; stereo record—playback, mono record—playback on either channel; 18 transistor circuit; moving coil record level indicator; digital counter with zero reset; stereo microphone and auxiliary inputs and speaker/headphone outputs; push button controls for operational modes; built-in amplifiers giving 4 watts r.m.s. per channel; operates on 230V a.c. mains supply and includes two 8×5 in speakers.

The STR-1 Tape Recorder uses British components and the well-known B.S.R. TD-10 tape deck. A full specification sheet may be obtained from Daystrom Ltd., Gloucester. The kit is priced at £45 18s. 0d. or can be supplied ready to use at £59 15s. 0d. free delivery in the U.K.

SPECIFICATION

- Tape speeds :** $7\frac{1}{2}$, $3\frac{3}{4}$ and $1\frac{7}{8}$ i.p.s.
- Wow and flutter :** Better than: 0.15% r.m.s. on $7\frac{1}{2}$ i.p.s.; 0.25% r.m.s. on $3\frac{3}{4}$ i.p.s.; 0.35% r.m.s. on $1\frac{7}{8}$ i.p.s.
- Tape size :** $\frac{1}{2}$ in wide, Long or Standard play.
- Reel size :** Standard, up to 7, $5\frac{1}{4}$ in spool and tape supplied.
- Digital counter :** 3 digit counter with zero reset.
- Heads :** $\frac{1}{2}$ track erase, record/playback.
- Microphone :** Moving coil hand microphone (mono) supplied.
- Semiconductor complement :** 18 transistor, 1 silicon bridge rectifier.
- Frequency response :** ± 3 dB, 40 c/s to 18 kc/s at $7\frac{1}{2}$ i.p.s.
 ± 3 dB, 40 c/s to 12 kc/s at $3\frac{3}{4}$ i.p.s.
 ± 3 dB, 40 c/s to $7\frac{1}{2}$ kc/s at $1\frac{7}{8}$ i.p.s.
- Signal to noise ratio (unweighted) :** Better than 40dB.
- Inputs per channel :** Microphone 0.35 mV. $50k\Omega$ impedance. Auxiliary 50 mV. $80k\Omega$ impedance.
- Output per channel :** 4 watts r.m.s. into 15 ohms. 250 mV r.m.s. (4000 ohm source).
- Speakers :** Two, high efficiency 8×5 in pm 15 ohms.
- Power Supplies :** Transformer operated, bridge rectifier.
- Power requirements :** 200–250V a.c. 50 c/s, 60 watts.
- Cabinet :** Materials : 9 mm plywood. Finish : Black Rexine with light grey panel and speaker grilles.
- Dimensions :** $19\frac{1}{2}$ wide \times $7\frac{1}{4}$ high \times $15\frac{1}{2}$ in deep.
- Net Weight :** 30 lb.



Crystal Controlled F.M. Receiver

AN F.M. TUNER UNIT MUST BE CONNECTED TO a suitable audio amplifier before it can be used. Therefore if one wishes to move an f.m. tuner into another room, one has the trouble of connecting it to a suitable amplifier and speaker system in that room. The design to be described does not suffer from this difficulty, since an audio amplifier and power output stage is included in the circuit.

The small internal output stage used in the present design will obviously not offer first class reproduction from an f.m. signal. An output is therefore provided which can be used to feed a high fidelity amplifier or tape recorder. This output is at a level of about 0.5 volt r.m.s. and is unaffected by the receiver volume control. The writer likes to be able to feed a signal through a long length of coaxial cable on some occasions and therefore it was considered essential to provide a low impedance output from the receiver so that the capacitance of the coaxial cable would not reduce the high frequency signal amplitude. A cathode follower circuit is employed to provide an output of very low impedance (a few hundred ohms). Thus a very long length of cable may be connected between the receiver and a high fidelity amplifier without any adverse effect.

Although the writer would not recommend an absolute beginner to construct the receiver to be described, the average home constructor should find no difficulty in obtaining satisfactory results.

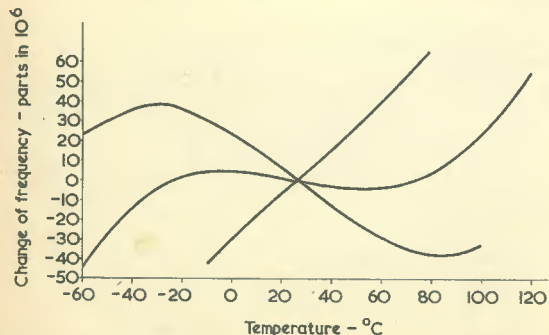
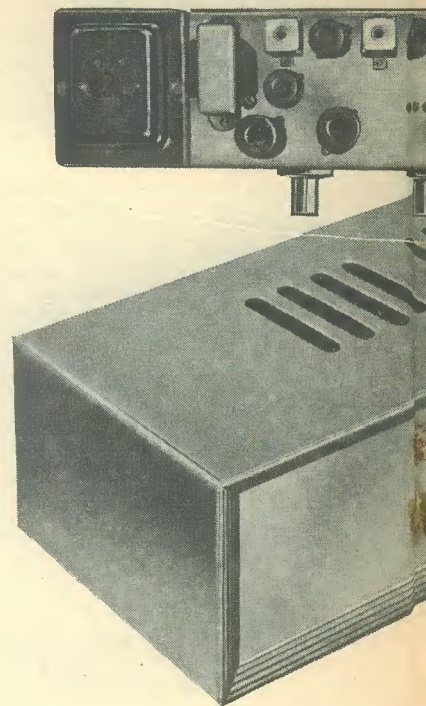

Fig. 1. Typical temperature coefficients for the S.T.C. triple-crystal units. (Courtesy Standard Telephones & Cables Ltd.)



In this and next month's issue our continuing series of articles on the S.T.C. receiver incorporating the S.T.C. triple-crystal units, well-established and reliable, and a cathode follower circuit, available. This month the author describes the receiver, concluding article, to be published next month.

Apart from the need for a slightly larger power supply, the only disadvantage of a complete receiver compared with a tuner is the additional drift which results from the heat generated in the power output stage. Local oscillator drift is, however, reduced to negligible amounts by the use of crystal control. When a tape recording of a programme is being made, the output from the receiver may be used for monitoring purposes, but if the receiver is used for feeding a high fidelity amplifier, the output from the receiver loudspeaker should be reduced to zero by the use of the volume control.

A normal ratio detector circuit is employed as the detector. Whilst a detector employing the pulse counting technique¹ would probably have given a response which would be somewhat more linear (that is, there would have been less distortion), it has been found that the signal output from the receiver to be described gives excellent results with a high fidelity amplifier and a Quad electrostatic loudspeaker. Such a system would readily show up any appreciable distortion in the tuner section of the receiver.

Switched Tuning

The writer feels strongly that a switched tuned

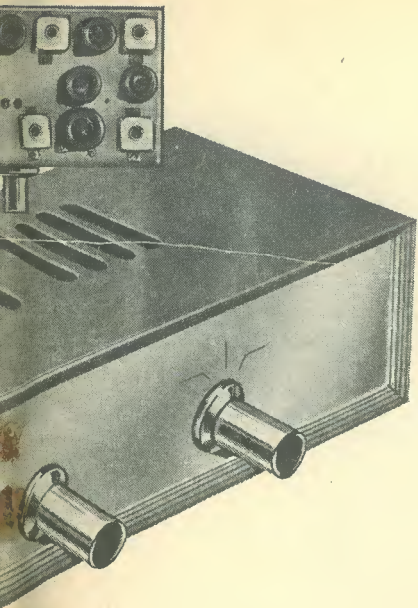

Part I

by J. B. DANCE, M.Sc.

Contributor describes a crystal controlled f.m. receiver-crystal unit. The circuitry employed is a frequency-follower output for hi-fi equipment. This article describes the circuit and its functioning. In the next month, details of construction are given

receiver is far more convenient for normal listening to local programmes than is a receiver employing continuously variable tuning, no matter whether the user is an electronics expert or knows nothing of the subject. The convenience of being able to select any one of the three programmes at the touch of a switch without having to adjust a knob carefully until a tuning indicator shows a maximum response is a very desirable attribute. The only disadvantage of a switch tuned crystal controlled receiver for local station listening occurs when one moves to another part of the country and requires a new crystal of a resonant frequency suitable for the reception of signals from the transmitter in the new locality.

The Circuit

The circuit of the receiver may be conveniently divided into four parts, namely:—

- (i) The crystal controlled oscillator circuit (Fig. 2).
- (ii) The r.f./i.f. Unit (Fig. 3).
- (iii) The audio circuits (Fig. 4).

(iv) The power supply circuit (Fig. 5). Each of these circuits will now be discussed in detail.

The Crystal Controlled Oscillator Circuit

If the standard protected intermediate frequency of 10.7 Mc/s is to be employed to receive the f.m. transmissions in the 90 Mc/s region, the local oscillator must provide a signal in the region of either 80 Mc/s or 100 Mc/s. The lower value of about 80 Mc/s is chosen for ease of circuit design. The actual oscillator frequency must be almost exactly 10.7 Mc/s away from the frequency of the particular transmission to be received and must not drift. Crystals which have a fundamental frequency of about 80 Mc/s are not readily obtainable. It is possible to use a crystal of a much lower frequency

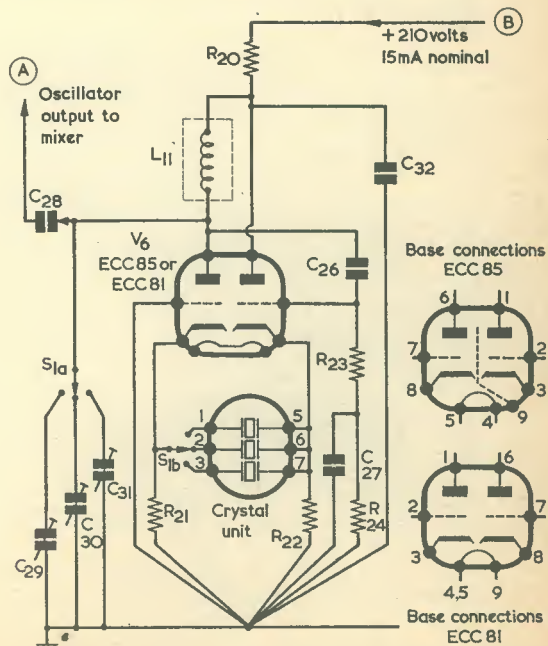

Fig. 2. The crystal-controlled oscillator circuit. The ECC85 is preferable but an ECC81 may also be used

Resistors

(All fixed values $\frac{1}{10}$ watt, 20%, unless otherwise stated)

R ₁	1k Ω $\frac{1}{4}$ watt
R ₂	1k Ω
R ₃	180 Ω
R ₄	10k Ω
R ₅	1M Ω
R ₆	1k Ω $\frac{1}{4}$ watt
R ₇	180 Ω
R ₈	1k Ω $\frac{1}{4}$ watt
R ₉	220 Ω
R ₁₀	1M Ω
R ₁₁	100k Ω
R ₁₂	100k Ω
R ₁₃	100k Ω $\frac{1}{4}$ watt
R ₁₄	8.2k Ω $\frac{1}{2}$ watt
R ₁₅	100k Ω 10%
R ₁₆	1k Ω 5%
R ₁₇	1.5k Ω 5%
R ₁₈	6.8k Ω $\frac{1}{4}$ watt 1% high stability
R ₁₉	6.8k Ω $\frac{1}{4}$ watt 1% high stability
R ₂₀	3.9k Ω 1 watt 10%
R ₂₁	120 Ω 10%
R ₂₂	120 Ω 10%
R ₂₃	100k Ω
R ₂₄	6.8k Ω
R ₂₅	1M Ω
R ₂₆	10k Ω
R ₂₇	680 Ω
R ₂₈	47k Ω $\frac{1}{4}$ watt
R ₂₉	150k Ω $\frac{1}{2}$ watt
R ₃₀	2.2k Ω
R ₃₁	250k Ω potentiometer (small) log track
R ₃₂	470k Ω
R ₃₃	390 Ω 1 watt 10%
R ₃₄	1.5k Ω 6 watts wirewound
R ₃₅	10k Ω 10%

Capacitors

(No tolerance is specified for high-value ceramic discs. These may have the wide tolerance associated with this type of capacitor.)

C ₁	5,000pF ceramic disc
C ₂	4.7 or 5pF ceramic 20% (Any temperature coefficient)
C ₃	1,000pF ceramic disc
C ₄	1,000pF ceramic disc
C ₅	10pF ceramic N330 10%
C ₆	47pF ceramic N750 20%
C ₇	1,000pF ceramic disc
C ₈	50pF silver-mica 5%
C ₉	50pF silver-mica 5%
C ₁₀	5,000pF ceramic disc
C ₁₁	5,000pF ceramic disc
C ₁₂	5,000pF ceramic disc
C ₁₃	50pF silver-mica 5%
C ₁₄	50pF silver-mica 5%
C ₁₅	0.1 μ F polyester 20% 25V wkg.
C ₁₆	5,000pF ceramic disc
C ₁₇	22pF ceramic or silver-mica 20%
C ₁₈	5,000pF ceramic disc
C ₁₉	10pF ceramic N750 10%
C ₂₀	39pF ceramic N330 10%
C ₂₁	5,000pF ceramic disc
C ₂₂	300pF silver-mica 5%

COMPONENTS

C ₂₃	300pF silver-mica 5%
C ₂₄	300pF silver-mica 10%
C ₂₅	10 μ F electrolytic 50V wkg.
C ₂₆	47 or 50pF silver-mica 10%
C ₂₇	1,000pF ceramic disc
C ₂₈	2.2pF ceramic 20%
C ₂₉	} 0.8—6.8pF trimmers. Mullard type COO4EA/6E (see text)
C ₃₀	
C ₃₁	
C ₃₂	1,000pF ceramic disc
C ₃₃	470pF silver-mica 10%
C ₃₄	8 μ F electrolytic 350V wkg.
C ₃₅	0.1 μ F polyester 125V wkg. (Mullard)
C ₃₆	1 μ F polyester 125V wkg. (Mullard)
C ₃₇	0.05 μ F paper or polyester 350V wkg.
C ₃₈	8 μ F electrolytic 350V wkg.
C ₃₉	50 μ F electrolytic 50V wkg.
C ₄₀	8 μ F electrolytic 350V wkg.
C ₄₁	8 μ F electrolytic 350V wkg.
C ₄₂	1,000pF ceramic disc
C ₄₃	1,000pF ceramic disc
C ₄₄	5,000pF ceramic disc
C ₄₅	5,000pF ceramic disc
C ₄₆	1,000pF ceramic disc

Inductors

L ₁ —L ₁₁	R.F. coils and i.f. transformers. Winding details are given in Part 2
*L ₁₂	Smoothing choke, 5H 80mA. Mounting centres 2.8in or less
*T ₁	Output transformer, 45:1. Mounting centres 1.25in or less
*T ₂	Mains transformer. Drop-through. Secondaries: 250—0—250V (or 230—0—230V) at 80mA; 6.3V at 3A. Chassis aperture 1.8 x 2.8in or less (component dimensions 3.7 x 3.1 in)

Valves

V ₁	EF91
V ₂	EF91
V ₃	EF91
V ₄	EF91
V ₅	EB91
V ₆	ECC85 or ECC81
V ₇	ECC81
V ₈	6BW6

Diodes

D _{1,2}	RS260AF (S.T.C.), Rec 51A (Radio-spares) or BY100 (Mullard)
------------------	---

Switches

S ₁	2-pole 3-way ceramic rotary switch
S ₂	See text

Crystals

Triple-crystal unit type 4434 (see text). (Standard Telephones and Cables, Ltd.)

Cut-Out

TC ₁	"Minitrip" thermal cut-out, 100mA (Belling and Lee, Ltd.)
-----------------	---

*Larger components can be used, but it may then be necessary to modify chassis dimensions.

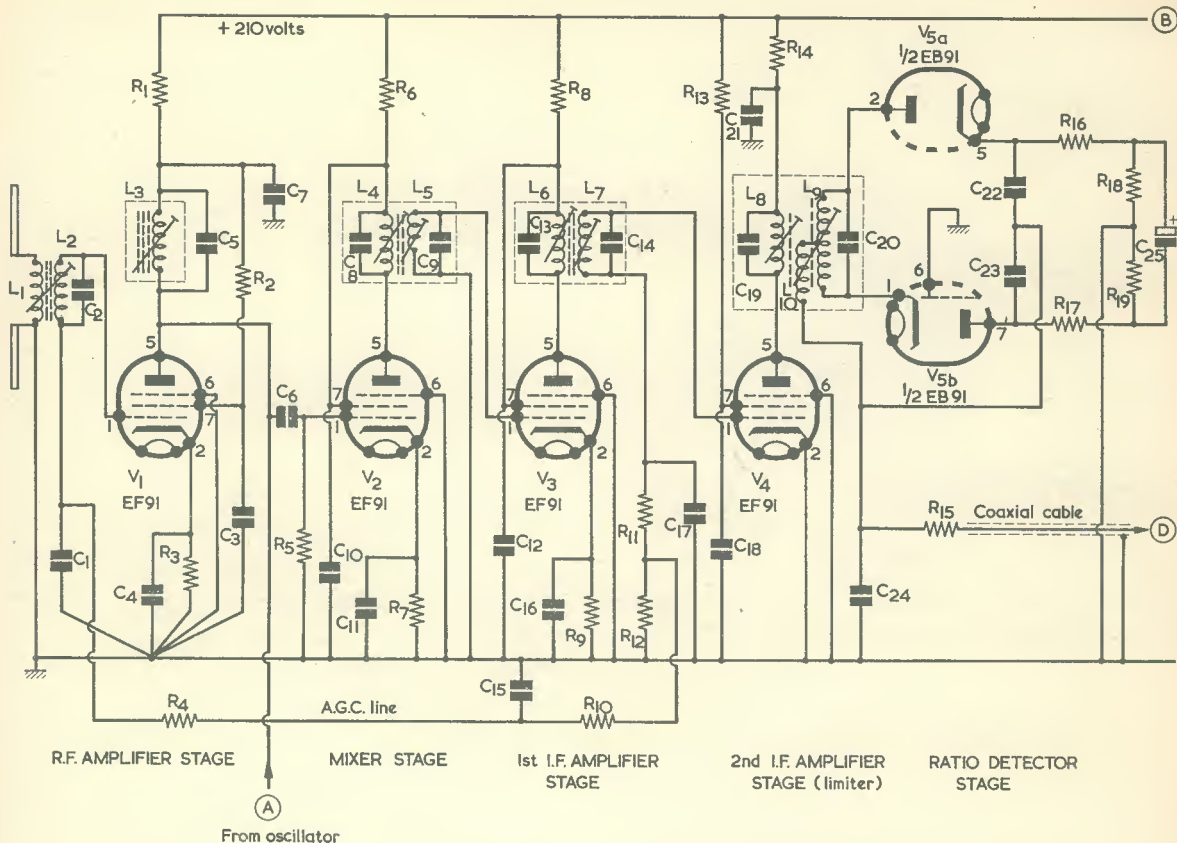

Fig. 3. The r.f./i.f. section of the receiver. Details of heater connections and decoupling are given in Fig. 5

Sockets

- 6 B7G sockets, ceramic with centre spigot, skirt and screen (for V₁ to V₅ and crystal unit)
- 1 B9A socket, ceramic with centre spigot, skirt and screen (for V₆)
- 1 B9A socket, type as desired, with skirt and screen (for V₇)
- 1 B9A socket, type as desired, (for V₈)
- 3 coaxial sockets
- 1 mains connector, type P.73 (Bulgin)

Loudspeaker

- 3Ω loudspeaker

Miscellaneous

(The chassis and general chassis components, such as tagstrips, insulated tags, etc., are discussed in Part 2)

- Chassis
- 2 Knobs
- Wire, nuts, bolts, etc.

together with one or more frequency multiplying stages, but a simpler solution involves the use of overtone crystals. Although these crystals have a lower frequency than the required local oscillator frequency, they can be used to stabilise an oscillator

operating at an harmonic of the crystal frequency.

The S.T.C. triple crystal unit type 4434 is undoubtedly the most convenient type for use in receivers employing a 10.7 Mc/s i.f. These crystal units consist of three separate crystals in a single glass envelope which plugs into a B7G valve base. A normal B7G screening can may be placed over the crystal envelope. The appropriate crystal unit must be selected (see the Table) for the local transmitter. The fifth overtone of the crystal will then beat with the incoming signal to produce the required 10.7 Mc/s i.f. One crystal is selected by a switch for reception of the Home Service, another for the Third Programme and the third crystal for reception of the Light Programme. These AT cut crystals vibrate under thickness shear. They are supplied adjusted at series resonance to the appropriate transmitter frequency. The rated level of drive is 2 milliwatts and the equivalent series resistance is 100Ω.

Drift

The use of one of the triple crystal unit virtually eliminates local oscillator drift. The variation of the resonant frequency of typical S.T.C. crystal units of this type with temperature is shown in Fig. 13. It can be seen that the maximum frequency drift likely to occur under normal conditions of use

TABLE

S.T.C. Crystal Type	Transmitter	Triple Crystal Frequencies (Mc/s) (5th Overtone)		
		<i>Light</i>	<i>Third</i>	<i>Home</i>
4434/A	Wrotham	78.4	80.6	82.8
4434/B	Peterborough, Divis & Thrumster	79.4	81.6	83.8
4434/C	Rosemarkie & Llanddona	78.9	81.1	83.3
4434/D	North Hessary Tor	77.4	79.6	81.8
4434/E	Sutton Coldfield	77.6	79.8	82.0
4434/F	Pontop Pike and Rowridge	77.8	80.0	82.2
4434/G	Meldrum and Blaen Plwyf	78.0	80.2	82.4
4434/H	Holme Moss and Orkney	78.6	80.8	83.0
4434/J	Douglas	77.7	79.9	82.1
4434/K	Kirk o' Shotts	79.2	81.4	83.6
4434/L	Llangollen	78.2	80.4	82.6
4434/M	Norwich	79.0	81.2	83.4
4434/P	Les Platons	80.4	83.75	86.4
4434/Q	Oxford	78.8	84.7	83.2
4434/R	Dover	79.3	81.7	83.7
4434/S	Wenvoe	79.25	86.1	81.425 (West)

Base Connections:—Pins 1 & 5 Light Programme
Pins 3 & 7 Third Programme
Pins 2 & 6 Home Service

S.T.C. crystal type numbers and frequencies.
(Add 10.7 Mc/s to obtain transmitted frequencies.)

is about 20 parts per million. This corresponds to a drift of 1.6 kc/s at the fifth harmonic of the crystal (about 80 Mc/s), which is quite negligible.

Some years ago the writer constructed a very similar switch-tuned receiver, but did not employ crystal control. Several methods of automatic frequency control were tried in this earlier receiver, but in every case the frequency stability was considerably worse than in the receiver being described. In addition the use of a crystal controlled local oscillator virtually eliminates any possibility of microphony due to capacitance changes in the local oscillator.

The Butler Oscillator

The manufacturers of the triple crystal control unit recommend a Butler overtone crystal oscillator, since it is one of the simplest v.h.f. crystal oscillators to set up. In addition it has a low harmonic content which results in quieter mixing. An ECC85 valve is recommended for the crystal oscillator circuit of Fig. 2, but the writer used an ECC81 (12AT7) which he happened to have available. The characteristics of the two valves are quite similar, but the construction of the ECC85 is more suitable for the application.

The inductor L_{11} , like all of the other inductors working at the r.f. or i.f. frequencies, was constructed on an "Aladdin" former of the type which is shielded with an aluminium can of $\frac{3}{8}$ in. square cross section. No core is used in the case of L_{11} . The triple crystal unit is connected between the valve cathodes as shown in Fig. 2. Both valveholders (for the valve and the crystal) should be of a material which has reasonably low losses, and ceramic or p.t.f.e. types are preferable.

A 3-pole 3-way ceramic wafer switch containing a single wafer was used for $S_{1(a)}$ and $S_{1(b)}$. Only two-thirds of the switch was used, since a 2-pole 3-way was really required. It is probably unwise to use a Paxolin switch, although this has not been checked in practice.

The Trimmers

C_{29} , C_{30} and C_{31} are trimmers which enable the anode circuit (L_{11} plus stray capacitance) to be brought to resonance at the oscillator frequency. Compression trimmers are quite unsuitable for this application. It had initially been intended to use the concentric type of Mullard/Philips trimmer, but these are not particularly small or easily mounted. In the opinion of the writer a much better type of trimmer is the Mullard/Philips COO4EA/6E which has a minimum capacitance of 0.8pF, a swing of 6pF and a working voltage of 400. This type of trimmer can be fixed beneath the chassis by a single hole and can be adjusted from the above the chassis by a screwdriver; the chassis acts as a screen preventing the presence of the screwdriver from affecting the tuned circuit wiring. These trimmers consist of an internally threaded ceramic tube in which an invar rotor is guided by a phosphor-bronze wire spring. The rotor can be adjusted from either end, a very accurate adjustment being possible. Although these trimmers are primarily intended for use in industrial electronic equipment, their price is well within the pocket of the amateur constructor. Other similar types with a capacitance swing of 3 to 12pF and types with a working voltage of 800 are available; almost any of these could be employed in the Fig. 2 circuit, but the writer has found that the 0.8 to 6.8pF type are the most suit-

able. A fixed capacitor would have to be placed in parallel with the 3pF type.*

The R.F. Stage

The use of an r.f. amplifier stage will improve the signal-to-noise ratio, assist in preventing radiation from the receiver oscillator and reduce the response to interfering signals on the image frequency. In areas where the field strength is very low, a suitable double-triode may be used as a cascode r.f. amplifier to provide very low noise. However, a simple pentode r.f. stage is used in the receiver being described, since the writer lives in an area where the local transmitter provides a signal of fairly good strength. Although a pentode stage does give more noise than a cascode amplifier, the difference in performance is not likely to be noticeable unless the receiver is some considerable distance from the transmitter or is in a very unfavourable location.

Most r.f. pentodes of high mutual conductance and sharp cut-off can be used for V_1 to V_4 inclusive. See Fig. 3. The EF91 was selected because it is small (B7G base) and is readily available.

The aerial circuit employs a transformer so that a.g.c. can be applied to the r.f. stage. (If a.g.c. were to be applied to the i.f. stages the pass band might be altered, since the effective input capacitance depends on the stage gain. This follows from Miller effect considerations.) The tuned circuit L_2C_2 is damped by the aerial loading and is very broadly tuned. An iron dust core is used to tune it to approximately the central frequency to be received (i.e. the Third Programme frequency). Ideally the dust core should be one of the low permeability cores designed for v.h.f. operation, but it has been found that satisfactory results can be obtained by the use of a standard dust core.

The valve V_1 is loaded by a single tuned circuit, L_3C_5 , the resonant frequency of this circuit being adjusted by means of a dust core (preferably a dust core designed for use at v.h.f.). The tuning of this circuit is considerably more critical than that of the aerial circuit, partly because there is much smaller loading and partly because the oscillator voltage appears across L_3 . At some settings of the dust core of L_3 the oscillator ceases to function.

The Mixer

An additive pentode mixer stage, V_2 , is employed, since this provides a higher conversion conductance (and hence a lower noise level) than a multiplicative mixer such as the common triode-hexode. Although V_2 is biased by its cathode resistor, some additional bias is developed by the flow of grid current through R_5 .

The I.F. Unit

The i.f. unit consists of a conventional amplifier stage, V_3 followed by a high level limiter, V_4 . The screen voltage of the latter stage is only about 100 volts under no-signal conditions owing to the comparatively high value of R_{13} . It is this low screen-grid voltage which enables adequate limiting action to be obtained. When a signal is received at

the grid of V_4 , grid current flows through L_7 , R_{11} and R_{12} . The potential developed in this way across the two resistors acts as a biasing voltage for V_4 .

The voltage across R_{12} is used as a.g.c. for control of the gain of the r.f. stage. Any amplitude modulation present in the signal in the i.f. stages is detected by V_4 and appears across the resistors R_{11} and R_{12} . The decoupling components R_{10} and C_{15} prevent it from reaching the r.f. stage.

I.F. Transformers

The i.f. transformers and ratio detector transformer are home-wound components, and full details are given in next month's concluding instalment of this article. They follow a basic design published in *Wireless World* some years ago and which is due to Amos and Johnstone.⁴ The i.f. transformers have a coupling factor (=coupling coefficient x Q factor) of about 1.2. The transformers must be accurately wound since an error of $\frac{1}{16}$ in the spacing between the two coils of a transformer can make a very large change in the coupling factor and hence in the resultant bandwidth of the i.f. unit.

The capacitors used in the i.f. transformers are 50pF silver-mica components which have a temperature coefficient of about +40 parts per million per °C. Although the gain of the i.f. stages could be raised by the use of a higher dynamic impedance (a larger inductance and a smaller capacitance) this extra gain is not required and the unit would be more prone to frequency drift. The use of a moderately large capacitor (50pF) ensures that any small changes in the circuit capacitance do not have a large effect on the resonant frequency.

The Ratio Detector

Much has been written in the past about the relative merits of the ratio detector and the Foster-Seeley circuit. The former is less susceptible to amplitude modulated signals (such as ignition interference), but the latter is somewhat more linear in its performance. As the receiver was to be used a few yards from a main road and the aerial could not conveniently be placed very far away from this road, it was felt that the use of a ratio detector might be advisable. The combination of a high level limiter followed by a ratio detector circuit has been found to render ignition noise inaudible at almost all times.

A double diode EB91 stage was chosen for the detector. Although the use of semiconductor diodes would have saved some space, the thermionic valve eliminates any possibility of matching errors.

High stability cracked carbon resistors were selected for R_{18} and R_{19} . Either 1% components should be used or they should be selected from a batch to be within 1% of each other. High stability resistors must, in any case, be used in these positions, since ordinary carbon resistors change their value when they are soldered into the circuit and during their life. The change of value of a cracked carbon grade 1 resistor or of a metal film resistor is much smaller.

Decoupling

Undesired feedback in the i.f. stages can result in an inadequate and unsymmetrical pass-band which is likely to give rise to distortion. The decoupling must not only be satisfactory at the i.f.,

*It should be possible to order the COO4EA/6E trimmers through component retailers. If difficulty is experienced, a suitable alternative is the 1-8pF Tubular Low Loss Trimmer available from Henry's Radio, Ltd. This may require to be mounted by its tags.—EDITOR.

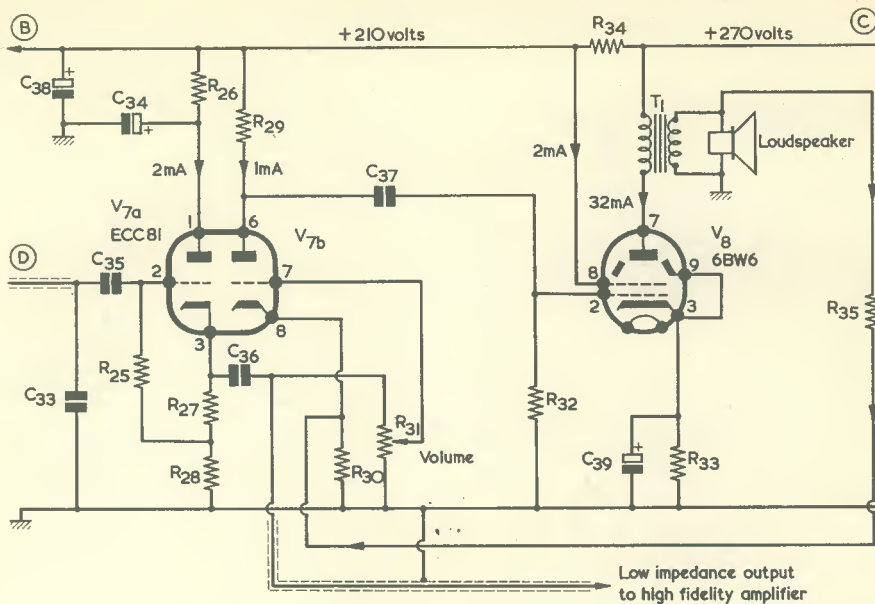

Fig. 4. The audio frequency circuits. The first half of the double-triode is a cathode follower, and it provides a low impedance output for high fidelity equipment

but it should also be efficient at very much higher frequencies in order to prevent the possibility of parasitic oscillation and i.f. harmonic feedback to the r.f. stages. Ceramic disc capacitors have been found to be very suitable for decoupling. Ceramic tubular capacitors may also be used, but the writer feels that they may not fit into the space available quite so easily and the leads may have to be longer—which would tend to reduce the efficacy of the decoupling. 1,000pF decoupling capacitors are suitable for use at 80 or 90 Mc/s in the oscillator and r.f. stages, but 5,000pF capacitors are better for the mixer and i.f. stages where a 10.7 Mc/s signal is present.

The detected signal is taken via R₁₅ through a few inches of coaxial cable (at the points marked D in Figs. 3 and 4) to the audio circuits of Fig. 4.

Pre-emphasis

The audio signals are passed through a resistance-capacitance circuit with a time constant of 50 microseconds before being transmitted by the B.B.C. This results in the amplitude of the high frequency signals being increased relative to that of the middle and lower frequencies, and the process is known as pre-emphasis.

After detection the audio signal must be passed through a similar resistance-capacitance filter network which is connected so as to produce the opposite effect to that produced at the transmitter and hence give the overall system a level response.

The components R₁₅ of Fig. 3 and C₃₃ of Fig. 4 are used to produce the de-emphasis. C₃₃, together with the capacitance of the short length of coaxial cable and the stray capacitance, will amount to about 500pF (=500 x 10⁻¹² farad). If this value is multiplied by the value of R₁₅ (100,000Ω), the result is a time constant of 50 x 10⁻⁶ seconds or 50 microseconds. A ceramic capacitor of the

Hi-K type should not be used for C₃₃ unless one is sure that its value is within the required tolerance. Many types of Hi-K capacitors are manufactured with tolerances which may be as wide as -25% to +25%, since such components are quite suitable for decoupling purposes where a large variation in value does not matter. If the value of C₃₃ is higher than that specified, there will be an attenuation of high frequency signals.

The purpose of using a pre-emphasis network at the transmitter and a similar but opposite de-emphasis network at the receiver is to reduce the noise level at the receiver output. Any high frequency noise ("hiss") introduced by the receiver r.f. and mixer stages will be reduced by the receiver de-emphasis network, thus producing a better signal-to-noise ratio.

The Audio Stages

The first audio stage, V_{7(a)}, is a cathode follower which provides a low impedance output for feeding a high fidelity amplifier or a tape recorder. R₂₆ and C₃₄ are the anode decoupling components. The grid resistor, R₂₅, is returned to a tapping on the cathode resistor chain. R₂₇ provides a suitable bias for the valve (via R₂₅), whilst R₂₈ is large enough to provide a suitable load. C₃₅ is a blocking capacitor. V_{7(a)} is biased so that its anode current is a little over 2mA.

The output from the cathode of V_{7(a)} is taken via the capacitor C₃₆. Although this component has a value of 1μF, it has a potential of little more than 100 volts across it and need not therefore be very large physically. A capacitor of this value has an impedance of the order of 5kΩ at the lowest frequency one is likely to require (about 30 c/s). Whilst it would have been possible to use a capacitor of a smaller value, it was felt worth-while to keep the output impedance reasonably low at all frequen-

cies. The wiring from $V_{7(a)}$ to C_{36} and from this capacitor to the coaxial output socket consisted of polythene insulated screened wire of a much smaller diameter than ordinary coaxial cable. However, the impedance of this part of the circuit is so low that the use of screened wire is not really necessary.

Negative Feedback

The output from C_{36} is also connected across the receiver volume control, R_{31} . The fraction of the output tapped off by the potentiometer is fed to the grid of $V_{7(b)}$; this valve is used as a normal audio amplifier stage, R_{29} being the anode load. Initial experiments (in which the negative feedback circuit from the secondary of the output transformer via R_{35} to the cathode of $V_{7(b)}$ was omitted) indicated that adequate volume could be obtained for normal purposes even if no cathode decoupling capacitor were used across R_{30} . However, the audio response sounded very uneven in the high frequency region, although this is only to be expected with a single pentode output stage. The use of the negative feedback loop via R_{35} made a great improvement to the fidelity and is, in the opinion of the writer, much more satisfactory than the use of a series capacitor and resistor across the primary winding of the speaker transformer. The latter arrangement also reduces the high frequency response. One does not, of course, expect high fidelity when using the internal power output stage of the receiver, but one can nevertheless make the results as good as possible.

The value of the resistor R_{35} was chosen experimentally and not as the result of calculation. It is essential to check that the reproduced volume is reduced when R_{35} is brought into circuit. If oscillation occurs when R_{35} is connected, the connections of the speaker transformer secondary winding must be reversed to make the feedback negative instead of positive. It is therefore a good idea to add R_{35} after the alignment of the receiver has been completed. If more volume is required from the receiver, the value of R_{35} may be increased to $15k\Omega$ or $22k\Omega$ or it may be omitted altogether and a $50\mu F$ 25 volt capacitor placed across R_{30} . The value of

R_{35} shown is suitable for a speaker transformer secondary impedance of 3Ω , but for other output impedances the value of this resistor should be adjusted in proportion to the square root of the output transformer secondary impedance.

To prevent possible damage to the speaker transformer, incidentally, volume control R_{31} should be kept at a low volume setting if no speaker is connected to the receiver.

When the receiver was first constructed, a slight hum could be heard when the volume was reduced to zero if the output stage was connected to a 12in speaker. Although this hum was completely masked by the sound of a programme (even at low volume) and was not noticeable with a 6in speaker, it was nevertheless felt desirable to remove it.

No hum was present in the high fidelity output.

The hum was unaffected by the removal of the 6BW6 output stage and was therefore due to magnetic coupling between the mains transformer and the speaker transformer, possibly via the steel chassis. Initially some attempt was made to remove the hum by the use of mu-metal shielding. It was found, however, that the use of the negative feedback circuit provided a much simpler and more effective method of reducing the hum to an inaudible level.

An ECC81 valve was chosen for V_7 partly because this valve has a fairly high mutual conductance and will therefore provide a low output impedance from the cathode follower stage. (The output impedance of a cathode follower is approximately equal to the reciprocal of the mutual conductance of the valve used.)

The Output Stage

The output from $V_{7(b)}$ passes through C_{37} to the 6BW6 output stage. A cathode decoupling capacitor is used here in order to give a little more gain and to keep the output impedance of the stage reasonably low in order to provide more electrical damping for the loudspeaker cone. (The omission of a cathode decoupling capacitor results in current negative feedback which increases the output impedance. Voltage negative feedback is

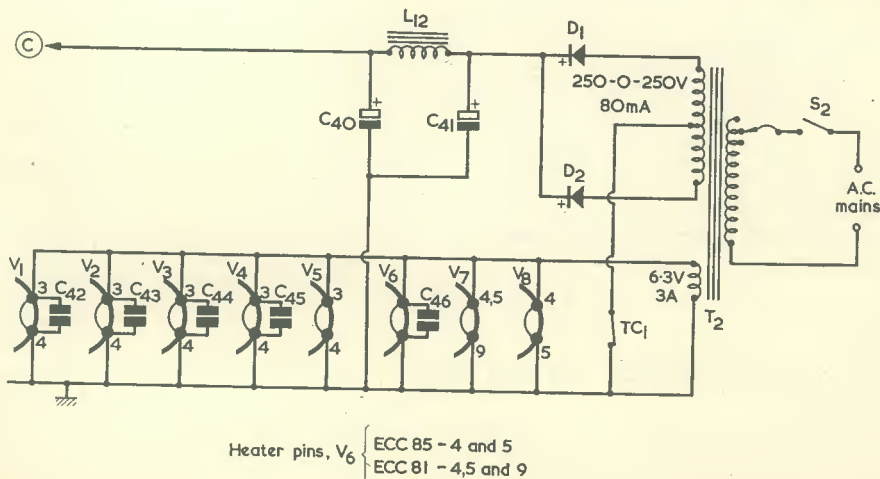

Fig. 5. The power supply. Capacitors C_{42} to C_{46} to inclusive are mounted directly the heater pins of V_1 , V_2 , V_3 , V_4 and V_6 , as indicated here

required to reduce the output impedance of a stage.) A fairly high value of bias resistor has been used to keep the anode current and hence the power dissipation reasonably low.

The resistor R_{34} , in combination with the electrolytic capacitor C_{38} , is used to smooth the supply to the screen-grid of V_8 and to the previous stages of the receiver. The anode current of the power output stage is appreciable, and it does not pass through R_{34} . This resistor also provides audio decoupling.

The valve suggested for the power output stage, the 6BW6, is the B9A equivalent of the well known octal based 6V6.

The Power Supply

The power supply circuit used by the writer in the prototype is shown in Fig. 5. Full wave rectification was employed, since the total current required is appreciable. A transformer with a 250-0-250 volt r.m.s. secondary h.t. winding was used but, if anything this is on the high side. A transformer with a 230-0-230 volt winding might be more suitable. The h.t. winding should be rated at 80mA. A 6.3 volt r.m.s. winding which will supply the heater current of just over 2.5 amps is also required.

It was felt desirable to keep the receiver as small as possible and to keep the power dissipation low to avoid excessive drift of the tuned circuits in the ratio detector and i.f. stages. For these reasons semiconductor diode power rectifiers were chosen instead of the common double diode valve rectifier. The forward voltage drop across the semiconductor diodes is much less than that across a thermionic rectifier. The inclusion of semiconductor diodes results in the appearance of the h.t. potential before the valves have warmed up, whereas the use of an indirectly heated valve rectifier would prevent this. The only practical result, however, is that the capacitors used in the h.t. circuits must be able to withstand the peak h.t. voltage at no-load for a period of about 15 seconds during the warming up time. They require a working voltage of 350.

The rectifiers used in the prototype were the S.T.C. type RS260AF (CV7024) which are encapsulated in a miniature case. The transformer h.t. voltage should not exceed 250-0-250 volts with these rectifiers. An alternative is the Radiospares Rec 51A; this is slightly larger than the S.T.C. type. Another suitable rectifier is the Mullard BY100.

As shown in Fig. 5, one side of the heater supply for each valve may be taken from an adjacent chassis connection, a single wire then carrying the 6.3 volt supply along the chassis. The heaters of V_1 , V_2 , V_3 , V_4 and V_6 are bypassed by ceramic disc capacitors, which must be connected to the

valveholder tags with very short leads. The heaters of V_1 to V_5 , and V_7 and V_8 may be run from a single 6.3 volt line. The heater of V_6 should have a separate 6.3 volt wire, this running from the a.f. stages and being kept well away from the components around V_1 and V_2 .

The mains on-off switch, S_2 , is not mounted on the chassis as the writer preferred to have the minimum of mains wiring in the receiver. Any suitable type of switch may be employed, and it could, for instance, be incorporated in a general control panel for a high fidelity installation. The writer fitted a 3-way connector on his chassis for the mains input, this connecting direct to the mains transformer primary. If desired, a mains earth connection to the chassis may be taken via this connector, but great care must then be exercised to ensure that the mains connections to the plug and socket are correct.

Thermal Cut-Out

The receiver is often used with a tape recorder, the mains input being controlled by a time switch, so that recordings can be made whilst no one is in attendance. It was partly for this reason that some form of fuse or other safety device was felt desirable. A Belling-Lee 100mA thermal cut-out was used in preference to a fuse, since it is very easily reset without any part having to be replaced. This is especially useful when the user is an experimenter who is liable, occasionally, to accidentally short-circuit the h.t. line to chassis.

The whole of the h.t. current passes through the cut-out which consists of a short length of resistance wire attached to a spring. When the current passing through the resistance wire exceeds 100mA, the heat generated causes the spring to release a piece of springy wire and so break the circuit. The time required for this to occur is a few seconds when the h.t. line is short-circuited to the chassis.

The writer has found the use of a thermal cut-out very convenient when experiments were being carried out on the circuit and it was desired to switch off the h.t. supply for a moment. One can merely lift the wire out of the spring with a pair of forceps and replace it when one has completed the alteration. The valve heater supply is not interrupted.

(To be concluded).

References

- 1 J. C. Hopkins. "A Simple Transistor F.M. Receiver". *Wireless World*, September 1965.
- 2 "Triple Crystal Units for Frequency Control of F.M. Tuners". S.T.C. Quartz Crystal Division Publication MQ/104, Edition 2.
- 3 S.T.C. Data Sheet for crystal type 4434/AT.
- 4 S. W. Amos and G. C. Johnstone. "Design For An F.M. Tuner" *Wireless World*, April and May, 1955.

THE NEW "TOLTEC" HAIR DRYER

This hair dryer, advertised elsewhere in this issue, has been tested by our technical department and found to be absolutely safe to handle. Voltage and insulation tests were made and the dryer was passed 100%, it conforming to the highest electrical standards.

Readers purchasing this very efficient appliance may rest assured that it represents very good value for money and is fully covered by a 12 months and money refund guarantee.

INTERNATIONAL MORSE CODE

Å or Ä	---	---	---
Ä	---	---	---
Å	---	---	---
A	---	---	---
B	---	---	---
C	---	---	---
CH	---	---	---
D	---	---	---
E	---	---	---
F	---	---	---
G	---	---	---
H	---	---	---
I	---	---	---
J	---	---	---
K	---	---	---
L	---	---	---
M	---	---	---
1	---	---	---
2	---	---	---
3	---	---	---
4	---	---	---
5	---	---	---
Apostrophe	---	---	---
Brackets	---	---	---
Break sign	---	---	---
Comma	---	---	---
End of message	---	---	---
End of work	---	---	---
Error	---	---	---
Fractional bar	---	---	---
Full stop	---	---	---
Hyphen	---	---	---
Inverted commas	---	---	---
Invitation to transmit	---	---	---
Note of interrogation	---	---	---
Preliminary call	---	---	---
Separation (used between whole number and fraction)	---	---	---
Underline	---	---	---
Understood	---	---	---
Wait	---	---	---

SPACING

A dot equals 1 unit A dash equals 3 units
 Space between symbols forming a letter equals 1 unit
 Space between two letters equals 3 units
 Space between two words equals 5 units

N.A.T.O. SERVICES TELEPHONY CODE

A — Alpha	H — Hotel	N — November	U — Uniform
B — Bravo	I — India	O — Oscar	V — Victor
C — Charlie	J — Juliet	P — Papa	W — Whisky
D — Delta	K — Kilo	Q — Quebec	X — X-ray
E — Echo	L — Lima	R — Romeo	Y — Yankee
F — Foxtrot	M — Mike	S — Sierra	Z — Zulu
G — Golf		T — Tango	



RADIO CONSTRUCTOR

Next Month's Special Features

**BUILD SOME OF THE
FASCINATING DESIGNS
FEATURED EACH MONTH**

Price 3/-

or 3/6 by post from

Data Publications Ltd.

57 Maida Vale, London, W.9.

- **3-Valve Short Wave Receiver**
- **Inductance Test Unit**
- **Audio Frequency Substandard**

★ **Plus 2 detachable Data Sheets**

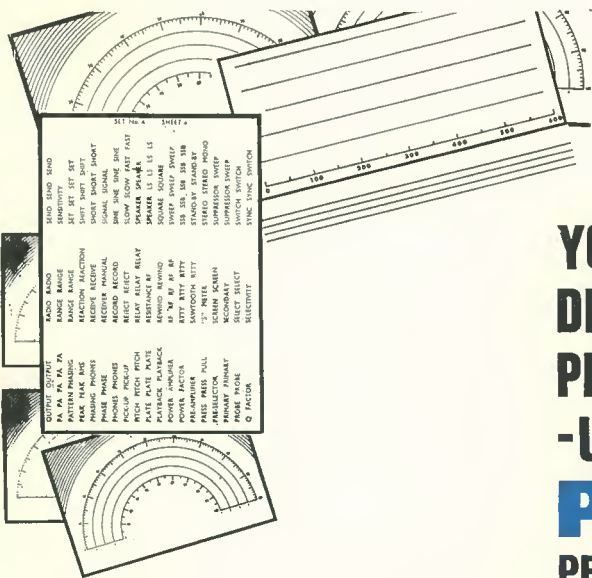

- ★ Set 3 Wording—WHITE
- ★ Set 4 Wording—BLACK
- 6 Sheets, over 1,000 words, etc.
- ★ Set 5 DIALS—clear background
- ★ Set 6 DIALS—black background

**YOUR FINISHED ASSEMBLY
DESERVES A REALLY
PROFESSIONAL FINISH
-USE 'CONSTRUCTOR'
PANEL SIGNS
PERMANENT PAINT
TRANSFERS**

4/6 per set (*postage 3d*)

Send to:

DATA PUBLICATIONS LTD., 57 MAIDA VALE, LONDON, W.9

RECENT PUBLICATIONS



BEGINNER'S GUIDE TO ELECTRICITY. By Clement Brown. 185 pages, 7¼ x 4½ in. Published by George Newnes Limited. Price 15s.

This book is intended to provide an introduction to electrical technology not only for the younger reader who intends to make electrical engineering or electronics his career but also for the layman of any age who takes an interest in technical matters. The subjects covered include industrial electrical engineering, domestic installations and automobile electrical systems. There is also a 26-page chapter devoted to electronics, and which covers valves and semiconductors.

The book starts by explaining the concept of electric current as a flow of electrons then proceeds to simple electrical circuits. The second chapter deals with the generation of electricity, both d.c. and a.c., and continues up to 3-phase and rectifier systems. A very interesting chapter on electricity distribution follows, including details of the British Grid system and nuclear power stations; after which there are chapters on electric motors, electricity in the home and automobile electrical systems. The next chapter is that devoted to electronics, and the book concludes with chapters on industrial electrical applications, future developments and careers.

The text is presented in a concise, non-mathematical and readable manner. Considering its publication in hard cover form this book retails at a very reasonable price, and the reviewer recommends it for both the classes of reader at whom it is aimed.

PRACTICAL WIRELESS SERVICING MANUAL. Revised by H. W. Hellyer, A.M.T.Sc., A.I.P.R.E., A.M.I.S.M. 288 pages, 7¼ x 5 in. Published by George Newnes Limited. Price 5s.

This, the 12th edition of a volume which first appeared in 1938, has been completely revised by H. W. Hellyer. Whereas constructional projects formed the greater part of previous editions, these have now been superseded by a text which places emphasis on test and repair procedures, with theory and circuits introduced as necessary.

An initial chapter reviews the type of equipment likely to be encountered in servicing work, this ranging from simple a.m. receivers through f.m. receivers, tape recorders, record players and radiograms to hi-fi equipment. The construction and functioning of components and valves are next described. After this, the major portion of the book deals with actual servicing and repair procedures for the equipment previously referred to. A chapter is devoted wholly to semiconductors, but these also make their appearance, where applicable, in earlier parts of the book. There are two useful sections on cabinet finishing and repairs and on workshop techniques, as well as a final chapter giving formulae, charts and tables. The book has a comprehensive index.

In its present edition, *Practical Wireless Servicing Manual* will offer greatest appeal to the hobbyist and the apprentice service engineer, but the established service engineer will find useful information in it as well.

ELECTRONICS POCKET BOOK. Edited by J. P. Hawker and J. A. Reddihough. 314 pages, 7½ x 4½ in. Published by George Newnes Limited. Price 21s.

This book, in its second edition, is intended to present an up-to-date picture of basic electronic techniques. Specialist contributors are Ian D. L. Ball, B.Sc., Maurice C. Bumstead, C.Eng., M.I.E.E., A.M.I.E.R.E., John Gilbert, Assoc. I.E.R.E. and Terence L. Squires, C.Eng., A.M.I.E.R.E.

Electronics Pocket Book deals with "electronics" as opposed to "signals and communications" in the r.f. sense, and it covers a very wide range of devices and applications in this field. The approach is to give a description of each subject at a depth which enables basic operation to be thoroughly understood. Since the book covers an extremely wide range some of the descriptions have to be brief, and the authors are to be commended for the manner in which the salient points are made in every case.

The many subjects dealt with include (as a selection taken at random) electron multipliers, relays, differential and operational amplifiers, wide-range pulse generators, d.c. converters, welding timers, analogue and digital computers, integrated circuits and field effect transistors. This list is a mere fraction of all the devices and circuits discussed.

The editors state their hope that, although it does not confine itself solely to the syllabus, this book should be of particular value to candidates for the Electronic Servicing certificate of The Radio Trades Examination Board and the City and Guilds of London Institute. A modest claim, indeed, for this competent and well-written reference book.

TAPE RECORDER SERVICING MECHANICS. By H. Schroder. 126 pages, 8½ x 5½ in. Published by Iliffe, Books Ltd. Price 21s.

Tape Recorder Servicing Mechanics was originally published in Germany in 1961, and the edition under review is a translation into English. The book is provided with "limp Linson" covers, whose edges are flush with the edges of the pages.

The subjects covered include drive motors (mains only—not battery types), tape transport systems, wow and flutter, head design and operation, response standardisation, level indicators, erase and bias oscillators (valve only), electrical measurements (including distortion, wow and flutter), and head and tape characteristic measurements.

The book offers much useful "hard" information in the form of facts and figures, and will be of particular interest to those undertaking the servicing of tape recorders, whether professional or amateur. This edition is edited by R. C. Glass, and the translation has been well carried out by Scripta Technica, Ltd.

Gas Filled Detectors for Nuclear Radiation

by M. J. DARBY

Geiger-Müller tubes are not the only devices which can detect nuclear radiation. In this article our contributor describes the operation and performance of the whole range of gas filled radiation detectors

WHEN THE NUCLEAR PARTICLES WHICH ARE emitted by the atoms of radioactive materials pass through matter, their energy is used to create ions and excited atoms. (Ions are charged particles, whilst excited atoms are atoms which have a high energy.) If the ions formed by a particle of nuclear radiation can be collected, they will provide an output pulse. These output pulses can be counted by an electronic circuit and used as a measure of the number of particles of nuclear radiation which have entered the detector.

Gas Filled Detectors

The first nuclear counters to be developed were gas filled ones; and such counters are still the most commonly used forms of detector, especially for elementary work. If one applies a potential between two parallel plates which are fairly close together no detectable current will flow, since the gas between

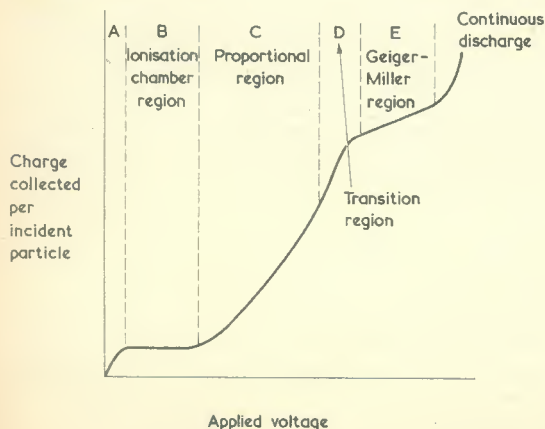

Fig. 1. Variation of the charge collected in a gas filled tube with applied voltage

the plates is an excellent insulator. If, however, a beam of X-rays, alpha particles, beta particles or gamma rays enters the gas between the two plates, ions will be formed and will be attracted to one of the electrodes according to the polarity of their charge. This flow of ions constitutes a small current which can be detected by means of a sensitive instrument.

As the applied voltage is increased, the total charge which flows through the system per unit time varies according to the type of curve shown in Fig. 1. In the region marked A, the electric field between the two plates is so weak that many of the ions recombine before they reach the plates. The current increases with the applied voltage, since the number of ions lost by recombination decreases as the potential between the plates increases.

Ionisation Chambers

In the region marked B virtually all of the ions of each sign reach the plates without recombining with an ion of the opposite sign. Detectors operating in this "saturation" region are normally referred to as ionisation chambers or ionisation pulse counters.

Instruments which are used for monitoring radiation fields to ensure that a region is reasonably safe to enter often operate in the ionisation chamber region. The current passing between the two plates is amplified by electrometer valves and is displayed on a meter which is calibrated in radiation field intensities (rads per hour).

Ionisation pulse counters also operate in region B of Fig. 1, but they detect each individual particle. The basic circuit is as shown in Fig. 2. Each nuclear particle entering the space between the plates causes ions to be formed; when these ions reach the plates, they lower the potential difference between the plates and a negative-going pulse is formed at the anode. The anode voltage rises again to its previous value as a current flows through the resistor R from the h.t. supply to charge the capacitor C.

An alpha particle entering the region between the plates will result in the formation of a negative-going pulse of perhaps one millivolt, whereas beta particles will produce pulses of only a few microvolts. A very sensitive low noise amplifier is therefore required and for this reason ionisation pulse counters are not normally found outside research laboratories; other forms of detector are usually more convenient.

Proportional Counters

If the field strength in a gas filled detector is to be increased further to region C of Fig. 1, it is usual to employ a central anode wire as the one electrode and a cylindrical cathode around it. The field strength near the anode wire can be extremely large if the diameter of the anode wire is small. This field strength, E, in volts/cm at a distance r from the centre of the tube is given by the equation

$$E = \frac{V}{r \log_e (r_2/r_1)}$$

where V is the applied potential and r_2 and r_1 are the radii of the cathode and anode respectively. The value of E may exceed 10^5 volts/cm for an applied voltage of about 1,000.

In such a tube with a fine wire anode, the ions are accelerated as before, but the electrons undergo such an acceleration when they approach the anode wire that they knock other electrons out of the atoms of the gas. These electrons in turn knock further electrons out of other atoms. Thus the number of electrons may be magnified by a very large factor. In the proportional region this "gas amplification factor" is often of the order of some thousands. The number of ions collected at the electrodes of a proportional counter is therefore much greater than in the case of an ionisation chamber detector; thus the negative-going output pulses produced (in the circuit of Fig. 2) are much larger than when an ionisation chamber is used.

In a typical case, the output pulses from a proportional counter are of a few millivolts in amplitude. For alpha counting, argon is often used as the filling gas at applied potentials of about 800 volts. For beta or gamma counting, methane may be employed at applied potentials of the order of 1,500 volts. Much higher gas amplifications are used for beta or gamma counting in order to obtain reasonably large output pulses.

The proportional counter derives its name from the fact that the output pulses have an amplitude which is proportional to the number of ions formed in the gas by the incident radiation. Under suitable conditions the number of ions formed is proportional to the energy of the incident radiation. Thus it may be possible to use the proportional counter to estimate the energy of the radiation being detected.

The output pulses from a proportional counter are not large enough to operate a scaler (which counts the pulses) directly and therefore it is essential to employ a high gain amplifier between the output of the Fig. 2 circuit and the scaler. Although this amplifier need not have such a high gain or such a low noise level as that required for use

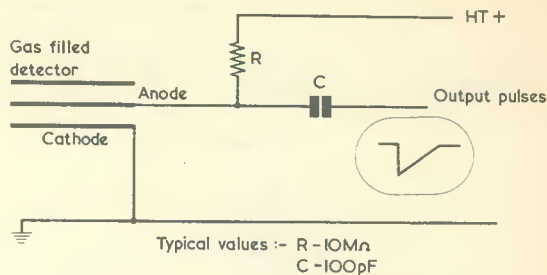

Fig. 2. The basic circuit for a nuclear counter

with pulse ionisation chambers, it is nevertheless quite an expensive item.

Transition Region

The transition region marked D in Fig. 1 is reached by increasing the potential applied to the detector tube or by changing the electrode geometry or the gas filling. It is a region of limited proportionality, but has little practical importance.

The Geiger-Müller region

The well known Geiger-Müller tube (often referred to as a Geiger tube) operates in region E of the curve of Fig. 1. This type of detector was developed by Geiger and Müller in 1928*. It has the advantage that it can provide large output pulses (of about 10 volts in amplitude) and does not therefore require an expensive amplifier in the associated equipment. For this reason Geiger-Müller counting equipment is the cheapest form of nucleonic apparatus. It is also quite versatile and is very suitable for simple educational experiments such as those recommended in the Nuffield Foundation's reports on the teaching of modern physics in schools.

In the Geiger tube a gas amplification of the order of 10^8 may be obtained and this gives rise to

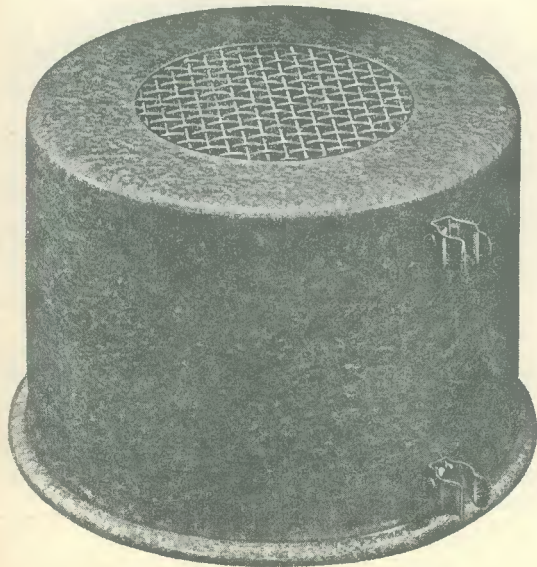

An ionisation chamber. A grid is fitted to the top of this chamber so that it can be used for the estimation of alpha particle ranges. (Courtesy Griffin and George Ltd.)

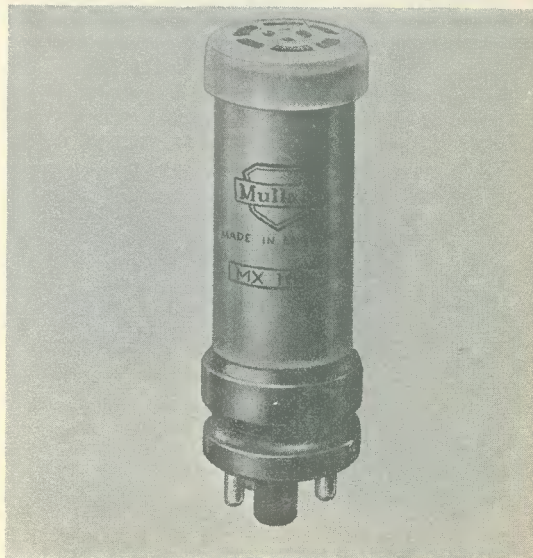

A plug-in end window Geiger tube intended for school use. A plastic end cap is fitted to prevent damage to the delicate mica end window. (Courtesy Mullard Ltd.)

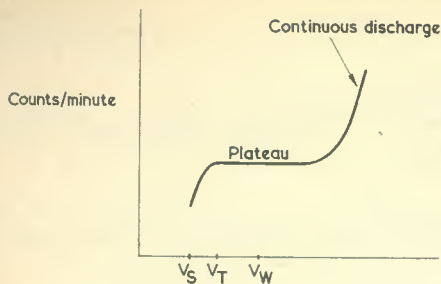

Fig. 3. A Geiger tube characteristic curve

the large output pulses. The Geiger tube may be compared with a super-regenerative radio receiver because it operates in what is, in effect, an unstable region. When ions are formed in a Geiger tube, the electrons move very rapidly to the centre wire, near to which the gas amplification takes place. A sheath of positive ions is thus formed around the centre wire which moves relatively slowly outwards towards the cathode, since the positive ions are heavy compared with the electrons. The space charge consisting of the positive ions reduces the electric field in the region of the anode wire and prevents further gas multiplication from taking place.

When the positive ions reach the cathode, they would cause a certain number of electrons to be emitted from it if suitable precautions were not taken and these electrons would give rise to spurious pulses. In order to prevent this happening, the system must employ some method of "quenching" the spurious pulses. The first method of quenching employed a monostable multivibrator in the external circuit which reduced the anode voltage for a short time after each output pulse. However, all modern Geiger tubes are self-quenching; that is, a gas is included in the gas mixture which will remove most of the energy from the positive ions or neutralise them so that they cannot cause electrons to be emitted if they strike the cathode.

Organically Quenched Tubes

An organically quenched Geiger tube contains a small amount of a polyatomic organic vapour

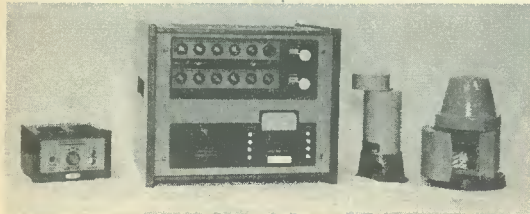

Professional Geiger counting equipment. A quench probe unit for determining the resolving time is shown on the left hand side. The large unit is the automatic counting equipment which will cease counting either after a preset time or when a pre-set number of counts have been reached. The round lead castle is used with a liquid sample counting tube, whilst the other lead castle on the extreme right is used with an end window counter for solid samples; the samples are inserted on one of the shelves under the end window of the tube. (Courtesy Isotope Developments Ltd.)

such as ethyl formate. When positive ions are formed in the gas, they give their energy to the molecules of the organic vapour. However, the molecules of the vapour are broken up and the decomposition products may be deposited on the sides of the tube. Thus, organically quenched tubes have a life which is usually limited to about 10^{10} counts (or even less if the tube is small). In addition organically quenched tubes normally require an applied potential in the range 1,200 to 1,650 volts.

Halogen Quenched Tubes

Halogen quenched Geiger tubes contain a small amount of the vapour of a halogen element, usually bromine, although chlorine has also been tried. When positive ions give their energy to the molecules of the bromine, the pairs of bromine atoms are sometimes split up into single atoms. However, these single atoms will later recombine to form bromine molecules. Thus, halogen quenched tubes have a more or less indefinite life. In addition, the working voltage of halogen quenched tubes is usually in the range of 400 to 750 volts. This enables them to be used with simpler equipment than the organically quenched tubes which require a much higher potential.

The quenching gas used (either organic or halogen vapour) also absorbs any ultra-violet photons and prevents these photons from producing spurious counts by causing photoemission from the cathode.

For elementary work halogen quenched tubes are generally more suitable than the organically quenched variety, although the latter have some properties which are useful in certain applications. Both types of Geiger tube produce pulses of an amplitude which is independent of the type of radiation incident of the tube.

The Geiger tube plateau

A Geiger tube characteristic curve may be plotted by allowing a constant number of nuclear particles to enter the tube per second and by finding the variation in the output pulse rate with the applied voltage. The type of curve shown in Fig. 3 is obtained. When the applied potential is below V_s no counts will be recorded, since the output pulses from the tube are not large enough to operate the counting equipment used. When the applied potential slightly exceeds the starting voltage, V_s , the counting rate will rise rapidly with increasing voltage. The plateau of the curve commences at the threshold voltage, V_t and continues until the region of con-

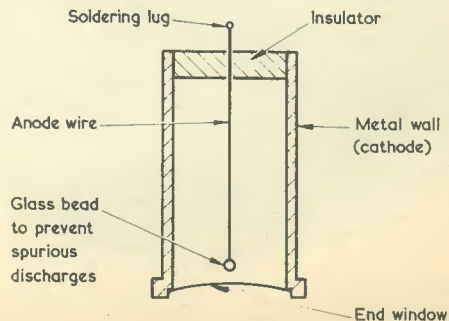

Fig. 4. An end window Geiger tube

tinuous discharge is reached. In the plateau region there is little change in the counting rate with a change in the applied potential. The working voltage is usually taken as about $(V_t + 80)$ volts in the case of an organically quenched tube or $(V_t + 40)$ volts in the case of a halogen quenched tube. This means that the working voltage is rather lower than the centre of the plateau. Any small changes in the applied potential due to mains voltage changes or other causes will not then cause the counting rate to be appreciably affected.

If this experiment is carried out with an organically quenched tube, care must be taken to ensure that the tube is not operated in the region of continuous discharge and that a voltage of reversed polarity is not applied to the tube. Organically quenched tubes are irrecoverably damaged by such actions, but halogen quenched tubes will not be affected for more than a short time.

Types of tube

Geiger tubes of many types are available. For gamma detection a metal walled tube may be used, since the gamma radiation can penetrate through a reasonable thickness of any material. In the case of beta radiation, however, a thin window must be employed in the tube through which the radiation can enter. One type of construction often used is shown in Fig. 4. A thin end window of mica enables low energy beta radiation to be detected. Such windows of mica can be made with thicknesses of under 2 milligrams/sq. cm and can even be used for the detection of alpha radiation. Thin aluminium windows of thickness about 7 milligrams/sq. cm are also used in Geiger tubes of a similar design. One manufacturer puts a layer of carbon on mica end window counter tubes to prevent light from entering the tube and causing photoemission of electrons from the cathode of the tube.

Another type of Geiger tube is used for determining the activity of samples of liquid. These liquid counter tubes consist of a central anode wire surrounded by a cathode in the form of a helix (see Fig. 5). The gas is enclosed in a thin glass walled vessel which is surrounded by an annular container for the sample of the liquid. The tube shown in Fig. 5 has a plug-in base, but other forms are available which have wire connections for making contact with a mercury pool.

Various other special forms of Geiger tubes are available, such as liquid flow types, needle counters for medical use, very low background tubes, etc.

Efficiency

One microcurie of a radioisotope has a disintegration rate of 3.7×10^4 atoms per second. This does not mean that if one microcurie of a radioisotope is brought near to a Geiger counter this counting rate will be obtained. In practice, the counting rate is very much less. If one considers the case of an end window counter tube, it is obvious that only a very small proportion of the particles emitted by the radioisotope will travel in such a direction that they enter the Geiger tube window. Similarly in the case of a liquid sample tube, some of the particles will not be travelling in the direction of the centre of the tube and some of them will be absorbed in the sample itself before they reach the tube. In a typical case only a few per cent of

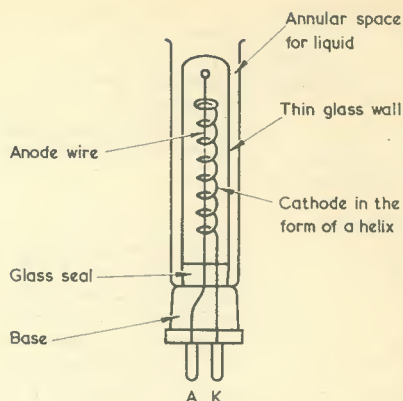

Fig. 5. A liquid sample Geiger tube

the emitted particles are detected by a Geiger tube. Provided that this counting efficiency remains constant, however, it is not a great disadvantage, since most Geiger tube experimental work is arranged so that one merely compares counting rates; the absolute rates have no particular significance.

Resolving Times

If two particles of radiation enter a Geiger tube almost simultaneously, they will be counted as one particle. The minimum time between the entry of the two particles which elapse for them to be counted individually is known as the resolving time of the Geiger tube. Typically, resolving times are of the order of one hundred microseconds. However, this value varies with the age of the tube and with the applied voltage, whereupon it becomes rather an indeterminate quantity.

If the resolving time of Geiger counting equipment is known, a correction can be made (using statistical principles) to allow for the number of counts lost due to the fact that the resolving time of the system is not infinitesimal. The resolving time of the system may be given a definite value by introducing a resolving time which is longer than the resolving time of the tube itself into the

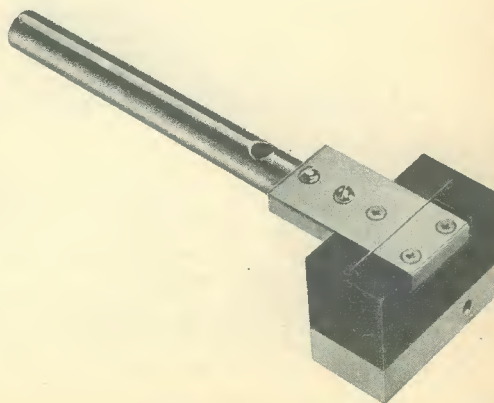

A simple spark counter for school use. (Courtesy Griffin and George Ltd.)

electronic equipment. For this purpose one normally uses one of the quenching probe units which set the resolving time, in a typical case, at perhaps 400 micro-seconds. Although this increases the errors due to the finite resolving time, it enables corrections to be made for the lost counts and therefore enables a more accurate value to be obtained.

Spark Counters

If a wire is placed about 2mm above an earthed metal plate and a potential of, say, 3,000 volts is applied to the wire, sparks will pass between the wire and the metal plate when an alpha emitting source is brought close to the system above the wire. A safety resistor of about $1M\Omega$ should be included between the power supply and the wire to prevent the possibility of serious shock.

The effect is due to the ions formed by the alpha particles in air being multiplied in number until there are sufficient charged particles for a spark to pass. Beta and gamma rays do not normally form enough ions per unit length of their path to cause sparking.

Spark counters are quite interesting for use in a school laboratory, but huge spark chambers are also employed for high energy physics research.

Cloud Chambers

Cloud chambers have the advantage that they provide a visual display of the paths taken by nuclear particles a fraction of a second earlier. There are two main types, the expansion cloud chamber and the diffusion (or continuous) cloud chamber. Each type depends for its operation on the fact that water or alcohol droplets form more easily on charged particles than on uncharged ones.

In the expansion cloud chamber, the gas (normally air) in the chamber is saturated with water or alcohol vapour or a mixture of both. The gas is suddenly allowed to expand so that the air cools and becomes temporarily supersaturated. The tracks of any charged particles can be seen as a line of fine droplets if the chamber is strongly illuminated from one side. The chamber is sensitive for only a fraction of a second.

In the continuous cloud chamber water or alcohol vapour is allowed to diffuse downwards to the base of the chamber which is cooled with solid carbon dioxide. Part of the chamber above the base is sensitive, any charged particles being shown as a line of liquid droplets.

Cloud chambers are very suitable for use with alpha emitting materials, but it is much more difficult to obtain really clear tracks with beta particles. Gamma emitters do not produce clear tracks in a cloud chamber. About 1/10th of a microcurie of a sealed alpha source such as radium is ideal. The decay of thoron gas with time (half life=55 seconds) can be observed in a continuous cloud chamber. A little thoron gas from above the surface of some thorium hydroxide may be blown into the chamber.

Acknowledgements

The writer is indebted to Messrs. Griffin and George Ltd., Messrs. Mullard Ltd. and Messrs. Isotope Developments Ltd. for providing the photographs reproduced in this article.

Reference

*. H. Geiger and W. Müller, "Das Elektronenzählrohr", Phys. Z. Vol. 29, p. 839 (1928) and Vol. 30, p. 489 (1929).



The "Secret Voter"

by R. MILLER

A simple device which allows an instantaneous vote to be taken at a meeting

THIS UNIT WAS DESIGNED TO ENABLE THE CHAIRMAN of a meeting to conduct an "instant vote", with each voter signalling by means of a bell-push and the device immediately indicating if the majority had voted "yes" or "no".

In practice it was found that not only was the vote instantaneous but, if each bell-push was held in the hand, it was secret as well. This has led to some surprising decisions being voted after a debate on a controversial issue.

The Circuit

The circuit, shown in the accompanying diagram,

is quite simple. The voters' bell-pushes (S_1 to S_5) are wired in series with the relay coil and a battery. Across each bell-push is a resistor which is short-circuited when the button is pressed. When sufficient buttons have been pressed the resistance in circuit is sufficiently low to enable the relay to operate.

A voter votes "yes" by pressing his bell-push. If it is not pressed the vote of "no" is automatically recorded. The system allows no abstentions.

The relay has a set of changeover contacts which, when the relay operates, change over a lamp circuit (PL_1 and PL_2) to give visual indication and cause a buzzer to sound.

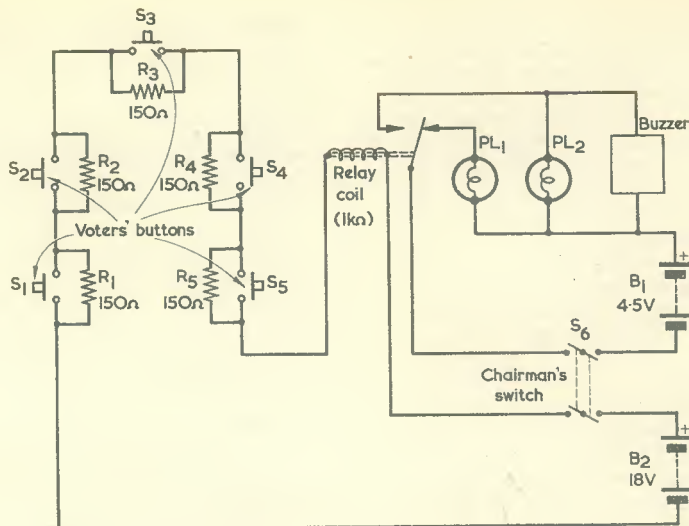

The circuit of the automatic voting indicator. The values of R_1 to R_5 have to be found experimentally as described in the text; those shown here apply to the prototype and are given to facilitate explanation only

The chairman is provided with the d.p.s.t. on-off switch, S_6 , this being closed only when a vote is being taken. All components except S_1 to S_5 and R_1 to R_5 are installed in a box at the chairman's side.

In the prototype B_1 was an Ever Ready "flat" pocket lamp battery type 1289, and PL_1 and PL_2 were 4.5 volt pilot lamps. The 18 volt battery was provided by two Ever Ready PP3 batteries in series. Alternative battery types or battery voltages, if desired, could of course be used to meet different requirements on the part of the constructor. Also, the buzzer could be replaced by a bell.

The relay employed by the writer had a $1k\Omega$ coil and required approximately 13.5mA to energise. Thus, it could not energise until at least three bell-pushes had been pressed, causing the resistance in series with its coil to be 300Ω or less.

The choice of relay is not critical, and readers wishing to make up the unit can employ any relay on hand which has reliable mechanical operation, which has suitable contacts and whose coil energising current is not excessively high. It is then only necessary to find the value of resistance needed across each bell-push.

To do this, the relay coil should be coupled to

B_2 via a series variable resistor, the resistance inserted by the latter being reduced until the current through the relay coil is just sufficient to allow it to energise reliably. This resistance is then measured, after which the required resistance across each bell-push is calculated according to the number of voters and the voting procedure. As an example, with the author's equipment it was found that the minimum resistance needed to energise the relay was 320Ω . Also, there were to be five voters and any motion would be carried if three or more voted "yes". Since this meant that the relay was required to operate if a maximum of two bell-pushes were left open, the resistance across each bell-push would have to be slightly less than one-half of 320Ω , and a value of 150Ω was chosen in practice.

Readers constructing the device may follow a similar process to evaluate the resistance needed across each bell-push, working from the number of bell-pushes required and the voting system. As is to be expected, the maximum number of voters' bell-pushes should be limited to around five if good operating reliability is to be obtained. Also, B_2 should be replaced when its voltage on load falls below its nominal figure by more than a volt or so.



"IN YOUR WORKSHOP"—POWER SUPPLY

In the stabilised power supply described in "In Your Workshop" in the December 1967 issue, it is possible for the dissipation in R_1 to exceed its 1 watt rating. In consequence, it is desirable to employ a 2 watt component in this position. The resistance of R_1 remains unchanged.

IN LAST MONTH'S ARTICLE IN THIS SERIES WE CONSIDERED the difficulties which occur when negative feedback is employed with audio frequency amplifiers. We saw that the most important problem is given if, due to phase shifts in the amplifier, the negative feedback becomes positive feedback. Given sufficient gain in the overall feedback loop the positive feedback can then cause oscillation at any frequency where the phase shift in the amplifier is equal to 180°, and we discussed the essential requirements for preventing such oscillation.

In this month's article we turn our attention to some other factors relating to negative feedback which have not yet been dealt with.

Shunt Voltage Feedback

In the examples of negative feedback we have examined up to the present a fraction of the output signal voltage, n , is applied back in series with the input signal voltage to the amplifier. It is possible, also, for the feedback voltage to be applied back in parallel, or *in shunt*, with the input voltage. Such a connection is referred to as *shunt voltage feedback*.

A general instance of shunt voltage feedback is illustrated in Fig. 1 (a) in which, for convenience, we assume that the input signal is provided by an

circuit of a valve) it can be shown that the overall gain with feedback (i.e. $\frac{V_{out}}{V_{in}}$) is approximately equal

to $\frac{R_f}{R_{in}}$ regardless of the actual gain of the amplifier.

This fact is not necessarily of great use for a.f. amplifier work, but it has applications in amplifiers intended for analogue computer work.

Apart from the fact that the internal impedance of the input signal source has to be taken into account with shunt voltage negative feedback, this method of connection offers the same advantages with respect to distortion and noise reduction, and to frequency response improvement, as does series voltage negative feedback.

Current Feedback

A further means of obtaining negative feedback is given by applying back to the input of an amplifier a voltage proportional to output signal current. The general arrangement is shown in Fig. 2 and it will be seen that the voltage dropped across resistor R_1 is applied back in series with the input signal voltage. The fact that we are now thinking in terms of output current infers that the amplifier has an

UNDERSTANDING RADIO

Negative Feedback

$$f = \frac{1}{2\pi\sqrt{LC}}$$





by W. G. Morley

a.c. generator. A fraction of the output voltage is fed back in parallel with the input by way of resistor R_f . The plus and minus signs at the amplifier input and output terminals indicate polarity during one half-cycle of the input signal, and are such that the feedback is negative.

It is interesting to note that, if the generator in Fig. 1 (a) has zero internal resistance, the addition of R_f to the circuit will not change the amplification offered. In practice, the generator (or the circuit it represents) must have an internal resistance. We represent this, in Fig. 1 (b), as R_{in} , and we draw it in series with the generator.

We retain R_f and R_{in} in Fig. 1 (c), in which diagram we now have the whole, instead of a fraction, of the output voltage applied back to the input via R_f . As before, negative shunt feedback is given. We also add the terms V_{in} to define the signal voltage at the generator terminals, and V_{out} to define the signal voltage at the output terminals. If, in Fig. 1 (c), the voltage gain provided by the amplifier without feedback is high, and if its input impedance is considerably greater than R_f or R_{in} (as could occur if the amplifier input was the grid

output load, and this load is also shown in Fig. 2. For the feedback to be effective the current flow in R_1 must be considerably greater than any current which flows at the input terminals of the amplifier. This would occur, for instance, if the amplifier input terminals connected to the grid circuit of a voltage amplifier, whilst resistor R_1 was in series with the feed to a loudspeaker.

Current feedback offers the same advantages as does voltage feedback in reducing distortion and noise, and in improving frequency response. As we shall see shortly, it has a different effect on output impedance, and this last factor qualifies its usefulness in a.f. amplifiers.

An interesting instance of current feedback is given when a valve operates with no bypass capacitor connected across its cathode, as in Fig. 3. The output signal current flowing in the load flows also through the cathode resistor, causing a signal voltage proportional to output current to appear across it. The signal voltage at the cathode has the same polarity as that at the grid (when the grid goes positive, so also does the cathode) with the consequence that the signal voltage between grid

and cathode is lower than the input signal voltage between grid and chassis. This is the same as applying a negative feedback voltage proportional to output current in series with the input signal voltage, and the degeneration in the circuit is therefore due to current negative feedback. From Ohm's Law, the signal voltage fed back at the cathode is equal to the output signal current multiplied by the value of the cathode resistor.

Input Impedance

The input impedance of an amplifier is altered by the addition of negative feedback. Let us consider first the case of series voltage feedback. It may be helpful, here, to assume for the moment that the impedance presented by the input terminals of the amplifier is due to the resistance of the grid resistor of the first valve, as in Fig. 4 (a).

When, in Fig. 4 (a), a signal input voltage, V_1 , is applied to the input terminals to cause a current, I , to flow, the impedance at the amplifier terminals is $\frac{V_1}{I}$.

In Fig 4 (b) we add series voltage feedback and apply a new signal voltage, V_2 , to the input terminals. V_2 now has to be $(1+nA)$ times V_1 to provide the same current flow as in Fig. 4 (a).^{*} Thus, the input impedance at the input terminals in Fig. 4 (b) is $\frac{V_1(1+nA)}{I}$. The term I is the same in both cases,

whereupon it may be seen that the addition of series voltage feedback has caused the input impedance to be increased by $(1+nA)$ times.

We assumed just now that the input impedance was equal to the resistance of the grid resistor but, in practice, the input capacitance of the valve and stray wiring capacitances have also to be taken into account. The input impedance, therefore, includes reactive components as well. At all frequencies where the amplifier output is 180° out of phase with the input, the input impedance will similarly be increased $(1+nA)$ times by the addition of series voltage negative feedback.

The input impedance is also increased with current feedback, applied as in Fig. 2, where a voltage proportional to output signal current is fed back in series with the input signal voltage.

Applying shunt voltage feedback, as in Figs. 1 (a), (b) or (c) causes a reduction in input impedance. This is because an additional current from the signal source flows through feedback resistor R_f .

We have not considered shunt current feedback as yet, but this is quite a feasible method of working and would be given if a voltage proportional to output signal current were applied in shunt with the input signal voltage. As with shunt voltage feedback, shunt current feedback also causes a reduction in input impedance.

Output Impedance

The application of voltage negative feedback to an amplifier (either series or shunt) reduces its effective output impedance.

This may be demonstrated with the aid of the simplified diagram shown in Fig. 5 (a). Fig. 5 (a)

^{*} As was explained in the December 1967 issue, input signal voltage with feedback has to be $(1+nA)$ times greater to achieve the same effect (i.e. the same output) as without feedback, where A is the gain of the amplifier and n is the fraction of the output voltage fed back.

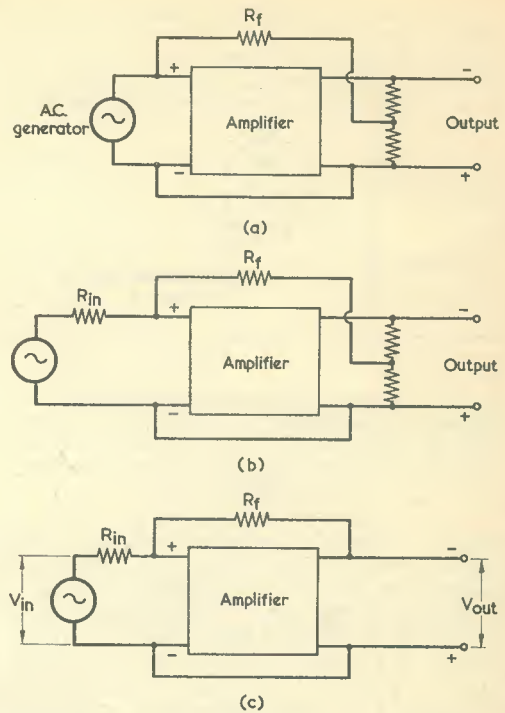

Fig. 1 (a). A basic shunt voltage feedback circuit (b). In practice, the internal resistance of the input signal source has to be taken into account. It is shown here as R_{in} (c). A special case of shunt voltage feedback. Under certain conditions, the overall gain is approximately equal to R_f divided by R_{in}

illustrates an amplifier having a voltage gain A , and it is assumed that its output impedance is given by the physical resistor R , there being zero impedance between the two wires leaving the compartment marked "Amplifier Circuits" to the left of R .

Now, one way of determining the output impedance consists of applying a measuring alternating voltage to the output terminals and seeing what current flows. The source of input signal is present but offers no actual signal input whilst this process is being carried out. In Fig. 5 (a) the measuring voltage is V and so the current which flows is $\frac{V}{R}$.

We need proceed no further with Fig. 5 (a) and, instead, we next turn to Fig. 5 (b). Fig. 5 (b) shows the amplifier of Fig. 5 (a) with voltage feedback

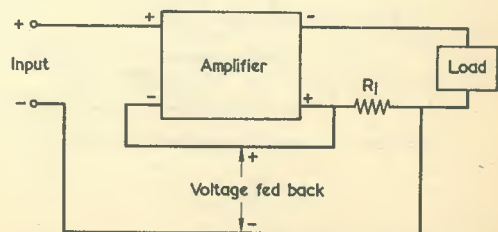

Fig. 2. The basic arrangement for current negative feedback. The signal voltage fed back is proportional to the output signal current flowing through R_L

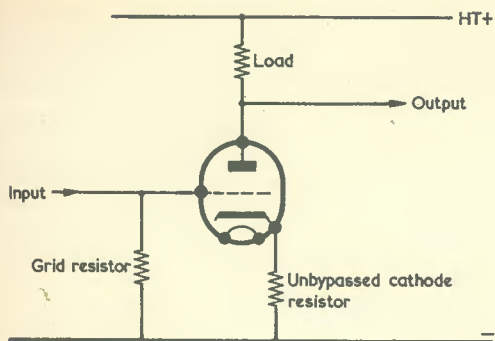
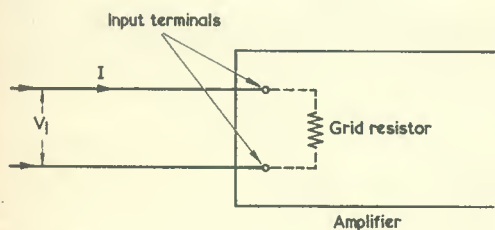

Fig. 3. If no bypass capacitor is connected across the cathode bias resistor of an amplifying valve, the resultant degeneration is due to current negative feedback. It is assumed here that the load is an anode resistor

added. This feedback causes a fraction, n , of the measuring voltage, V , to be fed to the input of the amplifier, whereupon an amplified voltage, nV multiplied by A (the gain of the amplifier), appears at the left hand side of R . Because of the 180° phase reversal in the amplifier, this voltage has opposite polarity to that of V , and so a greater current flows in R . This greater current is equal to the original $\frac{V}{R}$ plus the new $\frac{nVA}{R}$ and may be expressed

$$\text{as: } \frac{V}{R} + \frac{nVA}{R} = \frac{V(1+nA)}{R}$$



(a)

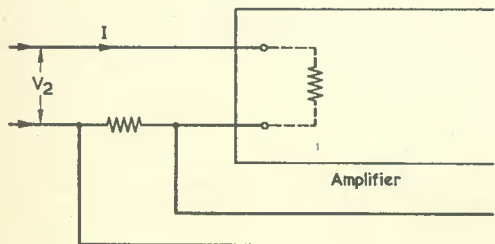

(b)

Fig. 4 (a). Determining the input impedance of an amplifier without feedback
(b). As is explained in the text, adding series feedback causes the input impedance to increase

Thus, the current which flows in R in Fig. 5 (b) is $(1+nA)$ times greater than in Fig. 5 (a). So far as the measuring voltage is concerned, the effective output impedance presented to it by the amplifier in Fig. 5 (b) is, therefore, $1+nA$ times lower than the impedance presented to it in Fig. 5 (a). The new impedance is, indeed, $\frac{R}{1+nA}$.

This applies to all amplifiers having voltage feedback. The effective output impedance, with feedback and "looking back" into the amplifier, is its output impedance without feedback divided by $(1+nA)$.

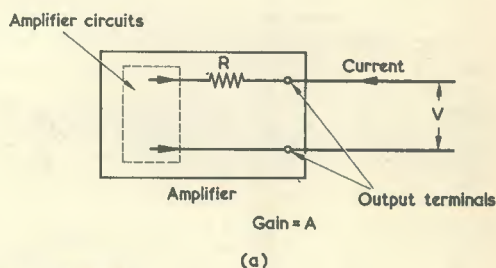

(a)

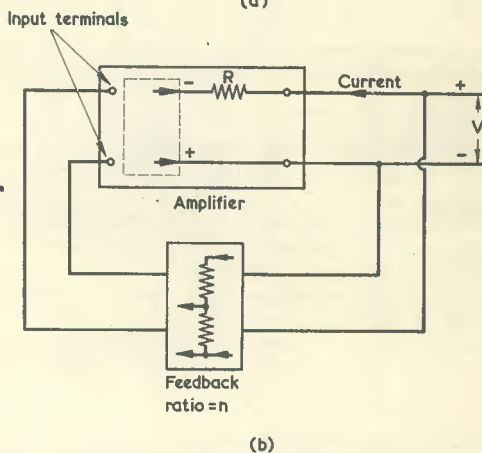

(b)

Fig. 5 (a). The output impedance of an amplifier may be found by applying an alternating measuring voltage to its output terminals and measuring the current which flows

(b). With voltage feedback the current increases, thereby giving the effect of a reduced output impedance

With current negative feedback an opposite effect takes place. Without unduly labouring the point this can be demonstrated by turning back to Fig. 2. If in Fig. 2 the load were replaced by a source of measuring alternating voltage, the polarities are such that the amplifier output resulting from the feedback is in phase with the measuring voltage, and the current from the source of measuring voltage decreases. If, for instance, the lower end of the load in Fig. 2 (now replaced, for argument, by a source of measuring voltage) goes positive, so also, due to the feedback, does the lower output terminal of the amplifier at the left of R_1 in this diagram.

In general, it is desirable for the output of a high quality a.f. amplifier to present a low impedance, as this tends to damp out any fundamental resonance

in the loud speaker. In consequence, voltage negative feedback is preferred for amplifiers of this nature.

As a final point, the reader should not confuse the output impedance which has just been discussed with the impedances from which the output transformer ratio is calculated. The impedance of an amplifier without feedback and from the loud-speaker transformer primary "looking back" is always equal to the r_a presented by the output valve or valves, and voltage feedback can reduce this

value. So far as general design work is considered the output transformer ratio required by an amplifier with feedback is the same as would be required without feedback. The feedback works externally to the valve and its output transformer.

Next Month

This concludes our examination of negative feedback. In next month's issue we shall introduce the subject of the superhet receiver. *

In your workshop



As occurs in most service establishments, the signal generators in the Workshop are simple and relatively low-cost valve instruments of some antiquity which are intended specifically for general repair work and troubleshooting. Dick discovers, nevertheless, that this does not mean that they mustn't be treated with the same care and respect as should be applied to all test equipment

"DO YOU WANT A HAND, DICK?" Tearing his attention away from the television receiver on his bench, Dick looked round in surprise at the Serviceman.

"Hey?" "Do you," Smyth repeated his offer, "want a bit of help? There's only an hour to go before we pack up and I've cleared up all my own work. So I thought I'd see whether you could do with a spot of assistance from me."

"Well, that is nice and matey of you," replied Dick, pleased. "As it happens, I'm just finishing up my own last job for the day. All I've got left to do is to fit a new capacitor to this TV and then give the 405 line sound i.f. channel a bit of a trim-up. The faulty capacitor was in one of the 38.15 Mc/s i.f.

tuned circuits, which is why I want to do some re-aligning after I've put the new component in."

Signal Generator Performance

"Fair enough," said Smyth. "We'll make it a combined operation, then."

He walked back to his bench to pick up his stool, then returned to Dick's side.

"Perhaps," suggested Dick, as Smyth settled himself comfortably alongside him, "you might be kind enough to oblige at the signal genny."

"Just as you like," replied Smyth equably.

He reached over and dragged a scarred and battered instrument towards him.

"I do feel," he remarked, examining Dick's signal generator with

evident disapproval, "that, whilst we don't use particularly expensive signal generators in this Workshop for ordinary servicing and line-up jobs, they should still be looked after with *some* care."

"Why, what's wrong?"

"It's this signal genny of yours that's wrong," snorted Smyth. "Just look at it! To start off with, it's all over dust and dirt. Then there are solder splashes on the front panel and the r.f. output lead braiding is just hanging on by a thread. Also, the enamel on the case is scratched in at least half-a-dozen places and there's pencil marks all over the scale."

"Not to worry," said Dick airily. "If test gear is used a lot, it's bound to show signs of wear and tear."

"There's nothing wrong with *fair* wear and tear," stated Smyth sternly, "but there's the dickens of a lot wrong with deliberate mis-handling. I must remind you that your signal genny is part of the Workshop equipment and, as such, constitutes a Capital Asset."

"What, that old thing?"

"What you refer to so carelessly as 'that old thing,'" retorted Smyth, "is a perfectly good and useful piece of test gear, and should be looked after with proper respect."

But Dick was too preoccupied with fitting his new capacitor to pay any heed to the Serviceman's words. With a sigh, Smyth picked up a cloth and carefully cleaned the worst of the grime from the front of his Capital Asset. He then picked up its mains plug, inserted it in a socket at the rear of Dick's bench and switched on.

"That's funny," he said.

"What's up now?"

"The light behind the scale doesn't come on."

"Oh, *that*."

Carelessly, Dick picked up a large screwdriver by its blade and gave the side of the signal generator a resounding thwack with its handle. After a preliminary flicker, the scale suddenly became illuminated.

"Ye gods," spluttered Smyth incredulously, "do you do that often?"

"Only now and again," said Dick cheerfully. "Most times the light comes on straightaway. Could I have 38.15 Mc/s please?"

Dick picked up the output lead from the now fully illuminated signal generator, whilst the glowering Serviceman selected the correct frequency range and switched on the modulation. He next put out his hand to the knob of the frequency control.

"Dear, oh dear," he grumbled. "What will I find next?"

"Don't tell me," called out Dick over his shoulder, as he clipped the output leads into his television receiver, "that there's something else wrong now."

"I'll say there is," growled Smithy wrathfully, "this darned tuning knob is slipping."

"That's only," replied Dick patronisingly, "because you don't know how to operate it."

"Don't know how to operate it?" repeated Smithy incredulously. "Hell's teeth, there's only one way to operate a flaming knob and that's to flaming well turn it, mate!"

"Not with *that* particular knob," replied Dick, adopting the careful tone of one who explains an obvious point to an idiot. "With that particular knob you have to give it a sort of tilt as well whilst you're turning it."

Smithy grabbed angrily at the knob once more, only to find that it detached itself completely from its spindle. As he gazed unbelievably at the knob in his hand, a small piece of crumpled paper fluttered to the surface of Dick's bench.

"I've seen everything now," muttered the Serviceman brokenly.

"This knob hasn't even got a grub screw in it!"

"I know it hasn't," replied Dick, a note of irritation creeping into his voice. "The grub screw got lost ages ago and, since then, I've just kept the knob in place with a bit of paper wedged down along the spindle."

"You've done *what*?" queried Smithy, turning a horrified gaze on his assistant. "If what you say is true, that's the most shocking thing I've heard of for years."

"It's all very well for you to criticise," returned Dick indignantly. "I didn't ask you to come over here to help me. *You* invited yourself over, and you've done nothing else but find fault ever since."

"It's a jolly good thing I did come over," replied Smithy accusingly, "because it's enabled me to see the self-inflicted troubles which you are placing in your own path. Dash it all, Dick, you should know as well as anyone else that the first rule of servicing is to keep your test gear on top line always, so that it's completely dependable and trustworthy. By far the most important part of servicing is fault diagnosis,

and the only tools you can use here are your items of test equipment. If your test gear cannot be relied upon, then you're liable to waste ages trying to trace what appears to be a fault when in actual fact you've arrived at a wrong diagnosis because the fault is in the test equipment. That slipping knob on your signal generator may appear to you to be a minor matter, but I should hate to have to add up all the time you've unconsciously been wasting because you can't control the signal generator output frequency properly. So, for goodness' sake find a grub screw from somewhere and get that darned knob stuck on properly. And we aren't going to do anything more at all until you've done just that."

A.F. Modulation

Taken aback at Smithy's outburst, a subdued Dick left his bench to forage in the tin where the odd nuts and bolts were kept. He soon found a suitable grub screw, whereupon he fitted this to the knob whose looseness had so enraged the Serviceman. This knob, in its turn, was then firmly and securely affixed to its spindle. Smithy rotated it with evident satisfaction.

"Now, that's more like it," he grunted. "You'd better turn on that TV whilst I select 38.15 Mc/s for you."

Obediently Dick switched on the receiver. After a short while a hiss became audible from its loudspeaker. Smithy rotated the signal generator frequency control, but all that happened was that the hiss from the speaker decreased in strength as the generator frequency approached 38.15 Mc/s. It was obvious that the signal generator was producing an r.f. output which was completely bereft of modulation, and that it was merely causing sound i.f. sensitivity to drop because of a.g.c. action.

With a nonchalant gesture that gave evidence of long custom, Dick reached over and turned the signal generator modulation off and quickly on again. The receiver loudspeaker at once gave voice to a loud 400 c/s tone. Hastily, Smithy adjusted the signal generator attenuators until the tone was reproduced at a more comfortable level. No sooner had he completed this operation than the 400 c/s tone suddenly tailed off and, with a plaintive wail, expired completely. Once more, Dick reached over and quickly clicked the modulation switch off and on, and once more the 400 c/s tone reappeared.

"It started doing that," he explained confidentially to Smithy, "about three months ago. Since then, when I first switch on the signal generator I have to keep wagging the modulation switch off and on for a bit. After a while, the modulation usually stays on for quite long periods!"

Smithy's eyes rolled up towards the ceiling.

"Please," he begged the electric light bulb above him, "please let me know that all this is really a bad dream and that it isn't truly happening. Do please tell me that this steaming great nit who's sitting beside me hasn't actually been trying, for a whole quarter of a year, to do servicing with a signal generator having intermittent modulation."

But no message of comfort was forthcoming. Smithy eventually lowered his eyes and turned a basilisk face towards his assistant.

At that instant the 400 c/s tone once more withered away and perished.

Dick reached out yet again for the modulation switch, then stopped short as Smithy raised an arresting hand after the manner of one holding up the traffic of Piccadilly.

"We shall," pronounced Smithy stonily, "attempt no further work whatsoever until we have repaired whatever fault it is in that signal generator which is causing its modulation to be unreliable."

"But that," protested Dick, "will mean digging around inside its works."

"It will mean exactly that," confirmed Smithy. "But with a relatively inexpensive signal generator of the type we have here, no harm will result so long as we don't mess around too much with the r.f. oscillator circuits and upset the calibration. The normal method of construction with these servicing signal generators is to double-screen the r.f. oscillator and all its tuned circuits by mounting these in a separate metal box inside the main metal case of the signal generator itself. The a.f. modulating oscillator will almost certainly be external to the r.f. oscillator box and, if we're lucky, we won't even have to open the latter to find the fault. Switch off that TV chassis of yours for the moment. We'll use it later to monitor the output of the signal generator."

Gravely, Smithy took the signal generator mains plug out of its socket, then proceeded to remove the screws holding its chassis in its case. He then carefully took out the chassis and placed it on the bench.

"Do you know," remarked Dick, "this is the first time I've ever seen inside that signal generator of mine! All the bits and pieces seem to be well spaced out, don't they?"

For the moment, however, Smithy had another matter to interest him. He pointed to an obvious poor joint on one of the tags on the bulb-holder mounted behind the frequency scale.

"For a start," he announced, picking up Dick's soldering iron and a length of solder, "here's the cause of that intermittent scale

lamp. This bulb-holder joint may have been good enough to get by the inspector at the signal generator factory, but it hasn't been good enough to stand up to all the bashing you've obviously been giving this piece of equipment. This dicey joint should be an object lesson to you to treat your test gear with more care. It *might* have been a joint in the innards of the r.f. oscillator section, and then we could have been in serious trouble."

Smithy applied his iron to the tag, then examined the re-made joint.

"Ah, that's better," he remarked. "Turning back to your remark just now, all the bits and pieces are comfortably well spaced out. You'll note that there's the internal metal box I mentioned just now, in which the r.f. oscillator section is housed. Outside this, and mounted on the main chassis, we've got a mains transformer, an a.f. transformer, a valve, and a few other odd bits and pieces. The a.f. transformer and valve will undoubtedly be in the modulating a.f. oscillator circuit, so the obvious thing to do first is to try the effect of a new valve."

Dick leaned over and removed the valve from its socket.

"Blimey," he remarked, "it's a 6J5GT. That's a bit ancient, isn't it?"

"It is, rather," agreed Smithy. "But this signal genny isn't, in itself, all that new. Also, you'll quite often find that test equipment of this nature tends to continue in production for quite long runs with the valves which were called up in the original design. This is for the simple reason that there's no point in the manufacturer altering them. It's not quite the same as with receiver production, where new chassis are introduced at much shorter intervals. The fact that this model uses valves instead of transistors may also give you an impression if its being dated but, for the same reason, this isn't entirely true in the test gear field. At any event, see if you can dig out a new 6J5GT."

Dick walked over to the spares cupboard.

"There's just one," he announced after a few moments. "Blimey, it must have been here since the Relief of Mafeking!"

"Well try it, nevertheless," said Smithy. "Switch on your TV chassis, and we'll see how the new valve works."

Smithy inserted the new valve, plugged in the signal generator to the mains and switched it on. He nodded in absent approval as the scale lamp became illuminated immediately. After a few moments, he swung the frequency control, only to find the same diminution in hiss level from the television re-

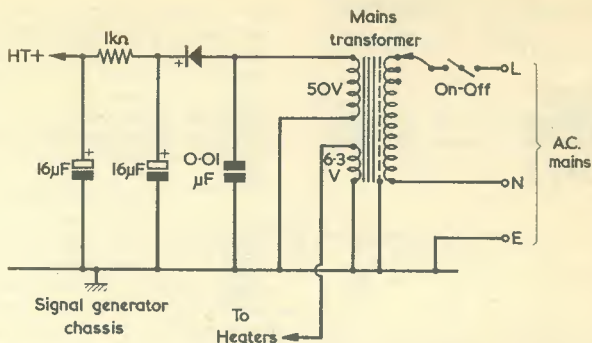

Fig. 1. The power supply sections of commercially manufactured servicing signal generators using valves are simple, and provide an h.t. supply at relatively low voltage and current. The function of the 0.01μF capacitor shown in this representative example is to prevent mains modulation

ceiver speaker that had occurred previously. Experimentally, he turned the modulation switch off and on again, to be rewarded by the immediate appearance of the 400 c/s tone. As with the previous valve, this died away after a short period. Smithy turned the modulation off again.

"Well, it's not the valve," he remarked, pulling Dick's testmeter towards him. "I'll just make a quick check of h.t. voltage. Ah, here we are! There's an h.t. voltage of 55 after the smoothing resistor."

"55 volts, eh?" repeated Dick. "That must be the cause of the fault then—low h.t. voltage!"

"Don't," said Smithy sternly, "jump to conclusions."

He reset Dick's meter to read a.c. volts.

"That 55 volt h.t. reading is quite reasonable," he continued, applying the test prods to the signal generator once more. "The mains transformer secondary only gives 50 volts a.c." (Fig. 1.)

"But," protested Dick, "isn't that very low?"

"Not in a signal generator it isn't," replied Smithy. "A signal generator doesn't have to provide much output power and so there's no point in using a high h.t. voltage which will merely cause greater heat to be dissipated inside the case and reduce the life of the valves. The power supply circuit we've got here is quite typical of the sort of thing you encounter in this sort of equipment. The h.t. current drain will only be about 5mA or so and a simple half-wave h.t. rectifier is

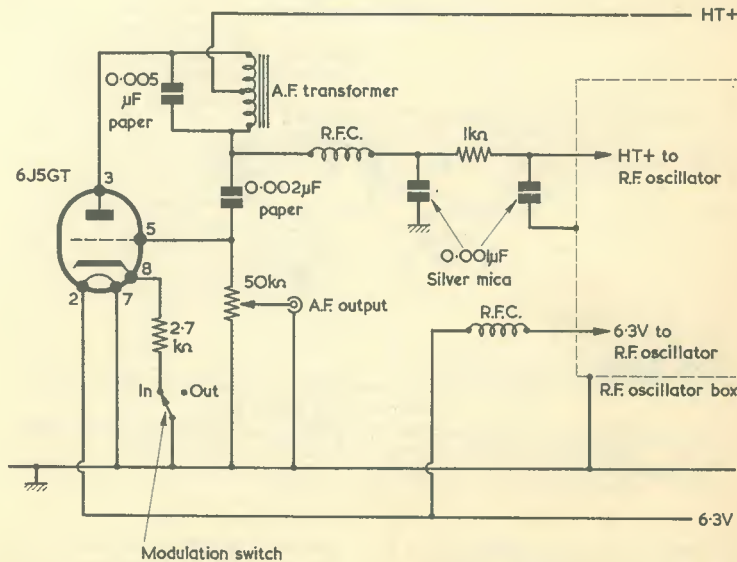

Fig. 2. A typical modulating a.f. oscillator, with representative component values, as encountered in servicing signal generators. Also shown are the filters in the h.t. and heater feeds to the r.f. oscillator box

more than adequate. Anyway, let's take a closer look at that a.f. oscillator circuit."

A.F. Oscillator

Smithy drew Dick's note-pad towards him and, after examining

here, either," he remarked. "All we've got is a simple straightforward Hartley a.f. oscillator. The tuned circuit is given by the total a.f. transformer winding and the $0.005\mu\text{F}$ capacitor connected across it. The $0.002\mu\text{F}$ capacitor and $50\text{k}\Omega$ pot

put that resistor in the cathode circuit?"

"To ensure that the a.f. oscillator gives a good sine wave," replied Smithy. "With the degeneration introduced by that $2.7\text{k}\Omega$ resistor, the oscillator will normally just be ticking over comfortably when it's switched on, with the result that it produces quite a nice sine wave. Incidentally, there are some rather crafty little design points in the circuit that I should point out to you. For instance, the $50\text{k}\Omega$ pot which functions as grid leak is also the attenuator for the a.f. output from the signal generator. Again, see how simple and effective the modulation switching is. When the modulation switch is open, h.t. is fed to the r.f. oscillator section via the lower part of the a.f. transformer winding. When the switch is closed, h.t. is still fed to the oscillator section via the winding but it now has the a.f. tone superimposed on it, thereby allowing the oscillator to be modulated."

"There seems," remarked Dick, "to be quite a bit of r.f. filtering in the h.t. supply to the r.f. oscillator."

"There is, indeed," agreed Smithy. "There's an r.f. choke, a $1\text{k}\Omega$ resistor and two $0.001\mu\text{F}$ silver-mica capacitors. These two capacitors will, by the way, also have an effect on a.f. oscillator frequency, but this factor will have been taken up in the initial design. The function of the filter network is to prevent r.f. from the r.f. oscillator box finding its way into the external wiring, where it could be radiated. The output of a signal generator should only appear, of course, at its output socket. Normally, there will be a further r.f. choke inside the r.f. oscillator box as well. There's an r.f. choke in the 6.3 volt heater supply line, too. Well, that's enough nattering about the circuit; let's get down to a spot of servicing!"

Smithy switched Dick's testmeter to a low d.c. voltage range and picked up the prods once more.

"A few simple voltage checks," he announced, "wouldn't be out of place. The $0.005\mu\text{F}$ and $0.002\mu\text{F}$ capacitors are paper types and, since we've exonerated the valve, are the components next most likely to cause trouble. I'll check between the valve grid and chassis."

Smithy applied his test-prods. (Fig. 3 (a)).

"Gosh," exclaimed Dick, looking at the meter. "There's about 3 volts positive of chassis on that grid!"

"Is there?" said Smithy, pleased. "Then it looks as though we've struck gold first time. That $0.002\mu\text{F}$ capacitor must be leaky."

He switched off the signal generator and, picking up a pair of side-cutters, cut the lead-out of the $0.002\mu\text{F}$ capacitor which coupled to the grid of the 6J5GT. (Fig. 3 (b)).

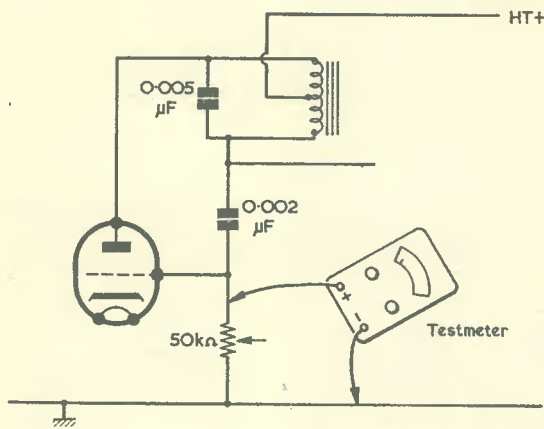

(a)

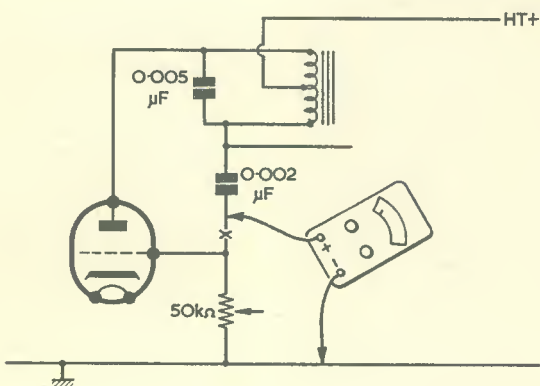

(b)

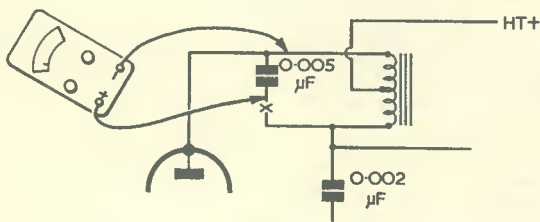

(c)

Fig. 3 (a). On first checking the a.f. oscillator circuit of Fig. 2, Smithy found a positive voltage on the triode grid
(b). Cutting the lower lead-out of the $0.002\mu\text{F}$ capacitor and re-checking with the testmeter confirmed that this capacitor was leaky
(c). Checking the leakage resistance of the $0.005\mu\text{F}$ capacitor across the a.f. transformer winding

the components and wiring in the signal generator, quickly sketched out the circuit of the oscillator and its coupling network to the r.f. section. (Fig. 2.)

"There's nothing very difficult

provide the grid capacitor and grid leak respectively, whilst the oscillator is switched on by completing the cathode circuit to chassis via the $2.7\text{k}\Omega$ resistor."

"Why," asked Dick, "do they

He then switched on again, set the testmeter to a higher voltage range, and re-applied his test prods between chassis and the free lead-out of the capacitor.

"Blow me," remarked Dick. "That meter's reading about 30 volts now!"

"Which finally proves," said Smithy, "that the 0.002 μ F capacitor is good and leaky. I always like to check a capacitor individually for leakage before I finally whip it out of a chassis, because it's not unknown for things like leakage across a valveholder or a tagstrip to give the impression that a capacitor is faulty. But there's no doubt in this case."

Smithy switched off the signal generator whilst Dick rummaged around in the spares cupboard for a new 0.002 μ F capacitor. He soon found a replacement and carefully soldered it into the circuit.

"What I can never understand about you," commented Smithy, as he watched his assistant at work, "is that when you fit a new component you take great pains to ensure that all the joints and wiring are immaculate, and yet you knock test equipment around as though it had done you an injury or something!"

"I'll take greater care with my test gear in future," promised Dick. "At any rate, you can't blame me because this capacitor went leaky."

"But I *can* blame you," returned Smithy, "for continuing to use the signal generator when it obviously wasn't working properly. Oh well, let's see how it works now."

Dick removed his soldering iron and Smithy turned on the signal generator. As it warmed up, the r.f. oscillator started to function and the hiss from the TV speaker on Dick's bench reduced in intensity. Smithy switched on the modulation, to be rewarded by a firm 400 c/s tone from the speaker.

The pair turned and beamed at each other.

The 400 c/s note suddenly tapered off and disappeared, leaving the r.f. signal unmodulated once more.

"Drat it," muttered Smithy. "That wasn't the main fault after all."

Irritably, he picked up his test prods and touched them to the chassis and the grid of the 6J5GT.

"Well, at any event," he pronounced, "there isn't a positive voltage on the grid any more, and so we have at least cured one snag."

He switched off the signal generator and scowled at it.

"All we can do," he continued, "is to follow a logical fault finding technique now. The next two most likely faults are the 0.005 μ F paper capacitor across the transformer winding going leaky and the 2.7k Ω cathode resistor going high. Since I can test the cathode resistor without

disconnecting it, I'll check that next."

Smithy set the testmeter to a resistance range and checked the resistor.

"Exactly 2.7k Ω ," sang out Dick, as he looked at the meter.

"Then we must try the 0.005 μ F capacitor," grunted Smithy. "Please unsolder one of its ends."

Quickly, Dick picked up the soldering iron and disconnected one of the capacitor lead-outs. (Fig. 3 (c).) Smithy applied his prods to the component. The meter needle indicated a resistance of approximately 100k Ω .

"Now that," remarked Smithy, "is most encouraging. There's a new capacitor wanted here, Dick, my lad!"

It took Dick only a minute or two to find a replacement capacitor and solder it across the transformer tags.

And this time, when the signal generator was switched on, the 400 c/s tone appeared as soon as the a.f. oscillator warmed up, and it maintained a constant level without the slightest indication of fading out.

Meter Trouble

"Another job done," commented Smithy with satisfaction, as Dick returned the signal generator chassis to its case and set about refitting and tightening up its securing screws. "You now have a fully serviceable signal genny once more. What was happening, of course, was that the 0.005 μ F capacitor had reduced the efficiency of the a.f. oscillator to the level where it could only just keep running for a short while after the initial kick given by switching it on. Since the faulty capacitor could exhibit a slightly higher leakage resistance as its temperature increased, the periods of oscillation lengthened as the whole instrument warmed up."

Smithy looked down at his watch. "Ah," he said, "it's just packing up time now. You can finish doing that TV set in the morning."

"Righty-ho," replied Dick agreeably, as he turned off the main switch for his bench. "This last hour has certainly been instructive."

As he and Smithy buttoned themselves up in their raincoats preparatory to walking out and braving the early March weather, Dick breathed a silent prayer of thanks that, in his present frame of mind concerning the sanctity of test equipment, Smithy hadn't found it necessary to take any current readings with the testmeter on his assistant's bench. That instrument still continued to work reliably on voltage and resistance readings and, as such, had enabled Dick to carry out quite useful servicing work over the past few weeks. But since its recent accident, at a moment when Smithy had been out of the Work-

Your Local Supplier

LONDON

Established 1910

H. L. SMITH & CO. LTD.

Comprehensive stocks of components
by all leading makers.

287-9 EDGWARE ROAD
LONDON W.2

Tel: 01-723 5891

TELERADIO ELECTRONICS

For Radio Control Devices, Miniature
components, Special Transistors,
Circuits and data on boat and
aircraft control.

QUOTATIONS GLADLY FOR PARTS USED IN
MAGAZINE ARTICLES

(S.A.E. Enquiries REF. D/P)

325/7 FORE STREET,
EDMONTON (3719)
LONDON, N.9.

WHY BI-PAK? FOR SEMICONDUCTORS

- ★ Fastest by return mail service
- ★ Lowest possible prices
- ★ Largest range available
- ★ Satisfaction guaranteed
- ★ For further proof see page 452

BI-PAK SEMICONDUCTORS
8 Radnor House,
93/97 Regent St., London W.1

THE MODERN BOOK CO.

Largest selection of English and
American radio and technical books
in the country.

19-21 PRAED STREET,
LONDON, W.2

Tel: PADDington 4185/2926

Your Local Supplier

LONDON

ELECTRONICS GALORE!

in the NEW

dca CATALOGUE

Send 1/6 now for your copy

to: DEPT. R/C

dca ELECTRONICS LIMITED

28 UXBRIDGE ROAD,
EALING, W.5

ESSEX

ELECTRONIC COMPONENTS

Valves, transistors, capacitors,
transformers, amplifiers,
tuners, etc., etc.

765 HIGH ROAD,
SEVEN KINGS
(opp. Seven Kings Hotel)
ILFORD, ESSEX

Telephone: GOODmayes 1826

MARKET CENTRE

For Semiconductors

Prompt, efficient mail order service for Mullard, Newmarket, Texas, Sinclair, S.T.C., Fairchild Semiconductors. We also offer a comprehensive selection of miniature components for transistor circuitry. Catalogue 1s.

L.S.T COMPONENTS

23 New Rd., Brentwood, Essex

HAMPSHIRE

BOURNEMOUTH

LARGEST HI-FI AND
RADIO COMPONENT
STORE IN THE SOUTH

FORRESTERS NATIONAL RADIO SUPPLIES LTD.

70-72 Holdenhurst Road
Bournemouth
Telephone 25232

shop, its needle had obstinately refused to give any indication of current whatsoever.

Still, as Dick put it mentally to himself, *anyone* with an excessively

overcrowded bench could, by moving just one item, cause an expensive multimeter further along to go crashing to the floor. . . .



Radio Topics

By Recorder

An old acquaintance, who used to contribute to *The Radio Constructor* in the past and who also ran his own electronics business, used to carry out a great deal of work in a spare room in his London flat. His grandmother came to visit every now and again, and she would sleep quite happily in a bed he set up right alongside the bench.

All these solutions have the advantage that one can leave bits and pieces lying around without having to clear them away when finishing for the day. Much contemporary home-construction is concerned with miniaturised components and semiconductors, and these, in their turn, reduce the space that is needed for working with them. A current contributor to *The Radio Constructor* does a great deal of experimental work with transistors, and he has found what is perhaps the best solution of all where domestic space is at a premium. He uses one of those old-fashioned roll-top desks which were popular in the earlier part of this century, this being fitted with mains sockets and the like inside. Roll-top desks are very sturdily built, have a wide variety of drawers and pigeon-holes, and offer a really wide and deep working surface which is ideal for use as a bench for electronic work. The greatest advantage of all is that the roll-top can be pulled down and locked when desired, which means that everything on the working surface can be left exactly as it is until the next time the desk is opened. Also, when the top is down inquisitive children cannot play around with any of the parts or, worse, receive shocks from any mains equipment that may be in use.

As a further point, the idea of a roll-top desk is, to my mind, an excellent one for the amateur transmitting enthusiast who wants to keep his gear out of sight when not in use.

Old roll-top desks are being sold at very low prices these days at auctions, for the simple reason that nobody wants them for their original purpose. Perhaps, when it is more generally realised how useful they are for our own hobby we may see the burgeoning of a thriving little

ONE OF THE EVER-PRESENT PROBLEMS which beset the average home-constructor is finding the space to do his home-constructing in. Modern houses seem to be designed for a mythical Mini-Briton reminiscent of the pygmy races of equatorial Africa, and allow little room for hobbies to be carried out in comfort. Also, some aspects of home-construction require a quiet and undisturbed background, which is by no means an easy thing to arrange in a present-day household.

Bedroom Radio

Quite a lot of the younger devotees to amateur radio overcome this problem by the simple process of building their equipment in the bedroom. Which is o.k., of course, so long as you ensure that components are kept in their proper places. The effect of snuggling down between the sheets and encountering the odd 10-henry choke could be quite traumatic. Seriously, though, this is not at all a bad idea, particularly if the bedroom is used for study and homework, as is very often the case.

The Editor of *The Radio Constructor* does his own spare-time work in a specially constructed wooden shed right away from the house (and the only snag is that it costs him a bomb for electricity for the fire during the winter). I, myself, have the good fortune to live in a rambling old house with several spare rooms at the top which, in the bad old days (and they were bad), were intended for domestic staff. In these times I wield my own vacuum cleaner, as is fit and proper, but one of those old upstairs rooms suits me very nicely for carrying out work in a completely undisturbed atmosphere.

market in them; and it could well be that the Small-Ads space in future issues of this magazine may be filled to overflowing with offers of roll-top desks for readers. Stand by, Advertising Department!

Hard Luck Stories

In these times of freeze and squeeze, it is a real pleasure to be able to recount one or two hard luck stories which have nothing to do with falling incomes or rising prices. Such stories are, of course, legion in the field of servicing.

The classic is the Bead Of Sweat Story which, if my memory serves me correctly, started circulating before the war. The overworked service engineer in question has finally tracked down an exceedingly elusive fault in a mains-driven set and is just putting the finishing touches to the repair when a bead of sweat falls from his forehead into the chassis. It drops between an h.t. positive point and chassis, and the results are a short-circuited h.t. line, the burning out of a smoothing choke and the demise of the h.t. rectifier.

Being of a distrustful nature, I've never known whether this story is true or not, but I repeat it if only to show you that, if you've heard it also, you aren't the only one.

Something rather similar, and which I can vouch for, happened to myself only a few days ago. I had been conned into fixing a little transistor set for a relative when, half-way through, one of my shirt buttons popped off and shot right into the back of the speaker. It took me almost ten minutes of holding the set at various angles and shaking it around before that wretched little button finally became dislodged and rattled out on to the bench.

Whilst talking about transistor radios, you can undergo quite a lot of hard luck when mending these if you don't first of all look for obvious damage. If, as is almost always the case, the back of the set has to be taken off to replace the battery, always make certain that some ham-handed Harry hasn't, by carrying out this very simple process, managed to wreck something somewhere else. In the smaller sets it is very common for the connections between the ferrite frame aerial and the printed circuit board to be carried by the aerial winding wire itself. These thin wire connections are usually the first to suffer if any man-handling has taken place. A broken lead here can often give quite misleading symptoms, of which a typical example is i.f. instability.

Another way of avoiding hard luck is given if, when replacing a series silicon diode for a TV heater string, you make quite certain that the new diode is connected right way

round. It sometimes happens that bias voltages or transistor stage supplies are taken from the rectified d.c. which flows in the heater chain.

Let me finish with a hard luck story which, like the first, goes back a bit. This one, however, is quite true and it demonstrates an effect which can occur in the very latest transistor receivers. The fault in question appeared in one of those pre-war status symbol American radio receivers in which valves sprouted up on an enormous chassis like quills on a porcupine's back. The older hands will remember those sets. If the circuit required a double-diode-triode, three separate valves were fitted.

In this particular set a 2-gang potentiometer functioning as a tone control had started to produce a loud scratching from the speakers (woofer and two tweeters) as it was turned. Since it was a component not directly available locally, the proud set-owner insisted that a replacement be obtained from the manufacturers in America. Although I hadn't been present previously, I happened to be on the scene when, considerably later and after quite a bit of expense and trouble, the replacement tone control arrived. I also had the job of fitting it, only to find that it was just as noisy as the old one!

The snag? The slider of one section of the tone control coupled, via an a.f. coupling capacitor, to a grid circuit in the early a.f. stages of the set, whilst the track connected between chassis and, via another capacitor, to a tone control network which was at h.t. potential. The latter capacitor was a common-or-garden paper component of 0.001 μ F. This 0.001 μ F capacitor had gone leaky and was causing h.t. to appear across the potentiometer track, whereupon there were little discrete jumps in direct voltage on the slider as this was rotated, giving the effect of noisy operation. The simple process of replacing the 0.001 μ F capacitor completely cleared the fault.

You get the same effect in transistor radios in which the volume control also forms the diode load. Tuning in a station causes the direct voltage resulting from the rectified carrier to appear across the volume control track, whereupon the control is liable to become noisy earlier in its life than would occur if it handled a.f. only.

Erudite

To conclude, I cannot resist passing on Tommy Trinder's definition of "erudite" in the radio programme *Does The Team Think?*

"Erudite," says Tommy Trinder, "is stuff you stick things together with."

Cheerio until next month!



Your Local Supplier

SURREY

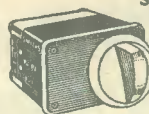

**SMITHS PRECISION
6 MINUTE DELAY
ACTION SWITCH**

Clockwork actuated

10/6 EACH

Post 2/6

(3 or more post free)

Separate switching up to 6 mins. Each action for loading up to 15 amps. 250 volts. For photographic timer, sequence switching operations, etc., etc. Brand new units at a fraction of their value. Connection sheet supplied.

Radio Component Specialists

337, WHITEHORSE ROAD,
WEST CROYDON, SURREY

Phone 01-684-1665 FULL LIST 1/-

SUSSEX

E. JEFFERIES

For your new television set,
tape recorder, transistor radio,
and hi-fi equipment.

PHILIPS, ULTRA, INVICTA, DANSETTE,
MASTERADIO, PERDIO, MARCONI,
PHILCO, FIDELITY.

6A Albert Parade,
Victoria Drive,
EASTBOURNE SUSSEX

WORCESTERSHIRE

Dept. C1, 176 HAGLEY ROAD
HALESOWEN
021-550 3210 WORCS.

Hi-Fi Equipment
Transistors and
Radio Components
Public Address Amplifiers

MARLISON
Electronics

EIRE

PEATS for PARTS

**ELECTRONIC COMPONENTS
RADIO & TELEVISION**

Also a postal service for:

The Radio Constructor,
Data Books and
Panel-Signs Transfers
for the convenience of
IRISH enthusiasts

Wm. B. PEAT & Co. Ltd.
28 PARNELL STREET
DUBLIN 1



IF YOU'RE BUYING A HOUSE

Mortgage Protection

is the best Policy for you

If you're buying your house with the help of a Building Society or a private loan, a "Yorkshire" Mortgage Protection Policy will take care of your outstanding payment in the event of your premature death. And, if you wish, you can arrange a Protection "Plus" Policy, which gives you a substantial cash return at the end of the mortgage term. It costs so little yet means so much to your dependants. Leave them a home not a mortgage!

Please send for further details, without any obligation, of course.

THE YORKSHIRE INSURANCE COMPANY LTD

Chief Offices: Rougier Street, YORK
and Becket House, 36-37 Old Jewry, LONDON E.C.2

Please send me further particulars of the
"Yorkshire" Mortgage Protection Policy

Name

Address

.....J/B

* SPECIAL OFFER

UNBEATABLE VALUE FOR YOU,
AS A READER OF
THE RADIO CONSTRUCTOR

THE NEW
TOLTEC
HAIR DRYER



SPECIFICATION

Moulded in beautiful symmetrical pastel blue impact resisting thermoplastic casing.

Quiet in operation.

Hot or cold air.

No radio or T.V. Interference-meets British standard specification.

Fitted with safety cut-out.

12 months & money refund guarantee.

230-250 volts A.C. only.

Value 80/9 in the shops

Send the coupon below with the sum of only 57/- (this includes 4/6d to cover postage, packing and insurance, unless you are collecting personally).

Please send me one Toltec Hair Dryer at the special privilege price as advertised in *The Radio Constructor*

I enclose cheque/postal order value.....

Name

Address

.....
(Block capitals please)

To: Toltec Electronic & Trading Co. Ltd.
Hatton House, Hurst Green, Etchingham, Sussex



SEMICONDUCTOR CENTRE BY MAIL

The famous "International Rectifier Semiconductor Centre" now available by mail: L.S.T. Components are proud to announce their appointment as official stockists.

ZENERS: 1 Watt 3.9V-27V supplied with 24 page free book incl. circuits 7/11 each

SELENIUM PHOTOCELLS: with free instructions and circuits, etc.

B2M photocell 0.2-0.4V 2mA 12/6 each

B3M photocell 0.2-0.4V 13-24mA 15/- each

SIM photocell 0.3-0.4V 10-16mA 19/- each

S4M photocell 0.3-0.4V 25-40mA 33/6 each

SOLAR DRIVE MOTOR: For use with photocells 39/6 each

UNIUNION: Type 2N2160 for transistor Ignition/SCR Firing, etc. 14/9 each

SILICONE GREASE: For use with heat sink and power transistors 61gm tube 6/- each

SILICON CONTROLLED RECTIFIERS: SCRO1 to O4 each supplied with 24 page booklet.

SEND NOW FOR YOUR COPY OF THE "SEMICONDUCTOR CENTRE" PRICE LIST AND DETAILS OF THIS FASCINATING RANGE OF TOP QUALITY EXPERIMENTAL DEVICES. PRICE 6d. (Stamp).

PLEASE NOTE: The listing above is only a small part of the range available.

SUPER SAVE PACKS

1 pair 2N1304/5 NPN/PNP	10/-	12 OA200 equivalents tested	6/-
3 BC109 High gain NPN	15/-	12 OA202 equivalents tested	9/-
4 2N2926 Yellow Planar	10/-	4 SL103 100piv 10A Stud diode	15/-
4 BC113 Fairchild Planar	10/-	60 Untested unmarked transistors guaranteed at least 50% usable	10/-
20 Mixed new transistors Germanium and Silicon marked and tested	20/-	4 SJ103 100piv 2A Stud 1 400piv 3A SCR Tested STC... ..	9/-
20 Mixed new diodes Germanium and Silicon marked and tested	15/-	2 12V 1W Zener diodes IN202	10/-
16 Red and White spot (8 Red, 8 White)	10/-	36 Square inches 0.15in. Veroboard	10/-
4 OC16 equiv. (V30/30P)	10/-	2 1,200V 1.5A Avalanche Rectifiers 5A surge rating RAS310-AF	12/-
2 OC19 New Mullard	10/-	150 Assorted ceramic capacitors mainly colour coded-worth £££'s	10/-
3 Mullard OC71 brand new	9/-	2 OC81 matched + OC81D Mullard	7/-
6 Valve OC45 brand new	12/-	2 OC45 + OC44 Mullard	7/-

AC107	14/9	OC140	9/6
AC126	6/-	OC170	4/-
AC128	4/-	OC171	6/-
AC176	6/-	OC169	6/-
ADT140	12/6	OC200	6/-
ACY17	5/-	OC201	15/-
ACY20	3/6	OC202	13/-
ACY21	4/-	OC203	8/6
AF114	4/9	OC204	11/-
AF115	4/9	OC205	10/6
AF116	4/9	OC206	19/6
AF117	4/9	OC207	9/6
BA131	4/-	ORP50	8/-
BC109	6/-	2G374	5/-
BCY30	7/-	2G381	5/-
BCY31	9/-	2N706	4/9
BCY32	13/-	2N1302	5/-
BCY33	6/-	2N1303	5/-
BCY34	8/-	2N1304	6/-
BCY38	10/-	2N1305	6/-
BCY39	19/-	2N1306	8/-
BCY40	16/-	2N1307	8/-
BFY50	6/-	ST140	3/-
BFY51	6/-	ST141	5/-
BFY52	6/-		
BSY95A	4/9		
BY100	5/-	OAS	2/5
BYZ10	11/3	OA10	2/6
BYZ12	7/6	OA70	1/6
BYZ13	5/6	OA79	1/6
GET103	4/4	OAB1	1/6
OC41	3/6	OAS5	2/-
OC42	4/-	OA90	3/6
OC44	3/-	OA91	1/6
OC45	3/-	OA200	4/-
OC71	3/6	OA202	4/-
OC72	4/6		
OC73	3/3		
OC75	5/-	OC20	22/6
OC76	4/-	OC22	13/-
OC81	3/-	OC23	25/-
OC81D	3/-	OC25	9/6
OC82	4/6	OC26	12/-
OC82D	4/6	OC28	15/-
OC83	4/-	OC29	15/-
OC84	6/-	OC35	12/-
OC139	12/-	OC36	14/-

INTEGRATED CIRCUITS

Mullard 263TAA	...	39/9
Fairchild uL900	...	9/6
uL914	...	9/6
U1923	...	12/6
5 page article on I'Cs	...	2/6

BARGAINS IN SEMICONDUCTORS ALL TYPES



LST COMPONENTS

7 COPTFOLD ROAD BRENTWOOD ESSEX BRENTWOOD 7904

24 HOUR POSTAL SERVICE

FAIRCHILD AF11 20W SOLID STATE AMPLIFIER KIT

£8.8.0 Complete Includes Printed circuit board, Semiconductors, Resistors, Capacitors, Heat sink and short circuit protection components. S.A.E. for details.

2N3819 FET 11/-
ST140 3/-
ST141 5/-
OCP71 Equiv. 9/6
BC107/85/- Each
NEW!! S-DEC THE 'BREADBOARD' FOR THE ELECTRONIC AGE LASTS INDEFINITELY RE-USE COMPONENTS AGAIN AND AGAIN IN STOCK AT L.S.T. 29/6 each S.A.E. DETAILS
2N2646 UJT 10/-

POST & PACKING 9d. per order

EXPORT ENQUIRIES WELCOME

TRANSISTOR MANUALS

R.C.A. 27/6
G.E. 29/9

RETAIL & WHOLESALE SUPPLIED

TECHNICAL AUTHOR

There is a vacancy for a Technical Author in the Company's Publications Department. We are looking for someone aged between 23 and 30 who can write effectively on the installation, operation, maintenance and servicing of mechanical, electro-mechanical and electronic equipment. In addition knowledge of colour photography would be a distinct advantage. Previous experience as a Technical Author is obviously desirable, but not essential if a candidate has the necessary background and aptitude. Writing ability will be tested at interview.

The successful applicant will be paid on an attractive salary scale and will enjoy generous employee benefits, including non-contributory pension and sickness benefit schemes. The Ruislip

offices of the Company are modern and within easy access of the countryside and towns of Buckinghamshire, Hertfordshire and Berkshire. There are good residential facilities in the surrounding areas and assistance may be given with removal expenses.

Please write, giving details of age, qualifications, experience and present salary to:

Personnel Department,

Kodak LIMITED

Victoria Road, Ruislip, Middlesex.

For 'Radio Constructor' Circuits

Sensitive Reflex T.R.F. (Jan). We are getting favourable reports from constructors who have built this simple but effective receiver. Transistors: selected HK301, HK101, + diode 5/- . R.f. choke, 2/6. Vol. control + switch, 5/6. Output trans. for speaker or low res. phones, 4/6. Fixed R & C kit 3/7. Ferrite slab 2", 2/6.

Miniature Two-Voltage Supply (Feb). Submin. mains trans., 9-0-9V, 80mA. 11/-; submin bridge rect. (30V, 150mA) 4/-.

Integrated Circuit A.F. Amp. (CA3020) (Feb). With data sheet, 33/- . Low-power output trans. (3Ω) 4/6. Push-on cooler, 1/-.

Transistor Bargains! Prices Down!

NOT 'seconds', NOT 'equivalents', NOT 'unmarked' rubbish, but BRAND NEW, FIRST GRADE. DISCOUNT PRICES (in brackets) for 5 OR MORE OF SAME TYPE. Full list, 3d.

AF239	10/- (8/6)	U.h.f. germanium pnp.
BC107	3/11 (3/1)	Npn silicon driver (hfe=250-500)
BC109	3/6 (3/-)	Npn silicon low noise (hfe=250-500)
BC168	2/6 (2/-)	Npn silicon universal (hfe=250-500)
2N706	3/4 (2/7)	Npn Si. Similar to ST140, ST141.
2N2926G	3/- (2/6)	Npn Si. universal (hfe=235-470)
2N4058	5/6 (4/7)	Pnp Si. low noise (hfe=100-400)

Mail order only. Cash with order. UK post free on orders over 10/- (under 10/- add 6d.) Discounts: 10% over £5; 15% over £10.

AMATRONIX LTD. (Dept RC3)
396 SELSDON ROAD, CROYDON, SURREY
CR2 ODE

JACKSON



the big name in **PRECISION** components
Precision built radio components are an important contribution to the radio and communications industry.

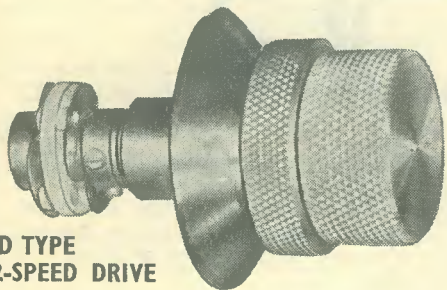

**D TYPE
2-SPEED DRIVE**

- ★ 1½ inches diameter satin anodised aluminium
 - ★ Mounts on outside of panel
 - ★ Always at correct height
 - ★ Smooth precise powerful 4½:1 and direct
 - ★ Knobs available separately to match
 - ★ Smart appearance
- ★ 29/- Each

JACKSON BROS. (LONDON) LIMITED
Dept. RC, KINGSWAY-WADDON, CROYDON, CR9 4DG
Phone Croydon (01-688) 2754-5. Grams Walfilco, Croydon

**RADIO
CONTROL FOR
MODELS**



RADIO CONTROL FOR MODELS

SHIPS, BOATS and AIRCRAFT

By **F. C. JUDD**

With sections on servo-
mechanisms by

RAYMOND F. STOCK

*More than 200 illustrations—circuits,
working diagrams, photographs & tables.
Each page is packed with information.*

192 Pages

15s. Postage 9d.

This book is basically an amalgamation of "Radio Control for Model Ships, Boats and Aircraft" and "Radio Control Mechanisms". Additional material has been added on Multi-Channel Operation; Transistorised Radio Control Receivers—Simple and Three-Channel; A Compact Efficiency Aerial; Deac Battery Information; Licence Conditions, etc.

To Data Publication Ltd., 57 Maida Vale, London, W.9

Please supply.....copy(ies) of your publication "RADIO CONTROL FOR MODELS" DATA BOOK No. 16.

I enclose cheque/crossed postal order for.....

NAME.....

ADDRESS

BLOCK LETTERS PLEASE

NEW STYLE SELF-BINDER for "The Radio Constructor"

The "CORDEX" Patent Self-Binding Case will keep your issues in mint condition. Copies can be inserted or removed with the greatest of ease. Rich maroon finish, gold lettering on spine.

Specially constructed Binding Cords are made from Super Linen of great strength, very hard twisted and twice doubled. They are attached to strong RUSTLESS Springs under tension, and the method adopted ensures PERMANENT RESILIENCE of the Cords. Any slack that may develop is immediately compensated for, and the Cords will always remain taut and strong. It is impossible to overstretch the springs, as a safety check-device is fitted to each.

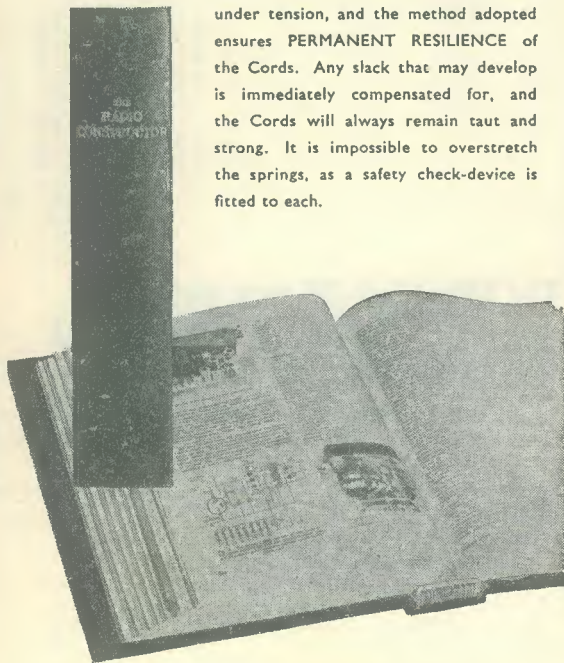

PRICE **15/-** Post Free

Available only from:—

Data Publications Ltd.
57 Maida Vale London W9

SMALL ADVERTISEMENTS

continued from page 513

"MEDIUM WAVE NEWS" Monthly during DX season—Details from: K. Brownless, 7 The Avenue, Clifton, York.

JOIN THE INTERNATIONAL S.W. LEAGUE. Free Services to members including Q.S.L. Bureau. Amateur and Broadcast Translation. Technical and Identification Dept.—both Broadcast and Fixed Stations, DX Certificates, contests and activities for the SWL and transmitting members. Monthly magazine, *Monitor*, containing articles of general interest to Broadcast and Amateur SWLs, Transmitter Section and League affairs, etc. League supplies such as badges, headed notepaper and envelopes. QSL cards, etc., are available at reasonable cost. Send for League particulars. Membership including monthly magazine, etc., 35s. per annum.—Secretary, ISWL, 60 White Street, Derby.

WANTED. Grundig tape recorder TK9 (Reporter) required for spares.—Connell, 37 Toorack Road, Wealdstone, Middlesex. Tel: HARROW 5096.

WANTED: Two 1U4 valves.—Hellen, Somerville Post Office, Ardleigh, Colchester, Essex.

ARE YOU A MOTORING ENTHUSIAST? The Seven Fifty Motor Club caters for all types of motor sport—racing, rallies, hill climbs, etc. Monthly Bulletin free to members. For full details write to: The General Secretary, Colin Peck, "Dancer's End," St. Winifred's Road, Biggin Hill, Kent.

BOOKS FOR SALE: *Alfred Noble* E. Bergengren £1. *Radioisotope Laboratory Techniques* R. A. Faires, 10s. *Atomic Medicine* Behrens, £1. *Medical Radiation Biology* Ellinger, 30s. *Effects of Atomic Weapons U.S.A.* Atomic Energy Commission, £1. *Physics in Medical Radiology* Russ, Clark & Pelc, 7s. 6d. *Disease & its Conquest* Hollis, 7s. 6d. *Earth's Envelope* T. Lobsack, 15s. *The Atomic Submarine* C. Blair, 7s. 6d. *Astronautics in the Sixties* K. W. Gatland, 30s. *Space Research and Exploration* D. R. Bates, £1. *Once Round the Sun* Story of the I.G.Y., Fraser, 10s. *Earth Satellite* P. Moore, 7s. 6d. *Frontier to Space* E. Burgess, 5s.—Box No. F316.

BUG TRANSMITTERS/RECEIVER. Circuit and details of 3 transmitters plus free booklet of suitable micro-sized receiver, 10s.—Mr. Bobker, 64 Choir Street, Salford 7, Lancs.

WANTED: To buy or loan, back copies *The Radio Constructor* with constructional details of an Electronic Organ.—J. Gough, The Bungalow, Collon Lane, Shantallow, Londonderry, N. Ireland.

WANTED: Retail outlets for NEW/SURPLUS radio-electronic spares. Excellent profits.—Details from Box. No. F321.

TRANSISTORS: AC107 4s. AF239 10s. 6d. BC107 & BC108 4s. OC35 6s. 6d. OC71 2s. 6d. OC75 2s. 9d. OC170 3s. ST140 4s. ST141 6s. 2N2926Y 3s. All post free with 12 month guarantee. Lists on request.—J. R. Hartley, 2 Waterloo Terrace, Bridgnorth, Shropshire.

FOR SALE: *Radio Constructor*. Volumes 2-14 bound. Volumes 15-18 loose. May & June 1962 missing. Will not separate. Offers?—Box No. F323.

MAKE MONEY FROM ELECTRONICS. 15 circuits of units specially designed for sale to shops, schools, etc. 5s. plus 9d. postage.—Box No. F325.

continued on page 515

SMALL ADVERTISEMENTS

continued from page 514

TECHNICAL DRAWINGS, Artwork, etc. Electronic and Radio Circuits a speciality. Moderate charges.—B. P. Meaney, 43 Forest Road, Worthing, Sussex.

BOOKS FOR SALE. *Science Projects in Electricity*, by E. M. Noll, 7s. 6d. *Electronic Systems*, by E. A. Altshuler, 10s. *Tubes for Computers*, Philips, 5s. 6d. *Industrial Rectifying Tubes*, Philips, 5s. 6d. *101 Ways to use your Audio Test Equipment*, by R. G. Middleton, 7s. 6d. *Transistor Radio Servicing Made Easy*, by Wayne Lemons, 10s. *Servicing Transistor TV*, by R. G. Middleton, 12s. 6d. *Radio Valves*, by Philips, 7s. 6d. *Electronics for the Beginner*, by J. A. Stanley, 10s. *How Television Works*, by W. A. Holm (Philips), 15s. All less than half price. All post free.—Box No. F326.

RESISTORS. Cracked carbon, high stability, $\frac{1}{2}$ W, 5% Tol. 100 Ω , 220 Ω , 330 Ω , 470 Ω , 1k Ω , 10k Ω , 33k Ω , 47k Ω , 68k Ω , 100k Ω , 220k Ω , 470k Ω , 1M Ω , 3.3k Ω , 5.6k Ω , 68k Ω , 3d. each. 2s. 6d. dozen, 6 of each value 15s. Skeleton Pots: 2k Ω , 5k Ω , 10k Ω , 25k Ω , 250k Ω , 1M Ω , 1s. 4d. each. Volume controls, 3in. spindle, 250k Ω , 1M Ω , 2s. 9d. each or with d.p.d.t. switch 4s. 6d. each. All log track. Please add 1s. postage.—P. & J. Barrow-Mawdsley, Box No. 327.

THIS COULD BE LISTENING TO YOU! The smallest Bug (wireless microphone) available commercially. 007 type. Rifle bullet size. Completely self-contained using one hearing aid mercury battery. £7 10s. 0d. Post free. Shirt-buon size ultra sensitive microphone 20s.—Box No. F38.

POSAL ADVERTISING? This is the Holborn Service. Making lists, addressing, enclosing, wrapping, facsimile letters, automatic typing, copy service campaign planning, design and artwork, printing and stationery. Please ask for price list.—The Holborn Direct Mail Company, Capaty House, 2-6 Rothsay Street, Tower Bridge Road, London, S.E.1. Telephone: 01-407-1495.

INNOVATION IN DX CLUBS ANNOUNCED! Formed in October, 1965, the Radio New York Worldwide Listeners Club now has 3,600 members in 86 countries! A unique club offering shortwave listeners monthly magazines containing listening tips and technical features, numbered wallet-sized membership cards and gold 8 $\frac{1}{2}$ in. by 11in. membership certificates. Multi-lingual report forms available for cost of postage. "We must be doing something right!" Find out . . . join now! Send 7s. 2d. (crossed domestic money order) for one year's membership to: The Radio New York Worldwide Listeners Club, 485 Madison Avenue, New York 10022, U.S.A.

ESSEX GARDENERS. Buy your bedding and rock plants, shrubs, etc. also cacti, from May's Nurseries, 608 Rayleigh Road, Hutton, Brentwood, Essex. Callers only, Monday to Saturday.

PROPERTIES for sale and to let in London and suburbs. Apply to Miggs & Stephens, Estate Agents, 229 Maida Vale, London, W.9. MA1da Vale 8123.

RECITALS OF RECORDED MUSIC. The second Saturday evening of each winter month. Next recital. 9th March, 1968 8 p.m. Woodford Green United Free Church, Woodford Green, Essex. Bus routes 20, 20A, 38A and 179—alight at "The Castle" stop. Programme includes works by Arne, C. P. E. Bach, Poulenc and Vaughan-Williams.

PLAIN-BACKED NEW STYLE SELF-BINDERS for your other magazines (max. format 7 $\frac{1}{2}$ " x 9 $\frac{1}{2}$ ")



The "CORDEX" Patent Self-Binding Case will keep your copies in mint condition. Issues can be inserted or removed with the greatest of ease. Rich maroon finish. Specially constructed Binding Cords are made from Super Linen of great strength, very hard twisted and twice doubled. They are attached to strong RUSTLESS Springs under tension, and the method adopted ensures PERMANENT RESILIENCE of the Cords. Any slack that may develop is immediately compensated for, and the Cords will always remain taut and strong. It is impossible to overstretch the springs, as a safety check-device is fitted to each.

PRICE **14'6** Post Free

Available only from:—

Data Publications Ltd.
57 Maida Vale London W9

CHASSIS and CASES by



H. L. SMITH & CO. LTD.
287/9 Edgware Road
London W2
TEL: 01-723 5891

BLANK CHASSIS—Same day Service

Of over 20 different forms made up to YOUR SIZE.
(Maximum length 35", depth 4".)

SEND FOR ILLUSTRATED LEAFLETS or order straight away, working out total area of material required (including waste) and referring to table below which is for four-sided chassis in 16 s.w.g. aluminium.

48 sq. in.	4/6	176 sq. in.	9/10	304 sq. in.	15/2
80 sq. in.	5/10	208 sq. in.	11/2	336 sq. in.	16/6
112 sq. in.	7/2	240 sq. in.	12/6	368 sq. in.	17/10
144 sq. in.	8/6	272 sq. in.	13/10	and pro rata	
P. & P. 3/-		P. & P. 3/6		P. & P. 4/6	

Discounts for quantities. More than 20 different sizes kept in stock for callers.

FLANGES (1/2" or 3/4"), 6d. per bend.
STRENGTHENED CORNERS, 1/- each corner.
PANELS

Any size up to 3ft at 6/- sq. ft. 16 s.w.g. (18 s.w.g. 5/3).
Plus postage and packing

CASES

ALUMINIUM, SILVER HAMMERED FINISH

Type	Size	Price	Type	Size	Price
U	4 x 4 x 4"	10/-	W	15 x 9 x 8"	44/-
U	5 1/2 x 4 1/2 x 4 1/2"	15/6	Y	8 x 6 x 6"	26/6
U	8 x 6 x 6"	21/-	Y	12 x 7 x 7"	41/-
U	9 1/2 x 7 1/2 x 3 1/2"	22/-	Y	13 x 7 x 9"	46/-
U	15 x 9 x 9"	44/6	Y	15 x 9 x 7"	48/6
W	8 x 6 x 6"	21/-	Z	17 x 10 x 9"	66/-
W	12 x 7 x 7"	34/-	Z	19 x 10 x 8 1/2"	71/-

*Height

Type Z has removable back and front panels.
Type Y all-screwed construction.

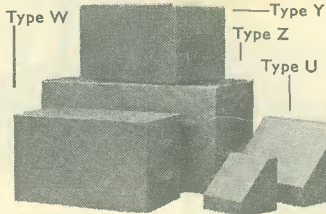

★ HAMMERITE HAMMER ENAMEL ★

AIR DRYING • JUST BRUSH ON
1/2 pint 8/-, p.p. 1/9, 1 pint 16/-, p.p. 3/-, Blue, silver, black, bronze (and others), NO PRIMERS NEEDED. Just try it. Brushed sample, interesting list FREE. **INDUSTRIALISTS 1 1 1 SAVE TIME AND £££!** (2 pints will do a Mini)

FINNIGAN SPECIALTY PAINTS (RC) Mickley Square, Stocksfield, Northumberland. Telephone: Stocksfield 2280



SPECIALISTS IN JOINERY MADE CABINETS

Made to your design to take stereo and wireless equipment. In beautiful wood veneer. Finish to match your own furniture.
Example: 4' x 18" x 18", Teak finish, from £45.

Send your enquiries to:

R. C. Whitby (Cabinets)
700 Foxhall Road, Ipswich, Suffolk.

BULK COMPONENT BARGAINS

★ **300 ASSORTED RESISTORS—HI-STAB 15/-**
(5% 1/10 to 1/2 watt, worth £3) 1/6 p. & p.

S.A.E. FOR LIST OF INDUSTRIAL COMPONENTS FOR THE HOME CONSTRUCTOR

Elmbridge Instruments Ltd. Island Farm Avenue, West Molesey Surrey

TRANSISTOR AND DIODE COMPUTER PRINTED

Circuit Boards 12/6 dozen—post paid. Minimum of 40 transistors per dozen boards. No information on transistors. Quantity enquiries available.

PLASTIC SILICON DIODES

1000 P.I.V. 500mA	3/-	400 P.I.V. 500mA	1/6
800 P.I.V. 500mA	2/6	200 P.I.V. 500mA	1/-
Surplus Transistors 2N2926			1/6
MAT Transistors			2/6
General Purpose Silicon NPN Transistors		doz.	12/-
Surplus P Channel F.E.T. with data			5/-
Sub-miniature Epoxy Silicon Double Diodes 100 P.I.V. 100mA each diode		pair	1/6

Printed Circuit Plastic Silicon Rectifiers (fits Veroboard)

200 P.I.V. 400mA	1/6
50 P.I.V. 400mA	1/-

STUD MOUNTING SILICON RECTIFIERS

800 P.I.V. 2 Amps Stud Anode	2/6
800 P.I.V. 2 Amps Reverse	2/6

J. BIRKETT

25 THE STRAIT, LINCOLN. Telephone 20767.



WANTED

Contact springs as shown

BEST PRICES PAID

S.a.e. to "Lanco", 76 Sedgemoor Road, Willenhall, Coventry, Warwickshire

YUKAN SELF-SPRAY SO PROFESSIONAL WE YUKAN AEROSOL WAY—
Get these air-drying GREY HAMMER NOW! OR BLACK WRINKLE (CRACKLE) finishes

Yukan Aerosol spraykit contains 16 ozs. fine quality, durable easy instant spray. No stove baking required. Hammers available in grey, blue, gold, bronze. Modern Eggshell Black Wrinkle (Crackle) all at 14/11 at our counter or 15/11 carriage paid, per push-button self-spray can. Also Durable, heat and water resistant Black Matt finish (12 ozs. self-spray cans only) 13/11 carriage paid.

SPECIAL OFFER: 1 can plus optional transferable snap-on trigger handle (value 5/-) for 18/11, carriage paid. Choice of 13 self-spray plain colours and primer (Motor car quality) also available.

Please enclose cheque or crossed P.O. for total amount to:
YUKAN, DEPT. RC/3 307A, EDGWARE ROAD, LONDON, W.

We supply many Government Departments, Municipal Authorities, Institutes and Leading Industrial Organisations—We can supply you too.

Open all day Saturday. Closed Thursday afternoons.

Only Yukan Air Dry Aerosols, 16.1. or 15/11 colour info: Z Chromate Or Lacquer Polishes; Grey, Blue, Bronze and Gold.



THE RADIO CONSTRUCTOR
ANNUAL SUBSCRIPTIONS to this magazine may be obtained direct from the publishers
ONLY 42/- per year, post free

Please send remittance with name and address and commencing issue required to:

DATA PUBLICATIONS LTD 57 MAIDA VALE LONDON W9

Please mention **THE RADIO CONSTRUCTOR** when writing to advertisers

THE RADIO CONSTRUCTOR

Price 3/- each, postage 6d.

Annual Subscription 42/-, post free.

Bound Volumes Vol. 19 August 1965 to July 1966 32/6, postage 4/6.
Vol. 20 August 1966 to July 1967 32/6, postage 4/6.

Cordex Self-Binders With title "The Radio Constructor" on spine, 15/-, post free.
With no title on spine 14/6, post free.

DATA BOOK SERIES

- DB5 TV FAULT FINDING**
124 pages. Price 8/6, postage 8d.
- DB6 THE RADIO AMATEUR OPERATOR'S HANDBOOK**
64 pages. Price 5/-, postage 5d.
- DB14 SHORT WAVE RECEIVERS FOR THE BEGINNER**
72 pages. Price 6/-, postage 6d.
- DB15 TWENTY SUGGESTED CIRCUITS**
48 pages. Price 3/6, postage 5d.
- DB16 RADIO CONTROL FOR MODELS**
192 pages. Price 15/-, postage 9d.
- DB17 UNDERSTANDING TELEVISION**
512 pages. Price 37/6, postage 3/-

PANEL-SIGNS TRANSFERS

Six sheets in each set

Set 3: WORDING—White

Set 4: WORDING—Black

Set 5: DIALS—Control Panels have a clear background

Set 6: DIALS—Control Panels have a black background

Price per set 4/6, postage 4d.

I enclose Postal Order/Cheque for..... in payment for.....

NAME

ADDRESS

(Please use Block Capitals for both name and address)

Postal Orders should be crossed and made payable to Data Publications Ltd.

Overseas customers please pay by International Money Order

All publications are obtainable from your local bookseller

Data Publications Ltd., 57 Maida Vale, London W.9

NEW SOLID STATE HIGH FIDELITY EQUIPMENT

Power Amplifiers—Pre Amplifiers—Power Supplies

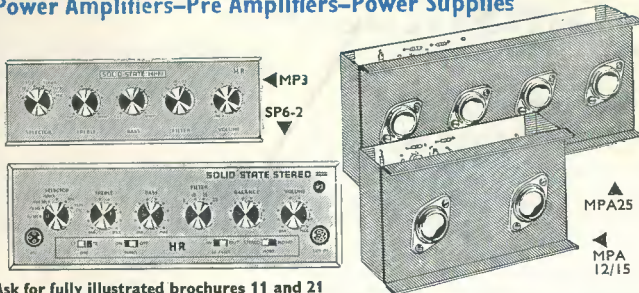

Ask for fully illustrated brochures 11 and 21

THE FINEST VALUE IN HIGH FIDELITY — CHOOSE A SYSTEM TO SUIT YOUR NEEDS AND SAVE POUNDS

(British made)

WE PROUDLY PRESENT THIS NEW RANGE OF AUDIO EQUIPMENT developed from DINSDALE Mk. II—each unit or system will compare favourably with other professional equipment selling at much higher prices. Brief details are below

SYSTEM	COMPRISING	SYSTEM PRICE
★A	5 watt mono for 3/5 ohm speakers.	£10.3.0
★1	12 watt mono for 3 to 5 ohm speakers.	£13.17.6
★2	12 watt mono for 12 to 16 ohm speakers.	£14.12.6
★4	24 watt mono two channel for 12 to 16 ohm speakers	£20.15.0
★8	20 watt mono/stereo for 12 to 16 ohm speakers.	£24.0.0
★9	24 watt mono/stereo for 3 to 5 ohm speakers.	£26.15.0
★14	40 watt mono/stereo for 7 1/2 to 16 ohm speakers.	£29.10.0

SEND FOR FULL DETAILS ON THESE BRITISH MADE PRODUCTS. FREE ON REQUEST

VHF FM TUNER



87/105 Mc/s Transistor Superhet. Geared tuning. Terrific quality and sensitivity. For valve or transistor amplifiers. 4 x 3 1/2 x 2 1/2 in. Complete with dial plate. 5 Mullard Transistors plus 4 Diodes. (Cabinet Assembly 20/- extra.)

TOTAL COST TO BUILD £6.19.6
Ask for Brochure 3. P.P. 2/6

FM STEREO DECODER



7 Mullard Transistors. Printed Circuit Design with Stereo Indicator. For use with any valve or transistor FM. Uses pot cores to Mullard design and ger. and silicon transistors. As used by B.B.C. and G.P.O.

COMPLETE KIT PRICE £5.19.6
Ask for Brochure 4. P.P. 2/6

BUILD A QUALITY TAPE RECORDER

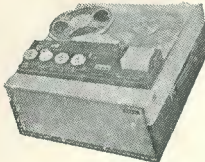

With a Martin Recordakit. ★TWO-TRACK. Deck £10.10.0. Amplifier £14.19.6. Cabinet and speaker 7 gns. Complete kits with MICROPHONE 7in. 1,200ft. tape, spare spool.

Today's Value £45. **29 gns. P.P. 15/-**

★FOUR-TRACK. Deck £13.10.0. Amplifier £15.19.6. Cabinet and speaker 7 gns. Complete kits with MICROPHONE 7in. 1,200ft. tape, spare spool.

Today's Value £50. **32 gns. P.P. 15/-**
Ask for Brochure 6.

QUALITY RADIO TUNER



Fully tunable MW/LW superhet with excellent sensitivity and selectivity. Output up to 1/2 volt peak. Complete with front panel, etc. 9 volt operated. For use with any amplifier or tape recorder.

TOTAL COST TO BUILD £3.19.6
Ask for Brochure 5. P.P. 2/6

MAYFAIR PORTABLE



Build this instrument stage by stage in your own home. A truly portable instrument for all enthusiasts. Fully TRANSISTORISED POLYPHONIC British design. Call in for a DEMONSTRATION. EXPORT PRICES ON APPLICATION

TOTAL COST 99 GNS.

ELECTRONIC ORGAN

DESIGNED BY L. W. ROCHE

Deferred terms available. **COMPLETE KIT.** Deposit £29.19.0. 12 monthly payments of £7. **TOTAL £113.19.0. READY BUILT & TESTED.** Deposit £36.8.0 and 12 monthly payments of £9. Total £144.8.0.

ORGAN COMPONENTS
We carry a comprehensive stock of organ components for TRANSISTOR AND VALVE FREE PHASE designs.



AUTO-BAN TRANSISTOR CAR RADIO. British Made



Ask for Brochure 15.

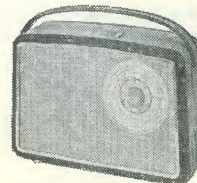

REGENT-6 MW/LW POCKET

Ask for Brochure 2. 6-Transistor superhet. Mullard Transistors. Geared tuning. Push-pull speaker output. Moulded Cabinet 5 x 3 x 1 1/2 in. Phone socket. **TOTAL TO BUILD £3.9.6** P.P. 2/6

Full tuning on both bands.

6-Transistor MW/LW Car Radio 12 volt operated. 3 watt output. Push-button, wavechange. Supplied built, boxed, ready to use with Speaker and Baffle. Car fixing kit and manufacturers' current guarantee. Special Bargain Offer. Positive or Negative Earth. **Our Price £9.19.6** P.P. 4/6

button version £11.19.6. P.P. 4/6

7-TRANSISTOR MW/LW SUPERHET NEW! PORTABLE

New printed circuit design with full power output. Fully tunable on both mw/lw bands. 7 Transistors plus diode, push-pull circuit. Fitted 5in. speaker, large ferrite aerial and Mullard transistors. Easy to build with terrific results. All local, and Continental stations.

TOTAL COST TO BUILD £6.19.6 P.P. 4/-
Ask for Brochure 1.

NEW 1968 TRANSISTOR LIST

SEND FOR YOUR FREE COPY TODAY

- ★ Largest range over 1000 types
- ★ S.C.R.'s from 5/-
- ★ Field Effect T'sistors from 8/6
- ★ Power Transistors from 5/-
- ★ Diodes & Rectifiers from 1/6

Send for Free List No. 36. 24 page Illustrated Brochure as above including Valves and Quartz Crystals. 1/- post paid.

GARRARD DECKS

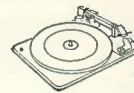

LATEST MODELS—COMPLETE RANGE IN STOCK.

FROM £5.19.6

Send for Illustrated Brochures 16 & 17

CATALOGUE

The most COMPREHENSIVE — CONCISE — CLEAR — COMPONENTS CATALOGUE. Complete with 10/- worth discount vouchers FREE WITH EVERY COPY

- ★ 20 pages of transistors and semi-conductor devices, valves and crystals.
- ★ 150 pages of components and equipment.
- ★ 50 pages of microphones, decks and Hi-Fi equipment.

SEND TODAY 8/6 POST PAID

LATEST EDITION

240 pages, 6000 items
1000 illustrations



HENRY'S RADIO LTD



Telephone (01) 723-1008/9
OPEN MON.-SAT. 9 a.m.-6 p.m. THURS. 9 a.m.-1 p.m.

303 EDGWARE ROAD LONDON W2

Transistors & Semi-Conductor Devices
We have the LARGEST RANGE OVER 650 TYPES & COMPETITIVE PRICES. FULLY GUARANTEED ★ 1st GRADE STOCKS. SEND FOR FREE LIST No. 36. Also 24-PAGE ILLUSTRATED BROCHURE LISTING 2000 DEVICES with data and circuits, including VALVES and QUARTZ CRYSTALS 1/- Post paid.