

THE

RADIO CONSTRUCTOR

Vol 20 No 10

MAY 1967
2/6

A DATA PUBLICATION

RADIO · TELEVISION
ELECTRONICS · AUDIO

The SCT/T1 SINGLE CHANNEL TONE TRANSISTOR TRANSMITTER

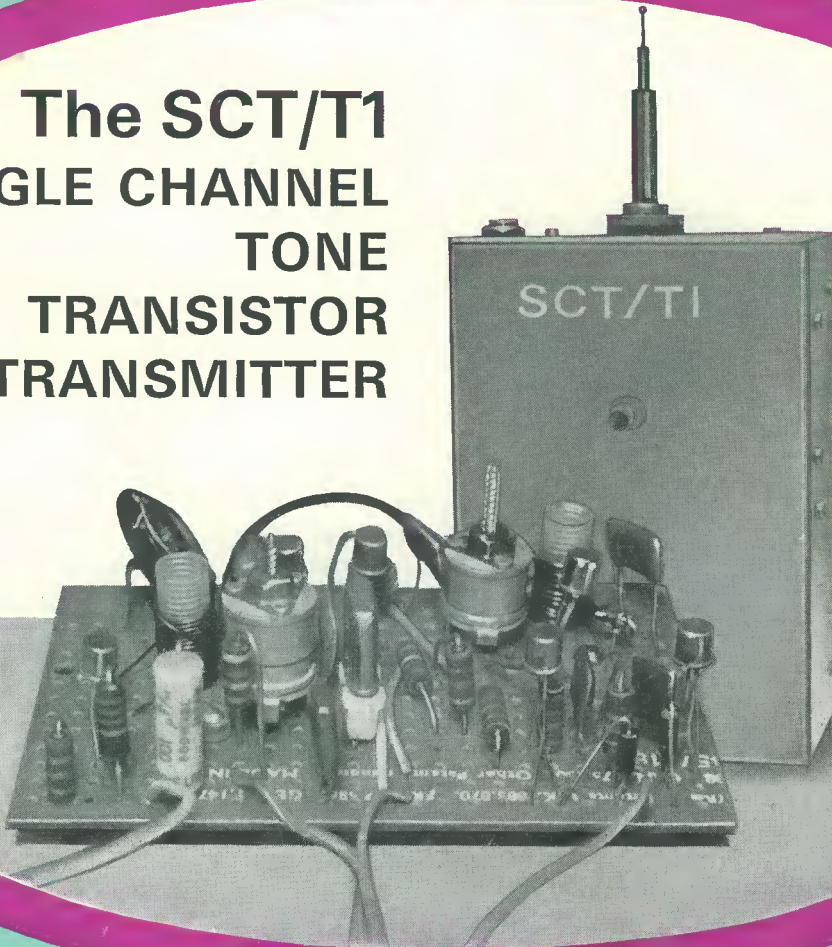

Basic
Radio
Control
Series
No. 4

High Performance
Signal Injector



2-Transistor
Bedside Receiver



Transistorised
3-Tone Generator



Tunable Aerial
Coupler

Scottish Insurance Corporation Ltd

66-67 CORNHILL · LONDON · EC3



TELEVISION SETS, RECEIVERS AND TRANSMITTERS

Television Sets, Receivers and Short Wave Transmitters are expensive to acquire and you no doubt highly prize your installation. Apart from the value of your Set, you might be held responsible should injury be caused by a fault in the Set, or injury or damage by your Aerial collapsing.

A "Scottish" special policy for Television Sets, Receivers and Short Wave Transmitters provides the following cover:

- (a) Loss or damage to installation (including in the case of Television Sets the Cathode Ray Tube) by Fire, Explosion, Lightning, Theft or Accidental External Means at any private dwelling-house.
- (b) (i) Legal Liability for bodily injury to Third Parties or damage to their property arising out of the breakage or collapse of the Aerial Fittings or Mast, or through any defect in the Set. Indemnity £10,000 any one accident.
- (ii) Damage to your property or that of your landlord arising out of the breakage or collapse of the Aerial Fittings or Mast, but not exceeding £500.

The cost of Cover (a) is 5/- a year for Sets worth £50 or less, and for Sets valued at more than £50 the cost is in proportion. Cover (b) (i) and (ii) costs only 2/6 a year if taken with Cover (a), or 5/- if taken alone.

Why not BE PRUDENT AND INSURE your installation—it is well worth while AT THE VERY LOW COST INVOLVED. If you write to the Corporation's Office a proposal will be submitted for completion.

Write for full details, quoting reference 5304, to:—

THE MANAGER
SCOTTISH INSURANCE CORPORATION LTD.,
66-67 CORNHILL, LONDON E.C.3

BARGAIN OPPORTUNITIES FROM

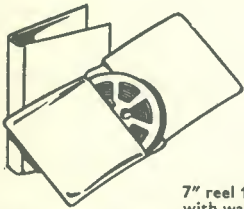

EXCLUSIVE TAPE OFFER

FREE LIBRARY WALLET WITH EVERY REEL
 With each reel of this tape by an internationally famous manufacturer we give you a beautifully made wallet strongly made in simulated leather with space for a reel of tape each side. This is professional quality full frequency tape with metalised leader/stop foils. These library wallets solve once and for all the problems of storing tapes efficiently and tidily.

7" reel 1800' with wallet **22/6**
 5½" reel, 1200' with wallet **17/6**
 5" reel, 900' with wallet **12/6**
 p. & p. 1/6 per reel

'CIR-KIT' INSTANT . . . CIRCUIT Indispensable for constructor. Enables you to produce "printed circuits" quickly and cleanly. Kit No. 3, inc. baseboard processed copper strip and sheet as advertised. 15/-.

TYGAN FRET or Vynair spkr. fabric, 12 x 12in. 2/-; 12 x 18in. 3/-; 12 x 24in. 4/-, etc.

BONDACUST Speaker Cabinet Acoustic Wadding, approx. 1in. thick, 18in. wide, any length cut, 2/3 ft. 6/- yd.

EXPANDED ANODIZED METAL. Attractive gilt finish ½ x ½in. diamond mesh 4/6 sq. ft. Multiples of 6in. cut. Max. size 4 x 3ft. 47/6 plus carr.

ENAMELLED COPPER WIRE—2 oz. reels, 14 g.-20 g. 3/-; 22 g.-28 g. 3/6; 30 g.-34 g.

4/3; 36 g.-38 g. 4/9; 39 g.-40 g. 5/-, etc.

TINNED COPPER WIRE—16-22 g. 4/- 2 oz.

VEROBOARD—All standard sizes including 2½in. x 5 in. 3/8; 2½in. x 3½in. 3/-; 3½ x 5in. 5/2; 3½ x 3½in. 3/8; 3½ x 17in. 12/6. All accessories and tools in stock.

RESISTORS — Modern ratings, full range 10 ohms to 10 megohms, 10% ± w. 6d. ea., 5% Hi-Stab. ½ w. 6d. ea. (below 100 ohms and over 1 meg. 9d. ea.). 1% Hi-stab. ½ w. 1/6 ea. (below 100 ohms 2/- ea.)

WIREWOUND RESISTORS 25 ohms to 10 K. 5 w. 1/3; 10 w. 1/6; 15 w. 2/-.

CONDENSERS Silver Mica. All values 2 pf. to 1,000 pf. 6d. ea. Ditto ceramics 9d. Tub. 450 v. T.C.C., etc. .001 mfd. to 0.1 9d. and .1/350 v. 10d. .02 mfd. to 0.1 mfd. 500 v. 1/- .25 T.C.C. 1/6. 5 T.C.C. 1/9. **CLOSE TOL. S/MICAS.** 10% 5 pf. 500 pf. 8d. 600-5,000 pf. 1/- .1% 2 pf.-100 pf. 9d. 100 pf. 9d. 100 pf. 11d. 575 pf. 5,000 pf. 1/6. **ALUMIN. CHASSIS.** 18 g. Plain undrilled folded 4 sides 2in. deep. 6 x 4in. 4/6d. 8 x 6in. 5/9; 10 x 7in. 6/9; 12 x 6in. 7/6; 12 x 8in. 8/-, etc.

APPOINTED SINCLAIR AND PEAK SOUND STOCKISTS

OUR MAY LIST is brimful of bargains and hard-to-find components. Send 3d. stamp for free copy.

TAPE AMPLIFIER

WITH 4 VALVES, FRONT PANEL, WIRED & TESTED £65.0

OUTSTANDING T.R.S. VALUE—Absolutely complete, mains powered amplifier for B.S.R. T.D.2 Deck. Supplied wired and tested. Facilities include mike/radio/P.U. inputs, playback switching, superimpose, magic eye, tone and volume controls, 3Ω outlet and monitoring. With front panel and knobs. £65/- (P. & P. 5/-)

Contemporary styled 2-tone cabinet to take above Size 14 x 13½ x 7½in. **39/6**
 Detachable lid. (P. & P. 7/6.)

T.R.S. Mullard Stereo 10-10

Valve amplifier by T.R.S. to exact Mullard spec. Complete with pre-amp and o/p transformers tapped for 3 and 15 Ω Bass, treble, volume, balance controls. Outlet for H.T. and L.T. for tuner. Switching for mono/stereo and speaker phasing. Shrouded pre-amp. Complete with plugs, sockets, escutcheon, knobs, etc.

£17.10.0
 (C/P 10/-)

At present supplied wired and tested. £19.10.0 (P. & P. 10/-)
 Kit version available very shortly.

7 Valve AM/FM RG Chassis

A superbly powerful high performance instrument for the keenest enthusiasts. Provides tuning on long, medium and F.M. wavebands. 3 wave-band L/M/FM Permeability tuning on F.M. Large clear dia. A.V.C., good neg. feedback. Magic eye 3 w. output. A.C. 200/250 v. Circuit diagrams available.

Aligned, tested and ready for use (Carr. and ins. 7/6.) S.A.E. brings full details. **£13.19.6**

TRS RADIO

COMPONENT SPECIALISTS
 Established 1946

70 Brigstock Road, Thornton Heath, Surrey

Tel.: THO 2188. Hours 9 a.m.—6 p.m. 1 p.m. Wednesdays
 A few doors from Thornton Heath Stn. (S.R. Victoria section.)

FREE TO AMBITIOUS ENGINEERS

—THE LATEST EDITION OF ENGINEERING OPPORTUNITIES

Have you sent for your copy?

ENGINEERING OPPORTUNITIES is a highly informative 132-page guide to the best paid engineering posts. It tells you how you can quickly prepare at home for a recognised engineering qualification and outlines a wonderful range of modern Home Study Courses in all branches of Engineering. This unique book also gives full details of the Practical Radio & Electronic Courses, administered by our Specialist Electronics Training Division—explains the benefits of our Appointments Dept. and shows you how to qualify for five years promotion in one year.

SATISFACTION OR REFUND OF FEE

Whatever your age or experience you cannot afford to miss reading this famous book. If you are earning less than £30 a week send for your copy of "ENGINEERING OPPORTUNITIES" today—FREE.

BRITISH INSTITUTE OF ENGINEERING TECHNOLOGY

(Dept. 409B), Aldermaston Court, Aldermaston, Berkshire

WHICH IS YOUR PET SUBJECT

- RADIO
- TELEVISION
- ELECTRONICS
- ELECTRICAL
- MECHANICAL
- CIVIL
- PRODUCTION
- AUTOMOBILE
- AERONAUTICAL
- PLASTICS
- BUILDING
- DRAUGHTSMANSHIP
- B.Sc.
- CITY & GUILDS
- GENERAL CERTIFICATE OF EDUCATION
- ETC., ETC.

PRACTICAL EQUIPMENT

Basic Practice and Theoretical Courses for beginners in Radio T.V. Electronics Etc. A.M.I.E.R.E. City & Guilds Radio Amateur's Exam. R.T.E.B. Certificate. P.M.G. Certificate. Practical Radio. Radio & Television Servicing Practical Electronics Electronics Engineering Automation

INCLUDING TOOLS!

The specialist Electronics Division of B.I.E.T.

NOW offers you a real laboratory training at home with practical equipment—

Ask for details.



POST COUPON NOW!

■ Please send me your FREE 132-page "ENGINEERING OPPORTUNITIES" (Write if you prefer not to cut page)

■ NAME.....

■ ADDRESS.....

■.....

■ SUBJECT OR EXAM.....

■ THAT INTERESTS ME..... 409B

THE B.I.E.T. IS THE LEADING INSTITUTE OF ITS KIND IN THE WORLD

HI-FI AMPLIFIERS ~~~~~ TUNERS ~~~~~ RECORD PLAYERS

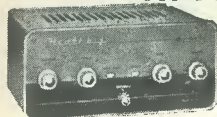

**3+3W
STEREO
AMP.
S-33H**



**10W
POWER
AMP.
MA-12**



**GARRARD
PLAYER
AT-60**

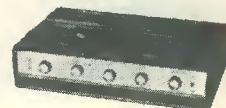

**20+20W
STEREO
AMP.
AA-22U**

10W POWER AMPLIFIER. Model MA-12. 10W output, wide freq. range, low distortion. For use with control unit. Kit **£12.18.0** Assembled **£16.18.0**

STEREO CONTROL UNIT. Model USC-1. Ideal for use with the MA-12 power amplifiers. Push button selection, gauged controls, rumble and variable low-pass filters. Kit **£19.19.0** Assembled **£27.5.0**

DE LUXE STEREO AMPLIFIER. Model S-33H. 3+3 watt output with two-tone grey perspex panel, and higher sensitivity necessary to accept the Decca Deram pick-up. Kit **£15.17.6** Assembled **£21.7.6**

HI-FI STEREO AMPLIFIER. Model S-99. 9+9W output. Ganged controls. Stereo/Mono gram., radio and tape inputs. Push-button selection. Printed circuit construction. Kit **£28.9.6** Assembled **£38.9.6**

TRANSISTOR PA/GUITAR AMPLIFIER, PA-2. 20W amplifier. Four inputs. Variable tremolo. **New Low Price** Kit **£39.19.0** Assembled **£54.10.0**

50W VALVE PA/GUITAR AMP., PA-1. Kit **£54.15.0** Assembled **£74.0.0**

TRANSISTOR MIXER. Model TM-1. A must for the tape enthusiast 4 channels. Battery operated. Similar styling to Model AA-22U Amplifier. With cabinet. Kit **£11.16.6** Assembled **£16.17.6**

20+20W TRANSISTOR STEREO AMPLIFIER. Model AA-22U. Outstanding performance and appearance. Kit **£39.10.0** (less cabinet) . Assembled **£57.10.0** Attractive walnut veneered cabinet £2.5.0 extra.

GARRARD AUTO/RECORD PLAYER. Model AT-60. less cartridge **£14.12.10** With Decca Deram pick-up **£19.7.4** incl. P.T. Many other Garrard models available, ask for Lists.

HI-FI MONO AMPLIFIER. Model MA-5. A general purpose 5W Amplifier, with inputs for Gram., Radio. Attractive modern styling. Kit **£11.9.6** Assembled **£15.15.0**



ENJOY YOURSELF AND SAVE MONEY

Finished models provide years of superlative performances

INSTRUMENTS

3" LOW-PRICED SERVICE OSCILLOSCOPE. Model OS-2. Compact size 5" x 7 1/2" x 12" deep. Wt. only 9 1/2 lb. "Y" bandwidth 2 c/s-3 Mc/s ±3dB. Sensitivity 100mV/cm. T/B 20 c/s-200 kc/s in four ranges, fitted mu-metal CRT Shield. Modern functional styling. Kit **£23.18.0** Assembled **£31.18.0**

5" GEN-PURPOSE OSCILLOSCOPE. Model 10-12U. An outstanding model with professional specification and styling. "Y" bandwidth 3 c/s-4.5 Mc/s ±3dB. T/B 10 c/s-500 kc/s. Kit **£35.17.6** Assembled **£45.15.0**

DE LUXE LARGE-SCALE VALVE VOLT-METER. Model IM-13U. Circuit and specification based on the well-known model V-7A but with many worth-while refinements. 6" Ernest Turner meter. Unique gimbal bracket allows operation of instrument in many positions. Modern styling. Kit **£18.18.0** Assembled **£26.18.0**

AUDIO SIGNAL GENERATOR. Model AG-9U. 10 c/s to 100 kc/s, switch selected. Distortion less than 0.1%, 10V sine wave output metered in volts and dB's. Kit **£23.15.0** Assembled **£31.15.0**

VALVE VOLTMETER. Model V-7A. 7 voltage ranges d.c. volts to 1,500. A.c. to 1,500 r.m.s. and 4,000 peak to peak. Resistance 0.1 Ω to 1,000M Ω with internal battery. D.c. input resistance 11M Ω. dB measurement, has centre-zero scale. Complete with test probes, leads and standardising battery. Kit **£13.18.6** Assembled **£19.18.6**

MULTIMETER. Model MM-1U. Ranges 0-1.5V to 1,500V a.c. and d.c.; 150μA to 15A d.c.; 0.2 Ω to 20M Ω. 4 1/4" 50μA meter. Kit **£12.18.0** Assembled **£18.11.6**

R.F. SIGNAL GENERATOR. Model RF-1U. Up to 100 Mc/s fundamental and 200 Mc/s on harmonics. Up to 100mV output. Kit **£13.18.0** Assembled **£20.8.0**

SINE/SQUARE GENERATOR. Model IG-82U. Freq. range 20 c/s-1 Mc/s in 5 bands less than 0.5% sine wave dist. less than 0.15μ sec. sq. wave rise time. Kit **£25.15.0** Assembled **£37.15.0**

TRANSISTOR POWER SUPPLY. Model IP-20U. Up to 50V, 1.5A output. Ideal for Laboratory use. Compact size. Kit **£35.8.0** Assembled **£47.8.0**



OS-2

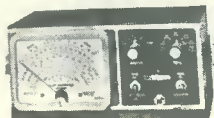

IM-13U



V-7A



RF-1U



IG-82U

MO Prices quoted,
Retail Prices in
general slightly higher.

Complete your motoring pleasure with this outstanding CAR RADIO, Model CR-1



Will give you superb LW and MW entertainment wherever you drive. Tastefully styled to harmonise with any car colour scheme. Available for your convenience in two separate parts, RF Amp. Kit **£1.13.6** incl. P.T. IF/AF Amp. Kit **£11.3.6**

Total Price Kit (excl. Loudspeaker) £12.17.0 incl. P.T. 8" x 5" Loudspeaker **£1.16.1** incl. P.T.

TRANSISTOR RADIOS

"OXFORD" LUXURY PORTABLE. Model UXR-2. Specially designed for use as a domestic, car or personal portable receiver. Many features, including solid leather case. Kit **£14.18.0** incl. P.T.



UXR-2

TRANSISTOR PORTABLE. Model UXR-1. Pre-aligned I.F. transformers, printed circuit. Covers L.W. and M.W. Has 7" x 4" loudspeaker. Real hide case. Kit **£12.11.0** incl. P.T.



UXR-1

JUNIOR EXPERIMENTAL WORKSHOP Model EW-1. More than a toy! Will make over 20 exciting electronic devices, incl: Radios, Burglar Alarms, etc. 72 page Manual. The ideal present! Kit **£7.13.6** incl. P.T.

STEREO TRANSISTOR FM TUNER

(Mono version also available)
14 transistor, 5 diode circuit. Tuning range 88-108 Mc/s. Designed to match the AA-22U Amplifier. Available in separate units, can be built for a total price.

Kit (Stereo) **£24.18.0** incl. P.T.
Kit (Mono) **£20.19.0** incl. P.T.
Cabinet extra **£2.5.0**.



FM Tuner

SEE HEATHKIT MODELS AT THE HEATHKIT CENTRE
233 Tottenham Court Road, London W.1

We open MONDAY-FRIDAY 9 a.m.-5.30 p.m.
SATURDAY 9 a.m.-1.0 p.m.
Telephone No: 01-636.7349

WHEN YOU ARE IN TOWN, WE HOPE YOU WILL VISIT US THERE

TAPE AMPLIFIERS TAPE DECKS CONTROL UNITS



**FM
TUNER
FM-4U**

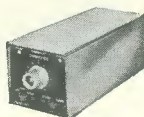

**STEREO
DECODER
SD-1**

HI-FI FM TUNER. Model FM-4U. Available in two units. R.F. tuning unit (£2.15.0 incl. P.T.) with I.F. output of 10.7 Mc/s, and I.F. amplifier unit, with power supply and valves (£13.13.0). May be used free standing or in a cabinet.
Total Kit **£16.8.0**
(Multiplex adapter available, as extra.)

HI-FI AM/FM TUNER. Model AFM-1. Available in two units which, for your convenience, are sold separately. Tuning heart (AFM-T1—£4.13.6 incl. P.T.) and I.F. amplifier (AFM-A1—£22.11.6). Printed circuit board, 8 valves. Covers L.W., M.W., S.W., and F.M. Built-in power supply.
Total Kit **£27.5.0**
(Multiplex adapter available, as extra.)

STEREO DECODER. Model SD-1. Converts FM Mono receivers to stereo at low-cost. Styled to match Heathkit models FM-4U and AFM-1 Tuners.
Kit **£8.10.0** Assembled **£12.5.0**



**TRUVOX
DECK**

MAGNAVOX "363" TAPE DECK. The finest buy in its price range. Operating speeds: 1½", 3¾" and 7½" p.s. Two tracks, "wow" and "flutter" not greater than 0.15% at 7½" p.s.
£13.10.0

TRUVOX D-93 TAPE DECKS. High quality stereo/mono tape decks. D93/2, ½ track, **£36.15.0** D93/4, ¼ track, **£36.15.0**

TAPE RECORDING/PLAYBACK AMPLIFIER
Mono Model TA-IM kit **£19.18.0** Assembled **£28.18.0**
Stereo Model TA-IM kit **£25.10.0** Assembled **£35.18.0**

HI-FI CABINETS. A wide range available for example: Malvern Kit **£18.1.0** incl. P.T.

MONO CONTROL UNIT. Model UMC-1. Designed to work with the MA-12 or similar amplifier requiring 0.25V or less for full output. 5 inputs. Baxandall type controls.
Kit **£9.2.6** Assembled **£14.2.6**



**AM/FM
TUNER**

Build Britain's Best Electronic Kits

No special Kit-building skills or Electronic Knowledge required



SPEAKER SYSTEMS

HI-FI SPEAKER SYSTEM. Model SSU-1. Ducted-port bass reflex cabinet "in the white". Two speakers. Vertical or horizontal models with legs, Kit **£12.12.0**, without legs, Kit **£11.17.6** incl. P.T.

THE BERKELEY Slim-line SPEAKER SYSTEM, fully finished walnut veneered cabinet for faster construction. Special 12" bass unit and 4" mid/high frequency unit. Range 30-17,000 c/s. Size 26" x 17" x only 7¾" deep. Modern attractive styling. Excellent value.
Kit **£19.10.0** Assembled **£24.0.0**

COTSWOLD SPEAKER SYSTEMS. Outstanding performance for price.

MFS: Size 36" x 16½" x 14" deep.
Kit **£25.12.0** Assembled **£33.17.0**

STANDARD: Size 26" x 23" x 14½" deep.
Kit **£25.12.0** Assembled **£33.17.0**



SSU-1

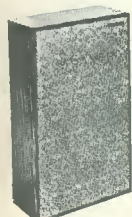

Berkeley

'AVON' Low-cost Mini Speaker System ... with Hi-Fi performance

6½" Bass speaker, 3¾" enclosed treble unit, Inductor-capacitor cross-over network. Kit **£4.18.0** incl. P.T. Strongly constructed, fully-finished walnut veneered cabinet Kit **£8.18.0**. Compact size gives wide 50-19000 c/s range.

TOTAL PRICE:
Kit **£13.16.0** incl. P.T.

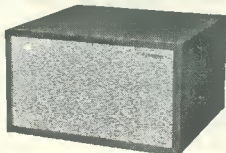

"AMATEUR" EQUIPMENT

THE "MOHICAN" GENERAL COVERAGE RECEIVER. Model GC-1U. With 4 piezo-electric transfilters, variable tuned B.F.O. and Zener diode stabiliser, this is an excellent fully transistorised general purpose receiver for Amateur and Short wave listeners. Printed circuits, telescopic aerial, tuning meter and large slide-rule dial.
Kit **£37.17.6** Assembled **£45.17.6**

AMATEUR BANDS RECEIVER. Model RA-1. To cover all the Amateur Bands from 160-10 metres. Many special features, including: half-lattice crystal filter; 8 valves; signal strength "S" meter; tuned R.F. Amp. stage.
Kit **£39.6.6** Assembled **£52.10.0**

160-10M TRANSMITTER. Model DX-100U. Careful design has achieved high performance and stability. Completely self-contained.

Kit **£81.10.0** Assembled **£106.15.0**

COMMUNICATIONS TYPE RECEIVER. Model RG-1. A high performance, low cost receiver for the discriminating listener. Frequency coverage: 600 kc/s-1.5 Mc/s and 1.7 Mc/s-32 Mc/s.
Kit **£39.16.0** Assembled **£53.0.0**

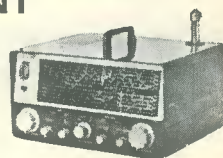

GC-1U

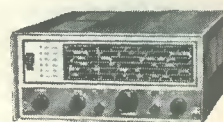

RG-1

Low-cost 3 + 3W Transistor Stereo Amplifier, TS-23



Incorporating all the essential features for good quality sound reproduction from record, radio and other sources. 16 Transistor, 4 diode circuit. Good frequency response, 6 position selector switch. Modern slim line styling.

Kit (less cabinet) **£17.15.0**

Kit (with handsome finished cabinet) **£18.19.0**

Send for this
Catalogue ...

... it's FREE!

28 pages packed with Britain's largest selection of electronic Kits. Mail coupon or write:

**DAYSTROM LTD., Dept. RC-5
GLOUCESTER. Tel. 20217.**

To **DAYSTROM LTD., GLOUCESTER**

Please send me **FREE BRITISH CATALOGUE**

Please send me details of models

Please send a
Catalogue to my
friend

Name
Address

NAME
ADDRESS

RC-5

RC-5

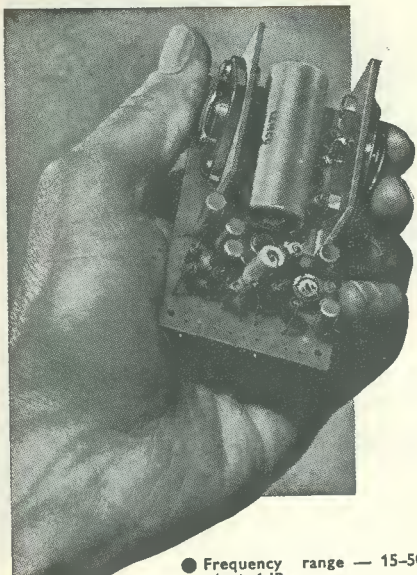

COMPACT, POWERFUL SINCLAIR Z.12

COMBINED 12 WATT
HI-FI AMPLIFIER
AND PRE-AMP

- ★ 12 WATTS R.M.S. OUTPUT CONTINUOUS SINE WAVE (24 WATTS PEAK)
- ★ 15 WATTS MUSIC POWER (30 WATTS PEAK)

The embodiment of power efficiency and reliability. Nothing could be better than this fine amplifier for use with space-saving plinth-mounted motor and pick-up assemblies. Equally, the light weight of the Z.12 makes it the ideal guitar amplifier, particularly since it operates efficiently on any power supply between 6 and 20 V.D.C. The pre-amp of this 8-transistor masterpiece will accept the outputs of pick-up, radio and microphone, etc. Full details for matching control, and selector switching circuits are in the manual supplied with each unit. The Z.12 is now in use all over the world and is the accepted standard for all hi-fi needs.

- Frequency range — 15-50,000 c/s ± 1 dB
- Ideal for use with a 12V car battery
- Can be used with 15, $7\frac{1}{2}$ and 3Ω speakers. Two 3Ω speakers can be used in parallel
- Size 3 x $1\frac{1}{2}$ x $1\frac{1}{4}$ in.
- Class B ultralinear output
- Input sensitivity—2mV into 2K ohms

Ready built, tested and guaranteed, with Z.12 manual of circuits

89/6

SINCLAIR MICRO FM

7 Transistor combined FM tuner-receiver

This unique, superbly engineered FM superhet is the only set in the world which can be used both as an FM tuner and an independent FM pocket receiver just whenever you wish.

Problems of alignment have been completely eliminated making the Micro-FM ready for use the moment you have built it. The pulse counting discriminator ensures best possible audio quality; sensitivity is such that the telescopic aerial included with the kit assures good reception in all but the very poorest reception areas. The Sinclair Micro-FM will give you all you want from a high quality FM unit. The case is elegantly styled in brushed and polished aluminium with spun aluminium slow motion tuning dial.

SIZE—less than 3 x $1\frac{1}{2}$ x $\frac{1}{4}$ ".

Needs no alignment when built



Complete kit inc. aerial, case, earpiece and instructions.

£5.19.6

SINCLAIR PZ.3 Transistorised A.C. mains power supply unit for two Z.12s with Stereo 25.

79/6

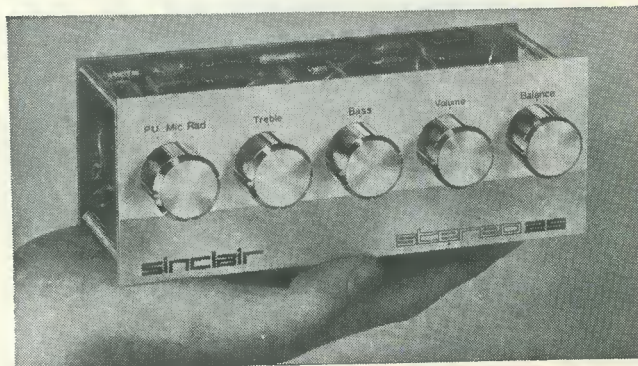

SINCLAIR STEREO 25

Pre-amp and control unit for use with two Z.12s or other stereo amp

THE SINCLAIR STEREO 25 has been designed specially to ensure the highest possible standards of reproduction when used with two Z.12s or any other first class-stereo power amplifier. The front panel of the Stereo 25 is in solid brushed and polished aluminium with beautifully styled solid aluminium control knobs. Mounting the unit is simple, and power is conveniently obtainable from the Sinclair PZ.3 which can also be used to supply two Z.12s to make a complete stereo assembly.

BUILT, TESTED AND GUARANTEED

£9.19.6

Performance figures obtained using Stereo 25, two Z.12s and a PZ.3.

- INPUTS for P.U., Radio and Mic.
- FREQUENCY RESPONSE (Mic. and Radio)—25 c/s to 30 kc/s ± 1 dB extending to 100 kc/s ± 3 dB.
- EQUALISATION Correct to within ± 1 dB on R1AA curve from 50 c/s to 20 kc/s.
- CONTROLS Volume, Treble, Bass, Volume, Input
- SIZE $6\frac{1}{2}$ x $2\frac{1}{2}$ x $2\frac{1}{4}$ " plus knobs.

Sinclair

SINCLAIR RADIONICS LIMITED
22 NEWMARKET ROAD, CAMBRIDGE. Telephone OCA3-52731

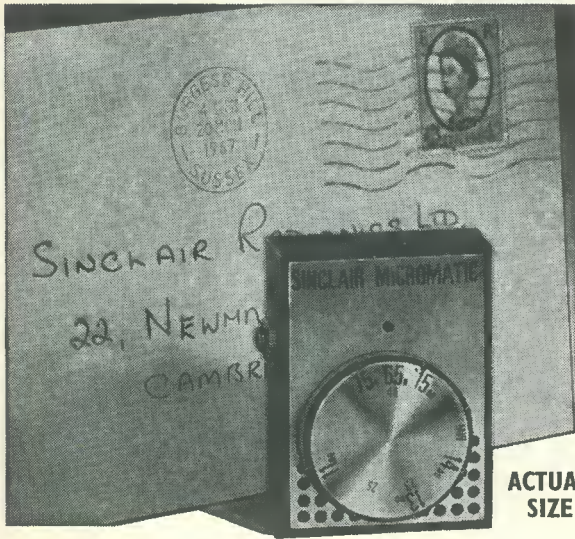

The original of this and countless other letters which enthusiasts send us can always be seen at our Cambridge offices.

The most remarkable letter we have so far received

P.O. Box 43, PAEKAKARIKI, New Zealand.
27th February, 1967.

Thank you very much for the new Micromatic which arrived safely by Airmail. Our 13-year-old son is highly delighted. On the first evening he logged several New Zealand stations. These included our one and only "pirate", Radio Hauraki, stationed in the gulf of that name well over 400 miles north of here. His biggest surprise was when 2CY, Canberra (10Kw) identified itself. Australia is more than 1,200 miles away! I tested the receiver within half a mile of 2YA and 2ZB (just north of Wellington). Selectivity remained perfect. Neither station swamped the other and the customary null was evident when the ferrite aerial was end on to the transmitters. In the metal coach of an electric train, the receiver functioned normally even under such noise producing conditions. You have produced a radio receiver which has no equal. Its design, size and performance are such that even you will not easily evolve a successor,

(Signed) Arnold S. Long

SINCLAIR MICROMATIC

The smallest set in the world

- 1 4/5" x 1 3/10" x 1/2"
- NEW 6 STAGE CIRCUITRY
- AMAZING POWER AND RANGE
- BANDSPREAD
- IN KIT FORM OR READY BUILT

This British-made six stage transistor receiver is a fully fledged radio with all the features essential to reliable listening. It is smaller than anything you have ever used before, yet it gives good choice of programmes anywhere, is selective, powerful, dependable. When, after two or three months or so, the two batteries need replacing, new ones are easily obtainable from radio shops, Boots Chemists, etc. Good listening works out to under a halfpenny an hour. Whether you buy the

MICROMATIC in kit form or ready built, you will be the proud owner of a most elegantly styled set brimful of power and ready to keep you in touch with the world wherever you are—in modern town buildings, travelling, walking or anywhere else. The well prepared instructions manual makes building an assured success, and as with all Sinclair products, the MICROMATIC is fully guaranteed built or in kit form.

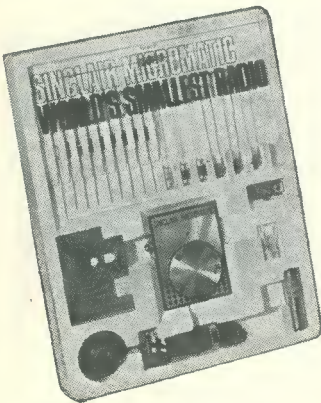

A superb specification

6-stage receiver having two R.F. stages, a double diode detector and a powerful three stage A.F. amplifier, the output from which feeds into a specially matched high quality lightweight earpiece. The MICROMATIC has its own built-in ferrite rod aerial and uses vernier type tuning over the medium wave band. A.G.C. counteracts fading from distant stations. The beautifully styled case is faced with an artist designed aluminium front panel of outstanding elegance, with aluminium tuning dial to match.

★ Full service facilities available to all Sinclair customers

USE THIS ORDER FORM FOR DELIVERY BY RETURN

Complete kit in new "see-for-yourself" quick check pack, instructions and solder

59'6

Built, tested and guaranteed with ear piece and batts.

79'6

Guarantee

Should you not be completely satisfied with your purchase when you receive it from us, your money will be refunded in full at once and without question.

SINCLAIR RADIONICS LTD., 22 NEWMARKET RD., CAMBRIDGE

Please send

NAME

ADDRESS

for which I enclose cash/cheque/money
order value £.....s.....d.

RCS

BI-PAK SEMICONDUCTORS

(DEPT. R)

8 Radnor House
93/97 Regent St.
London W1



Our vast stocks change daily with hundreds of Semiconductor bargains becoming available. Just send 2/6 to cover 3 months mailing of our latest stock lists, eqvt. charts, circuits, etc.

Minimum Order 10/- CASH WITH ORDER PLEASE. Add 1/- postage and packing per Order. GUARANTEED by return postal service. Overseas add extra for Airmail.

VALUE PAKS for '67 NEW · UNTESTED

120 GERM. SUB-MIN. DIODES 10/-

20 ALL TYPES MIXED VOLTS ZENERS 10/-

25 SIL. NPN M/Cs TRANSISTORS 10/-

20 1 Amp. GERM. up to 300 PIV RECTIFIERS 10/-

60 SILICON 200 mA DIODES 10/-

16 SILICON 750 mA TOP-HAT RECTIFIERS 10/-

50 TRANSISTORS 10/-
MIXED GERM.

10 SILICON RECT. 10/-
STUD. 2 AMP

10 SCR's UNMARKED, UNTESTED VOLTAGE RANGE 1 Amp 50-400 PIV 20/-

SCR's (THYRISTORS)

PIV	1 AMP (TO-5 can)	7 AMP (STUD)	16 AMP (STUD)	30 AMP (STUD)
25	7/6	7/6	10/6	30/-
50	8/6	8/6	10/6	35/-
100	8/6	10/-	15/-	45/-
200	12/6	15/-	20/-	55/-
300	15/-	20/-	25/-	—
400	17/6	25/-	35/-	80/-
500	—	40/-	45/-	95/-
600	—	40/-	50/-	—

LOWEST PRICE YET LARGEST RANGE EVER



FAIRCHILD

BRAND NEW—FROM USA
SCOOP PURCHASE—8 LEAD
EPOXY CASE—LOW COST—

μ L 900 "Buffer" 19/6
μ L 914 "Gate" 19/6
μ L 923 "J.K." 35/-
(FLIP-FLOP)

COMPLETE DATA AND CIRCUITS SEND 1/6 OR FREE WITH ALL IC ORDERS

THESE DEVICES OPEN UP A WHOLE NEW CONCEPT IN THE WORLD OF ELECTRONICS

INTEGRATED CIRCUITS

NEW SILICON RECTIFIERS TESTED

PIV	750 mA	3 AMP	10 AMP	30 AMP
50	2/-	3/-	4/6	9/6
100	2/3	3/6	6/-	15/-
200	2/6	4/6	6/6	20/-
300	3/-	4/9	8/-	22/-
400	3/6	6/-	9/-	25/-
500	4/-	6/6	9/6	30/-
600	4/3	7/-	10/-	37/-
800	4/9	8/-	15/-	40/-
1000	6/-	10/-	17/6	50/-

750 mA TOP HAT TYPE 3, 10 and 30A STUD STPE

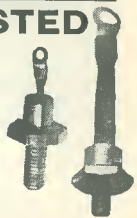

NEW—

SILICON BRIDGE RECTIFIERS —TESTED

600 PIV 2 Amp at 55°C 25s. each.
800 PIV 2 Amp at 55°C 30s. each.

TUNNEL DIODES

AEY11 Full Data
STC 1050 m/cs 15/- each

TRANSISTOR MANUAL

647 PAGE, BY G.E. (USA) CIRCUITS, APPLICATIONS CHARACTERISTICS THEORY

INCLUDING THE LIGHT ACTIVATED S.C.R. AND GATE TURN-OFF SWITCH THEORY, RATINGS AND APPLICATIONS ALSO COVERING A WHOLE RANGE OF RECTIFIER COMPONENTS

ALL THE INFORMATION YOU NEED 7TH EDITION

(30/- EACH) P.P. 2/6

S.C.R. MANUAL BY G.E. 409 PAGES 3RD EDITION

NEW TESTED VALUE PAKS

3 OC139 Trans. NPN Mullard	10/-
2 Drift Trans. 2N 1225 100 M/Cs PNP	10/-
6 Matched Trans. OC44/45/81/81D	10/-
4 OA10 Diodes Mullard	10/-
15 Red Spot AF Trans. PNP	10/-
5 White Spot RF Trans. PNP	10/-
4 Sil. Rects. 3A 100/400 PIV	10/-
4 NPN Trans. Switching	10/-
2 10 Amp. Sil. Rect. 50/100 PIV	10/-
8 Diodes 4 OA70, 4 OA79	10/-
1 5 AMP SCR 100 PIV	10/-
3 Sil. Trans. 25303 PNP	10/-
5 GET884 Trans. Eqvt. OC44	10/-
10 Assorted Computer Diodes	10/-
4 Zeners 5, 12 Vts Mixed	10/-
4 2G417 Trans. Eqvt. AF116/117	10/-
2 200 M/Cs Sil. Trans. BSY26/27	10/-
2 Bi-directional Trans. ASY66	10/-
4 High Current Trans. OC42	10/-
2 Power Trans. OC26/35	10/-
5 Sil. Rects. 400 PIV 250mA	10/-
3 OC71 Trans. Mullard	10/-
3 OC75 Trans. Mullard	10/-
3 NPN Sil. Trans. 70 M/Cs	10/-
1 Power Trans. OC20 100 Vts	10/-
1 OA47 Gold Bonded Diodes	10/-
4 OA202 Sil. Diodes Sub-Min	10/-
3 OC77 Trans. Mullard	10/-
8 OA81 Diodes CV448	10/-
3 Sil. Rects. 400 PIV 500mA	10/-

FREE One 10/- Pack of your own choice free with orders valued £4 or over FREE

3 High vit. AF Trans. PNP ACY17	15/-
3 BSY95A Sil. Trans. STC	15/-
3 Sil. Trans. OC200 Mullard	15/-
2 Sil. Power Rect. 6 Amp. 200 PIV BYZ13	15/-
1 AF139 GERM. Trans. 1500 M/Cs	15/-
1 Sil. Power Trans. 100 M/Cs TK201A NPN	15/-
6 Zener Diodes 3-15 Vts. Mixed 400mW	15/-
6 OA5 Gold Bonded Diodes Mullard	15/-
1 2N1132 PNP PLANAR Trans. Sil	15/-
2 2N697 NPN PLANAR Trans. Sil	15/-
4 GERM. Power Trans. eqvt. OC16 Mullard	15/-
1 UNIUNION Trans. 2N2646 G.E.	15/-
2 Sil. Trans. 60VCB 200 M/Cs ZT83/84	15/-
1 Sil. PLANAR Trans. BSY25 NPN 100 M/Cs	15/-
1 Sil. Trans. IS104 150 M/Cs HFE 200 NPN	15/-
2 SCR's 50 PIV 1 Amp. TO-5 can	15/-
1 Tunnel Diode IN3720 (TD-5) G.E.	15/-
1 2N2160 UNIUNION Trans. TO-5 can	15/-
2 Sil. Rect. 5 Amp. 400 PIV Stud	15/-
2 GERM. Power Trans. OC28/29	15/-
2 ZENERS 25 Watt 18 & 22 Vts	15/-
6 Sil. Rect. Type BY100 800 PIV 550mA	20/-
8 Sil. Rect. 400 PIV 200/500mA	20/-
25 Mixed Sil. & GERM. Trans. New Marked	30/-
40 Mixed Semiconductors New Marked	40/-
1 Logic Module Handbook & Catalogue	17/6

BI-PAK GUARANTEE SATISFACTION OR MONEY BACK

TRANSISTORISED SIGNAL GENERATOR

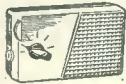

Size 5½" x 3½" x 1½". For IF and RF alignment and AF output, 700 c/s frequency coverage 460 Kc/s to 2 Mc/s in switched frequencies. Ideal for alignment to our Elegant Seven and Musette. Built and tested. 39/6. P. & P. 3/6.

TRANSISTORISED 1½ WATT AMPLIFIER

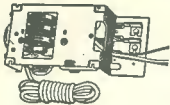

Comprising 2AC 128, 20C 75 and 2 AA129 separate bass and treble volume controls. Complete with Power Supply AC mains 240V size 7½" x 3½" x 2". Price 50/- plus 2/6 P. & P.

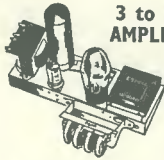

3 to 4 WATT AMPLIFIER KIT

3-4 watt Amplifier built and tested. Chassis size 7" x 3½" x 1".

Separate bass, treble and volume control. Double wound mains transformer, metal rectifier and output transformer for 3 ohms speaker. Valves ECC81 and 6V6. £2.5.0 plus 5/6 p.p. The above in Kit Form, 34/6 plus 5/6p.p.

8-watt 4-valve PUSH-PULL AMPLIFIER & METAL RECTIFIER

Size: 9" x 6" x 1½". A.C. Mains, 200-250V 4 valves. For use with Std. or L.P. records, musical instruments, all makes of pick-ups and mikes. Output 8 watts at 5 per cent of total distortion. Separate bass and treble lift control. Two inputs, with controls for gram, and mike. Output transformer tapped for 3 and 15 ohm speech coils. Built and tested, £4.4.0. P. & P. 11/-, 8" x 5" speaker to suit price 14/6 plus 1/6 P. & P. Crystal mike to suit 12/6 plus 1/6 P. & P.

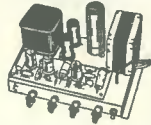

"MUSETTE" 6-Transistor Superhet Portable Radio

★ 2½" Speaker. ★ 6 Transistors Superhet Output 200mW. ★ Plastic Cabinet in red, size 4½" x 3" x 1½" and gold speaker louvre. ★ Horizontal Tuning Scale. ★ Ferrite Rod Internal Aerial. ★ IF 460 kc/s. ★ All components Ferrite Rod and Tuning Assembly mount on printed board. ★ Operated from PP3 Battery. ★ Fully comprehensive instructions and point-to-point wiring diagram. ★ Printed Circuit Board. ★ Tunable over medium and long waveband. ★ Car aerial and earpiece socket.

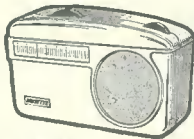

Price 39/6d inc. carrying strap. Circuit Diagram 2/6 -free with parts. P. & P. 3/6

ELEGANT SEVEN Mk. IIA

SPECIAL OFFER. 7" x 4" P.M. Speaker at no extra charge. Power supply kit to purchasers of "Elegant Seven" parts, incorporating mains transformer, rectifier and smoothing condenser, A.C. mains 200/250 volts. Output 9V 100mA. 7/6 extra.

Buy yourself an easy to build 7 transistor radio and save at least £10.0.0. Now you can build this superb 7 transistor superhet radio for under £4.10.0. No one else can offer such a fantastic radio with so many de luxe star features.

★ De luxe grey wooden cabinet size 12½" x 8½" x 3½". ★ Horizontal easy to read tuning scale printed grey with black letters, size 11½" x 2". ★ High "Q" ferrite rod aerial. ★ I.F. neutralisation on each separate stage. ★ D.C. coupled push pull output stage with separate A.C. negative feedback. ★ Room filling output 350mW. ★ Ready etched and drilled printed circuit board back printed for foolproof construction. ★ Fully comprehensive instructions and point to point wiring diagrams. ★ Car aerial socket. ★ Fully tunable over medium and long wave, 168-535 metres and 1250-2000 metres. ★ All components, ferrite rod and tuning assembly mount on printed board. ★ Parts list and circuit diagram 2/6, free with parts.

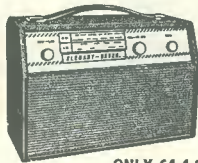

ONLY £4.4.0

Plus 7/6 Post & Packing

RADIO & TV COMPONENTS (ACTON) LTD.

21G High St., Acton, London, W.3

Shop Hours 9 a.m.-6 p.m. Early Closing Wednesday
Goods not despatched outside U.K. Terms C.W.O.
All enquiries Stamped Addressed Envelope.

Also at 323 Edgware Road, London, W.2.
Personal shoppers only. Early closing Thursday
All orders by post to our Acton address



IMPROVE YOUR HOME RECEPTION

UNBEATABLE VALUE FOR YOU, AS A READER OF THE RADIO CONSTRUCTOR

THE NEW TOLTEC HAIR DRYER



SPECIFICATION

Moulded in beautiful symmetrical pastel blue impact resisting thermoplastic casing.

Quiet in operation.

Hot or cold air.

No radio or T.V. Interference-meets British standard specification.

Fitted with safety cut-out.

12 months & money refund guarantee.

230-250 volts A.C. only.

Value 80/9 in the shops

Send the coupon below with the sum of only 52/6 (plus 4/6d to cover postage, packing and insurance, unless you are collecting personally) to:—

THE TOLTEC ELECTRONIC & TRADING CO. LTD.,
HATTON HOUSE, HURST GREEN, SUSSEX

If you are not delighted with your purchase, its price will be refunded if the appliance is carefully replaced in its mail-order pack and returned safely within seven days.

GET YOUR APPLICATION AWAY TODAY

THE RADIO CONSTRUCTOR

Toltec Hair Dryer Offer

VOUCHER WORTH 28'3

**THE CATALOGUE
FOR THE KEEN
CONSTRUCTOR...**

**HOME RADIO LTD.
187 LONDON RD.
MITCHAM
SURREY
CR4 2YQ
MIT 3282**



**...AND FOR EVERY
RADIO ENTHUSIAST!**

Once you get your copy of the Home Radio Catalogue you will wonder however you managed without it! It really is an essential book for every radio constructor, experimenter, electronic engineer and hi-fi enthusiast. It is laid out alphabetically for quick reference and every item listed is clearly priced. Almost every item ordered from this catalogue can be delivered immediately from stock.

218 pages
Over 1,000 illustrations
Over 6,000 components listed

ONLY
7/6
PLUS 1/6 POST

Please send me latest Component catalogue. I enclose 9/-

NAME

ADDRESS

HOME RADIO OF MITCHAM

DEPT. RC, 187 LONDON RD, MITCHAM, SURREY CR4 2YQ
MITcham 3282



**POST THIS
COUPON TODAY**



Vol. 20, No. 10

Published Monthly (1st of month)

Editorial and Advertising Offices
57 MAIDA VALE LONDON W9

Telephone *Telegrams*
CUNningham 6141 Databux, London

21st Year of Publication

© Data Publications Ltd., 1967. Contents may only be reproduced after obtaining prior permission from the Editor. Short abstracts or references are allowable provided acknowledgement of source is given.

Annual Subscription 36s. (U.S.A. and Canada \$5) including postage. Remittances should be made payable to "Data Publications Ltd". Overseas readers please pay by cheque or International Money Order.

Queries. We regret that we are unable to answer queries other than those arising from articles appearing in this magazine nor can we advise on modifications to equipment described. Queries should be submitted in writing and accompanied by a stamped addressed envelope for reply.

Correspondence should be addressed to the Editor, Advertising Manager, Subscription Manager or the Publishers as appropriate.

Opinions expressed by contributors are not necessarily those of the Editor or proprietors.

Production.—Letterpress/contact litho.

Published in Great Britain by the Proprietors and Publishers
Data Publications Ltd. 57 Maida Vale London W9
Printed by A. Quick & Co. (Printers) Ltd.
Clacton-on-Sea England

High Performance Signal Injector, <i>by W. Kemp</i>	586
Can Anyone Help?	589
Obtaining High H.T. Voltages with Standard Transformers (Suggested Circuit No. 198) <i>by G. A. French</i>	590
News and Comment	594
Transistorised Two-Tone Generator, <i>by M. Harding</i>	596
Future of the Tunnel Diode, <i>by J. B. Dance, M.Sc.</i>	599
Conversion of Medium Wave Portables to Top- Band Operation, <i>by L. Calcraft, G3SEW</i>	601
Catalogues Received	603
2-Transistor Bedside Receiver, <i>by G. Maynard</i>	604
The SCT/T1 Single Channel Tone Transmitter, (Basic Radio Control, Part 4) <i>by F. L. Thurston</i>	608
Wide-Band Photophone, Part 3, <i>by D. Bollen</i>	612
Tunable Aerial Coupler for Portable Receivers, <i>by R. L. A. Borrow</i>	616
Understanding Radio, (Practical Project—Adding an R. F. Stage) <i>by W. G. Morley</i>	619
In Your Workshop	626
Radio Topics, <i>by Recorder</i>	630



High Performance Signal Injector

W. Kemp

By providing an output which is partly square wave and partly sawtooth, this inexpensive unit offers a fundamental and all harmonics at a.f. together with odd harmonics at r.f. extending up to 30 Mc/s.

THIS INEXPENSIVE LITTLE UNIT GENERATES APPROXIMATE square waves at fundamental frequencies in the range 700 c/s to 1.4 kc/s, yet the performance of the transistors used is so good that harmonics of the basic signals can be detected at frequencies as high as 20 to 30 Mc/s. The unit thus makes an ideal signal injector, and may be used for carrying out functional tests on a whole range of equipment, ranging from simple audio amplifiers to high quality communication receivers.

The injector, which measures approximately $2\frac{1}{4}$ by $1\frac{1}{2}$ by 1in when built, uses only two transistors and costs about £1 to make, yet it has facilities for varying both the basic operating frequency and the output signal level of the unit. The device will operate satisfactorily from any supply battery in the range 1.5 to 6 volts, as preferred. Using a 4.5 volt supply current consumption is less than 1mA, giving a very long operational battery life.

The Circuit

The full circuit diagram of the unit is shown in Fig. 1 (a) and, as can be seen, consists of little more than a fairly simple astable multivibrator or square wave generator with variable output level facilities. The astable multivibrator is, basically, a two-state free-running switching circuit in which, at any given instant, one transistor will be cut off and the other transistor will be conducting. After a pre-determined time delay the "off" transistor will automatically switch on and thereby drive the "on" transistor off; after another pre-determined delay the states of the two transistors again changes,

reverting to the original condition, and the cycle of events will then repeat itself *ad infinitum*. When either of the transistors is cut off, virtually no voltage is lost across its collector load and the collector potential is therefore almost equal to that of the positive supply rail. When, on the other hand, either transistor is conductive, almost the full supply rail potential is dropped across its collector load and a collector potential of almost zero is obtained. Consequently, the collector potential of either transistor alternates between near-zero volts and the full supply rail potential, giving an output signal of approximately rectangular form with a peak-to-peak amplitude nearly equal to the supply potential.

If we adjust RV_1 to insert zero resistance, the off-period of TR_1 is controlled by the time constant R_3-C_2 . At the same time, the off-period of TR_2 is controlled by the time constant R_4-C_1 . If these two time constants are equal, as occurs here, an approximate square wave becomes available at either collector.

If RV_1 is adjusted to insert maximum resistance, the off-period of TR_1 is controlled by the time constant given by C_2 and R_3 plus RV_1 . Similarly, the off-period of TR_2 becomes controlled by the time constant given by C_1 and R_4 plus RV_1 . Adjusting RV_1 varies the frequency of the multivibrator whilst still retaining the approximate square wave form.

The output waveform is shown in Fig. 1 (b) and circuit constants are such that, in each cycle, there is an abrupt transition from one output

COMPONENTS

Resistors

(All fixed values $\frac{1}{2}$ watt, 10%)

R_1	4.7k Ω
R_2	4.7k Ω
R_3	10k Ω
R_4	10k Ω
R_5	2.7k Ω
RV_1	10k Ω , skeleton potentiometer
RV_2	250k Ω , skeleton potentiometer

Capacitors

(All miniature types)

C_1	0.05 μ F, ceramic
C_2	0.05 μ F, ceramic
C_3	16 μ F, electrolytic, 15V wkg.
C_4	16 μ F, electrolytic, 15V wkg.

Transistors

TR_1	ST140 (Sinclair)
TR_2	ST140 (Sinclair)

Miscellaneous

Veroboard panel, 0.15in hole matrix. $2\frac{1}{4}$ x $1\frac{1}{2}$ in (7 strips by 15 holes)
Battery (1.5 to 6 volts)
Battery terminals, etc.

level to the other (TR_2 becoming conductive), and a relatively slow transition in the other direction. The output waveform may be looked upon as having both the characteristics of a square wave and a sawtooth, with the square wave predominating.

This output waveform, obtained from TR_2 collector, is fed to variable resistor RV_2 via C_3 and R_5 , and the signal from RV_2 slider is then passed to the output leads via C_4 .

Harmonic Generation

Returning to the waveform of Fig. 1 (b), note that one cycle is the period between the start of one abrupt transition period and the start of the next. If there were 1,000 such cycles occurring per second, we would say that the "square wave" was operating at a fundamental frequency of 1,000 c/s or 1 kc/s. In a perfect square wave both transition periods would occupy zero time, and the waveform would contain an infinite number of odd harmonics of the fundamental signal; i.e. signals would be present at 3 kc/s (3rd harmonic), 5 kc/s (5th harmonic), 7 kc/s, 9 kc/s, etc. Note that only odd harmonics are generated by a perfect square wave. The amplitude of these harmonic signals would decrease progressively as the "order" of the harmonic is increased. If the fundamental signal had an amplitude of 5 volts, the 9th harmonic would have an amplitude of $5/9$ volts, the 33rd harmonic would have an amplitude of $5/33$ volts, and so on. If we had a perfect square wave with a fundamental amplitude of .5 volts and a frequency of 1 kc/s, we would also have a harmonic signal at 30 Mc/s with an amplitude of $166\mu V$. Were we to feed our fundamental square wave of 1 kc/s to the aerial of a receiver tuned to the 30 Mc/s range, the receiver would respond to the harmonics in the 30 Mc/s range and make it possible to tell in an instant whether it was working correctly or not.

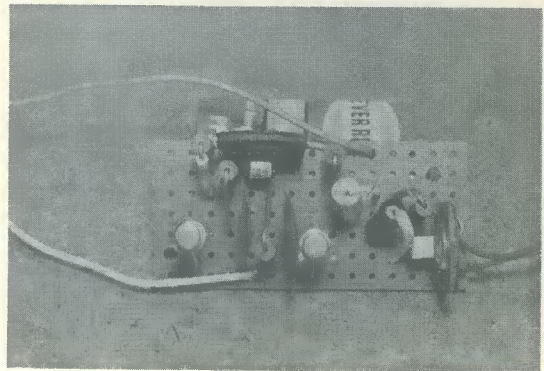

Top view of the injector. The PP3 battery, on which the Veroboard is resting, gives an indication of its size

In practice, it is impossible to obtain a perfect square wave. With our present circuit we have one very sharp transitional period per cycle, this being due to the use of Sinclair ST140 transistors, which have a cut-off frequency under present circuit conditions of 400 Mc/s. In consequence, reasonably strong harmonics can still be detected up to 30 Mc/s. If, on the other hand, transistors of, say, the OC44 class had been used, useful harmonics would only be available up to some 2 Mc/s.

A sawtooth also causes the generation of harmonics, these consisting of both the odd and even harmonics. The sawtooth element of the waveform given by the signal injector provides both even and odd harmonics over a limited range, whilst the square wave element provides odd harmonics over an extremely wide range.

This factor is of advantage because it is desirable, when checking a.f. amplifiers, to inject a signal which is rich in all harmonics. At radio frequencies, the even harmonics drop out, and the remaining odd harmonics are then sufficiently closely spaced

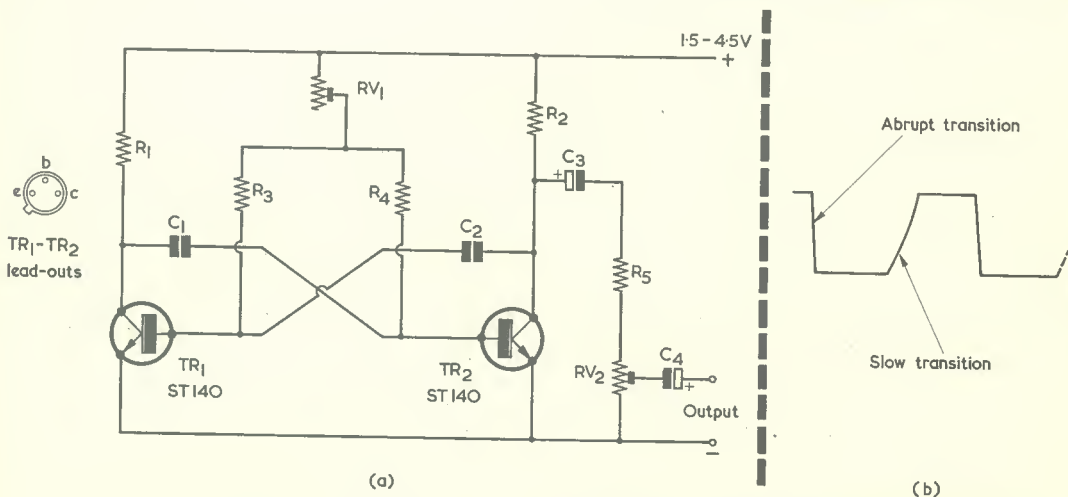

Fig. 1 (a). The complete circuit of the signal injector (b). The output waveform provided by the injector

A - mounting holes, drill 6BA clear

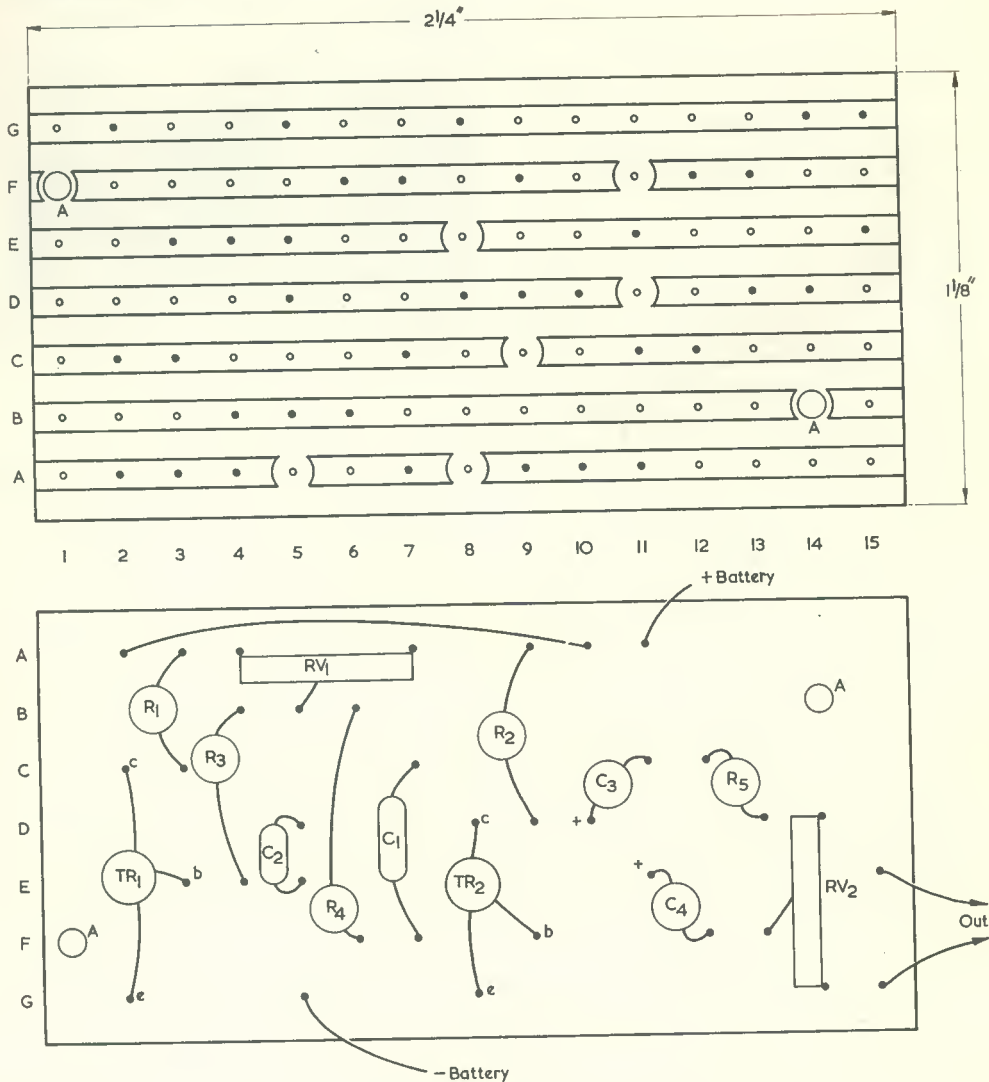

Fig. 2. Showing (above) the copper side of the Vero panel and (below) the components fitted during assembly.

at the test frequencies to give full coverage.

Construction

The unit is wired up on a small piece of Vero-board panel with 0.15in hole spacing. Construction should be started by cutting this panel to size and drilling the two small mounting holes to clear 6BA screws, as shown in Fig. 2. Next, break the copper strips, with the aid of a small drill or the special cutting tool that is available, where indicated.

The components and leads can now be soldered in place on the panel, as shown in the diagram. Note that all components are mounted vertically,

and that insulated sleeving should be used where there is any danger of components short-circuiting against one another. In this context, note also that the cases of TR₁ and TR₂ are "live", since they are internally connected to the transistor collectors. The mounting legs of RV₁ and RV₂ should be reduced in width with the aid of a file, so that they fit in the holes in the panel, before attempting to solder them in place. If desired, the unit can be fitted to a small metal case complete with battery and on-off switch. A probe (connected to hole 15e) may project from the case, whilst the case itself can be made common with the negative

battery connection. A flexible lead, terminated in a crocodile clip may be connected to the case to provide an earthy output connection. Access should be provided for adjustment of RV₂.

When construction is complete, the unit can be given a functional check by applying a suitable battery (1.5 to 6 volts) and connecting a crystal earpiece across the output terminals. Check that a tone signal is heard, that its frequency can be altered by RV₁ and its amplitude by RV₂.

Using The Unit

The unit is ideally suited for fault finding in defective equipment, such as audio amplifiers and radio receivers, the test signal being injected into different parts of the faulty circuit to isolate the "good" parts from the "bad". In general, testing should start at the output or speaker part of a circuit, working backwards towards the input or aerial end of the unit. Suppose, for example, that fault finding is to be carried out on a defective transistor superhet. In this case, a test signal should first be injected to the bases of the output power transistors. If the output stage is working correctly the test signal should be heard in the speaker; RV₂ should be set to provide a fairly large signal for this test. If the output stage is satisfactory, the test signal should then be moved to the base of the driver transistor; the input signal level should be reduced in this instance. If that stage is satisfactory, work progressively back towards the front of the circuit, injecting signals at the a.f. amplifier stage, the detector, the i.f. stages and the mixer. When the test signal fails to be heard, it can be assumed that the stage under test is at fault. When the signal is injected at the aerial, it should be heard on all wavebands of the receiver. Note that,

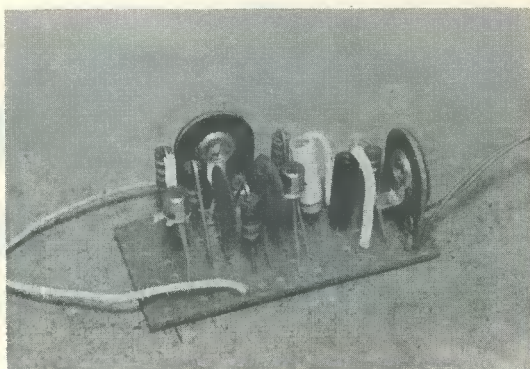

Side view of the completed signal injector

in practice, a direct connection to the aerial will rarely be required, it being sufficient to merely place the signal injector in close proximity to the aerial.

Where a high injection level is required, the earthy output connection (corresponding to hole 15g) may be clipped to the negative supply line of the equipment under test. The output frequency of the injector can be adjusted by RV₁ to suit the individual preference of the user.

It will be found helpful to gain experience with the instrument by using it initially on a serviceable receiver.

The signal injector is primarily intended for fault finding on low voltage transistorised equipment. If it is to be used on valve equipment, where much higher voltages can be anticipated, a 0.05 μ F, 500V wkg., capacitor should be inserted in series with the probe lead.



CAN ANYONE HELP ?

Requests for information are inserted in this feature free of charge, subject to space being available. Users of this service undertake to acknowledge all letters, etc., received and to reimburse all reasonable expenses incurred by correspondents. Circuits, manuals, service sheets, etc., lent by readers must be returned in good condition within a reasonable period of time

Echo Chamber.—M. D. Oliver, 16 Testwood Road, Windsor, Berks—borrow or purchase circuit diagram.

* * *

Receiver 1475 and Transmitter ART 13.—C. Brown, GW8AIB, Plas Amherst, Harlech, Merionethshire—circuit diagrams and any other information on these two ex-Government units.

Signal Generator Type 101.—R. H. Biddulph, 163 Manor Drive North, Worcester Park, Surrey—circuit or handbook of this u.h.f. signal generator (Ref. No.: 10SB/6016).

* * *

Cossor 339 Oscilloscope.—C. Q. Tarrant-Boyce, 24 Marchmont Road, Wallington, Surrey—purchase or borrow handbook or manual.

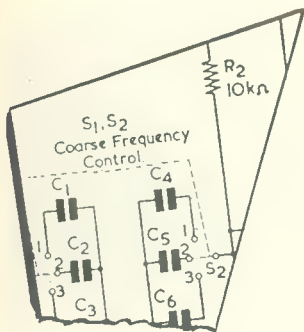

Obtaining High H.T. Voltages with Standard Transformers

SUGGESTED CIRCUIT No. 198

By G. A. FRENCH

HOME-CONSTRUCTORS WHOSE interests are mainly centred on receivers and low-power amplifiers using valves normally work with standard mains transformers having h.t. secondary voltages in the range of 200-0-200 volts to 300-0-300 volts. Occasionally, however, it becomes necessary to provide h.t. voltages at appreciable currents which are higher than can be obtained with transformers of this type. A typical example would, for instance, be given by the construction of a high-power p.a. amplifier.

In cases of this nature the constructor may find that the standard mains transformers he has on hand are not capable of providing the higher voltages required and he becomes faced with the possibility of having to buy a new mains transformer whose price may be relatively quite high.

Amateur transmitting enthusiasts frequently employ high h.t. voltages at high currents in their equipment, and may similarly encounter the necessity of purchasing expensive mains transformers with high h.t.

secondary voltages when they already have a stock of lower voltage transformers.

This month's "Suggested Circuit" describes a method of obtaining high h.t. voltages which uses two standard low-voltage mains transformers having centre-tapped h.t. secondaries, and which thereby enables constructors to employ components which may already be on hand to meet a high voltage requirement. The circuit suffers from two disadvantages, the first of these being that the h.t. secondary of one of the transformers employed operates at a higher potential above chassis than would be the case in normal service. Constructors using the circuit have, therefore, to accept the fact that there is an increased risk of insulation breakdown in the transformer concerned although, if the mains transformer is a well-designed component, this risk should not be too high. The second disadvantage is that a full-wave thermionic rectifier having a common cathode for the two diodes cannot be used in the circuit.

Readers making up the circuit should be familiar with simple power supply theory and practice as well as the precautions against shock which are necessary with high voltage equipment. Construction of the circuit should *not* be attempted by beginners who do not understand the principles involved.*

Employing Two Transformers

Before proceeding to the circuit proper, let us first examine one

* Power supplies were fully discussed in "Understanding Radio" in the issues for January to April 1965, inclusive.—EDITOR.

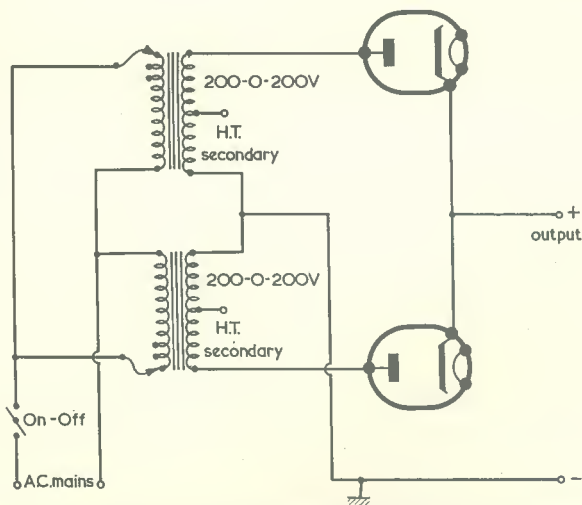

Fig. 1. Obtaining a high rectified voltage from two mains transformers having relatively low h.t. secondary voltages. Heater windings are not shown. The two rectifiers may, in practice, be combined in a single envelope to form a conventional full-wave rectifier valve. The rectifier heater supply can be obtained from a suitable winding on either transformer

simple method of obtaining an increased h.t. voltage from two transformers having relatively low voltage h.t. secondaries.

Fig. 1 shows two transformers, both of which have 200-0-200 volt h.t. secondaries. These are connected so that the entire h.t. secondary of one transformer couples to the anode of one rectifier and the entire h.t. secondary of the other transformer couples to the anode of a second rectifier. Also, connections are such that when one anode goes positive during the a.c. cycle the other goes negative, and vice versa. The result is exactly the same as would be given in a normal full-wave circuit in which the anodes are fed from a 400-0-400 volt h.t. secondary. Thus, the two transformers are able to provide an h.t. voltage which is twice that offered by a single transformer on its own.

The circuit of Fig. 1 is quite practicable if both transformers offer exactly the same h.t. secondary voltage. (This need not necessarily, of course, be the 200-0-200 volt figure shown in Fig. 1, which was chosen for purposes of explanation.) Ideally, the two transformers should be identical components, whereupon the maximum rectified h.t. current available from the rectifier cathodes is the same as that for which each h.t. secondary is rated. Should the two transformers be markedly dissimilar (as would occur if, say, one had a significantly lower h.t. secondary current rating than the other) the winding resistance and losses in the two halves of the rectifier circuit would become unequal and rectification efficiency would be lower on one half-cycle than on the other.

In Fig. 1, it should be added, heater windings and wiring have been omitted for simplicity of explanation. In practice, the two rectifiers could be combined in a single envelope as a conventional full-wave rectifier with a common cathode.

As may be gathered, the circuit of Fig. 1 is quite useful but it requires that, apart from offering the same h.t. secondary voltage, both transformers should be reasonably equivalent in other respects as well. Note, incidentally, that the end of each h.t. secondary remote from the chassis connection carries twice the alternating voltage that would appear if the transformer were employed under normal circuit conditions.

In Fig. 2, which represents this month's "Suggested Circuit", two mains transformers are employed in an alternative arrangement which offers a higher rectified h.t. voltage

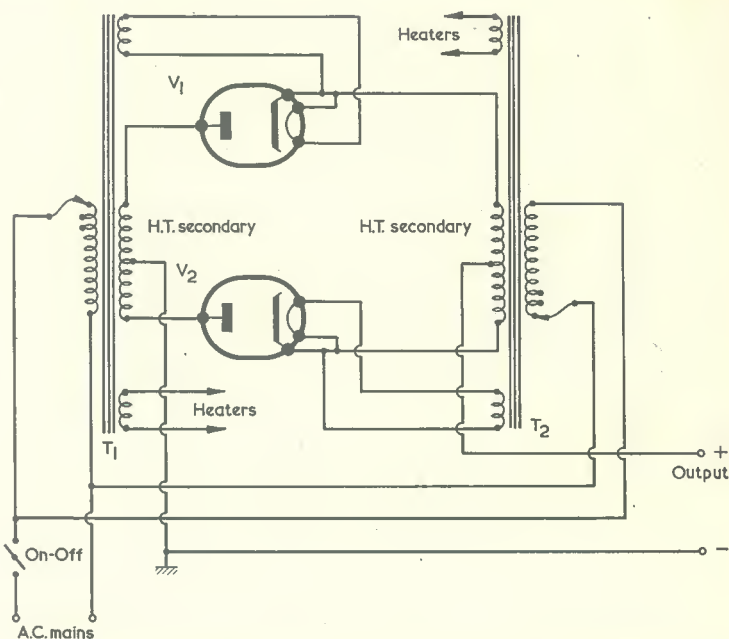

Fig. 2. An alternative method of using two transformers to obtain high h.t. voltages. Directly heated rectifiers can be employed instead of the indirectly heated types shown here. The heater windings on either or both transformers may be applied to equipment heaters in normal fashion

than is available from either. The transformers do not have to be identical and both the h.t. secondary voltage and current ratings may be different. The rectified h.t. voltage is the same as would be given, in a conventional circuit, with a full-wave h.t. secondary offering a voltage equal to the sum of the two h.t. secondaries in Fig. 2. Thus, if one transformer in Fig. 2 had an h.t. secondary voltage of 200-0-200 and the other an h.t. secondary voltage of 250-0-250, the rectified voltage would be the same as would occur with a conventional full-wave rectifier circuit using a single h.t. secondary of 450-0-450 volts. The maximum rectified current available is equal to the lower current rating of the two h.t. secondaries. If one transformer had an h.t. secondary current rating of 100mA and the other an h.t. secondary current rating of 60mA, the maximum rectified output current would be 60mA.

The transformers are connected so that the secondaries are applied to the rectifiers in anti-phase. When the upper end of T_1 h.t. secondary is positive during the a.c. cycle, the upper end of T_2 h.t. secondary is negative, and vice versa.

Operation

There are several ways of examining the operation of the circuit of Fig. 2 and the explanation which now follows is, perhaps, as simple as any.

Let us commence at an instant during the a.c. cycle when the upper end of T_1 h.t. secondary is at positive peak potential relative to chassis. Under this condition rectifier V_1 is capable of conducting, whereupon this positive peak potential becomes available at its cathode. At the same instant the upper end of T_2 h.t. secondary is at peak negative potential relative to its centre-tap, with the result that the voltage between its upper end and the centre-tap is added to that at V_1 cathode. The voltage at the positive output terminal at this instant is in consequence, equal to the voltage appearing across the upper half of T_1 h.t. secondary plus the voltage appearing across the upper half of T_2 h.t. secondary. At the peak in the next half-cycle it is the lower end of T_1 h.t. secondary which is at peak positive potential relative to chassis, and it is the lower end of T_2 h.t. secondary which is at peak negative potential relative to its centre-tap.

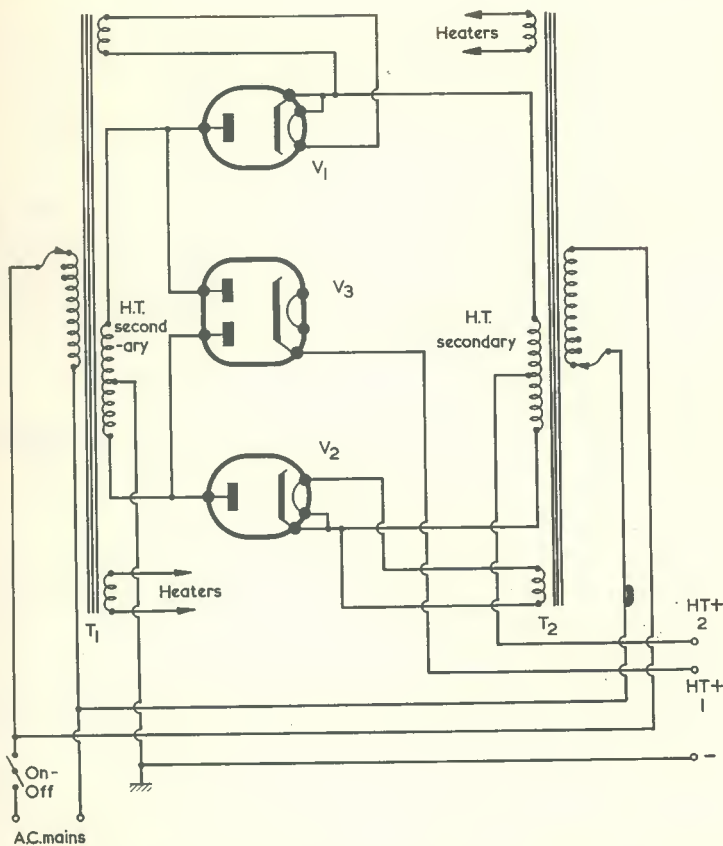

Fig. 3. Adding a full-wave rectifier to Fig. 2 enables a second and lower output voltage to be obtained. The manner in which V_3 may be heated is discussed in the text

This time V_2 conducts and, once again, a positive potential equal to the sum of the voltages in each half of the h.t. secondaries appears at the positive output terminal.

The output terminals of the circuit of Fig. 2 may be applied to either a choke input filter (in which the first smoothing component is a choke) or to a capacitor input filter (in which the first smoothing component is a reservoir capacitor). When the rectified output is applied to a choke input filter, the voltage at the positive output terminal will consist of rectified positive half-cycles in just the same manner as would be given by a conventional full-wave rectifier circuit. The arrangement of Fig. 2 is, indeed, a modified full-wave circuit, the only change being that the transformer windings are in effect split, with the rectifiers appearing at the junctions of the two sections instead of at their ends. If the output terminals are applied to a capacitor

input filter, the reservoir capacitor will tend to charge up to peak rectified voltage in the same way as occurs with a conventional full-wave rectifier circuit.

To find the peak inverse voltage applied to each rectifier, we may examine the circuit at an instant in the a.c. cycle when the upper end of T_1 h.t. secondary is at peak positive potential relative to chassis. Under this condition V_1 conducts and may be looked upon as a short-circuit. The inverse voltage applied to V_2 is then the peak voltage appearing across the entire h.t. secondary of T_1 plus the peak voltage appearing across the entire h.t. secondary of T_2 . This is the peak inverse voltage to which each rectifier is subjected. This peak inverse voltage is 1.4 times the r.m.s. voltage ascribed to each of the h.t. secondaries with the result that, if we were to use the 200-0-200 volt and 250-0-250 volt h.t. secondaries mentioned just now,

the peak inverse voltage applied to each rectifier would be $1.4 \times (400 + 500)$, or 12,600 volts. This is the same peak inverse rating that we would obtain with a conventional full-wave rectifier circuit using a 450-0-450 volt h.t. secondary, and in which the peak inverse voltage would be 1.4 times the r.m.s. voltage across the entire h.t. secondary. This peak inverse voltage figure applies when either a choke or capacitor input filter is employed.

With the circuit of Fig. 2, the insulation between the h.t. secondary of T_2 and the transformer metalwork and other windings is subjected to higher potentials than would occur in normal service. This is the first disadvantage referred to earlier. T_2 h.t. secondary centre-tap would normally be at chassis potential but it is now at rectified positive output potential (during peaks, with a choke input filter) and so the transformer insulation has to withstand this added potential. The constructor using the circuit has to accept the fact that the risk of transformer breakdown is increased in consequence. In practice, it would be desirable to use a reliable and well-made component in the T_2 position.

Thermionic rectifiers are assumed in Fig. 2 and it will probably be found most convenient, with practical transformers, to use the rectifier heater winding on one transformer for one rectifier and the rectifier heater winding on the other transformer for the second rectifier. Since the cathodes of V_1 and V_2 are not at the same potential it is not possible for these two diodes to be combined in a single envelope as occurs with a conventional full-wave rectifier circuit, and this represents a second possible disadvantage with the circuit. Instead of thermionic rectifiers, a chain of silicon rectifiers suitably bridged by parallel resistors and capacitors may alternatively be employed, these following standard high voltage practice.

Fuses

If it is intended to fuse the circuit when a choke input filter is employed, a fuse may be inserted in series with the anode of each rectifier. The fuses may be similarly inserted in series with the anodes when a capacitor input filter is employed, but it has to be remembered that the fuses will now also have to carry the ripple current in the reservoir capacitor and may need a higher rating than with a choke input filter. Also, it will be necessary to use thermionic rectifiers and to ensure that the a.c. mains is only switched on when these are cold. If the mains supply were

switched on with the rectifier cathodes at operating temperature the resultant charging current in the reservoir capacitor would blow the fuses. The fuses could similarly blow if silicon rectifiers were employed with a capacitor input filter.

Dual-Output Circuit

An interesting modification to the basic circuit of Fig. 2 is illustrated in Fig. 3 and this could be particularly useful for amateur transmitting equipment in which earlier stages are operated at a lower h.t. voltage than the final stage. In Fig. 3, a high h.t. voltage is obtained from the combination of the two transformer h.t. secondaries as before, this voltage being designated "H.T. + 2" in the diagram.

At the same time a lower h.t. voltage, indicated as "H.T. + 1", is obtained from a conventional full-wave rectifier, V_3 , coupled to the ends of the h.t. secondary of T_1 . V_3 and T_1 h.t. secondary form a standard full-wave rectifier circuit, and the H.T. + 1 output voltage is that to be expected from the voltage rating of T_1 h.t. secondary. The peak inverse voltage applied to the diodes of V_3 is 1.4 times the r.m.s. voltage across the entire h.t. secondary of T_1 , as is given with any normal full-wave circuit. A separate heater winding is required for V_3 although, if this valve is of the type in which a high potential is allowed between heater and cathode (as in the EZ81, for instance), it may be found possible to run its heater from a

common 6.3 volt heater line at chassis potential.

An advantage of the circuit of Fig. 3 is that the h.t. secondary current rating for T_2 need only be sufficiently high to satisfy the requirements of the H.T. + 2 output. The h.t. secondary current rating for T_1 must be equal to or greater than the sum of the H.T. + 2 and H.T. + 1 currents. Thus, the circuit arrangement of Fig. 3 is capable of enabling both high and low h.t. voltage requirements to be satisfied, whilst being relatively economic in h.t. secondary current ratings.



Pye Telecommunications

£250,000 Order

Wales Gas Board has placed a £250,000 order with Pye Telecommunications Limited for an integrated radiocommunication and telemetry network controlled from Cardiff. This is the first phase of a more comprehensive scheme which ultimately will cover the whole of South Wales.

This new control system will assist the Board to provide the most efficient and economic supply of gas to 325,000 consumers in an area of 1,800 square miles and to ensure the maximum security of supply.

The scheme is unique in the extent to which radio is used to carry the information provided by the telemetry system. The main radio station will be located at the top of Eglwysilian (1,250 ft.). From there radio links will radiate to the Control Centre in Cardiff and to 18 gas supply stations. Two repeater stations in the system near Swansea and Pontypool have had to be sited on high remote points where conventional buildings cannot easily be erected. To solve this problem, Pye are supplying prefabricated reinforced plastic buildings which will be transported direct from their Cambridge factories with the radio equipment already installed.

Instrumentation and telemetry equipment, installed at all the essential points in the gas transmission system, will provide the data from which the control staff in Cardiff will take their decisions. This data, transmitted over the radio network, will be presented visually and recorded automatically in the Control Centre. Scanning is automatic and continuous and therefore any change will be immediately signalled and recorded at the Control Centre.

The telemetry equipment is built up in modular form. It uses transistors and cold cathode trigger tubes. The latter employs a principle in which Professor F. Llewellyn Jones, the Principal of Swansea University, and his colleagues have made very significant contributions in their studies of electron emission from metal surfaces in gases.

Exports for Imports

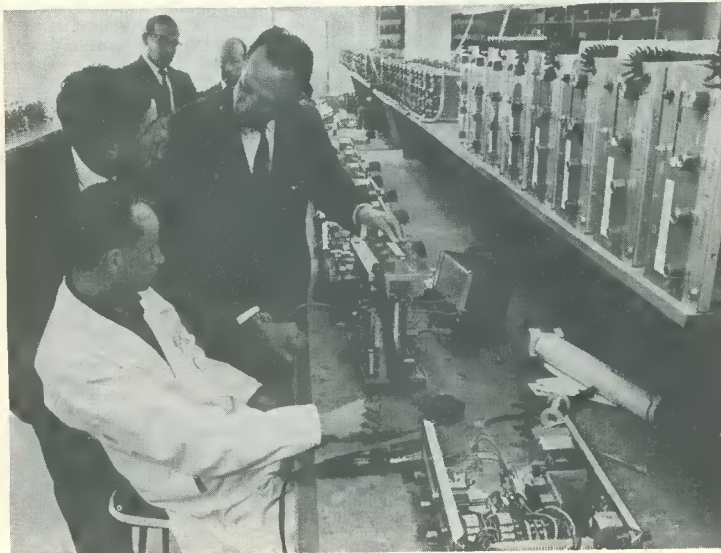

Like ourselves, New Zealand is more and more making a bid for a share of the world's manufacturing trade.

In manufactures New Zealand, at one time, did little more than supply ropes and spars to ships calling at their ports. Today, they are exporting more and more, especially electrical and electronic equipment for which there is such a hunger in these modern times.

Not long ago nearly all electrical equipment was imported, now much is exported. As an example, now on the assembly line at Amalgamated Wireless (A'sia) NZ Ltd., in Wellington, is the latest development—a marine radio-telephone seen in our photograph being discussed by the Senior Trade Commissioner for Australia (Mr. T. Collins) with the Company's General Manager (Mr. E. E. Pernase) and engineer cadet Mr. Long.

New Variable Capacitors for Printed Circuits

Specially designed for printed circuit mounting is a new piston-type trimmer introduced by Wingrove & Rogers Ltd., makers of the well-known range of "Polar" Variable Capacitors.

The new trimmer, type S60-01, has an overall diameter of 0.25in with 0.2in fixing centres and is variable from 2pF to 25pF by means of a screw-driver slot in the rotor. Overall height at minimum capacity is 0.928in and at maximum 0.678in. It has a polystyrene dielectric, but for operation in extremes of temperature, a P.T.F.E. dielectric can be supplied.

Another new type is the CG80-03, a miniature, three-section, ganged capacitor designed for v.h.f. receivers. Each section has a capacity of from 2.5pF to 17pF and the vanes are spaced at 0.12in. An internal gear and pinion drive gives a 3:1 reduction, and includes a robust end stop. High-grade ceramic posts insulate the stator from the frame, and the capacitor is 1.5in long, 0.65in wide and 0.85in high overall.

Full details of these advanced capacitors are

available from Wingrove & Rogers Ltd., Polar Division, 75 Uxbridge Road, Ealing, London, W.5.

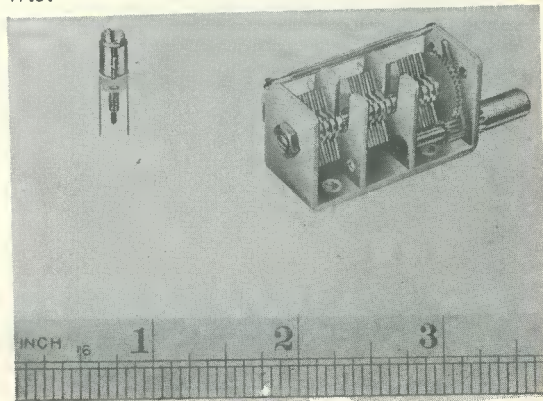

The two new variable capacitors announced by the "Polar" Division of Wingrove & Rogers Ltd.

COMMENT

Pirate Radio Ships

Many people do not realise all the implications of pirate radio broadcasting, especially commercially from ships outside territorial waters; to them any protest is the meddling of "fuddy duddies" in the enjoyment of others.

People have a right to receive the style of programme they like, provided it does not deprive others of their rights, does not endanger anyone either morally, or physically (by endangering shipping for example) or appropriate other people's property (frequencies, copyright etc.), without permission and without payment.

Undoubtedly pirate radio has provided a service a large number enjoy but, unfortunately, in doing so they offend against some of the principles mentioned in the previous paragraph.

Their programmes make enormous use of recorded material, in most cases without any payment to the composers, lyric writers or performers whose livelihoods are thus threatened.

There is no control over what is broadcast and, although it does not apply at present, there is always the danger that someone sometime will use a pirate station against the interests of this country. How many realise that of the 11 pirate radio broadcasting stations 10 are round the shores of Britain?

Wavelengths in the medium wave band are fully occupied and their use by pirate radio stations interferes with the legally allocated, by International agreement, transmissions.

New Compact Loudspeaker Enclosure System

At this year's International Audio Fair, Celestion demonstrated something new and different in compact (1 cu. ft.) loudspeaker enclosures—the Ditton 15.

The Ditton 15 is a 3 element 15 watt system incorporating a new type of Ultra low-frequency unit—the A.B.R. (Auxiliary Bass Radiator). The A.B.R. gives a deeper, cleaner bass in that important lowest octave, from 30-60 cycles, than is ordinarily obtained from simple closed boxes of comparable size. Other benefits include lower distortion and higher sensitivity. The other two units employed are the entirely new 8in long throw bass and middle speaker and the already well established HF1300 MK2 high frequency unit.

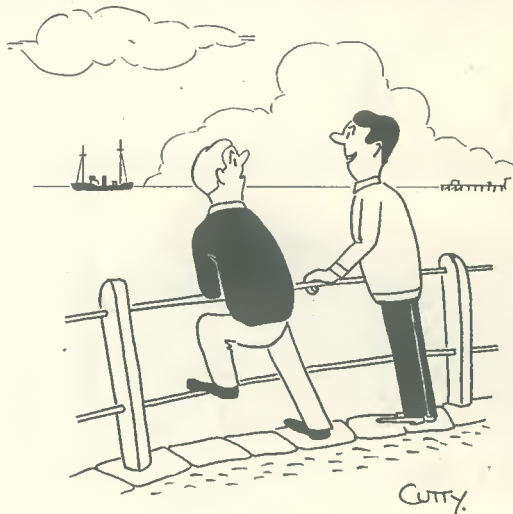

I understand he built it with a Pirate Radio Ship do-it-yourself kit

The radio amateur transmitter has to abide by stringent licence conditions and he realises the need for registration and regulation in the interests of all, although he may not agree with every regulation.

Is pirate radio an expression of freedom, or unlicensed licence?

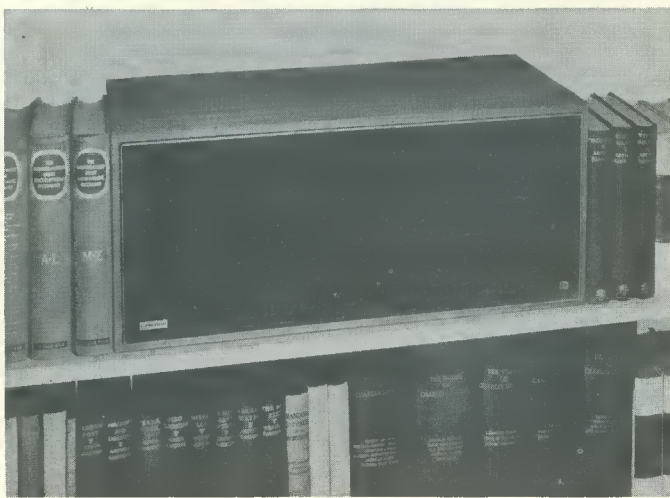

The Ditton 15 on a bookshelf

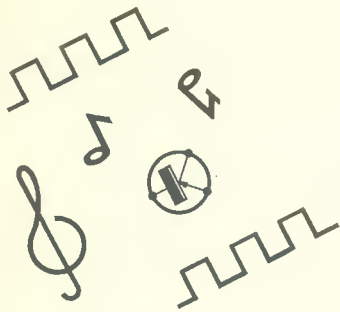

Transistorised Two-Tone Generator

M. HARDING

How to obtain two tone generating multi-vibrators from three transistors! This article describes an ingenious circuit design which provides an a.f. output alternating between 150 and 700 c/s for alerting personnel or for alarm purposes. Total consumption is 5mA at 9 volts, and all components may be conveniently mounted on an 18-way groupboard.

THE GENERATOR DESCRIBED IN THIS ARTICLE produces trains of square waves at two different audio frequencies, the two frequencies occurring alternately. The result is a distinctive two-tone signal which, if fed into a p.a. or intercom system, forms a useful calling or alarm tone for alerting personnel, etc.

COMPONENTS

Resistors

(All resistors $\frac{1}{4}$ watt 10%)

R_{1,4,6,7,10} 5.6k Ω

R_{2,3,5,8,9} 100k Ω

Transistors

TR_{1,2,3,4,5} OC71 or similar

Capacitors

C_{1,2} 0.05 μ F

C_{3,4} 0.01 μ F

C_{5,6,7} 2 μ F, electrolytic, 12V wkg.

Miscellaneous

18-way groupboard, wire, sleeving, etc.

(Continued on page 625)

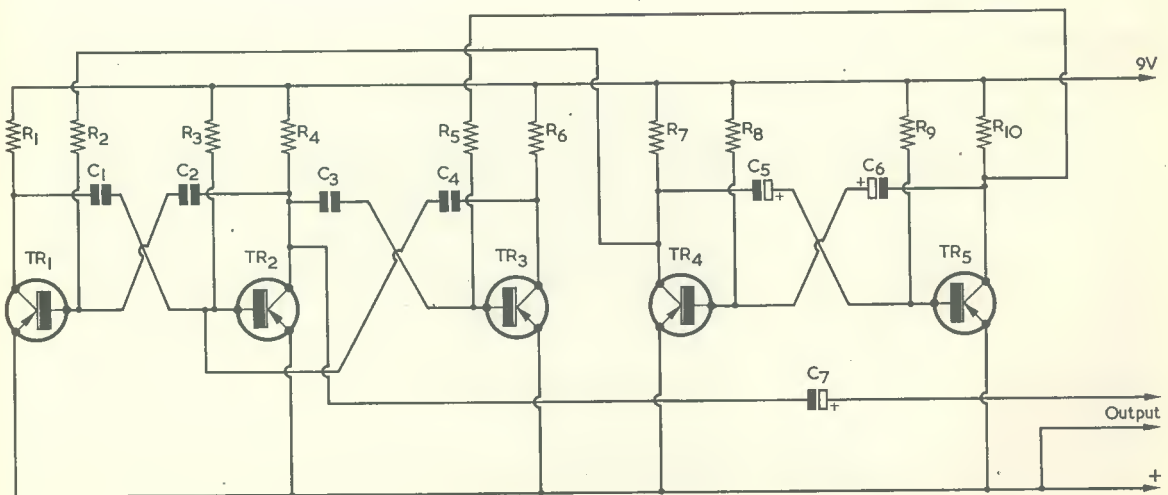
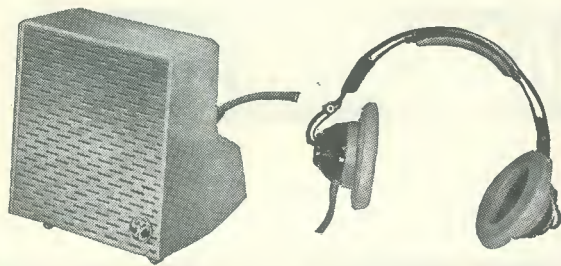
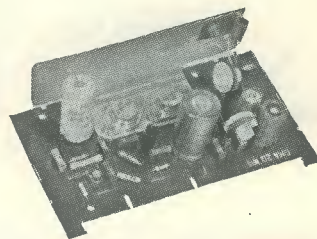

Fig. 1. The circuit of the two-tone generator. TR₂ is common to both audio multivibrators



1

2



3

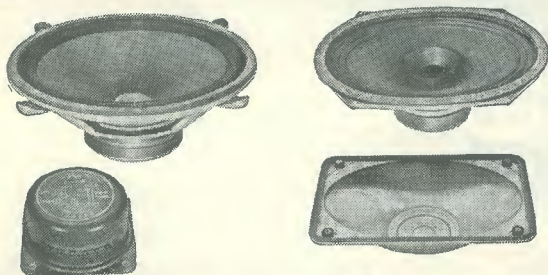

4

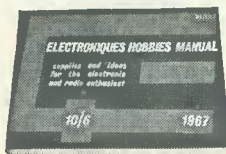
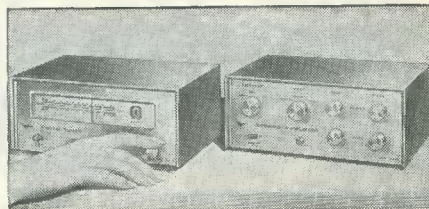

I should like a copy of the *Electronics Hobbies Manual*. Enclosed is a cheque/P.O. for 10/6.

NAME _____

ADDRESS _____

Audio is just one of the topics covered in the Electronics Hobbies Manual

With the new 600-page *Electronics Hobbies Manual*, you can obtain these and over 11,350 other items—either direct from *Electronics* or through your local *Electronics* dealer! The service is fast. The choice is the most comprehensive ever offered. And the components, which are supplied by 85 leading manufacturers, meet every kind of need—whether the project is advanced or elementary.

1. COMPONENTS A wide range of individual components is available. These include microphones, headsets, pickup arms, cartridges and styli. Hardware accessories such as audio connectors, transformers and microphone stands are also available. Featured above are the STC 4114 microphone price 32/6 and the STC 65/1A Stereo headset at £7.7.0. Both plus 3/6d. post and packing.

2. MODULAR UNITS Featured above is the GMA 20 audio amplifier module having a music power rating of 15 watts. This is one of a range of modular units including microphone amplifiers, audio amplifiers, modulators and tuners. Price of the GMA 20 is 82/6d. plus 3/6d. post and packing.

3. KITS This 25 watt Hi-Fi Loudspeaker kit is manufactured by our associates in Germany, and fulfils the highest standards. Supply direct from the factory enables us to offer these magnificent kits at the modest price of £7.10.3. plus 3/6d. post and packing.

4. COMPLETE EQUIPMENT A range of complete equipments is also available, and among these are included microphone mixers, pre-amps, tuners and stereo amplifiers. In the illustration are the Eagle Stereo Amplifier, price £18.5.0. and the Eagle AM/FM tuner, price £28.17.9. Both plus 3/6d. post and packing.

DESIGNS Throughout the *Hobbies Manual* are useful designs for building your own equipment. Included are circuit diagrams and details for audio amplifiers, tone controls, tape recorders and pre-amps.

For the 600-page *Electronics Hobbies Manual* or further details of the products displayed on this page write to: *Electronics* (Prop. STC) Ltd., Edinburgh Way, Harlow, Essex. Telephone: Harlow 26777.

electronics

High-grade components for amateur communications



RADIO CONSTRUCTOR

NEXT MONTH'S SPECIAL FEATURES



BUILD SOME OF THE FASCINATING DESIGNS FEATURED EACH MONTH

Price 2/6

or 3/- by post from

Data Publications Ltd.

57 Maida Vale, London W.9.

- "Explorer" 1-Valve Beginner's Receiver
- 4-Channel Mixer Preamplifier
- Car Voltage Regulators

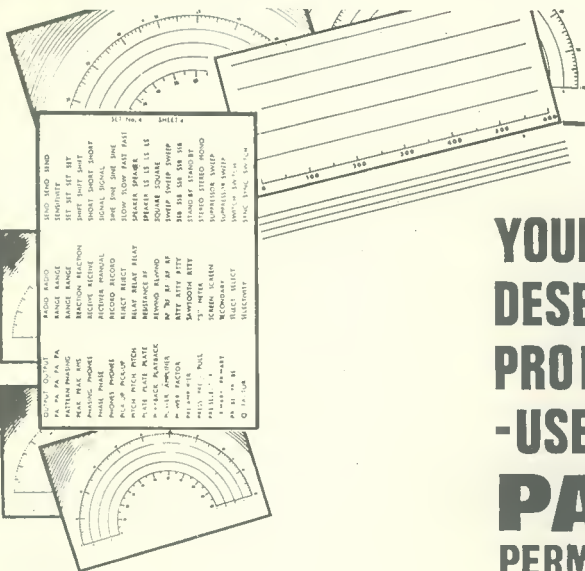

- ★ Set 3 Wording—WHITE
- ★ Set 4 Wording—BLACK
- 6 Sheets, over 1,000 words, etc.
- ★ Set 5 DIALS—clear background
- ★ Set 6 DIALS—black background

**YOUR FINISHED ASSEMBLY
DESERVES A REALLY
PROFESSIONAL FINISH
-USE 'CONSTRUCTOR'
PANEL SIGNS
PERMANENT PAINT
TRANSFERS**

4/6 per set (postage 3d)

Send to:

DATA PUBLICATIONS LTD., 57 MAIDA VALE, LONDON, W.9.

Future of the Tunnel Diode

J. B. DANCE, M.Sc.

Despite the spectacular entry of the tunnel diode, the rapidly improving performance of other devices in the semiconductor family has tended to arrest its advance in the field of practical electronics. Our contributor, who introduced the tunnel diode to readers in 1960 and 1961, briefly reviews its history over the intervening years and discusses its future

ABOUT SIX YEARS AGO A SERIES OF THREE ARTICLES by the present writer entitled "The Tunnel Diode in Theory and Practice" was published in this journal.¹ These articles were written only about two years after the discovery of the tunnelling effect in a semiconductor material² and at about the same time that tunnel (or Esaki) diodes first become commercially available in this country. It is therefore appropriate to review the present status of the device.

In the original series of articles¹ it was implied that the tunnel diode was a most important device, even to the amateur experimenter, being surpassed in importance only by the electronic tube and the transistor. Whilst it may still be true to say that the tunnel diode follows electronic tubes and transistors in importance as an amplifier, it certainly appears that the future of the device is not so bright as it seemed to be six years ago.

Use By Amateurs

The average amateur experimenter seldom considers the possibility of using a tunnel diode for any purpose whatsoever, although some of the more gifted amateurs have constructed tunnel diode converters for reception at frequencies of the order of 1 Gc/s (1,000 Mc/s). Papers discussing the use of tunnel diodes in other types of equipment of interest to amateur enthusiasts, such as crystal calibrators,³ have appeared in the literature.

In professional electronic equipment the tunnel diode has found some applications in extremely high speed switching circuits, including counting and logic circuits,^{4,5} especially for computer work. They are also used in oscillators, amplifiers and converters at microwave frequencies. Very high current tunnel diodes have found applications in special types of power supply.⁶

At one time it appeared that tunnel diodes would be the most useful of all the simple devices for microwave amplification and frequency conversion,

but the performance of transistors at very high frequencies has been much improved during the past few years. In addition the price of high frequency transistors has decreased considerably. It seems probable that tunnel diodes will continue to compete with transistors in the very high frequency (microwave) region of the spectrum for at least another five years, if not indefinitely.

Types Available

It is instructive to consider the types of tunnel diode currently available from the semiconductor manufacturers and to compare these types with those which became available about five years ago. British manufacturers appear to have ceased manufacturing tunnel diodes for work at relatively low frequencies (less than a few Gc/s), although at least one company has developed special new types of tunnel diode for use in the microwave region, for example as low noise amplifiers.^{7,8} A much wider range of tunnel diodes is available from various American manufacturers (Sylvania, Radio Corporation of America and General Electric) than from British companies. However, there is a distinct trend for these devices to be used at higher and higher frequencies where transistors have a more limited performance. It was suggested a few years ago that tunnel diodes would be used for amplification in u.h.f. tuners for television reception,⁹ but improvements in transistors have made this rather unlikely.

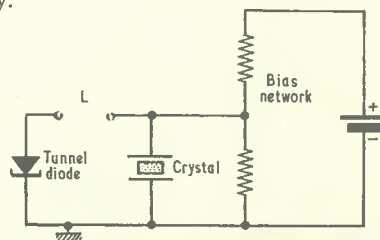

Fig. 1. A tunnel diode crystal controlled oscillator

Competition With Transistors

Undoubtedly the main reason why tunnel diodes have not been used more widely as amplifiers, mixers and detectors, especially at moderately high frequencies, is that transistors can be made which produce a rather better performance except possibly in the microwave region. In addition, it is impossible to cascade tunnel diode stages operating at the same frequency, since tunnel diodes are two terminal devices with no isolation of the input and output signals.

Oscillators

From the point of view of the amateur who is interested in the possibility of using tunnel diodes, one of the simplest ways of using them is as oscillators,^{10,4} at low power levels. Indeed, it is often easier to get a tunnel diode to oscillate than it is to prevent the oscillation when one wishes to use it for another purpose.

The power consumption of a tunnel diode oscillator can be extremely minute (about one microwatt) and many transmitting amateurs have used them for the construction of very low power transmitters. They can be used in very simple circuits for the construction of the "walkie-talkie" type of equipment.⁹

Crystal Calibrators

If the loading on a tunnel diode oscillator circuit is very small and the series circuit inductance relatively large, a type of relaxation oscillation will occur as the circuit switches repeatedly from the high voltage state of the tunnel diode through the unstable negative resistance region to the low voltage state and back again. Such oscillations are not sinusoidal and therefore they have a very high harmonic frequency content. Low power crystal controlled tunnel diode oscillators of this

type are therefore very useful as crystal calibrators³ where many high harmonics are required.

The basic circuit for a simple tunnel diode crystal controlled oscillator is shown in Fig. 1.

F.M. Reception

One of the simplest tunnel diode circuits suitable for use by the amateur experimenter is shown in Fig. 2. The potentiometer VR₁ is set so that the tunnel diode is biased in the negative resistance region of the tunnel diode characteristic curve close to the peak current point. Oscillations will occur in any case, but if an incoming signal from an aerial is applied, the oscillations will be synchronised to the frequency of the incoming signal even if the latter is quite weak. However, the incoming signal must have a frequency which is fairly close to that of the natural frequency of the tunnel diode oscillator circuit. If the signal frequency changes (that is, if it is frequency modulated), the voltage across the tunnel diode will change and this change in voltage at an audio frequency will pass through the coupling capacitor to the audio amplifier. Thus the simple circuit shown can be used as a complete f.m. tuner unit which can be used with an audio amplifier of a fairly high gain. A tunnel diode with a peak current of about 1mA is suitable for this application.

The writer has tried some circuits of the type shown in Fig. 2 at a distance of about 30 miles from a B.B.C. f.m. transmitter. Although the results were by no means spectacular, it was very easy to receive the three B.B.C. programmes. This circuit would appear to be one of the simplest f.m. tuner units that has ever been designed. One can make it in about ten minutes!

A better method of demodulating the signal from the tunnel diode involves the use of a ratio detector. It has been reported that this method will provide 20dB of gain over that of the circuit of Fig. 2,¹¹ but the circuitry is more complicated.

Tunnel Diode Measurements

The measurement of tunnel diode parameters involves a very interesting exercise in the welding of pure theory with practice^{4,12,13,14}. It is not difficult to plot the characteristics of most tunnel diodes which are not intended for operation at very high frequencies.

Conclusion

Tunnel diodes are very useful for low noise amplification at microwave frequencies and for use in high speed switching circuits.

Whilst they are fascinating toys for use at normal radio frequencies by the amateur enthusiast, they

(Continued on page 607)

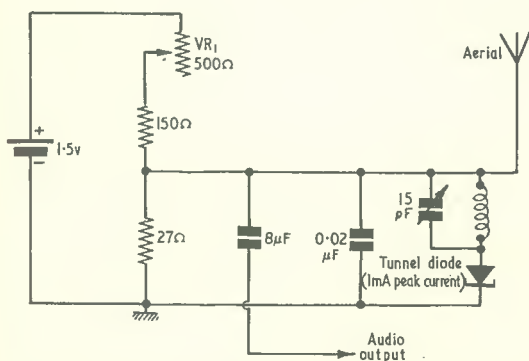

Fig. 2. A simple f.m. tuner unit employing a tunnel diode. Connection can be made to a transistor a.f. amplifier, which may also provide a polarising voltage for the 8μF capacitor

BECAUSE OF ITS SMALL SIZE AND CHEAPNESS, THE Japanese transistor radio offers the experimenter an attractive, compact and sensitive Top-Band receiver.

In the interests of economy of components, time and volume of the finished receiver, this article only considers methods of modifying receiver coverage without the aid of a converter unit. Thus, the object is to change the frequency of the tuned circuits in the receiver so that the set covers Top-Band. The two tuned circuits we are concerned with are the aerial tuned circuit and the oscillator tuned circuit. The aerial tuned circuit comprises the ferrite rod aerial and one section of the ganged tuning capacitor, whilst the oscillator tuned circuit comprises the oscillator coil (usually canned, but not always) and the other section of the ganged tuning capacitor.

Available Methods

We may modify these two circuits by one of two methods:

- (1) Reduction of inductance by removal of turns or, in the case of the oscillator coil, by screwing out the tuning slug.
- (2) Reduction of the capacitance of the tuned circuit by addition of a small series capacitor.

Let us first consider the inductance method. Removal of turns from the ferrite rod is an awkward task and involves an irreversible change to the set. It must be accompanied by the screwing out of the oscillator coil slug (since, in general, the oscillator coil wire is too fine to remove easily, tin and resolder) and this results in a large reduction in the Q of the oscillator tuned circuit, which was found in some cases to be enough to prevent the oscillator from functioning at all. Other coils were so constructed that the oscillator frequency could not be shifted more than about 100 kc/s, further removal of the slug being prevented by the coil screening can. This method has the further disadvantage that it offers no electrical bandspread, resulting in considerable difficulty in manipulating the tuning dial of the smaller type of set.

These difficulties are absent when the capacitance method is used.

The introduction of two small capacitors, one in series with each section of the tuning capacitor (see Fig. 1) provides us with a simple method of obtaining bandspread 160 metre coverage without drastically lowering the Q of the tuned circuits and without permanently damaging the set. The set may be returned to medium-wave coverage by simply short-circuiting the two capacitors.

Capacitor Values

The requirement for the capacitor to be inserted in the aerial circuit is that it must change the tuning from the range 0.5 to 1.5 Mc/s to the range 1.8 to 2.0 Mc/s. The capacitor to be inserted in the oscillator circuit must change the oscillator tuning from the range 0.97 to 1.97 Mc/s to the range 2.27 to 2.47 Mc/s.*

The author has modified two Japanese transistor

Conversion of Medium Wave Portables to Top-Band Operation

L. CALCRAFT, G3SEW

Our contributor describes his experiences in converting two small transistor radios for operation on the 160 metre (1.8–2.0 Mc/s) band, and gives general advice on the modifications required for other radios. It must be pointed out that these modifications are experimental and may not always be successful, and that they involve the cutting of printed circuit lines. In consequence, they should only be attempted by the reader who feels confident of carrying them out without damage to the radio concerned

receivers in this way, one of the small pocket medium wave-only sets and one of the larger medium and long wave sets.

It was found that both types required a 15pF capacitor in series with the oscillator tuning capacitor to bring the tuning into the correct range, but that different values were required for the aerial tuning capacitor. The pocket set worked best with about 10pF and the larger model with about 5pF.

* The oscillator frequency figures quoted in this article apply to receivers having an i.f. of 470 kc/s. Readers may, of course, adjust these figures to correspond with the actual i.f. of the receiver being modified.—Editor.

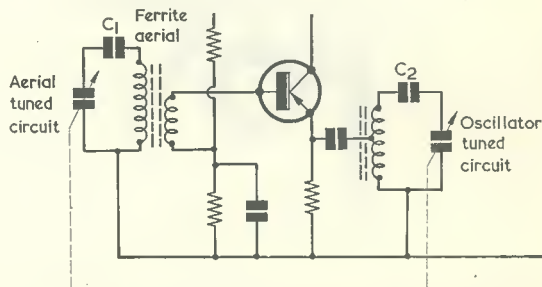

Fig. 1. A typical aerial and oscillator circuit, after modification for Top-Band coverage. The additional capacitors are C_1 and C_2

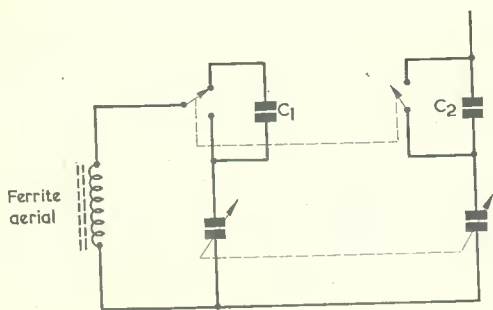

Fig. 2. The switching arrangements used by the author when replacing a long wave band by Top-Band

Insertion of Capacitors

The medium wave-only set was modified by direct insertion of the two capacitors, but the larger model was modified so as to cover medium wave and Top-Band by using the existing wavechange switch to bring the capacitors into circuit when in the "long wave" position. The circuit adopted for this is shown in Fig. 2.

It was found that the best method of insertion of the capacitors was to cut the copper laminate on the board with a sharp knife so as to break the fixed vane connections to the ganged tuning capacitor. Fig. 3 shows a layout commonly employed in these small radios and gives a typical example of the manner in which the printed circuit lines may be cut. The series capacitors are then connected across the gaps. In a medium wave-only set the capacitors may be fitted on the side of the board where there is most room for them. If the modification is to a medium and long wave set, and is to include a switching circuit such as that of Fig. 2, leads from the gaps may be run to the wavechange switch.

Alignment

Two different alignment systems will next be discussed.

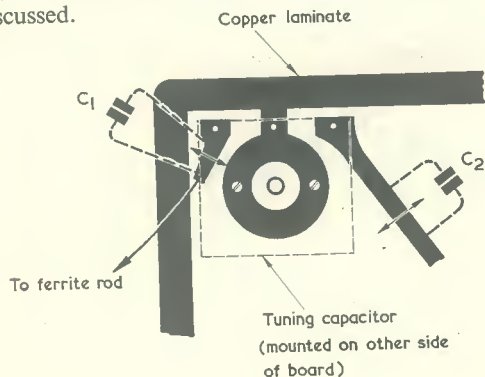

Fig. 3. A typical instance of the manner in which the printed circuit lines may be cut and the series capacitors added

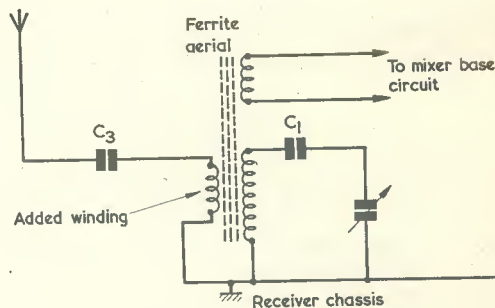

Fig. 4. Adding an aerial coupling winding to the modified receiver

(1) If the constructor has access to a capacitance bridge and a receiver that covers 2.37 Mc/s then the best procedure is to solder a 15pF capacitor into the oscillator circuit and check that the receiver will give Top-Band coverage by monitoring its local oscillator on the general coverage receiver.

The tuning capacitor should be set to mid-travel and the local oscillator core adjusted to bring the local oscillator frequency to about 2.37 Mc/s. The aerial tuned circuit may then be aligned by insertion of a 3 to 30pF trimmer in place of C_1 and adjusting this for maximum volume on a local station or on one of the beacons on 1.9 Mc/s (found at mid-travel of the tuning dial as a sort of "blimp-blomping" noise). The trimmer should then be replaced by a fixed capacitor of similar value.

Note that, during alignment, the receiver ferrite rod should be in the position that gives the minimum detectable volume from the station received, so that the receiver automatic gain control does not mask the effects of the alignment.

(2) If no auxiliary equipment is available, the best procedure is to insert the 15pF capacitor into the oscillator circuit and then to align the aerial circuit by trial and error insertion of capacitors in the 3 to 20pF range. This method is not as laborious as it sounds. Alignment experiments should be made on amateur signals (found in most abundance on Sunday mornings), on the beacon that appears on 1.9 Mc/s, or on the Loran beacon, which is best heard in the evenings and sounds like a sort of ignition interference spreading around 1.95 Mc/s.

External Aerial

The receiver may easily be modified for use with an external aerial by winding a few turns of wire around the aerial coil on the ferrite rod and making connections as shown in Fig. 4.

If a short whip aerial is to be used, C_3 should be made large or left out altogether, the coupling winding connecting directly to the aerial. When a long aerial is used, C_3 should be a few picafarads

(continued on page 607)

CATALOGUES RECEIVED . . .

HENRY'S RADIO LTD., 303 Edgware Road, London W.2.

The new 1967 edition of this well-known catalogue, illustrated herewith, supersedes all previous issues. Holders of the 1966 issue may obtain a copy of the latest edition by returning the cover of the old issue, together with 5/- plus 1/- postage (6/- in all). This offer closes on 30th April 1967. This 8th edition of over 200 pages contains more than 5,000 detailed and illustrated stock lines, many new items having been added both in the component and equipment fields. Every item likely to be required by both the home constructor and design engineer is included, a large and comprehensive range of electronic components and equipments being featured in its pages.

Within the covers of this catalogue are 40 pages of built units; 20 pages of transistors and semi-conductor devices; 60 pages of components and sundry items; 15 pages of test equipment and meters; 50 pages of microphones, decks and hi-fi equipment and 20 pages of quartz crystals, valves, tape, tools, circuits and special offers of all types.

The catalogue costs 7/6 plus 1/- postage and included are 10/- worth of discount vouchers (five vouchers of 2/- each) allowing a discount on purchases of 2/- in the pound, thereby reducing the cost of components etc., and reimbursing the original cash outlay.

On hi-fi and associated equipments, a discount is allowed as follows—List Price £25 and above, 2½%; £40 and above, 5%; £70 and above, 7½% discount. In addition, certain items carry a further discount of 5% after the standard discount rate, as shown above, has been deducted.



ARTHUR SALLIS RADIO CONTROL LTD. 93 North Road, Brighton, Sussex.

This 100 page catalogue (1967/68 number 17 in the series) is available direct from the above address at 3/- post free, a credit voucher to the value of 2/6d. being included for use with any single completed order over £3.

This catalogue lists countless items of Government surplus equipments and components of interest to the home constructor together with a whole range of new components such as resistors, capacitors, switches, transformers, transistor amplifiers and power units, meters and fuses etc. Amongst the surplus items are listed accumulators, aerials, amplifiers, blower motors, bomb sight computer, camera control unit, chassis, connectors, various control units, dials, gear units, generators, various indicator units, electric motors, receivers, test sets, valves etc., this section being a veritable mine of useful items and information on such equipments.

For those interested in obtaining government surplus equipment at very reasonable prices, this catalogue will prove of great practical use.

L.S.T. COMPONENTS, 23 New Road, Brentwood, Essex.

This company specialises in the supply of semiconductors at popular prices to the home constructor. Their new catalogue—Market Centre for Semiconductors—is of 16 pages, plus cover, and lists most types and makes of semiconductors; Mullard, Newmarket, Texas Instruments, Sinclair, S.T.C., Fairchild and those under the Jedec code.

In addition to transistors, other devices currently offered are rectifier diodes, thermistors, zener diodes, planars, epoxy planars, Thyristors, varicap diodes, tunnel diodes, unijunction and photo-transistors etc. Additionally, such items as resistors, capacitors, skeleton presets, neon bulbs and indicators, panel meters, heat sinks and Veroboard are listed.

Of interest to some home constructors will be the 'X' Line of modules—a complete electronic package, miniaturised and contained in one housing—that may be opened for inspection, modification or for servicing. These solid state devices may be mounted in any position, are ready built and soak tested. Among those offered we noted—general purpose amplifier, record player amplifier, intercom, metronome, burglar alarm, flasher units, guitar amplifier and various f.m. equipments.



2-Transistor Bedside Receiver

by G. Maynard

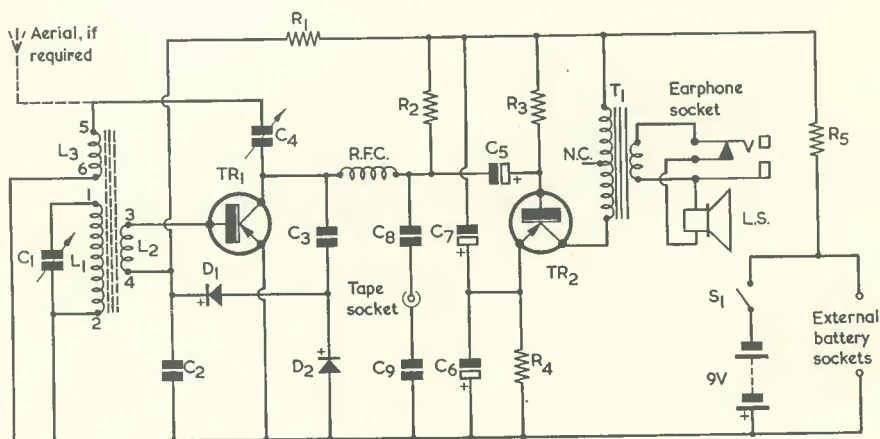

This simple design, intended for medium waves only, employs a miniature reflex circuit and drives a speaker at more than adequate volume for bedside listening. An unusual feature is the provision of a bass boost feedback circuit in the output stage

THIS LITTLE RECEIVER WAS INITIALLY INTENDED to be a bedside radio for local stations only, but it has proved to give a much better performance in practice and is nearly as good as many little 6-transistor portables.

The main requirements were: compactness, ease in carrying around, a good quality output and cheapness in construction. One thing that is not really necessary with a bedside receiver is a high level of volume and the output given by a single transistor is all that is needed for comfortable listening, since the receiver is usually placed not more than an arm's length away from the listener.

This receiver is also ideal for people who are ill in bed since, even before it is dark, approximately 100 stations can be picked up without an aerial. An earphone may be employed instead of a speaker, if desired.

The Circuit

The circuit diagram appears in Fig. 1. A ferrite rod aerial is employed, and the required signal is tuned in by L_1 and C_1 . The signal is then fed to the base of TR_1 through the coupling winding L_2 . The signal is amplified by TR_1 and it appears, in r.f. form, at the collector, whereupon the reaction capacitor C_4 provides regenerative feedback to winding L_3 . The collector of TR_1 is also coupled, via C_3 , to the detector circuit given by D_1 and D_2 , and the detected signal is applied back to the base of TR_1 by way of coupling winding L_2 . TR_1 now carries out its secondary function of a.f. amplifier, and an amplified version of the detected signal appears at its collector. This passes through the r.f. choke and is fed to the base of TR_2 via C_5 . TR_2 then drives the speaker by way of output transformer T_1 .

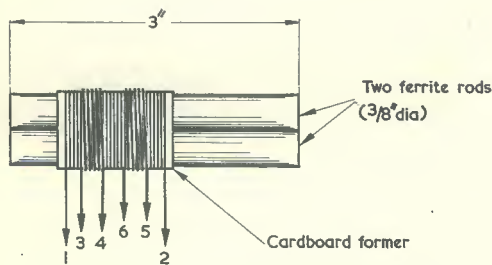

Fig. 2. The coils in position on the ferrite rods. Winding details are given in the text

As may be seen, the r.f. choke performs an important function in the circuit. It impedes the passage of r.f., thereby enabling the amplified r.f. at TR₁ collector to be applied to the detector diodes. At the same time it allows the amplified a.f. signal to be passed to TR₂. The value of R₂ may seem to be lower than is normal in a circuit of this type, but it was found experimentally that the value specified gave a considerable boost to the a.f. signal from TR₁. Constructors building the receiver may care to experiment with alternative values here, ranging from that shown to several kilohms.

Both the tuning capacitor, C₁, and the reaction capacitor, C₄, may be miniature variable capacitors with solid or plastic dielectric between the vanes. The author employed a 250pF compression trimmer for C₄, adapting this so that a knob could be fitted to the thread of the adjusting screw. An a.f. volume control was not incorporated, this function being carried out by C₄.

The output transistor, TR₂, causes a surprisingly high volume level to be available from the speaker.

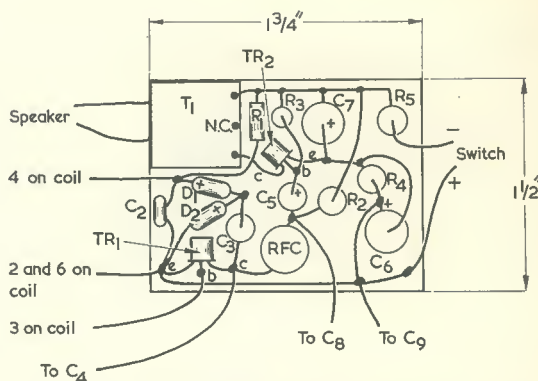

Fig. 3. In the prototype many of the parts were mounted on a small component board. C₈ and C₉ are near the earphone socket

The impedance offered by the speaker to TR₂ is not critical and, with the transformer shown in Fig. 1, good results were given with speakers ranging from 3 to 30Ω in impedance. Indeed, equally good results were obtained when a 75Ω 2½in speaker was connected directly between the collector of TR₂ and the negative supply line, transformer T₁ being out of circuit. This method of connection has the disadvantage that direct current flows through the speaker but the performance, in practice, was perfectly adequate. The speaker finally used was a 2½in type with an impedance of 25Ω. As stated, however, speaker impedance is not critical.

There is no stabilising in the output stage, but no trouble due to thermal runaway has been experienced with the prototype after many hours of continual use. Resistor R₄ limits the flow of excessive

COMPONENTS

Resistors

(All resistors ½ watt 10%)

R ₁	100kΩ
R ₂	220Ω
R ₃	22kΩ
R ₄	270Ω
R ₅	100Ω

Capacitors

(All fixed capacitors miniature low-voltage types)

C ₁	500pF variable
C ₂	0.05μF
C ₃	200pF
C ₄	250pF variable, or trimmer
C ₅	4μF electrolytic, 9V wkg.
C ₆	200μF electrolytic, 6V wkg.
C ₇	200μF electrolytic, 9V wkg.
C ₈	0.1μF
C ₉	0.1μF

Inductors

- L_{1,2,3} Ferrite rod aerial, see text
- T₁ 6.6:1 transistor output transformer type T/T2 (Radiospares)
- R.F.C. R.F. choke, 2.5mH

Semiconductors

- D₁ OA71
- D₂ OA71
- TR₁ OC44 or AF117
- TR₂ OC72 or OC81

Switch

- S₁ s.p.s.t. switch, miniature toggle

Miscellaneous

- 9-volt battery
- Loudspeaker (see text)
- Earphone jack
- Tape socket (phono)
- External battery sockets, "Miniature" (Radiospares) or similar

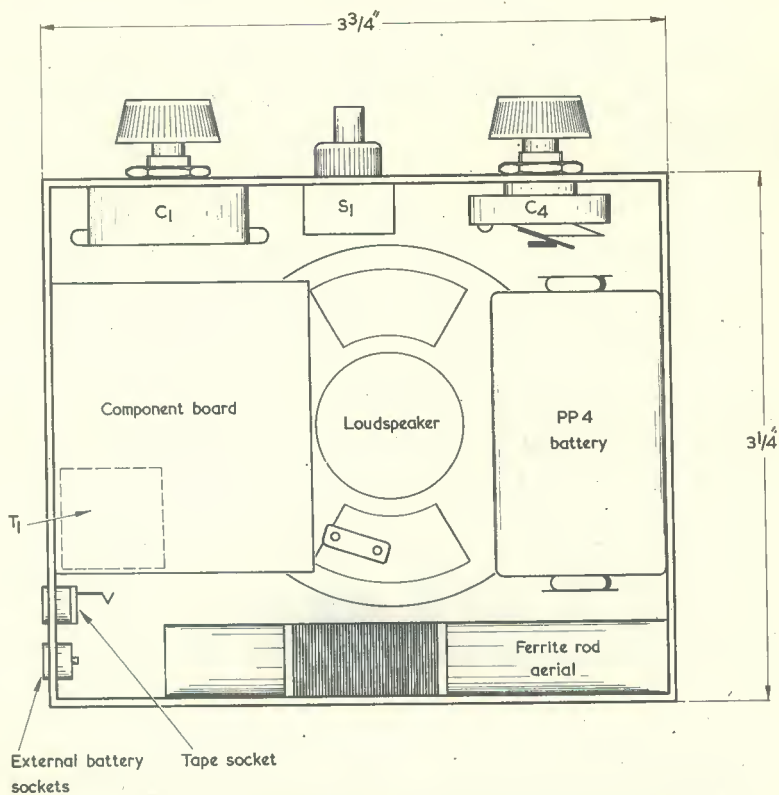

Fig. 4. Back view showing the layout of major components in the prototype

current. However, the main function of R_4 is its appearance in the feedback circuit given by C_7 and C_6 , this applying a small proportion of the a.f. output current back to the emitter of TR_2 . There is a significant increase in amplification due to this network which provides, in particular, a noticeable degree of bass boost. When connected to a large speaker the effect is that of a full-size domestic receiver. Resistor R_5 , in series with the negative supply, assists in the provision of this feedback.

Two sets of optional sockets appear in the circuit. The first of these is the Tape Socket, to which is applied the a.f. signal after amplification by TR_1 . There is plenty of volume to spare if this socket is coupled to the microphone input of a tape recorder. Secondly, External Battery sockets are provided. If desired, a large external battery may be connected to these, thereby enabling the small internal battery to be conserved if the receiver is used at home. However, the internal battery has quite a long life. The author's receiver employed a PP4 battery, and this lasts about 6 weeks or so with average use.

A third socket, for earphone, is also available. This causes the speaker to be muted when the

earphone is plugged in. Alternatively, a large external speaker may be plugged into this socket.

The Ferrite Rod Aerial

The ferrite rod aerial employs two 3in lengths of round ferrite rod taped together at the ends, each rod having a diameter of $\frac{3}{8}$ in. The coils are wound on a cardboard sleeve which is capable of sliding along the rods. L_1 is wound on first, and consists of a single close-wound layer of 36 s.w.g. enamelled wire having 40 turns. L_2 and L_3 each consist of 4 turns of the same wire, and are wound on top of L_1 . Fig. 2 shows the positions of the windings. The lead-out numbering in Fig. 2 corresponds to that shown in Fig. 1, and it is important that all lead-outs be connected to their correct points in the circuit, or regeneration may not be given when C_4 is adjusted. All coils should be wound in the same direction. The wire ends may be held in place after winding with a suitable glue, such as Durofix.

Sufficient pick-up should be given with this ferrite rod aerial for all normal purposes. Should it be desired to connect an external aerial, this may be applied to the non-earthly end of L_3 , as shown in Fig. 1.

Construction and Operation

Readers will have their own approaches towards construction, and the dimensions of the case used to house the receiver will, also, depend upon the size of the components used. By careful assembly, the writer was able to fit his receiver into a case measuring $3\frac{3}{4} \times 3\frac{1}{4} \times 1\frac{1}{4}$ in deep. Many of the components were initially mounted on a small panel of insulating material, taking up the layout shown in Fig. 3. This was then fitted in the case with components towards the front panel, together with the remaining parts as in Fig. 4. The aperture for the speaker is central in the front panel of the case, but the speaker is actually mounted slightly to one

side to provide room for the component board.

With a compact layout such as this, extreme care must be taken when soldering miniature components and semiconductors to ensure that excess heat is not applied at any time. A heat shunt should be used for all connections to semiconductors.

If a bigger case is used, it will be possible to house a larger speaker and/or a larger battery.

To operate the receiver, increase the capacitance of C_4 until a "squeak" or "pop" is heard, then slightly reduce the capacitance. Tune in the required signal with C_1 and adjust C_4 for the volume desired.

Variation of the tuning range covered can be obtained by sliding the coils along the ferrite rods.



Conversion of M.W. Portables to Top-Band Operation

(continued from page 602)

only. The criteria for the choice of C_3 are that it must be as large as possible for good signal sensitivity, but not so large that the signal frequency tuned circuit is swamped by strong signals on second channel frequencies.

Direction Finding

The modified receiver is well suited to d.f. operation. In order to obtain a bearing on a transmitter, the receiver should be rotated in a horizontal

plane until the volume is at a minimum, and the line of the ferrite rod taken as the line between the transmitter and the receiver.

Results

The receivers modified by the author were found to be quite sensitive on Top-Band (stations within a radius of 20 miles or so being heard without an external aerial), and both were undamaged by operation in close proximity to the station 10 watt transmitter. Greater signal sensitivity was obtained from both receivers when they were operated near any long runs of wire (e.g. the mains house wiring or the Top-Band aerial). These wires act as re-radiating aerials.

The Future of the Tunnel Diode

(continued from page 600)

have little practical application at such frequencies, since transistors can provide a much better performance. Readers requiring further information about tunnel diodes are recommended to consult reference⁴.

References

- ¹ J. B. Dance. "The Tunnel Diode in Theory and Practice". *The Radio Constructor*, November and December 1960 and January 1961.
- ² L. Esaki. "New Phenomenon in Narrow Ge p-n Junctions". *Phys. Rev.*, Vol. 109, p. 603 (1958).

³ L. G. Cox. "A Tunnel Diode Crystal Calibrator". *J. Brit. I.R.E.*, Aug. 1960.

⁴ "Tunnel Diodes". R.C.A. Technical Manual TD-30.

⁵ I. Aleksander and R.W.A. Scarr. "Tunnel Diodes as Switching Elements". S.T.C. Application Report MK/166.

⁶ J. B. Dance. "220 Amp Tunnel Diodes". *The Radio Constructor*, April 1965.

⁷ B. Easter. "The Performance and Limitations of Low-Level Amplifiers employing Tunnel Diodes". *Electronic Eng.*, p. 520, August 1965.

⁸ M. A. Lee. "Tunnel Diodes for Low noise Amplifiers". *Industrial Electronics*, p. 584, December 1965.

⁹ C. Sinclair. "Seven Circuits for Tunnel Diodes". *Radio Electronics*, Vol. 33, p. 36, November 1962.

¹⁰ M. R. McCann. "The Tunnel Diode as an Oscillator". S.T.C. Application Report MK/165 Ed. 1 (1961).

¹¹ M. R. McCann. "Techniques in Tunnel Diode Circuitry". *Radio and Electronic Components*, October 1962.

¹² J. B. Dance. "Tunnel Diode Measurements". *Wireless World*, March 1965.

¹³ "Die Tunnelodiode. Kenngrößen und deren Messung". *Telefunken Report* 6112 81.

¹⁴ "Technical Report on Tunnel Diode Measurements". Sylvania publication 9162G163.



International Transistor Guide

Avo (MI Group) has produced a new edition, the third, of its Transistor Data Manual.

This now well-established international reference book gives in-line data for more than 8,000 transistors including those of Russian manufacture. It provides a rapid and convenient guide for use not only with Avo instruments but also for wider application by laboratory and service engineers. Holders of the manual have no need to retain the data sheets published by individual transistor manufacturers.

In addition to in-line data for every transistor, a comprehensive list of transistor equivalents is included, with commercial equivalents of Service transistors. Connection diagrams are provided, enabling the engineer to minimise the risk of damage to a transistor under test.

Copies of the manual are available from the Spares Department, Avo, Avocet House, Dover, Kent, price £2 5s., postage paid in the United Kingdom.

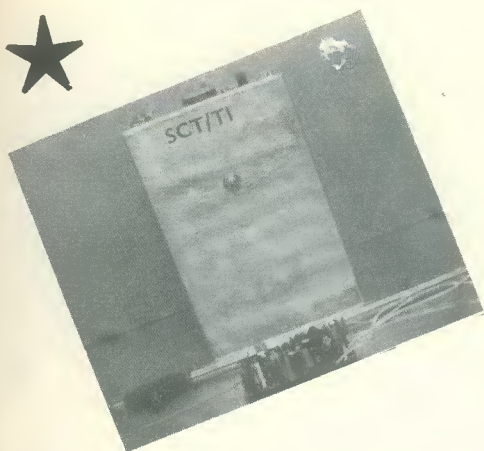

The SCT/T1 Single Channel Tone Transmitter

Introductory Note

SINCE WRITING THE FIRST THREE ARTICLES ON BASIC radio control, a new range of high performance low-cost silicon planar n.p.n. transistors have been introduced by Sinclair Radionics Ltd., and these are so ideally suited to radio control applications that the author has decided to design almost all future projects around these new semiconductors. This decision has made it necessary to revise some of the original plans that were made for these articles, hence the delay between the last and the present article. Now that these revised plans have been completed, however, practical radio control articles will be featured more regularly in this journal.

In the present series we feature a high performance low cost single channel tone transmitter and a matching super-regen receiver. Also to follow is a matching superhet receiver using transfilter i.f. stages; and both these receivers will employ tone filter switching and relay-less output stages.

Single Channel Radio Control Principles

Of the many alternative radio control systems that are in use, the single channel "tone" type is by far the most popular, particularly in the model aircraft field, and it is thus worth considering the general principles of this model in some detail. The block diagram of a typical system is shown in Fig. 1.

Here, the transmitter carrier signal is generated in the crystal oscillator stage and fed to the power amplifier, to be finally radiated by the antenna (aerial). The p.a. stage is also fed from a modulator circuit, enabling the carrier signal to be modulated with a signal from the built-in tone generator if

Following his articles in the July, August and single channel "carrier" transmitter and receiver continues the series by describing a model of comprehensive performance, the construction of next month. The transmitter featured here a field strength meter, such as that featured in the up purposes. Later, a suitable super-regenerative

required. In normal operation the carrier is permanently switched on when the system is in use, the tone modulation being applied, via the switch, only when required.

At the receiver end of the system the carrier signal is picked up by the antenna and passed to the receiver and detector circuits. These may be of either the superhet or super-regenerative type, and the detected signal is then fed through an audio amplifier and on to a tone operated "switch", which is tuned to the same frequency as the modulation signal of the transmitter. Thus, when either

HEADING ILLUSTRATION
Front view of the completed transmitter. In front of the transmitter are the antenna and the matching super-regenerative receiver, which will be described later in this series

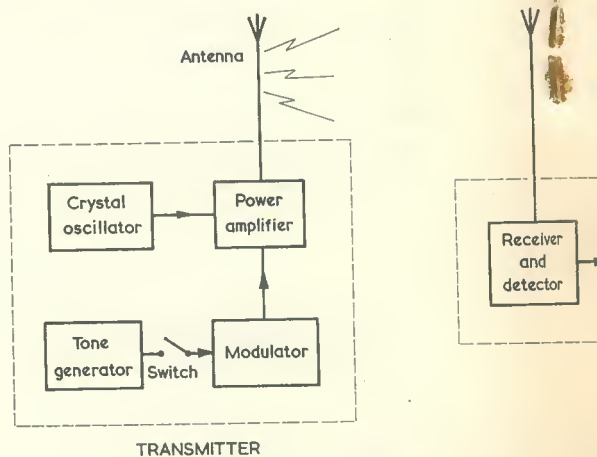

Fig. 1. Block diagram illustrating the functioning of



Cover Feature

Single Channel Transmitter

and September 1966 issues, in which a receiver were featured, our contributor a control transmitter offering a more detailed details of which will be published here and in the next issue will require a receiver in the previous August issue, for setting a sensitive receiver will also be described

Superhet v. Super-regen Receivers

Technically, it is a simple matter to produce a radio control system that offers "near perfect" results in terms of range and freedom from interference, but in practice financial considerations often preclude the use of such a system and make it necessary to settle for a compromise outfit that gives only tolerably good results, yet as a comparatively low cost. To be specific, a superhet receiver offers good sensitivity and very sharp selectivity, and thus gives a good control range with excellent interference rejection; but it is rather expensive to buy. The super-regen receiver, on the other hand, offers good sensitivity but poor selectivity, with consequent good range but poor interference rejection, and it has the outstanding advantage of comparatively low cost. Clearly, the superhet is, technically, the superior choice, while the super-regen is to be preferred from the financial point of view. Since financial considerations will be of paramount importance to many readers we will, from this point on, concentrate our attention on super-regen receivers and systems.

We have seen that the major disadvantage of the super-regen is its susceptibility to interference; in practice this means that when operating a model aircraft or boat the receiver may suddenly lock on to a radiated signal other than that of the correct transmitter, and control may be lost with disastrous results. This interference signal may come from another transmitter, from a radio "call" system installed in a local office block or hospital, from interference generated by an electric motor, or even from a signal radiated by another super-regen receiver. (A super-regen circuit is in a constant state of oscillation at its own tuned frequency,

no carrier or an unmodulated carrier is radiated by the transmitter the receiver "switch" remains in its normal off position, but when a correctly modulated carrier is radiated the tone "switch" goes On. The tone switch may be used to operate some part of the actual model via a servo or actuator.

These, then, are the basic principles of single channel "tone" operation; there are, however, a considerable number of possible variations in the details of such a system, and it is important that the reader should learn to appreciate the finer points. These will next be briefly discussed.

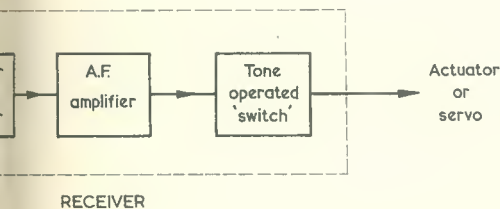

of a typical single channel "Tone" system

Basic Radio Control (4)

by F. L. Thurston

and thus radiates a weak r.f. signal via its own antenna while in operation.)

In a "good" super-regen system, steps are taken to minimise the effects of interference, and this may be achieved in a number of alternative ways, each with its own particular advantages and disadvantages. By using these "interference rejection" systems, it is possible to obtain results that are comparable to those of a superhet, and some of these systems will now be considered.

Interference Rejecting Super-regen Systems

Most readers will be familiar with the terms a.g.c. (automatic gain control) or a.v.c. (automatic volume control) as applied to the superhet. When no carrier signal is being received, the r.f. and i.f. stages of a set with a.g.c. give a very high gain and the circuit has a high degree of sensitivity. When a strong carrier signal is received, part of the signal at the detector is rectified and fed back to control circuits which automatically reduce the gain of the r.f. and i.f. stages, thus lowering sensitivity so that the output level of the receiver remains virtually constant over a wide range of input levels. It so happens that the super-regen receiver also contains its own inherent a.g.c. system, and its sensitivity automatically adjusts itself to suit the level of the input signal presented to its antenna.

Clearly, if two signals are presented to the super-regen antenna at the same time, sensitivity will be automatically adjusted to suit the stronger of the two signals, with consequent rejection of the weaker of the two carriers. Thus, one way of providing interference rejection is to employ a control transmitter that is so powerful that it will virtually "swamp" all sources of interference, the full carrier signal being radiated even when no modulation is applied. The snag with this system is that the transmitter will consume considerable power, with consequent short battery life and high running costs.

A system of the type described above is referred to as employing "downwards modulation", for the following reason. The range of control that may be obtained with a particular combination of transmitter and receiver is dictated by the *peak* amplitude of the carrier signal (see Fig. 2 (a)). When checking the strength of the radiated signal, however, a field strength meter is used, and this reads the *mean* or *average* strength of the signal. Thus, in Fig. 2 (a), the field strength meter shows full scale reading when carrier only is radiated. If, as in Fig. 2 (b), the carrier is now modulated to a depth of 100% with a square wave tone signal having a 1 : 1 mark-space ratio (as is the normal practice), the *mean* strength of the carrier will clearly fall to half of its earlier value, as shown by the field strength meter reading, even though the peak value of the carrier, and thus the range of control, remains unchanged. Since the field strength meter reading falls when tone modulation is applied, the transmitter is referred to as employing "downwards modulation".

The "downwards modulation" system is intended to prevent any kind of interference and loss of control, at the expense of high battery consumption. An alternative system, which is more economic in terms of battery consumption, employs "upwards modulation". This is designed not to prevent interference but to minimise the chances of its occurring, while at the same time enabling control to be regained if it is momentarily lost. The "upwards modulation" characteristics are shown in diagrammatic form in Figs. 2 (c) and 2 (d). In Fig. 2 (c) it can be seen that a carrier is radiated even when no modulation is applied, this carrier being of moderate strength and enabling the weaker forms of interference to be swamped at the receiver (by A.G.C. action). When the tone modulation is applied, however, the peak amplitude of the carrier signal is increased to about four times its normal level, enabling control to be regained from any interference signal, and thereby giving an "upwards" reading on the field strength meter.

As an alternative to "upwards" or "downwards" modulation, the transmitter may be designed to give maximum battery economy but negligible interference rejection, there being absolutely no carrier signal radiated between command signals. In this case the carrier signal is radiated only in the modulated form when the tone button is pressed, the transmitter being referred to as a "carrier plus tone" type. In this system, if control is momentarily lost to an interference source, it is usually possible to regain control by pressing the "tone" button.

We have seen that there are three basic ways in which the transmitter may be operated to give different degrees of interference rejection. It is also possible to obtain similar results by matching transmitter output power to some specific receiver sensitivity. Suppose, for example, that we have a transmitter that delivers an output of 100mW and a receiver that has a maximum sensitivity of 5 μ V, and that this combination gives a maximum range of $\frac{1}{2}$ mile. At the limit of this range, of course, the signal reaching the receiver will be very weak, and sensitivity will be at maximum, so that an unwanted signal of only 6 μ V will be sufficient to cause a complete loss of control. As an alternative, however, a transmitter giving an output of 1 watt may be used in conjunction with a receiver with a designed maximum sensitivity of only 50 μ V, and in this case, although the maximum range will still be limited to about $\frac{1}{2}$ mile, the low sensitivity of the receiver will make the system immune to interference signals of less than 50 μ V, even at maximum range. Such a system has, of course, the disadvantage of very high transmitter battery consumption.

Finally, steps can also be taken to reject interference in the receiver itself. In many circumstances, it is desirable that the super-regen receiver be of as simple a design as is possible, with consequent small size and low cost. Because of this simplified design the tuning of the "tone switch" of such a receiver may be very flat and responsive to a wide

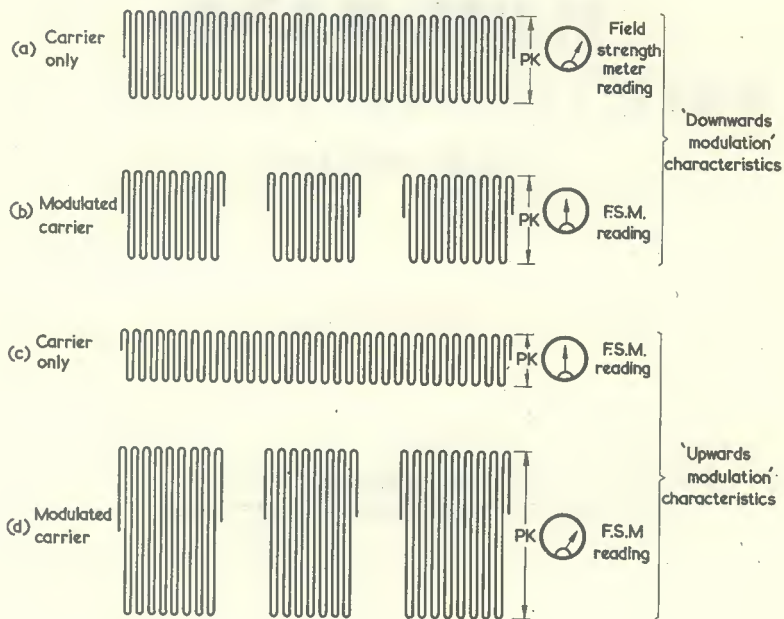

Fig. 2. Alternative transmitter modulation characteristics. These are discussed in the text

range of tone signals, whereupon it will give, basically, poor interference rejection. Alternatively, however, the circuit can be designed so that very sharp tuning of the "tone switch" is obtained, and in this case it becomes necessary to pick up both a carrier signal and a modulated signal at precisely correct frequencies before the "switch" can operate; a "combination lock" effect is thus obtained in the receiver, and interference rejection is very good. As is to be expected, this type of circuit has the disadvantages of increased physical size and cost.

It should at this stage be clear to the reader that these different systems of interference rejection can be used in a number of different combinations to give alternative advantages and disadvantages, and degrees of efficiency to suit individual needs. If, for example, a model is operated in a little-used field well away from a built-up area, very little interference rejection will be required of the control system, and a simple and economic system may be

used. If, on the other hand, the model is to be used on a popular flying field close to a built-up area, a high degree of interference rejection may be essential in the system.

In this latter case, a powerful transmitter with "upward modulation" may be used in conjunction with an insensitive and flatly tuned receiver, to give the required results at the expense of high battery consumption. Alternatively, equally good results may be obtained from a moderately powerful transmitter using "downward modulation" and a sensitive receiver with a flatly tuned tone switch, at the expense of moderately high battery consumption. Again, similar results can be obtained using a fairly low power transmitter with either "upwards" or "carrier plus tone" modulation in conjunction with a sensitive receiver employing a sharply tuned tone switch. This case gives good battery economy but an increase in the size and cost of the receiver. Many other combinations may be encountered.

(To be continued)

E.M.I. T.V. for Hong Kong

EMI Electronics have recently been awarded a contract for the supply of four telecine chains to Rediffusion, Hong Kong, the contractors who supply the wired Television service for the Colony. These are based on the well-known EMI Vidicon Camera type 201 and include the latest Philips 16 mm projector. Facilities for separate magnetic replay on 35 mm and 16 mm are provided, and common magnetic on 16 mm. Delivery will commence in June.

WIDE-BAND PHOTOPHONE, PT. 3

by D. BOLLEN

It should be noted that some of the equipment described in these articles is the subject of a provisional patent application

Pre-Amplifier Construction

Recourse was again made to that useful material, hardboard, in the construction of the receiver. See Fig. 12. Undoubtedly an aluminium box would be better, but hardboard allows quick fabrication of prototypes and can easily be made light-tight. The box also forms the lens tube or collimator.

The pre-amplifier is constructed on a small Paxolin panel mounted, together with the photocell, at one end of the collimator. A useful feature of the 90AV is that its transparent red cathode material is deposited on the glass of the photocell body and a small sighting tube, with lens taken from an old box camera, was arranged to "look through" the photocathode. This turned out to be something of a refinement as optical alignment of receiver to transmitter was not critical and could be done at hip-height with a quick scan in the general direction of the Photophone transmitter. It is, however, useful at extreme ranges for placing the distant light source on the most sensitive area of the photocathode. The portion of the pre-amplifier box forward of the lens acts as a hood to prevent direct sunlight falling on the photocell, and it may be furnished with grooves to take colour filters, if required.

The receiver lens was taken from a reading glass, and is of 3in diameter. The advantage of a large lens is that it collects more light than a small one. The lens is mounted so as to throw a sharply focused image of the distant light source on to the photocell cathode.

As the input impedance of the pre-amplifier is high, it is susceptible to interference and screening was found to be necessary. This was quickly expedited by covering the interior of the box, aft of the lens, with aluminium foil, which was earthed in contact with the valve base mounting bush.

Although the pre-amplifier could have been fitted with supply leads, it was decided to mount a small battery inside the box. This is particularly useful when the pre-amplifier unit is used in conjunction with a valve amplifier, since it gives no hum and no special power supply is required. The interior of the box should be painted matt black to cut down unwanted glare, and a lid with a light-tight ridge can be fabricated, also from hardboard.

Portable Amplifier

Hi-Fi headphones can give exceptionally good reproduction with a low power output, and they are light in weight. There are no baffle problems, with the result that such phones tend to flatter any signal fed to them. It was, therefore, decided to use phones with the amplifier circuit of Fig. 13. For those who consider that headphones are outmoded, or are inconvenient to use, the amplifier will also power a small speaker purely for communication purposes.

In Fig. 13 a tone network is provided which gives 10dB of bass cut and 10dB of boost, and the same amount of treble cut and boost. For a short range quality signal, say across a street, the controls can be employed to give a balance determined by individual preference. With long range communication the treble control can be backed off to cut down background noise, and the controls set for optimum clarity. If there is interference from street lamps, the bass control setting can be altered to drop the response at 50 c/s. The three position switch, S¹ (a), (b), (c), serves as an on-off switch and gives two gain settings. In position 2 R₁₉, which is of a fairly low value, is brought into circuit and provides enough negative feedback for a linear response, whilst R₈ serves to swamp out the diode effect of the base emitter junction of TR₂. In position

3, R_8 is short-circuited, and a different feedback resistor, R_{20} , is substituted, giving high gain at long ranges.

The characteristics of the amplifier are as follows: With the switch in position 2 and tone controls "flat" the response is 50 c/s to 20 kc/s ± 1 dB; and with maximum bass and treble cut, 400 c/s to 3 kc/s. With the switch in position 3 gain is increased by 20dB, giving 700 c/s to 5 kc/s ± 2 dB with controls "flat", and 1 kc/s to 3 kc/s with full treble and bass cut. So, the first position gives a wide band characteristic, and the second will furnish narrow band, high gain working.

The d.c. resistance of the phones used with the original was 500 Ω , but the amplifier will tolerate a variety of loads and may even be used with a 15 Ω speaker at low levels. The main criterion of the amplifier was that it should reproduce both a 100 c/s and a 10 kc/s square waveform without seriously degrading them, and this it did. There was a small amount of overshoot present on the 10 kc/s waveform but the rise time was good, and full bass boost would almost compensate for the slight top and bottom slope on the 100 c/s waveform.

Construction could take many forms. The prototype portable amplifier consisted of two small

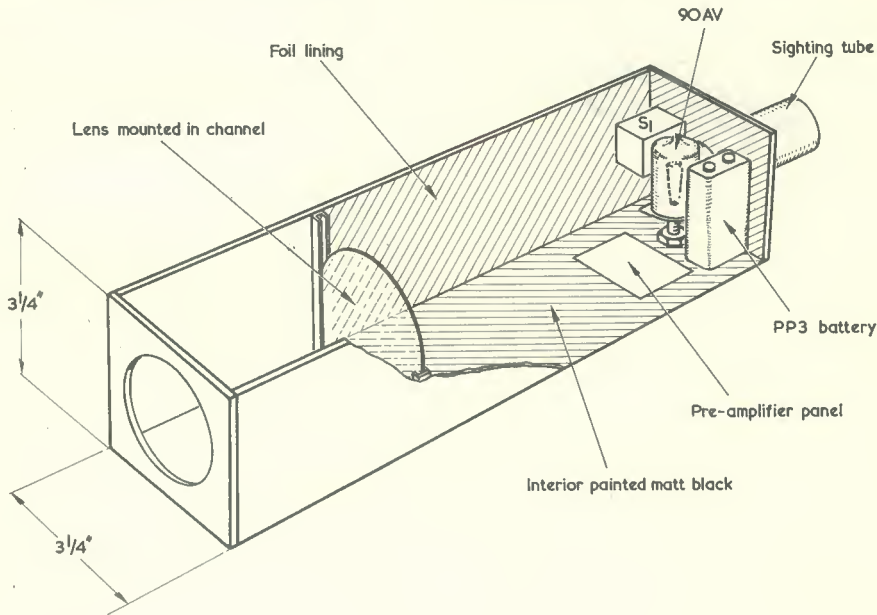

(a)

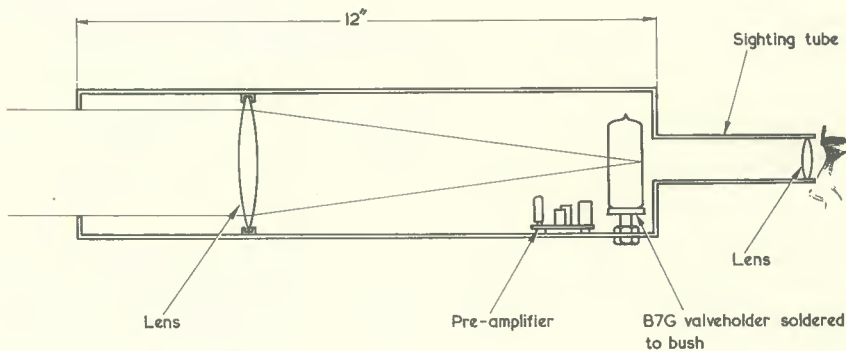

(b)

Fig. 12 (a). The manner in which the lens, photocell and pre-amplifier unit, and sighting tube are assembled. The dimensions for width and height are applicable to the 3in lens used by the author

(b). Side view of the assembly. The centre spigot of the B7G valveholder is soldered to a bush taken from a discarded potentiometer

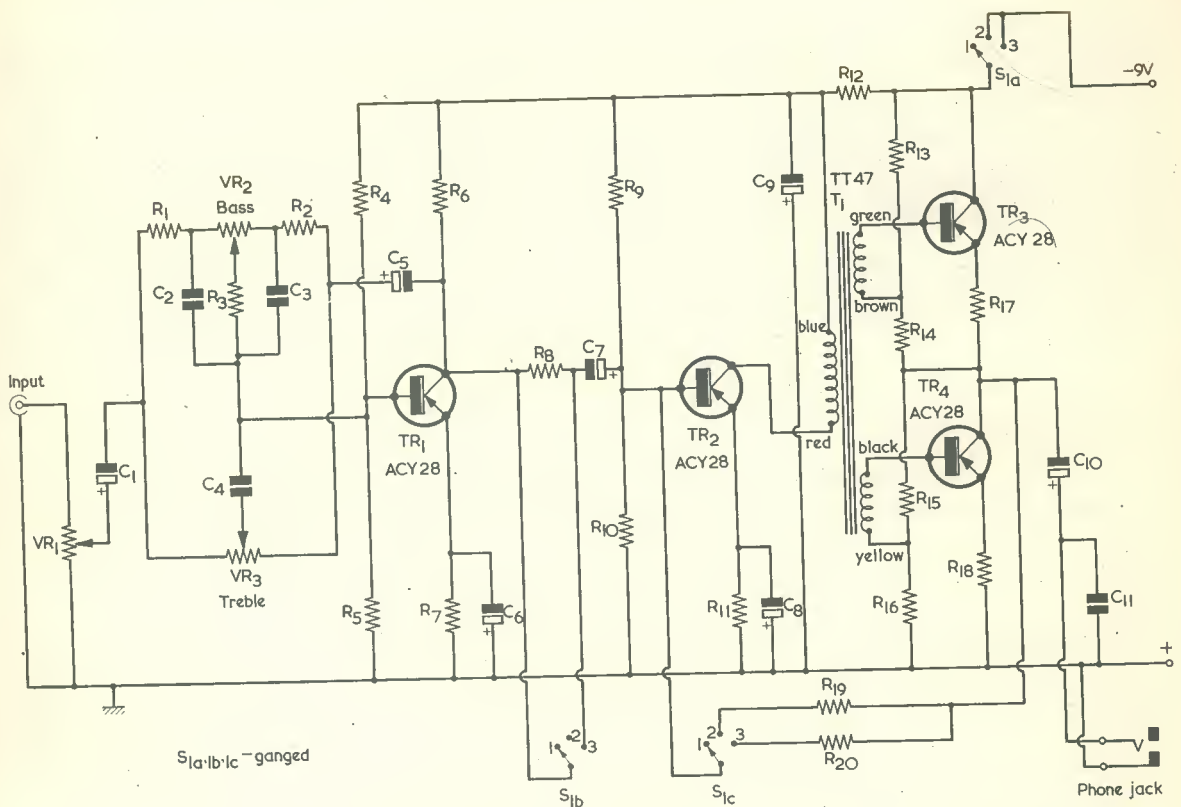

Fig. 13. The circuit of the portable a.f. amplifier. This follows the pre-amplifier of Fig. 11 and can feed headphones or a small loudspeaker

COMPONENTS

Resistors

(All fixed values $\frac{1}{4}$ watt 10%)

- R₁ 12k Ω
- R₂ 12k Ω
- R₃ 6.8k Ω
- R₄ 39k Ω
- R₅ 6.8k Ω
- R₆ 2.2k Ω
- R₇ 1k Ω
- R₈ 1k Ω
- R₉ 27k Ω
- R₁₀ 8.2k Ω
- R₁₁ 1k Ω
- R₁₂ 680 Ω
- R₁₃ 4.7k Ω
- R₁₄ 160 Ω
- R₁₅ 4.7k Ω
- R₁₆ 160 Ω
- R₁₇ 5.6 Ω
- R₁₈ 5.6 Ω
- R₁₉ 100k Ω
- R₂₀ 470k Ω
- VR₁ 10k Ω potentiometer, log track
- VR₂ 500k Ω potentiometer, linear track
- VR₃ 50k Ω potentiometer, linear track

Capacitors

- C₁ 15 μ F electrolytic, 12V wkg.
- C₂ 0.01 μ F paper
- C₃ 0.01 μ F paper
- C₄ 0.003 μ F paper
- C₅ 100 μ F electrolytic, 12V wkg.
- C₆ 100 μ F electrolytic, 12V wkg.
- C₇ 15 μ F electrolytic, 12V wkg.
- C₈ 100 μ F electrolytic, 12V wkg.
- C₉ 100 μ F electrolytic, 12V wkg.
- C₁₀ 1,000 μ F electrolytic, 12V wkg.

Transformer

- T₁ Transformer type TT47 (Repanco)

Transistors

- TR_{1,2,3,4} ACY28 (or equivalent)

Switch

- S_{1(a),(b),(c)} 3-pole 3-way, miniature rotary

Miscellaneous

- 1 phone jack
- 1 coaxial socket
- Control knobs

panels, one containing all the components associated with TR₂, TR₃, and TR₄, and the other those associated with TR₁. Both panels were mounted in a small plastic box, together with battery, switch, tone controls and volume controls.

Overall Results

To give some idea of the sensitivity of the receiver, a fly or other small insect, such as a midge, can be located at a distance of up to 12ft by the action of daylight reflected from its rapidly beating wings, causing a note to be heard. If the receiver lens is removed reception is possible at 150 yards, with nothing interposed between the photocell and a single 20 watt fluorescent tube.

One of the accompanying photographs shows a 5 kc/s square wave which was transmitted over the system, having passed through transmitter compensation network, pre-amplifier, power amplifier, fluorescent tube, receiving photocell, photocell pre-amplifier and the portable amplifier just described. Although there is a fair amount of rise and fall time evident the overshoot is small, despite some pre-emphasis on transmit.

Regarding susceptibility to weather conditions, the Photophone will transmit through rain, but not, of course, through thick fog. Four hundred yards is not a short distance when one has to keep walking it there and back, as the writer has come to learn! Many miniature radio control receivers do not offer a range greatly in excess of this, and it can be considered a useful distance for all sorts of applications. The effect of strong sunlight only become apparent if the transmitter lamp is placed on a large whitewashed wall. The glare from the wall will cause a slight drop in received signal strength.

Although the fluorescent tube cannot compete with gallium arsenide diodes for bandwidth, it does

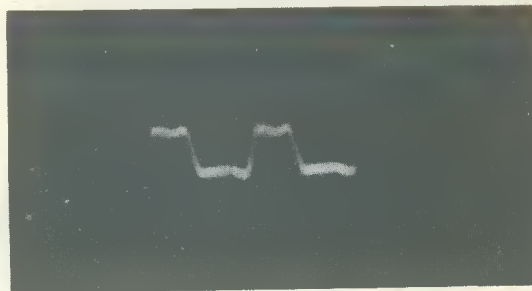

The appearance of a 5 kc/s square wave after passing through the entire Photophone transmit-receive system, including all the associated amplifiers

offer the possibility of virtually unlimited transmitter power with a response of at least 20 c/s to 25 kc/s, which is sufficient for audio purposes. Equally, with the state of the art, gallium arsenide diodes are of low power, requiring tight optical coupling, and are expensive. The equipment used with the fluorescent tube is conventional enough for much of it to be already on hand to the amateur constructor, and the tubes are not costly. If 50 to 100 watt power amplifiers are available, two 8ft 85 watt tubes could be employed to give a total light output of not less than 13,000 lumens, 13 times greater than a single 20 watt tube, and approximately equal to a filament lamp of 750 watts. With lensless receivers, and a 15 watt transmitter amplifier, reception could take place anywhere within a minimum area bounded by a circle of 150 yards radius, assuming no light-proof obstacles in the way. The equipment could then serve as an unobtrusive, licence-free paging system in large halls and open areas such as sports grounds.

(Conclusion)



Six Transmitters for New B.B.C. Programme

Six transmitters have been ordered for the new BBC popular music programme on 247 metres, from The Marconi Company, Britain's largest manufacturer and exporter of television and sound broadcasting equipment. These very modern, transistorised transmitters, each have an output of 1 kilowatt, and will be used to fill in gaps in the coverage of the existing Light Programme transmitters in the medium waveband which will be used for the new programme.

Originally designed by Marconi to provide an inexpensive and simple transmitter, capable of high quality performance for local radio operation, these transmitters have already been exported to Aden, Austria, Lesotho, Cyprus, the Seychelles, and Uganda. In addition, the BBC have previously ordered two of these units for modifications to the Third Network coverage. They are one of the few types fully transistorised up to the final stage available at this power level in the world.

The range of each transmitter will depend upon the type of aerial system used, and the prevailing level of co-channel interference.

Technical Note

These new transmitters, type B6023, are designed for the maximum simplicity and reliability, and are suitable for unattended operation. Full control is exercised by a single contact switch. Solid state silicon rectifiers are used in the power supplies, and the r.f. power output is provided by a simple triode valve, operated with zero bias, thus eliminating the need for grid bias voltage supplies.

Modulation is carried out at low power, and the fully modulated radio frequency signal is delivered to the final stage by a high efficiency transistorised circuit, patented by Marconi.



TUNABLE AERIAL COUPLER FOR PORTABLE RECEIVERS

R. L. A. BORROW

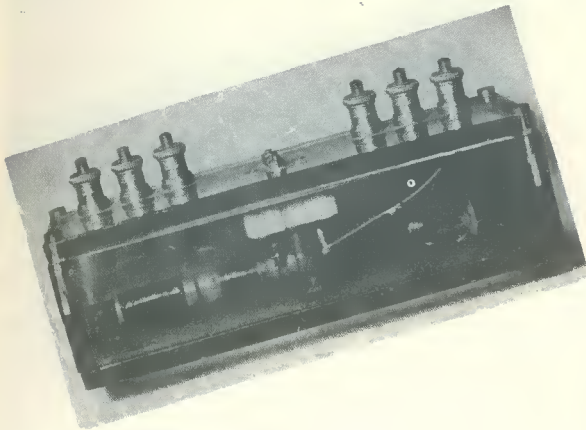

How an aerial may be coupled to a portable receiver to provide increased selectivity and sensitivity

WHEN USING THE AVERAGE TYPE OF TRANSISTOR portable one frequently finds that some stations are difficult to receive at sufficient volume in certain parts of the country.

One method of overcoming this limitation is found in the use of an external aerial. This, if long and high, raises the signal input level, but unless the aerial is suitably coupled to the receiver the high signal sensitivity may be found to be quite unusable.

A transistor portable normally obtains its input signals from a coil wound on a ferrite rod inside the receiver, this coil also entering the first tuned circuit. Frequently the set is provided with a socket for connecting an external aerial, and this is usually connected to a winding on the ferrite rod. If such a socket is not provided an external aerial can be coupled to the ferrite rod coil by winding two or three turns of wire round the outside of the receiver.

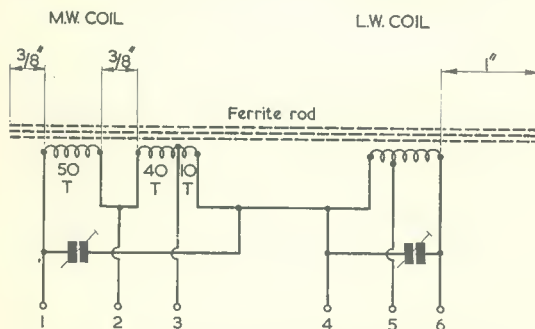

Fig. 1. The circuit of the tuned coupler. The dimensions show the approximate positions of the coils on the ferrite rod. The two trimmers are discussed in the text

External aerials coupled in this manner are not, of course, tuned to the signal required, consequently they raise the general signal and noise level and it is frequently found that, although the wanted signal is increased, it cannot be used because of interference from strong adjacent signals which are similarly raised in level.

Tuned Coupler

These difficulties can be overcome by using a tuned coupler between the aerial and the receiver. The coupler described here was designed to do this in a simple and convenient manner, and it can be applied to all medium and long wave portables fitted with ferrite aerials, irrespective of whether or not they include facilities for connecting external aerial.

The coupler consists of coils on a ferrite rod which may be connected to any external aerial and tuned to any particular signal in the medium or long wave band. As may be seen from the accompanying photograph the rod is mounted, together with terminals and tuning capacitance, in a Perspex box. The unit is coupled to the receiver by positioning it near the receiver ferrite rod and parallel to it. Coupling between the two sets of coils on the two ferrite rods is then analogous to the coupling between the two windings of, for example, an i.f. transformer. The degree of coupling can be altered by varying the distance between the coupler and the receiver.

The Perspex box in which the prototype coupler was built measured 6 x 2 x 1.5in. All sides of the box, except the lid, were cemented together. The complete coupler was attached to the lid, which was fastened to the rest of the box using 8BA screws.

A $\frac{3}{8}$ in diameter ferrite rod 5in long was employed. The medium wave coils were wound at one end of the rod, and the long wave coil was fitted at the other end. The medium wave coils were wound with 30 s.w.g. enamelled wire on a former made by wrapping the rod with a strip of gummed paper. The arrangement of the windings is shown in Fig. 1, the number of turns being 50, 40, and 10. The medium wave coils were single-layer wound and their position on the former is not very critical. In the author's version, the 50-turn winding commenced about $\frac{3}{8}$ in from the end of the ferrite rod and there was a gap, again of about $\frac{3}{8}$ in, between the end of the 50-turn winding and the start of the 40-turn winding. There was no gap between the 40-turn and 10-turn windings.

The long wave coil was a ready-wound component and consisted of a standard long wave ferrite rod replacement coil for a receiver, and having a tap for coupling to the base of the mixer transistor. Any long wave coil with a transistor base tap, and intended for a $\frac{3}{8}$ in ferrite rod can be employed. If a coil without a tap is to hand, and the constructor is prepared to unwind and rewind part of the coil, the tap may be inserted about $\frac{1}{4}$ of the coil from one end. This can be achieved by unwinding about $\frac{1}{4}$ of the turns, as observed visually, making the tap, then rewinding. In the coupler, the results given with a tap $\frac{1}{4}$ of the way along the coil may be better than with the transistor base tap, which will be about $\frac{1}{10}$ along the coil, but the process of making the tap can be a little laborious and, if Litz wire is employed, it is necessary to ensure that all strands are connected. In Fig. 1 the tap, at terminal 5, is closer to terminal 4 than to terminal 6. The long wave coil may be positioned about 1in from its end of the ferrite rod.

Fig. 1 also shows two trimming capacitors. Trimmers were used in the author's version as the coupler was used over long periods for reception of single stations, such as Luxembourg, and the trimmers could then be conveniently set up and left alone. Both trimmers have a minimum capacitance of 40pF and a maximum capacitance of 350pF. Many constructors may prefer to use normal knob-operated variable capacitors. Satisfactory results will be given with plastic dielectric capacitors having a maximum value of 250pF, and a suitable component is the Eagle 250pF capacitor measuring $\frac{3}{4} \times \frac{3}{4} \times \frac{3}{8}$ in, and having a $\frac{1}{4}$ in spindle tapped 6BA, which is available from Henry's Radio Ltd.

It is necessary to provide an earth connection for the coupler, and acceptable results will be given by using the earth point of a mains socket. If no earth connection is readily available, a length of wire laid on the floor or ground will function adequately.

Terminal Connections

Connections to the coupler terminals vary according to the length of the aerial and the frequency to be received. The various combinations are shown in Figs. 2 (a) to (f). If a short indoor aerial is employed, best results will be obtained with the circuits in Figs. 2 (a), (c) and (e). With a

long outdoor aerial, best results are more likely to be given with the circuits of Figs. 2 (b), (d) and (f). The longer aerial will bring in the weaker signals but, unless it is loosely coupled to the tuned circuits, as in Figs. 2 (b), (d) and (f), it will flatten tuning so much that the benefits of having a tuned circuit in the coupler become considerably reduced.

The individual circuits of Fig. 2 are employed in the following manner.

Fig. 2 (a). For the high frequency end of the medium waveband with a short aerial. Join 1 to 2 and connect to aerial. Connect earth to 4.

Fig. 2 (b). For the high frequency end of the medium waveband with a long aerial. Join 1 to 2, connect aerial to 3, and connect earth to 4.

Fig. 2 (c). For the low frequency end of the medium waveband with a short aerial. Connect aerial to 1, and connect earth to 4.

Fig. 2 (d). For the low frequency end of the medium waveband with a long aerial. Connect aerial to 2, and connect earth to 4. (Note: for very long aerials, connect aerial to 3.)

Fig. 2 (e). For the long waveband with a short aerial. Connect aerial to 6, and connect earth to 4.

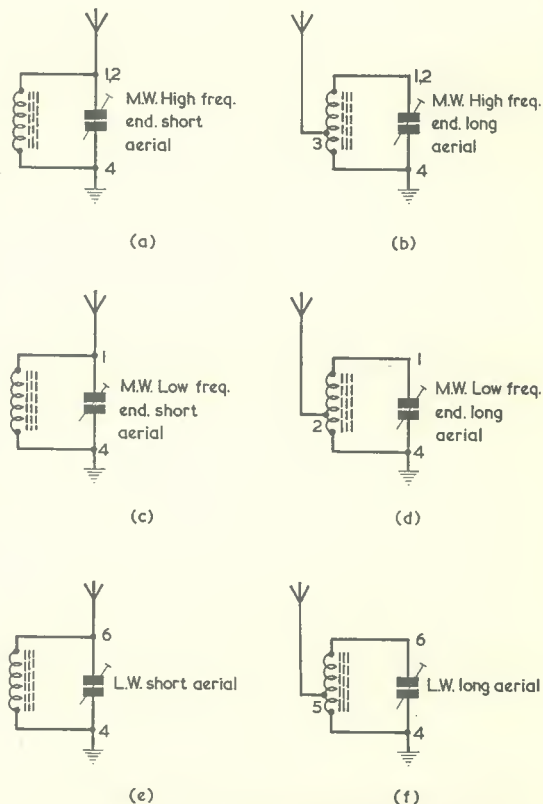

Fig. 2. Different methods of connecting up the coupler to cater for varying frequencies and aerials. The individual circuits are explained in the text

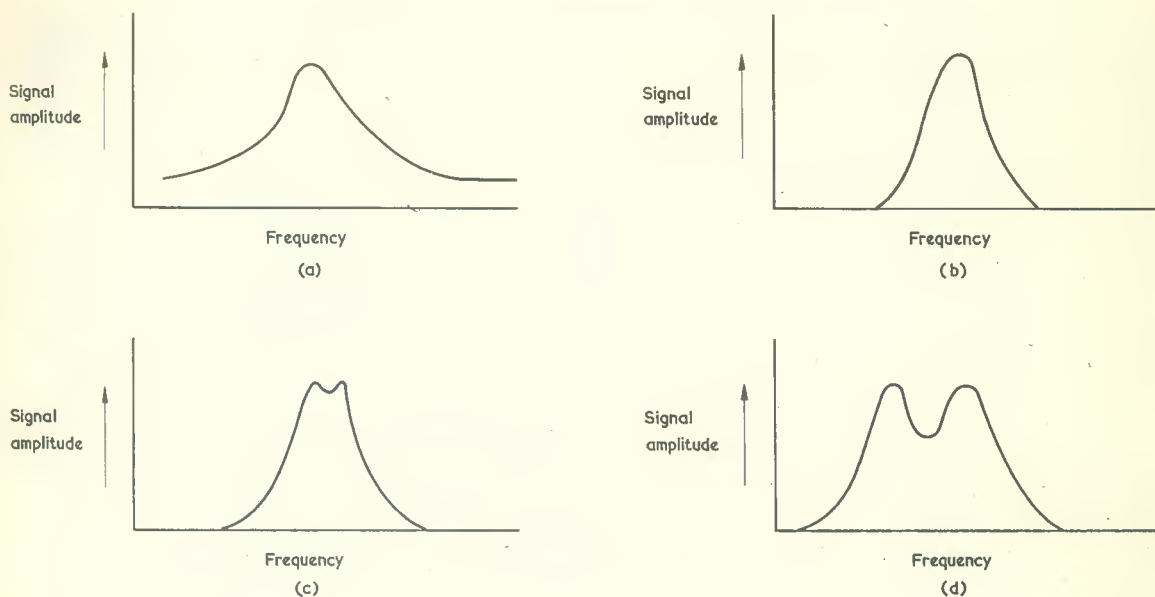

Fig. 3 (a). Typical frequency response for a receiver ferrite rod tuned circuit
 (b). The improved response given by introducing the tuned coupler
 (c). Coupling closer than the optimum position can cause two peaks to appear
 (d). The peaks become more widely spaced as coupling is further increased

Fig. 2 (f). For the long waveband with a long aerial. Connect aerial to 5, and connect earth to 4.

The wanted signal can usually be found with the coupler close to the receiver. The coupler trimmer or variable-capacitor is then adjusted to give maximum signal. When the circuits are all in tune it will be found that, as the tuner is brought closer to the receiver, the signal gradually increases up to a certain point and then stays constant. The point at which signal strength commences to be constant is the position of optimum coupling.

Frequency Response

The effect of using a tuned aerial coupler on the frequency response of a receiver is illustrated in Figs. 3 (a) to (d). In each case the amplitude of the signal is plotted against frequency.

Fig. 3 (a) shows the type of response obtained from a single tuned circuit, as used with the ferrite rod aerial in the receiver. The shape of this curve is determined by the quality of the inductor used and by the associated circuitry. The better the complete circuitry the sharper the resonance curve, but the curve will always spread at the base. In practice this means that a strong signal on a frequency adjacent to that to which the receiver is tuned can be accepted by the receiver and cause interference with the wanted signal.

Fig. 3 (b) shows the type of response curve

obtained when the coupler is used and coupling adjusted to optimum. It will be seen that the use of the second tuned circuit has cut the skirts of the curve which, of course, means that signals on frequencies outside the skirts will be rejected.

Figs. 3 (c) and (d) show the effect on the response curve of increasing the coupling beyond the optimum. This broadens the response but still gives better selectivity when considering interfering signals on frequencies not too close to the wanted signal.

Selectivity and quality in radio reception are difficult to combine and it is frequently necessary to compromise. Using circuits in which the coupling can be varied the operator can vary the response of his equipment to fit in with the prevailing conditions. Thus if the interference level is high he can, by reducing the coupling, reduce the interference whilst at the same time accepting a reduction in the frequency response of his receiving system to the wanted transmission. On the other hand if the interfering station is not too close in frequency he can, by using his two tuned circuits and increasing the coupling, maintain the quality of the received signal and still eliminate the interfering signal.

Users should find many applications for a coupler of this type and, in many cases, obtain satisfaction from their favourite programme without the irritation of constant interference from other stations.



IN LAST MONTH'S ISSUE WE COMMENCED THE modification of the 3-stage long, medium and short wave receiver so that it incorporated an r.f. stage with an improved reaction circuit. We shall now proceed directly to the further steps involved in this constructional project.

Further Wiring Steps

The next wiring steps should be carried out whilst referring to Fig. 1. The chassis should be stood vertically on the Side Plate at the output transformer end with the chassis underside towards the reader. Up to Step 16, all connections are soldered when made.

10. Remove the existing R_4 (180k Ω), R_5 (10k Ω) and C_5 (200pF) from the 5-way tagstrip having tags 11 to 15. If C_6 (0.01 μ F) has a working voltage of 300 or more, it may remain connected. If not, remove C_6 .

11. Fit R_{16} between tags 11 and 12, R_{17} between tags 12 and 15, and C_{20} between tags 12 and 13. If C_6 was removed, fit C_{21} between tags 12 and 14.

before soldering is carried out. In consequence, in the succeeding Steps soldering at a connection should only be carried out where expressly stated.

16. Keeping its lead-out wires short, connect C_{16} between pin 9 of L_1 valveholder and the adjacent chassis tag. Solder at the chassis tag.

17. Fit sleeving over its lead-out wires and connect R_{14} between tag 21 and pin 9 of L_1 valveholder. Solder at pin 9.

18. Solder a length of insulated wire to pin 8 of V_2 , run it along the route shown in Fig. 1, and connect its other end to tag 21.

19. Connect a short length of insulated wire between tags 21 and 25. Solder at tag 21.

20. Take up C_{18} , fully enmesh its vanes, and solder a 1in length of bare tinned copper wire to its moving vane tag, the wire projecting backwards. Fit C_{18} to the U-slot in the front Chassis Rail which was previously occupied by the reaction potentiometer, R_1 . It will be necessary to fit a $\frac{3}{16}$ in washer at the rear of the U-slot, as shown in Fig. 1, to enable the capacitor to be firmly mounted. In Fig. 1 the

UNDERSTANDING RADIO

Adding An R.F. Stage

$$f = \frac{1}{2\pi\sqrt{LC}}$$

by W. G. Morley

12. Remove C_3 (50pF), which connected between pin 1 of V_1 and pin 3 of L_1 valveholder. Using insulated wire, connect pin 1 of V_1 direct to pin 3 of L_1 valveholder, keeping the wire short.

13. Twist two wires together to form a twisted heater pair about 8in long. Bare the wires at one end, and connect one wire to pin 9 of V_1 and the other wire to the chassis tag adjacent to pin 9. The other end of the twisted pair is connected later.

14. Remove the wire which previously connected pin 9 of L_1 valveholder to its centre spigot. Similarly remove the wire which previously connected pin 4 of L_1 valveholder to its centre spigot.

15. Using a 6BA nut and bolt, mount a new 5-way tagstrip to the underside of the Chassis Plate No. 1 on which the tuning capacitor is mounted. This is the tagstrip shown in Fig. 1 with tags 21 to 25. It should be mounted centrally in the fourth row of holes from the front.

Most of the reaction circuit modification is now complete, and we are about to commence the new wiring involved in the added r.f. stage proper. This enables all wires to be fitted to an individual tag

capacitor and the section of the front Chassis Rail to which it is mounted are shown displaced forward for clarity since, in practice, the capacitor partly obscures L_1 valveholder. Note that the moving vane tag is closest to the chassis underside, and the fixed vanes furthest away (i.e. nearest to the reader). When the capacitor is firmly mounted, solder the 1in tinned copper lead, just fitted, to the centre spigot of L_1 valveholder, shortening as necessary. Carefully rotate the fixed vanes of the capacitor to ensure that they clear the wiring to L_1 valveholder centre spigot. If any fouling occurs, push down the wires concerned. At this stage, ensure also that none of the wires to the centre spigot are liable to short-circuit to pins 8 and 9 of L_1 valveholder. This applies in particular to the wire from the adjacent lead-through insulator which couples to the moving vanes of the 2-gang capacitor.

21. Temporarily fit the spindle extender to the spindle of C_{18} and cut its shaft so that, when a K402 knob is fitted, it is at the same distance from the front Chassis Rail as the knob on the a.f. gain control potentiometer. With the prototype, the

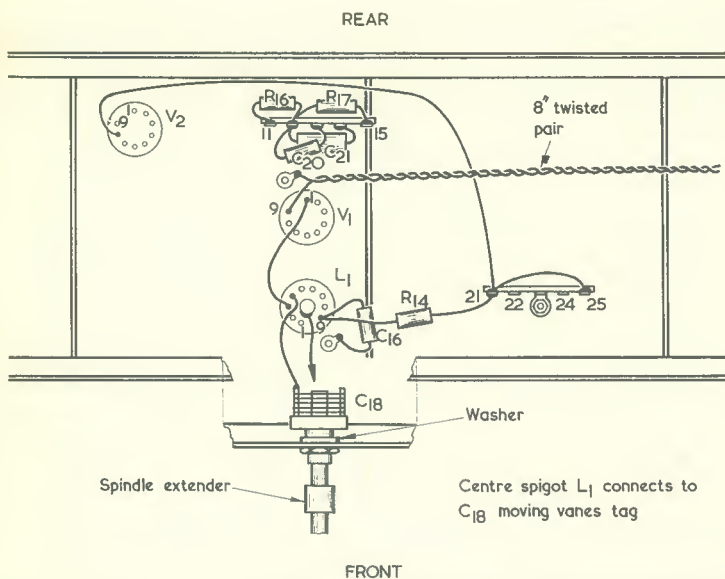

Fig. 1. In this diagram the modification to the reaction circuit is completed and the r.f. stage wiring commenced

spindle extender shaft had to be cut so that the rear of the K402 knob butted against the wider section of the spindle extender. If a new knob is fitted here, take care to ensure that proud metal on the inside of its grub-screw holes is not preventing the knob from being passed fully over the shaft. Fit the spindle extender and the knob.

Above The Chassis

The next Step is carried out above the chassis, and is shown in Fig. 2.

22. Insert two lead-through insulators in the Chassis Plate on which the 2-gang capacitor is mounted so that they take up the approximate positions shown in Fig. 2. Using the same thick-tinned copper wire as was employed for tuned circuit wiring in the 3-stage version of the receiver, connect the lower fixed vane tag of C_{12} (the rear gang) and the central moving vane tag of the tuning capacitor (to which another thick wire is already connected) to the appropriate lead-through insulators, as illustrated in Fig. 2. Keep wiring short and direct. Solder all connections.

23. The next process consists of mounting trimmer C_{17} to the front section, C_1 , of the 2-gang capacitor. This is achieved as shown in Fig. 3.

A piece of thin tinned copper wire is soldered to the upper fixed vane tag of C_1 , after which the trimmer is mounted, with a 6BA nut and bolt, to a hole already present in the front plate of the tuning capacitor frame. The tinned copper wire is then passed through the remaining tag of the trimmer, soldered, and the excess cut off. Note that the tag which bolts to the capacitor frame should be that which is common with the trimmer adjusting screw.

24. Return to Fig. 2. The new Chassis Plate No. 1 is next fitted vertically between the Chassis Plate on which V_1 and L_1 are mounted, and the Chassis Plate with the 2-gang capacitor, whereupon it functions as a screen between the two coils. Its lower edge fits snugly into the gap between these two Chassis Plates and it is secured, using 6BA nuts and bolts, by two small metal angle brackets, as illustrated in Fig. 2. The angle brackets may be made up from an odd piece of aluminium or similar, and their dimensions are unimportant provided that they hold the Chassis Plate No. 1 with adequate rigidity. The holes in the brackets may be marked out from convenient holes in the Lektrokit Chassis Plates. Most constructors will probably have suitable hardware in the spares box.

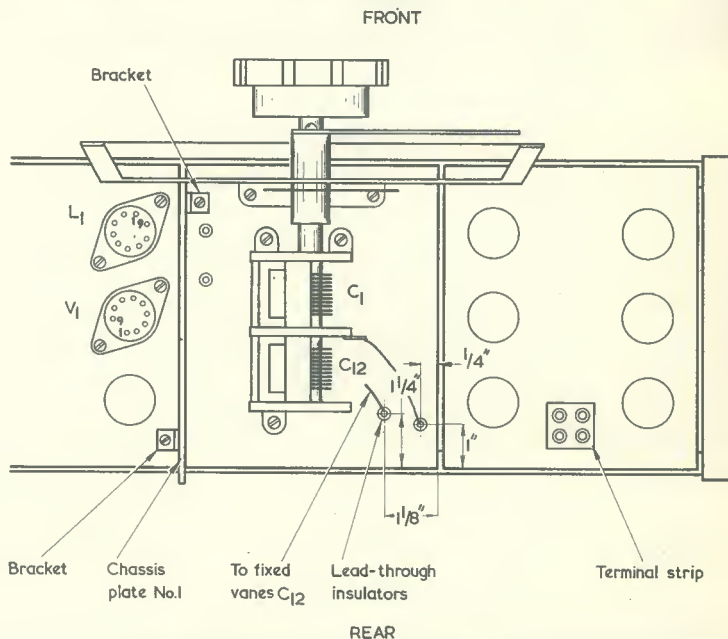

Fig. 2. The screen, provided by a Chassis Plate No. 1, is fitted vertically between V_1 and the 2-gang capacitor. Also shown here are the connections to the lead-through insulators for the r.f. stage

25. Turn the chassis round again and refer next to Fig. 4. It will be found that a long insulated wire connects pin 8 of L_1 valveholder to the lead-through insulator coupling to the aerial terminal. Unsolder this wire at the lead-through insulator and move it out of the way for the time being.

26. Fit L_2 valveholder (B9A) and V_3 valveholder (B7G) with the orientation shown in Fig. 4, and ensuring that two chassis solder tags are mounted under the securing nuts in the positions illustrated. Fit R_1 potentiometer in the Chassis Rail U-slot which is in line with these two valveholders, and with its tags away from the chassis underside (i.e. towards the reader). Fit a K402 knob to R_1 . The spindle of R_1 is, of course, already of the correct length.

27. Shortening as necessary, connect the free ends of the twisted heater pair fitted in Step 13 to pins 3 and 4 of V_3 . Solder both connections. The twisted pair should be kept close to the chassis underside.

28. Shortening as necessary, connect and solder the wire from pin 8 of L_1 valveholder (see Step 25) to pin 5 of V_3 . This wire must follow the shortest direct route between the two valveholder pins.

29. Connect the chassis tag adjacent to V_3 valveholder to the centre spigot of that valveholder. Solder at the spigot.

30. Fitting sleeving over its lead-out wires, connect R_{13} between tag 25 and pin 7 of V_3 .

31. Keeping the lead-out wires short, connect C_{15} between pin 7 of V_3 and the adjacent chassis tag. Solder at pin 7 and the chassis tag.

32. Using a 6BA nut and bolt, fit a 6BA chassis solder tag to the underside of the Chassis Plate on which the 2-gang tuning capacitor is mounted so that it takes up the approximate position shown in Fig. 4. Connect C_{14} between this tag and pin 6 of V_3 valveholder. Solder at the chassis tag. (The chassis

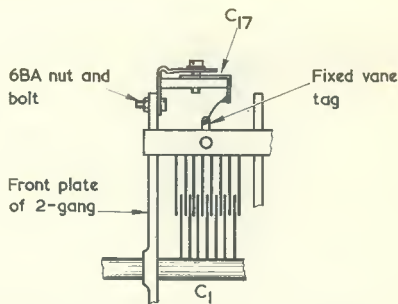

Fig. 3. Showing how C_{17} is fitted to C_1 , the front gang of the tuning capacitor

tag just fitted provides a short earth route to the tuning capacitor frame. If it were fitted to the Chassis Plate on which L_2 and V_3 are mounted there may be instability on the short wave range.)

33. Connect a short length of insulated wire directly between pins 2 and 6 of V_3 , routing this over the centre spigot. Solder at pin 6.

34. Fitting sleeving over its lead-out wires, connect R_{12} between pin 2 of V_3 and the centre tag of R_1 . Solder at pin 2 and the centre tag of R_1 .

35. Take up R_2 , which will have short lead-outs due to its previous use as $V_1(a)$ grid leak. Solder extension wires to these short lead-outs. Fitting sleeving over the extension wires, connect R_2 between tag 25 and the tag of R_1 furthest away from L_1 . Solder at tag 25 and the tag of R_1 .

36. Connect a length of insulated wire between tag 23 and the tag of R_1 nearest to L_1 . Solder at tag 23 and the tag of R_1 .

37. Using the thick wire employed for tuned circuit wiring, and keeping the wire short, connect

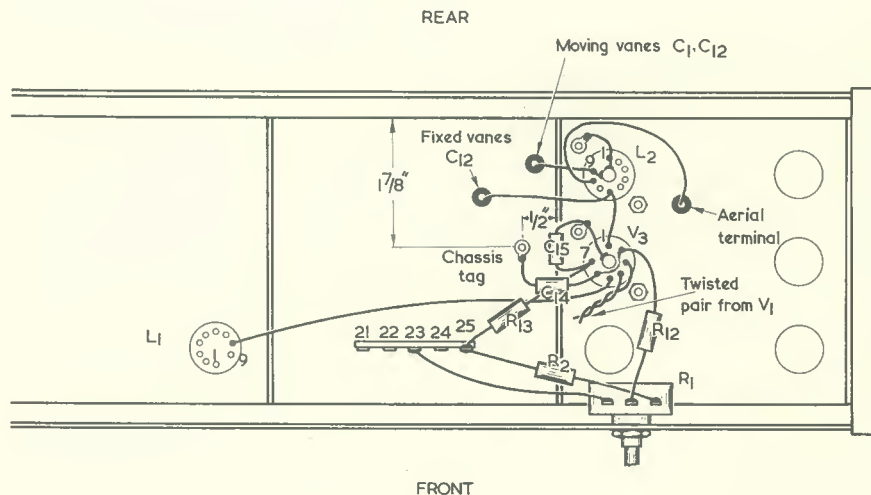

Fig. 4. Final steps in the wiring of the r.f. stage

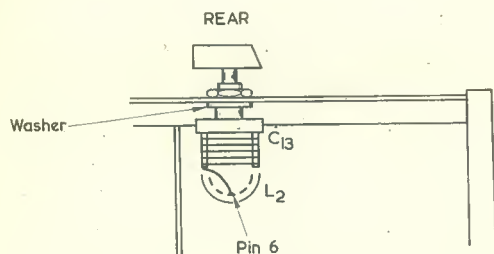

Fig. 5. C_{13} is fitted to the rear Chassis Rail, as shown here

the lead-through insulator from C_{12} fixed vanes to pin 6 of L_2 valveholder. Solder at the lead-through insulator.

38. Similarly using thick wire kept short, connect the lead-through insulator from the moving vanes of C_1 , C_{12} to pin 9 of L_2 valveholder. Solder at the lead-through insulator.

39. Using the same thick wire, connect pin 9 of L_2 valveholder to the centre spigot, and thence to pin 1 and the adjacent chassis tag. Solder at all four connections.

40. Reverting to ordinary insulated wire, connect pin 6 of L_2 valveholder to pin 1 of V_3 , keeping the wire short. Solder at pin 1 of V_3 .

41. Following the route shown in Fig. 4, and using insulated wire, connect pin 8 of L_2 valveholder to the lead-through insulator from the aerial terminal. Solder at pin 8 and the lead-through insulator.

42. Turn now to Fig. 5. Mount C_{13} to the rear Chassis Rail U-slot immediately behind L_2 valveholder, so that the fixed vanes are furthest away from the chassis underside (i.e. closest to the reader). Use a $\frac{3}{8}$ in washer in the same manner as when fitting C_{18} . Fit the pointer knob so that it is in line with the chassis length and pointing to the adjacent Side Plate when the vanes are fully enmeshed.

43. Using a short length of insulated wire, connect pin 6 of L_2 valveholder to the fixed vane tag of C_{13} which is immediately above. Solder at pin 6 and the fixed vane tag. (There is no necessity, with C_{13} , to make a connection to the moving vane tag as an adequate connection to chassis is made via the mounting bush and nut.)

44. The addition of the r.f. valve increases the heater consumption of the receiver to 1.05 amps, which is marginally above the maximum specified current of 1 amp per pin of the octal power plug.

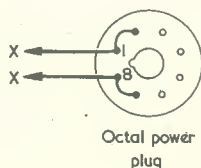

Fig. 6. Revised heater connections at the octal power plug

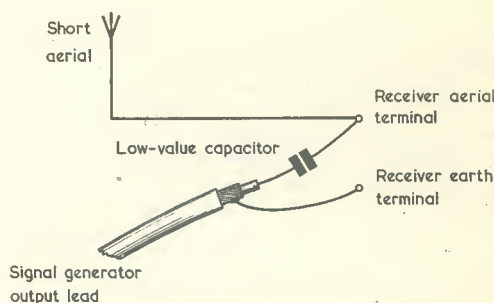

Fig. 7. Coupling a signal generator to the receiver for alignment. Alignment may alternatively be carried out with received transmissions

Take the octal power plug and re-wire it so that one side of the heater supply connects to pins 1 and 2 and the other side to pins 8 and 7. See Fig. 6. Do not alter the existing connections at pins 4 and 5.

Testing And Alignment

The modification and addition of the r.f. stage is now complete.

First check the chassis visually to ensure that all solder joints are soundly made and that no "blobs" of solder have fallen into the chassis. Check particularly for short-circuits between the h.t. positive wiring and chassis. If an ohmmeter is available this should indicate a high resistance (due to R_2 and R_1 , and to leakage resistance in the h.t. electrolytic capacitors) when connected between an h.t. positive point such as tags 21 or 25 and chassis.

Insert valve V_3 and fit Range 1 coils (long wave) into the L_1 and L_2 valveholders. The Blue coil fits into L_2 valveholder and the Green coil into L_1 valveholder, the projections on the coil bases corresponding to the gaps between pins 1 and 9 of the valveholders. Connect a speaker and some 12ft of wire to act as an aerial. Plug the receiver into the power supply unit and switch the latter on. The heater of V_3 should glow, whilst the subsequent illumination of the neon lamp in the power supply unit indicates that h.t. is present.

Tune in the Light Programme on 1,500 metres (200 kc/s). This will probably appear at a dial setting of around 60 to 80 and with low apparent sensitivity, but these points are unimportant at this stage. Ensure that reaction is obtained as C_{18} is advanced, and that sensitivity increases as R_1 is rotated clockwise. In nearly all locations in the U.K. it should be possible to obtain more than adequate speaker reproduction of the Light Programme under these conditions, whereupon the receiver may be considered to be working properly and alignment can be carried out.

If a modulated signal generator is available, alignment proceeds in the following manner.

Keep the short aerial connected and couple the signal generator to the receiver as illustrated in Fig. 7. The low-value capacitor shown in this diagram may be of the order of 5 to 10pF. In most

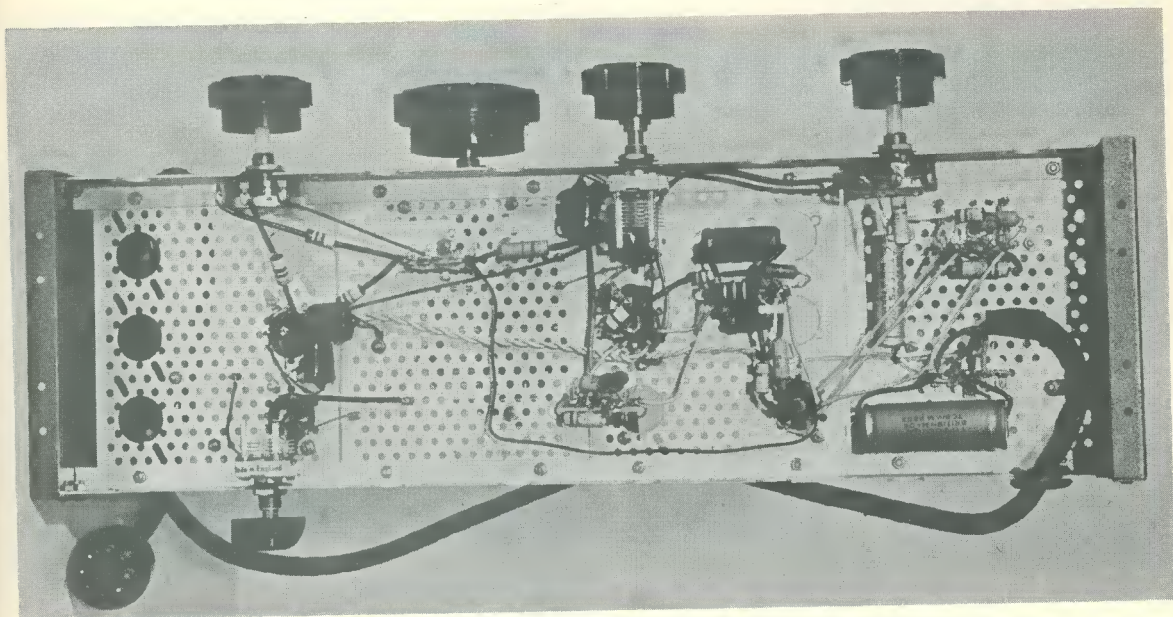

The underside of the receiver with its added r.f. stage

instances, sufficient capacitive coupling will be given by merely twisting the insulated non-earthly output lead of the signal generator several times round the aerial lead. Insert the Range 2 coils. Set the a.f. gain control to maximum and the r.f. gain control at about mid-travel. In all the adjustments which follow, C_{18} is always at the optimum reaction setting. Adjust the receiver dial to 6, and inject a signal at 1.5 Mc/s. Align C_{17} and C_{13} for maximum signal strength. Set the receiver dial to 80 and the signal generator to 600 kc/s and adjust the cores of L_1 and L_2 for maximum signal. Return to 6 on the dial and 1.5 Mc/s from the signal generator and re-align C_{17} and C_{13} . Repeat the core adjustment at 600 kc/s and, if it is felt necessary, finally retrim at 1.5 Mc/s. For later convenience make a mark on the rear Chassis Rail to indicate the setting taken up by C_{13} .

After this stage of the alignment, C_{17} is not touched again. It is set up to provide the requisite coverage on medium waves, whereupon adequate coverage on long and short waves should follow.

Remove the Range 2 coils and insert the Range 1 coils. Adjust the signal generator to 300 kc/s and tune for its output on the receiver with reaction at the optimum setting. The signal should appear around 28 on the dial. Tune in the signal accurately and adjust C_{13} for maximum signal strength. Tune to 97 on the dial and set the signal generator to 150 kc/s. Adjust the cores of both coils for maximum signal strength. Repeat the process, both at 300 kc/s, and at 150 kc/s.

Remove the Range 1 coils and insert the Range 4 coils. Set the signal generator to 12 Mc/s and tune for its output on the receiver with reaction at the optimum setting. The signal should appear around 15 on the dial. Tune in the signal accurately and adjust C_{13} for maximum signal strength. Set the

dial to 93 and the signal generator to 5 Mc/s, and adjust the cores of both coils for maximum signal strength. Repeat, both at 12 Mc/s and at 5 Mc/s.

Alignment is now complete.

The above process using a signal generator indicates, also, the alignment procedure required without such an instrument. Alignment on received signals is nearly as simple provided that the medium wave range is initially set up correctly, it being remembered that C_{17} is not touched again afterwards. In this respect, useful transmissions for trimming and padding are Radio Luxembourg (8 on the dial) and the 464 metre Third Programme transmission (70 on the dial). These may be fairly readily identified by their programme content, as opposed to the networked Home transmissions. A point to guard against is that, with a short aerial, the tuned winding of L_2 on Range 2 exhibits a high Q at the high frequency end of the medium wave band, with the result that adjustment of C_{13} may have the effect of tuning in stations on its own. The best procedure is to find the medium wave transmission against which it is intended to trim, and make adjustments to C_{17} and C_{13} until the signal appears at its maximum signal strength and at its correct point on the dial. When correctly aligned, the medium wave range offers a high level of selectivity with both tuned circuits playing their full part. As mentioned above, it is helpful to make a mark to indicate the correct setting for C_{13} on the medium wave band.

On Range 1, when aligning without a signal generator, the constructor should first accurately tune in any signal around 30 on the dial and then adjust C_{13} for maximum signal strength. The two cores may then be adjusted to cause the Light Programme on 1500 metres to appear at 62 on the dial. This process will ensure that the coverage given on long

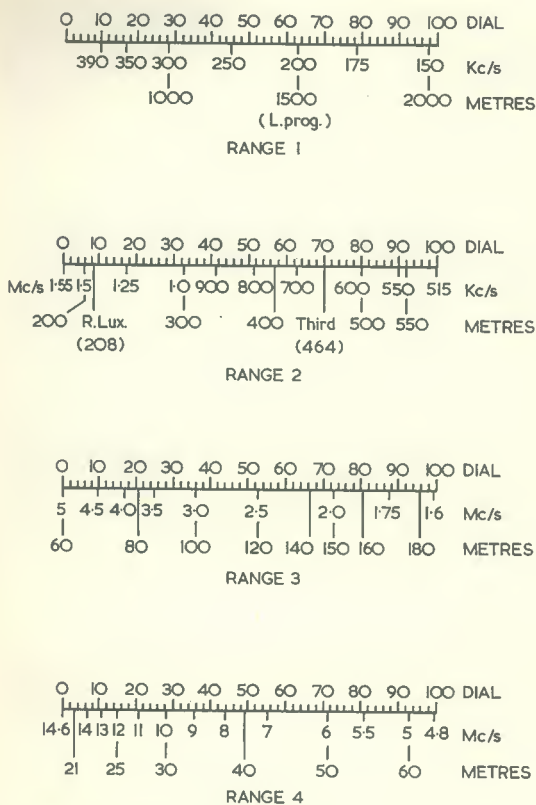

Fig. 8. Dial settings, with corresponding frequencies and wavelengths, as obtained with the prototype

waves is reasonably close to that obtained with the signal generator. Final adjustment of the cores (for maximum signal strength) may then be made on any transmission between 80 and 100 on the dial. Repeat the trimming operation at around 30 on the dial, and the padding operation between 80 and 100 on the dial.

Approximate alignment of Range 4 without a signal generator is easy to carry out, although it will be difficult to establish dial settings in terms of frequency until a few stations have been identified. Insert the Range 4 coils, tune in any signal at around 10 on the dial and adjust C_{13} for maximum signal strength. Then tune to a signal around 80 to 100 on the dial and adjust the cores for best signal strength. Repeat the trimming and padding operation. With the prototype the writer found that, when aligned with a signal generator, the core settings of the Range 4 coils were such that the threaded core stem tips were roughly flush with the top of the plastic mouldings.

Fig. 8 shows dial settings against frequency and wavelength for all three ranges, as obtained with the prototype. The information in this diagram should be of particular assistance to constructors without a signal generator. Although not included in the

Components List, the author also checked performance with Denco Range 3 coils as a matter of interest. Results were satisfactory, and the appropriate dial calibration settings obtained are also included in Fig. 8.

Using the Receiver

The receiver may be used on all three ranges with an aerial consisting of about 12ft of wire. A large aerial should prove beneficial for short wave reception, but it will in many cases be preferable to insert a fixed capacitor of some 50 to 100pF in series with such an aerial and the aerial input terminal of the receiver. A large aerial connected directly to the receiver tends to damp the tuned winding of L_2 and will, on medium waves, cause the setting of C_{13} to be much less critical. Since this infers a drop in selectivity, it is desirable to insert the fixed capacitor just mentioned to reduce the damping.

For short wave reception the r.f. gain control should be set to maximum when searching for stations, r.f. gain being reduced for the more powerful transmissions. On the medium wave band, which is extremely crowded with transmissions in the evening and at night, it is necessary to take maximum advantage of the selectivity offered by the reaction circuit. The a.f. gain control should be set to maximum and the r.f. gain control to about mid-setting, tuning being carried out with the reaction control just below oscillation point. Volume is then controlled by the r.f., and *not* by the a.f. gain control. This procedure ensures that signals are applied to the grid leak detector at optimum level. With powerful medium wave signals it may be necessary to reduce the setting of the a.f. gain control and slightly advance the r.f. gain control to obviate distortion. The necessity for obtaining maximum selectivity is not so acute on the long wave band, which is much less crowded, although it may still be found helpful to control volume with the r.f. gain control.

It should be found that there is negligible interaction between the r.f. gain control and the reaction control. If advancing the reaction control on long waves causes a howl or a "plop" as the oscillation point is reached, this effect may be due to a low self-capacitance in the screened wire from R_{19} to the grid of $V_{1(b)}$. The trouble may be cleared by adding

Voltage readings with the prototype.

Circuit Point	Voltage	
	R. F. Gain Minimum	R. F. Gain Maximum
V_3 anode (pin 5)	250	220
V_3 screen-grid (pin 7)	250	215
V_3 cathode (pin 2)	7	2.1
$V_{1(a)}$ anode (pin 1)	110	
$V_{1(b)}$ anode (pin 6)	90	

a fixed capacitor of some 20 to 50pF between the end of R_{19} remote from R_8 and the earthy tag of R_8 .

The accompanying Table shows voltage readings obtained with the prototype, using a 10,000 ohm per volt meter on the appropriate range for each reading.

Next Month

In next month's issue we return to theoretical matters and consider a section of our receiver which we have not yet discussed, this being the output stage.



Transistorised Two-Tone Generator

(continued from page 596)

The Circuit

The circuit, which is shown in Fig. 1, consists of three multivibrators. Two of these produce the required audio tones and the third controls the ratio of the times that each tone is active during the complete two-tone cycle. TR_1 , TR_2 and TR_3 form the two-tone generators and TR_4 and TR_5 the control multivibrator. The potentials at the collectors of TR_4 and TR_5 alternate between zero and the supply voltage at a rate determined mainly by R_8C_6 and R_9C_5 . When TR_4 collector is at the supply potential, base current for TR_1 is provided via R_2 . TR_1 and TR_2 then form a multivibrator running at approximately 150 c/s.

Clearly, the waveform at the collector of TR_2 is composed of one period of the 150 c/s tone and a second period of the 700 c/s tone, after which the whole two-tone cycle recommences.

Alternative Tone Frequencies

Any desired audio tone may be produced merely by changing the values of C_1C_2 and C_3C_4 . The ratio of the "on" to "off" times of the respective tones may be altered by changing the values of C_5C_6 . By choosing values in, say, a 4 to 1 ratio, for C_5 and C_6 , it is possible to make the high pitched or low pitched note predominate, according to whether C_5 is greater or smaller than C_6 .

The unit described consumes 5mA from a 9V Ever-Ready "Winner" grid bias battery. Any other suitable 9V battery could, of course, be used instead. The output is some 9V peak-to-peak

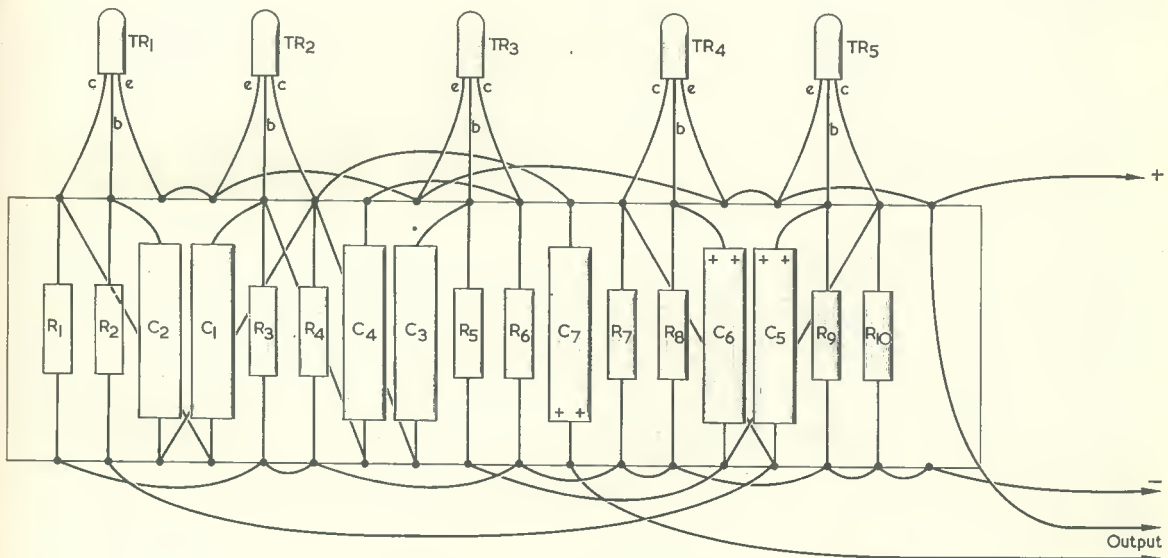

Fig. 2. Mounting and wiring the components on an 18-way groupboard

When the control multivibrator changes over, TR_4 collector potential drops to zero and stops the 150 c/s multivibrator. However, the collector of TR_5 now rises to the supply potential and provides base current via R_5 to TR_3 which, together with TR_2 , forms a multivibrator running at approximately 700 c/s.

and may well require simple attenuation before application to the power amplifier, this depending on the amplifier stage to which connection is made.

It is possible for all the components to be conveniently mounted on an 18-way groupboard, and Fig. 2 shows the wiring and component layout.



IN YOUR WORKSHOP...

"DEAR, OH DEAR," MOANED Smithy, "will they *never* finish?"

In the street outside the yard leading up to the Workshop, the compressor once more roared up to full volume.

"They're only," soothed Dick, as a second pneumatic drill added its staccato rattle to the din, "digging up the road, you know."

"I know they're digging up the road," shouted Smithy over the racket. "They've been digging up that darned road over the last three weeks. Last week the Water people dug it up and the week before that the Electricity people dug it up. Now it's the Gas people who are digging it up. They're *always* digging it up."

Suddenly a third drill swung into action, adding its clangour to the already intolerable racket given by the compressor and the first two drills. The noise rose to an ear-splitting peak. The Workshop windows shook in their frames and an expression of intense alarm spread over Smithy's face.

"Ye gods," he called out apprehensively. "Dash it all, Dick, something *happened* then. The drills and the compressor must have all combined together for an instant to produce a whacking great single frequency corresponding to the resonant frequency of our foundations! I distinctly felt the whole Workshop shudder!"

"You're imagining things," replied Dick. "Personally, I *like* it when they dig up the road. It makes a nice bit of background noise."

"Background noise?" yelled Smithy incredulously as three separate square waves of sound from the drills plus a waveform exceptionally rich in harmonics from the compressor rose once more to a thunderous crescendo. "You call this background noise?"

"This is nothing," replied Dick cheerfully. "You must come down to our local dance one of these Saturday evenings. Each guitar in our group has its own 40 watt amp and they even give the drummer a mike and separate amp as well. You should hear them when they get swinging into *L. S. Bumble-Bee* with all Fuzz-Boxes at full notch! Now, that's what I call a *noise*."

Strictly Visual Servicing

Dick grinned appreciatively at the memory, whilst the shattered Service-

man flopped down on his stool.

"This present racket," he yelled, "is more than enough for me, at any rate. All the outstanding jobs I've got are sound radios, and it's impossible to even attempt any work on them whilst those drills are going."

"Not to worry," called out Dick equably. "Come and give me a hand with this TV on my bench. It's got a fault in the vision circuits and I haven't been able to locate it yet. You won't have to listen to anything with this one!"

Resolutely, Smithy dragged his attention from the noise outside and looked over at his assistant.

"What's up with it?"

"There's no vertical scan," replied Dick. "I've found what looks like an open-circuit in the vertical deflector coils, but I haven't got round to locating exactly where it is yet."

"I might as well give you a hand," said Smithy morosely. "There's not the faintest chance of getting any other work done."

Smithy picked up his stool and wandered over to Dick's bench, where he settled himself comfortably.

"Show me," he commanded, "what you've done up to now."

"Righty-ho," replied Dick obligingly, pointing to the television chassis on his bench. "As soon as this set had warmed up I found that the vertical scan had gone up the wall and that all I could get was a horizontal line across the middle of the screen. So I first turned the brilliance down a bit to ensure that the line wasn't too bright."

"Very good," commended Smithy. "I know that, with modern aluminised tubes, there's little risk of the phosphors becoming 'striped' due to the bright horizontal line which appears after the vertical deflection has packed in, but I still hear rumours every now and again about it occurring. So it's always a good plan to keep the brilliance down a bit when there's no vertical scan. What did you do next?"

"Oh, the usual sort of thing," said Dick. "I tried a new vertical output valve, and then a new vertical oscillator valve, but there was no joy there. So I popped the old bottles back in again. I then had a quick shufti around for obvious faults but there was nothing doing there either, and I next whipped out the chassis. I got my testmeter out and prodded around a bit, to find that the vertical output and oscillator valves seemed

Life for the service engineer holds many trials, and these can become almost too great to be borne when they are augmented by the activities of the local Authorities. But Smithy, in company with his able assistant Dick, forges grimly ahead and is able to devote at least some of his attention to the operation of present-day vertical deflector coil circuits.

to be having the correct voltages on their electrodes. On a hunch, I disconnected one of the leads from the vertical deflector coils to the printed board and checked the deflector coils for continuity. And, blow me if they weren't completely open-circuit!"

"Excellent," remarked Smithy approvingly. "You've done exactly what I'd have done myself with a snag like that. I see you've got out the service manual for the set, which means that we can now have a quick butcher's at the vertical deflector coil circuit."

"Surely," protested Dick, "there's no circuit to look at! Won't there be just a pair of deflector coils and nothing else?"

"Things in this game are rarely quite as simple as that," replied Smithy. "There'll be a few other bits and pieces in addition to the coils, as I shall now proceed to demonstrate to you."

"Have you noticed," interjected Dick inconsequentially, "that we've started talking almost normally. Those pneumatic drills have stopped."

And, indeed, the noise from outside had dropped to a level which was relatively tolerable, and only the compressor was now audible. Suddenly, this gave an indignant snort as some unseen hand turned it off then it, too, relapsed into silence.

But Smithy was lost in the fever of the chase; his quarry being the exact location of the fault in the vertical deflector coil circuit.

"Don't fuss about incidentals," he said shortly. "Let's get down to the job in hand! Now, if you look at the deflector coil section in that service manual circuit, you'll see that it doesn't consist only of a couple of windings. There are two resistors and a thermistor as well." (Fig. 1.)

"Blimey, so there are," responded Dick, peering at the diagram. "I

sometimes think that TV manufacturers put in odd resistors here and there just to keep the resistor factories going! What on earth do they have to put resistors across the vertical coils for?"

"To stop cross-talk," replied Smythy briefly, taking out his pen and scribbling in the margin of the service sheet. (Fig. 2). "Without those resistors, the lines at the left-hand side of the picture would become all wavy, like this."

"Pull the other one," returned Dick scornfully. "This one's got bells on, mate!"

"I'm perfectly serious," stated Smythy. "Don't forget that there's bound to be some stray capacitive couplings between the line and vertical coils in the deflection yoke and, at the same time, that there's a large flyback pulse appearing across the line coils at the end of each line. This pulse can be coupled into the vertical coils by way of these stray couplings whereupon, unless any precautions are taken, the latter can become shock-excited and start to ring. The ringing frequency is at the natural resonant frequency of the inductances and capacitances in the vertical coils and the vertical output transformer, and the ringing consists, actually, of a damped oscillation at this frequency. This damped oscillation deflects the tube beam up and down and gives you the wavy effect I've just sketched out. And that's what's known as cross-talk."

Dick was suitably impressed with this explanation.

"Are those two resistors," he asked, "connected across the vertical coils to damp out this ringing effect?"

"That's right," confirmed Smythy. "The ringing frequency is quite a bit higher than the vertical scanning frequency, with the result that the reactance of the coils at the ringing frequency is greater than the reactance at the scanning frequency. The resistors have a value which is sufficiently low to considerably reduce the overall impedance at ringing frequency, without having too much adverse effect on the overall impedance at scanning frequency."

Vertical Coil Thermistor

"Well, that's something I didn't know before," remarked Dick. "Now, what about the thermistor?"

"It's function," said Smythy, "is to stabilise picture height at different ambient temperatures."

"Good show," replied Dick brightly. "I'm still no wiser!"

Smythy sighed.

"I can see," he remarked resign-

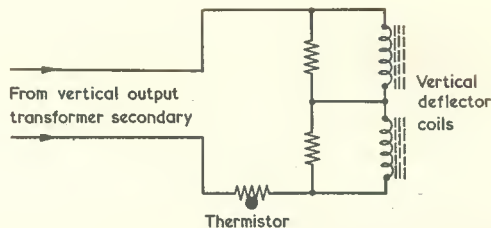

Fig. 1. In the receiver checked by Dick and Smythy, the deflection yoke assembly included the vertical deflector coils together with two resistors and a series thermistor. The resistors, whose values would be typically 1 k Ω , prevent cross-talk, whilst the thermistor stabilises picture height

edly, "that what started out as a simple repair job has now, as usually happens, degenerated into a long-term gen session. By the way, what's happened to those road-drills outside?"

"I told you they were stopping just now," Dick reminded him, "but you were too absorbed in this set to pay any attention."

"Was I?" replied Smythy absently. "Well, thank goodness they've stopped anyway. Over the last three weeks I've reached the conclusion that the local authorities are just using that bit of road outside our yard as a combat course for trainee pneumatic drillers. The Electricity, Gas and Water people must have been queuing up to get their new staff broken in on it."

"What fascinates me," remarked Dick, "is how each lot always gets it smoothed over just before the next lot moves in to dig it all up again. I think they must have got spies posted. Have you noticed how, at the very instant when the diesel-roller from one lot disappears around the corner, the next lot swings in in complete with all their gear?"

"I must admit," said Smythy in tones of grudging admiration, "that you can't fault them on their timing. Split-second, it is. Now that all three departments have had a go at it, I suppose the next thing will be a passing-out parade of all the trainee drillers and compressor-men."

"Stap me," breathed Dick, impressed by this unexpected prospect. "Now that *would* be something to see."

"We'll take time off to watch it," Smythy promised him. "But let's get back to those vertical deflector coils."

Unwillingly, Dick relinquished a colourful mental image of the massed staffs of the local Electricity, Gas and Water Departments marching past in three ranks with coin-slot meters and stop-cocks held at the ready. He reluctantly directed his thoughts to the mundane present.

"You told me," he remarked, "that the function of that thermistor is to stabilise picture height."

"Oh yes, so I did," said Smythy. "Well, now, to tell you how that thermistor works I must first take you back to the TV sets which were manufactured up to some twelve years or so ago, and which didn't have any type of height stabilisation fitted. What happened in those sets was that, after they'd been switched on, the deflection yoke, including the vertical deflector coils, gradually got hotter and hotter until it settled down to a final stable temperature after the set had been on for about an hour or so. This rise in temperature was due to the general rise in ambient temperature inside the TV cabinet, plus a wee bit of dissipation in the coils because of the current passing through them. Now, copper wire has a positive resistance-temperature coefficient of very slightly less than 0.004 per degree Centigrade. A rise of 25 degrees Centigrade in ambient temperature inside a TV cabinet after switching on for some time is by no means unusual, and this would cause the resistance of the



Fig. 2. Cross-talk, in which a ringing voltage is produced in the vertical deflector coils, imparts a wavy appearance to the line structure at the left of the picture

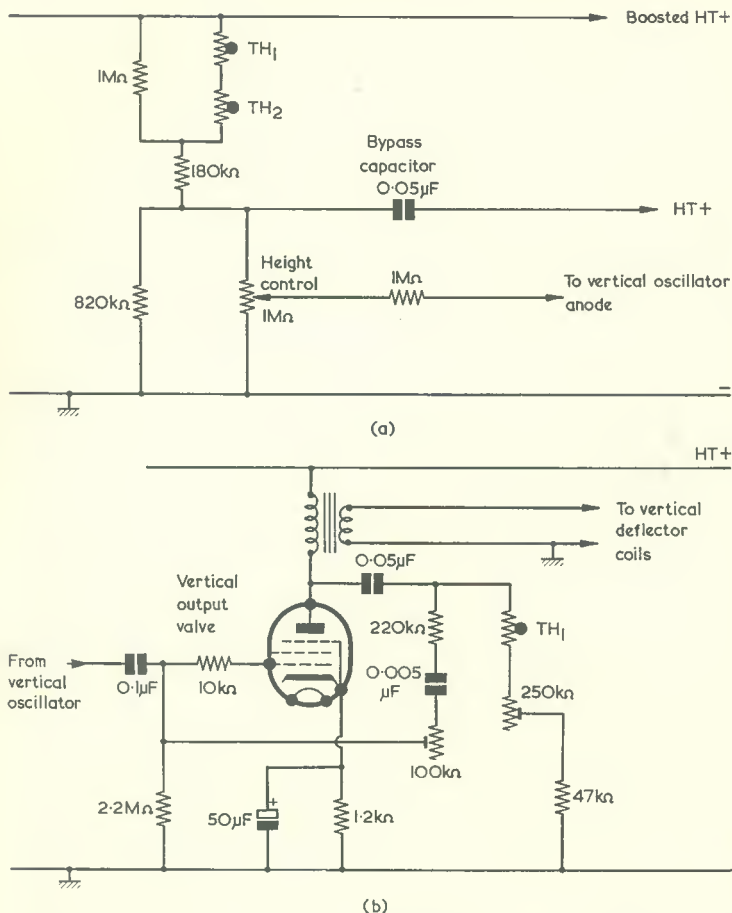

Fig. 3 (a). A height stabilising circuit in which, as thermistor resistance reduces, the amplitude of the sawtooth fed to the vertical output valve increases thereby counteracting frame shrinkage. The two thermistors in this diagram have a cold resistance of around 140 kΩ, and their effect is qualified by the fixed resistors in the height control network
 (b). A slightly simplified circuit in which a high resistance thermistor provides height stabilisation. Both potentiometers control linearity. As thermistor resistance reduces, less voltage is available for the feedback loop back to the grid and output amplitude increase

copper wire with which the vertical deflector coils were wound to increase by very nearly one-tenth of its value at the lower temperature.
 "That's a bit of an increase, isn't it?"

"It is," agreed Smithy cheerfully. "Many people working with radio and TV just don't realise how much the resistance of copper wire increases when you have large rises in temperature. In those old TV's the fact that the resistance of the vertical deflector coils increased by quite a large factor after the set had been switched on for some time meant that there was a corresponding

decrease in the deflection current which flowed through them."

"But surely," protested Dick, "that just couldn't happen! If what you say is true, the height of the picture would be continually decreasing during the first hour after switching on."

"And that," chuckled Smithy, "is exactly what took place! During the first half-hour or so after switching on the picture height used to shrink by quite a noticeable amount, after which it still continued to shrink, but at a reduced rate. We used to call it 'frame shrinkage'."

"Didn't the viewers notice it?"

"They hardly ever complained," grinned Smithy, "What we used to do was to set the height control so that the picture overscanned vertically after switching on, whereupon it shrank nearly to its proper height after the set had been switched on for half an hour or so! Fortunately, many of the earlier sets had pretty gigantic cabinets to accommodate the large tubes that were used at the time, and so the increases in ambient temperature weren't always as high as the 25 degree figure I mentioned just now. With these sets, frame shrinkage wasn't quite so troublesome. Nevertheless, set-makers still had to start paying attention to the problem and, about twelve years ago, a number of different thermistor height stabilising circuits began to appear. The idea which was eventually adopted is the simple thermistor in series with the vertical deflector coils which we have here, and this has now become a standard practice with modern sets including, of course, the 405/625 models. Don't forget also that modern sets, with their smaller cabinets, get really good and hot after they've been running for a while, whereupon some form of height stabilisation becomes virtually essential. Normally, the series thermistor is mounted on or near the deflection yoke so that it has about the same temperature as the vertical coils. The resistance of the thermistor decreases as its temperature goes up, with the result that it counterbalances the increase in resistance in the vertical coils."

Line Deflector Coils

"Well," remarked Dick, "you've certainly covered the functioning of that thermistor pretty thoroughly. Wait a minute, though—there's something fishy here!"

"What's wrong?"

"If," said Dick, "you have to put a thermistor in series with the vertical deflector coils, why don't you also have to put a thermistor in series with the line deflector coils?"

"That," remarked Smithy equably, "is a very good point, and I'm glad you raised it."

"It looks," commented Dick, pleased with himself, "as though I've stumbled on something here."

"Seeing that your normal progress," stated Smithy unkindly, "is nothing other than stumbling, I wouldn't argue with you. What you haven't realised is that, at vertical scanning frequency, the vertical deflector coils offer an impedance that is largely resistive, with the consequence that a change in the resistance of these coils can have a considerable effect on the scanning

current which flows through them. On the other hand, the line scanning frequency is very much higher, and the impedance presented by the line deflector coils is very nearly all inductive. The result is that a change in line coil resistance has much less effect on the scanning current which flows in the line coils. In practice, any horizontal shrinking which occurs due to an increase in line coil temperature is so small that it can be safely ignored."

"In other words," said Dick, "you can think of the vertical deflector coils in terms of resistance, and the line deflector coils in terms of inductance."

"The situation is not as simple and clear-cut as *that*," declared Smyth. "It would be better to say that resistance is much more predominant in the impedance of the vertical deflector coils than it is in the impedance of the line deflector coils, this being due to the large difference between vertical and line scanning frequencies. Incidentally, to provide a complete picture I should add that a contributory factor towards frame shrinkage will be given by an increase in the resistance of the secondary winding of the vertical output transformer due to rise in ambient temperature. However, this doesn't seem to offer as much trouble as occurs in the deflector coils themselves and it is usually at the latter point that the compensating thermistor is fitted. Well, that's more than enough nattering for now, so let's have a go at this set."

Dick needed no further encouragement, and he leaned over and investigated the deflector yoke housing. Almost immediately, he gave a cry of triumph and indicated to Smyth a small disc thermistor from which one of the lead-out wires had come adrift.

"That's it," said Dick exultantly. "The series thermistor has gone for a burton! Have we got any replacements, Smyth?"

"We'll have to order one," replied Smyth. "Thermistors in the vertical deflector circuits go faulty so infrequently that there wouldn't be any point in my stocking spares for all the sets we handle. Still, you can prove for certain that

the fitting of a new thermistor will clear the snag by temporarily soldering a fixed resistor in its place. A value of around 10Ω should do the trick."

Dick walked over to the spares cupboard to find the requisite resistor. Returning, he quickly soldered it into position in place of the defunct thermistor, then plugged the receiver into the mains and switched on.

After a while the e.h.t. rectifier reached operating temperature and a picture appeared on the screen. It was perfect in all respects except that the height was about two-thirds of its proper amplitude.

"That's fine," said Smyth, pleased. "It looks as though I erred a bit on the high side when I suggested a 10Ω resistor. There's no need to do any more work on that set for now, Dick. Just put it on one side till the replacement thermistor comes in."

"Okey-doke," replied Dick, switching the receiver off again. "Well, I've learnt something today, and that is that all the TV sets passing through my hands have a thermistor in series with the vertical deflector coils."

"Putting a thermistor in series with the vertical deflector coils," Smyth pointed out cautiously, "is a common practice on *later* receivers. As I said just now, quite a few alternative ideas were used when the set-makers first tried to clear frame shrinkage. Typical examples of what you'll bump into in old sets consist of having thermistors in series with the h.t. feed to the height control network (Fig. 3 (a)), or in the feedback circuit from the vertical output anode back to the grid (Fig. 3 (b)). Also, in the earlier receivers the thermistors weren't always fitted near the deflection yoke. Another point is that the thermistors used then had relatively high resistances. I should imagine that the current practice of putting the thermistor in series with the vertical coils couldn't be carried out until thermistors with sufficiently low resistances had been developed. A typical cold resistance for the thermistor in present-day circuits would be of the order of 4Ω , this dropping to about 0.3Ω at maximum operating temperature."

Return Of The Roadmen

"If that's the case," queried Dick, "why did you suggest that I put in a 10Ω resistor just now?"

"I was being ultra-cautious," confessed Smyth. "Without looking it up, I don't know what range of resistances the particular thermistor in that set is supposed to cover, and so I suggested a resistance value which could prove that the vertical deflection circuits would work without causing too much deflection current to flow. Which it did do."

Smyth rose from his stool.

"Well," he remarked, "that was an interesting little job but I must now get back to clear up some of my own stuff. I've certainly got plenty."

Smyth's last words were drowned in a sudden roar from outside, as the compressor in the street suddenly burst into action once more.

"Oh, no," yelled Smyth. "Don't tell me I've gone and wasted the only quiet period we've had today in repairing a purely visual fault!"

The Serviceman tottered, a broken man, back to his bench. As he reached it the three pneumatic drills, handled by operators who were manifestly on top of their form after their little break, burst forth with renewed vigour. The Workshop windows rattled with the nerve-shattering clatter, and Smyth gazed helplessly at all the radio receivers that were awaiting his repair. As he clapped his hands over his ears he was at least able to console himself with the thought that the last three weeks of torture must surely come to an end soon, now that the Electricity, Water and Gas authorities had all had their turns on that much disturbed section of road.

It was fortunate for Smyth's state of mind that he was not, at that moment, in the office of the local Telephone Manager. Whilst Smyth railed helplessly at the deafening din which invaded the Workshop, that worthy gentleman was thoughtfully marking off a certain section of road on a plan in front of him. A section of road which, he had decided, would *have* to be dug up in the following week . . .



NEXT MONTH . . .

The "Explorer". This is a quality 1-valve all-wave receiver specifically presented for beginner construction. Designed for headphone reception, the circuit consists of an ECC82 double-triode (detector and audio amplifier) and a metal rectifier with mains isolating transformer.

Beginner's looking for a suitable design with which to commence the hobby of radio construction should order their copy now!

Your Local Supplier

LONDON AREA

Established 1910

H. L. SMITH & CO. LTD.

Comprehensive stocks of components
by all leading makers.

287-9 EDGWARE ROAD
LONDON W.2

Tel: 01-723 5891

CRESCENT RADIO LTD

North London's electronic centre.
Quality components at competitive
prices.

Transistors, Diodes, Valves,
Speakers, Resistors, Condensers,
Cables, Plugs and Sockets, etc., etc.

40 MAYES ROAD,
WOOD GREEN,
LONDON, N.22

THE MODERN BOOK CO.

Largest selection of English and
American radio and technical books
in the country.

19-21 PRAED STREET,
LONDON, W.2

Tel: PADDington 4185/2926

TELERADIO ELECTRONICS

For Radio Control Devices, Miniature
components, Special Transistors,
Circuits and data on boat and
aircraft control.

(S.A.E. Enquiries REF. D/P)

325/7 FORE STREET,
EDMONTON (3719)
LONDON, N.9.

Radio Topics

by Recorder

A SHORT-TERM FREQUENCY STABILITY of the order of 1 part in 100,000,000 seems, to my mind, to represent an exceptionally high standard in any context. But when that frequency stability is achieved in an oscillator unit measuring only 3 x 1 x 1in, which offers a 1 volt peak-to-peak sine wave into 50Ω, and which is intended for such rough-and-tumble applications as military man-pack radio equipment, then the Recorder tither becomes elevated to its greatest altitude.

Microminiaturisation

This new advance in oscillator design is announced by the Marconi Company Ltd., who have developed the unit specifically for military and civil aerospace use and for portable military equipment. Modern usages in these fields include single-sideband transmission and reception, whereupon it becomes necessary to have available an oscillator having an exceptionally high frequency stability with, preferably, a very low power requirement. The maximum power consumed by the new Marconi module (at -55°C ambient temperature, when the crystal heating

element is working all out to maintain crystal temperature) is only 500mW from a 12 volt d.c. source.

The secret behind this performance is microminiaturisation. Frequency control is given by a tiny quartz crystal about $\frac{3}{16}$ in in diameter, this being cold-welded into a TO5 transistor can in company with a thermistor and a microcircuit which acts partly as a heating element. This microcircuit also operates as a sensitive amplifier for the varying resistances in the thermistor caused by different outside temperatures. Since the crystal has an extremely low thermal capacity, it is possible to obtain virtually constant crystal temperature over a very wide range by means of this technique.

To isolate the crystal and its associated heater circuitry from the outside environment, the TO5 can is mounted inside an evacuated glass envelope, the lead-out wires to the glass base consisting of fine-drawn platinum. These give a good electrical connection whilst keeping thermal losses to a minimum. The crystal, in fact, maintains its frequency stability over a temperature range from -55°C to +90°C.

The long-term stability of the Marconi unit is ± 5 parts in 1,000,000, taking into account all causes liable to shift frequency over a period of 6 months, whilst frequency range lies between 10 and 15 Mc/s.

Microelectronics is becoming pretty commonplace these days, but an application which allows a microcircuit to function as crystal heater and heater amplifier, with all parts enclosed in a TO5 can, is an approach which, to say the least, deserves full commendation.

Hand-Worn File

Not exactly in Mary Quant's latest collection, but definitely *de rigueur* for the handyman, is the

WHY BI-PAK? FOR SEMICONDUCTORS

- ★ Fastest by return mail service
- ★ Lowest possible prices
- ★ Largest range available
- ★ Satisfaction guaranteed
- ★ For further proof see page 582

BI-PAK SEMICONDUCTORS
8 Radnor House,
93/97 Regent St., London W.1

new Rawflex File now introduced by the Rawplug Company. This new file, made of carbon steel ribs on a canvas sleeve backing, is designed to fit over the four fingers of the hand like a mitten. Alternatively, a block of wood can be inserted into the sleeve, or it can be folded and held in the hand to make it into a rigid file.

When worn on the hand, the Rawflex File can be used in rather the same way as emery cloth is used, except that the abrasive action is much tougher and it stays automatically in place. It is particularly useful for materials such as wood, Formica and fibre-glass.

The Rawflex File has been developed by the inventor of the well-known Abraflex, and it retails for 4s. 6d.

Forward And Reverse

If you do any TV servicing, a point to watch out for in transistorised television circuits is the existence of a form of automatic gain control which is different to that you may have already become used to from experience with a.m. transistor radios. This alternative form of automatic gain control has been mentioned from time to time in the technical press (indeed, Gordon J. King referred to it in his article "Transistorised Television Circuits" Part 1, way back in our November 1963 issue) but most of the people I bump into don't seem to have heard about it.

The familiar type of transistor automatic gain control consists of a circuit which reduces the base current of a transistor amplifier as signal strength increases. If we have a transistor radio using p.n.p. transistors in the i.f. stages, the detector diode is so connected that the rectified signal voltage is positive. A proportion of this positive voltage is then fed back to the bases of the controlled transistors to form an a.g.c. loop. When signal strength increases, so also does the positive a.g.c. voltage. In consequence, less bias current flows in the base circuits of the controlled transistors and their gain decreases to counteract the increase in signal strength.

This method of automatic gain control is reminiscent of that used in valve circuits, where an increase in signal strength causes the valve grids to go more negative. In both cases the controlled electrodes (grids or bases) are taken nearer to cut-off with increase in signal strength. With transistors, this type of control is known as "reverse a.g.c."

The newer type of automatic gain control works in the opposite

direction. As with reverse a.g.c. the controlled transistor is initially biased to offer maximum gain at minimum signal strength, but as signal strength increases the a.g.c. voltage causes the transistor to go towards saturation, instead of towards cut-off. Where, with reverse a.g.c. you might have a positive-going a.g.c. voltage, with the newer type of a.g.c. the control voltage would be negative-going, and vice versa. To understand why transistor gain reduces as base current increases, it is helpful to assume that a signal applied between base and emitter passes through a series resistance, given inside the transistor by the resistance between the base and the base-emitter junction, before it actually encounters the base-emitter junction itself. This series resistance remains fairly constant with increasing base current, but the impedance of the junction decreases as base current goes up. There is, therefore, a potentiometer effect, and the signal voltage appearing across the junction proper decreases as base current increases (and base-emitter junction impedance decreases). This method of gain control is known as "forward a.g.c." As I mentioned just now, to operate a transistor in a forward gain circuit you must first of all bias it so that it offers maximum gain for minimum signal input. When signal strength increases, the forward a.g.c. causes base current to increase and gain to fall in consequence.

The main advantage of using forward a.g.c. is that a relatively heavy current is always flowing in the base-emitter junction of the transistor and there is little risk of this being exceeded by a heavy signal current, as may occur with a reverse controlled transistor which is near cut-off. Because of this, cross-modulation is much less likely to occur—an important point in television r.f. and i.f. amplifier transistors which have to handle both the sound and vision signals.

I see that the latest American transistorised circuits for colour TV use forward a.g.c. circuits, with transistors specifically intended for this mode of operation. Also, the recently introduced Mullard transistorised u.h.f. tuner type AT6380/02 is similarly intended for forward a.g.c.

So if, when prodding around in a recalcitrant transistorised TV, you find that some of the transistors draw increased current as signal strength goes up, don't delude yourself that you've suddenly located the snag. It is very probable that

Your Local Supplier

LONDON AREA

G. W. SMITH & Co (Radio) Ltd.

3-34 LISLE STREET,
LONDON, W.C.1.
Tel. GERrard 8204/9155
Open 6 days a week

CATALOGUE

Over 150 pages of electronic components, test, communication and Hi Fi Equipment. Fully illustrated. 5/- p & p 1/-

ELECTRONICS GALORE!

in the NEW

dca CATALOGUE

Send 1/6 now for your copy
to: DEPT. R/C

dca ELECTRONICS LIMITED

28 UXBRIDGE ROAD,
EALING, W.5

ESSEX

ELECTRONIC COMPONENTS

Valves, transistors, capacitors,
transformers, amplifiers,
tuners, etc., etc.

765 HIGH ROAD,
SEVEN KINGS
(opp. Seven Kings Hotel)
ILFORD, ESSEX

Telephone: GOOdmayes 1826

MARKET CENTRE For Semiconductors

Prompt, efficient mail order service for Mullard, Newmarket, Texas, Sinclair, S.T.C., Fairchild Semiconductors. We also offer a comprehensive selection of miniature components for transistor circuitry. Catalogue 1s.

L.S.T COMPONENTS
23 New Rd., Brentwood, Essex

Your Local Supplier

HAMPSHIRE

GLADSTONE RADIO

66 ELMS ROAD,
ALDERSHOT, HANTS.
Tel. 22240

Valves, Capacitors, Amplifiers,
Resistors, Transistors.

We operate a "By Return" Mail
Order Service. Catalogue 1/-

LANCASHIRE

BERWICK ELECTRONICS LTD.

Stockists of radio components for
the constructor. Cabinet coverings—
Tygan, Vynair, Metal Fret etc.

100 Tib Street, Manchester 4
Telephone Blackfriars 4416

NEW CROSS RADIO

Electronic components and
Equipment,
Transistor Panels,
all at competitive prices

6 Oldam Road, Newcross
Manchester 4

Telephone CEN 1541

SURREY

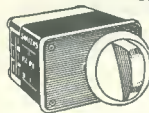

SMITHS PRECISION 6 MINUTE DELAY ACTION SWITCH

Clockwork actuated
10/6 EACH
Post 2/6
(3 or more post free)

Separate switching up to 6 mins. Each action
for loading up to 15 amps, 250 volts. For
photographic timer, sequence switching opera-
tions, etc., etc. Brand new units at a fraction
of their value. Connection sheet supplied.

Radio Component Specialists
337, WHITEHORSE ROAD,
WEST CROYDON, SURREY
THO 1665 — LIST 1/-

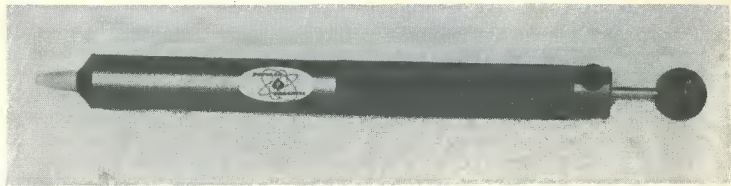

The new Picard de-soldering solution pump. The piston is released by pressure on a button catch, and the pump can be held and operated in one hand

that's the way those transistors are intended to behave!

Surplus Solder Pump

My accompanying illustration shows a new solder remover which will be particularly helpful in clearing surplus molten solder from printed circuit boards.

In this de-soldering pump suction is created by a powerfully sprung piston, which is released by pressure on a button catch. The solder is drawn through a pointed nozzle, being ejected on the return of the piston. A useful advantage is that simple one-hand operation is all that is required.

The pump is available from Henri Picard & Frère Ltd., 34/35 Furnival Street, London, E.C.4.

Slipping Slugs

And now, to conclude with, here's a little two-part tip which will be helpful if you ever encounter the infuriating situation where the brass or aluminium oscillator slugs in v.h.f. television tuner units start slipping into their formers as you try to adjust them.

The slipping slugs are normally encountered in s.r.b.p. coil formers having internal projections pressed in to take the thread of the slug. (The term "s.r.b.p.", by the way, stands for "synthetic resin bonded paper"; in home-constructor circles this material is usually referred to as "Paxolin".) Quite often the internal projections in the s.r.b.p. are weak and badly formed whereupon, on applying a screwdriver, the slug suddenly disappears into the depths of the former.

The first part of the dodge consists of removing the slug from the former, whilst the second part

has to do with re-inserting it so that it doesn't slip again. To remove the slug, lightly press the blade of a small screwdriver against the coil former at the point where the slug has come to rest. Care should, of course, be taken to ensure that no damage to coil windings results whilst doing this. Applying the screwdriver blade distorts the coil former and gives sufficient purchase to enable the slug to be gently screwed out. If the slug has slipped a long way into the former, the screwdriver blade will have to be placed at several successive points along the former as the slug becomes removed.

After having removed the slug it is next necessary to re-insert it and adjust it to the desired position without any further slipping. Take a piece of very thin paper, tear off a strip about $\frac{1}{8}$ in wide, pop it into the former and then insert the slug. The thickness of the paper will give the slug enough purchase for it to be successfully screwed into its final position. Cigarette paper is the best for this operation, and a packet of cigarette papers can be bought at the tobacconist's for several coppers only. In cases where the slug is very loose, two thicknesses of paper may be needed.

I wouldn't, incidentally, advise the use of the cigarette paper idea for slipping iron-dust cores. Iron-dust cores have much rougher surfaces than have brass or aluminium slugs, and can cause the paper to fold on itself as the core is turned. The result may well be that the core gets tightly jammed in the former. But with brass or aluminium slugs the cigarette paper scheme works very well indeed.



Transistor Direct-Reading Frequency Meter

It is regretted that, in the article under this title which appeared in the March 1967 issue, no value was specified for C₁₂. This component is a "speed-up capacitor" and its value may lie between 330 and 470pF.

Denco (Clacton) Limited

357-9 Old Road Clacton-on-Sea Essex Tel. Clacton 22807

In a piece of Electronic Equipment at Harvard University of America, London University of England, countless Equipments in our Fighting Services, Ships, Aircraft and Automation you will trace components being the handwork of our Craftsmen. In the records of some of our Country's Greatest Manufacturers of Electronic Equipments, which are reliable and World Renowned we are recognised for our Quality —Reliability and reasonable prices.

In many of the finest Home Constructor Technical Articles published by this Magazine and which for many years has encouraged the terrific growth of our Great Electronic Industry and Export Business, you will find mention of our products.

In these facts we take great pride. In the ownership of our products you may enjoy equal pride plus the guarantee of quality and long life.

Send 6d. in stamps for price list of components used in Articles or 2s. 6d. for comprehensive catalogue and, please, the courtesy of an S.A.E. with all other queries.



Happy Families

These are the times when Simon and Clare know that it has all been worthwhile. But they know too that such moments of happiness are only complete when there is also a feeling of security for the future. And Simon's "Family Unit" Policy with the "Yorkshire" guarantees them *all* a future — if the worst should happen.

Happiness in *your* family too—but for how long? If you or *your wife* should die, how would the rest of the family fare? A Yorkshire "Family Unit" policy provides for both these eventualities in a comprehensive way at a sensible premium. Just ask for a leaflet at your local "Yorkshire" branch and then see the manager. He'll be glad to tell you why . . .

it's **YORKSHIRE** for **INSURANCE**

THE YORKSHIRE INSURANCE COMPANY LIMITED

Chief Offices: Rougier Street, YORK
and Becket House, 36-37 Old Jewry, LONDON, E.C.2.

Branches and Agencies throughout the world

Please send me details of the Family Unit Policy, without obligation.

Name.....

Address.....

J.B.

THE MODERN BOOK CO

The Radio Amateur's Handbook. By A.R.R.L. 1967 ed. 40s. Postage 4s.

Transistor Electronic Organs for the Amateur. By A. Douglas & S. Astley. 18s. Postage 1s.

Transistors for Technical Colleges. By L. Barnes. 25s. Postage 1s.

Guide to Broadcasting Stations. Compiled by "WW". 6s. Postage 6d.

Building Your Amateur Radio Novice Station. By H. S. Pyle. 28s. Postage 1s.

Wireless for Beginners. By C. L. Boltz. 18s. Postage 1s.

The Radio Amateur's V.H.F. Manual. By A.R.R.L. 18s. 6d. Postage 1s. 3d.

Tape Recorder Servicing Manual. By H. W. Hellyer. 63s. Postage 2s.

Radio Handbook. by W. I. Orr. 104s. Postage 3s.
Car Radio Servicing Made Easy. By W. Lenons. 24s. Postage 1s.

Rapid Servicing of Transistor Equipment. By G. J. King. 30s. Postage 1s.

Understanding Amplitude Modulation. By I. M. Gottlieb. 25s. Postage 1s.

Colour Television. By W. A. Holm. 21s. Postage 1s.

Radio Television and Electrical Repairs. By R. C. Norris. 50s. Postage 2s. 6d.

Questions and Answers Audio. By C. Brown. 8s. 6d. Postage 6d.

2-Way Mobile Radio Handbook. By J. Helmi. 30s. Postage 1s.

Questions & Answers Radio & Television. By H. W. Hellyer. 8s. 6d. Postage 6d.

Radio Valve Data 8th ed. Compiled by "WW". 9s. 6d. Postage 1s.

We have the Finest Selection of English and American Radio Books in the Country

19-21 PRAED STREET (Dept RC) LONDON W2

Telephone PADdington 4185

Fast Mail Order for the Amateur Radio Enthusiast!

AERIAL EQUIPMENT

TWIN FEEDER. 300 ohm twin ribbon feeder similar K25, 8d. per yard. 75 ohm twin feeder, 6d. per yard. Post on above feeders and cable, 2/- any length.

COPPER WIRE. 14G, H/D, 140 ft., 30/-; 70ft., 16/-. Post and packing 3/3. Other lengths pro rata.

FEEDER SPREADERS. 6" Ceramic type F.S., 10d. each. Postage 2/6 up to 12.

CERAMIC CENTRE PIECE for dipoles, Type AT, 1/6 each. P. & P. 1/-.

2 METRE BEAM, 5 ELEMENT W.S. YAGI. Complete in box with 1" to 2 1/2" masthead bracket. Price 56/-. P. & P. 4/-.

SUPER AERAXIAL. 70/80 ohm coax. 300 watt very low loss, 2/3 per yard. 50 ohm 300 watt, 2/6 per yard. P. & P. 2/6.

TOUGH POLYTHENE LINE, type ML1 (100lb.), 2d. per yd. or 12/6 per 100 yds. Type ML2 (220lb.), 4d. per yd. or 25/- per 100 yds., ML4 (400lb.), 6d. per yd. ideal for Guys, L.W. Supports, Halyards, etc. Postage 1/6 on all line.

MIDLAND AGENTS FOR

EDDYSTONE

Receivers & Components

Transmitters, Receivers and Sundry Equipment by

- KW ELECTRONICS
- GREEN E.C.E.
- T.W. ELECTRONICS
- CODAR RADIO
- C.S.E.

NEW BOXED VALVES

3/6 each, 4 for 10/-. P. & P. 2/-.

TYPES

6N7GT	6SF7	6AB7	6SH7
6AC7	6F7	6SK7	956
6K7			

ABSORPTION WAVEMETERS, 3.00 to 35.00 Mc/s in 3 Switched Bands. 3.5, 7, 14, 21 and 28 Mc/s. Ham Bands marked on scale. Complete with indicator bulb. A MUST for any Ham Shack. ONLY 25/- EACH. Post free.

BANDCHECKER MONITOR, 3.00-35.00 Mc/s in 3 switched bands. 0-1 mA indicator. Monitor socket. Very sensitive. £3/13/6. P. & P. 3/6.

VARIABLE CONDENSERS. All brass with ceramic end plates and ball race bearings. 50pF, 5/9; 100, 6/6; 160, 7/6; 240, 8/6; and 300pF, 10/6. Extension for ganging. P. & P. 2/-.

SEALED RELAYS, 12v. 105Ω Coil Type A. 4 Pole, C.O. 15/-. Type B.2 Pole, C.O. + 2 Pole Norm. on, 12/6. P. & P. 1/6.

AMATEUR RADIO
CHAS. H. YOUNG LTD.

At your service G2AK, G3LAY, G3VFF
Please print your address. No. C.O.D. under £1.

The Widest Range in the Midlands

- ★ HIRE PURCHASE
- ★ PART EXCHANGE

Chas. H. YOUNG Ltd.

170-172 Corporation Street,
Birmingham 4

'phone 021-236 1635

Radio Control

SINGLE CHANNEL TRANSMITTER

TYPE 200

Parts £9. 15. 0d.



**MATERIALS AVAILABLE FOR ALL DESIGNS
EXPLAINED IN THIS MAGAZINE.
QUOTATIONS ON REQUEST**

BOOKS

Single channel R/C 6/9 post free
Multi channel control 13/6 post free
Model boat control 8/6 post free
Radio control components 1/-
Full lists on transmitters and receivers 1/-.

Get into this interesting hobby now

**TELERADIO ELECTRONICS,
325/7 FORE STREET, EDMONTON,
LONDON, N.9.**

DICTIONARY OF RADIO AND TELEVISION

W. E. Pannett, A.M.I.E.E.

This fully illustrated dictionary provides extended definitions of thousands of specialised words, terms, and abbreviations in use today in radio and television. Includes elementary terms and basic concepts, fundamental electrical and electronic terms; units, electronic devices, including valves and transistors; radio-telegraphy and radio-telephony; monochrome and colour television; sound and high fidelity reproduction; transmission lines, wave-guides; communication satellites; aerials, transmitters, etc. *380 pages, 220 line illustrations.* 36s.

*From all booksellers or in case of
difficulty by post 38s. from:*

GEORGE NEWNES LTD.

TOWER HOUSE, SOUTHAMPTON ST., W.C.2.

SITUATIONS VACANT

Ferranti EDINBURGH

Publications Department

DEVELOPMENT ENGINEERS

are continually sought—who are prepared to switch their activities from current design and development to writing about these advanced designs and developments.

We are looking for practising engineers with a degree or H.N.C. to join our teams of technical authors for the creation of Technical Manuals, to cover a wide field of new equipment being developed for the Military and Commercial markets.

This is a new profession whose expansion is taxing the rate of entry; thus offering good prospects for the future. It also offers the unique opportunity of obtaining a wide knowledge of the Company's products—design and operational requirements, production techniques, field operation and maintenance and factory overhaul.

Although we do not teach English, we train all new entrants in the science of publications, from the art of gathering information from designers to the printing and binding of the published volume—we back our authors with a complete publishing organisation.

Interviews can be arranged in London, Manchester or Edinburgh, to suit convenience of applicants.

Please send brief details of career to date to the Staff Appointments Officer, Ferranti Ltd., Ferry Road, Edinburgh, 5, quoting Ref. TA/111.

NEW STYLE SELF-BINDER for "The Radio Constructor"

The "CORDEX" Patent Self-Binding Case will keep your issues in mint condition. Copies can be inserted or removed with the greatest of ease. Rich maroon finish, gold lettering on spine.

Specially constructed Binding Cords are made from Super Linen of great strength, very hard twisted and twice doubled. They

are attached to strong RUSTLESS Springs under tension, and the method adopted ensures PERMANENT RESILIENCE of the Cords. Any slack that may develop is immediately compensated for, and the Cords will always remain taut and strong. It is impossible to overstretch the springs, as a safety check-device is fitted to each.

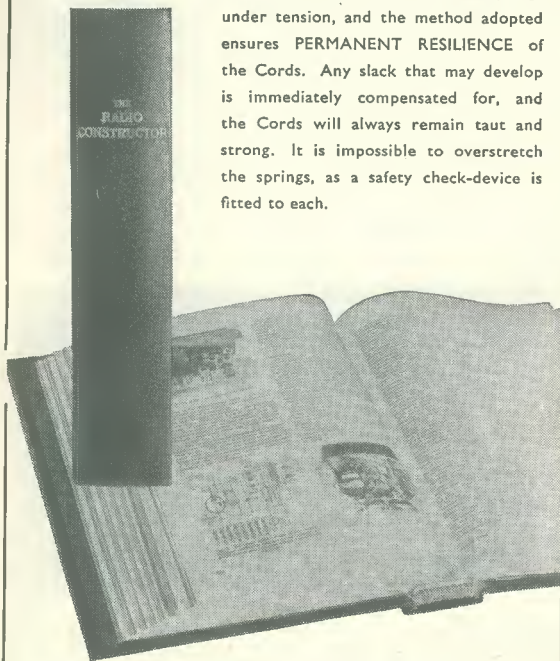

For your other magazines see opposite

PRICE **15/-** Post Free

Available only from:—

Data Publications Ltd.
57 Maida Vale London W9

SMALL ADVERTISEMENTS

continued from page 637

BRIGHTEN UP YOUR ADVERTISING! Break the ice with a cartoon, "tailor made" for your product. Reasonable charges. Box No. F294.

"MEDIUM WAVE NEWS" Monthly during DX season—Details from: B. J. C. Brown, 60 White Street, Derby.

JOIN THE INTERNATIONAL S.W. LEAGUE. Free Services to members including Q.S.L. Bureau. Amateur and Broadcast Translation. Technical and Identification Dept.—both Broadcast and Fixed Stations, DX Certificates, contests and activities for the SWL and transmitting members. Monthly magazine, *Monitor*, containing articles of general interest to Broadcast and Amateur SWLs, Transmitter Section and League affairs, etc. League supplies such as badges, headed notepaper and envelopes. QSL cards, etc., are available at reasonable cost. Send for League particulars. Membership including monthly magazine, etc., 35s. per annum.—Secretary, ISWL, 60 White Street, Derby.

WANTED. P. Jenkin, 16 Trelawney Road, Camborne, Cornwall, would buy TP20P model Valradio tuner. Good working order, for Magnaview TV.

BOOKS FOR SALE. *Fundamentals of Modern Semiconductors*, Kemp & McDonald, 13s. *Hi-Fi Projects for the Hobbyist*, Fieldman, 10s. *Transmitting Valves*, Heyboer & Zijlstra, 10s. 6d. *Radio Operating Questions & Answers*, Nilson, 5s. 6d. *Television Receiver Design*, Neeteson, 7s. 6d. *Germanium Diodes*, Philips, 3s. 6d. *Electronic Valves in A.F. Amplifiers*, Rodenhuis, 3s. 6d. *Tubes for Computers*, Philips, 5s. 6d. *Industrial Rectifying Tubes*, Philips, 5s. 6d. *U.H.F. Tubes for Communication and Measuring Equipment*, 5s. 6d. All post free. Box No. F297.

ASSORTED VALVES. Mostly new and boxed. All tested. Receiving, transmitting, ex-Government, etc. 20s. per dozen plus 3s. 6d. p. & p.—Box No. F298.

WANTED. V.H.F. Explorer, voice switch, time delay switch, transducer transmitter, or could anyone build same.—Thomas, 13 Sydney Road, Marton, Middlesbrough, Yorks.

FOR SALE. Mullard circuit amplifiers: Mono 10 watt, £10, stereo 3 watt, £9. Heathkit transistor tester, ex-factory, as new, £20 o.n.o. F.M. tuner, £6. Stereo decoder, £6. A. F. signal gen. sine/square 20 Mz-250 KHz, £10.—P. D. Coker, 54 Beaumont Avenue, St. Albans, Herts.

THE RADIO CONSTRUCTOR. Wanted, back copies August 1963 to July 1964 and August 1964 to July 1965.—Mr. B. W. Hughes, 11 Henley Road, Ludlow, Shropshire.

WANTED. Alco/Sirius steam portable generator, made by Lyons Co., as used in WW2 for battery charging by troops in Burma.—Box No. F299.

FOR SALE. Japanese dynamic microphone and stand. Small, neat unit. Hand held mic. Piezo make, £3.—Box No. F300.

MICRO-TRANSMITTER. Measures only 1½ x 1 x ¾in without case. A really sub-min FM transmitter. With instructions and circuit, 45s. post free. (Mr. Bobker) Box No. F301.

continued on page 639

SMALL ADVERTISEMENTS

continued from page 638

MICROPHONES. Crystal, stick, with anodised keyhole stand, outside customers' limits but guaranteed working order, from known manufacturer, 10s. 6d. each, p. & p. paid.—Box No. F302.

18 S.W.G. ALUMINIUM CHASSIS. Four sizes available. Hammer sprayed, drilled, punched to requirements. Full details on application.—Box No. F303.

ESSEX GARDENERS. Buy your bedding and rock plants, shrubs, etc., also cacti, from May's Nurseries, 608 Rayleigh Road, Hutton, Brentwood, Essex. Callers only, Monday to Saturday.

RESISTORS, CARBON FILM, LOW NOISE

¼w., 10%, 2/- doz., 15/- 100. ½w. 5%, 2/3 doz., 17/3 100.
Values 4.7Ω to 10MΩ to your choice.

(12 preferred values per decade only)
Many transistors in stock. Send for catalogue, 6d.
Examples: 2N1304/5, 4/- each; BC108, 5/6 each.

ELECTROVALUE

6 MANSFIELD PLACE, ASCOT, BERKSHIRE

**300 ASSORTED HIGH STABILITY
RESISTORS, 5% (¼, ½, 1 Watt,
WORTH £3).....15/-**

(P & P 1s. 6d. for one or more packs). C.W.O.
Elmbridge Instruments Ltd. Island Farm Avenue
West Molesey Surrey

RESISTORS

½ Watt carbon film 5%.

All preferred values in stock from 10 Ohms to 10 meg Ohms 2d. each.

Send S.A.E. for free sample. . . .

CAPACITORS

Mullard Miniature Metalised

Polyester P.C. Mounting all 250V D.C. working
.01mf .022mf .047mf .1mf .22mf all 6d. each.

Please include 1/- for postage and packing on all orders under £1.

Dept. RC 2.

BRENSAL ELECTRONICS LTD.
Charles Street, Bristol, 1.

RADIO MODELLER

"the magazine
for the
practical
enthusiast"

★ LATEST TRENDS & TECHNIQUES
in RADIO CONTROL

● CIRCUITS ● TESTS ● DESIGNS

2/6d monthly — send 6d stamp for free specimen copy!

64 WELLINGTON ROAD, HAMPTON HILL, MIDD.

PLAIN-BACKED NEW STYLE SELF-BINDERS

for your other magazines

(max. format 7½" × 9½")



The "CORDEX" Patent Self-Binding Case will keep your copies in mint condition. Issues can be inserted or removed with the greatest of ease. Rich maroon finish. Specially constructed Binding Cords are made from Super Linen of great strength, very hard twisted and twice doubled. They are attached to strong RUSTLESS Springs under tension, and the method adopted ensures PERMANENT RESILIENCE of the Cords. Any slack that may develop is immediately compensated for, and the Cords will always remain taut and strong. It is impossible to overstretch the springs, as a safety check-device is fitted to each.

PRICE **14'6** Post Free

Available only from:—

Data Publications Ltd.
57 Maida Vale London W9

DATA BOOKS SERIES

NEW REVISED AND ENLARGED EDITION

DB5 TV Fault Finding

124 pages. Price 8/6, postage 8d.

Profusely illustrated with photographs taken from a television screen depicting the faults under discussion and containing a wealth of technical information, with circuits, enabling those faults to be eradicated. Now includes B.B.C.II as well as B.B.C.I and I.T.A.

"... A book that should be in every television dealer's service workshop, and in every home-constructor's, for that matter."—*Journal of the Television Society*.

DB6 The Radio Amateur Operator's Handbook

64 pages. Price 5/-, postage 5d.

Contains Amateur Prefixes, Radio Zone Boundaries, Amateur Band Frequency Allocations, Call Areas, Charts and Maps, Areas, Codes, Mileage Tables, Prefixes/Directional Bearings, Post Office Regulations, and much other useful operating data. For the beginner there are notes on how to use the mass of information given to obtain the greatest satisfaction from the hobby.

"... For concise knowledge in this field a few shillings well worth spending."—*Electronics* (Australia).

DB14 Short Wave Receivers for the Beginner

72 pages. Price 6/-, postage 6d.

Contains a selection of both battery and mains operated short wave receivers, circuits, point-to-point wiring diagrams and many illustrations. Introductory chapter gives much information on the Short Wave Spectrum, Clubs, QSL'ing, Aerials, Amateur and Broadcast Band Listening, Frequencies, etc.

This book has been specially prepared for the beginner interested in short wave receiver construction and operation.

DB15 Twenty Suggested Circuits

48 pages. Price 3/6, postage 5d.

By G. A. French. Covers subjects ranging from electronic laboratory equipment to the simplest of periodic switches. Includes: simple and inexpensive two-valve capacity bridge, short wave regeneration preselector, one-valve speech operated switching circuit, transformer ratio analyser, series noise limiter, receiver remote mains on-off control, and many other circuits.

DB16 Radio Control for Models

192 pages. Price 15/-, postage 9d.

By F. C. Judd. Contains both theory and practical designs of simple and advanced transmitters and receivers; basic concepts, aerials, uses of radio components, transistorised receivers, multi-channel operation, etc. Sections on servo-mechanisms by Raymond F. Stock.

More than 200 illustrations. Circuits, photographs, tables and working diagrams.

DB17 Understanding Television

512 pages. Price 37/6, postage 3/-.

By J. R. Davies. This book, which deals with the principles of 625 line reception as fully as 405 line reception, fully explains: the nature of the television signal; the cathode ray tube; receiver tuner units; receiver i.f. amplifiers; a.f. and video amplifiers; vertical and horizontal timebases; deflector coil assemblies; synchronising; automatic gain and contrast control; power supplies and receiver aerials. Also includes a comprehensive introduction to colour television.

"... one of the best books that aims to explain television in simple language. . . ." R.S.G.B. Bulletin.

I enclose Postal Order/Cheque for..... in payment for.....

NAME

ADDRESS

(Please use Block Capitals for both name and address)

Postal Orders should be crossed and made payable to Data Publications Ltd.

Overseas customers please pay by International Money Order

All publications are obtainable from your local bookseller

Data Publications Ltd., 57 Maida Vale, London W.9

