

INDEX Vol. 19

INCLUDED **FREE** IN NEXT ISSUE

Vol 19 No 11

**JUNE 1966**

**2/3**

A DATA PUBLICATION

# THE Radio Constructor

RADIO · TELEVISION  
ELECTRONICS · AUDIO

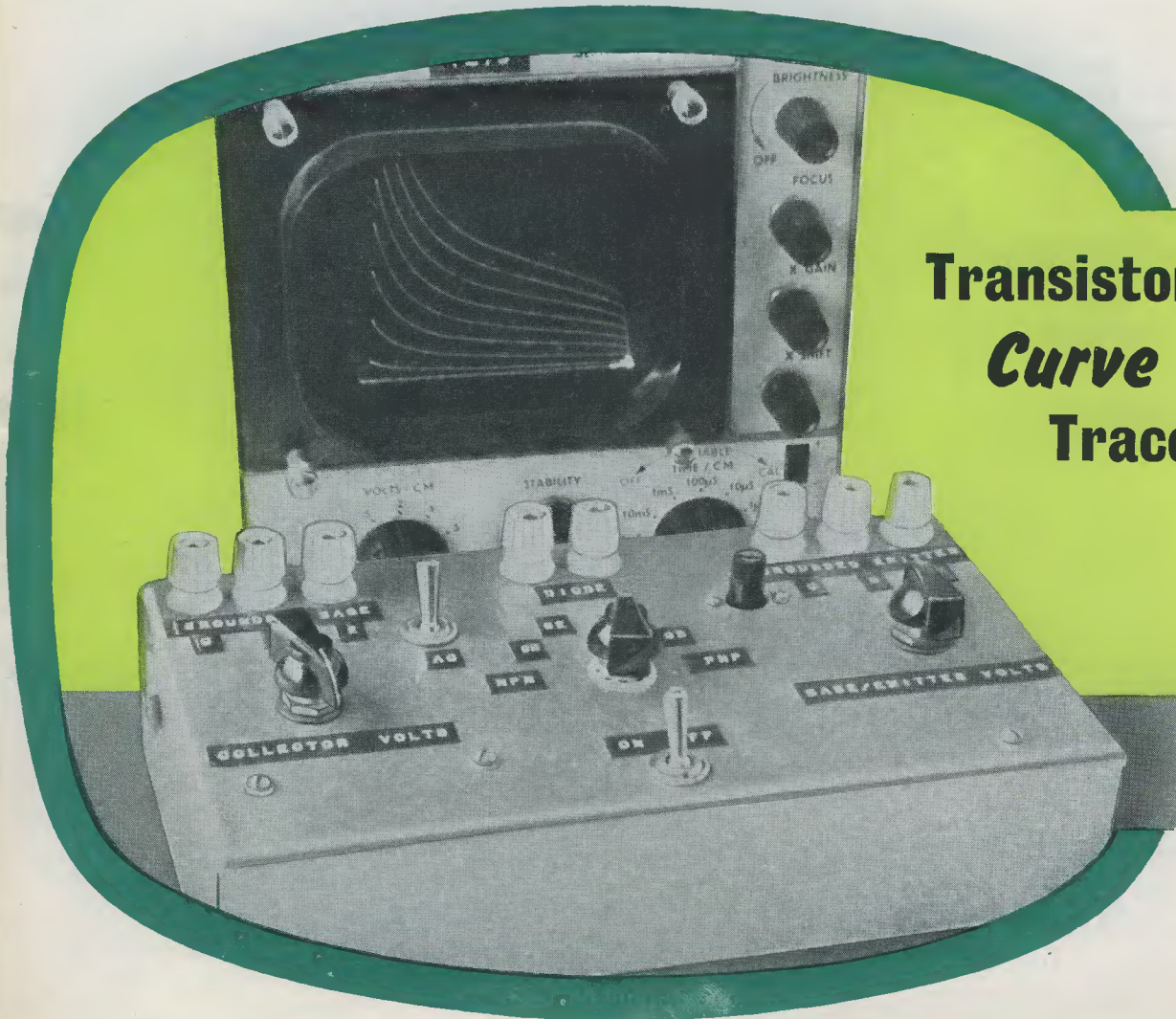

## Transistor *Curve* Tracer

Experimental Transistorised  
Time Switch



Record-Player  
Amplifier



Tape Accessories  
Without Batteries



Improved Volume  
Control



# Eddystone

HIGH STABILITY  
AMATEUR BANDS  
COMMUNICATIONS RECEIVER

**EA 12**  
**£185**

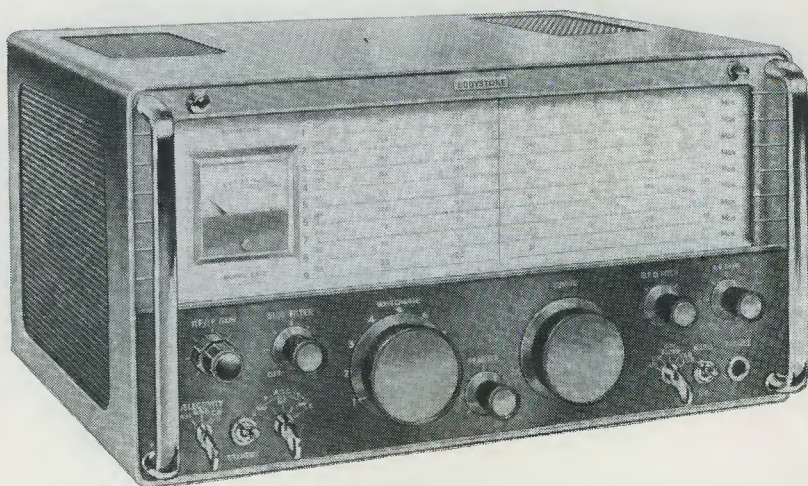

The Eddystone "EA12" receiver is specially designed and built to give the extremely high performance, allied with ease of control, necessary for communications on the amateur bands under present-day conditions. With the many refinements included, this model will produce first-class results with all modes of signal.

The first oscillator is crystal controlled. The oscillator which is tuned simultaneously with the first intermediate frequency section has very high stability, as is so essential with reception of s.s.b. and c.w. signals. The correct degrees of selectivity for optimum performance are obtained in the second intermediate frequency (100 kc/s) stages.

A more than adequate degree of bandspread is provided by the superb slow-motion drive (140/1 reduction ratio) in conjunction with the wide linear scales, each of which covers 600 kc/s. A crystal calibrator and cursor adjuster permit accurate frequency resolution.

Other features to note—full coverage on six amateur bands; switched sideband selection; fine tuning control (s.s.b.); crystal filter; deep slot filter; noise limiter effective all modes; large "S" meter; two AGC time-constants; independent gain controls; stand-by sensitivity control; bright scale illumination; robust construction; modern styling and fine finish.

*Comprehensive information obtainable from any Eddystone Distributor or from the Manufacturers*

## **Eddystone Radio Limited**

Eddystone Works, Alvechurch Road, Birmingham 31

Telephone Priory 2231 Cables Eddystone Birmingham Telex 33708

LTD/ED6

# Sinclair Z.12

COMBINED  
12 WATT  
AMPLIFIER  
AND PRE-AMP

For size alone, the Z.12 marks an important advance in quality design, for its amazing compactness opens up exciting new vistas in amplifier housing and application. Combined with this are the fantastic power and superb quality of the Z.12 which can provide an effortless output of 12 watts R.M.S. continuous sine wave from its unique eight transistor circuit. Basically intended as the heart of any good mono or stereo hi-fi system, the size and efficiency of this Sinclair unit make it equally useful for a car radio (with the Micro-6 for example), a high quality radio with the Micro FM, in a guitar, P.A. or intercom system, etc. Other applications are certain to suggest themselves to constructors. The manual included with the Z.12 details many mono and stereo tone and volume control circuits by which inputs can be matched (and switched in) to the pre-amp. The size, performance and price of the Z.12 all favour the constructor seeking the finest in transistorised audio reproduction—it is in fact today's finest buy in top grade high fidelity.

## NEW A UNIQUE TRANSISTORISED POWER SUPPLY UNIT SINCLAIR PZ.3

The SINCLAIR PZ.3 Power Supply Unit uses new and original circuitry based on advanced transistorised techniques to achieve phenomenally good smoothing and thus assure ideal operating conditions for the Z.12 for which it was designed. Ripple is a barely measurable 0.05V and the PZ.3 will power two Z.12s with ease. Output—20V d.c. For A.C. Mains Operation 200–250V.

**79/6**

## SINCLAIR MICRO-6

The  
smallest  
set  
in  
the  
world

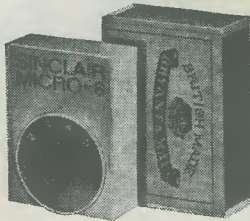

For power, selectivity and quality, this amazing six stage M.W. receiver is unequalled. 2 stages R.F. amplification, double diode detector, 3 stage A.F. amplifier, A.G.C. etc. Complete with self-contained aerial in white, gold and black case, size 1 1/2" x 1 3/10" x 1/2". Plays anywhere. Very easy to build. Complete kit of parts with ear-piece and instructions.

**59/6**

MALLORY MERCURY CELL ZM.312 (2 required) each 1s. 11d.

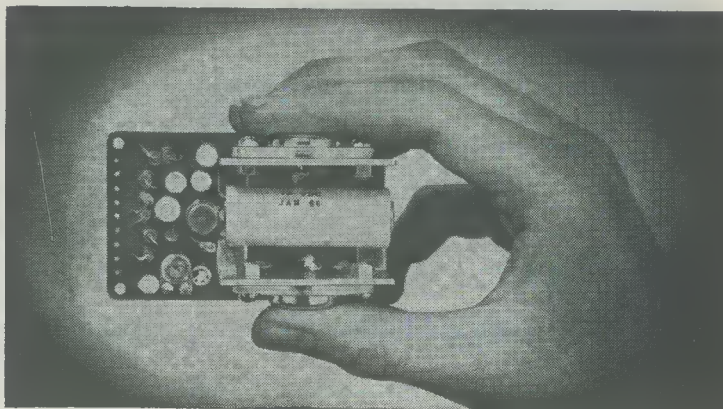

## 12 WATTS R.M.S. OUTPUT CONTINUOUS SINE WAVE (24 W. PEAK) 15 WATTS R.M.S. MUSIC POWER (30 WATTS PEAK)

- 8 special HF transistors.
  - Ultra-linear class B output and generous neg. feedback.
  - Response—15 to 50,000 c/s  $\pm$ 1dB.
  - Output suitable for 3, 7.5 and 15 ohm loads. Two 3 ohm speakers may be used in parallel.
- USE IT FOR HI-FI, RADIO, GUITAR, INTERCOM, P.A. etc.
- Input—2mV into 2K ohms.
  - Signal to noise ratio—better than 60dB.

Ready built, tested and guaranteed with Z.12 manual

**89/6**

## Sinclair MICRO FM

COMBINED POCKET SIZE FM TUNER/RECEIVER

For less outlay, you can enjoy building the most advanced F.M. set in the world when you buy the Sinclair Micro F.M. It is as outstanding in appearance as performance and it will operate in all but the worst F.M. reception areas.

### TECHNICAL DESCRIPTION

Measures less than 3in. high x 1 1/2in. wide with a depth of 1/2in. The set's R.F. amplifier is followed by a self-oscillating mixer and 3 stages of I.F. amplification to dispense with I.F. transformer and all problems of alignment. A pulse-counting detector ensures improved linearity and therefore better audio quality at the output stages. After equalisation the signal is channelled to one output for feeding to amplifier or recorder and to another in which the receiver's own audio amplifying stage enables the Micro FM to be used as an independent self-contained pocket portable. A.F.C. is used to lock the programme tuned in; the telescopic aerial included with the kit will be found sufficient for all but the worst signal areas.

- \* Supply voltage—9v from self contained standard battery.
- \* Consumption—5mA
- \* Sensitivity—Typical—3mV
- \* Signal to Noise Ratio—30dB at 30mV
- \* Audio frequency response—10-20,000 c/s. \* A.F.C.
- \* Inserting plug of ear-pieces or tuner lead switches set ON.



Complete kit inc. transistors, aerial, case, earpiece and instructions.

**£5.19.6**

### FULL SERVICE FACILITIES AVAILABLE TO SINCLAIR CUSTOMERS GUARANTEE

If you are not completely satisfied when you receive your purchase from us, your money will be refunded at once in full and without question.

SINCLAIR RADIONICS LTD., 22 NEWMARKET ROAD, CAMBRIDGE

Please send \_\_\_\_\_  
\_\_\_\_\_

for which I enclose cash/cheque/money order  
value £ \_\_\_\_\_ s. \_\_\_\_\_ d.

NAME \_\_\_\_\_  
ADDRESS \_\_\_\_\_  
\_\_\_\_\_

RC6

**Sinclair**  
**SINCLAIR RADIONICS LTD**  
22 NEWMARKET ROAD, CAMBRIDGE  
Telephone 52731

# HI-FI AMPLIFIERS ~~~~~ TUNERS ~~~~~ RECORD PLAYERS

20+20  
STEREO  
AMP.  
AA-22U

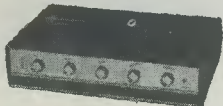

GARRARD  
PLAYER  
AT-60



10W  
POWER  
AMP.  
MA-12



3+3W  
STEREO  
AMP.  
S-33H

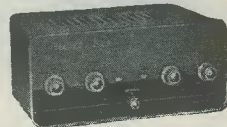

**TRANSISTOR MIXER. Model TM-1.** A must for the tape enthusiast. Four channels. Battery operated. Similar styling to Model AA-22U Amplifier. With cabinet. Kit £11.16.6 Assembled £16.17.6

**20+20W TRANSISTOR STEREO AMPLIFIER. Model AA-22U.** Outstanding performance and appearance. Kit £39.10.0 (less cabinet). Attractive walnut veneered cabinet £2.5.0 extra. Assembled £68.16.0

**GARRARD AUTO/RECORD PLAYER. Model AT-60.** less cartridge £13.1.7 With Decca Deram pick-up £17.16.1 incl. P.T. Many other Garrard models available, ask for Lists.

**HI-FI MONO AMPLIFIER. Model MA-5.** A general purpose 5W Amplifier, with inputs for Gram., Radio. Attractive modern styling. Kit £10.19.6 Assembled £15.10.0

**10W POWER AMPLIFIER. Model MA-12.** 10W output, wide freq. range, low distortion. For use with control unit. Kit £11.18.0 Assembled £15.18.0

**3 + 3W STEREO AMPLIFIER. Model S-33.** An easy-to-build, low cost unit. 2 inputs per channel. Kit £13.7.6 Assembled £18.18.0

**DE LUXE STEREO AMPLIFIER. Model S-33H.** De luxe version of the S-33 with two-tone grey perspex panel, and higher sensitivity necessary to accept the Decca Deram pick-up. Kit £15.17.6 Assembled £21.7.6

**HI-FI STEREO AMPLIFIER. Model S-99.** 9 + 9W output. Ganged controls. Stereo/Mono gram., radio and tape inputs. Push-button selection. Printed circuit construction. Kit £28.9.6 Assembled £38.9.6

**TRANSISTOR PA/GUITAR AMPLIFIER, PA-2.** 20W amplifier. Four inputs. Variable tremolo. Kit £44.19.0 Assembled £59.10.0

**50W VALVE PA/GUITAR AMP., PA-2.** Kit £54.15.0 Assembled £74.0.0



## The World Leader in Quality Kitsets

Easy-to-follow instruction manuals show you how to build the models

### NEW! TRANSISTOR FM TUNER

Designed to match the AA-22U Amplifier. Available in separate units comprising Models TFMT-1 RF Tuning Unit £5.16.0 incl. P.T. and TFA-1M (Mono) IF Amplifier, power supply, etc. £15.3.0 kit or TFA-1S (Stereo) IF Amplifier, etc. £19.2.0 kit. **TFM-1** 14 transistor circuit. Pre-assembled and aligned "front-end". 4 stage IF Amplifier. AFC. Printed circuit construction. Walnut veneered, finished cabinet available as optional extra. Can be built for:

**Total Price kit (Mono) £20.19.0 incl. P.T.**

**Total Price kit (Stereo) £24.18.0 incl. P.T.**

Cabinet £2.5.0 extra. Send for full details.



### INSTRUMENTS

**3" LOW-PRICED SERVICE OSCILLOSCOPE. Model OS-2.** Compact size 5" x 7 1/2" x 12" deep. Wt. only 9 1/2 lb. "Y" bandwidth 2 c/s-3 Mc/s ± 3dB. Sensitivity 100mV/cm. T/B 20 c/s-200 kc/s in four ranges, fitted mu-metal CRT Shield. Modern functional styling.

Kit £22.18.0 Assembled £30.8.0

**5" GEN-PURPOSE OSCILLOSCOPE. Model 10-12U.** An outstanding model with professional specification and styling. "Y" bandwidth 3 c/s-4.5 Mc/s ± 3dB. T/B 10 c/s-500 kc/s. Kit £35.17.6 Assembled £45.15.0

**DE LUXE LARGE-SCALE VALVE VOLTMETER. Model IM-13U.** Circuit and specification based on the well-known model V-7A but with many worth-while refinements. 6" Ernest Turner meter. Unique gimbal bracket allows operation of instrument in many positions. Modern styling. Kit £18.18.0 Assembled £26.18.0

**AUDIO SIGNAL GENERATOR. Model AG-9U.** 10 c/s to 100 kc/s, switch selected. Distortion less than 0.1%. 10V sine wave output metered in volts and dB's. Kit £22.10.0 Assembled £30.10.0

**VALVE VOLTMETER. Model V-7A.** 7 voltage ranges d.c. volts to 1,500. A.c. to 1,500 r.m.s. and 4,000 peak to peak. Resistance 0.1Ω to 1,000MΩ with internal battery. D.c. input resistance 11MΩ. dB measurement, has centre-zero scale. Complete with test prods, leads and standardising battery.

Kit £13.18.6 Assembled £19.18.6

**MULTIMETER. Model MM-1U.** Ranges 0-1.5V to 1,500V a.c. and d.c.; 150μA to 15A d.c.; 0.2Ω to 20MΩ. 4 1/2" 50μA meter. Kit £12.18.0 Assembled £18.11.6

**R.F. SIGNAL GENERATOR. Model RF-1U.** Up to 100 Mc/s fundamental and 200 Mc/s on harmonics. Up to 100mV output.

Kit £13.8.0 Assembled £19.18.0

**SINE/SQUARE GENERATOR. Model IG-82U.** Freq. range 20 c/s-1 Mc/s in 5 bands less than 0.5% sine wave dist. less than 0.15μ sec. sq. wave rise time.

Kit £24.10.0 Assembled £36.10.0

**TRANSISTOR POWER SUPPLY. Model IP-20U.** Up to 50V, 1.5A output. Ideal for Laboratory use. Compact size. Kit £35.18.0 Assembled £47.18.0

Prices and specifications subject to change without notice

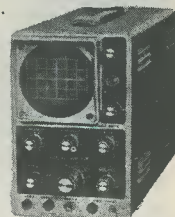

OS-2

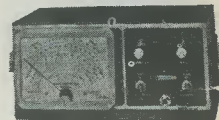

IM-13U



V-7A



RF-1U

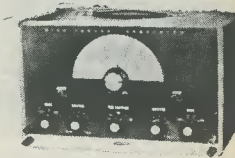

IG-82U

### TRANSISTOR RECEIVERS



UXR-2



UXR-1

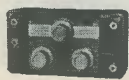

UJR-1

**"OXFORD" LUXURY PORTABLE. Model UXR-2.** Specially designed for use as a domestic, car or personal portable receiver. Many features, including solid leather case. Kit £14.18.0 incl. P.T.

**TRANSISTOR PORTABLE. Model UXR-1.** Pre-aligned I.F. transformers, printed circuit. Covers L.W. and M.W. Has 7" x 4" loud-speaker. Real hide case. Kit £12.11.0 incl. P.T.

**JUNIOR EXPERIMENTAL WORKSHOP. Model EW-1.** More than a toy! Will make over 20 exciting electronic devices, incl: Radios, Burglar Alarms, etc. 72 page Manual. The ideal present! Kit £7.13.6 incl. P.T.

**JUNIOR TRANSISTOR RADIO. Model UJR-1.** Single transistor set. Excellent introduction to radio. Kit £2.7.6 incl. P.T.

WELCOME TO OUR LONDON HEATHKIT CENTRE  
233 Tottenham Court Road

We open MONDAY-SATURDAY 9 a.m. - 5.30 p.m.  
THURSDAY ... .. 11 a.m. - 2.30 p.m.

Telephone No: MUSeum 7349

WHEN YOU ARE IN TOWN, WE HOPE YOU WILL VISIT US THERE

# TAPE AMPLIFIERS    TAPE DECKS    CONTROL UNITS



**FM TUNER  
FM-4U**

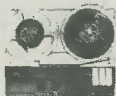

**MAGNAVOX  
Tape Deck**



**TRUVOX  
Tape Deck**



**AM/FM  
TUNER**

**HI-FI FM TUNER. Model FM-4U.** Available in two units. R.F. tuning unit (£2.15.0 incl. P.T.) with I.F. output of 10.7 Mc/s, and I.F. amplifier unit, with power supply and valves (£13.13.0). May be used free standing or in a cabinet. Total Kit **£16.8.0**

**MAGNAVOX "363" TAPE DECK.** The finest buy in its price range. Operating speeds: 1½", 3¼" and 7½" p.s. Two tracks, "wow" and "flutter" not greater than 0.15% at 7½" p.s. **£13.10.0**  
MAGNAVOX deck with TA-IM Kit **£31.5.6**

**HI-FI AM/FM TUNER. Model AFM-1.** Available in two units which, for your convenience, are sold separately. Tuning range (AFM-T1—£4.13.6 incl. P.T.) and I.F. amplifier (AFM-A1—£22.11.6). Printed circuit board, 8 valves. Covers L.W., M.W., S.W., and F.M. Built-in power supply. Total Kit **£27.5.0**

**TRUVOX D-93 TAPE DECKS.** High quality stereo/mono tape decks. D93/2, ½ track, **£36.15.0** D93/4, ¼ track, **£36.15.0**

**TAPE RECORDING/PLAYBACK AMPLIFIER.** Thermometer type recording indicators, press-button speed compensation and input selection. Mono Model TA-1M. Kit **£19.18.0** Assembled **£28.18.0**  
Stereo Model TA-1S. Kit **£25.10.0** Assembled **£35.18.0**

**MONO CONTROL UNIT. Model UMC-1.** Designed to work with the MA-12 or similar amplifier requiring 0.25V or less for full output. 5 inputs. Baxandall type controls. Kit **£8.12.6** Assembled **£13.12.6**

**STEREO CONTROL UNIT. Model USC-1.** Push-button selection, accurately matched ganged controls to ±1dB. Rumble and variable low-pass filters. Printed circuit boards. Kit **£19.10.0** Assembled **£26.10.0**

## First in dependability - first in performance

Convenient credit terms available in U.K. over £10



SSU-1

### SPEAKER SYSTEMS

**HI-FI SPEAKER SYSTEM. Model SSU-1.** Ducted-port bass reflex cabinet "in the white". Two speakers. Vertical or horizontal models with legs, Kit **£12.12.0**, without legs, Kit **£11.17.6** incl. P.T.

**THE BERKELEY Slim-line SPEAKER SYSTEM,** fully finished walnut veneered cabinet for faster construction. Special 12" bass unit and 4" mid/high frequency unit. Range 30-17,000 c/s. Size 26" x 17" x only 7½" deep. Modern attractive styling. Excellent value. Kit **£18.10.0** Assembled **£23.0.0**

**COTSWOLD SPEAKER SYSTEMS.** Outstanding performance for price.

**MFS:** Size 36" x 16½" x 14" deep. Kit **£25.12.0** Assembled **£33.17.0**  
**STANDARD:** Size 26" x 23" x 14½" deep. Kit **£25.12.0** Assembled **£33.17.0**

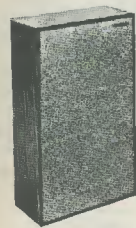

Berkeley

### HI-FI CABINETS

A wide range available including:

**GLOUCESTER.** Kit **£18.10.0** incl. P.T.

**MALVERN.** Kit **£18.1.0** incl. P.T.

**CHEPSTOW.** Kit **£11.12.6** incl. P.T.

We can also make available the well-known RECORD HOUSING range of fully finished cabinets.

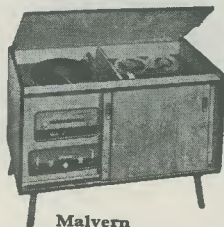

Malvern

## SEND FOR THE LATEST FREE CATALOGUE

INSTRUMENT AND AMATEUR RADIO BROCHURES  
AVAILABLE ON REQUEST

Prices quoted are Mail Order prices.

# DAYSTROM LTD

DEPT. RC.6  
GLOUCESTER

### "AMATEUR" EQUIPMENT

**THE "MOHICAN" GENERAL COVERAGE RECEIVER. Model GC-1U.** With 4 piezo-electric transfilters, variable tuned B.F.O. and Zener diode stabiliser, this is an excellent fully transistorised general purpose receiver for Amateur and Short wave listeners. Printed circuits, telescopic aerial, tuning meter and large slide-rule dial. Kit **£37.17.6** Assembled **£45.17.6**

**AMATEUR BANDS RECEIVER. Model RA-1.** To cover all the Amateur Bands from 160-10 metres. Many special features, including: half-lattice crystal filter; 8 valves; signal strength "S" meter; tuned R.F. Amp. stage. Kit **£39.6.6** Assembled **£52.10.0**

**160-10M TRANSMITTER. Model DX-100U.** Careful design has achieved high performance and stability. Completely self-contained. Kit **£79.10.0** Assembled **£104.15.0**

**COMMUNICATIONS TYPE RECEIVER. Model RG-1.** A high performance, low cost receiver for the discriminating listener. Frequency coverage: 600 kc/s-1.5 Mc/s and 1.7 Mc/s-32 Mc/s. Kit **£39.16.0** Assembled **£53.0.0**

**REFLECTED POWER METER and SWR BRIDGE. Model HM-11U.** Indicates reliably, but inexpensively, whether the RF power output of your TX is being transferred efficiently to radiating antenna. Kit **£8.5.0** Assembled **£10.10.0**

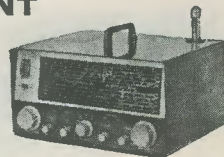

GC-1U

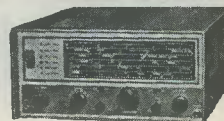

RG-1

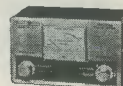

HM-11U

### OUTSTANDING "AMATEUR" EQUIPMENT

A wide range of American Amateur SSB equipment is now available in the U.K. Why not send for full details of range, for example:

**FILTER TYPE SSB TRANSCEIVERS.**  
Models for 80, 40 or 20 metre bands.  
Model HW-12 (80M) **£67.10.0**, Kit. incl. **£66.0.0**, Kit. duty.  
Model HW-22 (40M) **£66.0.0**, Kit. etc.  
Model HW-32 (20M) **£66.0.0**, Kit. etc.



80M Transceiver  
HW-12

Without obligation please send me  
FREE BRITISH HEATHKIT CATALOGUE.....

(Tick here)

FULL DETAILS OF MODEL(S).....  
(Please write in BLOCK CAPITALS)

NAME.....

ADDRESS.....

DEPT. RC.6

# Scottish Insurance Corporation Ltd

38 EASTCHEAP · LONDON · EC3



## TELEVISION SETS, RECEIVERS AND TRANSMITTERS

Television Sets, Receivers and Short Wave Transmitters are expensive to acquire and you no doubt highly prize your installation. Apart from the value of your Set, you might be held responsible should injury be caused by a fault in the Set, or injury or damage by your Aerial collapsing.

A "Scottish" special policy for Television Sets, Receivers and Short Wave Transmitters provides the following cover:

- (a) Loss or damage to installation (including in the case of Television Sets the Cathode Ray Tube) by Fire, Explosion, Lightning, Theft or Accidental External Means at any private dwelling-house.
- (b) (i) Legal Liability for bodily injury to Third Parties or damage to their property arising out of the breakage or collapse of the Aerial Fittings or Mast, or through any defect in the Set. Indemnity £10,000 any one accident.
- (ii) Damage to your property or that of your landlord arising out of the breakage or collapse of the Aerial Fittings or Mast, but not exceeding £500.

The cost of Cover (a) is 5/- a year for Sets worth £50 or less, and for Sets valued at more than £50 the cost is in proportion. Cover (b) (i) and (ii) costs only 2/6 a year if taken with Cover (a), or 5/- if taken alone.

Why not BE PRUDENT AND INSURE your installation—it is well worth while AT THE VERY LOW COST INVOLVED. If you write to the Corporation's Office a proposal will be submitted for completion.

---

Write for full details, quoting reference 5304, to:—

THE MANAGER  
SCOTTISH INSURANCE CORPORATION LTD.,  
38 EASTCHEAP, LONDON E.C.3

---

# UNIQUE OPPORTUNITY

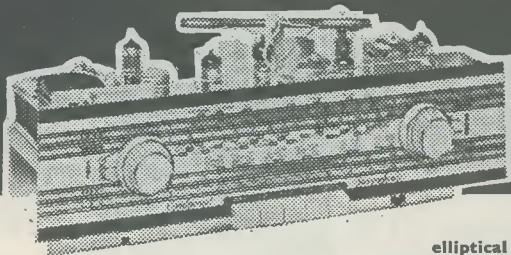

## TO PURCHASE STEREOPHONIC RADIOGRAM CHASSIS

Magnificent Stereophonic Radiogram Chassis complete with two 10" elliptical loudspeakers, plus a Mono/Stereo 4-speed automatic record changer.

**Only £29.19.6**

- ★ Easily fitted
- ★ No soldering or Technical knowledge necessary
- ★ Fits almost any cabinet with minimum trouble
- ★ Modernises your old radiogram

- ★ Built-in ferrite rod aerial
- ★ Piano key switching
- ★ Luxembourg and Caroline received at full strength
- ★ Listen to U.S.A., Russia, Africa, Canada and even Australia

- ★ Unique Lewis Radio 365 day guarantee, even on all the valves
- ★ All British make

**SPECIAL** terms available of £7.10.0 deposit followed by 18 monthly payments of £1.9.1 (total H.P. £33.13.6) + postage and packing 15/- extra.

**INDIVIDUAL CABINETS SUPPLIED ON REQUEST**

Send your cheque or P.O. today for £8.5.0 while stocks last to Dept. RC. 66

**LEWIS radio**

LEWIS RADIO, 100, CHASE SIDE, SOUTHGATE  
LONDON, N.14. Telephone: PAL 3733/9666

### NEW BRITISH RECORDING TAPE

Famous Mfr. Bulk Purchase—Genuine recommended Tape Bargain.

Unconditional Guarantee. Fitted Leader and Stop Foils (except 3 1/2").		D.P. (Military base)		Triple Play	
St'd. (PVC base)	L.P. (PVC base)	300ft. ...	6/6	3" 450ft. ...	12/6
3" 150ft. ... 3/9	225ft. ... 4/9	1,200ft. ...	23/6	4" 900ft. ...	25/-
5" 600ft. ... 11/6	900ft. ... 15/-	1,800ft. ...	29/6		
5 1/2" 850ft. ... 14/6	1,200ft. ... 17/6	2,400ft. ...	37/6		
7" 1,300ft. ... 17/6	1,800ft. ... 22/6				

Post and Packing—3" Reels 6d. Each additional Reel 3d. 4" to 7" Reels 1/-, Each additional Reel 6d. All tape accessories stocked.

EMPTY TAPE REELS (Plastic): 3" 1/3, 5" 2/-, 5 1/2" 2/-, 7" 2/3.

PLASTIC REEL CONTAINERS (Cassettes): 5" 1/9, 5 1/2" 2/-, 7" 2/3.

### TRANSISTOR COMPONENTS

Midget I.F.'s—465 kc/s 1/2" diam., first, second or third, each 5/6  
Osc. coil M. & L.W. 1/2" diam. 5/-  
Midget Driver Trans. 9/1 6/-  
Ditto O/Put Push-pull 3 ohms 6/-  
Elect. Condensers—Midget Type 15V 150mfd-50mfd, ea. 1/9. 100mfd, 2/-, 15 choke, 2/6.  
Ferrite Aerial—M. & L. W. with car aerial coupling coil, 9/3.  
Condensers—150V wkg. .01mfd. to .04mfd., 9d., .05mfd., .1mfd., 1/-, .25mfd., 1/3. .5mfd., 1/6, etc.  
Tuning Condensers, J.B. "OO" 208+176pF, 8/6. Ditto with trimmers, 9/6.  
365pF single, 7/6. Sub-min. 3" DILEMIN 100pF, 300pF, 500pF, 2/-  
Midget Vol. Control with edge control knob, 5kΩ with switch, 4/9, ditto less switch, 3/9.

### TUB-ELECTROLYTICS-CAN

25/25V, 50/12V, 1/9; 8+8/450V, 4/6; 50/50V, 100/125V, 2/-; 32+32/275V, 4/6; 8/450V, 4/350V, 2/3; 50/50/350V, 6/6; 16+16/450V, 5/6; 60/250/275V, 12/6; 32+32/450V, 6/6; 100+200/275V, 12/6.

### ENAMELLED COPPER WIRE

—1lb. reels 14g-20g, 3/-; 22g-28g, 3/6; 30g-34g, 4/3; 36g-38g, 4/9; 39g-40g, 5/-, etc.

### TINNED COPPER WIRE.

16-22g, 4/- 4lb.  
ERSIN MULTICORE SOLDER, 60/40, 4d. per yard, Cartons 6d., 1/-, 2/6, etc.

TYGAN FRET (Contem. pat.), 12 x 12", 2/-; 12 x 18", 3/-; 12 x 24", 4/-, etc.  
EXPANDED ANODISED METAL—Attractive gilt finish 1/2" x 1/2" diamond mesh 4/6 sq. ft. Multiples of 6" cut. Max. size 4' x 3', 47/6 plus carr.  
BONDACOUST Speaker Cabinet Acoustic Wadding (1" thick approx.) 18" wide, any length cut, 6/- yd.

Volume Controls—5K-2 Meg-ohms, 3" Spindles Morganite Midget Type, 1 1/2" diam. Guar. 1 year. LOG or LIN ratios less Sw., 3/6. D.P. Sw. 5/-. Twin Stereo less Sw., 7/6. D.P. Sw., 9/6 (100 k to 2 Meg. only).  
1/2 Meg. VOL Controls D.P. Sw. 1/2" flatted spindle Famous Mfrs. 4 for 10/- post free.

Condensers—Silver Mica, All values 2pF to 1,000pF, 6d. each. Ditto Ceramics, 9d. Tub. 450V T.C.C. etc. 0.001 mfd to 0.01 and 0.1 350V, 9d., 0.0-0.1500V, 1/-, 0.25 Hume, 1/6. 0.25 T.C.C., 1/9, etc., etc.  
Close Tol. S/Micas—10% 5pF-500pF, 8d., 600-5,000pF, 1/-, 1%

### 6 VALVE AM/FM TUNER UNIT



Med. and VHF 190m-550m, 86 Mc/s-103 Mc/s, 6 valves and metal rectifier. Self-contained power-unit, A.C. 200/250V operation. Magic-eye indicator, 3 push-button controls, on/off, Med., VHF. Diode and high output Sockets with gain control. Illuminated 2-colour perspex dial 1 1/2" x 4", chassis size 1 1/2" x 4" x 5 1/2". A recommended Fidelity Unit for use with Mullard "3-3" or "5-10" Amplifiers.

**BARGAIN PRICE.** Complete kit of parts, inc. Power Pack (as illustrated) Price £10.19.6, Carr. 7/6. Ditto, less Power Pack, £9.19.6, carr. 7/6. Circuit and constr's details, 4/6, free with kit.

### MULLARD "3-3" & "5-10" HI-FI AMPLIFIERS

**3 OHM & 15 OHM OUTPUT**  
"3-3" Amp. 3-valve, 3 watt Hi-Fi quality at reasonable cost. Bass Boost and Treble controls, quality sectional output transformer, 40 c/s-25 kc/s ± 1dB, 100mV for 3W, less than 1% distortion. Bronze escutcheon panel. Complete Kit only 7 gns. Carr. 5/-. Wired and tested £8.10.0.

**MULLARD "5-10" AMPLIFIER**—5 valves 10W, 3 and 15 ohms output. Mullard's famous circuit with heavy duty ultra-linear quality output tfr. Basic amplifier kit price £9.19.6. Carr. 7/6. Ready built 11 1/2 gns.

**2-VALVE PRE-AMP. UNIT**  
Based on Mullard's famous 2-valve (2 x EF86) circuit with full equalisation with volume, bass, treble, and 5-position selector switch. Size 9" x 6" x 2 1/2". Ready built, wired and tested, £7.19.6. Carr. 3/6.

**ALUMIN. CHASSIS.** 18 g. Plain Undrilled folded 4 sides, 2in. deep, 6in. x 4in., 4/6; 8in. x 6in., 5/9; 10in. x 7in., 6/9; 12in. x 6in., 7/6; 12in. x 8in., 8/-. etc.  
**ALUMIN. SHEET.** 18g. 6in. x 6in. 1/-; 6in. x 9in., 1/6; 6in. x 12in. 2/-; 12in. x 12in., 4/6 ea.

Jack Plugs. Standard 2 1/2" Igranite Type, 2/6. Screened Ditto, 3/3. Miniature scr. 1 1/2", 2/3. Sub-min., 1/3.  
Jack Sockets. Open Igranite Moulded Type, 3/6. Closed Ditto, 4/-. Miniature Closed Type, 1/6. Sub-min. (deaf aid) ditto, 1/6. Stereo Jack Sockets, 3/6. Stereo Jack Plugs, 3/6.

Phono Plugs, 9d. Phono Sockets (open), 9d. Ditto (closed), 1/-, Twin Phono Sockets (open), 1/3.

Send for detailed bargain lists, 3d. stamp. We manufacture all types Radio Mains Transf. Chokes. Quality O/P Trans., etc. Enquiries invited for Specials, Prototypes for small production runs. Quotation by return.

### RADIO COMPONENT SPECIALISTS

70 Brigstock Road, Thornton Heath, Surrey THO 2188. Hours: 9 a.m.-6 p.m., 1 p.m. Wed. Terms C.W.O. or C.O.D. Post and Packing up to 1/6, 1/-, 11b. 1/9, 3lb., 3/-, 5lb. 3/9, 8lb., 4/6.





ESTABLISHED

1865

Savings in this old established Building Society combine sound investment with an attractive return

# THE DUCHESS OF KENT PERMANENT BUILDING SOCIETY

Member of the Building Societies Association

Shares are in units of £25 each (maximum investment £5,000) . . . BUT, for the smaller saver, Subscription Share accounts may be opened with any sum from 1/- upwards. Interest is payable half-yearly on Fully Paid Shares—credited annually on Subscription Shares—all interest accrues monthly

*Withdrawals at short notice*

**INTEREST IS AT 4% PER ANNUM**

(There is NO DEDUCTION FOR INCOME TAX, as this is paid by the Society)

*For further information apply to*

**DUCHESS OF KENT  
PERMANENT BUILDING SOCIETY  
289/293 Regent Street London W1  
Telephone MUSEum 4876-9**

*Please send to me, without obligation, free brochure and a copy of the audited statement of accounts. (I understand that I shall not be troubled with calls by representatives)*

Name .....  
(If lady, please state Mrs. or Miss)

Address .....

R.C.

(Please use Block Capitals for both name and address)



# RADIO CONTROL FOR MODELS

SHIPS, BOATS and AIRCRAFT  
By F. C. JUDD

With sections on servo-  
mechanisms by  
RAYMOND F. STOCK

*More than 200 illustrations—circuits,  
working diagrams, photographs & tables.  
Each page is packed with information.*

## 192 Pages

## 15s. Postage 9d.

This book is basically an amalgamation of "Radio Control for Model Ships, Boats and Aircraft" and "Radio Control Mechanisms". Additional material has been added on Multi-Channel Operation; Transistorised Radio Control Receivers—Simple and Three-Channel; A Compact Efficiency Aerial; Deac Battery Information; Licence Conditions, etc.

To Data Publication Ltd., 57 Maida Vale, London, W.9

Please supply.....copy(ies) of your publication "RADIO CONTROL FOR MODELS" DATA BOOK No. 16.

I enclose cheque/crossed postal order for.....

NAME .....

ADDRESS .....

BLOCK LETTERS PLEASE



## THE MODERN BOOK CO

**The Radio Amateur's Handbook, 1966.** A.R.R.L. 40s. Postage 2s. 6d.

**TV Diagnosis and Repair.** By PF Reporter Ed. Staff. 13s. 6d. Postage 1s.

**ABC's of Silicon Controlled Rectifiers.** By A. Lytel. 16s. Postage 1s.

**Circuits for Audio and Tape Recording.** By F. C. Judd. 7s. 6d. Postage 9d.

**Instructions in Electronics.** By C. N. G. Matthews. 15s. Postage 1s.

**Know Your Signal Generators.** By R. G. Middleton. 20s. Postage 1s.

**Advanced Radio Control.** By E. L. Safford. 25s. Postage 1s.

**Radio and Television Test Instruments.** By G. J. King. 25s. Postage 1s. 6d.

**Transistors for Technical Colleges.** By L. Barnes. 25s. Postage 1s.

**Transistor Substitution Handbook.** Pub. Foulsham-Sams. 12s. 6d. Postage 1s.

**Servicing Electronic Organs.** By C. R. Pittman and E. J. Oliver. 30s. Postage 1s.

**Transistor Radio Servicing Made Easy.** By W. Lemons. 20s. Postage 1s.

**Semiconductor Devices.** By J. J. Brophy. 18s. Postage 1s.

**1966 World Radio TV Handbook.** 20th ed. 28s. Postage 1s.

**RSGB Amateur Radio Call Book.** 1966. 6s. Postage 9d.

**The Radio Amateurs' Examination Manual.** R.S.G.B. 5s. Postage 9d.

*Complete Catalogue 1s.*

We have the Finest Selection of English and American Radio Books in the Country

**19-21 PRAED STREET (Dept RC) LONDON W2**

Telephone PADdington 4185

THE WORD

**MAXI-Q**

IS THE REGISTERED  
TRADE MARK

OF DENCO (CLACTON) LIMITED  
IT IS ALSO A GUARANTEE OF  
WORKMANSHIP AND  
TECHNICAL PERFORMANCE

OUR RANGE OF PRODUCTS IS SO GREAT THAT WE NOW HAVE TO REQUEST THE AMOUNT OF 2s. 0d. FOR OUR GENERAL CATALOGUE AND TO SAVE YOU POSTAL ORDER POUNDAGE CHARGE WE REQUEST SEND 2s. 0d. IN STAMPS.

IN RESPONSE TO CONTINUOUS DEMAND we have commenced production of Self-Contained Multiplex Decoder Unit, aligned ready for immediate use, that will convert your two receivers—tuner and two amplifiers—tuner and stereo amplifier or stereo receiver without Multiplex provision to a complete B.B.C. Stereo Broadcast Reception Unit. Price £8.0.0, post paid. Technical Publication MDI, 4s. 0d., post paid.

IFT.11/465 kc/s centre tapped transformer for use in crystal filter circuits,  $1\frac{7}{8}'' \times \frac{11}{16}''$  square. 10s. 6d. plus 8d. post.

IFT.18/465 kc/s and 1.6 Mc/s Double Tuned transistor transformer  $1\frac{1}{2}'' \times \frac{1}{2}''$  square. 10s. 6d., plus 8d. post.

Please send S.A.E. with all enquiries. General Catalogue 2s. 0d.

**DENCO (CLACTON) LTD.**

(DEPT. R.C.)

357/9 OLD ROAD, CLACTON-ON-SEA, ESSEX

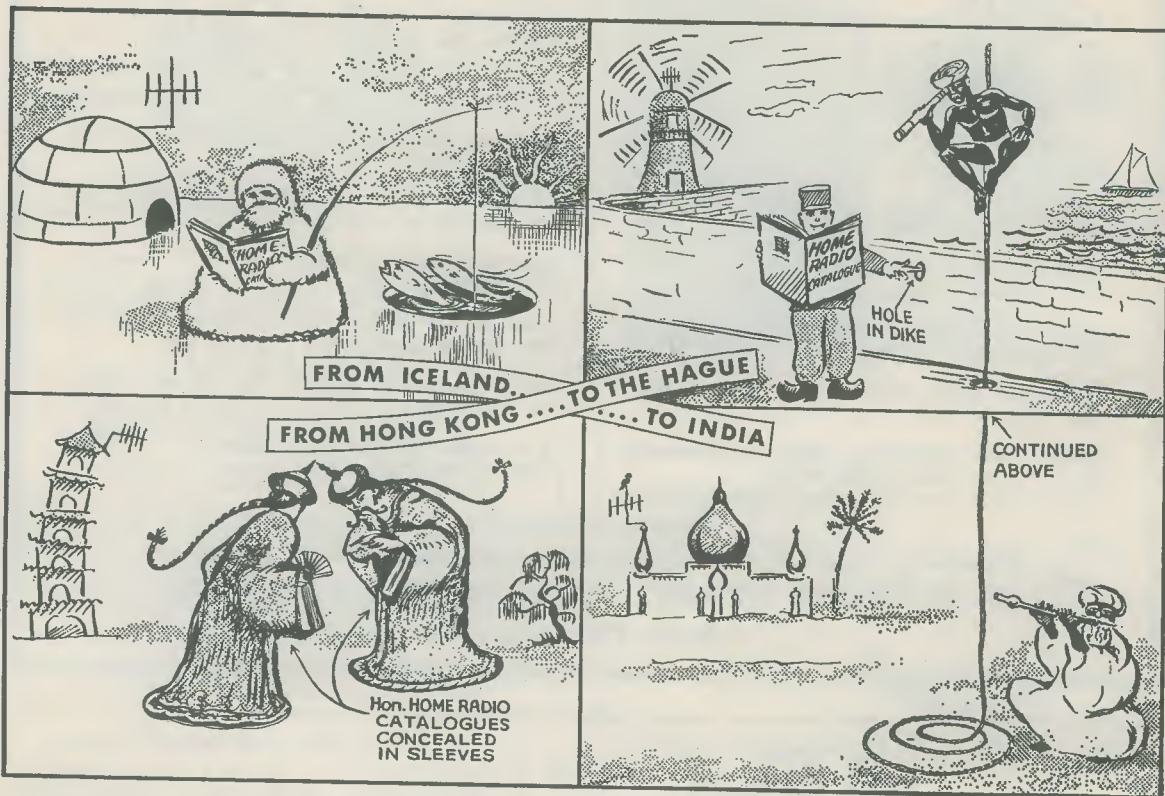

In our office at Mitcham we have a large map of the world. We stick a pin in it to mark each new area to which we have despatched our famous Components Catalogue. Our world has become a pin cushion! Yes, it's not only from Mitcham to Morden that our Catalogue is being used, nor even only from Putney to Pimlico . . . we know for instance that it is being used by the British Antarctic Survey Team at the South Pole, and as far North as the Arctic Circle. Fiji, Pekin and Budapest are just three more of the hundreds of places marked on our map. It is not by chance that the demand for the Home Radio Catalogue is world-wide. It is due to its reputation for accuracy, clarity and comprehensiveness. We have always set ourselves a high standard on these matters and we ensure that each edition is better than its predecessors.

Even if you *don't* live in Timbuktu or Wogga Wogga we shall be delighted to send you a copy of our catalogue. The price is still 7/6 plus 1/6 postage and packing. And remember—every copy contains five coupons, each worth one shilling when used as directed. Fill in the coupon on the right and send it today with your P.O. or cheque for nine shillings. Your catalogue will be sent by return post.

Please write your Name and Address in block capitals

Name .....

Address .....

Home Radio Ltd., Dept. RC, 187 London Road, Mitcham, Surrey

# THE Radio Constructor



Incorporating THE RADIO AMATEUR

**JUNE 1966**

Vol. 19, No. 11  
Published Monthly  
(1st of month)

*Editorial and  
Advertising Offices*  
57 MAIDA VALE LONDON W9

*Telephone*  
CUNningham 6141

*Telegrams*  
Databux, London

First Published  
1947

Experimental Transistorised Time Switch, <i>by E. Wright</i>	666
Simple Record-Player Amplifier (Suggested Circuit No. 187), <i>by G. A. French</i>	669
Tape Accessories without Batteries, <i>by A. J. McEvoy, B.Sc.</i>	671
Protect Your Power Pack, <i>by P. R. Woolley</i>	673
Can Anyone Help?	675
News and Comment	676
The Operator "j", <i>by J. B. Dance, M.Sc.</i>	678
Recent Publications	683
Transistor Curve Tracer, <i>by R. J. Barrett (Cover Feature)</i>	684
Semiconductor Tests with an Ohmmeter, <i>by Gordon J. King, Assoc. Brit. I.R.E., M.T.S., M.I.P.R.E.</i>	690
An Improved Volume Control, <i>by K. G. Harvey</i>	694
The 1966 Physics Exhibition	695
In Your Workshop	696
Labgear "Educational" Radioactivity Demonstration Equipment	701
The Design and Construction of Measuring Bridges, Part 1, <i>by W. Kemp</i>	702
Club Events	705
Understanding Radio, <i>by W. G. Morley</i> (Tuned Triode Circuit Oscillators)	706
Radio Topics, <i>by Recorder</i>	710

© Data Publications Ltd., 1966. Contents may only be reproduced after obtaining prior permission from the Editor. Short abstracts or references are allowable provided acknowledgement of source is given.

Annual Subscription 33s. (U.S.A. and Canada \$5) including postage. Remittances should be made payable to "Data Publications Ltd". Overseas readers please pay by cheque or International Money Order.

Published in Great Britain by the Proprietors and Publishers Data Publications Ltd. 57 Maida Vale London W9  
Printed by A. Quick & Co. (Printers) Ltd. Clacton-on-Sea England

# Experimental Transistorised Time Switch

By E. WRIGHT

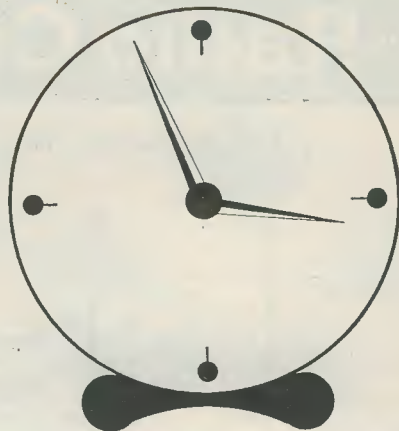

*An unusual method of obtaining long timing periods could consist of applying short pulses, with slightly different time spacings, to an "and" gate. When the pulses are coincident, an output pulse from the gate trips a flip-flop. Our contributor describes a circuit constructed to check the possibilities of this idea, and his article is particularly directed at the experimenter who likes to investigate interesting new techniques.*

THE WRITER WAS APPROACHED RECENTLY AND asked if he could design a time switch, having an on-off ratio of 1 : 1 over a complete cycle of one hour. At first he tried to do this by using an ordinary valve multivibrator. However, the necessity of having a sufficiently large time constant in the grid circuits of the valves gave considerable difficulty.

When an ECC83 was used as the multivibrator valve with load resistors of  $220k\Omega$  and coupling capacitors of  $16\mu F$ , it was found that there was so much leakage current in the electrolytic capacitors that both valves were rapidly put into the conducting state. In order to overcome this difficulty the writer considered driving the electrolytic capacitors with cathode followers but finally concluded that this was complicating the circuit too much, as well as still not giving the required time delay.

The writer next considered using an ordinary multivibrator, working in, say, a cycle of 100 seconds,

and then counting the number of output pulses down a series of cascaded binary counters. This scheme would, no doubt, have worked reliably, but it was abandoned, in its turn, because of cost considerations, and also because it could have had quite a lot of possible faults. In fact there would have been a total of six binary counters between the multivibrator and the output flip-flop, which itself is also a binary counter.

## The Final Circuit

The final circuit adopted is shown symbolically in the accompanying block diagram, Fig. 1. The two pulse generators are set to give, say, a 1 second pulse about every 40 seconds, but with different delays between their output pulses. If the two delays are, say, 40 seconds and 41 seconds, then the pulses will be coincident only once every 1,640 seconds (the product of the two delay times).

Therefore if we can arrange to have one output pulse every time these two pulses are coincident, then we can use this to drive a complementing flip-flop (or binary counter) with the relay in one of its output lines. This can in fact be quite easily done by using an "and" gate, an electronic circuit well known to computer design engineers. An "and" gate is a device which is so arranged that it will only give an output when all of its input signals are present.

As the final design did not require anything other than a simple pulse generator, an "and" gate and a complementing flip-flop, this made it

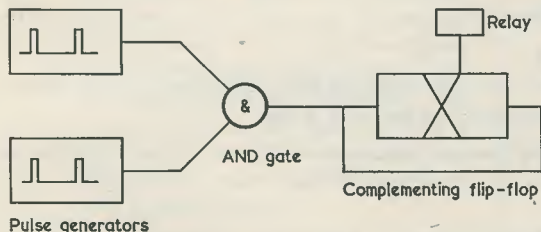

Fig. 1. Block diagram showing method of operation

far more a working proposition than the writer had first thought. As the switch was required to be portable, if at all possible, then it was considered that transistors would be much more suited to the job.

### The Pulse Generator

The complete circuit is shown in Fig. 2, and it

will be seen that it includes two identical pulse generators. The description which follows applies to either of these. It will be observed that each pulse generator is very simple, and incorporates only a minimum of components. The width of the output pulse (which is negative-going) is primarily determined by the values of  $C_1$  and  $R_3$ . As this is required to be of a short duration then,

### Components List

(See text for comments on components and component values.)

#### Resistors

(All fixed values  $\frac{1}{4}$  watt unless otherwise stated)

- $R_1$  100k $\Omega$
- $R_2$  22k $\Omega$
- $R_3$  47k $\Omega$
- $R_4$  2.7k $\Omega$   $\frac{1}{2}$  watt
- $R_5$  47k $\Omega$
- $R_6$  6.8k $\Omega$
- $R_7$  5.6k $\Omega$
- $R_8$  5.6k $\Omega$
- $R_9$  10k $\Omega$
- $R_{10}$  10k $\Omega$
- $R_{11}$  6.8k $\Omega$
- $R_{12}$  6.8k $\Omega$
- $VR_1$  1M $\Omega$  potentiometer, linear

#### Capacitors

- $C_1$  25 $\mu$ F, 25V wkg., electrolytic
- $C_2$  1,000 $\mu$ F, 25V wkg., electrolytic
- $C_3$  0.1 $\mu$ F
- $C_4$  0.1 $\mu$ F

#### Semiconductors

- $TR_{1,2}$  OC170 or any transistor having suitable ratings ( $TR_2$  should have a minimum  $\alpha$  of 50)
- $TR_{3,4}$  OC71 or any transistor having suitable ratings
- $D_{1,2,3,4}$  OA81
- $D_5$  OA71

#### Relay

Relay with 6k $\Omega$  coil resistance, energising at a maximum current of 2.5mA

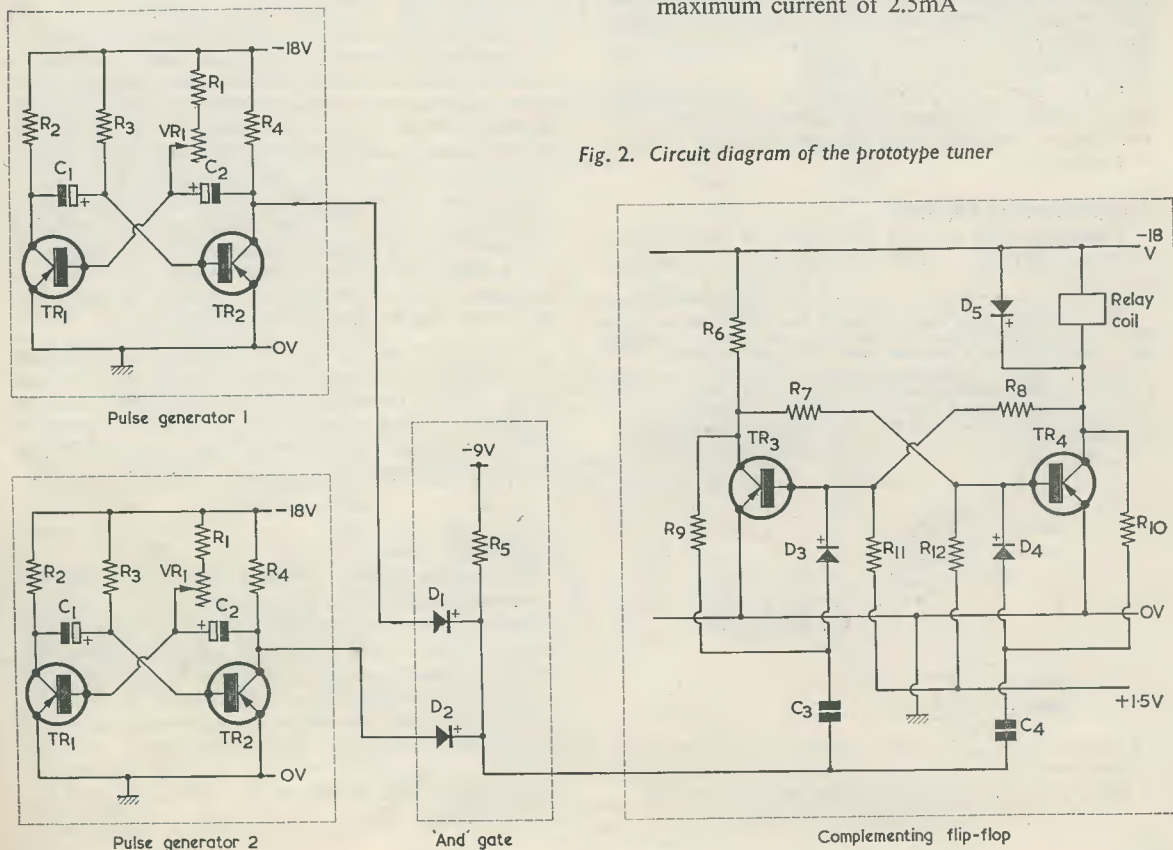

Fig. 2. Circuit diagram of the prototype tuner

accordingly, both of these components have been kept reasonably small in comparison with the other timing components  $VR_1$  and  $C_2$ .

So as to enable the capacitor  $C_2$  to charge as quickly as possible the value of  $R_4$  has been kept small, without running the risk of overloading  $TR_2$ . To allow  $VR_1$  to take a high value, and yet still have  $TR_1$  collector at as near zero volts as possible when conducting,  $R_2$  is made large. But  $R_2$  is not so large as to allow the collector leakage current in  $TR_1$  base taking excessive current drop across it.

$VR_1$  is included, in series with  $R_1$ , to enable the delay between output pulses to be varied from about 17 seconds to 170 seconds.\* However, due to varying leakage currents in transistors and in  $C_2$  it is not possible to predict the periods with any degree of accuracy.  $VR_1$  enables the switch parameters to be varied without difficulty, while  $R_1$  prevents  $TR_1$  base taking excessive current.

The output pulse is taken from the collector of  $TR_2$  in each pulse generator.

### The "And" Gate

The "and" gate consists of two diodes and a resistor. As the diodes are connected to the  $TR_2$  collectors, which are normally sitting at about  $-0.5$  volts, then these diodes are normally forward biased, and therefore the output potential is also about  $-0.5$  volt. If only one of the  $TR_2$  collectors goes negative there will be no appreciable change in the output voltage from the gate, since the other diode will still be forward biased.

If, however, the pulses from the  $TR_2$  collectors are so timed that they both appear together, then the output potential from the gate will rise towards  $-9$  volts.\*

### Complementing Flip-flop

The remaining part of the circuit is the complementing flip-flop. This is merely an ordinary

<sup>1</sup> In this instance, the timing period is not  $0.7 CR$ , as would be usual with a multivibrator, because  $C_2$  cannot charge to the full supply potential during the time that  $TR_2$  is off.—EDITOR.

<sup>2</sup> Since  $C_2$  cannot, in the present instance, charge fully when  $TR_2$  is off, the negative-going pulses applied to  $D_1$  and  $D_2$  may not reach the 9 volts gate potential. This will not, however, prevent the appearance of a gate output pulse when both input pulses are coincidental.—EDITOR.

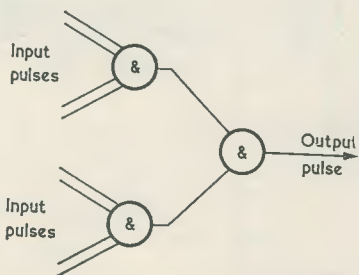

Fig. 3. Cascading "and" gates to obtain timing periods

bistable circuit, but with the addition of  $D_3$ ,  $D_4$ ,  $R_9$ ,  $R_{10}$ ,  $C_3$  and  $C_4$ . These components are so arranged that they will apply a positive pulse to the base of the transistor which is in the conducting state. This causes the input pulse to change the state of the bistable every time a pulse is applied from the gate circuit.

As the relay coil is in the collector of one of the flip-flop transistors, it will be alternately switched on and off by the pulses from the gate circuit. Diode  $D_5$  prevents the appearance of excessive voltage when the relay de-energises.

It should be noted that it is, in fact, the positive-going rather than the negative-going pulse which changes the state of the bistable. This method of working is adopted because the transistors are easier to switch off, due to the regenerative action around the feedback loop of the circuit.

In the prototype time switch it was found that the intervals between the switching processes was variable between about 3 seconds and 45 minutes. Once the circuit had settled down it was, at one particular setting of the resistors  $VR_1$ , switching at 9mins 55secs for almost two hours, and showing no signs of any deterioration in its performance.

### Possible Variations

It might be an interesting experiment to add more pulse generators to the system and increase the number of inputs to the "and" gate accordingly. This would then enable the switching period to be a function of three variables, with a corresponding increase in the number of terms to be multiplied to give an estimate of the time between the switching operations. The writer had thought of pursuing this subject further, and would be interested in finding the final limiting factor on the interval between output pulses from the "and" gate. If the number of inputs to the "and" gate becomes too great, then it might be possible to combine, say, three "and" gates, as shown in Fig. 3.

It should be added that the original investigations into the functioning of the circuit were made using time intervals of the order of milliseconds, thereby avoiding a long wait between operations. Even at these higher switching frequencies the circuit performed satisfactorily.

### Component Values

The values shown in the Components List are those employed in the prototype circuit. They are, however, open to variation as conditions might require. Care must be taken, when changing the value of  $R_4$ , to ensure that excessive current does not flow through  $TR_2$ . Capacitors  $C_1$  and  $C_2$  should have the 25 volt working rating shown in the Components List, and not a higher working voltage. The circuit of Fig. 2 will, of course, require two each of  $R_1$  to  $R_4$ ,  $VR_1$ ,  $C_1$  and  $C_2$ , and  $TR_1$  and  $TR_2$ .

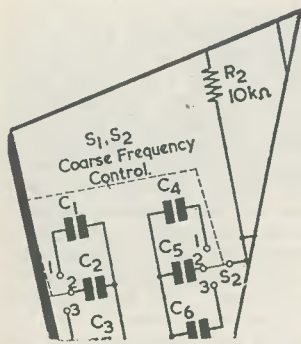

# Simple Record-Player Amplifier

SUGGESTED CIRCUIT No. 187

By G. A. FRENCH

ARTICLES DESCRIBING THE construction of audio frequency amplifiers are always popular with readers, this being probably because such amplifiers are usually fairly simple to build and get into working order, and because they frequently give results which are appreciated by the whole family.

Particularly welcome in the home are record-player amplifiers, and this month's "Suggested Circuit" article describes a relatively inexpensive amplifier which falls within this category. This amplifier will give an output quality which is commensurate with that offered by commercially made equipment employing the same type of output valve. The maximum output is 4 watts (when a mains transformer having a secondary voltage of 250 is used) and it is intended that the amplifier be coupled to a reasonably large speaker housed in an adequate cabinet. The input should be provided by a crystal pick-up, which may be fitted to a single-playing deck or to a changer. A triode-pentode valve is incorporated in the amplifier design, supplies for this being obtained by way of a low-cost mains transformer which offers complete isolation from the mains. The inclusion of this mains transformer eradicates, in one step, all the difficulties with hum, the problems of isolation and the risk of shock, which occur with an amplifier having a live chassis. Two simple tone controls are provided, one of these being pre-set. If desired, the performance of these tone controls may be modified to meet particular circumstances by altering the value of one capacitor in each control circuit.

## The Circuit

The circuit of the record-player

amplifier appears in Fig. 1. After consideration, it was felt that the best choice of valve to meet the present application was the ECL86, this combining a voltage amplifier triode and an output pentode in one envelope. The pentode section offers an output power of 4 watts at an h.t. voltage of 250, and represents a very satisfactory choice for this class of work. The triode section of the ECL86 offers a little more gain than will be required for pick-ups having high voltage outputs and, to counteract this, a small degree of attenuation is given in the input circuit.

The output of the crystal pick-up is applied to volume control  $R_2$  by way of the  $1M\Omega$  resistor  $R_1$ , this latter component providing the attenuation just referred to. The presence of  $R_1$  offers the incidental advantage of presenting a high input impedance to the pick-up. The audio signal tapped off by the slider of  $R_2$  is applied to the grid of  $V_{1(a)}$ , the triode section of the ECL86, which amplifies in normal manner. The amplified signal at the anode of  $V_{1(a)}$  is next passed to the grid of  $V_{1(b)}$  via  $C_4$ .  $V_{1(b)}$  also amplifies in normal fashion, its output coupling into the speaker

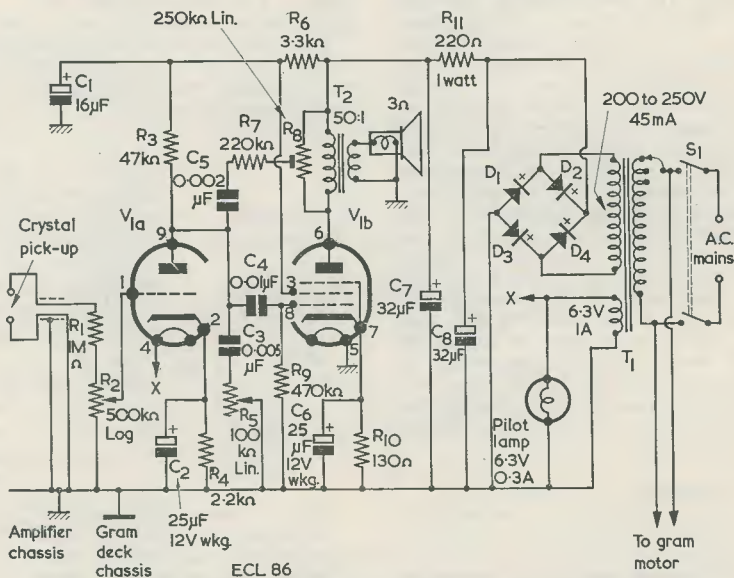

All fixed resistors 10% 1/4 watt unless otherwise stated.  $D_1$ - $D_4$ -contact-cooled bridge rectifier 250V 45mA  
All capacitors 350V wkg. unless otherwise stated

Fig. 1. The circuit of the record player amplifier. This has two tone control circuits, the bass boost control being pre-set

by way of the 50 : 1 speaker transformer,  $T_1$ .

Treble tone control is provided by  $C_3$  and  $R_5$ , these components operating in a normal "top-cut" circuit. Due to the presence of  $C_3$ , an increasing attenuation of the higher frequencies takes place as the slider of  $R_5$  is moved towards this capacitor. A somewhat unusual form of bass boost control is afforded by  $C_5$ ,  $R_7$  and  $R_8$ . When the slider of  $R_8$  is at the end of the track which is nearer the anode of  $V_{1(b)}$ , negative feedback takes place from this anode back to the grid. Capacitor  $C_5$  offers a relatively high reactance at the lower audio frequencies, with the result that the feedback is reduced at these frequencies and bass boost is realised. The degree of boost can be adjusted by means of  $R_8$ , which is shown as a pre-set component. Under normal conditions  $R_8$  may be set up for optimum results with the specific loudspeaker and enclosure with which the amplifier is to be used, after which it may be left alone.

An important feature of the power supply section is the use of a bridge h.t. rectifier instead of a half-wave or full-wave rectifier, as occurs so often with home-constructor designs. Contact-cooled bridge h.t. rectifiers have been employed for many years in commercial mains-driven equipment because of the obvious saving in transformer costs which result. The bridge rectifier required in the present circuit should have an input voltage rating of 250 volts r.m.s. and a current rating of 45mA or more. A suitable contact-cooled bridge rectifier is available from Henry's Radio Ltd., this being rated at 250 volts and 75mA. Any other bridge rectifier which meets the 250 volt and 45mA figures could also be used.

Care has been taken in the reservoir and smoothing circuit to keep hum at a low level. The rectified voltage appears across  $C_8$ , and this is smoothed by  $R_{11}$  and  $C_7$  before application to the anode of  $V_{1(b)}$ . Further smoothing is then given by  $R_6$  and  $C_1$ . The h.t. voltage across  $C_1$  is applied to the anode of  $V_{1(a)}$  and to the screen-grid of  $V_{1(b)}$ .

### Components And Construction

Few comments are needed concerning the components which are quite conventional.

The on-off switch  $S_1$  is a double-pole component which controls the a.c. mains supply both to the amplifier and to the gram motor. This may be a separate switch or it may be combined with  $R_5$ . It is prefer-

able to combine the on-off switch with  $R_5$  rather than with volume control  $R_2$  because, in the latter instance, the mains wiring would approach a section of the amplifier which is more susceptible to capacitive hum pick-up.

Mains transformer  $T_1$  requires an h.t. secondary offering 200 to 250 volts at 45mA or more. Suitable components are available through normal retail channels. The available a.f. output power from the amplifier reduces slightly for secondary voltages below 250. The heater secondary provides 6.3 volts at 1 amp for the ECL86 heater and a pilot lamp. If the pilot lamp is not required, the current taken from this winding is 0.7 amp only.

The contact-cooled rectifier must be mounted on a sheet of metal to provide adequate cooling. It is recommended that construction be carried out on a conventional metal chassis, whereupon the rectifier can be bolted to this.

Capacitors  $C_7$  and  $C_8$  could consist of a dual electrolytic component, in which case  $C_8$  should be the reservoir section. This section is usually indicated by a red spot on the positive tag.  $C_1$  may be a canned or wire-ended component, and it passes negligible ripple current.

Speaker transformer  $T_2$  should have a primary capable of passing the anode current of  $V_{1(b)}$  which, for 250 volts h.t., will be of the order of 36mA. The ratio specified, 50 : 1, applies for a 3Ω speaker.

The ECL86 is employed within its ratings, but it will run fairly warm in use. Adequate ventilation should, in consequence, be provided.

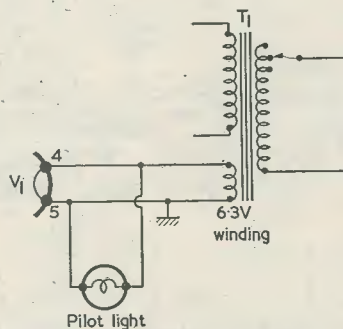

Fig. 2. Although the gain of the amplifier is not sufficiently high to warrant excessive precautions against hum, it may still prove helpful to wire the heater circuit in the manner shown here rather than pass the heater current through the chassis. The pilot light may be similarly wired

Construction should raise few difficulties. The overall gain is not sufficiently high to cause serious problems to arise with chassis hum loops and the like. Nevertheless, there is no reason why some of the elementary precautions applicable to higher-gain amplifiers should not be followed here. All the a.f. components will be positioned around the single valveholder, whereupon it becomes a simple matter to provide a common chassis point for the earthy connections of  $C_1$ ,  $C_2$  and  $C_6$ . The earthy end of  $R_2$  should also be returned to this chassis point. If  $R_2$  is mounted very close to the valveholder it will probably not be necessary to screen the lead from its slider to the grid of  $V_{1(a)}$ . For long distances, however, this wire should be screened. The lead to the pick-up should also be screened, and all screening may be returned to the common chassis connection just referred to. This connection can, incidentally, be given by several solder tags mounted by a single nut and bolt. Following the same policy, it would be helpful to wire up the valve heater in the manner shown in Fig. 2, in which the heater current flows through the connecting wires and not through the chassis itself. The chassis connection to one side of the heater circuit may then be made at any convenient point. There should be no need to twist the heater leads together, provided they are kept well away from the anode and grid circuits of  $V_{1(a)}$  and the grid circuit of  $V_{1(b)}$ . All mains and a.c. wiring should also, of course, be kept well clear of the anode and grid circuits of  $V_{1(a)}$  and the grid circuit of  $V_{1(b)}$ .

A further point with regard to construction is to note that  $R_1$  should be mounted close to  $R_2$ . In practice, one lead of  $R_1$  may be soldered direct to the appropriate tag of  $R_2$ .

The amplifier chassis and gram deck chassis should be bonded together. If the screened lead to the pick-up is insulated from the gram deck chassis, a separate wire may be used to bond the two chassis together. In general, this is preferable to having the bonding connection carried by the outer braiding of the screened lead itself.

### Operation

After construction and wiring have been completed and checked, the amplifier may be tried out.

Reproduction should be of good quality with a small reserve of gain in hand.  $R_8$  is next adjusted to provide the degree of bass boost which is required. The effect offered by this control should be particularly notice-



able if the amplifier feeds into a small loudspeaker in an inadequate cabinet. The range of frequencies over which bass boost occurs may be varied by changing the value of  $C_5$ , an increase in value in this capacitor causing the boost to appear at a lower range of frequencies, and vice versa. The onset of boost will be gradual as

frequency reduces, and it should be borne in mind that adjustments in  $R_8$  will also cause variations in overall gain at the middle and high audio frequencies.

$R_5$  and  $C_3$  function as a treble-cut control, but it may be found that, due to the presence of  $R_1$  in the input circuit, treble is not excessive with

some pick-ups. This condition may be alleviated by connecting a fixed capacitor across  $R_1$ , the value being found by experiment. A value of the order of 500pF will be adequate in many cases. The amount of treble cut which is given by  $R_5$  and  $C_3$  may be varied, if desired, by altering the value of  $C_3$ .

## Tape Accessories Without Batteries

by A. J. McEvoy, B.Sc.

*The cathode bias circuits of a tape recorder or amplifier offer a useful supply for transistor accessories.*

**A**MONGST THE GROWING NUMBER OF ACCESSORIES for tape recorders and amplifiers now on the market are such small transistorised gadgets as mixers, tuners and pre-amplifiers powered by radio-type batteries. The writer found this inconvenient and has adopted the practice of converting such items to operate on low voltage d.c. drawn from the recorder. A mixer unit with two transistors, for example, requires a power supply capable of providing approximately 5mA at 9 volts. As can be seen from the valve data book, a d.c. voltage of this order will probably already be available across the cathode resistor of the output valve. The accompanying Table shows typical operating conditions for commonly used valves. A few types, for example the ECL82 pentode, produce in certain circumstances a much higher voltage across this resistor, so that the resistor must be replaced by a potential divider in order to supply the required 9 volts.

It will be noticed that, in the example given above, the effective resistance offered by the accessory is 1,800Ω, a figure which is much higher than the cathode resistor used with most valves. Assuming that the cathode voltage is not too high, therefore, there is little interference with the operating conditions of the valve if the add-on unit is connected directly to the cathode resistor. If, on

the other hand the add-on unit draws a much higher current, or the cathode current of the valve is unusually low, the current drawn off by the add-on unit may be a more significant fraction of the whole, and operating conditions may be affected. In this case a new value of cathode resistor must be calculated in order to maintain design conditions. A worked example of the most difficult case will now be given.

### Practical Example

Take an f.m. tuner requiring 10mA at 9 volts, to be used with an amplifier employing an EL91 as output valve. It is found that the grid bias to be developed across the cathode resistor is -13.8 volts, and that the bias resistor is 750Ω. Cathode current is, therefore, 18mA. To obtain a 9 volt supply, the 750Ω resistor must be replaced by a voltage divider made up of two resistors in the ratio (13.8-9) : 9, and totalling 750Ω. (See Fig. 1.)

Hence, we get:

$$R_1 = \frac{(13.8-9) \times 750}{13.8} \\ = 261\Omega,$$

and

$$R_2 = \frac{9 \times 750}{13.8} \\ = 488\Omega.$$

However, we must remember that  $R_2$  is not a single resistor, but a fixed resistor in parallel with

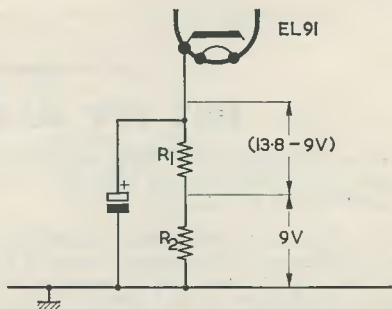

Fig. 1. First steps in the calculation to enable a 9-volt transistorised add-on unit to run from an EL91 cathode bias supply circuit. The values of  $R_1$  and  $R_2$  which meet the voltages shown are calculated

**TABLE**  
Typical Operating Conditions

Valve ∴ .. .. .	ECL82 (pentode section)	EL84	EL86	6BW6
Grid bias .. .. .	-22.5V	-7.3V	-12.5V	-12.5V
Cathode current .. .. .	33.5mA	53.5mA	75mA	52mA
Cathode resistor .. .. .	680Ω	135Ω	180Ω	240Ω

the effective 900Ω resistance of the tuner. (See Fig. 2.) Applying the formula for resistances in parallel, we get:

$$R_3 = \frac{900 \times 488}{900 + 488} = 1,070\Omega.$$

Taking the nearest preferred values, we get:

$$R_1 = 270\Omega, \\ R_3 = 1.1k\Omega.$$

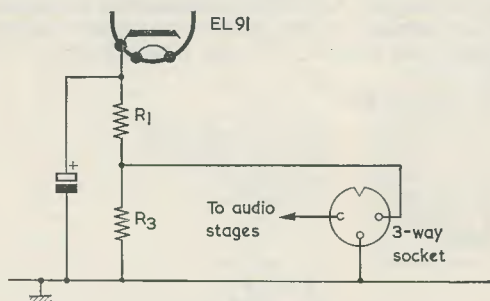

Fig. 2.  $R_2$  of Fig. 1 consists of  $R_3$  in parallel with the effective resistance offered by the add-on unit. A convenient means of connection is given by a 3-way socket

Remember that, when the tuner is not being used, an equivalent fixed resistor should be inserted in parallel with  $R_3$ .

### Wiring

The question of power supplies settled, we will now consider the wiring to be used. The device probably uses single screened cable to carry the audio to the amplifier. If this is replaced with twin screened lead, an extra conductor is available to carry the d.c., with the braiding acting as the d.c. negative return. Note, however, that in most cases the braiding can no longer be connected to the chassis of the tuner or other device, since in transistor circuits the positive is normally earthed. Instead, the second core is employed for the positive connection, and the braiding is taken to the former negative connection. It may be advisable to add a decoupling capacitor across the d.c. input to the accessory in order to avoid instability.

At the amplifier end, the arrangement depends on the type of input socket installed. Many popular tape recorders use 3- or 5-pin sockets, and on these one of the blank pins is obviously available to carry the d.c. positive line. In other machines, there would be no great difficulty in adding a socket for a wander plug. A spare plug fitted with a fixed resistor should be kept for insertion when the accessory is not in use in order to maintain the operating conditions for the output valve, as previously mentioned.

## EMI'S NEW ALL-TRANSISTOR PICTURE MONITORS

Picture monitors, Type TPM 1401, 1402, 1901, 1902, 2301 and 2302, now available from EMI Electronics Ltd, provide a high quality monochrome display, working from 525 or 625 line video signals. In each case, a version for working from 405 line signals can be supplied.

Monitors, Type TPM 1401, 1901 and 2301, are of the same circuit design, with 14, 19 and 23in. cathode ray tubes respectively and feature all-transistor circuits, a bridging or terminating input for composite or non-composite signals, black-level clamping of video signals, operation from an external sync input, built-in designation, and high picture black stability.

Type TPM 1402, 1902 and 2302 are similar in design but, in addition, they offer local or remote selection of two alternative inputs, local or remote selection of internal or external sync inputs, remote contrast control, remote brightness control, cueing indication. Local or remote selection of 405, 525 and 625 line standard can be supplied as an optional extra.

# Protect Your Power Pack

by

P. R. WOOLLEY



Valve power supplies are very vulnerable to one fault—a short-circuit across the output. This is particularly true when the power supply unit is used to supply h.t. current to a newly built, or experimental piece of equipment. This article describes two simple approaches towards protecting the power unit from damage due to h.t. short-circuits.

THE CONSEQUENCES OF accidentally short-circuiting an h.t. supply do not always end with replacing a fuse, as the writer has discovered to his cost. If the fuse fails to blow, even for a second or so, then the very heavy current surge which results from the short-circuit can easily destroy a valve or semiconductor rectifier, and may even damage the mains transformer. The cost of an accidental short-circuit may thus be £2 or more, which is a high price to pay for a moment's carelessness.

To prevent this kind of accident, the writer investigated various "current limiting" circuits; that is, circuits which prevent the output current from exceeding a given value. With these circuits, a dead short-circuit or a very low resistance across the h.t. output terminals causes the output voltage to drop at once to zero.

There are two ways of protecting the h.t. supply in this manner. Protection can be given either by mechanical means or by electrical means.

## Overload Trips

The basic mechanical method of current limiting consists simply of placing a relay in series with the h.t. output circuit, as shown in Fig. 1(a). When the current drawn exceeds the pull-in current of the

relay, the contacts open and cut off the supply. However, this immediately de-energises the coil and so the contacts close again; the cycle is repeated *ad infinitum* and

the relay behaves, in fact, like an electric buzzer.

The h.t. current may, however, be cut off completely by using the circuit of Fig. 1(b). When the relay contact in this diagram is pulled in by the current, the h.t. current passes through R and keeps the relay energised. The load can then be disconnected, the power pack being switched off momentarily to de-energise the relay coil. The relay should, of course, have make-before-break contacts. This kind of circuit is known as an "overload trip", for obvious reasons.

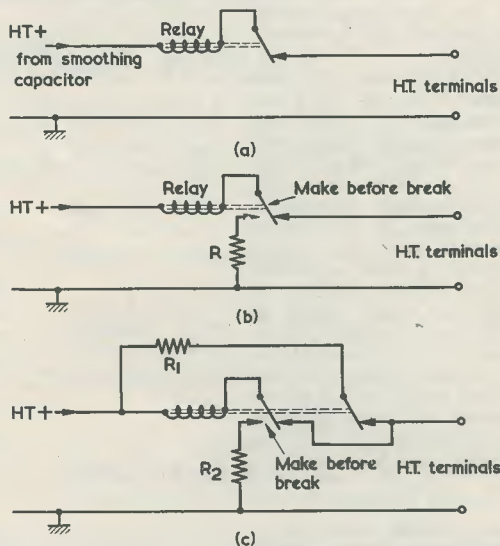

Fig. 1(a). The basic method employing a relay to protect an h.t. power supply  
 (b). To prevent "buzzer" action in the relay, make-before-break changeover contacts are used  
 (c). A second set of contacts enables the maintaining current in the relay coil to be reduced

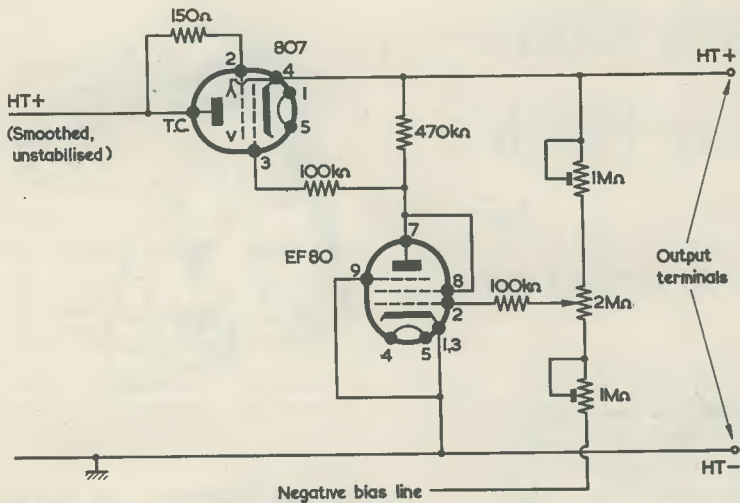

Fig. 2. A typical voltage stabilising circuit

In Fig. 1(b) the relay is chosen so that it energises when the power pack is supplying its maximum safe current, and the resistor R has a value which ensures that the current flowing through it will just keep the relay energised. If a more sensitive relay is available then the improved circuit of Fig. 1(c) can be used.  $R_1$  shunts the relay when it is de-energised, but when the relay contacts pull in the effective sensitivity of the relay is increased, so  $R_2$  can be made large enough to keep the current well below the safe maximum.

The overload trip has two main disadvantages. First, the relay has to be permanently in circuit, and a sufficiently sensitive relay will cause a significant voltage drop when current is taken from the supply. Second, there is a short time delay between the application of the overload and the closing of the contacts, a state of affairs which is not entirely satisfactory. There is also the minor bother of resetting the relay each time it energises. A point in favour of the overload trip circuit is that it can be used on all kinds of h.t. power pack, including the very simplest types.

#### Electronic Current Limiting

It is also possible to devise a suitable electronic circuit, which will carry out the function of the relay. As the load resistance on the power pack decreases, so the current taken increases until it reaches a predetermined value. At this point the internal resistance

of the power supply unit rises, thus maintaining the output current at a constant level.

The writer has encountered a published circuit which would carry out these requirements, but it was extremely elaborate and required a lot of extra components. It was felt that a circuit with the advantages of the electronic current limiter

and the simplicity of the relay-type overload trip would provide a far better alternative. The writer's power supply unit is of the stabilised type and it was found that current limiting could be achieved with the use of just one extra component. So far as the writer is aware, the method employed is unique.

Fig. 2 shows the circuit of the writer's stabilised h.t. supply. The circuit is fairly standard, and it functions in the following manner. Any voltage fluctuation at the output terminal is passed to the EF80 control grid by the potential divider chain. It appears, amplified and  $180^\circ$  out of phase, at the EF80 anode, and is then passed to the grid of the 807 series valve. The 807 acts as a cathode follower, so that the original fluctuation at the terminal is counteracted by another similar but opposite fluctuation. As the circuit (which is, in effect, no more than a negative feedback loop) is d.c. coupled throughout, the "fluctuation" may be a steady voltage change such as is caused by an increased load. The  $2M\Omega$  potentiometer is used to vary the output voltage.

Now consider the circuit of Fig. 2 with the h.t. output terminals short-circuited. It is clear that, in that instance, the circuit can be reduced, to that of Fig. 3(a), omitting

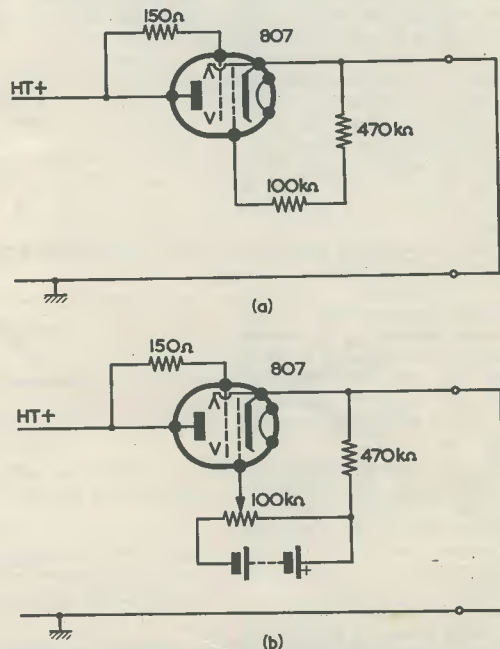

Fig. 3 (a). When the output terminals are short-circuited, the circuit of Fig. 2 reverts to this form  
(b). Adding a bias supply battery

the components which, since they are short-circuited have no effect. It is clearly possible to control the current passed by the 807 in Fig. 3(a) by introducing a bias, which may be adjustable. This is shown in Fig. 3(b) in which the 100kΩ grid resistor is replaced by a potentiometer in order to vary the bias.

It is now possible to see how the current limiting feature is introduced into the stabiliser circuit of Fig. 2. The 100kΩ fixed grid resistor for the 807 is replaced by the potentiometer, and the ends of the potentiometer track are taken to a two-way socket. When the current limiting facility is required, a battery is plugged in and the potentiometer adjusted until short-circuiting the terminals of the h.t. supply causes the required maximum current to flow. (Needless to say, the adjustment is made with the potentiometer initially at maximum setting.) The battery used is a pair of miniature radio-control batteries in series, offering a total of 27 volts. The circuit of the stabilising and current limiting stage of the writer's power pack is shown in Fig. 4

The setting of the 100kΩ potentiometer determines the current that will flow when the output is short circuited. The current drain on the batteries is very light, and they should last almost as long as their shelf life,

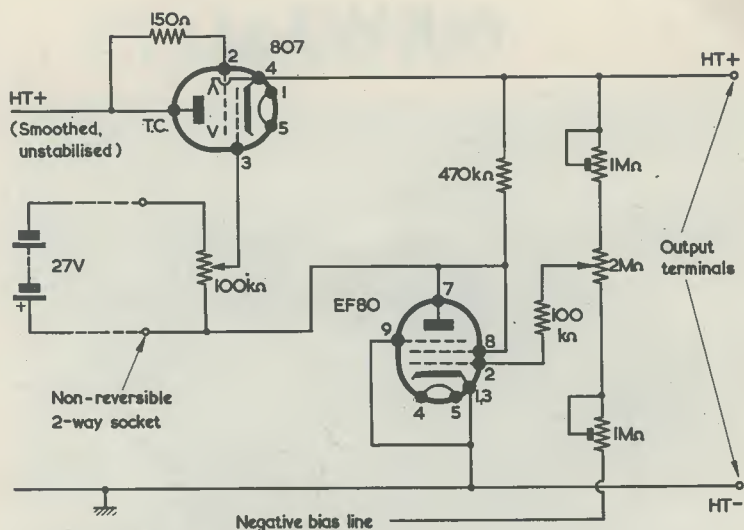

Fig. 4. The stabilising circuit of Fig. 2 with short-circuit protection

as they will not be permanently connected.

The circuit is reliable in operation and no trouble has been experienced with it. It has the disadvantage, however, of reducing the output voltage and the stabilisation factor\*

\* Stabilisation factor =  
Internal impedance of un stabilised supply unit  
Internal impedance of stabilised supply unit

of the circuit when the batteries are connected. It has been in use for over two years in the writer's own power supply unit, and has proved very worthwhile, particularly for "re-forming" electrolytic capacitors. Also, it has paid for itself many times over in preventing damage to components during the accidents which inevitably occur from time to time.

## CAN ANYONE HELP?

Requests for information are inserted in this feature free of charge, subject to space being available. Users of this service undertake to acknowledge all letters, etc., received and to reimburse all reasonable expenses incurred by correspondents. Circuits, manuals, service sheets, etc., lent by readers must be returned in good condition within a reasonable period of time

**R1155 Receiver.**—R. W. Sharp, 11 Lenham Road, Thornton Heath, Surrey—circuit or any information.

\* \* \*

**Walters "Metropolitan" Tape Recorder.**—R. Lakeman, 67 Goddington Road, Bourne End, Bucks—circuit, service manual, loan or purchase. Any information on availability of spare record/playback head. All expenses met.

\* \* \*

**McMichael Portable TV Model MP17.**—I. MacGregor, 1 High Barns, Boxworth, Cambs.—service sheet or manual.

\* \* \*

**Chromasonics Displays.**—P. J. Gillen, 2 Napier Drive, Dundee, Angus—circuits, magazine articles, and any general information—especially details of filters. Will purchase, borrow for photo-copy or gratefully receive. All letters answered, expenses refunded by return post.

**Binatone Hi-Fi Transistor Radio.**—J. Hopkins, 42 Woodward Road, Crosskeys, Mon.—circuit diagram (model TR-606).

\* \* \*

**Miniature Tape Recorders.**—J. S. Garforth, 10 Roundway Park, Devizes, Wilts.—any details or constructional plans (1in. spools).

\* \* \*

**B36 Tuner/Amplifier.**—T. Kirven, 2 Caxton Place, Wellesley Road, Ashford, Kent—circuit or manual of this ex-Admiralty receiver (W9232).

\* \* \*

**VHF Receiver.**—A. M. Fear, 65 Upjohn Crescent, Hartcliffe, Bristol 3—66 to 120Mc/s, thought to be of French manufacture, labelled S.A.D.I.R. and "Appareil Type R87", made in 1942. Has any reader any information?



## NEW ADVANCED UNIT FROM B.S.R. UA70 Turntable Unit

An instrument for the discriminating is how BSR describe their new UA70 automatic/manual turntable unit. Designed and engineered to the highest standards to meet the exacting needs of the hi-fi enthusiast and the fastidious listener, the unit has a multitude of quality features, a number of them exclusive to BSR.

One of these exclusive features is the calibrated stylus pressure control which ensures accurate low pressure tracking. The correct stylus pressure, depending on the type of stylus fitted, is set by turning the stylus pressure control, marked in grammes, to the prescribed figure. The finely stepped detent operated by the pressure control ensures precise location.

The low mass precision pick-up is of lightweight tubular aluminium and is counterbalanced, both vertically and laterally. A coarse and fine counterbalance adjustment facilitates balancing of the arm to suit the various cartridges which may be fitted. The arm is supported on horizontal ball bearing pivots making vertical friction virtually non-existent.

An interesting feature of the pick-up mechanism is the type of automatic lock again exclusive to the UA70, which secures the arm to its rest after a record has been played—or after the last record has been played when the instrument is being operated automatically.

The pick-up arm is protected against accidental damage by a series of overload devices.

The slim, lightweight cartridge shell compliments the tubular arm and has a finger lift which permits the safe and accurate positioning of the stylus on the record. The shell will accommodate all types of mono and stereo cartridge.

The 11in. diameter deep rim turntable, fitted with an attractively styled mat, is driven from a dynamically balanced four-pole motor located on butyl rubber mountings which prevent any mechanical vibrations affecting the reproduction of the recording. Corner mounting springs absorb any other vibrations outside the instrument.

Other features include interchangeable centre spindles for manual or automatic play, automatic disengagement of the idler wheel when the unit is shut off, four speeds, with manual selection of 7, 10 or 12in. diameter records and simple to operate, conveniently placed linear controls.

### It Had To Come

Kits of parts for home constructors enabling all types of radio gear to be built have been deservedly popular for a long time.

TV receivers have been the one omission. As far as the U.S.A. is concerned, this position has now been remedied. Conar Instruments Co. of Washington, a division of the National Radio Institute, have launched what is claimed to be America's first TV kit. The kit includes "every part—absolutely nothing else to buy". Also supplied are comprehensive step-by-step instructions.

The finished product will have no "amateurish" look about it, being housed in a steel cabinet 7½in. deep, 22in. wide and 16½in. high, with a baked-on rich dark brown finish.

Will some enterprising British supplier soon be following suit, perhaps spurred on by purchase tax provisions in the Budget? (These notes are being written before Budget Day.) Our enthusiasm for such a project would only be qualified because of the safety angle. Easy to follow step-by-step instructions bring with them the danger of people with very little electrical knowledge assembling something which could be lethal.

### Plessey Market Connector Labkits

The Plessey 603 printed circuit edge connectors are to be marketed as LabKits through the Blue-Arrow Service.

The kits comprise a 78-way strip, four pairs of mounting feet and four polarising keys. There are two basic kits: No. 1 and No. 2 with contact spacing of 0.156in. and 0.150in. respectively.

Intended for use by prototype and development engineers in industry, the universities and technical colleges, the connectors can be cut to size as shown in the illustration below, giving the user the exact number of terminations he requires.

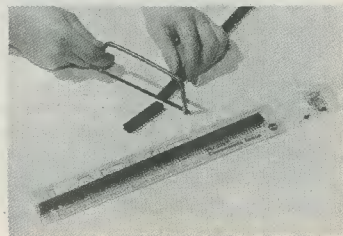

THE RADIO CONSTRUCTOR

# COMMENT



## New Heathkit Centre, London

To enable as many interested people as possible to see the Heathkit range of equipment "in the flesh", Daystrom Limited has opened a Showroom and Sales Centre at 233, Tottenham Court Road.

The locality was chosen as the most suitable in London for U.K. and Overseas visitors. The Centre is equipped with a Hi-Fi Demonstration Room and, besides the British range of Heathkit models, a selection of the American range is also presented.

The models are available in kit form or fully assembled, to suit various needs, and are purchasable at the Centre for taking away.

The Manager, Mr. H. Friedlander, and his staff will be pleased to show you round.

## Radio Doctor

The Rome correspondent of *The Times* recently wrote a most interesting article, in that paper, describing the work of the International Radio Medical Centre which acts as a free, long-range doctor to sick or injured seamen on board ships that do not have a doctor aboard.

The centre was founded by Professor Guido Guida, in the early twenties, and he spends half a day on his own practice and the remainder on patients he never sees.

The centre is housed in a two-storey villa in which there are two transmitters, one of 15,000 watts given by International Transport Workers' Federation, receivers, teletype room, library etc., rooms with wall maps dotted with flags showing the position of liners, with doctors on board, and the position of ships that have a patient who is being treated on advice given by the centre. Fifty of Italy's medical specialists have volunteered their services and may be contacted by telephone from the centre.

Originally the work was subsidised by Professor Guida himself but now has the support of the Italian Government and other bodies, such as the Belgian Navy.

Last year more than 8,000 messages were received and transmitted, over 1,000 patients treated and the centre co-operated in 86 air-sea rescues.

An anecdote recalled by the professor was of the sick sailor who complained that ship's doctors all gave the same treatment. "If it hurts above the waist give him an aspirin, if it hurts below give him an enema".

## 13th Electrical Engineers Exhibition Closes on a Successful Note

The Electrical Engineers Exhibition, sponsored and promoted by the Association of Supervising Electrical Engineers, at Earls Court, London, closed on a big note! Attendance figures steadily climbed to an all-time record of 103,420 including 1,323 from 81 overseas countries. Visitors and exhibitors described the Exhibition as the "most outstanding" ever.

More than 550 exhibitors took part and among these were some 74 exhibitors from 14 overseas countries, and goods to the total value of £12m. were on display.

## The British Amateur Electronics Club

We have recently been informed of the formation of the above club, the aim of which is to do for amateur electronics what The British Amateur Television Club has done so well for amateur television. Officials of the B.A.T.C. have, we understand, been most helpful in advising on the constitution of this new body.

It seems to us that there is a need for such an organisation and that it can be complementary to the existing societies which cater primarily for specialised interests such as transmitting, short wave listening, radio control, television, building of electronic organs etc.

There is no national society for radio constructors as such, and this new organisation may very well provide it.

Anyone requiring further information should write to Mr. Cyril Bogod, 26 Forest Road, Penarth, Glamorgan.

## INTERNATIONAL AWARD FOR MULLARD FILM

The Mullard film, *Thin-film Microcircuits*, was awarded a silver medal (1st prize) in its category at the 10th International Festival of Scientific-Teaching Films, organised by the University of Padua in conjunction with the 1965 Venice Film Festival. Over 150 films from 18 countries were entered.

*Thin-film Microcircuits* is a 16mm sound and colour film which deals with the manufacture of this new type of electronic component from design stage to the finished product. The film also describes typical applications including space vehicles, miniature computers and industrial electronic equipment.

Another Mullard film, *Electromagnetic Waves—Part II*, won a bronze medal (2nd prize) at the previous year's festival.

Our illustration is a still from the 1965 award winning film. It shows an operator assembling microminiature semiconductors on to a thin-film substrate.

As we go to press we learn that the film has been chosen by the National Film Archive for permanent preservation; the sixth Mullard film to be so honoured.

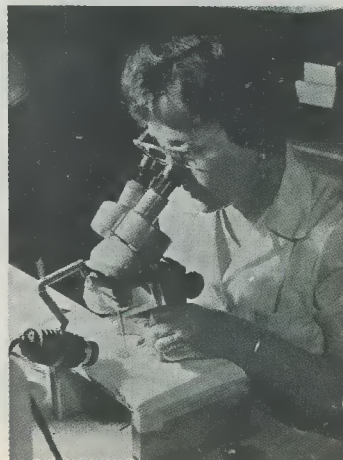

# The Operator "j"

by J. B. DANCE, M.Sc.

Get to grips with that mysterious bogey-man of basic electronics—the operator  $j$ ! In this short article our contributor dispenses with the embroidery which usually accompanies explanations at "popular" level of this symbol, and gives a lucid down-to-earth account of its exact purpose and use. It is assumed that the reader has a knowledge of simple algebra, this being necessary, in any case, if further work with the symbol is to be undertaken. And don't be deterred by the rather large equations which appear in the text. These are merely to get all the  $j$  terms together, after which things suddenly become very much simpler!

IF ONE LOOKS THROUGH ALMOST ANY BOOK ON circuit design (for example, "Thermionic Valve Circuits" by E. Williams\*), one almost always sees amongst the circuit design algebra a large number of small letter  $j$ 's. These can be most puzzling to the uninitiated unless there is some explanation of the symbol.

To make matters worse, if a young technician asks a typical serviceman about the symbol  $j$ , he will quite probably be told that it is the mysterious number  $\sqrt{-1}$  which doesn't really exist anyway. Alternatively the youngster may be told (by someone who doesn't understand the uses of  $j$  himself) that it is very complex and is connected with

\* Published by Sir Isaac Pitman and Sons, Ltd.

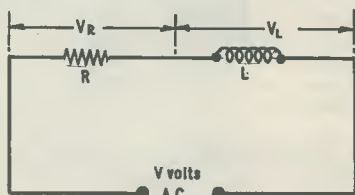

Fig. 1

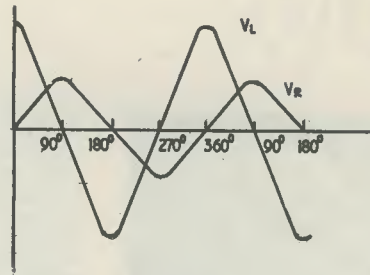

Fig. 2

Einstein's theory of relativity, the fourth dimension or "the other world". Such an "explanation" may achieve its object of preventing further awkward questions, but it can be most discouraging to the average youngster.

The use of the operator  $j$  can, in fact, be mastered quite easily by anyone who can carry out simple algebraical operations up to about 'O' Level standard of the G.C.E. The  $j$  symbol is, in fact, used to enable a.c. circuit calculations to be performed more easily without the necessity for drawing extremely complex vector diagrams.

It is hoped that readers will not be put off by some of the algebra given in the article, since it really is all very simple and straightforward, although it is not especially short.

## A.C. Circuits

If one has two resistors,  $R_1$  and  $R_2$ , in series, it is assumed that all readers will know that the total resistance of the combination will be  $R=R_1+R_2$ . This is so because if a potential  $V$  is applied across the two resistors, the current  $I$  flowing through them is given by Ohm's Law,

$$I = \frac{V}{R} = \frac{V}{(R_1 + R_2)}$$

If, however, one of these resistors is replaced by an inductor (Fig. 1) and an alternating potential is applied across the series combination, matters are not quite so simple. The reactance of the inductor,  $X_L$ , is given by the equation  $X_L = 2\pi fL$  where  $f$  is the applied frequency.  $X_L$  is measured in ohms, but one cannot simply add it to  $R$  to find the total impedance,  $Z$ , across the circuit. Similarly the applied voltage,  $V$ , is not equal to the sum of the measured voltages,  $V_L$  and  $V_R$ .

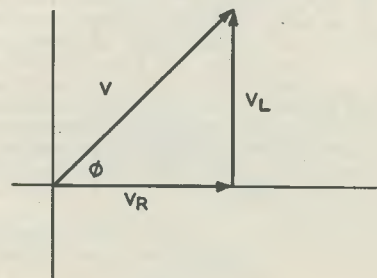

Fig. 3



Nevertheless, if one uses a double beam oscilloscope to display  $V_L$  and  $V_R$ , one finds that at any one particular instant of time  $V = V_L + V_R$ . The oscilloscope traces obtained are shown in Fig. 2. When one uses a normal meter, however, one measures the voltages in r.m.s. or possibly peak or peak-to-peak values; in this case  $V$  is not equal to  $V_L + V_R$ , since the peaks of  $V_L$  and  $V_R$  do not coincide in time.  $V_L$  leads  $V_R$  by  $90^\circ$ .

For this reason the impedance of L and of R cannot be added together in the normal way, but must be added "vectorially". Alternatively the  $j$  operator may be used; as we shall see this is based on vector diagrams.

### Vector Diagrams

The voltages in the simple circuit of Fig. 1 may be represented by the vector diagram of Fig. 3. All phase angles will be stated relative to the common current,  $I$ , passing through both R and L. Any voltages in phase with this current will be represented by a vector along the horizontal axis in Fig. 3. One such voltage is  $V_R$ , since it is a property of resistors that the current passing through a resistor is in phase with the voltage across it. Thus  $V_R$  is drawn along the horizontal axis as shown. The voltage  $V_L$  leads  $I$  by  $90^\circ$  (a property of inductors) and is therefore represented by a vertical line. If  $V_R$  and  $V_L$  are drawn so that the lengths of the lines are proportional to the values of the voltages, the length of the line  $V$  will be in the same proportion to the voltage  $V$ . Thus  $V$  may be calculated and the phase angle,  $\phi$ , by which  $V$  leads  $I$  may be found by measurement or by simple trigonometry.

Perhaps it should be mentioned that although Fig. 3 is normally referred to as a vector diagram, it should really be called a phasor diagram. The reason for this is that our reference direction is determined by  $I$  which is continually changing at the frequency of the alternating input voltage. The whole diagram should therefore be rotating at this frequency, but it is much easier to "freeze" the motion and call it a phasor diagram, since it shows the phases of each of the voltages relative to one another and to  $I$ .

### Impedance Diagrams

The equations relating  $I$  to the other quantities are:

$$R = \frac{V_R}{I}, \quad X_L = \frac{V_L}{I} \text{ and } Z = \frac{V}{I}$$

Thus, as  $Z$ ,  $R$  and  $X_L$  are proportional to  $V$ ,  $V_R$  and  $V_L$  respectively, the diagram of Fig. 3 can be re-drawn as Fig. 4 in which the lines represent impedance values of the components instead of voltages. This type of diagram is often more useful than those involving voltages or currents, since the results obtained from it for a particular circuit can be applied to a number of cases involving various voltages and currents.

One can see from Fig. 4 that  $Z = \sqrt{R^2 + X_L^2}$ . This does not tell us everything about  $Z$ , however.

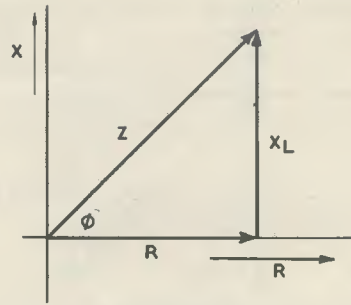

Fig. 4

To complete the picture we must know that the phase angle,  $\phi$ , is  $\tan^{-1} \frac{X_L}{R}$ .

Vector diagrams are very satisfactory for simple cases, but if there are more than about three components they become almost impossible to handle. An algebraical method of relating voltages, currents and impedances is therefore required which does not involve vector diagrams directly. This is where  $j$  enters our discussion.

### The $j$ Operator

If one wishes to write the impedance of the series components L and R in algebraical terms, one must somehow keep the resistive and reactive terms separate. One can write the impedance of a resistor and inductor connected in series in one of the following forms:  $(R + jX_L)$ ,  $(R + j\omega L)$  or  $(R + j.2\pi fL)$  where  $\omega = 2\pi f$ . The operator  $j$  is used merely to show that all terms containing it must be kept separate from those not containing it. Resistive ohms are thus kept separate from reactive ohms.

Another way of looking at  $j$  is that it signifies "turn left" on the vector diagram of Fig. 4(1). For example,  $R + jX_L$  means "proceed along the horizontal axis for a distance proportional to  $R$ , then turn left and proceed vertically for a distance proportional to  $X_L$ ". The distance  $Z$  is then proportional to the impedance of R and L in series.

Any impedance may be expressed in the form  $R + jX$ , including such things as amplifier output impedances, etc. If a circuit contains many components, the impedance between any two points

† This is just another way of saying that the  $\tan$  of  $\phi$  is  $\frac{X_L}{R}$ . "Tan-1" may be looked upon as meaning "the angle whose tan is".  
—EDITOR.

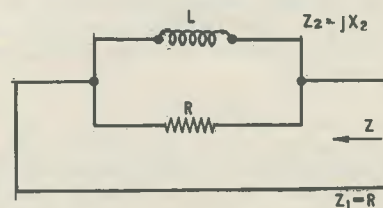

Fig. 5

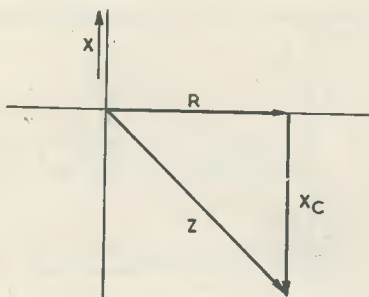

Fig. 6

can still be expressed in this general form, although R and X may each be some rather complicated functions of the resistors and reactances present in the circuit.

Incidentally, if any readers are pure mathematicians, they will realise that the operator  $j$  is derived from the mathematicians' Argand diagram. Mathematicians use the letter  $i$  to represent  $\sqrt{-1}$ . However, electronic engineers use  $i$  to represent current and therefore they use the next letter of the alphabet,  $j$ , to convert their phasor diagrams into algebraical terms.

$j^2$

If we are performing some calculations using  $j$  and we obtain a term involving  $j^2$ , this really means "turn left and then turn left again" on the vector diagram. The net effect is that one moves in a direction opposite to that which one was initially facing. On such a diagram, moving in the opposite direction is the same as adding a negative quantity. Thus instead of  $j^2$  one can always write  $-1$ . Sometimes  $j^2$  is said to equal  $-1$  whereupon, presumably,  $j = \sqrt{-1}$ . No number is known whose square root is  $-1$ . If one squares either  $+1$  or  $-1$  one obtains  $+1$ . Although there is some mystery as to what  $\sqrt{-1}$  really is, there is no difficulty if one understands that  $j$  means "turn left" on the vector diagram and each time one meets  $j^2$  one writes  $-1$  instead of it. Similarly  $j^4 = -j^2 = +1$ , and  $j^3 = -j$ .

Quantities like  $R + jX$  are referred to as complex quantities, since they contain two components, R and X, which must be kept separate. In view of the fact that  $j$  is referred to as  $\sqrt{-1}$ , the reactive term is said to be imaginary. Although we know that reactive terms are not imaginary—especially if our fingers get caught on the contacts of a high voltage charged capacitor—we shall use the term imaginary in one or two places so that readers will become familiar with the normal terminology of the subject.

### Simple Calculation

When using  $j$  one can employ all the usual rules for combining impedances. In particular, the impedance, Z, of two series impedances,  $Z_1$  and  $Z_2$ , is given by:  $Z = Z_1 + Z_2$ . The impedance, Z, of the same two impedances in parallel is given

by the equation:  $\frac{1}{Z} = \frac{1}{Z_1} + \frac{1}{Z_2}$  which may be rearranged to the form:

$$Z = \frac{Z_1 Z_2}{Z_1 + Z_2} \quad \text{Equation 1}$$

As a simple example let us work out the effective impedance of a resistor R in parallel with an inductor L (Fig. 5). Using equation 1, we can substitute in it the values  $Z_1 = R$  and  $Z_2 = jX_L$ :

$$Z = \frac{R(jX_L)}{R + jX_L}$$

It is almost always desirable to manipulate our equations so that we can separate real and imaginary terms. To do this we must remove any  $j$ 's from the denominator. The method one always uses for this involves the multiplication of both the numerator and the denominator by a number according to the following rule:

If the denominator is  $(R + jX)$ , multiply by  $(R - jX)$ ; if the denominator is  $(R - jX)$ , multiply by  $(R + jX)$ . Thus our equation now becomes:

$$\begin{aligned} Z &= \frac{R(jX_L)}{R + jX_L} \cdot \frac{(R - jX_L)}{(R - jX_L)} \\ &= \frac{R^2 jX_L - j^2 R X_L^2}{R^2 + jR X_L - jR X_L - j^2 X_L^2} \end{aligned}$$

It will be noted that the two  $jR X_L$  terms in the denomination cancel out.

Putting  $j^2 = -1$ ,

$$Z = \frac{R^2 jX_L + R X_L^2}{R^2 + X_L^2}$$

$$\text{or } Z = \frac{R X_L^2}{R^2 + X_L^2} + j \frac{R^2 X_L}{R^2 + X_L^2}$$

This shows that the parallel circuit of Fig. 5 behaves as a resistance of  $R X_L^2 / (R^2 + X_L^2)$  ohms in series with an inductive reactance of  $R^2 X_L / (R^2 + X_L^2)$  ohms. These are the series values which would be obtained if the parallel circuit of Fig. 5 were measured on a normal impedance bridge. The reactive term can, of course, be expressed in

the form of an inductance of  $\frac{R^2 X_L}{(R^2 + X_L^2) \cdot 2\pi f}$

henrys. It can be seen that the value of this inductance varies with frequency.

### Capacitors

For simplicity no mention has yet been made of capacitive reactance. If a resistor and capacitor are connected in series, the vector diagram used for finding the impedance, Z, of the series circuit is shown in Fig. 6.  $X_C$ , the reactance of the capacitor

is equal to  $\frac{1}{\omega C}$  or  $\frac{1}{2\pi f C}$ . The voltage across the

capacitor lags that across the resistor by  $90^\circ$  and therefore the capacitance must be treated as a negative inductance. This is shown in the vector diagram by drawing the  $X_C$  vector downwards.

In terms of  $j$  the impedance of a capacitor can be written as  $\frac{-j}{\omega C}$  or, since  $j^2 = -1$ , as  $\frac{1}{j\omega C}$ . The impedance of a capacitor in series with a resistor may be written as  $R - \frac{j}{\omega C}$ .

**Practical Calculation**

The  $j$  operator will now be used to find the effect of the resistance of an inductor on the resonant frequency of a parallel tuned circuit. It will be assumed that the capacitor is a perfect one and that all losses occur in the coil. In practice this is virtually true, since a good capacitor shows very small losses compared with a typical good inductor. The equivalent circuit is shown in Fig. 7;  $R$  may be represented as being in series with  $L$ .

Using equation 1 for two parallel impedances and putting in the values  $Z_1 = R + j\omega L$  and  $Z_2 = -j/\omega C$ , we obtain:

$$Z = \frac{(R + j\omega L) \left(\frac{-j}{\omega C}\right)}{R + j\omega L - \frac{j}{\omega C}} \dots \dots \text{Equation 2}$$

$$= \left(\frac{-j}{\omega C}\right) \frac{(R + j\omega L)}{R + j\left(\omega L - \frac{1}{\omega C}\right)}$$

To remove  $j$  from the denominator, we multiply both numerator and denominator by  $R - j(\omega L - 1/\omega C)$ , whereupon

$$Z = \frac{-j}{\omega C} \left\{ \frac{R^2 + j\omega LR - j\omega LR + \frac{jR}{\omega C} + \omega L \left[ \omega L - \frac{1}{\omega C} \right]}{R^2 + \left(\omega L - \frac{1}{\omega C}\right)^2} \right\}$$

(As will be seen, the two  $j\omega LR$  terms in the numerator cancel out.)

$$Z = \frac{1}{\omega C} \left\{ \frac{-jR^2 + \frac{R}{\omega C} - j\omega L \left(\omega L - \frac{1}{\omega C}\right)}{R^2 + \left(\omega L - \frac{1}{\omega C}\right)^2} \right\}$$

$$Z = \frac{R}{\omega^2 C^2 \left[ R^2 + \left(\omega L - \frac{1}{\omega C}\right)^2 \right]} - \frac{j \left[ R^2 + \omega L \left(\omega L - \frac{1}{\omega C}\right) \right]}{\omega C \left[ R^2 + \left(\omega L - \frac{1}{\omega C}\right)^2 \right]} \dots \dots \dots \text{Equation 3}$$

This is admittedly living up to its name as being a complex number!

Let us define resonance as the frequency at which the circuit becomes a pure resistance. This occurs when the imaginary part of the above expression becomes zero, that is, when:

$$\frac{R^2 + \omega L \left[ \omega L - \frac{1}{\omega C} \right]}{\omega C \left[ R^2 + \left(\omega L - \frac{1}{\omega C}\right)^2 \right]} = 0$$

This can only be true when the numerator = 0.

Thus  $R^2 + \omega L \left[ \omega L - \frac{1}{\omega C} \right] = 0$

$$R^2 + \omega^2 L^2 - \frac{L}{C} = 0 \dots \dots \dots \text{Equation 4}$$

Solving for  $\omega$ ,  $\omega^2 L^2 = \frac{L}{C} - R^2$

$$\omega = \sqrt{\frac{1}{LC} - \frac{R^2}{L^2}}$$

or  $f = \frac{1}{2\pi} \sqrt{\frac{1}{LC} - \frac{R^2}{L^2}} \dots \dots \dots \text{Equation 5}$

If  $R=0$ , it can be seen that Equation 5 becomes the well-known

$$f = \frac{1}{2\pi \sqrt{LC}}$$

**Q** In order to find the effect of losses in terms of the circuit  $Q$ , we will return to equation 4 and multiply it by  $\frac{C}{L}$ :

$$\frac{CR^2}{L} + \omega^2 CL - 1 = 0$$

$$\omega^2 LC + \frac{CR^2}{L} = 1$$

$$\omega^2 LC \left( 1 + \frac{R^2}{\omega^2 L^2} \right) = 1$$

$$\omega = \frac{1}{\sqrt{LC}} \cdot \frac{1}{\sqrt{1 + \frac{R^2}{\omega^2 L^2}}}$$

But  $Q = \frac{\omega L}{R}$ ,

hence  $\omega = \frac{1}{\sqrt{LC}} \cdot \frac{1}{\sqrt{1 + \frac{1}{Q^2}}}$

If  $Q = 100$ ,  $\sqrt{1 + \frac{1}{Q^2}} \approx 1.00005$ .

This will cause a change of only 0.005% in the frequency, but if the  $Q$  drops to 5, the resultant change in the resonant frequency is about 2%.

The resonant frequency was taken as that at

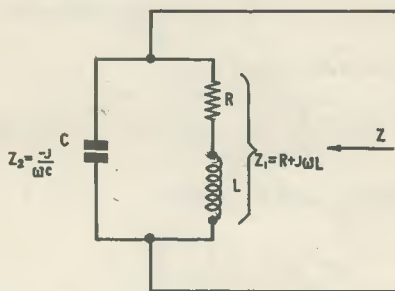

Fig. 7

which the imaginary part of equation 3 is zero, but one can define the resonant frequency in other ways, in which case equations slightly different from equation 5 are obtained.<sup>2</sup> If Q is large, these equations all approximate to  $f = 1/2\pi\sqrt{LC}$ . We can therefore use this last equation with confidence in almost every case, but it is nevertheless sometimes useful to know that the resonant frequency of a parallel tuned circuit is somewhat dependent on the way in which resonance is defined.

Matters are much simpler in series resonant circuits, since the resonant frequency is always equal to  $1/2\pi\sqrt{LC}$  no matter how resonance is defined. It is very easy to prove this for the case when resonance is defined as occurring when the reactive part of the impedance is zero (much easier than in the case of the parallel tuned circuit) and this proof is left as a half minute exercise for readers.

In many calculations it is necessary to know the dynamic impedance of a tuned circuit. This is given by equations 2 and 3, but it is perhaps more useful to simplify equation 2 for frequencies near resonance when  $\omega L$  is much greater than R. Hence we can omit R from the numerator:

$$Z = \frac{\frac{L}{C}}{R + j\left(\omega L - \frac{1}{\omega C}\right)}$$

R must not be omitted from the denominator, however, since at resonance  $\omega L = \frac{1}{\omega C}$  and therefore  $Z = \frac{L}{CR}$ . The circuit behaves as a pure resistance at this frequency, since no j terms are present.  $\frac{L}{CR}$  is called

the dynamic resistance of the parallel tuned circuit and is very useful in circuit calculations. It is the maximum impedance offered by the circuit as the frequency varies.

### Tuned Circuit Amplification

As a final example of the uses of the j operator, let us suppose that we have to find the voltage gain, A, of the circuit shown in Fig. 8 at an input frequency of 1 kc/s.  $A = \frac{V_o}{V}$ .

Let Z be the total impedance of R, L and C in

series.  $V_o = IX_C$  (compare  $V = IR$ ),  $V = IZ$ , then

$$\begin{aligned} A &= \frac{V_o}{V} \\ &= \frac{IX_C}{IZ} \\ &= \frac{X_C}{Z} \\ &= \frac{X_C}{R + jX_L - jX_C} \\ &= \frac{X_C}{R + j(X_L - X_C)} \end{aligned}$$

Now, in Fig. 8,

$$\begin{aligned} X_C &= \frac{1}{2\pi fC} \\ &= \frac{1}{2\pi \cdot 10^3 \cdot 10^{-6}} \\ &= 159.2\Omega, \end{aligned}$$

$$\begin{aligned} X_L &= 2\pi fL \\ &= 2\pi \cdot 10^3 \cdot 0.02 \\ &= 125.7\Omega, \end{aligned}$$

And  $R = 10\Omega$ .

Therefore,

$$\begin{aligned} A &= \frac{159.2}{10 + j(125.7 - 159.2)} \\ &= \frac{159.2}{10 - j33.5} \end{aligned}$$

In order to find A, we must use  $Z = \sqrt{R^2 + X_C^2}$  (this equation can be obtained by applying Pythagoras' Theorem to Fig. 6).

Therefore

$$\begin{aligned} A &= \frac{159.2}{\sqrt{10^2 + 33.5^2}} \\ &= 4.554 \end{aligned}$$

How is it that we can obtain a voltage gain without any power input? We should know that nature never gives us something for nothing and, as many of our readers will have doubtless guessed,

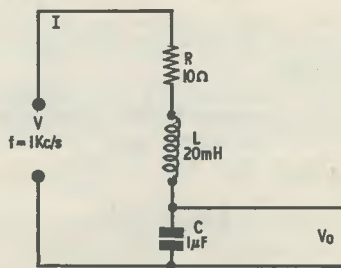

Fig. 8

as soon as we take a current from across C of Fig. 8,  $V_o$  will fall. Thus a tuned circuit can be used as a transformer. One could, in fact, plot the response curve of a tuned circuit by using the above equation for A.

#### Applications of the j Technique

Although the examples which have been used to illustrate the uses of the j operator have been mainly concerned with simple tuned circuits, this is by no means the only uses to which the operator can be put. For example, it can be used in the design of amplifiers where the effect of coupling and decoupling capacitors must be considered. It can also be used in the design of feedback circuits and of sine wave oscillators (including RC oscillators). It is especially useful in equivalent circuit analysis of many different types of component<sup>3</sup> and can be applied to the analysis of non-electronic equivalent circuits such as that of a loudspeaker.

The j notation cannot be applied when the voltages and currents in a circuit do not vary in a sinusoidal way, for example, in the design of multivibrator circuits.

#### Further Reading

Those readers who have not found this article

especially easy are encouraged to spend a little time using the j operator in problems of the kind which have been discussed. It is a technique which is not difficult to master and which is essential for a study of much of the literature of electronics. Readers may also like to refer to two articles which "Cathode Ray" wrote in *Wireless World* some years ago<sup>1, 4</sup>.

Those readers who have found this article much too simple and who wish to improve their knowledge of the basic mathematical tools used in circuit design may like to study the Heaviside Operation Calculus and Laplace transforms<sup>5, 6</sup> which enable circuits with non-sinusoidal voltages to be analysed. Alternatively they might like to try some Matrix Algebra<sup>7, 8</sup>.

#### References

1. 'Cathode Ray'. "j" *Wireless World*, February 1948.
2. F. Langford-Smith. "Radio Designer's Handbook", p. 151. Iliffe, fourth edition, 1953.
3. J. B. Dance. "Tunnel Diode Measurements", *Wireless World*, March 1965.
4. 'Cathode Ray'. "The Complex Number". *Wireless World*, February 1953.
5. W. D. Day. "Introduction to Laplace Transforms for Radio and Electronic Engineers". (Book) Iliffe, 1960.
6. B. J. Starkey. "Laplace Transforms for Electrical Engineers" (Book) Iliffe, 1954.
7. K. A. Pullen, Jr. "Topological and Matrix Methods" (Book) Iliffe, 1965.
8. G. H. Olsen. "Matrix Algebra" series of articles in *Wireless World* commencing in March 1965.  
(References 1 and 4 have been re-printed in the book by 'Cathode Ray' entitled 'Second Thoughts on Radio Theory'. Iliffe Books Ltd.)

## RECENT PUBLICATIONS . . .

### NEWNES RADIO AND TELEVISION SERVICING (1965-66 Models)

By J. P. Hawker and J. Reddihough. 496 pages, 9 x 6in. Now published by Buckingham Press Ltd. (Successors to S.B. Division of George Newnes Ltd.) Price 85s.

Every year a new edition of Newnes famous Radio and Television Servicing is published. Always in great demand, these annual volumes contain a wealth of circuits, data and repair hints for popular Television, Radio, Tape Recorders and record reproducers. The new 1966 edition has just been published and deals with 1965-66 models, nearly 50 principal makes.

The publishers, Buckingham Press Ltd. who are the successors to S.B. Division of George Newnes Ltd. have asked us to mention that their address has not changed, it remains—15-17 Long Acre, London, W.C.2.

Copies of Radio and Television Servicing are available on free trial, direct from Buckingham Press Ltd.

### SERVICING ELECTRONIC ORGANS. By Carl R. Pittman and Eugene J. Oliver. 197 pages. Price 30s.

Although this book is primarily aimed at the American serviceman who sets out to service American organs, it serves the secondary function of acquainting the English reader with American commercial organ practice. A large number of circuit diagrams (with component values) for the various sections of American organs are given, and these should prove to be of particular interest to the growing band of amateur organ constructors in the U.K. The ten manufacturers whose products are covered include Allen, Baldwin, Hammond, Kinsman and Wurlitzer.

The book commences with an introduction to musical terms and basic organ circuits, and continues through tone generators, pedal generators and pedal sustain, vibrato and tremolo, keyswitches, percussion, sustain, voicing, amplifiers and power supplies, tuning and adjustment, and additional speaker units. The reviewer feels that this book could well find a home on the bookshelf of many an organ enthusiast.

### ELECTRIC GUITAR AMPLIFIER HANDBOOK. By Jack Darr. 150 pages. Price 24s.

Jack Darr is the Service Editor of the American magazine *Radio-Electronics*, and wields one of the most practical and down-to-earth pens in the business. In consequence, the reviewer took up this particular book with enhanced interest. Nor was he disappointed. It has to be said that, like *Servicing Electronic Organs*, reviewed above, the present book is intended for the American service engineer, and so some of the material may not be entirely applicable to the English reader. Nevertheless, the basic servicing approaches described are common to equipment on either side of the Atlantic. At the same time, the book gives a considerable insight into American guitar amplifier design. There are plenty of circuits (with component values) showing commercial designs, these including circuits for complete amplifiers incorporating the refinements which are expected in equipment of this nature. The amplifiers circuits comprise three low power amplifiers, nine medium power amplifiers and ten high power amplifier. Some of these are transistorised. Also described are tone controls, tremolo, vibrato, echo and reverberation, and multi-input mixing.



Cover Feature

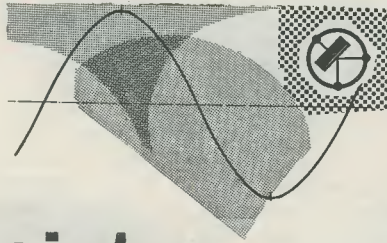

# Transistor Curve Tracer

by R. J. BARRETT

*Transistor characteristic curves can be displayed direct on the screen of an oscilloscope with the aid of the ingenious device described here. A family of curves showing collector current versus collector voltage are given with either base current or emitter current as parameter, and both p.n.p. and n.p.n. transistors can be accommodated. Collector current is limited to just over 1mA maximum, but this does not preclude the carrying out of many useful tests, including checks for leakage. Normal diodes and zener diodes may also be readily tested by means of this instrument.*

**T**HE PURPOSE OF THIS UNIT IS TO display the output characteristics of transistors on a cathode ray oscilloscope. It has facilities for testing both p.n.p. and n.p.n. types, and the display may be for the grounded emitter or grounded base configuration. It will indicate large values of leakage current ( $I_{co}$ ) and will clearly show the maximum collector voltage that may be used with a particular transistor ( $V_{ce\ max}$ ). A good approximation of the gain (Beta or  $h_{fe}$ ) of the transistor is indicated on the display, and the forward and reverse characteristics of the emitter base junction and the collector base junction can be shown. The unit can be used to test and measure diodes, and it includes a switch for displaying both forward and reverse characteristics together. The unit is built in a metal box measuring 9 x 5 x 2 in. and it requires a direct current power supply or battery giving 12 volts at 50mA.

The oscilloscope should have provision for access to the X plates and its Y amplifier should have a sensitivity of about 0.1 volt per centimetre. If the X sensitivity is not known, it is advisable to calibrate the instrument and also make a graticule if one is not already fitted. Simple instructions for doing this are included at the end of this article.

## Circuit Description

The circuit is best understood by reference to Figs. 1 and 2, together with the various wave forms that are generated. As will be seen, TR<sub>1</sub> is used with its associated transformer to generate an a.c. waveform of approximately 200c/s. This waveform is rectified by diode D<sub>1</sub>, and provides the varying voltage on the transistor test collector terminals. It may be switched to either positive for n.p.n. transistors or negative for p.n.p. types by the main selector switch, S<sub>3</sub>. By closing switch S<sub>1</sub> the diode D<sub>1</sub> is short-circuited, making the full a.c. voltage available at the diode test terminals for displaying both forward and reverse diode characteristics together. Both the positive and negative voltages are continuously variable from 0 to 20 volts, and the a.c. voltage on the diode test terminal from 0 to 40 volts. Output is taken from the emitter of TR<sub>1</sub> via the 0.1μF capacitor, C<sub>5</sub>, to the base of TR<sub>2</sub>, which bottoms every half cycle thus producing a square waveform at its collector. This wave is used to charge a 1μF capacitor, C<sub>1</sub>, through D<sub>2</sub>, each pulse adding to the voltage supplied by the last, and resulting in a stepped or staircase waveform building up across C<sub>1</sub>. TR<sub>3</sub> is included to linearise this wave-

form and assist in making the steps equal.

Because it is necessary to repeat the stepped waveform, TR<sub>4</sub> is connected across C<sub>1</sub> and discharges it at about 20 c/s. A silicon transistor is used for this function as its leakage current is extremely small. The frequency at which C<sub>1</sub> is discharged is determined by the astable circuit given by TR<sub>6</sub> and TR<sub>7</sub>. The mark-to-space ratio of this part of the circuit is determined by an 8μF capacitor and a 1μF capacitor (C<sub>8</sub> and C<sub>9</sub>) allowing C<sub>1</sub> a long charging time and a short discharge time.

It will thus be seen that we now have a repetitive staircase waveform available for supplying to the emitter or the base of the transistor under test. The waveform passes through an emitter follower transistor under test. The waveform passes through an emitter follower transistor TR<sub>5</sub> and is then switched to be either positive or negative going as is required at the transistor test terminal. The amplitude of the wave is continuously variable by adjusting the potentiometer VR<sub>3</sub>.

The vertical ordinate on the cathode ray tube, which represents the current flowing through the transistor under test, is obtained by measuring the voltage developed across the 1kΩ resistor, R<sub>14</sub>, in series with the collector terminal. This is done by connecting the Y input to the oscilloscope across this resistor. If the Y input sensitivity is set to 0.1 volt per centimetre this means that every centimetre on the tube face indicates 0.1mA collector current. Voltage applied to the device is shown by horizontal deflection on the screen obtained by connecting the X input across the base to collector, or emitter to collector, test terminals. It should now be clear that, as the voltage on the collector is swept from zero up to a maximum of 20 volts, the emitter or base current is increased in a series of steps, each step producing an increase in collector current as displayed on the oscilloscope tube in the vertical direction.

## Practical Example

To take an example of practical circuit operation, let us assume that a p.n.p. transistor is to be checked in the grounded emitter configuration. The transistor will be connected to the "Grounded Emitter" terminals and switch S<sub>3</sub> will be set to position 2, or "P.N.P. Grounded Emitter". The resultant circuit operation will now be described in detail.

### Components List

#### Resistors

(All fixed values 10% 1/2 watt)

R <sub>1</sub> 820Ω	R <sub>9</sub> 1.2kΩ
R <sub>2</sub> 680Ω	R <sub>10</sub> 10kΩ
R <sub>3</sub> 150Ω	R <sub>11</sub> 10kΩ
R <sub>4</sub> 43kΩ	R <sub>12</sub> 1.2kΩ
R <sub>5</sub> 4.7kΩ	R <sub>13</sub> 2.2kΩ
R <sub>6</sub> 1.2kΩ	R <sub>14</sub> 1kΩ
R <sub>7</sub> 22kΩ	R <sub>15</sub> 47kΩ
R <sub>8</sub> 15kΩ	

VR<sub>1</sub> 100Ω preset potentiometer, wirewound, linear track, (Radiospares—see text)

VR<sub>2</sub> 50kΩ carbon potentiometer, linear track.

VR<sub>3</sub> 50kΩ carbon potentiometer, linear track.

#### Capacitors

C <sub>1</sub> 1μF paper (Wima)
C <sub>2</sub> 3μF 15 V. wkg, electrolytic*
C <sub>3</sub> 50μF 15 V. wkg, electrolytic
C <sub>4</sub> 25μF 15 V. wkg, electrolytic
C <sub>5</sub> 0.1μF polyester
C <sub>6</sub> 0.1μF polyester
C <sub>7</sub> 0.1μF polyester
C <sub>8</sub> 8μF 15 V. wkg, electrolytic
C <sub>9</sub> 1μF 15 V. wkg, electrolytic

\*May be 1μF and 2μF in parallel.

#### Transformer

T<sub>1</sub> 3.6:1+1 transformer type T/T3 (Radiospares)

#### Semiconductors

D<sub>1</sub> MR1H (A.E.I.—see text)  
D<sub>2</sub> OA85 (Mullard)

TR<sub>1</sub> OC200 (Mullard)  
TR<sub>2</sub> NKT 272 (Newmarket) or OC81D (Mullard)  
TR<sub>3</sub> NKT 272 (Newmarket) or OC81D (Mullard)  
TR<sub>4</sub> OC202 (Mullard)  
TR<sub>5</sub> NKT 272 (Newmarket) or OC81D (Mullard)  
TR<sub>6</sub> NKT 272 (Newmarket) or OC81D (Mullard)  
TR<sub>7</sub> NKT 272 (Newmarket) or OC81D (Mullard)

#### Switches

S<sub>1</sub> s.p.s.t. toggle  
S<sub>2</sub> s.p.s.t. toggle  
S<sub>3</sub> 4-pole 4-way (made up from

#### Miscellaneous

8 Insulated Terminals, White (Radiospares—see text.)  
2 4mm Insulated Sockets, Red (Radiospares)  
1 4mm Insulated Socket, Black (Radiospares)  
2 Miniature Group Panels, one 12-way and one 18-way (Radiospares—see text)

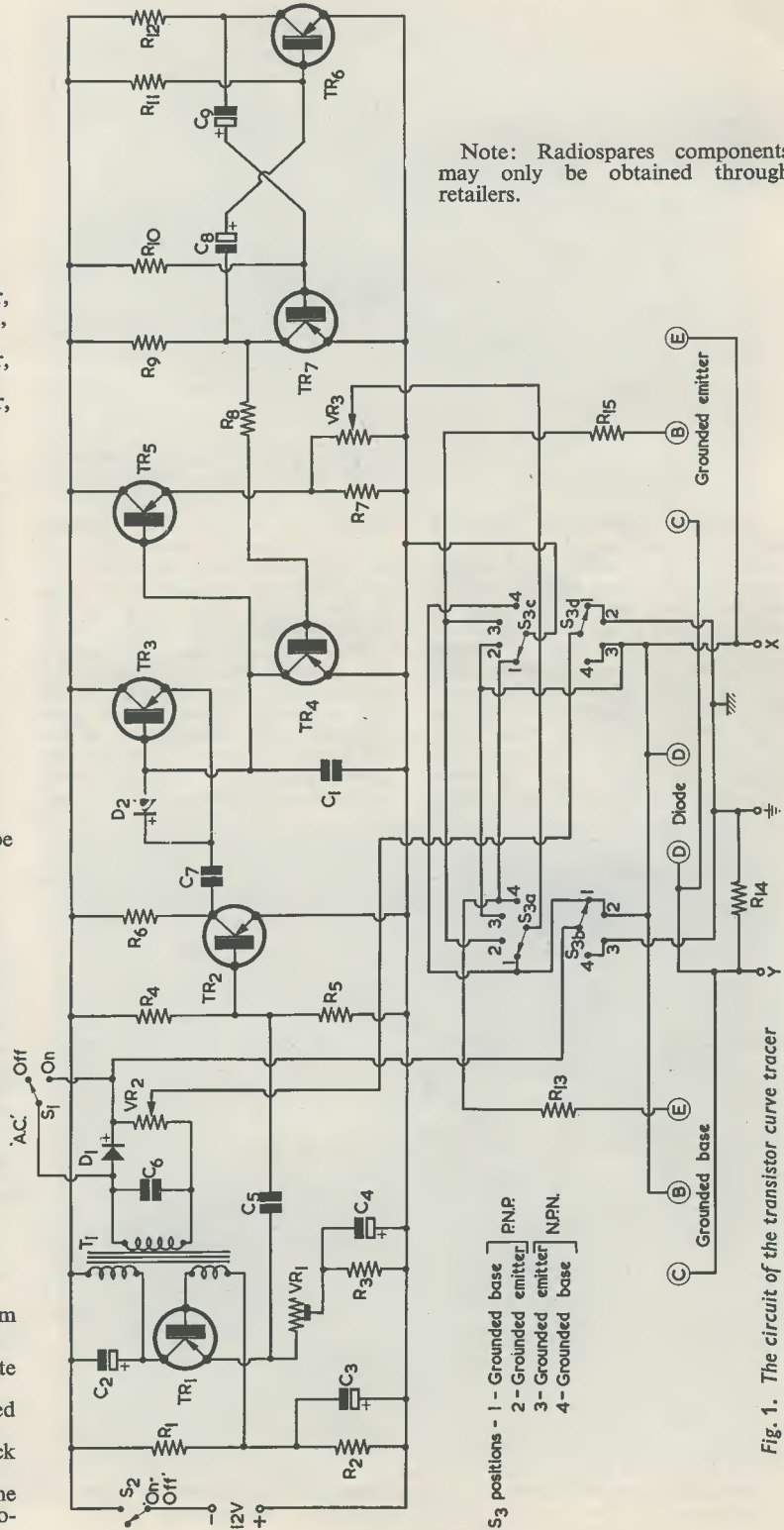

Fig. 1. The circuit of the transistor curve tracer

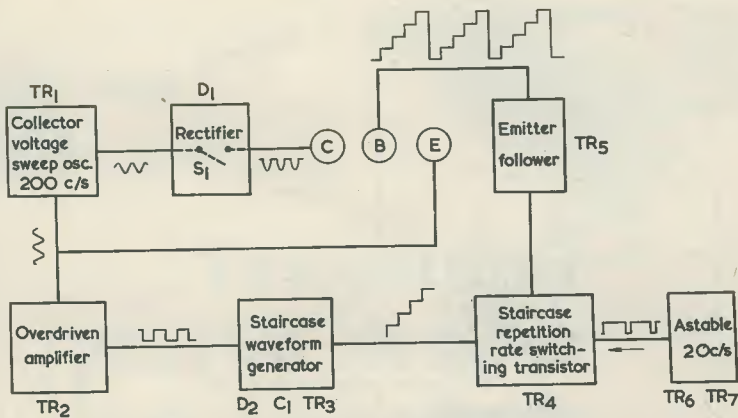

Fig. 2. Block diagram illustrating the functioning of the instrument when checking a transistor in the grounded emitter configuration

Available between the slider of VR<sub>2</sub> and the upper end of its track is the alternating voltage rectified by D<sub>1</sub>. The rectified voltage at the upper end of the track is positive with respect to the slider—alternatively, the rectified voltage at the slider is negative with respect to the upper end of the track. With S<sub>3</sub> set to position 2, the upper end of VR<sub>2</sub> connects, via S<sub>3(b)</sub>, to the emitter of the transistor under test. The slider of VR<sub>2</sub> connects, via S<sub>3(d)</sub> to earth and,

then, via R<sub>14</sub>, to the collector of the transistor under test. It will be noted that there is only one earth (or chassis) connection in the circuit, this being at the earth terminal itself.

Thus, S<sub>3(b)</sub> and S<sub>3(d)</sub> have caused the rectified alternating voltage to be applied to the transistor under test such that the collector goes negative of the emitter, as is required for a p.n.p. transistor. An earthy point (for convenience in connecting to the oscilloscope) has

been established at the slider of VR<sub>2</sub>.

The transistor characteristic curves offered by the instrument give collector voltage along the X axis and collector current along the Y axis, with (for grounded emitter operation) base current as parameter. Collector voltage is read by connecting the X circuits of the oscilloscope to earth and the emitter of the transistor under test, the relatively small voltage drop across R<sub>14</sub> (which is in series with the collector) being discounted. Collector current is read by applying the Y circuits of the oscilloscope to earth and the non-earthly side of R<sub>14</sub>, whereupon the voltage drop across R<sub>14</sub> causes vertical deflection.

During each trace given by the rectified half-cycle from D<sub>1</sub>, step capacitor C<sub>1</sub> offers a fixed potential. This rises between traces. The voltage step function appearing at the emitter of TR<sub>5</sub> and tapped off by VR<sub>3</sub> is, therefore, negative-going. The slider of VR<sub>3</sub> is connected, via S<sub>3(a)</sub>, to the base of the transistor under test by way of current limiting resistor R<sub>15</sub>. The lower end of VR<sub>3</sub> (which is also, incidentally, the battery positive supply line) connects, via S<sub>3(c)</sub>, to the emitter of the transistor under test. Thus, an increasing negative step voltage (with respect to emitter) is applied to R<sub>15</sub>. This is of correct polarity to cause an increasing step current in a p.n.p. transistor.

After some ten step functions have been obtained in this manner TR<sub>4</sub> conducts, and causes the process to start once more. By adjustment of the oscillator speed control, VR<sub>1</sub>, successive sets of traces may be made to coincide, resulting in the display of a complete family of curves.

If the remaining circuits switched in by S<sub>3</sub> are traced out, it will be seen that similar circuit configurations are provided.

#### Components

The components required for the instrument are specified in the Components List. Some further notes concerning these are given here.

An A.E.I. diode type MR1H was employed in the prototype for D<sub>1</sub>. However, any silicon diode with a peak inverse rating of some 40 to 100 should be quite satisfactory here.

Variable resistor VR<sub>1</sub> is shown in Fig. 1 and in the Components List as a preset control. In practice, this component requires fairly frequent adjustment. The Radiospares control actually employed has a

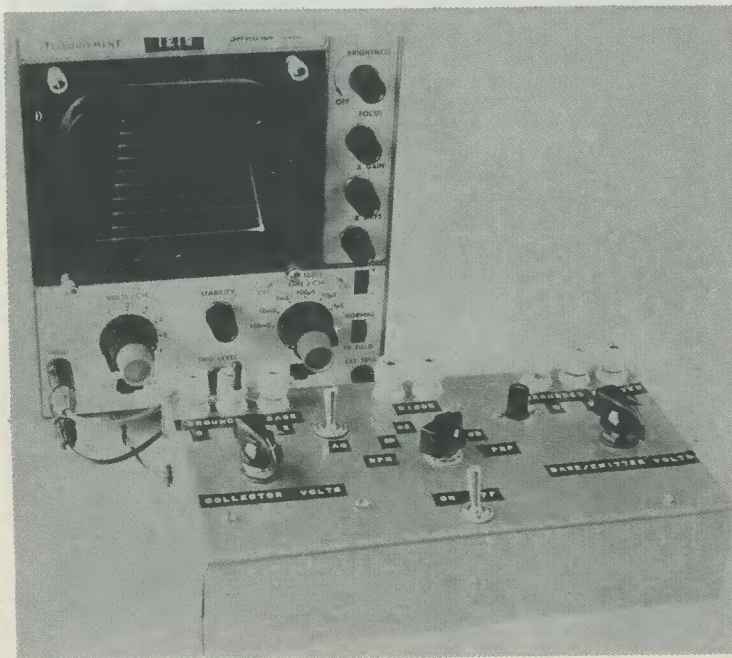

The curve tracer checking a p.n.p. transistor in the common base configuration. The family of curves provided is readily visible on the oscilloscope screen



knurled spindle with a screwdriver slot, and may be readily adjusted by hand. If a preset potentiometer of this type is not used, it might be advisable to employ a normal potentiometer fitted with a small knob. The appropriate dimensions in the drilling diagram of Fig. 3 then become modified accordingly. When the Radiospares component is employed, the mounting screws should not be longer than 0.28in.

Capacitor  $C_2$  is listed as  $3 \mu\text{F}$ . It may consist of a  $1 \mu\text{F}$  and a  $2 \mu\text{F}$  capacitor in parallel.

Two groupboards are also listed, one being 18-way and the other 12-way. These are Radiospares "Miniature" Group Panels, having a width of 1.5in. and a length, for the 18-way board, of 4.62in. If 12-way cannot be obtained, the 12-way board can be cut from an 18-way board. Both boards are mounted, in the present instance, to the front panel with 4BA bolts and spacing pillars, as discussed later.

The prototype employed eight Radiospares white insulated terminals. The threaded portions of these should be reduced in length to half an inch before assembly.

It should be added, incidentally, that Radiospares components may only be obtained through retailers.

### Construction

The curve tracer is assembled in a metal box, aluminium being a suitable material and it should be carefully marked out and drilled for the terminals, switches and potentiometers, as shown in Fig. 3. The box may be painted or sprayed or

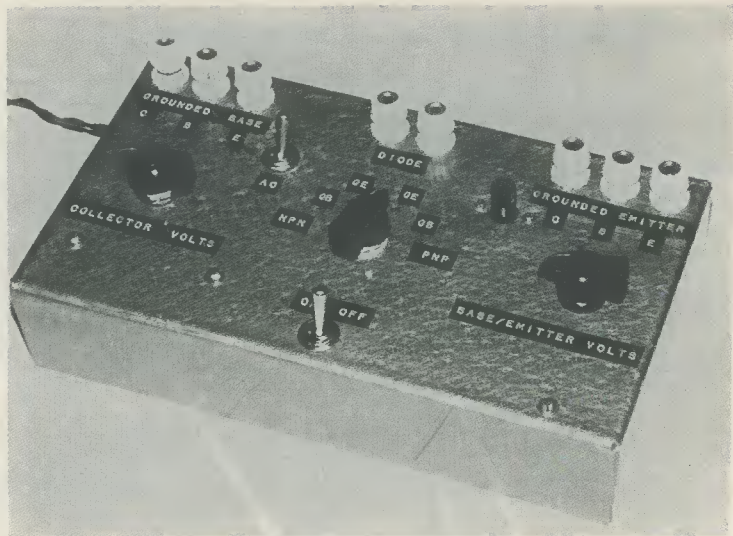

Top view of the panel showing the controls.  $VR_2$  is at the left,  $S_3$  in the centre and  $VR_3$  at the right

even covered with plastic such as "Contact".

The main selection switch,  $S_3$ , consists of two 2-pole 5-way wafers. Only four ways are used but this switch was chosen for its ready availability. The switch should be assembled and wired before fitting, and it will also be found convenient to proceed with as much wiring under the chassis as possible before installing the two generator sections, which are fitted on group boards. Except for the power supply leads all the wiring is solid

single wire p.v.c. covered. This should be laid neatly against the metal and care should be taken with all the soldered joints.

Potentiometers  $VR_2$  and  $VR_3$  should be connected such that output increases as they are rotated clockwise. With  $VR_2$  this occurs as the slider moves away from  $D_1$ , and with  $VR_3$  it occurs as the slider approaches the emitter of  $TR_5$ .

The two waveform generators are wired on Radiospares miniature Paxolin group boards. See Figs. 4 and 5. Note that some of the

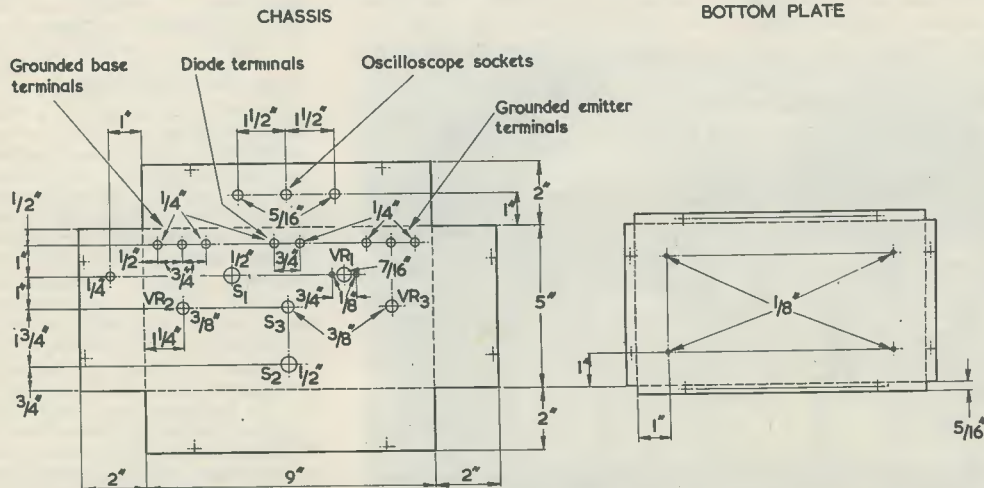

Fig. 3. The dimensions of the chassis (left) and the bottom plate (right). The chassis also provides the front panel and the view is looking down at the top. The  $\frac{1}{8}$ in holes in the bottom plate are for fixing rubber feet. The material is 18 s.w.g. aluminium

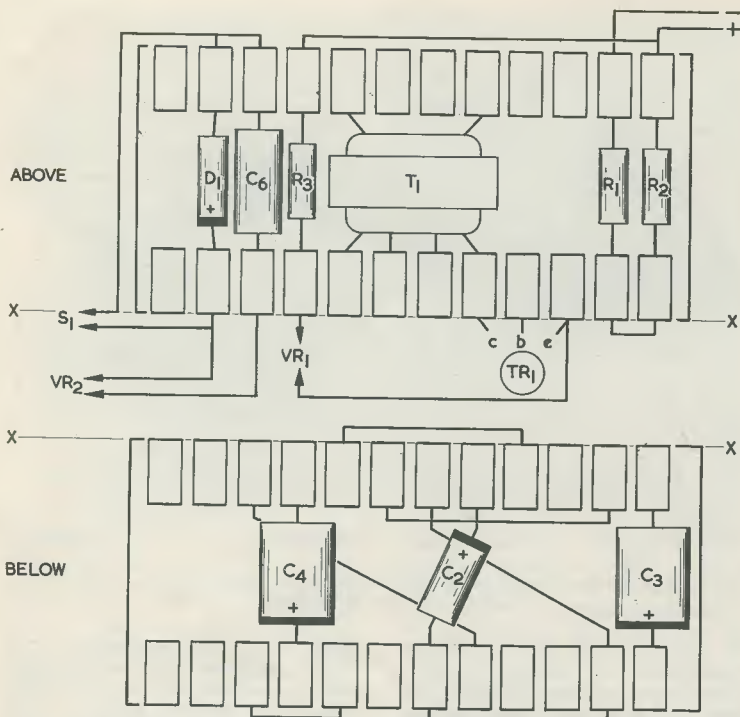
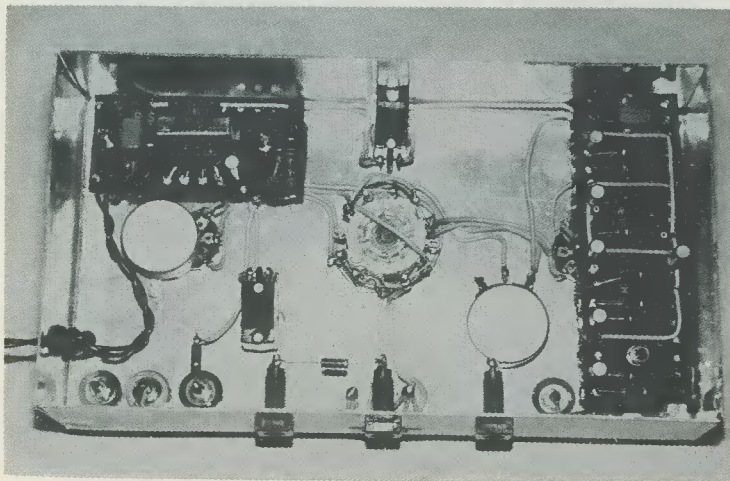

Fig. 4. The wiring above and below the 12-way group board, which holds the components for the collector voltage sweep oscillator. Connections into the external circuit on the panel of the instrument can be made by following Fig. 1. Note that the group board is shown rotated on the axis x-x

wiring on the underneath of the strips crosses terminals which are subsequently heated when soldering to them, and sufficient air space should be left or heat from the iron will melt the p.v.c. and may produce a short circuit. Two holes at convenient points in each board

have been enlarged to 4BA clearance size to enable long 4BA countersunk fixing bolts to pass through for mounting the generator sections in the box. (The bolt heads are at the front panel, and the hole positions are not shown in Fig. 3.)



The underside of the panel, showing the positions taken up by the 12-way and 18-way group boards

It is most important that transformer  $T_1$  is connected exactly as shown in Fig. 4. If this is not done the circuit may not oscillate or, even if it does, an incorrect waveform may be produced.

The transistors should be fitted on the boards last and the wiring should be carefully checked before mounting the generators in the box. These should take up the positions shown in the photograph of the underside. The whole unit can now be completed, and two flexible leads can be wired in for connection to the power supply or battery.

The curve tracer should now be switched on and the various waveforms may be checked with the oscilloscope connected between the collector and emitter terminals and then between the emitter and base terminals. Try the selector switch in all four positions and note how the waveforms change in polarity. In the grounded emitter configuration both waveforms should be negative-going for p.n.p. transistors, and positive-going for n.p.n. types. On the grounded base side the collector to base waveform should be measured between the appropriate terminals and, for p.n.p. transistors, should be negative-going. With the selection switch in the n.p.n. position this waveform will be positive-going. The emitter-to-base voltage goes positive for p.n.p. and negative for n.p.n. When all these waveforms have been checked and the variable controls  $VR_2$  and  $VR_3$  have been tested by observing that they reduce the amplitude of the waveforms when adjusted, then all is ready to display the first family of transistor curves.

### Using The Curve Tracer

Connect the X and Y inputs of the oscilloscope to the X and Y outputs on the unit. Connect a common earth lead from the earth terminal on the curve tracer to the oscilloscope. Turn the collector voltage control ( $VR_2$ ) and base current control ( $VR_3$ ) fully anti-clockwise. Connect a known good transistor of the p.n.p. type to the grounded emitter terminals and set the selection switch to the "P.N.P. Grounded Emitter" position. The switch marked "A.C." ( $S_1$ ) should be off. Connect the 12 volt power supply or battery to the unit, taking care to observe the correct polarity of the leads. Switch the oscilloscope timebase off—this is emphasised as the oscilloscope timebase is not required when using the curve tracer, and extremely mystifying

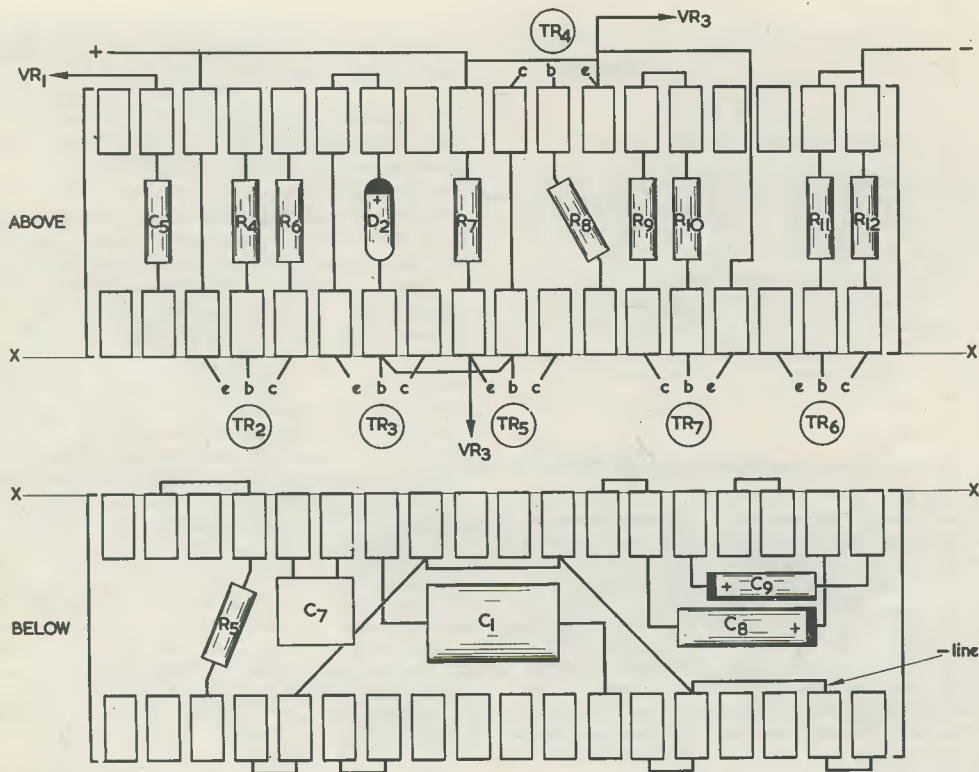

Fig. 5. The wiring above and below the 18-way group board. This holds the circuitry for the staircase waveform generator

results will be produced if the time-base is running.

If the oscilloscope has this facility, set the input switch to "D.C." Adjust the X and Y shift controls on the oscilloscope to give a spot near the centre of the tube, and adjust the focus and brightness controls for a sharp clear spot. Switch the curve tracer on and rotate the collector voltage control clockwise until the spot expands to a line across most of the tube. If the transistor being checked has a low breakdown voltage  $V_{ce}$  this line will curve up on the left hand side and, by observing the length of the scan before this occurs, the breakdown voltage may be ascertained.

Now turn the base current control slowly clockwise, whereupon a complete family of curves should be displayed as the staircase waveform is fed into the transistor base. Transistors with a low beta will require the base current control to be turned well up, but high beta transistors will only require a touch on the control to give considerable collector current. If a few transistors are tried like this, some may be found

which give a display similar to that shown in Fig. 6. The display indicates that collector current is flowing even when no base current is being introduced. This is a measure of leakage current  $I'_{co}$  in the device, and it can be measured by noting how many centimetres long the 'tail' is.

The speed control,  $VR_1$ , is used to change the frequency of the 200 c/s generator and should be adjusted to make the flyback lines stationary, when they appear less objectionable.

The display does not "lock in" as with a normal synchronising control, and the speed control may require frequent adjustments to give a steady display. N.P.N. transistors give a display that is "upside down" on the tube face, but it was not considered that the extra complications involved in inverting the display were warranted. Transistors can be tried on the grounded base terminals in exactly the same way.

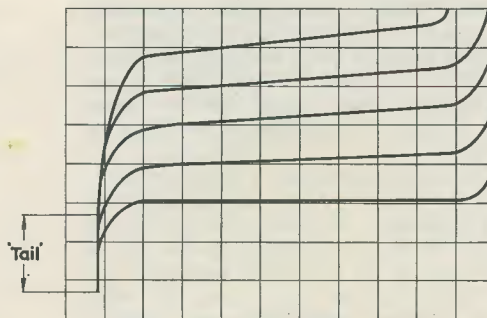

Fig. 6. The effect given by collector leakage

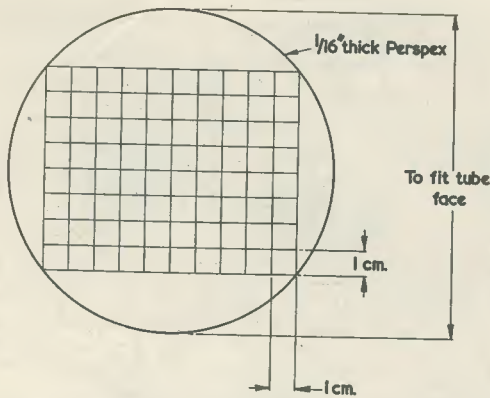

Fig. 7. Showing how a Perspex graticule may be made up

If a diode is connected across the diode terminals its forward and reverse voltage breakdown will be shown as the main switch is moved from p.n.p. to n.p.n. position. The "A.C." switch,  $S_1$ , may then be switched on, and both forward and reverse breakdown voltages will be shown together providing that they occur within the 40 volt range of the instrument. Zener diodes give very good displays and after a

little practice the characteristics of the emitter base junction and the collector base junction of transistors can be observed by connecting the device across the diode terminals. Voltage dependent resistor characteristics may also be observed by connecting them across the diode terminals.

The instrument was designed to provide a display of curves and characteristics rather than to be a

highly accurate measuring device. Nevertheless, many measurements can be made and a little experience will soon enable the user to produce clear displays which, as well as providing valuable data, are also highly educational.

#### Constructing A Graticule

If the oscilloscope has no graticule fitted, one may easily be made of 1/16 in thick Perspex sheet by scribing lines across the Perspex 1 centimetre apart at right angles to make 1 centimetre squares. The sheet should be cut to fit over the face of the cathode ray tube with the scribed lines facing towards the tube. See Fig. 7.

The oscilloscope may be calibrated by applying an a.c. voltage of known amplitude, the spot deflection being noted against the graticule lines. The voltage per centimetre deflection sensitivity can then be observed. The same should also be done with the X input. Remember that a 6.3 volt transformer, which may well be used for this test, gives a peak-to-peak voltage of  $6.3 \times 2.8 = 17.6$  volts. Therefore if a deflection of 8.8 centimetres is obtained this would indicate a sensitivity of 2 volts per centimetre.

## Semiconductor Tests with an Ohmmeter

By GORDON J. KING Assoc. Brit. I.R.E., M.T.S., M.I.P.R.E

*Your ohmmeter can double as a diode and transistor tester.*

A SIMPLE LOW-POWERED OHMMETER OR A MULTI-range testmeter switched to an "ohms" range can be used to reveal quite a few useful things about semiconductor diodes and transistors. Indeed, it is often possible for a suitable ohmmeter to provide almost as much information as an inexpensive transistor tester about semiconductor junctions and whether a transistor is working or not.

Before commencing, however, a few words of caution about the type of meter to be used for these tests are needed, for it is not difficult to ruin a perfectly good diode or transistor by the use of an unsuitable meter or by thoughtless testing.

Ohmmeters are of various types, these including the instrument designed specifically to measure resistance over several ranges, the multirange meter and ohmmeter facilities, the "ohms" ranges



of a valve voltmeter, and the Megger type of tester which applies a high voltage to its resistance measuring circuit.\*

To test a semiconductor junction, current must be passed through it from the ohmmeter. This current is usually supplied either by an internal battery (or batteries) or by a mains power unit in the case of a valve voltmeter switched to "ohms". The Megger type of tester may differ in that either a small hand- or motor-operated electromagnetic generator, or semiconductor generator, may be employed to provide the test current. The Megger type of tester should *not* be used for the tests described in this article.

Current flows through the test circuit and indicating movement because the e.m.f. of the ohmmeter power source is applied across the test terminals. A semiconductor junction under test is, therefore, subjected to the voltage of the instrument's power supply and the current available from the instrument, which is usually that required to provide full-scale deflection on the meter movement. An elementary ohmmeter circuit of this kind is shown in Fig. 1.

#### Important Points

This simple series type of ohmmeter is ideal for transistor tests, but in some instruments the circuit is modified over the various "ohms" ranges. A shunt resistance may be applied across the meter movement and the internal battery may be tapped up, or the mode of testing may differ from the series arrangement to the shunt arrangement, where the test circuit forms a shunt across the meter movement terminals. There are numerous arrangements, which cannot be dealt with here, but what we must discover before using the ohmmeter are (i) the voltage across the ohmmeter terminals on the range most suitable for semiconductor junction testing, (ii) the short-circuit current available at the instrument's terminals and (iii) the polarity of the voltage at the terminals.

This latter is important, for the positive or red test lead or terminal on a multirange testmeter is *not* always connected to the instrument's supply or battery positive when the instrument is switched to measure resistance.

\* "Megger" is the trade name of Evershed and Vignoles, Ltd.

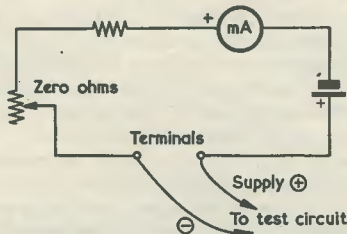

Fig. 1. Elementary "ohmmeter" circuit. Note that in the case of a multirange testmeter the red or positive terminal or socket may not always correspond with the positive of the internal battery

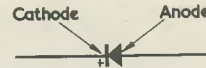

Fig. 2. The diode symbol

The voltage across the test terminals can usually be considered as being equal to the voltage of the internal battery. One could, of course, connect a voltmeter across the test terminals, but this would not read the true, open-circuit voltage. However, in the absence of a circuit of the instrument the voltmeter test is, in any case, necessary, in order to establish the polarity of the test leads. The short-circuit current can be determined by connecting a current meter across the ohmmeter test terminals.

#### Safe Power

Generally, an ohmmeter range that produces no more than 1.5 volts at 1mA can be considered to be perfectly safe to test any diode or transistor, no matter which way round the latter is connected to the instrument. Large power transistors are, of course, capable of handling powers far in excess of those corresponding to 1.5 volts at 1mA.

However, the emitter-base junction of even power transistors may not be able to stand the test power produced by instruments designed for "low ohms" measurements and by shunt type ohmmeters. So, ensure that both the voltage and current available at the ohmmeter terminals are low enough to be safe for testing semiconductor junctions. If in doubt, use no voltage higher than 1.5, and no current greater than 1mA.

Now let us see how the tests are made. From the d.c. aspect, a transistor can be considered as two semiconductor junctions, the emitter-base junction and the collector-base junction. A semiconductor diode features a very similar sort of junction, of course, but this works by itself, while the transistor effect is produced by the action of the two junctions with a common base.

We may start with the diode. The symbol for this is given in Fig. 2, the two electrodes being called "anode" and "cathode", to correspond with the electrodes of a valve diode. The cathode end of the semiconductor diode is usually coloured red or

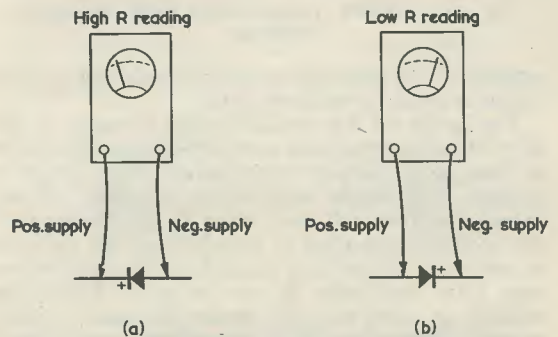

Fig. 3. Diode tests. Reverse resistance is checked at (a) and forward resistance at (b)

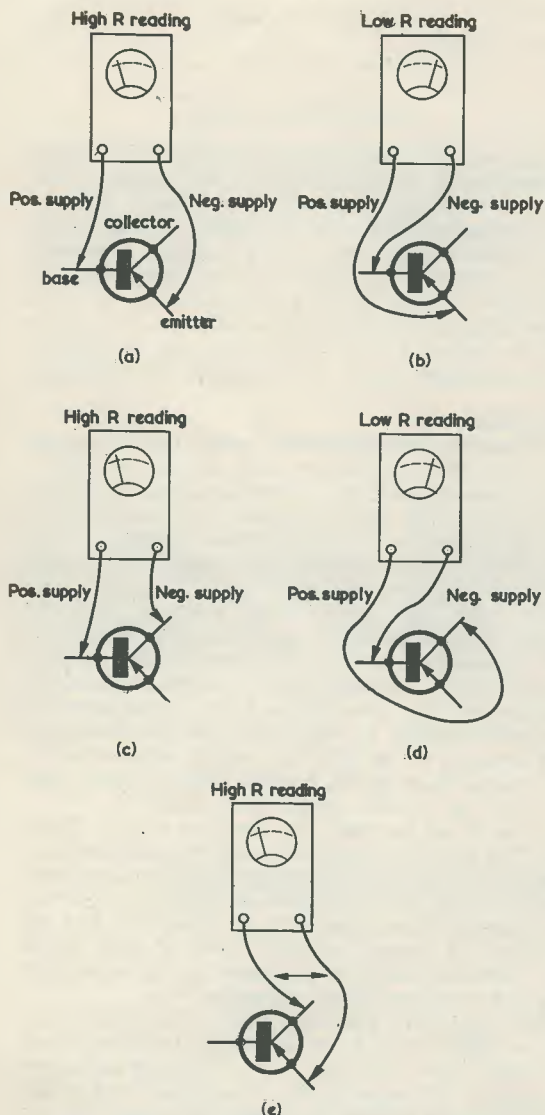

Fig. 4. Junction measurements with a p.n.p. transistor

marked with a plus sign while the anode end may be coloured black or marked minus.

The arrow on the symbol in Fig. 2 points in the direction of conventional current flow when the diode is biased for forward conduction. This means a current flow from positive to negative. Thus, forward current will flow through the diode when the anode is connected to positive and the cathode to negative. Under this condition, the diode offers very little resistance to the current. When the polarity is reversed, the diode becomes reverse-biased. Normally, only a very small current flows under this condition and the diode exhibits a very high resistance.

### Diode Tests

The ohmmeter with an internal battery is ideal for performing forward and reverse conduction tests and translating the current flow into values of resistance, as shown in Fig. 3. At (a) the ohmmeter biases the diode for reverse conduction and a very high resistance reading is given, while at (b) the polarity is reversed and forward current flows as is revealed by the low resistance reading.

It should be noted that, in Fig. 3 and the subsequent diagrams, the meter leads are designated "Pos Supply" and "Neg Supply". These indicate the polarity of the voltage appearing at the test leads due to the instrument's internal battery or other supply source. As was mentioned above, this polarity may be determined by a voltmeter connected to the test leads, and it may not necessarily correspond to any polarity markings provided on the instrument itself.

Exactly what the reverse and forward resistances of the diode of Fig. 3 are likely to be cannot be told, as they will depend on the nature of the diode under test and on the supply voltage across it. The main aspect of the test, however, is not so much to determine the actual values of the resistance, but to establish the ratio of the reverse to the forward resistance. Most diodes tested on a meter producing 1.5 volts across its test leads give forward resistance readings in the range of hundreds of ohms (a slightly higher voltage may reduce this to tens of ohms). Reverse resistance values, on the other hand, are up in the megohm ranges for good diodes of all types. Ratios in excess of 5,000 : 1 are commonplace with ordinary diodes tested at normal temperatures.

The reverse conduction reading will drop considerably should the test diode be checked in a hot environment, such as near a soldering iron. Germanium diodes are more subject to temperature influence than their silicon counterparts, and power silicon diodes may give a lower forward resistance than small germanium devices.

Any diode with a "conduction ratio" greater than 1,000 : 1 can be taken as good. Usually, the ratio will be much greater than this. Diodes with smaller ratios may also probably be in order, but they should be treated with suspicion. A faulty diode will usually exhibit a very low or high resistance in both directions, giving unity or a very small ratio.

### Transistor Tests

Now we come to transistors. These can be tested as two separate diodes, as shown in Fig. 4. The base of any transistor is common to both emitter and collector, and with p.n.p. types the emitter and collector can be considered as the anodes of the diodes, the base being the common cathode.

Thus, with the positive supply connected to the base and the negative supply to the emitter the reverse resistance of the emitter-base junction can be tested (a). The forward resistance of the same junction is obtained by reversing the test leads (b). Likewise, the reverse and forward resistances of the collector-base junction can be found, as shown in (c) and (d).

Whether or not the junctions are intact and

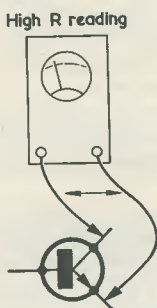
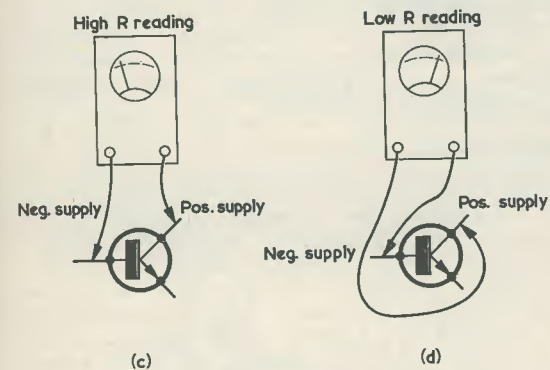
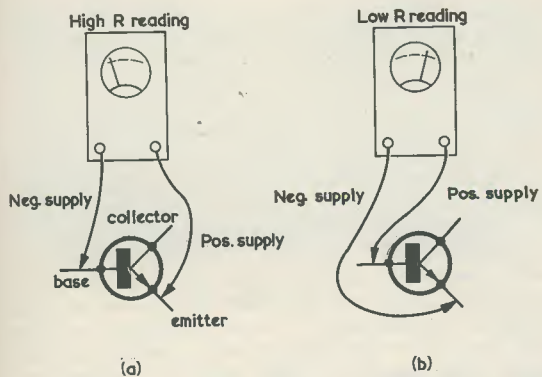

Fig. 5. Junction measurements with an n.p.n. transistor

working correctly is again determined by the ratio of reverse to forward conduction resistances. Some transistor junctions will exhibit extremely high ratios, while others will have relatively lower ratios, sometimes below those associated with semiconductor diodes.

Power transistors generally have the lowest forward resistance and silicon transistors the highest reverse resistances. With many transistors the "conduction ratio" is approximately the same at both junctions, but in a few instances the forward resistance of the emitter-base junction is less than that of the collector-base junction.

Ratios for germanium transistor junctions range upwards from about 1,000 : 1, and they are even higher with silicon types. Sometimes it is virtually impossible to get a useful reverse reading from a silicon transistor on a "safe" ohmmeter range. Nevertheless, there is never any doubt as to whether a junction is working or not from the tests described.

With n.p.n. transistors, the supply polarity has to be reversed to secure the readings in Fig. 4, as shown in Fig. 5.

Test (e) in both Figs. 4 and 5 will show a high resistance whichever way round the meter is connected. This is because the two junctions between emitter and collector are effectively connected in opposition, so that one exhibits reverse resistance when the meter is connected one way, and the other exhibits reverse resistance when the meter leads are changed round.

### Leakage Currents

When the supply negative test lead is connected to the collector and the positive test lead to the emitter of a p.n.p. transistor (or the positive to collector and negative to emitter in the case of an n.p.n.

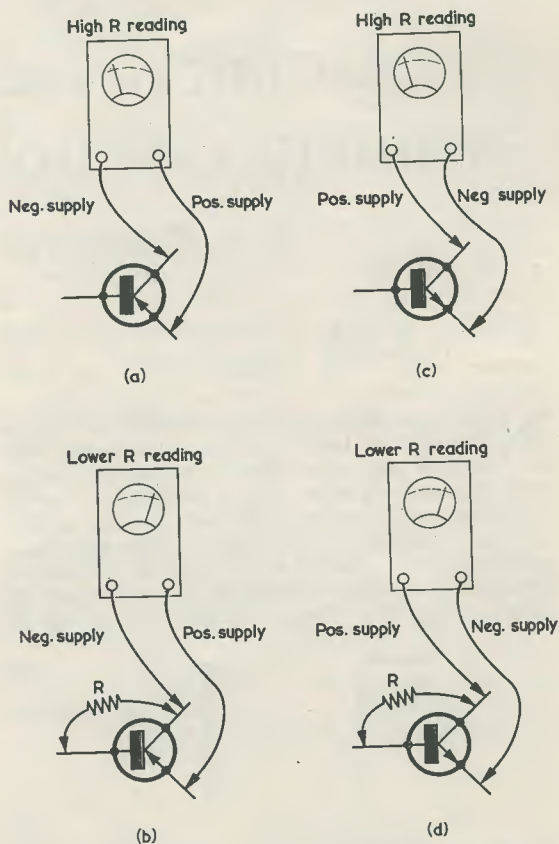

Fig. 6. Showing how the "transistor effect" can be checked for (a) a p.n.p. transistor, and (b) an n.p.n. transistor

transistor), the meter reads collector leakage current with the base open-circuit (i.e.,  $I_{ce0}$  or  $I'_{co}$ ). This reading is very much influenced by the temperature of the transistors, and even the heat from a finger holding a transistor while it is being tested can cause it to fall (the resistance measured being reduced). This applies especially to germanium types.

This test is best made, therefore, with the transistor suspended by its lead-out wires and away from any heat source. It is possible to match transistors on this reading and, generally speaking, the lower the resistance, the higher the d.c.  $h_{fe}$  (current gain).

Emitter leakage current checks with the collector open-circuit (i.e.,  $I_{eo}$  or  $I_{ebo}$ ) and collector leakage current checks with the emitter open-circuit (i.e.,  $I_{co}$  or  $I_{cbo}$ ) are given by tests (a) and (c) respectively in Figs. 4 and 5.

A fair idea of whether or not the two junctions of a transistor are working together to give the "transistor effect" can be gleaned by initially connecting the ohmmeter across the collector and emitter leads with supply negative to the

collector in the case of an p.n.p. transistor and supply positive to the collector in the case of an n.p.n. transistor. These connections are shown in Fig. 6 (a) and (c). Under this condition, as we have already seen, a good transistor will exhibit a high resistance (provided its temperature is at normal ambient level).

We can next use a resistor, R, of about  $4.7k\Omega$  to introduce a little forward current in the emitter-base junction, and thus produce the transistor effect. The connection of R is shown at (h) and (d) in Fig. 6. A transistor which is "good" will give a somewhat lower resistance reading when the resistor R is connected. The ratio between the previous high resistance reading and the lower resistance reading with the resistor connected offers a measure of the  $h_{fe}$  of the transistor. This test, in conjunction with the  $I_{ce0}$  test described earlier, provides a remarkably good indication of the condition of any transistor, and quite accurate assessments are feasible when one gets used to how a particular testmeter or ohmmeter behaves when connected to semiconductor junctions.

## An Improved Volume Control

by K. G. HARVEY

*Twin-gang stereo gain controls can offer useful advantages in mono equipment.*

**N**OW THAT STEREO IS WITH US AND TWIN GANGED volume controls are easily obtained, the writer has used these in equipment instead of single controls with distinct advantage.

The circuit employing a twin ganged control is shown in Fig. 1, and Fig. 2 gives the actual connections as seen from the back of the control (the rear section of which is shown smaller than the front section for reasons of clarity). It will be

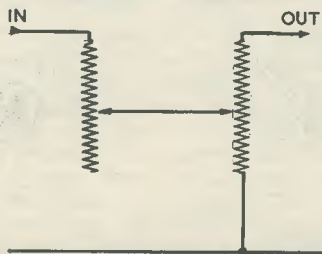

Fig. 1. Using the two sections of a twin ganged gain control to form a single control

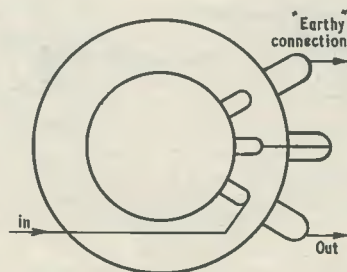

Fig. 2. How the twin ganged control is wired in practice. The rear section is shown smaller than the front section to clarify the wiring

seen that the impedance into the control and the impedance out remain constant.

One application in which the twin ganged control is of advantage is given in amplifiers where the slider of a normal gain control connects to a following grid and where operation of this control results in "scratch". Such a "scratch" may be apparent even when the gain control is a new component, and it can be particularly irritating if, for instance, it occurs in the middle of a tape recording. The "scratch" can be cleared by replacing the normal type of gain control with the ganged type, using the circuit of Fig. 1. With this, the following grid leak circuit is completed, not via the slider, but via the virtual fixed resistor given by the second section of the ganged control.

The writer has also found that the twin ganged control offers better apparent frequency response at low settings than does the conventional type of control. With his tape recorder he can, for instance, use "microphone" input for a high output crystal pick-up with the gain control hardly turned on.



On playback all the bass is reproduced, just as it was when recording more correctly (i.e. "radio" input with volume control turned fully on). Indeed, there is no noticeable difference between the two methods. With the normal type of gain control in the "microphone" position there was a considerable loss of bass with the crystal pick-up.

There are three points to bear in mind if it is decided to use a twin ganged control. Firstly, each section of the twin ganged control should be the same value as the control being replaced, and

the sections should, preferably, have linear tracks. Secondly, even if the body of the existing control is not earthed, the bodies of the twin control should be. Lastly, if the leads to and from the existing control are in one screened cable the twin ganged control will not be capable of cutting out sound entirely, as capacitive coupling will occur between the two leads in the cable. The solution is to cut one of the leads at each end of the screened cable (leave it in the cable—it will not matter) and fit a separate screened lead to take its place.

---

## The 1966 Physics Exhibition

**T**HE 1966 PHYSICS EXHIBITION, PRESENTED BY THE Institute of Physics and the Physical Society, was the 50th in the series, the first being held by the Physical Society in 1905. The present Exhibition was housed in the Great Hall at Alexandra Palace, and adequate space was available for the 175 exhibitors listed in the Stand Guide.

A fascinating feature of the Physics Exhibition is that, since many of the exhibits are of a non-commercial character, some of the displays are not always as highly finished and prettified as occurs when the primary object of exhibitors is to achieve sales. A few of the devices shown were obviously straight from the experimental laboratory with rough and ready metalwork and woodwork, and they displayed performance on battered oscilloscopes and similar measuring devices which had obviously served a long apprenticeship. Most of the exhibits, however, had the normal finish associated with technological exhibitions.

### Bi-Colour C.R.T.

A new development demonstrated by the General Electric Company was a cathode ray tube which presents traces in either red or green. The tube has a layer of red phosphors immediately behind its screen, behind this being a second layer of green phosphors. A low energy beam activates the green phosphors only, and causes a green trace to be shown. On the other hand, a high energy beam passes through the green phosphors and excites the red phosphors, whereupon a red trace is given. The tube shown by G.E.C. simultaneously displayed a red trace and a green trace. Using the same basic electronic switching technique which is normally employed for presenting two traces on a single oscilloscope screen, the tube was continually switched from red to green and back again. The colour change was affected by changing e.h.t. voltage; an e.h.t. of 10kV provided the low energy beam and gave the green trace, whereas an e.h.t. of 18kV provided the high energy beam and gave the red trace.

If terminated properly, a single wire kept well away from earthed objects can function as a transmission line for r.f. signals in much the same way as does coaxial and twin line feeder. The single line is known as a Goubau line or G-line, and may be described as a surface waveguide. The Research Department of British Railways are experimenting with the use of G-line for communication with trains in motion and for the detection of other trains and obstacles. The G-line can run alongside the track, the train being coupled to it by a short projecting probe. If a pulse is sent along the G-line, the disturbance in its field caused by equipment on the train results in an echo being returned to the transmitting end. The British Railways exhibit included a short length of miniature railway line with a G-line carrying signals of the order of 3,500 Mc/s, running alongside, and the positions of cars on this line were shown on a digital display. Also shown by British Railways was a novel method of cooling transistors employed in a battery charge/discharge equipment. The discharge facility is used for battery capacity measurements and can cause very heavy currents to flow through the regulating transistors. To prevent excessive temperature rise, these transistors are immersed in an inert liquid having a boiling point of 23.7°C. This liquid rapidly extracts heat from the transistors and vaporises, whereupon use is made of the latent heat of vaporisation and the unvaporised liquid remains at a constant temperature. The vapour passes through an air cooled condenser and then returns, as liquid, back to the bath in which the transistors are immersed.

Heat also plays an important part in the thermoelectric generators exhibited by Plessey. These generators consist of a number of thermoelectric modules which can be connected in parallel or in series as needed to provide the requisite overall voltage and current. One of the generators shown had an output of 120 watts. It is necessary for the modules to be hot on one face and cool on the

*continued on page 713*

# In Your Workshop

Many mains-battery radios are still giving excellent service these days as mains-only sets. In this episode, Smithy the Serviceman instructs his assistant, Dick, in a simple manner of clearing a very common complaint with these receivers.

"PRIVATE JOBS," SAID SMITHY sternly, "are not allowed."  
"But it's lunch-break," protested Dick.

"I don't care," pronounced Smithy firmly. "Private jobs are not allowed."

Disgustedly, Dick put the radio receiver he had unearthed back under his bench again.

"I seem to remember," he grumbled, "you doing a little job for yourself the other day. You did a little transistor radio for a nephew of yours."

"That," remarked Smithy, "is different. I'm the gov'nor. You're the staff."

"Well, that's charming, I must say," commented Dick sarcastically. "Democracy in action: one rule for the boss and one rule for the worker!"

"I couldn't have put it better myself," confirmed Smithy cheerfully. "I maintain a strict two-class system in this Workshop, with all benefits accruing to me."

## Mains-Battery Radio

Oblivious of the malignant glance directed upon him by his assistant, Smithy airily picked up his battered tin mug and drank deeply.

There was silence for a moment, then Dick returned to the attack.

"This set I wanted to fix," he offered carelessly, "is one of those mains-battery jobs. You know, the ones which use battery valves with the filaments connected up in series."

"I know them," said Smithy. "In fact, I sometimes think that they are becoming a bit of an embarrassment to the trade now that transistor radios, with their much less expensive battery demands, have moved in. Still, the mains-battery jobs represented an interesting place in receiver development."

Smithy fell silent for a moment, as he raked over nostalgic memories of the past.

"The earlier mains-battery sets," he continued musingly, "used to have valves with 50mA filaments. Later on, though, sets were introduced with 25mA filaments. A typical 25mA set would use a DK96 frequency-changer, a DF96 i.f. pentode, a DAF96 diode and a.f. pentode, and a DL96 output pentode. You had to be jolly careful when servicing these sets, too."

"Why's that?"

"Because," replied Smithy, "it was so easy to burn the filaments out. You only needed a test prod to slip and momentarily apply h.t. to the filament chain and you could have a whole string of open-circuit filaments. Dead dicey they were in that respect. You could even burn out one or more filaments by taking out a valve and plugging it in again whilst the set was switched on."

"Blimey," said Dick. "How could that happen?"

Smithy pushed his mug to one side and pulled over his note-pad.

"Come over here," he said, "and I'll show you."

Dick brought his stool alongside the Serviceman with alacrity. If Smithy continued in his present mood, there was a good chance of getting that radio fixed, after all.

"These mains-battery radios," continued Smithy, pulling out his pen and scribbling on his note-pad, (Fig. 1), "all follow the same basic scheme so far as the power supply section is concerned. When the set is switched for mains operation one side of the mains goes to chassis and the other side goes, via a limiter resistor, to a half-wave rectifier, which is usually of the selenium type. The rectified voltage then appears across a reservoir capacitor having a value of the order of 32 $\mu$ F or more. After the rectifier circuit you have a dropping resistor network which causes the rectified voltage on a second, smoothing, electrolytic to be about 90 volts. The 90 volts across the smoothing electrolytic then provides h.t. for the anodes and screen-grids of the valves. There's another dropper resistor from this electrolytic and this provides the current for the filament chain. Which is 50mA or 25mA according to the vintage of the set."

"What about this business," asked Dick, "of burning out a valve by taking it out and plugging it in again?"

"I'm coming to that," replied Smithy. "Now, with these sets it's necessary to insert one or two a.f.



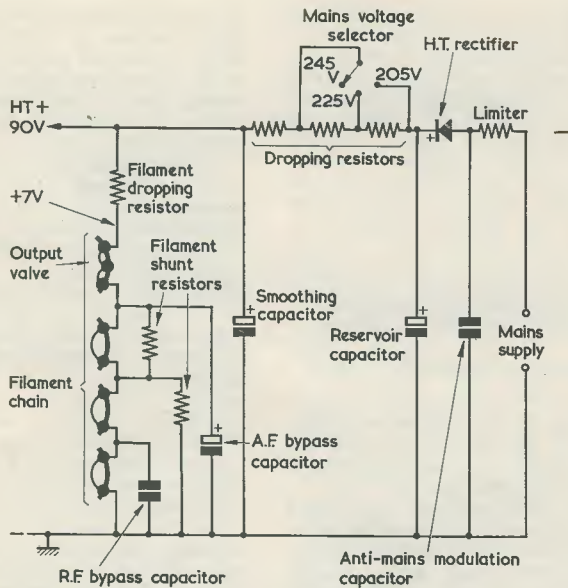

Fig. 1. The basic power supply arrangements given in a mains-battery receiver set up for mains operation. Switching circuits, which vary widely between receivers of different manufacture, are omitted here for reasons of clarity. The filament chain shown is illustrative only, and is partly intended to demonstrate that a.f. and r.f. bypass capacitors, and filament shunt resistors, also appear in this section of the circuit. The order in which the valves appear in the chain varies with different receivers

and r.f. bypass capacitors along the filament chain at strategic points since, otherwise, you're liable to get feedback along the chain and consequent instability. Don't forget that the anode and screen-grid currents of valves higher up in the chain flow through the filaments below.\* One of these bypass capacitors is usually an electrolytic of at least  $25\mu\text{F}$ . If, whilst the set is switched on and is running from the mains, you pull out a valve lower down the chain than the point where the electrolytic is connected, it can charge up to quite a high voltage. When you put the valve back in again the electrolytic passes a heavy discharge current which could easily burn out the valves you've replaced or any others below the electrolytic in the chain. So the moral with these sets is to always switch off before taking out a valve or putting one in."

"I notice," said Dick, looking at Smithy's circuit, "that you've shown resistors across some of the filaments in the chain."

"That's right," confirmed Smithy. "They're to bypass the anode and screen-grid current drawn by valves

higher up the chain, and they have values which ensure that each filament, apart from the output valve filament, has its nominal 1.4 volts across it. The output valve has a centre-tapped filament which, for series operation, has 2.8 volts across it. If the output valve is used in a battery-only receiver the

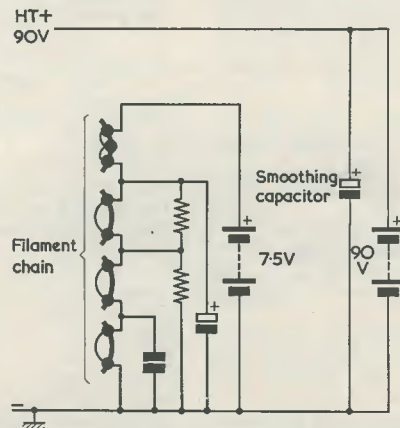

Fig. 2. When the receiver operates from batteries a 7.5 volt battery is applied across the filament chain whilst a 90 volt battery provides h.t. The smoothing capacitor is the same component as in Fig. 1, and it now provides a low source impedance across the h.t. lines

filament is connected with the two halves in parallel, whereupon it runs from 1.4 volts at twice the current."

"What happens," asked Dick, "when you go over to battery operation with a mains-battery set?"

"You simply connect," replied Smithy, busy with his pen again (Fig. 2), "the filament string to a 7.5 volt battery and the h.t. line to a 90 volt battery. I haven't drawn in any mains-battery switching because this varies quite a bit with different sets, but all it does is to transfer the h.t. line and the filament chain from the mains supply circuit to the two batteries."

#### A Concession

Smithy drained his after-lunch mug of tea.

"Anyway," he said, "there's not much point in my going on about these mains-battery sets any more. They're as old as the hills nowadays."

"They may," protested Dick, "be a pretty dead loss when compared with transistor radios so far as battery consumption is concerned. But, if you keep them switched to mains all the time, without any batteries fitted, they make jolly good mains sets with years of perfectly serviceable life left in them."

"Perhaps you've got a point there," conceded Smithy, "But why do you raise it?"

"Mainly because that's how my Aunt Evelina has been using her mains-battery set. And that's the set I'd been hoping to repair this lunch-break."

Smithy pondered this point. Dick had a multiplicity of aunts and the

\* This effect was described in detail in "In Your Workshop" in the March issue—Editor.

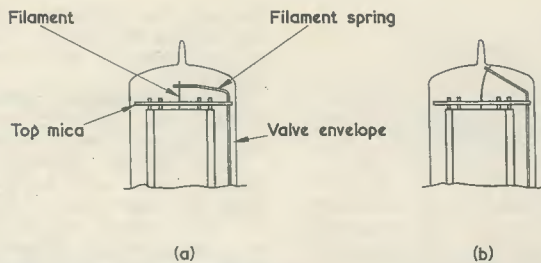

Fig. 3 (a). Normally, the filament spring of a 1.4 volt valve is under tension, as shown here. (Output valves with double filaments may have two filament springs)  
 (b). If the filament burns out, the filament spring reverts to the position shown here

Serviceman had difficulty in keeping track of them.

"Is she," he asked tentatively, "the one who keeps a cat?"

Dick's face took on an expression clearly indicative of a long-standing grievance.

"All my aunts," he replied bitterly, "have got cats. Great lazy furry things they are too, obese with boiled hake and Kit-E-Kat and all lolling around in the best chairs. Mad on cats my aunts are. Get a touch of cat 'flu in my aunts' neighbourhood and the P.D.S.A. has to send a second van down."

"There's nothing wrong," commented Smithy sternly, "in looking after one's pets."

"Perhaps not," allowed Dick, dismissing the subject for the moment. "Anyway, what about this set I've brought in? It's gone completely dead, and my aunt is pestering the life out of me to get it going again."

Smithy sighed.

"I suppose," he said resignedly, "that I'll get no peace either until you *do* have a go at it. But I must insist that no work can be done on it after lunch-break comes to an end."

Delighted, Dick retrieved the radio from its temporary resting place under his bench.

"Have you," asked Smithy, "done anything to it yet?"

"I had a quick shufti at it at my aunt's house," replied Dick. "I didn't have my meter with me, but I was able to check that the filaments were O.K."

"Dear me," said Smithy impressed. "We'll make a serviceman of you yet! How did you achieve this feat?"

"It's a dodge you told me about ages ago," said Dick. "These battery valves normally have their filaments secured at the top by a spring under tension. If the filament burns out, the spring moves up away from the

top mica in the internal assembly. (Fig. 3). So, if you can see the spring obviously under tension you know the filament is O.K."

"I'm glad to see," remarked Smithy, pleased, "that you've taken advantage of what I've told you. This visual check isn't entirely infallible, but it can usually enable you to spot an obviously burnt-out valve. Were you able to try the set with batteries?"

"There weren't any batteries in the house," replied Dick. "Those went out with the empty Kit-E-Kat tins years ago."

"A pity," commented Smithy. "Well, the next thing to do is to try the set on batteries in the Workshop. We've got a 7.5 volt battery and a 90 volt battery gathering dust somewhere in the cupboard. See how the set goes with these."

Quickly, Dick found the batteries, switched the radio for battery operation and connected them up. He switched the set on, and it immediately came to life. There was good sensitivity both on medium and long waves, and a surprisingly acceptable quality of reproduction.

"I must admit," said Smithy thoughtfully, "that these mains-battery sets aren't too bad to listen to at all. Still, I suppose it's to be expected. A DL96 can, for instance, give out nearly as much power as two OC81's in a single-ended output stage, and it does so at less distortion. Anyway, we've proved that there's nothing wrong with the signal circuits of this receiver. The fault lies in the power supply section which will, very probably, be applying too low a voltage to the filament chain. That's a very common snag with these sets, and there are two components which normally cause it, the first of these being the rectifier. The selenium rectifiers used in these sets tend to exhibit an increased forward resistance as the years go by. The other component is the

reservoir capacitor, which tends to lose capacitance. Either of these snags causes a gradual reduction in the voltage applied to the filament string, this voltage eventually becoming so low that the set stops working."

"What about the series dropping resistors?" asked Dick. "Couldn't these go high and also give reduced filament voltage?"

"It's doubtful," replied Smithy, "and particularly so if they're wire-wound components, which is almost certain to be the case. Anyway, if you get the works out of the box, we can soon investigate all these points."

### Voltage Readings

Smithy watched as Dick removed the chassis from the cabinet.

"I must say," he commented, "that I'm impressed by the dutiful attitude you're showing towards that aunt of yours. It must be very pleasant for her to realise that you're ready to help her out whenever her radio goes wrong."

"I keep well-in," replied Dick dispassionately, "with *all* my aunts. It's policy."

Smithy digested this information.

"Even when," he asked after a moment, "they seem to devote their lives to their cats?"

"Well," said Dick, busily unscrewing one of the chassis-securing bolts. "This cat business has its lighter side at times. There's old Josephine for instance. She tends to get *very* gay at times."

Smithy looked shocked.

"Is Josephine," he asked, "one of your aunts?"

This time it was Dick's turn to look shocked.

"Of course not," he retorted stiffly. "She's Aunt Evelina's old moggie. Aunt Evelina reckons that Josephine will go too far one of these days and bring trouble into the house; whereupon she'll have to be quite firm and send her to a Home. Aunt Evelina blames it all on the fact that Josephine never knew her father. Anyway, I've got this chassis out now."

Smithy tore his mind from the fascinating feline predilections of Dick's aunts, and concentrated on the chassis which his assistant now lay carefully on the bench.

"All right, then," he remarked. "Set it up for mains operation, plug it in and switch on. After which we'll do a few voltage measurements."

"Righty-ho," said Dick cheerfully, as he inserted the receiver plug into the appropriate mains

socket at the rear of his bench. "I'm all ready."

"Good," said Smithy. "You'd better first check, by the way, that the receiver mains voltage selector is at the correct setting and that the C.E.G.B. is pumping the right voltage into our mains sockets."

Dick did as he was bid.

"All O.K. there," he called out.

"Good," repeated Smithy. "The next thing to do is to find the reservoir and smoothing electrolytics and see what voltages there are across them."

"Finding them won't be difficult," commented Dick. "The only large electrolytic in the set is a dual component with its can at chassis potential, so it *must* comprise the reservoir and smoothing electrolytics."

Dick clipped his negative multi-meter lead to chassis and applied the positive lead to the positive terminals of the dual capacitor.

"I should guess that the tag marked red corresponds to the reservoir section," he remarked. "Anyway, I'm getting a reading of 170 volts here. The other tag is, I assume, for the smoothing capacitor, and this gives a reading of 75 volts."

"They're both," commented Smithy, "rather low. We might as well confirm that the second capacitor *is* the smoothing component by checking the voltage at some obviously identifiable h.t. point such as the output valve anode, where the voltage should be about the same. What type *is* the output valve, by the way?"

Dick looked closely at the valve in question.

"It's a DL96."

"The set has a 25mA filament string, then," commented Smithy. "Well, now, the anode of a DL96 is pin 2, and be very careful how you apply your test prod to it. One of the DL96 filament pins is pin 1 and if you accidentally short the two together you may find a few burnt-out valves on your hands."

A crackle from the loudspeaker indicated that Dick had located the anode tag in question and was applying the positive meter prod to it. (Fig. 4).

"It's the same again," he called out. "75 volts."

"Fine," said Smithy, "now check the voltage across the filament string."

"How do I do that?"

"By measuring," replied Smithy sweetly, "the voltage on the filament tag at the top end."

"But how do I know," persisted Dick, "which *is* the filament tag

at the top end?"

"You can trace it through with the meter," replied Smithy, "or you can trace it out by looking at the wiring. With these sets, there's no standard order in which the filaments appear in the string, and different manufacturers use different line-ups. All the valves in the usual 25mA line-up are B7G types with the filaments coming out at pins 1 and 7. The DL96 also has its filament centre-tap, but this comes out at pin 5. So, dig along the pins 1 and 7 of the valves with the meter until you find the one with the highest voltage."

"Okey-doke," said Dick equably. "I'm prodding away now."

There was silence for a moment, as Dick busied himself with the test meter prod.

"Here we are," he announced, "it's pin 1 of the DL96. And it's reading 5.8 volts."

"Are you *absolutely* sure," asked Smithy, "that that is the highest voltage in the string?"

"Dead certain."

"Well, check through again to make doubly sure," pronounced Smithy.

"Blimey," protested Dick, "you're being a bit fussy over this, aren't you?"

"With good reason," replied Smithy. "Because what I'll be doing later is to bring the voltage across that filament string to its proper figure, and I want to be certain, without any shadow of a doubt, that I am reading the voltage across the *whole* string."

Once more, Dick applied himself to the chassis.

"I'm quite positive," he announced finally. "The highest voltage in the string is definitely at pin 1 of the DL96. And it's 5.8 volts."

"Fair enough," commented Smithy. "Everything seems to be as I had expected, and the filament voltage *is* too low for the set to work. The h.t. voltage across the smoothing capacitor should normally be about 85 to 90, but in this case it's 75. And the voltage across the filament should normally be 7 but it's now 5.8. Both voltages are down by roughly the same proportion."

"How do you get this figure of 7 volts for the filaments? On batteries they run from 7.5 volts."

"Except for the DL96," explained Smithy in reply, "the nominal filament voltage for each valve is 1.4. The two DL96 filament sections are connected in series, and require a nominal voltage of 2.8. Three 1.4's and one 2.8 add up to 7 volts. Don't forget that the filament battery only has a voltage of 7.5 when it's new. This voltage gradually drops with use and averages at about 7 over its useful life."

"I get the point," said Dick. "What's the next move?"

"Well," replied Smithy, "the fact that both h.t. and filament voltages are low in about the same proportion would seem to exonerate the filament dropping resistor after the smoothing capacitor. The voltage across the reservoir capacitor seems lowish also, which indicates that either this or the rectifier is causing the trouble. However, we'd better make 100% certain that none of the resistors between the reservoir and smoothing electrolytic has gone high. Also, the limiter resistor in series with the mains input to the rectifier. Will it be much trouble to locate these in this particular set?"

"No trouble at all," replied Dick, examining the chassis. "The dropper resistors are combined in a single wire-wound unit connected to the

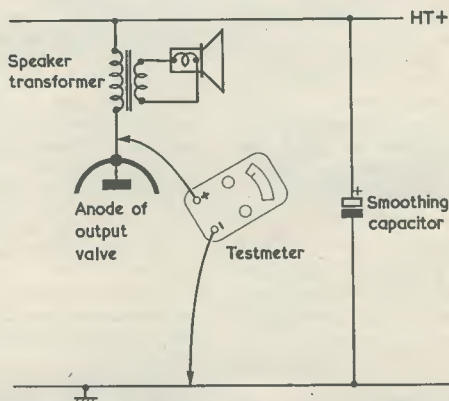

Fig. 4. To confirm that he had accurately located the smoothing capacitor, Dick checked the voltage on the anode of the output valve, whereupon he obtained the same reading

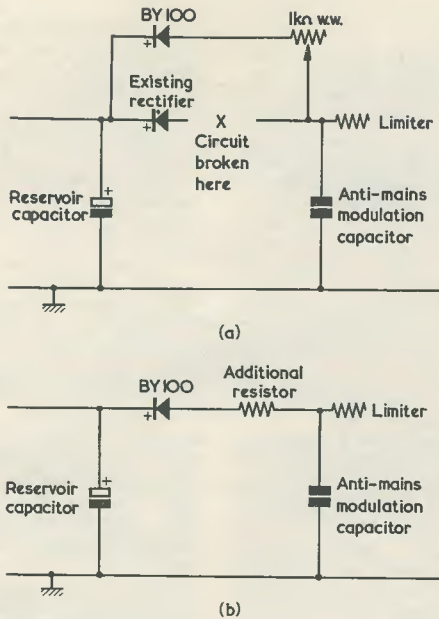

Fig. 5 (a). The existing rectifier in the receiver serviced by Dick and Smithy had a high forward resistance. Smithy disconnected the a.c. lead to the rectifier and temporarily added a BY100 and a 1kΩ wire-wound variable resistor set to insert maximum resistance  
 (b). The final repair consisted of removing the existing rectifier and fitting the BY100 with an additional fixed resistor in series. The additional resistor has the same resistance as that needed in the potentiometer to give correct voltage across the filament chain

mains voltage adjustment panel, and the limiter resistor is another wire-wound component sitting neatly at the end of the mains input lead. Despite the cooking they're undergone over the years I can still read the values that are printed on them." Dick removed the mains plug from its socket and checked the resistors in question.

"They are all," he announced, "reading the value they should have." "Excellent," said Smithy. "Next, check the h.t. line to chassis for leakage."

Dick applied his test prods again. "There's negligible leakage," he pronounced. "Just the usual initial kick in the needle when the electrolytics charge."

#### Final Steps

"Excellent, excellent," enthused Smithy. "Now the next thing to do is to check the reservoir electrolytic. What's its value?"

Dick examined the component in question.

"It's 32μF," he replied.

"Right," said Smithy briskly. "Clip your testmeter across the filament string so as to leave your

hands free, plug the set in and switch on. Next, see if the filament voltage goes up if you bridge the reservoir with a 16μF electrolytic. Right way round, mind!"

Dick concentrated on the task.

"There's no change at all," he remarked after a minute. "Adding the extra 16μF doesn't make a blind bit of difference!"

"That's it, then," pronounced Smithy. "New rectifier!"

"Have we got one of the right sort in stock?" queried Dick, glancing dubiously at the chassis. "The rectifier is one of those old-fashioned ones with square fins."

"We now live," replied Smithy grandly. "In the Age of the Silicon Rectifier. A BY100 with an extra limiter resistor in series will do the trick. Wait a minute, and I'll show you."

Smithy walked to the spares cupboard and returned with a BY100 and a potentiometer which he laid on the bench.

"I'll start," he remarked, "by pulling out the mains plug and doing a little unsoldering. First of all, I'm going to disconnect the a.c. lead from the rectifier in the receiver. Next, I'm

going to connect the positive end of this BY100 to the positive end of the receiver rectifier, which affords a convenient temporary anchor point."

"What's the value of that pot you've brought over?"

"It's a 1kΩ wire-wound component," replied Smithy, "which, by means of a few spare bits of wire and considerable manual dexterity on my part, I shall temporarily insert in series with the mains side of the BY100."

As he spoke, Smithy soldered up the connections he was describing. (Fig. 5 (a).)

"And now," he added briskly, "we approach the moment of truth. I'm going to insert all the resistance of the potentiometer track in series with the BY100, after which I'll switch on. There you are! What does that meter measuring the filament voltage say?"

"About 3.5 volts," replied Dick.

"Good," said Smithy. "I'm now going to reduce the resistance inserted by the pot, whilst you tell me what the meter reading is."

Slowly, Smithy adjusted the potentiometer.

"The voltage is going up gradually announced Dick. "It's 4 volts now, and still increasing. Ah, you've just passed the 5 volt point, and you're now coming up to 6 volts."

Abruptly, the radio began to reproduce the local station.

"Blimey," said Dick surprised. "What made it start up as suddenly as that?"

"Oscillator coming on," replied Smithy shortly. "Keep your attention on that meter, mate!"

"O.K., Smithy," said Dick. "Well, it's reading 6.5 now, and still going up. And you've now hit 7 volts."

Smithy took his hand from the potentiometer spindle.

"That's that, then," he remarked. "See what the h.t. voltage is."

Dick switched off the receiver, and unplugged the positive meter lead. He readjusted the meter and switched the set on again.

"The h.t. is spot-on," he called out happily after a moment. "It's spot-on at 90 volts!"

#### Finishing Up

"Good show," replied Smithy. "All you've got to do now is measure the resistance inserted by that pot and wire in the BY100 permanently with a fixed series resistor of the same value as was inserted by the pot. (Fig. 5 (b).) This will probably be of the order of 75 to 100Ω or so, and the resistor will need a rating of 2 to 3 watts. When you've done that, you can take the radio back to your Aunt Evelina with my blessing."

"It's good to see it fixed," said

Dick. "By the way, why did you suggest, just now, that I should bridge the 32 $\mu$ F reservoir with a 16 $\mu$ F component?"

"I was being ultra-cautious," explained Smithy. "If the fault was due to a low capacitance in the reservoir electrolytic, bridging it with another 32 $\mu$ F capacitor might conceivably have put too much reservoir capacitance into circuit, and might have caused *too* much rectified voltage to appear. The risk is very slight, I must admit, but experience

in the past has caused me to be very cautious indeed when handling these mains-battery sets. That's also why I commenced with a high value of added series resistance when I put in the BY100. Starting off with a high resistance in series is, in any case, *essential* here, because the BY100 will have a much lower forward resistance than the selenium rectifier it replaces could ever have had. If you'd simply replaced the existing rectifier with the BY100, you would have definitely put too high a voltage

on those filaments."

"So far as I can see," said Dick, suddenly inspired, "Finding the requisite fraction of the pot track represents the *pièce de résistance* of the whole operation!"

Whereupon Smithy's assistant, hugely delighted with his pun and ignoring the look of anguish it had caused to cross over the Serviceman's face, busied himself with the task of removing the defunct rectifier and installing the new BY100 and an added resistor in its place.

## LABGEAR "Educational" Radioactivity Demonstration Equipment

THE TEACHING OF NUCLEAR PHYSICS IN SCHOOLS is, one might say, a continuation of the teaching of radio physics, and it is interesting to note that descriptions of Geiger Counters and other similar electronic equipment appear with ever increasing frequency in the practical electronic and radio journals. Over the past few years descriptions of the construction of this type of apparatus have several times appeared in this journal and the recent articles on "Electronic Counting with Dekatrons", also come into this category.

It was of considerable interest therefore to read of the equipment currently being marketed by Labgear Educational, designed to meet the needs of those engaged in this aspect of science teaching, available at very reasonable prices.

Their Radioactivity Demonstration Set, Type D. 4155, contains apparatus for use with a book outlining a series of classroom experiments, written by C. C. H. Washtell, entitled *An Introduction to Radioactivity*. Basically, the apparatus consists of a stand and brackets for holding radioactive sources, for mounting a Geiger-Muller tube and for positioning various absorbers between the two. A metric scale enables measurements to be conveniently made of the distances between the source, the GM tube and the absorbing agents, etc. This kit provides a very convenient way of demonstrating many of the basic principles of radioactivity.

A Counting Rate Meter D. 4152/A and a Decade Counter D. 4151/A are available for GM counting requirements. These instruments are completely self-contained and have received the recommenda-

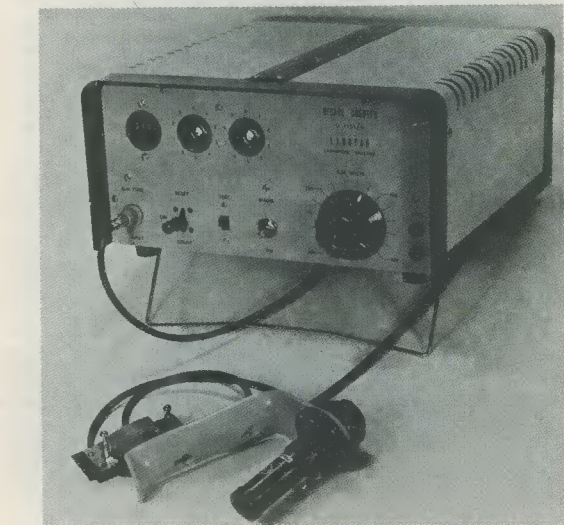

tion of the Science Masters' Association and the Nuffield Foundation in their report on the Teaching of Modern Physics.

A very conveniently designed GM Tube Holder, D. 4153, is also available. This is intended for use with either the Decade Counter or the Counting Rate Meter. It is suitable for plug-in GM Tubes in the Mullard and 20th Century ranges. In this connection, it is interesting to note that Mullard MX108 GM tubes, which have been extensively used for training purposes, particularly in the Services and Civil Defence, have been recognised as being unnecessarily elaborate and expensive for the needs of schools, and Mullard have therefore designed a new tube for school use—Type MX168. It retains the same characteristics, but its less sophisticated construction makes it far more suitable for school teaching purposes.

Further details, prices, etc., of this equipment can be obtained from Labgear Limited, Cromwell Road, Cambridge.

# THE DESIGN AND CONSTRUCTION OF MEASURING BRIDGES

Part I

by W. KEMP

*As is evident in correspondence from readers, there is a continual interest in the subject of measuring bridges. This present article is the first of a 3-part series dealing with the general attributes of bridges, and its author discusses some useful hints which will be of particular value to the home-constructor who requires a high level of accuracy with low-cost components.*

IN THIS SERIES OF ARTICLES, IT IS INTENDED TO give details of basic design principles for a wide range of measuring bridges, these being presented in as simple a manner as possible. Also, a number of practical circuits will be given for incorporation into bridges, these ranging from the simple to the fairly complex, from the "rough indication" to the "precision" types, and from the general purpose to the specialised. The snags which may be encountered in the designing and building of these instruments will be discussed, together with solutions to the problems which crop up. From the information contained in this series the reader should be able, with little difficulty, to build, design or modify a bridge to meet his own particular requirements and suit his own tastes or fancies.

## The Basic Bridge

Of the several possible ways of measuring component values the bridge method is probably the most attractive, both for the professional and for the amateur. As far as the home constructor is concerned the bridge offers the twin advantages of being the cheapest and the easiest of measuring devices to build, this being particularly true where high accuracy is required.

For resistance measurement the Wheatstone bridge is used. This is in fact one of the most versatile circuits employed in electronics, nearly all other bridges for the measurement of inductance, capacitance, impedance, etc., being evolved from it. The Wheatstone bridge is even used as the basis of a vast range of oscillators, detectors and sensing devices, etc.

The basic bridge consists of four resistance arms, arranged symmetrically, as shown in Fig. 1. Across one pair of arms is connected an energising source, such as a battery, and across the other a detector or indicator, such as a galvanometer.

When using the bridge to make a measurement it is necessary to arrange the values of the resistor arms in such a way that there is zero voltage difference between points C and D, so that no current flows through the indicator. The bridge is then "balanced", or adjusted to a "null" condition. When the bridge is balanced it is found that

$$\frac{R_1}{R_2} = \frac{R_3}{R_4},$$
 which is the same as saying that  $R_1 \times R_4$

$$= R_2 \times R_3, \text{ or } R_1 = \left(\frac{R_3}{R_4}\right) R_2.$$
 An easy way of remembering this is to say that "the product of one pair of opposites is equal to the product of the other pair of opposites", i.e.,  $R_1 \times R_4 = R_2 \times R_3$ .

It will be noticed that, with reference to the  $R_1 =$

$$\left(\frac{R_3}{R_4}\right) R_2 \text{ equation, the actual values of } R_3 \text{ and } R_4$$

are of little importance. Only their ratio to one another is of any consequence in the determination of the value of  $R_1$ . For this reason they are called the "ratio arms".

In practice  $R_1$  would be the resistance which we are trying to measure, for convenience called X, the unknown. The ratio of  $R_3$  and  $R_4$  would be known, and  $R_2$  could be a calibrated variable resistance. When the bridge has been balanced, it is then simply a matter of reading off the value indicated on the calibrated resistance and multiplying it by the ratio of the ratio arms in order to find the value of X. For example, if it is found that at balance  $R_3 = 100\Omega$ ,  $R_4 = 10\Omega$  and  $R_2 = 72\Omega$ , it

can be seen that  $X = \left(\frac{100}{10}\right) 72\Omega$ , so that  $X = 720\Omega$ .

If  $R_3$  and  $R_4$  are now changed to  $470\Omega$  and  $47\Omega$  respectively, it will still be found that the balance point occurs at the  $720\Omega$  position of  $R_2$ , as the ratio of  $R_3$  and  $R_4$  has not been changed.



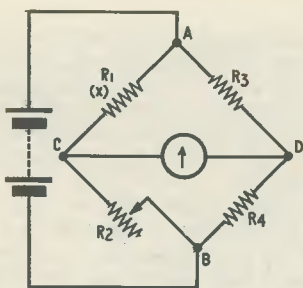

Fig. 1. The basic Wheatstone bridge

Having dealt with these basic ideas, we can now consider the individual sections of the bridge in detail, and some of the problems presented by them.

### The Bridge Energising Source

For the measurement of resistance a d.c. supply should be used, although low frequency a.c. (50 c/s) is permissible under certain circumstances, such as when great accuracy is not required or when non-reactive components only will be tested. This is because the inductive or capacitive components of the bridge or the resistance under test can introduce errors under a.c. conditions. Also, it might be desired at some time to find the resistance of a choke or some other large inductive component, and this can only be done under d.c. conditions.

In theory, the range of the bridge is limitless, but in practice a limit is set by the sensitivity of the indicator. The higher the range in use, the lower becomes the current in the indicator circuit and while this can be compensated for to a certain extent by raising the supply voltage, there are practical limits to this expedient. This fact should be borne in mind when contemplating the construction of battery powered portable equipment. In point of fact most of the commercial precision bridges do utilise batteries as their power source, although there is a lot to be said for alternative methods.

Most, if not all high accuracy resistance measurements will be made at a test bench either during an experiment or while building a piece of apparatus, so that portability is not always likely to be a real requirement. In this case there is no reason why the mains should not be used to supply a rectifier and smoothing circuit for feeding the bridge, so giving direct potentials of up to several hundred volts. A resistor should be fitted in series between the supply and the bridge so that the voltage across the bridge will automatically increase or decrease to meet the requirements of the range in use, by voltage divider action. The value of the resistor is not critical, and can be found by trial and error. As a starting point a value should be chosen that would limit the current at maximum voltage to about ten times the rating of the indicating meter in use on the bridge. In the commercial battery operated equipment mentioned above it is usual

to provide means of selecting different voltages manually, but the series resistance method helps to overcome this extra operation.

It might be worthwhile, if portability is an essential requirement of the bridge, to fit it with a transistor inverter to supply a high voltage from battery supplies.

Whichever of these power sources is used, a switch, preferably of the push button type, should be inserted between the supply and the bridge in such a way that the supply is only applied to the bridge when the switch is depressed.

### The Bridge Balance Indicator

The indicator used in the bridge should be as sensitive as possible, and be able to read both positive and negative potentials or currents. It is general practice to use a centre zero galvo or moving-coil meter, rated at about 25 to 50  $\mu$ A, but as these instruments are rather limited in their usefulness for other work and are expensive to buy, it will probably be better to use an ordinary microammeter (i.e. not centre-zero) connected to a bridge rectifier, as shown in Fig. 2. The references C and D in this diagram correspond to the similarly indicated points in Fig. 1. The use of the rectifier circuit reduces slightly the sensitivity of indicator, but not to a sufficient degree to be of any significance. Almost any diodes may be used as rectifiers, as they will be handling only a very small current. The bridge rectifier circuit ensures that the meter gives a forward reading regardless of whether point D is positive or negative of point C. Balance corresponds to zero reading.

It will be found that if a meter of sufficient sensitivity to give a sharp indication has been used, then when the bridge is only slightly out of balance the needle may be hard over against the stop. If the bridge is very much out of balance sufficient current might flow through the meter to damage it or even burn it out completely. This trouble is overcome in most commercial bridges by wiring a shunt resistor and a press button switch in series,

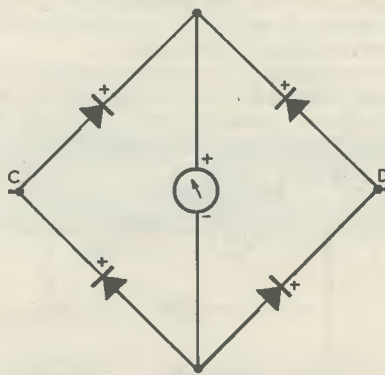

Fig. 2. To avoid the use of a centre-zero meter, the bridge circuit shown here enables a conventional instrument to be employed. The meter gives a forward reading regardless of the polarities at C and D

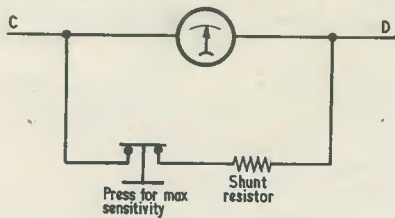

Fig. 3. A circuit which enables maximum meter sensitivity to be provided when the bridge approaches the null

and wiring the combination in parallel with the meter, as shown in Fig. 3. The shunt reduces the sensitivity of the meter, and it is taken out of circuit when the button is pressed, in which case the meter will be at maximum sensitivity. The button is only pressed when the bridge is seen to be near its balance point, and the chances of damaging the meter are thus reduced.

An alternative and probably better method of solving this difficulty is shown in Fig. 4. Here, two semiconductor diodes are wired in parallel with the meter and a resistor which is in series with it. The diode is a non-linear device, the resistance of which varies with the voltage applied to it. This is a characteristic of all semiconductor diodes. It is found that when a very small voltage in the order of microvolts is across the diode, it has a very high resistance, in the region of tens of kilohms. As the voltage is increased the resistance decreases until, when a potential of say 1 volt has been reached, the resistance may drop to as little as a few ohms only. In the circuit shown in Fig. 4, each diode functions as a shunt so that, when only a very low current is flowing (with the result that only a very small voltage is developed across the diode), the diode resistance is high and the meter sensitivity is almost unaffected. When the current reaches a higher value, with a subsequent increase in voltage, the resistance of the conducting shunt diode falls and the meter sensitivity is reduced. The shunt therefore varies automatically to maintain a high degree of sensitivity combined with freedom from overloading of the meter.

The two diodes of Fig. 4 are required if the meter is to read current in both directions. If the bridge rectifier scheme shown in Fig. 2 is used, only one shunt diode is needed, as in Fig. 5.

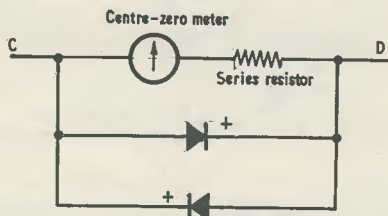

Fig. 4. Two semiconductor diodes connected across a centre-zero meter enable it to have high sensitivity at low currents and low sensitivity at high currents

The resistor in series with the meter is used to adjust the working point of the diode or diodes. The exact value will depend on the characteristics of both the meter and the diode (or diodes) and is best found by trial and error methods.

To give an idea of what can be given, in a test circuit of this type a  $50\mu\text{A}$  meter and a  $4.7\text{k}\Omega$  series resistor were used in conjunction with a surplus germanium diode, and fed from a bridge rectifier, as shown in Fig. 5. It was found that when an actual current of  $5\mu\text{A}$  was flowing into the bridge an indication of  $3.5\mu\text{A}$  was shown on the meter. The loss in sensitivity on low readings was thus about 30%. At mid-scale, however, when  $25\mu\text{A}$  was indicated, the actual current flowing into the bridge was  $150\mu\text{A}$ ; and at the full scale deflection of  $50\mu\text{A}$  the actual current flowing into the bridge was  $1,000\mu\text{A}$ . These figures correspond to very high losses in sensitivity.

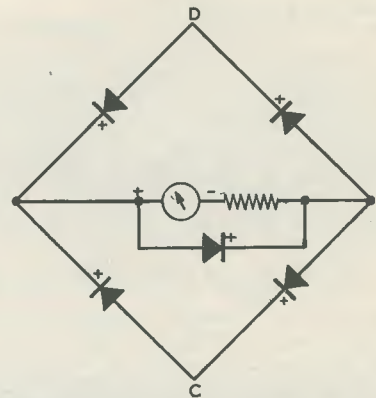

Fig. 5. When the bridge circuit of Fig. 2 is employed, only one sensitivity-limiting diode need be connected across the meter

If desired, a transistor amplifier may be fitted to the meter to increase its sensitivity, and if this is done the amplifier must be fed from its own separate power supply which must be floating; that is, neither its positive or negative lines must be connected to the supply lines of the bridge power source.

### The Bridge, General Points

The accuracy of readings given by the bridge naturally depends on the accuracy of the standard resistors used in it. It should be borne in mind that the final accuracy will be less than the accuracy, in terms of percentage, of the standards used. For example, let it be assumed that in Fig. 1 the three standards employed are all 1% tolerance components, and that at balance the following values are used:  $R_3=100\Omega$ ,  $R_4=100\Omega$ ,  $R_2=98\Omega$ . Then,

according to the equation  $R_1 = \left(\frac{R_3}{R_4}\right)R_2$ ,  $X=98\Omega$ .

Remembering that these components have a

tolerance of 1%, it could be that their true values are as follows:  $R_3=101\Omega$ ,  $R_4=99\Omega$  and  $R_2=99\Omega$ . In this case the true value of X is  $101\Omega$ . Thus the bridge has shown an error of 3%. While it is true that such an error is unlikely to occur in practice, it must be remembered that the possibility does exist.

The bridge may be built either as a complete instrument or it may consist of a number of separate and versatile "blocks", the indicator also serving as a voltmeter, for example, and the variable arm  $R_2$  as a resistance substitution box. If it is intended to build a precision Wheatstone bridge it should be remembered that it is a specialised instrument which may be used only very occasionally, and that the "block" method of construction has the advantage of reducing the cost.

#### The Variable Arm

Two alternative methods may be considered for the variable arm,  $R_2$ . Either a calibrated potentiometer may be used, or a decade resistance box.

Carbon potentiometers have the disadvantage that they cannot be relied on to retain their accuracy of calibration over a long period, and are not

recommended for bridge work except where high accuracy is not required or where regular recalibration can be carried out.

Wirewound potentiometers have the disadvantage that they do not change smoothly in value, but in a series of steps as the slider moves from one turn of the winding to the next. The smaller types generally used in radio and electronics may have only a couple of hundred of these steps and, once again, these are not recommended except when high accuracy is not required. The larger types, two or three inches and larger in diameter, will generally be found perfectly satisfactory for the more accurate instruments and are reliable so far as retaining their calibration is concerned. They tend to be rather expensive, however, particularly in the larger sizes.

For the real precision instrument, accurate to a fraction of 1%, the decade box is recommended, and it has the additional advantage that it can also be used as a resistance substitution box. Decade boxes are extremely expensive to buy, however, and the reader will no doubt prefer to make his own. More will be said on this subject later, when the design of a practical circuit is considered.

*(To be continued)*

---

## Club Events

#### *Derby and District Amateur Radio Society*

Hon. Sec. F. C. Ward, G2CVY, 5 Uplands Avenue, Littleover, Derby.

**June 1st**—Surplus Sale.

**June 4th**—National Field Day.

**June 8th**—Radio and component quiz with prizes.

**June 15th**—Film Show.

**June 22nd**—D. F. Practice night—social evening and ragchew for non-participants.

**June 29th**—Visit to Radiotherapy unit at Derbyshire Royal Infirmary.

#### *Basildon and District Amateur Radio Society*

Hon. Sec. J. Barker, Milestone Cottage, London Road, Wickford, Essex

**June 4th**—National Field Day.

**June 7th**—Social

#### *Mid-Warwickshire Amateur Radio Society*

Hon. Sec. K. J. Young, 180 Northumberland Court, Leamington Spa, Warwickshire

**June 13th**—Radio Receiver Servicing.

**June 27th**—Visit

---

## NEXT MONTH IN

## THE Radio Constructor

- Transistorised T.R.F. Receiver
- Radio Control, Part 1
- Experimental F.M. Tuner

IN THE LAST ARTICLE IN THIS SERIES WE DEALT WITH the tuned grid oscillator, the tuned anode oscillator, and the Hartley oscillator. We saw that grid leak bias offers an extremely convenient method of biasing for all these oscillators and noted that this type of bias is, in fact, employed in almost all practical oscillator circuits. Both the series-fed and shunt-fed versions of the oscillators were dealt with. A third version of the Hartley oscillator, in which the valve cathode connects into a tap in the tuned coil, was also examined.

We shall now carry on to some further basic oscillator circuits.

### The Colpitts Oscillator

As we noted in the previous article, the two ends of the tuned coil in the Hartley oscillator couple to

whereupon  $C_2$ , the capacitor at the grid end of the tuned circuit, may be given a reactance which is about half that of the capacitor at the anode end,  $C_1$ . About a third of the total signal across the tuned circuit then appears across  $C_2$ , in the same way that about a third of the total signal appears, in the Hartley oscillator, across the section of the coil between the tap and the grid. To provide half the reactance,  $C_2$  requires twice the capacitance of  $C_1$ . To take an example,  $C_1$  could be 200pF and  $C_2$  could be 400pF to achieve the required reactance ratio. It will be found, in most practical Colpitts oscillators employing the circuit of Fig. 347 (a), that the ratio between the two capacitances is, very roughly, of the order of 2 : 1.

The coil in Fig. 347 (a) is tuned by  $C_1$  and  $C_2$  in series. If, as in the example just mentioned, these

# understanding

## Tuned Triode Circuit Oscillators

By W. G. Morley



# radio

the anode and grid of the valve, a tap at cathode potential being made into the coil. Figs. 346 (a) and (b), published last month, illustrate these points.

The Colpitts oscillator, one version of which is shown in Fig. 347 (a), is very similar, with the exception that the tap at cathode potential is not made into the tuned circuit coil but into the tuned circuit capacitance. As may be seen from Fig. 347 (a), the capacitance tuning the coil in the tuned circuit consists of the two capacitors  $C_1$  and  $C_2$  in series, their junction being connected to the cathode. The resultant effect, so far as phase relationships at anode, grid and cathode are concerned, is just the same as if the cathode tap had been made into the coil. With the Hartley oscillator, the tap into the coil is usually about a third of the coil away from the grid end, this ensuring that the signal applied to the grid does not have excessive amplitude. It is common practice to follow the same course with the Colpitts oscillator,

capacitors have values of 200pF and 400pF respectively then, from  $C_{\text{total}} = \frac{C_1 C_2}{C_1 + C_2}$  the total tuning

capacitance becomes 133pF<sup>1</sup>, and the resonant frequency of the tuned circuit will be the same as if a single 133pF capacitor were connected across the coil. The Colpitts oscillator does not lend itself as readily as do the tuned anode and the tuned grid oscillators to being tuned over a wide range by a conventional variable capacitor. However, it can be conveniently tuned over a wide range if, say, fixed capacitors are fitted in the  $C_1$  and  $C_2$  positions and the inductance is made variable by means of permeability tuning.

The Colpitts oscillator of Fig. 347 (a) uses normal

<sup>1</sup> Calculation of the total capacitance of capacitors connected in series was discussed in "Understanding Radio" in the July 1962 issue.

grid leak bias, and an output may be obtained from it in the same manner as with the oscillators previously considered. The h.t. supply is applied to the anode via a resistor having a high impedance at the frequency of oscillation. The h.t. supply may alternatively be applied, via a resistor, to the grid end of the coil, as in Fig. 347 (b). The anode current now flows through the coil, but there is no alteration in circuit operation. When, as is usual practice,  $C_2$  has a larger value than  $C_1$ , there is a lower impedance between the grid end of the coil and the cathode than between the anode end of the coil and the cathode, with the result that connecting the series h.t. resistor to the grid end has less damping effect on the tuned circuit. The series resistor may also be applied to any point along the coil, and minimum damping will be given if it is applied to a point which is at the same potential, so far as oscillatory voltage is concerned, as the junction of the two tuning capacitors. A choke having a high impedance at the frequency of oscillation may be employed instead of the series h.t. resistor. It should be noted that the h.t. positive supply can only be applied to the Colpitts oscillator of Figs. 347 (a) and (b) via a resistor (or choke), whereupon these circuits become similar to the shunt-fed circuits we have previously considered. There is no series-fed Colpitts oscillator.

An alternative version of the Colpitts oscillator is shown in Fig. 347 (c). This corresponds to the Hartley oscillator circuit of Fig 346 (c) which was published last month, and the requirements for oscillation are met in the same way. The anode couples (via the h.t. supply, which is assumed to have negligible impedance) to one end of the tuned circuit, the grid couples to the other end of the tuned circuit, and the cathode connects to the "tap" in the tuning capacitance which appears at the junction of the two capacitors across the coil. The cathode is indirectly heated and is, in consequence, insulated from the heater, which is normally at chassis potential. Cathode current flows through a choke having a high impedance at oscillator frequency. With the Hartley oscillator, the cathode tap into the coil was roughly about a third of the way up from the chassis end. The same applies to Fig. 347 (c), and the lower capacitor in the tuned circuit will normally have a capacitance which is, speaking in very approximate terms, about twice that of the upper capacitor. Like the previous Hartley circuit, this Colpitts circuit may be incorporated in an electron-coupled oscillator.

### The Meissner Oscillator

A circuit which is usually referred to as the *Meissner oscillator* is illustrated in Fig. 348 (a). This employs a tuned circuit to which the grid is coupled by way of one coupling winding and to which the anode is coupled by way of a second coupling winding. Thus, feedback from anode to grid takes place via the three-step route given by the anode coupling winding, the tuned circuit, and the grid coupling winding. The frequency of oscillation is at the resonant frequency of the tuned circuit. Both the coupling windings should have fewer turns than the tuned winding to ensure that the resonant

frequencies given by their inductances and stray capacitances are well above the range of frequencies covered by the tuned circuit. Also, the coupling coils have to be connected in the correct manner to ensure that the signal fed back to the grid is  $180^\circ$  out of phase with that at the anode. Grid leak bias

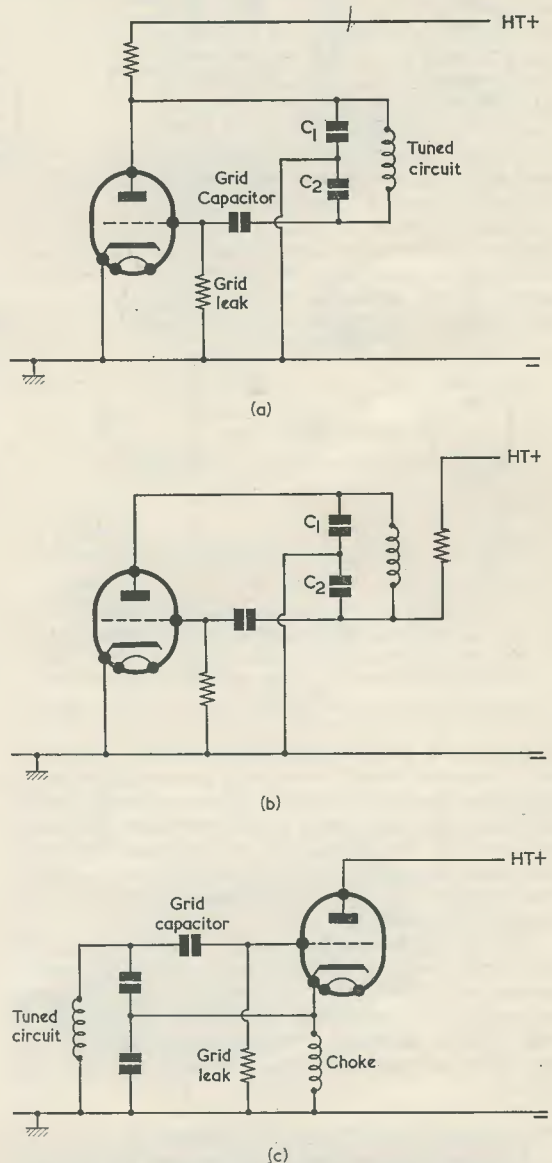

Fig. 347 (a). The Colpitts oscillator. With this oscillator a cathode tap is effectively made into the capacitance tuning the coil. The resistor in the h.t. positive supply to the anode must offer a high impedance at oscillator frequency  
 (b) The anode h.t. feed resistor may, with some advantage, be connected to the grid end of the coil instead of to the anode end  
 (c). In this version of the Colpitts oscillator the chassis connection is at one end of the tuned circuit

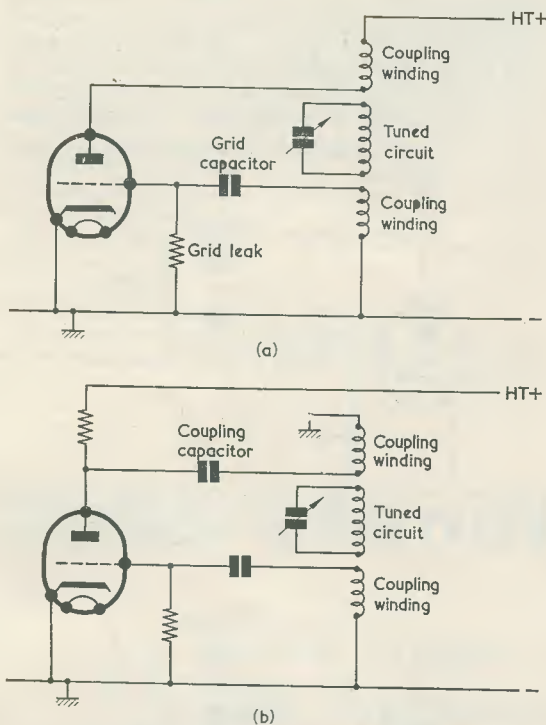

Fig. 348 (a). The Meissner oscillator circuit  
(b). The oscillator of (a) will also function if the anode coupling winding is shunt-fed, as shown here. The coupling capacitor has a low reactance at oscillator frequency

is employed, and an output at oscillator frequency may be taken from the circuit in the same manner as with the previous circuits. It is assumed, in the diagram, that the tuned circuit resonant frequency is adjusted by means of a variable capacitor. Resonant frequency could also be adjusted by having the capacitor in the tuned circuit fixed, and the inductance variable.

In Fig. 348 (a) the h.t. supply is applied direct to the upper coupling winding and thence to the anode, whereupon the circuit can be described as being series-fed. A shunt-fed version is illustrated in Fig. 348 (b), although it should be pointed out that this offers no particular advantage over the series-fed circuit.

### The Tuned-Anode Tuned-Grid Oscillator

An important oscillator is illustrated in Fig. 349, which shows the circuit of the *tuned-anode tuned-grid oscillator*. The tuned-anode tuned-grid oscillator differs from all the other oscillators we have considered up to now because feedback does not occur by way of inductive coupling or by coupling the anode to one end of the tuned circuit and the grid to the other. Instead, the feedback takes place via the self-capacitance between the anode and grid inside the valve.

There are two tuned circuits in the tuned-anode tuned-grid oscillator, one being in the grid circuit and the other in the anode circuit. It is assumed in the diagram that these are adjustable by means of variable capacitors. If these two tuned circuits are set up to resonate at *exactly* the same frequency the circuit does not oscillate, but if the anode tuned circuit is set to resonate at a slightly higher frequency than the grid tuned circuit, oscillation takes place. The amplitude of the oscillation varies if the anode tuned circuit is adjusted over a small range of frequencies above the resonant frequency of the grid tuned circuit. The oscillator is usually set up in such a manner that the anode tuned circuit resonates at a frequency which is just sufficiently higher than that of the grid tuned circuit for oscillations of good amplitude to be obtained, and which ensures reliable starting immediately the h.t. supply is applied.

The phase relationships between the two tuned circuits are a little complex, and it has been shown<sup>2</sup> that the actual oscillation frequency is lower than the resonant frequency of either of the tuned circuits. (When set up as just described, the actual oscillator frequency should only be very slightly lower than the tuned circuit resonant frequencies). The circuit does not have many applications in radio receiver work because, if a wide range of frequencies is to be covered, it is necessary to keep both tuned circuits in step whilst maintaining the optimum difference in frequency between them. On the other hand the circuit can be of considerable use in radio transmitters in which an oscillator is intended to run at a fixed frequency over long periods of time.

As with the preceding oscillators, grid bias may be conveniently obtained by means of a grid leak and capacitor. The series-fed circuit shown in Fig. 349 is almost invariably employed in practice. A shunt-fed circuit could also be made to oscillate, but it offers no advantages and may not perform as well. Normally, tuned-anode tuned-grid oscillators are employed in circuits where a relatively high output

<sup>2</sup> Emrys Williams, "Thermionic Valve Circuits", published by Sir Isaac Pitman & Sons, Ltd.

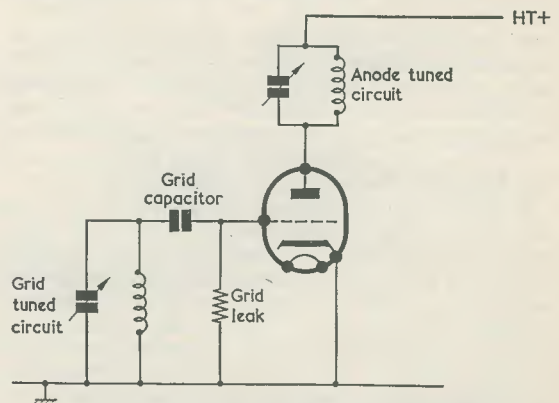

Fig. 349. The tuned-anode tuned-grid oscillator. Frequency adjustment by means of variable capacitors is assumed

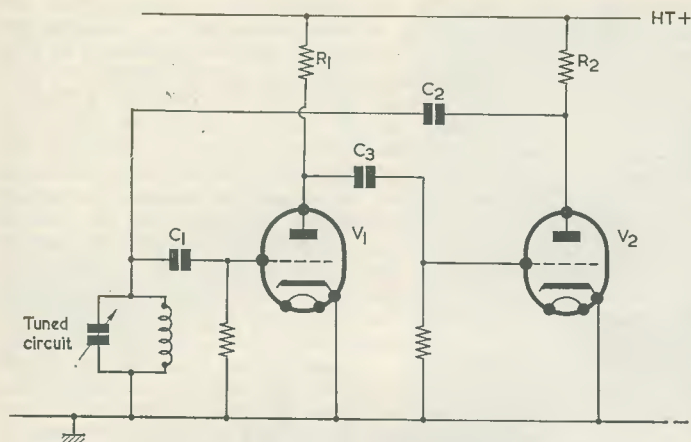

Fig. 350. The Franklin oscillator. This employs two triodes instead of one

to appear across the tuned circuit. This is then amplified until the circuit runs with full amplitude. The Franklin circuit is self-starting, in the same way as have been the previous circuits we have examined.

The two triodes of Fig. 350 are capable of providing far more amplification than is required to keep a tuned circuit oscillating. In consequence, it is desirable to introduce some form of attenuation (i.e. reduction of signal amplitude) into the circuit to counteract the excessive amount of amplification which is present. A neat approach here can consist of giving  $C_1$  and  $C_2$  very low values, of the order of several picofarads or even less. Capacitors having low values in the  $C_1$  and  $C_2$  positions not only provide the attenuation needed to offset the

power at oscillator frequency is required, this output being taken from the anode circuit.

### The Franklin Oscillator

A final triode oscillator, which will now be briefly considered, is the *Franklin oscillator* whose circuit is given in Fig. 350. Again, it is assumed that the tuned circuit is adjusted by means of a variable capacitor. The Franklin oscillator employs two triodes instead of one, and it will be helpful to consider its operation during a portion of the oscillatory cycle when the voltage on the upper end of the parallel tuned circuit is going positive. This positive-going voltage is applied to the grid of  $V_1$  via grid capacitor  $C_1$  whereupon, due to the inherent  $180^\circ$  phase reversal in this valve, an amplified negative-going voltage appears at the anode. The negative-going voltage is then applied via  $C_3$  to the grid of  $V_2$ , with the result that a second  $180^\circ$  phase reversal takes place and a further amplified positive-going voltage is fed back, via  $C_2$ , to the upper end of the tuned circuit. Thus, a positive-going voltage at the upper end of the tuned circuit has resulted in an amplified voltage of the same phase being fed back to it, and oscillation takes place with oscillator frequency being controlled by the tuned circuit.

Another way of looking at the circuit is to state that the two triodes are connected in cascade with the output being fed back, in phase, to the input. The parallel tuned circuit offers maximum impedance at its resonant frequency, with the result that it is at this frequency that the maximum amount of feedback takes place. In consequence, oscillation occurs at the resonant frequency of the tuned circuit.

When describing the functioning of the circuit, we made the assumption that it was already running. This assumption is permissible because a very small initial change in anode current in either triode will cause a voltage at oscillator frequency

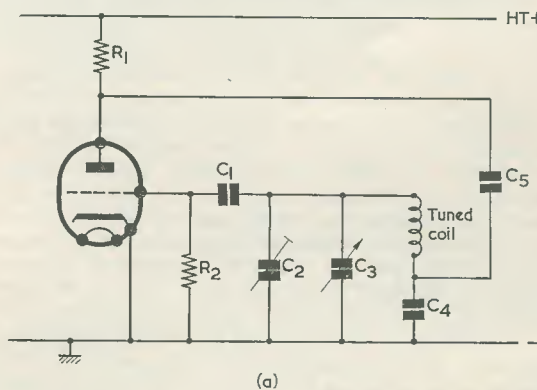

(a)

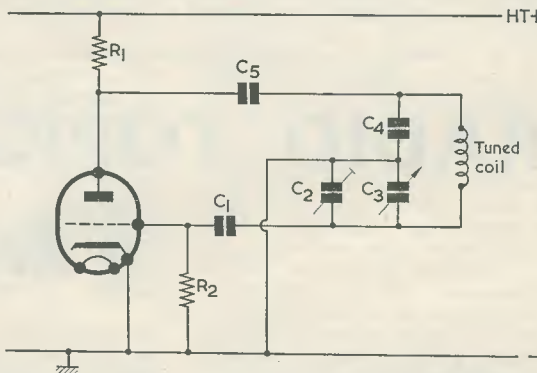

(b)

Fig. 351 (a). This oscillator circuit may be encountered in some superhet radio receivers intended for operation on medium and long waves.  $C_1$  and  $R_2$  are the grid capacitor and grid leak with typical values of  $100\text{pF}$  and  $47\text{k}\Omega$ . The other components have values, typically, as follows:  $R_1$ ,  $47\text{k}\Omega$ ;  $C_2$ ,  $60\text{pF}$  max;  $C_3$ ,  $500\text{pF}$  max;  $C_4$   $400\text{pF}$  and  $C_5$ ,  $200\text{pF}$   
(b). When the components of (a) are rearranged, it may be seen that the circuit is a Colpitts oscillator

high degree of amplification given by the two valves, but they also give the tuned circuit a high level of isolation from stray capacitances in the remainder of the circuit. This latter point can be of considerable advantage in some applications.

The values of the remaining components in Fig. 350 are not particularly critical. For oscillation at radio frequencies,  $C_3$  could have a value of 50 to 100pF and the anode loads,  $R_1$  and  $R_2$ , could have values of approximately 47k $\Omega$ . A similar value would be satisfactory for the two grid leaks.

A very convenient feature of the Franklin oscillator is that only two connections need be made to the tuned circuit and that it is capable of being tuned over a wide range of frequencies by a tuning capacitor of conventional construction whose frame can be mounted direct to chassis. On the other hand, the output power is not high and two valves are required instead of one.

### Oscillators—General Points

We have now discussed all the basic types of oscillator employing tuned circuits which can be built around the triode valve. As we will see later, there are several further oscillator circuits which require valves having more complex electrode assemblies than has the triode, but these are not generally encountered in radio receiver work. It must also be added that a certain class of radio receiver—the superhet—employs an oscillator to assist in the selection of the desired signal. How this process is carried out must also be left to a later article, but the point is introduced here in order to acquaint the reader with the fact that an oscillator is an integral part of many receivers.

The oscillator circuits most commonly employed in valve receivers working on long, medium and short waves are the tuned grid and tuned anode types, and these may be either series-fed or shunt-fed. An occasionally encountered variant is shown

in Fig. 351 (a), this being sometimes used for oscillators in receivers operating on medium and long waves. When the circuit components of Fig. 351 (a) are rearranged, as in Fig. 351 (b), it may be seen that the oscillator is a Colpitts. It will be noted that one of the two capacitors across the coil is variable and that the ratio of capacitance values will vary when this is adjusted over its range. In consequence, the amplitude of oscillation varies as the variable capacitor is adjusted, but the changes in amplitude are acceptable in the class of receiver with which the circuit is used. In practice, the position is alleviated also because the trimming capacitor connected across the variable capacitor will, in conjunction with stray capacitances, ensure that minimum capacitance at the grid end of the tuned circuit does not fall below some 50pF. The circuit has the advantage of low cost, due mainly to the fact that a coupling winding, as would be required for a tuned anode or tuned grid oscillator, is not needed.

Television receivers operating in Bands I and III may employ valve oscillators running at frequencies of the order of 70 to 240 Mc/s. Such oscillators use a Colpitts circuit in which the capacitances across the coil are partly provided by self-capacitances in the valve itself.

The Hartley, Colpitts and tuned-anode tuned-grid oscillators are more frequently encountered in transmitters and test equipment than in radio receivers. However, the principles of operation of these oscillators are applicable to a number of radio receiver circuits. The Franklin oscillator is mainly encountered in transmitting and test equipment work.

### Next Month

In next month's issue we shall deal with the question of oscillator frequency stability.

# RADIO TOPICS . . .

## by Recorder

*From ghoulies, ghosties and long-legetty beasties,  
And things that go bump in the night,  
Good Lord deliver us.*

**H**AD THE SCIENCE OF ELECTRONICS been in existence when the composer of that old Cornish lityny wrote his words, I am quite certain he would have added a footnote to cover radios and TV's that go intermittent in the night,

in the day, or at any period when the Fates which decide these things ordain that they shall occur.

### Intermittent Troubles

I speak with some feeling here, because the Recorder household has been plagued with an intermittent radio receiver ever since 1963. This particular set must, indeed, be a strong contender for the long-distance intermittent stakes.

The set is a commercially-made a.m./f.m. mains radio and, as I say, it gave evidence of its intermittent fault three years ago. After it had been switched on for some fifteen minutes its a.f. output suddenly disappeared, to be replaced by a loud hum. I was out of the house on the first few occasions when this occurred and the ladies of the family, who are nothing if not resourceful, soon discovered that the fault cleared if they switched the set off and quickly on again. After this, it worked normally for the remainder of the listening period, and gave no further trouble.

When, some days later, I found out what was going on, I immediately whipped the set off to my work-room, let it cool, and then tried it out with the back and bottom covers off. After a quarter of an hour



the hum appeared. There was no change when I short-circuited the grid of the output valve to chassis, and so it appeared safe to assume that the fault was occurring after that grid. I got the meter out. But before I could even apply a test prod the fault cleared of its own accord and no amount of component tapping, printed board flexing or wire wriggling would bring it on again. In consequence, I popped in a new output valve, kept my fingers crossed and returned the set to its proper place. Whereupon—success!—the receiver functioned perfectly and gave no further evidence of the snag. I then forgot all about it.

Six months later the fault returned. I was very busy at that period and, since the switching off and on business which unfailingly cleared the fault caused little trouble. I decided to leave the set alone and wait until the snag became more pronounced. That, believe it or not, took another six months. Then suddenly, one evening, the hum came on and stayed on. This state of affairs continued whilst I checked the set, and the hum disappeared when I applied a new electrolytic across the reservoir capacitor. So I took the line of least resistance and replaced that capacitor, with the result that the receiver returned to normal with no further trouble. Success again!

That was in 1964. In the middle of 1965 that darned set started behaving *exactly* as before. This time I really went to town on it, but I could discover absolutely nothing conclusive. Also, as in the first instance, the mere appearance of a meter seemed to be sufficient for the fault to disappear. So I started putting faults on the set, to see if these gave the same results as when the intermittent was present. I found that I could reproduce the same symptoms by temporarily short-circuiting a tone correction capacitor fitted between the output anode and h.t. negative. I wasn't entirely convinced but, as nothing else offered the same promise, I fitted a new component here. Whereupon—success yet again!—there was no further evidence of that dratted fault.

Last night, I switched on that radio. As has occurred ever since I put the new tone-correction capacitor in, it behaved perfectly. Until that is, it had been playing for quarter of an hour. Suddenly, a loud hum became apparent, which could be cleared by simply switching the set off and quickly on again, after which no further

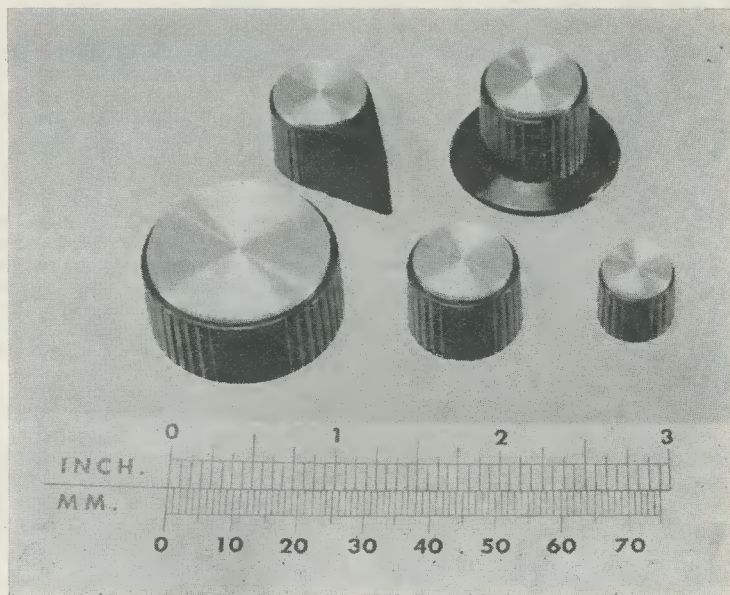

Five new knobs in the Bulgin "Designers Range" series. These are matching and may be fitted as desired on a single panel to meet particular control shaft requirements

trouble took place.

So far as I can see, the best thing to do with that bewitched set of mine is to couple it to a time switch and use it as a radio alarm in the bedroom. If I lay in bed longer than fifteen minutes after it has started playing, the hum caused by that truly infuriating intermittent will have me out of bed more quickly than the crack of doom!

#### Bulgin Knobs

At any event, intermittents can't be caused by knobs, and the accompanying photograph shows a further addition to the very wide range of instrument knobs which is already available from A. F. Bulgin & Co. Ltd. These knobs appear in the Bulgin "Designers Range" series and have all the high-grade features for which that company has such a deserved reputation.

A special point about the knobs is that they provide matching for instances where some controls on a panel are primary and more important than others, or where some are heavier and require more torque transmission. The two upper knobs, one of which is pointer-type and the other skirted, are particularly useful for fine adjustment. All the knobs match each other, enabling the designer to achieve a clean panel appearance whilst retaining

the individual characteristics required for each control shaft.

The finish is Standard Black or Grey with aluminium spin caps. All the knobs are fitted with keyed brass inserts and radial grub screws. Allen screws can be provided if a tighter grip is required.

The type numbers of the knobs in the illustration are as follows: top row from left to right, K515 and K516; bottom row from left to right, K512, K513 and K514. The K514 is intended for an  $\frac{1}{8}$  in. shaft, the remainder taking  $\frac{1}{16}$  in. shafts. All the knobs are currently in production.

#### Spiral Mowing

If you are closely associated with electronics people tend to ascribe "electronic" explanations to your activities, even when this is very far from being the case.

The truth of this statement is well borne out by the experience of a staff colleague who has been blessed with rather more than his fair share of inventiveness. Recently, his neighbours were greatly mystified to see his motor mower busily chugging away over his lawn, all on its own and without any human guidance whatsoever. Indeed, not only was there nobody on the lawn as the robot mower went methodically about its business, but there was nobody even in sight.

The mystery was rationalised when

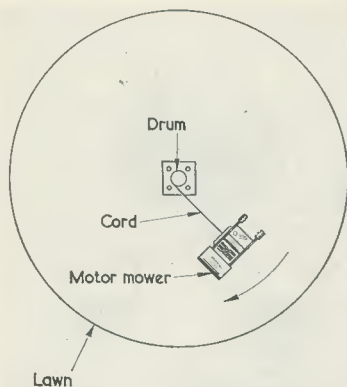

Fig. 1. How to impress one's non-electronic neighbours without even trying. See "Spiral Mowing"

my colleague's neighbours recalled his electronic connections, and the word was then put out that he had built and was now operating a radio-controlled mower.

Much as I would like to confirm this impression and give a description of the equipment which would then have been used, I have to state that my colleague's automatic mowing device was far from being electronic. Had his neighbours looked a little more closely, they would have seen a length of thin cord guiding the mower as it bustled about the lawn.

Despite its non-electronic mode of operation, the method adopted for controlling that lawnmower is so simple and ingenious that it more than deserves a few brief words here. My colleague's lawn is both large and circular and, when it requires mowing, he mounts a circular drum at its centre. The circumference of the drum is equal to the blade width of the mower. One end of a length of thin cord line is attached to the drum, and the line is then wound around it, its free end being coupled to the inside end of the front roller of the mower. At this stage of the proceedings the mower is alongside the drum. The mower is next started and left to run on its own, whereupon it attempts to move tangentially. It is, however, re-

strained by the cord, with the result that it traces out a spiral, gradually unwinding the cord in the process. In my Fig. 1 the mower has already passed over about half the lawn as it follows its spiral path towards the outer periphery.

All this is cunning enough, but we now come to a bit of really fiendish craftiness. The cord is just long enough to enable the mower to reach the periphery so that, as soon as the mower runs along the outside edge of the lawn, the cord is completely unwound. The cord then begins to wind on again in the opposite direction! The consequence is that the mower now follows a second spiral path, this being from the outside of the lawn back towards the centre again.

Just before the mower is due to reach the drum on its return journey, my colleague glances at his watch, puts down his cup of tea and saunters out of the house to finally turn the mower off.

The circular drum at the centre of the lawn is made up in the manner shown in Fig. 2. The drum, which can consist of wood or any other suitable material, is fixed to a square wooden base, from the bottom of which protrude four long bolts. When required, the drum is set in position by pushing these four bolts into the earth.

My colleague says that the only snag now outstanding is that he still has to mow the centre bit of the lawn himself!

#### Ferrite Aerial Checks

You may recall that, in the March issue, I described a means of checking the inductance of ferrite rod aeriels when these are mounted in such a manner that the coil cannot be easily moved along the rod. Ferrite aerial inductance can be increased by bringing another ferrite rod up to the aerial being investigated, and reduced by bringing one pole of a permanent magnet up to the end of the ferrite rod which is closer to the coil. If either of these operations causes an increase in signal strength from the associated receiver, when tuned to a signal at the low frequency end of the

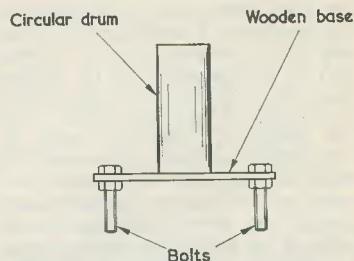

Fig. 2. Side view of the circular drum fitted on its square wooden base. There are four bolts in all, one being at each corner of the base

band, then the ferrite aerial requires more or less inductance as applicable.

We have since had an interesting correspondence with a reader, Mr. R. Wallace of Teignmouth, Devonshire, who has been successfully using the additional ferrite rod scheme for increasing ferrite aerial inductance for quite some time now. At the same time he has been employing quite a different approach from the permanent magnet idea for reducing inductance, this consisting of slipping a closed loop or "shorted turn" of wire on to the end of the aerial rod nearer to the coil being checked. The loop is moved from the extreme end of the rod towards the coil, whereupon it reduces inductance progressively. If this results in an increase in signal strength the ferrite aerial has too much inductance.

In many cases, the ferrite aerial rod is mounted on brackets which prevent a closed loop being passed over its ends. Mr. Wallace points out that, in these instances, a simple solution consists of taking a short length of the workshop supply of cored solder. This can easily be threaded round the aerial rod in the receiver, the ends then being pinched together between finger and thumb to form a small loop, which should not have a diameter greater than about 1in. The test can then be carried out with this loop of solder.

## Fleet Street Uses Pocketfone

Mr. John Brinkley, Managing Director, Pye Telecommunications of Cambridge, said that he was delighted that the Evening Standard is the first newspaper in the world to use the new Pye Pocketfone, and to provide one of the fastest and best Election news services.

The Pocketfone, a new British invention working on a U.H.F., is a two way instant radio, small enough to fit into a suit pocket or handbag. It will now enable reporters to send immediate on-the-spot reports to their news desks, instead of having to rely on the public telephone.

This is only one of many uses for the Pocketfone, which, as well as helping the police to fight crime, is employed in oil refineries, and has great service potential for the public services and industry.

## THE 1966 PHYSICS EXHIBITION

(continued from page 695)

other and typical figures here are 500°C and 50°C respectively. The high temperature may be provided by the burning of Calor gas, and the low temperature by large cooling fins. Each module gives about 1 volt off load and about 0.5 volt when working at optimum efficiency into an external load. The overall efficiency of the thermoelectric generators, in terms of electrical output against the thermal energy in the fuel, is low, and a figure of 1% was mentioned to the writer. But the generators have the advantage of exceptionally high long-term reliability and are attractive as power supplies for unattended equipment such as microwave links.

### Speech Segmentation

Exhibited by Standard Telecommunication Laboratories Ltd., was their Speech Microscope, this being an equipment which can continually play back a portion of a magnetic tape recording and simultaneously display its waveform on an oscilloscope. The Speech Microscope can be used for experiments and studies in speech, and for subjective evaluation of the effects of removing part of a word. It is found, for instance, that as much as half of some uttered words can be removed without the listener being aware of any significant change. The writer was given a demonstration of the effects given with the spoken word "six". Quite a high proportion of the initial "s" sound in this word could be removed without any serious change to its sound or intelligibility. When the initial "s" sound was almost entirely removed, however, the word sounded like "tix" and then, with even less of the "s" sound, like "dix". The "s" sound at the end of the word was next removed, whereupon the word became "dick". By returning both "s" sounds to their original true level and duration and then removing the second half of the initial "s" sound, the word changed to "sticks". An interesting incidental feature of the equipment is that the recording tape is held stationary against a third of the edge surface of a rotating drum. The drum carries two pick-up heads, the output from which provides the sequentially repeated sound or group of sounds intended for study. This approach makes the selection of the desired section of tape a very simple matter.

### Lasers

As was to be expected, lasers were in evidence on a large number of stands. What was probably the most effective demonstration was staged by the Ministry of Defence and included a recently developed gas laser employing a mixture of carbon dioxide, nitrogen and helium. This laser is d.c. excited and runs at 50 to 150mA at 3.3kV. It offers an output of about 50 watts and is especially attractive for applications where controllable intense local heating is required. It was displayed carrying out three simple functions, the first of these being the cutting of a razor blade. The second demonstration was the making of holes in plastic strip

whilst, in the third, the laser beam was focussed on to the centre of a slowly moving strip of paper tape. Since the laser was excited by unrectified a.c. it did not cause a straight unbroken line to be cut in the paper. Instead, it produced a series of tiny holes, resulting in an exceptionally neat perforation.

Another laser of considerable interest was a continuously operating solid state laser shown by the Royal Radar Establishment. The laser uses yttrium aluminium garnet for the host lattice, this being doped with about 1% of neodymium impurity. The solid-state crystal appears in the form of a rod about 30mm long and 3mm in diameter, the ends being optically polished to form convex surfaces with a radius of 25mm. Highly reflecting mirrors are then formed on these ends. Pumping is given by a conventional quartz-iodine tungsten filament lamp and, under ideal conditions, an output of several watts is feasible.

The coherent light offered by the laser makes the production of images by holography a practical proposition. In holography, an image is not photographed by means of a lens. Instead an image is reconstructed from its photographed diffraction pattern, or hologram. There is an intense interest in holography at present because the reproduced image is three-dimensional with all the attributes of parallax and perspective. If the observer moves, say, from left to right, image details on the right which were previously hidden come into view. A number of exhibitors showed holography equipment and, in some instances, actual displays of images reproduced by holography. These included the Marconi Company, the British National Committee for High Speed Photography, and Scientifica and Cook Electronics.

### Integrated Circuits

Integrated circuits were to be seen on a number of stands and a helpful display for the newcomer to this field was shown by Admiralty Surface Weapons Establishment. Their display covered the assembly and manufacture of micro-electronic circuits using the thin film and the monolithic techniques. Also shown was a thin film wideband amplifier having a useful gain up to 300 Mc/s and a 10-layer printed wiring board assembly which connects into its external circuit by flexible film wiring.

A section of the exhibition was devoted to suppliers of educational equipment and a particularly interesting exhibit here was a simple low-cost oscilloscope on the Mullard stand which could be assembled, in sections, by students. An educational digital computer, the "Lan-Dec" computer, was displayed by Lan-Electronics Ltd. This instrument demonstrates the properties of a digital computer by performing arithmetic operations and simulating a simple memory function. It has fifteen NOR elements, ten of these having four available inputs and five having two inputs. These circuits may be interconnected with each other by patch cords for different functions, this process being analogous to the programming of a full-scale digital computer.

**Queries.** We regret that we are unable to answer queries other than those arising from articles appearing in this magazine nor can we advise on modifications to equipment described. Queries should be submitted in writing.

**Correspondence** should be addressed to the Editor, Advertising Manager, Subscription Manager or the Publishers as appropriate.

**Opinions** expressed by contributors are not necessarily those of the Editor or proprietors.

**Contributions** on constructional matters are invited, especially when they describe the building of particular items of equipment. Articles should be written on one side of the sheet only and should preferably be typewritten, diagrams being on separate sheets. Typewritten articles should have maximum spacing between lines. In handwritten articles, lines should be double-spaced. Diagrams need not be large or perfectly drawn, as our draughtsmen will re-draw in most cases, but all relevant information should be included. Sharp and clear photographs are helpful, where applicable. If negatives are sent, we usually work from these rather than from prints. Colour transparencies normally reproduce badly—black and white photographs are very much better. Details of topical ideas and techniques are also welcomed and, if the contributor so wishes, will be re-written by our staff into article form. All contributions must be accompanied by a stamped addressed envelope for return, if necessary, and should bear the sender's name and address. Payment is made for all material published.

**Production.**—Letterpress/contact litho.

# LEARN **ELECTRONICS** AS YOU **BUILD 25** CIRCUITS . . . EXPERIMENTS . . . TEST GEAR . . .

including

## ● CATHODE RAY OSCILLOSCOPE

- |                          |                          |                          |
|--------------------------|--------------------------|--------------------------|
| ● VALVE EXPERIMENTS      | ● SQUARE WAVE GENERATOR  | ● SIGNAL TRACER          |
| ● BASIC AMPLIFIER        | ● SIMPLE TRANSMITTER     | ● BASIC COMPUTER CIRCUIT |
| ● BASIC RECTIFIER        | ● TRANSISTOR EXPERIMENTS | ● BASIC RADIO RECEIVER   |
| ● PHOTO ELECTRIC CIRCUIT | ● BASIC OSCILLATOR       | ● MORSE CODE OSCILLATOR  |
| ● TIME DELAY CIRCUIT     | ● ELECTRONIC SWITCH      | ETC. ETC.                |

This complete practical course will teach you all the basic facts of electronics by making experiments and building apparatus. You learn how to recognise and handle all types of components—their symbols and how to read a circuit diagram. You see how circuits are built and how they work **BY USING THE OSCILLOSCOPE PROVIDED.** Applications of all the main electronic circuits are

demonstrated—radio reception and transmission; photo-electrics; computer basics; timers; control circuits; etc.; including servicing techniques. **NO MATHS USED OR NEEDED. NO THEORY NEEDED. NO PREVIOUS KNOWLEDGE OR EXPERIENCE NEEDED.** Tutor service available. No extras needed—tools provided. Send now, for *Free Details* without obligation, to address below

**POST  
NOW**



To **RADIOSTRUCTOR**, Dept. K3, **READING, BERKS.** Please send free details of your electronics kit set to:

NAME \_\_\_\_\_

ADDRESS \_\_\_\_\_

# SMALL ADVERTISEMENTS

Rate: 9d. per word. Minimum charge 12/-.  
Box No. 2/- extra.

Advertisements must be prepaid and all copy must be received by the 4th of the month for insertion in the following month's issue. The Publishers cannot be held liable in any way for printing errors or omissions, nor can they accept responsibility for the *bona fides* of advertisers. (Replies to Box numbers should be addressed to: Box No.—, *The Radio Constructor*, 57 Maida Vale, London, W.9.)

**SERVICE SHEETS, 1925–1965.** From 1s. Catalogue 6,000 models, 2s. 6d. S.A.E. enquiries.—Hamilton Radio, 13 Western Road, St. Leonards, Sussex.

**GOVERNMENT SURPLUS electrical and radio equipment.** Our new catalogue No. 16 ready now, 2s. 6d. post free, cost refunded on purchase of goods over £2.—Arthur Sallis Radio Control Ltd., 93 North Road, Brighton, Sussex.

**FOR SALE. Oscilloscopes—Galvanometers—Evershed & Vignolles Meggers.** Also other items and components. Free list. Stamp please.—R. & E. Mart, Box 9 G.P.O., Tunbridge Wells, Kent.

**CONVERT ANY TV SET INTO AN OSCILLOSCOPE.** Instructions and diagrams, 12s. 6d.—Redmond, 42 Dean Close, Portslade, Sussex.

**40 SEMICONDUCTORS** commonly used in radio and electronic circuits, consisting of 20 transistors OC42-45-71-81 etc., 10 silicon rectifiers 50-800 p.i.v. 200-800mA. Incl. BY100's plus 10 diodes OA70-79-81 zener and gold bonded. All brand new. Valued over £5. For only 40s. plus post and packing 1s. To:—BI-PAK SEMICONDUCTORS, 8 RADNOR HOUSE, 93/97 REGENT STREET, LONDON W.1.

**SEMICONDUCTORS—Good quality, close equivs.,** OC35, 4s. 9d., OC72, 2s., OC71, 1s. 9d., OC44, 2s., OC170, 2s. 6d., BY100, 4s. 3d., OA70, 8d. P. & P. 9d.—A. P. Wise, 19 Harbeck Road, Bournemouth, Hants.

**ANY PRINTED CIRCUIT BOARD SUPPLIED** against your full size drawing. 6d. sq. in. plus 2s. 6d. processing. Post free. Prices include drilling.—Temple, 12 Beech House Road, Croydon, Surrey.

**WANTED. Information on meteorological FAX radio** reception systems, brochures, circuits, surplus equipment, etc.—Box No. F250.

**WANTED. To purchase secondhand classical L.P. records** in good condition. Reasonable.—Box No. F251.

**FOR SALE. RTTY converter, Type A.P. 66286, £5** plus carriage.—Box No. F254.

**EXCITING HOLIDAYS with Adventure, Variety and Fun.** Sailing, Snorkelling, Pony Trekking, Canoeing, Caving. Please write for our attractive brochure.—P.G.L. Holidays, Department 82, Commerce Lane, Letchworth, Herts.

**FOR SALE. Heathkit Balun Coil Unit, B-1U. £4.** —Box No. F259.

continued on page 717

# BENTLEY ACOUSTIC CORPORATION LTD.

38 Chalcot Road, Chalk Farm,  
LONDON, N.W.1.

47 Norfolk Road,  
LITTLEHAMPTON, Sussex,  
Littlehampton 2043

Please forward all mail orders to Littlehampton

OA2	5/9	6/30L2	8/9	AZ31	7/9	EF36	3/6	GZ34	10/-	PY800	5/9
OB2	6/-	9D7	7/6	DAF96	6/-	EF37A	7/-	GZ37	14/6	PY801	7/6
1L4	2/3	10C1	9/9	DF96	6/-	EF39	5/-	HA8C80	9/3	U25	8/6
1R5	4/-	10C2	12/-	DK92	8/-	EF41	6/6	KT66	12/3	U26	8/6
IS	3/3	10F1	10/-	DK96	6/6	EF80	4/3	PAB8C0	6/9	U191	9/6
1T4	2/3	10F18	9/9	DL96	6/6	EF85	4/6	PC86	9/9	U301	11/-
2D21	5/6	10LD11	9/6	DM70	5/-	EF86	6/6	PC88	9/-	U329	9/6
3D6	3/9	10P13	12/-	DY87	7/6	EF89	4/3	PC95	6/9	U404	6/-
3Q4	5/3	10P14	11/6	E88CC	12/-	EF91	3/-	PC97	5/9	U801	15/-
3S4	4/9	12AT6	4/6	E88C80	5/9	EF92	2/6	PC900	9/6	UABC80	5/6
3V4	5/-	12AU6	5/9	EAF42	7/9	EF97	10/-	PC84	5/6	UAF42	7/-
5Y3GT	4/9	12AV6	5/9	EB91	2/3	EF98	9/9	PC85	6/9	UBC41	6/3
5Z4	7/6	12BA6	5/3	EBC41	6/6	EF183	6/9	PC88	10/6	UBC81	6/3
6AQ5	5/9	12BE6	4/9	EBC81	6/3	EF184	6/6	PC89	11/6	UBF80	5/6
6AT6	3/6	12BH7	6/-	EBF80	5/9	EHP90	9/6	PC189	8/9	UBF89	6/3
6AU6	5/9	12AQ5	7/3	EBF83	7/3	EL33	6/6	PCF80	6/6	UBL21	10/9
6AV6	5/6	20D1	10/-	EBF89	9/9	EL36	9/9	PCF82	6/-	UC82	6/3
6BA6	4/6	20F2	11/6	EBL21	10/3	EL41	7/-	PCF84	8/6	UCC84	8/-
6BE6	4/3	20L1	14/-	EC92	6/6	EL42	7/9	PCF86	8/3	UCC85	6/6
6BH6	5/3	20P3	12/-	ECC40	10/-	EL84	4/6	PCF801	9/9	UCF80	8/3
6B16	5/6	20P4	13/-	ECC81	3/6	EL85	7/6	PCF802	10/-	UCH21	8/-
6BQ7A	7/6	20F5	11/6	ECC82	4/6	EL86	7/3	PCL82	6/6	UCH42	8/-
6BR7	8/3	30C15	10/-	ECC83	4/6	EL95	3/-	PCL83	9/6	UCH81	6/6
6BW6	7/6	30C17	11/9	ECC84	5/6	ELL80	13/6	PCL84	7/6	UCH82	7/3
6CDDG	18/-	30C18	8/-	ECC85	5/9	EM71	15/6	PCL85	8/6	UCL83	9/6
6CH6	6/6	30F5	8/3	ECC88	8/9	EM80	6/3	PCL86	8/9	UF41	6/9
6F1	9/6	30FL1	9/3	ECC189	11/6	EM81	7/-	PEN45	7/-	UF42	4/9
6J5G	3/9	30FL14	11/-	ECCF80	7/3	EM84	6/-	PFL200	14/6	UF80	6/3
6J7G	4/6	30L15	10/6	ECCF82	6/6	EM85	6/-	PY123	9/-	UY21	6/9
6K7G	1/3	30L17	11/6	ECCF86	10/-	EM87	7/6	PL81	6/9	UF86	9/-
6K8G	3/3	30P12	7/6	ECH21	10/-	EY51	5/6	PL82	5/3	UF89	5/6
6LG6T	7/3	30P19	12/-	ECH35	6/-	EY81	7/3	PL83	6/-	UL41	8/9
6L18	10/-	30PL1	9/6	ECH42	8/-	EY83	9/3	PL84	6/3	UL84	5/6
6LD20	6/6	30PL13	10/6	ECH81	5/9	EY84	9/6	PM84	9/3	UM80	8/3
6Q7G	5/6	30PL14	11/3	ECH83	6/6	EY86	5/6	PY23	8/9	UY21	6/-
6SL7	4/9	30PL15	9/6	ECH84	5/9	EY88	8/9	PY80	4/9	UY41	5/-
6SN7	4/6	35W4	4/6	ECL80	5/9	EZ40	5/6	PY81	5/-	UY85	4/9
6V6G	3/6	85A2	6/6	ECL82	6/6	EZ41	6/3	PY82	4/9	VP48	12/-
6X4	3/9	8O7	11/9	ECL83	10/-	EZ80	3/9	PY83	5/6	X41	10/-
6X5	5/3	5763	7/6	ECL86	8/-	EZ81	4/3	PY88	7/3	X78	26/2

Terms of business: Cash with order only. No C.O.D. Post/packing 6d. per item. Orders over £5 post free. All orders despatched same day. Complete catalogue including transistor section and components with terms of business 6d. Any parcel insured against damage in transit for 6d. extra. We are open for personal shoppers 9 a.m.—5 p.m. Saturdays 9 a.m.—1 p.m.



## MAKE 5 DIFFERENT RADIOS FOR 35/-

Amazing Radio Construction Set! Become a radio expert for 35/-. A complete Home Radio Course. No experience needed. Parts include instructions for each design, Step-by-Step plan, all Transistors, loudspeaker, personal phone, knobs, screws, etc., all you need. Box size 14" x 10" x 2" (parts available separate). Originally £6. NOW 35/- plus 3/6 p. & p.

## NEW RADIO ONLY 19/6



**New RADIO Anyone CAN BUILD in 2-3 hours! Only 19/6. EVEN THE OLDER CHILDREN BUILD THEM! No soldering.**

Only 16 connections! Then hear it reach out bringing in station after station. 4 1/2" x 2 1/2" x 1 1/2". Many Testimonials:

M.H. of Bradford, writes: "... I have just completed one of your sets successfully, it is the first time I have ever tackled anything like a radio and I must state here and now, I am amazed how easy it is to a layman like me. Your instructions and plan have obviously been very carefully thought out so that even the most dim can follow them. ... " 19/6 plus 2/6 post, etc.

## ASTONISHING CIGARETTE RADIO

Yes a perfectly ordinary packet ONLY of cigarettes!—but it fetches in station after station, loud and clear! Holds 10 Cigarettes—yet cleverly conceals highly sensitive, fully transistorised circuit (incl. tiny battery). Even a young boy can assemble it in under 2 hours. No soldering. No experience necessary. Only 16 connections. From our buying testimonial file Mr. D. B. of Huddersfield writes: "... I have fitted the parts in and it is working wonderfully. ... " ALL PARTS including Semiconductors, A.B.C. Plans, etc. ONLY 18/6 plus 2/6 post, etc.



CONCORD ELECTRONICS LTD (Mail Order Only)  
(Dept. R.C.13.) • 77 NEW BOND STREET • W.1

# PANEL SIGNS TRANSFERS

## Set 3 Wording—WHITE

Wording for Receivers, Amplifiers, Transmitters, Test Equipment and other Radio Apparatus. Six sheets, over 1,000 words and symbols. 4s 6d. Postage 3d.

## Set 4 Wording—BLACK

Wording and symbols as in Set 3. 4s 6d. Postage 3d.

Height of all wording approximately  $\frac{3}{32}$  in.

**Radio Constructor**

**PANEL SIGNS**  
PERMANENT PAINT TRANSFERS

**SET 3** WHITE WORDING

Six sheets containing more than 1,000 words and symbols: Amplifiers, Transmitters, Test Equipment, etc. Full Instructions for use on back of envelope.

**4/6**

**Radio Constructor**

**PANEL SIGNS**  
PERMANENT PAINT TRANSFERS

**4** BLACK WORDING

Six sheets containing more than 1,000 words and symbols: Amplifiers, Transmitters, Test Equipment, etc. Full Instructions for use on back of envelope.

**4/6**

**Radio Constructor**

**PANEL SIGNS**  
PERMANENT PAINT TRANSFERS

**SET 5** DIALS

Six sheets containing one large and two medium scales, large horizontal tuning scale, frequencies, 12 control panels (white markings on black background). Full Instructions for use on back of envelope.

**4/6**

**Radio Constructor**

**PANEL SIGNS**  
PERMANENT PAINT TRANSFERS

**6** DIALS

Six sheets containing one large and two medium scales, large horizontal tuning scale, frequencies, 12 control panels (white markings on black background). Full Instructions for use on back of envelope.

**4/6**

## Set 5 DIALS

Six sheets containing one large and two medium Scales, horizontal Tuning Scale, Control Panels (switches, potentiometers and variable capacitors) having white markings on a clear background. 4s 6d. Postage 3d.

## Set 6 DIALS

As in Set 5, but the control panels have white markings on a black background. 4s 6d. Postage 3d.

To: Data Publications Limited, 57 Maida Vale, London, W.9

Please supply PS3 ....., PS4 ....., PS5 ....., PS6 .....

I enclose cheque/crossed postal order for.....

NAME .....

ADDRESS .....

.....(BLOCK LETTERS PLEASE)

## SMALL ADVERTISEMENTS

continued from page 715

**BOOKS TO CLEAR.** "Electronic Music & Musique Concrete" (Judd) 7s. 6d. "Man in Space" (Haber) 10s. "Realities of Space Travel" (Carter) 10s. "The Story of Astronomy" (Draper and Lockwood) 5s. "Santos-Dumont" (Peter Wykeham) 17s. 6d. "Teach Yourself Russian" 5s. "The Manual of Rugby Union Football" 5s. "How to develop a Super-Power Memory" (Harry Lorayne) 10s. "The Principles of Modern Book-Keeping" (Hamilton) 5s.—Box No. F260.

**RESERVE CAPACITY AVAILABLE** mechanical, electro-mechanical assembly, electronic assembly and wiring. Lead time six weeks. Top quality assurance and supporting technical service. Based North Wales.—Box No. F262.

**OC170.** Six OC170's and over 24 sub-min diodes (mounted on printed circuit board). Send 15/- P.O. or S.A.E. for details. Box No. F263.

**BOUGHT A KIT?** Have it expertly assembled at low cost. For immediate quotation send full construction information to: John C. Muggleton, 24 Essex Gardens, Market Harborough, Leics.

**H.R.O. FOR SALE.** Complete set coils, power unit and headphones. Also loads of components. The lot £18 o.n.o. Box No. F264.

**RADIO CONSTRUCTOR AC MILLIVOLTMETER.** Printed circuit panel supplied drilled 10/- each. Or complete with all components ready to assemble as specified in the April issue, including transistors, 65/- Terms C.W.O. Wasco Electronics, 40 Hill Street, Carnforth, Lancs.

**CONSTRUCTOR SELLING UP.** Valves, meters, transformers, components, twin-gangs, relays, many misc. items. All cheap. Callers evenings. S.A.E. for list. Gott, 25 Cherry Nook Road, Deighton, Huddersfield, Yorks.

**TECHNICAL DRAWINGS, Artwork, etc.** Electronic and Radio Circuits a speciality. Moderate charges.—B. P. Meaney, 43 Forest Road, Worthing, Sussex.

**ARE YOU A MOTORING ENTHUSIAST?** The Seven Fifty Motor Club caters for all types of motor sport—racing, rallies, hill climbs, etc. Monthly Bulletin free to members. For full details write to: The General Secretary, Colin Peck, "Dancer's End", St. Winifred's Road, Biggin Hill, Kent.

**POSTAL ADVERTISING?** This is the Holborn Service. Mailing lists, addressing, enclosing, wrapping, facsimile letters, automatic typing, copy service, campaign planning, design and artwork, printing and stationery. Please ask for price list.—The Holborn Direct Mail Company, 2 Mount Pleasant, London, W.C.1. Telephone: TERminus 0588.

**"MEDIUM WAVE NEWS"** Monthly during DX season—Details from: B. J. C. Brown, 60 White Street, Derby.

continued on page 719

# How would you like to be an officer in the Royal Navy? and then train to be a fully qualified Electronic Engineer? Impossible? Very possible!

Not many people know this: but it's possible to train to be a graduate member of the Institution of Electronic and Radio Engineers while you're an officer in the Royal Navy.

As an electrical officer, you are given a training that lasts 4 years and which costs literally thousands.

You then get the technical and administrative experience to qualify you for the standing of chartered engineer. Which is getting the best of both worlds: a commission and an excellent civilian qualification.

**What of the future?** The Defence Review has re-affirmed the world-wide role of the Royal Navy. The vital protection of our shipping remains its constant task. The most modern technologies of nuclear propulsion, guided missiles and electronics are developing, and Polaris will take over the deterrent role by the 1970s. Here's a career that offers you responsibility, rich opportunities—and real reward.

**Entry - Qualifications:** G.C.E. 'O' level in English, with (i) suitable O.N.C., or (ii) three further G.C.E. passes including 2 at 'A' level. (One 'A' level should be in an appropriate maths or physics subject.) Scottish or Northern Ireland certificates equivalent to the above. **Age Limits:** 17½-25. **Training Course:** 4 years. **Service Period:** 16 years (pensionable) with every opportunity to put in for a permanent commission.

For full details complete and send the coupon below. You should apply before the end of July.

<b>Royal Navy</b> 	Captain J. H. F. Eberle R.N., Officer Entry Section (836 UI), Old Admiralty Building, London, S.W.1.
Please send me full details about the opportunities of training for a commission in the Electrical Branch.	
NAME _____	
ADDRESS _____	
Date of birth _____	

# SMALL ADVERTISEMENTS

Use this form for your small advertisement

To: The Advertisement Manager, Data Publications Ltd., 57 Maida Vale, London, W.9  
Please insert the following advertisement in the ..... issue of **THE RADIO CONSTRUCTOR**

1			

16 words at 9d.  
= 12/-

**ALL WORDING  
IN  
BLOCK LETTERS  
PLEASE**

I enclose remittance of ..... being payment at 9d. a word. **MINIMUM 12/-.**  
Box Number, if required, 2/- extra.

NAME .....

ADDRESS .....

*Copy to be received four weeks prior to publication. Published on the 1st of every month*

**FREE** inside every copy!

## 24-PAGE POCKET GUIDE TESTING VALVE AND TRANSISTOR CIRCUITS

Another handy reference booklet in the **PRACTICAL WIRELESS** Circuit Series. It contains all you need to know to test and trace faults in modern circuits.

Also in this issue: **GRID DIP OSCILLATOR - WIDE RANGE AUDIO OSCILLATOR**

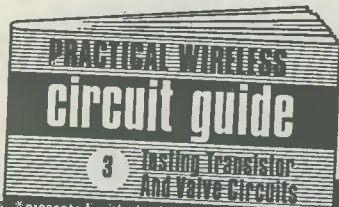

S.W. RECEIVER  
FOR THE YOUNG  
CONSTRUCTOR

A.G.C. IN TAPE  
RECORDING.

**JULY ISSUE  
OUT JUNE 9-2/6**

**PRACTICAL  
WIRELESS**

## SPECIAL OFFER

1 Watt S.T.C. 300 Mc/s N.P.N. Silicon Planar 100% Transistors, £1 for 6.

3/- each OC44, OC45, OC70, OC71, OC81, OC81D, OC200, GET16, GET20.

4/- each AF114, AF115, AF116, AF117, OC170, OC171.

5/- each OC139, OC140, GET7, GET8, GET9, XC141, BY100, OA211.

### SUN SOLAR CELL KIT

4 Sun Solar Cells plus 24-page Booklet on Experiments, 11/- set.

### G.P.O. DIAL TELEPHONES

20/- each 35/- pair

Send 6d. for Full Lists including S.C.R. Zeners, etc.

# CURSONS

78 BROAD STREET, CANTERBURY, KENT



## SMALL ADVERTISEMENTS

continued from page 717

**YOUR KITS BUILT PROFESSIONALLY FOR YOU.**  
Send S.A.E. for enquiries, quoting clearly a description and price of equipment, to—D. Kew, 5 East Avenue, Walthamstow, London, E.17.

**JOIN THE INTERNATIONAL S.W. LEAGUE.** Free Services to members including Q.S.L. Bureau. Amateur and Broadcast Translation. Technical and Identification Dept.—both Broadcast and Fixed Stations, DX Certificates, contests and activities for the SWL and transmitting members. Monthly magazine, *Monitor*, containing articles of general interest to Broadcast and Amateur SWLs, Transmitter Section and League affairs, etc. League supplies such as badges, headed notepaper and envelopes. QSL cards, etc., are available at reasonable cost. Send for League particulars. Membership including monthly magazine, etc., 35s. per annum.—Secretary, ISWL, 60 White Street, Derby.

### MORSE MADE EASY FOR THE S.W.L.

Don't miss the thrill of receiving rare D.X. because you think learning Morse is difficult. You can master the code at 18/20 w.p.m. in about 3 weeks with only 20 minutes practice daily.

Send 8d. in stamps for full details to:  
G3CHS/D, 45 Green Lane, Purley, Surrey.

### HAMMERITE HAMMER PATTERN BRUSH PAINT FOR PANELS, METALWORK, ETC.

● JUST BRUSH ON ●

COLOURS: blue, silver, black, or bronze.  
2½oz tins, 3/6. ½ pint, 7/6. 1 pint, 15/-. ½ gallon, 35/-\* 1 gallon 58/-\*  
Carr. up to 5/-, 9d., up to 10/-, 1/9, over 10/-, 2/9. \* Sent by road.  
From component shops or direct from the manufacturer:  
FINNIGAN SPECIALITY PAINTS (RC), Mickley Square, Stocksfield, Northumberland. Telephone: Stocksfield 2280

**YUKAN SELF-SPRAY** AIR DRYING MODERN WRINKLE (CRACKLE) EGG SHELL FINISH

Black same price as Hammer finishes (see our main advert., page 720)

*Like our hammers?  
Now have a crack  
at our—* **WRINKLES!**

## SITUATIONS VACANT

### KEEN AMATEUR CONSTRUCTOR

Excellent opportunity to join a small team engaged in the manufacture and modification of specialised television test equipment. Varied and interesting work. Applicants are required to be adaptable and capable of good workmanship. 37½ hour week, staff position and superannuation scheme. Apply in writing to:—

Production Supervisor,  
Test Engineering, Radio Rentals,  
Works Centre, 14 Beresford Avenue,  
Wembley, Middlesex.  
Or telephone Wembley 7871 Ext.11.

## SITUATIONS VACANT



## TELECOMMUNICATIONS

Vacancies exist for Young Men keen to make Electronics their career who have not necessarily acquired great practical or theoretical knowledge, but who have suitable interest and who have possibly already constructed some equipment themselves. Training will be provided and applicants will be encouraged to take technical studies to further their careers.

Applications to Personnel Manager,  
Cambridge Works Ltd.,  
Haig Road, Cambridge.  
Telephone: Cambridge 51351.

## TECHNICIANS

Vacancies exist for men with good standard of education, mechanical aptitude and/or knowledge of basic electronics to train for interesting and rewarding careers in our Technical Service Division. Commencing salary at age 20 is £630 p.a., at 21 and over £710 plus bonus. For our advanced equipment there are vacancies for men with electronics experience in which the starting salary can be up to £900 per annum plus bonus. Possibilities of advancement to an income of £1,200 per annum. Good holiday, pension and sick pay arrangements. Please apply to:—

Personnel Officer,  
The National Cash Register Co. Ltd.,  
206/216, Marylebone Road, London, N.W.1.  
Phone PAD 7070 Ext 172.

# CHASSIS and CASES by



287/9 Edgware Road  
London W2

TELEPHONE  
PADdington 5891/7595

## BLANK CHASSIS—Same Day Service

Of over 20 different forms made up to YOUR SIZE.  
(Maximum length 35", depth 4").

SEND FOR ILLUSTRATED LEAFLETS or order straight away, working out total area of material required (including waste) and referring to table below which is for four-sided chassis in 16 s.w.g. aluminium.

48 sq. in.	4/6	176 sq. in.	9/10	304 sq. in.	15/2
80 sq. in.	5/10	208 sq. in.	11/2	336 sq. in.	16/6
112 sq. in.	7/2	240 sq. in.	12/6	368 sq. in.	17/10
144 sq. in.	8/6	272 sq. in.	13/10	and pro rata	
	P. & P. 3/-		P. & P. 3/6		P. & P. 4/-

Discounts for quantities. More than 20 different sizes kept in stock for callers.

FLANGES (1/4" or 3/8"), 6d. per bend.  
STRENGTHENED CORNERS, 1/- each corner.  
PANELS

Any size up to 3ft at 6/- sq. ft. 16 s.w.g. (18 s.w.g. 5/3).  
Plus postage and packing

## CASES

ALUMINIUM, SILVER HAMMERED FINISH

Type	Size	Price	Type	Size	Price
U	4 x 4 x 4"	10/-	Y	8 x 6 x 6"	26/6
U	5 1/2 x 4 1/2 x 4 1/2"	15/6	Y	12 x 7 x 7"	41/-
U	8 x 6 x 6"	21/-	Y	13 x 7 x 9"	46/-
U	15 x 9 x 9"	44/6	Y	15 x 9 x 7"	48/-
W	8 x 6 x 6"	21/-	Z	17 x 10 x 9"	66/-
W	12 x 7 x 7"	34/-	Z	19 x 10 x 8 1/2"	71/-
W	15 x 9 x 8"	44/-		* Height	

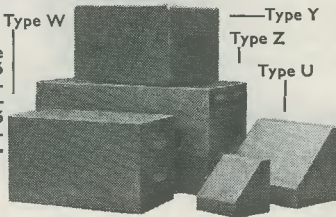

Type Z has removable back and front panels.  
Type Y all-screwed construction.

## BRASS · COPPER · LIGHT ALLOYS · ALUMINIUM BRONZE · STAINLESS STEEL

ROD, BAR, SHEET, TUBE, STRIP, WIRE. 3,000 STANDARD STOCK SIZES  
No Quantity too small List on application

**H. ROLLET & CO LTD**  
HOWIE ST. LONDON SW11 BATTERSEA 7872  
Also at Liverpool, Birmingham, Manchester, Leeds, Glasgow

the unique **PANL** black crackle paint

4/-d. per 1/8 pt. Can  
(We regret we can only supply on cash with order basis)

**BRUCE MILLER LTD.,**  
219 Coastal Chambers,  
Buckingham Palace Road, S.W.1.

Thinking of using Semiconductors?—Then you'll probably find that all the items you require are available, at highly competitive prices, through our Mail Order service.

Send a 1/3 P.O. for a price listing of over 1000 transistors, many of which are available from stock; or, alternatively, send a 2/- P.O. and receive in addition: specimen transistor data summaries—covering approx. 200 common types held in stock, and also details of our SEMI-CONDUCTOR INFORMATION SERVICE, (which will be brought into operation later this year).

Examples of our stock: OC 83, 6/-; OC 139, 12/-; OC 171, 9/-; OC 200, 10/-; AC 127, 9/6; AF 124, 11/-; AF 181, 14/-; 2G 302, 5/8; 2G 381, 4/9; 2N 697, 13/6; 2N 706, 9/-; 2N 2926 (red), 4/-; 2N 2926 (green), 4/9; 2N 3663, 14/9; 2N 3702, 7/-; etc.

Please add 1/- P. & P. on all orders of £2 or less.

TERMS: C.W.O.

MAIL ORDER ONLY PLEASE.

**M. R. CLIFFORD & CO. (C5)**

66, OLD OSCOTT LANE,

BIRMINGHAM, 22A.

## "EXPERIMENTAL" PRINTED CIRCUIT KIT

(1) 2 Copper Laminate Boards 4 1/4" x 2 1/2". (2) 1 Board for Matchbox Radio. (3) 1 Board for Wrist Watch Radio. (4) Etchant. (5) Resist Solvent. (6) Cleanser/Degreaser. (7) 16-page booklet. "PRINTED CIRCUITS FOR AMATEURS" containing full etching instructions. Also free with every kit (8) 30 SUGGESTED PROJECTS which you can build on a P.C. chassis. Triple-reflex with self-adjusting regeneration, 2 Intercoms, Wrist-Watch Radio 1.15" x .80". Amplifiers. Photoelectric Alarms. Light Controlled Robot. Human Body Radiation Detector. "Perpetual Motion" Machine. Transistor Tester and many more. Price 8/6. Post and pack. 1/6. **YORK ELECTRICS, 181a York Rd., London S.W.11.** Send S.A.E. for details.

## YUKAN SELF-SPRAY

SO PROFESSIONAL  
... THE YUKAN  
AEROSOL WAY!

GET THIS AIR DRYING HAMMER FINISH  
NOW!

YUKAN Aerosol spraykit contains 16 ozs. fine quality, durable, easy instant spray. No stove baking required. Available in Grey, Blue, Gold, Bronze at 14/11 at our counter or 15/11, carriage paid, per pushbutton self-spray can. SPECIAL OFFER: 1 can plus optional transferable snap-on trigger handle (value 5/-) for 18/11 carr. paid.



Choice of 13 self-spray plain colours and primer (motor car quality) also available.

Please enclose cheque or P.O. for total amount to:

**YUKAN · DEPT RC/6 · 307a EDGWARE ROAD · LONDON · W.2**

## THE RADIO CONSTRUCTOR—BOUND VOLUMES

Volume 18, August 1964 to July 1965. Price £1 10s. 0d. Postage 3s. 6d.

Where all issues are returned: Price £1. Postage 3s. 6d.

We regret earlier volumes now sold out.

Send for list containing details of our other publications

**DATA PUBLICATIONS LTD 57 MAIDA VALE LONDON W9**

Please mention **THE RADIO CONSTRUCTOR** when writing to advertisers

---

# BOOK LIST

---

## DATA BOOKS SERIES

### DB5 TV Fault Finding

96 pages. Price 6/-, postage 6d.

Profusely illustrated with photographs taken from a television screen depicting the faults under discussion and containing a wealth of technical information, with circuits, enabling those faults to be eradicated.

Covers both B.B.C. and I.T.A.

"... A book that should be in every television dealer's service workshop, and in every home-constructor's, for that matter."—*Journal of the Television Society*.

### DB6 The Radio Amateur Operator's Handbook

64 pages. Price 5/-, postage 5d.

Contains Amateur Prefixes, Radio Zone Boundaries, Amateur Band Frequency Allocations, Call Areas, Charts and Maps, Areas, Codes, Mileage Tables, Prefixes/Directional Bearings, Post Office Regulations, and much other useful operating data. For the beginner there are notes on how to use the mass of information given to obtain the greatest satisfaction from the hobby.

"... For concise knowledge in this field a few shillings well worth spending."—*Electronics* (Australia).

### DB14 Short Wave Receivers for the Beginner

72 pages. Price 6/-, postage 6d.

Contains a selection of both battery and mains operated short wave receivers, circuits, point-to-point wiring diagrams and many illustrations. Introductory chapter gives much information on the Short Wave Spectrum, Clubs, QSL'ing, Aerials, Amateur and Broadcast Band Listening, Frequencies, etc. This book has been specially prepared for the beginner interested in short wave receiver construction and operation.

### DB15 Twenty Suggested Circuits

48 pages. Price 3/6, postage 5d.

By G. A. French. Covers subjects ranging from electronic laboratory equipment to the simplest of periodic switches. Includes: simple and inexpensive two-valve capacity bridge, short wave regeneration preselector, one-valve speech operated switching circuit, transformer ratio analyser, series noise limiter, receiver remote mains on-off control, and many other circuits.

### DB16 Radio Control for Models

192 pages. Price 15/-, postage 9d.

By F. C. Judd. Contains both theory and practical designs of simple and advanced transmitters and receivers; basic concepts, aerials, uses of radio components, transistorised receivers, multi-channel operation, etc. Sections on servo-mechanisms by Raymond F. Stock.

More than 200 illustrations. Circuits, photographs, tables and working diagrams.

### DB17 Understanding Television

512 pages. Price 37/6, postage 2/6

By J. R. Davies. This book, which deals with the principles of 625 line reception as fully as 405 line reception, fully explains: the nature of the television signal; the cathode ray tube; receiver tuner units; receiver i.f. amplifiers; a.f. and video amplifiers; vertical and horizontal timebases; deflector coil assemblies; synchronising; automatic gain and contrast control; power supplies and receiver aerials. Also includes a comprehensive introduction to colour television.

"... one of the best books that aims to explain television in simple language . . .". R.S.G.B. Bulletin.

I enclose Postal Order/Cheque for .....

NAME .....

ADDRESS .....

(Please use Block Capitals for both name and address)

Postal Orders should be crossed and made payable to Data Publications Ltd.

Overseas customers please pay by International Money Order

All publications are obtainable from your local bookseller

Data Publications Ltd., 57 Maida Vale, London W.9

# 1966 150 BIG PAGE CATALOGUE

5,000 stocked items. Fully detailed and illustrated. FREE vouchers give 2/- in the £ discount.

PRICE 6/- (post paid)

# PROVED & TESTED DESIGNS

## FULL AFTER SALES SERVICE AND GUARANTEE

Largest range available of components and accessories  
Let us quote for your circuit

DETAILED LEAFLETS FREE ON REQUEST

### REDUCTIONS

Please note special price reductions from this month. New large purchases reduce many items.

### MW/LW POCKET SUPERHET RADIO

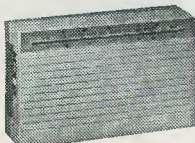

**RADIO**  
TOTAL COST TO BUILD  
**69/6** P.P. 2/-  
(Battery 2/6  
Phone 5/-)

★ All parts sold separately.

- ★ 6-Transistor design. Push-pull output.
- ★ 2½" Cleartone speaker. Printed circuit.
- ★ Attractive moulded cabinet.
- ★ Slow motion tuning.
- ★ Full medium and long waves.
- ★ Size: 5" x 3" x 1¼".

● AMAZING SENSITIVITY AND SELECTIVITY ●

### TOURMASTER CAR RADIO

NEW 7-TRANSISTOR MW/LW CAR RADIO

3 watt output. R.F. Stage 12 volt operated. Push-Button wavechange. Supplied built, boxed, ready to use with speaker and baffle, car fixing kit and manufacturers current guarantee. Special bargain offer.

PRICE  
**£9.9.0**  
P.P. 3/6



TWO WAVEBAND ALL-TRANSISTOR

### 2- AND 4-TRACK TAPE RECORDERS TO ASSEMBLE

Pre-built Equipment—6 Valves—Collaro Studio Decks—Portable Cabinets with Speakers. Complete record and playback.

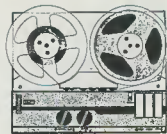

★ 2 track deck 10 gns. P.P. 5/-, Amplifier 11 gns. Cabinet with speaker 5 gns.

OR SPECIAL PRICE **£26** P.P. **TWO TRACK**

★ 4-track deck £13.10.0. P.P. 5/-, Amplifier 12 gns. Cabinet with speaker 5 gns.

OR SPECIAL PRICE **£30** P.P. **FOUR TRACK**  
(Now with new '363' decks) 8/6

Prebuilt and tested units. Low distortion, low noise

### 10W & 20W HI-FI AMPLIFIERS

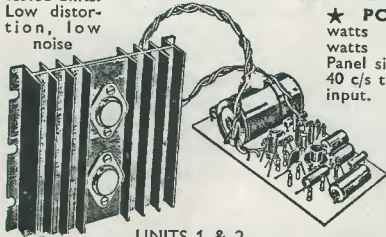

UNITS 1 & 2

★ **POWER AMPLIFIERS.** 10 watts R.M.S. music power. 20 watts peak. 6-Transistor design. Panel size 4" x 2½" x ¾". Response 40 c/s to 20 kc/s. 100mV into 33kΩ input.

UNIT 1. For 12/15 ohm speakers. 40 volt supply.

PRICE BUILT **£5.5.0** P.P. 2/6

UNIT 2. For 3 to 5 ohm speakers. 24/28 volt supply.

PRICE BUILT **£4.10.0** P.P. 2/6

★ **MAINS UNITS.** 59/6. To power one amplifier or 69/6 to power two amplifiers. (State 24 or 40 volt version.)

★ **PREAMPLIFIERS** Mono and stereo versions, 8 inputs, 1½ to 300mV at 1k to 500k. Response 30 c/s to 20 kc/s. Complete range of controls. Mains unit or battery operated. For pickups, tuners, tape, microphones, etc.

UNIT 3. Mono full-function pre-amplifier. Size 9½" x 2½" x 2".

PRICE BUILT **£5.10.0** P.P. 2/-

(Brown/Gold front panel plate 8/6)

UNIT 4. Simplified version of Unit 3. Price 65/-, P.P. 1/6. Panel plate 6/6.

UNIT 5. Stereo preamplifier for use with two units 1 or 2. Size 9" x 3½" x 1½".

PRICE BUILT **£10.19.6** P.P. 3/6

(Front panel plate 12/6)



UNIT 5

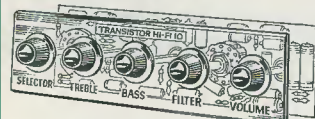

UNIT 3  
THE FINEST QUALITY HI-FI AT UNBEATABLE PRICES

### TRANSISTOR TRANSMITTER/RECEIVERS



★ ½ mile range, price per pair **£7.19.6**

★ 5 mile range, price per pair **£22.10.0**

### 4-CHANNEL MICROPHONE MIXER



Transistorised, 4 inputs up to 100kΩ. Full mixing. 49/6

Stereo 72/6

### SINCLAIR FM RADIO POCKET VHF Kit £5.19.6

X20 AMPLIFIER Kit £7.19.6

Z12 AMPLIFIER 89/6

MICRO-6 MW RADIO 59/6

### 5 WATT AND 1½ WATT PACKAGED AMPLIFIERS

★ 6-Transistor push-pull printed circuit designs.

★ Size only 2½" x 2" x 1½".

★ 5 watt 18 volt, 1½ watt 12 volt.

★ For 3 to 5 ohm speakers.

★ 7mV into 1kΩ. 30 c/s to 16 kc/s.

PRICES BUILT

1½w 59/6 P.P. 1/6      5w 69/6 P.P. 1/6



### ● Mono PREAMPLIFIER

Full range of controls, inputs for mics, p.-u., tuner, etc. Output 6-10mV. Suitable for any sensitive transistor amplifiers as above. 7½/12/18V operated. Price built/tested incl. panel 79/6. P.P. 2/6.

### HI-FI ALL MAKES AVAILABLE—New Hi-Fi Demonstration Room now open

### TRANSISTOR PORTABLE TEST EQUIPMENT

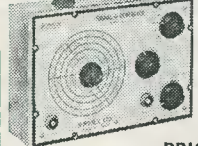

All units size 6½" x 4½" x 2½".

★ RF generator, 150 kc/s to 350 Mc/s in 8 ranges. RF, Mod. RF, AF outputs.

PRICE **£9.10.0** P.P. 2/6

- ★ Resistance/capacitance bridge. £8.5.0. P.P. 2/6.
- ★ Audio generator 10 c/s-100 kc/s. 4 ranges. £16.15.0. P.P. 2/6.

### NEW SW/MW/LW PUSH-BUTTON PORTABLE TO BUILD. 3 wavebands

TOTAL COST  
**£7.19.6**  
P.P. 3/6

The only fully Tunable 3-waveband radio for home construction.



- ★ Push-button coil pack.
- ★ 1 watt push-pull output.
- ★ Ferrite aerial/Telex. aerial/special car coils.
- ★ Printed circuit 6-transistor design.
- ★ SW 17/50m. LW 1100/1900m. MW 195/550m.
- ★ Car aerial and tape sockets.
- ★ Attractive sturdy cabinet with handle. Size 11" x 7½" x 3¼". Black fabric with chrome fittings.

LET US QUOTE PARTS FOR YOUR CIRCUIT, SEND LIST FOR QUICK REPLY

### VHF/FM TRANSISTOR TUNER TO BUILD

TOTAL COST  
**£6.19.6**

P.P. 2/6 (complete with frontplate) (Goldsprayed cabinet 20/- extra).

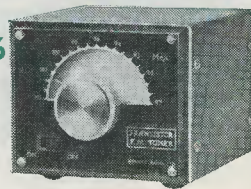

- ★ 5-Transistor 4 diodes.
- ★ Printed circuit superhet.
- ★ Geared tuning 87 to 105 Mc/s FM.
- ★ RF stage and double tuned IFT's.
- ★ Output up to 1 volt peak up to 100kΩ.
- ★ 9 volt 9mA supply.
- ★ Size in cabinet 4" x 3½" x 2¼".
- ★ All parts sold separately.

### HENRY'S RADIO LTD.

303 EDGWARE ROAD, LONDON, W2  
PADddington 1008/9

Open Mon. to Sat. 9-6. Thurs. 1 p.m.  
Open all day Saturday

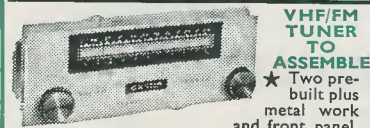

### VHF/FM TUNER TO ASSEMBLE

★ Two pre-built plus metal work and front panel.

Total Cost  
**£12.17.6**  
P.P. 2/6.

- ★ Size: 9½" x 3½" x 4".
- ★ 88 to 108 Mc/s tuning.
- ★ 100mV to 100kΩ output
- ★ 6-Transistor printed cct. superhet design.