

"YOU CAN RELY ON US"

COILS
Wearite "P" Coils.
All types in stock including AF.1, RF.1.
Price 3/-
Midget I.F. Transformers Type 800. 21/- per pair. Standard Type 500/501 (465Kc/s) 20/- per pair.

HIGH IMPEDANCE HEADPHONES
New Ex-Government
Price 12/6 per pair.

SCOTCHBOY TAPE
1200ft Reels 35/-
Spare Reels 4/3

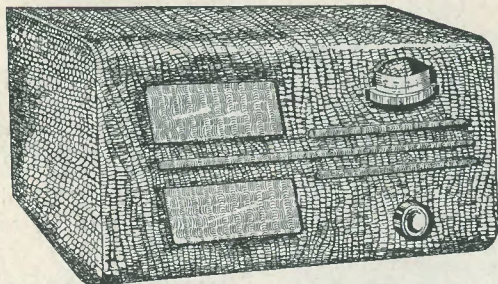

COILS
Osmor Midget iron-cored "Q" Coils 4/- each. Leaflet on request.
Coilpacks Type H.O. 52/-, LM 43/4, MTS 54/2, TRF 43/4 all including Tax.

TRIMMERS
All new Postage Stamp Ceramic. 4-70pf 8d, 40-100pf 10d, 20-150pf 1/- 100-550pf 1/3.

LINECORD
3-way 3a at 60ohms per foot 6d ft., 2a at 100-ohms per foot 8d ft.

The "MAXIMITE" AC/DC SUPERMIDGET SUPERHET — Full Plans 1/-

WAVECHANGE SWITCHES
Midget rectangular Type, 2P2W 2/6, 2P3W 2/6.
Midget Circular Type IP12W, 2P6W, 3P4W, 4P3W, each 3/6.
Standard Yaxley Type (2 Bank) 2P11W, 4P5W, 6P3W, 8P4W, 7/6 each.
All above are NEW and have 2" Spindles

METAL RECTIFIERS
RM1 5/3, RM2 6/3, RM3 7/-, RM4 21/-, K3/45 8/2, K3/50 8/8, K3/100 14/8. Westinghouse 36EHT100 29/4, 14A86 20/4, 14D36 11/-, WX6 3/9, WX6 3/9.

T.C.C. CONDENSERS
Midget Picopack, 1mfd 350v, 2mfd 150v, 10mfd 25v, 20mfd 12v, each 2/6
Visconal High Voltage, .001 6kv 6/-, .001 12kv 10/-, .001 15kv 10/-, .01 6kv 10/-, .1 7kv 20/-, Micadiscs, 500pf 1/6, Type 543, .1 500v 1/3, 750v 1/6

ENGRAVED KNOBS
1 1/2" WALNUT or IVORY... Volume, Focus, Contrast, Brilliance, Brightness, On/Off, Record/Play, Tone, Bass, Treble, Wavechange, Tuning, Radio/Gram., Brill/OnOff, S.M.L.Gram. All 1/6 each.

RADIO SERVICING COMPANY (Dept. K) 444 WANDSWORTH ROAD, LONDON SW8
MACaulay 4155

The **RADIO CONSTRUCTOR**

Vol. 6
Number 9
MAY
1953

for the Radio and Television Enthusiast

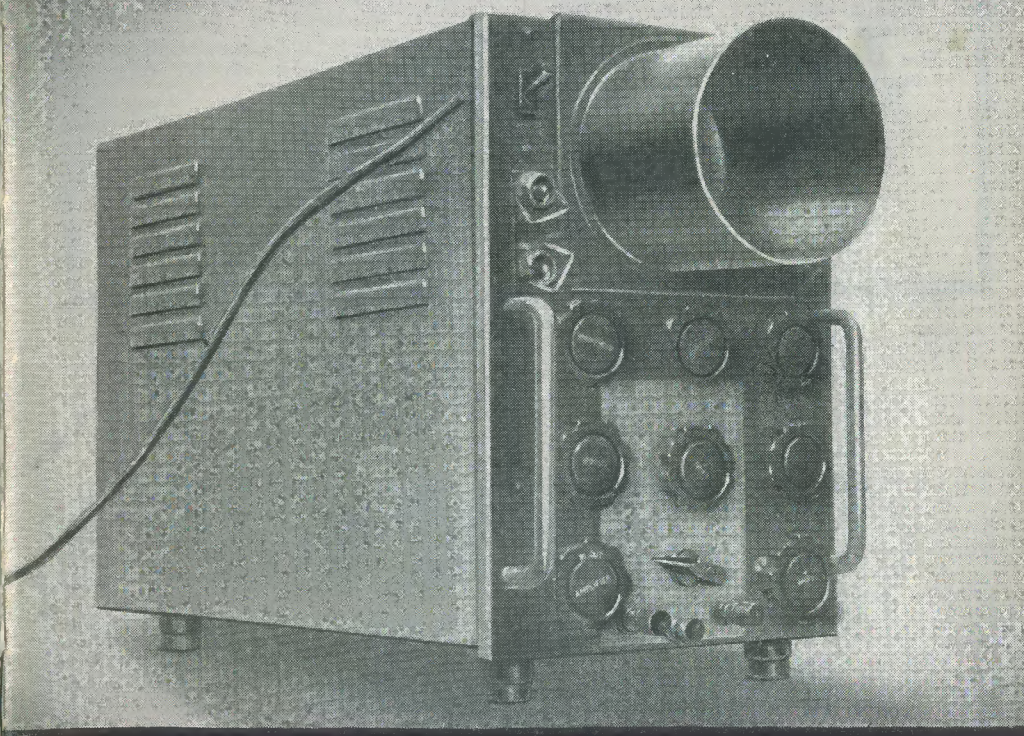

ALSO IN THIS ISSUE

VERSATILE OSCILLOSCOPE FOR THE AMATEUR'S LABORATORY

AN ECONOMICAL PORTABLE · COMPACT TV AERIALS · TV/VHF TUNED CIRCUITS READY REFERENCE · Add-On CW Filter · Let's Get Started Radio Control Equipment · Audio Pre-Amplifiers · Electrolytic Condenser Tester etc. etc.

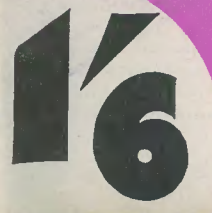

EDDYSTONE FINE COMMUNICATION RECEIVERS

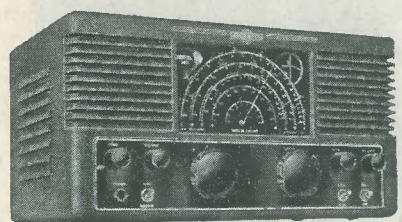

MODEL '740'

- Sound design
- Eight valves
- High performance
- Geared Drive
- Mechanical bandspread

£42 : 15 : 0 (exempt from Purchase Tax)

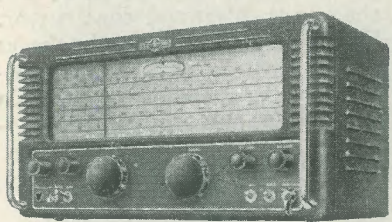

MODEL '750'

- Double superheterodyne
- Eleven valves
- Variable selectivity
- Long linear scales
- Chrome handles

£68 : 0 : 0 (exempt from Purchase Tax)

For full specifications, please apply to your local Eddystone Distributor or to:—
STRATTON & CO. LTD., EDDYSTONE WORKS, BIRMINGHAM, 31



THE MODERN BOOK CO.

Sound Reproduction by G. A. Briggs. 3rd edn. 17s 6d. Postage 6d

Amplifier Circuits by N. H. Crowhurst. 2s 6d. Postage 2d.

Radio Engineers' Servicing Manual, edited by E. Molloy. 42s 0d. Postage 1s 0d.

Personal Receivers by E. N. Bradley. 3s 6d. Postage 2d.

Radio Interference Suppression by G. L. Stephens. 10s 6d. Postage 4d.

Television Engineers' Servicing Manual edited by E. Molloy. 42s 0d. Postage 1s 0d.

The Use of a.f. Transformers by N. H. Crowhurst. 3s 6d. Postage 2d.

TV Fault Finding compiled by *The Radio Constructor*. 5s 0d. Postage 4d.

The Radio Amateur Operator's Handbook compiled by the Staff of *The Radio Amateur*. 2s 6d. Postage 2d.

Inexpensive Television for the Home Constructor. 2s 6d. Postage 2d.

Television Receiver Practice by R. Holland. 5s 0d. Postage 3d.

The Amateur's Guide to Valve Selection by Mullard. 1s 6d. Postage 2d.

Radio Valve Data compiled by *Wireless World*. 3s 6d. Postage 3d.

The Radio Amateur's Handbook by the A.R.R.L. 1953. 30s 0d. Postage 1s 0d.

We have the finest selection of British and American radio books in the Country. Complete list on application.

19-23 PRAED STREET (Dept. RC) LONDON W2
PADDington 4185

SCOTTISH INSURANCE CORPORATION LTD.



62-63 CHEAPSIDE LONDON, E.C.2.

TELEVISION SETS AND SHORT WAVE TRANSMITTERS

Television Sets and Short Wave Transmitters/Receivers are expensive to acquire and you no doubt highly prize your installation. Apart from the value of your Set, you might be held responsible should injury be caused by a fault in the Set, or injury or damage by your Aerial collapsing.

A "Scottish" special policy for Television Sets and Short Wave Transmitters/Receivers provides the following cover:—

- (a) Loss or damage to installation (including in the case of Television Sets the Cathode Ray Tube) by Fire, Explosion, Lightning, Theft or Accidental External Means at any private dwelling house.
- (b) (i) Legal Liability for bodily injury to Third Parties or damage to their property arising out of the breakage or collapse of the Aerial Fittings or Mast, or through any defect in the Set. Indemnity £10,000 any one accident.
- (ii) Damage to your property or that of your landlord arising out of the breakage or collapse of the Aerial Fittings or Mast, but not exceeding £500.

The cost of Cover (a) is 5/- a year for Sets worth £50 or less, and for Sets valued at more than £50 the cost is in proportion. Cover (b) (i) and (ii) costs only 2/6d. a year if taken with Cover (a), or 5/- if taken alone.

Why not **BE PRUDENT AND INSURE** your installation—it is well worth while **AT THE VERY LOW COST INVOLVED**. If you will complete and return this form to the Corporation's Office at the above address, a proposal will be submitted for completion.

NAME (Block Letters)

(If Lady, state Mrs. or Miss)

ADDRESS (Block Letters)

...../JB

FREE!
TO HOME CONSTRUCTORS

This fully illustrated booklet tells you how to build your own big screen Magna-View receiver with the 16-inch 'English Electric' metal C.R. tube

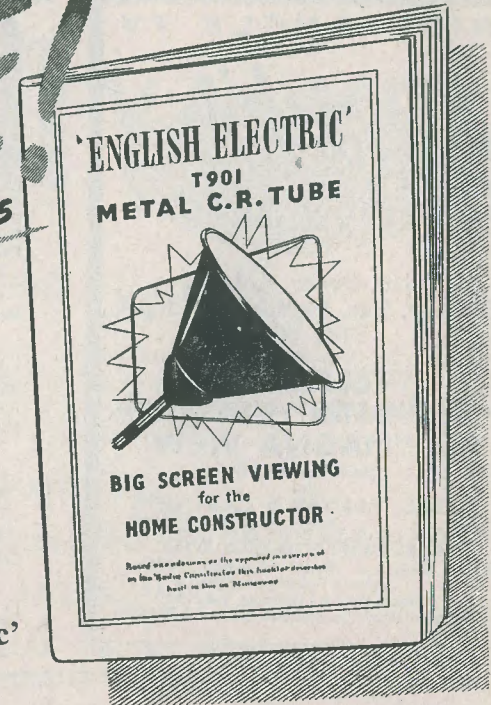

Chosen for its brilliance, resolution, long life and high safety factor, the 'ENGLISH ELECTRIC' British Made Metal C.R. Tube T901 is the one around which most home constructors' circuits—including the Magna-View—are designed. This comprehensive booklet gives you full instructions for building the famous Magna-View 16-inch receiver, together with details of the necessary components.

'ENGLISH ELECTRIC'

LONG LIFE 16-inch METAL C.R. TUBE

British Made

<p>FILL IN AND POST THIS COUPON TO THE ADDRESS BELOW WITHOUT DELAY</p>	<p>Please send me POST FREE full instructions for building the big screen Magna-View Television receiver.</p>
	<p>NAME</p>
	<p>ADDRESS</p>
	<p>.....</p>

If there is any difficulty in obtaining supplies write to
THE ENGLISH ELECTRIC COMPANY LIMITED, TELEVISION DEPT., QUEENS HOUSE, KINGSWAY, LONDON, W.C.2

WIDE ANGLE TV

Smith's
of
EDGWARE ROAD

Allen, Denco, Colvern
Dubilier, Elac, McMurdo, Morgan
STC, TCC

for the
"TELEKING"
"VIEWMASTER" CONVERSION
and **"MAGNA VIEW"**

(Radio Constructor)

also

TUBES, VALVES & CABINETS
etc. Price Lists on receipt of SAE

H. L. SMITH & CO. LTD.
287/9 Edgware Road London W2
Telephone Paddington 5891
Hours 9 till 6 (Thursday 1 o'clock)
Nr. Edgware Road Stations, Metropolitan & Bakerloo

Radiocraft Pre-Selectors

There is no reason why you should be missing that elusive DX—it is there and can be made quite readable. Why not invest in a two stage preselector giving a gain of 19-20dB and stop being out in the cold when DX is about. Radiocraft preselectors make those S3 signals into S9 locals and at the same time give a vastly improved signal to noise ratio with your receiver. If you are troubled with second channel or image interference a preselector makes an effective cure once and for all. These units will revolutionise your listening and you will wonder how you managed without one before! PS7 Unit—2 tuned RF stages with built in power pack, housed in attractive Imhof cabinet, calibrated dial, RF Gain, aerial trimmer, 1.5-30 mcs in 3 bands with fourth position of the switch to cut off the HT and connect the aerial straight through to the receiver. Valves used are 6AM6 (EP91, Z77) type. The price of the PS7 is £9.12.6 carriage paid. Other models also available and details are given in List TR7. Special offer of DET18's (35T) used but guaranteed OK at 19/- each. Single screened wire at 3/- per dozen yards, or 3d. per yard. R1155 owners please note that we can alter your receiver so that it covers the 160m band, dial recalibrated, including return carriage at a cost of £2. Quotations supplied for special gear.

RADIOCRAFT Ltd. 25 Beardell St. Upper
Norwood, London, SE19. Telephone GIPsy
Hill 5585

ARTHURS HAVE IT!

LONDON'S OLDEST RADIO DEALERS

LARGE VALVE STOCKS

AVOMETERS IN STOCK

Avo Test Meters and Signal Generators
and Taylor Meters.

Leak Point One Amplifiers and Tuning
Units.

Chapman Tuning Units.

Crystal and Moving Coil Mics.

Decca Replacement Heads and Pickups,
Goodman's Axiom 150 Speakers.

Partridge Output Transformers for William-
son Amplifier.

All Components for the Radio Constructor's
16" Televisor.

Weare & Wright Tape Deck £35.

LATEST VALVE MANUALS

Mullard, Osram & Brimar No. 4 5/- each
Mazda 2/- each Postage 6d. extra

TELEVISION SETS, WIRE AND TAPE
RECORDERS ALWAYS IN STOCK

Goods offered subject to price alterations
and being unsold.

Arthurs Est.
1919
first

PROP: ARTHUR GRAY LTD.
OUR ONLY ADDRESS: Gray House
150-152 Charing Cross Road
London, W.C.2

TEMPle Bar 583314 and 4765 WRITE FOR LISTS

TELEVISION
CABINETS

All Sizes up to 16" Tube

Specially Designed for 'Radio Con-
structor' Set, and illustrated on the
September Front Cover

Price **£18 : 10** Carriage £1

SEND FOR ILLUSTRATED LEAFLET

H. ASHDOWN

98 HERTFORD ROAD

TOT 2621 EDMONTON N9

BRIMAR VALVES

BRITISH MADE

*The Choice of the *Expert!*

The discerning Home Constructor will build a High Quality
RADIO TUNER UNIT for his MAGNA-VIEW receiver and will
use the BRIMAR Miniatures specified on page 368 because BRIMAR
reception tested valves combine:—

- HIGH QUALITY
- OUTSTANDING PERFORMANCE
- GREAT RELIABILITY

* The Designer appreciated this fact when he chose the
following BRIMAR types:—

12AH8	Miniature Triode Heptode.
6BA6	" Vari-Mu R.F. Pentode.
6AT6	" Double Diode Triode.
12AX7	" High-Mu Double Triode.
6AQ5	" Output Beam Tetrode.

The natural choice for the power supply was the BRIMAR DRM2B Metal Recti-
fier, rated at 250 volt RMS maximum input, 100 mA DC maximum output.

BRIMAR Miniatures
6BA6 and 12AH8

are also recommended for the
CORONET S.W. CONVERTER

Brimar Miniatures—"The little things that count"

Further data on the
above may be obtained
from the Brimar
Publicity Department
at the address below.

Standard Telephones and Cables Limited

Brimar Valve Works, Footscray, Sidcup, Kent. FOOTscray 3333

**ALL-ROUND
DEPENDABILITY**

UNIVERSAL BRIDGE
HEAVY DUTY METER
UNIVERSAL METER
THE D.C. MINOR
VALVE CHARACTERISTIC METER
ELECTRONIC TEST METER
ELECTRONIC TEST UNIT
WIDE RANGE SIGNAL GENERATOR

AVO
*Precision ELECTRICAL
MEASURING INSTRUMENTS*

See the complete range of
"AVO" Instruments at the
PHYSICAL SOCIETY EXHIBITION
Imperial College of Science
Stand No. 79
London
April 13th-17th

You can depend on "Avo". When choosing
instruments, consult our complete cata-
logue, a copy of which may be had free on
application.

THE AUTOMATIC COIL WINDER & ELECTRICAL EQUIPMENT CO. LTD.
WINDER HOUSE • DOUGLAS STREET • LONDON S.W.1. Telephone: V1 C 2404-2



The Radio Constructor

Vol. 6. No. 9.

Annual Subscription 18/-

May 1953

Editorial and Advertising Offices—57 Maida Vale Paddington
Telephone CUNingham 6518 London W9

Edited by C. W. C. OVERLAND, G2ATV

CONTENTS

SUGGESTED CIRCUITS: AN ADD-ON FILTER FOR CW RECEPTION, by G. A. French	446
TRADE NOTES	447
RADIO CONTROL EQUIPMENT, PART 3, by Raymond F. Stock	448
COMPACT TV AERIALS, by F. C. Judd, G2BCX	453
BOOK REVIEWS	459
IN YOUR WORKSHOP, by J. R. D.	460
VALVES AND THEIR POWER SUPPLIES, PART 6, by F. L. Bayliss, A.M.I.E.T.	463
VERSATILE OSCILLOSCOPE FOR THE AMATEUR'S LABORATORY, by R. A. H. Seal, A.Inst.Ex.E.	466
RADIO MISCELLANY, by Centre Tap	474
LET'S GET STARTED ON THE FIRST PRINCIPLES OF RADIO, by A. Blackburn	475
AUDIO PRE-AMPLIFIERS, PART 2, by D. Nappin	480
AN ECONOMICAL PORTABLE, by J. Saunders	483
A READY REFERENCE TO THE CONSTRUCTION OF TV AND VHF TUNED CIRCUITS, by H. E. Smith, G6UH	487
FROM OUR MAILBAG	489

NOTICES

THE CONTENTS of this magazine are strictly copyright and may not be reproduced without obtaining prior permission from the Editor. Opinions expressed by contributors are not necessarily those of the Editor or proprietors.

THE EDITOR invites original contributions on construction of radio subjects. All material used will be paid for. Articles should be typewritten, and photographs should be clear and sharp. Diagrams need not be large or perfectly drawn, as our draughtsmen will redraw in most cases, but relevant information should be included. All Mss must be accompanied by a

stamped addressed envelope for reply or return. Each item must bear the sender's name and address.

TRADE NEWS. Manufacturers, publishers, etc., are invited to submit samples or information of new products for review in this section.

ALL CORRESPONDENCE should be addressed to *Radio Constructor*, 57 Maida Vale, Paddington, London, W.9. Telephone CUN. 6518.

A Companion Journal to THE RADIO AMATEUR

Suggested Circuits for the Experimenter

The circuits presented in this series have been designed by G. A. FRENCH specially for the enthusiast who needs only a circuit and the essential relevant data

No. 29 An Add-On AF Filter for CW Reception

Fitting a parallel-tuned circuit resonating at AF to a receiver in order to obtain increased selectivity for CW reception is by no means a new idea; such a scheme has been, and still is, employed quite often in commercial communication receivers. This month, we describe a circuit illustrating an add-on unit which incorporates an AF tuned circuit, and which may be connected to almost any short-wave receiver not already so fitted.

detection equal to that of the AF tuned circuit, interfering signals are greatly reduced in strength.

In the circuit shown here, the AF tuned circuit is connected to the receiver at any suitable high impedance AF point by means of a short length of screened cable. In most cases, the receiver circuits should not need to be altered.

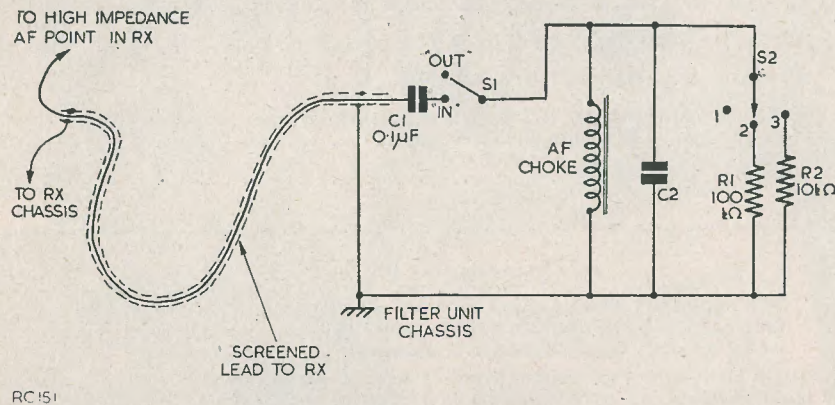

RC 151

In conventional applications it is usual to insert the AF tuned circuit in the anode circuit of the amplifier valve immediately following the second detector. When switched in, the tuned circuit then attenuates considerably all notes save that to which it is tuned. The result is that, by setting the receiver BFO (or receiver tuning with a straight set) such that a required signal has an audio frequency after

Components

As may be seen from the circuit, the filter unit is very simple in design. The tuned circuit is supplied by the AF choke and C2, the capacitance of the latter being such that the circuit resonates at a comfortable operating frequency. It is common practice to have this frequency at or about 1 kc/s. The best value for C2 will need to be determined experimentally.

The AF choke should be a component which has a relatively large inductance. It will in most instances be found that the larger the value of the choke the better will be the results obtained.

Three degrees of selectivity are offered; these being selected by switch S2. In positions 3 and 2 this switch connects parallel damping resistors across the tuned circuit; whilst in position 1 (which gives sharpest selectivity), no damping is applied at all. S1 is used to switch the filter unit in and out.

The connection to the receiver is made via C1, this capacitor being inserted to prevent the filter unit from upsetting any DC voltages in the circuit to which it is connected. The screened connecting lead between the filter unit and the receiver should not be longer than four feet or so, and should have a fairly low internal capacitance.

Receiver Connections

The filter unit may be connected into the receiver at any AF point which has a sufficiently high impedance to earth. If two AF stages are used after the detector, the filter unit can be connected to the output grid, assuming that the previous anode load is at least 100 kΩ. (The same applies to straight receivers, in which a leaky-grid detector may be considered as an AF amplifier.) Another useful point is to the "live" end of the AF volume control track immediately after the second detector. In some cases, however, hum may be induced if the filter unit is connected to too early a stage of the AF amplifying chain.

It must be remembered that headphones should not be connected across the same part of the receiver AF stages as is used by the filter unit, since the relatively low impedance of the headphones would prevent the latter from functioning correctly.

Trade Notes

The English Electric Co. Ltd., announce, in connection with the "Magna-View" 16" large screen television, that they have produced a high grade rubber mask with tinted perspex filter front, and also a polythene envelope which covers the metal cone of the T.901. These components are of great value when mounting this tube.

The prices are as follows:—

Mask	£2 2 0
Filter	19 6
Polythene envelope	6 2
Insulating ring	10 10

In case of difficulty, write directly to the English Electric Co. Ltd., Television Dept., Queens House, Kingsway, London, W.C.2.

The McMurdo Instrument Co. Ltd., inform us that they have a complete range of valveholders suitable for home constructors designs. Sub-miniature, B7G, B8A, Noval, Loctal, Octal, British and UX bases are available in bakelite and low loss nylon loaded bakelite, the latter types being eminently suitable for designs embodying TV and VHF techniques.

Wholesale and retail enquiries should be made to Cyril French Ltd., High Street, Hampton Wick, Middlesex. Telephone Kingston 2240.

G.P.O. Radio and Models Exhibition

The Radio Group of The Institution of Post Office Electrical Engineers is holding its Second Radio and Models Exhibition at Metropole Hall, Northumberland Avenue, S.W.1, on May 7th, 8th and 9th, 1953 (11.0 a.m.—8.0 p.m.).

The emphasis will be on "Home Construction," and the Exhibition will include additional exhibits of interest to the Radio and Model Enthusiast.

Admission is by programme, which is also obtainable at the door.

Secretaries of Radio Clubs or Societies are invited to write for further information to:—

Hon. Group Secretary,
23 Surrey Lane,
Battersea S.W.11.

Lasky's Radio have informed us of a number of interesting items which they are offering. Amongst these is a Vidor mains power unit, size 5" x 2 1/2" x 7 1/2", and for 200-250V AC input. The output is 90V HT and 1.4V DC. It is thus an ideal unit for converting all-dry receivers for AC mains working, simply by plugging in.

Another useful piece of equipment from the same supplier is a two-way sound powered intercom unit. This has an effective range up to 500 feet. Each unit runs off a couple of self-contained U2 batteries. Two-way communication is achieved by the use of two "Sub-station" units, priced at 27s 6d each. A "Master-unit" with station selector switch is also available, priced at 37s 6d, with which up to four sub-stations may be employed. 5" PM loudspeakers are used.

Radio Control Equipment

PART 3

By RAYMOND F. STOCK

All types of escapement are easy to make, but a few important points should be observed when laying out the geometry of the claw and wheel.

Fig. 10 is a diagram of a four-tooth wheel and claw. Tangents from the pitch circle have been drawn passing through the two tooth positions at which the claw operates. Where these tangents cross is the centre for the claw pivot. By observing this simple rule, it will be seen that the only loading on the claw teeth is in a radial direction and therefore purely frictional; this ensures that the power required to shift the claw is a minimum and thus conserves battery power for the electromagnet.

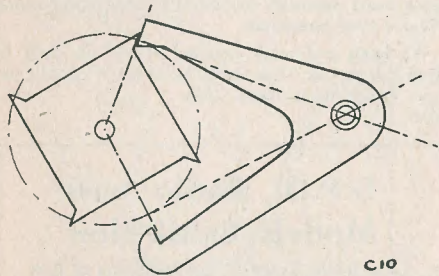

Fig. 10. The second tooth on the claw must engage just as the first one releases.

The design of the latter rather depends on the power of the clockwork motor, but a reasonable design for the average case is shown in Fig. 11. This drawing is to scale, and the bobbin is wound full with 30 swg enamelled wire (about 750 turns). Varying the voltage applied between 2 and 12 volts should give sufficient flexibility to cover most requirements.

The power needed is from 0.25A to 1.5A at these voltages, and since the current is required only in short pulses even the larger value can be supplied by cells of the size used in grid bias batteries.

When an escapement is made, the movement of the claw should be reduced to the absolute minimum necessary to ensure positive action with no slipping. This permits the air-gap in the magnetic circuit to be as small as possible, and helps keep down battery weight.

The chief disadvantage of escapements is the crude steps in which they operate. This makes them unsuitable for accurate manoeuvring, or for fast models, or, of course, for land vehicles. Increasing the number of teeth in the wheel permits finer control, but this expedient increases the length of sequence and thus suffers by prolonging the time delay before a required position is achieved.

One possible compromise is to use the 'half' positions when the claw is attracted to the electromagnet and the wheel has rotated through 45°. This gives eight positions on a four-tooth wheel, and means that a control change is produced at both beginning and end of a signalled pulse.

The disadvantage is that both transmitter and local control power (in the model) are being used whenever the half position is being held. Fig. 12, however, shows an attachment which can be used to cut the current drain in the operating gear.

Mounted on the motor frame are a pair of contacts, which are opened by one of the wheel ratchet teeth whenever the half position is obtained; the electromagnet winding is in two parts, one a normal low resistance one of perhaps 6 or 7 Ω, the other several times as high. Normally the high resistance winding is short-circuited by the contacts, but when the armature is fully attracted, and the wheel has advanced through 45°, the contacts open and reduce the current through the electromagnet considerably. Naturally the flux through the core falls, but is sufficient to

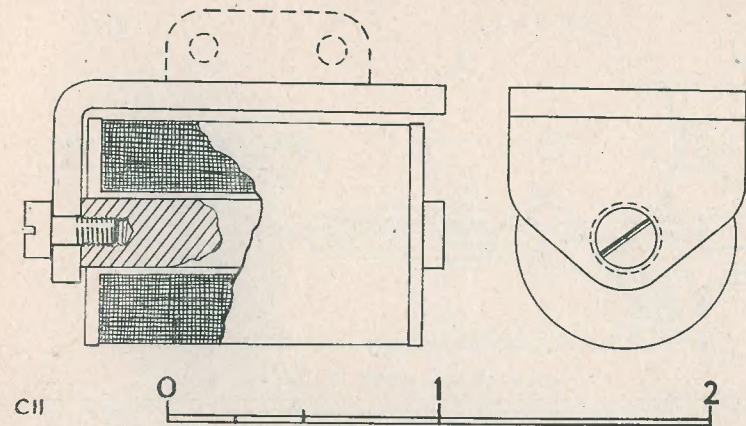

Fig. 11. Electromagnet; scale in inches. A tab may be bent up (as shown in pecked lines) for mounting purposes.

retain the armature in position though it would be too small to attract it across an air-gap.

The value of the high resistance winding must be found by experiment, since it will vary widely from one installation to another; in this case it may assist to remove the rivet from the armature and permit it to touch the core when fully home.

It is not necessary to take off power from the actual ratchet wheel or its shaft. When the spring motor is fairly powerful the loading may be rather high on the claw, and this entails a considerable magnetic pull. The pull required, and therefore the watts consumed, may be reduced by placing the ratchet wheel on a shaft in the gear train which is geared up from the output shaft. Thus, Fig. 13 illustrates a ratchet wheel geared up 4 : 1 from the power take-off shaft, and since the latter is intended to have four positions the ratchet 'wheel' needs only one tooth; it makes one complete revolution for each step of the power shaft.

Engine Driven Escapement

Though perhaps not quite as efficient as the escapements described, Fig. 14 shows a unit which represents the ultimate in simplicity since it needs no driving motor. The principle is exactly as described for spring-driven units, but the tendency for the ratchet wheel to rotate is provided by a spring-loaded clutch from an engine-driven shaft. This can be

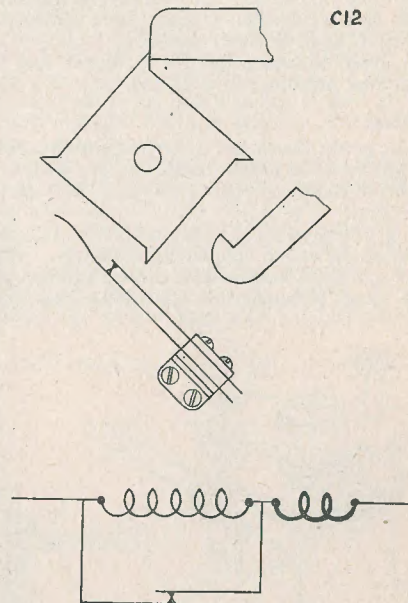

Fig. 12. Current saving device for the 'half' positions

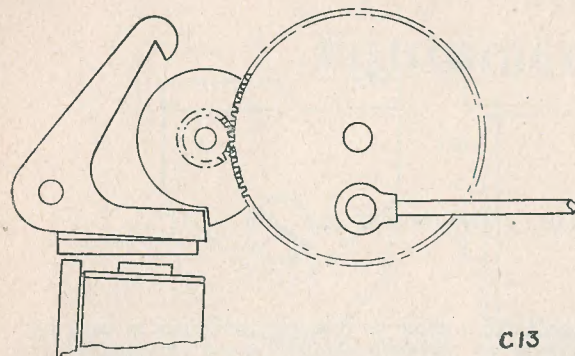

Fig. 13. Reducing the load on the claw

applied to a very small 'diesel' powered boat or ship model. A worm is provided on the propeller shaft and is thus constantly rotated; meshing with it is a worm wheel spring-loaded against the ratchet wheel. The latter thus tends constantly to rotate. A drag is imposed on the worm wheel (which should rotate at about 300 r.p.m.) but this is relatively insignificant, and most small engines have plenty of power in hand to cover this loss.

A great advantage of this system is that it eliminates winding up a spring.

General

The power developed by any escapement can be applied by a simple crank, as described, or, if non-linear movement is required, by means of a cam.

Fig. 15 shows a cam mounted on the escapement shaft, and a simple cam follower. The cam, cut from brass sheet, can be profiled to suit most contingencies, providing that the

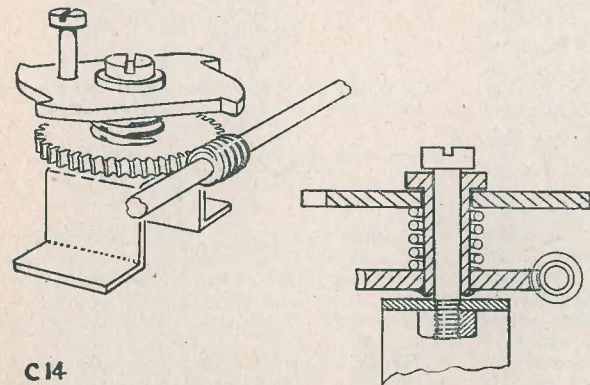

Fig. 14. Engine-driven escapement

angle of the edge is kept within about 30° to the base circle when designing the curves.

More than one cam can be mounted on the shaft, so that two functions can be controlled in a pre-set combination sequence. One small clockwork actuator was marketed some years ago, provided with an 8-step sequence and two cams cut to give a combination of positions intended for controlling both elevators and rudder of a model aircraft.

Experience generally proves that model aircraft are best controlled by rudder alone, or with the simple addition of a two-speed engine control. In model boats, however, the second cam could be designed to operate a pair or pairs of contacts included in the propulsion motor circuit, if electrically driven, and thus to obtain 'Stop', 'Ahead' and 'Astern' positions.

Control Box for Escapement Systems

The control box is required in this case to generate simple pulses only, whose length is

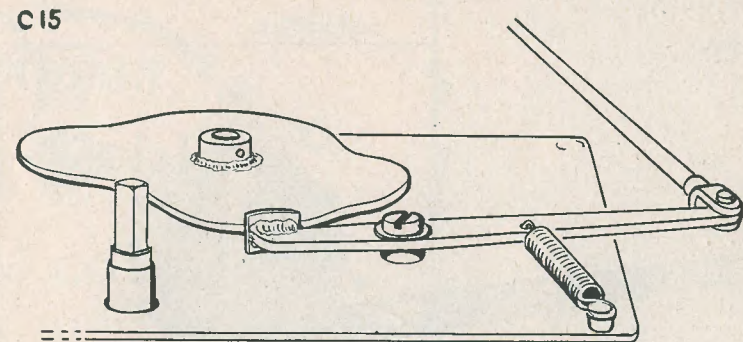

Fig. 15. Power take-off from a cam

unimportant. Obviously, the simplest gear is a micro-switch or press button, but this places the onus of remembering the sequence upon the operator. This is reasonable when no more than four steps are included in a sequence, but more than this requires a mechanical aid.

The easiest solution is to make up a control box on the end of a few yards of twin conductor, and to fit in it a simple contactor device such as is shown in Fig. 16.

The star wheel simply trips the contacts whenever it is rotated through 90°, and it should have a click mechanism fitted to it (perhaps converted from an old Yaxley switch) to locate it positively at the end of each step.

The control knob on the outside of the box may be marked with the relevant positions and a pointer marked out on the panel adjacent.

The operator must remember only to turn the knob in the correct direction, but as it is easy to forget in the (often exciting) business of controlling a model, a non-return ratchet and pawl salvaged from an old clock can be added. Any number of positions can be controlled by this device, the number of points on the star wheel being cut to suit the sequence.

Another popular component is a surplus P.O. telephone dial mechanism, which can be used to key the transmitter as the dial returns from a set position.

Both these methods suffer from a lack of realism in their use, in that the way in which the control is used is unnatural. A steering wheel with its instinctive sense of 'left' and 'right' is most desirable, and it does not involve taking one's eyes off the model to see the dial. Full proportional control of a rudder is not, in any case, obtainable with such simple gear, but there are two devices

which can, at least, afford a compromise. One of these is pictured in Fig. 17. It consists again of an old clock mechanism wound up through the front of the control box. Mounted on one of the shafts (the escapement is, of course, removed) is a small disc about 1 inch diameter. This can be of thin brass sheet soldered on to the steel spindle, either between or outside the motion plates. Soldered into the disc are three small pins of brass or steel, $\frac{1}{16}$ -inch diameter, and these are placed at 120° apart and also on three different pitch circles, each $\frac{1}{8}$ -inch apart.

Overhanging the disc is the end of a control lever which carries a small peg riveted or soldered on; the peg is arranged so that its tip just clears the disc but interferes with the pins. It thus prevents the disc from rotating and holds it in one of three positions. As it is moved, however, the disc rotates through either 120° or 240° according to which position

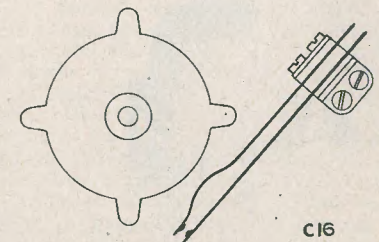

Fig. 16. Four-step sequence controller

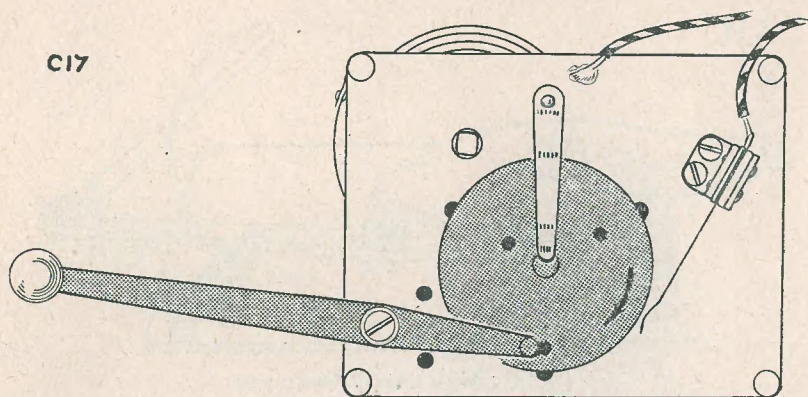

Fig. 17. Clockwork pulsing unit.

the control lever is moved to. Naturally the lever is constrained in its movement so that at its extreme positions the peg lies opposite the inner and outer pins.

Around the periphery of the disc are soldered three silver contacts taken from an old relay (or the disc itself may have three small projections on its edge). As these rotate, they

pass under a static contact strip — silver tipped if possible — and thus key the transmitter. The keying leads are connected one to the static contact strip and one to the clockwork frame; to ensure good electrical continuity a light brass or copper foil brush can be soldered to the frame so that it bears on the centre part of the disc.

The control lever is thus capable of three movements, to port, to amidships and to starboard; each time it is moved, the disc rotates the right amount to send the correct signal, either one or two pulses, and its movement is in a logical and natural sense. The pivot of the lever should not be sloppy, for obvious reasons, and the feel of the unit is improved if a click mechanism is fitted to provide three definite positions.

This type of pulsing unit can be adapted to work with more steps in the sequence; but with this type of control 3 steps is usually sufficient.

It may be appreciated that this device forms an exact counterpart of the clockwork escapement in the model, and demonstrates how the first unit "codes" a signal while the second "decodes" it. Though the analogy is often less obvious, the Control Box and the Operating Gear must always work in this reciprocal fashion.

(To be continued)

Compact TV Aerials

By F. C. Judd, G2BCX

Sometime ago the writer was called upon to devise some form of 'compact' and portable television aerial that could be used in emergency installations, such as the last minute sale of a receiver, the installation being completed later. In a great many instances these portable aerials proved reasonably efficient and were capable of good results at distances up to 20 miles from Alexandra Palace (London area TV). This led to the development of aerials specially designed for compactness and portability, and investigation into the possibilities of folded aerials of higher efficiency than was hitherto available. There was at the time an increasing demand for compact aerials, especially by flat dwellers, TV owners residing in certain types of council houses, and others unable to instal a TV aerial anywhere outside the house.

It must, however, be emphasised that an aerial reduced in size, or folded in some way, can never be equal in efficiency to an original of theoretically perfect shape. For example, a dipole may be folded or bent to fit into a small space, or made with short elements, but some efficiency will be lost and the field pattern distorted to some extent, particularly in the case of folded aerials. By careful design, however, this loss in efficiency may be kept to a minimum, and where the field strength of the transmitting station is relatively high may be ignored. With normal aerials, an attenuator often has to be fitted in order to reduce the strength of signal to the receiver. In such cases a smaller or less efficient aerial could well be used, and the writer has noted instances where even an indoor aerial (in the loft) has required an attenuator because of high field strength.

The installation of a compact or folded aerial should be very carefully considered, particularly where the aerial is to be fitted into a loft or in the same room as the TV

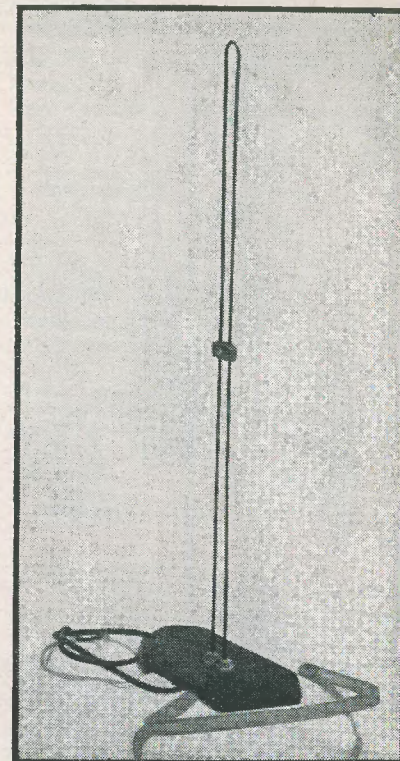

For details see Fig. 3

receiver. The structure of the building should also be taken into account, especially if it contains much steel work. Reflection, ghost images, and loss of signal might result from a badly placed aerial.

Dipoles

The familiar dipole may be altered to fit into a small space such as a loft, and may be constructed with smaller elements. It should be borne in mind, however, that efficiency is reduced as the elements become smaller. To compensate for the shortening of the elements, the aerial is loaded at the centre with an inductance into which is taken the feeder line from the receiver. A typical example is a dipole with elements of half normal length, and a diagram with dimensions is given in Fig. 1. Such an aerial is simple to construct, and in many cases may be small enough to erect vertically in a loft. The writer constructed a similar aerial which was

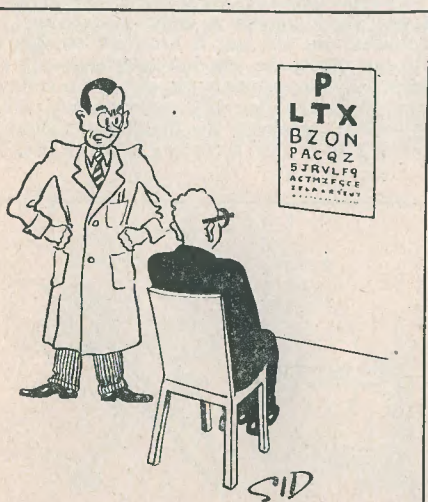

"Waddy mean, my test card needs a frame linearity control!"

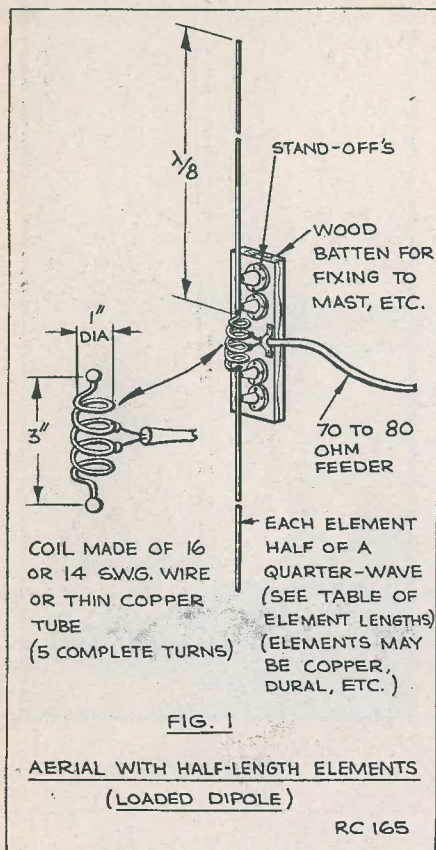

used some 7 miles from A.P., and set on a pole 15 feet high. Good results were obtained, more than enough signal being provided.

A dipole may be bent in various ways but the bulk of the aerial must be vertical, and where possible, contain the feed point (Max. current and centre of aerial). A full dipole may be bent at the centres of each element as shown in Fig. 2A, and fitted so that the now horizontal portions of the elements point toward the TV station. A dipole may also be bent as shown in Fig. 2B with the horizontal portion pointing toward the TV transmitter. If such arrangements are installed in lofts, care must be taken to keep them as far away as possible from water tanks and pipes, etc. It may be necessary to experiment in order to find the best position for maximum signal

and least reflection. In the case of Fig. 2B, turning the horizontal element slightly away from the TV station may help to improve reception and reduce reflection.

Other methods of folding are shown in Figs. 2C and D, where the aerial elements are bent to fit the shape of the loft or some other part of the house. Care should be taken not to have too much of the elements horizontal, as poor reception will result. All TV transmissions are vertically polarized. Again, aerials folded in this manner and installed inside a house are a compromise and should be adjusted accordingly. Better a compromise than no aerial at all, or at least a very inefficient one. Folded aerials, properly installed, will give good results up to 20 miles from a TV transmitter, but for shorter distances (up to approx. 10 miles) even smaller aerials may be used.

The diagram of Fig. 3, shows a design for a portable aerial which is particularly useful for flat dwellers where no other kind of aerial may be installed. It also has the advantage that it may be taken into another room along with the receiver. Basically it is a two element folded dipole, a type of aerial very popular with Amateur Transmitters. It does, however, have a centre or feed impedance of approximately 300 ohms, so it is necessary to effect an impedance change in order to match the aerial to the receiver; most sets have a 70 to 80 ohms input to the aerial socket. To match the folded dipole with a 70 to 80 ohm feeder line, and therefore the receiver, a matching transformer of the 'Q' type must be used. This may be made from a length of 150 ohm twin transmission line which is inserted between the aerial and a normal 70 to 80 ohm twin or co-axial feeder line. Alternatively, the matching transformer may be used at the end of the feeder line nearest the receiver, but in this case the feeder itself must have an impedance of 300 ohms in order to match directly into the aerial.

Details for another version of this type of aerial are given in Fig. 4. Here the elements are made from 300 ohm flat twin transmission line, this forming a normal 2-element folded dipole. The matching transformer is taken from the centre and coupled to a 70 to 80 ohm feeder line as above. Such an aerial, properly installed, has a slight gain over a dipole and may, of course, be used with both elements fully vertical, in which case maximum efficiency is obtained (Gain over a dipole approx. 0.8 db.). A folded dipole of this nature will respond to a slightly wider band of frequencies than will a dipole, and has a field pattern similar to the one shown in Fig. 8.

Vertical Quarter-Wave Aerials with Ground-Planes

A single vertical quarter-wave aerial may be used with good effect, and providing a ground-plane is used may be connected straight into a 70 ohm co-axial or twin line. Such an aerial is illustrated in Fig. 5, which shows how a half-wave ground-plane element is used. These aerials are useful for installation in lofts, but care should be taken to avoid reflections, etc. More than two ground-plane elements may be used, and four or five are not uncommon in a full ground-plane aerial. As an alternative to the ground-plane elements of metal rod, meshed wire may be used, and this should extend for at least a quarter of a wavelength around the aerial. The vertical aerial rod may be mounted on a stand-off insulator, as shown in Fig. 6.

Aerials for Picture Rail and Wall or Door Fitting

Very compact but less efficient aerials may be constructed and installed as shown in Figs. 7A and B. They should be used only in areas where the field strength is high; up to 5 or 6 miles from the transmitter. They must be carefully situated so as to effect maximum pick-up; because of this it is well worth the trouble of trying other positions, noting at the same time the level at which contrast and sensitivity controls have to be set. The object is to obtain maximum signal with least noise, and have reasonable control over contrast. These aerials may be constructed from flexible insulated wire (both elements) or with one element of copper or dural rod and the other of wire. They may also be made as 'folded dipoles,' as shown in Fig. 4.

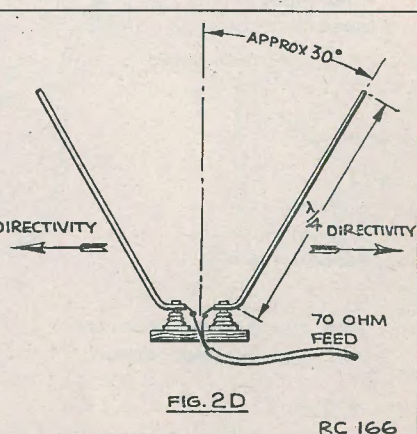
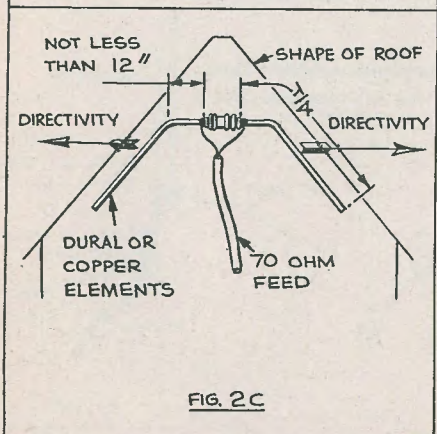
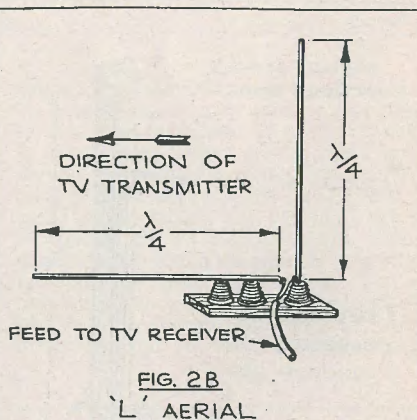
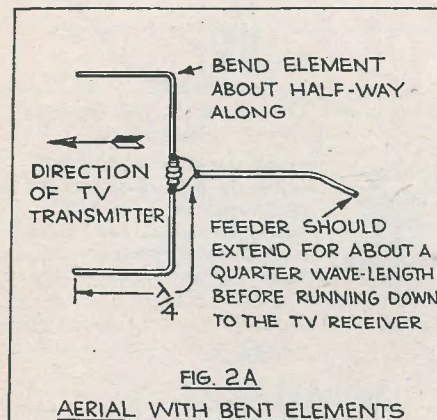

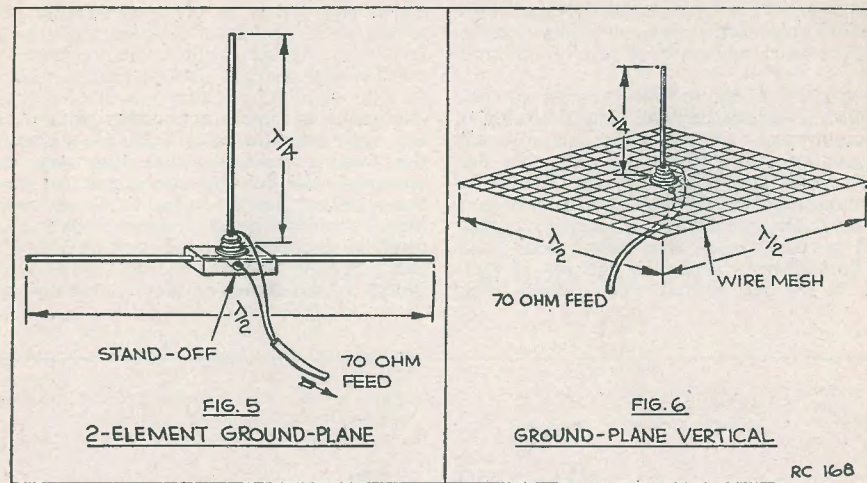
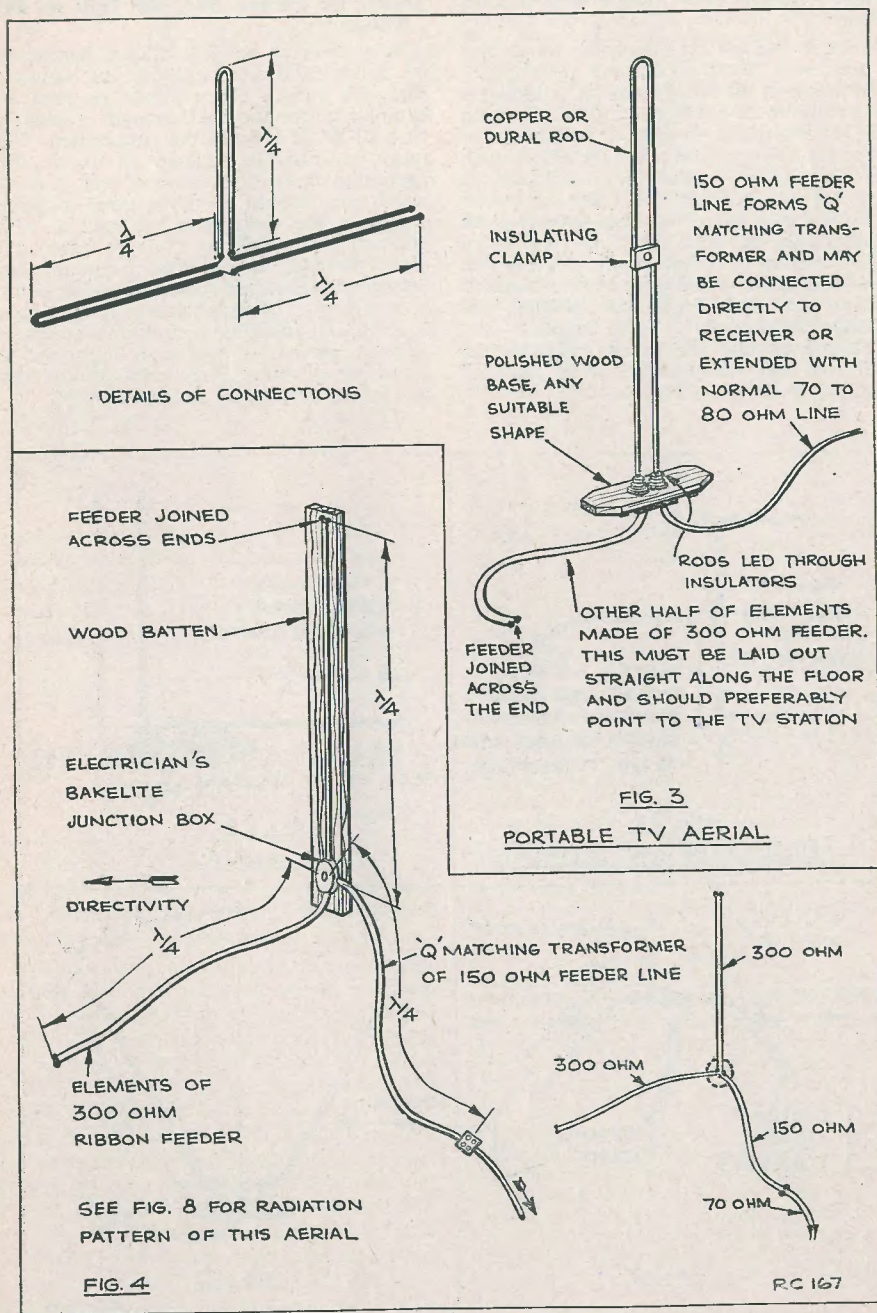

Some Notes on Installation

Whatever type of aerial is used, it should always be installed as far as possible from metallic objects likely to cause reflection or screen the aerial in any way. In lofts, the water tanks, pipes, electric light conduits and wiring, etc., are likely to cause trouble. Aerials installed in the same room as the TV receiver may be affected by electric wiring, and even gutter spouts outside. Beware installations in metal prefabs, which form almost perfect screening boxes. Care must be taken also with sets having *live* chassis, and in such

cases the aerial should be constructed from well insulated wire or rod or else installed in a loft out of reach. It may be noted that in many cases indoor aerials often give less trouble with regard to car ignition interference, particularly aerials situated on a ground floor; and for this reason, and providing the signal strength of the TV station is great enough, it may be worth trying the effect of re-positioning the aerial to reduce interference. The writer has known cases where an indoor aerial moved into another room has resulted in great reduction, and in some instances complete

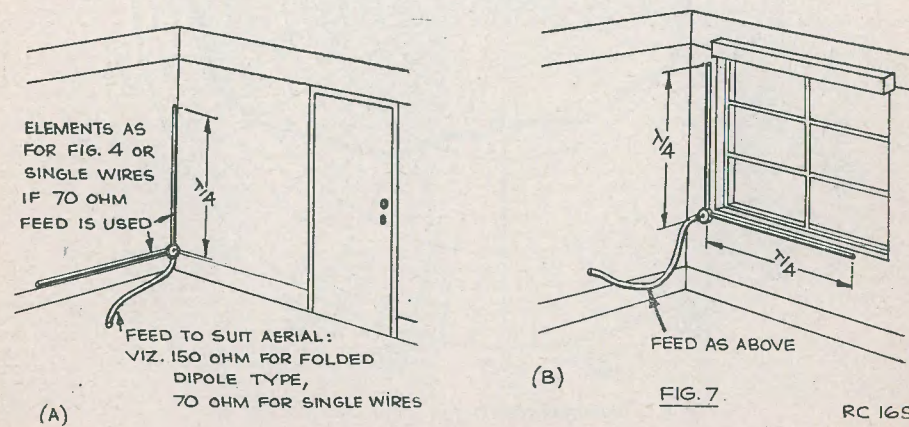

elimination, of car ignition interference. This applies to other forms of electrical interference, but must nearly always be a case of trial and error.

Beware of badly installed aerials by unqualified or careless people. The following is an actual case:— A very cheap aerial which consisted of two elements of 300 ohm flat ribbon feeder line joined in a small insulating and connecting block to about 3 yards of 70 ohm co-axial cable, was installed (?) *inside* a partly-metal prefab house. The aerial was fitted with *both elements horizontal* and was, in fact, fixed to the picture rail with *drawing pins*.

The writer makes no comment on the price of the aerial or its construction since it was later used with good effect, but the owner of the TV was charged no less than £3 10s 0d for the so-called installation. It was found impossible to obtain a viewable picture, and the only resemblance of any picture at all was from a signal so weak that even with sensitivity and contrast controls set at maximum neither line or frame timebases would lock. With the aerial properly installed and fitted in another position to avoid reflection and screening due to the metal walls of the prefab, a perfectly good picture was obtained

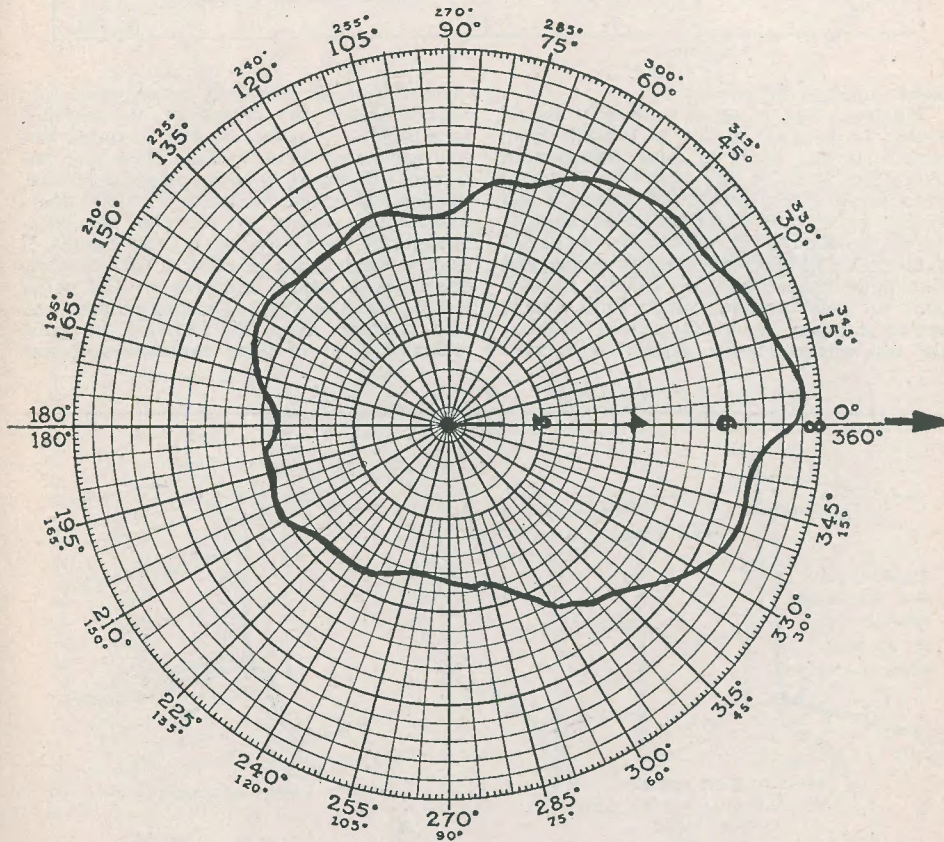

Fig. 8. Radiation pattern for aerial shown in Fig. 4.

with sensitivity and contrast controls at reasonable levels. The only fault was slight ignition interference from cars on a main road only 50yds away. The whole job took only half an hour!

This is an extreme case, and in fairness to everyone it should be mentioned that there are instances where it is impossible to obtain good results from indoor aerials. In such cases an outside aerial is the only answer. Selection and installation of these is not within the scope of this article, but the reference quoted below is recommended and contains much useful information on normal dipoles and beam aerials suitable for television reception. Ref. (1). The following table may be of use in deciding the element lengths of aerials described in this article. Quarter and half-wavelengths are quoted for the various channels now in use. As a matter of interest, a polar diagram of the 'L' shaped aerial of

Fig. 2B is shown in Fig. 8. This was taken from a model of the aerial operated at a frequency of 3000 Mc/s. (10 centimetres). However, it should be noted that the field strength patterns of *any* aerial may be distorted by the presence of other conductors. (Ref. 2).

Quarter and Half-wavelengths for TV aerials

	Quarter-wave	Half-wave	
Channel 1 (45 Mc/s)	5' 2"	10' 4"	} × 2 for λ
Channel 2 (51.75 Mc/s)	4' 6"	9' 0"	
Channel 3 (56.75 Mc/s)	4' 3"	8' 6"	
Channel 4 (61.75 Mc/s)	3' 9½"	7' 7"	
Channel 5 (66.75 Mc/s)	3' 6½"	7' 1"	

Ref 1. *TV Fault Finding*. (Data Book No. 5). Amalgamated Short-Wave Press Ltd.

Ref. 2. Series of articles

Radiation Patterns and other Measurements with High Frequency Models of Aerials. Nov., Dec. and Jan. (53) *The Radio Amateur*, by F. C. Judd, G2BCX.

Book Reviews

TELEVISION PICTURE FAULTS. By John Cura and Leonard Stanley. 68 pages, 150 actual screen photographs, over 16,000 words. Price 3s 6d. Published by *Television Times Ltd.*

Messrs. Data Publications (Amalgamated Short Wave Press, Ltd.), 57 Maida Vale, Paddington, London, W.9. are the sole radio trade distributors of the book.

This excellent collection of John Cura's "Tele-Snaps" is designed to appeal to the non-technical home viewer and the technician alike; its two-fold objective is undoubtedly achieved. It is excellently produced, great pains obviously having been taken to secure clear reproduction of both text and photographs.

Twenty-three chapters provide considerable information on almost every abnormal condition one is likely to encounter in picture reproduction. The first describes how to tune a receiver correctly on a picture signal; the second shows tuning procedure with the aid of Test Card "C". There follow nine chapters dealing with Control Faults, covering Picture Proportions, Brightness, Contrast, Focusing, Line and Frame Hold, Line and Frame Linearity, and Limiting. Later chapters discuss Scanning Coil faults, Picture Positioning, Tube Faults, Magnetic Distortion, Time-base Faults and Miscellaneous Faults. The following five chapters are concerned with Interference and cover electrical apparatus, electro-medical apparatus, car-ignition, aircraft flutter and RF radiations, and the final chapter illustrates correct reception by means of actual screen pictures.

John Cura and his co-author Leonard Stanley have divided these chapters into several parts, each dealing with a particular aspect of a specific fault. Their written descriptions of the faults depicted in the "Tele-Snaps" are clear, yet free from irrelevant matter or confusing technical terms. A feature of the text is that the material most likely to be understood by the non-technical reader is printed in heavy type, while the more technically-minded are given their information in lighter type. The book concludes with a useful Glossary of Control Names, and a sensible Index.

The authors claim they are able to give only a brief guide to each fault. Having regard for the amount of information they have collected within the covers of a very reasonably-priced book, one must acknowledge the modesty of their claim.

WORLD RADIO HANDBOOK. 7th Edition. Published and edited by O. Lund Johansen. 124 pages. Price 8s 6d. Distributed in England by Wm. Dawson and Sons Ltd., Cannon House, Macklin Street, London, W.C.2.

For those who consistently listen to foreign stations this book is almost indispensable. It is also one of the finest collections of information regarding the broadcasting stations of the world that a listener could have to enable him to identify stations accurately.

Within its pages there is a large amount of material concerning the usual broadcast-band and short-wave stations. Times of transmissions, wavelengths used, forms of announcements, interval signals and all other relevant information is given for each station. Other useful items of interest are the address of the station, the leading personalities associated with it, and the form of verification, i.e., by letter or QSL-card. In many instances, where a station transmits a few bars of music as an interval signal, the title and composer and a reprint of the actual music appears.

Several pages are devoted to lists of Long, Medium and Short wave stations in ascending order of frequency, the wavelength and power, together with call-sign where applicable being stated. The same treatment is given to lists of the world's TV and FM stations. The standard frequencies radiated by WWV and WWVH have not been overlooked. On another page there is a handy list showing differences between local time and G.M.T. for all countries.

It cannot be denied that this book represents a monumental task in collecting so much detail. Apart from its obvious utility, it provides interesting reading and learning. It is well worth the price charged and deserves a wide circulation.

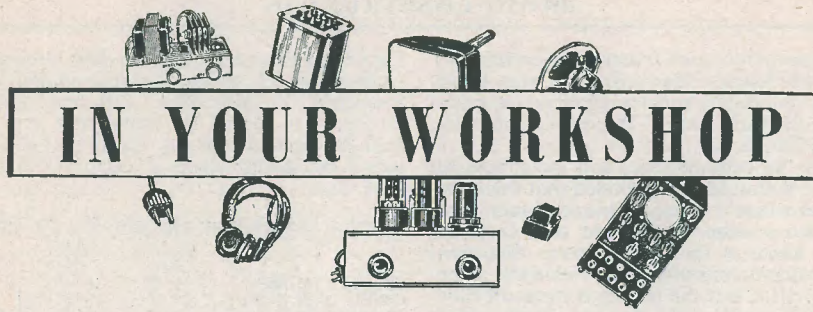

In which J. R. D. discusses Problems and Points of Interest based on Letters from Readers and his own experience.

I have several times been asked by readers whether I know of any method of testing electrolytic capacitors for capacitance and leakiness. This question has been rather a poser as I have not usually paid a great deal of attention to these components. Whenever an electrolytic capacitor has broken down or, more frequently, lost its capacitance, I have merely replaced it by a new component and thrown the old one away. On the odd occasions when I have tested for leakiness I have usually charged up the capacitor and checked that it held its charge after some twenty seconds or so.

Incidentally, the last part of the test was carried out by applying a voltmeter to the capacitor; not by shorting it to see how fat the spark was!

Capacitor Tester

Nevertheless, a simple arrangement for testing electrolytic capacitors would definitely

be useful in some workshops. Its main requirements would have to be simplicity of operation and, considering the fact that it would be used only infrequently, cheapness.

A suggested idea is shown in Fig. 1. The tester illustrated here works on the bridge principle. An unsmoothed rectifier voltage is obtained from the rectifier and is applied to the bridge circuit. C5 is fitted for reservoir purposes only; it offers little smoothing. The capacitor under test is connected in the C1 position in the bridge, and different capacitors of known value are connected in the C2 position. When C2 has the same value as C1, there will be minimum hum in the headphones. R3 acts as a volume control and should always be set to maximum resistance when tests are commenced. The capacitors C3 and C4 isolate the headphones from any voltages which may damage them or cause shock to the user. Leakage currents may be checked by connecting a milliammeter (switched

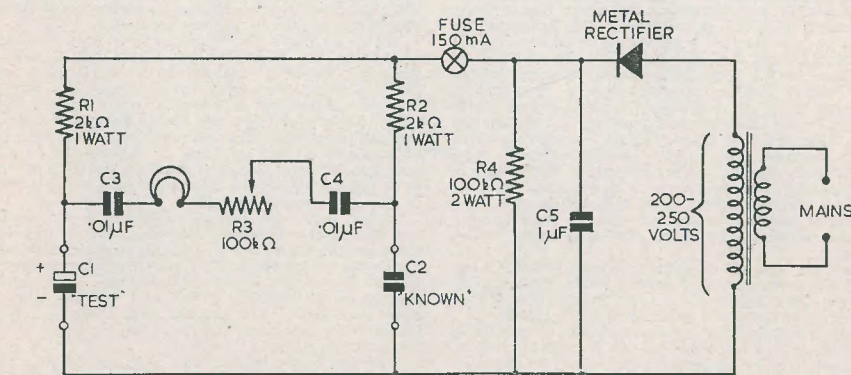

RC152

Fig. 1

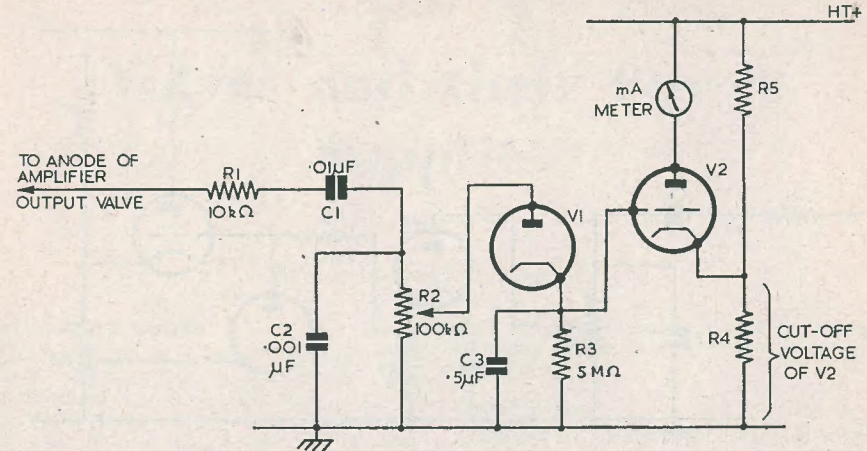

RC153

Fig. 2

initially to a high current range to prevent damage) in series with the capacitor under test.

The circuit of Fig. 1 can be slightly simplified, if desired. For instance, the transformer could be removed and the bridge circuit connected direct to the mains. If this is done, the usual safety precautions must be observed, of course.

It will have been noticed that only one HT voltage is used for testing the electrolytic capacitors. This should be quite sufficient in practice but, if something more elaborate is needed, the circuit could be modified by using a transformer with a tapped primary or secondary. A voltmeter connected across C5 would, further, give a more accurate indication of the voltage applied to the capacitor under test.

The same circuit should cope quite well with low-voltage electrolytics (so long as their capacitance is not very large), the AC applied to the rectifier being reduced to the requisite voltage.

Volume Indicators

Volume indicators for tape recorders are usually quite simple devices. Some constructors prefer to use magic eyes instead of meters for this purpose, although the latter are usually easier to read.

When meters are used, however, it is often found that they suffer from one small disadvantage. If the amplifier volume level is allowed

to rise accidentally to too high a value, the meter is liable to swing hard over and suffer damage accordingly.

A typical volume indicator circuit is shown in Fig. 2. In this circuit AF from the output valve of the amplifier is applied, via the pre-set potentiometer, R2, to the diode V1. V1 rectifies the AF, a DC voltage (positive at the diode cathode with respect to chassis) being built up across the long time-constant circuit R3/C3. V2 is normally biased to cut-off by the potentiometer arrangement, R4, R5. In the presence of AF, however, the rectified voltage built up across R3 causes the grid of V2 to become positive with respect to chassis (or less negative with respect to its cathode). The anode current of this valve then varies according to the volume level at the amplifier output anode; a visual indication being given by the meter.

The circuit of Fig. 2 is quite conventional and it suffers, as was just mentioned, from the fact that it is possible for the meter to swing hard over on high volume levels.

Fig. 3 shows how this snag may be cleared. This is achieved by fitting an additional diode V3, and a resistor R6. These new components do not alter the working of the indicator at normal volume levels. When the rectified voltage built up across R3 becomes too high, however, V3 conducts; and the excess voltage is built up across R6 instead of being applied to V2.

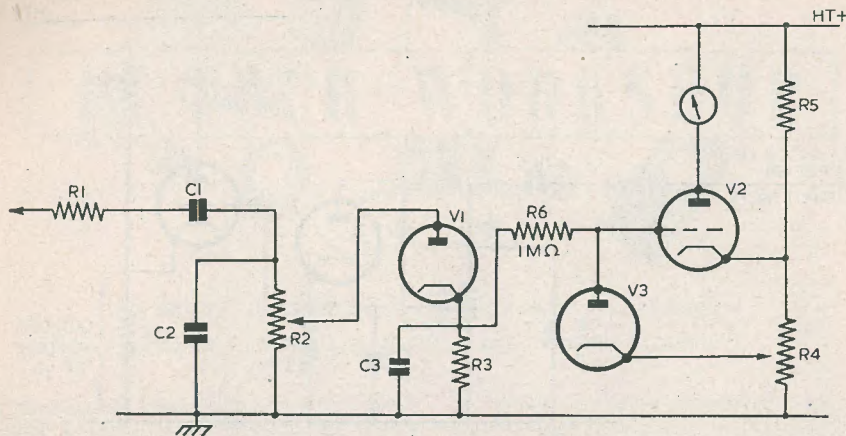

RC154

Fig. 3.

The point at which the cathode of V3 is tapped into R4 depends upon the valves and meter employed. It should be such that, at excess volume levels, the meter just indicates full-scale deflection. Fig. 3 shows R4 as a variable potentiometer but, in practice, it should be possible to use two fixed resistors. It is doubtful whether the values needed will be very "critical."

Incidentally, the components R1 and C2 in Figs. 2 and 3 are used to filter out any bias that may be applied to the recording head.

Distortion

There is a tale concerning the engineer who maintained a very large electronic brain. On being told that the brain was multiplying certain numbers incorrectly, he said: "Ah yes, now that will probably be R4590."

The normal serviceman cannot usually hope to locate his faults so easily; although it is, indeed, often possible to make a fair guess at what has gone wrong before taking an item of equipment from its case.

In my own experience I have often found that slightly leaky coupling capacitors in the AF section of receivers show marked symptoms. What happens in such cases is that the faulty receiver functions fairly well for about one to ten minutes; after which time distortion creeps in, getting progressively worse as time goes by.

It would be ridiculous to make a hard and fast statement but I have found that, out of a fair number of receivers of different makers showing such symptoms, approximately sixty per cent had leaky coupling capacitors, the replacement of which cleared the fault completely.

IDENTIFYING THE CONNECTIONS OF AN IF TRANSFORMER

Take the IF transformer carefully out of the screening can. First ascertain that the windings are wound in the same direction. The opposite ends of the windings should then be made "hot," i.e., the anode and grid are connected to opposite ends of the coils.

This has two objects (1) Unwanted capacity which affects the coupling is reduced to a minimum. (2) The output and input voltages are in the same phase or sense and this makes the overall feedback negative instead of positive, resulting in better stability. The worst results come from connecting one coil only the wrong way round, for then the capacitive coupling opposes the inductive coupling, and a very peaky response will result.

G.B.

Valves and their Power Supplies

Part 6

By F. L. Bayliss A.M.I.E.T.

AC/DC/Battery Circuits

The popularity of 1.4 volt valves for both battery and mains-battery receivers is great, and shows no sign of diminishing.

A mains-battery supply circuit has already been described by Mr. French, in the May 1952 issue of this journal, and constructors requiring a good orthodox type of circuit are referred to that article.

Another type of circuit, however, not so usual, but having distinct advantages, has been evolved by the writer and is shown in Fig. 18.

The circuit is based upon a midget two-valve AC/DC circuit, also by Mr. French, which was described in the September 1951 issue.

The 4-pole, 3-way switch (Fig. 18) serves as combined on/off, mains and battery switch; the arrangement, when correctly wired, is quite simple but very effective. Mistakes cannot happen, as it is impossible for both mains and the battery to be on together.

For battery working, the circuit is identical to that of Fig. 15, Part 5 of this series.

For mains working, however, V4, the 1.4 volt output tetrode, is switched out of the circuit, the tetrode section of the 70L7 now serving as the output valve.

Advantages

The great advantage of this scheme is, of course, that on mains the receiver gives real mains power . . . 1.5 watts to 1.8 watts, the undistorted output rating of the 70L7. The receiver is thus not merely a compromise—a battery set that may be worked off the mains—but a real dual-purpose instrument, that may be used as a household receiver, yet be small and convenient enough to carry around as a portable.

A further advantage is that it is quite simple to obtain a highly accurate filament chain current, on mains, and that HT smoothing may be made more effective by the inclusion of a choke instead of a resistor, and by the use of larger value smoothing capacitors—

since the values need not now be restricted by virtue of the filament chain being in the same circuit.

Circuit Points

The 70 volt heater of the 70L7 is supplied with the 0.15A current via R5, direct from the mains.

R6 drops the 230 volt mains to approximately 110 volts (receiver current 60 mA) for the V6 anode—the anode of the rectifier section of the 70L7.

HT is taken from the valve cathode (rectifier section) and smoothed by C5, the choke, and C6.

With the usual choke DC resistance of 300Ω to 350Ω, the smoothed voltage available as HT is thus approximately 90 volts. This voltage terminates at the "MAINS" control of the mains/battery switch S3.

The total current of the 70L7 tetrode section is 49 mA. The required bias for this valve is -7.5 volts, equivalent to a cathode resistor of 150Ω.

These conditions would be almost perfectly met by arranging for the filaments of the four battery valves to serve as the bias resistor. However, the battery output valve is not wanted in circuit when the 70L7 is functioning, so, although V1, V2 and V3 may, in series, form part of the bias resistor, the remainder must consist of a 68Ω component (R1), to drop the remaining 3 volts.

The top of the chain is not the best position for an output valve, on account of danger of feedback; but as V3 filament is virtually at chassis potential, and C1, C2, R1 form an effective audio smoothing circuit, the feedback should be negligible, so far as the two audio valves are concerned. The anode loads of V1 and V2 have much too low an impedance to give any appreciable gain to audio signals appearing across their respective filaments (if they would appear, which is unlikely) so that, all in all, quite stable working should be achieved.

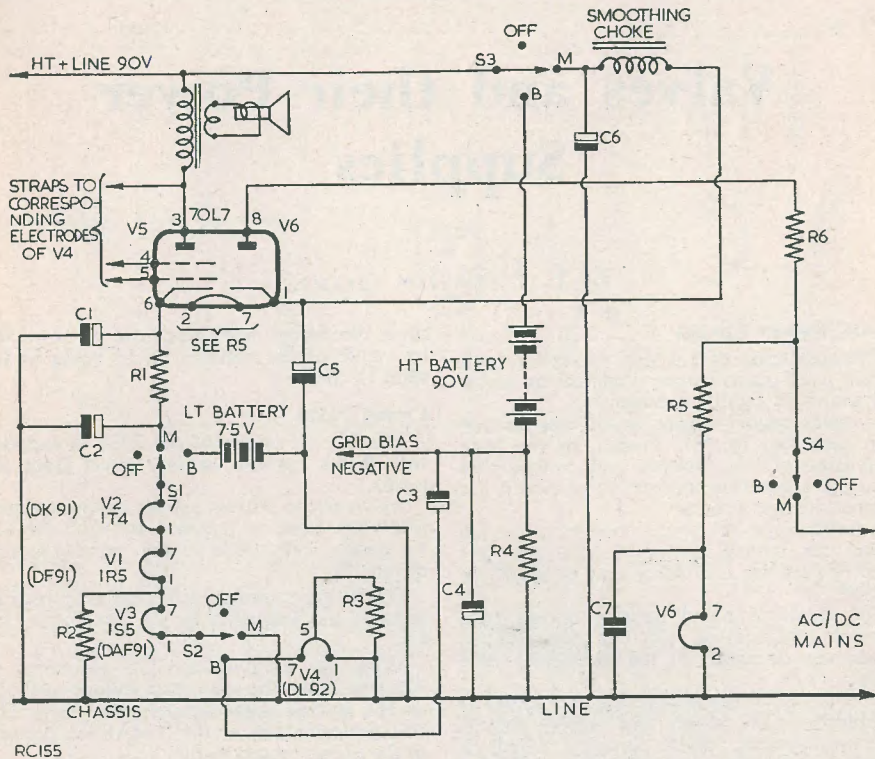

Fig. 18

List of Components

R1	68Ω, ½W	C5, C6	16 μF+16 μF, 450V elect.
R2, R3	1 kΩ, ½W	C7	0.01 μF, 1 kV
R4	800Ω, ½W	Choke	20 Henrys, 60 mA, 300Ω
R5	1 kΩ, 25W	Switch	4-pole, 3-way, miniature or Yaxley
R6	2 kΩ, 5W	V1, DF91, IT4; V2, DK91, IR5; V3, DAF91, IS5, 1U5; V4, DL92, 3S4; V5, V6, 70L7—See Footnote*	
C1, C2, C3, C4	25 μF, 12V elect.		

Before connecting-in the battery valves, it is a good plan to check the total emission current of the 70L7, by a milliammeter in the tetrode cathode lead, with a fixed resistor of 150Ω as the bias resistor. If a low resistance wire-wound potentiometer is available as the temporary bias resistor, so much the better. The potentiometer may be adjusted until a reading of 50 mA is obtained, then, by ascertaining the resistance used in the potentiometer and subtracting from it 84Ω (the resistance of V1, V2, and V3 in series) one is left with the

required value of R1.

Alternatively R1 may consist of a 100Ω wire-wound potentiometer which, with the three battery valves and a milliammeter in series in the bias circuit, is carefully brought down from *maximum resistance* until a reading of 50 mA is obtained. The potentiometer, if of the slider type, may then be set permanently to this value.

Finally, the anodes control grids and screens of the two output valves V4 and V5 must be strapped (anode to anode, grid to grid, etc.)

Grid Bias

The negative grid bias lead from R4 is taken to the end of the V4 grid resistor remote from the grid.

So far as AGC voltage and permanent bias on V1 and V2 are concerned, the notes in Part 5 of this series may be followed. The notes in Part 5 in respect of returning V3 diode and grid leads to V3 pin 1 also apply here.

Alternative Valves

Other valves of the beam tetrode/rectifier type may be used instead of the 70L7—117L7, 117M7, 117P7—but, of course, it is essential that the external component values should be altered to suit the valve, where necessary.

With the 117L7, for instance, R6 is not required and the rectifier anode is connected to pin 7, the heater pin. R5 thus serves to drop the voltage for both anode and heater, and both heater current (0.09A) and receiver

current (60 mA) flow through it. R5 thus becomes 750Ω, 20 watts, and drops the mains voltage to approximately 117 volts, the correct voltage for both heater and rectifier anode.

The negative bias required by the 117L7 is lower than that required by the 70L7—5.2 volts—consequently R1 must be reduced to 22Ω, to obtain the correct tetrode bias voltage and battery valve filament-chain current.

The valve-base connections are different, too, pin 4 being g, pin 5 g2, pin 6 the rectifier anode and pin 8 the tetrode cathode.

Providing these three points are attended to, however, the circuit can be quite a universal one for beam tetrode-rectifier valve types, and, since a rectifier has to be purchased for an AC/DC/battery receiver, one stands to lose nothing, but to gain everything, by making it a tetrode-rectifier and carrying out a most interesting experiment.

*The 70L7, 117L7 and other equivalents mentioned above are obsolete types and are extremely difficult to obtain. A suitable modern arrangement would consist of a 35L6GT in place of the pentode section, and a DRM1B in place of the rectifier section. The value of R5 now becomes 1175; other values remain unaltered.

DON'T MISS THIS HANDBOOK!

INDISPENSABLE TO

THE AMATEUR

TRANSMITTER

AND LISTENER



It contains all those details of information which the transmitter and SWL constantly require.

Right up-to-the-minute Amateur Band Prefix lists, both alphabetically and by country, Zone Boundaries, Call Areas, Mileage Tables, QSL Bureaux, "Q" and "Z" Codes, WWV Skeds, and much other information, as well as a selection of maps of DX areas.

Price 2/6, postage 2d.

DATA PUBLICATIONS 57 MAIDA VALE LONDON W9

Versatile Oscilloscope for the Amateur's Laboratory

By R. A. SEAL, A.INST.EX.E.

The writer has for some time been very interested in the design and construction of oscilloscopes suitable for use in Television and Audio Frequency Engineering. After a careful study of all published designs, the conclusion was reached that no single design in itself met with all his requirements. Even commercial models, with the exception of high priced instruments, appeared to be very limited in their application. After very careful deliberation, the writer decided that the only way out was to design and construct a unit, bearing in mind his fundamental requirements and cost. These two considerations brought about two important design factors. Firstly, making do with available components whenever possible and, secondly, designing a unit that could be easily set up without the need of special test equipment.

The design as far as constructional considerations would allow was based on the conversion of a Test Set 73, a very convenient unit for conversion to a standard oscilloscope in view of the lay-out and the fact that the power supply is already available for operation on 230V AC mains. Unfortunately the writer's unit had a burnt out mains transformer and, as a direct replacement was unobtainable, some alternative had to be found. This took the form of two standard transformers, although considerable difficulty was experienced in making them fit into the very limited space available. The direct result was that only a limited HT voltage was available, and this ruled out the use of DC coupling or Cathode coupled amplifiers. This meant that it was necessary to design a circuit to overcome these difficulties, and at the same time ensure that the performance was adequate to fulfil the writer's requirements. Therefore the following broad specification was finally decided upon.

(1) Y Amplifier

Capable of handling frequencies up to 3 Mc/s response, and as flat as possible up to 1 Mc/s. Gain variable.

(2) Time Base

Frequency range at least 25 c/s-75 kc/s, with provision for 50 cycles sweep and external sweep.

(3) Synchronising

Internal or external, with either positive or negative signals; phasing and amplitude to be continuously variable on "internal."

(4) X Amplifier

Suitable frequency response to handle sawtooth waveforms generated by time base, and suitable amplitude to give some trace expansion. Gain variable.

(5) Shift

Symmetrical to avoid astigmatic distortion.

(6) X and Y Plates

Provision for switching to respective amplifiers or to sockets for direct connection with or without built-in attenuator.

(7) CRT

Adequate trace brilliance to give satisfactory display on high speed timebase, and also suitable beam blanking for flyback suppression.

Y Amplifier

The "Y" amplifier consists of an EF50 feedback amplifier feeding a pair of EF50's in paraphase push-pull. Y gain is variable by means of potentiometer R5, which controls current negative feedback to V1. This method of gain control has proved entirely satisfactory, even though it is not possible to reduce the gain to zero. A straightforward potentiometer in the grid circuit was undesirable owing to its effect on frequency response due to high stray capacity. It will be noticed that a

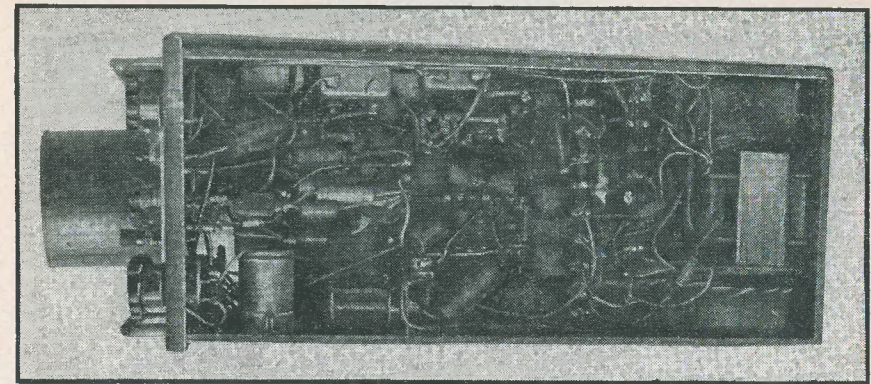

Underchassis View

certain amount of "coiling" has been introduced in the anode circuits of V1, V2 and V3, and these coils, namely, L1, L2 and L3, should be adjusted for optimum response at the high frequency end of the spectrum. This usually entails peaking these circuits round about 1 megacycle. Likewise trimmers C4 and C5 should be adjusted to give optimum balance of the paraphase amplifier at the higher frequencies. Potentiometer R12 is the internal synchronising control which is connected between the two cathodes of the paraphase pair, so that with the moving arm in the centre position no synchronising signals are fed to the timebase, and rotating the control to either side of centre gives signals in either a positive or negative sense.

Timebase and X Amplifier

The timebase is a form of transitron and works on the same principles as the standard circuit, the only difference being the low impedance screen and suppressor circuits which were found to give better results, especially in waveshapes when using the VR116 HF pentode. This valve, in spite of its unusual characteristics, is readily available on the surplus market. The control R54 should be adjusted to give minimum output consistent with satisfactory operation on all the timebase ranges.

One of the main difficulties to be overcome in the design of the timebase and associated amplifier was the provision of a gain control or amplitude control. The same question arose regarding a potentiometer and its stray capacities and non-linearity at high frequencies.

This was overcome by employing a cathode follower with a low impedance output, so that the stray capacities would have little effect. A point to be remembered when wiring the circuits shown is to support the coupling condensers, especially C14 and C2, well away from the chassis to avoid unnecessary shunt capacities to earth.

The main timebase switch, S1, is connected so that on positions 1-5 a saw-tooth time base is fed to the X amplifier. Position 6 is 50 cycles and position 7 external sweep. The X amplifier is similar to that used on the Y axis, except that some curtailment of frequency response was unavoidable in order to obtain the required sweep amplitude.

Tube Circuits

These are fairly straightforward, although there are one or two points worth mentioning.

In order to obtain symmetrical shift on both X and Y axis it was necessary to employ ganged potentiometers. These are easily obtainable, but should any difficulty be met in doing so it is possible to earth the slider connections to R36 and R38 and replace these two potentiometers with 2.2 megohm fixed resistors. This will give a fair amount of shift, although some astigmatic distortion will be visible.

Switches S3 and S4 should be mounted at the rear of the instrument adjacent to the tube base, and likewise the components and sockets comprising the X and Y attenuators. If it is desired to use these attenuators at high frequencies some capacitive compensation may be necessary. It will be seen that due

COMPONENTS LIST

Desig.	Value	Tolerance	Wattage	Type
R1	10kΩ	20%	1	Fixed
R2	3.5kΩ	20%	1	"
R3	1.0MΩ	20%	1/2	"
R4	150Ω	20%	1/2	"
R5	20kΩ	—	—	Pot.
R6	1.0MΩ	20%	1/2	Fixed
R7	150Ω	20%	1/2	"
R8	3.5kΩ	5%	1	"
R9	20kΩ	5%	1	"
R10	27kΩ	5%	1/2	"
R11	1.0MΩ	20%	1/2	"
R12	2.5kΩ	—	—	Pot.
R13	3.5kΩ	5%	1	Fixed
R14	150Ω	20%	1/2	"
R15	50kΩ	—	—	Pot.
R16	1.0MΩ	20%	1/2	Fixed
R17	100Ω	20%	1/2	"
R18	5.0kΩ	20%	1/2	"
R19	2.2kΩ	20%	1/2	"
R20	2.2MΩ	5%	1/2	"
R21	1.0MΩ	5%	1/2	"
R22	1.0MΩ	5%	1/2	"
R23	2.2MΩ	5%	1/2	"
R24	1.0MΩ	5%	1/2	"
R25	1.0MΩ	5%	1/2	"
R26	2.2MΩ	5%	1/2	"
R27	1.0MΩ	5%	1/2	"
R28	1.0MΩ	5%	1/2	"
R29	1.0MΩ	5%	1/2	"
R30	2.2MΩ	5%	1/2	"
R31	1.0MΩ	5%	1/2	"
R32	2.2MΩ	20%	1/2	"
R33	2.2MΩ	20%	1/2	"
R34	2.2MΩ	20%	1/2	"
R35	2.2MΩ	20%	1/2	"
R36	2.0MΩ	—	—	"
R37	2.0MΩ	—	—	Ganged Pot.
R38	2.0MΩ	—	—	"
R39	2.0MΩ	—	—	Ganged Pot.
R40	300kΩ	20%	1	Fixed
R41	250kΩ	—	—	Pot.
R42	330kΩ	20%	1	Fixed
R43	100kΩ	—	—	Pot.
R44	100kΩ	20%	1/2	Fixed
R45	1.0MΩ	20%	1/2	"
R46	250kΩ	20%	1	"
R47	10kΩ	20%	1/2	"
R48	100kΩ	—	—	Pot.
R49	10kΩ	20%	1/2	Fixed
R50	1.0MΩ	10%	1	Hi-stab.
R51	50kΩ	10%	1	Fixed
R52	2.2kΩ	5%	1/2	"
R53	500Ω	5%	1/2	"
R54	100kΩ	—	—	Pre-set Pot.
R55	100kΩ	20%	1/2	Fixed
R56	1.0MΩ	20%	1/2	"
R57	150Ω	20%	1/2	"
R58	3.5kΩ	—	—	Pot.
R59	200kΩ	20%	1/2	Fixed

Desig.	Value	Tolerance	Wattage	Type
R60	1.0MΩ	20%	1/2	Fixed
R61	15kΩ	5%	1	"
R62	150Ω	20%	1/2	"
R63	100kΩ	5%	1/2	"
R64	500kΩ	5%	1/2	"
R65	100kΩ	5%	1/2	"
R66	1.0MΩ	20%	1/2	"
R67	15kΩ	5%	1	"
R68	200Ω	20%	1/2	"
R69	150Ω	20%	1/2	"

Condensers

Desig.	Value	Voltage	Type
C1	0.1μF	500	Paper
C2	0.5μF	500	"
C3	8.0μF	500	Electrolytic
C4	50pF	—	Ceramic trimmer
C5	50pF	—	"
C6	0.5μF	500	Paper
C7	0.1μF	350	"
C8	0.5μF	350	"
C9	0.1μF	500	High Grade paper
C10	0.01μF	500	Mica
C11	0.001μF	500	"
C12	100pF	500	"
C13	50pF	500	"
C14	2.0μF	500	High Grade paper
C15	16.0μF	350	Electrolytic
C16	0.001μF	500	Mica
C17	0.0025μF	500	"
C18	0.02μF	500	"
C19	0.2μF	500	High Grade paper
C20	1.0μF	500	High Grade paper
C21	0.25μF	2000	—
C22	0.1μF	350	Paper
C23	0.5μF	350	"
C24	1.0μF	350	"
C25	0.5μF	350	"
C26	0.5μF	350	"
C27	0.1μF	2000	—
C28	0.5μF	500	Paper
C29	0.5μF	500	"
C30	0.5μF	500	"
C31	0.5μF	500	"

Miscellaneous

L1	270 μH	Variable dust Core.
L2	"	"
L3	"	"
V1	EF50	"Y" AMP
V2	EF50	"
V3	EF50	"
V4	6SH7	Sync. C.F.
V5	VR116	Time Base
V6	6SH7	"X" AMP. C.F.
V7	EF50	"X" AMP.
V8	EF50	"X" AMP.

V9	EA50	D.C. Restorer.
		Beam Blanking.
S1	4 × 1p. 7w.	Rotary.
S2	1p. 2w.	"
S3	2p. 2w.	"
S4	2p. 2w.	"

Variable Components and Controls
(Values given above)

R5	"Y" Gain.
R12	Sync. Amplitude and Phase.
R15	External Sync. Amplitude.
R36, 37	"X" Shift.
R38, 39	"Y" Shift.

R41	Focus
R43	Intensity.
R48	Fine frequency.
R54	Pre-set Time base amplitude.
R58	"X" Gain time base amplitude.
C4	Pre-set "Y" Balance.
C5	"
L1	Pre-set "Y" amp. Frequency response
L2	"
L3	"
S1	Time base and "X" amplifier Input.
S2	Sync. EXT/INT.
S3	"Y" Plates Amplifier/Direct.
S4	"X" Plates Amplifier/Direct.

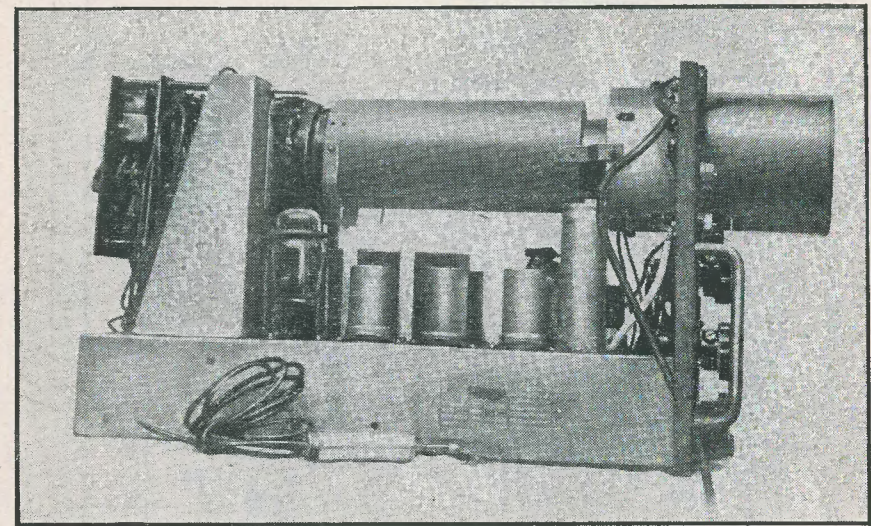

Side View showing general arrangement of top deck

to the way the attenuators and sockets are connected it is possible to obtain several combinations of attenuation, both with balanced and unbalanced inputs.

Power Supplies

In view of the fact that many constructors prefer to rig up power supplies with whatever components they may have on hand, no attempt has been made to describe a suitable power supply. The power requirements for this unit are:—

- 1500V DC at 1 mA.
- +350/375 DC at 100 mA.
- 4.0V AC at 1.5 Amps. Tube and diode heaters. This requires an insulation of 2 kV.

6.3V AC at 3 Amps. Valve heaters and pilot lamps.

The EHT supply can be obtained from either a straightforward half-wave supply or from one of the many voltage boosting circuits that are in common use today.

Ancillary Equipment

When designing certain types of circuit it is often desirable to display two waveforms simultaneously, such as when it is desired to observe the outputs across both halves of a push-pull circuit for balancing purposes. The writer has employed for this purpose one of the high speed switch motors at present available on the surplus market. An electronic

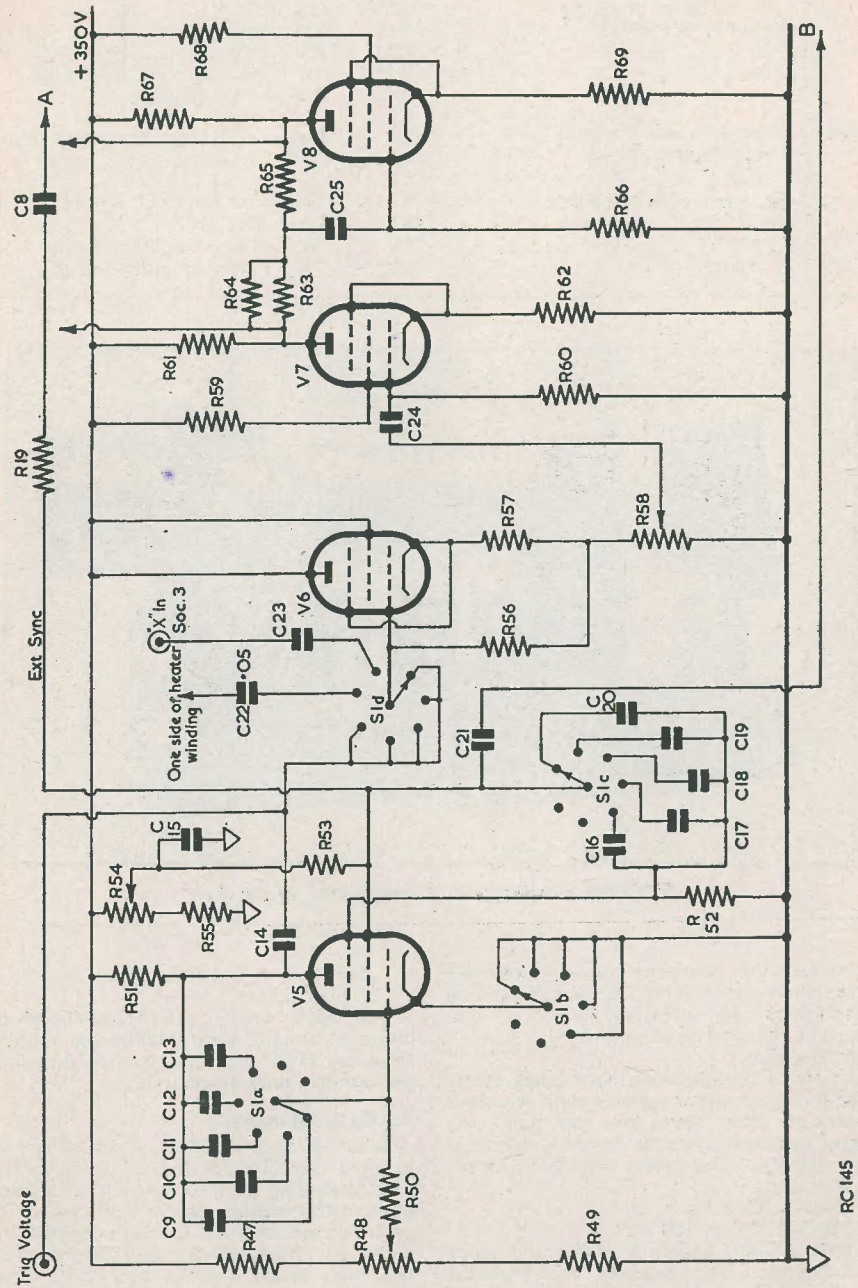

Versatile Oscilloscope—Timebase and "X" amplifier section

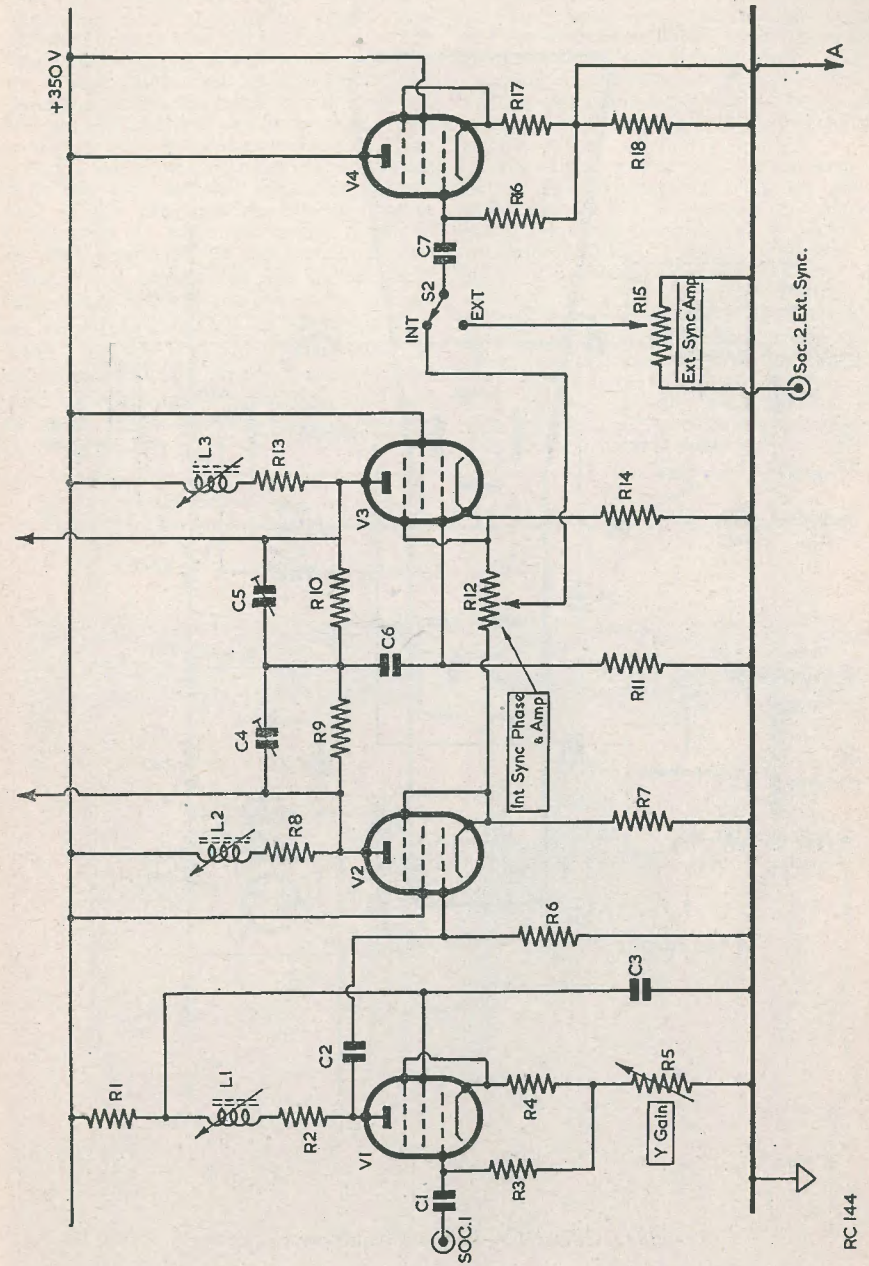

Versatile Oscilloscope—"Y" Amplifier section

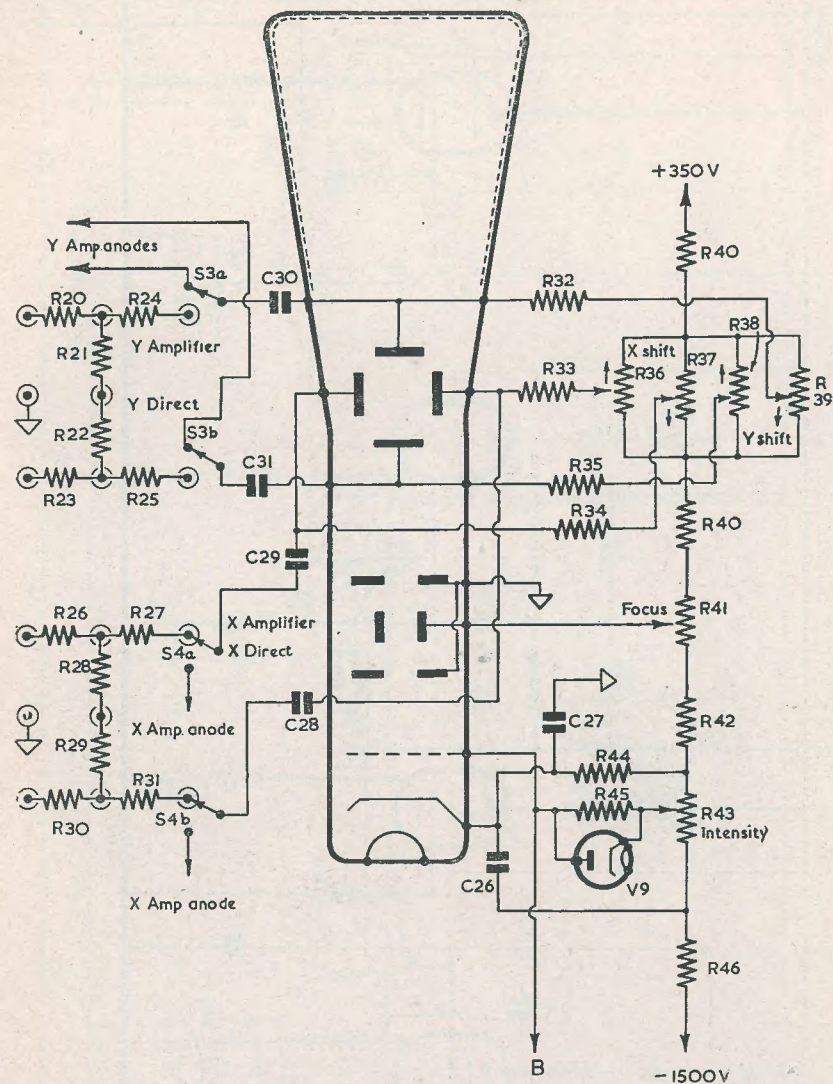

RC146

Versatile Oscilloscope—Indicator and Network Section

switch is, of course, more versatile in many respects, but is not so simple to obtain. The main disadvantage with the mechanical switch is that the switching is not readily variable over a wide range, thus making it difficult to examine waveforms much above 2500 cps when two are displayed simultaneously. This can be improved in many cases by employing the second half of the switch motor for applying shift to one plate and thus displacing the two traces; in this case it is possible to operate the timebase at twice the speed normally used when displaying the two waveforms side by side. It is essential to lock the timebase to the switch motor. The switch motor contacts should be adjusted to give minimum "break" consistent with good timebase synchronisation. The writer found that the optimum switch speed was between 1500 and 3000 rpm with the timebase running between 25 and 50 cps.

Another useful item of ancillary equipment for the display and measurement of small voltages such as noise and hum is the variable frequency calibrated voltage source, and this, in conjunction with the switch and oscilloscope, enables unknown amplitudes to be compared with and measured against a known calibrated source.

This voltage source can take the form of an audio signal generator with an accurate attenuator which is capable of giving 10 microvolts and upwards, or a simple RC oscillator fed into a cathode follower via a series of calibrated potential dividers. When using the switch motor and oscilloscope for amplitude measurements it is advisable to keep the source impedance as low as possible, otherwise the condenser C1 in the Y amplifier may take longer to charge than the space time allowed between switching, in which case the two signals may be unevenly displaced making measurement difficult.

RUFUS—THE RADIO CONSTRUCTOR— ... tackles Colour TV

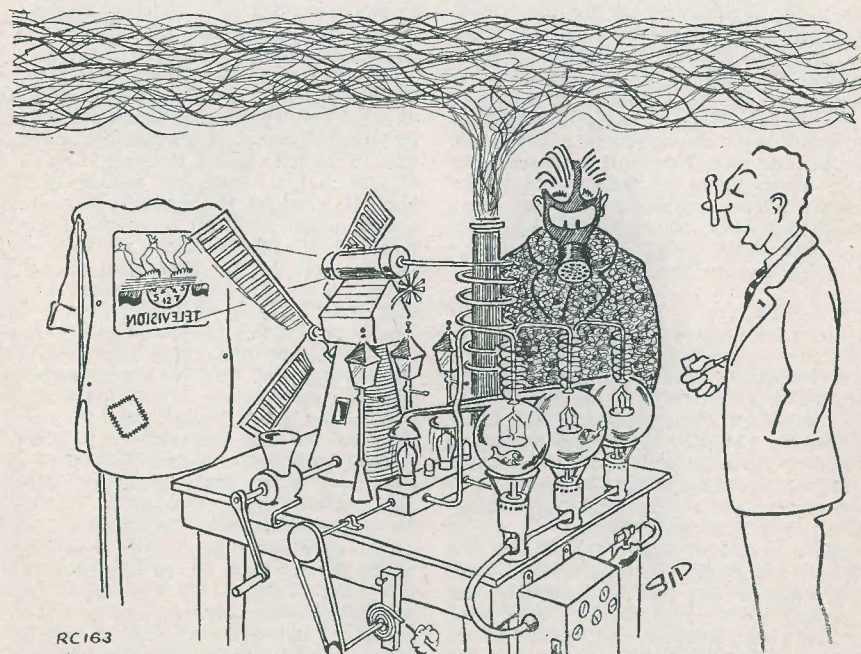

RC163

"Actually, I could get more than the three colours out of it, only it would make the rig a bit complicated!"

Radio Miscellany

A couple of months ago I commented on the RSGB Annual General Meeting. My chief reasons for doing so were (a) the unusual circumstances which decided the result of the voting and (b) in order that potential members, who may have no other means of knowing, might learn there was to be no immediate change in subscription rates. There was, too, an important factor affecting new members — that it was proposed an Entrance Fee of 10s should be charged. I certainly had no intention of supporting either side of the argument, whatever my personal views. It was purely for the members to decide. Any attempt on my part to influence opinion one way or the other would have been presumptuous although, had space been available for writing at greater length, a fair summary of the arguments used by both sides would have been perfectly justifiable. After all, the affairs of the Society are of immediate concern to all radio-minded non-members. It is *the* National Society. In private, and in public, I have rigidly supported the principle that it should remain a democratic monopoly. As such there must be no suspicion that its affairs might be manipulated to the detriment of those on the outside. Any single representative body has responsibilities to all comers, most particularly to potential members who, in future years, may become its mainstay.

Middle Course

Within a few days of the appearance of that issue letters began to arrive. Most of the writers seemed to think I was biased on the side of the Council, but a few took the opposite view. All the letters were reasonable and mostly very friendly. In fact, those who thought I had strayed from the path of strict neutrality rebuked me more in grief than in anger — and kindly pointed out at what points my understanding of the facts were wrong.

I replied to each as well as I could, but one fact stood out grimly. It was the never completely quiescent fear that BRS members are not wanted. Many non-members, other than those who have written also appear to be uneasy on this point and suspect that the proposed subscription revision, plus the entrance fee, is a step towards their exclusion.

News of this must surely have reached the Council; no time should be wasted not only in correcting this impression to stimulate the recruitment of new members, but in the maintenance of existing BRS interests.

Unfortunately there is no BRS representation on the Council, but to my personal knowledge in many of the Regions and Groups particular attention is given to ensure their inclusion in local Committees.

Full House

When the Special General Meeting was called two months after the Council's recommendation of the new subscription rate had been defeated, it was hardly surprising that there was a large attendance. A few more would have made it an overflow meeting. As it was, there were not enough pegs in the cloak-room for late-comers!

Some members I talked with were disturbed that the Council, despite the previous rejection, were back with the same plan and were making no outward gesture of compromise or conciliation. They felt a defeat would have meant loss of face and a consequent weakening of the Society's prestige. Rather than risk a situation which might result in a schism they were prepared to reverse their previous voting. Others were firmly determined to stick to theirs. A few, for various reasons, swung the other way. Taking this as a sample of the whole membership, I offered evens that the result would be the same as before. All I won was ten cigarettes. But it's not the value of the winnings that matters — it is the smug satisfaction you get by being right.

There was the inevitable preliminary discussion, although everyone knew that all the eloquence in the world could not affect the result at that stage. The proxy votes would far outweigh those of the members present. There were some good brief speeches, and telling thrusts were scored by speakers from the floor. Two of the opposition speakers won rounds of applause by concise and closely reasoned statements of the "Nay" case. Indeed one felt a regret that those two members were not on the Council. They stated a case rather than personal opinions, and their able-

ness could be turned to good account in the management of the Society's affairs.

Personal Triumph

The necessary majority fell some hundreds short — a result which one might suppose, after reading the *Bulletin*, would have been near calamitous. Strong criticism had been made by one of the early speakers at the unfair use to which the *Bulletin* had been put in misrepresenting the opposition. It was not suggested that this was deliberate, I imagine, but rather a case of misguided fervour.

There is, of course, no doubt that the Society can, and will, continue to flourish if the subscription rates are fixed at the level suggested by the opposition. I think it must have been that common-sense view which led the President, who rose to the occasion magnificently, to emerge from a difficult situation with flying colours. Up to that point he had simply acquitted himself creditably, but with good sense and sportsmanship he was calm and hopeful in the face of this second defeat of the Council's plan. This he accomplished in the face of an embarrassing position brought about by the sorry spectacle of several Council members calling on him publicly to accept their resignations. Disregarding them, the President rose, unruffled, and calmly told the meeting that *he* had no intention of resigning. His refusal to be stampeded by ungracious gestures and his expression of willingness to compromise (on a new basis) was in keeping with the best traditions of amateur radio.

G5LC certainly measured up to the situation and proves himself worthy of the fullest confidence of all members, whatever their views. Had he allowed personal feeling to sway his judgment only harm could have come out of it.

CENTRE TAP talks about the R.S.G.B. S.G.M.

A senseless charge of "emotionalism" had previously been levelled at the opposition. Just how unfair this had been was fully demonstrated by their complete absence of exultation in "victory." There was not so much as a single handclap and I felt proud that, even in these days when patriotism is sneered at as "Imperialism" or worse, the tradition of British sportsmanship and common-sense is still very much alive.

Maybe a decrease in membership might result if the full increase of subscription does finally come about. Whatever drop does ensue will not, I am sure, be due to ill-nature. It will only be the economic circumstances of individual hobbyists who have to make economies in their personal budget who will allow their

membership to lapse.

What a pity the approach to this vexed question was such that it still remains undecided.

Puzzle Corner

It is a curious fact that while seven hundred odd might have turned the scales, many times that number of members failed to use their vote. Although the votes cast must have been an all-time record, it was well below 50 per cent. It is difficult to believe that on an issue of immediate concern to all, over half the members do nothing about it when all they had to do was to fill up the proxy form sent them. The mystery is even more unaccountable than the "Don't know" group in a Gallup Poll. They are, perhaps, understandable when you look at some of the dim types you meet in most walks of life. But while we do find a few cranky sorts in radio, it would be impossible to find any so dumb as to be unable to make up their minds on a straightforward question.

It intrigues me. I can appreciate a small percentage who overlook it or forget to post their forms until too late. Also a few more who might feel their vote probably wouldn't affect the result and so don't bother. To these we might add others who the issue does not affect personally and who feel they would rather leave the matter to those who have to look very carefully at odd shillings. Supposing these account for five per cent, what happened to all the others?

On this question, at least, you can count me in with the "Don't knows."

Other Business

Oddly enough I have several interesting points brought up in readers' correspondence but there is no space for them this month. Too much has been happening in the hobby as a

whole during recent weeks.

Another radio monthly disappears to add a further name to the long list of journals fading from memory. How many readers still remember *Modern Wireless* and *The Wireless Constructor*? Two of the earliest casualites.

Another reduces its price, and we are reminded all round that money is becoming tighter. New components, after several recent price increases, are steadying. "Surplus" grows scarcer and the further outlook is as unsettled as our climate. I shall have to polish up the horn-rims and do a spot more crystal gazing. It pleases my vanity when I'm right and amuses readers when I'm wrong. At least I think it must. They write such pleasant letters pointing out just where I go astray.

Let's get Started on the First Principles of Radio

By A. Blackburn

Brass Tacks

With so many books in the world on how to teach yourself everything from Public Speaking to Dairy Farming, I was a little surprised the other day to hear a friend complain that he didn't know "how to start."

Such an ambiguous remark deserved discreet silence, but his despair prompted my sympathy. I was rewarded.

"A marvellous invention, Radio," he enthused, as though he were introducing me to the latest developments in interplanetary flight, "and an excellent hobby—if you can get started," he added to my astonishment. He then explained that his greatest difficulty was to find out what radio really is—some of its general principles.

"It's no good my taking a book out of the library and reading it up that way," he said. "I start confidently enough, but when I flick through the later pages and see what's in store for me, I get panicky and discouraged. The prospect of wading through a volume—however well written—of diagrams and formulae, puts me off at the outset."

Well, I asked him, what did he want? Evening classes or private tuition?

"No, nothing so strenuous. This is a hobby—not a job of work. What I want are evening classes in book form. Something I can read and enjoy in easy stages. Don't forget, I know nothing at all about the subject."

I could see his point. There is a subtle difference between learning from a text book and learning from periodical articles. Text-books smack too much of the classroom; they do not so much invite serious study as demand it. Periodical articles, on the other hand, can be read and digested in comfort either at odd times during the day, or after the evening meal and a day's work.

This series of articles for the beginner is designed with that difference borne in mind. Older hands will perhaps find it of value in clearing up a longstanding confusion on some particular aspect of the subject.

The Most Important Technique in Radio

For some reason, valves are regarded by the uninitiated with a respect amounting almost to

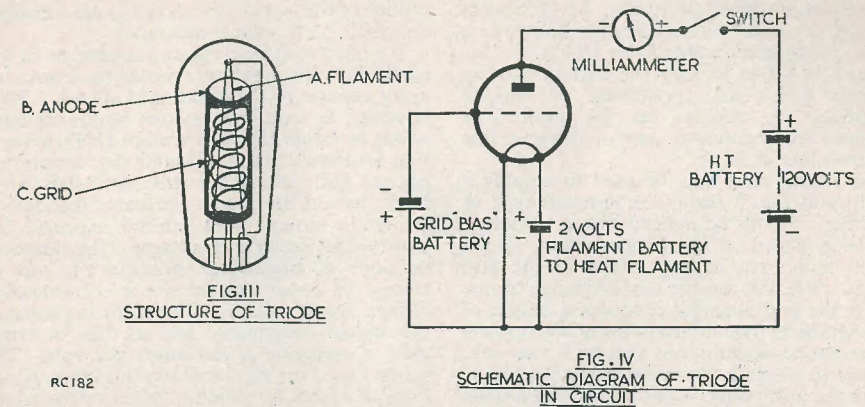

RC182

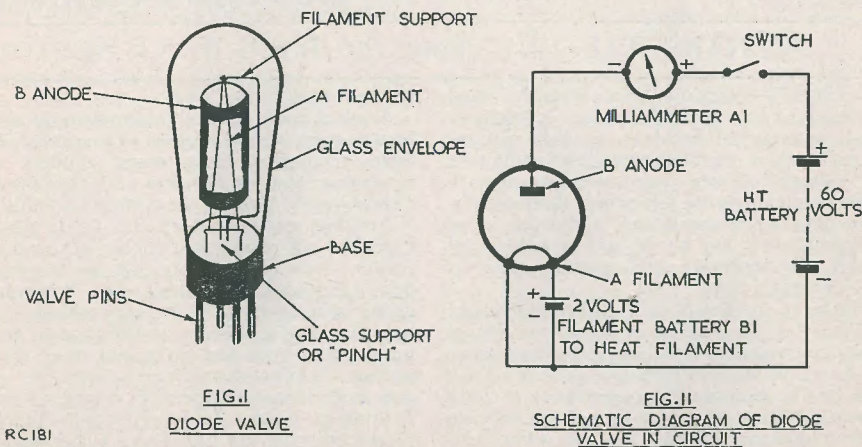

RC181

superstitious dread; as though they possess a sort of magic quality rendering them immune from the usual laws of nature. Until you know how a valve is made, however, and understand something of its behaviour, you will always feel at a disadvantage with radio. When an essential part of a machine means nothing more to you than a resigned and mystified shrug, then it is high time some simple facts were brought to your notice.

For a start, get rid of the idea that a valve is possessed of a mind of its own. A normally docile and co-operative creature, the valve will only voice its disapproval when subjected to misuse.

A valve containing two electrodes, only, is called a *diode*, and its internal structure is shown diagrammatically in Fig. 1. *A* is a specially treated wire *filament*. Current passing through this wire will heat it, in exactly the same manner as the filament of a torch bulb is heated, and will release electrons from its surface. The action is similar to that one observes at the surface of a glass of fizzy lemonade. The electrons behave like the tiny drops of liquid that occasionally shoot into the air and fall back again. Now an important feature of the electron is that it holds a negative charge of electricity and, obeying the same laws as the poles of a magnet, is repelled by a body holding a negative charge and is attracted by a positive charge.

It follows, therefore, that if a positively charged body is introduced near to the filament the electrons will not fall back, but will be attracted to that body. This effect is produced by the metal tube *B*, known as the *anode*. Let us consider, now, the implications of this electron business.

The diode valve is shown schematically in Fig. 2. This method of drawing is really a sort of shorthand, which enables us to draw complicated circuits without actually having to make detailed drawings of all the components. As before, *A* is the filament and *B* the anode, the filament being heated by the battery *B*₁. When the switch is off, the electrons released from the filament return to it again without having produced any effect. Directly the switch is on, however, the anode has a positive charge and the electrons leap towards it, completing the circuit by returning to the positive end of the battery, to be replaced at the filament from the negative end. In fact, a current flows—despite the fact that there is *no apparent electrical connection* between filament and anode.

Now, in order to allow the filament to be heated to a high temperature, the filament and anode are placed in the familiar glass envelope, the air is pumped out, and the envelope is sealed. If we wire in an ammeter, *A*₁, as shown in the circuit, the value of this current may be determined, as it would be if the circuit contained only batteries and resistances.

Now suppose we mounted a spiral of wire in the electron stream between the filament and anode. Remembering that the electron "dislikes" a negatively charged body and is repelled by it, a negative charge on this *grid* would stop some of the electrons reaching the anode. As a result, the current flowing through the valve to the battery would decrease. If the negative charge on the grid is made so great that all the electrons are prevented from passing, no current would flow through the valve, and it is said to be "cut off." This type

of valve has three electrodes, i.e. filaments anode and "grid," and is therefore known as a triode, shown diagrammatically in Fig. 3. Its purpose in life is to vary the current flowing through it by the application of varying potentials, or charges, to the grid. The schematic or theoretical way of drawing this is shown in Fig. 4.

The triode valve may be used to amplify a signal, and Fig. 5 shows the simplest type of amplifier. It will be noticed that a resistance has been added in the anode circuit, and a switch and extra battery added in the grid circuit. We will assume that a change of one volt in the grid potential produces a change of 2 milliampères (two thousandths of an Ampere) in the anode current, and that with two volt, applied to the grid the anode current is 5 mA. When the grid switch is put to position 2 there will be a change of grid voltage of 2 volts, and as the anode current changes by 2 mA for every one volt change on the grid, for a 2 volt change the anode current will change from 5 mA to 1 mA. You will notice that the greater the negative potential at the grid, the smaller the anode current. Now the voltage developed across the resistor R with 5 mA flowing is, from Ohms law (Volts=Amperes \times Ohms) $0.005 \times 10,000 = 50V$, and the voltage developed across it with 1 mA flowing is only $0.001 \times 10,000 = 10V$. For a two volt change in grid potential, therefore, we have produced a 40V change in anode potential — an amplification of 20 times!

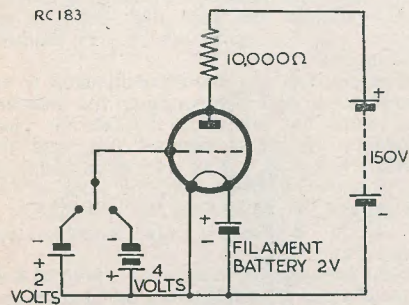

FIG. V
SIMPLE TRIODE AMPLIFIER

This example is sufficient to show that a valve will amplify. However, there are many types of triode valve, and the difficulty now is to know which one to choose to suit a particular requirement. We shall have to have an

outline of the ways in which valves are classified and their performance measured.

We have seen that the anode current in the particular valve we choose varies by 2 mA. for every change of 1V in the grid circuit. This, however, is true only at one anode voltage, which is called the *high tension* (HT) voltage. Fig. 6 shows a graph of anode current plotted against grid voltage for this particular valve. Each line on the graph represents the change in anode current that can be expected for various changes in grid voltage. The steepness or slope of these lines indicates the *rate of change of anode current for a corresponding change in grid voltage*. This slope is known as the *mutual conductance* and, as may be imagined, is measured in milliamps per volt. The symbol used for this in most valve tables is *gm*. Typical values for modern valves of the triode type are between 1 and 5 mA per volt.

Another and very important measure of a valve's performance is the *amplification factor*, usually designated by the Greek letter μ (mu). This is the ratio of the change in anode voltage for a given change in grid voltage *when the anode current is maintained at a constant value*. μ gives an approximate indication of the amplification that can be expected from the valve under certain conditions, which we shall deal with in a future article.

The third quality is known as either the *AC resistance* or *anode resistance*, and is designated by the symbol *Ra*. This is also available from curves (see Fig. 7). In this figure it can be seen that the anode voltage is plotted against anode current for various grid voltages. Once again the slope of the lines gives the quantity in which we are interested. In the curves shown, the *Ra* is 10,000 ohms.

μ and *Ra* are the most important of the three parameters detailed above, as most of the calculations concerning triodes are made using these.

There are many excellent tables of valve characteristics and base connections, most of which merely tabulate the μ , *Ra* or *gm*. Curves for any particular valve are obtained from the manufacturer concerned. The tables do, of course, include the recommended filament, bias and HT voltages. Unfortunately, all these lists are not consistent, in so much that if you are told the *Ra* and the μ in the case of one type of valve, another type will only have listed the *gm* and *Ra*. If, therefore, you are trying to find an equivalent type for replacement purposes, it would seem impossible to decide which are equivalent. This difficulty may be overcome by using a simple formula:

$$\mu = gm \times Ra$$

which connects the three quantities we have examined.

RC 184

FIG. VI
CURVES OF ANODE CURRENT (*Ia*)
PLOTTED AGAINST GRID VOLTAGE

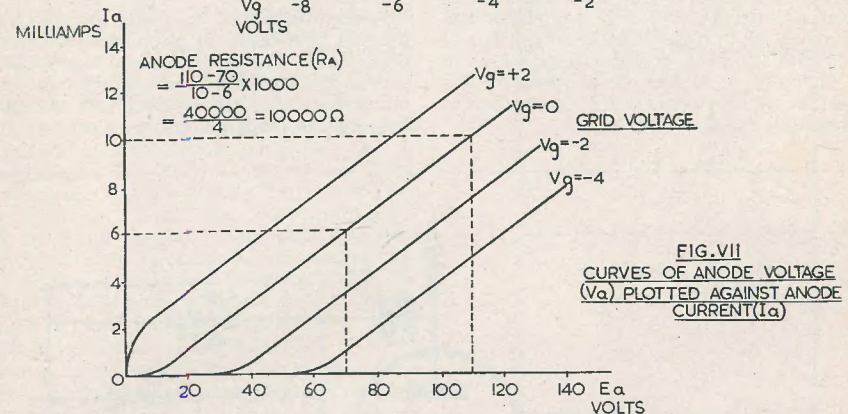
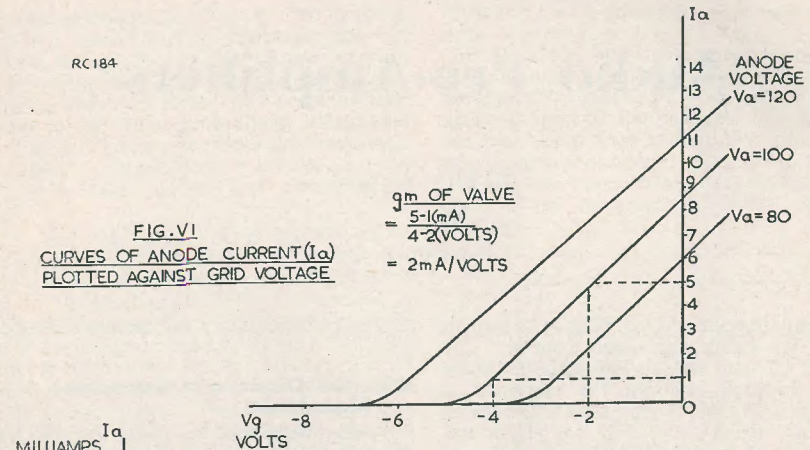

FIG. VII
CURVES OF ANODE VOLTAGE
(*Va*) PLOTTED AGAINST ANODE
CURRENT (*Ia*)

If you cannot get the hang of this at first, don't let it worry you. It will become easier to understand as you progress. The important thing to do is to read through this article carefully, and to get the feel of the expressions; get used to seeing certain words in their context. Once you have become familiar

with the technical terms, you will see that the sense comes to you quite naturally.

It is hoped in the next article to describe other types of valves, and to apply these valves and the elementary principles contained here to the design of a simple amplifier.

Coming Shortly . . .

An AC/DC Table/Console Model Large Screen Televisor,
covering all channels, and suitable for all mains inputs
200-250V AC or DC

Audio Pre-Amplifiers

By D. Nappin

PART 2

The basic circuit of this filter is shown in Fig. 4, R3 being the slope control. The capacitor C2 with resistor R4 shifts the phase of the feedback, causing the response to become as in Fig. 5b, the response of the circuit without C2 being as in Fig. 5a. High frequency roll-off, introduced by means of R and C, removes the peak giving a response as in Fig. 5c. For a further description of this circuit the writer would refer the reader to Williamson's series of articles.

described is necessary for complete compensation.

Distortion Occurring in Gramophone Reproduction

A few distortions occurring in radio reproduction also occur in gramophone reproduction, and hence correction networks as previously outlined are suitable for their correction. Among these are lack of musical balance and loudspeaker distortions.

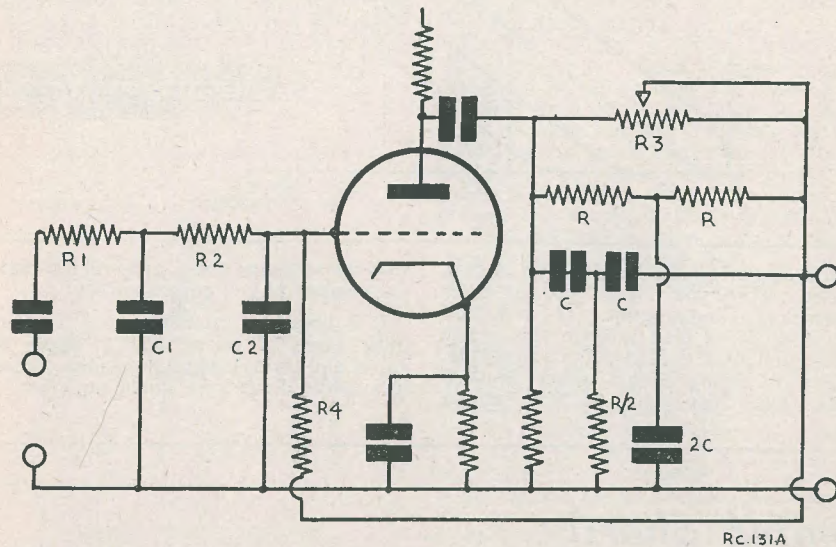

FIG. 4.

The above form of filter may only be used for variable slope of cut, boost not being obtainable, hence a normal RC circuit as previously

As is well known, gramophone records are cut to one of a number of characteristics. Considering 78 RPM recordings, there are two

main characteristics liable to be encountered, the E.M.I. and DECCA characteristics. Of these the former, for constant voltage input to the recording amplifier records, causes the recording stylus to move with constant rms. velocity for all frequencies above 300 c/s and with constant amplitude below this frequency. The DECCA characteristic is similar, but the velocity increases at 3 db per octave above 3 kc/s.

This low frequency cut is introduced to avoid the stylus developing large amplitudes at low frequencies and cutting away the groove walls. The high frequency boost, if applied, is introduced to improve the signal-to-noise ratio of the record, as surface noise is confined chiefly to the upper frequencies. A further characteristic which may be met is the American N.A.B. characteristic. This follows the ortho-acoustic system which records with constant amplitude below 750 c/s, and above this the velocity increases with frequency at 5 db. per octave from 1500 c/s, the slope from 750 c/s being about 3 db. per octave.

However, such large extents of boost tend to cause tracing distortion, particularly if the recorded high frequency amplitudes are large, as occurs with certain percussion instruments, e.g. Cymbals. Data has been published (Ref. 5) giving the maximum sound pressure from cymbals at 3 ft. between 8 kc/s and 12 kc/s as 57 dynes/sq.cm. This compares with the pressure of a 75 piece orchestra at 15 ft. which reaches a peak amplitude over the same frequency range of 8.2 dynes/sq.cm.

In view of the multiplicity of these characteristics, some means of compensation is necessary.

The form this compensation will take depends upon the pick-up.

Pick-ups fall basically into two classes, velocity pick-ups whose output is proportional to the lateral stylus velocity, and amplitude pick-ups, the output of which is proportional to the stylus amplitude.

With the first class, into which fall moving coil, moving iron and ribbon pick-ups, the output is, when plotted against frequency, the record velocity characteristic with variations due to the mechanical and electrical properties of the pick-up.

The second class, comprising crystal and capacitance pick-ups, give a response level to 300 c/s and falling after this at 6 db per octave.

Some crystal pick-ups are available which tend to a velocity characteristic due to the method of mounting the crystal. Such are the micro-cell class of pick-up, which are also notable in presenting a low mechanical impedance to the record, thus reducing acoustic output from the pick-up and permitting the use

of low tracking pressures, minimising record wear.

On account of the many types of compensation, the writer considers it preferable to apply correction by means of a separate equalising network fitted at the pick-up. These circuits are best determined empirically with the aid of a constant frequency record, e.g. DECCA K 1804. However, much information may be culled from an article by Kelly and West (Ref. 6).

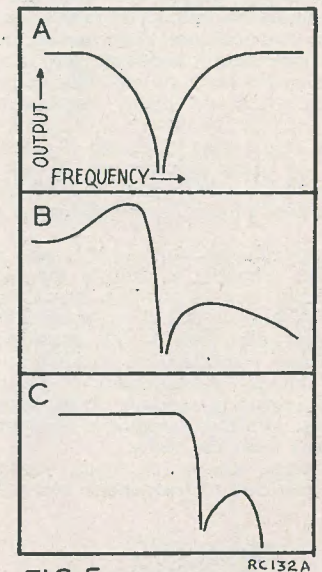

FIG. 5

A switchable circuit incorporated in the pre-amplifier, providing a 3 db per octave cut from 3 kc/s, is convenient, although the Decca characteristic may be catered for by the top-cut circuit already described.

Plug-in equalisers are by far the best system, and these may be placed either on the motor board or attached to the pre-amplifier.

However, if the constructor wishes to incorporate switchable networks in the pre-amplifier, an input stage may be incorporated to Williamson's revised specification (Ref. 7).

Other distortions occur in gramophone reproduction, one of which, namely *tracing distortion*, has already been referred to. Tracing distortion occurs when the radius of the recorded wave in the groove becomes comparable with the stylus tip radius. This form of distortion increases with increase of fre-

quency and decrease of groove speed as the centre of the record is approached, resulting in the crowding up of the undulations.

High frequency boost increases the amplitude of the curve and thereby decreases the radius. This trouble is accentuated by worn styli as these have a greater radii. As one cannot reduce the stylus diameter below a certain amount, otherwise the stylus tip would plough along the bottom of the groove, very little control over the extent of tracing distortion is possible. It may be seen by consideration of a stylus tracing a groove with recorded wave radius comparable with stylus radius that both frequency and non-linear distortion occur.

The compensation necessary here is a case of choosing the lesser of two evils. One may either accentuate the higher frequencies and thereby increase the distortion, or remove the distorted frequencies by means of a low pass filter. The latter appears to be the best solution, to the writer's point of view, and the variable slope of cut filter should prove useful here.

Intermodulation distortion may also occur, this being primarily a fault of the pick-up. Again little cure is possible, but a variable amount of top cut should prove beneficial.

The last distortion to be considered in gramophone reproduction is surface noise. This is due to inhomogeneity of the record material imparting random displacements to the stylus. Further extraneous noise may be introduced from the motor.

This noise, known as motor rumble, is mostly restricted to frequencies below 30 c/s,

and thus a suitable low frequency cut-off introduced by appropriate choice of coupling components should suffice to minimise this trouble. Surface noise, however, is mainly present at upper frequencies, which phenomenon is due in part to the random disturbances tending to excite the stylus mechanical system to oscillate at its resonant frequency.

Thus the scratch level exhibits a broad peak around this frequency. If the pick-up be so designed as to bring this resonance above the audible range, i.e. in the 20 kc/s range, and also to reduce its amplitude by suitable damping, a considerable reduction in surface noise should result. However, in the absence of such a pick-up much may be accomplished by the top cut controls previously mentioned, without too much degradation of quality.

[to be continued

References

- (1) Roddam, P., *Intermodulation Distortion*, *Wireless World*, April 1950.
- (2) Cocking, W. T., *Diode Detector Distortion*, *Wireless World*, May 1951.
- (3) Williamson, D. T. N., *High Quality Amplifier*, *Wireless World*, October 1949.
- (4) *Correspondence*, *Wireless World*, Decem-1949.
- (5) Olson, H. F., *Elements of Acoustical Engineering*, pages 481-2.
- (6) West, R. L. and Kelly, S., *Pickup Input Circuits*, *Wireless World*, November 1950
- (7) Williamson, D. T. N., *High Quality Amplifier Modifications*, *Wireless World*, May 1952.

Can Anyone Help?

Dear Sir,

Would you be so very kind as to advise me as to where I can obtain a circuit diagram and operating instructions for the ex-Service receiving unit (AM) R3170A. Of special importance to me are the characteristics of the two power transformers included in this unit. I have a number of these mains transformers on hand which I would like to use; but the chassis I have are all minus valves and with no indication as to input voltage.—

E. M. E. Decottignies, BRS1762, 58, Leigh-cliff Road, Leigh-on-Sea, Essex.

Dear Sir,

I have a Trophy 8 Receiver which is badly in need of alignment. As I have no gen on the above Receiver, I wonder if any of my fellow readers can help me with any gen on lining up, etc.—

I. P. Walker, 40 Devon Street, Beswick, Manchester 12.

An Economical Portable

By J. Saunders

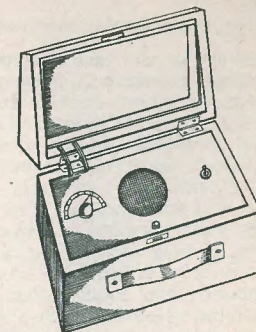

RC 158

Many people must have been restrained from buying or making a portable receiver, not by the initial cost, but by the high cost of batteries which have to be frequently renewed. People in country districts, too, who have no supply mains, are interested in a receiver which has a low drain on batteries, and this class of people seem to have been ignored by most manufacturers and radio journals, since most non-portable battery sets still use the old 2V accumulator and 120V block.

A receiver designed as an occasional portable should be readily portable, and have self-contained batteries and aerial, but it need only

be able to receive the B.B.C. and its battery need only be large enough to last the summer season; whereas a receiver for those unfortunates with no mains must have a larger battery and can with advantage receive foreign stations, but it need not be portable and it will usually have a separate aerial and earth.

This receiver was designed in an attempt to satisfy both classes of listeners and to this end a certain amount of compromise has to be made, especially so when you consider that this set is also to be very economical on batteries, and so certain components must be used which make it somewhat less portable

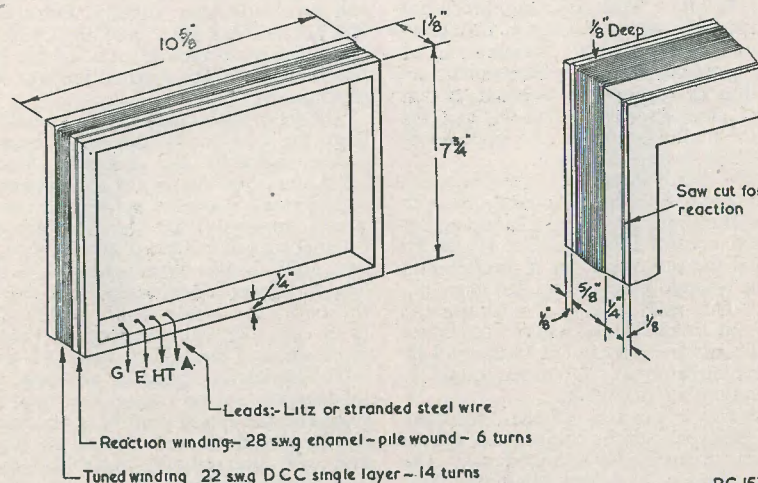

RC 157

(Practical details of Frame Aerial Construction)

than the usual 'personal' portable.

Most commercial battery sets have four valves and have an HT drain of 8 or even 10 mA, at an HT voltage of at least $67\frac{1}{2}$ volts. It is commonly thought that to have a comfortable volume from a loudspeaker, an output valve taking 3, 4 or more mA is necessary, and that for reception from a frame aerial a four valve superhet is necessary. This, however, is only true in the case of out-of-date valves or with inefficient midget components, especially the loudspeaker, in a 'personal' portable which has such a small frame aerial that great amplification is necessary. It has been found in practice, in this receiver, that using a moderate sized frame aerial, a loud signal can be heard from the Light and Home services using only two valves with a total HT current of 2 mA at 45V and 100 mA at 1.4V LT. To achieve this, however, some care has to be exercised in the selection of components. The frame aerial has to be made with care, and with thick wire so that it has a high Q, and the coupling and output transformers have to be of good quality, the former with a mu-metal core. The two valves may be bought surplus, if they are available, but it is not recommended that other types should be tried than the IN5 and 1A5 or their equivalents.

Circuits and Components

The receiver is a two valve TRF, the first valve being a leaky-grid detector with reaction, and the second a pentode output valve. The condenser-resistance combination at the grid of the first valve has the unusual values of 25 pF and 10 M Ω . This high impedance has the disadvantage of encouraging instability and, indoors, hum pick-up. However, if, as in the author's case, these two components are attached directly to the grid terminal so that the 10 M Ω goes directly to chassis, and the 25 pF to the tuning condenser, no trouble will be experienced in this direction.

This slight disadvantage is counterbalanced by the complete freedom it gives from such defects as 'threshold howl' and 'popping' as the reaction control is advanced. It will be noticed that the first valve has a positive bias of half the voltage drop across the filament, i.e. 0.7V. This was done as it increases the sensitivity for small signals, whilst it does not increase the anode current of 0.5 mA total by any appreciable amount. It causes, however, a small amount of distortion.

The reaction control is of the 'throttle' type and must be used in conjunction with a good RF choke, preferably a canned one. The reaction condenser is of the single-hole fixing, ceramic insulation type, air spaced. The coupling between the valves is a transformer,

as this is by far the most efficient method. This transformer should be of good quality, with a mu-metal or similar nickel-iron core, and, due to the low anode current, it may be of the type designed for parallel feed, as in the author's case. It may be found, especially with an old HT battery, that reversing the connections to one of the windings will increase the volume; this is due to feedback via the internal impedance of the HT battery.

The output valve is biased by the 1 k Ω resistor, with its 50 μ F by-pass condenser, and the output transformer is a good quality small component. No tone condenser was found to be necessary. In order to get as much volume as possible the loudspeaker is a 5" Rola with a high flux-density. In the author's locality (Manchester) the Light programme on 247 metres is sufficiently strong for a long wave winding on the frame aerial to be unnecessary, but a long wave winding, together with a wave-change switch, could easily be added in order to tune 1,500 metres. If the set is to be sometimes used as a non-portable it will be an advantage to add aerial and earth terminals, connecting the aerial terminal to the frame aerial via a 50 pF condenser. This enables the stronger continental stations to be received with adequate volume.

Construction

The construction of this receiver does not present any unusual difficulties, and the layout is not critical, with the exception of the grid leads to the first valve, as mentioned above. Although the sizes of the components used will no doubt vary slightly, these variations will not be very great, and so it was thought that a fairly detailed account of the constructional details of the original receiver would be of some use.

The set could be packed into a smaller layout than the one to be described, especially if smaller batteries and a smaller loudspeaker were used, but this is not recommended as it would entail a smaller aerial, and the receiver would probably not be satisfactory. The original set was built in a wooden box, attaché case style, inside dimensions $10\frac{3}{8} \times 7\frac{3}{8}$ " plan. The lid sloped downwards from the front to the back, the inside depth being $3\frac{1}{4}$ " at the front and $2\frac{3}{8}$ " at the back. The outside dimensions of the cabinet were $11\frac{3}{8} \times 9 \times 5\frac{1}{2}$ ".

The panel was made of plywood, with the loudspeaker in the centre, the switch on the right and the tuning control to the left, symmetrically placed on each side of the centre line, and with the reaction control to the front. The components are attached partly to this panel, and partly to an aluminium chassis, $3 \times 10\frac{3}{8}$ " to which is attached two brackets

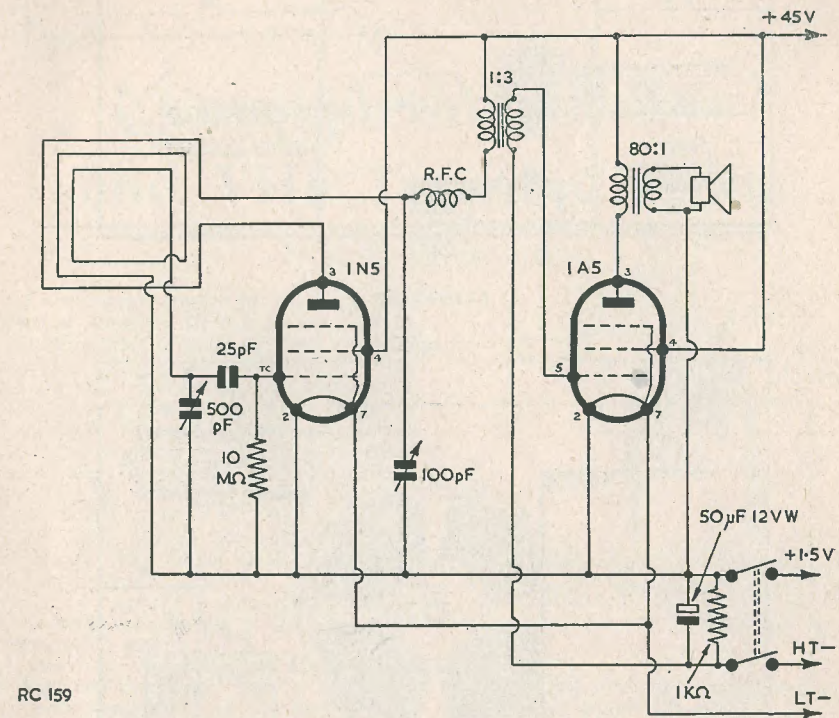

RC 159

Circuit of the Economical Portable

$3 \times 1\frac{1}{2}$ ", which support the valveholders. The chassis is cut away in the centre, close to the front panel to accommodate the loudspeaker, and the small brackets may need cutting away at the bottom front because of the slope of the set. The HT battery is supported away from the on-off switch by means of pieces of wood, and it is held in place by strong rubber bands, or by a spring clip. The LT battery is held by a spring holder, attached to the front panel.

The four connections to the aerial go to an American type mica insulated plug, 9-pin, the socket of which is attached to the side of the case. The leads from this socket to the frame aerial should be of good flexible wire with a heavy rubber covering, otherwise trouble may be experienced from the wire breaking inside its sheath. These wires should be clamped at each end, whilst leaving a certain amount of slack. Two holes should be cut in the front

panel for these wires, so that the two wires to the tuned coil run together, as do the two to the reaction. If a guide is attached to the case underneath the panel so that the wires are prevented from moving away from the side of the case, then it will be found that the wires move smoothly in and out when lowering and raising the lid.

The frame aerial is constructed from four pieces of wood, two $10\frac{3}{8} \times 1\frac{3}{8} \times \frac{1}{4}$ " and two $7\frac{3}{8} \times 1\frac{3}{8} \times \frac{1}{4}$ ". These are cut at the ends so as to form a frame, which can be reinforced at the corners by wooden brackets. Grooves $\frac{1}{8}$ " deep are cut for the windings, one $\frac{3}{8}$ " wide for the tuned winding, and a wide saw cut $\frac{1}{4}$ " away from the tuned winding for the reaction winding. If this spacing is not observed the reaction control will not be able to oscillate over the whole tuning range, due to capacity effects. The tuned winding consists of 14 turns 22 swg double cotton covered in one

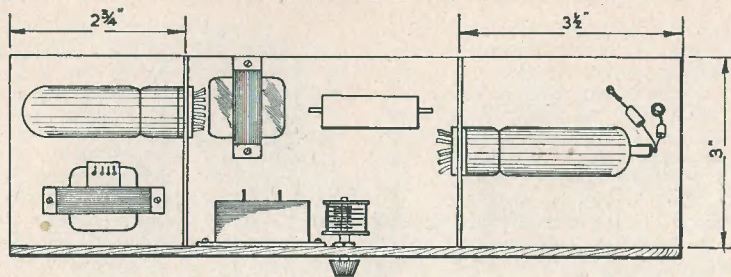

ELEVATION

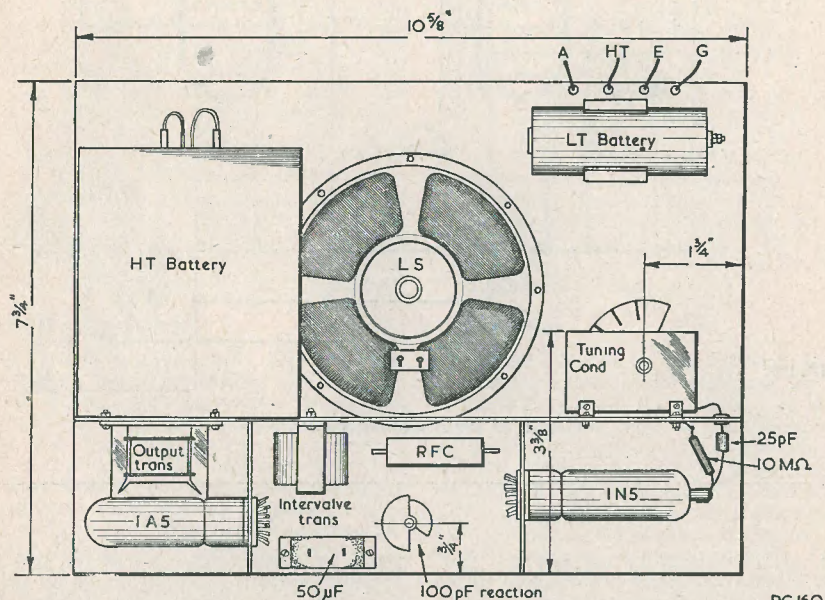

PLAN

layer, the grid end being the end furthest from the reaction winding, which is 6 turns 28 swg enamel wire, pile wound. If the receiver will not oscillate, the usual precaution of reversing the connections to the reaction winding can be taken. The lid can be held up by any suitable stay.

Calibration of the receiver is simple and consists merely of tuning to known stations and marking their positions on the dial, which consists of an aluminium pointer attached to an epicyclic slow motion drive, and a plastic scale. A tuning range of 170m to 520m approx. may be expected.

List of Components

500 pF tuning condenser.
100 pF reaction condenser.

25 pF fixed condenser, mica or ceramic.
50 μ F 12VW electrolytic condenser.
10 M Ω resistor.
1 k Ω resistor.
RF Choke.
3:1 interval transformer.
80:1 output transformer.
2 International octal valveholders, paxolin or amphenol.
DPST on-off switch.
5" PM speaker.
V2 1A5GT/G
V1 1N5G (DF33).
2 knobs, 5:1 drive, chassis, case etc.
45V Ever-Ready B.104 (Drydex 504) HT Battery.
1.5V U2 or U17 dry cell LT Battery.

A Ready Reference to the Construction of TV and VHF Tuned Circuits

By H. E. Smith, G6UH

It is not an easy matter for the home constructor to translate from a circuit diagram the actual number of turns required when the inductance value is given in microhenries. If the job under construction is for operation on the lower frequency bands, say from 14 Mc/s down to 500 kc/s, it is not so important to be highly accurate as any error to within 5% or so may be corrected by an adjustment of the trimmer across the tuning capacitor. For frequencies above 14 Mc/s and up into the TV and VHF region, the translation from microhenries into actual turns becomes a matter requiring great accuracy, and the usual ABAC's are normally a little complicated to follow, unless one has had a fair amount of experience with them.

As an aid to the constructor the following data has been compiled. Bear in mind that all coils are wound with 16 swg enamelled or silver plated wire, wound 8 turns to the inch (i.e., $\frac{1}{8}$ " clearance between each turn), on $\frac{1}{2}$ " diameter formers. All values given include $\frac{1}{4}$ " leads to the coil, and the capacitance values given are exclusive of circuit "C" or valve capacitance (*more on this later*).

By carefully following the details given, the constructor will have little difficulty in winding his coils for VHF receivers, TV strips, or absorption wavemeters, and they will be right first-time, thus avoiding much waste of time in finding a coil to be too small and having to remove and rewind it.

Before going any further, however, we must now see how much reduction in the values given in the tables is necessary to compensate for the additional capacitance introduced by the valve and the associated circuit.

Taking the circuit "C" first, we must allow about 1 to $1\frac{1}{2}$ pF for the circuit "C" of a well-built VHF or TV circuit. If the coil is screened, as much as 4 or 5 pF will have to be allowed. (It should be noted that if an absorption wavemeter is being built, the figures will remain unaltered. For instance, a wavemeter of this type for the 2 metre band could consist of a 6-turn coil tuned with a variable capacitor of 8 pF maximum capacitance,

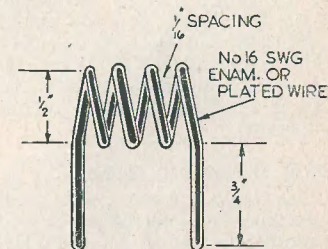

METHOD OF CONSTRUCTING THE COILS.
1 TO 4 TURN COILS MAY BE SELF-SUPPORTING FOR THE LARGER COILS A $\frac{1}{2}$ PAXOLIN FORMER IS RECOMMENDED

RC156

ance, and this will resonate to 145 Mc/s with the vanes at about half mesh.

Valve input and output capacitance

The constructor of TV or VHF equipment should know what capacitance any given valve will place across the circuit. This information can be obtained from valve manufacturers, but for the convenience of readers a short list of the better known types of valves, with their input and output "C" is given below. (Knowing the output "C" will assist in estimating the value of capacitance required in the anode circuits of RF amplifiers).

Type	Input "C"	Output "C"
6AB4	2.2pF	0.5pF
6AH6	10.0pF	2.0pF
6AK5	4.3pF	2.1pF
6AM6	7.5pF	3.25pF
6AU6	5.5pF	5.0pF
6C4	1.8pF	1.3pF
6J4	5.5pF	0.24pF (as G.G. triode)
6J6	2.2pF	0.4pF
12AT7	2.5pF	0.4pF

The latter two are the figures for each half of the valve, so that when used in a push-pull circuit the figures may be halved.

Taking an example, then, we find that if we are to use a 6AK5 as an RF amplifier, at 45 Mc/s, the table gives us 14 turns for the coil, and 17pF for the tuning capacitor. From this latter value we must subtract 4.3pF to allow for the valve capacitance, and a further 1½pF for circuit "C," thus making the required capacitance 11.2pF (near enough 11pF).

Some constructors may prefer to use the dust-iron slug method of resonating the coil, which usually means that it is not possible to mount the coil close to the valveholder. So, remember that by increasing the length of the lead to the coil you increase its total inductance, and lessen the chances of obtaining stable results because of the long leads carrying RF being liable to radiate into the next stage. This is often the cause of oscillation in RF amplifiers.

Effect of dust iron tuning

Dust iron plunger tuning increases the inductance and lowers the "Q." This method is frequently used in TV and VHF RF amplifiers because a sharply tuned and selective circuit is not necessary; in fact, it is undesirable. For the coils described above, a ¾" × ¾" dust-iron plunger will increase the inductance value by approximately twice when it is fully engaged within the coil. In other words, a 6-turn coil, as described above, with a valve and circuit capacitance of 4 pF, and tuned with a dust-iron plunger mounted centrally through the coil, will tune from approximately 150 Mc/s to approximately 110 Mc/s. As the frequency decreases the coverage will be less. For instance, a 1µH coil increased to 2µH by a dust-iron slug, with 10pF or so of valve and circuit "C," will provide a coverage of from 50 to 36 Mc/s. (These few notes on dust-iron tuning are intended only as a guide. There are so many variable factors involved, such as

the actual type of dust-iron slug used, that it is not possible to lay down any tables for frequency coverage using this system of tuning)

No. of turns	µH	Frequency	Capacitance (pF)
1	0.05	450 Mc/s	2.5
		400 Mc/s	3.0
		350 Mc/s	4.0
		300 Mc/s	5.5
2	0.08	300 Mc/s	3.5
		250 Mc/s	5.0
		200 Mc/s	7.5
		150 Mc/s	13.0
3	0.12	200 Mc/s	5.0
		150 Mc/s	9.0
		140 Mc/s	10.5
		130 Mc/s	12.0
		120 Mc/s	14.0
4	0.18	150 Mc/s	6.0
		145 Mc/s	6.5
		140 Mc/s	7.0
		120 Mc/s	10.0
		100 Mc/s	14.0
6	0.28	150 Mc/s	4.0
		100 Mc/s	9.0
		90 Mc/s	11.0
		80 Mc/s	14.0
8	0.4	95 Mc/s	7.0
		80 Mc/s	10.0
		70 Mc/s	13.0
		60 Mc/s	17.0
10	0.5	70 Mc/s	10.0
		60 Mc/s	13.5
		50 Mc/s	20.0
		40 Mc/s	30.0
14	0.7	50 Mc/s	14.0
		45 Mc/s	17.0
		40 Mc/s	22.0
		30 Mc/s	40.0
19	1.0	30 Mc/s	28.0
		29 Mc/s	30.0
		28 Mc/s	32.0
		20 Mc/s	60.0

The above figures are accurate to within approximately 1%, and when fixed capacitors are used they should be of 1% rating.

THE RADIO AMATEUR

April issue contents include

- "THE GROUND PLANE AERIAL"
- "AERIAL RADIATION PATTERNS-HELIX"
- "HUNA QUWAIT"
- "UNEQUAL EQUALITY"
- "THE DESIGN OF MAINS TRANSFORMERS" contd.
- "SW BROADCAST STATION LIST"

as well as the usual Broadcast Bands Review, Amateur Bands Commentary, On the Higher Frequencies, Strictly for the Beginner, etc., etc.

Nife Batteries

Dear Sir,

We should like to draw your attention to a reference to NIFE ALKALINE Accumulators appearing on page 285 of your current issue in which the author's remarks are rather misleading.

In the first place, NIFE cells have a potential of 1.2 volts, and not 2.5 volts per cell, although it is true that some twin cell units are made which consist of two cells welded together, the container acting as the series connector. Such cells have a potential of approximately 2.5 between the main terminals, and the steel container is at a potential midway between the terminals.

Secondly, we are of the opinion that the filament life of the valves would be considerably curtailed if such a twin cell 2.5 volt battery were used to run 2.0 volt valves unless a suitable resistance was used in series.

NIFE cells should be topped up with pure distilled water and never with electrolyte. Sulphuric acid would, of course, destroy the cells.

Incidentally, a single NIFE cell is suitable for supplying 1.4 volt valve filaments but we regret that, at the present time, we are not in a position to supply any cells for domestic or portable radio equipment.

We shall be pleased to give you any further information you may desire and would assure you of our co-operation at all times.—
A. E. DIGGENS, Publicity Dept., Nife Batteries, Redditch, Worcs.

Sir, May I thank Messrs. Nife Batteries for their interest in and comments upon part three of "Valves And Their Power Supplies"?

The Edison cell, of which "Nife" cells are perhaps a development, does have a potential of 1.2 to 1.3 volts, as Messrs. Nife suggest, but as Nife batteries are popularly obtainable as twin cell units I did not consider it worth while mentioning the rather rare single cell type.

Although valve manufacturers most certainly would not agree, I see little additional harm in running 2V valves from the 2.4V or 2.5V of a Nife battery.

The plain fact of the matter is that these valves never have received their correct potential. A fully charged lead-acid accumulator has a potential of 2.3V on the comparatively light loading of a battery receiver—whilst in some cases, e.g. when a large capacity accumulator is used with a very small set, the potential may be as high as 2.5V.

It is not altogether impossible, too, that Nife twin cell batteries were manufactured with a special eye to battery receiver valves.

However, constructors may use a series resistor of 1 ohm, if they prefer to do so (three

from our



Mailbag

yards of 34 S.W.G. enamelled copper wire wound upon a small bobbin, is quite suitable, and thereby lengthen the life of their valves.

Inadvertently, I stated that distilled water and sulphuric acid should not be added to an alkali accumulator. Distilled water may, of course, be added, but sulphuric acid may not.

As the case of the "Nife" battery (twin cell type) is at a potential of 1.2V to the negative terminal, the steel case must not be allowed to come into contact with the receiver chassis. These cells, in fact, are better and more safely used if contained in a small wooden box.—
Yours faithfully, F. L. BAYLISS, Binley Woods, Coventry.

For
SUCCESSFUL
wide-angle
scanning

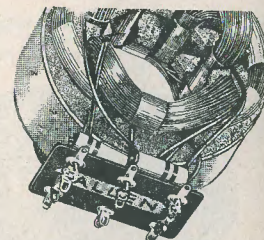

ALLEN DEFLECTOR COILS

70° Scan with minimum deflection defocusing High-efficiency castellated "FERROXCUBE" core. Suits any wide angle C.R.T. up to 27" double (d) Scan.

LARGE SCREEN TELEVISION
Can only be achieved by using high efficiency components throughout. ALLEN can supply the complete range.

For prices and details of the full range of ALLEN components—Write to

For circuit diagram of line and Time Base send 9d. and stamped addressed envelope to

ALLEN

WORKS LIMITED
Crown Works 197 Lower Richmond Rd
Richmond Surrey
Telephone Prospect 9013

NEW!**E·M·I INSTITUTES
EXPERIMENTAL KIT****LEARN THE PRACTICAL WAY**

A specially prepared set of radio parts from which we teach you, in your own home, the working of fundamental electronic circuits and bring you easily to the point when you can construct and service a radio set. Whether you are a student for an examination, starting a new hobby, intent upon a career in industry, or running your own business—this Course is intended for YOU—and may be yours at a very moderate cost. Available on Easy Terms. WE TEACH YOU: Basic Electronic Circuits (Amplifiers, Oscillators, Power Units, etc.) Complete Radio Receiver Testing & Servicing

POST IMMEDIATELY FOR FREE DETAILS

TO: E.M.I. INSTITUTES Dept. 179 X
Grove Park Rd., Chiswick, London, W.4

Name

Address

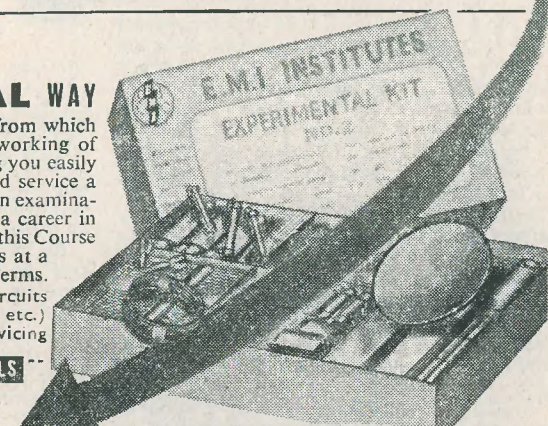

EMI INSTITUTES
Associated with
MARCONIPHONE
COLUMBIA & HMV
His Master's Voice

I.C.12

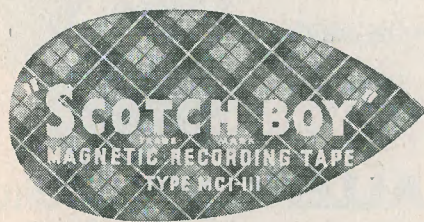

This plastic backed, strong and reliable tape offers high fidelity reproduction over a wide range of playing speeds and recording conditions.

Medium coercivity gives a high signal output with an extended high frequency response, while retaining ease of erasure.

'Scotch Boy'
is now available in
6
reel sizes

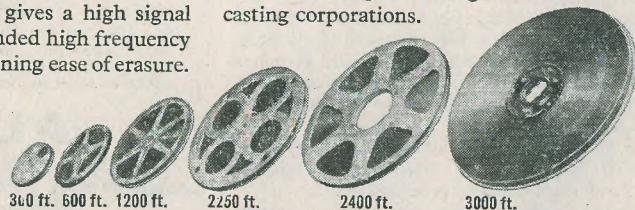

360 ft. 600 ft. 1200 ft. 2250 ft. 2400 ft. 3000 ft.

Write for further particulars

Minnesota Mining & Manufacturing Co. Ltd, 167 Strand, London W.C.2

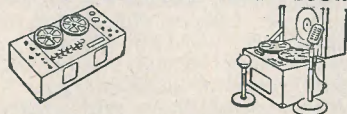
ANOTHER **3M** PRODUCT**TO FIT ALL MAKES OF TAPE RECORDER**

Signal/noise ratio is high; transfer and distortion negligible.

'Scotch Boy' is used by the B.B.C. and most other big recording and broadcasting corporations.

DUKE & CO.**Coronation
QSL's**

Why not send a
distinctive QSL this year?

Special designs to celebrate
Coronation Year, available
from G6MN who has supplied
'special' QSL's for discriminating users all over the world.

Attractive
"Coronation-1953" designs
now available from . . .

**G6MN Castlemount
Workshop Notts.**

LOUD HAILER. Very powerful P.A. system. New. No Valves to break or damage. Works off 12 or 24 volts, independent of mains failures. Weather-proof. Consists of microphone and combined amplifier/speaker. PRICE £8/17/6. Carriage 5/6.

TRANSFORMERS. Clearance of unused, but store soiled, O.P. transformers. Match all normal O.P. valves to 2-5 ohms. OFFERED at 1/9. Post 6d.

CONDENSERS. Unused, store soiled, tested, .0005mfd, two-gang, standard size tuning condensers at 2/9. Or BARGAIN OFFER of 3 for 7/-.

VALVES. Surplus and salvage sale. At 8/9: PL81, PL82, PL83, PY80, PY82, ECL80, 20F2, 10F1, 35Z4, 10P13, X66, 1S4, 1S5, 1R5, 1T4, EF91, 6F15, EL91. At 2/6: 4D1, 8D2, 9D2, 15D2. VR78 (D1, diode) at 3 for 2/6.

SUPERHET RECEIVER. Six-valve, superhet, V.H.F. Six channel switching, 30.5 to 40 mc/s, I.F. 7 mc/s. Receives TV, Police, Fire, Taxis, amateurs, and most British and Continental stations. Since the valve line-up has been easily available at ex-W.D. prices we are offering the chassis at 7/6, or complete with valves at 17/6. Post 2/9. Components include 30 ceramic trimmers, 30 small condensers, six valve holders, cans and covers, 30 resistances (½ to 1 watt), 2 transformers, 3 coils, etc.

ACCUMULATORS. Brand new. 2 volt, 14a/H. Lead acid. 1½" x 1½" x 6". BARGAIN 4/6. Post 1/-.

RADIO-TELEPHONE. New and boxed walkie-talkie sets. 53-75 mc/s. Visual range. Tunable. Telephone handset operation. Works off set of internal batteries, or vibrator unit from 12 volts. Offered less batteries or vibrator at SPECIAL PRICE of £9/17/6, or £18/17/6 per pair. Vibrators 37/6 each. Carriage 6/6 each.

C.W.O. or C.O.D. Money Back Guarantee

621 REMFORD ROAD LONDON E12

Stamp for Catalogue

Telephone GRA 6677

BENTLEY ACOUSTICS LTD

38 CHALCOT ROAD NW1

PRImrose 9090

OZ4	6/6	807	8/6	12J5	4/9
7C5	7/0	6B8	5/6	6K6	7/6
5Z4	9/0	6SA7	7/6	7C6	7/0
7S7	7/0	7Y4	7/0	6SS7	5/0
6SN7	8/6	6SK7	5/6	12SQ7	8/6
6SJ7	6/6	6X5	7/0	6SL7	8/0
6N7	6/6	6AC7	5/0	6J5	4/6
6K7	4/6	12SK7	7/0	MH4	5/0
12AH7	9/0	16Z5	5/0	7R7	7/0
6SG7	6/0	12C8	9/0	6F6	8/6
6F7	8/6	77	6/6	12AU7	9/0
12AT7	9/0	1T4	7/0	QP21	10/0

All Guaranteed.

Post 6d.

WE ARE ALL BROKE

That's a FACT

Then send S.A.E. for

LAWRENCE'S SMASHING BARGAINS LIST

of Radio and Model Railways

Lawrence Frankel

MAIL ORDER

134 Cranley Gardens London N10
Telephone TUDor 1404**SPECIAL OFFER****12 volt PHILIPS MOTORRADIOS**Brand New in makers cartons
with full guarantee

List Price £34 4s. 6d.

OFFERED at £17 17s. 0d. (carriage etc. 10/-)

Limited quantity only and unrepeatable
when stocks sold**J. T. ANGLIN**160 CLEETHORPE ROAD GRIMSBY Lincs
Telephone 56315**ADCOLA**

(Regd. Trade Mark)

SOLDERING INSTRUMENTSReg. Design No. 860302
(British, U.S. and Foreign Patents)

Designed for wireless assembly and Maintenance

Supplied for all volt ranges from 6/7v to 230/250v.
3/16" Dia. Bit Standard Model 25/6Sole Manufacturers **ADCOLA PRODUCTS LTD.**Sales Office and Works: Cranmer Court,
Clapham High St. London SW4 (MAC 4272)

See the Coronation on Large Screen TV.

Magnaview Tele-King, Viewmaster



DARK SCREEN FILTERS (LATEST TINT)

12 1/2 in. x 14 1/2 in. For 16 and 17 in. c.r. tubes, 25/-, 1 1/2 in. x 13 1/2 in. For 9, 10 and 12 in. c.r. tubes, 15/11.

PERSPEX

13 1/2" x 10 1/2" x 1/2". Neutral shade, slightly marked, 5/11 Per piece.

THE TELE-KING
Large screen television for home construction. Superhet, 5 channel, 32-page booklet and full-size wiring diagrams.
PRICE 6/- POST FREE

VIEWMASTER. LARGE SCREEN CONVERSION. Write for Details.

ALL THE NEW W/B COMPONENTS NOW IN STOCK.

ELECTROLYTIC CONDENSERS

8 mfd. 450 v.w.	2/3	12x12 mfd. 350 v.w.	3/6
8 mfd. 500 v.w.	2/11	15+16 mfd. 500 v.w.	4/6
16 mfd. 350 v.w.	2/6	16+24 mfd. 450 v.w.	5/11
16 mfd. 500 v.w.	3/6	32+100 mfd. 450 v.w.	7/6
32mfd. 500 v.w.	4/11	60+100mfd. 350 v.w.	9/6
50 mfd. 350 v.w.	3/11		
60 mfd. 350 v.w.	3/11		
250 mfd. 12 v.w.	2/-		
250 mfd. 350 v.w.	4/11	25 mfd. 25 v.w.	1/6
8+8mfd. 450 v.w.	4/6	50 mfd. 12 v.w.	1/6
8+16 mfd. 500 v.w.	4/11	50 mfd. 50 v.w.	1/6
		75 mfd. 12 v.w.	1/-

ALL BRAND NEW AND GUARANTEED (NOT EX-GOVT.)
All other types, Paper, Tubular, Waxed, etc., in stock.

LASKY'S RADIO

Lasky's (Harrow Road) Ltd. 370 HARROW RD PADDINGTON LONDON W9

(Opposite Paddington Hospital) Telephones CUNningham 1979 and 7214. All Departments. Hours Mon. to Sat. 9.30 a.m. to 6 p.m., Thurs. half day 1 p.m.

MAIL ORDER & DESPATCH DEPARTMENTS 485/487 Harrow Road Paddington London W 10
Terms Pro Forma, Cash with Order, or C.O.D. on post items only. Postage and packing on orders value £1-1/- extra, £5-2/- extra, £10-3/6 extra. Over £10 carriage free. All goods fully insured in transit.

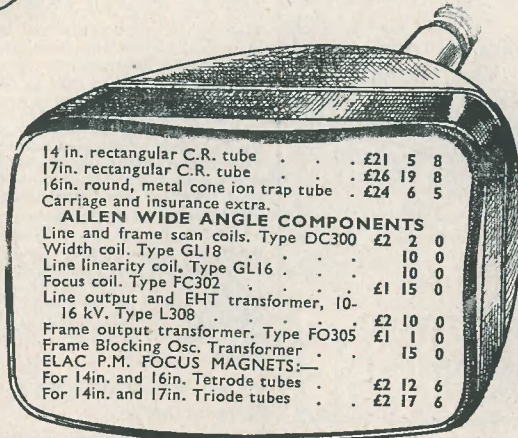

14 in. rectangular C.R. tube . . . £21 5 8
17 in. rectangular C.R. tube . . . £26 19 8
16 in. round, metal cone ion trap tube . . . £24 6 5
Carriage and insurance extra.

ALLEN WIDE ANGLE COMPONENTS

Line and frame scan coils. Type DC300 £2 2 0
Width coil. Type GL18 . . . 10 0
Line linearity coil, Type GL16 . . . 10 0
Focus coil. Type FC302 . . . £1 15 0
Line output and EHT transformer, 10-16 kv. Type L308 . . . £2 10 0
Frame output transformer. Type FO305 £1 1 0
Frame Blocking Osc. Transformer . . . 15 0
ELAC P.M. FOCUS MAGNETS.—
For 14 in. and 16 in. Tetrode tubes . . . £2 12 6
For 14 in. and 17 in. Triode tubes . . . £2 17 6

THE MAGNAVIEW

Large screen television. Construction booklet.
PRICE 6d. POST FREE

SPECIAL CORONATION C.R. TUBE OFFER.

Brand new and unused 12 inch ion trap cathode ray tubes. By famous manufacturer, 6.3 volt heater, 7-9 Kv. E.H.T. 35mm neck. Black and white picture. £11 19s 6d with slight screen blemishes. £12 19s 6d absolutely perfect. Carriage and insurance 15/- per tube extra.

CATHODE RAY TUBES MASKS

New aspect ratio.

9 in. Sorbo, 5/-.
10 in. Double D. Metal 7/6.
12 in. 15/-.
12 in. Flat Face, 15/-.
14 in. Rect., 21/-.
16 in. Double D., 31/6.
17 in. Rect., 27/6.
12 in. Soiled, 7/6.
12 in. Soiled, with fit.ed safety glass, 11/6.

THE VIEWMASTER

Television for the home constructor at its finest. 32-page booklet and 8 full-size wiring diagrams.
PRICE 7/6. Post F.ree. State station required

ARMOUR PLATE GLASS

15 in. Actual size, 18 1/2 in. x 19 1/2 in. x 3/4 in. 7/11. 12 in. Actual size, 13 in. x 10 1/2 in. x 3/4 in. 4/-. 9 in. Actual size, 9 in. x 8 in. 3/4 in., 3/-.

15 INCH CATHODE RAY TUBE MASKS No. 1. Cream rubber. Latest aspect ratio. Overall dimensions: 17 ins. wide, 13 ins. high. Price 17/6. Postage 2/- extra

No. 2 Plastic, incorporating gold finish tube escutcheon, and dark screen filter. Latest aspect ratio. Overall dimensions 15 in. wide, 12 in. high. Price 21/-. Postage 2/- extra.

T.C.C. VISONOL HIGH VOLTAGE CONDENSERS ("CATHODRAY")

.001 mfd. 12.5 Kv., 7/6
.001 mfd. 15 Kv., 10/-
.001 mfd. 25. Kv., 18/-
.0005 mfd. 25 Kv., 18/-
.0005 mfd. 12.5Kv., 10/-
.1 mfd. 7 Kv., 15/-
.04 mfd. 12.5 Kv., 7/6
Plastic case, single bolt fixing.

WE HAVE THE GOODS

WRITE, 'PHONE CALL NONE TO BEAT LASKY'S

Small Advertisements

Reader's small advertisements will be accepted at 2d per word, minimum charge 2/-. Trade advertisements will be accepted at 6d per word, minimum charge 6/-. If a Box number is required, an additional charge of 1/- will be made. Terms: Cash with order. All copy must be in hand by the 12th of the month for insertion in the following month's issue.

PRIVATE

EXCHANGE. Nine volumes *Second Great War* with bookcase, for unmodified R1155 with mains power pack and loudspeaker. Box. No. C116.

SELLING OUT. All post free, 807 8/6, 5R4GY 8/-, 6SH7 4/6, SP61 4/6, 6SK7 5/6, 6F8 5/-, few other types, list free. Parcels containing fuses, valveholders, wire, sleeving, cable markers, condensers, resistors, trimmers, nuts, bolts, washers, switches, etc., 5/6 per parcel. Genuine offer. George, 164 West Street, Gorseinon, Swansea.

UNIQUE BARGAIN. VCR97, 1355 complete Vision receiver and Time Bases with HT and EHT Units in working order. Spare tube and valves with magnifier. RF25 and RF26 units. Want sound strips added, particulars included. Owner used separate set. Best offer over £8 for quick sale. Box No. C115.

FOR SALE. Eddystone S640, choice of two, mint condition, matching speakers; two German receivers and spares; model 18 receiver. Offers, buyer collects. Fawkes, St. Chloe Green, Amberley, Surrey.

FOR SALE. Perfect CRM92 deflection and focus coils, 45 Mcs Pye Strip with Video and Sync and circuit, also sound receiver 4xEF50. The lot £9. Banting, 75 Queens Avenue, London, N.20.

FOR SALE. RF26/1355 Vision unit with 2500/500/6.3 power pack. RF26/1355 Sound unit with mains pack VCR97 with Time Base (needs completing), £12/10s the lot. RF25/1355 modified for Sutton Coldfield, with mains pack, £4. VCR97 £1. Other units, valves, etc. Purdue, Gladstone Road, Birmingham, 11.

FOR SALE. Communication receiver, AR88 (top line), elliptical mains speaker incorporated, £40. Box No. C111.

FOR SALE. Experimenter has few Z77 valves surplus to present requirements. Guaranteed brand new and unused. 7/6 each. (No dealers). Box No. C112.

FOR SALE. AVO Valve Tester, roller panel, booklet, etc. £10. VCR 97 two for 37/6. EHT Transformer 27/6, magnifying lens for same 15/-. EF50's 4/-, 6SN7's 6/6. Box No. C114.

FOR SALE. Receiver R1155, slightly used but in order. DF components removed, available. Also power pack for above (new components), Solon soldering iron (as new), sundry booklets, etc. £8 the lot. Box No. C113.

HENRY'S

5 HARROW ROAD LONDON W2

Open Mon. to Sat. 9-5.30 (Thurs. 1 p.m.)

Telephone PAD 1008/9 and 0401

SPECIAL VALVE OFFER

Pen EF50 Brand New (Ex-Units) 55/- set.

SET OF 5 MAINS VALVES
6K8CT, 6K7GT, 6Q7G, 5Z4, 6V6G or KT61, at 42/6 Set.

SET 5 AC/DC VALVES
6K8GT, 6K7G, 6Q7G, 25A6G, 25Z6G at 42/6 Set.

SET 5 AC/DC VALVES
6A7G, 6D6, 6C6, 43, 25Z5 at 42/6 Set.

SET 5 AC/DC VALVES
12K8GT, 12K7GT, 12Q7GT, 35Z4GT, 35L6GT or 50L6GT at 42/6 Set.

SET 5 AC/DC VALVES
12SA7GT, 12SK7GT, 12SO7GT, or 12SR7GT, 35Z4GT, 35L6GT or 50L6GT at 42/6 Set.

SET OF 4 BATTERY MINIATURE 1.4v. VALVES
1R5, 1S5, 1T4, 1S4 or (3S4 or 3V4) at 32/6 Set.

SET OF BATTERY VALVES 2 volt MAZDA TYPES
TP25, HL23/DD; VP23, PEN25 or QP25 at 27/6 Set.

COMPLETE SET OF 10 SPECIFIED VALVES FOR "PRACTICAL TELEVISION" PERSONAL REC.
5-6AM6, 2-6AK5, 1-EA50, 1-616, 1-614 and 3BP1 C/R Tube in case at £5.12.6 Set.

L.T. RECT'S

6v. 1 amp G.E.C.	4/-
12v. 2 1/2 amp. Westinghouse	12/6
12v. 4 amp. S.T.C.	17/6
12v. 8 amp. S.T.C.	32/6
S.T.C. RECT'S, E.H.T.	
K3/25 650v. 1 m/a.	4/7
K3/40 1000v. 1 m/a.	6/-
K3/100 8,500v. 1 m/a.	14/8
K3/200 10,500v. 1 m/a.	26/-
H.T. RECT'S	
S.T.C. 150v. 120 m/a.	4/6
S.T.C. 250v. 250 m/a.	18/-
G.E.C. 1 m/a. Meter Rect.	11/6

RECEIVER R1355. As specified for *Inexpensive Television*. Complete with 8 valves VR65 and 1 each 5U4G, VU120, VR92. Only 55/- carriage 7/6. Brand new in original case.

RF24 25/-, RF25 25/-, RF26 59/6, RF27 59/6.

CATHODE RAY TUBES

VCR97. Guaranteed full picture 40/-, carriage 5/-.
VCR517. Guaranteed full picture 40/-, carriage 5/-.
3BP1 Suitable for 'scopes 25/-, carriage 3/-.
Mu-Metal Screens 12/6. 6" Enlargers 18/6.

PYE 45 Mc/s STRIP. Special purchase of M.O.S. Type 3583 Units. Size 15" x 8" x 2". Complete with 45 mc/s Pye Strip, 12 valves, 10 EF50, EB34 and EA50, volume controls and hosts of Resistors and Condensers. Sound and vision can be incorporated on this chassis with minimum space. New condition. Modification data supplied. Price £5, carriage paid.

INDICATOR UNIT TYPE 1B2A. This unit contains VCR517 Cathode Ray 6" Tube, complete with Mu-metal screen, 3 EF50, 4 SP61 and 1 5U4G valves, 9 wire-wound volume controls and quantity of Resistors and Condensers. Suitable either for basis of Television (full picture guaranteed) or Oscilloscope. Offered BRAND NEW (less relay) in original packing case at 79/6. Plus 7/6 carriage.

VCR517C BLUE AND WHITE 6 1/2 in. TUBE
This Tube replaces the VCR97 and VCR517 without alteration and gives a full Blue and White picture. BRAND NEW in original crates, 45/-, plus 5/- carriage.

"WEYMOUTH" 3-WAVE BAND COIL PACKS
Short, Med. and Long with Gram. Switch. Brand New Miniature type complete with circuit, 19/6. P.P. 1/6 Absolute bargain.

SEND FOR 3d. 28-PAGE CATALOGUE

FRED'S Radio Cabin

Olympic Coil Packs, 3 Wave Band	24/6
AC/DC Amplifiers	£3.15.0
AC. TRF Midget Sets	£6.10.0
Tyana Soldering Irons	16/9
Sleeving (12yds.)	2/9
400Ω w/w Pots	2/6
VR54	2/6
6K, 7K, 10K, 30K, w/w 2 Low Res.	1/6
50 pF and 20 pF Ceramic Trimmers	1/-
3P., 3w., WCS	2/3
Indoor T.V. Aerial	7/6
10 Amp. Mains Filters	10/-
4P., 2w., WCS	2/6
8 way Jones Plugs, 1/-	6 Pin, 6d.
3 Link Aerial Insulators	6d.
1", 1½" Plastic Tube	1/- yard
Yaxley Wafers, 2P., 4w.	3d. ea., 2/6 doz.
.005/1,000 volt, Tubular Condensers	6d.
.5 and .25, 350 volt	6d. ea., 4/- doz.
240,000Ω, 5w., Carbon	6d. ea., 4/- doz.
.0003 T.C.C., Mica Condensers	6d. each

77 NEWINGTON BUTTS
ELEPHANT AND CASTLE
LONDON SE 11
RODNEY 2180

Aerial Coupling Unit. Contains variometer 2" round thermoammeter reading 0-350. All contained in neat aluminium box 5"x5"x5" with a 5"x5"x1" lid. Complete with a carrying strap, 8/6 Post 1/9.

VCR97 Bases. Brand new, 2/6. Post 6d.
Uniselectors Minor Type. 2 banks of 10 contacts, will operate from 24V or 12V with slight adjustment, has electro magnetic release when wipers reach end of the bank. Resistance of drive coil 50 ohms, release coil 70 ohms. These are ideal for sequence switching, model radio control telephone exchanges, etc. Used, but new condition, 25/-, Post 1/6.

Magnetic Movements 12V operating ratchet which in turn revolves 120 tooth wheel, suitable for slave clocks, etc. Price 1/6. Post 9d.

Rotary Converters D.C. input 12V. A.C. output 230V. 50 cy. sp. at 100 watts. Price £6 0s 0d. Carriage 7/6. Ditto D.C. input 24V. A.C. output 230V. 50 cy. sp. at 80 watts. £5 0s 0d. Carriage 7/6.

Mumetal Screens VCR 97. 8/6. Post 1/-.
Camera Control Units Less relays but containing press switch, toggle switch, indicator light, condenser, etc., all contained in grey metal box 8"x5"x3". 3/6. Post 1/9.

Variable Condensers Single Gang. Brand new. 3/- Post 1/-.

Our new list No. 9, containing over 400 ex-Government items, is now available, price 6d inland, 1/6 overseas air mail.

A. T. SALLIS

93 NORTH ROAD BRIGHTON SUSSEX
Telephone BR1GHTON 25806

FREE

A VALUABLE BOOK

which details the wide range of Engineering and Commercial courses of modern training offered by E.M.I. Institutes—the only Postal College which is part of a world-wide Industrial Organisation.

Courses include training for:

City and Guilds Grouped Certificates in Telecommunications; A.M.Brit.I.R.E. Examination, Radio Amateur's Licence, Radio & Television Servicing Certificates,

General Radio and Television Courses, Radar, Sound Recording, etc.

Also Courses in all other branches of Engineering.

EMI

Institutes
associated with
MARCONIPHONE
COLUMBIA
H.M.V. ETC.

POST NOW

Please send, without obligation, the FREE book. — E.M.I. Institutes, Dept. 179k, 43 Grove Park Road, Chiswick, London, W.4.

Name _____

Address _____

Courses £1 per month from

NEW!
HOME
EXPERIMENTAL
KITS NOW
AVAILABLE

IC. 108K

IKOPATENTS

LTD.

Managing Director

E. G. O. ANDERSON

Consultants

● RADIO

● TELEVISION

● ELECTRONICS

17 CRISP ROAD W6
RIVERSIDE 2678

Small Advertisements

(continued from page 493)

FOR SALE. VCR97, VCR517, £1 each. Feed Chokes LUS8F and LUS6L, new, 30/- the two, Stacey, 41 Northumberland Grove, Tottenham, N.17.

FOR SALE. Ex-Govt units, components, etc., cheap, send SAE for list. Box No. C110.

FOR SALE. TV power unit comprising complete set "EE" parts, but 2.5kV EHT, £6. TUSB Top Band Transmitter, £2. SAE lists of Radio/TV components Roberts, 38 Mumbles Road, Swansea.

FOR SALE. Canadian Marconi No. 52 13 valve Communication Receiver, must sell, only £10. Boyer collects. G. Ullman, 46 Randolph Gardens, London, N.W.6.

OKAY TYPE SWITCH SERVICE. Multi-Way Switches made to specification, approx cost 2/6 Clicker Plate + 2/- per wafer. Components new Vol. On/Off Switches, ¼m, ½m, Long Spindle 3/-. Controls 100k, 250k, 500k 1/-, 6V, 4-pin Vibrators 3/-. Ceramic Trimmers 5-80pf 5d., High Stability Resistors — 2% 9d., SM Condensers 6d. each, Flex 1½d. yard, 3 W.B. Coil Pack with circuit 19/-, 15 Watt Horn Speaker 36 inch Flare £3. Box No. C117.

TRADE

VALVES, VALVES, VALVES. 12AT7, 12AX7, 12AU7, 616, 9/-, EF91, 6X4, 7/6, 6AL5, 6/6, EF92, 6C4, EAC91, 6/-, Skillman, 74 Franchise Street, Weymouth.

CHEER UP. SAE for Smashing Bargains List, Radio, Converters, Model Railways. Lawrence, 134 Cranley Gardens, N.10.

I.P.R.E. PUBLICATIONS. 5,500 Alignment Peaks for superhets 5/9. Sample copy *The Practical Radio Engineer* 25/- Membership-examination particulars 1/-. Syllabus of TV and radio courses free and post free. Secretary, I.P.R.E., 20 Fairfield Road, London, N.8.

FREE! Brochure giving details of Home Study Training in Radio, Television, and all branches of Electronics, Courses for the Hobby Enthusiast or for those aiming at the A.M. Brit.I.R.E. City and Guilds Telecommunications R.T.E.B., and other professional examinations. Train with the College operated by Britain's largest Electronic organisation. Moderate fees. Write to E.M.I. INSTITUTES, Postal Division, Dept. RC28, 43 Grove Park Road, London, W.4. (Associated with H.M.V.).

METALWORK. All types cabinets, chassis, racks, etc. to your own specification. Philpott's Metalworks, Ltd. (Dept. R.C.), Chapman Street, Loughborough.

DUKE & CO. Offer Micro-Switches. Latest American midgets. ½"x¼"x¼". 250 volt, 3A. Price 5/- Radio-gram Chassis. 1953 models. Superhet, 5-valve, six waveband. Negative feed-back, flywheel tuning. Built for Export market. **OUR PRICE** £15 15s. Also Home market model, Long, Medium and Short bands, otherwise similar. £10 17s. 6d. Carriage 5/-. Both chassis measure 11½"x7"x8½". **SPECIAL FREE GIFT** with either of these chassis of an 8" P.M. speaker, and/or special reduction to 12/6 for a 10" P.M. speaker.—621 Romford Road, London E12.

TRANSFORMERS.—Manufactured to our specification and fully guaranteed. Normal Primaries. 425 v.-0-425 v. 200 ma., 6.3 v. 6 a., 6.3 v. 6 a., 5 v. 3 a., 0-2-4-6.3 v. 3 a. ONLY 72/6. 425 v.-0-425 v. 200 ma., 6.3 v. 4 a., 6.3 v. 4 a., 5 v. 3 a. ONLY 50/-, 350 ma., 0-350 v. 160 ma. 6.3 v. 6 a., 6.3 v. 3 a., 5 v. 3 a. ONLY 42/6. 250 v.-0-250 v. 100 ma., 6.3 v. 6 a., 5 v. 3 a. ONLY 32/6. The above are fully shrouded, upright mounting. Universal Mounting 350 v.-0-350 v. 80 ma., 0-4-6.3 v. 4 a., 0-4-5 v. 2 a. ONLY 18/6. Top shrouded, drop through 260 v.-0-260 v. 70 ma., 6.3 v. 3 a., 5 v. 2 a. ONLY 16/6. The following are upright mounting. EHT for VCR97 Tube, 2,500 v. 5 ma., 2 v.-0-2 v. 1.1 a., 2 v.-0-2 v. 2 a. ONLY 37/6. EHT 5,500 v. 5 ma., 2 v. 1 a., 2 v. 1 a. ONLY 72/6. EHT 7,000 v. 5 ma., 4 v. 1 a. ONLY 82/6

PLEASE ADD 1/6 PER TRANSFORMER POSTAGE.
TRANSFORMER, for use on trains, models, etc., giving outputs of 3 v., 4 v., 5 v., 6 v., 8 v., 9 v., 10 v., 12 v., 15 v., 18 v., 20 v., 24 v., 30 v., at 2 amps from normal mains input. ONLY 17/6 (postage 1/-).

TRANSFORMERS.—Ex. W.D. and Admiralty, built to more than 50 per cent. safety factor, with normal A.C. Mains Primaries. All Brand New and Unused. 300 v.-0-300 v. 200 ma., 5 v. 3 a., 6.3 v. 5 a., C.T., 20 v. 750 ma., 70 v. 100 ma. Weight 12 lb. ONLY 42/6 (postage, etc., 2/6). 330 v.-0-330 v. 100 ma., 4 v. 3 a. Weight 7 lb. ONLY 22/6 (postage 1/6). L.T. 5 v.-0-5 v. 5 a., 5 v.-0-5 v. 5 a., 5 v.-0-5 v. 5 a. By using combination of windings will give various voltages at high current. Weight 11 lb. ONLY 35/- (postage, etc., 2/6). L.T. 6.3 v. 7.7 a., 4.2 v. 2.5 a., 4 v. 1 a. ONLY 19/6 (postage 1/6). EHT 1,400 v. 2 ma., 520 v. 10 ma., 300 v. 10 ma., 2 v. 1.5 a. ONLY 21/- (postage, 1/6). Cash with order, please, and print name and address clearly. Amounts given for carriage refer to inland only.

U.E.I. CORPORATION

The Radio Corner

138 Gray's Inn Rd. LONDON WCI

Open until 1 p.m. Saturdays. We are 2 mins. from High Holborn (Chancery Lane Stn.) and 5 mins. by bus from King's Cross.

VALVES BY RETURN

OZ4	6/6	615	6/6	12SC7	6/-	EF50	5/6
1A5gt	7/6	616	10/-	12SG7	5/-	EF54	5/6
1LD5	6/6	617	9/-	12SH7	5/-	EF91	10/6
1LN5	6/6	6K6	7/6	12SJ7	6/-	EL32	7/6
1R5	8/6	6K7gt	6/6	12SK7	8/-	EL35	5/-
1S4	8/6	6K7g	6/6	12SQ7	9/6	EL91	8/6
1S5	8/6	6K8m	10/6	12Y4	7/6	HL2	3/6
1T4	8/6	6K8g	10/6	15D2	4/-	KT24	5/6
1625	4/6	6L6g	10/6	35L6	10/-	KT44	9/6
2C26	5/-	6Q7	10/6	39/44	5/-	KT63	8/6
2C34	4/6	6SA7	9/6	50L6gt	10/-	KT66	10/6
2V3g	3/6	6SH7	6/-	75	12/6	KTZ41	7/6
3D6	2/3	6SL7	11/6	76	7/6	KTW61	7/6
3S4	8/6	6SN7	10/6	77	7/6	N78	10/6
4D1	3/6	6SQ7	7/6	21SSG	5/-	P61	3/-
5R4g	12/6	6SS7	7/6	84E24	7/6	PEN46	8/-
5U4g	9/-	6V6g	9/-	807	12/6	PEN220A	5/-
5Y3	10/-	6X5gt	7/6	956	3/6	QP21	7/6
5Z4	10/-	7C7	7/6	1626	4/-	RK34	3/6
6AB7	6/6	7D8	8/-	1632	7/6	S13Q	5/-
6AC7	10/-	7Q7	7/6	AP15	5/-	SP41	3/-
6B7	7/-	8D2	3/-	DI	2/6	SP61	3/6
6B8	7/-	9D2	3/-	E1148	3/-	VR116	3/6
6C5g	6/-	10F9	7/6	EA50 3 for 5/-	5/-	VU39A	10/6
6CD6	11/6	12AT7	10/6	EB91	9/6	VU111	3/6
6CH6	9/-	12C8	9/-	ECC32	10/6	VU120A	3/6
6F6	8/6	12J5	5/-	EF36	6/-	VU133	3/6
6G6	7/6	12K7	12/6	EF39	6/6	U21	6/6
6H6	3/6	12SA7	8/6				

All the above Valves Tested, Boxed and Guaranteed Free replacement if faulty

LARGE STOCKS of NEW and EX-GOV'T COMPONENTS

The shop with the helping hand for Hams

NORMAN H. FIELD

68 Hurst St., Birmingham 5 Telephone MIDland 3619

continued on page 496

CLYDESDALE

Ex Services Electronic Equipment

THE P40 V.H.F. RECEIVER UNIT. Adm. Ref. W7945.A
A Crystal controlled 9 valve (3/EF54, EC52, 2/EF39,
EB34, 6J5, 6V6) Receiver Unit. Range 85-95 mcs. I.F.
2.9 mcs., with valves less crystal in louvred metal case
11½x5½x4½ins. Finish Grey.
(HT. 175 V. D.C. 60 mA. L.T. 12.5 V. 2.5A) Power require-
ments, EXTERNAL.

ASK FOR **£4 : 19 : 6** Each POST
No. B/H357 PAID

S-440-B V.H.F. TRANSMITTER CHASSIS
Partly stripped by the M.O.S., less valves, tuning coils and
crystal, but otherwise fairly intact. A fine basis for V.H.F.
Tx. or 144 mcs. rig. Original frequencies 85-98 mcs.,
valve types 3/RK34, 2/6N7, 6V6. Housed in louvred
case, finished grey crackle. Dim. 14x8x7ins.

ASK FOR **27/6** POST
No. B/H517 PAID

**RH32 V.H.F. R/T RECEIVER UNIT 19 INCH RACK
MOUNTING.** Range: 100-124 mcs.
A 10 valve superhet with 4/VR 53 (EF39), VR54 (EF34),
VR57 (EK32), 2/VR65 (SP61) VR66 (P61) VR67 (6J5G),
plus stabiliser VS70 (7475) 'S' meter, screened R.F.
section, B.F.O., etc., in enclosed chassis, size 19x19½x11ins.,
finish dark grey. Circuit supplied.

ASK FOR **£5 : 19 : 6** Each CARRIAGE PAID
No. B/H915 PAID
NEW LIST No. 8D gives details and illustrations of ex-
service and other items. Price 1/6. (Credited on first
10/- purchase).

Order direct from: Telephone SOUTH 2706/19

**CLYDESDALE SUPPLY
CO. LTD.**

2 BRIDGE STREET GLASGOW G.5
Branches in Scotland England and North Ireland

We are sorry . . .

that we cannot repeat our December publicity offer, but as we are continually being asked for the L.M.S.2 coil-pack together with the specially matched pair of I.F. transformers we are now offering a parcel comprising these items. The price is surprisingly low at **£2.7.6 post paid.**

L.M.S.2. Miniature Coil Pack
38/6 Post & Pkg. 1/6

- *3 wave band.
- *High quality—outstanding performance.
- *Only 5 wires to solder—one nut to tighten.

Miniature 465Kc. I.F. Transformers
12/- Post & Pkg. 1/-
*Specially matched to L.M.S.2. Coil unit.

Supplied Separately or in bargain parcel.

5" Loud Speakers brand new nearly all sold
last few 11/6 post paid

DEAL COMPONENT CO.

105 Evering Road N16

Small Advertisements

(Continued from page 495)

KENDALL AND MOUSLEY, Manufacturers of
Laboratory Equipment, chassis and instrument cases,
also suppliers of B.V.A. valves, Radio and T.V. com-
ponents. 99 Dudley Port, Tipton, Staffs.

Announcement

New Service for the Amateur and Experimenter

A stamped addressed envelope will bring you details of the new series of blue-prints of aerial tested circuits, from single valve to six and seven valve super-hets. In the near future, kits of parts will be offered, both for the home constructor and the Amateur Transmitter and Receiver. Coming off the drawing board shortly is a Simple Communications Receiver circuit. Further announcements will be made shortly concerning equipment for the T/V home constructor, including wide band pre-amplifiers, etc., at prices which will be right for your pocket. Get your name and address on the files NOW by sending your S.A.E. to J.H.G. Box No. C107.

AMATEUR STATION RECORD CARDS, 6" x 4",
best quality card, for recording that QSO and full
details of the contact. An invaluable aid to quick
reference of stations worked etc., 3/- per 100 from
Data Publications, 57 Maida Vale, London, W.9.

"**GLOBE-KING**" (Regd.) Miniature Single Valve
Receiver gets real Dx. Amateur Radio enthusiasts,
should send for free copy of interesting literature
and catalogue (enclose stamp for postage). Write
to makers: Johnsons (Radio), 46 Frair Street, Wor-
cester.

BOOKBINDING. Volumes of *Radio Constructor* and
Radio Amateur fully bound, imitation leather, gold
lettering, 7s 6d post free. Prices for other publications
on application. Jerome Alcock, CHEADLE, Stoke-
on-Trent.

JOIN THE ISWL. Free services to members including
QSL Bureau, Translation, Technical and Identification
depts. Dx certificates, contests and activities for the
SWL. Monthly magazine 'MONITOR' duplicated,
containing articles of general interest to the SWL and
League member, 10/6 per annum, post free. ISWL
HQ, 86 Barrenger Road, London, N.10.

VIEWMASTER, exact specified parts at list price by
return of post, also valves and CRT's, stamp for
list. James H. Martin and Co., Dept. R.C., BCM/
EDHWA, London, W.C.1.

BLUEPRINTS. High Gain 10 Metre Converter, with
a de-luxe circuit comprising EF91 RF stage, ECC91
double triode mixer and oscillator, EF92 IF amplifier,
with stabilised voltage supply via a 7475. 1s 8d
post free with full instructions. A.S.W.P., 57 Maida
Vale, London, W.9.

REPRINT Converting the TR1196 Receiver. Full
details on converting this unit, which may be purchased
quite cheaply, into a very sensitive all-wave receiver.
6d post free. A.S.W.P., 57 Maida Vale, London, W.9.

Miller's "PANL"—the air drying black crackle enamel.
From dealers 3s 6d jar or direct 4s 6d including postage.
—8 Kenton Park Crescent, Kenton, Middx.

OSMOR—for efficient coils, coilpacks etc. Send 5d
stamp for FREE circuits and lists. Dept. RCC,
Osmor Radio Products Ltd., Borough Hill, Croydon,
Surrey. Tel. Croydon 5148/9.

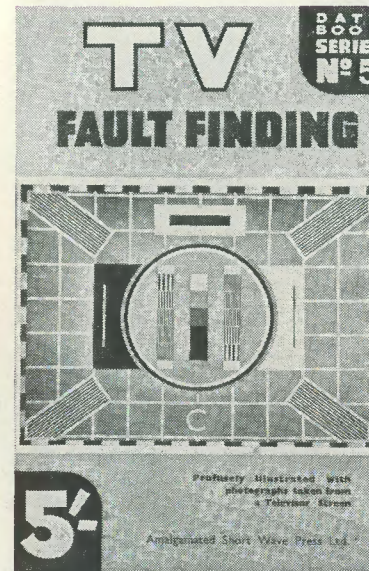
BOOKS FOR THE TV ENTHUSIAST

"... A book that should be in every television dealers service workshop, and in every home-
constructor's, for that matter."

Journal of the Television Society

"... The book will undoubtedly be of value to TV service engineers, particularly those who are not fully experienced in translating the appearance of faulty pictures into the necessary adjustments or receiver fault location."

Wireless and Electrical Trader

Lavishly illustrated by photographs taken from the screen of a television exhibiting the faults under discussion.

80 pages, size 8½" x 5½"

Price 5s. Postage 3d.

Edited by John Cura and Leonard Stanley, and illustrated with 150 "Tele-Snaps," this book caters for both the home viewer, and the more advanced constructor. We regard both these books as complementary, and have no hesitation in recommending them to all television servicemen and constructors.

68 pages, size 7¼" x 5"

Price 3s. 6d. Postage 2d.

Both books available from your usual supplier, or direct
(Trade enquiries invited)

DATA PUBLICATIONS
57 Maida Vale London W9

