

# RADIO CONSTRUCTOR

1/3

Vol. 1 No. 1

August  
1947

*For Every Radio Enthusiast*



## Contents

- A Decade Box
- The Straight Receiver
- The "Good Companion"  
AC/DC TRF3
- A 25/- Output Meter
- Short Wave Superhets
- Radio Conditions
- Aerial Change-over  
Switch
- A 100 Watt Transmitter
- Set Review



AN AMALGAMATED SHORT WAVE PRESS PUBLICATION

# PREMIER RADIO

MORRIS AND CO. (RADIO) LTD.,

All Post Orders to: JUBILEE WORKS, 167 LOWER CLAPTON RD.

LONDON, E.5

(Amherst 4723)

Callers To: 169 FLEET STREET, E.C.4

(Central 2833)

▲  
Build the "GOOD COMPANION" T.R.F. Receiver

▲  
All component Parts can be delivered from stock

▲  
Trade enquiries invited

BAKELITE CABINET	...	...	...	...	...	...	...	25/-
DRILLED CHASSIS	...	...	...	...	...	...	...	4/6
2 GANG CAPACITOR	...	...	...	...	...	...	...	8/6
COMPLETE DRIVE AND DIAL	...	...	...	...	...	...	...	3/6
4 OCTAL VALVE HOLDERS, The Set	...	...	...	...	...	...	...	2/-
SELENIUM RECTIFIER	...	...	...	...	...	...	...	5/-
SMOOTHING CHOKE	...	...	...	...	...	...	...	4/6
P.M. SPEAKER WITH OUTPUT TRANS...	...	...	...	...	...	...	...	20/-
LINE CORD	...	...	...	...	...	...	...	11/6
TUNING COILS (Complete Set)	...	...	...	...	...	...	...	7/-
WAVE CHANGE SWITCH	...	...	...	...	...	...	...	4/-
SET OF 3 VALVES	...	...	...	...	...	...	...	37/9
POTENTIOMETER WITH SWITCH	...	...	...	...	...	...	...	6/-
SET OF 11 RESISTORS	...	...	...	...	...	...	...	6/-
16+18 ELECTROLYTIC CAPACITOR	...	...	...	...	...	...	...	7/6
SET OF SEVEN TUBULAR CAPACITORS...	...	...	...	...	...	...	...	5/3
25 MF 25v ELECTROLYTIC CAPACITOR...	...	...	...	...	...	...	...	1/6
2 MF ELECTROLYTIC CAPACITOR	...	...	...	...	...	...	...	2/6
2 TRIMMERS, The Pair	...	...	...	...	...	...	...	2/-

## ALUMINIUM CHASSIS

Substantially made of bright aluminium, with four sides

Size	Price
7x3½x2 ins. ...	4/6
9½x4½x2 ins. ...	5/6
10x 8x2½ ins. ...	7/-
12x 9x2½ ins. ...	7/9
14x 9x2½ ins. ...	8/3
16x 8x2½ ins. ...	8/6
20x 8x2½ ins. ...	10/6
22x10x2½ ins. ...	13/6

## ALUMINIUM PANELS

Size	Price
7x4 ins. ...	2/-
9½x4 ins. ...	2/3
10x7 ins. ...	2/9
12x7 ins. ...	3/-
14x7 ins. ...	3/3
16x7 ins. ...	3/6
20x7 ins. ...	4/-
22x7 ins. ...	4/3

**RADIO CAREERS**  
AN IMPORTANT GUIDE

"Engineering Opportunities" indicates clearly how all engaged in the rapidly expanding Wireless industry can safeguard their future by becoming technically equipped to accept highly paid key appointments that will not be affected by any return to competitive labour conditions.

This modern guide contains 112 pages of highly useful information. It gives full details of our very comprehensive series of modern **WIRELESS COURSES**, including **General Wireless, Short Wave, Wireless and High Frequency, Sound-film Projection Engineering, Television and Radio Servicing, etc.**

**TELEVISION AND RADIO SERVICING**

There is no doubt about it that there will shortly be an enormous boom in Television and unlimited opportunities for trained men. Our special **TELEVISION and SERVICING** Courses are fully described in the handbook.

**WE DEFINITELY GUARANTEE**  
"NO PASS—NO FEE"

The Wireless industry is alive with possibilities. In your own interests you should write for your copy of "ENGINEERING OPPORTUNITIES" today. It will be sent **FREE**, and the book is bound to indicate more opportunities which otherwise you might miss.

**BRITISH INST. OF ENGINEERING TECHNOLOGY**

854 Shakespeare House,  
17/19 Stratford Place, London, W.1

**METAL WORK**  
*with a Difference!*

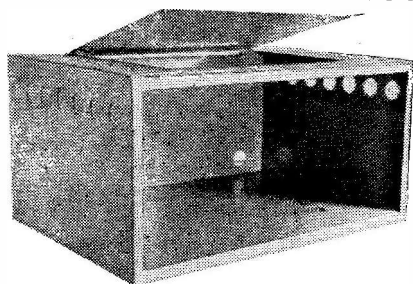

This is an example of gear which can be made to **YOUR OWN** dimensions and layout.

For full details and address of nearest agent, contact—

**L. J. PHILPOTT (G4BI)**

(E. J. PHILPOTT)

**Chapman St., Loughborough** Te'. 2864

**LYONS RADIO**

3 GOLDHAWK ROAD, SHEPHERDS BUSH

LONDON, W.12

Telephone: Shepherds Bush 1729

**SELECT GOVT. SURPLUS BARGAINS**

**WAVEMETER TYPE W1239**

Frequency range 39-51 mc/s. Rectifier type. Fitted Muirhead S/M tuning control. In copper lined wooden cases 15½x9x10ins.. For A.C. mains (200-250v). Complete with following valves: VR92, 6J5, V1103, 6x5. Condition as new. Price £3 19s. 6d. (Carriage 4/6).

**MUIRHEAD SLOW MOTION DRIVES**

Ratio 50:1. Fit standard ¼in spindles. 3in Dia. Engraved 0-180°. One of the finest slow motion drives ever made. 10/- each. (Postage 6d.)

**VIBRATOR TRANSFORMERS**

Input 6-0-6v. Output 140v. at 30 m.a. Best make fully impregnated. Approx size 2x2x2ins. 7/6 each. (Postage 9d.)

Our new lists are now available and will be forwarded on receipt of stamp.

**ODEON RADIO**

G4HV

**EVERYTHING FOR THE AMATEUR**

We carry a complete range of components and equipment for the transmitting amateur short wave listener and experimenter, and all specified parts, or satisfactory equivalents, for equipment described in the "Radio Constructor" can be supplied from stock.

Appointed distributors of Eddystone, Denco and Labgear products.

Large stocks available of British and American valves, including many "difficult" types.

No catalogues at present, so please enquire for your needs. Post orders receive prompt attention.



**ODEON RADIO**

56 COLLEGE ROAD HARROW

Telephone: Harrow 5778

# CLYDESDALE

THE RADIOMAN'S SHOP  
FOR BARGAINS IN EX-SERVICES ELECTRONIC EQUIPMENT.

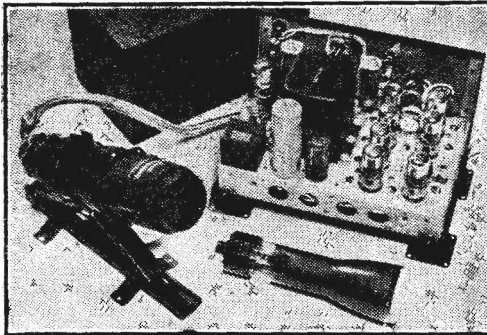

## BRAND NEW EX-U.S. NAVY CATHODE RAY INDICATOR AND AMPLIFIER UNIT

Model A.N./A.P.A.1

Aircraft Radar Equipment, comprising  
Cathode Ray Tube Indicator  
3in. C.R.T. No. 3 B.P.1. in  
adjustable case with calibrated  
glare proof screen, overall  
length 24in., base 12in., black  
crackle.

Indicator Amplifier, 11 valves  
supplied, 7 of 6SN7G, 6H6,  
6G6G, 2 x 2/879 H.V. Rectifier,

6X6GT Rectifier, plus relays, condensers and other V.H.F. gear in shock-proof  
mtg. metal case, 12½in. x 7¼in. x 9½in., finish black crackle. Input 110-120v.  
400-2400 cycles A.C.

**CONTROL UNIT** size 8in. x 2½in. x 3in. can be fitted to CRT Ind. the whole  
packed in original special carton, with **Instruction Book**.

OUR  
PRICE  
ONLY

**£4 19s. 6d.**

Carriage  
and packing  
12/6 extra

## MORSE PRACTISE UNIT

as shown, comprising Morse Key Buzzer with  
adjustable note, battery mounting, and two large  
terminals for headphones, on board 6½in. x 6½in.  
x ½in.

Our Price Only **6/11** each, post free.

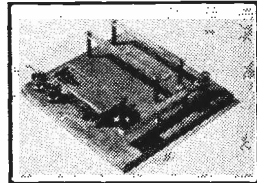

**MORSE KEYS**, Ex-R.A.F. Type F (10F/7741) in sealed bakelite moulded case.  
Brand New at 3/11 each. Post free.

**EX-ARMY**, Key and Plug Assembly No. 9a, in metal case. 5½in. x 2in. x 1½in.,  
with leads, jackplug, at 2/11 each. Post free.

**EX-TANK CORPS**, Key and Plug Assembly No. 8, in metal case 5½in. x 2in. x 2in.,  
with leads, jackplug, Rec/send switch, and 4-way flex skt. at 4/11 each. Post free.  
Receivers still available, CWS43AAY 24. at 42/6, carr. 7/6

CZR43AAX, 12v. at 42/6, carr. 7/6 R.1124 at 30/-, carr. 5/-.

U.S.A. made Paper Condensers with Ceramic insulated connectors, 4mfd. 350v.  
D.C. wkg. at 3/- each, post 3d.; 4mfd. 500v. D.C. working at 3/6 each, post 3d.

SEND NOW FOR NEW ILLUSTRATED LIST

# CLYDESDALE

2 BRIDGE STREET - GLASGOW

**SUPPLY  
CO LTD**

- C.5

\*Phone : SOUTH 2706/9

VISIT OUR BRANCHES IN SCOTLAND, ENGLAND AND NORTHERN IRELAND



# Radio Constructor

Vol 1 No. 1

Annual Subscription 16/-

August 1947

Editors :

ARTHUR C. GEE, G2UK

W. NORMAN STEVENS, G3AKA

Advertisement & Business Manager :

C. W. C. OVERLAND, G2ATV

## Editorial

IT is with great pleasure that we present the first number of our new journal "THE RADIO CONSTRUCTOR."

We were the first to produce a post-war amateur radio monthly publication and our experience with that journal—*The Short Wave News*—has made us realise what a large section of the community is now making radio its hobby. Short wave listening and the building of short wave receiving equipment has shown a boom almost as remarkable as the boom in broadcast reception after the first World War, whilst amateur transmitting is at present enjoying a popularity quite unique in its history. Still more interesting is the demand for literature of all types devoted to the hobby of radio. As we have said before, the liveliness of a hobby can be judged from the amount of literature available for its participants and judging from the present demand for suitable literature, radio as a hobby would seem to be in an extremely healthy condition.

A feature of our *Short Wave News* correspondence has been the frequently repeated request for more and more constructional material. Pressure on the available space in the *Short Wave News* has precluded us from giving as many constructional features as we should have liked, and there seems no possibility of rectifying the position for many months to come. To satisfy this demand for constructional articles we decided therefore to go ahead with the publication of a journal for the radio enthusiast whose primary interest is in construction rather than in DX Notes,

VHF News, Broadcast Data, Amateur Band News and so on. We propose covering as wide a field as possible in the way of constructional features in "The Radio Constructor" and we shall devote space to amateur transmitters, amateur and general coverage short wave receivers, normal medium and long wave broadcast receivers, car radios, gramophone and public address amplifiers, radio test gear, radio controlled models—in fact any aspect of electronic equipment which could be built by the home constructor.

We propose, also, including a certain amount of theoretical material in each issue as this appears to be popular, but we shall confine such articles to those likely to be of use to the constructor. Each issue will also contain a brief summary of radio conditions on all bands during the past month so that constructors may know what to expect of the apparatus they build.

When we started the *Short Wave News* we asked for our readers comments—and we got them. We have moulded the *Short Wave News* according to the criticisms and suggestions its readers have made from time to time and we feel that much of its success is due to the friendly spirit of co-operation which exists between readers and editorial staff. We shall carry this spirit on into "The Radio Constructor" and we accordingly ask readers for their opinions on our first number. Tell us what you want and we will try to fill the need.

Here then is our first number. We hope you will like it and find it of value in enabling you to get still more interest out of your hobby.

A.C.G.

## NOTICES

THE EDITORS invite original contributions on construction of radio subjects. All material used will be paid for. Articles should be clearly written, preferably typewritten, and photographs should be clear and sharp. Diagrams need not be large or perfectly drawn, as our draughtsman will redraw in most cases, but relevant information should be included. All MSS must be accompanied by a stamped addressed envelope for reply or return.

Each item must bear the sender's name and address.

COMPONENT REVIEW. Manufacturers, publishers, etc., are invited to submit samples or information of new products for review in this section.

ALL CORRESPONDENCE should be addressed to "Radio Constructor," 57 Maida Vale, Paddington, London, W.9. Telephone CUN 6579.

AUTHENTIC AND UP-TO-THE MINUTE INFORMATION ON V.H.F., BROADCAST BAND AND AMATEUR ACTIVITIES IS GIVEN IN OUR MONTHLY PUBLICATION "SHORT WAVE NEWS."

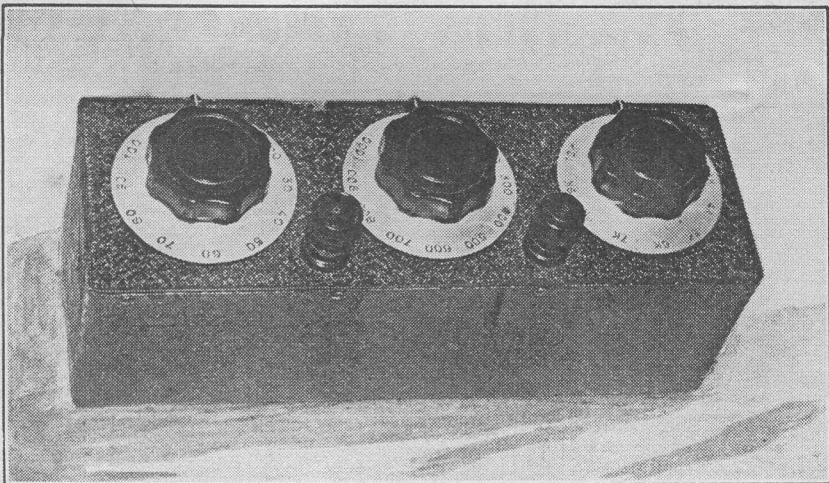

## A Decade Resistance Box

By G2ATV

**A** DECADE resistance box is quite a useful instrument to have in the shack, particularly for those who wish to carry out serious experimental work. The one described here was built up in order to calibrate a resistance-capacitance bridge, the balance potentiometer of which was found to be non-linear to a sufficient extent to render inaccurate the normal method of calibrating. Those who are interested in the uses to which such an instrument can be put will find much useful reading on the subject in the "Radio Laboratory Handbook" by M. G. Scroggie.

The Circuit of the decade box is shown at Fig. 1a. It consists in effect of three switched variable resistors in series, each sub-unit comprising ten resistors, any number of which can be switched into circuit as required. The resistors in any one unit are of equal value, but vary from one unit to another, being arranged for convenience in ratios of 10-1. Thus, in the box in question, the lowest value unit contains ten resistors of 10 ohms each, the next unit ten resistors of 100 ohms each, and the third unit ten resistors of 1000 ohms each. It is thus possible to set the box to any value, in steps of 10 ohms, from 10 to 11100 ohms. Lower or higher values could be chosen, of course, but the values given are those most easily constructed.

**Constructional Details** are as follows. The case is of sheet iron with an aluminium panel thick enough to take the fixing screws. The overall dimensions are 9 inches long by 3 inches wide and 3 inches deep. Both case and panel are finished in black crackle. The dials are of frosted aluminium, the numbers being stamped on by means of "Imperial" number punches, and afterwards filed in with cobbler's heel-ball. The indicators consist of raised head 4BA screws, with the slots filled in with white paint.

The switches are of the Yaxley pattern, single pole-twelve way, and have each two banks, which are connected in parallel to minimise contact resistance. The resistors themselves are wound with 40 swg enamelled Eureka wire, and two methods of winding were used as shown in Fig. 1b. In the case of the 10 ohms resistors, paxolin strip half an inch wide and a sixteenth inch thick was employed for the formers, the direction of winding being reversed half way along in order to minimise reactance effects. With the 100 and 1000 ohms resistors this method would have resulted in unwieldy sizes, and they were therefore wound in slotted formers. These can be turned up in a lathe from fibre or ebonite rod, as in this case, or alternatively they could be wound on the stripped formers of old type RF chokes. An even number of slots are required in each former, the direc-

tion of winding again being reversed at every other slot. Denco polystyrene coil dope was used to fix the turns in position once the resistors had been finally checked for accuracy.

In the instrument described, this checking was done with the aid of a bridge, two "standard" resistors of 100 ohms enabling the 1-1 ratio point to be accurately determined. It was then a simple matter to wind ten other 100 ohms resistors. These ten in series, and one of the standards, were next connected to the "Match" terminals of the bridge, and the 10-1 and 1-10 ratio positions established. From these it was then possible to construct the 10 and 1000 ohms resistors. Each of the latter were further checked in the "Match" terminals against the ten 100 ohms resistors, and the ten 10 ohms resistors against one of the standards.

Where a bridge is not available, the resistors can be measured with fair accuracy by means of an ohm-meter. In this case it is advisable to purchase a "standard" for each of the ranges required, and to use an applied voltage of such a value that an almost full scale reading is obtained.

The box illustrated has been tested on a Sullivan bridge, and was found to be accurate to within  $\pm 1$  per cent. on the 100 and 1000 ohms units, and to within  $\pm 2\frac{1}{2}$  per cent. on the 10 ohms unit. It is not, of course, necessary that the resistors for this instrument be home wound. Where the higher cost is no objection, resistors with a very high degree of accuracy can be purchased, as, for example, the "Spot-On" wirewound resistors, which are accurate to within  $\pm .01$  per cent.

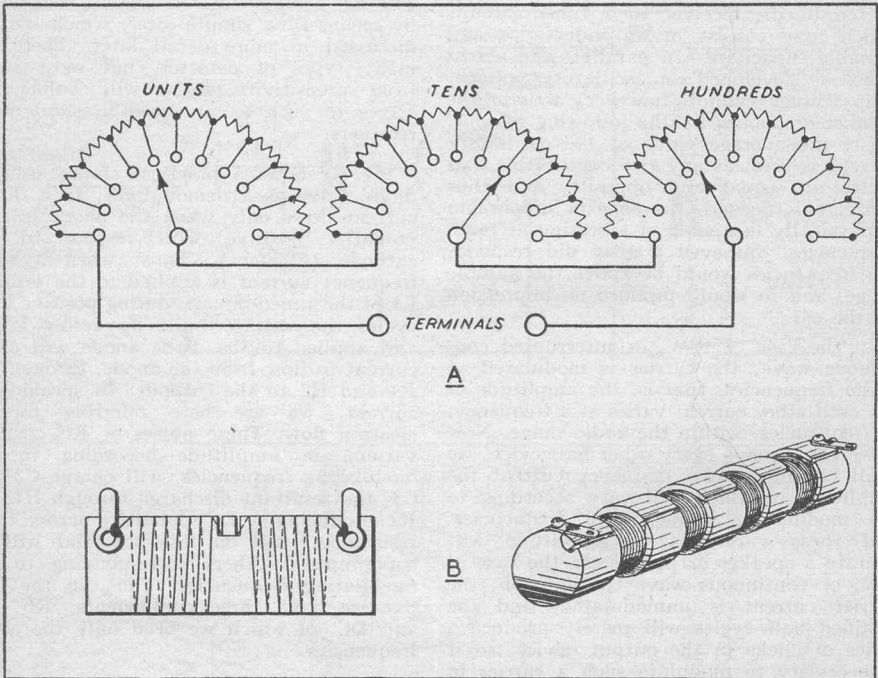

Fig. 1

**The Editors invite . . .**

- Articles suitable for inclusion in this journal.
- Constructive comments and suggestions on the magazine.
- Photographs and short descriptions of readers workshops.

# The Straight Receiver

## A brief outline of the theory

By H. A. Emm

**T**HE Straight Receiver consists primarily of a detector, or demodulator as it is now more correctly termed, to which may be added radio-frequency and/or audio frequency stages of amplification. Let us first consider the process of demodulation, which is essential, incidentally, in any type of receiver.

At the transmitter, radio-frequency currents, set up in the aerials, produce electromagnetic waves which, at their destination, induce similar currents in miniature in the receiving aerial. This aerial is connected in the receiver to a tuned circuit, which may consist of an inductance and variable capacitance in parallel, and across which is developed an oscillatory voltage. This voltage cannot, however, actuate the speaker or phones for the following reasons. First, the average value of the oscillatory current is zero, as any two consecutive half cycles are equal and opposite, and thus cancel out. Second, the cone or diaphragm is physically incapable of vibrating at radio frequencies, and, even if they did respond, the frequencies would be above the audible range, and so would produce no impression on the ear.

In the case of ICW, or interrupted continuous wave, the carrier is modulated at audio frequencies, that is, the amplitude of the oscillatory current varies at a frequency, or frequencies, within the audio range. Now if we can remove every other half cycle, we shall obtain a radio frequency current the amplitude of which will vary according to the modulating frequency or frequencies, and these variations of amplitude will operate a speaker or phones. In the case of CW, or continuous wave transmission, the carrier current is unmodulated, and the rectified half cycles will merely produce a series of clicks in the output device, so it is necessary to modulate such a carrier in the receiver, a process which will be further discussed later.

The DETECTOR, or demodulator, is essentially a rectifier, that is, it allows current to flow in one direction only. In practice, this is not achieved, but there are several devices that have a much greater resistance to the flow in one direction than in the other, giving an excess of current in one direction in the form of pulses, each of

which will actuate a reproducer. If these pulses occur at an audio frequency, as they will if the signal is so modulated, then the speaker or phones will produce an audible note corresponding to that frequency. It is, of course, necessary that the output circuit of the detector should possess some impedance across which the varying current can produce a similar voltage, and where the reproducer does not fulfill this purpose, as when stages of audio amplification are used, then the impedance takes the form of an AF choke, transformer, or grid leak. The RF component still present is removed by means of a simple filter, which will be discussed in more detail later. There are many types of detector, but most suffer from insensitivity, so we will confine ourselves to such as are used in short wave receivers.

Fig. 1 shows a practical circuit using a diode valve as a demodulator. In a diode, current flows only when the anode is at a potential positive with respect to the cathode (filament). Thus, when a radio frequency current is applied to the primary L1 of the tuned circuit, during positive half-cycles the voltage built up across L2/C1 and applied to the diode anode will cause current to flow from the anode, through L2, R1 and R2 to the cathode. In speaking of current, we are here referring to the electron flow. These pulses of RF current, varying in amplitude according to the modulating frequencies, will charge C2 and C3, the resultant discharge through R1 and R2 producing a DC potential across these resistances, and on this potential will be superimposed others corresponding to the modulating frequencies. Thus, in the output we have three components, RF, AF and DC, of which we need only the audio frequencies.

The DC component is removed by inserting a capacitance C4, the reactance of which must be low to those audio frequencies that we require to pass on to the next stage. The unwanted RF component is by-passed to the negative line, usually earth, by the capacitances C2 and C3. The reactance of these must be low compared with the impedance of R1 and R2 at radio frequencies, but the reverse at audio frequencies.



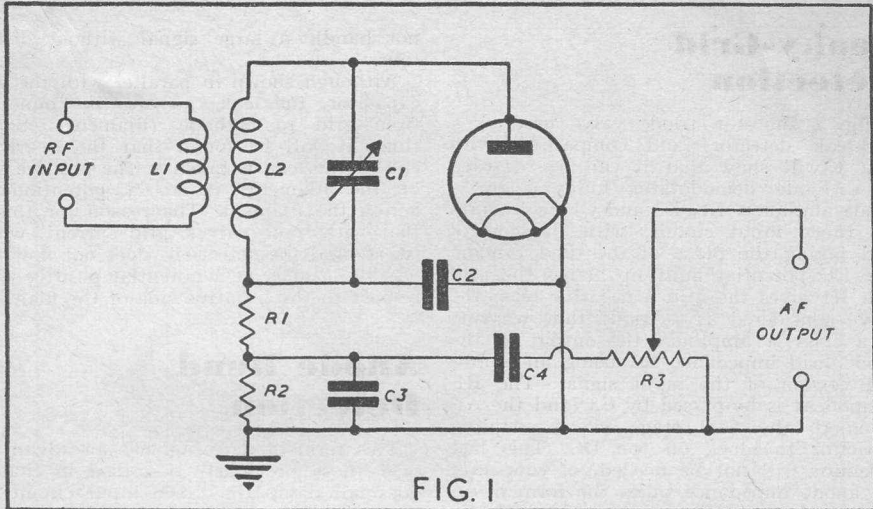

FIG. 1

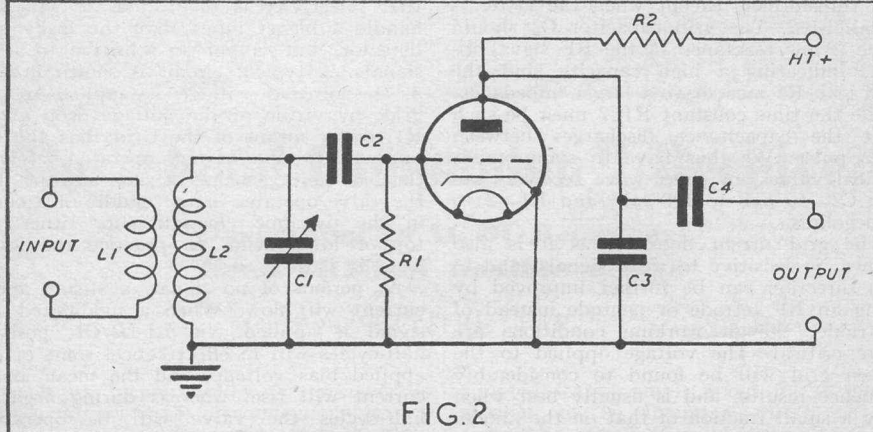

FIG. 2

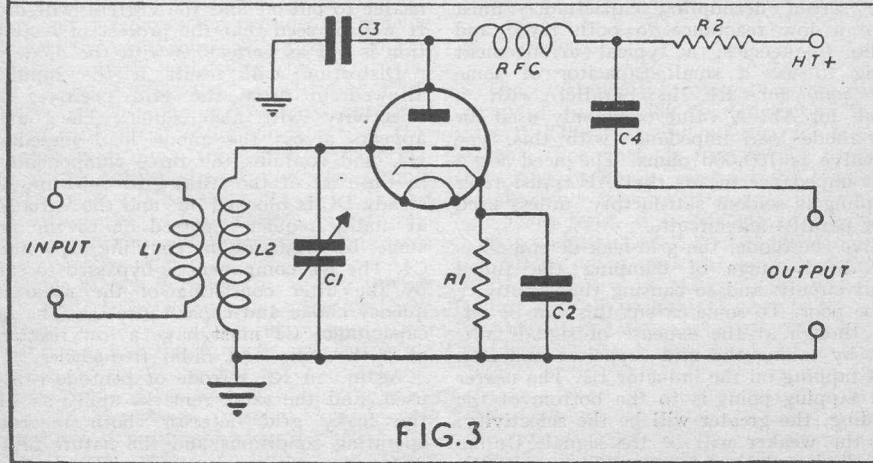

FIG. 3

## Leaky-Grid Detection

Fig. 2 shows a triode valve used as a grid-leak detector, and comparison with Fig. 1 will show that it can be regarded as a diode demodulator followed by a triode amplifier. L1, L2 and C1 again form the tuned input circuit, with the control grid taking the place of the diode anode. The DC potential built up across the grid leak R1 gives the grid a negative bias, the valve considered as a triode thus working as a class A amplifier, the output in the anode load impedance R2 being an amplified version of the input signal. The RF component is by-passed by C3, and the AF taken to the next stage via a coupling capacitor to block off the DC. This last capacitor will not be needed, of course, if the anode impedance takes the form of an AF transformer, except when the latter is parallel-fed. The grid capacitor C2 should have a low reactance to the RF signal input, indicating a high capacity, but the grid leak R1 must have a larger impedance, while the time constant R1C2 must be such that the capacitance discharges between each pulse. We thus have to compromise, typical values for short wave receivers being: C2—50  $\mu\text{F}$  to 100  $\mu\text{F}$ , and R1—2 to 5 megohms.

The grid-current detector, as it is also known, is sensitive to weak signals, and in this direction can be further improved by using an RF tetrode or pentode instead of a triode, though working conditions are more critical. The voltage applied to the screen grid will be found to considerably influence results, and is usually best when only a small fraction of that on the anode. The screen decoupling capacitance must have a low reactance to both radio and audio frequencies, a typical arrangement being to use a small capacitor of some 300  $\mu\text{F}$  for RF in parallel with a .1  $\mu\text{F}$  for AF. A value commonly used for the anode load impedance with this type of valve is 100,000 ohms. The need for a high impedance means that AF transformer coupling is seldom satisfactory, unless used in a parallel-fed circuit.

Like the diode, the grid-leak detector has the disadvantage of damping the tuned input circuit, and so causing the selectivity to be poor. To some extent this can be offset, though at the expense of signal voltage, by taking the grid capacitor and leak to a tapping on the inductor L2. The nearer this tapping point is to the bottom of the winding, the greater will be the selectivity, but the weaker will be the signal. Unlike the diode, the grid-current detector will

not handle a large signal without distortion.

Although shown in parallel with the grid capacitor, the leak can also be connected from grid to cathode (filament). Sometimes it will be found that the "earthy" end of the leak is taken to the positive side of the filament, or to a potentiometer across the filament. The reason for this is that with some valves, grid current, which is essential for detection, does not flow unless the grid is at a potential positive with respect to the negative side of the filament.

## Anode Bend Detection

This form of detection has an advantage over those previously described in that it does not damp the tuned input circuit, so that selectivity is unaffected. It will also handle a bigger input than the leaky grid detector, but is not so sensitive to weak signals. A typical circuit is shown in Fig. 3. A negative voltage is applied to the grid, by virtue of the voltage drop across R1, or by means of the Grid Bias Battery in the case of a battery operated receiver, the bias voltage being of such a value that the valve operates in the middle of a curve in the dynamic characteristic, either the top or lower bend. In practice the lower bend is most used.

At periods of no signal, a steady anode current will flow. When a modulated RF signal is applied, via L1-L2/C1, positive half-cycles will in effect cancel some of the applied bias voltage, and the mean anode current will rise, whereas during negative half-cycles the valve will be operating nearer to cut-off and the current will drop. It will be seen that the process of rectification is not as perfect as with the diode.

Distortion will result if the input is allowed to drive the grid positive, and selectivity will also suffer. The output appears across the anode load impedance R2, and contains the three components as in the case of the leaky-grid detector. The steady DC is blocked off, and the variations at audio frequency passed on to the next stage, by means of the coupling capacitance C4. The RF component is bypassed to earth by the filter consisting of the radio frequency choke and capacitance C3. The bias capacitance C2 must have a low reactance at both audio and radio frequencies.

Again, an RF tetrode or pentode can be used, and the same remarks apply as with the leaky grid detector, both regarding operating conditions and the nature of the anode impedance. [To be continued]

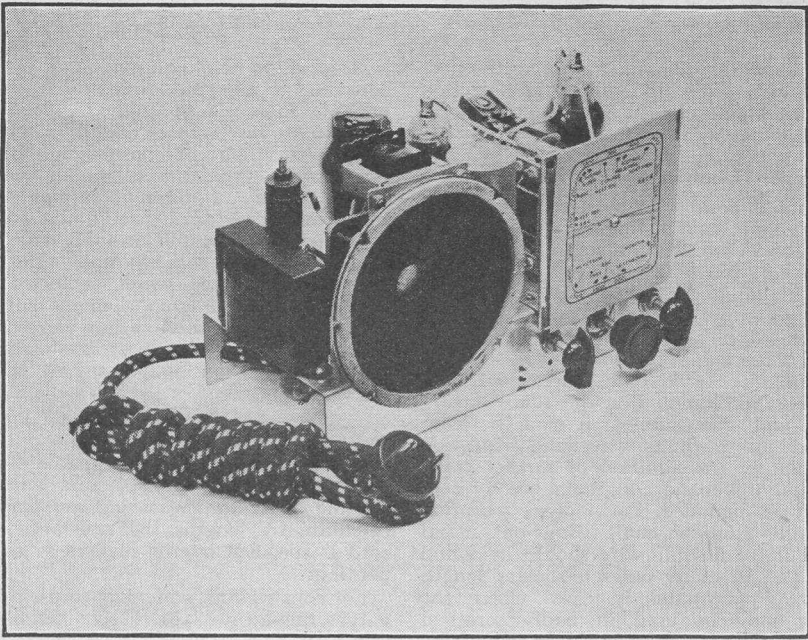

# The "Good Companion" Receiver

**Describing an AC/DC Broadcast  
Band TRF3 of flexible design**

By "CENTRE TAP"

AS its name implies this receiver is intended as a companionable set which can be carried from room to room, on holidays, for fireside or bedside use, in the workshop or nursery, indeed anywhere where either AC or DC mains are available. At the same time, it is capable of standing up to hard everyday usage if required, although a set of this description, fitted with a small speaker, is best suited to a multi-purpose role. Ample volume is available and with a large well baffled speaker, reproduction comparable to an expensive radio-gram is possible from the local broadcasters.

It was at first proposed to design the set as a midget but had this intention been adhered to, the scarcity of midget components would have been a stumbling block to many would-be constructors. However, for those readers who possess, or are able to obtain midget components, dimensions considerably smaller than the original are easily possible—the layout

adopted leaves ample room for a midget speaker to be mounted direct on the chassis as seen by the photograph.

## ● Circuit

The technically minded will readily recognise that anode bend detection is employed. This is general practice for receivers of this type both in commercial manufacture and in home construction. While the anode bend detector is not as sensitive as the leaky grid, it is capable of handling a stronger signal and less liable to distortion. It will be noted from the component values the bias resistor of V2 is 25000 ohms—this value is fairly critical as also is the value of the resistor in the screen to ensure the valve working on the "bend." The bend of course is the lower curve in the valves characteristics. It is of interest to note that the anode current rises as a signal is accurately tuned and indeed, a meter can be inserted in the anode circuit to act as a

tuning indicator. This is the opposite effect to that obtained with leaky grid detection when the anode current falls as the signal is correctly tuned.

● **Simple Operation**

Volume is controlled by using a variable-mu RF stage making for simplicity both in design and use. No reaction control is necessary. With a small adjustment, described later, the regeneration is sufficiently good throughout the tuning range to keep the sensitivity to a high level and little, if anything, is lost by dispensing with the reaction circuit general to leaky grid TRF receivers. For the sake of simplicity and compactness it can be constructed for medium waveband reception only, but by the addition of further coils, or a dual waveband coil, long wave reception may be included. Satisfactory reception obtainable from a small throw-out aerial and 15 ft. of flexible wire should be found ample and in many cases a shorter length will prove adequate. In cases where the receiver may be used in badly screened positions such as in ground-floor flats some distance from desired stations, a clip may be fitted to the end of the aerial which can be attached to any suitable object to serve as an aerial extension. The writer used a receiver of this type in part of his Army career and regularly found the springing of W.D. bedsteads admirable for this purpose!

● **Valves**

Any chain of suitable valves all of the same current consumption may be used irrespective of their voltages—the voltage

is dropped to the required figure by a line cord or a suitable resistor. It is thus possible to mix 6, 12, 13, 25, 35, 50 and 70 volt valves if required, all in series so long as their current consumption is of the same order. For the more knowledgeable reader, valves of different ratings may be substituted providing that shunts are used.

If the valves chosen are 6J7, 6K7, 25A6, 25Y5 plus a 12 volt .3 Amp. pilot lamp, their total voltage wired in series would be 74 volts, and from a mains supply of 230 volts, 156 volts would have to be dropped. To find the resistance necessary a simple calculation in Ohms Law is made, viz.:

$$\frac{156}{.3} \text{ equals } R \text{ (520 ohms)}$$

and a length of line cord capable of carrying .3 A is cut. Constructors without a reliable meter for measuring resistance may calculate by length—the resistance of the cord is specified by the makers as so much per foot.

For constructors preferring to use a .15 A. valve line-up (12J7, 12K7, 50L6, 35Z4 plus 12V. .15 A. pilot lamp) the resistance of the line cord is similarly calculated. Their voltages total 121, and from 230 V. mains, 109 V. will have to be dropped. This we discover to be approximately 721 ohms.

$$\frac{109}{.15} \text{ equals } R \text{ (721 ohms)}$$

If a rectifier of a maximum AC anode voltage of less than 250 ohms is used, the supply to the rectifier will have to be tapped off down the line cord and in this case allowance for the HT consumption must be made. 50 mA. will be near enough to

*Showing an alternative rectifier circuit using a selenium metal rectifier.*

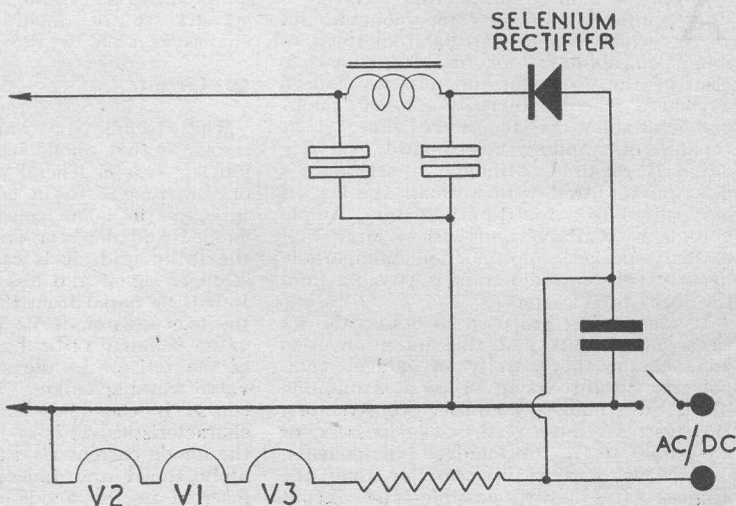



suit this requirement and the calculation will become:

$$\frac{109}{.2} \text{ equals } R \text{ (545 ohms)}$$

Any deviation from these valves, providing they are equivalent types to the originals, is permissible with corresponding adjustment to the line cord. As already mentioned it is possible for the more advanced constructor to use valves of odd current ratings by employing suitable shunts across the valves of lower consumption and the shunt values determined by applying Ohms Law. It is to be noted that the designer prefers the use of line cord instead of a dropper resistor as the former keeps the heat out of the cabinet and permits smaller chassis dimensions, but there is, of course, no objection to a dropper resistance on other grounds. If one is used, the leads to it should be made by terminal joints in preference to soldered connections as the heat will frequently melt the solder joints.

### ● Alternative Rectification

An excellent alternative arrangement, which is used in the model illustrated, employs a selenium rectifier. This means, of course, that a voltage fed to the valve heaters is smaller by the value required by the valve rectifier, i.e., a larger value mains drop or line cord is required. This alternative arrangement is shown in Fig. 2. Assuming the valves used are, as in the model, 6K7, 6J7, 25A6 and no pilot light, the total valve voltage will be 37, leaving 193 volts to drop. The required resistance will be:

$$\frac{193}{.3} \text{ equals } 643 \text{ ohms approx.}$$

Advantages are that the selenium rectifier is more robust than a valve and can be considered permanent, while there is little difference in initial cost.

### ● Speaker

The speaker used may be either of the permanent magnet or of the energised type. In the latter case the field is used instead of an LF choke and a more compact construction obtainable. A field resistance of 500 ohms would be a suitable value but as these are not generally readily obtainable, a permanent magnet was used with the original and an LF choke mounted on the chassis, used for smoothing.

### ● Wiring

In wiring up commencement should be made with the valve heater circuit and it

is important that the detector valve is at the earthy end of the chain, as shown in the theoretical circuit. The heater wiring should be of heavy gauge, well insulated, and the leads kept close to the chassis. With the detector at the earthy end of the chain, the order of wiring is RF, LF and rectifier: this is, of course, to keep hum level at a minimum.

The coils are mounted one on the sub-chassis and the other above chassis and as a further precaution against possibility of interaction the former can well be mounted horizontally and the latter vertically. Trimmers on the two-gang capacitor may be used if the set is designed for single waveband reception only, but for more than one band separate trimmers may be mounted on each coil. If well matched dual-waveband coils are used a single trimmer may be all that is necessary and the best adjustment for both medium and long wavebands can be found by experiment. If separate coils, such as the Wearite type "P," are used it is better to mount the trimmer on each coil itself and the trimmers (if any) fitted to the two-gang capacitor either removed or ignored. With the Premier coils, used on the original set, a trimmer is necessary only on the MW band; and the switching arrangement is shown in the circuit diagram by dotted lines.

### ● On/Off Switch

If a variable tone control is used the on/off switch may conveniently be ganged with it, but it is inadvisable to use a switch coupled to the RF volume control owing to the liability of introducing hum in this most sensitive part of the receiver. The value of the volume control is 10000 ohms but for those who prefer a control which spreads the volume range more widely through its rotation, 5000 ohms may be used. The designer prefers lower values for this purpose; only too often does one meet a control which reduces volume to inaudibility in less than a third of its travel, and after all if it is wanted to reduce the volume level to nothing it is more economical to switch the set completely off! A fixed bias resistor is used so that when the volume control is fully up some small bias is applied to the valve. The biasing circuit is designed to maintain constancy of tuning irrespective of the setting of the volume control. The rest of the circuit does not appear to call for much special comment and it should prove simple and straightforward even to the beginner, but there are a few points to be noted in making final adjustments.

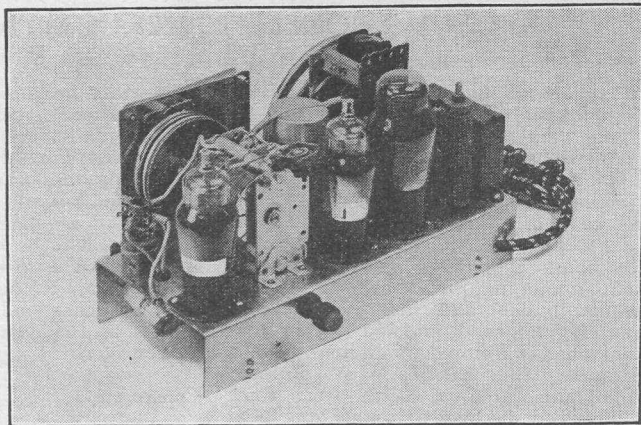

*The receiver as seen from the rear.*

### ● Regeneration

As previously mentioned, reaction is not used. Owing to the close spacing of the stages there will be ample regenerative effect and this can be controlled by positioning of the grid leads to the detector and RF valves. They **must not** be screened and if the regeneration is not sufficient to give full volume these leads should be moved closer together. If the contrary is the case regeneration is excessive when the volume control is fully up, oscillation will result, and wider spacing must be allowed between these grid leads. The most suitable adjustment is found by tuning to the station of the longest wavelength on the band for which the set is to be most frequently used and spacing the grid leads to give just the right amount of regeneration without oscillation. As the set is tuned to stations of shorter wavelength it will, at some point, slide gently into oscillation. This will disappear as the volume control is slackened off slightly, leaving the set at its maximum sensitivity.

### ● Mains Connection

When used on DC mains, the receiver will only work when the plug is connected one way round—that is when the positive side of the mains is connected to the anode of the rectifier, and if after the usual warming up period there is no response, the mains plug should be reversed. With AC mains, the set will work whichever way round the plug is connected, but it is possible that in some cases a slight tendency to hum (on signals) will be found. This will disappear when the mains plug is reversed.

A small throw-out aerial of about 15 ft. length will be ample as a signal collector, but an aerial of greater length may be used, particularly if reception of more distant stations is required. No earth connection is needed but if one is used it must not be connected direct to the chassis, but through a high-voltage working capacitor (of double mains voltage) as shown in the circuit. It must be remembered that with AC/DC sets the chassis is alive and care must be exercised in handling. The capacitor in the aerial circuit (.001  $\mu$ F) should be capable of comfortably withstanding mains voltage and is included as a precaution against damage should the throw-out aerial ever come in contact with "live" objects or wiring.

The grub-screws of the knobs should be well sunk below the surface so that there is no possibility of the fingers making a chassis potential contact at any time.

No particular suggestions are put forward as to a cabinet design as it is felt that most constructors will have a number of special uses for a set of this type. Most will probably prefer a compact cabinet and its construction of course will depend on the materials and workshop facilities available. Messrs. Premier Radio supply a moulded bakelite cabinet eminently suitable for such a purpose and which is made to fit with the chassis and control layout as shown on our model. Others may prefer to incorporate the set in a bedside cabinet or occasional table when it is possible to use a reading lamp as part of the voltage dropper, so it is felt best to leave the question of housing the set to each individual constructor.

# A 25/- Output Meter

By LIONEL HOWES, G3AYA

THE useful output meter illustrated herewith really was constructed for the very modest sum of 25/-, despite the professional appearance of the finished job! The meter itself, a 4 inch moving iron AC movement by E. Turner of High Wycombe, was purchased for 15/- at the local "surplus stores." From the same source came the case, which originally housed an eliminator, and which put the exchequer in debt a further five shillings. It was in good condition and a thin coat of black enamel restored its original pristine appearance. The handles cost nothing, being manufactured at home from some mild steel rod discovered in the junk box. The further five shillings covers the cost at one time or another of the few remaining components needed.

## Circuit

As will be seen from the theoretical diagram, the circuit is not at all complicated; in fact it is simply a multi-range AC meter with capacitors fitted in each input lead in order to block any DC which may be present in circuit. Of course, an



The meter

elementary instrument of this type will not meet the requirements of those who wish to measure output in actual milliwatts, but it does provide at a low price a means of accurately measuring the effect (in terms of audio output) of adjustments to a receiver or amplifier.

It may here be remarked that an output meter is **not** a satisfactory substitute for an S meter—an R7 signal will not necessarily give a higher audio reading than an R4 signal, as the depth of modulation has to be considered.

## Construction

Little needs to be said about construction, except that the resistors and capacitors should be rigidly mounted—for preference on a mounting strip. C1 and C2 are of the tubular type, and a capacitance of 0.1  $\mu$ F is suitable. R1, 2 and 3 should be capable of dissipating several watts, as the meter will, if of the moving iron variety, have a full scale consumption of at least 10 mA, and probably much more.

A refinement can be added in the shape of an extra pair of terminals to bypass the capacitors, which would make the instrument suitable for measuring mains and valve heater voltages, though in this connection too much reliance should not be placed on the readings obtained when measuring heater voltages in AC/DC circuits, where there is a comparatively high series resistor in circuit, should the meter have a high current consumption. In such a case the reading obtained would be lower than the voltage actually present.

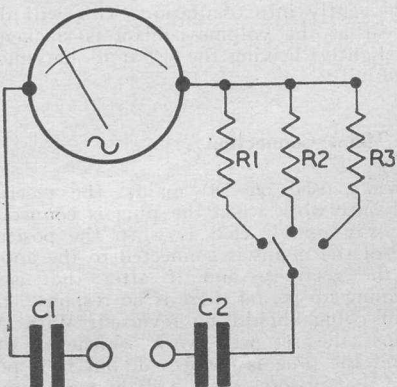

The circuit



# On Short Wave Superhets

A discussional article with some rather unorthodox suggestions for the constructor

By ROBERT DALY

IF a census could be taken of the type of receivers used by SWL's, it would be certain to reveal that the vast majority use straight sets, and that comparatively few have home-constructed superhets.

Let us first investigate the pros and cons of the two types of receivers. Is the straight set superior to the superhet? The answer to this question can surely be found in the fact that practically every modern communications receiver employs a superheterodyne circuit.

A communications type of receiver is normally expensive to buy, and a superhet receiver built on the usual communications lines would be equally costly to make. So we may safely say that cost might be one reason why the constructor keeps to the straight set, although it is not generally realised that a really efficient superhet can be built quite cheaply.

The writer, however, is of the opinion that many constructors fight shy of building a superhet through lack of confidence in their ability to make one and, to a lesser extent, lack of suitable testing equipment to make the set work really efficiently.

## Straight v. Superhet

The attraction of a straight receiver (at least as far as the novice or newcomer to radio is concerned) is that providing the characteristic "plop" is heard when the regeneration control is advanced, it can usually be taken for granted that the receiver is working, and that stations will be received on it. This is at least encouraging at the time, even if the set subsequently proves to bring in less stations than its predecessor!

On the other hand the newly constructed superhet, when first switched on almost invariably results in exactly nothing. Not a sound is heard, not a funeral note! The questions then arise: Are the IF's out of alignment? Is the oscillator functioning? Or is it just due to a wiring mistake?

The wiring can be carefully checked and voltage readings taken, and still—silence! Such an experience may well turn the SWL off a superhet, and out of sheer desperation he will avow that in future he will concentrate entirely on straight receivers.

## Effect of IF Misalignment

It is unfortunately true that IF misalignment can be a serious pitfall to successful superhet construction when a signal generator is not available. A little ingenuity here is helpful. It is not usually essential that the IF's of a short wave superhet be lined up to any particular frequency. For instance, if the IF's are rated as being 465 kcs. they will invariable tune to any frequency between say 450 and 470 kcs., and, providing each IF circuit is tuned to the same frequency, the receiver will operate at its maximum efficiency, always assuming that the constructor has decided to use separate controls for the signal frequency and oscillator circuits, or a panel-operated trimmer in conjunction with a gang capacitor.

## Where There's a Will There's a Way!

During the war, when the writer was stationed in Khartoum, he used an electric drill as a means of roughly aligning his IF stages! The electric drill, being a means of creating electrical interference, was simply switched on, and the IF's trimmed for maximum noise; the interference being so powerful that even if the IF's were hopelessly out of alignment some noise was always picked up! Once the IF's were roughly in alignment, a powerful station was picked up, and the IF's once again peaked for maximum signal strength. The final trimming was then accomplished by tuning in a weak signal, and re-adjusting the IF's. This is essential, as a weak signal ensures that the AVC (if used) is inoperative, due to the delay voltage on the AVC diode. If the YL or OW has a vacuum cleaner or hair dryer, your trouble is over!

## Watch the Second Detector Wiring

One very common mistake is to return the second detector diode lead to earth, as shown in Fig. 1a (Fig. 1b being the correct version). The result would be that the voltage due to the cathode bias would make the diode anode negative by a volt or two to its own cathode, and only those signals sufficiently strong to overcome this bias would be rectified and heard. This mistake is quite easy to detect aurally, as the set

would sound "dead" until a loud station is tuned in, when it would suddenly come to life, the characteristic "superhet hiss" being heard.

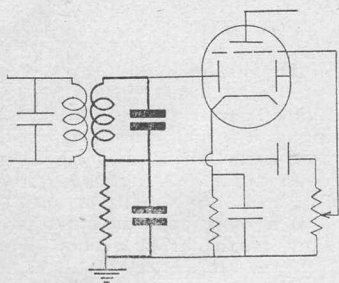

Fig. 1a

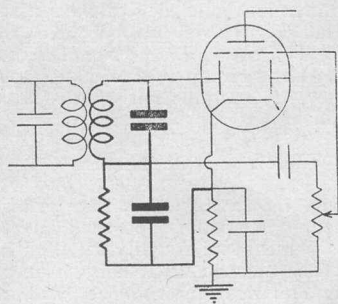

Fig. 1b

### Utilising Superhet Hiss

Superhet hiss can often be utilised as a means of aligning the IF's, especially if a BFO or some other means of obtaining IF oscillation is incorporated, as the hiss will then be very much more pronounced when the BFO is switched on. The IF's would of course be trimmed for maximum hiss.

If a separate oscillator tuning capacitor is used, once again the hiss will be most pronounced at the position of correct alignment with respect to the signal frequency circuits (i.e., displaced in frequency by the amount of the IF frequency). The tuning controls should be rotated with this point in view.

If when the oscillator control is rotated, no difference in hiss level is noticed, the fault is almost certain to be that of non-oscillation (of the oscillator stage). A simple check can be made by connecting a voltmeter across the bias resistor of the frequency changer valve, noting the reading obtained, then shorting the fixed and moving vanes of the oscillator tuning capacitor

via a large value capacitor, when the meter reading should rise slightly. If a battery type frequency changer is used, or a separate oscillator valve, the HT feed must be broken (at the "earthy" end) and a milliammeter placed in series. The reading should still rise when the capacitor vanes are shorted, as indicated above.

### Oscillator Frequency Drift

As the oscillator tuning is extremely sharp, precautions against frequency drift due to varying HT supply should be taken, and the writer recommends that the series oscillator circuit in conjunction with a centre-tapped bleeder HT supply (as shown in Fig. 2a) be used, rather than the more usual shunt arrangement (Fig. 2b). The shunt fed oscillator must of necessity incorporate a resistor in its anode lead, which serves the dual purpose of an oscillator load and voltage dropper (as approx. 100v. is required for the osc. HT). As this has rather a high value—usually 50000 ohms—any slight change of anode current will cause an appreciable change of anode voltage which may result in frequency drift. This series anode resistor is not required in the Fig. 2a circuit, and a comparatively low resistance bleeder can be used to supply the required 100v.

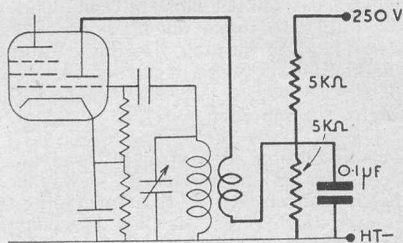

Fig. 2a

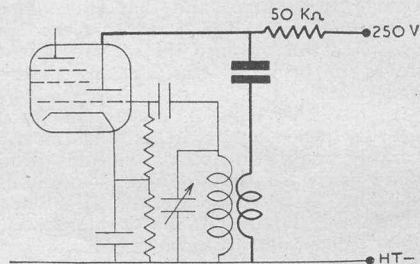

Fig. 2b

### Pre-Selection

An RF stage ahead of the mixer valve is a well worthwhile addition, both from the

selectivity and sensitivity viewpoints, and such a circuit need not complicate ganging difficulties, even when using home-made coils and a three-gang capacitor if a manually (Panel) operated trimmer is incorporated in the mixer circuit.

Referring to Fig. 3, the first tuned circuit (RF stage) tunes sufficiently broadly to permit the use of a fixed trimmer as shown, and the alignment will normally hold good over the full frequency coverage of the gang capacitor. The second stage (mixer) is quite sharp, and the panel-operated trimmer would require slight adjustment as the gang is rotated. Using the circuit of Fig. 3, a separate oscillator control is quite unnecessary, and would only complicate tuning and add to the cost of building the receiver.

### A High Value IF and Variable Selectivity

It is often advantageous to use a rather high value of IF—say around 1600 kcs. Second channel interference is reduced to negligible proportions, and frequency drift due to oscillator "locking" is minimised. An economy can be effected by using ordinary broadcast-band coils, such as the Wearite P type, or home-wound, for the IF transformers tuning being accomplished by means of a 30  $\mu\mu\text{F}$  compression-type trimmers.

A very effective method of obtaining variable selectivity is to use the old "two circuit tuner" principle, so popular in the early '30's. The coupling capacitor C1 (Fig. 4) which controls the selectivity, should have a value of 100  $\mu\mu\text{F}$  max., and when

fully enmeshed gives **minimum** selectivity. This may be panel operated if so desired.

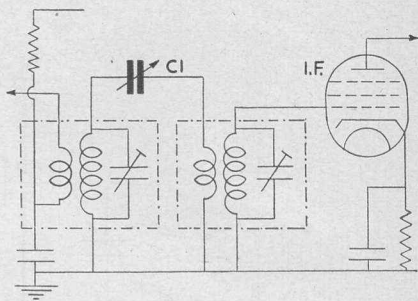

Fig. 4

### IF Regeneration and Noise Suppression

If AVC can be dispensed with (AVC is never normally used for receiving CW) the second detector could be a reacting triode or pentode. A pentode with fixed screen voltage and a high ohmic value of anode load provides a very useful noise suppression circuit, as, when a signal of much greater intensity than the normal signal level is received (as for instance, ignition static) the anode potential goes less positive than the screen potential, creating a cut-off. By using a comparatively low value of screen-grid potentiometer for controlling regeneration, noise suppression is effectively secured as well. Typical values for such a circuit are given in Fig. 5.

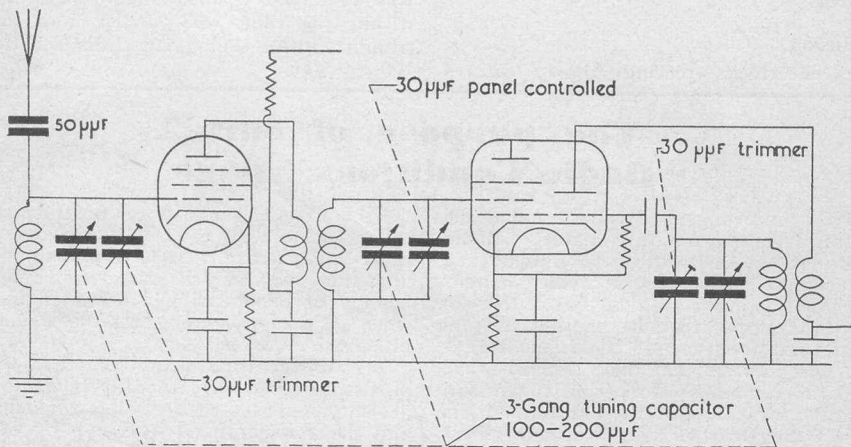

Fig. 3

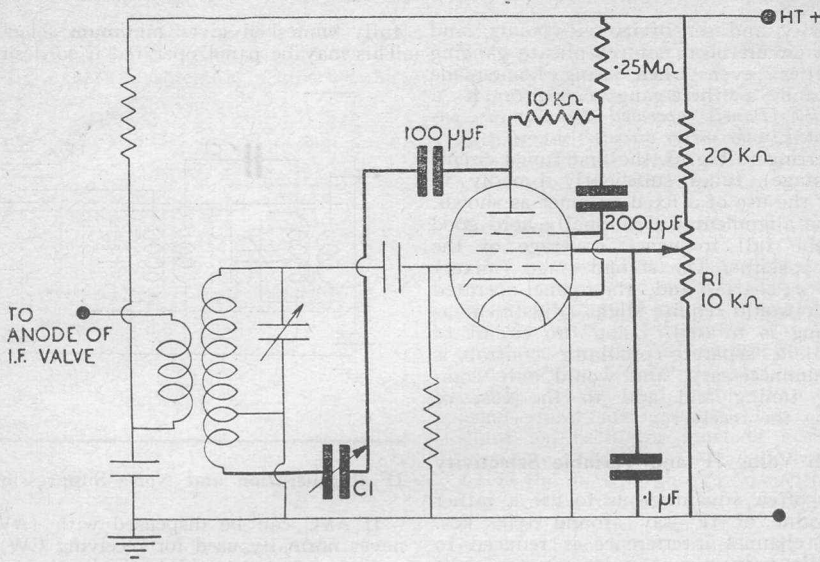

Fig. 5

Regeneration is initially adjusted as follows. The pre-set capacitor C1 (Fig. 5) is first set to its minimum capacity. The regeneration control R1 is set approximately half way, and a rather weak 'phone signal tuned in. R1 is then adjusted for maximum signal strength and left in that position. C1 can now be slowly increased in value until the second detector just oscillates. It will then be found that when R1 is turned back slightly, oscillation ceases. No further adjustment of C1 is required.

**Conclusion**

By effectively piecing these features

together, a really sensitive and selective superhet receiver can be built, at a modest cost. The constructor need not make any attempt at oscillator padding, as the mixer stage trimmer keeps the signal circuits aligned, the RF stage tuning being made fairly flat to suit.

Using an IF of somewhere near 1600 kcs. a rough guide to coil windings can be given by stating that if the oscillator coil has 10 per cent. less turns on than the RF and mixer coils, alignment will be within the range of the RF and mixer trimmers, using tuning capacitors of between 100-200 μμF.

**The purpose of our  
"Radio Conditions" page**

On the following page will be found the first of a regular monthly feature "Radio Conditions." This feature is not intended to be a comprehensive report of the amateur and broadcasting activities, but rather to indicate the type of conditions that are prevalent, and the type of conditions to expect. Our view is that once a short wave set has been completed the constructor will naturally want to put the set through its paces. Owing to the vagaries of short wave conditions it may well be possible that the preliminary testing period of a receiver will coincide with a very bad spell of conditions. We trust, therefore, that the foregoing page

will be of some guidance to constructors on just what to expect when tuning over the short wave bands. There have probably been numerous receivers that have suffered the ignomy of being stripped down as useless when all that was wrong was the prevailing propagation conditions.

The broadcasting band column is compiled by Conrad G. Tilly, ISWL/G211, one of the foremost listeners in this country, and the amateur band section is by G6DH and G6GH, two of the most consistent "DX-chasers" we have. Readers' co-operation in either section is invited.

# Radio Conditions

A survey of Conditions on the Broadcast

Bands—By ISWL/G211 (Bristol)

All times in GMT

**D**ETAILS of conditions in your locality would be appreciated for this column; also strongest signals heard over certain periods. Address all letters to: ISWL/G211 c/o "The Radio Constructor" to reach me by the 5th of the month.

Conditions during June have been very poor generally for DX on most Bands. Best day-light reception has been on the 17 and 21 Mcs. Bands, when several W stations have been heard at good strength. Signal strength of many stations has fallen greatly since the Solar Eclipse of the Sun, even the strongest such as FZI in Brazzaville on its 11970 kcs. channel has often times faded to an R3.

The Rx by the way is an Hallicrafters S20 with speaker and the aerial is an  $\frac{1}{2}$  Wave Windom N.N.W.-S.S.E. 35 ft. high. Now back to the news. The 21 Mcs. Band has been open till 2100 and 17 Mcs. to 2230. 15 Mcs. has not produced much in the way of Dx except for VLC11 Shepparton on 15210 kcs. which has been heard with R9 QSA4 signals (QRM at times from WBOS Boston is experienced). Many Moscow stations were heard causing heavy QRM to stations on all Bands. These Moscow stations use very heavy modulation and speech quality is generally roughish.

Oslo has been heard with excellent signals from 1600 onwards on 15170 kcs. South American stations have not been heard at their usual good strength. PRL7 9720 kcs. being the most consistent with R7 signals. "Radio SEAC," Colombo, Ceylon on its 15120 kcs. channel has been good when giving its weekly BC to the British Isles on Sunday evenings from 1630-1830. Power used is 100 kW. and quality is very FB on these broadcasts. "Radio Maroc," Rabat, French Morocco has been another good signal on 16670 kcs. and heard 1400-1430 on Sundays. Signals often peak R9 from this 25 kW. transmitter. Strongest signal on the 17 Mcs. Band was CKNC Sackville, Canada on 17820 kcs. with very strong QRM from 1400-1500. VLC9 has been heard with very good signals at 2145 when it gives a news bulletin for the Forces in Asia. Frequency 17840 kcs. When not QRMd by Algiers, VLA8 11760 kcs. was heard at a good R8-9 although when it comes on the air at 1745 it is almost impossible to listen to its broadcasts due to the heavy QRM. In the clear after 1800 until close at 1915. This transmission is beamed to the British Isles.

## Amateur Band Predictions

### DX PREDICTION FOR MID-JULY TO MID-AUGUST

(14 Mcs. through courtesy of Geoff. Hutson, G6GH. 28 and 60 Mcs. with acknowledgement to Denis Heightman, G6DH.)

#### 14 Mcs. Conditions

0400—W6, W7, VE6, VE7.  
0500—W6, W7, VE6, VE7.  
0600—As above, also VK, ZL.  
0700—VK, ZL.  
1400—J, VK, VU, PK.  
1500—As above, also VS1, KA.  
1600—W6, W7.  
1800—KA, KG, J.  
1900—KA, KG, J.  
2000—CX, KP4.  
2100—W5, W6, LU, PY, CX.  
2200—As above, also VP2, VP4.  
2300—W5, OA, CE, PY, LU.  
2400—As above.

#### 28 Mcs. Conditions

Conditions for DX will be similar to those of last month. Best signals will come in from S.W. of a line drawn through the Red Sea. The early evening should be the best period with signals from S. Africa and S. America proving the most reliable. There may be occasional openings to the Far East. N: American signals will be almost non-existent. European short skip signals are likely from 0700—2200 GMT during this period.

#### 60 Mcs. Conditions

Sporadic E propagation is now at its height and signals from an ever increasing number of European countries are being received. These conditions should continue during the coming month.

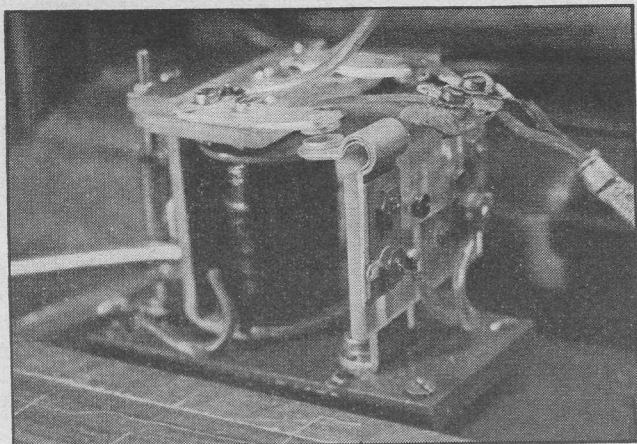

## An Aerial Change-over Switch

By

C. H. HENDERSON

*Editorial Note: Most of the surplus ex-service gear now being made available is of little value to the amateur in its delivered form, but all of it is a most valuable source of useful components. We should like to hear of any ideas our readers may have had for utilizing this equipment to its best advantage. Any information which we publish will be paid for and we start the ball rolling with a description of an aerial change-over switch constructed from one of the relays in the 1196 Set.*

THOSE who have examined the 1196 Set will know that between the transmitting and receiving sections, there is a small compartment housing a number of switching relays. The construction of one of these is such that it can be rebuilt very easily into an excellent double pole aerial change-over switch. The relay referred to is the main on/off relay and has the code number 24v. AM IOF/679, stamped on its base. Its general appearance can be seen from the photo.

In its original form, the armature has a U shaped metal fang with two massive contacts at the ends. These make contact with two similar contacts on insulated pillars. The alterations necessary to convert the relay into an aerial switch can all be seen from the photo. The first step is to remove the U shaped fang from the top of the armature and cut it into two, so that there are two separate arms each with its own contact. Next cut a piece of thick polystyrene or paxolin sheet about  $1\frac{1}{2}$  inches long by  $\frac{3}{4}$  inch wide. Drill holes in this so that it can be fitted to the armature by means of the screws which originally held the contact in place. Next fit one of the pieces of the U to each end of this piece of polystyrene and replace the strip on the armature.

Attention must next be paid to the contacts on the pillars. Detach each contact and cut a suitably shaped piece of polystyrene to carry these contacts in such a position that they are directly under those on the armature. Fix the contacts to the

strip and the strip to the two upright pillars. We now have a two pole switch which will take twin feeders from the transmitter. We also need a couple of contacts for the receiver. These can be obtained from one of the other relays in the 1196 Set and fitted as shown on a piece of polystyrene bent to a right angle and fixed with screws or cement to the first piece of polystyrene between the two transmitter contacts. All this detail can be seen in the photo quite clearly.

Various adjustments are available on the relay and by slackening the tension of the spring and making the gap between the armature and the magnet smaller, the relay will work very well from a 12 volt DC supply. In our own shack, a 12 volt metal rectifier and suitable transformer provides power for working a number of relays. Just what sort of relay system is used will vary with the layout of each particular station. In our own case, a very simple arrangement is used. All stages of the transmitter are biased to cut-off from an external bias supply, so that when the crystal oscillator is switched off, the transmitter is off the air. One relay is in series with the crystal oscillator anode HT supply, so that when the crystal oscillator is switched on, the relay is energised. This relay closes the 12 volt supply, thus energising the aerial change over switch and a relay in the receiver HT supply, which cuts the HT off the receiver. The single act of switching on and off the crystal oscillator thus switches the whole station from send to receive.

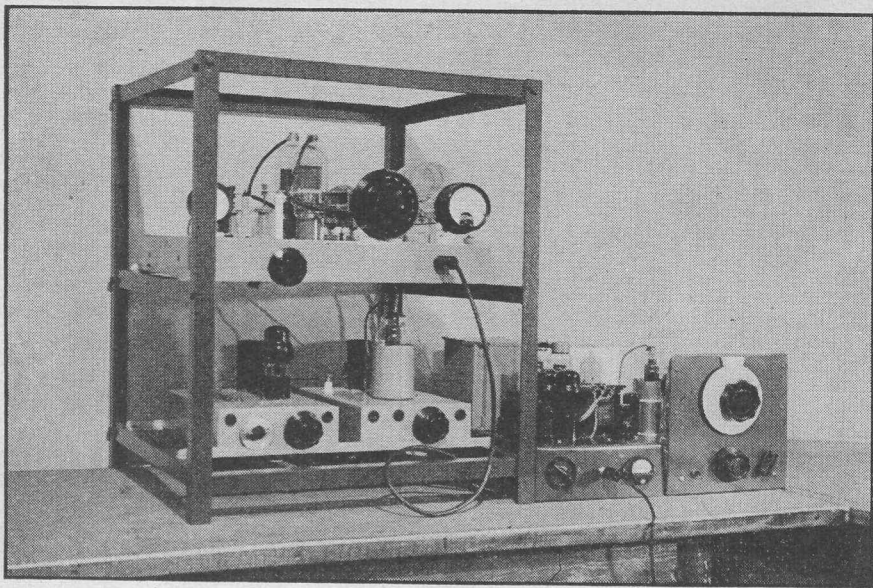

## A Versatile 150 watt TX

By G2UK

*EDITORIAL NOTE.—We describe herewith an efficient, easily constructed, and not too expensive, 150 watt transmitter. In this issue, the transmitter itself is described. In our next issue, a very efficient Franklin V.F.O. drive unit which has been used with this transmitter will be described, following which will be a description of a suitable modulator. The photograph in the heading shows the CO, FD and PA stages in the rack. Next to the rack is the modulator and at the extreme right is the Franklin V.F.O.*

### INTRODUCTION

THE rack and panel style of transmitter has been with us for so long, that a change for changes sake seemed justifiable. Getting back on the air again after the war gave use the excuse for trying out new ideas and this transmitter was built up in a style somewhat different from that usually employed by amateurs. With these thoughts in mind, the ideas for this rig were worked out.

A transmitter was wanted which would give 150 watts input to the final stage, using materials and equipment which was readily available. The layout was suggested when we saw the excellent enamelled steel chassis made by Messrs. E. J. Philpott. It was at once apparent that a very attractive rig could be built up unit by unit, using these chassis. A 6F6 crystal oscillator stage and an 807 doubler or p.a. stage were first built up and mounted side by

side in a light angle iron frame, raised up from the bench on small rubber feet—a sort of modified bread board style. It looked fine, but the addition of the p.a. stage in similar style, made a rather spread out job, so we decided the next step was a small rack to take the chassis. As the p.a. stage was on a chassis almost twice the size of the smaller stages, it fitted conveniently over these two. A visit to the local iron merchant produced some one inch angle iron and after a bit of drilling and hack-sawing, the rack shown in the photo was constructed in next to no time. The dimensions of the various chassis are:—Two lower ones for the xtal oscillator stage and doubler, 11 ins. by 6½ ins. by 2¼ ins. deep. The p.a. chassis is 17 ins. by 10 ins. by 2¼ ins. deep. The overall size of the rack to take these chassis is 23 ins. high, 18½ ins. wide and 18½ ins from back to front. The





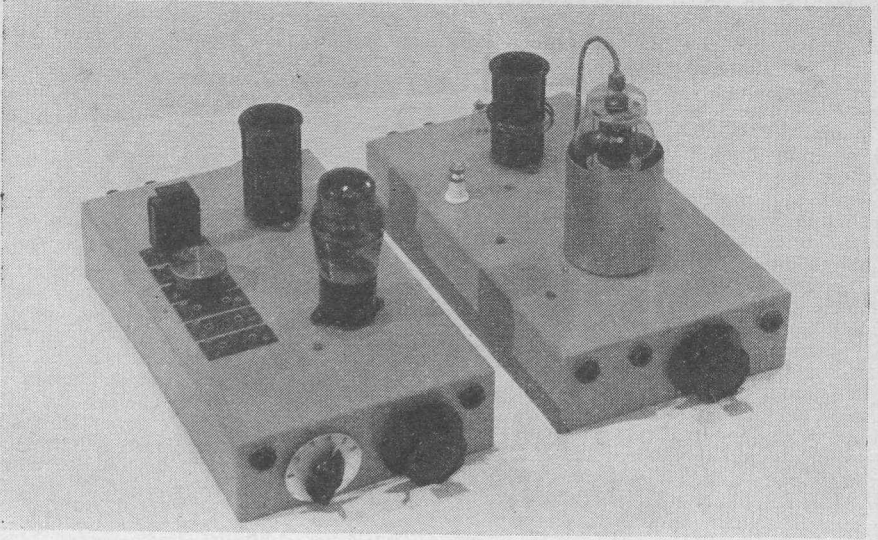

*The Crystal Oscillator and Frequency Doubler Units*

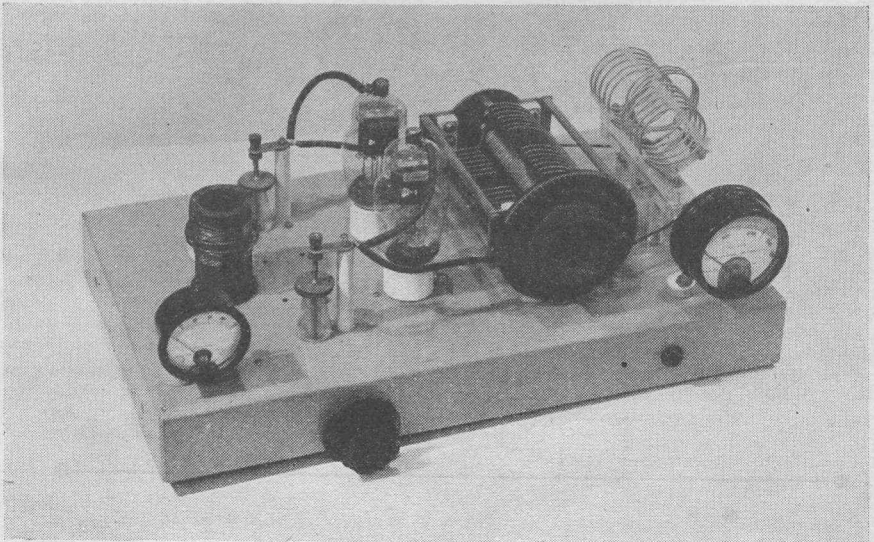

*The push-pull power amplifier*

even a quadrupler stage. In the rig described herewith, an 807 is used and it can be operated in any of these ways. As a straight amplifier, it will give more than enough RF to drive the succeeding P.A. As a doubler, quite sufficient drive for phone operation is obtained when used as a doubler from 7 Mcs. to 14 Mcs., and as a quadrupler enough drive has been obtained from 7 Mcs. to 28 Mcs. to drive the P.A. to a fairly reasonable output.

The layout of the components is similar to that in the crystal oscillator stage. C3, the tuning capacitor, is mounted on a small insulated bracket under the chassis close to the coil holder. An extension spindle connects to the knob on the front of the chassis. Some screening is advisable for the 807, particularly if its use as a straight amplifier is anticipated. All resistors, capacitors, etc., are mounted beneath the chassis. C2, the input coupling capacitor, should be of good quality—preferably mica. It connects directly between the feed-through input terminal and the grid of the 807. The RFC in the grid bias lead should be of the small transmitting type and resistor R1 should be of 5 watt rating. Battery bias is used on both this stage and the P.A. Resistor R2 may need some experimentation to get the right value for maximum RF output. Anything from 100 to 500 ohms should be tried. Try say 250 ohms first and then adjust for maximum output with normal 807 tube rating.

Resistor R3, the screen dropping resistor, should be of the 20 watt rating variety and have an easily adjustable tap. The heavy

duty wire wound *Bulgin* types are ideal for this purpose. It is very important for satisfactory operation of the 807 to get the right screen voltage and an adjustable tap on the dropping resistor is a great help in getting the voltage correct.

The jacks shown are closed-circuit type and are in the bias, cathode and anode leads respectively. Keying is carried out in the cathode circuit.

A two turn coil of 14 SWG wire is supported from two small Denco insulating pillars—just visible in the photo, behind the coil former.

This stage can be used very satisfactorily as a small transmitter, either as a straight P.A. or as a doubler or quadrupler, a doublet aerial or an aerial tuning unit being connected to the link. Whilst completing the P.A. stage, we used these two units together on the air for several weeks with great success and those who do not wish to go on to build the high power P.A. stage, can be confidently recommended to use the two units so far described as a complete, small, low power transmitter.

### The Power Amplifier Stage.

From the circuit diagram and the photo of the p.a. stage, it will be seen that a conventional push-pull triode stage is used. The two triodes shown are HY 25's, but any RF triode can of course be used in this circuit. T20's or T40's would do excellently. The various components and their position on the chassis can be well seen from the photo. On the left is the grid coil. Behind

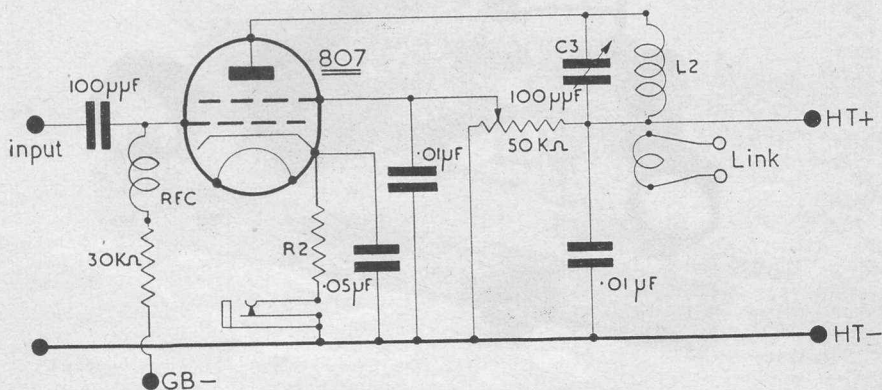

*The Frequency Doubler Circuit*

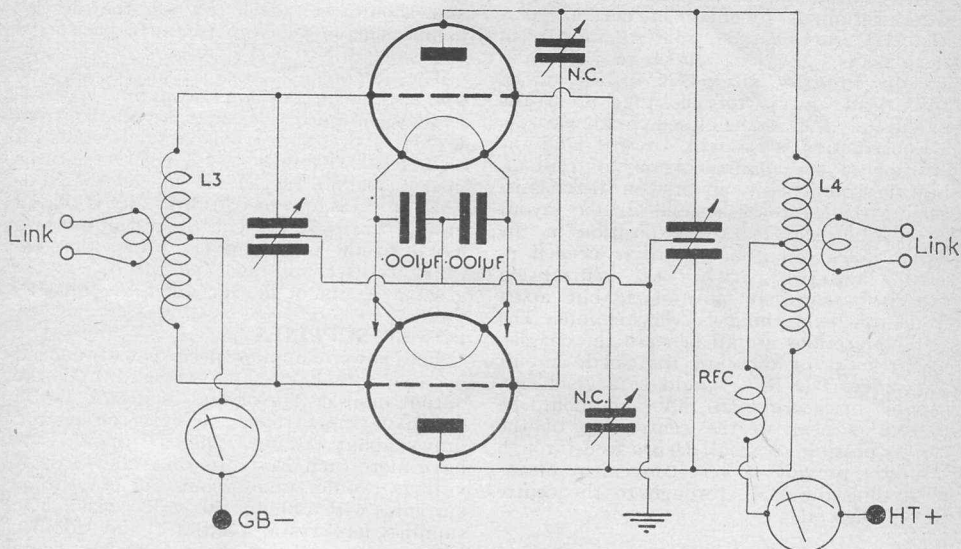

Circuit of the push-pull P.A.

it are two small stand-off insulators supporting a couple of turns of 14 SWG wire disposed round the centre of the grid coil. This is the link coupling from the doubler stage. Next, are two neutralising capacitors, about which more will be said later. The valves have their anode connections at the top and should be connected to the neutralising capacitors and the anode tuning capacitor with heavy insulated wire as shown.

The tuning capacitor is a 60-60µF split stator transmitting type. The rotor is earthed, i.e.: it is connected by a short thick piece of wire to the chassis. The anode inductance is one of the *Labgear* type, for push-pull operation with central swinging link. These coils and their supports are really excellent, being rigidly built up on stout polystyrene strip, and the swinging link makes a most convenient and adjustable coupling for RF output.

The two meters are supported on small *Denco* feed through insulators, connections to the meters then being made beneath the chassis. The grid circuit meter reads 50 mA. full scale; the p.a. circuit meter, 250 mA. full scale.

The tuning capacitor for the grid coil is placed beneath the chassis, because this is the most convenient place for it and because the connections in the grid circuit can then be kept really short. A split stator type of the same value as the anode

capacitor is needed, but it must be of small physical size as the chassis is not very deep. If a suitable one cannot be found, a larger one can be used and connected to the tuning knob on the front of the chassis by means of a flexible coupling.

The neutralising capacitors shown are home made ones and were used in preference to other types because with this type, the grid leads can be kept really short, and they fit in better with the general layout than those having both connections above the chassis. Each is made up from a large *Denco* feed-through insulator, a 2½ inch *Eddystone* insulator pillar and two 1¼ inch diameter brass blanks. These brass blanks can be purchased from model engineering dealers, or you may be able to get them from the local metal works. One blank is soldered to the top of the *Denco* insulator, the other to a piece of screwed rod. The upper one is supported from a short length of brass strip, drilled and fitted to the *Eddystone* insulator pillar as shown. The connection to the grid is of course made to the lower terminal of the feed-through insulator. If it is felt that this constructional work is too involved, the usual type of neutralising capacitor now on the market could be used, but the lead from the grids of the valves will have to be brought through the chassis via a small feed-through insulator or insulated from the chassis by rubber grommets, etc.

All connections should be made in heavy wire. Terminals for filament current, bias and H.T. supplies are fitted to the rear of the chassis. The jack shown in the photo on the front of chassis is in the anode H.T. lead and is for the plug from the modulator. It is of the closed circuit variety.

Construction is straight forward, and the position of the components is not critical. Lay the components out first on the chassis, getting them into as systematical a layout as possible and mark the position of the fixing holes, etc. Some care is needed in getting the two parts of the neutralising capacitors correctly positioned, but apart from this everything is very simple. The grid connections are all beneath the chassis, whilst most of those of the anode circuit are above. The RFC should be a good one, capable of carrying 250 mA. and should be placed as near to the centre tap of the coil as possible. A small *Denco* feed-through insulator provides a very convenient means of feeding the H.T. through to the centre tap of the coil.

#### COIL DATA

Coils L1, L2 and L3 are all wound on four pin formers of the plug in type and this makes the transmitter very versatile, as any number of arrangements are available. If output on 14Mcs. is required, the crystal oscillator stage is best run at 7 Mcs., though by quadrupling in the second stage, 3.5 Mcs. crystals can be used. If output on 7 Mcs. is primarily required, 7 Mcs. crystals can be used, using the second stage as a straight amplifier or 3.5 Mcs. crystals using second stage as a doubler, or 1.7 crystals using second stage as a quadrupler and so on. As already mentioned, quite satisfactory operation can be had on 28 Mcs. running the crystal oscillator stage on 7 Mcs. and using the 807 as a quadrupler to 28 Mcs. In giving the data for the coils therefore, various coils for each stage are specified, the correct combination required to give the desired output being left to individual choice.

Coil L1. 40 turns d.c.c 22 SWG close wound for 1.7 Mcs. 16 turns enamelled 22 SWG spaced 1/16th inch for 3.5 Mcs. 8 turns for 7 Mcs.

Coil 2. Using 22 SWG enamelled spaced 1/16th inch apart, 20 turns for 3.5 Mcs., 10 for 7 Mcs., 5 for 14 Mcs. and 3 for 28 Mcs. The 28 Mcs. coil should have  $\frac{1}{4}$  inch spacing between coils.

Coil L3. 12 turns enamelled 22 SWG centre tapped spaced 1/16th inch between turns and  $\frac{1}{4}$  inch between each half of the windings for 14 Mcs., twice this for 7 Mcs., and half for 28 Mcs.

Coil L4. These are standard *Labgear* and should be purchased for the desired band, using a variable tuning capacitor of 60-60 $\mu$ f.

The doubler stage is connected to the p.a. by means of link coupling. As already mentioned the links are made from 14 SWG wire, supported on small stand-off insulators. The link on L2 is of two turns placed around the H.T. end of the coil. That on L3 is also of two turns and is placed in the centre of the coil, between the two halves of the coil windings. Connection between the second stage and the p.a. is via a short length of flex or other 80 ohm RF feeder.

#### POWER SUPPLIES

The power supplies needed will depend on the actual p.a. valves used and the output desired. The crystal oscillator should not have more than 300 volts on it and draws about 20 mA. The 807 should not have more than 750 volts on it and at that voltage would take about 50 mA. total current, with 40 to 50 volts bias. The supplies for crystal oscillator and doubler stages may well be taken from the same power pack. The p.a. stage will need a power supply in keeping with the ratings of the valves actually used.

This transmitter has been somewhat sketchily described, but its main features are well illustrated by the photographs and we feel that this layout will prove a popular one. In our next issue a Franklin VFO Unit will be described which has been used with this transmitter for the past six months and has proved very satisfactory indeed on frequencies as high as 28 Mcs. on both phone and CW.

---

#### INTERNATIONAL SHORT WAVE LEAGUE

This society is sponsored by our sister journal "Short Wave News" and presents an opportunity to get to know your local enthusiasts. League Chapters have been formed in London, Birmingham, Darlington, Uxbridge, Chelmsford, Malvern, Portsmouth and other localities are making plans to start local groups. Overseas, too, the League has its meeting plaecs: at present in Tel-Aviv, Karachi and Khartoum, with prospective group in the U.S.A.

#### ANYONE IS MADE WELCOME AT AN I.S.W.L. CENTRE!

Aside from the social activities, the I.S.W.L. offers such facilities as a unique two-way QSL Bureau, Translation Services, Technical Query Services, European Exchange Holiday Scheme, Broadcast Station Query and Schedule Service, Correspondence Bureau, etc.—[continued on page 26]

# Set Review



## The Eddystone "640"

IT is gratifying to be able to write-up a receiver which has been designed primarily for Amateur Communication purposes and is at the same time British built.

This receiver covers without a gap, a tuning range of 1.7 to 31 Mcs. and thus will cover all the normal amateur bands—including the proposed 21 Mcs. band. This frequency range is covered in three bands:

- Band 1 32 to 12.6 Megacycles
- Band 2 12.6 to 4.5 Megacycles
- Band 3 4.5 to 1.7 Megacycles

Selection of any particular range is by a low loss, low capacity switch, which is actuated by a chromium plated lever fitted beneath the left hand tuning control. This is quite a novel feature which adds greatly to the ease of operation. Separate three-gang capacitors are used for bandsetting and bandspreading, but the dial mechanism has been so designed that indication of bandset and bandspread is shown on one dial by two separate pointers concentrically pivoted like the hands of a clock. The left of the two tuning knobs actuates the band-setting capacitor and the longer of the two pointers, which moves over the outer part of the dial where the various amateur bands are indicated by green lines. For reception of the amateur bands, this bandset pointer is made to coincide with the left hand edge of the green line. On all but the lowest frequency band, tuning is then carried out with the right hand knob, which moves the shorter of the two pointers over a scale graduated 0-100. On "top band" tuning is carried out on the bandset control, the bandspread control being used for fine vernier adjustment if desired. The bandspread drive is through a flywheel

mechanism which gives very smooth action.

The makers specify the following as being outstanding features of this receiver:—

Separate Electrical Bandspread. High Signal to Noise Ratio. Excellent Sensitivity. High Adjacent Channel Selectivity. Large Attenuation of Image Signals. Good Frequency Stability. Accurate Calibration. Efficient Crystal Filter. Robust Construction. A trial of this receiver will convince the most skeptical that these claims are justified. The construction in particular is very noteworthy. Really robust construction has been carried through in every part of the receiver. The front panel and the tuning unit are diecast in aluminium and provide an extremely rigid foundation for the whole receiver. The power supply, IF and audio chasses are of brass. The external cover is of sheet steel. All components are tropicalised. The finish is pleasing, cabinet and panel being in ripple black and as can be seen from the photos, the general appearance is extremely attractive.

### Circuit Details

A nine valve superheterodyne circuit is employed using EF39 in RF stage; 6K8GT in freq. changer; EF39 in 1st IF amplifier; EF39 as 2nd IF amplifier; 6Q7GT as Det. AVC and audio amplifier; 6V6GT as output amplifier; 6X5GT as rectifier; EB34 as noise limiter and EF39 as BFO. All these valves are of the international octal base type so that replacements can be made without difficulty.

Associated with the first IF is a crystal filter, giving an adjacent channel attenuation of 45 db.

Aerial arrangements provide for either single wire or feeder type. In the latter

case, the impedance is 400 ohms. On the audio side, an output transformer is incorporated and either a 2.5 ohms speaker or high resistance phones may be used.

### Controls

The controls, which are all arranged on the front panel, comprise:

Main Tuning. Bandsread Tuning. Band Selection Switch. RF Gain. AF Gain. BFO Pitch Control. BFO on/off Switch. Crystal Phasing. Crystal in/out Switch. Noise Limiter on/off Switch. AVC on/off Switch. Send/Receive Switch. Mains on/off Switch.

### Selectivity

With the crystal out, the selectivity curve shows a drop of 25 db. at 10 kilocycles off resonance. With the crystal in, selectivity is controlled by the setting of the phasing condenser and can be made extremely high for CW reception. The image attenuation ratio is given as:—

At 30 Mcs. image down 45 db.

At 10 Mcs. image down 60 db.

At 2.5 Mcs. image down 90 db.

### Sensitivity

Special measures have been taken to ensure an even sensitivity over the whole frequency range. Sensitivity is better than 2

microvolts input for 50 milliwatts output. The low noise level makes possible the reception of very weak signals.

### Amateur Band Coverage

The bandsread dial is divided into 100 divisions extending over a semi-circle. On this the amateur bands cover the following number of divisions:—28 Mcs.—45. 14 Mcs.—66. 7 Mcs.—51. 3.5 Mcs.—84.

From this brief description, it will be seen that this receiver is in a class which can easily hold its own with the more established communication receivers and it is good to find British manufacturers going to so much trouble to produce an amateur communication receiver of such a high standard.

---

I.S.W.L.—[continued from page 24]

Although the League was only formed in October, 1947, it now has a membership in excess of 1,100, with representation in 32 countries throughout the world.

Membership to the League is only 1/- a year! If you are not a member, write now to I.S.W.L. HQ., 57, Maida Vale, London, W.9., for full particulars of this flourishing and progressive society.

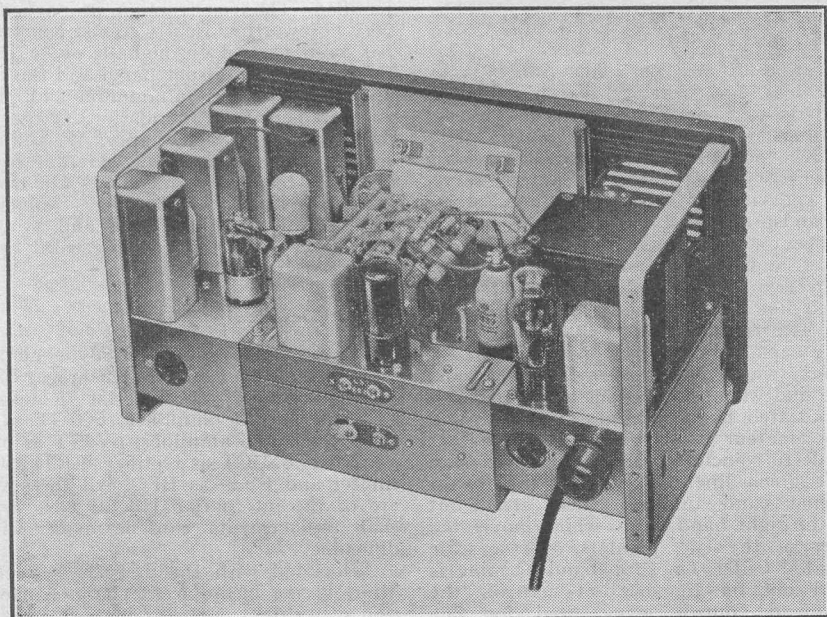

*Rear view of the "640"*

★ We have the finest stock of British and American radio books in this country.

Write or call for complete list—

**THE MODERN BOOK COMPANY**  
(Dept.RC)

19-23 Praed Street, London, W.2

"You'll probably get it at

*Smith's*

EDGWARE ROAD!"

The Book on how to make it,  
The Material to make it with,  
The Components to put in it,  
The Equipment to test it with,  
The Cabinet to put it in.  
(AND a fair deal!)

**H. L. SMITH & CO. LTD.**

287-9 EDGWARE ROAD, LONDON, W.2

Near Edgware Road Met. and Bakerloo  
Phone PAD. 5891 :: Hours 9-6 (Thurs. 1 o/c.)

## THESE YOU CAN HEAR

*A QUALITY PRODUCTION OF 36 PAGES, ON ART PAPER THROUGHOUT AND LAVISHLY ILLUSTRATED*

Price

2' -

The booklet is designed for those about to make a hobby of Broadcasting Station listening, and in addition to descriptions of various well-known stations, contains a host of information to aid the beginner.

from your bookseller, or direct from the publishers in case of difficulty.

**AMALGAMATED SHORT WAVE PRESS LTD**

57 Maida Vale, London, W.9

**D  
E  
N  
C  
O**

### **TECHNICAL BULLETIN No. 1**

**OBTAIN YOUR COPY, NOW, FROM OUR NEAREST APPROVED STOCKISTS (or direct in case of difficulty)**

CONTAINS TEN LARGE PAGES ON :—

- (1) COMPLETE TECHNICAL DATA ON THE MAXI-Q RANGE OF COILS.
- (2) DETAILED DESIGNS AND CIRCUITS FOR HIGH PERFORMANCE SUPERHET, T.R.F., AND VHF CONVERTOR.
- (3) OTHER USEFUL INFORMATION ON THE APPLICATION OF MAXI-Q COILS.

PRICE 3/-

It is our intention to publish, from time to time, similar bulletins on our other products.

You can now obtain good delivery of all DENCO components from our stockists.

**OLD ROAD, CLACTON-ON-SEA, ESSEX**

# SMALL ADVERTISEMENTS

Readers' small advertisements will be accepted at 3d. per word, minimum charge 3/-. Trade advertisements will be accepted at 6d. per word, minimum charge 6/-. If a Box Number is required, an additional charge of 1/6 will be made. **Terms:** Cash with order. All copy must be in hand by the 10th of the month for insertion in the following month's issue.

## TRADE

**TESTED VALVES:** 2/6; New ceramic EF50 valveholders 6d.; Shrouded 180 mA. chokes (weight 4½ lbs.) 10/6; 90V.-1½V. batteries 5/-; Large capacity 1½V. with terminals 1/-; Moving coil hand mikes 5/6; SW RF chokes, wavewound in sections, 1/6. Send 2d. stamp for complete list: Carters, 67 Ball Lane, Marston Green, Birmingham.

**AMERICAN MAGAZINES:** "Radiocraft," "QST," "Television," "Esquire," "Life," etc. Yearly subscriptions arranged. Leading popular publications. Details from Smith & Co., 14a, Market Place, North Walsham, Norfolk.

**G6MN** for the "best" QSLs and approved log books, send for samples, Bridge Street Workshop.

**HAM GEAR.** Components for RX and TX crystals, test gear, special equipment built. Hamrad, Eddystone, Raymart, Labgear, Q-Max, Denco, Woden, Wearite and all well-known components. Large stocks; quick service. No lists, send stamp with enquiry, prompt reply. RX and TX valves including many rare types. Newson, G3GY ex-G2GF, 28 Market Place, North Walsham, Norfolk. Phone 219.

## SHORT WAVE (HULL) RADIO G5GX.

### RECEIVER KITS

- 2 Valve O.V.1. Bandsread tuning, plug in coils, 9-200 metres, Pentode output. Price, less cabinet and batteries **£5 10s.**
- 4 Valve 1. (Tuned) V2 Bandsread tuning 9-200 metres, Black crackle steel cabinet. Price, less batteries and speaker **£12 12s.**

### TRANSMITTER KITS

- 10 watt C.W. Tx with Xtal and coils for 160-80-40-20, **£11 0s.**
- 25/50 watt C.W. Tx with standard panel, meter, drilled chassis, Xtal and coil for one band, all components and valves, **£19 10s.**

Further details supplied on request.

## SHORT WAVE (HULL) RADIO

30/32, PRINCE'S AVENUE  
Phone 7168

# LITERATURE FOR RADIO ENTHUSIASTS

## CURRENT PRICE LIST

"The Radio Constructor," 1/3 monthly from local booksellers or 16/- on annual subscription. For the Practical Radio Man.

"Short Wave News," 1/3 monthly from local booksellers or 16/- on annual subscription. For the DX fan, VHF enthusiast, etc. General interest and constructional articles also covered.

"The Short Wave Listeners Annual," 1947 Edition. Acclaimed throughout the world as the most comprehensive publication of its kind ever produced. 84 pages crammed tight with essential data for the listener and DX fan. Price 2/9 post-paid, or 2/6 from local booksellers.

"These You Can Hear." A quality production, on art paper throughout, and lavishly illustrated, for the beginner to Broadcast Station listening. Price 2/3 post-paid, or 2/- from local booksellers.

Listener Reporting Pads. 50 printed report sheets for the compilation of really useful reception reports. With card cover and full instructions. Price 2/6 post-paid.

## AMALGAMATED SHORT WAVE PRESS LTD

57 Maida Vale, Paddington, London, W9  
G2UK \* G3AKA \* G2ATV

# M.O.S.

MAIL ORDER SUPPLY CO  
24 New Road London, E.1  
Telephones:  
STEPney Green 2760 and 3906

## 10 Valve FREQUENCY MODULATION

### COMMUNICATIONS RECEIVERS

(Ex U.S. Army Signal Corps Type BC603D)

Supplied complete with 10 valves  
and 24v power unit.

**ONLY £6 19 6**

Carriage and Packing 7/6

### SPECIFICATION

1. Frequency coverage—20-28mc.
2. Push Button and manual tuning.
3. 24v Input power unit, 220v 80m/a output. (easily removable, if 12v supply to be used, or else provision for Batteries).
4. Valve Line up:—  
V1.6AC7 R.F. Amplifier.  
V2.6AC7 Modulator.  
V3.6J5 R.F. Oscillator.  
V4.1SG7 I.F. Amplifier.  
V5.1SG7 I.F. Amplifier.  
V6.6AC7 Limiter.  
V7.6H6 Detector.  
V8.6V6GT 2nd Audio amplifier.  
V9.6SL7GT A.V.C. and squelch.  
V10.6SL7GT 1st Audio amp. and I.F. Osc.
5. Circuits supplied with each receiver.
6. Provision for fitting speaker inside receiver.
7. Overall sizes 11ins. x 7ins. x 11½ins. approx.