

Practical

Wireless

SEPTEMBER 1987 E1-20

ISSN 0141-0857

The Radio Magazine

The Siskin TNC 220
Reviewed

Valved Communications
Receivers -
The Hallicrafters S-27D



Build The PW 'Blenheim' v.h.f. to h.f. receive converter

Reg Vard & Co. Ltd.

1 Western Parade, West Street, Axminster, Devon, EX13 5NY.
Telephone: Axminster (0297) 34918

Yaesu

FT1	HF Transceiver	P.O.A. (—)
FT980	HF Transceiver	1750.00 (—)
SP980	Speaker	110.00 (2.50)
FT767		1550.00 (—)
FEX767(2)	2m Module (767)	169.00 (2.50)
FEX767(70)	70cm Module (767)	169.00 (2.50)
FEX767(16)	6m Module (767)	215.00 (2.50)
SP102	Speaker	75.00 (2.00)
SFT290	MkII New Super 290	429.00 (—)
FT290	2m M/Mode Port/Transceiver	379.00 (—)
FT290	With Mutek front end fitted	409.00 (—)
NC11	Charger	10.50 (1.50)
MMB11	Mobile Bracket	10.50 (1.50)
CSC1	Carrying Case	6.50 (1.50)
YHA15	2m Helical	7.50 (1.50)
YHA44D	70cm 1/2wave	12.50 (1.50)
YM49	Speaker Mike	22.00 (1.50)
MMB15	Mobile Bracket	14.55 (1.50)
FT23	2m Mini H/H	243.50 (2.50)
FT73	70cm Mini H/H	223.50 (2.50)
FN89	Spare Battery Pack (23/73)	25.00 (1.50)
FN10	Spare Battery Pack (23/73)	30.00 (1.50)
FN11	Spare Battery Pack (23/73)	46.00 (1.50)
NC.18C	Charger (23/73)	12.35 (1.50)
NC.28	Charger (23/73)	15.40 (1.50)
NC.29	Base Charger (23/73)	53.00 (2.50)
PA6	Car Adap/Charger (23/73)	16.00 (1.50)
MH12A2B	Speaker Mic	27.00 (1.50)
FT727	2m/70cm H/H	425.00 (3.00)
FN83	Spare Battery Pack	41.00 (1.50)
FN84	Spare Battery Pack	46.00 (1.50)
FN85	Empty Cell Case	10.00 (1.50)
FT209R	NEW 2m H/Held/CW FN83	P.O.A. (—)
FT709R	70cm H/Held	P.O.A. (—)
FT270RH	2m 45W F.M.	299.00 (—)
FT21RH	2m FM 45W	299.00 (—)
FRG9600M	60-95MHz Scanning RX	509.00 (—)
MMB10	Mobile Bracket	10.00 (1.50)
NC9C	Charger	11.50 (1.50)
PA3	Car Adaptor/Charger	21.85 (1.50)
FN82	Spare Battery Pack	25.00 (1.50)
YM24A	Speaker Mike	27.00 (1.50)
FT26F	2m Base Station	999.00 (—)
430/726	70cm Module for above	349.00 (3.00)
FRG8800	HF Receiver	639.00 (—)
FRV8800	Converter 118-175 for above	100.00 (2.00)
FRT7700RX	A.T.U.	59.00 (2.00)
MH18B	Hand 600 8pin mic	21.00 (1.50)
MD18B	Desk 600 8pin mic	21.00 (1.50)
MF1A3B	Boom mobile mic	25.00 (1.50)
YH77	Lightweight phones	19.99 (1.50)
YH55	Padded phones	19.99 (1.50)
YH1	L/weight Mobile H/set-Boom mic	19.99 (1.50)
SB1	PTT Switch Box 208/708	22.00 (1.50)
SB2	PTT Switch Box 290/790	22.00 (1.50)
SB10	PTT Switch Box 270/2700	22.00 (1.50)
FF501DX	Low Pass Filter	38.50 (1.50)

Icom Products

IC761	New Super HF Transceiver	P.O.A. (—)
IC751A	HF Transceiver	1465.00 (—)
IC735	New HF Transceiver	949.00 (—)
AT100	100W ATU (751/745)	365.00 (3.50)
AT150	150W ATU (735)	315.00 (3.50)
PS55	Ext PSU (735)	185.00 (3.00)
IC505	50MHz multi-mode portable	459.00 (—)
IC290D	2m 25w M/Mode	542.00 (—)
IC28E	25W FM	359.00 (—)
IC28H	2m 45W FM	399.00 (3.00)
IC Micro	2E New Mini H/H	229.00 (3.00)
IC2E	2m The Original H/H	225.00 (3.00)
IC02E	2m H/H	299.00 (3.00)
IC275E	New 2m 25 Base Stn	1029.00 (—)
IC4E	70cm H/H	285.00 (3.00)
IC04E	70cm H/H	299.00 (3.00)
IC48E	70cm 25W FM Mobile	449.00 (3.00)
IC490	70cm 10W M/Mode	617.00 (—)
IC3200	2m/70 Dual Band FM Mobile	559.00 (—)
IC12E	23cm H/H	428.00 (3.00)
ICR71	Gen Cov RX	825.00 (—)
IC7000	VHF/UHF Scanner	957.00 (—)
AH7000	25-1300MHz Discone	82.00 (2.50)
SP3	Ext Speaker	61.00 (2.50)
K70	DC Cable (R70/R71)	7.00 (1.50)
EX257	NC Band (R70/R71)	41.00 (1.50)
G55	World Clock	43.00 (2.00)

HAND HELD ACCESSORIES

AQ2	Waterproof Bag all Icom H/H	14.38 (1.50)
BC35	Desk Charger	70.15 (2.00)
BP3	Battery Pack 8.4V (2/4E/02/04E)	29.90 (1.50)
BP4	Empty Battery Case (2/4E/02/04E)	9.20 (1.50)
BP5	Battery Pack 10.8V	60.95 (2.00)
BP7	Battery Pack 13.2V (02/04E only)	74.75 (2.00)
BP8	Battery Pack 8.4V	71.30 (2.00)
CP1	12V Charge Lead BP3/7/8	6.90 (1.50)
DC1	DC/DC converter operate from 12v	17.25 (1.50)
FA2	2m Helical BNC	9.20 (1.50)
FA3	70cm Flexible 1/4λ Antenna (BNC)	9.20 (1.50)
HM9	Speaker/Mic	21.85 (2.00)
HS10	Head set Boom Mike	20.70 (1.50)
HS10SA	Vox Unit HS10 (02/04E only)	12.25 (1.50)
HS10SB	PTT SW Box HS10	20.70 (1.50)
LC3	Leatherette Case 2E/4E + BP5	6.90 (1.50)
LC1	Leatherette Case 2E/4E + BP3	6.90 (1.50)
LC11	Leatherette Case 02E/04E + BP3	9.20 (1.50)
LC14	Leatherette Case 02E/04E + BP5/7/8	9.20 (1.50)
SS1	Shoulder Strap	10.35 (1.50)

OTHER ACCESSORIES

SM6	600ohm 8P Base Mic	46.00 (2.00)
SM8	1.3K/600Q 8P Base Mic	82.00 (2.00)
SM10	Comp/Graphic Mike	116.00 (2.50)

Kenwood

TS940S	9 Band TX General Cov RX	1995.00 (—)
AT940	Auto/ATU	244.88 (2.50)
SP940	Ext Speaker	87.55 (2.50)
TS300S	9 Band TX General Cov RX	1695.00 (—)
AT930	Auto/ATU	206.03 (2.50)
SP930	Ext Speaker	90.94 (2.50)
TS440	NEW 9 Band TX General Cov RX	1138.81 (—)
AT440	Auto/ATU	144.82 (2.50)
PS50	Hi/Duty PSU	222.49 (2.50)
TS530S	16m 10m Transceiver 9 Bands	1098.00 (2.50)
AT530	All Band ATU/Power Meter	208.67 (2.50)
SP230	External Speaker Unit	66.49 (2.50)
TS530SP	160m-10m Transceiver	927.51 (—)
TS430S	160m-10m Transceiver	974.23 (—)
PS430	Matching Power Supply	173.78 (3.50)
MB430	Mobile Mounting Bracket	15.80 (2.50)
FM430	FM Band For TS430	48.05 (2.50)
SM220	Station Monitor	343.62 (3.00)
BS8	Band Scope Unit (830/940)	77.00 (2.50)
TL922	10/160 2K Linear	222.49 (2.50)
TR751	2M 45W Mobile FM	317.17 (3.00)
TM421ES	70cm 25W Mobile FM	372.08 (3.00)
TH21	2M Mini H/H	189.00 (2.50)
TH41	70cm Mini H/H	268.00 (2.50)
TH205	2M H/H	215.26 (3.00)
TH215	2M H/H Keyboard	252.13 (3.00)
TR751	2M 25W M/M Mobile	1495.00 (7.00)
TR851	70cm M/M Mobile	699.00 (—)
TS711	2M 25W Base Stn	940.00 (—)
TS811	70cm 25W Base Stn	1094.05 (—)
R2000	Gen Coverage HF/RX	595.00 (—)
VC10	118-174MHz Converter (R2000)	152.91 (2.00)
RS000	NEW Gen Cov HF/RX HF/RX	875.00 (—)
VC20	118-174MHz Converter (R5000)	167.21 (2.00)

HAND HELD ACCESSORIES

BT2	Empty Battery Case TH21/41	11.86 (1.50)
DC21	DC Power Supply TH21/41	25.00 (1.50)
EB2	Ext. Battery Case TH21/41	6.77 (1.50)
HMC1	Headset with Vox TH21/41	32.91 (1.50)
PR21	Nicad Pack TH21/41	24.36 (1.50)
BC6	Desk Charger TH21/41	99.00 (2.00)
SC8	Soft Case TH21/41	11.86 (1.50)
SMC30	Speaker/Mic TH21/4/2600	28.31 (1.50)

ACCESSORIES

MC60	4P Desk Mic	46.08 (2.50)
MC80	8P Desk Mic	88.22 (2.50)
MC80	Electric Desk Mic	53.98 (2.50)
MC85	Desk Mic Audio Level Comp	99.00 (2.50)
MC43	8P Fist Mic	22.22 (1.50)
MC35	4P Fist Mic	21.72 (1.50)
MC55	Mobile Mic (6br 8p)	52.67 (2.50)
LF30	HF Low Pass Filter	32.26 (2.00)
XX3	Receiver ATU (Mizuhou)	67.28 (2.50)
HS6	Lightweight H/phones	24.36 (2.00)
HSS	Deluxe H/phones	37.54 (2.00)
SW100A	SWR/Power Meter 1.8-150MHz	49.50 (2.00)
SW100B	SWR/Power Meter 140-450MHz	49.50 (2.00)
SW200A	SWR/Power Meter 1.8-150MHz	107.99 (2.50)
SW200B	SWR/Power Meter 140-450MHz	107.99 (2.50)
SW2000	SWR/Power Meter 1.8-54MHz	117.17 (2.50)
SWT1	2m ATU	38.18 (2.00)

Linear Amps

TOKYO HI POWER		
HL 160V	2m, 10W in, 160W out	244.52 (2.50)
HL 82V	2m, 10W in, 85W out	144.50 (2.50)
HL 110V	2m, 10W in, 110W out	249.00 (2.50)
HL 35V	2m, 3W in, 30W out	76.00 (2.50)
HL 30	2m, 3W in, 30W out	64.00 (2.50)
HL 30V	70cms, 3W in, 30W out	122.50 (2.50)

MICROWAVE MODULES

MML144/30-LS	inc preamp (1/3 w i/p)	98.90 (2.50)
MML144/30-S	inc preamp, switchable	106.95 (2.50)
MML144/100-S	inc preamp (10w i/p)	149.95 (3.00)
MML144/100-HS	inc preamp (25w i/p)	159.95 (3.00)
MML144/100-LS	inc preamp (1/3w i/p)	163.95 (3.00)
MML144/200S	inc preamp (3/10/25 i/p)	369.94 (3.00)
MML432/30L	inc preamp (1/3w i/p)	165.95 (2.50)
MML432/50	inc preamp (10w i/p)	149.50 (2.50)
MML432/100	linear (10w i/p)	334.65 (3.00)

B.N.O.S.

LPM 144-1-100	2m, 1W in, 100W out, preamp	235.00 (3.00)
LPM 144-3-100	2m, 3W in, 100W out, preamp	235.00 (3.00)
LPM 144-10-100	2m, 10W in, 100W out, preamp	205.00 (3.00)
LPM 144-25-180	2m, 25W in, 180W out, preamp	305.00 (3.00)
LPM 144-3-180	2m, 3W in, 180W out, preamp	355.00 (3.00)
LPM 144-10-180	2m, 10W in, 180W out, preamp	355.00 (3.00)
LP 144-3-50	2m, 3W in, 50W out, preamp	145.00 (3.00)
LP 144-10-50	2m, 10W in, 50W out, preamp	145.00 (3.00)
LPM 432-1-50	70cm, 1W in, 50W out, preamp	255.00 (3.00)
LPM 432-3-50	70cm, 3W in, 50W out, preamp	255.00 (3.00)
LPM 432-10-50	70cm, 10W in, 50W out, preamp	215.00 (3.00)
LPM 432-10-100	70cm, 10W in, 100W out, preamp	395.00 (3.00)
LPM 432-3-100	70cm, 3W in, 100W out, preamp	395.00 (3.00)

HANSEN

FS50VP	50-150MHz 20/200 Interval PEP/SWR	106.70 (2.50)
FS300V	50-150MHz 20/200 PWR/SWR	53.50 (2.50)
FS300H	1.8-60MHz 20/200/10W	53.50 (2.50)
FS210	1.8-150MHz 20/200 Auto SWR	63.50 (2.50)
W720	140-430MHz 20/200W	52.75 (2.50)

WELZ

SP10X	1.8-150MHz PWR/SWR	39.95 (2.50)
SP122	1.8-60MHz PWR/SWR/PEP	79.95 (2.50)
SP220	1.8-200MHz PWR/SWR/PEP	67.95 (2.50)
SP225	1.8-200MHz PWR/SWR/PEP	99.95 (2.50)
SP420	140-525MHz PWR/SWR/PEP	59.95 (2.50)
SP425	140-525MHz PWR/SWR/PEP	119.95 (2.50)
SP825	1.8-200-430-800-1240MHz	169.00 (2.50)

TOYO

T430	144/432 120 W	52.50 (2.50)
T435	144/432 200 W	58.00 (2.50)

Scanning Receivers

SX200	VHF/UHF Scanner	325.00 (3.00)
SX400	VHF/UHF Continuous Coverage	645.00 (3.00)
AOR72002	VHF/UHF Continuous Coverage	487.00 (3.00)
HX2000	HH Scanner	269.00 (3.00)

SPECIAL OFFERS

YAESU FT209R(3)	WAS £299	NOW £218
YAESU FT209R(4)	WAS £305	NOW £229
YAESU FT209R(4)	WAS £325	NOW £199
YAESU FT757GX	WAS £895	NOW £789
YAESU FT757GX	WAS £1168	NOW £899
KENWOOD TH21 2m H/H	WAS £225	NOW £189
KENWOOD TH41 70cm H/H	WAS £288	NOW £218
KDK FM740	WAS £399	NOW £299

Datong Products

PC1	Gen. Cov. Con.	137.40 (2.00)
YLF	Very low frequency conv.	34.90 (2.00)
EL2	4-band audio filter	89.70 (2.00)
EL3	Active filter for receivers	129.00 (2.00)
ASP/B	r.f. speech clipper for Trio	82.80 (2.00)
ASP/A	r.f. speech clipper for Yaesu	82.80 (2.00)
ASP	As above with 8 pin conn	89.70 (2.00)
D75	Manual RF speech clipper	56.35 (2.00)
D70	Morse Tutor	56.35 (2.00)
MK	Keyboard morse sender	137.40 (2.00)
RFA	RF switched pre-amp	36.00 (2.00)
AD270-MPU	Active dipole with mains p.s.u.	61.75 (2.00)
AD370-MPU	Active dipole with mains p.s.u.	69.00 (2.00)
MPLU	Mains power unit	6.90 (2.00)
DC144/28	2m converter	39.67 (2.00)
PTS1	Tone squelch unit	46.00 (2.00)
ANF	Automatic notch filter	67.85 (2.00)
SRB2	Auto Wordpecker blinder	86.25 (2.00)

CW/RTTY Equipment

Tono 550	Reader	329.00 (3.00)
----------	--------	---------------

ICS/AEA	Complete Packet/Amtor terminal	239.00 (3.00)
PK64	Packet/RTTY Terminal	269.00 (3.00)

BENCHER	Squeeze Key, Black base	67.42 (2.50)
BY2	Squeeze Key, Chrome base	76.97 (2.50)

VIBROPLEX

lambic Standard		66.33 (3.00)
lambic Deluxe		78.09 (3.00)
Vibrokeyer Standard		63.98 (3.00)
Vibrokeyer Deluxe		78.09 (3.00)
The Original Standard		73.54 (3.00)
The Original Deluxe		82.74 (3.00)

HI-MOUND Morse KEYS

HK703	Up down keyer	38.35 (2.00)
HK704	Up down keyer	26.35 (2.00)
HK706	Up down keyer	21.80 (2.00)
HK707	Up down keyer	20.15 (2.00)
HK710	Up down keyer	39.95 (2.50)
HK711	Up down solid brass	60.00 (2.50)
HK802	Up down solid brass	104.50 (2.50)
HK803	Up down keyer	66.95 (2.00)
MK703	Twin paddle keyer metal base	34.50 (2.00)
MK705	Twin paddle keyer marble base	32.78 (2.00)
MK706	Twin paddle keyer	30.48 (2.00)
MK706	Twin paddle keyer	54.70 (3.00)
STARMASTER	Keyer Unit CMOS Memory	95.00 (3.00)

KENPRO

KP100	Squeeze CMOS 230/13.8v	109.25 (3.00)
KP200		

Practical Wireless

The Radio Magazine

SEPTEMBER 1987 (ON SALE 13 AUGUST)

VOL. 63 NO. 9 ISSUE 966

NEXT MONTH

A High-stability
VFO

Guide to 2m
Operating

The ICOM IC-
751A reviewed

PLUS

“Valved Comms
Receivers”
I.F. Transformer
Alignment

and

All the usual
features

Don't miss
it—place
your order with
your
newsagent now!

On sale
September 10

Contents subject to last-minute revision

- 24 PW Review**
Siskin 220TNC
Mike Richards G4WNC
- 30 CT2—Mobile Telephones**
Chas E. Miller
- 32 Kangaroos and Kiwis, via
Mode K**
John Branegan GM4IHJ
- 34 Friedrichshafen 87**
Peter Laughton
- 36 PW “Blenheim” VHF Converter**
Bryan Roberts G4POL
- 42 PW Review**
Kent Twin Paddle Morse Key Kit
The Kanga Gang
- 44 Valved Communications
Receivers**
Hallicrafters S27D by Chas E. Miller
- 48 Mains On/Off for Battery Radios**
R. T. Irish
- 49 Multiple Choice**
Practice Questions for the RAE
(Answers)
- 50 A Smarter Repeater—1**
J. M. Bryant G4CLF
- 68 Errors and Updates**
Selection and Use of Capacitors,
Aug. '87
- 69 Names from the Past**
Hiram P. Maxim
Tony Smith G4FAI

We are sorry that *Practically Yours* and *Microwave MESFETs—2* have had to be held over this month, due to pressure on editorial space.

Regular Features

71 Advert Index	54 On the Air	31 Subscriptions
40 Book Service	38 PCB Service	47 Swap Spot
19, 49 News Desk	65 Short Wave Magazine	16 Write On

Editorial and Advertisement Offices:

Practical Wireless
Enefco House
The Quay
Poole, Dorset BH15 1PP

☎ Poole (0202) 678558 (Out-of-hours
service by answering machine)
Prestel 202671191

Editor Geoff Arnold, T.Eng FSERT G3GSR
Assistant Editor Dick Ganderton, C.Eng. MIERE G8VFH
Art Editor Steve Hunt
Technical Features Editor Elaine Richards G4LFM
Technical Projects Sub-Editor Richard Ayley G6AKG
Technical Artist Rob Mackie
Advertisement Manager Roger Hall G4TNT
☎ 01-731 6222
Administration Manager Kathy Etheridge
Clerical Assistant Claire Horton
Accounts Annette Martin

COPYRIGHT © PW Publishing Limited 1987. Copyright in all drawings, photographs, and articles published in *Practical Wireless* is fully protected and reproduction or imitation in whole or in part is expressly forbidden. All reasonable precautions are taken by *Practical Wireless* to ensure that the advice and data given to our readers are reliable. We cannot however guarantee it and we cannot accept legal responsibility for it. Prices are those current as we go to press.

the new dual band transceiver from KENWOOD, the **TW4100E**.



Using the latest in technology, the designers of the TW4100E dual band FM mobile transceiver have achieved increased performance and, at the same time, made operation even easier. The operator can pre-set the transceiver according to the band plan and his preferences. Options available are shift (+, - or duplex), frequency stepping (5, 10, 12.5, 20, 25 or 50 KHz) and repeater shift (600 KHz, 1.6, 5, and 7.6 MHz).

With the KENWOOD TW4100E, not only do you have the normal simplex and repeater modes but crossband duplex as well. Priority channel monitoring takes on a new meaning if the full audio can be heard whilst you are transmitting instead of the usual "bleep" and loss of signal. If you work another amateur who can also simultaneously transmit on one band and listen on the other, and many stations do have this facility, then a telephone style conversation is possible. Anyone who has not experienced duplex operating will soon come to prefer the natural conversation style that is possible.

With the high level of traffic on today's roads, it is essential that a mobile transceiver is easy to operate. KENWOOD engineers have simplified the rig's operation by providing ten memories, each of which will hold information on frequency, simplex or repeater operation and whether or not the tone burst is on or off. By pushing a single button all this information can be transferred to the VFO. Of course the original information is still held in memory for future use. You therefore have ten independent VFOs. KENWOOD's attention to detail is shown by the following additional facility. If having transferred a repeater frequency to the VFO, you move onto an adjacent simplex channel, you can, by the push of two buttons, cancel the tone burst and reset the shift from repeater

to simplex. Of course, two more presses of the same buttons restore the facilities.

Linear amplifiers are not needed with the KENWOOD TW4100E! Power output from the transceiver is 45 watts on two metres and 35 watts on seventy centimetres, more than enough to cope with difficult terrain.

The TW4100E has another facility not mentioned in the handbook. Not mentioned because unless you are a RAYNET member on an approved operation or engaged on a real emergency, to use the equipment in such a way is outside the compass of the licence as we presently know it.

The facility is that the TW4100E will act as a private crossband repeater. This means that you can park your car in a decent location and wander off into an RF black spot. Armed with a small low power handheld, you can talk back to the TW4100E which, since you left it, has been constantly checking the two pre-set crossband frequencies. Your transmission is received and simultaneously transmitted by the TW4100E on the other band. When a station replies, the message is again simultaneously retransmitted to you. Of course you need to have another amateur in your car to oversee the operation and it must be a recognised RAYNET use. In repeater mode the KENWOOD TW4100E has automatic time-out after approximately three minutes.

The TW4100E has provision for DCL (digital channel link) and DCS (digital code squelch) when the optional MU1 board is fitted.

TW4100E £699.00 inc VAT, carriage £7.00

45 watts on 2 metres, the TM221E. 35 watts on 70 centimetres, the TM421E.



The new KENWOOD TM221E and TM421E two metre and seventy centimetre FM mobile transceivers have been specifically designed to condense maximum performance and operating convenience into a compact package. Output power is 45 watts on two metres (TM221E) and 35 watts on 70 centimetres (TM421E). Receiver sensitivity matches the output power of the set and measures an amazing 0.14µV for 12dB SINAD (across 144-146). The figures are those given by Chris Lorek in his recent TM221E review published in the July edition of HAM RADIO TODAY.

Much discussion has taken place recently regarding 12.5 and 25 kHz spaced frequency channels on the two metre band. With the new mobiles channel spacing is not a problem. KENWOOD with their usual attention to detail have made the frequency step user selectable. The steps available are 5, 10, 12.5, 15, 20 and 25 kHz. Once programmed either microphone up/down button or the transceivers front panel knob can be used to step the transceiver across the band. Of course should it be necessary the selected step can easily be changed.

A new orange backlit liquid crystal display gives the transceiver an amazingly clear frequency readout that can be read in the brightest of sunlight.

The transceiver has all essential operating aids. There are 14 memory channels, each of which holds frequency, whether simplex or repeater operation is required and whether or not the tone burst is on or off. Scanning can either be memory with the ability to lock out unwanted channels or band with the scan limits set by the operator. The usual priority channel facility is also included to make sure that no call is missed. As well as showing the operating frequency the display also indicates which of the facilities are being used.

Occasionally a piece of equipment comes along which catches the imagination; the RC10 remote controller/handset for the TM221E and TM421E does just that. Designed to operate with either transceivers or link both together, the RC10 looks more like a cellular radio car phone than a piece of amateur radio equipment.

In fact the RC10 not only looks like a car phone, but as a speaker and microphone are built-in, operates as would a telephone handset. Easily mounted in any car, dashboard or transmission tunnel, the RC10 controls all transceiver front panel functions with the exception of on/off and high/low power selection. The functions controlled by the RC10 are volume, squelch on/off, frequency readout, keypad frequency entry, memory selection and frequency or memory scanning. Full duplex operation is possible when both transceivers are fitted.

From a security point of view it may even be possible to mount the transceivers out of sight and only have the controller on view. Since most thieves now know that a cellular phone is not a saleable item, owning an RC10 may be a wise investment!

Although I have not seen the RC10, I am of the opinion that it will do much more than I have already described. I suspect that it will be possible for the RC10, when used in conjunction with both 2 metre and 70 centimetre transceivers, to operate as a personal repeater. Parked at the top of a multi-storey car park and left unattended, I would not be surprised if you could not talk in to the installation from another small handheld on 70 centimetres (say a TH41E) and have your transmission re-broadcast at a higher power from the good location on 2 metres. Any reply would be re-transmitted to you on 70 centimetres. Useful and ideal for staying in contact when wandering around town. Helpful also for RAYNET use.

TM221E £317.50 inc VAT carriage £7.00
TM421E £378.00 inc VAT carriage £7.00

LOWE ELECTRONICS LTD.

Chesterfield Road, Matlock, Derbyshire DE4 5LE
Telephone 0629 2817, 2430, 4057, 4995.



the KENWOOD TS530SP HF transceiver, a sensible rig.

The **TRIO TS530SP HF transceiver** is similar to the TS830S in that it also uses a pair of 6146B valves in its PA stage. The transceiver has been designed for the amateur who has no need for the additional facilities that are part of the TS830S but who still requires a high level of performance from his equipment.

The **TRIO TS530SP covers the amateur bands** from 160 through to 10 metres. Modes of operation are USB, LSB and CW.

Operating from 240 volts AC the transceiver has its own internal power supply.

IF shift is built into the TS530SP to allow the IF passband to be moved around the received signal and away from interfering signals and sideband splatter. Even greater selectivity is achieved when an optional YK88SN (1.8 kHz), YK88C (500 Hz) or YK88CN (270 Hz) filter is installed.

A tunable notch filter is built into the audio system of the TS530SP.

The **speech processor** in the TS530SP combines an audio compression amplifier with a change of ALC time constant for extra audio punch and increased average SSB output.

To cope with pulse type noise (such as ignition), the transceiver has a noise blanker.

Both **RIT** and **XIT** (receiver as well as transmitter incremental tuning) are included to aid operating, XIT being a distinct advantage when calling a station that is listening "off frequency".

TS530SP HF transceiver..... **£927.51 inc VAT**, carriage £7.00.



FREE

Send only **£1** to cover postage and packing and we will send you, by return, a **FREE** copy of the new full colour **KENWOOD** catalogue which lists the features and specification of every model and accessory currently available. We will also include, **FREE OF CHARGE**, a copy of our general catalogue which, along with items to enhance your operating, contains much useful information. Finally, to cheer you up, we will add the latest edition of our price list.

LOWE SHOPS.

In Glasgow,
the shop manager is Sim, GM3SAN,
the address, 4/5 Queen Margaret Road,
off Queen Margaret Drive, Glasgow,
telephone 041-945 2626.

In the North East,
the shop manager is Hank, G3ASM,
the address, 56 North Road, Darlington,
telephone 0325 486121.

In Cambridge,
the shop manager is Tony, G4NBS,
the address, 162 High Street, Chesterton, Cambridge,
telephone 0223 311230.

In Cardiff,
the shop manager is Carl, GWOCAB,
the address, c/o South Wales Carpets, Clifton Street, Cardiff,
telephone 0222 464154.

In London,
the address, 223/225 Field End Road, Eastcote, Middlesex,
telephone 01-429 3256.

In Bournemouth,
the shop manager is Colin, G3XAS,
the address, 27 Gillam Road, Northbourne, Bournemouth,
telephone 0202 577760.

Low Electronic Shops are open from 9.00 am to 5.30 pm, Tuesday to Friday and from 9.00 am to 5.00 pm on Saturday. Shop lunch hours vary and are timed to suit local needs. For exact details please telephone the shop manager.

DAIWA meters

CN410M ... Frequency range 3.5 to 150 MHz, forward power switchable 15/150 Watts, reflected 5/50 Watts, SO239 connectors.

CN460M ... Frequency range 140 to 450 MHz, forward power switchable 15/150 Watts, reflected 5/50 Watts, SO239 connectors.

NS448 with remote head ... Frequency range 900 to 1300 MHz, forward power switchable 5/20 Watts, reflected 1.6/6.6 Watts, N type connectors.

NS660P ... switchable meter reading (average, normal PEP and hold PEP) and provision for optional remote head (U66V), frequency range 1.8 to 150 MHz, forward power switchable 15/150/1500 Watts, SO239 connectors.

U66V ... remote head, frequency range 140/525 MHz, max 300 Watts, N type connectors.

SC20 ... extension cable for U66V, approx 20 metres long.

CN410M ... **£61.72 inc VAT**, carriage £1.50.



NS660P ... **£115.00 inc VAT**, carriage £2.50.

CN460M
... **£65.40 inc VAT**,
carr £1.50.

NS448 ... **£86.60 inc VAT**,
carriage £2.50.

LOWE ELECTRONICS LTD.

Chesterfield Road, Matlock, Derbyshire DE4 5LE
Telephone 0629 2817, 2430, 4057, 4995.



2 NEW MOBILE MASTERPIECES

IC-900 Super Multiband FM System.

This new addition to ICOM's Ham radio equipment is a multiband FM transceiver system that allows the mobile operator to customize a communications system for his favourite bands. Up to 5 optional band-units can be installed with the IC-900 for instant access to a wide range of frequencies from the 28MHz HF band to the 1240MHz UHF band. Only a small remote controller is necessary for control of all these bands. A flexible optical fibre is used between the Remote Controller and the Interface Unit. The IC-900 has independent, full duplex capability on all bands, providing simultaneous receive and transmit operation. The function display on the Remote Controller shows two separate operating frequencies simultaneously. The IC-900 system transceiver is equipped with 10 fully programmable memory channels in each Band Unit. The system can therefore store up to 50 different memory channels.

This revolutionary new concept in Multiband operation is available from your ICOM dealer. Also feel free to contact ICOM (UK) LTD for assistance or information. The IC-900 Multi-band system consists of a Remote Controller, Interface Unit A, Interface Unit B and a series of specially designed Band Units.

UX19	28—30MHz	10 watts
*UX59	50—54MHz	10 watts
*(No mobile operation allowed in UK)		
UX29	144—146MHz	25 watts
UX29H	144—146MHz	45 watts
UX49	430—440MHz	25 watts
UX129	1240-1300MHz	10 watts



IC-1200, 23cms FM Mobile.

To complete the range of VHF/UHF FM Mobiles this new model is now available for the 23cm Ham band, it is based on similar features to the already existing IC-28E 2m and IC-48E 70 cms mobile units. This Mini-mobile transceiver will fit easily anywhere in your vehicle or shack. Power output is 10 watts or 1 watt low. The IC-1200 is so new we do not even have a picture of it, however, the large front panel LCD readout is designed for wide angle viewing and front panel controls are straightforward to make mobile operation safe and easy. The IC-1200 is a superb example of ICOM's dedication to exploring new communication equipment.

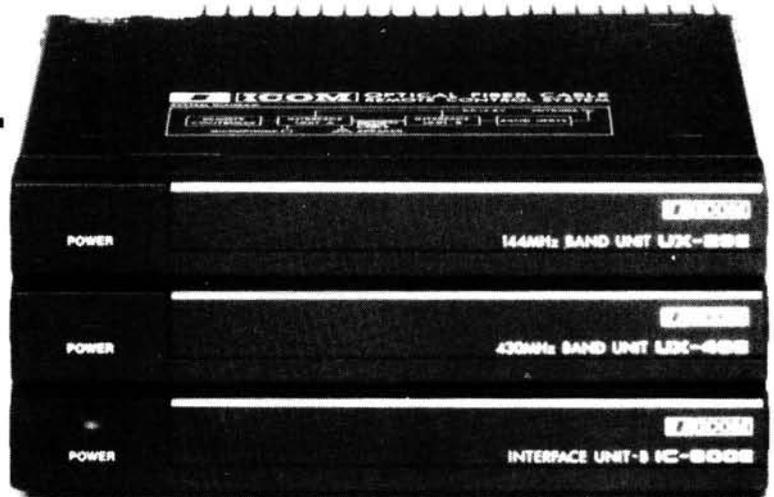

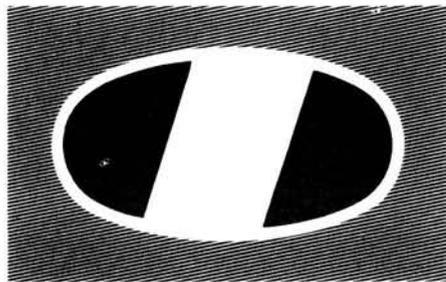

ICOM

Communications



THE HOTTEST ITEMS THIS SUMMER



VHF/UHF FM Handportables

If you want a handheld with exceptional features quality built to last and a wide variety of interchangeable accessories, take a look at the ICOM range of FM transceivers, all ICOM handportables come with a nicad battery pack, AC wall charger, flexible antenna and wrist strap.

Micro 2E/4E

These new micro-sized 2 metre and 70 centimetre handportables give the performance and reliability you've come to expect from ICOM. Measuring only 148 x 50 x 30 the Micro fits in your pocket as easily as a cassette tape. The Micro 2E/4E features an up/down tuning system for quick frequency adjustments, 10 programmable memories, a top panel LCD readout, up to 2.5 watts of output (optional).

IC-2E 2 metre Thumbwheel Handportable

This popular handheld from ICOM is still available. For those amateurs who require a straightforward and effective FM transceiver the IC-2E takes some beating. Frequency selection is by means of thumbwheel switches (with 5Khz up switch) simplex or duplex facility. Power output is 1.5 watts or low 150 milliwatts (2.5 watts possible with BP5A battery pack).

IC-02E/04E 2 metre and 70cm Keypad Handportable

These direct entry CPU controlled handhelds utilise a 16 button keypad allowing easy access to frequencies, memories and scan functions. Ten memories store frequency and offset, these handhelds have an LCD readout and power output is 2.5 watts or low 0.5 watt. 5 watts is possible with the IC-BP7 battery pack or external 13.8v DC.

IC-12E 23cm Handportable

Similar in design and style to the 02E/04E this 1296Mhz handheld utilises ICOM's experience in GHz technology, gained by the excellent IC-1271E base station. Power output is 1 watt from the standard BP3 nicad pack, external 13.8v DC powering is available to the top panel jack. With the growing number of repeaters on 23cm, the IC-12E makes it an ideal band for rag chew contacts.

ALSO AVAILABLE FOR ICOM HANDPORTABLES ARE A LARGE RANGE OF OPTIONAL EXTRAS INCLUDING A VARIETY OF RECHARGEABLE NICAD POWER PACKS, DRY CELL BATTERY PACKS, DESK CHARGERS, HEADSET AND BOOM MIC, LEATHERETTE CASES AND MOBILE MOUNTING BRACKETS.



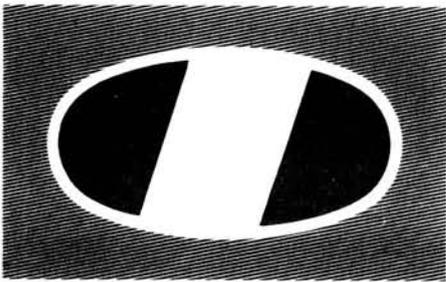

ICOM



IC-751A.



IC-751A

Features:

- All mode.
- 100kHz-30MHz General Coverage Receiver.
- 100 watts.
- 12v Operation.
- 105dB Dynamic Range.
- 32 Memories.
- Electronic Keyer.
- Full Break In (40wpm).
- 500 Hz CW Filter.
- HM36 Microphone.



TOP HF

IC-761, HF TRANSCEIVER with General coverage receiver.

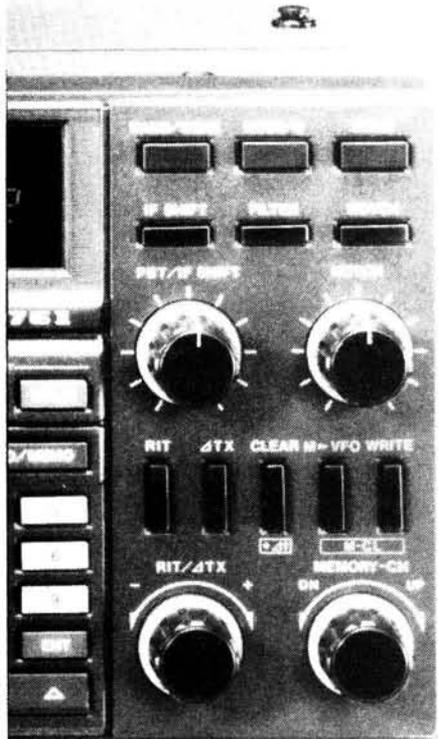

The new ICOM IC-761 H.F. Transceiver has many features making it probably the best top of the line Amateur transceiver available today. This all mode transceiver features an internal aerial tuning unit and A.C. power supply. The A.T.U. boasts a 3 second band selection and tune up with a VSWR matching of less than 1.3:1.

For the serious operator the 100kHz-30MHz general coverage receiver and 105dB dynamic range make it ideal for DX chasing. Frequency selection is by the main VFO or via the front panel direct access keypad.

And for when reception is difficult, pass band tuning, I.F. shift, notch filter, noise blanker, pre-amp and attenuator should enable you to copy even those weak DX stations whether amateur or broadcast.

The C.W. operator will appreciate the electronic keyer, 500Hz filter and full break in (40wpm) other filter options are available.

The IC-CR64 high stability crystal is standard as is the CI-V communications interface for computer control. Twin VFO's and split mode for cross band contacts the IC-761 features program scanning, memory scan and mode select scan and the 32 memories can store frequency and mode.

The transceivers operating system is held permanently in ROM and is not dependant upon the lithium battery. The cell is used for memory back up only. A new style meter gives P.O., A.L.C., IC, VC, COMP and SWR readings.

This new equipment is fully compatible with existing ICOM accessories such as the IC-2KL 500 watt linear amplifier. Here we believe the IC-761 will set a new trend that others will surely follow. For more information please contact your nearest ICOM dealer

Telephone us free-of-charge on:

HELPLINE 0800-521145.

— Mon-Fri: 09 00-13 00 and 1400-17 30 —

This is strictly a helpline for obtaining information about or ordering ICOM equipment. We regret this service cannot be used by dealers or for repair enquiries and parts orders. Thank you

You can get what you want just by picking up the telephone. Our mail order department offers you free same day despatch whenever possible, instant credit, interest free H.P. Barclaycard and Access facility, 24 hour answerphone service.



Datapost

IC-735.



IC-735

- Small Compact Size.
- 100kHz-30MHz General Coverage Receiver.
- 100 watts.
- 105dB Dynamic Range.
- FM Standard.
- 12v Operation.
- Large LCD Readout.
- 12 Memories.
- CI-V Communications Interface.
- HM12 Microphone.



ICOM (UK) LIMITED
 Dept PW, Sea Street,
 Herne Bay, Kent CT6 8LD.
 Tel: 0227 363859.



South Midlands

SCHOOL CLOSE, CHANDLERS FORD IND. EST., EASTLEIGH

From the 1st July Amateur Electronics and South Midlands Communications have amalgamated. With the combined talents, expertise and stocks of both companies, the range of equipment and services will be unsurpassed in Europe.

★ OPEN DAY – FOR AMATEURS ★

10 am – 5 pm SUNDAY 30th AUGUST

10% OFF ALL NEW EQUIPMENT PURCHASED (EXCEPT MASTS) – CASH ONLY
CAR BOOT SALE – APPROX. 100 FREE SPACES – NO TABLES PROVIDED

FREE RADIO SPEC. CHECK – 1.8 – 430MHz only

WIN AN FT290R – and NUMEROUS OTHER PRIZES

LICENSED BAR & REFRESHMENTS AVAILABLE ON SITE

Numerous local attractions – why not make it a family day out?

TALK IN ON S22

BEST VALUE ON 2M & 70CMS

FT211RH
£309.00

FT711RH
ETBA

- ★ 45(35)*5(4)* Switchable RF Output
- ★ Easy 'one touch' push button operation
- ★ Reversible sloped front panel
- ★ Large green easy to read LCD
- ★ Ten memories (independent Tx & Rx)
- ★ Switchable 12.5/25kHz steps
- ★ Priority channel monitoring
- ★ C/w Hand mic and mobile mounting bracket

FT211RH and FT711RH

the NEW



* FT711RH

OPTIONAL ACCESSORIES

SP55	External Speaker.....	£19.55
YH1	Headset (C/W Mic).....	£19.99
SB10	PTT Switch Unit.....	£22.00
MH 10F8	Speaker/Mic.....	£25.00
MH 14A8	Speaker/Mic (C/W Tone Burst).....	£23.00
MF 1A3B	Boom Mic (Via SB10).....	£25.00

THE ULTIMATE HF COMBINATION



- ★ ALL MODE LSB/USB, CW, FSK, AM & FM
- ★ All BAND Transmit, General Coverage Receive
- ★ Optional VHF/UHF units (6M, 2M & 70cms)
- ★ 100% DUTY CYCLE (Key down CW for 30 mins)
- ★ Built in AUTOMATIC ATU (One memory on each band)
- ★ Computer & Packet radio compatibility

- ★ ALL BAND (Automatic Selection with FT757, FT767 & FT980)
- ★ 500W P.E.P. RF OUTPUT (75 Watts drive)
- ★ 100% FULL CARRIER for 2 mins.
- ★ Fully automatic built in ATU (Manual override)
- ★ Full Safety Monitoring of TEMP, SWR etc.

FT767GX £1550.00 inc. VAT

FL7000 £1600.00 inc. VAT

LEEDS
SMC (Northern)
Nowell Lane
Industrial Estate
Leeds LS9 6JE
Leeds (0532) 350606
9-5.30 Mon-Sat

CHESTERFIELD
SMC (Midlands)
102 High Street
New Whittington,
Chesterfield
Chest. (0246) 453340
9.30-5.30 Tues-Sat

BUCKLEY
SMC (TMP)
Unit 27, Pinfold Lane
Buckley, Clwyd
Buckley (0244) 549563
10-5 Tues, Weds, Fri
10-4 Sat

JERSEY
SMC (Jersey)
1 Belmont Gardens
St. Helier, Jersey
Jersey (0534) 77067
9-5 pm Mon-Sat
Closed Wed

N. IRELAND
SMC N. Ireland
10 Ward Avenue
Bangor
County Down
0247 271875

BIRMINGHAM
SMC (Birmingham)
504 Alum Rock Road
Alum Rock
Birmingham B8 3HX
B'Ham (021237)
14976313
9.30-5.00 Tues-Sat

AXMINSTER
Reg Ward & Co Ltd
1 Western Parade
West Street,
Axminster
Devon EX13 5NY
Axminster (0297) 34918
9-5.30 Tues-Sat



Southampton Showroom open 9.00-5.00 Monday to Friday, 9.00-1.00 Saturday. Service Dept open Mon-Fri 9.00-5.00.

AGENTS: JOHN DOYLE, TRANSWORLD COMMS, NEATH (0639) 52374 DAY (0639) 2942 EVE
BOOTH HOLDINGS, SALTFORD, BRISTOL 02217 2402

DAVID STENNING, G4JA, LOUTH 0507 604967
JACK McVICAR, SCOTCOMMS, EDINBURGH 031 657 2430

SUMMER SPECIALS

ONLY AVAILABLE WHILST STOCKS LAST



2M & 70CMS HANDHELD BARGAINS

FT703R(3)	£189
FT703R(4)	£189
FT209R(3)	£219
FT709R(3)	£199
FT709R(4)	£199

GRAB ONE TODAY!

MOBILES



FT270RH	£299
FT770RH	£299
FT790R	£369
FM240	£299
FM740	£299

FT757GX + FP757GX



**ONLY £895
SAVE £273**

ALL THE ABOVE ITEMS CARRY FULL 1 YEAR WARRANTY

A SELECTION FROM OUR CATALOGUE

ANTENNA ROTATORS

KR250	Bell type twist switch control	£78.00
AR40	Bell type turn push control	£125.00
KR400RC	Bell type 360 deg. round meter	£169.00
AR50	Bell type 5 position pre-select	£149.00
CD45	Bell type meter readout	£219.00
KR600RC	Bell type 360 deg. round meter	£219.00
HDR300	Bell type digital readout	£699.00
KR800SDX	Bell type 450 deg. variable speed	£325.00
KR1000SDX	Bell type 450 deg. variable speed	£368.00
KR2000RC	Bell type heavy duty round meter	£445.00
KR2000	Bell type meter control +/- 90 deg.	£445.00
KR400	Bell type meter control +/- 180 deg.	£139.00
KR500	Elevation meter calib. +/- 90 deg.	£149.95
KR500B	Heavy duty version of KR500	£259.95
KR5400	Azimuth/elevation dual control	£279.00
KR5400A	Azimuth/elevation computer control	£339.00
KR5600	Azimuth/elevation heavy duty	£369.00
KR5600A	Azimuth/elevation HD comp. control	£389.00
KR010	Intell. i face KR5400A/KR5600A	£275.00

ROTATOR HARDWARE

50425	Ubolt clamps AR22/AR40 std.	£10.18
50463	Ubolt clamps CD45 etc. heavy duty	£16.68
KS050	Rotary bearing 1 7/8" mast	£19.95
KS065	Rotary bearing 2" mast	£29.95
KC038	Rotary bearing for KR400/KR600	£16.95

ROTATOR CONTROL CABLE

RC5W	5way for KR400RC etc.	per mtr. £0.48
RC6W	6way for KR250/400/500 etc.	per mtr. £0.66
RC8W	8way for CD45/KR2000RC etc.	per mtr. £0.72

Carriage on rotator cable £1.90 up to 20 metres, over 20 metres £2.65.

SWR & POWER METERS

HANSEN

FS710V	50-150MHz 15/150W PEP Auto SWR	£107.80
FS710H	1.8-60MHz 15/150W PEP Auto SWR	£107.80
FS50VP	50-150MHz 20/200W Inter PEP/SWR	£106.70
FS500H	1.8-60MHz 20/200/2000W PEP	£89.50
FS300H	1.8-60MHz 20/200/1000W	£53.50
FS300V	50-150MHz 20/200W	£53.50
FS602M	50-150MHz 20/200W	£62.16
FS210	1.8-150MHz 20/200W Auto SWR/Power	£65.50
FS301M	2-30MHz 20/200W	£42.25
FS301MH	2-30MHz 200/2000W	£42.25
FS711H	2-30MHz 20/200W Head/Display	£43.65
FS711U	430-440MHz 5/20W Head/Display	£43.65
FS711V	50-150MHz 20/200W Head/Display	£43.65
W720S	130-440MHz 20/200W Head/Display	£52.75
FS5E	3.5-150MHz 20/200/1000W (1KW HF)	£42.75

SWR50B	3.5-150MHz Twin Meter	£36.75
FS20DL	3-150MHz 1/10W Dummy/SWR/Power	£43.65
FS20D	3-150MHz 5/20W Dummy/SWR/Power	£43.65

JD

JD110	1.5-150MHz 10/100W	£16.50
-------	--------------------	--------

SMC

T3-170L	3.5-170MHz Relative Power	£22.20
---------	---------------------------	--------

WELZ

SP220	1.8-200MHz 2/20/200W Power/SWR	£67.95
SP420	140-525MHz 4/20/200W Power/SWR	£74.95
SP425	140-524MHz 5/15/150W Power/SWR	£119.95

Carriage extra. Small items £1.50, Large items and Antennas £3.50

VHF/UHF FIXED ANTENNAS

JAYBEAM 2 Metre

HO2M	Halo head only	£7.13
HM2M	Halo with 2ft. mast	£8.34
UGP2M	Ground plain folded radiator	£15.41
C5/2M MK2	Vertical Colinear 4.8dbd	£89.70
LR12M	Vertical Colinear 4.3dbd	£35.71
LR22M	Vertical omnidirectional	£28.18
LW52M	5 Element Yagi 7.8dbd	£17.31
LW82M	8 Element Yagi 9.5dbd	£21.85
LW102M	10 Element Yagi 10.5dbd	£28.23
LW162M	16 Element Yagi 13.4dbd	£42.44
PBM102M	10 Element Parabeam 11.7dbd	£55.20
PBM142M	14 Element Parabeam 13.7dbd	£68.08
Q42M	4 Element Quad 9.4dbd	£35.31
O62M	6 Element Quad 10.9dbd	£46.28
D52M	5 over 5 slot fed Yagi 10.0dbd	£30.82
D82M	8 over 8 slot fed Yagi 11.1dbd	£42.38
5XY2M	5 Element crossed Yagi 7.8dbd	£33.41
8XY2M	8 Element crossed Yagi 9.5dbd	£43.01
10XY2M	10 Element crossed Yagi 10.8dbd	£53.94
PMH2C	2 Way harness circ. polarisation	£12.82
PMH22M	2 Way harness for 2 Metres	£14.15
PMH42M	4 Way harness for 2 Metres	£35.25

JAYBEAM 70 CENTIMETRES

C8/70 MK2	Colinear vert. omni	6.1dbd	£95.68	2.85
D8/70	Yagi 8/8 slot	12.3dbd	£31.51	2.85
PBM18/70	Parabeam 18 ele	13.1dbd	£38.53	2.85
PBM24/70	Parabeam 24 ele	15.1dbd	£51.41	2.85
LW24/70	Yagi 24 element	14.8dbd	£33.35	2.85
MBM28/70	Multibeam 28 ele	11.5dbd	£25.70	2.85
MBM48/70	Multibeam 48 ele	14.0dbd	£42.44	2.85
MBM88/70	Multibeam 88 ele	16.3dbd	£57.96	2.85
8XY/70	Yagi 8 ele cross	10.0dbd	£50.14	2.85
12XY/70	Yagi 12 ele cross	12.0dbd	£61.64	2.85
PMH2/70	2 way 432MHz harness		£13.46	1.85
PMH4/70	4 way 432MHz harness		£27.60	1.85

Prices subject to fluctuation.

FREE FINANCE . . .

On many regular priced items SMC offers Free finance (on invoice balances over £120) 20% down and the balance over 6 months or 50% down and the balance over a year. You pay no more than the cash price!

Details of eligible items available on request.

FREE S.M.C. SERVICE INTERLINK DELIVERY . . .

Free interlink delivery on major equipment. Small items, Plugs, Sockets, etc. by post £1.75. Antennas, Cables, Wire & larger items. Roadline up to £5.00. Interlink delivery available, upon request, for items other than radios, from £7.30 depending on weight. Same day despatch whenever possible.

GUARANTEE

Importer warranty on Yaesu Musen products. Ably staffed and equipped Service Department. Daily contact with the Yaesu Musen factory. Tens of thousands of spares and test equipment. Twenty-five years of professional experience.

● 2 years warranty on regular prices Yaesu products.

South Midlands Communications

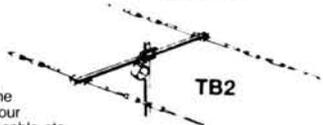

HF ANTENNAS

South Midlands Communications has the largest stocks and range in Europe - your one stop source for antennas, rotators, cable etc.

NEW Jaybeam Minimax. At last a professionally manufactured minibeam built to Rolls Royce standards.

MINIMAX 10.15.20M, gain (pk) 6dbd F/B 12db typical LE 16.1ft. Boom 9.8ft. wt 15kgs

£327.75 £4.50

			p&p
GQ2E	2 Ele. Ant. 10-15-20M	299.00	5.90
12AVQ	Vertical 10-15-20M	78.95	3.75
14AVQ	Vertical 10-15-20-40M	106.00	3.75
105BA	5 Ele. Yagi 10 metres	220.00	3.95
153BA	3 Ele. Yagi 15 metres	135.00	3.90
203BA	3 Ele. Yagi 20 metres	259.00	4.95
205BA	5 Ele. Yagi 20 metres	499.00	9.40
DB10-15A	3 Ele. Yagi 10-15M	209.00	4.80
TH3JNR	3 Ele. Yagi 10-15-20M	299.00	4.50
TH2MK3	2 Ele. Yagi 10-15-20M	279.00	4.50
EX14	5 Ele. 10-15-20M 'Explorer'	499.00	7.50
TH5MK2	5 Ele. 10-15-20M 'Thunderbird'	649.00	7.70
TH7DX	7 Ele. 10-15-20M 'Thunderbird'	755.00	9.75
VR3 MK3	Vertical 10-15-20M	70.15	2.90
TB3 MK3	3 Ele. Yagi 10-15-20M	299.00	5.90
TB2 MK3	2 Ele. Yagi 10-15-20M	202.40	4.90
TB1 MK3	Rotary Dipole 10-15-20M	101.20	2.35
TB3/SSKIT	Converts TB3 MK2 to TB3 MK3	59.80	3.50
HQ1	Mini 'Quad' 6-10-15-20M	199.00	4.00
G4MH	Mini Beam 10-15-20M	98.00	4.50
TD-HP	Trapped Dipole 10-20-40-80M 1000W PEP	49.00	2.65
G5RV	H.F. Dipole	16.68	2.65
HF3VNB	Vert. 12-17-30M 1000 PEP	73.15	3.00

MOBILE ANTENNAS

TRIBANDEP 96	Antenna Two Sections 10-15-20M Slide Switch	36.34	2.20
GWBASESTND	Base Standard	8.45	1.00
LFCOILS	Loading Coil 30M/40M/80M/160M	8.45	1.00
LFWHIP	Telescopic Whip	5.87	1.00
FLEXIWHIP	Antenna Mast + Telescopic Whip (10M Basic)	27.54	2.20
FCCOILS	Loading Coil 15M/20M/40M/80M/160M	8.45	1.00
FLEXI 10	Mobile 80-40-30-20-17-12-10-2 Coils	61.53	2.35
PL SERIES	PL259 Mount 20M/40M/80M/160M	From 18.34	2.35

SCHOOL CLOSE, CHANDLERS FORD IND. ESTATE EASTLEIGH SO5 3BY. Tel: 0703 255111



SPECTRUM TRANSCEIVE

The TX-3 RTTY/CW/ASCII TRANSCEIVE program is now available for the Spectrum. It has all the facilities of the BBC and CBM64 versions and will operate with an interface or T.U.

Forget what you thought you knew about Spectrum direct decode systems. This one will transceive 300 baud RTTY or ASCII at 170Hz shift with only a simple interface. Its performance and facilities outclass other software by a large margin yet it is very easy to use. Some of the features are:

Split-screen type-ahead operation, receive screen unwrap, 24 large memories, clock, review store, call sign capture, RTTY auto CR/LF, CW software filtering and much, much more.

The program comes with an adapter board which plugs into the Spectrum expansion port and accepts the interface or T.U. It will work with any 48/128k Spectrum, including the +2. Tape + adapter £35. Users of the CW QSO program can upgrade for £25. BBC and CBM64 program £20 tape, £22 disc.

TIF1 INTERFACE has computer noise reduction, RX filters, TX outputs for MIC, PTT and KEY. Perfect for our TX-3 and RX-4 programs. Kit £15 (assembled PCB + cables & connectors), ready-made boxed with all connections £25 (state rig).

SPECTRUM RX-4 RECEIVE

We now have a version of this amazing program using the adapter board mentioned above. This enables even better reception of RTTY/CW/SSTV and AMTOR with any 48/128k Spectrum, including the +2. Uses TIF1 (see above) for all modes or a T.U. for RTTY and CW. Tape + adapter £40. Existing RX-4 users can upgrade for £21. RX-4 is also available for BBC, CBM64 and VIC20 £25 tape, £27 disc (not VIC20). The BBC RX-4 is now completely compatible with the Master Series. Master users may exchange their programs free of charge.

We also have superb BBC, CBM64, Spectrum, VIC20, Electron programs for Morse Tutor £6, Locator £7, Logbook £8 and RAE Maths £9 as well as a great UK/Europe and World Map and Locator for BBC/Electron £10. Any BBC or CBM64 program also on disc at £2 extra.

Prices include VAT and 1st Class p&p Inland, airmail overseas, normally by return. Eire, C.I., BFPO deduct 13%.



technical software (P.W.)

Fron, Upper Llandwrog, Caernarfon LL54 7RF. Tel. 0286 881886



VALVES

*High Quality
**Very High Quality
Prices correct as at 7/4/1987
but may fluctuate. 15% VAT incl.

A1065	1.40	EF89	0.80	EF86	1.25	EY51	0.90	PF1200	1.10	UBF89	0.80
A2393	7.00	EC52	0.65	EF89	1.60	EY81	0.75	PL200*	2.80	UCB4	0.75
A2900	12.75	EC91	4.40	EF91	1.60	EY86/87	0.60	PL36	1.10	UCB5	1.80
A76	1.15	EC92	1.85	EF92	2.15	EY88	0.65	PL81	0.85	UCH2	2.50
ARP3	1.15	EC81	0.95	EF95	0.95	EZ80	0.70	PL82	0.70	UCH1	0.75
ARP35	0.70	EC82	0.95	EF96	0.60	EZ81	0.70	PL83	0.60	UCB2	1.60
A1P4	0.90	EC83	0.75	EF183	0.75	GM4	8.90	PL84	0.90	UCB2	1.35
B12H	6.90	EC84	0.60	EF184	0.75	GS01	1.30	PL508	1.25	UF41	1.35
CY31	1.40	EC85	0.75	EF182	0.75	GZ32	1.40	PL508	2.00	UF80	1.60
DAF70	1.75	EC88	0.80	EF1200	1.85	GZ33	4.20	PL509	5.05	XF85	1.20
DAF96	0.75	EC189	0.95	EH90	0.85	GZ34	1.40	PL519	5.85	UX84	0.95
DE122	32.80	EC80A	0.65	EL32	0.85	GZ34*	3.80	PL802SE	3.45	UM80*	1.60
DF52	0.65	ECF80	0.95	EL34	2.10	GZ37	3.95	PY80	0.70	UM84	0.70
DF96	0.70	ECF82	0.95	EL34*	4.55	K156*	15.50	PY81/800	0.85	UY82	0.70
DH76	0.75	ECF802	1.80	EL82	0.70	K177**	14.00	PY82	0.75	UY85	0.85
DL52	1.10	ECF82	1.20	EL84	0.95	K188	17.00	PY88	0.60	VR105/30	1.45
DY86-87	0.65	EC81	0.70	EL86	0.95	K188**	25.00	PY500A	2.10	VR150/30	1.80
DY802	0.70	EC84	0.80	EL90	1.75	ML4	3.20	QDV03/10	5.95	X61M	1.70
E92CC	2.80	EC180	0.65	EL91	6.50	ML6	3.20	QDV03/10*	7.50	X66	1.80
E180CC	11.50	EC182	0.75	EL95	5.25	MX120/01	29.50	QDV03/20A	27.50	Z148	0.75
E1148	0.58	EC185	0.75	EL504	2.70	N78	9.90	QDV06/40A	28.50	Z759	19.00
E476	1.60	EC186	0.90	EL509	5.85	OA2	0.70	QDV06/40A*	49.50	Z800U	3.45
EB34	0.70	EF9	3.50	EL519	7.70	OB2	0.80	QV03/12	5.75	Z801U	3.75
EB91	0.60	EF37A	2.15	EL821	8.45	PC182	0.95	SP61	1.80	Z803U	18.50
EB133	1.85	EF37B	1.10	EL822	9.95	PC184	0.85	TT21	3.70	Z900T	2.45
EB390	0.90	EF80	0.85	ELL805E	4.50	PC186	0.80	TT22	37.50	1A3	2.75
EB391	0.90	EF83	3.90	EM80	0.80	PLC85/95	0.95	UAB200	0.75	1L4	0.65
EB980	0.95	EF85	0.60	EM87	2.50	PS50/510	4.30	UBF80	0.70	1R5	0.80

VALVES AND TRANSISTORS Telephone enquiries for valves, transistors, etc. Retail 749 3934, trade and export 743 0899. POSTAGE: £1-£3 5p, £3-£5 6p, £5-£10 8p, £10-£15 £1.05, £15-£20 £1.60. Minimum order £1.00. Delivery by return.

COLOMOR (ELECTRONICS LTD.) 170 Goldhawk Rd, London W12
Tel: 01-743 0899 or 01-749 3934. Open Monday to Friday 9 a.m.-5.30 p.m.

AMATEUR ELECTRONICS UK

G6XBH
G1RAS
G8UUS

R.A.S. (Nottingham)
Radio Amateur Supplies
Tel: 0602 280267



Visit your Local Emporium

Large selection of New/Used Equipment on Show

AGENTS FOR:

F.D.K.
AZDEN
ICOM
YAesu
ALINCO
KEMPRO

ACCESSORIES:

Welz Range
Microwave Modules
Adonis Mics
Mutek Pre-Amps
Bareno Mast Supports
DRAE Products
BNOS Linears & P.S.U.'s

AGENTS FOR CELLNET and VODAFONE RADIOS
AERIALS, Tonna, Halbar, New Diamond Range of Mobile Whips, Jaybeam
BRING YOUR S/H EQUIPMENT IN FOR SALE

JUST GIVE US A RING

Monday: CLOSED Tuesday-Saturday: 10.00am to 5.00pm

3 Farnon Green, Wollaton Park, Nottingham NG8 10U
Off Ring Rd., between A52 (Derby Road) & A609 (Ilkeston Road)

FREQUENCY COUNTERS

HIGH PERFORMANCE
HIGH RELIABILITY
LOW COST

EX-STOCK
DELIVERY

- ★ Measuring typically 2Hz - 1.5GHz
- ★ Sensitivity <50mV at 1500MHz
- ★ Setability 0.5ppm
- ★ High Accuracy
- ★ 3 Gate Times
- ★ Low Pass Filter
- ★ Battery or Mains
- ★ Factory Calibrated
- ★ 1-Year Guarantee
- ★ 0.5" L.E.D. Display

PRICES (Inc. adaptor/charger, P & P and VAT)

METEOR 100 (100MHz)	£117.30	METEOR 1000 (1GHz)	£204.70
METEOR 600 (600MHz)	£148.35	METEOR 1500 (1.5GHz)	£232.30

ALSO: FUNCTION GENERATOR • COUNTER-TIMER • PAL PATTERN GENERATOR • DIGITAL MULTIMETERS

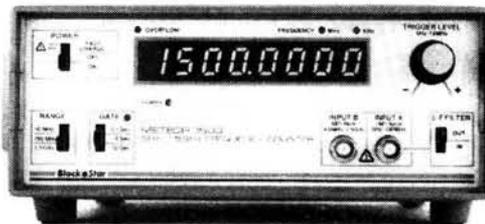

Designed and
manufactured
in Britain.



Black Star

BLACK STAR LTD, 4 Stephenson Road, St. Ives,
Huntingdon, Cambs. PE17 4EB, England.
Tel: (0480) 62440 Telex: 32762

THE LONDON AMATEUR EMPORIUM
FOR EVERYTHING RADIO

191 FRANCIS ROAD
LEYTON · E10 6NQ · LONDON
TELEX 8953609 LEXTON G

PHONE
01-558 0854
01-556 1415
FAX 01-558 1298

dressler
FOR ICOM

OPEN MON - SAT
9AM - 5.30PM
INTEREST FREE
HP FACILITIES AVAILABLE
ON MANY ITEMS
PROMPT MAIL ORDER



dressler
FOR PRIVATE MOBILE RADIO

IC28E/IC48E



VERY LATEST MINI-MOBILE
25/45 watts. RX 138-174MHz
£££ unbelievable value.

ICOM R7000 25MHZ-2000MHZ
SPECIAL OFFER!!



FREE
ARA 900.
ACTIVE ANTENNA
WORTH £139.00
£969

**LATEST REMOTE
CONTROLLED ICOM**

28MHz - 50 - 144 - 432 - 1200
All in one unit. Full duplex.
600 CH memory, etc.



ICOM MICRO 2
HANDHELD

ICOM IC-02E

ALSO
AVAILABLE
IC275E

ALL SONY PRODUCTS
UK SUPPLIED

SONY AIR 7

PORTABLE-AM-FM
144-174MHz
108-136MHz
150KHz-2194KHz

£249



£239 inc. NiCad
Charger & Case



£275



£854
SPECIAL OFFER

BUY A
R71 FOR £825
& RECEIVE AN ARA 30
FREE
WORTH £129

WIDE RANGE OF YAESU/ICOM,
TRIO/KENWOOD, H.F., V.H.F., U.H.F.
SCANNING RECEIVERS AND
TRANSCIVERS IN STOCK ICOM ICA2 ALL
CHANNELS TX/RX 5 WATTS, 108-135 AND
175 MHz £450 — COMMERCIAL,
PROFESSIONAL, MARINE, CELLULAR
AND AMATEUR RADIO SALES AND
SERVICE.

SONY ICF 200ID

76-108 MHz
116-136 AIRBAND
153kHz-29.995MHz
FM - AM - SSB 32 MEMORIES
INC PSU, CARRY STRAP
& EARPHONE

£325



SONY ICF 7600D
76-108MHz

76-108MHz
153kHz-29.995MHz
Complete with case,
mains power supply,
earphone and
frequency list.

£169

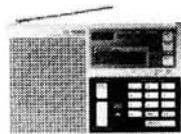

THE PRO-80
NOW IN STOCK

NEW! ICOM IC275

2M
Multimode
Base
Station



£940

ACTIVE ANTENNAS

dressler - ara 30 -
active antenna

50 kHz . . . 40 MHz
WITH LIMITED PERFORMANCE UP TO
100MHz

Professional electronic circuitry with very wide
dynamic range. Meets professional demands
both in electronics and mechanical ruggedness.
75 cm long glass fibre rod. Circuit is built into
waterproof 2,5 mm thick aluminium tube. Ideal
for commercial and swl-receiving systems. £129.
See Review in August 1985 Issue p.35

**DRESSLER
ARA 900
ACTIVE ANTENNA**

50MHz to 1300MHz
Gain 17dB Typical

TECHNICAL SPECIFICATIONS
FOR ARA 900

Gain 17dB Typical (14-17dB)
Frequency Range 50-1300MHz
Noise Figure 1dB at 50-180MHz
1.5dB below 300MHz
2.0dB below 350MHz
2.7dB below 400MHz
3.0dB below 500MHz
3.8dB below 650MHz
4-6dB below 1300MHz

£139.00

Intercept Point 3rd Order: +18dbm at Input
Post £3.00 or Securicor £7.00 extra

Both antennas come complete with 7 metres of cable, interface, power supply and brackets.

LINEARS

SPECIAL OFFER
4 ONLY D200S £925

D200 2 MTR 500W SSB £858
D200S 2 MTR 750W SSB SEE PANEL ABOVE
D70 70 CMS 550W SSB £1030

CARRIAGE FREE - SECURICOR

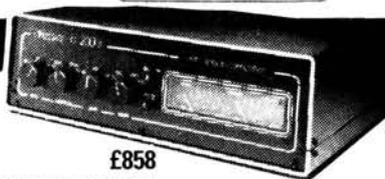

PRE-AMPS - NEW MODELS

MODEL	FREQ.	NOISE	GAIN	POWER	PRICE
EVV1296C	1.25-1.3GHz	0.9-1.2	16-18dB	100W	£162
EVV700SMD	430-440MHz	0.5-0.9	15-18dB	500W PEP	£124
EVV2000SMD	144-146	0.6-0.9	16-18dB	1KW PEP	£124
EVV200VOX	144-146	0.6-0.9	16-18dB	450W PEP	£112
EV2GAAS	144-146	0.6-0.9	15-18dB	100W PEP	£75
VV INTERFACE FOR ABOVE PRE-AMPS					£31

RECEIVE PRE-AMPS

MODEL	FREQUENCY	NOISE	GAIN	PRICE
EWPA 560	50-600-1GHz		16.5dB-1dB	£79
EWPA 560(N)	50-600-1GHz		16.5dB-1dB	£89
IP3 order			+18dBm	
ERPA 1296	1.25-1.30	0.8	17-18dB	£120
ERPA 435	430-440	0.5	15-18dB	£70
ERPA 144	144-146	0.7	16-18dB	£66
ASA 12	0-1GHz		Masthead Antenna Switch	£59

IDEAL FOR VHF SCANNERS, CARAVANS,
AND BOATS. SUPERB TV RECEPTION.

C.M.HOWES COMMUNICATIONS

Eydon, Daventry,
Northants NN11 6PT.
(mail order only)
Phone: 0327 60178

PLEASE NOTE: DUE TO EXPANSION, WE HAVE MOVED!

Our range of good quality radio kits enable you to build yourself many interesting projects. We have receivers, transmitters, transverters, filters, ATUs, mics, speech processors, oscillators, and more, sitting on the shelf at our new mail order premises. If you haven't got a copy of our summer catalogue, why not send an SAE for one? Alternatively, why not call on one of our stockists and see the kits for yourself? One or other of our stockists will be at most rallies this year, and we will be attending some in person too.

UK Dealers include:—

Bonex Ltd, Acton, London 01-992 7748
J. Birkett, Lincoln 0522 20767
MGR Services, Birkenhead 051-653 3437
Southdown Radio, Eastbourne 0323 639351
Ward Electronics, Birmingham 021-328 6070

Watch out for our new 2 to 6m transverters!

73 from Dave G4KQH, Technical Manager.



EASY TO BUILD KITS BY MAIL ORDER

ELECTRONIC MORSE KEYS

Can be used as twin paddle or single paddle keyer. Internal or external paddle versions available.



Wide range speed control. Adj. sidetone, vol. and tone. 'TUNE' switch. Extremely quiet screened reed relay keying circuit. Runs from 12v. D.C. or 240v. A.C. P.S.U. available.

Tested under a wide range of R.F. conditions.

ALL ready built units have 100 hour soak test for reliability.

TA2 - Ready built keyer with internal paddle	£49.90
TA3 - Kit with paddle unit pre-assembled	£34.90
TA6 - Ready built keyer. Requires external paddle	£42.50
PU1 - 240v. A.C. P.S.U. in mains plug case	£7.50

All prices are fully inclusive of all charges.

TARGA ELECTRONICS
3, Raven Avenue, Tibshelf, Derbyshire DE5 5NR

BILLINGTON VALVES

VALVES AND TRANSISTORS - RARITIES OUR SPECIALITY! Phone your inquiry or send s.a.e. today for brand new catalogue. Inquiries from Govt. depts., colleges, schools and dealers welcome. Overseas inquiries welcome.

SPECIAL OFFER. New EL34 £2.05. This years manufacture, good quality E. European. Used Mullard ECC81/CV4024 80p. Used Mullard ECC82/CV4003 60p. Please add 50p P&P per order and 15% VAT.

WE WILL BUY VALVES AND TRANSISTORS. Types PX4, PX25, PP3/250, DA30, DA100, MZ2-200 especially required. Clearance parcels, complete shop clearance etc., considered.

TRANSFORMERS. Send today for listing or phone your inquiry e.g. New Wayrad duty cycle rated transformer In = 0-10-20-0-105-110-200-230-250. Out = 1185-0-1185 or 360mA, 1/3 duty cycle rated i.e. 5 mins on 10 mins off. £25 delivered.

INCREDIBLE BARGAIN PACKS. 20lbs (9kg) of mixed i.c.s, transistors, relays, capacitors, resistors, potentiometers, etc. £9 + VAT delivered. 1000 resistors or 1000 capacitors £3.50 delivered.

USED GOVT SURPLUS TEST EQUIP. Repaired Avo 8 multimeters £75 delivered. Tektronix 465 dual trace scope 100MHz as new condition, works perfectly, with probes + lid £750 delivered.

RF PLUGS & ADAPTORS, PL259 ETC. - Phone your inquiry. Brand new "N" type nickel plated chassis mounting female socket for screw fixing £1.50 + VAT each. Brand new PL259 standard male u.f.t. coaxial plug, internal diameter 9.5mm. 45p + VAT each. Brand new r.f. adaptor PL259 with female BNC socket at other end £1.50 + VAT each.

Send 26p stamp today for catalogue of transformers, Variacs, r.f. plugs and component bargains.

BILLINGTON VALVES, 39 Highlands Road, Horsham, West Sussex RH13 5LS

Tel: 0403 864086. FAX 0403 210108. Telex: 87271 PRODSS G.

If visiting in person, please phone first to check that office is attended.

what is a KENWOOD RC10?

TO FIND OUT TURN TO PAGE 2 AND READ ABOUT THE TM221E & TM421E!

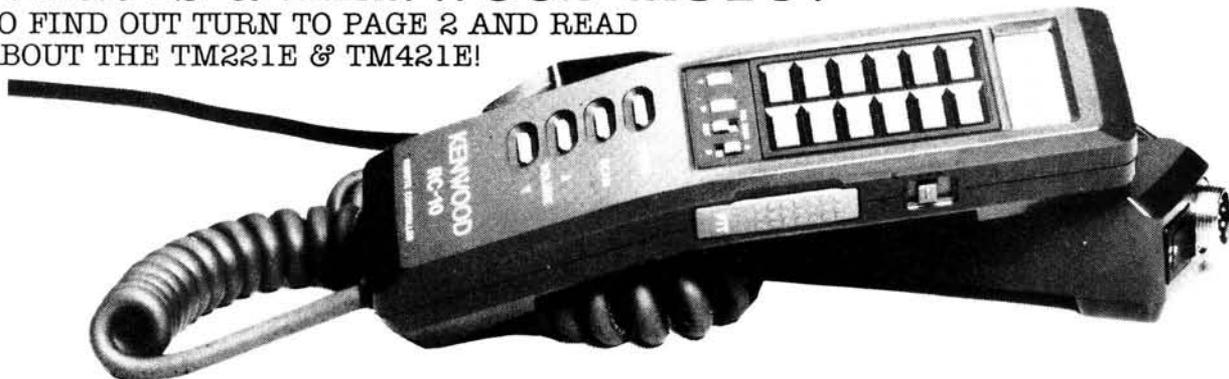

PRACTICAL WIRELESS KITS



Downton. Freq. to Voltage Converter	June 87	19.70
Side Tone Oscillator	June 87	9.60
Itchen. LCR Bridge	April 87	26.90
Woodstock. Short Wave Converter	March 87	26.50
Masthead Preamp For 14MHz	Feb 87	38.30
Westbury Basic Wobbulator	Jan 87	16.50
High Z Mosfet Voltmeter	Dec 86	24.50
Taw. VLF Converter	Nov 86	14.20
Active Antenna	Nov 86	17.80
Automatic Nicad Charger	Oct 86	18.20
Simple 50MHz Converter	Sept 86	21.50
Arun Parametric Filter	May 86	49.30
Meon 2. 50MHz Transverter (144MHz IF)	April 86	43.30
Rtly Morse Modern (No Case)	Jan 86	31.85
Two Tone Oscillator	Dec 85	21.30
Meon. 50MHz Transverter (28MHz IF)	Oct 85	43.30
Capacitance Meter	Oct 85	21.30
Fet Dip Oscillator	Oct 85	19.90
Add On BFD		
(Inc. C804 + Optional Comps.)	Aug 85	12.95
Triambic Keyer	Feb 85	18.45
Morse Sending Trainer	July 84	12.00
Auto Notch Filter	June 84	25.90
Morse Practice Oscillator	Jan 82	9.20

COMPONENTS		
DIODES		
BAT85	26	2N3904 14
1N914	94	2N3906 14
1N916	14	2N4126 35
1N4001	05	
1N4002	06	555 22
1N4005	08	555 CMOS 64
1N4148	03	741C 20
0A47	14	CA358 44
0A90	09	CA3140E 42
0A91	10	CA3240E 108
WRO5	22	ICM7555 64
1F351	46	
TRANSISTORS		
BC107	14	LM358 44
BC108	14	LM566 128
BC108C	18	MC1458 46
BC109	14	MC1496 160
BC109C	18	5042P 230
BC148	11	SBL1 655
BC178	21	SL1621 610
BC212L	16	SL1640 510
BC213	11	SL6440 480
BC214L	16	11BA810 98
BC237	10	11L071 46
BC478	28	11L072 55
BC547	11	11L084 100
BC548	11	XR2206 480
BC549	11	XR2211 346
BC559	11	
BF180	36	REGULATORS
BF199	19	7805 42
BF200	36	7812 42
BF224	38	7815 42
BF241	31	7824 42
BF244	36	78L09 55
BF245A	48	78L12 29
BF256	43	78L15 29
BF256L	48	CMOS
BF961	77	4001B 16
BF981	84	4011B 16
BFY90	88	4015B 39
BSX20	34	4017B 35
C304	78	4021B 38
J309	74	4023B 16
J310	74	4046B 49
TIP41	44	4047B 49
TIP41A	48	4060B 45
TIP42A	50	4070B 20
VN10KM	80	4075B 16
VN10LM	76	4077B 29
2N2926	18	4053B 22
2N3055	59	4541B 42
2N3704	14	40105B 145
2N3706	14	74HC04 26
2N3819	40	74HC32 26
2N3846	130	74HC390 88

RECHARGEABLE NI-CAD BATTERIES	
AA (HP7)	500mAh 1.35
C (HP11)	1200mAh 2.25
D (HP2)	1200mAh 2.50
PP3 Type	4.40

UNIVERSAL NI-CAD CHARGER	
Will Charge All the Above Types	£7.50

SOLDERING IRON	
25w High Quality with Long Life Element 1.7 metre lead (240v)	£4.45

MEON COMPONENTS	
31 333MHz Crystal	2.95
22MHz Crystal	3.45
22pf Trimmer	24
65pf Trimmer	33
S18 Yellow Aluminium Axial Chokes	70
Toko 10K Coils	35
Relay ZPCO	50
BNC Socket 50R Square	1.70
5 pin din sockets	16
T05 Heatsink	16
Diecast Box (Eddystone)	5.55

BEGINNERS MORSE KEY	
Well Designed Key Fully Adjustable	£1.95

ADVANCED MORSE KEY	
All Metal Professional. High Speed Key. Fine Adjustment	£4.90

PRICES DO NOT INCLUDE VAT, WHICH SHOULD BE ADDED TO THE TOTAL ORDER VALUE AND P&P CHARGES. P&P = 70p UNLESS SPECIFIED. ARTICLE REPRINTS 50p (IF REQUIRED). ALL KITS ARE COMPLETE (LESS BATTERIES), UNLESS SPECIFIED INCLUDING PCB, CASE, ALL COMPONENTS, CONNECTORS AND HARDWARE. ALL COMPONENTS ARE NEW AND TO FULL SPECIFICATION CHEQUE, P.O., OR ACCESS TO:

CPL ELECTRONICS, 8 Southdean Close, Hemlington, Middlesbrough, TS8 9HE
 TEL: 0642 591157
 Other kits are available plus a wide range of components etc.
 ACCESS, MAIL OR TELEPHONE ORDERS WELCOMED. FREE PRICE LIST ON REQUEST.

GAREX THE SCANNER SPECIALISTS

Just a small advertisement this month to let you know that we are still very much in business. See our previous ad for product details.

Ask for our secondhand scanner bargain list.

MEET US AT THE FOLLOWING MOBILE RALLIES FOR STORES CLEARANCE BARGAINS AND REGULAR LINES AT POST-FREE PRICES: Brighton 12th July; Woburn 2nd Aug; Derby 9th Aug; Torbay 30th Aug; Lincoln 13th Sept; Harlow 27th Sept.

MAIN DISTRIBUTOR OR REVCO PRODUCTS
 PRICES INCLUDE UK P&P and 15% VAT
 Good normally despatched by return

GAREX ELECTRONICS

HARROW HOUSE, AKEMAN STREET, TRING, HP23 6AA
 Phone Tring (044 282) 8580 Callers by appointment only

J. BIRKETT

RADIO COMPONENT SUPPLIERS

25 The Strait
 Lincoln, Tel. 20767
 (LN2 1JF)
 Partners J.H. Birkett.
 J.L. Birkett.

C804 TYPE VARIABLE CAPACITORS 10p.f. Wide Spaced @ £1.95, 15p.f. Wide Spaced @ £2.30, 20p.f. Wide Spaced @ £2.30, 25p.f. Wide Spaced @ £2.50, 50p.f. @ £2.30, 75p.f. @ £2.30, 150p.f. @ £2.50.

AIR SPACED TRIMMERS 20p.f., 27p.f., @ 20p., Sub-Min 15p.f. @ 20p.

200 ASSORTED MINIATURE POLYESTER CAPACITORS For £1.00.

ITT CRYSTAL FILTER 024CD 10.7MHz BW 6kHz @ £5.

TAG ENDED ELECTROLYTICS 8 + 8 + 8uf 450v @ 45p., 16 + 16uf 450v @ 45p., 20 + 20uf 450v @ 45p., 20 + 20 + 20uf 350v @ 45p., 32 + 32uf 450v @ 45p., 50uf 450v @ 40p., 1000uf 63v @ 20p., 1200uf 350v @ 45p., 1500uf 50v @ 20p., 4700uf 40v @ 60p., 4700uf 63v @ 75p., 10,000uf 16v @ 50p., Wire Ended 4.7uf 450v @ 45p., 10uf 450v @ 45p.

TOKO FM TUNING FRONT END Suitable For Converting To 2M Receiver. With Details @ £4.60.

MULLARD 10.7MHz IF MODULE LP1171 With Details For Use With Above Tuner @ £3.

TRANSMIT-RECEIVE PIN DIODES VHF 5 for 60p., UHF 5 for 75p.

D TYPE CONNECTORS 15 Way Sockets @ 50p., 37 Way Sockets @ 60p.

CARBON MIKE INSERTS @ 25p each or 5 for £1.00.

VERNI TRON CERAMIC FILTERS 10.7MHz @ 6 for £1.00.

455KHz CERAMIC FILTERS Murata BFB455 @ 6 for £1.00.

VMO5 POWER VN10KN @ 50p., WM211 @ 40p., VN90AA @ 80p., VN10LM @ 40p.

SOLID DIELECTRIC VARIABLE CAPACITORS 17 + 27 + 87 + 145p.f. @ 50p., 18 + 18 + 88 + 146p.f. @ 50p., 24 + 24 + 24 + 270 + 270p.f. @ 50p.

DISC CERAMICS 0.01uf 50v 15 for 40p., 0.01uf 500v @ 5p.

WOOD AND DOUGLAS KITS AVAILABLE BY POST AND FOR CALLERS. ACCESS AND BARCLAY CARDS ACCEPTED, P.P. 60p UNDER £5, OVER FREE.



"The Oldest Name In Amateur Radio"

NEW BRASS RACER IAMBIC



£54.59

The newest addition to the Vibroplex family — the Brass Racer Iambic — A distinctive new design of Iambic paddle crafted from solid brass and mounted on a base of polished hardwood. No springs to fly off the middle of a contact. Superior Vibroplex quality. Always worth the difference and now a new Vibroplex look.

BRASS RACER EK-1 NEW

An even more exciting step is the new Brass Racer EK-1, an electronic keyer built into the base of our new Brass Racer Iambic paddle. Using the Curtis 8044 chip, this self-contained keyer and paddle is fully Iambic with dot/dash insertion and adjustable speed control. Use on either tube or solid state rigs. The perfect unit for mobile, DXpedition, or just plain fun.



£120.26

THE IAMBIC



Presentation £115.00
 Deluxe £ 78.09
 Standard £ 66.33

The distinctive look and quality of the Vibroplex Original is fashioned into the finest Iambic paddle anywhere. The dual paddles allows the operator to utilize automatic dot/dash insertion and other unique features of the modern electronic keyer. Vibroplex distinction for the modern operator.

THE VIBROKEYER



Deluxe £78.09
 Standard £63.98

The Vibrokeyer is designed for "Bug" operators who want to move to electronic keyers without relearning keying. The single lever paddle initiates the automatic dots and dashes of the electronic keyer with the same motion used to operate the "Bug". For those who want to combine traditional skill with modern electronics.

THE ORIGINAL

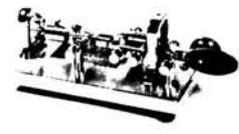

Presentation £129.62
 Deluxe £ 82.74
 Standard £ 70.54

In 1890 Horace Martin searched for relief from the "glass arm" telegraph operators were getting from pounding the straight keys. His answer, the Vibroplex Original was an instant success. The vibrating lever bar automatically produces dots while dashes are made manually. Still popular today, the distinctive sound of the "Bug" can still be heard. It is the signature of the true C.W. expert.

All of our keys are available in Standard and Deluxe models. The Original and the Iambic are also available in the Presentation models.

Standard Model: All Standard models come with a neat, crisp, textured, painted base with polished and chromed top parts. Attention to detail in the finishing process gives Vibroplex an unexcelled quality appearance. Highly conductive large coin-silver contacts provide a clear, sharp signal, and non-skid rubber feet keep the keyer in its place.

Deluxe Model: All Deluxe models feature a chromed base, buffed and polished to a mirror finish. As in fine watches and other precision instruments, their jeweled movement serves to prolong life, maintain smoother, easier operation and prevent binding.

Presentation Model: The Presentation model is the top of the line at the top. Available in the Original and Iambic, the Presentation features 24 carat gold-plated base top, engraved with name and call and makes a truly personal gift. The Original has the adjustable super speed control main spring for a wider range of sending speeds.

**DEWSBURY ELECTRONICS, 176 LOWER HIGH STREET, Stourbridge, West Midlands, DY8 1TG
 Tel: Stourbridge (0384) 390063/371228**

Lee Electronics



NORMAN
G4THJ

21 MEMORIES
5/25 WATTS
2 VFOs
PRIORITY CHAN.
BRIGHT LCD
DISPLAY
FULL SCAN
SCAN DELAY
QUICK RELEASE
MOBILE
MOUNT



THIS IS THE ACTUAL SIZE!!!
SAE FOR LEAFLET

£299.00



C120

2M 144-148MHz
SPECIAL PACKAGE
PRICE OF:
EMPTY CELL CASE
3W BATTERY PACK
AND WALL CHARGER
£269.00

Mail Order + Retail
All prices are inclusive
of VAT and are correct
at time of going to press



400 EDGWARE ROAD,
LONDON W2
01-723 5521, Tlx 298765

NEAREST TUBE: OPENING TIMES:
EDGWARE ROAD MON-SAT
PADDINGTON 9.30am-6pm

Normally 24hr despatch but please allow 7 days for delivery

ADONIS MICS

AM303	Base Mic SSB/FM Switch	39.95
AM503	Desk Compressor Mic as 803 with One Output. Two levels of compression	55.00 (1.15)
AM803	As 503 with Meter & 3 Outputs	89.95
FX1	Swan Neck Fet Mic with Control Box	49.00 (1.15)
202S	Flexible Neck Clip Mic with Control Box	37.50 (1.15)
HW7	Head Set Boom Mic For Yaesu/Icom/Trio	27.50 (1.15)

WELZ PRODUCTS

SP330	1.8-500MHz 200W Dash Mount	95.00 (1.50)
SP600	1.6-500MHz 20/200/2kW	169.00 (1.50)
SP825	1.8-1.3GHz 2/150W	169.00 (1.50)
SP10X	1.8-500MHz 200W Pocket Size	34.00 (1.00)
AC38	3.5-30MHz Coax ATU 200CW/400C PEP	95.00 (1.00)

SPECTRUM COMMUNICATIONS

MANUFACTURERS OF RADIO EQUIPMENT AND KITS

4 and 6m EQUIPMENT

RECEIVE CONVERTERS 4 or 6m antenna input, 10 or 2m i.f., variable gain 0-26dB, n.f. less than 3.5dB. Buffered local oscillator output, types RC4-10, RC4-2, RC6-10 and RC6-2. PCB kit £17.25, PCB built and tested £24.50, boxed kit £29.25, boxed, built and tested £41.00.

TRANSMIT CONVERTERS 4 or 6m variable power 80mW to 2.5W, 2m or 10m drive 10mW to 100mW. Local oscillator input matches receive converters. Types TC4-10H, TC4-2H, TC6-10H, TC6-2H. PCB kit £27.50, PCB built and tested £37.75, boxed kit £39.50, boxed built and tested £53.00.

TRANSCEIVE CONVERTERS Single board version of receive converter and 500mW transmit converter, 10m drive 25mW to 500mW. Types TRC4-10 and TRC6-10. PCB kit £39.00, PCB built and tested £54.00, boxed kit £54.00, boxed, built and tested £83.25.

TRANSCEIVE CONVERTERS Separate receive converter and 2.5W transmit converter in a single boxed unit, 2m or 10m drive 10mW to 100mW only, requires r.f. sensing switch and attenuator for use with 2.5W 2m rigs. Types TRX4-10H, TRX4-2H, TRX6-10H and TRX6-2H. Boxed kit £60.00, boxed and built £99.50.

TRANSCEIVE CONVERTERS As above but including on interface providing RF sensing alteration and PTT switching. 1/2W-5W 2M drive. Types TRX4-2I and TRX6-2I. Boxed kit £67.00, boxed and built £115.00.

CB to 10m

CB TO 10 FM CONVERSION BOARDS - THE FIRST COMMERCIALY AVAILABLE, suits all UK FM CB rigs to give 29.31 to 29.70MHz. Size only 63x40x13mm. Built and aligned board SC29 £15. Or send your rig and we'll fit it. £28 inc. return P&P for mobiles. £31 inc. for base rigs.

MULTIMODE CB CONVERSIONS, send your 120 channel rig and we'll convert it to give 28.01 to 29.70MHz in straight sequences without gaps. Colt 1200DX, Cobra 148, Hy Gain 5, Multimode 2, Major M360, Tristar 747 & 777, Super Star 360, Concorde, etc., £62 inc. return P&P. Jumbo or Colt Excalibur 1200, £65. 80 Channel rigs such as Stalker 9 or Major M588 are modified to give 28.31 to 29.70MHz in straight sequence without gaps. £45.00 inc. return P&P. 200 Channel in 4 bands of 50 are converted to give 28.00 to 30.00MHz or 28.00 to 29.70MHz as required. Super Hy Gain 5, Lafayette 1800, Super Star 2000, £45.50 inc. return P&P. Nato 2000 £52.50, Super Star 2000-5x40CH £70. Colt 1600, 4x40CH, £65.50.

VAT & P&P INC PRICES
Delivery within 14 days subject to availability. 24 hr answering.

UNIT B6, MARABOUT INDUSTRIAL ESTATE,
DORCHESTER, DORSET. TEL: 0305 62250

RST

MAIL ORDER CO.
Langrex Supplies Ltd.,
Climax House,
159 Fallsbrook Road,
Streatham, SW16 6ED.

SPECIAL EXPRESS MAIL ORDER SERVICE

£ p	EM81	2.50	PL519	6.00	6AK5	5.99	8KD6	8.00
CL33	EM87	2.50	PL802	6.00	6AL5	1.50	8LGG	5.00
DY807	EN91	6.50	PY33	2.50	6AM6	6.02	8LGGC	5.75
E88CC	EY51	2.75	PY81	1.50	6AN5	4.75	8L7	2.50
E180F	EY86	1.75	PY82	1.50	6AN8A	3.50	8L06	7.50
EB10F	EY88	1.75	PY83	1.25	6AD5	3.25	807	3.75
EABC80	EY500A	3.00	PY88	2.00	6AR5	25.00	8RH8B/6KN8	
EA91	EZ80	1.50	PY500A	4.00	6AS6	8.66		10.00
EBF80	EZ81	1.50	PY801	1.50	6AS7G	8.75	6SA7	3.00
EBF89	GY501	3.00	PY801	1.50	6AT6	1.25	6SC7	2.75
EC91	GZ32	4.00	QOV02-6	38.00	6AU5GT	5.00	6SJ7	3.25
ECC33	GZ33	4.75	QOV03-10	26.25	6AU6	2.50	6SK7	3.50
ECC35	GZ34	4.00	QOV03-20A		6AW8A	3.75	6SN7GT	3.00
ECC81	GZ37	4.75		48.38	6B7	3.25	6SN7GT	3.00
ECC82	KT61	5.00	QOV06-40A		6B8	3.25	6SS7	2.75
ECC83	KT66	15.00		46.00	6BA6	1.50	6SG7M	2.50
ECC85	KT77 GOLD	12.00	QV03-12	6.80	6BA7	5.00	6J8A	2.25
ECC88	KT89 LION	20.00	R19	2.50	6BB6	1.50	6V5GT	4.25
ECC91	N78	15.00	R19	9.24	6BH6	6.00	6X7	3.00
ECF80	OA2	3.25	SP41	6.00	6B16	2.25	6XSGT	1.75
ECH35	OB2	4.35	SP61	4.00	6BN6	2.00	12AX7	1.75
ECH42	OC3	2.50	U19	13.75	6BQ7A	3.50	12BA6	2.50
ECH81	OD3	2.50	U25	2.50	6BR7	6.00	12BE6	2.50
ECL80	PC86	2.50	U26	2.50	6BR8A	3.50	12BY7A	3.00
ECL82	PC88	2.50	U37	12.00	6B86	6.00	12E1	20.00
ECL83	PC92	1.75	UABC80	1.25	6B87	1.50	12HG7	4.50
ECL86	PC97	1.75	UBF89	1.50	6BZ6	2.75	30FL1/2	1.38
EF37A	PC900	1.75	UCH42	2.50	6C4	1.25	30P19	2.50
EF39	PCF80	2.00	UCH81	2.50	6C6	3.50	30P113	1.80
EF41	PCF82	1.50	UCL82	1.75	6CB6A	2.50	30P114	1.80
EF42	PCF86	2.50	UCL83	2.75	6CD6GA	5.00	57Z8	55.00
EF50	PCF801	2.50	UF89	2.00	6CL6	3.75	805	45.00
EF54	PCF802	2.50	UL41	5.00	6CH6	13.00	807	3.75
EF55	PCF805	1.70	UL84	1.75	6CW4	8.00	811A	18.33
EF80	PCF86	2.50	U21	4.00	6D6	3.50	812A	47.50
EF86	PCH200	3.00	UY85	2.25	6D05	7.50	813	65.00
EF91	PCL82	2.00	VR105/30	2.50	6D06B	4.75	866A	35.00
EF92	PCL83	3.00	VR150/30	2.50	6E8A	3.00	872A	20.00
EF183	PCL84	2.00	Z759	25.00	6E85	1.85	931A	18.50
EF184	PCL85	2.50	Z803U	25.00	6F6	3.00	2050	7.50
EH90	PCL86	2.50	Z821	3.25	6G6	3.25	6146B	12.00
EL32	PCL805	2.50	3B28	50.00	6H6	3.00	5763	4.50
EL33	PD500	6.00	4CX250B	58.00	6H56	3.77	5814A	4.00
EL34	PFL200	2.50	5R4GY	5.50	6J5	4.50	6080	14.00
EL36	PL36	2.50	5U4G	3.00	6J6	8.93	6146A	12.00
EL80	PL81	1.75	5V4G	2.50	6J7	4.75	6146B	12.00
EL81	PL82	1.50	5Y3GT	2.50	6J8A	6.50	6550	10.00
EL84	PL83	2.50	5Z3	4.00	6J8C	7.50	6883B	12.50
EL86	PL84	2.00	5Z4GT	2.50	6J58C	7.50	6973	7.50
EL91	PL504	2.50	630L2	1.75	6K6GT	2.75	7025	4.50
EL95	PL508	5.50	6AB7	3.00	6K7	3.00	7027A	8.00
EL360	PL509	6.00	6AH6	5.00	6K8	3.00	7360	10.00
							7586	25.00
							7587	13.00

Open daily to callers: Mon-Fri 9 a.m.-5p.m.
Valves, Tubes and Transistors - Closed Saturday
Terms C.W.O. only, allow 7 days for delivery. Tel: 01-677 24247.
Prices excluding VAT add 15% Quotations for any types not listed S.A.E. Telex 946708
Post and packing £1.00 per order Prices correct when going to press

FIRST IN HAM RADIO WITH PRICES TO PROVE IT!

ICOM IC 735 £869



Call or telephone 01-992 5765 for latest prices and information plus full range of H.F. equipment and accessories.



IC 761 £POA



AMERITRON AL 84 H.F. Linear Amp now just £499

AL 80A — £799 incl. carriage.
Low, low prices — with high, high performance!
Order NOW 01-992 5765

FT757 MK II **YAESU** £899



Telephone 01-992 5765 for latest information on the YAESU value for money high performance equipment. Full range of accessories available.



FT 767 P.O.A.

ICOM



ICμ2 2m. Handheld

Surprisingly great performance from this mini-handie!!
Just £199 inc VAT!

FULL ICOM PMR RANGE IN STOCK
Call 01-992 5765

AMERITRON RC S4



Remote Coax Switch with shack console £129

Freq: up to 150 MHz no control cable reqd. 4 antenna positions on switch Power: 240 V

AMERITRON ATR 15



ANTENNA TUNER

1500 W 'T' network A.T.U. 1.8-30 MHz in 10 dedicated bands with balanced input — long wire and 3 co-axial inputs V.S.W.R/ Power Meter £299

YAESU

FT209R 2m.

Synthesized key frequency entry 2½ watts
Giveaway price £179 inc VAT
Call now for immediate delivery 01-992 5765



COMPLETE RANGE OF OTHER MAKES OF HANDHELDS — PRICES TO SUIT YOUR POCKET!

YAESU FRG 8800 — Continuous Coverage Receiver



Twin VFO's plus keyboard/computer interface control — all mode SSB, CW, AM & FM. Memories, scanning, filters. Includes 2-dimensional LCD, graphical SIMPO. £575

ICOM R71 General Coverage Receiver

Keypad entry, 32 memories SSB, AM, RTTY, CW & FM (optional) 0.1-30 MHz. Twin VFO's Scanning, Selectable AGC, noise blanker, pass band tuning and deep notch filter! Super value!!



ONLY £739

FRG 9600



THIS EXCELLENT RECEIVER FROM YAESU WILL NOW COVER 60MHz-950MHz —NOW ONLY £479

CLOSED FOR ANNUAL HOLIDAYS 30th AUGUST-14th SEPTEMBER INC.

FT 727R HANDHELD 5W 2M & 70 IN ONE



FT 211 RH 45W FM ADVANCED MOBILE BASE — 15% SLOPING FRONT



FT 23/73 SUPER 2M AND 70CMS



CALL FOR PRICE!

HANDHELD TWINS!



ICOM 7000 £859

Prices subject to currency fluctuations. E. & O.E.

Amcomm
—of London



AR 2002 £459

CLOSED MONDAYS

373 Uxbridge Road, London W3 9RN. Tel: 01-992 5765/6. Telex: 24263 Fax: 01-861 2591



Good Operating Practice

During an on-air discussion, this phrase popped up and led to a vigorous debate in the context of c.w. practice. We often see the phrase "good operating practice", indeed it is required study in the RAE, together with the equally contentious "procedure". From this and subsequent discussions, there appears to be no real agreement as to what these phrases actually mean, in real live c.w. conversations. Even in "rubber stamp" contacts there is confusion.

The RSGB booklet on Morse and the *Examination Manual* differ in their recommendations on procedure. Both, in their

way, are logical in their positioning of \overline{CT} and \overline{AR} . In one case at the very beginning and end of the traffic, in the other **after** the call signs at the beginning and **before** them at the end—in other words at the start and end of the actual information being passed. It could be said that this latter is the better, as in practice it allows the operator time to review the last traffic and compose his reply.

There are other practices which make some folk grind their teeth, but which are quite common. For example, what does the \overline{VE} mean at the beginning, apart from the fact that the operator was RAF trained? (I think that is what it means!) RTU and BTU are in common use, especially on the v.h.f. band; understandable perhaps, but are they "good practice"? What about the use of the question mark when an error has been made? I gather this is a carry-over from the old days and is really IMI, meaning "I say again". Where do we stand on the subject of abbreviations?

Not the "standard" ones, but all those others that we can use, for example BE4 for before, EM for them, and many others. REMBER NT TLKG ABT RBR STMP QSO WID NON-ENGLISH SPKRS, BUT WID DEM WAT SPK DE LANG HI. Is it "good" or "bad" to send RIG ABCD/100W/W3DZZ instead of "My rig is ABCD running about 100 watts to a trapped dipole"?

From speaking to a number of c.w. addicts I get the impression that there is no such thing as "good operating practice and procedure" for c.w.—other than the fact that the practice and procedure followed should be understandable at the other end. Let me add that most of it is!

Is it all a matter of convention? If so where do those who are concerned with RAE classes and Morse classes stand? What do they recommend to their students? Does it really matter so long as the RAE tutors go by the manual? If so, the students can answer

the RAE questions, but when it comes to the Morse classes they may well have to unlearn and be subject to the personal foibles of the Morse tutor. As a result they continue in the use of these "habits", believing that they are the accepted and only procedures, merely to be confounded when they get on-air.

In short, does the phrase "good operating practice and procedure" really have any definite meaning in the realms of c.w.? If any readers have any thoughts on this, please write to me QTHR (there's another!), and I will try to compile a compendium of views.

**R. G. Wilson G4NZU
Nottingham**

The abbreviations \overline{CT} and \overline{AR} are used by commercial operators to indicate the beginning and end respectively of each message (telegram) rather than each transmission. When in "chat mode", as in the vast majority of amateur communications, they are perhaps not really appropriate, though they are widely used. Beware though,

QRV?*

Ten pounds will not go very far to help Mr S. Mayer G6KYO in his search for a sound-proof room in which to take his Morse Test. I wish him all the luck in the world.

When I took my test some thirty-plus years ago, at the Post Office Headquarters in St-Martin's-le-Grand, London, I do not recall the signals being "single-signal". I sat at a table in the middle of a large room. People were milling around and teleprinters (not the modern silent type) were chattering away in one corner—in fact the general hubbub of a very busy office. It did not bother me, as I suppose it did not bother the many thousands of other would-be amateurs who took their tests in similar circumstances.

I wonder if G6KYO has ever seen, let alone worn, the headphones of that period—bear-traps for headbands and earpieces that seemed to weigh as much as a bag of sugar, each! Perhaps today's tests are carried out using a

loudspeaker, I wouldn't know. At least G6KYO should have been able to ignore the QRM, as indeed he will have to if he is to get much enjoyment out of c.w.

Most of my training was done as an s.w.l. prior to serving my king and country, and indeed during and subsequent to this service. How many of today's amateurs can say that they have spent two or three years learning to cope with all kinds of conditions, before even thinking of taking the test?

I wonder what the percentage of passes was at G6KYO's test, and how many other candidates jumped to their feet complaining of the noise. When and if he does pass his test, I dread to think of his reaction to the neighbours' kids screaming outside his shack whilst he is operating. What, I wonder, will he say to the chap next door who is mowing his lawn.

Let's face it, Steve, you were simply NOT prepared. It is not enough merely to be able to copy or send code at

14 w.p.m. in order to pass at 12 w.p.m. Get your friendly neighbourhood amateur to send you some live practice on a crowded part of the band. Better still, try copying the various broadcasts from RAFARS, RNARS, RSARS, VERON, W1AW, etc., and get your good lady to start Hoovering at the same time!

**E. H. Ross GM3LWS
Glenrothes, Fife**

*QRV? – Are you ready?

In answer to the letters from Steve Mayer and M. D. Hiam in July 1987 *Practical Wireless*, I would suggest that Mr Mayer does not take his Morse Test at a Rally, as I had exactly the same treatment. I treated it as an Act of God, though—how can you stop a Rally just to allow people to take their tests. I had to contend with a very loud Tannoy system and model aircraft flying around. The test was conducted in a, for want of a better word, "shower", and the Morse reverberated around the room. I'm not saying the examiners were bad, just the room, which

was quite cramped as well.

I do not wish to knock the RSGB for taking over the Morse Tests, for they have at least halved the cost compared with what the DTI charged. There are more test centres than before too.

I can thoroughly recommend our local test centre at Winchester, where you are treated extremely well and the test is done to perfection.

So don't despair lads, you will pass it in the end.

Remember, though, if you can't read Morse with a bit of interference, how on earth are you going to cope with listening on h.f., with about half a dozen stations on the same frequency?

**Reg Keeley-Osgood GOGIA
Gosport, Hants**

Well, even candidates for professional Morse qualifications aren't expected to cope with more than one signal at a time in their tests. Once you're out in the real world, of course, you will have to learn to read one Morse signal out of a whole jumble of dots and dashes, but that's something that only comes with practice.—Ed.

that according to The ARRL Handbook, \overline{AR} has a different meaning to US amateurs!

I would be interested to learn the origin of the signal VE. I had always accepted it as roughly meaning the same as repeated pairs of dots, in other words: "Hang on whilst I find the next message, which just fell on the floor", or something similar. Now you mention it, though, our Morse instructor at radio college was an ex-RAF man!

Many years ago, when I first went to sea in the Merchant Navy, I questioned the origins of some of the two-letter abbreviations used on c.w., which seemed to have no logical format to them, and was told that they were "leftovers" from earlier versions of the "Q-code", with the "Q" dropped. Although the "Q-code" gives the impression of having been "graved on tablets of stone", that is not strictly true, as quite a few of the codes have been given new meanings over the years, to meet changing needs in radio equipment and operating practices.—Ed.

Balance

I wish to disagree with H. Thomson (*Write On, Practical Wireless*) February 1987). In my opinion PW has a good balance of articles and should not be changed. All the projects he says he wants to see have been published over the past few years anyway.

I would like to congratulate those who write the *On the Air* articles. These are truly informative and of most interest. I have not seen anything like them in any other magazine so I suggest rather than reduce their content as H. Thomson wants, you give them more space.

Keep up the good work. It is most appreciated.

Robert Dawkes
Christchurch, NZ

The Way In

There are a couple of matters that to me are completely illogical. As these are no doubt controversial, I state at the outset that I am a dedicated "B" licensee and have no

wish to go on h.f.

First, what is the validity of the Morse Test when it is a one-off with no retesting annually? The majority, I am sure, just dispose of their key and get stuck into phone. In a very short time, as preparation for the test was mostly unenthusiastic dedication, it is all forgotten and that's the end of it.

The other problem is that any candidate can bypass the "B" licence, pass the RAE and the Morse Test and go straight on h.f. with no previous operating or listening experience at all. A "B" licensee with a few years (yes, years) experience is far more deserving and able to merit an "A" licence without passing the Morse which is so quickly forgotten.

A better alternative to the Morse would be a written

and practical test on h.f. to see if the candidate has a real knowledge of the bands—those that have done no time as a s.w.l. will have to gen up! In many cases I have had to give advice to "A" licensees as I was an s.w.l. for 30 years and still have my log-books to prove it.

No doubt this will stir the dust, and a good job too! If there was an annual Morse retest I would be all in favour of letting things stay as they are. However, I do think that: 1. Only a "B" licence should be issued after passing the RAE. 2. An "A" licence should be issued only after a period of operating experience and passing a practical and written examination on h.f. procedure.

J. C. R. Middleton G6BJP
Bury St. Edmunds

EFFECT OF HEIGHT $N\lambda$ ABOVE GROUND

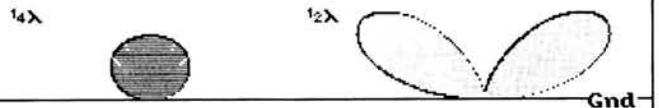

ON THE VERTICAL RADIATION FROM A

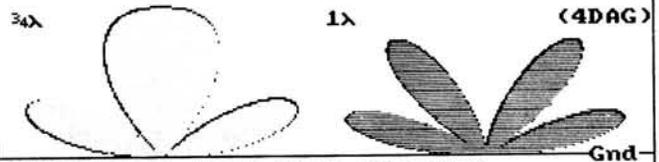

HORIZONTAL HALF-WAVE (dipole)

EFFECT OF HEIGHT $N\lambda$ ABOVE GROUND

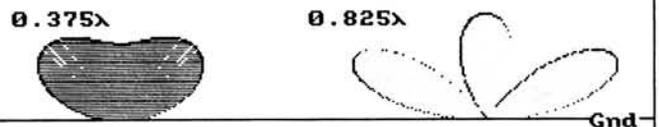

ON THE VERTICAL RADIATION FROM A



HORIZONTAL HALF-WAVE (dipole)

Idealised radiation patterns

Radiation Patterns

In *Practically Yours* in July PW, Glen Ross talks about vertical radiation from antennas, and the effect on this of the height of the antenna above ground. Whilst what he says is true, there is unfortunately no height below that where the so-called "free space" conditions prevails, at which vertical radiation at really low angles becomes possible with horizontal antennas. A height of one-half of a wavelength (0.5λ) is reasonable, giving two lobes at about 30° , whilst at a height of 0.25λ or less, vertical radiation is maximum at 90° but considerably attenuated because of the close proximity of the antenna to ground. At 0.75λ the major proportion of total radiation is also at high angles, and although there is some at relatively low angles, it is not sufficient to be of real value. At a height of one wavelength, the two lower lobes are at useful angles but power is wasted in the

two high-angle lobes.

For the benefit of readers who may find it difficult to visualise vertical radiation with respect to ground, I include print-outs of computer-generated vertical radiation patterns for a horizontal half-wave antenna at the heights shown. The magnitudes of the patterns are relative.

It should be emphasised that these patterns are with respect to ground having perfect conductivity, and may not necessarily be obtained in practice. However, both the article referred to above and the radiation patterns clearly indicate that the height of horizontal uni-directional, bi-directional or multi-directional antennas (beam, half-wave or long wire) needs careful consideration.

Since height in terms of wavelength is also relative to the frequency of operation, it becomes a quite important factor where antennas for the h.f. bands such as 14, 21 and 28MHz are concerned.

F. C. Judd G2BCX
Cantley, Norfolk

WRITE ON . . . the page where you have your say

Safety

As a serving police officer I must endorse the recommendations set out in the new Highway Code, together with the RSGB safety tips regarding the use of microphones, particularly when on the move.

However, I feel that no police officer can honestly institute process against any driver using a hand microphone whilst mobile when many forces, including my own, still provide the

ancient style telephone handset. Single crewed vehicles are often required to use the radio en route to a call.

I have seen many references to committing an offence of using a microphone on the move. There is no such offence. Process would be under the "catch-all" of Section 3 of the Road Traffic Act 1972 of driving without due care and attention.

Name and address supplied

Mobile Safety

I noticed on the cover of the May 1987 *PW*, that the MG car had an ICOM rig equipped with a standard hand microphone. And since the YL driver has her hands on the steering wheel, I think we are supposed to think that she is driving.

I thought that a new law had just come into effect outlawing the use of hand microphones by drivers, and that some sort of boom mic and headset should be used.

I'm only 14 years old, and hoping for a letter soon, saying I've passed my RAE, so it doesn't affect me yet. Don't you think, though, that you should explain this new law to the radio amateur

community, and especially to 17/18 year old amateurs about to take their driving licence.

*Owain Betty
(hopefully soon a G7?)
Rhayader*

The latest edition of The Highway Code does warn against the use of hand-held microphones or telephones by drivers whilst the vehicle is in motion, and indeed against the use of radio equipment at all if it might distract the driver's attention.

In our defence, although the driver in our cover picture has her hands on the steering wheel, the car was not moving. We found the photographer couldn't run fast enough on his knees!—Ed.

Prized Membership

Amateur Radio has always seemed, at least to the writer, to carry with it an image of mutual help and education, a feeling of comradeship and a desire to pass on to others the rewards of a fascinating hobby or profession.

Feeling this way, one tends not to rock boats except in extreme circumstances for all sorts of hopefully obvious reasons—not least the assumption that we have all adopted a similar helpful view of life.

Perhaps such an attitude is naive but it has always seemed sufficient reason for avoiding involvement in the various criticisms levelled at that august body, The Radio Society of Great Britain. Eventually though, something occurs which demands comment. The recent marketing activities

of the Society seem to fall into that category.

If local experience is anything to go by then a good many licensed addresses have received a package from the RSGB purporting to be a fine offer to the recipient. Join this month (June 1987) and you obtain a free gift and some nice tasty reduced-price reading matter. And remember, it is ONLY through the efforts of the RSGB and no-one else that Class B holders will have use of 50 and 70MHz.

Oh, and by the way, don't forget that until you are all members we can't possibly do all the nice things WE want to. And to those amongst you who are not members, it is your fault we have been so slow in the past.

Perhaps I have paraphrased the various documents unkindly but the spirit of the package is quite clear. The RSGB have

HAVING PROBLEMS

Finding a copy of the 1987 World Radio TV Handbook?

*Don't despair,
we have it
in stock, now!*

See our Book
Service Page 40

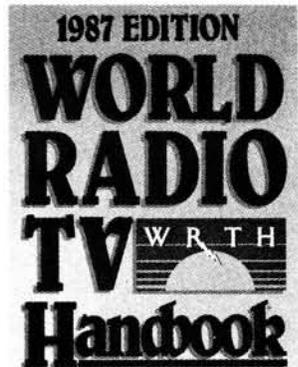

adopted *Readers Digest* tactics to Sell the Society. And here I apologise to *Readers Digest* for any unintended insult.

Worse, they appear to feel that they, and only they, act for amateur radio interests in the UK.

It is difficult to understand how the RSGB feel the need to go in for Free Gift sales tactics when one remembers the pleasant and comfortable offices at Potters Bar, the powerful computer they have, the nice cars parked outside. Surely the Society is not That poor.

As for representation of the amateur interests—many responsible folk with absolutely no personal interest in our activities take part in the decisions which govern our world. The RSGB is only one voice in many, whatever stance it might take. Certainly there can be no shame in not being a member, particularly in the light of the current (is it new)

subscription rate of £18.50 for corporate membership. Many millions of folk in the UK simply can't afford that sort of outlay from the poverty trap of unemployment or jobshare wages.

There is a clear feeling in this matter that the corporate ego of the RSGB is growing perhaps a little too large for the general good of amateur radio. Could it be that we need some fresh ideas and organisations.

I for one would welcome a British Radio Relay League which served the present and ongoing interests of its members at a cost to them minimised by charter—not profit. If any others of similar view would care to contact the writer he would be glad to act as a focus for sensible activity.

*R. D. Railton GW6RXA
Glas-coed
Rhydargaeau
Carmarthen
Dyfed SA32 7JT*

RAE Courses

Brighton: Brighton College of Technology, Pelham Street, Brighton. Enrolment is September 7/8 between 1600 and 2000. Course lecturer is P.D. Simmons G3XUS.

Cambridge: Coleridge Community Centre, Radekund Road, Cambridge. Morse classes on Mondays at 7.30pm. More details from the college.

Clacton on Sea: Colbaynes High School, Pathfield Road, Clacton on Sea. Enrolment at Clacton Adult Education Centre, Green Lodge, 180 Old Road between September 7 and 18. RAE classes commence September 23 from 7 to 9.15pm. Morse classes start September 22 from 7 to 9pm. More information from M.J. Harris G3LWM, the course tutor, on Clacton 432621 (daytime only).

Fareham: Adult Education Centre, Wickham Road, Fareham, Hants. Full 28-week course, Fridays 7 to 9pm. Short 12-week revision course for the December exam, Mondays 7 to 9pm commencing September 14. Details from the Centre on Fareham 280709 or the tutor G3CCB on Fareham 288139.

Farnborough, Hants: South Farnborough Centre, Wavell School, Lynchford Road, Farnborough. RAE course commences September 24. Morse classes commence September 21 and advanced Morse classes on September 24. More details from 0252 540084.

Leamington Spa: Mid Warwickshire College of

Further Education, Warwick New Road, Leamington Spa. The course will run on Thursday evenings, commencing on September 17. Enrolment is on September 7/8.

Manchester: North Trafford College of Further Education, Talbot Road, Stretford. Theory Monday or Thursday evenings or Wednesday mornings. Morse classes Tuesday evening or Wednesday afternoon. Advanced Morse Monday evening. Enrolment September 2-4. Course tutor is J.T. Beaumont G4NGD on 061-872 3731.

Manchester: Pendlebury High School, Cromwell Road, Swinton. RAE course on Mondays at 7.30pm commencing end of September. Details from G4HYE on 061-794 3706. Morse classes on Tuesdays at 7.30pm commencing end of September. Details from Swinton AEC on 061-794 5798.

Melton Mowbray: Melton Mowbray College of Further Education. Course starts September 8. Enrolment is 2/3 September or at the first class which starts at 7pm. Details from Ken Melton G3WKM, the course tutor, on Leicester 608596.

Newcastle: Gosforth Adult Education Centre, Regent Centre, Gosforth. Class starts September 22 from 7 to 9pm. Enrolment by post or at the college on September 12/13. Course tutor G8BGU. More details from G8BGU, QTHR or 066 1 32020.

Portsmouth: Adult Education Centre, Drayton Road, North End, Portsmouth. Tuesday and

Thursday 6.30 to 8.30pm. More details from G6NZ on Portsmouth 819968.

Rugeley: Aelfgar Sixth Form College, Taylors Lane. Enrolment is September 7/8 from 7 to 9pm. Classes commence September 24 at 7pm. More details from C.J. Teece G4DBR on 08894 2912.

Stevenage: SITEC, Telford Avenue, Stevenage. Stevenage & District ARC class starts October 6 at 8pm. Details from Peter Daly G0GTE on Stevenage 724991 or Prestel MBX 219994795.

Stockport: Avondale Evening Centre, Heathbank Road, Edgeley, Stockport. Enrolment is September 14 to 17 between 7.15 and 8.15pm. More information from the course tutor, Rik Whittaker G4WAU, on 061-477 2382.

Stockport: Reddish Vale Evening Centre, Reddish Vale Road, Stockport SK5 7HD. RAE course is 25 sessions on Monday evenings between 7 and 9pm. Morse classes for 25 lessons on Thursdays from 7 to 9pm. Further details on 0606 41511 between 12.30 and 1pm, ask for Dave Wood.

Walsall: The Barr Beacon School, Old Hall Lane, Aldridge, Walsall WS9 0RF. The 12-week course begins on Thursday September 10, 7 to 9pm. Enrolment is at 6.30pm on the 10th.

Wigan: Dept of Eng Technology, Wigan College of Technology, Parsons Walk, Wigan. RAE course starts in September, Wednesday evenings 7 to 9pm. Contact Roy Hesford G4UAE at the college.

Digital Capacitance Meter

Levell Electronics have just sent me details of their new 7705 digital capacitance meter, priced at £49.00 + VAT.

This is a hand-held instrument with a 3½ digit liquid crystal display with ranges from 200pF to 2000µF. Accuracy on most ranges is quoted as ±0.5 per cent of the reading +1 digit, and resolution is 0.1pF. The test voltage applied to the capacitor being measured is 3.2V peak and this is applied twice per second. Input protection is by a fuse.

The instrument is powered by a PP3 battery and low battery and over-range indicators are provided for on the display.

The case is moulded in high-impact ABS plastics and is fitted with a tilt stand for bench use. All-up weight of the 7705 is 350g and it measures 180 x 87 x 42mm.

Further details from **Levell Electronics Ltd., Moxon Street, Barnet, Herts. Tel: 01-449 5028.**



Antenna for Scanners

Waters and Stanton have sent me advanced information on their new wide-band antenna, which they claim is the first with such a wide frequency range to be offered to the hobbyist.

Suitable for both listening and transmitting, and covering the frequency range 105 to 1300MHz, the antenna is in the form of a 19-element log-periodic beam capable of handling a

maximum of 500 watts of r.f. power and providing a gain of 11 to 13 dBi.

Front-to-back ratio is 15dB and the beamwidth is 60 degrees. Nominal impedance is 50 ohms with a v.s.w.r. of 2:1. The length of the boom is 1.4m while the longest element is also 1.4m and the total weight is 3kg.

No price has yet been announced and only limited supplies will be available

some time around July. Further details from **Waters & Stanton Electronics, 18-20 Main Road, Hockley, Essex SS5 4QS. Tel: (0702) 206835.**

HF Convention

The 1987 HF Convention will be held at the Belfry Hotel, Milton Common, which is east of Oxford on the M40, on Sunday September 27. Attractions include a lecture programme, presentation of

trophies, RSGB committee stands, special interest group, a boot sale, c.w. pile-up competition, DX Quiz to name but a few.

Doors open at 10am and the organisers say that if there is enough interest, FCC test for US amateur licences will be held at the hotel on Saturday the 26th. If you are interested in the US licence exam then contact **Greg Lambert G0/KK1J 27 Redcliffe Road London SW10 9NP Tel: 01-352 2746**

Rally Dates

August 23: The Newbury & District ARS are holding a radio car boot sale at The Acland Hall and Recreation Ground, Cold Ash, Newbury. Gates open from 10am to 5pm. Pitches are £5 or £4 if pre-booked (limited supply). **Mike Fereday G3VOW** can tell you more on **0635 43048**.

August 30: The annual rally of the British Amateur Radio Teleprinter Group (BARTG) have their rally at Sandown Park Racecourse. It is THE rally for the RTTY enthusiast, but also has plenty to interest all radio amateurs. There will be a car boot sale, plenty of free car parking and catering facilities. Doors open between 10.30am and 5pm.

August 30: The Galashiels & District ARS are holding an open day at the Focus Centre, Livingstone Place, Galashiels. There will be trade stands, bring and buy as well as all the usual activities. They also hope to have Morse testing. More from **John G. Campbell GMOAMB. Tel. 0896 55569**.

August 31: The Doncaster & District RAYNET Group are holding their rally at the Bircotes Sports Centre, Bircotes, Doncaster (Grid Ref: SK630922). Doors open at 11am (10.30 for the disabled). Admission is 50p.

September 6: The South Bristol ARC are holding their rally at the Hareclive Youth and Hartcliffe Community Centres, Hareclive Road, Hartcliffe, Bristol. Doors open between 10am and 5pm. There will be radio dealers, bring and buy as well as general traders. Admission is 50p. For more information, contact **Len Baker on Bristol 834282**.

September 6: The 20th Annual Rally for the Preston ARS will be held at Lancaster University. The rally starts at 11am with early entry for the disabled.

The University entrance is on the A6 trunk road (leave M6 at junction 33). Talk-in on S22. There will be trade stands, a large Bring & Buy, RSGB stand and bookstall, licensed bar, snack and a restaurant. Morse tests are available, pre-booked with the RSGB. Further details from **Godfrey Lancefield**

G3DWQ on 0772 53810.

September 6: The West Kent AR Rally is being held in the Angel Centre, Tonbridge, Kent. Doors open between 10.30am and 4pm. There will be talk-in on S22, SU8 and 29.5MHz f.m. using the callsign GBOWKS. There is free parking, a bring and buy, club stands, many trade stands and a stamp fair. More from **Nigel Peacock G4KIU on 0892 515678**.

September 13: Dunstable Downs Radio Club are holding The National Amateur Radio Car Boot Sale at the Shuttleworth Collection, Old Warden Aerodrome. Open from 10am to 5pm. Admission 50p. **Phil Norris G6EES on 0582 607623** can tell you more.

***September 13:** The Scottish National Amateur Radio Convention will be held at the Magnum Leisure Centre, Irvine, Ayr. The leisure complex includes restaurant, cafe and licensed bar facilities, as well as water slides, etc., for the junior ops. The PW Tennamast Scotland Trophy for the highest placed Scottish station in the PW QRP Contest will be presented. **Bob Low GMOECU, QTHR**, can tell you more.

***September 13:** The Telford Rally will be held at Telford Racquet & Fitness Centre, Telford. Talk-in will be via GB4TRG on S22 and SU8. Doors open 11am (10.30am for the disabled). There will be lectures by MAXPAC on packet radio, G3RZP/G4FNC on linear amplifiers and G3SEK on extra long Yagi antennas. Full catering and bar facilities are available. Morse tests will be available (pre-book with RSGB). There will be a huge flea-market, plus over 100 trade stands. More from **Martyn Vincent G3UKV on 0952 55416**.

***September 13:** The Lincoln Short Wave Club call their rally Hamfest '87, and this will be held at the Lincolnshire Showground and Exhibition Centre—6km north of the city on the A15. In addition to the usual stands of interest to the radio amateur they hope to have helicopter rides, model car racing, the police, fire brigade and lots more. There

is ample parking, caravans by arrangement, refreshments and a licensed bar with real ale! More details can be obtained from **Pam Rose G4STO on Gainsborough 788356**.

September 20: The annual rally of the Vange ARS will be held at Nicholas School, Nicholas Lane, Basildon. Doors will be open from 10am to 4.30pm. There will be the usual assortment of traders and a car boot sale outside (weather permitting). There is adequate parking at the school and admission is 50p. Please note, only guide dogs can be brought into the main hall.

September 20: The Trafford Rally and Components Fair will be held at Old Trafford Cricket Ground, Talbot Road, Stretford, Manchester. Doors open at 10.30am (10 for the disabled) and the rally closes at 5pm. There is free parking on site for over 700 cars and there will be a bar, tea, coffee and snacks available. Talk-in on S22.

***September 27:** This year the Harlow Rally returns to its traditional date of the last Sunday in September. It will take place at the Harlow Sports Centre.

Expansion at the Sports Centre will mean better facilities for this year's rally, a second hall has been added that will enable a

larger number, and greater variety, of traders to be accommodated. The Sports Centre has easy access from either the M11 (junction 7) or the A414. It will be fully signposted with talk-in by G6UT on S22.

As last year, Morse tests will be available and there will be exhibits by a number of special interest groups. Reserved parking is available for the disabled and there will be a separate entrance for the Bring & Buy participants.

Entrance costs £1 and accompanied children go in free. More details from **G4KVR on 0279 22365** (daytime) or **G3UEG on 0279 27788** (evening and weekends).

***October 4:** The Great Lumley ARES are holding their rally at The Community Centre, Great Lumley, Co. Durham. Doors open 11am. Talk-in on S22, RBO and GB3NT. Contact **Keith Watt, 7 Turfside, Leam Lane Est, Gateshead, Tyne & Wear** for more details.

***October 4:** The Welsh Amateur Radio Convention will be held at Oakdale Community Centre, Blackwood, Gwent. See **Brian GW3KYA on 0495 225825** for more details.

*** Practical Wireless and Short Wave Magazine in attendance.**

1kW PSU

Advance Power Supplies has introduced the P1000, a 1000W switched mode power supply which has up to five outputs.

It features a main output of 5V at 150A and a range of auxiliary outputs including 5V or 12V at 15A; 24V at 8A and 48V at 5A. The a.c. operating range is 88–132V or 176–264V, which is user selectable.

Other features include constant current protection as standard and a hold-up

facility whereby all output will stay within regulation for at least 30ms after the nominal line voltage (110/220V) is removed.

The P1000 is supplied in an industry standard 5 x 8 x 1.1in fan cooled box and has an operating temperature range on 0-70°C.

More information can be obtained from **Advance Power Supplies, Raynham Road, Bishop's Stortford, Herts CM23 5PF**.

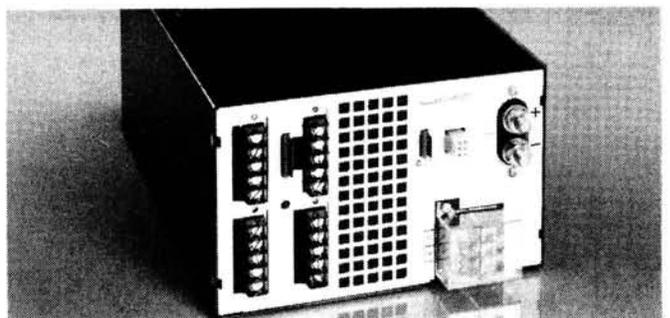

RS 50

RS Components Ltd had its origins in Birchington Road, London in 1937. Run by its founders, Mr Sebestyen and Mr Waring, Radiospares, as it was then called, set firm standards of service, made promises and kept them: full stockholding of every product line (all 238 of them!); same day dispatch and fixed prices.

The two gentlemen believed they could provide a faster and more efficient service than any that existed. They were right.

Their first catalogue was launched in 1937, in 6 pages it offered 238 product lines at prices from 2d to 7/6 each. By 1967, the

catalogue had grown to 70 pages and 2200 products. Then by 1977 it was 169 pages and 4100 products, in the last decade there has been exceptional growth in their range of products.

Tools, instruments, technical books, semiconductors, computer products and process control equipment have all been introduced. Today they supply over 14 000 lines.

With every issue of their catalogue over 500 new products are added.

They still do same day despatch from stock at a fixed price, and recently launched Electromail to provide a mail order service to the enthusiast.

Frequency Counter

Lowe Electronics are to introduce a new frequency counter to their product range. The unit is small enough to fit in a shirt pocket, yet sensitive enough to be used with a simple telescopic whip antenna for general off-air monitoring.

The frequency range of the counter extends to 1300MHz, and gives resolution to 100Hz with a full 8-digit readout. Power is derived from an internal rechargeable NiCad pack, which gives you "pick and use" convenience. The battery pack is automatically recharged when the counter is connected to any d.c.

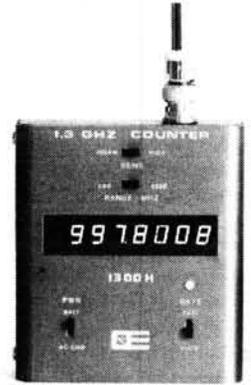

supply between 9 and 15V. You can use the counter on the same external supply.

The 1300HC frequency counter costs £135 inc VAT and the case is £9.80 inc VAT. For more details contact your nearest branch of Lowe Electronics.

G4AR Memorial Transceiver

Readers of the April 1987 issue of PW will have seen the obituary of Eric Dowdeswell G4AR. Eric was a regular contributor to PW and made many friends through his down-to-earth approach to technical matters and his readiness to help newcomers to amateur radio. He was also an active member of the Wimbledon & District ARS.

To help keep the memory of Eric alive, his son and daughter have donated his TS-530S to WDARS. It now bears an inscribed brass



plate and will take pride of place at field days and special event stations.

The picture shows (l-r),

Eric's daughter Susan, his son Michael, G6XJA, G4SYT, G4WYJ and G4RBQ at the controls.

SMC Open Day

South Midland Communications are holding another open day at their headquarters premises near Southampton.

There will be lots of bargains to be had—10% off new equipment (except masts) with cash only, many ex-demo and second hand bargains, odd length cables at half price, car boot sale (100 places but no tables), free radio check 1.8–430MHz, win an FT-290R and numerous other prizes. There will be a licensed bar and refreshments available on site. There are plenty of local attractions so you could make it a family day out.

Talk-in will be on S22, so make a note in the diary, August 30, 10am–5pm at SMC at Chandler's Ford.

C. M. Howes on the Move

Due to the continued expansion of their product range, Howes have run out of space at their present location. So they are relocating the business in new, larger premises.

The address you should write to now is:

C. M. Howes Communications, Eydon, Daventry, Northants, NN11 6PT.

Tel: 0327 60178.

Any post sent to the old address won't be lost, as everything is being redirected.

Low Noise Op-Amp

Raytheon Semiconductors have designed the OP-47, which is a low noise op-amp where a wide bandwidth and high slew rate are required.

The spec looks impressive:

Spectral noise density

3nV/Hz

V_{OS} Drift

0.2 μ V/month, 0.2 μ V/°C

Gain bandwidth product

70MHz
CMRR and PSRR
120dB

Raytheon offers OP-47 for two temperature ranges (0° to 70°C and -55°C to +125°C) and in two different packages (d.i.l. and TO-99).

For detailed data sheet and availability information contact **Raytheon Semiconductor Intl. Co., UK-Branch, Ogilvie Road, High Wycombe, Bucks HP12 3DS.**

Flat Holm '87

The Barry College of Further Education RS will be taking an expedition to Flat Holm between 28/8 and 1/9.

The station, GB2FI, celebrated the 90th anniversary of Marconi's pioneering tests from the island. They will be active as GW3VKL on 50MHz, 70MHz, 144MHz, 430MHz, 1296MHz, 2.3GHz and 10GHz wideband f.m. as well as the h.f. bands.

Sked frequencies are 50.12MHz, 70.22MHz, 144.27MHz, 432.27MHz and 1296.27MHz. For skeds on v.h.f., u.h.f. and s.h.f. please contact GW8NVN or GW1JCB, both QTHR.

You should note that this station is one of the few required for the Marconi Award and is a rare square for WAB (ST26).

OP-47

Pin	Function
1	V_{OS} Trim
2	Inverting Input
3	Non-Inverting Input
4	V^-
6	Output
7	V^+
8	V_{OS} Trim

TO-99
Metal Can

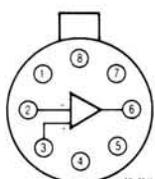

8-Lead
Plastic Dual-In-Line

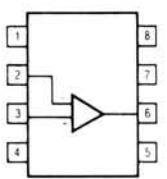

• OP-47BT • OP-47BT/883B

• OP-47FT • OP-47GT

• OP-47BDE • OP-47FDE

• OP-47FNB • OP-47GDE

• OP-47GNB

Special Event Stations

GB2MQS: The second commemorative station will be operating on September 5/6 from Stirling Castle. If you worked the first station in February '87 then you can apply for a MQS Certificate. Send both QSL cards or log extracts with an A4 s.a.e. to PO Box 20, Motherwell, Scotland.

GBOWEM: This will be on the air on Saturday September 5 to commemorate the 1987 Carnival in the North Shropshire market town of Wem. The station will be active on 'phone and RTTY on h.f., 144 and 430MHz. More from **Eric GOHRU** on **0939 33638**.

GB4PLS: The Exmouth ARC are commemorating the Pleasure & Leisure Show, Bicton Park, East Budleigh, Devon. All visitors are welcome and there is talk-in on S22.

GB1RLD: Four members of Radio Link, Derby Hospital Broadcasting, will be operating from the Outside Broadcast Caravan at the City Hospital. They'll be using 144MHz on September 19 and 20 from 10am to 4pm.

SMC Expanding

From July 1, Amateur Electronics and South Midlands Communications are amalgamating.

The merged group will trade with the title South Midlands Communications Ltd., and the shop in Birmingham at Alum Rock Road will trade under the name SMC Birmingham.

SMC will now be the sole UK distributor for the Yaesu range of products and will have a vast range of spares to cater for both guarantee work and repairs. They will be supplying the Yaesu products to all authorised Yaesu dealers.

Any Yaesu equipment sold retail with foreign or photocopied manuals or with different type numbers, e.g., FRG-965 in place of FRG-9600 will not have the support of spares and back-up of the SMC Group.



Radio Car Boot Sale

Each year, Dunstable Downs Radio Club organises and runs the National Amateur Radio Car Boot Sale. This event caters mainly for amateurs selling to amateurs, yet there are many traders at the event too.

Last year there were over 250 places, and there were more than 2500 visitors.

It is a day out for the whole family as the event is

held at one of this country's famous aircraft and motor museums called The Shuttleworth Collection.

This year the date will be September 13 and the event is open from 10am to 5pm, admission 50p (parking free). The address is **The Shuttleworth Collection, Old Warden Aerodrome, near Biggleswade, Bedfordshire.**

Enquiries about the event and advance plot bookings can be made to Wendy on 0582 451057 or Clive 0582 27907.

Micro-miniature Coaxial Connectors

The MCX series of coaxial connectors, recently introduced by Greenpar, uses the proven SMB contact system in a robust, yet smaller, body.

Designed to meet CECC

specifications, the comprehensive range includes p.c.b., bulkhead and cable entry versions. The cable entry connectors include full crimp versions giving a fast, consistent and reliable connection at a low cost.

A bright nickel or hard gold plated brass body is

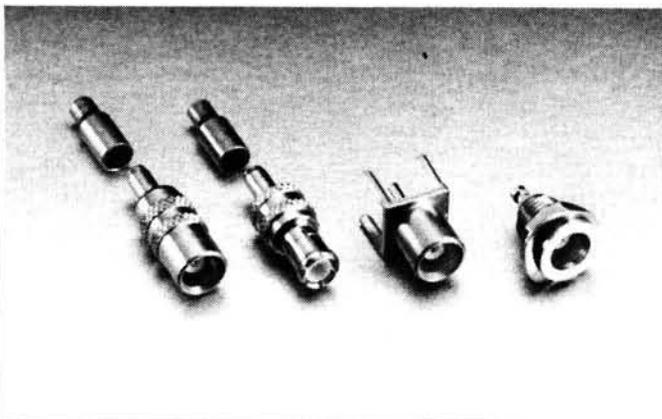

RANTS Award

This is the Radio Amateurs National Trust for Scotland Award. To claim the award, for UK or Irish stations, you must work four of the six special event stations they are running this year using the callsign GB2NTS.

The last one will be from the Island of Iona on

September 26/28.

To claim the award, send an A4 s.a.e. to GB2NTS, PO Box 20, Motherwell, Scotland. You must also send either 4 QSL cards or a log extract.

Overseas stations need 3 QSL cards or log extracts. More information from GM3MTH, QTHR.

Isle of Wight Award

The Binstead ARS have an award running at the moment. You need to work 10 Isle of Wight stations which must include the club station G0BAR for the v.h.f. award; or 5 Isle of Wight stations including the club call for the h.f. award. A copy of your log, witnessed and signed by another amateur, must be sent to J. Willis G1BZC, QTHR. The award is in four colours and costs £2.50.

Home Taping Royalty

A home taping royalty of 10 per cent will be added to price of blank audio tapes, as part of a new copyright law. The proceeds of the royalty will be distributed to the performers, composers and producers of sound recordings. The new legislation will be introduced during the 1987-88 session of Parliament.

Such a move will bring the UK into line with the majority of its EEC partners.

fitted with either gold plated, heat-treated, beryllium copper female or gold plated, brass male contacts. The male contact is surrounded by beryllium copper spring "fingers" which are compressed by mating with the socket and grip an internal recess to give a secure connection.

The frequency range of the new connectors is d.c. to 3GHz with a nominal impedance of 50 ohms and a typical v.s.w.r. of 1.35 to 3GHz.

A data sheet giving part numbers, dimensioned outline drawings, performance data and step-by-step assembly instructions is available from **Greenpar Connectors, Cambridge Road, Harlow, Essex CM20 2ER. Tel: (0279) 27192.**

Apologies

Paul Newman, the author of Computing Corner, has let us know he was not able to get to the AMSAT convention after all. So to any readers who were intending to meet him there he would like to extend his apologies.

MICRONTA[®]

NEW PRECISION MULTITESTERS



A £34⁹⁵

A 28-Range FET VOM. Perfect for electronics testing! 10 megohms per volt DC sensitivity. Measures: 1000 volts DC in seven ranges and 1000 volts AC in five ranges. DC current to 10 amps, resistance to 100 megohms. Decibels: -20 to +62 dB. Fuse protected. Requires one 9v and one "C" battery. Measures: 7¹/₁₆ x 5¹/₂ x 2³/₄".
22-220 £34.95



B £29⁹⁵

B 43-Range Multitester. 50,000 ohms per volt DC sensitivity. Fuse and overload protected. Measures to 1000 volts DC in 12 ranges and 1000 volts AC in 8 ranges. DC current to 10 amps, resistance to 20 megohms. Decibels: -20 to +62 dB. Requires one 9v and one "AA" battery. Measures: 6¹/₁₆ x 4⁷/₈ x 2³/₈".
22-214 £29.95

Tandy[®]

For The Best In High Quality Electronics

Over 300 Tandy Stores And Dealerships Nationwide.
See Yellow Pages For Address Of Store Nearest You

Tandy UK, Tandy Centre, Leamore Lane, Bloxwich, Walsall, West Midlands. WS2 7PS

PW REVIEW

Having followed Roger Cooke's series on packet radio, Mike Richards G4WNC reviews a TNC, the TNC-220, that could set you on your way.

The history of the TNC-220 is a long and interesting one. It is a direct descendant of the original TNC-1 which was launched about 3 years ago and retailed at around £600. The manufacturers, Pac-Comm, are a pretty dedicated bunch, being amateurs themselves who gave up their jobs to start this company. Their development success can be summed up by the fact that the TNC-220 is three times smaller, more powerful and less than a third of the price of its predecessors. I only wish more amateur radio equipment manufacturers could achieve this sort of result!

The TNC-220 was launched on the UK market in January of this year and thanks to the efforts of Siskin Electronics this was ahead of the USA release!

Construction

The TNC-220 can be purchased in either kit form or ready-built. Although the review model was supplied ready-built I can comment on the constructional details—the instructions were in a 23-page appendix at the back of the very comprehensive manual. The initial task of component checking is made easy by the very clearly laid out components list. To help with the identification of the resistors the appropriate colour sequence is printed next to each resistor value i.e. 68ohm 5% (blue grey black gold), a nice touch of quality. Another point is the inclusion of a separate p.c.b. overlay drawing giving the component positions for each stage of construction. There are a total of five such overlays.

Once all the components have been mounted the manual takes the user through a very logical commissioning procedure. The basic tests performed are a digital loop-back, this involves looping the TNC output to its input internally in order to prove the correct operation of the digital section. The next test is the analogue loop which loops the modem input and output, again, to prove that the modem is OK. Whilst in these loop-back modes, the user is requested to enter various commands to prove the system. This commissioning procedure has the advantage of familiarising the user with the basic commands before going on air. I would advise buyers of ready-built units to familiarise themselves with



this section as it is a very useful fault location system for use in the event of a TNC failure.

The final job is to install the assembled and tested p.c.b. is the high quality extruded aluminium case. The overall size is a mere 150mm wide, 185mm deep and 46mm high. The finished appearance of the unit is very smart indeed.

Circuit Description

As you have probably realised by now the TNC-220 is a very sophisticated microprocessor controlled communications device.

The heart of the logic section is a Z-80 c.p.u. (central processing unit) using a 2.4576MHz crystal derived clock. It is possible to run the c.p.u. at 4.9152MHz by altering a jumper, but this would mean changing several devices for faster and hence more expensive types. Next essential is the operating software which, in this case, is held in a single 27256 e.p.r.o.m. The random access memory (r.a.m.) for the storage of parameters and buffers comprises two 6264 i.c.s giving a total capacity of 16K. This can be increased to 32K by replacing the two 6264s with one 62256 and moving an address jumper. An additional feature of the r.a.m. is that when the power is turned off, a battery back-up circuit puts the memory into standby and preserves the last used operating parameters ready for use when the TNC is next switched on.

The serial interface is derived by using an 8530 serial communications controller (SCC). As this is a dual device, one half is used to run the computer interface and the other to drive the modem. Channel B of the

8530 is set up as an asynchronous port and is connected to 1488 and 1499 t.t.l. to RS-232 drivers. A 74HC157 is used as a programmable switch to select either t.t.l. or RS-232 levels at the computer interface. Channel A of the 8530 is operated as a full duplex HDLC (high level data link control) channel to drive the modem as per AX-25 recommendations.

The modem (MODulator-DEModulator) used in this design is an AMD7910 which is a very sophisticated l.s.i. (large scale integration) i.c. For those of you not familiar with data terminology, a modem can be roughly equated to a RTTY terminal unit. Its main function is to convert incoming digital signals into two tones, one for a binary 1 and the other for a binary 0. The AMD7910 is rather more complicated than a RTTY terminal unit as it can generate several different tone pairs along with some control signals. In order to optimise the performance, the audio signals from the radio transceiver are filtered and limited before being applied to the modem. The v.h.f. port is fed via a two-pole low-pass filter and limiter, while the h.f. port has a six-pole band-pass filter and limiter. The extra filtering provided on the h.f. port is required to overcome the more difficult working conditions on these bands. In order to make the audio interface as versatile as possible both the filters and the modem can be separately disabled to allow the use of external units. The software selection of ports is achieved using a 74HC4053 analogue switch.

One extra feature included is a "watch-dog" timer. This timer uses a 555 device to monitor the p.t.t. line, and resets the TNC if this line remains in the transmit state for more than 45

Practical Wireless, September 1987

ARE YOU ENJOYING PACKET RADIO YET?

STOP PRESS
Kamronics KAM
all-mode
now in stock

NO? Thousands of amateurs around the world are now hooked on packet radio, from rare dx to local mailboxes. Getting started is a lot easier than you think. With any transceiver, a suitable home computer (most are) with a simple communications program and the Pac-Comm TNC-220 you can soon be joining in this fascinating new mode.



Phone (evenings and weekends too!) or write to find out how easy it really is to start enjoying packet radio.

All products usually despatched same day.

Prices:

TNC-220 built **£159**
TNC-220 kit **£139**

Here are just some of the TNC-220 features –

- Dual ports (software selectable!)
- HF and VHF filtering
- RS-232 or TTL (C-64 or VIC-20) interface
- Tuning indicator option (to make HF tuning easier)
- 7910 single chip modem
- Enhanced command set (full TNC-2 compatibility)
- AX.25 Level 2 version 2 protocol
- 12v DC operation

Siskin Electronics

P.O. Box 32,
Hythe, Southampton.
SO4 6WQ.
England.

Tel: 0703 849962 or 04893 5081



**SCOTTISH
AMATEUR**



**RADIO
CONVENTION**

SARCON '87 Sunday, 13th
September
at The Magnum Leisure Centre, 10.30am

Bring the XYL's, the YL's, OM's and the junior ops to visit Europe's largest leisure complex while you visit

SARCON '87

Talk in on AY, CS, and S22.

TRADERS : LECTURES : RAFFLES : BRING & BUY

U Aerials, Tenamast, JayCee, Clan Communications, A. Kelly, Interbooks, Sandpiper Aerials, Practical Wireless, Arrow Electronics, Hatley Antennas, Marco Trading, MGR Services, Microwave Modules, Computer Junkshop, Lowe Electronics, R.S.G.B., Heatherlite Microphones, Barenco Supplies, Computer Depot, Scotcomm, Cap Co Ltd, Apollo Aerials, Taurus Components, Paddock Press QSL's, Worked all Britain, RAFARS, G QRP Club, AMSAT, BARTAG, BYLARA, J.E.P., plus many many more.

LICENSED BAR, RESTAURANT AND CAFE

Organised by the Cunninghame & District A.R.C.; Kilmarnock & Loudoun A.R.C.; Ayr Amateur Radio Group and Cumnock A.R.C. For further details contact Bob Low. GMOECU. QTHR.

Admission: – SARCON '87 – £1.50. Magnum Centre only – 30p

Sponsored by Irvine Development Corporation

seconds. The "watch-dog" timer is a regulatory requirement in the USA hence its inclusion. The final section is the power supply which accepts a nominal 12V input and derives +5V, -5V and -10V. The negative voltages are generated by a 555-based charge-pump voltage inverter.

Connecting-up

The computer interface provided is very versatile and well implemented. This makes a nice change as this is an area which causes more confusion than any other. The first requirement is for the user to have a computer with a serial interface, preferably to RS-232C. This is where the confusion begins as the RS-232 standard is probably the most non-standard standard of them all! Unfortunately many computer manufacturers over the years have created their own implementation of RS-232 which bears very little resemblance to the original. Fortunately the designers at Pac-Comm have designed the TNC-220 to take most of these variations in its stride. If you are lucky enough to have a computer with a real RS-232, then connection is simply a case of using a standard DCE to DTE, (Data Communications Equipment to Data Terminating Equipment), lead from the 25-way "D" connector on the rear of the TNC-220. If your computer supports RS-232 but only with t.t.l. levels, then you will need to make a special lead and move a link inside the TNC-220. The simplest connection is a three wire lead, i.e. transmit data, receive data and ground, but if required full hardware handshaking is available.

As mentioned earlier the TNC-220 supports both v.h.f. and h.f. operation and to enable this two ports, (180° 5-pin DIN sockets), are provided on the rear panel. Port 1 is for connection to an h.f. transceiver and port 2 for v.h.f. The connections to both ports are similar and comprise the following: audio input, audio output, p.t.t. and f.s.k. (h.f. only). The audio input requires 200mV for optimum performance but the design is such that it will accept a very wide range of input levels. The audio output is fully adjustable from 0V to 0.5V r.m.s. by way of a multi-turn potentiometer on the p.c.b., one for each port. The p.t.t. signal switches to ground on transmit which should suit most transceivers, the switching is actually achieved by a VN10 power f.e.t. To allow a transceiver to be directly frequency shift keyed, an f.s.k. line is provided on the h.f. port. As with the p.t.t. line the switching is by a VN10 power f.e.t.

If you intend to use f.s.k., there are a few points of which you should be aware. First, the standard shift used for amateur packet is 200Hz and most amateur transceivers are set for the RTTY shift of 170Hz. This is not too serious a problem as most transceivers can be adjusted to give the required 200Hz shift. The second point to note

is that the TNC-220, along with most TNCs, requires the received audio tones to be 2025Hz and 2225Hz. If your transceiver is set-up for the European RTTY tones of 1275Hz and 1445Hz you will end up transmitting and receiving, on different frequencies, not the best way to get a reply to a CQ! If you're not sure about your equipment then I would recommend that you use the microphone input. With all this sensitive equipment, especially microphone leads, it is vitally important that all connecting leads are well screened.

Commands

Don't be fooled by the small physical size of the TNC-220 as it's packed with facilities! The command set comprises some 101 instructions and that doesn't include the diagnostic commands. Although the commands are well documented in the manual, I think it is appropriate to describe some of them here as the main difference between TNCs is in their command set. Rather than describe the function of each command word I will cover the facilities available. For those of you already involved in packet, the TNC-220 supports TAPR TNC software release 1.1.4. but adapted for the TNC-220 hardware.

This first group of commands affect the way the TNC and the terminal, (your computer) interact. These commands allow the TNC to communicate with the terminal in a form which is most compatible with the terminal. The default values for the terminal baud rate and data structure are: 1200 baud, 7 bit, even parity. This can be altered to any one of 5 baud rates between 300 and 9600 baud, with 7 or 8 data bits and odd, even or no parity. The delete or rubout key often causes confusion as some computers use a backspace as a delete instead of a true delete. The TNC-220 can be set to handle backspace or delete, also the way the deletion is echoed back to the terminal can be set as a backspace-

space-backspace or as a backslash. The echoing of typed characters to the terminal can also be enabled or disabled as required. If your terminal has a screen length other than the default length of 80 columns the TNC can be adjusted to any width between 0 and 255 columns. If the width is set to 0 then all the formatting is left to the terminal and automatic carriage returns and line feeds are omitted.

When accessing other computer systems you may hit problems if you receive an escape character, as some terminal programs treat this as a special command. Don't worry as this character can be trapped by the TNC and converted to a harmless \$.

An essential part of any terminal to TNC interface is the flow control. In simple terms this is the method used to tell the terminal to stop sending data when the TNC is busy and vice versa. With the TNC-220 you can choose between hardware or software flow control. Additionally, when using software control, the start and stop characters can be set to any ASCII character. The default setting is the standard control S and control Q.

The final few commands in this section allow the user to change the characters that control the following: cancel a line; cancel a packet; re-display a line; send a packet; and enter command mode.

Radio Interface

The TNC-220 has several features which enable the user to optimise the interworking of the TNC and the transceiver.

The first essential is to be able to key the transceiver and adjust the power/modulation levels. The TNC-220 has this facility and more, as you can send either of the two modem tones singly or alternate them at the appropriate baud rate. The radio baud rate can also be altered in the same way as the terminal rate, but they don't have to be the same.

One other critical factor is the time

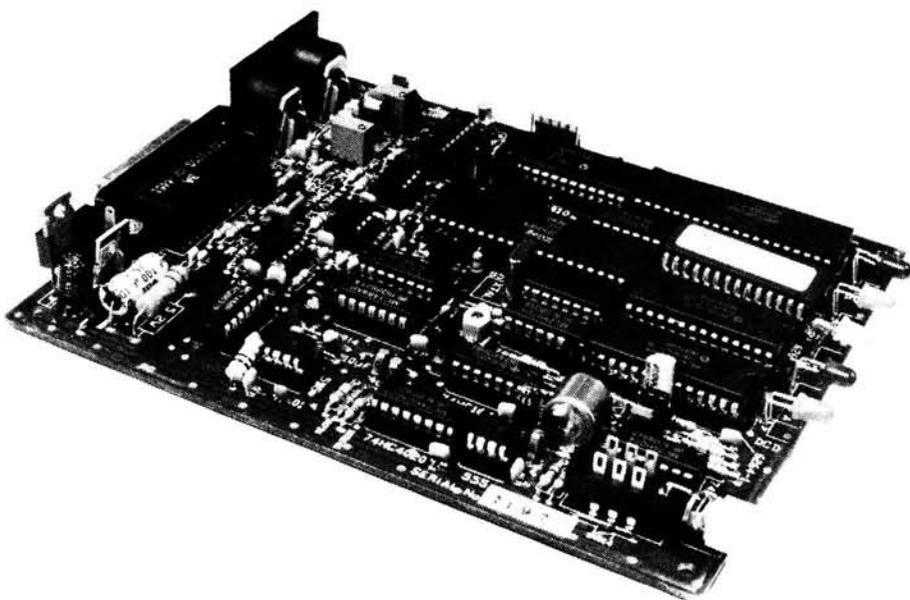

taken for the transceiver to switch from transmit to receive, if the TNC was to start sending data before the transceiver was ready, data would be lost. The TNC-220 can be set to accept any delay up to 1.2 seconds which should be more than adequate. If you send packet data via a voice repeater you will need to include another delay to compensate for the response time of the repeater. The TNC-220 handles this situation with two commands, one inserts the delay while the other disables the delay if the repeater is already keyed-up, all very clever. During the transmit delay the TNC sends continuous flags as specified in the AX-25 protocol.

One other facility is the ability to disable transmitter keying whilst leaving the TNC working normally. This can be useful to temporarily stop transmission without having to reset the TNC. Last radio command is the switching between h.f. and v.h.f. radio ports. The ports are called port 1 and port 2 and to change between the two you merely type "port" and the port number and switching is effected along with the pre-set change of baud rate.

Protocol

Having described the commands that control the TNC-220's interaction with the outside world, we can now look at the facilities within the packet environment. With the rapid development occurring in the packet field, it is difficult to draw the line between standard commands and additional features. Suffice it to say that the TNC-220 supports all the basic commands required to adjust important parameters and set up connections. I will therefore concentrate my efforts on extensions to the basic command set.

One difference between the various TNCs on the market is the monitoring facilities provided.

The TNC-220 can be set to monitor the following:

- (1) All frames at all times.
- (2) Connected frames only, i.e. not UNPROTO.
- (3) Only frames connected to you.
- (4) All frames whilst you are unconnected.
- (5) Include or exclude the digi-peater path.
- (6) Display data frames only.
- (7) All frames including errors.
- (8) Frames from up to eight selected stations only.
- (9) All frames excluding up to eight selected stations.

The facility to reject up to eight selected stations can be very useful, for example, to reject traffic from a busy local mailbox. The selective monitoring could also be used to run a net.

The TNC-220 features an automatic log which stores the last 18 stations heard and, if the clock is set, it will time stamp them as well. In addition the log can be recalled or erased at any time. In order to enable the time stamping of monitored traffic the clock

Practical Wireless, September 1987

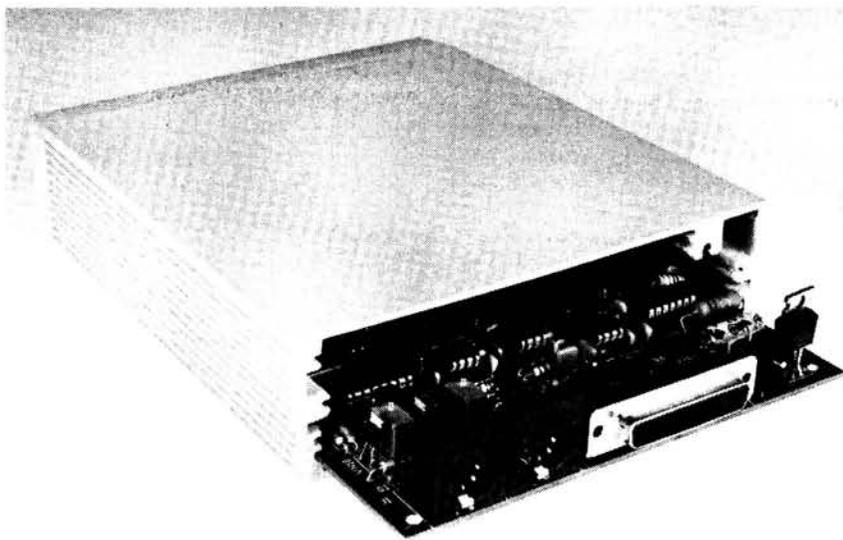

must, of course, be set. This is achieved by entering the year, month, hour and minute. The default display format is the American style of month first, but this can be changed to the UK convention of day first with a simple command. One minor criticism here is that the clock needs setting every time the TNC is powered-up as the battery back-up is only used to support the r.a.m.

Having decided the type of information to monitor you now have the ability to customise the way the information is presented by having the header and information frames on different lines.

The option to receive all frames including errors may seem a little pointless but it can prove useful as a tuning aid when operating conditions are poor.

The next few commands affect the way the TNC operates during a connection.

When a connection is initially made you can set the TNC to automatically send a message of up to 120 characters. If you are running the station unattended you can use this message to let others know you are unavailable and then subsequently force a disconnect. Under normal circumstances the retry counter is used to monitor the quality of the link and abandon the connection if the retry limit is exceeded. With the TNC-220 this counter can be disabled and the connection made permanent, which may prove useful under difficult conditions. The way in which the TNC switches from command mode to converse or transparent mode can also be adjusted to suit the particular application.

One of the really powerful features of the TNC-220 is multi-connect, which allows up to 10 simultaneous connections to be set-up. This can be compared to a small telephone switchboard with 10 lines where you could have up to 10 calls in either direction at any time. The most obvious use for such a facility is to run a multi-user mailbox, but manual use of two or

three connections is quite feasible. Some relatively simple terminal software should allow error free net operation. To select a different connection or stream a user defined character is typed followed by a letter representing the required stream, A-J. Incoming frames from every stream are displayed on the terminal with the stream letter as a prefix. If you want to examine the streams a simple command will give a display of the status of every stream. If it all gets too much you can disable the multi-connect facility entirely!

With equipment at this level of complexity it is important to be able to examine the settings of all the parameters and switches. Fortunately PacComm have provided extensive health monitoring facilities.

The "display" command shows the state of all user definable parameters including the text of any messages. As this information is rather long the list can be split into six groupings for ease of viewing. The six sections are:

- (1) Asynchronous port.
- (2) User defined characters.
- (3) Health counters.
- (4) I.D.
- (5) Monitor parameters.
- (6) Timing details.

The health section is particularly interesting as it contains sixteen counters which log the following events:

- (1) Loss of data from terminal to TNC.
- (2) Battery back-up failure.
- (3) Digipeated frames.
- (4) Loss of data from HDLC receiver.
- (5) Loss of data to HDLC transmitter.
- (6) Frame reject frames received.
- (7) I frames received.
- (8) REJECT frames received.
- (9) Addressed SABM frames received.
- (10) Error free frames received.
- (11) Errored frames received.
- (12) Frame reject frame transmitted.
- (13) I frame transmitted.
- (14) REJECT frame transmitted.
- (15) Good frame transmitted.
- (16) Discarded frames.

If you want to examine the workings

of the protocol you can activate the trace command which displays all frames, including headers, in full hexadecimal form.

Finally if you get in a mess with all the commands you can either type "reset" to return to the default values or "restart" to return to the battery back-up values.

That sums-up the command set, but don't be put off by the apparent complexity as all the variables have sensible default values which are stored in r.o.m. The majority of users will find that they will only have to change a small number of variables to suit their particular requirements.

Performance

The initial performance tests were made in the *PW* test lab. The power supply requirements were confirmed as 12-16 volts with the current consumption of the review model measuring 470mA at 13.2 volts.

Moving on to the radio ports, the modem tones were analysed for frequency accuracy and purity, the frequencies measured are shown here:

h.f. modem tones	2025Hz
	2225Hz
v.h.f. modem tones	1200Hz
	2200Hz

The analysis showed that the frequency accuracy was better than 0.1% and the noise and distortion better than -40dB. A very creditable performance.

The six-pole band-pass filter in the h.f. port was measured next and the result is shown in Fig. 1. The response shows a good steep slope on the l.f. side. The apparently poorer slope on the h.f. side is of little consequence as the i.f. filters in the transceiver will tidy this up.

For on-air testing the TNC-220 has been in use at the home QTH for some months with the following equipment:

h.f. Icom IC-720A transceiver
v.h.f. Icom IC-02E transceiver

The following computers have also

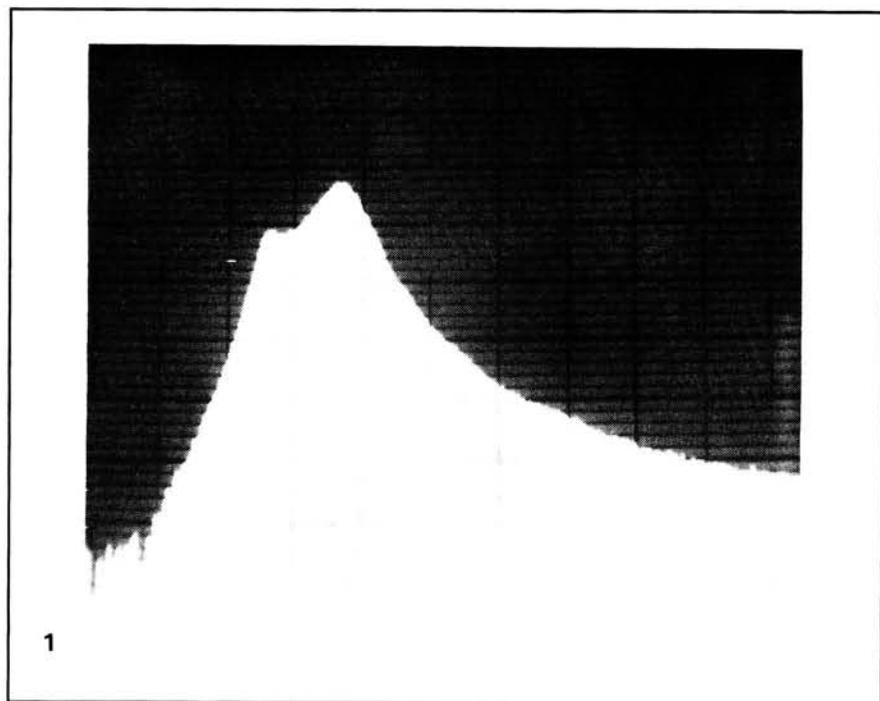

been used:

Commodore VIC-20.
Amstrad PCW-8512.
Acorn BBC-B.

The interfacing to both radio and computer proved to be very simple, thanks to the well written setting-up sections in the manual.

If you are using a VIC-20 or C-64 there is even a simple driver program in an appendix to the manual.

The very neat front panel i.e.d.s gave a very clear indication of the status of the packet link as shown here:

DCD, Data Carrier Detect, indicates reception of carrier frequencies. This i.e.d. also responds to noise so its use as a tuning indicator is a bit limited.

PTT, this lights when the p.t.t. line is in the transmit state.

STA, STATus, this is used to indicate that there is traffic outstanding.

CON, CONNecTion, this lights when a connection has been established.

PWR, power on indicator.

Whilst in use at the home QTH I think I used virtually all the facilities with no problems, including manual multi-connect! The very early units, the review model was one of the first, suffered a few minor software and hardware problems but these were quickly corrected by the importers. The software release of the review model was 1.1.4.C. The only apparent bug was that the default value for SOFTDCD was wrong.

Operation on h.f. produced some very good results, though with the narrow shifts and tight filtering, accurate tuning was essential. In order to ease the tuning problems I readjusted my Toni-Tuna to cope with the 200Hz shift. I understand from Siskin Electronics that Pac-Comm have produced a tuning indicator that fits inside the TNC cabinet and comes complete with a new front panel. Unfortunately at the time of writing it is still winging its way across the Atlantic! Perhaps a hot-air balloon would be quicker!

Summary

This very neat TNC has shown itself to be a very comprehensive and up-to-date unit featuring all the facilities required for modern packet operation. The design is such that any new developments can be easily incorporated in the form of a new software release in e.p.r.o.m. Pac-Comm have also managed to produce a very good manual which remains very readable despite its necessary technical content.

For the amateur who wants to add packet to his range of activities this must represent very good value for money.

The TNC-220 is available from Siskin Electronics, P.O. Box 32, Hythe, Southampton SO4 6WQ. Prices are £159 ready built or £139 in kit form. My thanks to Siskin Electronics for the supply of the review model.

Practical Wireless, September 1987

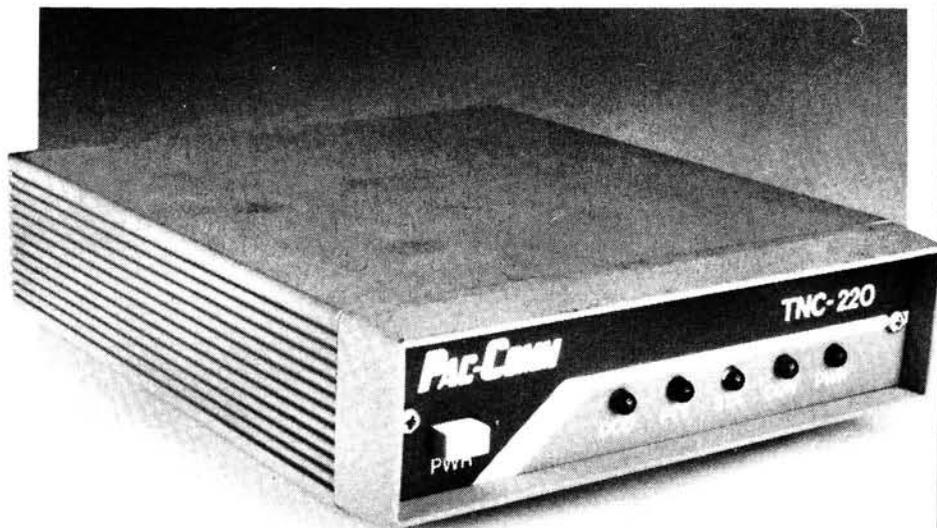

R. WITHERS COMMUNICATIONS LTD

Manufacturers, importers and suppliers of world famous communications products
 584 HAGLEY ROAD WEST, OLDBURY, WARLEY, BIRMINGHAM B68 0BS
 021-421 8201/2/3. VODAFONE 0836 514009. PRESTEL MBX 214218216 FAX 021-421 2468
 Amateur Radio. Business Radio. Radio Telephones. Sales. Service Accessories and antenna systems.



YAESU



**THE TECHNICALLY ORIENTATED
 RADIO COMMUNICATIONS
 SPECIALISTS.**

**100kHz TO 950MHz IN ONE BOX
 ALL MODES**

YAESU FRG9600/RWC MK3 HF-UHF SERIES

After many months of research and development RWC LTD are pleased to announce their latest HF modification for the Yaesu FRG9600 which now includes LF/HF/VHF/UHF coverage from 100kHz to 950MHz and improved 'S' Meter and a typical receiver *sensitivity now $>2\mu\text{V pD HF}$, $>1.5\mu\text{V}$ 60-950MHz all @ 12dB SINAD. (Please contact us for detailed specifications).

We have fitted a High performance HF Front-End made for us by AKD. The new HF section is fitted internally with switching circuits and a small toggle Switch on the rear apron to enable band change whereby the display changes to read actual frequency (100kHz-60MHz). The standard SO239 antenna connector has now been changed for an 'N' connector for coverage from 60-950MHz and an SO239 connector fitted for HF coverage 100kHz-60MHz. (UHF extended coverage is now standard as per our original MK2 modification up to 950MHz).

As an 'N' connector is now fitted to all RWC FRG9600s for VHF-UHF coverage it is possible to use a wide-band discone antenna such as the ICOM AH7000 which is supplied with low-loss coaxial cable and 'N' connectors. A dipole or long-wire antenna can be used for HF coverage with very good results. **This facilitates use of two antennas for all bands.**

All modifications are Fully Guaranteed for twelve months from date of purchase/ modification providing our modifications seals are unbroken. See the reviews or s.a.e. for a copy!

© RWC LTD 1987

* We reserve the right to change specifications due to continuous development and modification of this product.



YAESU FRG9600/RWC MK3

AM-FM (WIDE & NARROW) LSB, USB. 100kHz-950MHz
 BROADCAST MONITOR AND SCANNING RECEIVER



No other radio is available with these features and facilities at this price! Check it out!

FRG9600 MK2 Model 60-950MHz 'N' connector @ £499.00 + 5.00 carriage. (Modified unit only).

FRG9600 MK3 Model 100kHz-950MHz 'N' connector and SO239 for HF @ £599.00 + £5.00 carriage. (Modified unit only).

RWC Exclusive Base Station Complete HF-UHF Package FRG9600 MK3 Model, Icom AH7000 ant, G5RV HF multiband, PA4C ac-13V dc adaptor, inclusive carriage UK £699.00.

Overseas dealers please note we will soon be offering conversion modules. Apply now for a franchise in your country.

**Tel: 021 421 8201 (24hr answerphone)
 Telex: 337676 TELEX-G**



AH-7000

SUPER WIDEBAND
 OMNIDIRECTIONAL ANTENNA

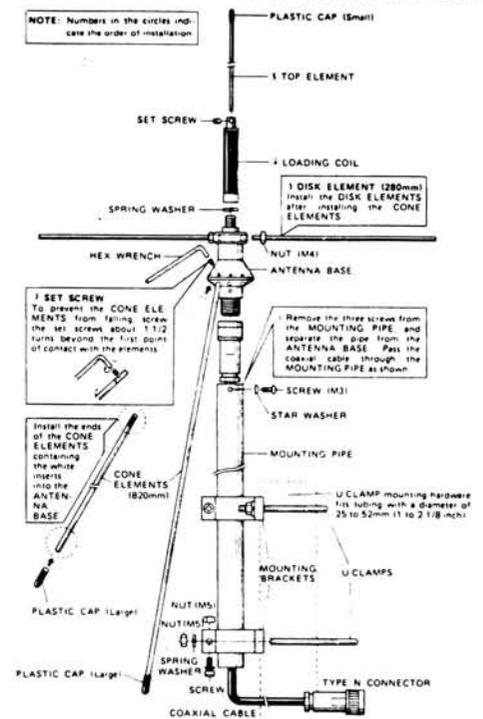

SPECIFICATIONS

Frequency coverage	Receive: 25 to 13000MHz Transmit: 50, 144, 430, 900, 1200MHz bands
Input power rating	200 watts
Input impedance	50 ohms
Supplied connectors	Type N
Supplied coaxial cable	5D-2V (50 ohm)
Type of antenna	Discone
Length	1.7 meters
Weight	1kg

Icom AH7000 @ £82.50 (inc free carriage UK mainland).

YAESU/RWC FRG9600 Options

PA4C ac adaptor £16.50 inc post.

FIF232C RS232 computer interface @ £75.00 inc post.

Raycom GP900 900-950MHz 3dB, base station ant @ £22.00 inc post.

AM-FM wide & narrow IF filters POA.

RWC 9600 MK2 owners HF mod @ £99.00 inc carriage (send unit).

FRG9600 existing owners HF & UHF mod - 100kHz-950MHz. Send unit carriage paid @ £129.00. (UK owners only.)

YAESU FRG9600 Service Manual (inc Cat Prog) @ £12.50 inc post.

Raycom VHF-UHF Discone 60-600MHz SO239 connector @ £27.50 inc carriage.

RWC Modified Video Unit. 6.00MHz IF video (modified from NTSC) @ £27.50 inc post.

Please call or telephone for other available options.

ASK FOR COLOUR BROCHURE & SPECIFICATIONS.



CT2—Mobile Telephones for the Man in the Street

Some time ago, an article in PW described the Vodafone and Cellnet systems, just prior to their introduction. Chas E. Miller looks at another system in the pipeline

Since the introduction of cellular radio, the coverage of the two networks has proceeded apace. Vodafone for one has just been able to announce that it now covers 90 per cent of the UK population, two and a half years early on the scheduled date (as specified in its operating licence). However, the cost of hiring or owning the equipment, and of the calls themselves, is still high enough to make mobile telephones largely the province of business, etc., users who can justify the cost. The Department of Trade and Industry (DTI) hopes that the CT2 system may extend mobile telephone facilities to (literally!) the man in the street.

In crude terms CT2 works on the principle of the now familiar private "cordless" telephones. These have a mains-powered base station transmitter-receiver which is connected to the telephone line and use a battery-powered mobile handset. Likewise, CT2 will have base stations linked to the British Telecom telephone network and located in places frequented by the public, such as railway stations, airports, large stores and so on. These will work in conjunction with small handsets carried by subscribers.

The Idea

The idea is that a subscriber, wishing to make a telephone call whilst out, will simply position himself within range of one of the base stations (which will probably be called "Phonepoints" or "Tele Points" and which will be installed by both BT and private contractors) and use the handset just like an ordinary cordless telephone. The range of each base station is expected to be about 100m, and in time there should be sufficient of them to give good coverage of all large centres of population.

The handsets for CT2 will be about the size of a pocket calculator and will operate on frequencies between 864 and 868MHz, in which band 40 channels of 100kHz width can be allocated.

Domestic cordless telephones use two communications channels, one for receiving and one for transmitting, but CT2 sets need only one channel. They will employ digital encoding of the speech signals in both directions with a continuous rapid switching of each to the single r.f. frequency. The switching rate is so rapid that it is impossible for the user to detect any difference from the conventional two-way operation. Decoders in both handsets and base stations translate the digital signals back into normal audio frequencies.

Cost and Limitations

The power output of the base stations is limited by the DTI to only 10mW. This restricts the range of each and makes it possible for a large number to be installed throughout a large town, for example, without danger of mutual interference. This, plus the ability of each of the 40 operating channels to carry a two-way conversation makes it feasible to predict that the CT2 system will be able to cater for 5000+ subscribers per square mile.

Each handset will have a unique serial number embedded in its electronic system which positively identifies it and makes sure that call charges are correctly allocated to the user via his normal telephone account. It will also be possible for an owner to enter his own personal identification which will prevent unauthorised calls being made without his knowledge.

Unfortunately, at present, the exact costs of using CT2 have not been quoted, which does hamper making a complete analysis of its likely appeal. But, certain pros and cons are well in evidence. Given the widespread dissatisfaction with public call-boxes (e.g., finding one that works, and feeding the thing with coins) the ability to have all the advantages of a domestic telephone in one's pocket is bound to have great appeal to people needing to make frequent calls. There are, however, some potentially serious drawbacks.

Perhaps the most serious is that the CT2 handset cannot receive calls, so the business man on the move would still need to resort to "ringing in" at intervals to keep in touch. This deficiency could partially be offset if the handsets were to be equipped with a paging device with a read-out facility able to display a short message, as an extension of the present radio paging service already used on a nationwide basis. Then, of course, the question of range must be considered. The subscriber moving about on foot in urban districts well served by base stations ought to be able to make calls freely and to respond quickly to paging, but it will be less easy for a motorist. Driving to within range of a base station might well necessitate negotiating heavy town traffic and finding a suitable parking place, with the all too well known problems that this involves. Having base stations at motorway service areas would help somewhat in this respect, but it would appear that CT2 has little to offer business men and the like who operate in mainly rural areas. Nevertheless, within its limits, the system is potentially of great value to subscribers who, at present, need to make frequent use of urban call boxes, and provided that costs can be kept low enough to make it competitive, its future is promising.

Little Publicity

A number of firms and concerns have been working on CT2 equipment for some time, including BT itself and Shaye Communications, a new firm that has its origins in Sir Clive Sinclair's previous organisation, whilst Mullard has been engaged on reproducing a special series of i.c.s for the sets. To date there has been little publicity of progress in order, it is said, to keep possible Far East rivals in the dark.

We hope to bring you further details of the technical aspects of the CT2 system in a future article.

PW

Practical Wireless, September 1987

NOW YOU SHOULD PANIC!

The cover price of *Practical Wireless* went up to **£1.20** this month, but there's still time to buy a subscription at the old rate if you're quick.

Subscribe now, to make sure of the next 12 issues of your favourite magazine **AND** save money too.

UK addresses — Now: £13.00
 After August: £14.00
 Overseas — Now: £15.00
 After November: £18.50*

* Copies to Overseas addresses will in future be sent by Accelerated Surface Post, to give much earlier delivery without the high cost of an Airmail service.

MORE SAVINGS!

Our UK readers can save a few pennies more by using our new FREEPOST address (no stamp required) . . .

**PW PUBLISHING LTD. FREEPOST, SUBSCRIPTIONS DEPT.,
 ENEFCO HOUSE, THE QUAY, POOLE, DORSET BH15 1PP.**

TAKE ADVANTAGE OF THIS GREAT SUBSCRIPTION OFFER

Wherever you live, a Postal Subscription will ensure that you receive your copies of PRACTICAL WIRELESS and/or SHORT WAVE MAGAZINE regularly, through your own letterbox, before it gets onto your newsagent's shelf. Order a Joint Subscription and you will qualify for the Special Discount.

Fill in the Order Form below and post it to: PW Publishing Ltd., FREEPOST, Subscriptions Dept., Enefco House, The Quay, Poole, Dorset BH15 1PP (no stamp required). Credit Card Orders taken on (0202) 678558.



Please indicate the type of subscription required:

Special Joint Subscription



- £13.00 (UK)
 - £15.00 (Overseas)
 - £17.00 (UK)
 - £17.00 (Overseas)
- (Prices correct at May 1987)

- £27.00
- £27.00

To: PW Publishing Ltd., FREEPOST, Subscriptions Dept., Enefco House, The Quay, Poole, Dorset BH15 1PP (no stamp required).

Name

Address

I enclose cheque/PO (Payable to PW Publishing Ltd) £

Charge to my Access/Visa Card the amount of £

Card No.

Valid from to

Signature

Kangaroos and Kiwis via Satellite Mode K

Are Australia and New Zealand likely to be in range of the UK, via the new RADIO-SPORT-10/11 Mode K satellite? John Branegan GM4IHH is optimistic!

For 20 years now the Mode A OSCARs and RADIOSPORTs have given coverage out to the 6000km limit set by line-of-sight for their 145MHz uplinks; and O-10 was able to reach Australia from its very high orbit. But despite many attempts, no UK to New Zealand contacts have been reported.

RS-10/11, launched on June 23 this year, could change that: its Mode K 21MHz uplink and 29MHz downlink might allow us to extend normal line-of-sight coverage to worldwide coverage, via ionospheric propagation. One way this might be possible is shown in Fig. 1. It displays a great circle map of the Southern hemisphere centred on the UK antipodeal point (that's the point you would come out at if you dug a hole straight down from the UK). This distant antipodeal point is important because right from the very first SPUTNIK flights it was noticed that satellites over this spot could be copied in the UK, even when no Australian or New Zealand signals could be heard.

How these signals might get to the UK via ionospheric propagation is shown in Fig. 2. It also indicates the clear advantage the satellite has over the ground stations beneath it.

500km a satellite over Australia can often "see" the underside of the ionosphere over Java—nearly a third of the way back to UK.

To check out the present situation I decided to do some tests, listening for Salyut/Cosmos 1686 on 19.955MHz (near Mode K up) and RS-7 on 29.502MHz (near Mode K down). The 8 tracks, south of Australia and New Zealand, where Salyut/Cosmos was heard 7 times and RS-7 heard once in the period July to November 1986, right at the bottom of the solar cycle can be seen in Fig. 1.

Frankly, I thought this was a fluke; but test predictions using a powerful new prediction algorithm called FRED (Frequency Duct Plotting) suggest it is not. Even at relatively low sunspot numbers, propagation from satellites in this "antipodeal groove" south of Australia is possible at 19.955MHz. This FRED plot is shown in Fig. 3; the top half is a map of the bird's-eye view from a signal travelling great circle to the UK from a spot south of New Zealand near the antipodes. This track is divided into 20 equal steps, and at each step the computer calculates the predicted Maximum Usable Frequency

(m.u.f.) and the Lowest Usable Frequency (l.u.f.) for propagation at that point. Treating these readings as the "walls" of a duct, it is clear there are enough high m.u.f. spots to get the signal to UK, provided the m.u.f. in the first "box" is low enough to allow the signal to penetrate downwards. If it can penetrate, it can then go the full width of the second, bigger, box before it needs to be propagated by the ionosphere.

Clearly we can get a 21MHz signal from, and probably to, the satellite—but can we in the UK hear the 29MHz downlink propagated from it? Probably not at solar minimum. But from now on we are coming out of the minimum, and by late '87 or early '88 propagation at 29MHz should at times be possible.

Would-be antipodeal DXers should therefore keep a careful watch on G3IOR's column in this magazine. Pat will undoubtedly be giving full up-to-date uplink and downlink frequencies and orbit details now the satellite is orbiting. Then by listening to the 29MHz downlink for unmistakable antipodean English, everyone will be able to join in the fun.

Antipodean readers will, I hope, alert their radio amateur and s.w.l. communities to these possibilities. They should also note that in addition to this route to UK and Europe generally (probably around 1100 to 1300 UTC), there may well be a reciprocal event with satellite Mode K overhead UK being propagated to VK and ZL around 0500 UTC—though the FRED predictions suggest that this second event may be limited by high ionospheric absorption.

Anyway, GM4IHH will be looking for you both ways! Till then, "G'day to ya, cobber". **PW**

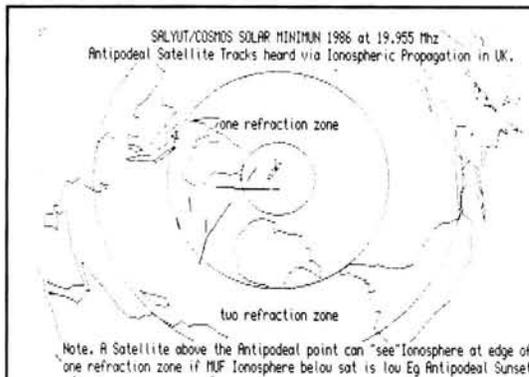

◀ Fig. 1: A great circle map of the Southern hemisphere centred on the UK antipodeal point showing the antipodeal satellite tracks heard via ionospheric propagation during the bottom of the last solar cycle

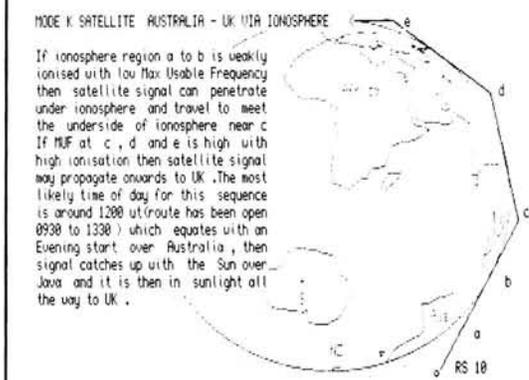

◀ Fig. 2: How the signals might reach the UK, showing the advantage the satellite has over ground stations beneath it

▶ Fig. 3: The Frequency Duct Plot showing a bird's-eye view from a signal travelling great circle to the UK

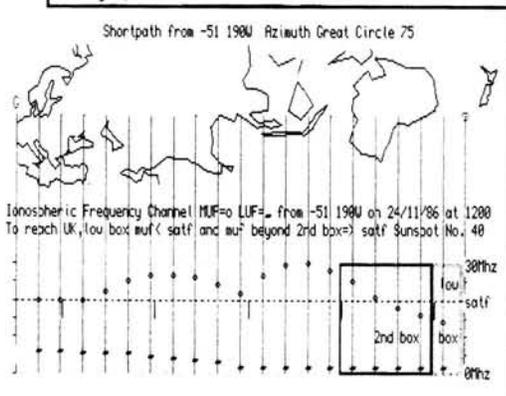

YOUR ONE STOP LISTENER SERVICE!

HUGE STOCKS — BEST PRICES — GOOD BACKUP — FREE SECURICOR*

*AVAILABLE ON MOST MAIN ITEMS

**WE STOCK MOST PRODUCTS
ADVERTISED IN THIS MAGAZINE**

"NOW FREE CREDIT TO CALLERS!"

SONY ICF7600D PORTABLE COMMUNICATIONS!

Not a toy, but a serious communications receiver. 150KHz-30MHz AM/SSB plus FM 76-108MHz. Digital readout, memories, clock and provision for external antenna. Listen to the DX at work! Mains or battery.

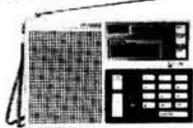

£169 FREE SECURICOR

SONY ICF2001D RECEIVER SUPER PORTABLE + BASE HF + AIR BAND COVERAGE

Described as "the best portable on the market" by a reviewer, it covers 150KHz-30MHz plus FM air band. Memories scanning, etc., at a bargain price. External aerial socket and a host of other features. 230V AC or battery.



£329 FREE SECURICOR

NEW SONY PRO-80 RECEIVER

AM/FM/SSB 115kHz-223MHz

A major innovation in monitor receivers. Just think a complete short-wave and vhf monitoring system in your pocket! Memories, scanning etc. Order today.



£329.00 CARRIAGE FREE

TR10 R5000 JUST ARRIVED! TOP SPECIFICATION RECEIVER

The newest and best receiver so far from Trio. A high specification covering 100KHz-30MHz AM/FM/SSB/CW. Comprehensive facilities include memories and scanning, etc. Send today for full specification. PX welcome!



£895 FREE SECURICOR

R537S AIR-BAND MONITOR

118-136MHz
This well known receiver is ideal for air-band monitoring. Pocket size and battery powered with whip antenna. Highly sensitive and used by many professionals.



£69.00 CARRIAGE £2.00

ICOM R7000 VHF/UHF MONITOR COMPLETE COVERAGE TO 2GHz

The best VHF/UHF monitor on the market! 26-2000MHz and highly sensitive. It's not cheap but it really is a superb monitor for the serious user. Every possible facility you will ever need!



£939 FREE SECURICOR

ALINCO MINI 2M FM ALR22E 25 WATTS Direct Factory Price £269.00!

Here's your chance to purchase a brand new rig



at a price that cannot be beaten... This rig has all the latest features such as scanning, memories, priority, tone-burst, repeater shifts, dual vfo's and much more. Price includes up/down microphone and mobile quick release bracket. Measures only 5.5" x 1.5" x 6.5" and that's small!

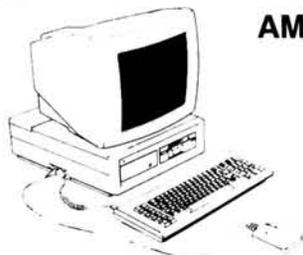

AMSTRAD COMPUTERS IN STOCK Part Exchange Ham Gear Welcome!

We can now supply the complete range of AMSTRAD computers from stock plus accessories and software. So now you can buy your computer equipment from your reliable ham radio store. We are approved stockists and can offer on site service contracts if required. You can also save £'s by part exchanging your ham gear. Prices below INCLUDE VAT and Securicor to your door.

PC8526	Single disc Word Processor	£425 00
PC8512	Dual disc Word Processor	£573 00
PC1512DM	Dual drive PC mono	£640 00
PC1512DC	Dual drive PC colour	£835 00
PC1512HDM	20Mb PC mono	£1030 00
PC1512HDC	20Mb PC colour	£1219 00
DMP3	Printer	£195 00
DMP4	Printer	£395 00
CPS8256	Printer	£62 95
Wordstar 1512	Supercalc 2 PCW	£49 00
Supercalc 1512	Locospell PCW	£39 00
Reflex 1512	LocoMail PCW	£39 00
Sidekick 1512	Ability 1512	£89 00
Sage Bookkeeper PC	Sage Accountant PC	£139 00
Sage Accountant +	PC Promise	£65 00
Gemdraw	Flight Simulator	£44 00

STOP PRESS New PC1640

DD model £899 + vat

20MB model £1199 + vat

THE UK'S BEST FREQUENCY GUIDES

COMPLETE VHF/UHF FREQUENCY GUIDE 26-2250MHz

£4.95 + 80p p&p

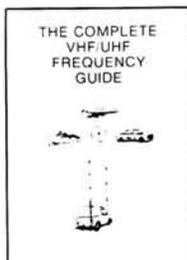

This guide has sold over 4,000 copies since its publication last August and is still selling well. Mainly because it is recognised as being of tremendous value and unique in radio literature. If you are one of the many who are curious to know who transmits where, in the wide VHF/UHF spectrum, then this is a guide that you should not be without. This book gives comprehensive details of all the main users of this part of the radio spectrum. The frequency range is subdivided into sections under appropriate headings for the type of services using the particular sub-divisions. All kinds of service are covered including land, sea, air and space. Full details are included of duplex splits for bases and mobiles plus some useful editorial. If you are at all interested in this part of the radio spectrum, you will find this a most valuable and absorbing book.

UK LISTENERS CONFIDENTIAL FREQUENCY LIST 1.6-30MHz

£5.95 + 80p p&p



NEW FOURTH EDITION

1978 EDITION This famous listing is now in its fourth edition. Completely updated for 1987 and a lot thicker. Yet the price is the same as the 1986 edition! Many additional frequencies have been added and of course some have been deleted where the service is known to no longer exist. Packed full of information on all that happens between 1.6 and 30MHz, you will find this fascinating reading. Covering all aspects of the shortwave service, here is just a selection of the listings included: AVIATION, BROADCAST, MARINE, EMBASSY, MILITARY, RTTY, FAX, PRESS, and much more. Not only frequencies and stations, but in many cases times of transmissions as well. This is not an American import, but a UK printed manual specially for UK listeners. If you are one of the few people that haven't purchased one of these yet, then you really don't know what you have been missing. If on the other hand you have our previous editions, we know that you will want to get the latest edition. Available end of March. Order your copy today.

VHF/UHF AIRBAND FREQUENCY GUIDE + FREE UPDATE SERVICE

£5.95 + 80p p&p

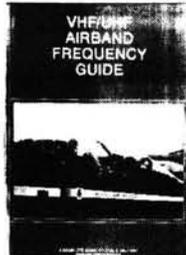

Just published, this is the UK's foremost list of military and civil radio frequencies. Nearly three times as large as the 1986 edition and bang up-to-date. Every conceivable airfield is listed from the smallest grass field to the largest of our international airports. We have now included full airways listings plus helipads and off-shore rigs. In addition, there are listings of company frequencies, VOLMETS and miscellaneous air-to-air frequencies. Don't confuse this with other guides you may have seen. This one is REALLY comprehensive and packed with information. For the newcomer there is some interesting editorial plus photographs, and a very useful telephony designation list. Full colour semi-stiff covered in large format style makes this one of the best presented guides yet. Undoubtedly the best manual there is available to the enthusiast today. There is also a free up-date service to purchasers so you won't need to worry about the information becoming out of date. That's real service!

Better Short Wave Reception
Oceanic HF Airband Frequency Guide
World Radio HF Teletype Frequency List
World Radio & TV Handbook (1987)

£6.00 + £1.00 p&p
£2.95 + £0.60 p&p
£3.95 + £0.60 p&p
£17.95 + £1.75 p&p

Air Traffic Control by David Adair £6.99 + £1.00 p&p
Air Traffic Control by Ian Allan £3.50 + £0.70 p&p
Air Band Radio Handbook £4.99 + £1.00 p&p
Scanners: A VHF/UHF Listeners Guide £7.95 + £1.00 p&p

WATERS & STANTON

RETAIL & MAIL ORDER:- 18-20, Main Road, Hockley, Essex SS5 4QS.
Tel: (0702) 206835, 204965
RETAIL ONLY:- 12, North Street, Hornchurch, Essex RM11 1QX.
Tel: (04024) 44765
Visa and Access by telephone. 24hr. Answerphone.

Friedrichshafen 87



Just mention the fair at "Friedrichshafen" to any amateur radio operator in the German-speaking parts of Europe, and he or she knows exactly what you mean. Yet you see little mention of it outside Germany, Austria and Switzerland. In fact, the annual ham radio fair in June on the shores of Lake Constance, or the "Bodensee" to the locals, attracts some 10 000 visitors, and it is the largest in Western Europe. Peter Laughton paid a visit on behalf of PW.

The current exhibition and ham radio seminar has grown out of co-operation between the German, Austrian and Swiss national amateur radio societies who couldn't afford to mount their own individual conventions. Each year the meeting has grown, up to its present size, covering three large exhibition halls, plus an outside area for antenna demonstrations. The fact that the meeting is heavily supported by the equipment manufacturers, some of whom have their European headquarters in West Germany, means that there's plenty of new equipment exhibited for the first time.

Smaller With More Power

In the h.f. transceiver field there were three new introductions. Yaesu displayed their new FT-757GX-II and flew in the design technician who put it together. Capable of 100W p.e.p. with

s.s.b., c.w. and f.m. the unit is designed to fit in the car, or is equally suited to field-day and base operations. The size and styling reminds one of the mini hi-fi sets, being just 238 × 238 × 93mm. Although based on the older FT-757GX model, Yaesu have incorporated a number of additional features. The 10 memories now store the mode of transmission/reception as well as the frequency, a notch filter is offered as a standard, and there's more flexibility with the dual v.f.o.s. They've managed to retain the continuous coverage receiver and added the facility for the AMTOR mode. Despite its size, the show unit managed to run remarkably cool under the rather demanding demonstration conditions.

For a few hours only, Yaesu also showed the press a simplified and cheaper version of the FT-757GX-II, due for release later in the year. The FT-747GX transceiver is the same size, but much lighter. It doesn't offer

all the same options, such as AMTOR, but on the other hand an optional v.h.f./u.h.f. converter can be installed. The new FT-747GX remains in the h.f. transceiver class though—the v.h.f./u.h.f. converter is for reception only.

From the Top Down

Kenwood didn't have any news on the h.f. front this time, but report that they're pleased with sales of their current models TS-940S and the smaller TS-440S. Japan Radio Corporation, on the other hand, presented their new JST-125D. JRC make most of their h.f. sales in the maritime field, so their amateur radio products are designed from the top down, with specifications rather than price in mind. The new JST-125D is no exception, combining simplicity and performance . . . for a price. A highly stable synthesiser allows resolution to 10Hz, and the microprocessor allows you to use the two v.f.o.s in different modes if desired. Power is continuously variable between 10 and 100W, and 72 memories are offered in a rugged package that weighs in at 10kg.

Icom has followed up on its successful series IC-735 and IC-751A by launching the IC-761 at Friedrichshafen. The manufacturer's specification sheet points to a high frequency stability and excellent dynamic range. The antenna tuner is controlled automatically, whilst the built-in power supply is big enough to allow continuous operation at 100 watts. The new IC-761 was certainly one of the easiest sets to operate at the show, and the memories make for versatile operation once you get the hang of them. Once again, the receiver section is continuous coverage.

VHF and Beyond

Judging from the hand-held portables in use at the exhibition, mobility is an important point. Icom scored a number of points with their recently announced IC-900E system. A small compact base unit makes up the first section, after which you can add up to 5 separate units. This allows you to operate on 28, 50, 144, 430 and 1296MHz when fully installed, or just select the bands of interest. The operation of the unit is identical regardless of the band, and output power varies between 10 and 45W.

Kenwood and Yaesu were also busy promoting their mobile equipment. Kenwood's latest hand-held portables, the TH-205 for 144MHz and TH-405 for 430MHz deliver no less than up to 5 watts.

Practical Wireless, September 1987

Encouraging Growth

There are currently just over 53 000 amateur radio operators in West Germany, of which about 80 per cent belong to the German Amateur Radio Club, DARC. Part of the success of holding the ham radio fair in a vacation area is that visitors can combine the visit with a family holiday. The weather this year was unusually unkind, yet I spoke to many people who'd left the not-so radio orientated members of the family elsewhere, while they spent a day looking round the exhibition. In contrast to some other West German trade fairs, the foreigner without the local language ability isn't left to fend for him or herself. The international character of ham radio ensures that those behind the stands can at least command a fair knowledge of English, and were clearly pleased that there was interest from abroad. Indeed, some of the Japanese representatives could only speak English.

The number of newly licensed amateur radio operators is still growing at the rate of a few per cent a year in West Germany. The DARC have just launched a campaign in youth-orientated magazines to recruit new members, as well as persuading local authorities that high-tech interests also lead to people with high-tech qualification. The quality of the commercial stands in Friedrichshafen would match any trade show, though in comparison with other ham shows in Europe, Friedrichshafen is expensive. Much of the equipment being sold represents a great deal of investment by the purchaser, however, but the West Germans take the view that people will be more likely to buy something big from an importer with a good display and service guarantee, than someone in the corner selling things from plastic bags. The exception is the flea market, of course. This year there was quite a lot of vintage radio equipment about, though rather expensive. And it's amazing to see how much money was invested in early computing equipment which is now obsolete and, because of the lack of software, rendered useless!

For the first time, radio societies from abroad were invited to set up a stand. Oman, Austria, Switzerland, and the UK accepted the invitation. RSGB's David Evans and his team did a commendable job in waving the British flag, and also ensured that the stand was manned by someone who spoke German. Language ability is quite often forgotten by companies exhibiting overseas.

Practical Wireless, September 1987



A magnetic loop

Two British companies, Siskin Electronics and Capco Electronics, decided to split the costs and share a commercial stand. At the end of the 3-day fair they reported their visit to have been thoroughly worthwhile, and had opened new markets in Germany for their respective products. Siskin specialise in packet radio software and hardware. Capco demonstrated their precision range of a.t.u.s, a clear example that British craftsmanship is still alive and well. All it needs is publicity.

On the receiving side, Lowe's HF-125 communications receiver was on show, though sadly tucked away behind glass. This is certainly a "hands-on" receiver to appreciate its simplicity. Sony launched their new PRO-80 hand-held portable receiver. This covers 150kHz to 108MHz continuously with modes s.s.b., a.m. Wide, a.m. Narrow, f.m. and n.b.f.m. By fitting a separate battery-operated converter on top of the antenna socket, the coverage extends further to 220MHz. A switch inside the PRO-80 allows you to compensate for the frequency shift by the converter. The correct frequency is therefore displayed on the l.c.d. digital readout. One West German company has specialised in making converters for the Icom IC-R7000 and Yaesu FRG-9600 receivers. The units fit in the antenna socket, and extend the coverage of these scanner receivers down to 150kHz. The cost is in the region of £110. If money really is no object, then you could try building a receiver using the component units manufactured by Karl Braun. This

company is really into perfection at a price . . . you need about £3000 for a basic receiver.

Antennas

Putting up the right antenna, and still keeping the neighbours happy, was clearly a topic of conversation at this year's Ham-Radio exhibition. Several companies will happily sell you solutions. For £200 the Muehlau company was offering a collapsible omni-directional cage which seemed quite compact.

Out in the antenna display area, the Kaerlein company of Darmstadt put up their series of magnetic loop antennas. These work using the magnetic as opposed to the electric component of the electromagnetic wave. The principle is very old, and is currently widely used in military circles. It hasn't been very successful in amateur radio due to difficulty of tuning the loop accurately, and the cost. A 250W loop covering 7-25MHz continuously, and measuring 800mm in diameter, costs some £300. The main advantage is that such a loop does not have to be placed high above the ground. Excellent results were demonstrated using the loop on a stand just 1 metre above the floor. Indeed, putting it up higher gives very little improvement. Because it's such a selective tuned circuit, Kaerlein have designed an automatic tuning unit. A few seconds of carrier from the transmitter is enough for the unit to tune the loop to resonance within about 5 seconds, with a near perfect s.w.r. Depending on the mounting, the magnetic loop can either be made to work directionally or omni-directionally. The antenna has its price, though—around £260.

Construction is Back

Judging by the rows of component stands, making equipment one's self is enjoying a come-back in Germany. The emphasis is clearly on interface units with computers, filters, FAX, AMTOR and packet radio. There were plenty of stands with amateur software, too. One of the most ambitious "home-brew" projects is clearly the AMSAT Phase 3-D. The West German AMSAT group is working to a deadline of 1991 to provide the amateur radio world with a satellite offering five times as much communication capacity as existing OSCARS. But they need about 5 million DM to reach their goal, and that means an extensive fund-raising campaign in the communications industry to get sponsorship.

Ham Radio 88 will be held in Friedrichshafen June 17-19.

PW

The PW "Blenheim" v.h.f. Converter

Following hot on the heels of the popular PW "Woodstock" converter, Bryan Roberts G4POL has decided to reverse the process by designing a converter that will give you v.h.f. coverage on a short wave receiver.

This converter when used ahead of a short wave receiver is capable of receiving signals in the 118 to 144MHz v.h.f. spectrum. This portion of the band contains the commercial aircraft frequencies from 118 to 136MHz, weather satellites in the 137 to 139MHz band and lastly the 144MHz amateur band.

Circuit Description

The block diagram of the converter, the heart of which is the SBL1 double balanced mixer, is shown in Fig 1. This little device when correctly matched gives good isolation between the input and output ports and is capable of handling signals from d.c. to 500MHz. The circuit diagram of the converter is shown in Fig. 2, signals from the antenna appear at the input of a seven-element Chebyshev high-pass filter. This filter rejects all signals below 116MHz, and at the intermediate frequencies of between 2 and 30MHz the rejection is greater than 50dB. The signal is then fed to a broad-band amplifier which gives a gain of approximately 16dB over the entire 118 to

146MHz band. The signal is then fed directly into the mixer port.

The output from the mixer is fed via C20 to SK2, from here the converter's output may be fed to any suitable general coverage short wave receiver. The SBL1 mixer is a passive unit and has a conversion loss of 6dB, subtracting this from the 16dB gain of the pre-amplifier gives an overall stage gain of 10dB. This is sufficient to provide

signals at a good strength throughout the band providing that a reasonable antenna is used ahead of the converter.

Construction

The component layout and double-sided track patterns of the p.c.b. are shown in Fig. 3. The board is made from copper-clad glass fibre material. The upper surface is used as a ground

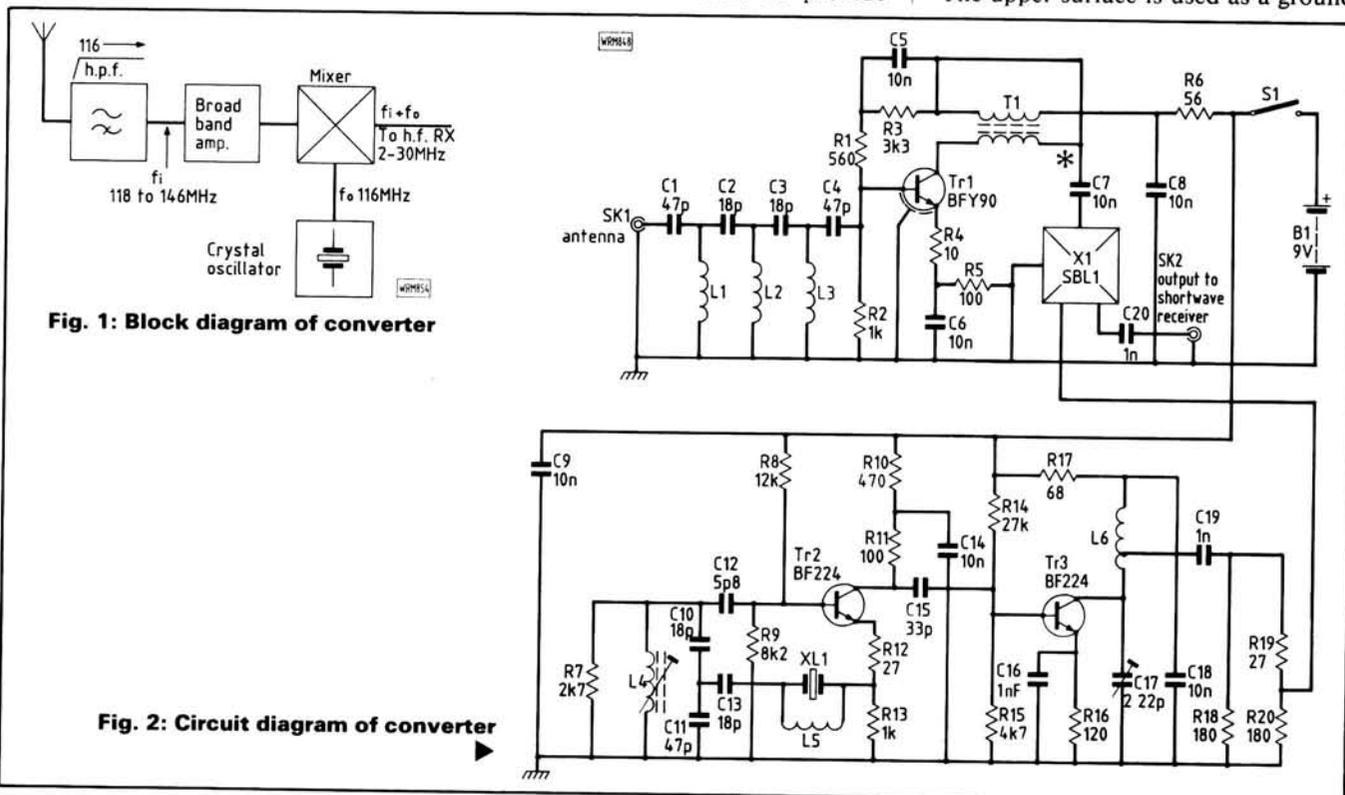
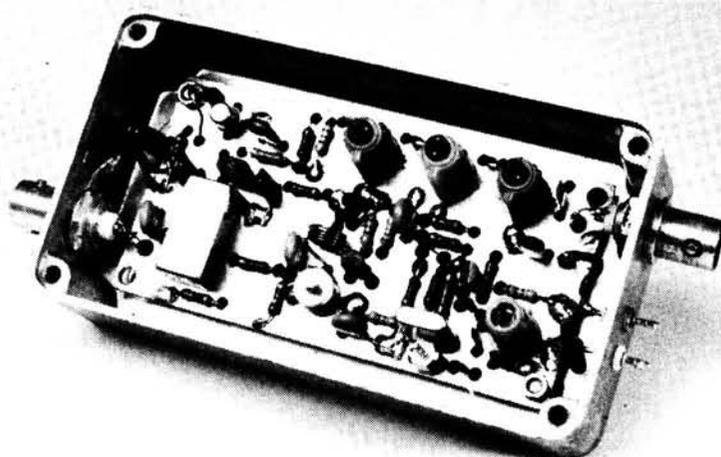

Fig. 1: Block diagram of converter

Fig. 2: Circuit diagram of converter

plane. All holes, other than the two used for earthing the mixer X1, should be cleared to prevent a short circuit when components are mounted on the board. This may be done with a suitable drill bit. When the p.c.b. has been prepared, first solder in all the resistors, followed by the capacitors. Note, all connections (except those of X1) to earth are made on the upper earth plane surface of the p.c.b., rather than by passing the lead through a hole in the board. Care should be taken to bend the "earthy" leads of ceramic plate capacitors outwards using fin-nosed pliers, to avoid damaging the fragile body of the component. Next install the crystal and coils, the construction of the 4:1 balun T1 will be described further on.

Once the p.c.b. is fully populated check for any solder bridges or dry joints. Finally the board can be mounted in a screened enclosure that is fitted with suitable coaxial terminations. If an internal battery is fitted, a switch in the supply rail should be included.

Balun

Take two 152mm lengths of 32 s.w.g. enamelled copper wire, twist them together at about 3mm pitch (8 turns to the inch). Wind this twisted wire through the balun core twice, then identify the ends of each wire using a meter. Connect the start of one winding to the finish of the other to complete the transformer construction.

Alignment

Once the converter is installed in its enclosure the alignment procedure is relatively simple. First, using the correct trimming tool, set the cores of L1, 2 and 3 so that they all protrude 2mm above the top of their formers. Next set the core of L4 to 2mm just below the top of its former. Finally set C17 to its half-meshed position. Note, if a plastics trimming tool is not used the cores may easily be broken and accurate frequency setting of the crystal oscillator will be impossible due to the detuning effect on the coil. Once the alignment procedure has been completed, connect a receiver to SK2 of the converter and suitable antenna to SK1. Note, all r.f. connection to and from the converter should be made with coaxial connectors and cable.

Set the short wave receiver to a known frequency in the v.h.f. band, e.g. a 144MHz beacon or repeater output frequency. If you are unsure exactly where you are in the v.h.f. band with regards to the tuning scale on your receiver, refer to the frequency conversion chart in Fig. 4. Once a signal has been found set L4 to tune the correct frequency of the oscillator, and adjust C17 for maximum S-meter reading. This completes the alignment procedure.

For those who have access to a frequency counter, the crystal frequen-

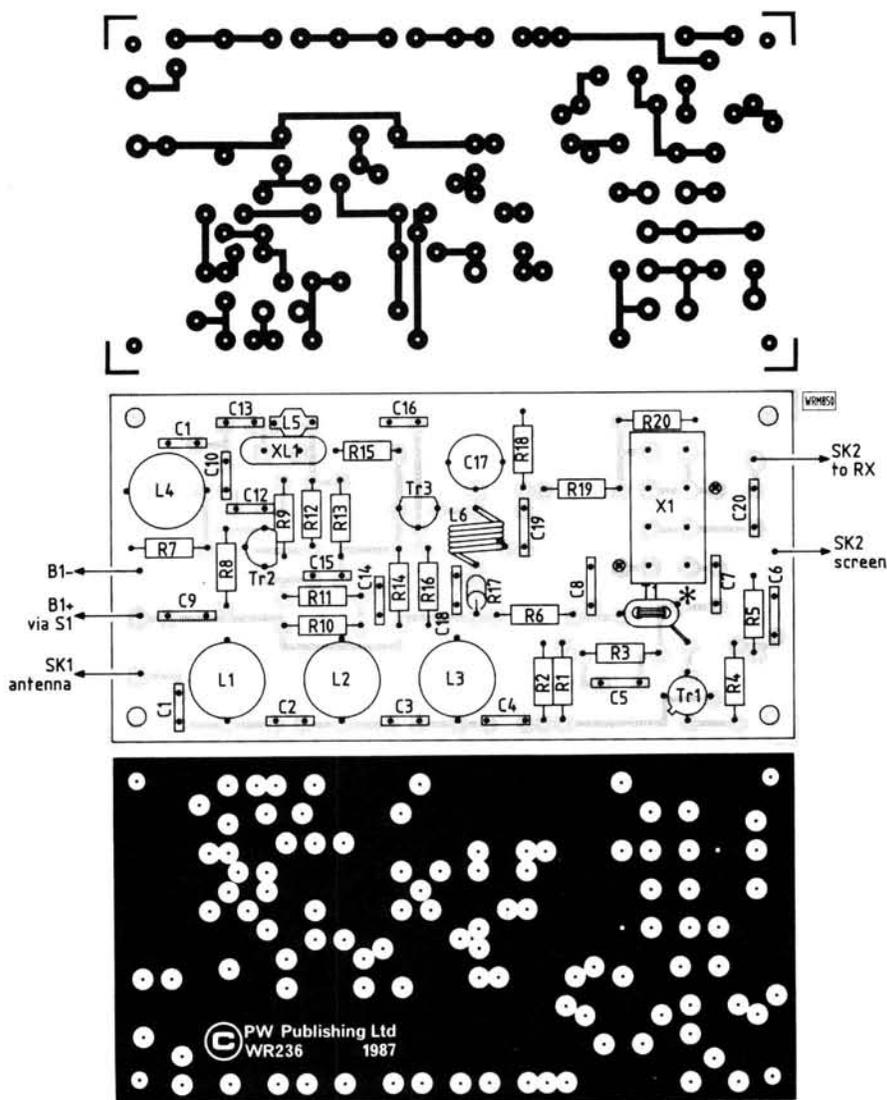

Fig. 3: Full-size double-sided track pattern and component location diagram of converter

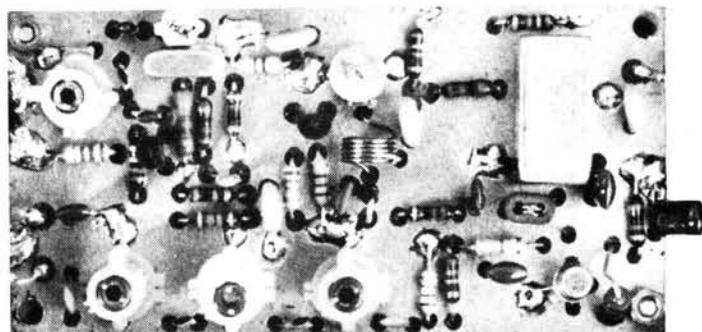

Fig. 4: Frequency conversion chart

Table 1: COIL WINDING DATA

Coil No	Turns	Wire s.w.g.	Coil Former	Remarks
L1	—	—	Toko S18	Red with Ferrite core
L2	—	—	Toko S18	White with Ferrite core
L3	—	—	Toko S18	Red with Ferrite core
L4	—	—	Toko S18	Orange with Ferrite core
L5	—	—	Toko 7BS	1µH
L6	5	24	6mm dia	Tapped at 1½ turns from Tr3 end, self-supporting
T1	—	—	—	Ferrite core 28-43002402, see text

cy may be measured at the junction of R18, 19. Capacitor C17 may then be peaked as before for maximum S-meter reading, as before.

The author made two holes in the lid of the enclosure of the prototype, to coincide with L4 and C17, as it was found that the oscillator shifted about 1kHz in frequency when the lid of the enclosure was fastened in place. Lastly the overall current drain of the unit is about 30mA.

General

The author used a dipole mounted vertically and fed with 50Ω cable, this was sited in the loft space of his house. The ultimate passive antenna for use with this type of equipment is the discone, the basic design of which can be found in the *PW* reprint *Wires & Waves*.

This converter was designed as a cheap home constructor's alternative to high-priced units currently available on the market. At a cost of around £25 this objective has been met and should provide the constructor with hours of pleasure.

If you are fortunate enough to own a short wave receiver that will cover frequencies up to 50MHz the converter gives good account of itself all the way up to 200MHz, after this the sensitivity starts to fall off. **PW**

SHOPPING LIST

Resistors

0.25W 5% Carbon Film

10Ω	1	R4
27Ω	2	R12,19
56Ω	1	R6
68Ω	1	R17
100Ω	2	R5,11
120Ω	1	R16
180Ω	2	R18,20
470Ω	1	R10
560Ω	1	R1
1kΩ	2	R2,13
2.7kΩ	1	R7
3.3kΩ	1	R3
4.7kΩ	1	R15
8.2kΩ	1	R9
12kΩ	1	R8
27kΩ	1	R14

Capacitors

Ceramic Plate

5.8pF	1	C12
18pF	4	C2,3,10,13
33pF	1	C15
47pF	3	C1,4,11
1nF	3	C16,19,20

Mylar film

10nF	7	C5-9,14,18
------	---	------------

Miniature Foil Trimmer

2-22pF	1	C17
--------	---	-----

Semiconductors

BF224	2	Tr2,3 ⁽²⁾
BFY90	1	Tr1

Miscellaneous

XL1 116MHz (HC18/U overtone xtal)⁽¹⁾; X1 SBL1 double balanced mixer ⁽¹⁾; L1-6, T1 (see coil table)⁽¹⁾; p.c.b.; 50Ω coaxial sockets (2); Veropins; Aluminium project box; 300mm of 24 s.w.g. enamelled wire; s.p.s.t. toggle switch; Battery connector; Wire; 6BA nuts, Screws, washers; 304mm 32s.w.g. enam cu wire.

⁽¹⁾ Cirkit Holdings PLC, Park Lane, Broxbourne, Hertfordshire EN10 7NQ. Tel: 0992 444111

⁽²⁾ Cricklewood Electronics Ltd, 40 Cricklewood Broadway, London NW2 3ET. Tel: 01-450 0995



0202 678558

Practical Wireless

0202 678558

PCB SERVICE

Printed circuit boards for recent *PW* constructional projects are now available from the *PW* PCB SERVICE. The boards are fabricated in 1.5mm glass-fibre, and are fully drilled and roller tinned. All prices include VAT and postage and packing for UK orders. Add £2.00 per order for despatch to overseas addresses.

Orders and remittances should be sent to: **PCB Service, Practical Wireless, Enefco House, The Quay, Poole, Dorset BH15 1PP. Cheques should be crossed and made payable to Practical Wireless.**

When ordering, please state the Project Title and Issue Month as well as the Order Code. Please print your name and address clearly in block capitals, and do not send any other correspondence with your order. You may phone your order using Access or Visa. A telephone answering machine will accept your order outside office hours.

Please allow 28 days for delivery. Always check the latest issue of *PW* for the current details of price and availability. Please enquire for earlier p.c.b.s.

PROJECT TITLE (Issue)	ORDER CODE	PRICE
PW Teme—VFO/Doubler (12/84)	WA001	£3.76
PW Teme—RX (1/85)	WA002	£5.46
PW Triambic Keyer (2/85)	WAD280*	£4.26
FRG-7 BFO Mod (2/85)	WAD249	£4.00
PW Colne (4/85)	A004	£4.14
	A005	£4.08
PW Colne (5/85)	WR198	£5.01
PW Colne (6/85)	WR197	£4.97
Battery Charge Control (6/85)	WAD302	£3.94
Crystal Tester (7/85)	WR200	£3.43
Add-on BFO (8/85)	WR201	£3.42
UHF Prescaler (9/85)	WR202	£4.76
PW Meon 50MHz Transverter (10/85)	WR199	£8.28
Capacitance Meter (10/85)	WR203	£3.74
WQ MW Loop (11/85)	WR204	£3.45

RTTY/Morse Modem (1/86)	WR205	£6.73
	WR206	£3.78
Crystal Calibrator (1/86)	WR207	£2.90
Simple Audio Oscillator (3/86)	WR209	£5.50
RF Speech Processor (3/86)	WR208	£5.21
PW Meon Filter (4/86)	WR211	£4.04
PW Arun Parametric Filter (5/86)	WR210	£9.87
FRG-7 CIO Mod (6/86)	WR213	£3.61
Simple 50MHz Converter (9/86)	WR215	£4.86
NiCad Charger (10/86)	WR217	£3.30
Active Antenna (11/86)	WR216	£3.24
PW Taw VLF Converter (11/86)	WR222	£3.82
High Impedance MOSFET Voltmeter (12/86)	WR223	£3.82
Modifying the SRX-30D (12/86)	WR214	£3.99
Basic Wobblulator (1/87)	WR224	£4.52
2m Mast-head Pre-amp (2/87)	WR218	£5.33
	WR219	£3.37
PW "Woodstock" (3/87)	WR225	£5.28
PW "Blandford" (4/87)	WR227a	£11.11
	WR226a	
	WR228	
	WR228	
PW "Itchen" (4/87)	WR298	£4.49
PW "Axe" (5/87)	WR230a	£5.07
	WR231	£4.24
	WR232	£3.82
PW "Downton" (6/87)	WR233	£5.04
Side-tone Oscillator (6/87)	WR234	£3.65
Mains On/Off for Battery Radio (9/87)	WR235	£3.97
PW "Blenheim" VHF to HF Converter (9/87)	WR236	£5.99



0202 678558

Practical Wireless

0202 678558 

BOOK SERVICE

The books listed have been selected as being of special interest to our readers. They are supplied from our editorial address direct to your door. Some titles are American in origin. A number of new titles have been added to the service. Watch out for further additions in the months to come.

RADIO

AN INTRODUCTION TO RADIO DXING (BP91)

R. A. Penfold

How to find a particular station, country or type of broadcast and to receive it as clearly as possible. 112 pages £1.95

A TV-DXERS HANDBOOK (BP176)

R. Bunney

Information on transmission standards, propagation, receivers including multi-standard, colour, satellites, antennas, photography, station identification, interference, etc. Revised and updated 1986. 87 pages £5.95

BEGINNER'S GUIDE TO RADIO (9th Edition)

Gordon J. King

Radio signals, transmitters, receivers, antennas, components, valves and semiconductors, CB and amateur radio are all dealt with here. 266 pages 0/S

BETTER RADIO/TV RECEPTION

A. Nallawalla, A. T. Cushen and B. D. Clark

An Australian publication giving guidance and advice both to listeners seeking reliable reception of some distant radio station, and to DX listening hobbyists. 134 pages £9.95

BETTER SHORTWAVE RECEPTION (USA)

W. S. Orr W6SAI & S. D. Cowan W2LX

Receivers, antennas, propagation, DX listening techniques for the short waves and v.h.f. 158 pages £7.32

COMMUNICATION (BP89)

(Elements of Electronics—Book 5)**F. A. Wilson**

Fundamentals of line, microwave, submarine, satellite, digital multiplex, radio and telegraphy systems are covered, without the more complicated theory or mathematics. 256 pages £2.95

FOUNDATIONS OF WIRELESS AND ELECTRONICS (10th Edition)

M. G. Scroggie and S. W. Amos

Covering d.c. and a.c. circuits, L, C, tuned circuits and selectivity, valves, semiconductors, transmission lines, antennas, radiation, oscillation, modulation, detection, amplification, superhet receivers, c.r.t.s, waveform generators and switches, computers and power supplies. 551 pages £8.95

GUIDE TO BROADCASTING STATIONS

19th Edition (1987/88)**Philip Darrington**

Frequency and station data, receivers, antennas, Latin American DXing, reporting, computers in radio, etc. 240 pages £6.95

INTERFERENCE HANDBOOK (USA)

W. I. Orr W6SAI and S. D. Cowan W2LX

How to locate and cure r.f.i. for radio amateurs, CBers and TV and stereo owners. 253 pages £6.75

INTERNATIONAL RADIO STATIONS GUIDE (BP155)

Revised and updated in 1985, this book shows the site, country, frequency/wavelength and power of stations in Europe, the Near East and N. Africa, North and Latin America and the Caribbean, plus short-wave stations worldwide. 128 pages £2.95

QUESTIONS & ANSWERS RADIO

Eugene Trundle

Basics of electrical theory, radio and semiconductors, receivers, amateur and CB radio, and test equipment. 110 pages £2.95

RECEIVING STATION LOGBOOK (RSGB)

Standard logbook for the s.w.l. in horizontal A4 format. 32 lines per page. 50 pages £2.35

THE COMPLETE VHF/UHF FREQUENCY GUIDE

This book gives details of frequencies from 26—2250MHz with no gaps and who uses what. There are chapters on equipment requirements as well as antennas, etc. 60 pages £4.95

VHF/UHF AIRBAND FREQUENCY GUIDE

A complete guide to the airband frequencies including how to receive the signals, the frequencies and services, VOLMET and much more about the interesting subject of airband radio. 74 pages £5.95

WORLD RADIO TV HANDBOOK (1987)

Country-by-country listings of long, medium and short wave broadcasters and TV stations. Receiver test reports. English language broadcasts. The s.w.l.'s "bible". 576 pages £17.95

DATA & REFERENCE

DIGITAL IC EQUIVALENTS AND PIN CONNECTIONS (BP140)

A. Michaels

Equivalents and pin connections of a popular selection of European, American and Japanese digital i.c.s. 256 pages £5.95

INTERNATIONAL DIODE EQUIVALENTS GUIDE (BP108)

A. Michaels

Possible substitutes for a large selection of many different types of semiconductor diodes. 144 pages £2.25

INTERNATIONAL TRANSISTOR EQUIVALENTS GUIDE (BP85)

A. Michaels

Possible substitutes for a popular selection of European, American and Japanese transistors. 320 pages £3.50

LINEAR IC EQUIVALENTS AND PIN CONNECTIONS (BP141)

A. Michaels

Equivalents and pin connections of a popular selection of European, American and Japanese linear i.c.s. 320 pages £5.95

NEWNES COMPUTER ENGINEER'S POCKET BOOK

This is an invaluable compendium of facts, figures, circuits and data and is indispensable to the designer, student, service engineer and all those interested in computer and microprocessor systems. 203 pages Hardback £8.95

NEWNES ELECTRONICS POCKET BOOK

5th Edition

Presenting all aspects of electronics in a readable and largely non-mathematical form for both the enthusiast and the professional engineer. 315 pages Hardback £8.95

NEWNES RADIO AND ELECTRONICS ENGINEER'S POCKET BOOK (17th Edition)

Keith Brindley

Useful data covering maths, abbreviations, codes, symbols, frequency bands/allocations, UK broadcasting stations, semiconductors, components, etc. 201 pages Hardback £6.95

POWER SELECTOR GUIDE BP235

J. C. J. Van de Ven

This guide has the information on all kinds of power devices in useful categories (other than the usual alpha numeric sort) such as voltage and power properties making selection of replacements easier. 160 pages £4.95

RSGB RADIO DATA REFERENCE BOOK

G. R. Jessop G6JP

The 5th Edition of an essential book for the radio amateur's or experimenter's workbench. 244 pages Hardback £8.56

SEMICONDUCTOR DATA BOOK

A. M. Ball

Characteristics of about 10 000 transistors, f.e.t.s, u.j.t.s, diodes, rectifiers, triacs and s.c.r.s. 175 pages £7.50

TRANSISTOR SELECTOR GUIDE BP234

J. C. J. Van de Ven

This guide has the information on all kinds of transistors in useful categories (other than the usual alpha numeric sort) such as voltage and power properties making selection of replacements easier. 192 pages £4.95

PROJECT CONSTRUCTION

HOW TO DESIGN AND MAKE YOUR OWN P.C.B.s (BP121)

R. A. Penfold

Designing or copying printed circuit board designs from magazines, including photographic methods. 80 pages £1.95

INTRODUCING QRP

Collected Articles from PW 1983-1985

An introduction to low-power transmission, including constructional details of designs by Rev. George Dobbs G3RJV for transmitters and transceivers from Top Band to 14MHz, and test equipment by Tony Smith G4FAI. 64 pages £1.50

POWER SUPPLY PROJECTS BP76

R. A. Penfold

This book gives a number of power supply designs including simple unregulated types, fixed voltage regulated types and variable voltage stabilised designs. 91 pages £2.50

PRACTICAL POWER SUPPLIES

Collected Articles from PW 1978-1985

Characteristics of batteries, transformers, rectifiers, fuses and heatsinks, plus designs for a variety of mains-driven power supplies, including the PW "Marchwood" giving a fully stabilised and protected 12V 30A d.c. 48 pages £1.25

AMATEUR RADIO

A GUIDE TO AMATEUR RADIO (RSGB)

Amateur Radio—the hobby, the equipment, workshop practice, the licence, the RAE (including sample questions). 154 pages £3.62

AMATEUR RADIO CALL BOOK (RSGB)

Spring 1987 Edition

This useful work now incorporates a 48-page reference section of useful information for amateur radio enthusiasts. 310 pages 0/S

AMATEUR RADIO LOGBOOK (RSGB)

Standard logbook for the transmitting amateur in horizontal A4 format. 25 lines per page. 96 pages £2.32

AMATEUR RADIO OPERATING MANUAL (RSGB)

A mine of information on just about every aspect of amateur operating, including international callsign series holders, prefix lists, DXCC countries list, etc. 204 pages £6.16

HOW TO PASS THE RADIO AMATEURS' EXAMINATION (RSGB)

G. L. Benbow G3HB

The background to multiple choice exams and how to study for them with nine sample RAE papers for practice, plus maths revision. 91 pages £3.15

INTRODUCING MORSE

Collected Articles from PW 1982-1985

Ways of learning the Morse Code, followed by constructional details of a variety of keys including Iambic, Triambic, and an Electronic Bug with a 528-bit memory. 48 pages £1.25

INTRODUCING RTTY

Collected Articles from PW 1980-1983

Basics of RTTY, ways of generating and decoding it. A simple and inexpensive way of trying out RTTY using a Sinclair 16K ZX81. 33 pages £1.00

MOBILE LOGBOOK (RSGB)

Pocket-sized for the mobile operator. £1.00

PASSPORT TO AMATEUR RADIO

Reprinted from PW 1981-1982

The famous series by GW3JGA, used by thousands of successful RAE candidates as an aid to their studies. Plus other useful articles for students of amateur radio. 96 pages £1.50

QUESTIONS & ANSWERS AMATEUR RADIO

F. C. Judd G2BCX

What is amateur radio? The Radio Amateurs' Exam and Licence. The technology, equipment, antennas, operating procedure and codes used by amateurs. 122 pages £2.95

RADIO AMATEURS EXAMINATION MANUAL (RSGB)

G. L. Benbow G3HB

A standard aid to studying for the Radio Amateurs Examination, covering the whole of the 1986-88 syllabus. 155 pages £3.62

RADIO AMATEUR'S GUIDE RADIO WAVE PROPAGATION (HF Bands)

F. C. Judd G2BCX

The how and why of the mechanism and variations of propagation in the h.f. bands. 144 pages £8.95

RADIO AMATEUR'S MAP OF NORTH AMERICA (USA)

Shows radio amateurs prefix boundaries, continental boundaries and zone boundaries. 760 x 636mm £2.25

RADIO AMATEURS PREFIX MAP OF THE WORLD

Showing prefixes and countries, plus listings by order of country and of prefix. 1014 x 711mm £1.60

RADIO AMATEUR'S WORLD ATLAS (USA)

17 pages of maps, including the world-polar projection. Also includes the table of allocation of international callsign series. 20 pages £2.75

RADIO COMMUNICATION HANDBOOK (RSGB)

A comprehensive reference work on the theory and practice of amateur radio experimentation and practice. 794 pages £12.80

SWM GREAT CIRCLE MAP OF THE WORLD

Showing Great Circle bearings and distances, callsign prefixes, time zones and DX Zones. 1018 x 634mm 0/S

TELEPRINTER HANDBOOK (RSGB) 2nd Edition

This covers the theory and practice of radio teleprinter equipment, both European and American. In addition it covers description and maintenance data on most of the popular machines. 354 pages Hardback. £6.10

THE COMPLETE DX'ER (USA) Bob Locher W9KNI

Equipment and operating techniques for the DX chaser, from beginner to advanced. 187 pages £8.21

THE RADIO AMATEUR'S DX GUIDE (USA) 15th Edition

The guide contains information not easily obtained elsewhere and is intended as an aid and quick reference for all radio amateurs interested in DX. 38 pages. £2.75

THE SATELLITE EXPERIMENTER'S HANDBOOK (USA)

A guide to understanding and using amateur radio, weather and TV broadcast satellites. 207 pages. £9.25

UNDERSTANDING AMATEUR RADIO (ARRL)

Understanding and building transmitters, receivers, antennas, power supplies and accessories. 222 pages O/S

VHF HANDBOOK FOR RADIO AMATEURS (USA)

H. S. Brier W9EGQ & W. I. Orr W6SAI
VHF/UHF propagation, including moonbounce and satellites, equipment and antennas. 335 pages £13.37

VHF/UHF MANUAL (RSGB) G. R. Jessop G6JP

Theory and practice of amateur radio reception and transmission between 30MHz and 24GHz. 520 pages Hardback £9.86

ANTENNAS (AERIALS)

AERIAL PROJECTS (BP105)

R. A. Penfold
Practical designs including active, loop and ferrite aerials plus accessory units. 96 pages £1.95

ALL ABOUT CUBICAL QUAD ANTENNAS (USA)

W. I. Orr W6SAI & S. D. Cowan W2LX
Theory, design, construction, adjustment and operation of quads. Quads vs. Yagis. Gain figures. 109 pages £7.63

ALL ABOUT VERTICAL ANTENNAS (USA)

W. I. Orr W6SAI and S. D. Cowan W2LX
Theory, design, construction, operation, the secrets of making vertical work. 191 pages £7.50

BEAM ANTENNA HANDBOOK (USA)

W. I. Orr W6SAI & S. D. Cowan W2LX
Design, construction, adjustment and installation of h.f. beam antennas. 198 pages £8.00

HF ANTENNAS FOR ALL LOCATIONS (RSGB)

L. A. Moxon G6XN
Taking a new look at how h.f. antennas work, and putting theory into practice. 260 pages £6.17

OUT OF THIN AIR

Collected Antenna Articles from PW 1977-1980
Including such favourites as the ZL Special and "2BCX 16-element beams for 2m, and the famous "Slim Jim", designed by Fred Judd G2BCX. Also features systems for Top Band, medium wave/long wave loop designs and a v.h.f. direction finding loop. Plus items on propagation, accessories and antenna design. 80 pages £1.80

SIMPLE AMATEUR BAND AERIALS (BP125) E. M. Noll

How to build 25 simple and inexpensive aerials, from a simple dipole through beam and triangle designs to a mini-rhombic. Dimensions for specific spot frequencies, including the WARC bands. 80 pages £1.95

THE ARRL ANTENNA BOOK 14th Edition (USA)

A station is only as effective as its antenna system. This book covers propagation, practical constructional details of almost every type of antenna, test equipment and formulas and programs for beam heading calculations. 327 pages. £9.10

THE ARRL ANTENNA COMPENDIUM Volume 1 (USA)

This book makes fascinating reading of hitherto unpublished material. Among topics discussed are quads and loops, log periodic arrays, beam and multi-band antennas, verticals and reduced size antennas. 175 pages £9.25

THE RADIO AMATEUR ANTENNA HANDBOOK (USA)

W. I. Orr W6SAI and S. D. Cowan W2LX
Yagi, quad, quagi, l-p, vertical, horizontal and "sloper" antennas. Towers, grounds and rotators. 187 pages £8.47

TWO-METRE ANTENNA HANDBOOK

F. C. Judd wrote this book for radio amateurs new to the 144-146MHz band. The range of antennas described will cater for most situations, particularly those where space is a problem. £5.95

WIRES & WAVES

Collected Antenna Articles from PW 1980-1984
Antenna and propagation theory, including NBS Yagi design data. Practical designs for antennas from medium waves to microwaves, plus accessories such as a.t.u.s, s.w.r. and power meters, and a noise bridge. Dealing with TVI. 160 pages £3.00

SIMPLE, LOW-COST WIRE ANTENNAS FOR RADIO AMATEURS (USA)

W. I. Orr W6SAI and S. D. Cowan W2LX
Efficient antennas for Top Band to 2m, including "invisible" antennas for difficult station locations. 191 pages £10.45

25 SIMPLE INDOOR AND WINDOW AERIALS (BP136)

E. M. Noll
Designs for people who live in flats or have no gardens, etc., giving surprisingly good results considering their limited dimensions. 64 pages £1.75

25 SIMPLE SHORT WAVE BROADCAST BAND AERIALS (BP132)

E. M. Noll
Designs for 25 different aerials, from a simple dipole through helical designs to a multi-band umbrella. 80 pages £1.95

25 SIMPLE TROPICAL AND MW BAND AERIALS (BP145)

E. M. Noll
Simple and inexpensive aerials for the broadcast bands from medium wave to 49m. 64 pages £1.75

FAULT-FINDING

ARE THE VOLTAGES CORRECT? Reprinted from PW 1982-1983

How to use a multimeter to fault-find on electronic and radio equipment, from simple resistive dividers through circuits using diodes, transistors, i.c.s and valves. 44 pages £1.50

PRACTICAL HANDBOOK OF VALVE RADIO REPAIR

Chas E Miller
The definitive work on repairing and restoring valved broadcast receivers dating from the 1930s to the 60s. Appendices giving intermediate frequencies, valve characteristic data and base connections. 230 pages Hardback £15.95

QUESTIONS & ANSWERS RADIO REPAIR

Les Lawry-Johns
How to fault-find and repair valved and transistorised receivers, car radios and unit audio equipment. Suggested lists of tools and spare parts. 106 pages £2.95

SERVICING RADIO, HI-FI AND TV EQUIPMENT

Gordon J King
A very practical book looking at semiconductor characteristics, d.c. and signal tests, fault-finding techniques for audio, video, r.f. and oscillator stages and their application to transistor radios and hi-fi. 205 pages £8.95

TELEVISION INTERFERENCE MANUAL (RSGB)

B. Priestley
TV channels and systems, spurious-radiation TVI, strong-signal TVI, audio breakthrough, transmitter design. 78 pages £2.02

TEST EQUIPMENT FOR THE RADIO AMATEUR (RSGB)

H. L. Gibson G2BUP
Techniques and equipment for tests and measurements on devices, systems and antennas. 142 pages Hardback £5.76

COMPUTING

AMATEUR RADIO SOFTWARE (RSGB)

John Morris GM4ANB
Using a computer for c.w., RTTY, data, plus calculations for antennas, distance, bearing, locators, satellites, sun, moon and circuit design. 328 pages Hardback £7.29

AN INTRODUCTION TO COMPUTER COMMUNICATIONS (BP177)

R. A. Penfold
Details of various types of modem and their applications, plus how to interconnect computers, modems, and the telephone system. Also networking systems and RTTY. 96 pages £2.95

AN INTRODUCTION TO COMPUTER PERIPHERALS (BP170)

J. W. Penfold
Covers monitors, printers, disk drives, cassette recorders, modems, etc., explaining what they are, how to use them and the various types of standards. 80 pages £2.50

MICROPROCESSING SYSTEMS AND CIRCUITS (BP77)

(Elements of Electronics—Book 4)
F. A. Wilson
A comprehensive guide to the elements of microprocessing systems, which are becoming ever more involved in radio systems and equipment. 256 pages £2.95

NEWNES COMPUTER ENGINEER'S POCKET BOOK

This is an invaluable compendium of facts, figures, circuits and data and is indispensable to the designer, student, service engineer and all those interested in computer and microprocessor systems. 203 pages £8.95

AUDIO FREQUENCIES

AUDIO (BP111)

(Elements of Electronics—Book 6)
F. A. Wilson
This book studies sound and hearing, and the operation of microphones, loudspeakers, amplifiers, oscillators, and both disc and magnetic recording. 320 pages £3.50

THEORY & CALCULATIONS

BEGINNER'S GUIDE TO ELECTRONICS

Owen Bishop
For youngsters thinking of a career in electronics, theory and applications in computers, radio, TV, recording, medical and industrial electronics. 240 pages O/S

CARE AND FEEDING OF POWER GRID TUBES (USA)

This handbook analyses the operation of EIMAC power grid valves and provides design and application information to assist the user of these valves. 156 pages £6.75

RADIO FREQUENCY INTERFERENCE (USA)

What causes r.f.i.? Are all r.f.i. problems difficult, expensive and time-consuming to cure? These questions and many more are answered in this book. 84 pages £4.30

THE SIMPLE ELECTRONIC CIRCUIT AND COMPONENTS Book 1 BP62

The aim of this book is to provide an inexpensive but comprehensive introduction to modern electronics. 209 pages £3.50

HOW TO ORDER

O/P = Out of Print
O/S = Out of Stock



An Introduction to
Computer
Communications

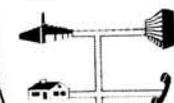

NEWNES
RADIO and
ELECTRONICS
ENGINEER'S
POCKET BOOK

Audio

Digital IC
Equivalents
and Pin
Connections

ADRIAN MICHAELS

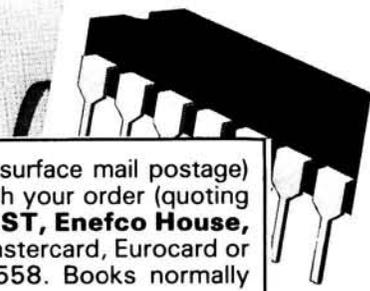

Add 75p per order postage (overseas readers add £1.50 for surface mail postage) and send a postal order, cheque or international money order with your order (quoting book titles and quantities) to **PW Publishing Limited, FREEPOST, Enefco House, The Quay, Poole, Dorset BH15 1PP**. Payment by Access, Mastercard, Eurocard or Visa also accepted on telephone orders to Poole (0202) 678558. Books normally despatched by return of post but please allow 28 days for delivery.

PW REVIEW

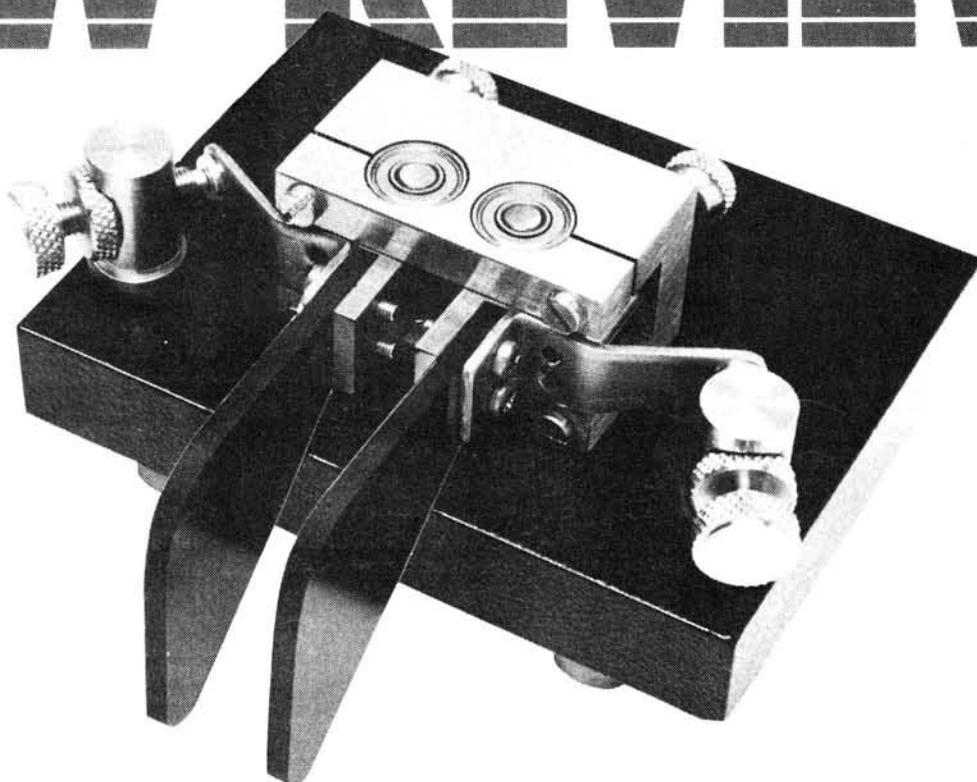

The Kanga Gang heard about the Kent Twin Paddle Morse Key Kit at the NEC in March, and promptly offered to review it.

We kept contacting them at shows and kept hearing stories of woe and seeing abortive prototypes! In fact a dozen designs were tried until all defects were removed, the result is what we now see. We were promised a kit at the end of the NEC show, but by Saturday morning all available kits had been sold and the demonstration model had to be reserved for this review. This caused much disappointment to many who wished to purchase it.

In some ways this also rather hindered the review as we had seen the kit already made-up and did not have the experience of making it up from "cold". We did however take the kit apart and rebuild it from the instructions and no problems were encountered, in fact the instructions are very concise and clear.

Bearings

The kit is supplied with the main bearing assembly pre-assembled removing any problems that might exist here. Prior to re-assembly the bearings were checked for friction and found to be very free, in fact so free that when holding the assembly frame horizontal it was almost impossible to stop the arms from moving with normal (?) hand shaking. On checking the slap in the bearings, it was impossible to feel any whatsoever.

The key took twenty-five minutes to re-assemble taking care not to take short cuts and reading the instructions at every stage of the job. This proved that anyone should be able to put it together within the hour stated in the instructions. The kit contains everything needed, including an Allen key in case your tool-kit does not contain the correct size.

Sufficient screw adjustment exists on the tension springs for tension to be adjusted from zero to far above that which is likely to be required. This is a very desirable feature, as it has been noted on several very expensive keys that come from the USA that it is impossible to reduce the tension to a level to suit our liking. On more than one occasion it has been necessary to shorten the springs!

As on the other key in the Kent range, the threads on the adjusting screws are very fine allowing the necessary adjustment to the contacts to be made without undue fuss. The contacts themselves are substantial and are solid silver thus reducing the "dirty contact" problem often experienced these days with very low keying currents. In the old days, with a few hundred milliamps flowing, current problems were very slight. Nowadays with keying currents measured in the order of a few picoamps, it can be

extremely troublesome. The brass contact arms are substantial and have very little "give" giving the action a nice feel, the only softness being given by the flexibility of the injection-moulded paddle arms.

Professional Look

The brasswork has a brushed finish and looks very smart but functional on the fine black crackle finish of the base. The size of the base is only 76 × 102mm, but is 16mm solid steel. This gives an overall weight of 1.2kg which should not move on the table even with the most enthusiastic operator!

We think that having read this so far you will have realised that we are very pleased with the key and were at home with it within seconds, but the best news is still to come and that is the price. At £38.50 plus £2.50 p&p for a really solid piece of engineering that will last a lifetime we join with all the others that purchased the paddle at the NEC in saying well done Mr Kent, thanks for bringing out a good paddle at a sensible price!

The Kent twin paddle Morse key kit is available from **R.A. Kent (Engineers), 243 Carr Lane, Tarleton, Preston, Lancashire PR4 6YB. Tel: 077473 4998.**

PW

Practical Wireless, September 1987

MAIL ORDER
IS OUR
SPECIALITY

58 High Street, Newport Pagnell, Bucks. MK16 8AQ.

Kenwood

PLEASE NOTE LOWER KENWOOD PRICES

SPECIAL OFFERS WHILE STOCKS LAST

		P&P
1M201A	2M 25W Mobile	259.00 (5.00)
TH21E	2M Mini Handheld	189.05 (4.00)
TH41E	70cms Mini Handheld	228.76 (4.00)
TR2800E	2.5W 2M Handheld with DCS	199.00 (4.00)
TR3600E	70cms Handheld with DCS	299.00 (4.00)
TS440S	NEW Amateur band transceiver General coverage RX	1138.81 (7.00)
PS50	Heavy Duty PSU for TS440S	222.49 (5.00)
AT440	Auto ATU for TS440S	144.82 (3.00)
TS940S	9 Band 1X General Cov RX	1995.00 (7.00)
AT940	Auto ATU for TS940S	244.88 (4.00)
TS930S	9 Band 1X General Cov RX	1695.00 (7.00)
TS830S	160m-10m Transceiver 9 Bands	1098.00 (7.00)
AT230	All Band ATU Power Meter	208.67 (5.00)
SP230	External Speaker Unit	66.49 (5.00)
TSS30SP	160m-10m Transceiver	927.51 (7.00)
TS430S	160m-10m Transceiver	974.25 (7.00)
PS430	Matching Power Supply	173.78 (5.00)
SP430	Matching Speaker	40.81 (3.00)
MB430	Mobile Mounting Bracket	15.80 (2.50)
FM430	FM Board for TS430	48.05 (1.50)
LF30A	HF Low Pass Filter 14W	32.26 (2.50)
YK88A	6kHz AM filter for TS430S 440S	49.37 (1.50)
YK88C	500Hz CW filter for TS430 440 830 530	46.08 (1.50)
YK88CN	270Hz CW filter for TS430 440 830 530	54.64 (1.50)
YK88SN	1.8kHz SSB filter for TS430 440 830 530	46.71 (1.50)
MC50	Dual Impedance Desk Microphone	46.08 (2.50)
MC35S	Fist Microphone 50K ohm IMP	21.72 (1.50)
MC85	Deluxe Desk Mic with Audio Regency	107.59 (3.00)
MC43S	Up-Down Hand Mic 8-Pin 500 Ohm	22.22 (1.50)
MC40S	Up-Down Hand Mic 6-Pin 500 Ohm	19.07 (1.50)
MC60A	Desk Mic with built-in Pre-amp	88.22 (3.00)
MC55	Mobile Microphone with control box (up/down etc.) 6 or 8 pin	52.67 (2.50)
TR751E	2M Multimode (mobile)	599.00 (5.00)
MU1	DCCL option for TR751E	30.95 (1.00)
TS711F	2M Base Stations	740.00 (7.00)
H55	Deluxe Headphones	37.54 (2.50)
SP40	Mobile External Speaker	21.06 (2.00)

NEW

TH205E	2M Handheld Transceiver	215.26 (4.00)
TH215E	2M Handheld with Keypad Entry	252.13 (4.00)
PB1	Nicad Pack 12v 800mAh	57.27 (2.00)
PB2	Nicad Pack 8 4v 500mAh	34.22 (2.00)
PB3	Nicad Pack 7 2v 800mAh	38.82 (2.00)
PB4	Nicad Pack 7 2v 1600mAh	63.19 (2.00)
B75	Dry Battery Case	11.86 (1.50)
BC7	Rapid Charger	97.42 (3.00)
SC12	Case for (PB2 3)	13.87 (1.50)
SC13	Case for (PB1 4)	14.49 (1.50)
PG2V	DC Power Cable for TH205E 215E	3.96 (1.50)
SMC30	Speaker Mic for TH21E 41E 2600 3600E	28.31 (2.00)
HMC1	Headset Unit with VDX for TH21E 41E 2600 3600E 32 91	32.91 (2.00)
RA2	Rubber Flexible Antenna for TR2400 2500 2600E 9 87	11.50 (1.50)
RA3	Telescopic Whip Antenna for TR2400 2500 2600E 13 74	13.74 (1.50)
TM221E	2M FM Mobile Transceiver 45W	317.30 (5.00)
TM421E	70cms FM Mobile Transceiver 35W	372.08 (5.00)
TH405E	70cms Handheld Transceiver	288.00 (4.00)
TH415E	70cms Handheld with Keypad Entry	298.85 (4.00)
TR81E	70cms All Mode Transceiver	699.00 (5.00)
TW4100E	VHF UHF FM Mobile Transceiver	699.00 (5.00)

Yaesu

FT209RH	NEW 2m H.Held C/W FNB3	239.00 (—)
FT1709R	70cm H.Held	319.00 (—)
MMB10	Mobile Bracket FT209-709	10.00 (1.50)
NC9C	Charger	11.50 (1.50)
PA3	Car Adaptor Charger	21.85 (2.00)
MH188	Hand 600 8pin mic	21.00 (1.50)
MD188	Desk 600 8pin mic	79.00 (3.00)
MF1A3B	Boom mobile mic	25.00 (2.00)
YH7F	Lightweight phones	19.99 (2.00)
YH55	Padded phones	19.99 (2.00)
YH1	L weight Mobile H.set-Boom mic	19.99 (1.50)
YH2	L weight Mobile H.set-Boom mic	19.95 (1.50)
SB1	PTT Switch Box 208 708	22.00 (1.50)
SB2	PTT Switch Box 290 790	22.00 (1.50)
SB10	PTT Switch Box 270 2700	22.00 (1.50)

NEW

FT690RMKII	2.5W 6M multimode portable/mobile base	399.00 (5.00)
FT211RH	2M 45W Mobile	309.00 (4.00)
FT767GX	HF Gen Coverage trans. with optional VHF/UHF 6M modules	1550.00 (—)
FEX-767-2	2m module for FT767	169.00 (3.00)
FEX-767-7(B)	70cms module for FT767	215.00 (3.00)
FEX-767-6	6m module for FT767	169.00 (3.00)
FL7000	Solid State linear with built in auto ATU	1600.00 (—)
FT727R	Dual Band handheld transceiver 144-146MHz 430-440MHz up to 5W on each band	425.00 (3.00)
FT290RMK II	2M multimode portable/mobile base	429.00 (3.00)
FT23R FNB10	2M mini handheld with LCD display 5W	249.00 (3.00)
FT23R FNB10	70cms mini handheld with LCD display 5W	269.00 (3.00)

Royal Blue



Photo Acoustics have pleasure in presenting the ROYAL BLUE — a Short Wave Listeners folded dipole antenna that covers 2-30MHz. Its neat and compact design (just 6' tall) makes it ideal for unobtrusive outdoor or indoor use. It will work quite happily on your roof or stood in the corner of your shack. It is a truly versatile antenna that will pull in the DX and which works exceptionally well with modern receivers such as the Yaesu FRG8800, Icom R71, Trio R2000 and so on.

To buy this superb new antenna, just send us £25, plus £3 for postage and packing and we will rush one to you.

Receivers

	P&P
Trio R2000 HF general coverage receiver	595.00 (7.00)
Trio VC10 VHF converter for R2000 118-174MHz	161.94 (3.00)
Trio R5000 NEW HF general coverage receiver	875.00 (7.00)
Trio VC20 VHF converter for R5000 108-174MHz	167.21 (3.00)
Yaesu FRG8800 HF general coverage receiver	639.00 (7.00)
Yaesu FRV8800 VHF converter for FRG8800 118-175MHz	100.00 (3.00)
Icom R71E HF general coverage receiver	825.00 (7.00)
Icom RC11 remote control unit for ICR71E	62.00 (2.00)
AR2002 VHF-UHF scanner 25-550MHz and 800-1300MHz	487.00 (5.00)
FRG9600 VHF-UHF scanner 25-950MHz	509.00 (5.00)
Icom R7000 VHF UHF scanner, all modes 25-2000MHz	957.00 (7.00)
Icom RC12 remote control unit for R7000	62.00 (2.00)

NEW

Regency MX4200 Portable Scanner. Covers 60-89MHz, 118-136MHz.	ONLY 328.50 (5.00)
144-174MHz, 380-495MHz and 800-950MHz	
HF125 HF general coverage receiver 30kHz-30MHz (Made in Britain)	375.00 (5.00)
RS32 synthesised arband receiver 110-139.995MHz	224.05 (4.00)
RS37S Air band portable. Tunable 118-136MHz	69.51 (3.00)

Icom

IC751A HF Transceiver	1465.00 (—)
IC735 New HF Transceiver	949.00 (—)
PS15 P.S. Unit	158.00 (4.00)
PS30 systems p.s.u. 25A	343.85 (2.00)
SM6 Base microphone for 751/745	46.00 (1.00)
IC2900 2m 25W M.Mode	542.00 (—)
IC505 10W/3W 6M multimode, portable base	459.00 (5.00)
IC3200E 2m/70cms dual band mobile, with built in duplexer	556.00 (5.00)
IC02E 2m H.Held	299.00 (—)
IC04E 70cm handheld	299.00 (—)
BC35 Base Charger	70.15 (1.50)
HM9 Speaker mic	21.85 (1.50)
BP3 Empty Battery Pack	29.90 (1.50)
BP4 High Power Battery Pack	9.20 (1.50)
CP1 Car Charging Lead	6.90 (1.50)
DC1 12v Adaptor	17.25 (1.50)
IC48E 10W 70cms FM mobile	449.00 (3.00)
IC28E 25W FM mobile (Tiny)	359.00 (3.00)
IC28H 45W FM mobile (Tiny)	399.00 (3.00)
IC-Micro 2 mini hand portable LCD display 1W	239.00 (3.00)

NEW

IC-275E 2M Multimode Base Station inc. PSU. 25W	1039.00 (7.00)
IC-475E 70cms Multimode Base Station inc. PSU. 25W	1125.00 (7.00)
IC-1200 23cm FM Mobile. 10W output, style similar to 2BE	559.00 (4.00)
ICOM 761 HF general coverage transceiver with internal PSU and auto ATU	2459.00 (7.00)

Power Supplies

DRAE		BNOS	
4 amp	43.90 (3.00)	6 amp	75.00 (3.00)
6 amp	65.00 (3.00)	12 amp	125.00 (3.00)
12 amp	86.50 (3.00)	25 amp	185.00 (4.00)
24 amp	125.00 (4.00)	40 amp	385.00 (4.00)

Aerial Rotators

DAIWA MR750E Heavy Duty rotator. Can have up to 4 motors	254.10 (5.00)
KR400 Med/H Duty	139.00 (5.00)
KR500 6 core Elevation	149.50 (5.00)
KR400RC 5 core Medium Duty	169.00 (5.00)
KR600RC 6 core Heavy Duty	219.00 (5.00)
KC038 lower mast clamps	17.45 (2.00)
KS065 Rotary Bearing	29.95 (2.50)
AR1002 Lightweight VHF Rotator	52.95 (4.00)

Switches

Sigma 2 way S0239	20.20 (1.50)
Sigma 2 way n SxTs	22.95 (1.50)
Weiz CH20A 2 way S0239	30.75 (1.50)
Weiz CH20N 2 way n SxTs	54.00 (1.50)
Drae 3 way S0239	15.40 (1.50)
Drae 3 way n SxTs	19.90 (1.50)

CW/RTTY/Equipment

BENCHER		P&P
BY1	Squeeze Key, Black base	67.42 (3.00)
BY2	Squeeze Key, Chrome base	76.97 (3.00)
HI-MOUND MORSE KEYS		
HK708	Straight Key	21.50 (2.50)
HK702	Deluxe version of above on Marble Base	42.50 (3.00)
HK706	Straight key	22.00 (2.50)
HK707	Straight key	22.00 (2.50)
MK704	Squeeze paddle	20.00 (2.50)
MK705	Squeeze paddle on Marble Base	32.20 (3.00)

NEW

RTTY-EQUIPMENT		P&P
PK-232	Packet Amltor. RTTY. CW. ASCII transceive in one unit. Works with any computer equipped with an RS232 interface. 12V operated	269.95 (4.00)
FAX-1	NEW HF Fax receiver. Obtain weather maps, press photographs and satellite cloud cover detail on any Epson FX-80 compatible printer	279.95 (4.00)

NEW PK232 Packet Amltor/RTTY/CW/ASCII/Fax. Works with any computer equipped with an RS232 interface. 12V operated **289.95** (4.00)
NEW FAX option for existing PK232 users (includes new manual) **49.95** (2.00)
NEW PK-87 1200aud Amateur Packet Radio TNC **169.50** (4.00)
NEW PK-90 Commercial Packet Radio TNC **465.25** (14.00)

SOFTWARE PACKAGES

PK232/C64/128 Cartridge, overlays, cable, handbook	69.00 (1.50)
PK232/BM-PC & Compatibles. Disc, handbook	35.00 (1.50)
167/C64/128 Cartridge, overlays, cable, handbook	69.00 (1.50)
PK87/BBC-B & Master. E-PR0M, overlay, cable, handbook	35.00 (1.50)

NEW FAX-1 Radio Facsimile Weather Map demodulator with double screened printer cable. Includes mounting bracket and NEW RTTY receive facility. **329.00** (4.00)

CD660 Data Receiver for CW RTTY TOR AMTOR ASCII	264.97 (5.00)
CD670 As above but with built in LCD display	327.77 (5.00)

KEYERS & ACCESSORIES

Star Master Key Electronic Keyer	54.70 (3.00)
NEW Star Masterkey electronics CMOS memory keyer	95.00 (3.00)
TRX3 Morse Oscillator	13.85 (1.50)
Datong D70 Morse Tutor	56.50 (2.50)

G-Whip Aerials

Tribander Helical 86. 10 15 20 metres	37.55 (3.00)
LF coils for above. 30 40 80 160 metres. EACH	8.75 (1.50)
LF telescopic 2 section whip for above. (1 only needed)	6.10 (1.50)
Basement single hole fitting with 4 metres of coax	8.75 (2.00)
Multiselect 86. 10 15 20 metres. Self selecting mobile antenna	39.85 (3.00)
MS coils for above 30 40 80 160 metres. EACH	8.75 (1.50)
MS telescopic whip for above. (1 only needed)	6.10 (1.50)
Heavy duty ball basement for above, with swivel	7.50 (2.50)
Heavy duty Basement as above but with Spring	12.25 (3.00)
Bumperstrap with antenna mount integral	12.25 (3.00)
Flexibasic 10 metre mobile antenna	28.50 (3.00)
LF coils for above for 12 15 17 20 30 40 80 160 metres. EACH 8.75	1.50 (1.50)
GPL259 Antennas. A range of small light antennas suitable for gutter mounting, has a Male PL259 fitting on the antenna. GPL for 15 20 40 metres, c/w whip. EACH	19.00 (3.00)
GPL for 80 or 160 metres c/w 2 section adjustable telescopic	20.20 (3.00)
(NOTE) A thread adapter is needed when fitting to heavy duty mounts or bumper strap. (not GPL range)	1.50 (0.75)
Base station	
G8 100 An 8 Band Self Selecting vertical antenna	100.90 (10.00)

Aerials

AH-7000 Wideband Discone Antenna 25-2000 MHz	82.00 (4.00)
Revcone Wideband Discone Antenna 25-550 MHz	30.50 (4.00)
GSRV Full size 102"	16.75 (2.50)
GSRV Half size 51"	14.25 (2.50)
HB9CV 2 metres	3.95 (3.00)
HB9CV 70cms	3.95 (2.00)
2 metre Slim Jim	8.95 (3.00)
4-1 Baluns	12.95 (2.00)
3.7 and 7 1MHz Traps (pair)	9.50 (2.00)
Dipole Centrepieces	2.25 (0.50)
Copper wire 50M rolls hard drawn	7.95 (2.50)
3" Feeder spreaders in lots of 20	3.80 (1.50)
3" Ribbed end insulators (Polypropylene)	0.60 (0.75)
Limpet Mag Mounts	20.50 (3.00)
BOOKS Confidential Frequency List (NEW Edition)	5.95 (1.00)
Air Traffic Radio	2.25 (0.75)
The Complete guide to VHF-UHF frequencies 25-2000MHz (NEW)	4.95 (1.00)
The International VHF FM guide	2.00 (0.75)
GUIDE TO FACSIMILE STATIONS	9.95 (1.00)
Towards the RAE (Questions and answers book)	4.25 (0.75)
Logbooks	3.50 (1.00)

SPECIAL OFFER

Alnico ALM-203E 2M Handheld C/W 30W Amplifier, Nicad. Charge	269.95 (4.00)
Alnico ALR206E 25W FM mobile transceiver	249.95 (3.00)

NORTH LONDON AGENT: JIM SMITH G3HJF, 64 Galley Lane, Arkley, Barnet, Herts. EN5 4AL. For a demonstration of selected equipment, please Tel: 01-449 7135 10am-7pm Monday-Saturday. Only 2 miles from M25.

SPEND UP TO £1,200 INSTANTLY WITH A PHOTO ACOUSTICS LTD. CREDITCARD CARD — APPLY FOR DETAILS
PART EXCHANGE WELCOME, ASK FOR KERRY G6IZF OR ANDY G4YOW
RETAIL SHOWROOM OPEN TUESDAY-FRIDAY 9.30-5.30, SATURDAY 9.30-4.30

Feature

The Hallicrafters Model S-27 appeared in the early 1940s, being one of the first commercial receivers capable of working at what were then regarded as ultra high frequencies; at the time this referred to those above about 60MHz (5m). The S-27 covers from 27.8MHz to 143MHz (yes! everyone says why not 144) in three bands, 27.8-47, 46-82 and 82-143MHz. Add to this the facility for f.m. reception as well as a.m. on all bands, and a high-quality, push-pull output stage and it will be seen that this is a rather unusual communications receiver, says Chas. E. Miller.

Valved Communications Receivers

The United States Bureau of Ships adopted the S-27 for military purposes, and in this guise it was known as the CHL-46130 or CHL-46130-A when rack-mounted; when fitted in a table cabinet the designation was RBK-1, which seems to indicate a certain capriciousness on the part of whoever doled out the type numbers! (In any case, the sets still bore the Hallicrafters S-27 type number on the front panel.) This is an impressive receiver with a good array of controls, but of which none is superfluous.

Commencing at the left side of the cabinet, along the bottom, there are knobs for r.f. gain; antenna trimmer; i.f. bandwidth/mains on-off; a.f. gain; a.m./f.m. mode; and b.f.o. pitch. Toggle switches below provide on-off control of the a.g.c., noise limiter and b.f.o. Along the approximate centre line are knobs for wave band, tuning and tone. There is, in addition, access through the panel to the potentiometer that zeroes the S-meter. This latter is mounted upper right, alongside the logging scale which has a similar bezel. The main tuning scales are to the upper left, visible through a wedge-shaped window, and they also carry a logging scale to be used in connection with the one just referred to above. There is a jack socket on the panel for headphones, and close by another toggle switch for send-receive when the set is being operated in conjunction with a transmitter. Normally the receiver operates from a.c. mains of 100V-250V, but it is possible to substitute storage batteries and a vibrator pack for semi-portable use.

Circuit Description

Antenna input is to one of three r.f. transformers, selected by the wave-band switch, and thence to the grid of the r.f. amplifier (V1, 956). This is an "acorn" type mounted in a special low-loss ceramic holder. It is a straight r.f. pentode and no a.g.c. is applied to this valve. Similar r.f. transformers trans-

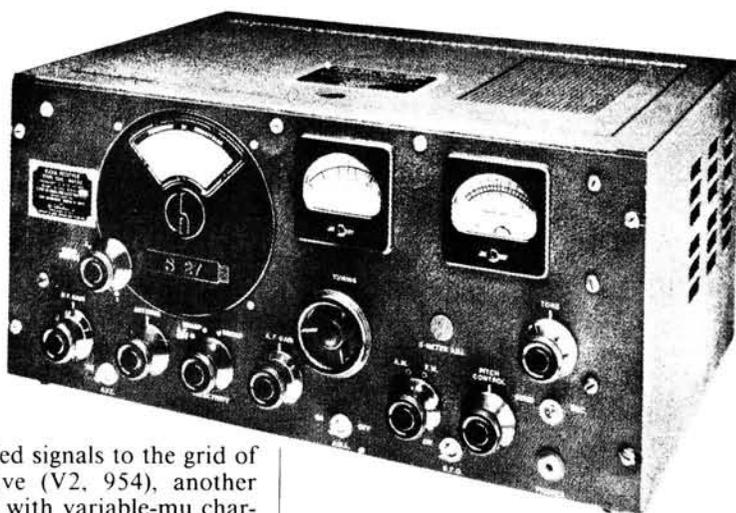

fer the amplified signals to the grid of the mixer valve (V2, 954), another acorn pentode with variable-mu characteristics and which is thus controlled by a.g.c. The local oscillator (V15, 955) is an acorn triode operating in a modified Hartley mode, and with cathode injection to the mixer, which produces output at the unusual intermediate frequency of 5.25MHz.

The coupling to the first i.f. amplifier (V3, 1852/6AC7) is by a transformer with an extra winding that may be switched in and out at will to modify the bandwidth characteristic. The 1852/6AC7 is a high slope (9mA/V) pentode originally intended for television receivers, and endows this stage with excellent gain. A similar i.f. transformer to the first passes the signal on to the second amplifier (V4, 1853/6AB7) which is another television type pentode but of smaller mutual conductance, 5mA/V. Both V3 and V4 operate with either manual or automatic gain control.

A third i.f. transformer, again similar to the first, couples the signal to the third amplifier (V5, 6SK7). Although the 6SK7 is a variable-mu valve it is here operated without a.g.c. or manual control; but in the f.m. mode, in which it plays no active part, its gain is reduced by the inclusion of an extra cathode bias resistor. The a.m. signal path is via a simple transformer in the 6SK7 anode circuit to a diode detector (Part of V6, 6H6). In typical American manner the a.g.c. voltage is derived from the signal diode load, a practice that seems more appropriate to a cheap

"midget" than to a communications receiver. Apart from anything else, this system does not allow of any delay being applied to the a.g.c. to restrict its operation on weak signals. The other section of V6 is employed as a noise limiter.

The FM Path

On f.m. the i.f. signals are diverted from V5 to a limiter stage (V7, 1852/6AC7). This valve operates with low anode and screen volts (70V for both) and is thus relatively unresponsive to a.m. signals, although passing f.m. readily enough. It is coupled by an i.f. transformer with tapped secondary to the ratio detector (V8, 6H6).

The Audio Stages

The a.f. signals from either detector are applied via the mode switch to the volume control and thence to the grid of the first a.f. amplifier, one section of a twin triode (V9, 6C8G). Negative feedback from the output transformer is applied to the cathode of this valve. Amplified signals (in anti-phase to those at the grid) appearing at the anode are fed to the grid of one of the twin output valves (V11, V12, 6V6G) and also to that of the other section of V9, which in turn drives the other output valve. Thus V9 operates as a push-pull amplifier driving a push-pull

Practical Wireless, September 1987

output pair. The tone control is a four-position switch which progressively modifies the negative feedback and introduces top-cutting components to reduce the high-frequency response and enhance that of the low-frequencies as required. Curiously enough, instead of the usual inflated claims made for power outputs, the rating of the stage is only 3W with 5 per cent distortion, but the fidelity with the tone control in its inoperative position is quoted as within $\pm 3\text{dB}$ from 40Hz to 10kHz.

The BFO stage

This is a triode (V14, 6J5) operating in a Hartley mode with tuning by variable permeability, the core of the oscillator coil being thread coupled to the "pitch" control on the front panel. Thus as the knob is turned the thread moves the core in or out of the coil former, giving a fine control over its frequency. The b.f.o. output is coupled to the detector diode section of V6. As is usual with older communications receivers, the b.f.o. was intended solely to render c.w. signals audible and not to enable s.s.b. to be resolved, but again as usual very reasonable results may be obtained on this type of signal with careful adjustment of main and b.f.o. tuning.

Power Supplies

All valve heaters are wired in parallel and supplied from a single 6.2V winding on the mains transformer. Three levels of h.t. are provided from a full-wave rectifier (V13, 5Z3) and a smoothing circuit incorporating two chokes. The highest voltage (265V) is applied to the anodes of the push-pull output pair only; their screen grids and the rest of the main h.t. lines operate at 250V. For the local oscillator, the mixer and the screen grid of V4, a stabilised 150V supply is provided with the aid of a neon-type regulator (V10, VR150-30). A switch in the lead from the h.t. winding centre-tap to earth provides the muting facility for when an associated transmitter is operated.

The voltages are fed to the receiver via an octal socket which normally contains a shorting-link plug. When the latter is removed another may be inserted to feed in external voltages, those of the internal power pack being automatically disconnected.

The mains input to the receiver is via r.f. chokes and filter capacitors to eliminate mains-borne interference. The primary winding has two alternative tappings, for either a nominal 110V or 230V. The power consumption is 80W.

Alignment

It cannot be stressed too strongly that an accurate signal generator operating on fundamental frequencies is essential for this work. Few inexpensive service

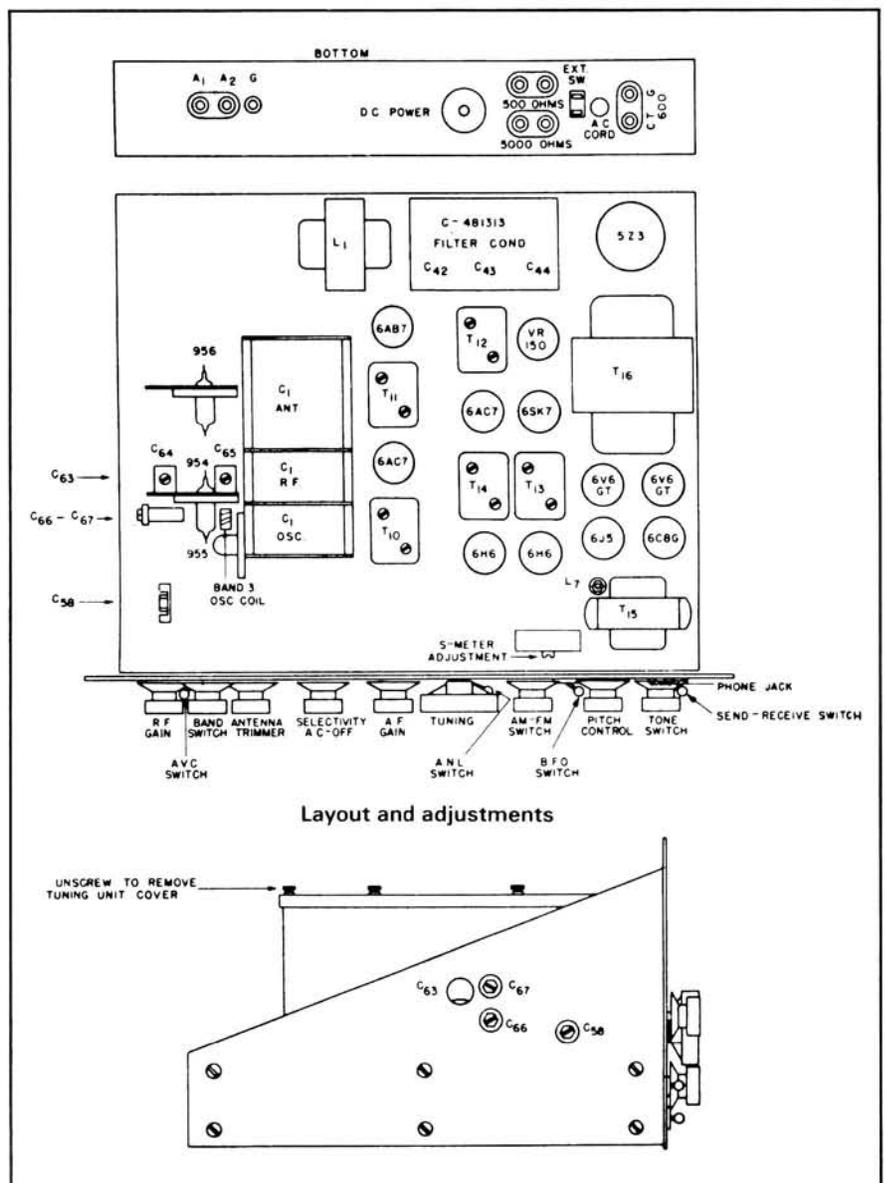

oscillators are capable of going up to 143MHz except on harmonics, and at these frequencies there is considerable danger of selecting the wrong one. As always, a wobulator and oscilloscope are invaluable for accurate realignment of the i.f. stages. If only an a.m. generator is available, proceed as follows:

Set the receiver controls thus: r.f. gain at max; a.f. gain at max; selectivity at sharp; band switch at 2; mode switch at a.m.; a.v.c. (a.g.c.) switch at off; a.n.l. switch at off; b.f.o. switch at off. Connect the generator output to the grid of the mixer valve V2 via a 0.1 μF series capacitor. Take care, as these valves are rather brittle and excess pressure on a pin may fracture the glass envelope. Connect an output meter into the loudspeaker circuit. Inject a 5.25MHz a.m. signal and tune T10, T11, T12 and T13 for peak response on the meter, reducing the input level as necessary. Use a **non-metallic trimming tool**. For the f.m. mode the discriminator transformer T14 has to be adjusted subsequent to the above step. Leaving the generator operating as before, change the selectivity switch to broad and the mode switch to f.m. Looking at the top of T14 adjust the secondary trimmer (that nearer to the

front of the set) until the output meter reading falls to zero. This is reached suddenly, so careful adjustment is called for. Readjust the trimmer so that the meter registers a small but readable amount. Adjust the primary (rear-most) trimmer for maximum reading on the meter. Then readjust the secondary for zero reading.

The accuracy of the alignment should now be checked by detuning the generator to either side of the centre frequency and noting the output meter readings obtained. These should be the same if the circuit is balanced properly. If they are dissimilar, make a written note of the readings and tune the generator to the side of the centre frequency that gives the lower amount. Readjust the primary trimmer so that the meter reading rises to approximately a half of the difference between the two previous readings. Now retest for balance as described above, and repeat the readjustments, if necessary, until satisfactory results are obtained.

Should it prove impossible to obtain a balance it is an indication that the secondary trimmer is not at the correct point of adjustment and very gentle readjustment must be made. Try turning it one way and the other, choosing the direction that will produce equal

Practical Wireless, September 1987

peaks. Very great care is necessary here as even a very small imbalance will result in considerable distortion when f.m. signals are being received. If necessary, slight readjustment again may be made on a broadcast signal, but this must not be relied upon instead of the full procedure given above.

RF Alignment

Set the main controls as for i.f. alignment (a.m.), except for the band switch, which should be at 1. Inject the signals to the antenna and earth sockets. Tune both receiver and generator to 42MHz and adjust the oscillator trimmer C66 for maximum response. (Note that on this band the oscillator frequency is higher than that of the incoming signal, but on the other two bands it is lower). Adjust C63 and the antenna trimmer for maximum. Tune receiver and generator to 28MHz and adjust the padder capacitor C58 for maximum, whilst "rocking" the receiver tuning. Finally, repeat the high-frequency adjustment.

For Band 2 tune to 75MHz and adjust C67, followed by C64 and the antenna trimmer. There is no low frequency adjustment on this band or on Band 3. For alignment of the latter, initially only the trimmer C65 and the antenna trimmer should be adjusted, as no variable oscillator trimming is provided. Should the dial readings be grossly in error the oscillator coil itself has to be adjusted, a matter calling for a great degree of skill. To obtain access to the coil the cover over the r.f. unit must be removed. It will be seen that one of the windings is of white coloured wire (be prepared for discolouration!) and this is the primary. The free end of this winding may be shifted a

VALVE ELECTRODE VOLTAGES

(Measured to ground with 1000 ohm per volt meter from socket pin)

Valve	Description	Acorn Valve Elements				
		Heater	Heater	Anode	Screen	Cathode
V1-956	RF Amplifier	0	6.2 a.c.	155	100	2.5
V2-954	1st Detector-mixer	0	6.2 a.c.	150	65	4
V15-955	High Freq. Osc.	0	6.2 a.c.	95		0

SOCKET PIN NUMBERS

	1	2	3	4	5	6	7	8
V3-6AC7	0	0	0	0	1.8	140	6.2 a.c.	225
V4-6AB7	0	0	0	0	1.8	150	6.2 a.c.	225
V5-6SK7	0	6.2 a.c.	5.5	0	5.5	95	0	225
V6-6H6	0	6.2 a.c.	0	0	0	0	0	0
V7-6AC7	0	6.2 a.c.	0	0	0	70	0	70
V8-6H6	0	6.2 a.c.	0	0	0	0	0	0
V9-6C8G	0	6.2 a.c.	95	2.2	0	105	0	2.5
V10-6V6G	0	6.2 a.c.	235	230	0	0	0	15
V11-6V6G	0	6.2 a.c.	235	230	0	0	0	15
V12-VR150	0	0	155	0	155	0	155	0
V13-5Z3	260	250 a.c.	250 a.c.	260				
V14-6J5	0	6.2 a.c.	0	0	0	0	0	0

little to provide frequency adjustment. When the correct tuning is obtained the winding should be re-fixed in position with polystyrene cement.

Some readers may wish to perform what was known in the Services as an "unauthorised modification" and extend the coverage to 144MHz. It should not prove too difficult a job, and the dial does extend a long way past the 143MHz mark.

Other Servicing

As with all vintage receivers, deterioration of capacitors may have taken

place over the years, although it must be said that those originally fitted to the S-27 were generously rated, those in vulnerable positions being 600V working or better types. A comparison of the voltages quoted in the tables reproduced above and those found in the receiver will give a good indication of which capacitors, if any, need to be investigated. Make due allowance for the fact that the quoted readings were obtained with a 1000ohms/volt meter, and that higher readings should be expected with more sensitive modern types.

PW

SWAP SPOT

Have Datong DC144/28 v.h.f. convertor as new. Would exchange for similar 430 or 50MHz with cash adjustment or w.h.y? Charles 0609 71636. C998

Have Sommerkamp FLDX500 and FRDX500. Would exchange for receiver with 1.8 to 28MHz plus 144 and 50MHz coverage. Both in good condition. C. Niven, 7 Tom Morris Drive, St Andrews, Fife KY16 8EW. D022

Have Cossor double beam scope 1035 w/o with manual, PW 1960-84 (297 issues), *Radio Constructor* 1953-82 (349 issues), *Electronics/Computing* 1981-2 (12 issues), 1000 valves, many boxed, some vintage, several working valve radios from 1950 v.g.c. Would exchange for w.h.y? Tel: 0293 31409. D023

Have Grundig 2100 Satellit, 13 waveband portable radio, plus 8 s.w. bands with spread, manual all in nice condition. Would exchange for 934MHz CB outfit or possibly v.h.f./u.h.f. receiver. Possible cash adjustment on 934MHz. Tel: Croughton 810270 after 5pm not weekends. D027

Have Commodore CBM64, joystick, cassette, paddles, games, etc., hardly used. Would exchange for communications receiver, FRG-7, DX302 or similar. John, 126 Meddon Street, Bideford, N. Devon. Tel: 02372 77631. D031

Have Colt 1200DX, 28-29.95MHz, f.m., a.m., s.s.b., converted by Spectrum Communications. Would exchange for p.s.u. 13.8V 15A+, offers? Tel: 038 673 532. D044

Have Partridge Joymatch a.t.u., Model 4RF, 400W p.e.p., 500µA meter fitted; test meter high impedance adaptor, KH type PE220, turns Avo 8 into 1MΩ/volt, 5.25in centres; Eagle model H-402 i.f.t.

Practical Wireless, September 1987

Got a camera, want a receiver? Got a v.h.f. rig, want some h.f. gear to go with your new G-zero? In fact, have you got anything to trade radio-wise?

If so, why not advertise it FREE here. Send details, including what equipment you're looking for, to "SWAP SPOT", *Practical Wireless*, Enelco House, The Quay, Poole, Dorset BH15 1PP, for inclusion in the first available issues of the magazine.

A FEW SIMPLE RULES: Your ad. should follow the format of those appearing below, it must be typed or written in block letters; it must be not more than 40 words long including name and address/telephone number. Swaps only—no items for sale—and one of the items MUST be radio related. Adverts for ILLEGAL CB equipment will not be accepted.

The appropriate licence must be held by anyone installing or operating a radio transmitter.

and coil kit: Amtron miniature amplifier kit UK195; Amtron radio control RX UK310 (worth at least £30). Would exchange for w.h.y? C. M. Lindars, 41 Blenheim Gardens, Wallington, Surrey SM6 9PV. D044a

Have Yaesu FT-757GX, FC-757AT, FP-757HD, hand mic. All mint condition. Would exchange for Yaesu FT-77 with f.m. and p.s.u. plus cash. G4OLC QTHR. Tel: 0670 855953. D058

Have Realistic DX200 5-band receiver. Would exchange for 4 octave keyboard in perfect order. J.H.E. Dunsford, 39 Quemerford, Calne, Wilts. D065

Have 50MHz unit for Yaesu FTV transceiver. Would exchange for 144MHz or 430MHz transceiver, linear or w.h.y? K. Mos. Rode Paard 4, 1602 DH Enkhuizen, Netherlands. Tel: 02280 16338. PAOKME. D066

Have Olympus XA11 camera with dedicated flash, Tasco ER19 zoom telescope, Boots wide angle 16x50 binoculars, will split. Would exchange for aircraft band receiver or w.h.y? Les. Barnsley 764545. D067

Have Selena 215 radio with cash. Would exchange for Sony ICF2001D or any other digital receiver. Tel: 0462 33690 evenings. D073

Mains On/Off for Battery Radios

The practice of fitting battery/mains equipment with only low voltage d.c. on/off switching is becoming increasingly popular. While this saves on manufacturing costs it could compromise the long term safety of slightly under-rated mains components. With this in mind R.T. Irish has come to our rescue with a small but ingenious circuit.

I was recently acquainted with a slightly dated radio-tape recorder, made by a reputable manufacturer, and was asked to look into the possibilities of incorporating a mains p.s.u. to replace the ever more expensive batteries. To my great satisfaction, opening the set revealed that the manufacturers had already installed a mains power unit. Only then did I notice INSIDE the set was a label marked "Switch off at mains". Further investigation showed that the set's on/off switch only controlled the 9 volt supply line and the very worrying possibility of the mains being left permanently applied to the p.s.u. was realised, this practice being dangerously unattractive.

A circuit has therefore been developed which overcomes this problem by switching the mains supply on or off using low voltage switching, making the whole system intrinsically safe.

Circuit Description

The heart of this arrangement is shown in Fig. 1, the circuit can be installed just after the mains power pack reservoir capacitor, before any voltage regulation circuitry.

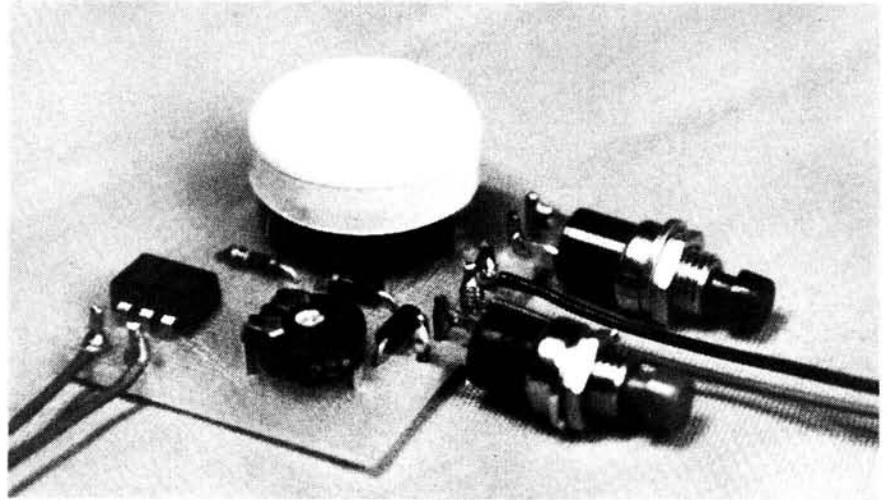

Completed p.c.b.

The mains voltage switching is carried out using an optically-fired Triac, IC1. The supply for the l.e.d. within this device is obtained from the d.c. output of the supply via D1, the 10kΩ preset resistor R1 and the normally-closed "off" switch S2. When the unit is running, the current passing through the l.e.d. in IC1 is adjusted to the point where the Triac just fires, maintaining

the supply. When the "off" button is pressed, the current through the l.e.d. falls to zero and the Triac no longer conducts. The reduction in supply voltage during the short time the "off" button is depressed ensures that the supply will not be reactivated when S2 is released.

To switch the circuit on, a small rechargeable 3-6 volt NiCad battery is

Fig. 2: Full size track pattern and component layout for switch p.c.b.

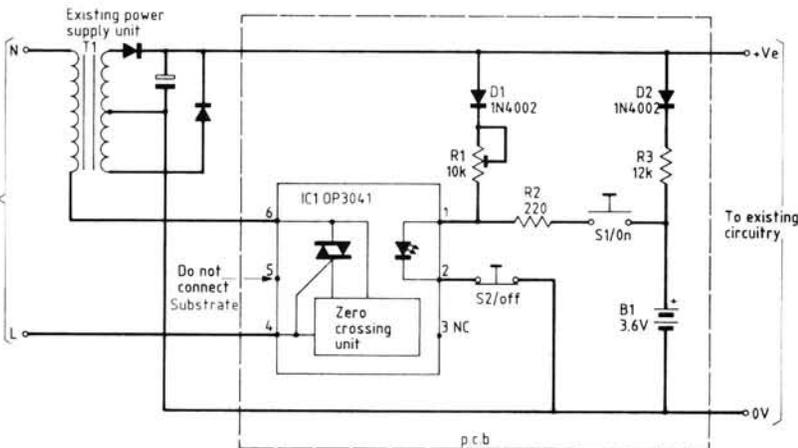
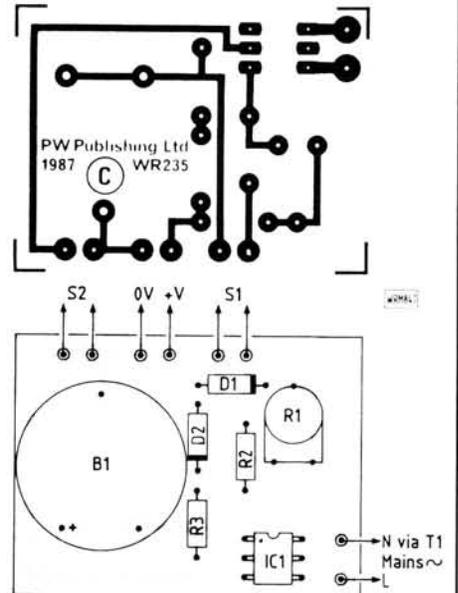

Fig. 1: Power supply and switching system

incorporated. When the "on" switch S1 is closed, a current flows from B1 through the l.e.d. in IC1, via a limiting resistor R2, this in turn fires the Triac, starting the power supply, which on the release of S1, will maintain itself. When working, there is a 1mA trickle charge current to the battery, via D2 and resistor R3.

Circuit Application

As has already been discussed, this arrangement has been devised with small transistor radios or cassette recorders in mind. There is no reason however, why it should not be used in other areas where the low voltage mains control has safety attractions.

Suppression

In view of the zero-crossing switching characteristics of the Triac, interference suppression components are not required. **PW**

SHOPPING LIST

Resistors

0.25W 5% Carbon film
220Ω 1 R2
12kΩ 1 R3

Horizontal skeleton Preset
10kΩ 1 R1

Semiconductors

Diodes
1N4002 2 D1,2

Integrated Circuits
OP 3041 1 IC1
Maplin order code RA56L



Miscellaneous

B1 3-6V NiCad p.c.b. mounting, Maplin order code RK46A; S1 Push-to-make switch; S2 Push-to-break switch; Veropins; Wire; p.c.b.

NEWS DESK

Can You Help?

Mr J.H. Robinson is looking for a Mustang Instant Sound radio in new condition. Apparently it is mains/battery, a.m., air, f.m., solid state and made in Hong Kong. If you can help him, please write to 20 Ramsay Place, Glenrothes, Fife KY6 1DY.

Another reader looking for help is Gerard Craig G4IUT. He is trying to trace a school friend who started him on the road to radio. He was Thomas Dawson and lived in Droylsden, Manchester. They lost contact in 1955 when they left school. If you know of Tommy's whereabouts, drop me a line.

Another reader would like two output transistors, the

M341 Z189 and the M401 Z188, for a Leak 2000 receiver. Otherwise, does anyone know of equivalents or another Leak 2000 going for spares? If you can help either write to Mick Cooper at 3 Artillery Close, Paulsgrove, Portsmouth, Hants PO6 4HD or telephone him on 0705 37 1018.

We also have pleas for help from overseas readers. This time we are looking for a circuit diagram for a Philips BX511A radio. It's the i.f. strip that is driving our reader up the wall, with its tendency to oscillate. If you can help with more information on this piece of equipment, please write to: Reynir Heidberg Stefansson TF6-005, Holtagotu 3, IS-730 Reydarfirdi, Iceland.

CB Licence Evasion

A concerted campaign to combat CB licence evasion is being carried out in London by the DTI Radio Investigation Service.

The campaign is part of a continuing effort by the DTI to ensure that CB users are licensed. As well as countering licence evasion, the RIS will also be checking on the use of illegal equipment. Linear amplifiers, a.m. and single sideband equipment. Linear amplifiers,

a.m. and single sideband equipment as well as certain types of antennas are all outlawed under CB regulations.

A CB licence currently costs £10 and can be bought from Post Offices. The maximum penalty for unlicensed use is a fine of up to £2000 and/or up to three months imprisonment. The courts are also empowered to order forfeiture of equipment.

Practical Wireless, September 1987

multiple choice... multiple choice... ANSWERS multiple choice... multiple choice...

The answers to "Multiple Choice Questions", page 52, August 1987

Question 8-1. Answer-a.

It is worth remembering the formula for the effective resistance of 2 resistors in parallel:

$$R = \frac{R_1 \times R_2}{R_1 + R_2}$$

In this case, $R = 10\Omega$ and $R = 90\Omega$

hence $R = \frac{10 \times 90}{10 + 90} = \frac{900}{100} = 9\Omega$

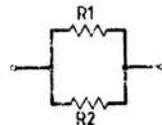

Question 8-2. Answer-c.

An ammeter needs to go *in* the wire taking the current to be measured. In contrast, a voltmeter to measure the voltage *across* the terminals of the receiver would go at position D.

Question 8-3. Answer-d.

Who can operate the station and when they may do so is stated in Clause 1 (2) (c) of the Licence.

Question 8-4. Answer-b.

In a circuit containing only capacitance the current lags the voltage by 90 degrees.

Question 8-5. Answer-a.

The output impedance of an amateur transmitter is normally 50Ω. The a.t.u. tunes the antenna so that it presents an impedance of 50Ω to the transmitter. In CB jargon an a.t.u. is often called an antenna matcher; and "matcher" is in fact a more accurate description of what it does.

Question 8-6. Answer-b.

$$\text{Velocity ratio} = \frac{\text{velocity of wave in the cable}}{\text{velocity in free space}}$$

Radio waves travel more slowly through a cable than through space, so the velocity ratio (sometimes called velocity factor) is always less than 1. The actual value depends on the dielectric in the cable; for semi-air spaced coaxial cable the velocity ratio is approximately 0.86.

A Smarter Repeater

Part 1

The use of microprocessors, or even a small personal computer such as the CBM-64, ZX81 or HP41, in the control system of a repeater allows very complex control algorithms to be programmed, and evaluated in service, with much less trouble and no more expense than is necessary to implement very simple control systems in hard-wired logic. At very little increase in cost and complexity a host of extra features might be added to improve the repeater function, reduce the possibilities of abuse, and provide several novel services to the Amateur community.

This article, by J.M. Bryant G4CLF, contains a number of ideas, ranging from the obvious to the outrageous, which might be implemented in a new repeater.

Timing the Repeater

Since each different interval to be measured in early repeaters required a separate timing circuit (using either a 555 timer or t.t.l./c.m.o.s. counters) the number of different intervals traditionally has been kept to a minimum. A microcomputer can simultaneously measure a large number of different periods and, with the addition of an extra inexpensive chip and back-up lithium battery, function as a 20-year clock/calendar which retains its timing during power loss at the main machine.

Early repeaters contained a timer which was reset at the start of each new transmission and turned off either the audio or the transmission after a preset interval which was generally in the range 45-180 seconds. This logic provided the opportunity for the ill-intentioned to jam the repeater for indefinite periods—so more modern repeaters often remove the timeout and permit either unlimited or very long transmissions.

This is sensible—repeaters should not limit the duration of transmissions but should, at the end of all transmissions over five minutes long, transmit their duration so that the verbose user is advised of the length of his over. The form in which this information might be transmitted is discussed later.

Access

The choices for repeater access are carrier, tone and key. A carrier-accessed repeater opens whenever a carrier at the correct frequency is detected at its antenna; this is a very convenient system and is widely used in the USA, but has the disadvantage that a mobile station outside the service area and working another repeater on the same channel may continually open the repeater for short bursts and annoy people monitoring it. Carrier access is sometimes combined with modulation detection so that an unmodulated carrier will not open the repeater, thus preventing one variety of jamming.

A tone-accessed repeater requires a short toneburst (1750Hz in the UK and most of Europe, 1800Hz in the USA) to open it. The duration of the toneburst needed varies from 100ms to 50

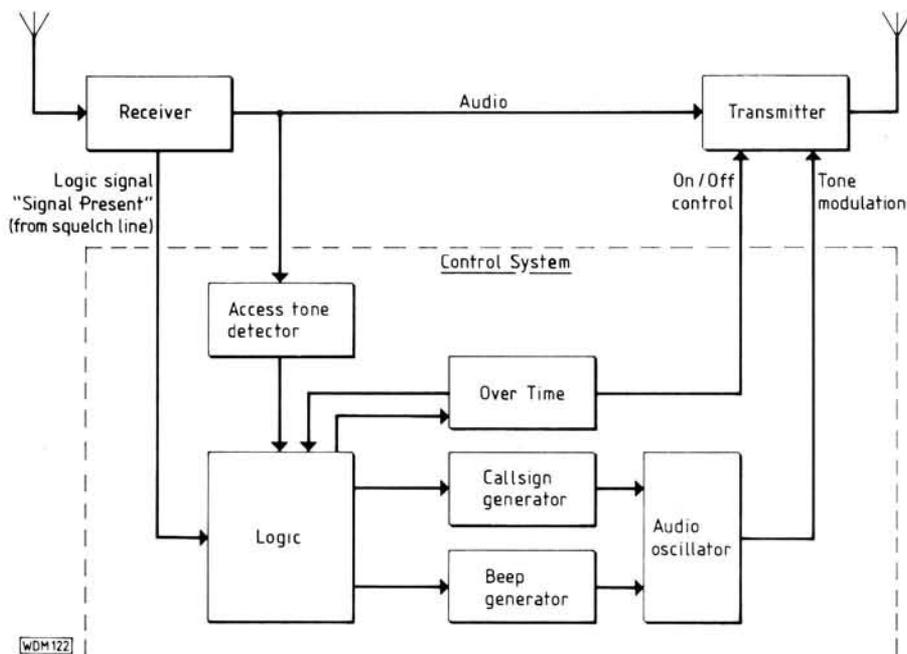

Fig. 1: Typical repeater (Note: details of antenna multiplexing not shown)

1 second for different repeaters. Some tone-accessed repeaters require a toneburst at the start of every subsequent transmission, others will re-access with carrier alone. Most tone-accessed repeaters contain either a sharp notch filter at the toneburst frequency or an audio mute circuit which functions while a tone is detected. Modulation detectors are frequently used to prevent the repeater latching open unless modulation is present as well as tone.



“... The verbose user is advised of the length of his over...”

Tone access with carrier re-access is the best system for public repeaters. Modulation detectors are also useful but should not be too demanding in the standard of transmission they expect (if the opening phrases of transmission do not meet the local standards of over- or under-deviation, no signal is relayed). Burst length should be short—100ms is ample. The tone should be suppressed with a notch filter rather than an audio mute as some automatic tonebursts can be up to a second in duration and many operators talk over them; tone-triggered mutes suppress the first words of an over (often a callsign) in such cases. If the controller detects a series of short carrier re-accesses with modulation such as might arise from a weak mobile station it would shut down after a period. (If anyone wants to hear what is happening during such low-level “flutter” they may override the shut-down with a toneburst which will, of course, open the repeater again for another “period”.) The duration of “short” and “a period” will require experiment, but initial values might be 0.5–1.5 and 20 seconds respectively.

Key access is normally reserved for private repeaters; there are no key-accessed repeaters in the UK. Access is by the transmission of a complex code which identifies an authorised user to the repeater. While a UK repeater cannot be key accessed for normal use, it might very conveniently be fitted with key access codes for remote control of mode of interrogation of its log or other records by authorised users, such as the Repeater Operating Group (licensing regulations prohibit some types of remote control as being liable to jamming but this should not prevent non-essential functions being accessible in this way; if they do the RSGB should consider renegotiating them in the interests of versatility!). To prevent abuse these might be interactive: on receipt of the first key the repeater sends a challenge to which the station requiring access must make the correct response. It is improbable that a prospective jammer could learn the correct responses—particularly if each was used only once.

Additional features of the access and re-access which are intended only to minimise jamming of the repeater and do not affect its legitimate use are described in the section on jamming in Part 2.

Re-access

The simplest re-access of a repeater occurs with a carrier-accessed (or re-accessed) repeater with no timeout. When one station ceases transmitting another may start; the Malvern Hills repeater, GB3MH, uses this scheme. It has the drawback that a weak background station working another co-channel repeater may be confused with a station trying to break in.

Another common system is for the repeater to send a short tone when the carrier drops—another station may then gain access. A development of this sends two tonebursts, one as soon as the carrier is dropped and another 2 or 3 seconds later. Stations involved in a QSO are supposed to wait until the second tone before re-accessing so that other stations may break in during the pause. This is an excellent system when observed.

Some operators do not observe the system and re-access after the first tone (for some reason they always seem to be the operators who talk for 10 minutes per over!). This can be frustrating for a station waiting to break in and dangerous in an emergency; a repeater which times out after 20 seconds if re-accessed between tones will discourage such abuse. However, such a system is incompatible with the occasional brief loss of signal due to mobile flutter and may be a drawback when a station breaks in to report an emergency. This is where a microcomputer, properly programmed, can provide real benefits. If the receiver in the repeater has an S-meter with a digital output available to the controller, a simple routine can recognise a mobile signal from its

varying level before it drops out, and allow for it when it does. Furthermore, the nature of the timeout can be changed by a smart system: the first time in a QSO that the repeater is accessed between tones the timeout is no more than a superimposed tone after the 20 seconds, with a warning given at the end of transmission. Subsequent offences can be dealt with less leniently, probably by loss of audio.

Beacon Mode

There is a case to be made for allowing all repeaters to transmit continuously, whether they are relaying a signal or not, so that they may be used as beacons in addition to their primary function. This may not be practicable under UK licensing regulations and is certainly not done. Nevertheless, some repeaters do send their callsign from time to time, whether accessed or not, and this allows them to be used as beacons.

A smart repeater containing an accurate clock/calendar can send accurately timed callsigns—say, on the hour and at exactly 10, 20, 30, 40 and 50 minutes past—so that remote stations wishing to use it as a beacon may easily identify it and distinguish it from other repeaters on the same channel; stations may also use it as a time signal. These timed callsigns should have absolute priority.

A repeater should also send its callsign when first opened and before closing down. If either of these callsigns would still be in progress when one of the timed ones is due, or is triggered during one of the timed ones, then a smart controller allows only one to be sent—and that the timed one.

Some repeaters will only send their callsign after being accessed by toneburst and several seconds of modulated carrier. This seems unnecessary: it is quite legitimate for a station to check that it can access a repeater before attempting to use it, and transmission of a toneburst should therefore trigger a response. This has not been done in the past because of the activities of fools who continually access a repeater without identifying themselves or using it. Here again a smarter controller is of use—if only 2 such short, unmodulated accesses are permitted in any 5 minute period, the function can be allowed but abuse is minimised.

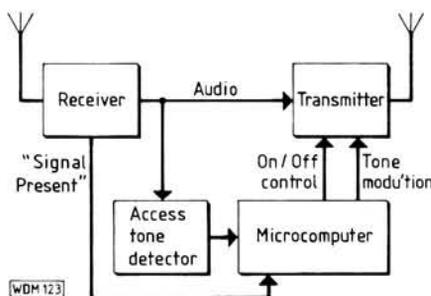

Fig. 2: Basic microcomputer-controlled repeater (microcomputer may contain a clock/calculator)

Information Provider

The purpose of a repeater is to relay signals between two stations that might otherwise be out of range; any other use should be strictly secondary and not allowed to become obtrusive. It is perfectly possible for a repeater to provide a large quantity of information to users, but it should not do so except on request—repeaters that play a long tune of coded tones at the end of each transmission are a bore.

There must, therefore, be some simple way of requesting the repeater to provide data: the simplest way would be to send a toneburst followed by a short, unmodulated carrier. The duration of the carrier would determine the particular information required. Non-standard tone frequencies or tone durations might also be used but these would make the service unavailable to the casual user.



“... Repeaters that play a long tune of coded tones ...”

The commonest data provided by repeaters are details of the user's carrier frequency, toneburst frequency, signal strength and deviation (if data is requested by an unmodulated carrier the deviation figure would have to refer to the previous transmission). Quite simple measuring circuitry in the repeater's receiver could provide these measurements and also details of residual a.m., level of 100Hz hum, level and frequency of reference sidebands from p.l.l. synthesisers, and duration of toneburst. If the repeater has a direction-finder (see section on jamming) it might indicate, on request, the bearing of a station as well.

The above information relates to the station using the repeater. A repeater might also provide other information of use to amateurs, such as the time, details of propagation conditions (which could be obtained automatically if the station was equipped with a receiver tuned to a distant beacon), meteorological conditions (which again could be measured automatically on site), details of local clubs, and local and national amateur radio news—if such a service could be licensed and someone was willing to update it regu-



"Might indicate the bearing of a station on request..."

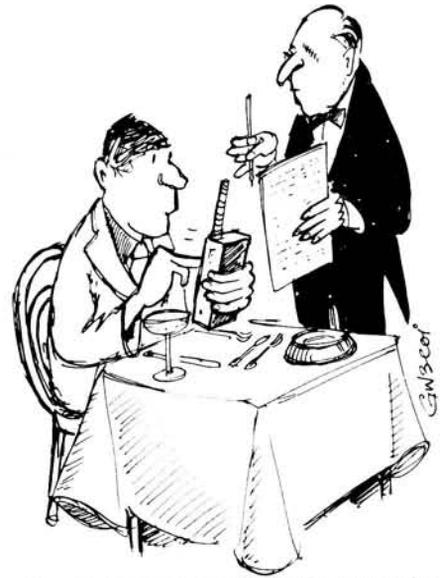

"... Selects items from the menu by keying..."

larly. Any long transmission should not be available at times of heavy traffic, but most of the other information could be conveyed by a tone, c.w., or RTTY and would not greatly affect other repeater users.

Some information might be encoded as voice. Speech synthesizers are available for microcomputer interface which cost only a few pounds and have ample vocabulary for the above purposes. Research is needed, however, to find out whether speech, c.w., RTTY, or coded tones are more convenient. With a smart controller it would not be difficult to provide all four on demand.

With voice output the information services might be menu driven: the user accesses the information program with a toneburst and 1-2 seconds of carrier, and the repeater responds with a menu of available information. The user selects items from the menu by keying his transmitter at the appropriate moment. Such a system does have a drawback, however, in that it prevents normal repeater use while information is sought, and repeater designs must strike a balance between information and communication. This balance may be altered at different times of the day according to activity levels.

In Part 2, J. M. Bryant G4CLF looks at jamming repeaters and how to combat it, as well as some advanced features for the smarter repeater.

SWAP SPOT

Have hundreds of new valves. Would exchange the ones you need for a copy of operating instructions and data on a Lafayette Radio Tube and Transistor Tester, Model TE-21. Tom Valentine GM1XHZ. 38 Grampian View, Montrose, Angus DD10 9SX. Tel: 0674 76503. *D086*

Have 9.5mm projector with films, cartoons, etc. Working order but needs brighter lamp. Also mint cine camera to match. Would exchange for MD1B8 desk mic or 28MHz mobile multi-mode or w.h.y? Tel: 0508 31229. *D096*

Have Marconi 1920s V2 receiver complete with distribution box and handbook. Would exchange for hand-held scanner. Ray. Tel: 0476 66047. *D097*

Have QRO 10GHz klystron, 75mW WG flange output, micrometer tuned. Would exchange for signal generator. G4FFO. Tel: Cambridge 860150. *D106*

Have Heathkit Experimenter Trainer ET-3100B, in kit form unused in original packing, plus electronics communications course EE-3106 again unused. Would exchange for general coverage receiver e.g. FRG-7, SRX30 etc. Alex G4ZDX. Tel: 0602 625146. *D110*

Have FRG-9600 Withers Mark II still under guarantee. Would exchange for Sony ICF2001D similar condition plus cash adjustment. Peter. Tel: Kings Lynn 841119. *D125*

Have Yaesu FT-100 h.f. rig. Would exchange for R600 receiver or 144MHz multi-mode or w.h.y? Tel: 0952 57670. *D135*

Have PRO-2004 25-520 and 760-1300MHz scanner boxed as new also DX302 10kHz-30MHz receiver in good condition. Would exchange for FRG-9600 in good condition with p.s.u. Steve. Tel: Bloxwich 493331. *D141*

Have Sony HV200P video camera worth £150. Would exchange for general coverage receiver e.g. R600 or R1000, etc., or older with cash adjustment. Might also consider 430MHz multi-mode transceiver or disk drive for BBC. Phil Gabel. Tel: 0604 864249, 6-8pm. *D152*

Have microwave components, e.g. lengths of WG16 complete with flanges and rings, burglar alarm, unit guns, etc. and PW back numbers for construction of PW "EXE" Microwave Transceiver. Would exchange for signal generator and or frequency meter. Tel: Warrington 62410. *D154*

Have Olympus XA2 35mm compact with A11 flash, new condition in case. Would exchange for Philips 580A mains radio. Roy. Tel: 0272 776891. *D168*

Got a camera, want a receiver? Got a v.h.f. rig, want some h.f. gear to go with your new G-zero? In fact, have you got anything to trade radio-wise? If so, why not advertise it FREE here. Send details, including what equipment you're looking for, to "SWAP SPOT", Practical Wireless, Eneco House, The Quay, Poole, Dorset BH15 1PP, for inclusion in the first available issues of the magazine. A FEW SIMPLE RULES: Your ad. should follow the format of those appearing below, it must be typed or written in block letters; it must be not more than 40 words long including name and address/telephone number. Swaps only—no items for sale—and one of the items MUST be radio related. Adverts for ILLEGAL CB equipment will not be accepted. The appropriate licence must be held by anyone installing or operating a radio transmitter.

Have 1000 new boxed valves from vintage (AC/Pen) to modern (6F33). Would exchange the whole lot or just the one you want for any good d.i.y. tools or materials. Tel: 021-472 3688 (answer phone when not in). *D181*

Have 934MHz Reftec transceiver with 2x18-element Yagi v.g.c. Would exchange for 144MHz or 430MHz transceiver. Jon G1DYG. Tel: 0249 712009. *D182*

Have ex-RAF mains p.s.u. suitable for R1332 receiver plus large RSGB world prefix wall map, mint unused. Would exchange for 19 Set rotary p.s.u. Type less generators wanted. Callers only, item heavy. Mr T. Heslop, 75 Alder Park, Brandon, Durham DH7 8TJ. *D185*

Have a collection of early cigarette cards, 106 sets, catalogue value £1100. Nothing rare but a nice general collection. Would exchange for general purpose receiver or transceiver could be ex-government equipment. Mr Howlett, 122 Victoria Avenue, Hull HU5 3DT. Tel: 0482 441255. *D186*

Have Uniden 175XL base scanner plus discone antenna with cable and plugs. Both in mint condition, only one month old with guarantee. Would exchange for Uniden 100XL hand-held scanner. Must be in good condition. Dave Jnr. Tel: Wigan 227782. *D206*

Have Ferrograph Series 5 reel-to-reel tape recorder also pair of Heathkit Berkeley loudspeaker units (each cabinet containing 12 inch and 3 inch speakers). would exchange for BRT400, Eddystone, AR88 or similar receiver. Tel: Whitby 601567. *D208*

Have s.s.b./c.w. 3.5/28MHz transceiver. Three crystals each band plus v.x.o. with matching speaker and p.s.u. Would exchange for general coverage receiver or 144MHz multi-mode or FT-101E accs. Brian. Tel: 06462 2825. *D225*

SITUATED AT SOUTHERN END OF M23 — EASY ACCESS TO M25 AND SOUTH LONDON

HF RECEIVERS	£	(c&p)
Icom ICR71	825.00	(—)
Kenwood R2000	595.00	(—)
Kenwood VC10 V.H.F. Converter	161.94	(2.00)
Kenwood R5000	875.00	(—)
Yaesu FRG8800	639.00	(—)
Yaesu FRV8800 V.H.F. Converter	100.00	(2.00)
Lowe HF125	375.00	(—)

HF TRANSCEIVERS	£	(c&p)
Kenwood TS940S	1995.00	(—)
Kenwood TS930S	1695.00	(—)
Kenwood TS440S	1138.81	(—)
Kenwood TS430S	974.23	(—)
Kenwood TS830S	1098.00	(—)
Kenwood TS530SP	927.51	(—)
Yaesu FT980	1785.00	(—)
Yaesu FT757GXII	969.00	(—)
Yaesu FT767GX	1550.00	(—)
Icom IC735	949.00	(—)
Icom IC751A	1465.00	(—)

V.H.F. SCANNING RECEIVERS	£	(c&p)
Icom ICR7000	957.00	(—)
Yaesu FRG9600M 60-950MHz	509.00	(—)
A.O.R. AR2002	487.30	(—)
Signal R532 "Airband"	224.00	(—)
Sony Air 7	249.00	(—)

V.H.F. SCANNER ACCESSORIES	£	(c&p)
A.K.D. HFC1 HF Converter	49.00	(1.00)
Revcone Discone Antenna 30-500MHz	31.50	(2.00)
Icom AH7000 Antenna 25-1300MHz	82.00	(3.00)

ANTENNA TUNER UNITS	£	(c&p)
Yaesu FRT7700 Short wave listening	59.00	(2.00)
Yaesu FC757AT	349.00	(—)
Kenwood AT230	208.67	(2.50)
Kenwood AT250 auto	366.00	(—)

Z.M. TRANSCEIVERS	£	(c&p)
Kenwood TH21E Handheld	189.00	(—)
Kenwood TR751E 25w multimode	599.00	(—)
Kenwood TS711E base station	940.00	(—)
Kenwood TH205E Handheld	215.26	(—)
Kenwood TH215E Handheld	252.13	(—)
Kenwood TW41000E 2m/70cm FM Mobile	699.00	(—)
Yaesu FT290II Portable multimode	429.00	(—)
Yaesu FT270RH 45w F.M. mobile	469.00	(—)
Yaesu FT276R base station (70cm optional)	999.00	(—)
Yaesu FT23R + FNB10 Handheld	253.50	(—)
Icom IC2E Handheld	225.00	(—)
Icom IC02E Handheld	299.00	(—)
Icom IC28E 25w mobile	359.00	(—)
Icom IC271E base station	835.00	(—)
Icom IC3200E 2m/70cm F.M. mobile	556.00	(—)
Icom Micro II Handheld	239.00	(—)

70cm TRANSCEIVERS	£	(c&p)
Kenwood TH41E Handheld	218.00	(—)
Kenwood TS811E base station	1094.05	(—)
Kenwood TH405E Handheld	273.18	(—)
Kenwood TH415E Handheld	298.85	(—)
Yaesu 70cm module for FT26R	349.00	(—)
Yaesu FT73R + FNB10 Handheld	273.50	(—)
Icom IC4E Handheld	285.00	(—)
Icom IC04E Handheld	299.00	(—)
Icom IC471E base station	927.00	(—)

KENWOOD ACCESSORIES	£	(c&p)
MC 50 Desk Microphone	46.08	(2.00)
MC 60A Desk Microphone with Pre-amp	88.22	(2.00)
MC 55 Mobile Microphone with Control Box	52.67	(1.00)
MC 35S Hand Microphone 4 pin	21.72	(1.00)
MC 40S Up/down Hand Microphone 6 pin	19.07	(1.00)
MC 43S Up/down Hand Microphone 8 pin	22.22	(1.00)
SMC 30 Speaker Microphone TH21	28.31	(1.00)
LF 30A Low Pass Filter 1KW	32.26	(2.00)
FF501DX Low Pass Filter	37.50	(2.00)
SP 40 Mobile Speaker	21.06	(1.00)
HS 7 Miniature Headphones	15.80	(1.00)
HS 6 Ultra Light Deluxe Headphones	24.36	(1.00)
HS 5 Deluxe Headphones	37.54	(1.00)
HMC 1 Headset with Vox TH21 etc.	32.91	(1.00)
VS 1 Voice Synthesizer Module	32.26	(1.00)
AD 1 Screwed Phono to BNC		
Adaptor TH21E/41E	3.85	(0.50)
IF 232C RS232 Interface TS711/811E/940/440/R5000	72.89	(1.00)

ANTENNA BITS	£	(c&p)
HI-Q Balun 1:1 5kW P.E.P.	12.50	(1.00)
Bricomm Balun 4:1 1kW	11.20	(1.00)
Bricomm 7.1MHz Epoxy Traps (pair)	9.95	(1.50)
Self Amalgamating Tape 10M x 25mm	4.25	(0.75)
T-piece polyprop Dipole centre	1.60	(0.25)
Small ceramic egg insulators	0.65	(0.20)
Large ceramic egg insulators	0.85	(0.20)

CABLES ETC.	£	(c&p)
URM67 low loss coax 50 ohm	0.75	(0.25)
UR76 50 ohm coax dia. 5mm	0.30	(0.10)
UR70 70 ohm coax	0.35	(0.10)
UR95 50 ohm coax dia. 2.3mm	0.40	(0.10)
4mm Polyester Guy Rope (400kg)	0.20	(0.10)
50mtrs. 16 swg hard drawn copper wire	6.95	(1.50)



GOODS NORMALLY DESPATCHED WITHIN 24 HRS — PRICES CORRECT AT TIME OF GOING TO PRESS — E&OE — MAIL ORDER AND RETAIL

BREDHURST ELECTRONICS LTD HIGH ST, HANDCROSS, W. SX. RH17 6BW (0444) 400786

VARIACS. All 240v I.P. var O.P. all 0 to 270v 2 amp £18.50 8 amp £40. 10 amp £48. **SCOPES.** Solartron general purpose dual beam DC to 15 Megs at 100 Mill V T.B. 0.5 Us to 200 Mill/Sec Cm 5" flat tube 4Kv size 13" x 7" 17" modern style unit with leads & book tested. £95 **DISPLAY UNIT** Aircraft head up display units uses projection type CRT to project image via mirror & lens unit onto A.C. windscreen. as 4" dia F 0.97 lens unit. 45" mirror. 24v DC motor drive ass., ground glass screen. req ext EHT & Deflection amp. £35 in case or £30 less case. **COMP. K.B.R.D.** by NCR as 52 keys size 12" x 7" 4" no info. £8.50 **SPK UNIT** Army AFV spk 3 ohm in metal case 5 1/2" x 3 1/2" £8.50 **TRIPODS** Army ex missile launcher heavy duty will support 50kg length closed to top 41" legs fixed length but adjust to 45" as motorised Pan to 360° 24v DC with fixed elevation with cable drum & 60 Mt cable. £85 **ARENOID CAPSULES** by Smiths 2 1/2" dia with connection via small bore pipe & 1/2" threaded union, as connection for pointer or similar new. £3.50 **MONOC SIGHT.** Army elbow sight 5" x 27.5mm adjust focus. £9 **MOTOR** very slow speed for 240v mains reversible 2 mm per rev as two shafts 5.8th by 5.16th dia motor size 5" x 5" 3 1/2" £14.50 **HEADSET** Ampitox modern style padded 600 ohm new. £16.50 **AERIAL KITS** 30ft with 10" x 1" dia screw sections also inc guys, stakes, base insul. base spike carry bag etc new cond. £36 **METERS.** 500 Ua 2" dia. £3. 1 Ma 1 1/4" dia £4 100 Ua 2 1/4" dia £5 also mixed 6 different for £7.50 **PROTECTION UNIT.** Army unit used to provide over voltage & s/c protection for 12/24v DC equip adjustable voltage protection and S-C protection at 20 amps fitted DC voltmeter reqs DC I.P. & mains size 16" x 10" x 6" £18 **AUTO TRANS** 240 115v at 500w enclosed £18 also 150w £7.50 mains trs 240v Sec 60-0-60v at 5 amps. £14.50 also 6.3 5a 6.3 2a at £7.50 **V.H.F. Ae.** aircraft mt type 1/4 wave norm 125 Mc s 29' long with insul mt base & coax connec. £8.50 **U.H.F. Rx.** single chan crystal controlled Rx made for CA by STC tunable to any freq in range 225-400Mc/s with suitable crystal reqs 12v DC as low level AF-U.P. size 19" x 4 1/2" x 3 1/2" £33. **DISH AE.** aircraft X band radar dishes 32" dia 5" deep Dural some perforations new. £26.50. **COAX** 75 ohm type UR57 10mm OSD HD 15mts for £6.50 30p mt over this.

Above prices include Carr/Post & VAT. Goods S/Hand unless stated new. 2 x 18p stamps for List 40/1 allow 14 days for delivery.

A.H. SUPPLIES
122 Handsworth Rd, Sheffield S9 4AE.
Phone: 444278 (0742).

CRICKLEWOOD ELECTRONICS LTD

It's no secret!

that there is a real difference at Cricklewood Electronics. That's why you should never be without the **FREE CRICKLEWOOD ELECTRONICS COMPONENTS CATALOGUE**, for sheer variety, competitive prices and service from the U.K.'s number one 100% component shop. No gimmicks, no gadgets or computers, just components, millions of them, all easily available by mail order, calling or credit card telephone orders. Just pick up the phone (for a pen) to get your **FREE** copy now (no SAE required). You have nothing to lose.

CRICKLEWOOD ELECTRONICS LTD.
40 Cricklewood Broadway NW2 3ET.
01-450 0995 & 01-452 0161
ALL MAJOR CREDIT CARDS ACCEPTED
Telex 914977 Phone or write today

USED AMATEUR EQUIPMENT?

I Buy, Sell & Exchange!

Whether **SELLING** or **BUYING**, if you're talking **TOP QUALITY USED AMATEUR EQUIPMENT.**

Phone **G4TNY** for the **BEST** deals around !!

Phone Dave on 04024 57722 or 0836 201530, 9am to 7pm, Mon to Sat

Ask about our new 'RIGSEARCH' services.

Send SAE for lists.

Personal callers by appointment, please.

G4TNY AMATEUR RADIO

MAIL ORDER

132, Albany Road, Hornchurch, Essex RM12 4AQ

PART EXCHANGE

On The Air

On The HF Bands

Reports to Paul Essery G3KFE
Practical Wireless, Enefco House, The Quay, Poole, Dorset BH15 1PP

What a pleasure to receive so much mail this time! So—thanks to all concerned.

There seems to be doubt among the readers as to precisely what should be reported. . . YOUR DX and news, I reply. As to the definition of DX, that is a very personal thing. To a chap with 350 countries in the log, a VK or a ZL is a commonplace hardly worth a mention; to a new licensee on his first log page, it is a DX dream realised, and well worth a mention. You decide what to mention, and normally, I list your DX in full. However, when space is short, I do sometimes have to prune a long list down, by picking out the calls I feel will be of most interest to readers generally.

Clot of the Month

I was on 14MHz c.w., just quietly having a listen round one lunchtime when I heard a Russian station with a T2 note, and I.f. parasites giving him offspring about every 10kHz up and down the band. He was calling CQ, and when he went "over", our Clot of the Month called him and had a QSO during which he handed out a report of "T9 fb signal, om"! Just how barmy can you get?? Admittedly his Russian locals will be searching him out to tell him he has a problem, but why not warn him first by way of an honest report? No way was he T9, so anyone giving such a report is a twit, to put it mildly.

Don't forget, all entries in this section go in the hat for the Clown of the Year Award!

Contests

I have never been of the lobby that says "Ban all contests". However, the question must be asked whether something could not be done about the proliferation of lesser contests, to the extent that every weekend of the year sees one at least, and usually more. Indeed, sometimes there are four in a single weekend. Some are important—the VK/ZL/Oceania, the ARRL, the CQ WW, the Russian and European ones—and can usually be relied on to create activity from faraway places with strange-sounding names. Most of the others are parochial affairs indeed, set up by people who have no idea of what dates are already booked or where to find out. Heaven help us, W1WY's column in *CQ Magazine* must be the standard list, and Frank has passed details to most columnists for several decades now. Couldn't the world's national societies get together and get a grip on the contest scene, so that non-contesters get a fair crack of the whip, and so that local contest organisers don't foul up major contest dates, most of which have been settled for decades, as for instance NFD.

The 28MHz Band

June is usually the time when this band opens up during sunspot minima, and certainly this minimum has demonstrated clearly that in previous cycles the band was often "dead" for no better reason than lack of activity; lots of people listening, no-one calling CQ equals "dead" band even if it's open!

G4STB (Truro) runs a Stalker multimode CB conversion in the car, into a 5/8λ DX27

boot mounted; contacts included ones with I4DSP, DL4HBL, I4LEC and CN2AQ, all between 1445Z and 1620Z; obviously lunch time and on the drive home.

G4HZW (Knutsford) uses a TS-820 into a two-element quad on 28MHz, and during the month of June found plenty of Sporadic-E; normally Ws are noted towards the end of June but this year they appeared as early as June 8. Also noted, two-hop Sporadic-E contacts with UA9 and one in Zone 18. This underlines the importance of looking both ways—everybody works Ws but doesn't realise about the UA9/UAOs. Tony made it to UA9, CE3HI, CN2AQ, CT, DL, EA, EA6, EA8, EA9, F, GB0SWR/MM (the Operation Raleigh ship on the way home), G4XCV, G0AIX both in Cornwall, HH2MC, HB0, HB9, I, LA, OY6FRA, OZ, OH, SM, UZ6, UA9YGC, RA9HZZ, RA9XBM, RA9UAD (Zone 18), RC2, RA3, UM8MIG, TZ6FK, W1, W2, W3, W4 and W0 (Iowa). Gotaways included HG, YU and YV2CTT. That is 28MHz at the BOTTOM of the sunspot cycle!

G4KJV (Chippenham) made 28MHz contacts with 5A0A (twice), YU, EAs and DL1SN. Incidentally, on June 5, DL1SN was hooked on, successively, 24.899, 10.116, 28.030, and 21.030MHz over a period of 30 minutes!

G4XDJ (Billingham) notes his contacts with F9QQ, F6EHE, G0GKO/M, EA2BUN and EC4CRB; all were with five watts to the FT-200.

Newcomer G0GWK (Newbury) has dipoles for 14 and 28MHz at about 5.5m up, and on 3.5MHz makes the odd QSO using a mobile whip; the rig is FT-757. All s.s.b. contacts on 28MHz included CE4JLK, VE1BNN, 4U2ITU, EA8MT, ZC4AP, 9Y4BA, LU2DYT, 3G2Z (Chile), PY2AEB, K2SIG, KA2YXP, WB2MNO, WA2EOV, KA2UWI, NF1Y, KA1MAE, KA1QAH, K3WUW, HB0/DA1WA, TK/DL6RBS, EA6BO, plus DJ, EA5, EI5DR, HB9, IY4FGM, LA4RJ, OE8MOK, PA3DZN, SM00WX, UA6AMO and YU7BCO.

G3BDQ (Hastings) went on the band and found ZC4AP and DL1KBQ/EA6 on s.s.b., as well as enjoying many cross-band 28/50MHz contacts.

Even G2HKU (Sheppey) has visited the band; Ted used c.w. to work LA9HF, HB9M, G6ZY/EA6 and ED9EXP.

G3BSN (London SW9) still suffers from the QRM from computers and fruit machines and notes there was a super opening the day after his last letter. Phillip managed CT, DL, EA, F, I, OH, LA, PA, SM, SP, UA, YU and 4X, plus most of the beacons. Although 5A0A hardly comes into the category of a beacon—Bert has been dishing out Libya QSOs to all and sundry for some time now, but closed down and returned to Poland at the end of June. Other stations to fall for the wiles of G3BSN's r.f. included DH1AAE, DL1MDV, DL2NBU, IK1HFH, IK3HUE, I7DKE, DJ2KB, DL6KT, G2FHX, HA5AAP, OE3ATW,

OE5KPN, SM7GNG, SM0DJZ, SP5JR, SP7MUZ, UQ2GFB and YU7BW, plus, from the mobile rig, c.w. with CN2AQ. More "true DX" were CE3HF1, CX7AR, PY3ARR and K3WW. Phillip also listened to some of the cross-band 28/50MHz work noting WA2BQT, WA1EKV, WA2BSX, W3RTL, KS3L and W1AN all making contacts. However, the Icom 751 had to go on the bench as it developed a fault in the p.l.l.

Now for G4ELV; Dale has a dipole which is up at about 13m, and in the clear some 146m a.s.l. The "first bounce" appears to land in the Atlantic, and could account for some of Dale's success with QRP. On 28MHz the QRP signal went out to OX3KM, DL, HB9, EA, F, HB0, YU, TK4HC, GB0SWR/MM, OZ, SM, UZ9CWW, 5N0/JG1FVZ (QSL via JF1EEK), CN2AR, TZ6FIC (QSL via FE6CRS), CX4HS, 5T5NU, 9Q5NW and CE3AEZ.

G4VFG (Ivybridge) comes next, and he also noted Ws around 2100Z. The mobile station has been updated by way of the CP163 broadband linear (useful for the QRP-er who occasionally wants a bit of muscle he says!) From home c.w. gave EA7FFB, IK4GNH, YU4PH, EA7FTN, UB5ZDA and KA1DWWX; from the mobile, c.w. reached EA7FTN again and SM3CFV. On the s.s.b. front, contacts were made with LU1HOO, EA, DL, G, I, SM5FZD, HB9, ON6YQ, GM, UP2BKY, SP3DYZ, IS0VMB, CT1CFV, YU, OE, LA, Y53ED, EA8SK, TU2QT, CE3AYZ, EA9IB, CX6JV, 5T5NU, 4U1ITU, 5B4SA, some being from the mobile rig.

Our final 28MHz reporter this time is G0FBG/PA. Godfrey has been QRT of late due to lack of a pair of "bottles" for the p.a. of the HW101. However, now they are there, and effort is all-out for DXCC on this band before the year-end. So far four continents have been worked: Europe of course, plus CN2AQ for Africa, a brace of 4X4s for Asia, and YV6CAX for S. America.

So that's 28MHz; the biggest number of reports on this band ever, so we'll have to cramp the rest in somewhat.

The 1.8MHz Band

Most of those who work the DX on this band are well-known to me, but they just don't like writing, and they work DX when I'm safely tucked in bed at that. I did have high hopes of a few new ones last month, when a friend came to talk about and demonstrate kite antennas at the club, but alas, the wind chickened out on us.

G3BRD (Seaford) found he had almost completed 5BDXCC, and not many more for Honour Roll, and looked for a new game. This was found by firing up on Top Band, and in the last six months some 80 countries have been worked, including 4MOARV raised first call after which there was a horrendous pile-up. The antenna is a 27m top-loaded vertical with fifty tuned, insulated resonant radials, all grid-dipped to be resonant on 1.840MHz. Of course, the vertical is rather prone to pick up noise, and so already thoughts are being turned to a rotatable loop for reception. DX worked includes PY1MAG, PY1RO,

Your next three deadlines are:
August 28, September 25 and
October 26

LU2YE, CE8ABF (Puntas Arenas), HC7BI, OA4ZV, VE1ZZ, VE7BVL, UK0EAQ, UO5OGB, UD5DC, UW9CZ, UZ9AWO, UA9CBO, TF3SZ, and around thirty European countries in the last month. On a different tack, John held VE3BRG for a long time, and doubtless worked many a reader over the years, as he did yours truly.

A very mixed bag this month, says G3BDQ. However, before the season starts, John will put some more copper out in the form of earth mats—if the weather improves in time! G3BDQ managed RA3AUU, UB4LDD, UV9FM, UB5ZAL, UA2FF, UA3LHE, 4NOCW, TV6BIL, UB4MWA, UA6HOF, 4N2E, LZ2CJ, UC2OR, RA3DX, UQ1GYT, all on May 30, plus C30DAW (G4UPS, Ted) on June 2.

G2HKU (Sheppey) is thankful the island is well anchored, else the rain would wash it away! However, between tending anchor-lines, Ted worked DK7CN, EA7AIN, GW3NWR/P and ON7PW.

The 3.5MHz Band

Again, more reports than usual. G4VFG has managed to improve the p.s.u. and so raise more r.f. out of his 807 (that'll bring back memories for older readers!); Contacts using c.w. were made with G3RXA, G3LHJ, E19BT, GOGQL, F6BWF, G0BHI, G3VXX, G3XTL, OH3WP and GODZB.

G3BSN was involved with the Clifton club's NFD entry, in which as G3GHN/P from Wrotham, they made 245 scoring QSOs on 3.5MHz, including, at 0229Z N4AA, and at 0327Z, K4PQL. Somewhat handicapped was the poor soul operating HB0/DL6PX/M—what a fistful of a call on the key!

GOGWK mentions that he pops up on this band for the ISWL and WAB nets, plus the odd other QSO, the most interesting being GB2DB for a Dam Busters commemoration.

G4XDJ says he has a sked with SM6LJU, in which they hop between 14, 7 and 3.5MHz to see which is best. In addition to this weekly sked, Brian mentions GI4PCY and ON4CC both on c.w.

Angela GOHGA (Stevenage) is back on the band, with three wags; this netted c.w. QSOs with DL0II/P, ON4TB/P, SP6FXX, Y58ZA, OK3CSA, SM0COX, GM3TMK, GI3CKF, GW8WJ, DK1XC, ON4CW, PA3DHR and DL5NAX. Gotaways were K8ZI and OY7XA.

The 7MHz Band

There is a lot of quiet unreported DX worked on this band. G4XDJ mentions the c.w. contacts with VK2KM and UD6DCF, while s.s.b. made it to GM3XOQ in Shetland. QRP made it across to SM6LJU, SM5LNE, EI5BH, DL6YT and GOEGA.

GOHGA offers just one this time, and a Gotaway at that: KA8PTL, who was almost certainly not quite copying her call while Angie was running 150 milliwatts; each time she called him, he came back with a "??"

G2HKU was also using c.w. for W2BA, HK1QQ, VE2FU, N4UB/3, OY/DF7JC, W2BA again, K9QVB and 4Z9AAC. On

the other hand, G3BDQ stuck to s.s.b. for his 7MHz contacts with ZC4AP, UA2FP and UA9CDO.

New Bands

G4VFG found 10MHz noisier than ever, and wonders when we shall see the end of the sharing. Nonetheless, Peter worked UB5GA, DK0BW, W1XU, and OE3JS, while 18MHz yielded a QSO with GM3HBT, and hearing, faintly, DL, OK and PY.

We have already mentioned G4JKV working DL1SN on five bands; in addition 18MHz gave QSOs with F9OQ and DL1RX.

On 24MHz, G3BSN mentions his twin brother GOGTO who heard IK1HFX and I1JQJ, and used his c.w. to raise EA5CHT and I2VSG.

Ted at G2HKU mentions his c.w. QSOs with VK5AOL on 10MHz and F9KP on 18MHz.

Grapevine

The buzzes, in the main, come from W1WY and his "Contest Calendar" each month, plus *The DX Bulletin* from Chod Harris VP2ML and the *DX News Sheet*. *TDXB* and *DXNS* are weekly, and can be supplemented by over-the-air contacts; the pity is that it is so long between writing this and it reaching you that most events noted therein have come and gone. However, we can mention a few. First, lots of conflicting rumours are coming out of Russia, about a YA operation. *TDXB* mentions word of a YA1AP activity, and American operators mention YAOEBL. On the other hand *DXNS* has it that there will be no activity from YA in the foreseeable future, and the latter seems to have it from the horse's mouth namely Box 88. Work them first, worry later is the motto here—the odds are, you've found Kabul Slim, but on the other hand, there is seldom smoke without fire!

ZL8HV is breaking through from the Kermadecs and will be there till October we understand.

DXers generally will be sad to hear of the passing of LU2DX, Jose "Joe" Ahumada, on June 27. Back in 1951 he obtained DXCC No 251, and he continued to operate from DX spots through the years. His stations in Springfield and Buenos Aires were of the QRO variety, with 54m high antennas; and his XYL Patricia, LU3YL/W4 sat above him in the Honour Roll; they both operated from various exotic spots. Joe will be missed from the pile-ups indeed.

The 14MHz Band

GM4ELV has managed 119 countries so far with QRP on 14/28MHz. On 14MHz, the s.s.b. signal raised GM4NSZ/VO2, VP8VK (QSL via G4RFV), SN2JP, SN5JP (Papal visit to SP-land), UM8MO, UL8LYA, RW9A, 5L7S, KL7IVO, ZC4AK, TF3BM, 5L2BS, TV6BIL, KT4A, C53FH, LU1BSN, 6W6JX, AH6CS, OX3CS, TZ6VV (QSL via W0BLD) and smaller fry; c.w. accounted for AL7IJ, UZ0QG, VE3CRG and VK2DHE.

exactly which mechanism was responsible for some of the contacts.

Beacon News

Mike Harsey G8ATK (SRY) has given some first hand news of the "Cornish

Back in May, G3TTC was in Hong Kong and operated as G3TTC/V56; 14 and 21MHz dipoles and an IC-735 resulted in some 300 contacts in 42 countries before the end of the month; and the return trip was made via China, Mongolia, and the USSR, stopping off at various places on the way. Keith had hoped to meet G4LJF in Moscow, but they didn't quite make it due to a cancellation.

GOGWK hooked VE8RCS, VP2EZ, 4X4JU, plus Europeans, including TV6MED on Pomegue Is and 7SOMG in Sweden.

Turning to G4XDJ, we find him working G3IOR/LZ, LU1FGI, UM8MID, UL7FOO all with QRO, and turning to QRP for DL3YDN/SV, HB9BQZ, KB2ALA, W7DMV, KA1EFO, VE2VIO, LZ1KWT, EA1EMX, LU1FGI and OF8MA, plus two-way QRP with OH8BGM and UT5JBD.

GOHGA had two Gotaways to record as she didn't click with T77C, who seemed to get tired of the pile-up and just went QRT, and K1TCL who started strong but then dropped into QSB. On the other hand there were lots of Europeans including 4NOUNI—she cracked the pile-up on that one so QRP c.w. is having a considerable sharpening effect on the GOHGA operating technique. One begins to suspect that all licensees would benefit from a year, say, on QRP c.w. before the arrival of a QRO and 'phone ticket.

We've already mentioned rumours of YA operations; G3BDQ mentions working a YA1CW on June 17, being organised by RW6AC, so as John says, he MIGHT be kosher, with signal dipping to 449 from 589. Others included c.w. with JE7MQB, KH6IJ, UI8OAE, GBOSWR/MA/EA8, C30LDZ, LU9EDY and HZ1FM.

The 21MHz Band

Lucky there aren't many reports here this time, or the Editorial axe would have had to swing. G2HKU offers his c.w. with G6ZY/EA6.

At G4VFG the key was paddled for PY4ABF, HK1KXA, ED9EXP, YZ9I and various small fry, while the s.s.b. offering included GM3JDR, who used to contribute regularly from Golspie but then moved further north, PY7ZZ, CE6EJZ, XQ5CFR, 4X6TK and UB5IQA.

Apart from PY1QN it was sideband the whole way for G3BDQ, who managed ZS5YY, 9K2MJ, 5T5AU, 3D6CW, YB3EUO, ZS4OKC, J28EM, ZS6ACE, Z21BP, TU4CJ and 5B4TI.

GOHGA stuck to c.w., and managed YU, IK2GVU, EA8FYZ for a best DX yet (and a 519 report!), more I and IK stations, EA8BJU for a better report, DLs, SMs, HB9, EC3CLW, UA1BYL, OF1AF in the contest, EF7CW and for a Gotaway, WA4FCP.

On to G4XDJ who used the QRP to work EC2CRD, F6IOL, Y53YE, LB7ZC, CT1KNC, 4NOUNI, YZ9GIJ, EA1CSB, OE3HPA, SM3MGO and EA8AMT.

That's it for another month. Let's see even more letters next time, arriving by the given deadline.

VHF Up

In June the lack of any reasonable tropospheric propagation was more than made up for by some welcome Sporadic-E propagation on 144MHz. There were some spectacular periods of E-layer propagation on 50MHz leaving the experts wondering

Practical Wireless, September 1987

Reports to Norman Fitch G3FPK
40 Eskdale Gardens, Purley, Surrey CR2 1EZ.

Beacon" situation following the dismantling of the antennas in mid-May. At the beginning of July he visited the site and found the foundation for the new Gas Board mast had been poured but no new mast was in evidence.

The new 1296MHz beacon for GB3CTC has been built and tested and is ready to operate. The South Birmingham ARS has donated 30.5m of LDF7-50 feeder cable with connectors.

In the June issue I included the comments from Geoff Holland G3GHS about the future of the v.h.f. and u.h.f. GB3CTC beacons. G8ATK reports that their antennas are still quite serviceable after all, and have been cleaned up. It now seems that the Mid-Cornwall Beacon and Repeater Group will be operating the 70, 144 and 432MHz beacons again once the new tower is installed.

Contest Notes

A somewhat thin time for contest addicts this month. On Aug 23 there is the 1296/2320MHz event from 0900-1500UTC. This is in two sections, Fixed and All other with one point per kilometre scoring on each band, but half points for crossband QSOs.

Sept 5/6, 1400-1400 sees the 144MHz Trophy and s.w.l. contest, coinciding with the IARU Region 1 event. Radial scoring in the former, one point per km in the latter. Single-op., multi-op. and s.w.l. sections here.

The last leg of the 10GHz Cumulatives is on Sept 13, 0900-2100 and entries, post-marked no later than Sept 28, go to G4FRE at 15 Ferry Lane, Cavendish Park, Felixstowe, Suffolk IP11 8UR.

DXpeditions

The Squarebushers Expedition Group sent me a mini poster of their Perseids activity from the Isle of Man but it missed last month's deadline. They should be operating from XO69h until August 15 using the call signs GB2XO and GB4GD on all bands from 50MHz to 2.3GHz and perhaps on higher bands too.

The m.s. frequencies are 144.132 on c.w. and 144.432MHz on s.s.b. with 144.165MHz the tropo QRG. On all other bands they use decimal 165. On m.s. 2½ minutes periods on c.w. and one minute on s.s.b. with DX stations to start. Maximum c.w. speed 800 l.p.m. They should be QRV on the 14MHz v.h.f. net. All QSLs to P.O. Box 136, Cardiff, Wales CF4 6YL.

John Lemay G4ZTR (ESX) has sent information on another visit to Anglesey (XN) from Aug 18 to 28, taking in the 1.3/2.3GHz contest on the 23rd. Activity promised on 50, 144 and 430MHz, 1.3 and 2.3GHz, also 10GHz wide-band f.m. If enough requests received, 70MHz, 10GHz narrow-band and 24GHz operation may be available. Callsign GB4XN.

Equipment details: 50MHz 10W, 5-ele on 50.19MHz; 144MHz 200W, two 14-ele on 144.355MHz; 430MHz 100W, eight 21-ele on 432.260MHz; 1.3GHz 100W, 2m dish on 1296.180MHz and 2.3GHz 4W, 66-ele on 2320.210MHz. More details from G4ZTR on 0206 860238 between 7 and 8pm only or G4VIX on 04024 55870 between 8 and 9pm only. Both are QTHR.

The Awards

Two more QTH Squares Century Club certificates have been issued. Member number 79 is **Peter Pospichal OE3RIW** (II73g) from Himberg in Austria whose confirmed total on 144MHz is 104. 60 QSOs were on tropo, 41 by Es and the remaining three by Auroral mode. No personal or station details were sent with Peter's application.

Member no. 80 is **Silvio Rua IW1AZJ** (DF79j) from Torino in Italy who has

exactly 100 squares confirmed on 144MHz. His city QTH is very poor for v.h.f., his best direction being to the south. Even the best equipped stations in the I1 call area can only work 80-90 squares on tropo, it seems.

Silvio's station comprises a modified Icom IC-202 with Tono 2M50 amplifier giving 28W at the antenna and 11-ele Yagi by Fracarro. He uses a Dressler 3SK97 GaAs f.e.t. pre-amplifier and a speech processor by Daiwa for m.s. and DX working. A 150W amplifier using a pair of MRF215 devices and a new antenna for tropo working are planned.

The mode breakdown of IW1AZJs QSOs is 64 by tropo, 10 via Es and 26 by m.s. and, considering Silvio's poor QTH and low power, he has done very well to get 100 squares confirmed. Both certificates were issued on June 23.

Haydn Barker G6XVV (YSS) has submitted a further 13 cards for his 144MHz QTHCC certificate no. 68 and is now at 152 confirmed. His 150 sticker was dated June 18. New ones included IWOAKA (GB) and YU1LA (KE) via Es, OK1VOX (HJ) on c.w. and SP6AZT/4 (LM) on s.s.b, both via m.s. and on tropo on 30 Sept 1986 OK2BFH (JJ) and SP6FID (IK).

The 430MHz VHF Century Club certificate no. 44 has been awarded to **Jaap Nap PE1JVH** (CM65d) from Breukelen in the Netherlands. His station comprises a Yaesu FT-780R transceiver, Electronic Developments 2C39BA 50W amplifier, Pope H-100 feeder and a 21-ele Tonna Yagi 17m a.s.l. Jaap is a Worked All Britain enthusiast and has book no. 4818.

Operation from 4U1ITU

Graham Daubney G8MBI (HFD) has sent an account of the recent trip to Geneva with Mark Turner G4PCS (BFD) when they operated the IARC station 4U1ITU on v.h.f. The station is in the ITU Headquarters building and it is very simple to get permission to operate the station on the production of your own licence or validation certificate.

They arrived in the shack on June 15 to find the h.f. station well organised and equipped, but the v.h.f. one "... a shambles." The first problem was the v.h.f. antenna array for 144MHz. This comprised four 19-ele Yagis but the rotator was broken and defied twelve hours of effort by G4PCS to mend it. The next problem was the MuTek masthead pre-amp which did not seem to be powered from the shack at all.

They took their own 144MHz equipment consisting of an Icom IC-275, a 4CX350 amplifier, LDF4-50 coaxial cable, GaAs-f.e.t. pre-amp, Bencher keyer paddles and home-made 1000 l.p.m. keyer. The antenna was the horizontal part of a 10-ele crossed Yagi, probably a Jaybeam product.

For 50MHz cross-band operation they had a MuTek transverter, FDK Multi-2700 and 5-ele Yagi fixed in a northwest direction.

Activity began on the afternoon of the 15th. Meteor scatter activity in their previously announced random sessions was not too productive until they got their antenna system working properly on the 17th. They heard GW4TTU and almost completed with G8XVJ on s.s.b. but the only completed s.s.b. QSO was with G6OYL.

On c.w., m.s. skeds were completed with G0CUZ, GODAZ, G1DXI, G1EFZ, G4RGK and G4XEN, while they also

worked EI4VVG (UM), another DXpedition. Tropo contacts were made into both East and West Germany and into Italy by back scattering the signal off the mountains.

Two Es events were experienced, the first at 1830 on the 16th bringing 9H1CG and IT9RIF, while the second more extensive affair produced QSOs with OZ, SMs in the 0, 4, 5, 6 and 7 districts with OF1ZAA the best DX.

On 50MHz many cross-band QSOs were made with EI, G, GI, GJ and GM stations. There were two openings to the USA and the first cross-band contact was on the 17th at about 2100 when five states were worked. Other QSOs were with ZC4VHF/5B4 and 9H1CG but they had no luck with CT1WW. Nothing was heard from Norway even though it seems the band was open that way.

They ended the activity on the night of the 18th and Mark and Graham enjoyed the experience very much. They might go there again, perhaps for a major meteor shower next summer.

The 50MHz Band

As far as Europe is concerned the 50MHz band has been open for E-layer contacts frequently in June. I would suggest it is hardly appropriate to refer to this as Sporadic-E, since for hours on end the layer is sufficiently ionised to sustain reliable propagation.

Paul Galea 9H1BT started activity on June 6 and had made about 100 QSOs with the British Isles within three days. The Maltese amateurs have 50-52MHz and a power output of 10W but with no antenna restrictions. Paul only QSLs direct, his QTH being 63 Ellul Mercer Street, Dingli, Malta. An s.a.e. and one IRC are requested for rapid reply.

Mark Page G1EGC (BKS) was QRV for June 1 with a MuTek transverter but remarks, "What a noisy band, especially when there is Es." He worked EA1MO, 9H1BT, 9H1CG, CT1WW and ZC4VHF/5B4, plus others cross-band. Many Ws were heard from the W1 region on the 19th and W6JKV/YVO (Aves Is. in Zone 8) on the 24th.

Don Stoker G1GEY (TWR) is QRV with 10W to an indoor dipole and has worked a few locals direct. Cross-band QSOs have been made with EA4CGN (YA), EA3ADW (BB), OH1ZAA/P/OFO (Aaland Is), I4UJB (GE), OZ9QV (GP) and F6ACU (DI), all to 28MHz.

John Heys G3BDQ (SXE) has written after a long time. He uses an Icom IC-202, MuTek transverter at 10W to a 5-ele Tonna Yagi at 12m. He lists many cross-band QSOs the pick of which were OH1ZAA/OFO (JP90) on June 6, YO2IS (KN05) on the 7th, 4U1ITU on the 15th and OY6FRA (WW77f) on the 18th.

In the USA opening on the 19th s.s.b. mode brought contacts with W9IP/2 (FN24), K1TOL and K1GBJ (FN44), WA1OUB (FN43) and VE1YX (FN74), then K1TOL again on c.w. These between 1924 and 2008 with rapid fade at 2015 and all gone by 2020, local sunset time. John wonders if this is linked to the collapse of the D-layer since he does not believe this to be triple-hop E-layer propagation.

Ted Chatfield G3BLG (ESX) reports beacon GB3RMK (I077UO) at S9 + 40dB on May 28 at 1800 until 1820 when it suddenly faded out. (There was a major Es opening that day, OM).

Ken Osborne G4IGO (SOM) heard beacon FY7THF on 50.039MHz on May 28,

COMMUNICATION CENTRE OF THE NORTH

The largest range of communications equipment available in the North. Full range of receivers, transceivers, antennas, power supplies, meters. Ali tubing – wall brackets – rotators – insulators.

We are the original amateur radio suppliers in the North West with 20 years experience in all types of equipment. Wide range of Base, Mobile, Antennas for all applications. Full range of equipment on display. Guaranteed after sales service. Official Kenwood stockist for North.

Also stockists for Tonna, Welz, G.Whips, Jaybeam, RSGB Publications, Diawa, Microwave Modules, Capco Antenna Tuners.

RECEIVERS

Full range of receivers for all modes and frequencies.

KENWOOD R5000 General Coverage Receiver	£895.00
VC20 VHF Converter for R5000	£171.94
KENWOOD R2000 General Coverage Receiver	£637.26
VC10 VHF Converter for R2000	£170.76
JRC NRD 525 General Coverage Receiver	£1,195.00
CMK165 VHF/UHF Converter for NRD525	£391.35
HF125 General Coverage Receiver	£375.00
AR2002 Wide Band Scanning Receiver	£487.00
R532 Synthesised 100 Channel Airband Receiver	£224.00
R537S Hand Held Airband Receiver	£69.50
AT1000 SWL Antenna Tuner	£69.00

Please send SAE for full information and up-to-date prices as these fluctuate to change in sterling rates.

For the caller a wide range of Aluminium Tubing, Clamps, etc. at competitive prices, i.e. 12' x 2" Ali Tubing £10.95.

Full range of RSGB and ARRL publications in stock.

Part Exchanges welcome. Second hand lists daily.

Send S.A.E. for details of any equipment.

HP terms. Access/Barclaycard facilities.

Open 6 days a week. 24 Hour Mail Order Service.

Goods normally despatched by return of post.

Phone 0942-676790.

STEPHENS JAMES LTD.

47 WARRINGTON ROAD,
LEIGH, LANCS. WN7 3EA.



COMPACT Spacesaver ANTENNAS

AQ6 20, 2 Ele and 3 Ele
4 BAND, 6, 10, 15, 20 M
AQ6-20, 4 Ele **NEW**

Our own unique design that WORKS

CLOSE COUPLED – HI 'Q' – CAPACITY HAT LOADED YAGI

Special features:

- Unique Altron fully sealed coils for max stability
- Resonant length elements for improved VSWR (1-1)
- Selectively detuned for optimum performance and gain (no gimmick quad needed)
- Easy trim spokes with lock nuts and spares
- Minimized wind load and weight
- Double insulated elements

As reviewed by
G4HCL in HRT
April '87

Antenna model	AQ-20/2E	AQ6-20/3E	AQ6-20/4E
Forward Gain Dbd	3.8 to 4.8	5.5 to 7.5	7 to 9
Front to Back Db	13 to 15	16 to 18	18 to 23
Side Null Db	25	25	30
VSWR (typical)	1.1:1	1.1:1	1.1:1
Weight	7.5lb	12lb	16lb
Wind load	2ft ² 0.18M ²	3ft ² 0.27M ²	4ft ² 0.37M ²
Turning radius	76"/1930mm	96"/2438mm	117"/2971mm

PRICE + p&p £114.50 (6.00) £169.00 (8.00) £230.00 (10.00). Carriage UK mainland.

PRICES ARE INCLUSIVE OF VAT. TERMS. CWO. ACCESS. VISA.
PRICES CORRECT AT TIME OF GOING TO PRESS.

WE DESIGN – WE MAKE – WE SELL DIRECT. You get best value

Callers welcome.
Open Mon-Fri 9am-5
Sat 9am-12.15pm
HP Terms



ALLWELD ENGINEERING

Unit 6, 232 Selsdon Road
S. Croydon CR2 6PL
Telephone: 01-680 2995 (24 hr) 01-681 6734

STOCK ITEMS NORMALLY DESPATCHED WITHIN 7 DAYS

We are pleased to introduce a new range of antennas shown thus (N). The dipoles have been redesigned and now include a fully sealed 'N' socket supplied complete with 'N' plug for coaxial cable. Absolutely NO matching or tuning required. Also a new 1296MHz 55 element yagi. Send for details.

50MHz	
5 element	£41.69(a)
144MHz	
4 element (N)	£26.60 (a)
4 element crossed (N)	£34.96 (a)
9 element fixed (N)	£30.87 (a)
9 element portable (N)	£33.12 (a)
9 element crossed (N)	£57.86 (a)
13 element portable (N)	£46.00 (a)
17 element fixed (N)	£61.54 (a)

ANTENNES TONNA (F9FT)

435MHz	
9 element (N)	£28.62 (a)
19 element (N)	£34.35 (a)
19 element crossed	£39.66 (a)
21 element 432MHz (N)	£44.57 (a)
21 element ATV (N)	£44.57 (a)

144/435MHz	
9 & 19 element Oscar	£39.66 (a)
1296MHz also 1250MHz	
23 element	£30.26 (b)
4 x 23 element – power splitter	
– stacking frame	£160.00 (a)
55 element	£46.20 (a)

POWER SPLITTERS – STACKING FRAMES
PORTABLE ALUMINIUM TELESCOPIC MASTS

PLEASE ADD CARRIAGE AS SHOWN (a) £5.00. (b) £2.20. ALL PRICES INCLUDE VAT AT 15%
ACCESS – VISA – Just telephone your card number for immediate despatch.

FOR FULL SPECIFICATIONS SEND 40p FOR CATALOGUE

Callers welcome, but by telephone appointment only please.

Goods by return.

RANDAM ELECTRONICS (P)

12 Conduit Road, Abingdon, Oxon OX14 1DB. Tel: (0235) 23080 (24 hours)

Books for radio amateurs





THE 'HAM SHACK'

for the Radio Enthusiast

AERIAL ACCESSORIES AND MASTS





ELLIOTT ELECTRONICS



MICROWAVE MODULES



INSTANT HP AVAILABLE

APPOINTED DISTRIBUTOR

JAYBEAM AMATEUR ANTENNAS

RIGS, ANTENNAS, SWR BRIDGES, POWER SUPPLIES, TEST GEAR, COMPONENTS, MORSE KEYS, COAXIAL CABLES, ROTATORS, MICS, PLUGS AND SOCKETS, SWITCHES

Call us on (0533) 553293
OR COME AND LOOK AROUND AT
26/28 Braunstone Gate, Leicester



OSY OLD MAN TO





ICOM (UK) LTD/RETAIL.

Everything you need for your shack is available from Icom UK's retail shop. Andy G6MRI is on hand with new and secondhand stock from ICOM plus Yaesu, Trio, MET, Tono, Jaybeam, Welz, Drae, BNOS and many more. RSGB publications also available, if Andy can't help, you've got a problem. Why not call in, we are on the corner of Stanley Road and Kings Road, Herne Bay, Kent and open 9 – 5.30 mon-sat, lunch is 1-2.15, ½-day closing thursday afternoons open 9-1.00. BCNU.

Credit facilities available, plus VISA & ACCESS accepted.



ICOM (UK) LIMITED.

2 Stanley Road, Herne Bay, Kent CT6 6SH. Tel: 0227 369464.



2012-2049 up to S9. The Cyprus group were worked at 1348 on June 7 and at 1604 on the 11th. They were heard for brief periods 1721 and 1843 that day and at 1152 on the 16th.

G4IGO caught the big opening to the USA and Canada on the 17th, 2220-0037 when he closed down. Ken managed to work WA1OUB, K1TOL, W4CKD (VA), VO1MP (GN37), W4NHH (EM90), W4GJO (EM74), N4RA (FM18), KA1GD (MD) and N4MM (FM09). Many others were heard including W5SUQ and WB8VBF.

On the 18th, Ken reports unusual back scatter conditions from 0720-1210. At 1124 VE1YX was worked and at 1151 N4EJW (EL97). WB4OSN (EL96) was heard up to 1220. OX3VHF beacon was up to S5, 2046-2100 and he reports G4NDG hearing FY7THF at about 2000.

On the 19th, between 1750 and 2015, WA1VTA (FN42), W9IP/2, VE3NBP and VE3KKL (FN25) were contacted with other W1s and W2s, VE1s, and VE2s heard. FY7THF was maximum S2 from 1750 to 1800.

Martyn Jones G4TIF (WKS) has been busy on the band working into 5B4, CT and EA on June 7, 11 and 14. The 15th brought C30DAW (AC) and he worked many of the Ws already reported on the 19th plus KA1CDZ (FN42), AF1T (FM43), K1JRW (FN32), K1ZFE (FN31). But the cream must be W6JKV/YVO (FK85) on the 24th. CT4PI (IM59) and CT4KQ (IN60) were worked on the 28th.

Cross-band to 28MHz QSOs included OY9JD on the 13th, 4U1ITU (DG) on the 15th then OF1ZAA and LA9DL (JO59), EA7EHE and EA7AG (IM86) on the 18th and EA6FB (JM08) on the 20th.

John Jennings G4VOZ (LEC) seems a bit disappointed by the very short, contest-style QSOs that seem to be the norm. So he was pleased when he had a long QSO on June 15 with CT1WW during which Tiago played back a recording of the GB3ANG beacon signal on 70.060MHz. His best DX was the YVO station on the 24th who was working British Isles stations, contest-style, which is understandable, of course.

John Palfrey G4XEN (NHM) runs 20W to "... a brake pipe dipole." He worked WA1VTA at 1848 on June 19 and W6JKV/YVO at 1751 on the 24th. 4U1ITU was worked cross-band on the 15th. G4ZTR uses 10W to a 2-ele Yagi and has worked 9H, 5B4, G and GM.

Mike Johnson G6AJE (LEC) has noticed "... an echo signal ..." off GB3NHQ during Es openings. Anyone else noticed this sort of effect? I would not expect a delay on a back scatter signal to be more

Annual v.h.f./u.h.f. table January to December 1987

Station	70MHz		144MHz		430MHz		1296MHz		Total Points
	Counties	Countries	Counties	Countries	Counties	Countries	Counties	Countries	
G1KDF	—	—	91	11	62	7	18	4	193
G4NBS	41	5	54	10	44	11	15	6	165
G1SWH	—	—	92	9	56	7	—	—	164
G6XVV	—	—	70	13	50	8	12	2	155
G8HKM	—	—	63	14	45	9	19	4	154
G1LSB	—	—	63	19	48	15	—	—	145
G1GEY	—	—	65	15	41	8	—	—	129
G4DEZ	—	—	34	10	42	11	13	5	115
G4MUT	26	1	43	13	18	3	5	2	104
G4WJR	—	—	78	10	—	—	—	—	88
G6AJE	—	—	39	10	30	6	1	1	87
GW6VZW	—	—	58	16	9	2	—	—	85
G3FPK	—	—	67	16	—	—	—	—	83
G1EHJ	—	—	39	7	25	6	—	—	77
GW4FRX	—	—	65	12	—	—	—	—	77
G4VOZ	32	4	—	—	31	7	—	—	74
G4AGQ	13	1	29	9	13	4	7	1	69
G4ZTR	12	2	22	5	21	4	2	1	66
G4TGM	—	—	50	15	—	—	—	—	65
G4YIR	—	—	53	12	—	—	—	—	65
GBXTJ	—	—	54	11	—	—	—	—	65
GBMGL	—	—	25	6	25	2	1	3	62
GOHDZ	—	—	49	11	—	—	—	—	60
GBMXL	—	—	31	7	12	4	3	1	58
G1CRH	—	—	47	9	—	—	—	—	56
ON1CAK	—	—	40	14	—	—	—	—	54
G4SEU	30	3	11	4	2	1	—	—	51
G1VTR	—	—	16	2	22	5	—	—	45
GOHGA	—	—	34	5	—	—	—	—	39
GM4CXP	—	—	26	5	3	3	—	—	37
G2DHV	7	1	20	4	3	1	—	—	36
GW4HBK	32	4	—	—	—	—	—	—	36
G4WND	25	4	—	—	—	—	—	—	29
G6XRK	—	—	8	6	—	—	—	—	14

Three bands only count for points. Non-scoring figures in italics.

than 7–10 milliseconds. Can one detect such a short echo?

Julie Yates G8MKD (WMD) has a Yaesu FT-690R Mk 1 and 30W p.a. to an indoor crossed dipole. Cross-band QSOs have been made with D, F, OH, OZ and SM and with OY6FRA at 1849 on June 18. A 2-ele home-made Yagi is destined to go up on the mast any time.

Steve Damon G8PYP (DOR) has written for the first time though a reader for several years. He uses a Yaesu FT-726R with two indoor dipoles. During June he worked GJ4ICD, CT1WW, 9H1BT, C30DAW, GM8SXX (IO87) and GU1IWW, plus some previously mentioned Europeans cross-band to 28MHz.

Philip Hocking G8ZDS (CNL) worked DC3CY on June 18 even though the German amateurs do not have a 50MHz allocation. Many Ws were heard on the 19th but none worked from Camborne. For Derrick Dance GM4CXP (BDS) the highlight of June was working Ted Collins C30DAW on s.s.b. on the 15th, his last day in Andorra.

Dave Lewis GW4HBK (GWT) describes band conditions as superb, his best DX being C30DAW on June 6, ZC4VHF/5B4 on the 11th, WA1OUB on the 17th and K1TOL on the 19th. The 24th brought the YVO and 9H1CG with many Ws and three VEs heard. QRM is described as unbelievable.

Geoff Brown GJ4ICD uses a professional panoramic RX to monitor the v.h.f. spectrum and this enables him to "see" very easily the development and movement of E-layer propagation. From this he has produced daily charts in histogram form which I only wish I had enough space to include.

On June 6 Geoff worked CT and 9H via E-layer. GB3RMK was S9 at 1800 and a CQ call brought replies from GM4s UPL and DGT (YQ). GB3RMK was copied all the next day on tropo with many long bursts of 15–30 seconds as it was the peak of the Arietids meteor shower. 9H1BT was worked at 1304. VE1SIX beacon and

VE1ASJ were heard as were the Cyprus folk. They were worked at 1715 on the 11th.

On the 14th Geoff worked EA1MO (IN71), CT1WW, CT1LN, GM4DGT, G3BW (YO), GM4UYE (YQ) and PA0XMA who was S9 with the beam at 350°, all these between 0803 and 0931. At 1315, GB3RMK was S2–S7 at QTE 300–020° but CQ calls were unanswered. At 1530 GM4ZUK/P (YQ) was S9 for 8 mins. At 1548 GM8FFX (YR) was worked.

From 1619 to 1826, GJ4ICD heard US stations in the 4th and 5th call areas; N4EQT, K5CM, N5JHV, (DM62), ND2X/5 (EL09) and the last heard KN5S, QTE 300° at 1824. On the 18th there was a big British Isles opening and Geoff lists 34 stations worked, mostly GMs but also OY9JD. The OX beacon was heard at 2050 and an Icelandic TV test card on E3 was seen.

Finally, on the 19th, GJ4ICD caught the W opening at 1848 working AF1T, K1TOL, K1JIW (?) W9IP/2 and WA1VTA at 1921. **Paul Turner G4IJE** (ESX) worked WA1OUB at 1425 on June 7 exchanging RST599/579 reports. He reports that G18YDZ (IO65QF) worked ZC4VHF/5B4, (KM64KW) that day, a QRB of 3759km.

Once again I make no apologies for advising everyone to not exceed the licensed e.r.p. of 100W. For some years the French have been running a subscription TV service well above 50MHz. Now, however, they are licensing many stations on Channel 2, vision on 49.25MHz, 6MHz bandwidth and positive modulation, with a.m. sound on 55.75MHz. The stations can be on 21 hours a day. Some transmissions are not encoded but many are. According to GJ4ICD the late night stuff is quite disgusting, but very popular! I am sure the French authorities are looking for any excuse to get HMG to revoke all our 50MHz licences. They have right on their side, of course, since the 50MHz part of the v.h.f. spectrum is allocated primarily to broadcast use in ITU Region 1.

Practical Wireless, September 1987

Annual c.w. ladder

Station	Band (MHz)				Points
	70	144	430	µWave	
G4ZEC	—	434	—	—	434
G4XEN	—	182	11	—	193
G4ZNU	—	151	3	—	154
G4WHZ	—	139	—	—	139
G4OUT	—	122	—	—	122
G4ZVS	—	102	—	—	102
GOHGA	—	68	—	—	68
GODJA	—	57	—	—	57
G4YIR	—	55	—	—	55
G4VOZ	27	—	22	—	49
G4AGQ	11	17	14	1	43
G2DHV	5	23	2	—	30
GM4CXP	—	26	—	—	26
E15FK	—	10	6	—	16
GW4HBK	4	—	—	—	4

Number of different stations worked since January 1.

The 70MHz Band

Bill Somerville-Large E19FK (Wicklow) worked in all but one session of the Cumulatives from a /P site in IO63WC "... and the WX smiled." He made cross-band QSOs with DL9RM on May 28, OZ7JV on June 13 and 18 and HB9CRQ on the 18th. Most European v.h.f. addicts on 28MHz monitor 50MHz but few 70MHz, it seems, so many cross-band opportunities are being missed. Bill planned to operate in the Perseids from UL square on 70.195MHz and may be QRV from there or VL the evening of August 18 and morning of the 25th.

Dave Meadows G4TGB (NOT) worked DL9RM cross-band on June 18, initially with 60W, finally with only 800mW for an S2 report. Gunther is in JN69CX. Thanks to G4VOZ for passing on Dave's letter.

G4VOZ reports increasing Midlands f.m. activity. Some Class B licensees have started up and eight have been heard using s.s.b. with their own gear. He has been giving support to the GB3CTC folk to get the 70MHz beacon back as soon as possible. G4VOZ lists 13 new stations worked, 10 of them Class B operators.

GW4HBK reports 70MHz as "dismal" best in-band DX being G4BWW (LNH) and cross-band DK1PZ on June 18.

The 144MHz Band

First the overseas input and Silvio Rua IW1AZJ (DF79j) added G4KUX (ZO) in May on m.s. Via Es on June 7 he got LZ1KAD (NC), LZ2BC (ND) and RB5AGG (QK) bringing four more squares.

Johan Van De Velde ON1CAK (Liedekerke) has worked 68 UK counties all-time but is looking for ALD, ARM, CTR, FMH, HLD, LDR, LTH, OKE, SLD and WIL. (Try GU3EJL for Alderney, OM). On June 11, he worked I7RNI (IA) via Es and now has 14 countries worked this year.

Now the reports from "home" stations started with new contributor **Colin Mister G0DAZ** (HWR) who uses a Yaesu FT-726R, 400W from a 4CX250B amplifier, Heliac LDF4-50 feeder to four 14-elle long Yagis by MET with MuTek masthead pre-amp. QTH is 60m a.s.l. plus a 20m tower. He is very active on m.s. mode at 2000 and he and Colin Morris G4CUZ (WMD) compare reflexions heard which often prove to be very different although they are only 32km apart. His squares/countries tally is 147/33.

Laurence Howell GM4DMA lives in Aberdeenshire but is also QRV from a North Sea QTH in the Phillips Maureen Alpha Oil Production Platform (AS69e). There he runs 110W p.e.p. from a Yaesu FT-480R with amplifier through low-loss cable to a home-made, stainless steel 5-over-5 Yagi at 64m on the Helideck. On June 6, while chatting to LA6OJ, they were interrupted by some strong Es propagation to the Ukraine resulting in six QSOs in KO60 and KO70 squares from 1715.

As space is at a premium, I will now cover the Es events. Readers reporting working DX on this mode were G1EGC, **Paul Brockett G1LSB** (LCN), G4IGO, **Ray Baker G4SFY** (NOR), **John Wimble G4TGK** (KNT), **Bob Ainge G4XEK** (SFD), G4XEN, G6AJE, **Ron Reynolds G6WEM** (ESX), G6XVV, G8MKD, **Erik Gedvilas G8XVJ** (CHS), G8ZDS, GJ4ICD, **John Eden GM0EXN** (HLD) and **Paul Baker GW6VZW** (GWT).

Events were reported on May 28 and June 6, 7, 11, 16, 17, 18, 24 and 25. The May 28 one was adequately covered last

month. The one on June 6 was quite late, from 2005 to 2031 according to G4IGO. Stations worked by various readers were YU1WP (JE), IK5CQV (FD), IOAMU, IONNY, and IWOAKA (GB), IODTK (GC) and IT9TDN (HY).

Next, the June 7 openings, the first of which was from 1115 to 1300 in which the following were worked: IO CUT, IO KIB, IO NLK/O and IO HKA (GB), IK6IHM (GC), IO UZF, IO QFH and IO KOFEC (GD), IO WES, IO CQF and IO 8EGJ (HA), IK7FPU, IK7FVF and IK8EVE (HB), IW6MIE (HC), IT9TDN, I7MCO, I7RNI, I7VYU, I7ZBB, IK7AKZ and IK7IJF (IA), I7DFV, I7WAN and I7ZPB (IB), IK8FGM (IY), I8TUS and IK8GGT (IZ), I7IWN (JA), 4N2D (JC) and probably the pick of the bunch SV8JE (KY).

The second opening on the 7th featured from 1705 to 1840: YU2CCB (IF), YU1WP (JE), YU4EDO (JF), YU8ALN (KC), YU1ZF (KD), YU1JB, YU1AFS, YU1PSF, YU7AU and YU7MJA (KE), YO2BUG (KG), LZ1KDP (LC), YO7DL (LE), LZ2WY (MD), LZ2KSL (NE), YU4FK and YU8AB (?).

On the 11th, 1617-1750 another Mediterranean event with 9H1GB and 9H1BT (HV), Italians in GB, GC and HA and for GJ4ICD, SV1AAF (LY), SV1OE (LX) and SV2JL (LA) worked between 1725 and 1750.

On the 16th, from 0830-0920, there was a limited event mainly to Malta. Stations worked were 9H1s BC, CG, EL, FBS, GB and GP/M, IT9LEM, IW9AQS (GX), and IOXKD (FC). At 1032, G1LSB found HG1YI/MM (KM03WT) off the Libyan coast, a QRB of 2723km.

From 1045 to 1145 we have EA6QB (AY), EA6IF (CA), FC1FIH (CD), IO5DKU, IO5YFG (EZ), IK5HM (HD), I7RNI, IK7IMP (JA), IK7QP, DL5DM/YU2 (HE), EA5BY (ZX) and EA5CHT (ZY).

On the 17th a mainly Polish affair from 1337-1423 with SP6s FUN, HFT and NIO (IL), SP9AI, SP9DHQ and OK2BFH (JJ), SP7OGR (KL), SP5EFO (KM) and SP8NCJ (LM) worked. Also heard by G4IGO in unidentified squares: SP5AAS, SP7s CSQ, DSB, IDG and ZX.

Another Balkan opening occurred on the 18th mainly favouring more northerly stations, with G8XVJ doing very well. Worked by several readers were: YT4AM (IE), YU2CCB, HG3CR (IG), SP6BIB (IK), SP6s ARE, BTI, GUV, GZZ, HEI, HFT (IL), YU4GM (JD), YU7s AJH and WAY (JF), HG8VF (JG), HG6NQ, HG6OQ (JI), OK2BFH, SP9CSQ, (JJ), SP9s AHB, EWU, HWY, MM and NWG (JK), YU1s GT and MXL (KE), YO2IS and YU7s AW, EW, FF and TU (KF), HG0DG (KH), SP5EFO (KM) and SP7IDG, SP9COO, SP9AI, and HG8KAX. This event was from 1310 to 1436.

G4SFY reports hearing ON and PA stations calling for YU and LZ around 1800 on June 24 but nothing heard at his QTH. At 0915 on the 25th, G8XVJ worked EA7DZI (WW). And that is about it for the June Es.

On the tropo scene, nothing very exciting to report. Everyone has praised the excellent effort by the Five Bells Contest Group from Co. Kerry, UM60f. Assorted members were worked on June 14 by G1EGC, **Keith Killigrew G6DZH** (HWR), G6XVV and G3FPK. G4TIF worked them on the 19th and 26th.

An interesting one was the *Sir Walter Raleigh* which has been at sea a long time sailing around the world. GB0SWR/MM was worked by G4SFY on June 27 when off the GU coast and by G3FPK. They made a special excursion to BM square on the 28th before heading to Hull, their final

destination, and gave many their first crack at this "wet" square.

Another /MM was SM6AFH/MM who was worked by **John Nelson GW4FRX** (PWS) on July 5 when in ZQ square. He was up to S7 with John but only came up to R5 very briefly at G3FPK while having a long over to a northern G.

Gerry Schoof G1SWH (MCH) is still winking out rare Irish counties and reports EI3VTF/P from Monaghan on May 16, Longford on the 25th and Roscommon on the 25th. The portable was using 2W to a 4-elle Yagi. EI8FV/P (Offaly) was worked on June 14, Gerry's 92nd 1987 county.

There was a tropo opening to the Canary Islands from southwest England on June 6 and **Dave Gregory G8JDX** (DVN) worked EA8XS (IL28GA) exchanging RS57 reports.

GM0EXN, the most northerly mainland station, monitors the Scottish repeaters to assess conditions and finds the band open over long-than-expected distances sometimes. Going back to May 19, John reports an Es QSO with OH5LK (NU) at 1335, also worked by GM4DMA. On May 24, from 0900, LA5VHF beacon in JP77KI (Dubus gives JP76CW, John) was positively identified at S5 on tropo from well inside the Arctic Circle.

On May 29 at 1430, GM0EXN had an Ar QSO with LA8KV (JP52QQ), a rare event at this stage of Cycle 22. John's station comprises a Kenwood 9130, 150W amplifier, 10XY antenna, 3SK88 pre-amp and Datong speech processor.

The PW QRP Contest on June 21 attracted many participants. Some signals were very loud for 3W p.e.p. considering the distances involved. I was only able to operate for a couple of very brief spells but the reasonable weather meant that many portables were out.

Thank you to the following readers who contributed this month: G1GEY, G8PYP, **Ian Rose G0HDZ** (ESX), **Angela Sitton G0HGA** (HFD), **Pat Billingham G4AGQ** (SRY), **Ian Cornes G4OUT** (SFD), **June Charles G4YIR** (ESX) and **Paul Thompson G6MEN** (SPE).

The 430MHz Band

G0DAZ runs 400W to four 17-elle long Yagis by MET on this band, similar to his 144MHz station, and which has brought Colin 91 squares in 19 countries so far. G1GEY runs 100W to two 17-elle Yagis and is up to 41 counties and eight countries including LA, SM and Shetland, GM.

Prize catch for G1LSB was OY9JD (WW) on May 24, a QRB of 1113km for a new square and country on the band. Paul worked LA1CYA/P (DS) the following day and on June 16 he got EI4VBF (UM) for square no. 107. G1SWH worked the latter on the 14th for county no. 56 this year.

Phillip Stanley G3BSN (LDN) reports superb conditions at the end of May with PAs accessing local repeaters. Regulars were G4CYA (YSS), G6ICR (MSY), G6UUR (WMD) plus G8EXI. The DX were ON1BBV (CL), PE1EWR (BL) and PA0FRE (CM), while on c.w. he mentions London stations G4PDL and G4WGY.

PA0FRE told Phillip that OY6UHF beacon on 432.885MHz was due to come on air. G8XVJ only added two squares as most of the time he is out with his contest group.

Using borrowed equipment, GW6VZW operated in the May 30 contest in "... extremely grotty ..." conditions. Paul's best DX were GW4BVY/P (CWD) and G4NBS (CBE) from Gwent.

The Microwave Bands

G3BSN lists regulars as G8XIR (KNT), G8CHW (HFD) and G8IFT (WMD). Others heard/worked were G4LU (SPE), G3JXN and G6ST1 (LDN), G8HHI (SRY), G4DDK and G3XDY (SFK), G4FUF (ESX) and G3CKR (CHS) with GW4LIP/P (I083KB) on c.w. The DX included PAOFRE and PAOCWM (CM) and PAOZM (CL).

With the help of G8NCT, Phillip is building a pre-amp to be installed inside his Icom IC-1271 and using an MGF 1402 GaAsf.e.t. device. He would like to thank Ron Hanson G6BOC of Waycom Ltd for supplying the excellent chip capacitors.

The foregoing refers to 1296MHz for which band G6AJE has at last finished his transverter. It is a "slightly customised" LMW Electronics product running 500mW to a 25-ele quad loop antenna through 6m of UR-67 cable. Up to June 24, Mike's only QSO was with G8ZQB (LEC) and he is contemplating more power, a masthead pre-amp and better feeder to improve performance.

G8XVJ is now on 1296MHz with 18 squares worked and OE and HB already in the log but F still to be entered. **John Tye G4BYV** (NOR) made the PW keyer from the October 1984 issue and says it works very well and is particularly useful on the microwave bands. He sometimes leaves it running on 1296.200MHz to get a QSO.

John has at last worked **Keith Hewitt G6DER** (YSS) on 3.4GHz (9cm) on May 25, the latter's signal coming up to S8. Keith runs 150mW to a 0.8m dish and it gave John his 19th square on the band. Noting that many people are reportedly listening on 432.2 and 1296.2MHz, he suggests if more actually called, more QSOs would result. I would suggest calling every half hour otherwise we will all be

**Your next three deadlines are:
September 2, September 30
and October 28**

licensed listeners.

G8ATK reports that Cyril James G3VVB (CNL) is now QRV on 2.32GHz (13cm) probably the only station on the band from XK square.

Final Miscellany

I have been plagued with an annoying carrier on 144.338MHz for many months. I have now positively identified it as coming from a cordless telephone next door. So, if any of you hear carriers on 144MHz, it could be from nearby cordless handsets. What frequency are they supposed to be on?

G4XEN asked for the horizon distance formula. Working in feet for height and miles for distance it is $DX = 1.42\sqrt{H}$ or in metres and kilometres, $DX = 4.14\sqrt{H}$, both based on normal refractive index for air.

Sorry, no room for the Squares Table this month. Nobody sent in any figures for the 2.32GHz All-time Table yet so let me have them a.s.a.p.

RTTY

Reports to Mike Richards G4WNC
200 Christchurch Road, Ringwood, Hants BH24 3AS.

We start this month with a letter from **Brian Fields G4XDJ**. He has recently taken up RTTY after spending the last 3 years working c.w. only. Although he is thoroughly enjoying the new mode he is concerned about his typing speed. My advice to you is keep practicing, virtually everybody has to start with one finger typing, but if you persevere you will be surprised how quickly your speed increases. One of the "tricks of the trade" for apparently fast sending is to use the programmable memories to store your standard replies i.e. QTH, name, equipment, etc. Whilst the standard replies are being sent you can type your text into the type-ahead buffer, assuming your program has one. Another tip, which also requires a type-ahead buffer, is to start typing your reply while still receiving. The overall result of these "tricks" is to give the illusion of a very fast typist. Having achieved a reasonable speed myself, the next problem is to improve my spelling!

In his report for this month Brian has worked a good range of European stations on 14MHz and one Spanish station on 7MHz. Don't worry about the lack of DX as there was very little about. Brian's RTTY station comprises a Yaesu FT-200 running 50 watts into a delta loop via a home-brew Z-match. The computer is a ZX Spectrum.

Another newcomer to this column is **Ray Parnell** from Bude in Cornwall. Ray's interest in radio expanded to take in the data modes after he acquired a 48K Spectrum some 12 months ago. During the last year he has logged some 46 countries on RTTY and SSTV. Ray's listening equipment comprises a Sony ICF-6700W receiver with a FRV-7700 v.h.f. converter and uses a 40m long-wire for h.f. and 3 half-wave dipoles for the v.h.f. bands. The Technical Software RX4 receive program is used to decode both RTTY and SSTV. To minimise the amount of computer generated QRM in the shack, Ray has used extensive screening and filtering on all his equipment. His efforts have paid off as he has reduced the noise level by about 4 or 5 S points. Ray is hoping to have a crack at the RAE soon so I wish him well.

Len Fennelaw G4ODH, has sent in his usual comprehensive chart for RTTY and AMTOR. Despite the generally poor

conditions Len managed to log a few rarer countries i.e. Monaco (3A2), Haiti (HH) and Algeria (7X4). Thanks for the report.

John Barber G4SKA must qualify for an endurance prize for operating in the ANARTS contest on the 6 to 8 June. John reported band conditions as the worst for many years with little sign of life until 14MHz opened up on the Sunday at 2300hrs. Apparently by that time most of the regulars had packed up and gone to bed! His efforts were rewarded with several interesting stations, one of which may have foxed a few listeners, XQ3BLJ was a special call from Chile.

John's good news is that he has just received 2 QSL cards which take his confirmed RTTY total to 101 countries. He is now able to apply for the much coveted

RTTY DXCC award. Congratulations John.

There have been no packet radio reports sent in this month so I am canvassing for support. I'm sure there are readers who could spare a little time to send in a monthly report on packet activity. All that is required is a summary of the stations heard and a few notes about band conditions, operating problems or anything that may be relevant to the packet operator. All reports are welcome and you don't need to be an expert to contribute.

My own packet log for this month has shown activity to be still growing, though not too much DX about. One new call for me was ZF1GC (Cayman Is.), I think that is a first on any mode for my log. One aspect of packet radio which is worrying me at present is the operating practice used by

Prefix (Country)	Band (MHz)				
	3.5	7	14	21	28
A,K,W (USA)			R		
A22 (Botswana)				R	
A4 (Oman)			R		
CE (Chile)			R	R	
CN (Morocco)			R		
CP (Bolivia)			R		
CT (Portugal)			R	R	R
C31 (Andorra)			R		
DA,F,J,K,L (W. Germany)	AR	AR	APR	AR	
EA,C (Spain)		A	APR	R	
EAG (Balearic Is.)			R		
EAB (Canary Is.)			APR		
EAG (Ceuta & Melilla)			R		
EI (Eire)			R		
F (France)		R	APR	R	R
G (England)	R	R	APR	R	
GI (N. Ireland)			P	R	
GM (Scotland)			APR		
GW (Wales)			R		
HA (Hungary)			PR		
HB (Switzerland)			AR	R	
HC (Ecuador)			R		
HH (Haiti)			R		
HI (Dominican Republic)			R		
HK (Columbia)			R		
HL (Korea)			R		
HR (Honduras)			R		
I (Italy)	R	R	APR	R	R
IS (Sardinia)			R	R	
IT9 (Sicily)			APR		
JA,G (Japan)			R		
J7 (Dominica)			R		
J88 (St. Vincent)			R		
KL7 (Alaska)			R		
LA (Norway)			PR	R	
LX (Luxembourg)	R		PR		
LZ (Bulgaria)			R		
OA (Peru)			P		

Prefix (Country)	Band (MHz)				
	3.5	7	14	21	28
OD (Lebanon)			R		
OE (Austria)			PR	R	
OH (Finland)			PR		
OK (Czechoslovakia)		R	R	R	
OY (Faroe Is.)			R		
OZ (Denmark)			R		
PA (Netherlands)	R	R	PR	R	
PP,T,Y (Brazil)			R	R	
RA,T (USSR)			R		
SG,K,L,M (Sweden)	R	R	APR	R	
SP (Poland)	R		R	R	
ST (Sudan)			A		
SU (Egypt)			A		
SV (Greece)			PR		
TA (Turkey)			R		
UA,B (USSR)			R	R	
VE (Canada)			APR		
VK (Australia)			AR		
VU (India)			R		
XE1 (Mexico)			R		
YB (Indonesia)			R		
YO (Romania)			R		
YU (Yugoslavia)			PR	R	
YV (Venezuela)			R		
Y2 (E. Germany)			R		
ZF (Cayman Is.)			P		
ZS (South Africa)			R	R	
3A2 (Monaco)			R		
3V8 (Tunisia)			R		
4X (Israel)			R	R	
5H (Tanzania)			AR	R	
5N (Nigeria)			A		
5Z3, 4 (Kenya)			R		
7X4 (Algeria)			R		
9H (Malta)			PR		
9K2 (Kuwait)			PR		
9L1 (Sierra Leone)			R		

WE WOULD LIKE YOU TO VIEW ALL OUR PRODUCTS!!!



**ONLY AVAILABLE
IN OUR NEW CATALOGUE
PRICED 75p**

Send for a copy of our brand new glossy covered illustrated **CATALOGUE** for Summer '87. We've got some surprises for you, with the introduction of new Multi-standard Televisions/Monitors, a new range of Aerial Rotators and many, many more items. We've retained all of the well established and popular products, but have taken this opportunity to introduce lots of exciting new items for you the enthusiast. Our extensive listings cover domestic, fringe and DXing installations within Bands 1 to 5 inclusive. **AERIAL TECHNIQUES** provide a complete and comprehensive consultancy service for ALL reception queries and problems. **WOULD YOU LIKE TO RECEIVE AN EXTRA ITV CHANNEL AT LITTLE EXTRA COST? IF SO, SEND FOR OUR CATALOGUE AND INCLUDE AN SAE TOGETHER WITH DETAILS OF PRESENT ITV REGION RECEIVED.** For a speedy dispatch, ACCESS and VISA Mail and Telephone orders may be placed for any of the products listed in our NEW illustrated Catalogue. We are active TV/FM DXing specialists — your guarantee of honest and knowledgeable advice.

AERIAL TECHNIQUES IS UNIQUE —

OUR NEW HIGH QUALITY CATALOGUE COSTS ONLY 75p



AERIAL TECHNIQUES (PW)
11, Kent Road, Parkstone,
Poole, Dorset, BH12 2EH. Tel: 0202 738232.



LOSING DX?

ANTENNA TUNER for outside or **INDOOR** antennas, end-fed LONG WIRES or dipoles, **BOOST DX** and reduce interference 100KHz-30MHz in 6 overlapping ranges, **IDEAL** for FRG7700 etc or 10W tx, **BANDPASS** design (not just usual "T" high pass) with pre-wound high Q coils, **£29.20**, hear **WEAK DX**.

ANTENNA FAULT? Poor reports? Not getting out? Check **FAST** with an **ANTENNA NOISE BRIDGE**, measure **RESONANCE** 1-160MHz and **RADIATION RESISTANCE** 2-1000 ohms, **SIMPLY** null the noise, **only £26.20**, GET answers, **MORE DX**.

Each fun-to-build kit (ready-made to order) includes **ALL** parts, **CASE**, **pcbs** are fibre-glass, **CONNECTORS**, instructions, by-return postage, (Europe same, Giro 21.923.4000) and **FREE "Kit News"**.

CAMBRIDGE KITS

45 (PJ) Old School Lane, Milton, Cambridge.



SATELLITE TV

Systems, components, everything you need to join the exciting world of satellite television.

DIY-24 channel remote control receivers, plus 1.2m dish, LNB, polarswitcher etc. £485 ex. VAT! Technical back-up included.

Vast range of dishes, LNBs, plugs, books — you name it we have it.

Send now for our comprehensive component catalogue (S.A.E. required A4 size).

**4 Station Road, Parkstone, Poole, Dorset
Telephone: 0202 749495**

S.E.M. UNIT P, UNION MILLS, ISLE OF MAN Tel: MAROWN (0624) 851277

S.E.M. QRM ELIMINATOR. Just had a 'phone call to say "It's b..... marvellous." A neighbour had installed an ex-arcade game machine for his kids and this station couldn't operate because of the QRM until he used our **ELIMINATOR** — can do the same for you! Any sort of interference, it can be next to your receiver (your computer?) or several miles away, any freq. 1.5-30MHz. Connects in your aerial lead and removes the interference before it gets to your receiver, and you can transmit through it. **£85 Ex-stock.**

If you don't believe its true, try one for 10 days, if it doesn't solve your problem, we'll refund, less £5 to cover costs. We have many delighted owners now, who can't speak too highly of performance. With comments such as "I can operate for the first time for years" or "you have got a winner".

NEW S.E.M. Dummy load, 100W with dummy load/through switch. So you leave it plugged in line. **£22.00 Ex-stock.**

NEW S.E.M. TRANZMATCH Mk III. Now has a switch to select **DIRECT** to aerial, **BALANCED** or **UNBALANCED** or **DUMMY LOAD**. The matching unit retains its tremendous versatility capable of matching virtually any aerial to 50 ohms at up to 1kW, balanced or unbalanced. The link coupled output isolates the aerial from the rig, which can cure TVI both ways. Their robust construction is proved by the ones in daily use for 15 years. 1.8-30MHz £110. Ezitune built in £39.50 (see below). Built in dummy load £8.90 Ex-stock.

S.E.M. 2 metre Transmatch, match your V.H.F. aerial, 1KW max. **£32.00 Ex-stock.**

S.E.M. EZITUNE. Do you use an antenna matcher? You need our Ezitune to tune it to your frequency without transmitting. Listen to the S9+ noise on your receiver and adjust your aerial tuner for a dip in the noise and you are matched up to 50 ohms (1:1 SWR). Protect your radio and stop tuning QRM. **£45** boxed, or p.c.b. + fixing bits and instructions to fit in any A.T.U. **£39.50.** Ex-stock.

VERY WIDE BAND PRE-AMPLIFIERS

They cover from 3-500MHz with a noise figure of 1.5dB and an unprecedented +30dB 3rd order IP at the INPUT. Gain is 9dB. We make three types. Straight pre-amp, this has a signal loss if you switch it off. **£32.00.** One which switches to "straight through" when switched OFF, can be used for transmitting through (100W) if supplied with 12V on receive and 0 on TX, costs **£37.00.** An R.F. switched unit is **£45.00.** All Ex-stock. We are continuing to make our highly acclaimed dedicated 2 Metre pre-amps with adjustable 0-20dB gain and 1dB N.F. Receive only **£21.90.** R.F. switched **£34.00** and with 240V P.S.U. **£39.00.** Ex-stock.



CONVERTERS for LF, MF, HF, VHF, UHF.

Our new H.F. CONVERTER opens new horizons for receivers, use with the new all mode V.H.F., U.H.F. receivers FRG9600 and ICR7000, extends their coverage down to 100kHz, giving you LF, MF, HF, VHF and UHF. You tune your RX from 100MHz up, e.g. 103.500 is 3.5MHz. It has two aerial sockets, one for H.F. into the converter and one for V/UHF switches straight through into your RX when you switch the converter OFF, i.e. No plugs to change. All this for **£45.00.** Ex-stock.

R.F. NOISE BRIDGE. If you are experimenting with aeriels you need one of these units. Tells you the resonant frequency and impedance of your aeriels and also invaluable for measuring 1/4, 1/2, etc., wavelength of feeders, etc. **£45.00.** Ex-stock.

WAVEMETER. A pretty little absorption wavemeter, to satisfy the licence conditions. 1.5-30MHz with a meter indication. **£39.50.** Ex-stock.

IAMBIC KEYS. We use the world famous CURTIS chip which eliminates the little idiosyncracies common in other keys. Opto-isolators from the chip ensure that R.F. can't get in, a common problem with multi-chip keys. Compatible with any TX. **£45.00.** An excellent twin paddle key often mistaken for ones costing several times more at **£19.50.** Ex-stock.

2 METRE LINEAR POWER AMP/PRE-AMP. People are constantly telling us that comparing different makes our Pre-amp is best. (See Pre-amps for spec.) Three models. Sentinel 40 14x power gain e.g. 3W IN-40W OUT. Ideal for FT290 **£85.00.** Sentinel 60, 10W IN-60W OUT **£95.00.** Sentinel 100 10W IN-100W OUT **£135.00.** All Ex-stock.

AUDIO MULTIFILTER. Has fully adjustable BAND PASS, HIGH PASS, LOW PASS and 2 NOTCH filters. From 2.5kHz to 20Hz. Making the most versatile filter available. **£75.00.** Ex-stock.

T.V.I. Our Braid Breaker/High Pass Filter cures T.V.I. by plugging into the TV aerial socket. **£7.50.** Ex-stock.

S.E.M. SWITCH. 3 way ant. switch + 4th position to earth. 1kW. S0239S D.C.-150MHz. **£23.00.** Ex-stock.

12 MONTHS COMPLETE GUARANTEE INCLUDING ALL TRANSISTORS.

Prices include VAT and delivery. C.W.O. or phone your CREDITCARD No. Ring or write for further data. Orders or information requests can be put on our Ansaphone at cheap rate times.

some continental mailboxes. There are one or two which send very long beacon messages, I timed one the other day at 20 seconds! This sort of operation is totally unnecessary and causes severe congestion on the channel. I would recommend leaving a complaint on the mailbox if you hear any operating that way.

All readers reports, including my own, have been combined to produce the chart shown in Fig. 1.

Amstrad PCW Computers

If you are the proud owner of one of these computers I expect you have been wondering if anyone will ever write a RTTY program. Well, your prayers have been answered as **Dave G4EVS** has just released a program to be sold by BARTG.

The program will run on a PCW-8256 or 8512 and requires an Amstrad compatible serial interface and a terminal unit suitable for use with RS-232 levels. The main features are listed below:

- 1) Send and receive Baudot (ITA No2) or ASCII.
- 2) Operates from 45.45 to 9600 baud with suitable terminal units.
- 3) Selectable save of received data to RAM disk.
- 4) Set-up your own files of standard messages i.e. QTH, name, station details.
- 5) Auto carriage return & line feed at end of line.
- 6) On-screen clock with automatic time message at the end of the transmission.
- 7) Can be used in conversational mode or set for file transfers.

The program does not, in its present

form, include split screen working or a type-ahead buffer. I have spoken to Dave and depending on the amount and nature of the feedback he receives, he may include split screen and type-ahead in a later version. I have already ordered my copy and I hope to include a report on its performance in next month's *RTTY*. For those of you who can't wait the program is known as **Amstrad PCW 8256 RTTY** by **G4EVS**, the price is £15.00 incl. from BARTG⁽¹⁾.

Contests

If you have received this copy of *PW* on time you still have time to join in the SARTG (Scandinavian Amateur Radio Teleprinter Group) RTTY contest on August 15 and 16 as mentioned last month.

The next contest in the calendar is a new one, The First Annual CQ Magazine-RTTY Journal World-Wide RTTY DX Contest. A bit of a mouthful but it sounds interesting, there is even an AX-25 packet section. The basic details are as follows.

Contest Period: 0000UTC September 26 to 2400UTC September 27 1987.

Operating Period: 48hrs, with the exception of single operator stations who must have 18hrs break at any time in periods of not less than 3hrs.

Operating Class: A; single operator. B; multi-operator, single transmitter.

Categories: A; all band. B; single band. Modes: Baudot, AMTOR (FEC/ARQ), ASCII and AX25 (no digipeating!).

Bands: 1.8, 3.5, 7.0, 14.0, 21.0 and 28.0MHz.

Message: All stations outside the US and VE, RST and CQ zone only.

For more complete details see DATACOM summer 1987, available from BARTG⁽¹⁾.

50MHz

I have received several reports of openings to the USA during the last month, but no RTTY, AMTOR or Packet. Has anyone worked the USA using a data mode on this band? If so please write with details, if not—then why not monitor this band and let me know the results.

Rallies

In an attempt to meet readers, I shall be working on the *Practical Wireless* stand at several rallies this year. I would be very pleased to hear from you so please come and visit.

The confirmed rallies are shown here.

Lincoln Hamfest	September 13
Harlow Mobile	September 27
Blackwood	October 4

That's it for another month, but please keep those reports and comments coming.

(1) BARTG Components Manager, John Beedie GW6MOK, Ffyonnonlas, Salem, Llandeilo, Wales SA19 7NP.

**Your next three deadlines are:
September 2, September 30
and October 28**

Amateur Satellites

Reports to Pal Gowen G3IOR
17 Heath Crescent, Hellesdon, Norwich, Norfolk NR6 6XD

This month our column carries the excellent news of the long-awaited new USSR "Radio" satellite, which is now orbiting earth, and providing many QSOs to both h.f. and v.h.f. satellite enthusiasts with all systems working to perfection. As long-standing readers will know, we have been giving details of this coming satellite system for over a year now, with many potential launch dates that had to be postponed. Our latest launch forecast gave early June, but with a further slight delay possible. This proved quite accurate! Now follows all the information, based on incoming news and practice, that you will need to operate and track the latest satellite transponder system.

Launch

Following a further short delay, the new amateur-radio satellite transponder system was eventually launched at 0724UTC on Tuesday 23 June 1987 from the Plesetsk launch site complex in northern USSR, located at 62.8N, 40.3E. This first placed the payload into an initial 1000km apogee 200km perigee transfer orbit. A second launch vehicle rocket burn took the package to its current circular 1000km apogee 985km perigee 104.9857 minute, 26.2414 degree increment, 82.9265 degrees inclination orbit. Instead of the single, or even the expected pair of separate amateur radio satellites, both the RS-10 and RS-11 systems are contained in the same spacecraft, designation number 87-54A, which also houses the Cosmos 1861 navigational satellite that transmits on both 150 and 400MHz.

Within a few hours from launch, the command station uplinked computer signals to the program decoder and it could be heard transponded via the telemetry beacon frequencies. By the evening of the same day the transponders, beacons, telemetry and ROBOTS were under test and in use, all apparently working to perfection. The first reported signal was heard by G3BGM, closely followed by G3IOR, who in turn alerted the AMSAT network by amateur radio and telephone.

The System Complex

Although officially RADIO-9, being the ninth RS satellite to be placed in orbit, to avoid complication with the earlier designated RS-9, we will refer to the new spacecraft as RS-10/11, as these are the identifiers used both by the telemetry and the ROBOT callsigns. In this way, confusion will be minimised.

The satellite itself houses two separate amateur radio transponders, RS-10 and RS-11, and each of these has five differing modes of transponder operation, alternative telemetry frequencies and alternative frequency automatic "ROBOT" communicators. Yet to be heard are message codestores, which are likely to be contained.

The transponder modes on both satellites are as follows:

Mode "K"—15m (21MHz) uplink, 10m (29MHz) downlink.

Mode "T"—15m (21MHz) uplink, 2m (145MHz) downlink.

Mode "A"—2m (145MHz) uplink, 10m (29MHz) downlink.

Mode "KT"—15m (21MHz) uplink, 10m + 2m (29 + 145MHz) combined downlink.

Mode "KA"—15m + 2m (21 + 145MHz) uplink combined, 10m (29MHz) downlink. The frequencies employed by the systems are as follows.

RS-10

Mode "K": Uplink passband 21.160–21.200MHz to give a 29.360–29.400MHz linear non-inverting downlink. (All frequencies supplied are non-Doppler corrected, e.g. nominal frequencies).

Mode "T": Has the same 21.160–21.200MHz uplink as mode "K", giving a 145.860–145.900MHz downlink, linear, non-inverting.

Mode "A": Uplink as mode "T" downlink (145.860–145.900MHz) giving downlink as mode "K" (29.360–29.400MHz).

Mode "KT": Has an uplink as for mode "K" (21.160–21.200MHz) to give simultaneous downlinks as "T" and "K" modes, e.g. both 29.360–29.400MHz and 145.860–145.900MHz.

Mode "KA": Has combined uplinks as modes "K" and "A" frequency ranges, and gives a single downlink as mode "K" in the 10m band, e.g. 21.160–21.200MHz plus 145.860–145.900MHz to give a 29.360–29.400MHz linear non-inverting downlink.

RS-10 Beacons

Beacons, associated with the mode or combination modes in use, are to be found

Practical Wireless, September 1987

on 29.357MHz, 29.403MHz, and on 145.857MHz and 145.903MHz, e.g. separated 3kHz out from the edges of the transponder downlink passbands. All frequencies supplied are modified by Doppler shift, being slightly higher at acquisition of signal, nominal at the time of closest approach and maximum elevation, and lower at loss of signal.

The ROBOT

Both RS telemetry and the "ROBOT" functions are downlink frequency interchangeable, but the RS-10 ROBOT downlink will normally use a 29.403MHz or 145.903MHz downlink according to mode. They can be switched to 29.357MHz and 145.857MHz to interchange with the telemetry channel. The ROBOT automatic QSO device may be called on either 21.120MHz or 145.820MHz (allowing for Doppler shift within the narrow uplink passband) according to the mode instruction given, e.g. "CQ CQ CQ de RS10 QSU 21120kHz". The reply should be "RS10 de (your call) AR" sent at a similar speed, ensuring that the "AR" is barred, i.e. not sent with a space between the "A" and the "R".

When accepted, i.e. as read without an error from the downlink, a response to your callsign and QSO number will be evoked. Instructions such as "QRZ", "QRQ", "QRS" will be supplied if the format is unacceptable or incomplete. The ROBOT will match the speed of the caller between 8 and 65w.p.m. Morse, and can be commanded to switch to the alternate band uplink to establish QSOs. Up to 128 callsigns and serial numbers can be stored in the memory, and when this is dumped via the same downlink, the callsigns and serial numbers of all the stations worked in the log will be transmitted by the orbiting satellite.

RS-11

RS-11 has a similar transponder, telemetry and ROBOT system, with the same bands used, but the frequencies employed differ.

Mode "K" has its uplink from 21.210–21.250MHz, to give a 29.410–29.450MHz linear non-inverting downlink.

Mode "T" has the same uplink as mode "K", giving 145.910–145.950MHz downlink, linear, non-inverting.

Mode "A" uplink is as mode "T" downlink (145.910–145.950MHz) giving the same downlink spectrum as mode "K" (29.410–29.450MHz).

Mode "KT" has an uplink as for mode "K" to give simultaneous downlinks as modes "T" and "K".

Mode "KA" has combined uplinks as modes "K" and "A" frequency ranges, and gives a single downlink as mode "K" in the 10m band.

Beacons

RS-11 beacons, associated with the mode in use, are to be found on 29.407MHz and 29.453MHz, and also on 145.907 and 145.957MHz. A 435.395MHz beacon is said to be flown also, but as yet permission to turn this on has not been granted.

Telemetry Decoding

The telemetry values are a little more complex than first understood, so some explanation is necessary. Both the ISKRA

amateur radio pair of satellites and the earlier RS-1 to RS-8 series of spacecraft used the two letters preceding the two figures only as an indicator to show the channel, but RS-10 and 11, which have common telemetry, use the letters as a status indicator, plus the figures following for an actual value. Thus, the sixteen channels observed are actually sixteen analogue channels plus sixteen descriptive channels, one of each in each line.

The series commences with the call of the transponder, i.e. RS10 or RS11 followed by a pause, and then follows the run, terminating with a pause, and the callsign sent again.

To make matters a little more complex, the actual prefix first letter that indicates the status will have an extra "dit" in the Morse code added at the beginning of the letter when the spacecraft is under command from the ground control stations RS3A. Thus, the first line of the frame, normally "IS" (di-dit, di-di-dit) or "NS" (dah-dit, di-di-dit) now becomes "SS" (di-di-dit, di-di-dit) or "RS" (di-dah-dit, di-di-dit). What is more, "computer" sounds (like you hear when you play a computer program on your audio tape recorder) will often be heard when the command station is loading messages into the memory for later replaying on the Morse codestore, this replacing the normal Morse code telemetry.

The first line prefix is either "IS" or "NS" (or "SS" or "RS" when under command instruction and loading) and indicates the smoothed mean value of later readings. If "IS" (or "SS") is the prefix, then the telemetry is fixed in a 90 minute period, if "NS" (or "RS") is the prefix, then it is fixed in a 10 minute sampling period. The following figures give the power supply voltage, nominally 20V. The formula is "n" the number, divided by four, or power supply $V = N/4$.

Line 2: "IR" or "NR" gives the sensitivity of the 2m transponder receiver. If the prefix is "IR" then the 20dB attenuator is in the receiver input, if "NR" then it is nominal, with no attenuation. The figure gives the 2m power output, formula $N/10 = 2m$ power output in watts.

Line 3: "ID" indicates the transponder receiver sensitivity as -10dB, "ND" shows nominal, i.e. 0dB attenuation. Figures show 29MHz power output, formula $N/10 = 10m$ power output of transponder in watts.

Line 4: "IG" indicates that the 21MHz uplink to the transponder is off, whilst "NG" shows it to be on. The following figures give the 21MHz RX i.f. voltage a.g.c., as $N/5 = \text{volts}$.

Line 5: "SU" indicates the 2m receiver of the transponder off, "NU" on, and the following number gives the 145MHz receiver i.f. a.g.c. voltage, as $V \text{ i.f.} = N/5$.

Line 6: The special service channel indications for inter-command station use (frequencies intentionally not given) called the "service channel" is given by "IW" when off, "NW" when on. The RX i.f. voltage follows by the formula $N/5 = V \text{ i.f.}$

Line 7: The beacon power level of the lower frequency beacon in use is given by "IK" when maximised to 1 watt, and by "NK" when at 300mW power. The figure following is a command station indicator loading not required by observers.

Line 8: This shows the upper beacon as "IO" when running at the 1 watt maximum, "NO" when QRP to 0.3 watts. The figures are again command values.

Line 9: This indicates that status of the first memory board as "AS" when off, "MS"

when on, with the 29MHz transponder temperature then given as $N-10 = \text{degrees celsius}$.

Line 10: The status of the second memory board, "AR" when off, "MR" when on. The temperature of the 2m transmitter is given by the number, as $N-10 = \text{degrees celsius } 2m \text{ TX}$.

Line 11: The special channel allocated to the memory, and when the command transmitter is loading "AD" is indicated when open. When closed, "MD" is given, indicating the memory is accepted. The figure following in the temperature of the 20 volt power supply, where $N-10 = \text{temperature in degrees celsius}$.

Line 12: As line 11, except that it is now for the second memory board. "AG" means open, "MG" means closed. The temperature of the nine volt power supply follows, as T in degrees $C = N-10$.

Line 13: The channel opening for the memory board beacon No. 2 if "AU" and "MU" if beacon No. 1. The 9 volt supply for the other transponder uplink receiver (RS-10 or RS-11) is shown by the number, if RS-10 then $V = N/5$.

Line 14: The sensitivity of the 21MHz ROBOT receiver, with "AW" given if -10dB pad is in circuit, "MW" if zero attenuation. The reading on the nine volt 21MHz ROBOT uplink receiver power supply follows, as $V = N/5$.

Line 15: The sensitivity of the 2m ROBOT uplink, with "AK" indicating -10dB of attenuation pad, "MK" no attenuation. The power supply voltage of the 2m ROBOT receiver follows as $N/5 = V$.

Line 16, finally, indicates the r.f. power of the special service channel transmitter, frequency not stated. "AO" shows 1 watt, "MO" indicates 0.3 watts. The figures following give the storage level of the ROBOT memory. Up to 32 QSOs stored it will indicate a value of 00. From 32 to the 128 maximum capacity it will give a figure between 80 and 99, thus alerting the command station to dump and empty the memory ready for the next batch of ROBOT QSOs.

The "G" and "K" prefixes occasionally thrown in have yet to be explained.

The ROBOT

The RS-11 listens on 21.130 and/or 145.830MHz, normally transmits on 29.407MHz, or 145.907MHz, according to mode, and is similar in calling format and reply to the RS-10 accompanying system, except that the callsign is now "RS-11". The alternative 10m and 2m frequencies may be employed.

Performance

The satellite system is not in as high an orbit as the earlier RS series, and thus would normally have a similar range to that of the earlier AMSAT-OSCAR-8, only slightly greater. In the first five days of operation your scribe had adequate QSOs with both North America (W1, 2, 3, 8, VE1, 2, 3, etc.) and Asia (UA9, UG6, UL7, etc.) plus many Europeans (UA1, 3, 4, UB5, UD6, HA, SM, DL, G, F, PA, ON, OZ, HB9, I, etc.).

The first evening of Mode "T" operation came as a surprise to many, who, having heard that the 144MHz band was giving good Es DX, and knowing that OSCAR-10 was not in range, suddenly heard two way QSOs between South American stations using the uplink passband. The users did not realise that the transponder was putting them down at excellent strength on 145MHz, and thus were not employing the

normal through-satellite terminology. The result was that quite a lot of new G callsigns were excitedly calling LUs, HCs, OAs in great hope and amazement! Even so, with an active E and F2 layer, the 29MHz downlink signals are audible well below horizon, and the hope of antipodal communications is high at this orbital height with the h.f. bands employed.

Uplink Efficiency

The receiver is very sensitive, and gave a perfectly readable downlink for just 200mW e.r.p. on the 145MHz uplink, and 10W e.r.p. on the 21MHz uplink, despite the presence of many QRO stations using the 21MHz uplink band for terrestrial communications (most of whom could not be heard via the F2 or E layers!).

Mobile stations using only 8 watts of power to a quarter wave mobile whip on the 145MHz uplink (G3PXT/M) and 50W to a compressed mobile G-Whip on the 21MHz uplink (G3RRX/M) could be copied solidly. Many fixed stations have already been worked faultlessly using just 10W to a simple dipole or ground plane antenna, thanks to the high receiver sensitivity and the closer passes.

QRM

The one problem is that when the accompanying Cosmos 1861 scientific satellite is commanded on (and a major experiment was planned for much of July) the 150MHz RTTY-like signal causes severe electromagnetic incompatibility to the 145MHz receiver on Mode "A", giving severe attenuation and blocking evidenced over the entire 29MHz downlink pass-band. The result of this is that when important data is being transmitted from the main payload, RS-10 and 11 may be limited to the 21MHz to 29MHz "K" mode, or even off to conserve power.

Downlink Excellence

The downlink, having 5 watts of power, is very strong, and defeats the worst of the attenuating effect due to passage of the 10m downlink through the dense summer E layer. The antennas perform well, with few nulls in the radiation pattern on any band, uplink or downlink.

The new system is known as the "BRTK" transponder (which initials stand for the Russian equivalent words for "on-board radio technical system") was built (like the previous RS satellites) at Kaluga, near Moscow, under the direction of Alexander Papkov. It is an excellent performer,

and quite the most effective communicating system yet orbited, as it provides superb space communications for a wide range of amateurs using simple and inexpensive equipment.

Tracking

A set of Keplerian elements, taken on launch day by laser radar, gives the following values, which are checking out extremely well in tracking to within a few seconds.

```
Epoch Year:      87
Epoch Day:      174.595 933 05 (23
                  June '87, 1408:08
                  UTC)
Rev. NO/Orbit    4
Drag/Decay       0.000 000 06 (6E-8)
Inclination      82.9265
Right Ascension  53.3166
Eccentricity     0.001 030 1
Arg. of Perigee  259.8854
Mean Anomaly     100.1119
Mean Motion     13.718 831 40
```

The period is 105.0245 minutes, and the increment 26.3820 degrees per orbit. Topical equator crossings will be given in the various AMSAT nets, and two are provided here. For Sunday 16 August 1987, 012UTC at 330° west, and for Sunday 29 August, 0055UTC at 346° west.

All the passes as seen from eastern England for 16 August, the acquisition time, the loss time, and the time and degrees of maximum elevation are shown in Fig. 1. The mode it will employ is not known at this time.

The first, middle and last passes of this same day with two minute tracking steps, so that those with beams can follow the satellite, and relate its position and DX available, can be seen in Fig. 2.

The map from the GM4IHJ "eqxer" program is in Fig. 3, and shows the satellite footprint at 1743 on the same day, when most of north east America is in common range of the UK and south west Europe, i.e. in the unshaded area. "S" marks the satellite position over mid north Atlantic, whilst "A" shows the antipodal point.

Listeners to the top end of the 144MHz band should not be surprised to hear amateurs from the southern hemisphere (ZS, PY, LU, CE, etc) who are not evident on the 21MHz uplink, as the refraction in our hemisphere is insufficient to return the signal to earth. It is, however, subtended sufficiently to enter the satellite receiver at 1000km altitude, and the stations employing the uplink band for terrestrial contacts may be quite unaware of their retransmission by RS-10 and 11.

AMSAT AMS-64 TRACKING SYSTEM									
ACCESS SPEED FROM: 16AUG87 000000									
DAY	ROS	LOS	MAX	DX	EL	AZ			
16AUG	0130	0143	0136	12					
16AUG	0312	0329	0321	61					
16AUG	0456	0515	0507	31					
16AUG	0649	0701	0636	07					
16AUG	1032	1040	1036	03					
16AUG	1218	1233	1225	17					
16AUG	1403	1421	1418	70					
16AUG	1549	1605	1557	28					
16AUG	1738	1744	1741	00					

Fig. 1

RS10/11	* 16/8/87	KUUUU4UAV9B			
UTC	EL	LAT	LONG	L6042XR4UMY	
1402	348	-6	52	79	*.....*
1404	349	0	80	31	*.....*
1406	352	7	75	10	*.....*
1408	355	18	69	2	*.....*
1410	3	34	62	357	*.....*
1412	33	61	55	354	*.....*
1414	128	56	49	352	*.....*
1416	151	31	42	351	*.....*
1418	157	15	35	350	*.....*
1420	161	6	28	349	*.....*
1422	163	-2	22	349	*.....*

RS10/11	* 16/8/87	KUUUU4UAV9B			
UTC	EL	LAT	LONG	L6042XR4UMY	
1737	330	-2	72	58	*.....*
1739	318	1	66	52	*.....*
1741	304	2	59	48	*.....*
1743	289	1	52	46	*.....*
1745	276	-1	46	44	*.....*

RS10/11	* 16/8/87	KUUUU4UAV9B			
UTC	EL	LAT	LONG	L6042XR4UMY	
0129	126	-4	27	328	*.....*
0131	117	1	34	327	*.....*
0133	105	5	41	327	*.....*
0135	89	10	47	325	*.....*
0137	70	11	54	324	*.....*
0139	51	10	61	321	*.....*
0141	36	6	67	317	*.....*
0143	24	1	74	309	*.....*
0145	16	-4	79	292	*.....*

Fig. 2

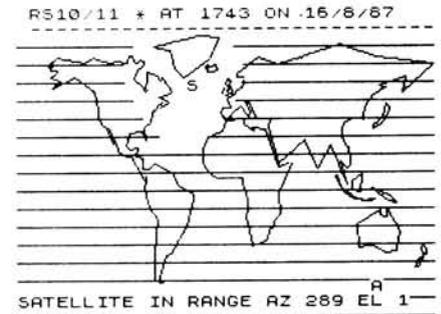

Fig. 3

The life expectancy of this satellite is quite high, as the lower orbit puts it well out of range of the Van Allen belt radiation, hence the memory solid state circuitry and the solar cells should last well.

Next month we shall try to catch up with the rest of the news, with some interesting findings on other satellites, the DX on OSCAR-10, a fresh set of Keplerian elements, and the success of the now fully functioning JO-12 Mailbox.

Propagation

Reports to Ron Ham
Faraday, Greyfriars, Storrington, West Sussex RH20 4HE

"We certainly have a great deal yet to learn about the vagaries of the ionosphere," remarked **Len Fennel G4ODH** (Wisbech) at the end of his extensive log for the month prior to June 22. You're quite right Len and it's all action this time, as I soon discovered when I read your letters.

Solar

The clear skies in Selsey enabled **Patrick Moore** to make drawings of the sunspot groups which he observed around 0800 on May 19 and 28, Figs. 1 and 2. From his observatory in Bristol, **Ted Waring** located a single spot on June 17.

"The solar flux showed a sharp rise from 78 s.f.u. on the 1st to peak at 98 on the 19th for four days and after the 22nd it fell rather sharply to end the month at 75," reports **Neil Clarke G0CAS** (Knottingley). He points out that the mean solar flux for May was 88, compared with 71, 74 and 85 for February, March and April respectively.

While studying the sun with his spectrohelioscope, **Cmdr Henry Hatfield** (Sevenoaks) located one group with 1 large and about 7 small spots and 2 small flares on May 24, 1 double spot on the 28th and single spots on the 30th and June 20. Henry noted the presence of filaments on May 24, 28, 30, June 4, 10, 12, 15 and

20. He also recorded bursts of solar radio noise, at 136MHz, on May 20, 21, 22, 24, 29, June 8, 10, 11 and 16. There is little doubt that the radio noise recorded by Henry between the 20th and 24th was associated with the sunspots illustrated in Fig. 1.

Dave Coggins (Knutsford), seen with his gear in Fig. 6, heard bursts of noise around 26MHz at 0755 on May 30 and an "echo" on Radio Norway's 15MHz signal at 2205 on June 7. Len Fennel reports hearing tone-A signals from the 50MHz beacon at Potters Bar (GB3NHQ) on May 20, 27, 29, 31, June 1, 3, 4, 5, 9 and 15, as well as from the 144MHz beacon at Wrotham (GB3VHF) on May 20, 27, 29,

**AUDIO FILTERS
MODELS FL2, FL3, FL2/A**

Model FL3 represents the ultimate in audio filters for SSB and CW. Connected in series with the loudspeaker, it gives variable extra selectivity better than a whole bank of expensive crystal filters. In addition it contains an automatic notch filter which can remove a "tuner upper" all by itself. Model FL2 is exactly the same but without the auto-notch. Any existing or new FL2 can be up-graded to an FL3 by adding Model FL2/A conversion kit, which is a stand alone auto-notch unit. Datong filters frequently allow continued copy when otherwise a QSO would have to be abandoned.

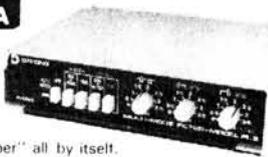

Prices: FL2 £89.70, FL3 £129.37, FL2/A £39.67

ACTIVE RECEIVING ANTENNAS

Datong active antennas are ideal for modern broadband communications receiver—especially where space is limited.

- highly sensitive (comparable to full-size dipoles).
- Broadband coverage (below 200 kHz to over 30 MHz)
- needs no tuning, matching or other adjustments.
- two versions AD270 for indoor mounting or AD370 (illustrated) for outdoor use.
- very compact, only 3 metres overall length.
- professional performance standards.



Prices: Model AD270 (indoor use only) £51.75 Both prices include mains power unit. Model AD370 (for outdoor use) £69.00

MORSE TUTOR

The uniquely effective method of improving and maintaining Morse Code proficiency. Effectiveness proven by thousands of users world-wide.



- Practise anywhere, anytime at your convenience.
- Generates a random stream of perfect Morse in five character groups.
- D70's unique "DELAY" control allows you to learn each character with its correct high speed sound. Start with a long delay between each character and as you improve reduce the delay. The speed within each character always remains as set on the independent "SPEED" control.
- Features: long life battery operation, compact size, built-in loudspeaker plus personal earpiece.

Price: £56.35

Our full catalogue plus further details of any product are available free on request. All prices include VAT and postage and packing. Goods normally despatched within 3 days subject to availability.

Barclaycard, Access Orders Tel: (0532) 744822

DATONG ELECTRONICS LIMITED
write to dept. P.W.
Clayton Wood Close
West Park
LEEDS LS16 6QE
Tel: (0532) 744822 (2 lines)

**RADIO AMATEURS EXAM?
PASS FIRST TIME!**

Before you enrol check the benefits of RRC'S unique Home Tuition Service

RRC has helped thousands of students to success in their examinations with this unique system of postal tuition, one which guides you, step-by-step, to qualify in the shortest possible time. Only The Rapid Results College offers you all these advantages:

- A qualified personal tutor
- Study material prepared by specialists
- Completely self-contained courses
- Handy pocket-sized booklets
- Personal study programme
- Regular marked tests
- Courses regularly updated
- 48 hour despatch
- Free advice before you enrol
- Telephone Helpline
- Free 'How to Study' Guide
- Instalment Plan
- Free Postage on course material
- Worldwide Airmail Service
- Extra tuition free if you don't pass first time

POST COUPON TODAY FOR FREE RADIO AMATEURS PROSPECTUS
Please send me my prospectus as quickly as possible.

Mr/Mrs/Miss/Ms _____

Address _____

Postcode _____

RRC The Rapid Results College
Dept. JX23, Tutor House, London SW19 4DS. FREE ADVICE: 01 947 7272 (9am-5pm)
PROSPECTUS: 01 946 1102/24 hour Recordcall Service quoting Dept. No. JX23

CALLING ALL LISTENERS . . . CALLING ALL LISTENERS

AUGUST ISSUE OUT NOW



ANTENNAS FOR SCANNERS

Find out about wide-band antennas and build a simple indoor discone.

INTRODUCTION TO DXTV-1

Keith Hammer & Garry Smith start a new series aimed at the newcomer to the fascinating hobby of long-distance television viewing.

All the regular features:-
Seen & Heard, Airband Bandscan, Grassroots, etc.

PLACE A REGULAR ORDER WITH YOUR NEWSAGENT

MAKE YOUR INTERESTS PAY!

More than 8 million students throughout the world have found it worth their while! An ICS home-study course can help you get a better job, make more money and have more fun out of life! ICS has over 90 years experience in home-study courses and is the largest correspondence school in the world. You learn at your own pace, when and where you want under the guidance of expert personal tutors. Find out how we can help YOU. Post or phone today for your FREE INFORMATION PACK on the course of your choice. (Tick one box only!)

Electronics	<input type="checkbox"/>	Radio, Audio and TV Servicing	<input type="checkbox"/>
Basic Electronic Engineering (City & Guilds)	<input type="checkbox"/>	Radio Amateur Licence Exam (City & Guilds)	<input type="checkbox"/>
Electrical Engineering	<input type="checkbox"/>	Car Mechanics	<input type="checkbox"/>
Electrical Contracting/Installation	<input type="checkbox"/>	Computer Programming	<input type="checkbox"/>
GCE over 40 'O' and 'A' level subjects			<input type="checkbox"/>

ICS Name _____ P. Code _____
Address _____
International Correspondence Schools Dept EES 97, 312/314 High St., Sutton, Surrey SM1 1PR. Tel: 01-643 9568 or 041-221 2926 (24hrs).

HAVING DIFFICULTY GETTING YOUR COPY OF PRACTICAL WIRELESS?

Then place a regular order with your newsagent **NOW!**

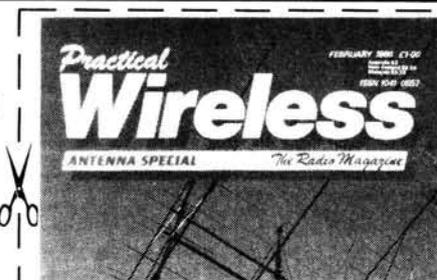

Dear Newsagent, please reserve/deliver my monthly copy of PRACTICAL WIRELESS
Name _____
Address _____
Signed _____

Distributed by Comag

noted a "quiver" on the signals from DKOTEN and DLOIGI when he turned his quad south.

"A new beacon, CTOWW, appeared on 50.30MHz, at 1807 on the 20th, while I was beaming towards GB3RMK on 340 degrees," said Len Fennelow. He monitored it for some time around S2-4. "I could not find it by directing my antenna towards CT-land, so clearly back scatter was in evidence here," he remarked. Len understands that the Portuguese amateur CT1WW recently proposed such a beacon, so this may well have been an initial test.

Although Norman Hyde copied signals from the 50MHz beacons in Scotland and Wales, GB3RMK and SIX, by meteor trail reflection every day throughout this period, at 0700 on June 6, another form of propagation enabled several complete callsign sequences to be heard.

I received a 599 signal from GB3RMK during the intense Sporadic-E opening around 1900 on May 28.

"The 14MHz beacons have, as expected, been solid copy for almost all of the period," Fig. 4, wrote Len Fennelow. He was delighted to hear JA2IGY for the first time on May 21 and again, along with LU4AA, on the 25th.

Brian Fields G4XDJ (Cleveland) heard all of the 14MHz beacons, except the JA, during the first 3 weeks of June.



Fig. 6

Tropospheric

Norman Hyde is now active on the 1.3GHz band (23cm) with two rigs; a home-brew driver into a Microwave Modules transverter and an Icom IC-1200. At present he uses a corner reflector antenna directed toward the Reading repeater, GB3RU, on RM9. "Over this 65km path the repeater, depending on conditions, is about S8-9 with me and I had my first QSO through it with G8NXJ in Twyford on June 21," said Norman.

In general, conditions on all v.h.f., u.h.f. and microwave bands depend largely on the prevailing weather and the atmospheric pressure, which is reason enough for me to prepare a monthly chart, Fig. 3, showing the changes which occur during a given period. The slightly rounded figures for

noon and midnight in Fig. 3, were recorded by the barograph installed at my QTH in W. Sussex. Barometer readings in Essex, supplied by Ted Owen, showed a peak of 1024mb on May 29 and 30 and a low of 1000mb on June 19.

The 934MHz Band

"Within any 24-hour period, our members run up to 6 daily checks on the frequency; 0730-0800, 1300-1330, 1530-1600, 1730-1800, 2030-2200 and 2330 to midnight, so if a lift comes up, we have a very good chance of being in the right place at the right time," wrote John Raleigh DW-04 from Bedford. John is the secretary of The Four County 32cm Club. He reports that at 2230 on May 20, David Hodges GB-01 worked into London and Swindon from his QTH in Leighton-Buzzard. At 2030 on the 24th, Bill Ellis WE-641 (Houghton Regis) and Ralph Rowlett GR-587 (Upper-Caldecote) worked into S. Humberside. On June 16 John Raleigh and Ralph Rowlett heard stations operating in London and Kent.

At various times on May 25, 26 and 27 and June 2, 7, 11 and 12, John Levesley UK-627, using a Cybernet Delta One transceiver and a Nevada PA7E collinear antenna, heard or worked GY-186 in Guernsey and JY-77, 604 and 808 in Jersey.

Broadcast Round-up

Peter Shore

It never ceases to amaze me just how controversial a subject broadcasting can be, especially international broadcasting. Whilst most of the world's population doesn't even know about shortwave radio, various governments in different parts of the world are constantly bickering. At the present time, there is controversy over the recent signing in Washington of an agreement between the United States and Israel on the establishment of a new transmitter site for the Voice of America and Radio Free Europe in the Arava Valley, a bleak desert area, just south of the biblical town of Sodom. Opposition from within Israel was vociferous: the Arava Valley is on the main migration route for millions of birds who nest in Europe and Asia but winter in Africa. Naturalists were appalled at the prospect of thousands upon thousands of birds, including pelicans, storks and eagles, flying into some of the twenty-two antenna arrays. And what would happen to the birds' natural navigational systems when they flew near to the transmitter and received enormous doses of radio frequency radiation?

Eventually, the local residents were bought off with a US 16 million dollar development grant, and peace, of sorts, now reigns in Israel.

But within days of the signing of the agreement, Poland jumped in on the act, with Government Spokesman Jerzy Urban claiming that the VoA was an "instrument of propaganda aggression against Poland and other socialist countries". Mr Urban added that if the construction of the site went ahead, Poland would "regard this as a hostile act against Poland". It will be interesting to see how this story develops during the construction of the site. The VoA hopes that when completed, its programmes will be heard, without jamming, over a huge area of the southern USSR, with Radio Free Europe and Radio Liberty transmissions similarly clearly audible.

Meanwhile, the new BBC relay station in Hong Kong is currently carrying out very limited tests, and is expected to be operational in the autumn. Watch this space for details of frequencies and times as soon as they become known. Staying with the BBC for the present, there is a little controversy here, too, as the Foreign Office is blocking the External Services' request to commence operations in Korean and Sinhala. With so much activity in South Korea at the moment, the Corporation feels that it is appropriate to broadcast to Koreans in their own tongue for at least half-an-hour a day. The Corporation also believes that its Tamil service should be supplemented by a Sinhalese service for Sri Lanka. Tamils are in a minority in that country, where Sinhala is the language of the majority. The BBC last broadcast in Sinhala in 1975. Doubtless John Tusa, Managing Director of BBC External Services will be lobbying the Foreign Office hard in the coming weeks as the next budget is sought.

International Broadcasting News

NOTE: all times UTC (GMT)

Europe

Bayrak Radio in Cyprus has been heard to sign-on at 0838 on 6.155 MHz with the signal drifting between 6.150 and 6.160 during the day until 1530, when an Arabic newscast is heard. Radiofonikos Stathmos Makedonias in Thessaloniki can be heard between 0700 and 2215 in Europe on 11.595 MHz and to the Middle East on 9.935MHz. On Sundays the station opens at 0500.

Finland has been experiencing continued problems with its new transmitter facilities at Pori. The station is off the air for lengthy periods on short wave and medium wave frequencies. The problem seems to in-

volve line difficulties twixt the studios and the transmitter site, and staff shortages.

Whilst these problems continue, it seems that Finland is planning to drop all domestic programming from long and medium wave, and rely entirely on f.m. It is intended that only external programming will be carried on a.m. frequencies henceforth. Radio Finland also plans to stop using 558kHz within a year.

The External Service of the Voice of Greece sneaks in the occasional English language newscast into its daytime Greek service:

0840-0850 on 15.625, 9.420MHz
1040-1050 on 15.630, 11.645MHz
1235-1245 on 15.630, 11.645, 9.855MHz
1540-1550 on 17.565, 15.630, 11.645MHz
1840-1845 on 15.630, 11.645, 11.610MHz
2335-2345 on 11.645, 9.395MHz

Beware, though, for sometimes the English portions do not materialise! Main English language programming is heard:

1920-1930 on 9.425, 9.395, 7.430MHz

As summer progresses more stations throughout Europe are putting on special programmes: following a successful summer season last year, Radio Danubius in the Hungarian capital, Budapest, is back on the air with programmes in German on 100.5 and 103.3MHz. A programme produced by the popular German magazine *Neue Revue* is being aired on this station—the first arrangement of this type in Eastern Europe. The station claims that it reaches some 4.5 million German visitors and residents of eastern Austria. In the Austrian province of Corinthia, the regional ORF station has begun programmes in Dutch for tourists. There's a daily newscast, whilst the feature programmes come from Radio Nederland! In Moscow, Radio Moscow has expanded its medium wave

foreign-language programming to include Arabic, Spanish, French, German and Japanese in addition to the existing English language programming.

During August, Radio Netherlands has some interesting features on *Media Network*: on August 13, the programme looks at Off-Shore Radio on the eve of the twentieth anniversary of the Marine Broadcasting Offences Act, whilst on August 27, Media Network visits the famous Berlin International Audio and Video Fair to find out what's new at the largest consumer electronics show in Europe. Media Network is heard on Thursdays with airings at 1150 and 1450 on 5.955 for Europe, and a less reliable 1850 on 6.020 MHz.

Radio Polonia is heard in English to Europe:

0630-0700 on 15.120, 7.270, 6.135MHz
1200-1225 on 7.285, 6.095MHz
1400-1430 on 7.285, 6.095MHz
1600-1630 on 9.540, 6.135MHz
1730-1800 on 9.540, 6.135MHz
1830-1855 on 7.285, 6.135, 5.995, 1.503MHz
2030-2055 on 7.285, 6.095MHz
2230-2300 on 7.270, 7.125, 6.135, 5.995, 1.503MHz

Additionally, there are music programmes on the air at 0500 on 7.270, 6.135, 5.995, 1.503MHz; 1130 on 7.285, 6.095MHz; and 2305 on 7.270, 7.145, 7.125, 6.135, 5.995, 1.503, 1.260, 1.206, 0.738MHz. On Sunday Holy Mass may be heard at 1300-1355 on 7.285, 6.095, 1.503MHz.

Programmes from Radio Beijing may be easier to hear soon, as an agreement has been reached between Swiss Radio International and the mainland Chinese station. Walter Fankhauser, SRI's Press Officer says that one or perhaps two transmitters will be used by either side, and that Radio Beijing is expected to get airtime between 2100 and 2300 UTC for programmes in English, German, French and Spanish, using omni-directional antennas for Europe. In Switzerland, there are problems for Swiss Radio International which wishes to construct a new transmitter complex, with higher powered transmitters to replace the Schwarzenburg site which cannot be expanded further. This site is situated in an idyllic part of the countryside (mind you, isn't all of Switzerland idyllic chocolate box scenery?) and local residents have objected to the construction of new larger antenna arrays and buildings for the transmitters. So for the time being, SRI will continue to use Schwarzenburg whilst the PTT searches for an answer to the problem.

Middle East

English from Radio Baghdad may be heard 2000-2200 on 9.875 whilst at 0000-0200, English to North America is carried on 11.705MHz. Arabic programming from Radio Qatar is heard on 9.585 0245-0700, 15.395 0900-1300, 15.265 1300-1700, 11.820MHz 1700-2100.

Africa

The new 1000kW transmitter on 200kHz from Algeria has been heard testing in Northern Europe during the night: a difficult catch here in the UK with BBC World Service generally carried on the frequency after Radio Four closes. Arabic programming has been heard from Algiers at 0900 on 15.150MHz.

Radiodiffusion Nationale Tchadienne has been heard between 2100 and 2200 on 4.9045 and on 4.920MHz.

The wonderful thing about short wave radio is that one can leave the country without having to bother about cancelling the milk and standing in package holiday check in queues at ungodly hours in the morning. If you want a taste of North Africa, tune into Radio Mediterranee International on 9.575MHz between 0600 and 2400. This a commercial station with programmes in Arabic and French, and puts in a good signal during the day here in the UK. With temperatures in the eighties as I write this, I'd much rather stay in Britain . . . !

The latest schedule from Radio RSA in South Africa has landed on my desk within the last few days, but seems to be outdated already. English is heard:

0630-0730 to Africa on 17.705, 11.900, 9.585, 5.980MHz
1100-1156 to Africa on 15.185, 11.900, 7.295MHz
1300-1556 to Africa on 21.590, 15.185, 11.900, 9.585MHz
2100-2156 to Europe on 9.585, 7.270MHz

Asia

If you wish to keep up-to-date with National Reconciliation in Afghanistan, listen to Radio Afghanistan's English programmes:

0900-1030 on 17.655, 15.435, 9.635, 6.085, 4.450MHz
1900-1930 on 9.665, 9.635, 9.530, 7.160MHz

The home service can be heard here in Europe after dark on 4.740MHz (a USSR relay), with programmes in Dari and Pashto.

Listen closely to 9.740 between 0850 and 0900 and you may be able to hear the BBC Far Eastern relay signing on with Bow Bells, and a brief transmitter identification.

The Voice of Free China from Taiwan broadcasts in English to Europe at 2200-2300 on 17.845, 15.440 and 9.955MHz.

Australia

Radio Australia was hit by a strike of journalists at the beginning of July, with no Australian and Pacific news broadcast at the usual 30 minutes past the hour placing. Music replaced the newscasts after a continuity announcement apologising to listeners.

The ABC's inland short wave service from Lyndhurst closed down on June 12 when VLR and VLH ceased broadcasting.

The Lyndhurst site continues to be used by the VNG Standard Time and Frequency station on 4.500, 7.500 and 12.000MHz.

North and South America

Radio Canada International's current schedule for European English services is [weekdays]:

0500-0530 and
0545-0600 on 6.050D, 6.140, 7.295D, 9.750MHz
1900-1930 on 7.235D, 9.555D, 11.945, 15.325, 17.820MHz
2000-2100 on 7.235D, 9.555D, 11.945, 15.325, 17.820, 17.875MHz
2100-2200 on 11.960, 15.325MHz

On Saturdays and Sundays the 1900 and 2000 are replaced by a broadcast at 2000 lasting for sixty minutes. The frequencies marked "D" are broadcast from Daventry in the UK. The *SWL Digest* programme is heard on Saturday evening during the 2000 programme. The AFRTS can be heard with fair reception on 15.265 from 1000 GMT until mid afternoon, and on 15.430 in the evenings. Two excellent programmes relayed by AFRTS come from National Public Radio, the US public broadcasting system. These are *All Things Considered* heard at 2100 and *Morning Edition* at 1100. English from KNLS in Alaska has this schedule:

0800-0900 on 11.860MHz
0900-1000 on 11.820MHz
1000-1100 on 11.930MHz
1630-1930 on 11.700MHz

WHRI is adding a second 100kW transmitter to its complement and will be operating 24 hours-a-day to Europe, the Middle East, South America and the Caribbean by late July, reports Sweden Calling DXers. The current schedule is:

0400-0600 on 7.400MHz
0600-0800 on 9.620MHz
0800-1100 on 7.355MHz
2100-2300 on 9.770MHz
2300-0100 on 11.770MHz

WRNO broadcasts at 2000 on 15.420 and at 2100 on 11.705MHz. HCJB in Ecuador operates in English to Europe:

0645-0700 on 9.845 [Mon-Fr]
0700-0830 on 11.835, 9.860, 9.845MHz
1900-2000 on 17.790, 15.270, 11.740MHz
2130-2200 on 17.790, 15.270MHz

That completes our world tour for this month. Be sure to join Broadcast Round-up next month for more news from the short wave broadcast bands.

**Your next three deadlines
are:
September 2, September
30 and October 28**

ERRORS & UPDATES

The Selection and Use of Capacitors, August 1987

Half-way down the left-hand column on page 24, the two mathematical expressions have each lost a square root sign. They should read:

$$I = \sqrt{\frac{W}{R}}$$

Therefore:

$$I = \sqrt{\frac{50}{4}} = 3.5A$$

Hiram Percy Maxim

◊ NAMES from the PAST ◊

by Tony Smith G4FAI

H.P. Maxim at ARRL HQ station,
W1MK, in the 1930s *Courtesy ARRL*

In his lifetime, Maxim was one of the best known radio amateurs in the world, although remembered in popular history in the United States for something quite different.

His father was Hiram Stevens Maxim, inventor of the Maxim machine-gun, who became a British citizen, and was knighted by Queen Victoria. His uncle, Hudson Maxim, invented the explosive Maximite, and other ordnance devices. It is hardly surprising that Hiram Percy also became a distinguished inventor, with 59 patents to his credit, and became famous in the field of armaments.

Originally an automobile pioneer, who built an early petrol powered tricycle, he designed the Columbia electric motor-carriage, and superintended the development of a complete range of road vehicles before the turn of the century.

He was a keen hunter and marksman and, whilst working on the problem of muffling motor exhausts, invented the "silencer", which virtually eliminated the sound of gunfire from sealed-breech rifles. He formed his own company in 1908, and produced various versions of this over the succeeding years.

It caused a sensation. The press condemned it, in the mistaken belief that it could be used with hand guns. It came to be considered a menace to public safety, many states stopped its sale, some countries banned its importation, and production finally ceased in 1930.

In the 1920s Maxim adapted the silencer to reduce noise in a variety of industrial and marine applications, and it was used in US fleet submarines. A Maxim window silencer ventilated rooms whilst keeping out noise, and his company was the first to develop a successful device to convert sea water to fresh water.

He was a man of many interests. An enthusiastic film-maker, he was organiser, and president, of the Amateur Cinema League. He was a pioneer in aviation, particularly gliding, and he had an active amateur radio station with his son as early as 1910, with the callsign SNY. He wrote a weekly "science for the layman" feature for a newspaper syndicate, the scenario for a Pearl White film, and several books. He wrote and lectured about astronomy, and was a keen yachtsman.

Practical Wireless, September 1987



In 1914, when relaying a long distance message through an intermediate amateur radio station, he conceived the idea of a national organisation of relay stations, handling messages across America. That year, together with Clarence Tuska, its first secretary, he founded the American Radio Relay League, becoming its first president. The following year, they jointly started ARRL's famous magazine, *QST*.

By 1917, when America entered the first world war, there were over 6000 amateurs in the USA, and ARRL was well established as their national representative body. As in Britain, the war curtailed all amateur activities, and the League closed down. After the war, the US government was reluctant to allow amateur radio to start again. Maxim called together the old board of directors of ARRL, who raised funds to relaunch the League and, under his leadership, pressurised the government until amateur radio took to the air again on 1 October 1919.

In 1924, Maxim came to Europe on behalf of ARRL, who believed there was a need for a body to represent the interests of radio amateurs at international conferences, and to encourage world-wide fraternisation. He met representatives of various organisations in France, who then invited all known national amateur radio societies to meet in Paris in March 1924.

As a direct result of this meeting, the International Amateur Radio Union

was formed which, at its first Congress the following year, elected Maxim its International President. The headquarters of IARU were located at West Hartford, HQ of ARRL, and Maxim was now deeply involved in international, as well as national, amateur radio affairs.

In 1927, an International Radio Telegraphic Conference was held in Washington DC, but the official British delegation had no instructions to consider the interests of radio amateurs in their negotiations. Maxim and Kenneth Warner, secretary of both ARRL and IARU, attended the conference and, by arrangement with the Radio Society of Great Britain, represented the interests of British amateurs. They pressed hard for the allocation of wavebands on a world-wide basis, and their efforts resulted in the adoption of the harmonically related frequencies for the main amateur bands as we know them today.

Maxim died in 1936, still president of ARRL and IARU. He was mourned by amateurs everywhere, who had gained so much from his work on their behalf. His call, W1AW, can still be heard on the air from the Hiram Percy Maxim Memorial Station, located at ARRL HQ in Newington, Conn. The operation of this station is a daily tribute to a man who, in the midst of an already full life, gave so much of his time and effort for his fellow radio amateurs around the world. **PW**

USE THIS

SMALL ADS

Whilst prices of goods shown in advertisements are correct at the time of closing for press, readers are advised to check with the advertiser both prices and availability of goods before ordering from non-current issues of the magazine.

The prepaid rate for classified advertisements is 40 pence per word (minimum 12 words), box number 60p extra. Semi-display setting £13.24 per single column centimetre (minimum 2.5 cm). Please add 15% VAT to total. All cheques, postal orders etc., to be made payable to Practical Wireless. Treasury notes should always be sent registered post. Advertisements, together with remittance should be sent to the Classified Advertisement Dept., Practical Wireless, Enefco House, The Quay, Poole, Dorset BH15 1PP. Telephone (0202) 678558.

Receivers and Components

RADIO CANADA, Peking, Australia, Voice of America. A Vega 206 (6x SWM/LW) pulls these and dozens more. £25.45. Back by public demand. Year's guarantee. Return despatch. CORRIGAN-RADIOWATCH, Building 109, Prestwick Airport, KA9 2RT.

SCANNER MODIFICATIONS. Specialist reception equipment. Extensive frequency listings. For FREE catalogue send large SAE to: S.S.C. PO Box 71, Bournemouth, Dorset BH9 1DL.

QUARTZ CRYSTALS and FILTERS

Large numbers of standard frequencies in stock for amateur, CB, professional and industrial applications. Stock crystals £5.00 each (inc. VAT and UK post). Any frequency or type made-to-order from £6.50. Phone or SAE for lists.

COLLEDGE ELECTRONICS
Merriott, Somerset, TA16 5NS.
Tel: (0460) 73718.

MEDIUM WAVE DXing equipment. SAE details: D. J. Stanton (Radio), 16 Addison Road, Worcester WR3 5EA.

PW MEON in kit form inc. box £44 or built £70. Also components, kits etc. Details of 70m send sae to: FJP KITS, 2 Market Street, Hednesford, Staffs WS12 2SA. Tel. 05435 6487.

Special Offers

FREE MEMBERSHIP to a new national electronics club. For details and a free pack of components worth over £10 send only £1 p&p to: WOODSIDE, Dowsett Lane, Ramsden Heath, Billericay, Essex CM11 1JL.

Wanted

SERVICE MANUALS for telequipment scopes models 31 and 33. Also mains transformer for model 33. Tel. 092 52 6605 after 6pm.

WANTED. Operating instructions or photocopy for Verner International Frequency Counter No. 1000F-MK2 V1S/72/2 Handbook No. V1S/14, 091 4772420.

Veteran and Vintage

COLLECTOR REQUIRES Heathkit DX100U and Vanguard working or not. Tel. Darlington 481418 after 6pm.

Service Sheets

TECHNICAL INFO SERVICES 76 Church St - Larkhall - Lanarks

FULL SIZE SERVICE SHEETS
Ctv/Mus-c/Combis £3.50 per set + Isae
Any other published £2.50 + Isae

Complete TV Repair Course £9.50
Complete Radio Servicer/Repair £9.50
Practical Transistor Yearbook £5.80

Repair data/circs most TVs and Video
Mono TV or Videos £10.50; CTV £12.50

Almost every SERVICE MANUAL stocked
Main supplier NEWNES TECHN BOOKS
Sole supplier TV TECHNIC BOOKS
S.a.e. for free Review and pricelists

FOR FAST QUOTES
PHONE 0698 884585
After 5pm - 0698 883334

WORKSHOP SERVICE MANUALS

Thousands stocked. Most Makes, Models, Types, Audio, TV, Video, Test, Amateur etc. LSAE enquiries/quotation and FREE Review/price lists with details of our Unique Repair and Data Guides, from Valves to Video's.

MAURITRON (PW)
8 CHERRY TREE ROAD, CHINNOR, OXON, OX9 4QY.

Books and Publications

VHF/UHF FREQUENCY LIST 28 to 1300 MHz £3.00 inc p&p.
DAVINA SYSTEMS, 51 Glyne Street, Farnworth, Bolton, Lancs.

Software

COMMODORE COMPUTERS (+4, C16, 64, 128). "MICROCOM" cw/rtty tx/rx with superb morse tutor. "TURBO LOG" ultimate high speed station log. "MICROCOM INTERFACE" ready built. S.A.E. to: Moray Micro Computing, Enzie Slackhead, Buckie, Moray, AB5 2BR. Tel. 0542 7384.

RF ENGINEERING SOFTWARE

FOR BBC(B). ON TAPE. WITH WRITTEN NOTES. FOR PROFESSIONAL USE. ALSO SUITABLE FOR SERIOUS AMATEUR WORK.

SMITHCHART. A comprehensive chart matching program. Computes and displays results for up to 12 points. Up to 8 matching sections selected from 13 types (£48 incl.)

THREEPROBE. Computes complex impedance at distant load point, using simple measuring system with 3 voltage probes. Especially suitable VHF/UHF. Hardware described but not supplied (£42 incl.)

(OTHER RF SOFTWARE SHORTLY)
Details from:

SCIENTIFIC AND ENGINEERING SOFTWARE
PO Box 416, Marlow SL7 1XU. (06284) 2508

Masts & Antennas

RACAL 3-75MHz loop antenna. Ex-army, never used, everything there £100. (0604) 411308.

MASTS

Wind-up
Tilt over
Mobile and static.

Prices from £160 complete for our economy model. 25ft to 40ft, VHF & HF



COME AND VISIT
OUR STAND AT
SARCON 87

Tennamast

is a new name
a new product
a new design.

Please write or telephone with your requirements. 24hr answer service.

PROMPT DELIVERY



**MAINS ROAD
BEITH
AYRSHIRE
KA15 2HT**
Tel: (05055) 3824
GM4 VHZ

© TENNAMAST Scotland 1986



ORDER FORM PLEASE WRITE IN BLOCK CAPITALS

Please insert the advertisement below in the next available issue of Practical Wireless for
insertions. I enclose Cheque/P.O. for £ CAT. heading
(Cheques and Postal Orders should be made payable to Practical Wireless)

NAME

ADDRESS

PRACTICAL WIRELESS

Classified Advertisement Department,
Enefco House, The Quay, Poole,
Dorset BH15 1PP. Telephone (0202) 678558
Rate 40p per word, minimum 12 words.
Box No. 60p extra.
PLEASE ADD 15% VAT TO TOTAL

Company registered in England. Registered No. 1980539. Registered Office: Towngate House, 2 Parkstone Road, Poole, Dorset, BH15 2PJ.

9/87

For Sale

VERSATOWER STANDARD (13M20) series with top bearing £300.00. As new. Tel. (0772) 316299.

TRIO TS530SP as new £595. Plus Eddystone 99 O/R VHF comms RX £120. 0487 831396.

FT290R 2M handheld with FNB. As new £190. Tel. Weston Super Mare (0934) 518417.

GILL'S SUMMER SALE. FT101 Mk1, B.E.C.W filters 350Hz 6 pole £31.00 p.p. 8 pole 250Hz £39.90 p.p. Pair 6146B + 12BY7A £31.00 p.p. Cash/cheque specials. FT1757 Mk1 & Mk2 phone. FT1790R £359. FT1690 £275. FT209RH + FNB4 £259. FT1709R + FNB3 £209. FT1703R + FNB3 £189. FT1770RH £349. FT1726R £799. FT290 Mk2 £385. FT101ZD Narrow SSB & CW Filters. Phone. HOLDINGS/AMATEUR ELECTRONICS, 45, Johnston Street, Blackburn BB2 1EF. (0254) 59595. Closed Thursday, 15 mins. June. 31. M6. Free parking.

TRIO R2000 RECEIVER, mint condition. Less than half price £300. 0644 845526 evenings.

30FT STURMECH TOWER, Kenpro h/duty rotator, 3 ele tri-band, 16 ele para/beam, may split. Offers, 08045 59145 after 6pm.

HEATHERLITE MOBILE MICROPHONES Telephone 0482 871762

Lightweight and fully flexible, good audio quality. Can be worn around the collar or over the head. Complete with control box, mic gain control, PTT, LED on TX.

with plug, with scan buttons	£26.00
with plug, without scan buttons	£24.00
For single Earphone on any of above	add £3.00

TYPE SW for hand portables using jack plug connections, mix, with switching box, jack plugs, earphone

MIC and COAX only, circuit to make own control box	£7.50
Mic, single earphone, coax, circuit	£10.50

*please state rig" p&p add £1.50 per order

EXPLORER VALVE AMPLIFIERS

2M EXPLORER VHF linear amp with single 4CX208	£535
HF EXPLORER linear amp 2 x 3-500Z valves	£1050
Carriage on amps	£15

Heatherlite Products, 1 Beverley Business Centre, St. Nicholas Road, Beverley, North Humberside HU17 0QM

INDEX TO ADVERTISERS

A.H. Supplies	53
Aerial Techniques	61
Allwell Engineering	57
Amcomm of London	15
BARTG	71
Billington Valves	12
Birkett, J.	13
Black Star	10
Bredhurst Electronics	53
C.P.L. Electronics	13
Cambridge Kits	61
Colomar Electronics	10
Cricklewood Electronics	53
Datong Electronics	65
Dewsbury Electronics	13
Dorset Dish	61
Dressler	11
Elliott Electronics	57
Garax	13
Golledge Electronics	70
G4TNY	53
Heatherlite	71
Howes, C.M. Communications	12
I.C.S. Intertext	65
ICOM (UK) Ltd	4, 5, 6, 7, 57
Lee Electronics	14
Lowe Electronics	2, 3, 12
Maplin Electronics	Cover 4
Maurifon	70
MH Electronics	71
Photo Acoustics	43
QSL Mailbox	39
R.A.S. Nottingham	10
Radio Component Specialists	71
Radio Shack Ltd	72
Random Electronics	57
Rapid Results College	65
RST Valve	14
Rylands, F.G.	71
S.E.M.	61
SARCON '87	25
Scientific & Engineering Software	70
Scientific Wire Co	71
Siskin Electronics	25
South Midlands Communications	8, 9, 10
Spectrum Communications	14
Stephens James	57
Tandy	21
Targa	12
Technical Info Services	70
Technical Software	10
Tennast Scotland	70
Uniden	Cover 3
Ward, Reg & Co	Cover 2
Waters & Stanton	33
Withers, R. Communications	29

Miscellaneous

THE SCIENTIFIC WIRE COMPANY
811 Forest Road, London E17. Telephone 01-531 1568

ENAMELLED COPPER WIRE

SWG	1 lb	8 oz	4 oz	2 oz
8 to 34	3.63	2.09	1.10	0.88
35 to 39	3.82	2.31	1.27	0.93
40 to 43	6.00	3.20	2.25	1.61
44 to 47	8.67	5.80	3.49	2.75
48	15.96	9.58	6.38	3.69

SILVER PLATED COPPER WIRE

14 to 30	10.10	5.20	2.93	1.97
----------	-------	------	------	------

TINNED COPPER WIRE

14 to 30	3.97	2.41	1.39	0.94
----------	------	------	------	------

Fluxcore Solder 5.90 3.25 1.82 0.94
Post free, please add VAT @ 15%. Orders under £300 add 50p. SAE for list of copper and resistance wire. Dealer enquiries welcome.

FREE BARGAIN LIST Crystal/Ceramic Filters etc. Hendriksen, PB314, 7200AH Zutphen, Holland.

GZF Inventor and proprietor of Patent for **VARIABLE HIGH FREQUENCY FRAME ANTENNA** offers circuit and full assembly details for the modest sum of £5. A Do-It-Yourself project. Components required to be found in most Ham shacks. Most expensive components, two variable tuning capacitors. Antenna twenty-one inches square, mounts on top of control box, fully rotatable from operating position, tunable all the way 80 to 10 metres there being only one inductance. SWR One to One 40, 15 and 10 and One Point Five to One 80 and 20. S3 on CW from JA, W areas 0 to 3, VE 1 to 5 and all Europe. Ninety awards obtained with frame. Maximum power 100 watts. **NEW EFFICIENT LW AND M WAVE FRAME ANTENNA**, 21 inches square. D.I.Y. project. Circuit, parts list, assembly data £3. Ideal caravan and flat dwellers. **DIY LOOP ANTENNA** for BC and SWL's. Tuning range 1500 to 10 Metres. Parts List Assembly data £3. SAE for details. F. G. Rylands, 39 Parkside Avenue, Millbrook, Southampton SO1 5AF. Tel (0703) 775064

CASES, 19" rack and free standing from £12.00. NEWRAD, Wick Ind. Est., New Milton, Hants. Tel. 621195.

MORSE CODE PREPARATION
Cassette A: 1-12 wpm for amateur.
Cassette B: 12-25 wpm for professional examination preparation.
Each cassette is type C90.
Price of each cassette (including booklets) £3.95.
Morse key with separate battery (PP3) — driven solid-state oscillator and sound transducer produces clear tone for sending practice. Price of key with electronic unit £8.95.
Price includes postage etc. Europe only.
MH ELECTRONICS (Dept PW)
12 Longshore Way, Milton, Portsmouth PO4 8LS

HAVE YOU GOT your copy of the Tiger Antenna Magazine yet? June issue out now. Send 50p in stamps to ANT PRODUCTS, Foundry Works, Old Great North Road, Ferrybridge, West Yorks. WF11 8NN.

HEATHKIT U.K. Spares and Service Centre. CEDAR ELECTRONICS, Unit 12, Station Drive, Bredon, Tewkesbury, Glos. Tel. (0684) 73127.

WAVEGUIDE, FLANGES & DISHES. All standard sizes & alloys (new material only) from stock. Special sizes to order. Call: **EARTH STATION** 01-228 7876. 22 Howie Street, London SW11 4AR.

YOUR GEAR IS PRECIOUS, protect it. The Electroguard is an in-line alarm for radios, videos, computers, microwaves, TV's. Only £25 from FOX INDUSTRIES, Dept PW1, Free-post, 54 High St., Stourport, Worcs. DY13 8BR.

ANALOGUE DEVICES 3½ DIGIT DPM'S: AD 2010 £85, AD 2003 £65, AD 2001 £55. All full scale range +/- 199.9 mV c/w data sheets. Advance PMA 54, 0-30Vdc 10A Stabilised Power Supply £95. All equipment in excellent condition. E & M DESIGN ASS. LTD. Tel: 01-391 0545, Fax: 01-391 5258.

TO FILL THIS SPACE PHONE KATHY ON 0202 678558

BRITISH AMATEUR RADIO TELEPRINTER GROUP ANNUAL RALLY
on **SUNDAY 30th AUGUST** at **SANDOWN PARK RACECOURSE ESHER, SURREY**

★ BARTG Kits Components etc ★
★ Talk-in on S22 ★ Car Boot Sale ★
★ Refreshments ★ Ample free car parking ★ Easy access by car ★
★ Admission £1 ★ Open 10.30-17.00 ★
★ Many trade stands ★

This Rally is not only THE Rally for the RTTY enthusiast but has a limited number of regular rally stands to give the mix that makes this Rally of interest to ALL radio amateurs.

As usual, among the the trade and exhibition stands will be most of the "bits and pieces", books, publications and software for RTTY, Amtor, Fax and Packet radio.

Further details available from:
PETER NICOL,
G8VXY, BARTG Rally Manager,
38 Mitten Avenue, Rubery, Rednal,
BIRMINGHAM B45 0JB
Telephone 021 453 2676

★ BAKER ★

GROUP P.A. DISCO AMPLIFIERS post £4

150 watt Output, 4 input Mixer pre-amp, illustrated	£90
150 watt Output, Slave 500 mv. Input 3 Speaker Outputs	£89
500 watt Heavy duty mono slave amplifier	£275
150 watt P.A. Vocal, 8 inputs. High/Low Mixer Echo Socket	£148
60 watt Mobile 240V AC and 12V DC. 4-8-16 ohm + 100v line	£89
Compact PA amp +20 Stereo or 40 watts Mono	£65
30 watt Guitar/PA Amplifier, 2 inputs, Treble, Bass etc.	£89
30 Watt Guitar COMBI, 12in. Speaker, Treble, Bass etc.	£95

FAMOUS LOUSPEAKERS

Make	Model	Site	Watts	Ohms	Price	Post
GOODMANS	HIFAX	7 1/2 x 4 1/4	100	8	£28	£2
GOODMANS	HB WOODER	8in.	60	8	£16	£1
BAKER	DISCO/GROUP	10in.	50	8/16	£22	£2
BAKER	MID-RANGE	10in.	100	8	£30	£2
BAKER	DISCO/GROUP	12in.	75	4/8/16	£24	£2
BAKER	DISCO/GROUP	12in.	120	8/16	£34	£2
GOODMANS	DISCO/GROUP	12in.	120	8/15	£38	£2
WEM	DISCO/GROUP	12in.	300	8	£65	£2
H+H	DISCO/GROUP	15in.	100	4/8/16	£54	£4
GOODMANS	HF/BASS	15in.	250	8	£32	£4
GOODMANS	HPD/BASS	18in.	230	8	£32	£4

LOUSPEAKERS REPLACEMENT TYPE STATE IMP REQUIRED.
2in. 3in. 5in. 6x4in. 7x4in. £2.50. 6in. 8in. 8x5in. £4 P&P 75p.
8in. £5. 10in. £7.50 PP £1. Many others in stock.

MAINS TRANSFORMERS All 240V Primary

250-0-250V 80mA. 6.3V 3A. 0, 5, 6V 2A.	Price Post
350-0-350V 250mA. 6.3V 6A. C.	£10.00 £2
220V 25mA. 6V 1 Amp £3.00. 220V 45mA. 6V 2 Amp	£16.00 £2
Auto Wound 120V/240V. 150W. 9V. 250W £12. 500W £15. Post £2	£4.00 £1

LOW VOLTAGE TRANSFORMERS £5.50 each post paid
9V. 3A. 12V. 3A. 16V. 2A. 20V. 1A. 30V. 1 1/2A. 30V. 5A + 17-0-17V. 2A. 35V. 2A. 20-40-60V. 1A. 12-0-12V. 2A. 20-0-20V. 1A.

VARIABLE POWER SUPPLY 0 to 12 volts up to 400 M.A. D.C. Ready made on P.C. board. Size 5x2 1/2x2in. £8.50 P.P. £1.

PANEL METERS 50µA. 100µA. 500µA. 1mA. 5mA. 100mA. 500mA. 1 amp. 2 amp. 5 amp. 25 volt. VU 2 1/4x2x1 1/4in. £5.50 post 50p

MINI MULTI TESTER Volts AC-DC, ohms, milliamps £8.50
DELUXE RANGE DOUBLER METER 50K O.P.V. £25.00 PP £1
Ohms to 20 meg. AC/DC volts to 1000V. Amps 50µA to 10A.

PROJECT CASES Black Vinyl Covered Steel Top. All Base 4 x 2 1/2 x 2 1/4in. £3.00. 6 x 4 x 1 1/2in. £4.00. 8 x 5 x 2in. £4.50. 10 x 6 x 3in. £5.00. 11 1/4 x 6 x 5in. £10.00. 15 x 8 x 4in. £13.50.

ALUMINIUM PANELS 18 s.w.g. 6. 12 x 12in. £2.50. 14 x 9in. £2.40. 6 x 4in. 65p. 12 x 8in. £1.50. 10 x 7in. £1.50. 8 x 5in. £1.00. 14 x 3in. £1. 12 x 5in. £1.15. 16 x 10in. £2.70. 16 x 6in. £1.00.

ALUMINIUM BOXES. PLEASE ADD EXTRA POSTAGE.
4 x 2 1/2 x 2in. £1.35. 3 x 2 x 1in. £1.15. 6 x 4 x 2in. £2.20. 8 x 6 x 3 £3.40. 12 x 5 x 3in. £4.00. 6 x 4 x 3in. £2.50. 10 x 7 x 3in. £4.00.

HIGH & LOW VOLTAGE ELECTROLYTICS Many others in stock.
20/500V 75p 470MF 400V £3 20 + 20/350V 75p
32/350V 50p 680MF 350V £3 32 + 32/500V £2
47/350V 75p 2200MF 400V £5 32 + 32/350V 85p
220/400V £2 8 + 8MF 450V £1 80 + 40 + 20/350V 95p

470MF 63V 40p. 1000MF 40V 50p. 100V £1.20. 1200MF 76V £1. 1500MF 63V 80p. 100V £1.20. 2000MF 63V £1.50. 100V £1.80. 2500MF 50V 70p. 3300MF 63V £2. 4700MF 63V £3. 6800MF 100V £5.50. 30,000MF 25V £2.50.

AIR-SPACED GEARED TWIN GANGS 365 + 365 + 25 + 25p £2.00.
VERNIER DIALS, 0:100, 36mm, £3.00, 50mm, £3.50.
MORSE CODE TAPPER & BUZZER Practice Set £3.00.
RESISTORS, CAPS, DIODES, TRANSISTORS 1000s IN STOCK

RADIO COMPONENT SPECIALISTS
337 WHITEHORSE ROAD, CROYDON
SURREY, U.K. Tel: 01-884 1665
Post 65p Minimum. Orders Welcome
List, Large S.A.E. Delivery 7 days Closed Wednesday

YOUR LOCAL DEALERS

STOKE ON TRENT
MRZ COMMUNICATIONS LTD
 ICOM - Amateur/PMR/Marine/Air.
 YAESU - Amateur MRZ Desk PSU
 for ICOM/YAESU Portables.
 UK and EXPORT
Tel: (0782) 619658

IRELAND
Radcom Electronics
 Approved dealer for Icom,
 Yaesu and most accessories
**25 Riversfield
 Midleton, Co. Cork,
 Ireland
 Tel: 021 632725/632804**

WORCESTERSHIRE
A. Kelly Electronics and Communications Equipment
 RSGB Publications, Mutek, DRAE,
 Microwave Modules, Starmaster Keys,
 TAL Aerials, ALINCO. We buy and sell
 second hand equipment.
**3 Stoke Road, Aston Fields,
 Bromsgrove, Worcs. B60 3EQ.
 Tel: 0527 71165**
(Open 6 days a week, evenings by Appointment)

ESSEX
Selectronic
 The UK's leading suppliers of
 934MHz personal radio
 equipment
**203 High Street, Canvey
 Island, Essex
 Tel: 0268 691481**
(Open Mon-Sat 9-5.30)
 Amateur radio equipment also in stock

HERNE BAY
ICOM (UK) LIMITED
 The Official Icom importer
**2 Stanley Road
 Herne Bay, Kent
 CT6 5SH
 Tel: 0227 369464**
*(Open Mon-Sat 9-5.30,
 except Thurs 9-1)*

SOUTHAMPTON
South Midlands Communications
 Official Yaesu Importer
**S.M. House, School Close,
 Chandlers Ford Industrial Estate,
 Eastleigh Hants SO5 3BY.
 Tel: 0703 255111**

PORTSMOUTH
Telecomms
 Importers of the Nevada
 range of 934MHz equipment
**189, London Road,
 North End, Portsmouth,
 Hants, PO2 9AE
 Tel: 0705 662145**

DEVON
Reg. Ward & Co. Ltd.
 The South-West's largest amateur
 radio stockist. Approved dealer for
 Trio, Yaesu and Icom
**1 Western Parade,
 West Street, Axminster,
 Devon, EX13 5NY
 Tel: 0297 34918**
(Closed 1.00-2.00 and all day Monday)

BUCKINGHAMSHIRE
Photo-Acoustics Ltd.
 Approved Trio, Yaesu and
 Icom dealer (part exchange
 always welcome)
**58 High Street, Newport Pagnell,
 Buckinghamshire MK16 8AQ
 Tel: 0908 610625**
(Mon-Fri 9.30-5.30, Sat 9.30-4.30)

TYNE & WEAR
ESR Electronic Components
 Official North East dealer for
**VELLEMAN KIT
 Station Road, Cullercoats
 North Shields,
 Tyne & Wear NE30 4PQ
 Tel: 091 251 4363**
(Mon-Sat 9.30-5.30. Closed Thurs)

LONDON
AMCOMM OF LONDON
 Approved dealer for Yaesu
 and Icom
**373 Uxbridge Road,
 London W3 9RN
 Tel: 01-992 5765**
(Mail order a speciality)

DERBYSHIRE
Low Electronics
 The official importer of the
 TRIO range of equipment (See
 main ad. for the full list of all
 our shops)
**Chesterfield Road, Matlock,
 Derbyshire, DE4 5LE
 Tel: 0629 2817/2430/4057**

LONDON
Henry's
 27MHz/934MHz Rigs &
 accessories in stock.
 Lists - S.A.E. (A4) - 26p
 Full catalogue (TG/P) -
 large S.A.E. £1.00
**404 Edgware Road,
 London W2 1ED
 Tel: 01-724 0323**
(Open 6 days a week)

MERSEYSIDE
MGR SERVICES
 Wirral based communications
**ICOM - YAESU - M. MODULES - HOWES
 - CIRKIT - WOOD & DOUGLAS -
 PART-EX - AERIALS - PMR - MARINE -
 MET ANTENNAS - ALINCO -
 HEATHERLITE - SPECTRUM COMMS**
 48, Shrewsbury Road,
 Oxtou, Birkenhead, L43 2HZ.
 Tel: 051 653 3437
(Callers by appointment 9 am-9 pm, Mon-Sat)

LONDON
**D & D ELECTRONICS
 (Kennington)**
*The sort of shop you used to see in
 Lisle St. All sorts of surplus supplies,
 so come along and browse or send
 SAE for info. sheets.*
**3a Braganza Street
 London SE17 3RD
 Tel: 01-793 0054**
(Open 6 days a week)

**PLEASE MENTION
 PRACTICAL WIRELESS
 WHEN REPLYING TO
 ADVERTISEMENTS**

RADIO SHACK SAVES YOU MONEY ON SCANNERS!

**THE FINEST EVER SCANNER
 AT AN UNBEATABLE PRICE
 25-520, 760-1300 MHz, 300
 MEMORIES ALL FOR £349.95**

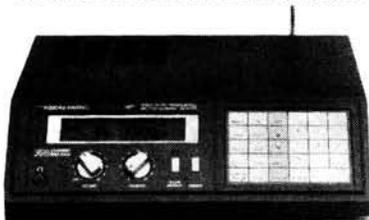

**£349.95
 (P&P £3.45)**

SPECIAL OFFER
 1 month only PRO 32, 200 Channel Hand-
 Held Scanner **£199.95**. Postage £3.45
 Set of Memory Batteries **£3.60**
Call For Details

Continuous tuning from 25 to 520 MHz and 760 to 1300 MHz
 300 permanent memories in ten banks of 30 plus an additional
 ten channels used for temporary storage when in search mode.
 Switchable audio squelch allows you to ignore blank carriers.
 Three reception modes. AM, FM, (Wide) and FM (Narrow).
 Adjustable step size, 5kHz, 12.5 kHz and 50 kHz. Sensitivity
 (NFM) 0.5uV for 20dB S/N up to 1100 MHz. Extremely
 attractive, information packed blue LCD display Headphone jack
 socket, tape recorder socket, external speaker socket, attenua-
 tor switch, 240 Volt operation and 13.8 VDC with optional
 mobile power lead.

**Also still available
 BC-200FB 16 CHANNEL SCANNER**

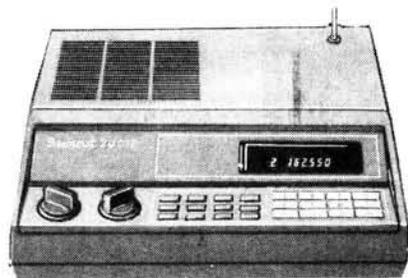

**£199.95 NOW SAVE £40
 £159.95 (CP&P £3.45)**



RADIO SHACK LTD

**188 BROADHURST GARDENS,
 LONDON NW6 3AY**



(Just around the corner from West Hampstead Station on the Jubilee Line)

Giro Account No. 588 7151 Telephone: 01-624 7174 Telex: 23718

Published on the second Thursday of each month by PW Publishing Limited, Eneco House, The Quay, Poole, Dorset BH15 1PP. Printed in England by Benham & Co Limited, Colchester, Essex. Distributed by COMAG, Tavistock Road, West Drayton, Middlesex UB7 7QE, telephone West Drayton 44055, Telex 8813787. Sole Agents for Australia and New Zealand - Gordon and Gotch (Asia) Ltd.; South Africa - Central News Agency Ltd. Subscriptions INLAND £13 and OVERSEAS (by surface mail) £15, payable to PRACTICAL WIRELESS, Subscription Department, Competition House, Farndon Road, Market Harborough, Leicestershire LE16 9NR. PRACTICAL WIRELESS is sold subject to the following conditions, namely that it shall not, without the written consent of the Publishers first having been given, be lent, resold, hired out or otherwise disposed of by way of Trade at more than the recommended selling price shown on the cover, and that it shall not be lent, resold, hired out or otherwise disposed of in a mutilated condition or in any unauthorised cover by way of Trade, or affixed to or as part of any publication or advertising, literary or pictorial matter whatsoever.

SCAN IN ON THE ACTION

uniden[®]
Beacon[®]
SCANNERS



uniden[®]

Uniden U.K. Limited, Uniden House,
East Portway, Andover, Hampshire SP10 3LX
Tel: (0264) 55133. Facs: (0264) 55103.
Telex: 477435

U.K. Suppliers: Telecomms
189 London Road, North End, Portsmouth PO2 9AE
Tel: (0705) 662145. Telex: 869107

www.americanradiohistory.com

APACHE



**COMPLETE*
SYSTEM ONLY
£49.95!
(YP25C)**

The Apache

A superb ready-built scale-model off-road racer complete with a 2-CHANNEL DIGITAL PROPORTIONAL RADIO CONTROL SYSTEM – for the price of the RC system alone!
All this is included in the price:
Ready-built 1/4 scale model car (overall size 325 x 186 x 130mm, 12.8 x 7.3 x 5.1in.).
Front and rear low-profile semi-pneumatic rubber tyres.
Front wheel independent suspension.
High or low gear selection.
Sealed box with differential gearing.
Powerful motor gives scale speeds up to 140 mph.

Front and rear coil-spring shock absorbers.
2-channel digital proportional radio control transmitter (and receiver).
(Standard 27MHz AM – no licence required in UK).
Servo-controlled proportional steering.
Proportional motor speed control in forward and reverse.

* Batteries and ni-cad charger not included. Car requires 8 AA cells (ni-cad recommended YG00A £1.35 each).
Transmitter requires 6 AA cells, (alkaline FK64U 55p each or ni-cad as above). NB – and if you have a collision at 100mph or more, you'll be pleased to hear that spare parts are available.

Maplin Maplin Electronic Supplies Ltd.
P.O. Box 3, Rayleigh, Essex, SS6 8LR. Telephone, Credit Card Sales (0702) 554161 Enquiries (0702) 552911
Shops at: Sutton New Road, Erdington, Birmingham. Tel: 021-384 8411. 159-161 King Street, Hammersmith, London W6. Tel: 01-748 0926.
8 Oxford Rd., Manchester. Tel: 061-236 0281. 46-48 Bevois Valley Rd., Southampton. Tel: 0703 25831.
282-284 London Rd., Westcliff-on-sea, Essex. Tel: 0702-554000.

Please rush me my Apache model racer, with 2 channel digital proportional radio control system. I wish to receive:

	Code	Qty	Price
Apache model racer	YP25C		
AA ni-cad battery	YG00A		
AA alkaline battery	FK64U		
		Total	

All prices include VAT. Please add 50p towards postage.
If order below £5.00, please add 50p handling.

I enclose cheque/postal order made payable to Maplin Electronic Supplies Ltd., or see credit card details.

Here are my personal details:
Customer Number
Name
Address
Post Code

I authorise you to debit my Credit Card account for the cost of goods despatched.

Credit Card Number

Access/American Express/Mapcard/Visa/
Delete as required

Note: Goods will be despatched only if the address given is the cardholder's address.
If ordering by Credit Card please sign:

Signature: Expiry Date