

# PRACTICAL WIRELESS

MARCH  
1975

30p

## FREE INSIDE

FREQUENCY  
ALLOCATION  
WALL CHART

PW 'Easubuild'  
ELECTRONIC  
ORGAN  
PART 1

PW  
**FREE**  
Competition

**£500**  
worth of HEATHKIT equipment  
to be won!

# NEW EDU-KIT MAJOR

Completely Solderless Electronic Construction Kit  
Build these projects without soldering iron or solder

- ★ 4 Transistor Earpiece Radio.
- ★ 5 Transistor Push Pull Amplifier.
- ★ Batteryless Crystal Radio.
- ★ Signal Tracer.
- ★ 7 Transistor Loudspeaker Radio MW/LW.
- ★ One Transistor Radio.
- ★ Signal Injector.
- ★ 5 Transistor Short Wave Radio.
- ★ 2 Transistor Regenerative Radio.
- ★ Transistor Tester NPN-PNP.
- ★ Electronic Metronome.
- ★ 3 Transistor Regenerative Radio.
- ★ 4 Transistor Push Pull Amplifier.
- ★ Electronic Noise Generator.
- ★ Audible Continuity Tester.
- ★ Sensitive Pre-Amplifier.

Components Include: 24 Resistors • 21 Capacitors • 10 Transistors • 3 1/2" Loudspeaker • Earpiece • Mica Baseboard • 3 12-way connectors • 2 Volume controls • 2 Slider Switches • 1 Tuning Condenser • 3 Knobs • Ready Wound MW/LW/SW Coils • Ferrite Rod • 6 1/2 yards of wire • 1 Yard of sleeving etc. • Parts Price List and Plans 55p. (Free with parts).

## Total Building Costs

**£7-23** P P & Ins. 44p  
(Overseas Seamail P & P £2-35)  
(+ 8% VAT 57p)

## NEW ROAMER NINE

WITH V.H.F. INCLUDING AIRCRAFT

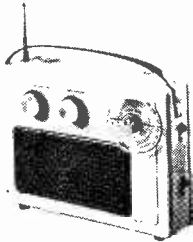

Nine Transistors, 9 Tunable wavebands as Roamer Ten. Built in ferrite rod aerial for MW/LW. Retractable chrome-plated telescopic aerial for VHF and SW. Push Pull output using 600 mW transistors. 9 Transistors and 3 diodes, tuning condenser with V.H.F. section, separate coil for aircraft, moving coil loudspeaker, volume ON/OFF and wavechange controls. Attractive all white case with red grille and carrying strap. Size 9 1/2" x 7 1/2" x 2 1/2" approx. Parts Price List and Plans free with parts.

**Total Building Costs £6-95** P P & Ins. 44p  
(Overseas Seamail P & P £2-35)  
(+ 8% VAT 55p)

## POCKET FIVE

NOW WITH 3" LOUD-SPEAKER

3 Tunable wavebands, M.W. L.W. and Trawler Band, 7 stages, 5 transistors and 2 diodes, supersensitive ferrite rod aerial, attractive black and gold case. Size 5 1/2" x 1 1/2" x 3 1/4" approx. Plans and Parts Price List 20p (Free with parts). (+ 8% VAT 20p) (Overseas Seamail P & P £1-70)

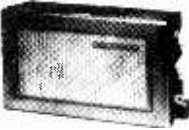

**Total Building Costs £2-50** P P & Ins. 36p  
(Overseas Seamail P & P £1-70)

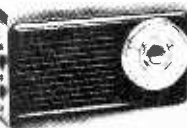

## TRANSONA FIVE NOW WITH 3" LOUDSPEAKER

Wavebands, transistors and speaker as Pocket Five. Larger Case with Red Speaker Grille and Tuning Dial. Plans and Parts Price List free with parts. (Overseas Seamail P & P £1-70)

**Total Building Costs £2-75** P P & Ins. 36p  
(+ 8% VAT 21p)

## TRANS EIGHT

8 TRANSISTORS and 3 DIODES

6 Tunable Wavebands: MW, LW, SW1, SW2, SW3 and Trawler Band. Sensitive ferrite rod aerial for M.W. and L.W. Telescopic aerial for Short Waves. 3in. Speaker. 8 Improved type transistors plus 3 diodes. Attractive case in black with red grille, dial and black knobs with polished metal inserts. Size 9 x 5 1/4 x 2 1/2 in. approx. Push pull output. Battery economiser switch for extended battery life. Ample power to drive a larger speaker. Parts price list and plans free with parts.

**Total building costs £4-48** P P & Ins. 40p  
(+ 8% VAT 36p)  
(Overseas Seamail P & P £2-00)

## ROAMER SIX

CASE AND LOOKS AS TRANS-EIGHT

6 Tunable Wavebands: MW, LW, SW1, SW2. Sensitive ferrite rod aerial and telescopic aerial for Short Waves. 3in. Speaker 8 stages—5 transistors and 2 diodes. Attractive black case with red grille, dial and black knobs with polished metal inserts. Size 9 x 5 1/4 x 2 1/2 in. approx. Plans and parts price list free with parts.

**Total building costs £3-98** P P & Ins. 40p  
(Overseas Seamail P & P £2-00)  
(+ 8% VAT 32p)

## NEW Everyday Series

Build this exciting New series of designs

E.V.5, 5 Transistors and 2 diodes. MW/LW. Powered by 4 1/2 volt Battery. Ferrite rod aerial, tuning condenser, volume control, and now with 3" loudspeaker. Attractive case with red speaker grille. Size 9" x 6 1/2" x 2 1/4" approx. Parts Price List and Plans free with parts.

**Total Building Costs £2-95** P P & Ins. 36p  
(Overseas Seamail P & P £1-70)  
(+ 8% VAT 23p)

E.V.6. Case and looks as above. 6 Transistors and 3 diodes. Powered by 9 volt battery. Ferrite rod aerial. 3" loudspeaker, etc., MW/LW coverage. Push Pull output. Parts Price List and Plans free with parts.

**Total Building Costs £3-60** P P & Ins. 36p  
(Overseas Seamail P & P £1-70)  
(+ 8% VAT 29p)

E.V.7. Case and looks as above. 7 Transistors and 3 diodes. Six wavebands. MW/LW, Trawler Band, SW1, SW2, SW3, powered by 9 volt battery. Push Pull output. Telescopic aerial for short waves. 3" Loudspeaker. Parts Price List and Easy Build Plans free with parts. Overseas P & P £1-65.

**Total Building Costs £4-08** P P & Ins. 38p  
(Overseas Seamail P & P £2-00)  
(+ 8% VAT 32p)

## ROAMER EIGHT Mk I

NOW WITH VARIABLE TONE CONTROL

7 Tunable Wavebands: MW1, MW2, LW, SW1, SW2, SW3 and Trawler Band. Built in Ferrite Rod Aerial for MW and L.W. Chrome plated Telescopic aerial can be angled and rotated for peak short wave listening. Push pull output using 600mW transistors. Car aerial and Tape record sockets. Selectivity switch. 8 transistors plus 3 diodes. Latest 4 1/2 watt ferrite magnet loudspeaker. Air spaced ganged tuning condenser. Volume/on/off, tuning, wave change and tone controls. Attractive case in rich chestnut shade with gold blocking. Size 9 x 7 x 4 1/2 in. approx. Easy to follow instructions and diagrams. Parts price list and plans free with parts.

**Total building costs £6-98** P P & Ins. 47p  
(Overseas Seamail P & P £2-50)  
(+ 8% VAT 56p)

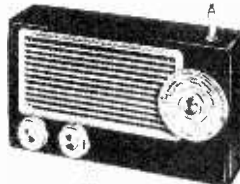
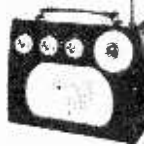

## ROAMER TEN Mk 2

WITH VHF INCLUDING AIRCRAFT

Now with free earpiece and switched socket.

10 Transistors. Latest 4 1/2 watt Ferrite Magnet Loudspeaker. 9 Tunable Wavebands, MW1, MW2, LW, SW1, SW2, SW3, Trawler Band, VHF and Local Stations also Aircraft Band. Built in Ferrite Rod Aerial for MW/LW. Chrome plated 7 section Telescopic Aerial, can be angled and rotated for peak short wave and VHF listening. Push Pull output using 600mW Transistors. Car Aerial and Tape Record Sockets. 10 Transistors plus 3 Diodes. Ganged Tuning Condenser with VHF section. Separate coil for Aircraft Band. Volume on/off. Wave change and tone Controls. Attractive Case in black with silver blocking. Size 9" x 7" x 4". Easy to follow instructions and diagrams. Parts price list and plans 50p (FREE with parts).

**Total building costs £9-50** P P & Ins. 52p  
(Overseas Seamail P & P £2-50)  
(+ 8% VAT 76p)

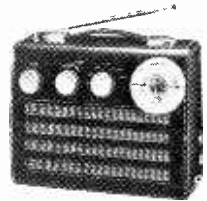

## "EDU-KIT"

Build Radios, Amplifiers, etc., from easy stage diagrams.



Five units including master unit to construct.

Components include:

Tuning Condenser; 2 Volume Controls; 2 Slider Switches; Fine Tune 3" Moving Coil Speaker; Terminal Strip; Ferrite Rod Aerial; Battery Clips; 4 Tag Boards; 10 Transistors; 4 Diodes; Resistors; Capacitors; Three 1/2" Knobs. Units once constructed are detachable from Master Unit, enabling them to be stored for future use. Ideal for Schools, Educational Authorities and all those interested in radio construction. Parts price list and plans free with parts.

**Total building costs £5-50** P P & Ins. 40p  
(Overseas Seamail P & P £2-00)  
(+ 8% VAT 44p)

## RADIO EXCHANGE LTD

★ Callers side entrance "Lavelle" shop.  
★ Open 10-1, 2.30-4.30, Mon.-Fri. 9-12 Sat.

To RADIO EXCHANGE CO., 61a HIGH STREET, BEDFORD, MK40 1SA  
Tel.: 0234 52367. Ref. No. 788372.

I enclose £..... for .....  
Name .....  
Address .....  
(Dept. PW3.)

# PRACTICAL WIRELESS

VOL. 50 NO. 11

ISSUE 817

MARCH 1975

BRITAIN'S PREMIER MAGAZINE FOR THE DO-IT-YOURSELF RADIO AND ELECTRONICS CONSTRUCTOR

**Editor**

Lionel E. Howes, G3AYA

**Assistant Editor**

Eric Dowdeswell, G4AR

**Art Editor**

Peter Metall

**Production & News Editor**

Collin R. Riches

**Technical Sub-Editor**

Bill Tull

**Technical Artist**

Alan Martin

**Secretarial**

Jenny Maunder

01-634 4292

Susan King

**Adverts. Manager**

01-634 4293

Roy Smith

**Classified Adverts.**

01-634 4301

Collin R. Brown

Published by IPC Magazines Ltd.,  
Fleetway House, Farringdon Street,  
London EC4A 4AD. Tel. 01-634 4444

**SUBSCRIPTIONS**

Publisher's Subscription Rate for one year to the UK is £3.85 and to the rest of the world £4.95 (\$13.50 USA/CAN) including postage. Enquiries to Subscription Department, IPC Magazines Ltd., Carlton House, 68 Gt. Queen Street, London, WC2 5DD. Phone 01-242 4477. International Giro facilities Account No. 5122007. Please state reason for payment "message to payee".

Binders (£1.34) and indexes 30p (inc. VAT) can be supplied by the Binders Dept at the same address.

**BACK NUMBERS**

We regret that we are unable to supply back numbers of Practical Wireless. Readers are recommended to enquire at a public library to see copies. Requests for specific back numbers of Practical Wireless and Television only can be published in our CQ Column.

**COPYRIGHT AND QUERIES**

© IPC Magazines Limited 1975. Copyright in all drawings, photographs and articles published in "Practical Wireless" is fully protected and reproduction or imitation in whole or in part is expressly forbidden. All reasonable precautions are taken by "Practical Wireless" to ensure that the advice and data given to readers are reliable. We cannot, however, guarantee it and we cannot accept legal responsibility for it. Prices are those current as we go to press.

We regret that we cannot answer technical queries by telephone nor can we provide information or advice on manufacturers' products other than that given in the magazine. We will endeavour to assist readers who have queries relating to articles published but we cannot offer advice on modifications to our published designs. All correspondents expecting a reply should enclose a stamped addressed envelope.

## ● NEWS & COMMENT

- 986 **THOU SHALT NOT LISTEN**—Leader article
- 987 **NEWS . . . NEWS . . . NEWS . . .**
- 1011 **NEXT MONTH IN PRACTICAL WIRELESS**
- 1022 **PRODUCTION LINES** by *Colin Riches*
- 1032 **ON THE AIR**
- 1032 **Amateur Bands**—*Eric Dowdeswell, G4AR*
- 1035 **Broadcast Bands—Short Wave**—*Derek Bell*
- 1036 **LETTERS**—Readers comment
- 1039 **HOTLINES** on recent developments by *Ginsberg*
- 1040 **TELEVISION**—Coming in the March issue

## ● CONSTRUCTIONAL

- 988 **2 VHF CONVERTERS**—Part 1—*G. Severn*
- 991 **P.W. 'ASCOT' STEREO CASSETTE DECK**—Part 2—*Keith Cummins & Tony Francis*
- 1001 **MODEL CONTROL BY RADIO**—Part 3—Actuators and Monitor—*F. G. Rayer, G3OGR*
- 1012 **P.W. 'EASYBUILD' ELECTRONIC ORGAN**—Part 1—*M. J. Hughes, M.A., C.Eng., MIERE*
- 1024 **TAKE 20, No 69 MORSE CODE OSCILLATOR**—*David Andrews*

## ● OTHER FEATURES

- 997 **IC OF THE MONTH**—Fairchild  $\mu$ A720 A.M. Receiver
- 1009 **GOING BACK**—Earlier days of Wireless—*Colin Riches*
- 1027 **SPECIAL PRODUCT REPORT—SINCLAIR 'SCIENTIFIC' KIT**

1030 **HEATHKIT COMPETITION—YOUR CHANCE TO WIN A PRIZE!**

★ **FREQUENCY ALLOCATION WALLCHART—FREE INSIDE**

# HUGE DISCOUNTS

**ON LEADING BRAND HI-FI** ALL RSC PRICES INCLUDE VAT  
**LOW DEPOSIT CREDIT TERMS**  
Full labour and material guarantees for 12 months

	List Price	RSC Price
WHARFEDALE DENTON II	£45.49 Pr.	£29.95
„ DENTON I (White)	£33.78 Pr.	£24.95
WHARFEDALE LINTON	£56.33 Pr.	£38.95
„ LINTON Spkr Kit	£26.61 Pr.	£19.50
LEAK 2030 L/Spkr	£83.99 Pr.	£65.00
LEAK 2060 L/Spkr	£72.54 Ea.	£57.50
FANE MODE I Spkr Kit	£21.95 Pr.	£18.95

Amplifier	£68.04	£49.95
LINEAR 202 Amplifier	£39.23	£24.95
ROTEL RX150A Tun/Amp	£77.09	£54.95
ROTEL 152 Tuner/Amp	£92.50	£65.95
ROTEL 154A (Quad) Amp	£144.85	£89.95
ROTEL 202 Tuner/Amp	£104.50	£74.95
ROTEL RT222 AM/FM Tuner	£56.45	£38.95
ROTEL RT 322	£73.16	£53.50
LEAK 2000 Tuner/Amp	£178.16	£149.50

Also Shure Cartridges, Bass Tapes, Koss H/Phones, etc.  
Prices of above correct at Jan 10 1975

## AKAI TAPE UNITS

Model	Rec. Price	£86.90	£62.95	GXC 510D	Rec. Price	£189.90	£135.95
CS 30D				GXR 82D		£122.65	£89.95
GXC 36D		£110.72	£72.50	4000 DS		£130.10	£94.95
GXC 38		£147.19	£105.95	4000 DB (Dolby)		£196.27	£139.95
GXC 38D		£137.38	£97.95	1722 L		£125.18	£91.95
GXC 46D		£157.59	£109.95	CR 81D		£98.10	£69.95
GXC 40T		£186.09	£135.95	CS33D		£105.81	£75.95
GXC 75D		£199.90	£142.95				

**GOLDRING GL72 T/Table & G800 £29.95** (Approx. value £46) Carr. 75p  
**GOLDRING GL75 T/Table & G800 £34.95** (Approx. value £65) Carr. 85p  
**PIONEER PL12D T/Table on plinth & cover £41.75** List £61.90  
**T/TABLES with MAGNETIC CARTRIDGE/PLINTH & COVER**  
**GARRARD SP25 MK IV with G850 Special Price £22.95** (Carr. £1)  
**RANK BD2000** Rec. Price £67.25 **£48.95** (Carr. £1)

## FANE HIGH FIDELITY SPEAKERS

Limited number at approx. 1/3 off list prices.

Model	Special Price	Model	Special Price
5" 501	8 ohms £5.20	12" 122/14*	8 & 15Ω £11.50
8" 804*	8 ohms £3.65	12" 122/14LR	8Ω £12.95
10" 1005LR	15Ω £5.75	12" 122/17*	8 & 15Ω £12.95

Above are available by Mail Order carr. free or may be ordered through Branches

\*Basic models made to individual specification of equipment manufacturers

## HI-FI 7 Watt LOUDSPEAKERS fitted Parasitic Tweeter Imp 8Ω

8" x 5" £1.25 ea. 6 1/2" £1.45 ea. 8" £1.85 Carr. 20p

## GENERAL PURPOSE 3-4 Watt SPEAKERS Imp 8Ω

4" 88p. 5" or 6" x 4" 95p. 8" x 5" 99p Carr. 20p

Model	Price	Notes
MEB 13 x 9 1/2 x 6 1/2 in.	£3.95	Both cut for 8in. speaker
JEB 16 x 11 x 9 in.	£5.95	
SE10 25 x 16 x 9 in.		Cut for 10in. and Tweeter £8.95
SE12 25 x 16 x 9 in.		Cut for 12in. and Tweeter £8.95

## AUDIOTRINE HI-FI SPEAKER SYSTEMS

Consisting of matched 12in. 11,000 Gauss 15 Watt 15 ohm high quality speaker, cross-over unit and tweeter. Smooth response and extended frequency range **£6.95** Carr. 45p  
OR SENIOR 15 WATT INCLUDING **£8.95** Carr. 50p  
HF123 13,000 GAUSS SPEAKER

## R.S.C. TA6 6 Watt HI-FI AMPLIFIER

200-250v. AC mains operated. Response 20-20,000 c.p.s. - 2dB. Separate Bass and Treble 'lift and cut' controls. 3 input sockets for Mike, Gram, Radio or Tape. Input selector switch. Output for 3-15 ohm spkrs. Max. sensitivity 5mV. O/P rating I.H.F.M. Enclosed enamelled case 9 1/2 x 9 1/2 x 6 1/2 in. Silver finish fascia 10 1/2 x 8 1/2 in. **FACTORY BUILT** Complete kit, wiring diagrams and instructions. **£7.95** Carr. 40p. **£10.95**

## R.S.C. TA12 MKIII 6.5+6.5 WATT STEREO AMPLIFIER

Fully Transistorised. HI-FI o/p of 6.5 watts per channel. Optimum performance with any crystal or ceramic P.U. Cartridge, Radio Tuner, Tape Rec. etc. Input Sel. Switch. Bass, Treble, Vol. & Bal. Controls. **COMPLETE KIT OF PARTS WITH FULL £12.95** Carr. 40p.  
Wiring Diagrams & Instructions. **£19.55** Dep. £2.50 & 8 mthly pymts 12 mths guarantee **£16.61** Or in Teak **£19.55** Dep. £2.50 & 8 mthly pymts 12 mths guarantee **£26.60** (Total £28.60).

## RSC G66 MkII 6.6 WATT high quality STEREO AMPLIFIER

Controls: Bass, Treble, Vol. and Bal. 10 Transistors plus Diodes. Output rating I.H.F.M. Frequency range 20-20,000 c.p.s. Bass Control ± 12db. Treble Control ± 13db. Selector switch for Crystal P.U. or Tape/Radio. For speaker output impedances of 3 - 15 ohms. For standard 200-250v. A.C. mains operation. Attractive Black and Silver finished metal fascia plate and matching control knobs. **COMPLETE KIT OF PARTS INCLUDING FULLY WIRED PRINTED CIRCUIT and COMPREHENSIVE WIRING DIAGRAMS & INSTRUCTIONS £12.95** 40p. as illustrated £16.95 or dep. £2.12 and 8 monthly payments £2.12 (Total £19.08).



COMPREHENSIVE WIRING DIAGRAMS & INSTRUCTIONS £12.95 40p. as illustrated £16.95 or dep. £2.12 and 8 monthly payments £2.12 (Total £19.08).

## AUDIOTRINE HIGH FIDELITY SPEAKERS

Heavy construction. Latest high efficiency ceramic magnets. Plasticised Cone surround. "D" or "T" indicates Tweeter Cone providing extended frequency range up to 15,000 c.p.s. Impedance 3 or 8-15 ohms. PLEASE STATE CHOICE.

Model	Size	Price	Model	Size	Price
HF808T	8" 10W	£8.55	HF150D	15" 15W	£8.50
HF102D	10" 10W	£8.50	HF180	18" 15W	£7.95
HF120	12" 15W	£6.95	HF180D	18" 15W	£8.80

## AUDIO FIDELITY MODEL 80 HI-FI SPEAKER

A full range 8in. 10 watt unit for excellent sound quality, in suitable enclosure. Roll P.V.C. cone surround and long throw voice coil to achieve very low fundamental resonance of 30 c.p.s. Tweeter cone is fitted to extend high note response. Frequency range 25 Hz to 15 KHz. Gauss 10,000. Impedance 8-15 Ω. **£4.50 ea. £7.98** pr.

MODEL 83 8" 15w. with parasitic Tweeter. 45.99 ea. **£10.95** pr. Response 25 Hz to 15 KHz. Gauss 13,000 Imp 8-15Ω.

## R.S.C. MkIII SUPER 30 HIGH FIDELITY STEREO AMPLIFIER

BUILD AN AMPLIFIER WORTH APPROXIMATELY DOUBLE THE KIT PRICE INCLUDING CABINET

- Only high grade components by leading manufacturers
  - Push Button Selector Switching
  - Jack Socket for Headphones
  - Neon Indicator
  - Satin Silver Finish Metal Fascia
  - Solid State Circuitry
  - Twenty Silicon Transistors
  - Four Diodes, Four Rectifiers
  - Send S.A.E. for full descriptive leaflet.
- For Magnetic or Ceramic Pick-Ups regardless of Price. Output (per channel) 15 watts RMS into 8Ω. Frequency Response 7 Hz to 70 KHz ± 1 1/2 dB. Assembled unit in cabinet £42.50



COMPLETE KIT (less cabinet). **£22.95** Carr. 70p. Cabinet if req. £4.90 extra.

## R.S.C. TRANSFORMERS, L.F. CHOKES & RECTIFIERS FULLY GUARANTEED. Impregnated and Interleaved where necessary. Primaries 200-250V. 50/60c/s. Screened.

Model	Price	Model	Price
MIDGET CLAMPED TYPE 2 1/2 x 2 1/2 x 2 1/2 in.		TOP SHEATHED DROP-THRO' TYPE	
250v.-250v., 6.3v. 2a	£1.50	250-0-250v. 70mA, 6.3v. 2a. 0-5-6.3v. 2a.	£2.25
250-0-60mA., 60mA 6.3v 2a	£1.60	250-0-250v. 100mA, 6.3v. 3.5a.	£2.50
FULLY SHEATHED UPRIGHT MOUNTING		250-0-250v. 100mA, 6.3v. 2a., 0-5-6.3v. 1a.	£2.75
250-0-250v. 60mA, 6.3v. 2a., 0-5-6.3v. 2a.	£2.25	350-0-350v. 60mA, 6.3v. 2a., 0-5-6.3v. 2a.	£2.75
250-0-250v. 100mA, 6.3v. 4a., 0-5-6.3v. 3a.	£3.75	250-0-250v. 100mA, 6.3v. 4a., 0-5-6.3v. 3a.	£3.75
300-0-300v. 100mA, 6.3v. 4a., 0-5-6.3v. 3a.	£3.75	300-0-300v. 100mA, 6.3v. 4a., 0-5-6.3v. 3a.	£3.75
300-0-300v. 130mA, 6.3v. 4a., c.t. 6.3v. 1a.	£4.50	300-0-300v. 130mA, 6.3v. 4a., c.t. 6.3v. 1a.	£4.50
For Mullard 610 Amplifier	£4.50	350-0-350v. 100mA, 6.3v. 4a., 0-5-6.3v. 3a.	£3.75
350-0-350v. 100mA, 6.3v. 4a., 0-5-6.3v. 3a.	£4.50	350-0-350v. 150mA, 6.3v. 4a., 0-5-6.3v. 3a.	£4.50
350-0-350v. 150mA, 6.3v. 4a., 0-5-6.3v. 3a.	£4.50	FILAMENT or TRANSFORMER POWER PACK	
425-0-425v. 200mA, 6.3v. 4a., c.t. 5v. 3a.	£8.60	6.3v. 6.3v. 1.5a. 92p; 6.3v. 2a. 92p; 6.3v. 3a. £1.45p;	
425-0-425v. 200mA, 6.3v. 4a., Twice 5v. 3a.	£8.70	6.3v. 6a. £2.25 12v. 1a. 96p; 12v. 3a. or 24v. 1.5a. £2.25; 0.9-18v 12v. £1.95; 0-12-25-42v 2a. £2.75	
450-0-450v. 250mA, 6.3v. 4a., c.t. 5v. 3a.	£9.00		

## SELENIUM RECTIFIERS F.W. (Bridged)

All 6/12v. D.C. output. Max. A.C. input 18v.

1a. 38p. 2a. 48p. 3a. 65p. 4a. 81p. 6a. 97p.

## L.F. CHOKES

150mA, 7-10H, 250 Ω £1.10; 100mA, 10H, 200 Ω 95p; 60mA, 10H, 400 Ω 55p.

# RSC 100 watt DISCO SYSTEM

50 WATT SPEAKER 50 WATT SPEAKER  
TWIN TURNTABLE WITH PRE-AMP. and POWER AMPLIFIER

AT FANTASTIC LOW PRICES!

Complete with lid HEADPHONES MICROPHONE

- Units listed below
- (a) DISCOMASTER TWIN TURNTABLE CONSOLE with integral 100W amplifier
  - (b) PAIR OF HI-FI HEADPHONES
  - (c) MATCHING DYNAMIC 'MIKE' (attached to h'phone)
  - (d) PAIR 50 WATT SPEAKERS Black Rexine covered Cabinets Size approx. 18" x 18" x 8"
- (a) (b) (c) & (d) Carr. £3-00 **£159-95**

# RSC TDI DISCO CONSOLE

Incorporating twin Garrard SP25 or BSR MP60 type turntables and Sonotone or Aco's Cartridges with diamond stylus. Separate Vol. controls for each turntable. Also MONITORING FACILITIES, plus Treble and Bass Controls. Separate input for 'mike' with vol. control switch. Black Vynide covered Cabinet with lid, see illustration on left.

Or Dep. £9-00 and 18 fortnightly pymts. **£79-95**

£4-61 (Total £91-98) Carr. £1-50

DEP. £19-95 & 18 fortnightly payments of £9-11 (Total £183-93).

STEREO VERSION OF ABOVE SYSTEM  
Or DEP £28-95 and 18 fortnightly pymts. **£199-95**  
£11-11 (Total £229-93) Carr. £3-50

TD2S STEREO VERSION OF ABOVE SYSTEM  
Terms. Dep. £15-00 and 18 fortnightly payments £6-81 (Total £132-18) Carr. £1-60

## DISCOMASTER TWIN TURNTABLE POWER CONSOLE £109-95

Garrard SP25 or McDonald MP60 turntables. Sonotone or Aco's cartridges with diamond stylus. Facilities as TDI Console but with built-in 100 watt Power Amplifier, complete with lid. Or Deposit £12-95 and 18 fortnightly payments £6-31 (Total £128-53) Carr. £2-50

STEREO DISCOMASTER £145 or DEP. £20 and 18 fortnightly pymts £8-15 (Total £168-70). Carr. £3

### R.S.C. COLUMN SPEAKERS IDEAL FOR VOCALISTS AND PUBLIC ADDRESS

All types 15 Ohms covered in Rexine and Vynair

TYPE C132 30-40 WATTS Fitted two exceptionally efficient, low feedback howl characteristic high flux 1 1/2" x 8" 20 watt speakers. Terms: Dep. £3-95 and 8 m'thly payments £2-87 (Total £25-31) Carr. 65p.

TYPE C370 70 WATTS Fitted three 1 1/2" 25 watt Highly sensitive high flux speakers with high power voice coils. Size approx. 6 1/2" x 14" x 1 1/2". Dep. £5-11 & 8 m'thly pymts. £5-11 **£39-95** (Total £45-99) Carr. 85p

## FANE ULTRA HIGH POWER SPEAKERS & KITS

All power ratings are R.M.S. continuous. 3 YEARS' GUARANTEE High flux ceramic magnets. ALL CARRIAGE FREE.

'POP' 100	'POP' 60	'POP' 50
18" 100 Watt 14,000 gauss 8/15 Ohm <b>£29-95</b>	15" 60 Watt 14,000 gauss 8/15 Ohm <b>£16-95</b>	12" 50 Watt 13,000 gauss 15 Ohm <b>£12-95</b>
Dep. £3-80 and 8 m'thly payments £3-80 (Total £34-20)	Dep. £2-17 and 8 m'thly payments. £2-17 (Total £19-58)	Terms for pairs Dep £3-90 & 8 m'thly pymts £3-16 Total £29-15

PAIR SUITABLE FOR BASS GUITAR, ELECT. ORGAN, ETC.

## ALL RSC PRICES INCLUDE VAT INTEREST ON Credit Purchases REFUNDED settled in 3 months

### SUPER MINSTREL GUITAR AMP.

Incorporating Tremolo and 13" x 8" or 10" Speaker. Output 10 watts R.M.S. Continuous. 3 Jack Inputs for Microphone and Instrument. Mains Neon Controls: Volume, Tone, Tremolo Speed Tremolo Intensity.

Terms: Deposit £6-73 and 8 monthly payments £3-00 (Total £30-73) Carr. free **£26-73**

### 'POP' 25/12" 25W. PH50 HIGH POWER TWEETER

Dual cone. 15 ohm Imp. (Not for Bass Guitar use) **£8-95**

Rating 50 Watt Imp 8 Ohm with 2 to 4 mfd. Non elect. filter available 55p **£5-95**

## MODEL D40 FULL RANGE 40 WATT SPEAKER KIT £19-99

Consisting of 12" 40 watt Bass Unit HPX1 200w Cross-over and PH50 Tweeter Rating 40w R.M.S. Imp. 8 ohms. Terms: Deposit £3-99 and 8 m'thly payments £2-50. (Total £23-99).

### FAL MAESTRO COMBINED 30W AMP. AND 12" SPEAKER £47-88

For Lead Guitar, Mic, Gram, Radio, Tape (Not for use with Bass instruments) Inc. 3 inputs and 2 vol controls plus Treble & Bass, TREMOLO with associated controls. Attractively finished in black with silver-finished fascia. Compact size Fitted carrying handle. Deposit £7-88 and 8 m'thly payments £5-75 (Total £53-88) Carr. £1-50

RSC 'PHANTOM 50' Rating 50 watts, 3 inputs, 2 vol. controls, Bass, Treble, Presence **£55-00** Carr. £1-50  
Terms: Deposit £8-00 & 8 m'thly. pymts. £5-76 (Total £62-08).

### HIGH QUALITY LOUDSPEAKER UNITS ALL TWO TONE VYNIDE AND VYNAIR FINISH

L12/2 50 WATT Fitted pair of 12" 30 watt high flux speakers for conservative rating. Impedance 8-15 ohms. Carr. £1-50 Or deposit £5-11 and 8 monthly pymts. of £5-11. Total £25-89

L12/25G 12" 25 WATT 13,000 lines 10 ohms Terms for Pairs. Dep. £3-32 & 8 m'thly pymts £3-82 **£12-95** Carr. 55p.

L12/10 10-15 Watt Vynide cabinet 12" unit 8-15 ohm. Approx. 14" x 14" x 9" **£7-95** Carr. 55p. Terms for Pairs. Dep. £2-05 & 8 m'thly pymts £2-05 (Total £18-45).

### FAL PHASE 50 Mk. III AMPLIFIER 50 WATT

Solid state. 4 Separately controlled inputs Plus master vol. control. Ind. Bass and Treble Controls. Protective Circuitry against serious output overloading. Output for Speaker/s 8 to 15 ohms. Size 17" x 7" x 7 1/2". 200-250v. A.C. mains. Output 50 watts music rating. Or deposit £7-88 & 8 monthly payments £5-75. Total £53-88. Carr. Free **£47-88**

## NOW AVAILABLE I.S.E. CA 127 JINGLE MACHINES £79-95

### REGENT 50X 50 WATT AMP.

A powerful high quality unit for lead, rhythm guitar, vocalists, gram, radio, tape. 50w Peak O/P rating. Not for Bass Guitar.

- \* Two Fane heavy duty high flux 12in. spkrs.
- \* Four Jack inputs and two Volume Controls for instant use of up to four pick-ups or "mikes". Bass and Treble controls.

Send S.A.E. for leaflet. Credit Terms: Deposit £9-95 & 18 fortnightly payments of £4-15 (Total £84-65) **£74-95** Carr. £2-50

REGENT 50B for Bass Guitar and general purposes. Or Dep. £10-85 & 18 fortnightly payments £4-78. **£84-95** (Total £96-09). Carr. £2-50

### GP30 AMPLIFIER

For Guitar, Vocal or Instr. Group, Gram, Radio or Tape. 4 inputs. 2 Vol. Controls. Current Valves. Phase o/p rating. Strong Vynide covered cabinet with carrying handles. Black/Silver Fascia. Neon Indicator. For 200-250v A.C. For 3 or 15 Ohm speakers. Send SAE for leaflet. Terms: Dep. £5-88 & 8 m'thly pymts £3-58 (Total £34-22) **£29-95** Carr. 75p

### LIQUID WHEEL from PROJECTORS £27-50

### COMPLETE PULSAR £99-95

### 'SOUND TO LIFE' SYSTEM

AT A WORTHWHILE SAVING ON INDIVIDUAL UNITS purchased separately. Terms: Deposit £11-48 and 18 fortnightly payments £3-74. (Total Credit Price £114-80). Super S.L. Unit. 1000 watt per channel. Manual override buttons, 2 spotbanks with 6 bulbs (3 sep. colour) 8 yd and 10 yd leads, fitted plugs. Units sold sep.

### FAL DISCO PRE-AMPLIFIER

T/Table mixing inputs. Headphone Monitoring. Mic. Jack & Tape inputs. Independent Vol. Control. Std. 200-250v A.C. Mains operation **£18-50**

### REGENT '50' AMPLIFIER

As supplied with Regent 50x or 50B. Terms: Dep. £5-11 & 8 m'thly pymts £5-11 (Total £45-99) **£39-95** Carr. £1-50

## NEW BRANCHES AT BOLTON, COVENTRY DONCASTER, PRESTON and STOCKPORT

OPEN ALL DAY SATURDAYS (5 Day Week)

BRADFORD 10 North Parade (Closed Wed.). Tel. 25349  
BOLTON 23 Deangate. (Closed Wed.). Tel. 33512  
BIRMINGHAM 30/31 Great Western Arcade. Tel. 021-235 1279 (Closed Wed.)  
COVENTRY 17 Shelton Square. The Precinct. Tel. 25983  
DERBY 97 St. Peter's Street. (Closed Wed.). Tel. 41361  
DARLINGTON 19 Northgate (Closed Wed.). Tel. 68043

# RSC

Barclaycard and Access accepted

All items subject to availability. Prices correct at 10.1.75 E. & O.E.

### HI-FI CENTRES LTD.

DONCASTER 3 Queensgate, Waterdale Centre. (Closed Thurs). Tel. 63069  
EDINBURGH 101 Lothian Rd. (Closed Wed.). Tel. 229 9501  
GLASGOW 326 Argyle St. (Closed Tues.). Tel. 248 4158  
HULL 7 Whitefriargate (Closed Thurs.). Tel. 20505  
LEICESTER 32 High Street (Closed Thurs.). Tel. 56420  
LEEDS 5-7 County (Mecca) Arcade, Briggate (Closed Wed.). Tel. 28252  
LIVERPOOL 73 Dale St. (Closed Wed.). Tel. 236 3573  
LONDON 238 Edgware Road, W.2. (Closed Thurs.). Tel. 723 1629

MAIL ORDERS & EXPORT ENQUIRIES TO:-  
AUDIO HOUSE, HENCONNER LANE, LEEDS, 18. Tel: Pudsey (09785) 77681.  
MAIL ORDERS MUST NOT BE SENT TO SHOPS  
TERMS C.W.O. or O.O.D. No O.O.D. under £1.  
POSTAGE 40p PER ORDER OR AS QUOTED.  
TRADE SUPPLIED.  
S.A.E. PLEASE WITH ENQUIRIES.

MANCHESTER 60A Oldham Street (Closed Wed.). Tel. 47096  
MIDDLESBROUGH 106 Newport Road (Closed Wed.). Tel. 236 2778  
NEWCASTLE UPON TYNE 24 Newgate Shopping Centre (Closed Wed.). Tel. 21468  
NOTTINGHAM 19/19A Market Street (Closed Thurs.). Tel. 48068  
PRESTON 41 Friargate Walk, St. Georges Shoppg Prec. Tel. 51978  
SHEFFIELD 13 Exchange Street (Castle Mkt. Bldg.). (Closed Thurs.). Tel. 20716  
STOCKPORT 8 Little Underbank (Closed Thurs.). Tel. 480-0777  
SUNDERLAND 5 Market Sq. (Closed Wed). Tel. 70573

# If you're interested in electronics You'll like the NEW LITESOLD SUPER IRONS

We've been supplying the electronics industry with soldering irons for many years and we have now put all our experience into an iron for the electronics enthusiast.

The new LITESOLD SUPER IRONS have all the features you have been looking for; a neon indicator which glows only when the supply is connected correctly and the iron is safely earthed, an unbreakable nylon handle, a burn-proof mains lead, a special oxydised binding, a long life element, a range of bit shapes to suit every job and a special bench stand.

## There are three SUPER IRONS

the S90

12 watts for miniature jobs at £4.77

the S142

20 watts for medium jobs at £4.85

the S187

24 watts for heavy jobs at £4.89

and the special spring stand at £2.24.

Get your LITESOLD SUPER IRON direct from

Light Soldering  
Developments Limited  
97-99 Gloucester Road  
Croydon Surrey  
Telephone 01-689 0574

All prices include postage, packing and VAT but not the diamond ring.



16 CHERRY LANE  
BRISTOL BS1 3NG

## THE RADIO SHOP

TELEPHONE  
0272-421196



### TRIACS



1-6 AMP PLASTIC TOS		6-5 AMP ISOLATED TAB		16 AMP ISOLATED TAB	
NAS0161W 100V	27	NAS0651W 100V	46	NAS1001W 100V	83
NAS0161X 100V	28	NAS0651X 100V	44	NAS1001X 100V	80
NAS0162W 200V	30	NAS0652W 200V	58	NAS1002W 200V	78
NAS0162X 200V	28	NAS0652X 200V	56	NAS1002X 200V	74
NAS0164W 400V	40	NAS0654W 400V	84	NAS1004W 400V	109
NAS0164X 400V	38	NAS0654X 400V	80	NAS1004X 400V	104
NAS0166W 600V	55	NAS0656W 600V	105	NAS1006W 600V	134
NAS0166X 600V	52	NAS0656X 600V	100	NAS1006X 600V	128

3 AMP "CLIPPED" TAB		8-5 AMP ISOLATED TAB		16 AMP ISOLATED METAL	
NAS0301W 100V	30	NAS0851W 100V	52	NAS1601W 100V	90
NAS0301X 100V	28	NAS0851X 100V	50	NAS1601X 100V	82
NAS0302W 200V	36	NAS0852W 200V	67	NAS1602W 200V	95
NAS0302X 200V	34	NAS0852X 200V	64	NAS1602X 200V	88
NAS0304W 400V	52	NAS0854W 400V	87	NAS1604W 400V	140
NAS0304X 400V	50	NAS0854X 400V	82	NAS1604X 400V	132
NAS0306W 600V	70	NAS0856W 600V	120	NAS1606W 600V	185
NAS0306X 600V	66	NAS0856X 600V	114	NAS1606X 600V	175

Devices with internal Trigger have "W" suffix. "X" denotes Standard Triac.



### THYRISTORS



1-6 AMP MIN. TOS		4 AMP ISOLATED TAB		6 AMP ISOLATED TAB	
NAS006P 50PIV	25	NAS106P 50PIV	26	NAS206P 50PIV	37
NAS006Q 100PIV	28	NAS106Q 100PIV	30	NAS206Q 100PIV	42
NAS006R 200PIV	31	NAS106R 200PIV	36	NAS206R 100PIV	50
NAS006S 400PIV	40	NAS106S 400PIV	57	NAS206S 100PIV	77
NAS006T 600PIV	52	NAS106S 400PIV	57	NAS206S 100PIV	77

8 AMP ISOLATED TAB		16 AMP ISOLATED TAB	
NAS306P 50PIV	41	NAS806P 50PIV	50
NAS306Q 100PIV	47	NAS806Q 100PIV	58
NAS306R 200PIV	59	NAS806R 200PIV	73
NAS306S 400PIV	85	NAS806S 400PIV	115

Quantity prices on application, S.A.E.

NE 555 Integrated circuit timer 8 pin dill only 82p.  
MULTITURN POTENTIOMETERS EX. EQUIPMENT RELCON 1k + or - % good condition 25p.  
2 1/2in 75 ohms or 40 ohm miniature speaker 45p each.

Please add 8% VAT to all listed prices. Postage & packing 15p per order. Send 13p for latest catalogue. Callers welcome.



## become a RADIO-AMATEUR!

learn how to become a radio-amateur in contact with the whole world. We give skilled preparation for the G.P.O. licence

**free!**

Brochure, without obligation to:

**BRITISH NATIONAL RADIO & ELECTRONICS SCHOOL** Dept. WB35, P.O. Box 156, JERSEY

NAME : \_\_\_\_\_

ADDRESS : \_\_\_\_\_

\_\_\_\_\_ BLOCK CAPS please

**no extras**  
all prices inc VAT  
FREE delivery



ALL ITEMS SUBJECT TO  
MANUFACTURERS INCREASE  
AND AVAILABILITY  
**Personal  
Callers are  
Welcome!**

**High Quality  
Construction  
Kits, stocked  
at all branches  
Send for  
catalogue!**

**AMPLIFIERS**

Teleton SAQ3078+8 watt £27.00  
Rotel RA211 £43.95  
RA311 £54.95  
RA611 £86.95  
Leak Delta 30 £54.75  
Samsui AU101 £48.25  
AU505 £74.95  
Sinclair 2000 £34.95  
Sinclair 4000 £45.95

**TUNERS & RECEIVERS**

Leak Delta AM/FM £58.75  
Sinclair 2000/4000 Tuner £34.95  
Rotel RT222 £42.75  
Rotel RX150A Tuner/  
Amp. £59.95  
Rotel 152A £69.95  
Samsui  
210 AM/FM/MPX £84.25  
310 AM/FM/MPX £99.50  
350A AM/FM/MPX £106.95

**RECORD DECKS**

SP25 Mk III £11.00  
Garrard SP25 MkIV £12.95  
BSR MP60 £11.95  
BSR Invicta P & C/SC7M £9.95  
Garrard  
SP25 MkIV P & C G/800 £21.00  
AP76 Module £30.00  
Goldring GL78 P & C/  
G800E £59.95  
Connoisseur  
BDI Kic £13.50  
BD2 Chassis/SAU2 £32.50  
SAU2 £14.25  
SCU1 £5.95

**TAPE DECKS (Insurance 2.00)**

Akai  
4000DS Reel to Reel £93.95  
4000DB Reel to Reel  
Dolby £149.50  
1721L Special Offer £77.95  
GX C36D £82.00  
GX C38D £103.95  
C533D £79.95  
Akai CR81D 8-track Rec.  
player £73.95

**SPEAKERS**

**Chassis Speakers**  
EMI (Plain) 13in x 8in,  
3, 8 or 15 ohm Bass unit £2.30  
with Single Tweeter  
(only Bohm) £2.45  
with Twin Tweeter £3.95  
Type 350 Kit 15 watt 8 ohm £8.25  
13in x 8in Bass unit  
15 watt 8 ohm £4.95  
8in x 5in 5 watt 3, 8 or  
15 ohm £1.50  
8in x 5in 10 watt  
Dualcone 8 ohm £2.50  
6 1/2" 10 watt 8 ohm £2.65  
8in 10 watt 8 ohm £3.90  
12in 20 watt 8 ohm £6.95  
Fane 8in 4 or 15 ohm £2.25  
Fane 7in x 4in 3 or 8 ohm £1.20  
Elac 8in 8 ohm Dualcone £2.50  
Elac 10in 8 ohm Dualcone £3.75  
Goodman 6 1/2in 8 ohm  
Dualcone £2.40  
Baker Group 25 12in 8 or  
15 ohm £7.95  
Adastra 'Top 20' 12in  
25 watt 8 or 15 ohm £8.25

Adastra 'Hi-Ten' 10in  
10 watt 8 or 15 ohm £3.60  
Also 5in 8 ohm speaker £0.99  
2 1/2in 8 or 64 ohm  
speaker £0.50

**WHARFEDALE SPEAKER  
BARGAINS**

Denton 1 pr. £26.75  
Denton 2 pr. £32.00  
Linton 2 pr. £40.75  
Glendale 3 pr. £60.95  
Kingsdale 3 ea. £64.95  
Dovedale 3 ea. £44.95

**KITS**

Linton 2 pr. £20.95  
Glendale 3 pr. £35.95  
Dovedale £55.50

**SPEAKER CABINETS IN  
KIT FORM (Teak Veneer)**

12in x 8in x 6in  
(8 x 5 or 7 x 4 cutout) £2.50  
14in x 12in x 9in  
(10", 8 x 5, 8", 6 1/2" & 3 1/2") £3.75  
18in x 11in x 9in  
(8" x 3" or 13 x 8) £4.95  
22in x 14in x 9in  
(12" x 3" or 13 x 8) £6.25

**TWEETERS & CROSSOVERS**

EMI 3 1/2" c/magnet in 3 or  
8 ohm £1.25  
Cone Tweeter 10 watt  
8 or 15 ohm (K2006) £2.70  
Cone Tweeter 3 watt  
8 ohm (K2003) £1.55  
Horn Tweeter 3 ohm  
(K2007) £6.50  
Dome Tweeter 8 ohm  
(K2011) £5.50  
2-way Crossovers (CN23,  
CN28, CN216) £1.30  
3-way Crossover (CN38) £2.75

**CARTRIDGES & STYLII**

ACOS	Cart.	D/D Styli £	£
GP91/2SC or 3CS (ster. comp)	1.10	1.25	
GP93/1 or 95/1 ster. cryst.	1.35	1.25	
GP94/1 or 96/1 ster. ceram.	1.75	1.25	
GP101 cryst. comp.	90	—	
GP104 ster. ceram.	1.75	1.25	
BSR XSM or XSH cryst. comp.	1.75	1.25	
SX6M or SX6H cryst. ster.	2.00	1.25	
5CSM ster. ceram.	2.75	1.25	

**SONOTONE**  
9TAHC or  
9TAHC/G  
(Diam.) 1.85 1.25  
3509 Magnetic 1.90 1.25  
**AUDIO TECNICA**  
AT55 1.95 —  
EMPIRE 999 REX 3.95 —  
**GOLDRING**  
G850 2.95 1.95

G800	3.95	1.95
G800H	3.95	1.95
G800E	6.99	3.95
SHURE		
M44G	4.95	3.95
M55E	6.25	4.95
M75ED Type 2	11.75	8.25
MJ5EJ Type 2	9.75	6.25
VI5 Type 3	32.25	—

**MICROPHONES**

UDI130 50K/600 ohm  
uni-dir. ball metal £5.95  
UDI147 £9.25  
Condenser Mic. 600 ohm  
uni-dir £9.50  
Cassette Stick Mic. with  
R/Control £1.60  
Mic-Mixers Mono/stereo £5.50  
AKAI ADM14 £5.95

**HEADPHONES**

Rotel  
RH430 £4.75  
RH 630 £7.75  
RH 700 £11.50  
Koss  
K711 £10.95  
KRO711 £10.95  
K6 £11.50  
K6LC £14.00  
K0727B £16.00  
K0747 £20.75  
HVI £21.95  
PRO4AA £26.95  
PRO54 £29.95  
K6LCQ £26.00  
Samsui SS10 £14.20  
\*Headphone adaptor  
(Junction box) £2.50  
extension lead 2ft curly £1.35

**CASSETTES**

	C40	C60	C90	C120
Low Noise	—	35p	45p	55p
Philips	—	55p	75p	110p
Memorex	65p	79p	110p	155p
Ampex (360)	45p	55p	70p	99p
Ampex (20-20+)	59p	65p	99p	135p
Chromium Dioxide	—	99p	140p	—
Cassette Head Cleaner	—	—	45p	—
Ampex Head Cleaner/Demag	—	—	£1.65	—
BIB Stereo Test Cassette	—	—	£2.15	—
Cassette Racks (hold 6)	—	—	£0.45	—
Cassette Rotating Racks (hold 20)	—	—	£3.50	—
Cassette Carrying Case (BIB) (hold 12)	—	—	£1.60	—
<b>8-Track Cartridge Blanks</b>				
C40 C64 C80				
Ampex	80p	95p	£1.10	—
8-track H/Cleaner Demagnetiser	—	—	£1.90	—
8-track Carrying Cases (BIB)	—	—	£1.65	—

**TAPES & CASSETTES**

	Std	LP	DP	Cases
5"	55p	65p	1.00	20p
5 1/2"	65p	86p	1.35	25p
7"	80p	110p	1.85	30p
High frequency Ampex	—	—	—	—
5"	—	1.40p	1.55p	—
7"	—	1.90p	2.95p	—
AKAI Metal Reel 7"	—	—	—	£1.99

**CALCULATORS**

Sinclair Cambridge Build £19.95  
Scientific £29.95

**SINCLAIR PROJECT 80**

Stereo Pre-amp. £11.95  
Active Filter Unit £6.95  
Z40 15 watt Amp £5.45  
Z60 25 watt Amp £6.95  
P25 Power Supply for 240 £4.98  
P26 Power Supply for 240 £7.98  
P28 Power Supply for 260 £7.98  
FM Tuner £11.95  
Stereo Decoder £7.45  
Q16 Speaker £7.10

**PORTABLE RADIOS**

Vega Jade £5.75  
Vega Zircon £8.25  
Vega Sapphire £7.25  
Vega VEF206 £13.95  
Micado LM/MW/FM/5SW £18.95  
Murphy  
B833 MW/VHF £9.95  
BA838 LW/MW/VHF  
M/Batt £18.50  
MA5003 Lead Set  
Radio LW £7.95  
Bush  
VTR165 LW/MW/VHF £22.00  
VTR127 LW/MW/VHF £15.50  
VTR178 VHF/MW/25W/  
AIR M/Batt £27.50  
VTR 175 LW/MW/VHF £13.95  
VTR188 LW/MW/VHF/1  
25W M/Batt £31.95  
BY5661 LW/MW/VHF £14.95

**CLOCK RADIOS**

Bush CR128 LW/MW £13.60  
Bush CR232 MW/VHF £24.95  
Murphy MV5600  
MW/VHF £22.95

**CASSETTE RECORDERS**

Murphy BA206 £16.95  
Bush TP66 M/Batt £25.75  
Murphy BA200 M/Batt £22.75  
Bush BT8504 (miniature) £25.50

**RADIO CASSETTES**

(Mains/Batt.)  
Micado 8155 AM/FM £25.95  
Murphy BA209 MW/VHF £33.50

**STEREO RECORD PLAYER  
& SYSTEM**

Bush SPR58 £29.50  
Bush SPR59 £31.50  
Bush A1005 £56.50  
Hanimex H101 £39.95  
Hanimex HRC5060 8-track  
AM/FM/MPX & Speaker £116.95

**CAR AUDIO**

Bush Car Cassette BT8501 £36.75  
Hitachi Car Radio  
WM702R LW/MW £16.50  
KM1510 LW/MW/VHF £32.50  
Hitachi Car Cassette  
CS114 £45.00

ALL ITEMS SUBJECT TO  
MANUFACTURERS INCREASE  
AND AVAILABILITY

**PERSONAL CALLERS  
WELCOME**

ALL MERCHANDISE FULLY GUARANTEED

**NEWMART  
ELECTRONICS**

Mail Order Dept PW/3  
Belmont St, Monton,  
Eccles, Manchester.  
Tel: 061-789 5268

Manchester  
30-32 Shudehill. tel 061-832 7710  
Leeds  
4 New Market St tel 0532 42708  
Liverpool  
15 Whitechapel tel 051-236 0738

# BENTLEY ACOUSTIC CORPORATION LTD.

7a GLOUCESTER ROAD, LITTLEHAMPTON, SUSSEX  
All prices inclusive of V.A.T. Telephone 6743

0B7	.40	8BA6	.25	6LI	2.00	12K5	1.00	35W4	.50	DM71	1.50	EOL80	.55	ET97/6	.35	PCL82	.35	UBF80	.40	Transistors	AF117	.21	BYZ13	.28	
0Z4	.47	8BC8	.60	8L6GT	.55	12K7GT	.50	35Z3	.75	DY87/6	.85	EOL82	.34	ET88	.48	PCL83	.50	UBF89	.40	& Diodes	AF121	.23	PSY11A	.25	
1A1	.45	8BE6	.35	6L7	.50	12Q7GT	.45	35Z4GT	.70	DY80Z	.35	EOL83	.70	EY01	.58	PCL84	.45	UBL21	.77	IN4744	.15	AF125	.28	PSY41A	.25
1A5GT	.50	8BH6	.60	6L18	.55	12BCT	.50	35Z5GT	.75	E800C	2.00	EOL84	.60	E240	.50	PCL85	.47	UCB4	.45	2N966	.58	AF126	.30	OA10	.47
1A7GT	.55	8BJ6	.55	6L19	2.00	12BGT	.40	.42	.50	E800F	1.40	EOL85	.60	E241	.55	PCL86	.55	UCB5	.75	2N968	.58	AF128	.30	OA17	.47
1B3GT	.60	8BK7A	.60	6L20	.75	12BH7	.65	.43	1.00	E800G	1.20	EOL86	.45	E260	.35	PEN45	.55	UCB8	.45	2N1756	.55	AF180	.53	OA47	.11
1B5GT	.60	8BQ7A	.55	6L21	.60	12BZ7	.45	6B5	.60	E800H	1.00	EOL87	.45	E261	.35	PEN45DD	.55	UCF80	.70	2N1247	.75	AF186	.61	OA70	.17
1L4	.25	8BR7	1.00	6QGT	.50	12BZT	.45	6B5C	.60	E800I	1.00	EF40	.75	EY501	.75	.80	.80	UCH21	2.00	2N1297	.25	BA115	.15	OA73	.17
1B6GT	.65	8BR8	1.50	6QGT(M)	.55	14H7	.65	50EH5	.75	E182CC1.25	.25	EF41	.70	EZ32	.50	PEN46	.50	UCH42	.75	2N1269	.15	BA116	.30	OA79	.16
1B8	.85	8BW6	1.40	6Q7(M)	.65	14H7	.65	50EH5	.75	E182CC1.25	.25	EF42	.70	EZ33	1.25	PEN46DD	.50	UCH81	.40	2N1805	.35	BA129	.14	OA81	.16
1B4	.85	8BW6	.80	6R7G	.60	14B7	.30	50L6GT	.85	E1148	.53	EF43	.50	EZ34	.60	.3.00	.3.00	UCH81	.40	2N1805	.35	BA129	.14	OA81	.16
1U4	.60	8BW7	.70	6R7M	.75	14B7	.50	55A2	.60	E2A76	1.00	EF44	.55	EZ35	1.00	PENDD	.50	UCH81	.40	2N1805	.35	BA129	.14	OA81	.16
1U8	.75	8BZ8	.45	6B4T	.44	19G6	6.00	85A3	.60	E2A76	1.00	EF45	1.50	EZ36	1.00	PENDD	.50	UCH81	.40	2N1805	.35	BA129	.14	OA81	.16
SD21	.45	8C4	.35	65C7GT	.25	20P2	.75	90A3	2.50	RAC80C	.35	EF46	1.00	EZ37	1.00	PENDD	.50	UCH81	.40	2N1805	.35	BA129	.14	OA81	.16
SD25	.55	8C5	.50	65C7GT	.44	20L1	1.10	90C1	.75	EAC91	.75	EF47	.85	EZ38	1.00	PENDD	.50	UCH81	.40	2N1805	.35	BA129	.14	OA81	.16
2K2	.60	8C6	.40	68H7	.44	20P3	.80	90C2	2.40	EAF42	.75	EF48	.85	EZ39	1.00	PENDD	.50	UCH81	.40	2N1805	.35	BA129	.14	OA81	.16
2A4	.60	8C9	1.00	69J7	.55	20P4	1.00	150B2	.75	EAF401	.75	EF49	.37	HL41	1.00	PL36	.60	UF85	1.40	AA129	.17	BC108	.14	OA95	.10
SD4	.40	8CD8G	1.25	68K7GT	.44	20P5	1.30	2158G	.60	EB34	.85	EF50	.37	HL41DD	1.00	PL36	.60	UF85	1.40	AA129	.17	BC108	.14	OA95	.10
8Q4	.60	8CG8A	.75	68Q7GT	.55	20A6	.60	807	1.00	EB31	.85	EF51	.37	HL41DD	1.00	PL36	.60	UF85	1.40	AA129	.17	BC108	.14	OA95	.10
3Q5GT	.85	8CL8	.65	6V6G	.17	20A6G	.60	807	1.00	EB31	.85	EF52	1.00	HAC800	.60	PL200	.70	UF42	.70	AA119	.17	BC109	.14	OA200	.10
3B4	.40	8CL8A	.85	6V6GT	.25	20P2	.75	90A3	2.50	RAC80C	.35	EF53	.85	HL23	.60	PL200	.70	UF42	.70	AA119	.17	BC109	.14	OA200	.10
3Y4	.70	8CM7	.75	6X4	.40	28Z4G	.40	8060	1.00	EBF89	.60	EF54	.85	HL23DD	.75	PL33	.50	UF80	.35	AA120	.17	BC109	.14	OA200	.10
4C3B	.55	8C6U5	.75	6X54T	.45	25Z5	.60	6067	1.00	EBF89	.60	EF55	.85	HL23DD	.75	PL33	.50	UF80	.35	AA120	.17	BC109	.14	OA200	.10
5C08	.55	8CW4	1.00	7B6	.75	25Z6G	.70	7193	.58	EBF89	.60	EF56	.85	HL23DD	.75	PL33	.50	UF80	.35	AA120	.17	BC109	.14	OA200	.10
5B4GT	.40	8DE7	.75	7B7	.70	28D7	1.00	9002	.60	EBL21	2.00	EF57	.85	HL23DD	.75	PL33	.50	UF80	.35	AA120	.17	BC109	.14	OA200	.10
5U4G	.40	8DT6A	.75	7H7	.75	30A5	.85	9006	.60	EC88	.70	EF58	.85	HL23DD	.75	PL33	.50	UF80	.35	AA120	.17	BC109	.14	OA200	.10
5V4G	.40	8EW6	.75	7R7	.80	30C15	.50	ACFEN	1.00	EC81	.75	EF59	.85	HL23DD	.75	PL33	.50	UF80	.35	AA120	.17	BC109	.14	OA200	.10
5WGT	.45	8E5	.75	7Z4	.80	30C15	.50	DD	1.00	EC82	.45	EF60	.85	HL23DD	.75	PL33	.50	UF80	.35	AA120	.17	BC109	.14	OA200	.10
5Z4	.45	8F6G	.50	9D7	.65	30F5	.50	ACCFEN	1.00	EC82	.45	EF61	.85	HL23DD	.75	PL33	.50	UF80	.35	AA120	.17	BC109	.14	OA200	.10
5Z4GT	.45	8F13	.70	10C2	.87	AC/TH1	.87	AC/TH1	.87	EC84	1.00	EF62	.85	HL23DD	.75	PL33	.50	UF80	.35	AA120	.17	BC109	.14	OA200	.10
6J30L2	.30	8F14	.75	10DK7	.75	30FL3	.67	ATL4	1.00	EC81	.75	EF63	.85	HL23DD	.75	PL33	.50	UF80	.35	AA120	.17	BC109	.14	OA200	.10
6ABG	1.25	8F15	.65	10F1	.75	30FL12	.90	ATP4	.60	EC81	.75	EF64	.85	HL23DD	.75	PL33	.50	UF80	.35	AA120	.17	BC109	.14	OA200	.10
6AC7	.49	8F18	.65	12P9	.65	30FL12	.90	ATP4	.60	EC81	.75	EF65	.85	HL23DD	.75	PL33	.50	UF80	.35	AA120	.17	BC109	.14	OA200	.10
6A08	.87	8F28	.85	10F18	.55	30PL14	.75	AZ31	.60	EC84	.35	EF66	.85	HL23DD	.75	PL33	.50	UF80	.35	AA120	.17	BC109	.14	OA200	.10
6AH6	.60	8P24	.85	10LD11	.70	30L15	.75	AE41	.25	EC88	.45	EF67	.85	HL23DD	.75	PL33	.50	UF80	.35	AA120	.17	BC109	.14	OA200	.10
6AJ5	.65	8P26	1.00	10P13	.75	30L17	.70	BL63	2.00	EC88	.45	EF68	.85	HL23DD	.75	PL33	.50	UF80	.35	AA120	.17	BC109	.14	OA200	.10
6AK5	.40	8P28	.87	10P14	.80	30P4MR	.80	OL3	1.60	EC88	.45	EF69	.85	HL23DD	.75	PL33	.50	UF80	.35	AA120	.17	BC109	.14	OA200	.10
6AK6	.40	8P28	.87	10P14	.80	30P4MR	.80	OL3	1.60	EC88	.45	EF70	.85	HL23DD	.75	PL33	.50	UF80	.35	AA120	.17	BC109	.14	OA200	.10
6AK6A	.80	8P28	.50	12A5	1.00	30P13	1.00	GY31	.50	ECF80	.45	EF71	.85	HL23DD	.75	PL33	.50	UF80	.35	AA120	.17	BC109	.14	OA200	.10
6AMB8A	.60	8086G	.60	12AC6	.70	30P13	.80	GY31	.50	ECF80	.45	EF72	.85	HL23DD	.75	PL33	.50	UF80	.35	AA120	.17	BC109	.14	OA200	.10
6AN8	.70	8018A	.65	12AD6	.65	30P13	.80	GY31	.50	ECF80	.45	EF73	.85	HL23DD	.75	PL33	.50	UF80	.35	AA120	.17	BC109	.14	OA200	.10
6AQ5	.45	80K6	.65	12AE6	.65	30P4	.75	DAF96	.50	ECF86	.75	EF74	.85	HL23DD	.75	PL33	.50	UF80	.35	AA120	.17	BC109	.14	OA200	.10
6AR8	.40	80G7	.75	12AT8	.65	30P13	.85	DC90	.50	ECF86	.75	EF75	.85	HL23DD	.75	PL33	.50	UF80	.35	AA120	.17	BC109	.14	OA200	.10
6AR8	1.00	80G7	.25	12AU8	.45	30P13	.85	DF91	.30	.3.25	.3.25	EF76	.85	HL23DD	.75	PL33	.50	UF80	.35	AA120	.17	BC109	.14	OA200	.10
6AT6	.45	835GT	.45	12AV6	.50	30P14	1.10	DF96	.50	EOH21	2.00	EF77	.85	HL23DD	.75	PL33	.50	UF80	.35	AA120	.17	BC109	.14	OA200	.10
6AU6	.60	836	.30	12BA6	.45	30P15	.90	DK40	.70	EOH25	1.25	EF78	.85	HL23DD	.75	PL33	.50	UF80	.35	AA120	.17	BC109	.14	OA200	.10
6AV6	.45	837G	.20	12B26	.50	35A3	.65	DK92	.70	EOH24	.70	EF79	.85	HL23DD	.75	PL33	.50	UF80	.35	AA120	.17	BC109	.14	OA200	.10
6AW6A	.95	8JUS8A	.75	12BH7	.60	35C5	.75	DK96	.60	EOH24	.70	EF80	.85	HL23DD	.75	PL33	.50	UF80	.35	AA120	.17	BC109	.14	OA200	.10
6AX4	.75	8K7G	.30	12E1	.80	35D5	.75	DL86	.55	EOH23	.44	EF81	.85	HL23DD	.75	PL33	.50	UF80	.35	AA120	.17	BC109	.14	OA200	.10
6B6G	.80	8K8G	.45	12J7GT	.60	35L6GT	.75	DM90	.60	EOH24	.44	EF82	.85	HL23DD	.75	PL33	.50	UF80	.35	AA120	.17	BC109	.14	OA200	.10

VALVES ALSO REQUIRED FOR CASH. LOOSE OR BOXED, BUT MUST BE NEW. OFFERS MADE BY RETURN.  
All goods are unused and subject to the standard 90 day guarantee. Cash or cheque with order only. Despatch charges:—Orders below £5, add 10p total to cover up to three items, then each additional item 3p extra. Orders between £5 and £10 add 25p total. Orders over £10 are post free. Same day despatch. Any parcel insured against damage in transit for only 3p per parcel extra. Terms of business free on request. Many others in stock too numerous to mention.  
Please enclose S.A.E. for reply to any correspondence.

## CJL PRICES INCLUDE P&P AND V.A.T.

- AERIAL, telescopic, 15-120cm. £1.20
- AERIAL, telescopic, h and v swivel, 15-80cm. £1.78
- EARPHONE, stethoscope style, 8 ohm dynamic. £1.00
- HAND DRILL, (Leytool), Compact precision drill, 5/16" chuck. Gears totally enclosed, S/L bearings. £2.90
- INTEGRATED CIRCUITS**
- AUDIO POWER AMPLIFIER (National) LM380 £1.00
- A.M. RADIO RECEIVER (RCA) CA3123E £1.40
- F.M. STEREO DECODER (Motorola) MC1310P £2.40
- I/C TIMER (Signetics) NE555V £0.78
- D.I.L. SOCKETS (pk of 3)  8 pin £0.50  14 pin £0.55
- KEYNECTOR, rapid connect—single/multiple leads to mains. Built-in piano switches, neon & 13A fuse. £3.20
- MICROPHONE, lightweight dynamic, remote start/stop 200 ohms, 100-10,000Hz, 6mV average output. £1.80
- MULTIMETER, small and attractive, Vdc-10, 50, 250, 1,000. Vac-10, 50, 250, 1,000. Idc-100mA. R-150k. £4.95
- POWER SUPPLY COMPONENTS**
- SILICON BRIDGE RECTIFIER, 100 P.I.V./2A £0.40
- ELECTROLYTIC CAPACITOR, 2,200uF/50V £0.57
- ELECTROLYTIC CAPACITOR, 5,000uF/25V £0.63
- SILICON POWER TRANSISTOR, 2N3055 £0.60
- VOLTAGE REGULATOR (Fairchild) ua7805 £1.70
- VOLTAGE REGULATOR (Signetics) NE550A £0.80
- SIGNAL INJECTOR produces audio through video signals, excellent—servicing amplifiers, radios, televisions, etc. £3.92
- SOLDERING IRON, 25 WATT, (Antex), X25, 240V, Very low leakage, 1/8" long life bit (interchangeable). £1.85
- 3/32" bit £0.45  3/16" bit £0.45  Element £0.95
- STAND, (Antex), ST3, High grade base, chrome plated spring, sponges and accommodation for spare bits. £0.95
- SPEAKER, miniature, 8 ohms, 70mm dia. £0.80

**CJL** CJL LTD PO BOX 34, CANTERBURY, CT1 1YT

## QUALITY STEREO SOUND

ALMOST 1/2 PRICE OFFER!

MADE TO SELL AT DOUBLE THE PRICE IN CABINET FORM

OUR PRICE £49.95

**SOLENT AUDIO SYSTEM**

**£5 down**



# BI-PRE-PAK

Bargains in Semi-Conductors, components, modules & equipment.

## Bargains from our FREE Catalogue

20 large pages, filled with real bargains in transistors, I.C.s, components, equipment, etc. Send large S.A.E. with 6p stamp for your FREE copy of 6th Edition by return. Meanwhile, for prompt delivery order from this month's ad. NOW.

### BPP TRANSISTOR PACKS ALL AT 50p EACH TESTED & GUARANTEED

<b>B79</b>	<b>4</b>	IN4007 Sil. Rec. diodes, 1,000PIV 1 amp. plastic	<b>H39</b>	<b>6</b>	Integrated circuits 4 gates BMC 962, 2 flip flops BMC 945
<b>B81</b>	<b>10</b>	Reed Switches, 1" long 1/2" dia. High-speed P.O. type	<b>H41</b>	<b>2</b>	BD131/BD132 Complementary Plastic Transistors
<b>H35</b>	<b>100</b>	Mixed Diodes, Germ. Gold bonded, etc. Marked and Unmarked	<b>H65</b>	<b>4</b>	40361 Type NPN Sil. Transistors TO-5 can comp. to H66
<b>H38</b>	<b>30</b>	Short lead Transistors, NPN Silicon Planar types	<b>H66</b>	<b>4</b>	40362. Type PNP Sil. Transistors TO-5 can comp. to H65

### UNMARKED & UNTESTED

<b>B1</b>	<b>50</b>	Germanium Transistors PNP, AF and RF	<b>B86</b>	<b>100</b>	Sil. Diodes sub. min. IN914 and IN916 types
<b>B86</b>	<b>150</b>	Germanium Diodes Min. glass type	<b>H20</b>	<b>20</b>	BY126/7 Type Silicon Rectifiers 1 amp. plastic. Mixed ed volts
<b>B83</b>	<b>200</b>	Transistors, manufacturers' rejects, AF, RF, Sil. and Germ.	<b>H34</b>	<b>15</b>	Power Transistors, PNP, Germ. NPN Silicon TO-3 Can
<b>B84</b>	<b>100</b>	Silicon Diodes DO-7 glass, equlv. to OA200, OA202	<b>H67</b>	<b>10</b>	3819N Channel FET's plastic case type

### PLASTIC POWER TRANSISTORS— 2 ranges

In NPN or PNP at shattering low prices sold to you under our Tested and Guaranteed terms.  
Range 1. V.CE. Min 15. HFE Min 15  
1-12 13-25 26-50  
40 Watt 20p 18p 16p 40 Watt 30p 28p 26p  
90 Watt 24p 22p 20p 90 Watt 35p 33p 30p  
Please state NPN or PNP on order.

### NEW X-HATCH GENERATOR Mk.2



Essential for Colour T.V. alignment of 4 patterns. Featuring plug in IC's and a more sensitive sync. pick-up circuit. The case is virtually unbreakable—ideal for the engineer's toolbox—only measures 3" x 5 1/4" x 3". Operates from 3 U.2 type batteries (extra).

Complete kit **£7-93** Ready built unit only **£9-93**

### OVER 1,000,000 TRANSISTORS

of all most needed types in stocks including power, diode, rectifier, etc., etc., marked, tested and guaranteed. Hundreds of worthwhile bargains will be found in our FREE CATALOGUE (6th edition). Also Zener diodes, I.C.s, etc.

### SUNDRY

Metrication Pocket Charts 12p. 8 assorted relays £1-00. Rev. counter device (for cars) £1-00. U.H.F./TV Tuner Units £2-50. L.M.380 Audio I.C. £1-00 and technical books of all kinds.

### TERMS OF BUSINESS

V.A.T. Prices shown do not include V.A.T. Please add 8% to total value of your order including postage. No. V.A.T. on overseas orders.  
**POSTAGE** Except where stated, add 15p for postage & packing in U.K. Overseas—add £1, any difference being charged or refunded.  
**PAYMENT** Cash with order, Cheque or money order. Minimum value—50p. You can also pay by ACCESS.  
**IMPORTANT**—Every effort is made to ensure accuracy of prices and description at time of preparing this advertisement and going to press. Prices are subject to alteration without notice.

## BI-PRE-PAK LTD

Co. Reg. No B201919

222 224 WEST ROAD, WESTCLIFF-ON-SEA, ESSEX SSO 9DF.

TELEPHONE: SOUTHEND (0702) 46344.

WRITE ORDER SEPARATELY AND ATTACH COUPON IF REQUIRED



challenging values!

# Stirling Sound

**STIRLING SOUND AUDIO MODULES** come to you as basic units assembled on P.C.B.s enabling you to add required components in layouts of your own choice. Modules are tested and boxed before despatched and include well printed instructions.

### AMPLIFIER MODULES

**Pre-amplifiers; tone control**  
**SS.100** Active tone control unit to provide bass, treble, balance and volume controls **£1-60**  
**SS.101** Pre-amp for ceramic cartridge, tape and radio **£1-60**  
**SS.102** Pre-amp for low output magnetic cartridge, tape and radio. With R.I.A.A. correction  $\pm 1$ dB at 1K **£2-25**

### POWER AMPLIFIERS

**SS.103** Compact I.C. amp. with 3 watts R.M.S. output. Operating voltage 6 to 22. Size 3" x 2" **£1-75**  
**SS.103-3** Stereo version of above using one I.C. on each channel **£3-25**  
**SS.105** A compact and useful all-purpose amplifier which will run excellently on a 12V supply. With 5 watt output, two make a good stereo amp. Size 2 1/4" x 1 1/2" **£1-95**  
**SS.110** Similar in size to SS.103 but with a 10 watt output. Ideal for many domestic and small-size P.A. applications. Operates from 26 to 32V. **£2-40**  
**SS.140** Excellently designed 40 watt R.M.S. (into 4 ohms) hi-fi amplifier. S/N ratio better than 75dB. THD better than 0.2%. Power requirements—45V. d.c. With 0.15" centre glide connections. Two can be bridged to give 80 watts R.M.S. into 4 ohms **£3-60**

### TUNER MODULES

**SS.201** Ganged tuning condenser with accurately engineered slow-motion drive in rugged housing. Excellent sensitivity. Tunes 88-108MHz. With A.F.C. facility. Operates from 6V—16V **£6-25**  
**SS.202** I.F. stage (with I.C.) Pre-tuned. A.F.C. connection. Operates from 4.5 to 14V **£5-25**  
**SS.203** Stereo Decoder. Designed essentially for use with SS.201 and 2, this module can also be used in most mono FM tuners. A LED may be attached. Operating voltage 9-16V. d.c. **£5-62**

### POWER SUPPLY STABILIZER

**SS.300** Add this to an unregulated supply (say typically 45V output) to obtain a steady powerful working output adjustable from 12 to 60V. Essential or your audio and special systems. Money saving and very reliable **£3-25**

### ● ALL MODULES TESTED AND GUARANTEED

### ● WITH WELL PRINTED INSTRUCTIONS

### ● FULL RANGES OF ANCILLARY COMPONENTS AVAILABLE—SEE CATALOGUE

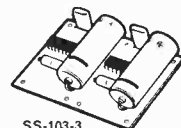

SS-103-3

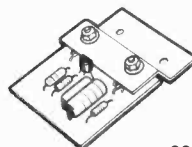

SS-105

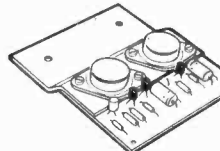

SS.140

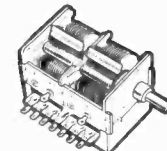

SS.201

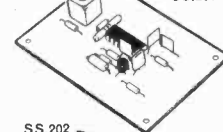

SS.202

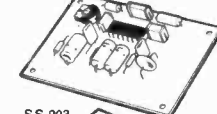

SS.203

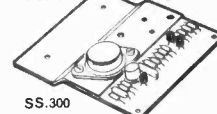

SS.300

To BI-PRE-PAK, 224-226 WEST RD., WESTCLIFF-ON-SEA, ESSEX

Please send .....

for which I enclose.....Inc. V.A.T.

Name .....

Address .....

PW3

LISTEN TO

**CODAR**® THE WORLD!

★ **CR70A**



**COMMUNICATION RECEIVER**

The CODAR CR70A is an outstanding general coverage communication receiver, ideal for the keen S.V.L. It tunes from 540 metres medium through to 10 metres with no gaps. Covers shipping, coastguard and distress frequencies, all six amateur bands 160-10 metres, International broadcast, Met. stations etc. etc. giving world-wide reception. Exclusive features include Air-spaced CODAR-COIL Hi-"Q" Aerial input, illuminated Meter and Slide Rule Scale, Two Speed vernier tuning, Switched B.F.O. for CW/SSB signals. Separate output for Tape recorder. Ready to plug in to 200/240 volts A.C. it only needs your aerial and a 2/3 ohm loudspeaker to bring the world to your finger tips. 12 months full guarantee.

★ **IMPORTANT NOTE**

This fine receiver is not a mass produced item, but each set is hand built to your order, individually checked and air tested. Please allow for this when ordering—your delivery date will be shown on your receipt, sent by return.

★ **MADE TO ORDER!**

**£37.15!**

VAT PAID  
CARR. 85p



★ **P.R.40** ★

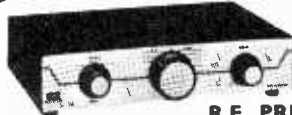

**£10.93!**  
VAT PAID  
CARR. 32p

**R.F. PRESELECTOR**

The PR40 R.F. Preselector is the solid state version of the world famous PR30 which it now supersedes. It employs Silicon "N" Channel FET (Field Effect Transistor) front and followed by silicon NPN Broad Band R.F. Amp., and will substantially improve receiver performance over the range 1.5 to 35 MHz, providing a considerable increase in gain up to an overall average of 30dB, with improved image rejection and noise ratio. Supplied complete with co-ax plug (less standard 9 volt PP6 Battery). 12 months Guarantee . . .



**MULTIBAND-6** ★

**SHORT WAVE RECEIVER KIT**

**£16.90!** CARR. 43p

All transistor T.I.F. Receiver tunes 550 KHz to 30 MHz (540 to 10 metres) complete coverage—no gaps. Medium waves—Trawlers—Ship / Shore Telephone—All Six Amateur Bands 160-10 metres—International Broadcast from Australia, Far East, Russia, USA etc. using 4 miniature plug in Coils. Hi-Gain FET Regen. Det./AF/AF Module giving full loudspeaker output to any external 2/3 ohm speaker. Receives AM/CW/SSB. Separate Electrical Bandsread, Calibrated Main Tuning. A Quality CODAR-KIT with 12 months Guarantee. No technical knowledge required. Simple to build, printed circuit and Pictorial Instruction Manual. Fully detailed step by step. Complete Kit with 4 Coils (less standard PP6 battery).

ILLUSTRATED LEAFLETS FREE ON REQUEST

ON THE DESIGN STAFF—  
G3SZM G3JRE

**CODAR**®

TO COPE WITH INCREASING DEMAND—PLEASE  
NOTE NEW SALES OFFICE TEL NO. 02-73-38345  
MON-THURS-9.30 a.m.-4.30 p.m.

**VALCON WORKS · BURRELL BUILDINGS · CHURCHILL INDUSTRIAL ESTATE · LANCING · SUSSEX**  
WORLD-WIDE MAIL ORDER—EXPORT QUOTES FREE. **BN15 · 8TZ**



ERSIN

**Multicore**

5 CORE SOLDER

**for fast easy reliable soldering**  
**EASY TO USE DISPENSERS AND REELS**  
**IDEAL FOR HOME CONSTRUCTORS**

Ersin Multicore Solder contains 5 cores of non-corrosive flux. Instantly cleaning heavily oxidised surfaces. No extra flux is required.

**SAVBIT** handy solder dispenser



A coil of Ersin Multicore Savbit Solder in a dispenser 7 1/2 in of 18 s.w.g. (2.2 metres of 1.22mm). The Solder that reduces the wear of soldering iron bits.

Size 5  
32p

**SAVBIT** solder for general purpose work

A handy plastic reel of SAVBIT alloy. 63ft of 18 s.w.g. (19.2 metres of 1.22mm)

Size 12 £1.72



**ALU-SOL** for soldering aluminium

New Multicore Alu-sol flux-cored solder in 16 s.w.g. No extra flux needed. Plastic reel holds 36ft. Supplied with full instructions. Also available in solder dispenser.

Size 4 £2.32



**Fine gauge solder** for soldering small components

Fine gauge solder for soldering small components 138ft of 22 s.w.g. (42.0 metres of 0.71mm) Ersin Multicore 5 core solder wound on a plastic reel. Suitable for intricate work and small components.

Size 10 £1.44



**For soldering fine joints**

Dispensers of Ersin Multicore Solder make those small jobs easier. 21ft of 22 s.w.g. (6.4 metres of 0.71mm) solder, specially suitable for soldering fine wires, small components and for repairing printed circuits.

Size 15 36p

Or size 19A for kit wiring or Radio and T.V. repairs 7ft. (2.1 metres) of 18 s.w.g. (1.22mm) Ersin Multicore Solder.

Size 19A 34p

**NEW BIB WIRE STRIPPER & CUTTER**



Fitted with unique 8 gauge selector with handle locking device and easy grip handles. Spring incorporated for automatic opening. Strips insulation from flex and cables in seconds and can also be used as a cutter.

Model 8B, 70p

**NEW SOLDER WICK**



Absorbs solder instantly, from tags and printed circuits. Only needs 40 to 50 Watt soldering iron. Quick and easy to use. Does not need flux and is non-corrosive.

Size 18 90p

**Bib Hi-Fi Accessories Limited,**

Sole U.K. Sales Concessionaires, P.O. Box 78 Hemel Hempstead, Herts. HP2 7EP

Prices shown are recommended retail excluding V.A.T. From Electrical and Hardware Shops. If unobtainable, send 15p P&P. Prices and specifications subject to change without notice.

# TRANSFORMERS

## POWER UNIT Type A125

Supplying 6 or 9 Volt DC at 200 mA.

In moulded case forming a 2 pin 5A mains plug.

2 metre output lead with 4-way multiplex giving 2-1 and 2-5 mm sockets and 3-5 mm plugs.

Price £2-25. Post 10p.



## 2" and 4" PANEL METERS

2"		4"	
SIZE: 60mm Wide 45mm High 40mm Deep.	Movement	SIZE: 110mm Wide 82mm High 43mm Deep.	Movement
0-50 micro A.	1250	0-50 micro A.	1400
0-100 micro A.	580	0-100 micro A.	730
0-500 micro A.	170	0-500 micro A.	200
0-1 mA	170	0-1 mA	200
0-5 mA	170	0-5 mA	200
0-10 mA	6	0-10 mA	6
0-50 mA	0-5	0-50 mA	0-5
0-100 mA	0-5	0-100 mA	0-5
0-500 mA	0-5	0-500 mA	0-5
0-1 AMP	0-5	0-1 AMP	0-5
0-2 AMP	0-5	0-2 AMP	0-5
0-25 Volt	15K	0-25 Volt	15K
0-50 Volt	50K	0-50 Volt	50K
0-300 Volt	300K	0-300 Volt	300K
"g" Meter	170	"g" Meter	200
VU Meter	5250	VU Meter	5250

VU Meters are complete with detectors. Modern wide view. Price 2" £3-15 Post 10p. Price 4" £4-15 Post 10p. Lamps 75p per set.

1/2 watt CARBON FILM RESISTORS  
1/2 watt at 70°C E 12 range 10Ω-1MΩ 5% tol above 470 KΩ 10% tol at 95p per 100.

## C1000 MULTIMETER

**Special Offer**  
Compact General Purpose Mini Multimeter. Input Resistance 1000 ohms per volt.  
Ranges:  
AC Volts 0-15, 50, 250, 1000 V  
DC Volts 0-10, 50, 250, 1000 V  
DC Current 0-1 mA 0-100 mA  
Resistance 0-150K ohms  
Size 60 x 24 x 90 mm  
Complete with Batteries, Test Prods, Instructions. Special price £3-20 Post 20p.



## C1001 MULTIMETER

Input Resistance 20,000 ohms per volt  
Overload protection  
150 μA movement, clear scale  
Ranges—AC Volts 0-10, 50, 250, 1000V  
DC Volts 0-5, 25, 125, 500, 2500V  
DC Current 0-50 mA  
Resistance 0-60 Kohms, 0-6 Mohms  
Decibels -20 to +22 dB.  
Carrying Case, Test Prods and Batteries included.  
Size: 11-3 x 8-3 x 2-7 cm.  
Price £9-85. Post 20p.

## CASED TRANSFORMERS

Housed in smart resin-cased steel cases, with 3-core power cable and outlet socket, fused primary winding. Isolation types are fitted with 3-pin outlet sockets, and are available with 110 volt or 240 volt output. (Please state). Auto types are fitted with 2-pin flat style sockets up to 500 VA. 3-pin sockets from 750 to 3000 VA. See Auto and Isolation sections for prices.

## SAFETY ISOLATING

Prim. 120/240V. Sec. 120/240V. Centre Tap with Screen.

VA (watts)	Ref. No.	Price Cased £	Price Plugs 2 Pin 1 Earth £	Price Open £	Post £
60	149	7-35	0-80	4-00	0-38
100	150	8-22	0-80	4-80	0-52
200	151	10-20	0-80	7-40	0-52
250	152	11-88	0-80	8-88	0-65
350	153	14-10	0-80	10-80	0-80
500	154	15-88	0-80	12-38	1-00
750	155	24-83	1-00	18-72	1-20
1000	156	32-49	1-00	26-50	1-20
1500	157	38-18	1-00	30-34	O.A.
2000	158	45-20	2-40	34-88	O.A.
3000	159	68-50	2-40	53-35	O.A.

## 12 & 24 Volts Prim. 200-240V.

Amps	Ref. No.	Price £	Post £
12V 24V			
0-2	0-16	2-42	1-34
0-5	0-25	1-11	1-38
1	0-5	2-13	1-58
2	1	2-71	2-09
4	2	18	2-68
6	3	7-9	3-80
8	4	10-8	4-20
16	4	7-2	4-80
12	5	11-6	5-01
16	8	17	6-22
20	10	11-5	9-47
30	15	18-7	11-95
40	20	22-2	13-26
50	30	22-6	15-30

## 30 Volts

Amps	Ref. No.	Price £	Post £
0-5	112	1-72	0-22
1	79	2-21	0-38
2	3	3-26	0-38
3	20	4-10	0-42
4	21	4-68	0-52
5	51	6-80	0-52
6	117	6-50	0-52
8	86	8-50	0-67
10	89	8-97	0-67

## AUTO TRANSFORMERS

VA Watts	Ref. No.	Price Cased £	Price Plugs 2 & 3 pin £	Price Open £	Post £
Tapped at 115, 220, 240 Volts					
		113	3-00	0-15	1-55
Tapped at 115, 200, 220, 240 Volts					
150	4	5-80	0-15	3-98	0-39
200	65	6-40	0-15	4-50	0-40
300	66	7-27	0-15	5-28	0-52
500	67	9-99	0-15	8-29	0-67
750	85	12-36	0-75	9-78	0-82
1000	84	15-70	0-75	12-40	0-82
1500	93	19-88	0-75	16-58	1-50
2000	95	30-10	1-44	22-05	1-50
3000	73	43-58	1-90	32-00	1-90

## 50 Volts

Amps	Ref. No.	Price £	Post £
Prim. 200-240V. Sec. 19, 25, 33, 40, 50V.			
0-5	102	2-33	0-30
1	103	3-00	0-38
2	104	4-57	0-42
3	105	5-20	0-52
4	106	6-89	0-52
6	107	11-17	0-67
8	118	14-19	0-97
10	119	15-47	0-97

## 60 Volts

Amps	Ref. No.	Price £	Post £
Prim. 230-240V. Sec. 24, 30, 40, 43, 60V.			
0-5	124	2-08	0-38
1	126	2-96	0-38
2	127	4-83	0-42
3	125	6-84	0-52
4	123	7-94	0-67
5	40	8-86	0-67
6	120	10-15	0-82
8	121	13-68	1-00
10	122	18-15	1-00
12	189	16-00	1-10

## MINIATURE AND EQUIPMENT

Sec. 1 Volts	Sec. 2	Sec. 1 Milliamperes	Sec. 2	Ref. No.	Price £	Post £
3-0-3		200		228	1-23	0-10
0-6	0-6	500	500	234	1-30	0-10
0-6	0-6	1000	1000	212	1-93	0-22
9-0-9		100		13	1-23	0-10
0-9-9	0-9	330	330	225	1-43	0-10
0-8-9	0-8-9	500	500	207	1-75	0-22
0-8-9	0-8-9	1000	1000	206	2-80	0-36
15-0-15		40		240	1-21	0-10
0-15	0-15	200	200	236	1-30	0-10
0-20-20		30		241	1-23	0-10
0-20	0-20	150	150	237	1-30	0-10
0-15-20	0-15-20	300	300	205	2-47	0-38
0-20	0-20	300	300	214	1-72	0-22
0-20	0-20	3500 (NO SCREEN)		1116	3-00	0-40
20-12-0 12 20		700 (NO SCREEN)		221	1-21	0-10
0-15-20	0-15-20	1000	1000	206	3-22	0-28
0-15-27	0-15-27	500	500	203	2-73	0-38
0-15-27	0-15-27	1000	1000	204	3-52	0-38

## PLASTIC CASED SILICON BRIDGE RECTIFIERS

One Amp	Two Amp	Four Amp	Six Amp
50 P.I.V. 25p	50 P.I.V. 35p	100 P.I.V. 55p	50 P.I.V. 65p
100 P.I.V. 25p	100 P.I.V. 40p	200 P.I.V. 60p	100 P.I.V. 70p
200 P.I.V. 28p	200 P.I.V. 45p	400 P.I.V. 65p	200 P.I.V. 80p
600 P.I.V. 30p	400 P.I.V. 50p	600 P.I.V. 75p	400 P.I.V. 90p

ADD 10p P & P PER ORDER

PLEASE ADD 8% FOR VAT

## POWER UNIT Type CC 12-05

Output switched 3, 4-5, 6, 7-5 and 12 volts at 500 mA D.C. Operates from 240 V mains, suitable for Radios, Tape Recorders, Record Players etc. Size 7-5 x 5-0 x 14-0cm. Price £3-95. Post 25p.



## MINIATURE NEONS

6mm dia., 12mm length leads length approx. 20mm. Recommended ballast resistor 150K ohms for 240 Volt operation. Price: Packet of 10 for 50p. Postage 10p.

# A.S.P. LTD.

DEPT PW 3, SIMMONDS ROAD, WINCHEAP, CANTERBURY, KENT. Tel: (0227) 52436

## CRYSTALS

Fast delivery of prototypes and production runs

### INCLUDING:

- Statek LF crystals in TO5 package
- Buckman LF, clock, and mobile radio crystals
- Astro Filter crystals
- Jan General purpose crystals

Interface Quartz Devices Limited, 29 Market Street, Crewkerne, Somerset.

Tel: (046031) 2578 Telex: 46283

## TTL & DIODES AT LOW PRICES! ALL DEVICES EX-STOCK. PRICES INCLUDE VAT.

Type	1/24	25/99	Type	1/24	25/99	Type	1/24	25/99
7400	0-15	0-14	7440	0-15	0-14	7480	0-50	0-47
7401	0-15	0-14	7442	0-73	0-68	7483	0-95	0-89
7402	0-15	0-14	7445	0-99	0-92	7486	0-35	0-34
7403	0-15	0-14	7447	0-98	0-98	7489	3-56	3-33
7434	0-18	0-16	7450	0-15	0-14	7490	0-54	0-50
7430	0-15	0-14	7474	0-36	0-34	7423	0-72	0-67
7408	0-18	0-16	7453	0-15	0-14	7493	0-54	0-50
7410	0-15	0-14	7454	0-15	0-14	7495	0-73	0-68
7412	0-23	0-21	7460	0-15	0-14	7496	0-83	0-78
7413	0-33	0-32	7472	0-29	0-27	74107	0-36	0-34
7420	0-15	0-14	7473	0-33	0-32	74121	0-36	0-34
7432	0-31	0-29	7474	0-36	0-34	74123	0-72	0-67
7437	0-31	0-29	7475	0-51	0-50	74127	0-87	0-81
			7476	0-35	0-32	74175	1-01	0-95

DIODES 1N4148 4p, 1N4001 41p, 1N4002 5p, 1N4003 6p, 1N4004 6p. All devices full spec. by famous manufacturers. TTL MAY BE MIXED FOR 25/99 PRICES. S.A.E. for full lists (includes capacitors and transistors). 10p P. & P. on orders under £1, otherwise POST FREE.

J. C. JONES (Dept. PWB) 46 BUNSTELLARS, ST. IVES, HUNTINGDON PE17 4XX (Mail Order only)

# The Largest Selection

## BRAND NEW FULLY GUARANTEED DEVICES

AC107	0-22	AD161 & 0-22	BC151	0-22	BD133	0-72	BF184	0-28	MJE3440	0-55	2G307	0-21	2N1893	0-41	2N3053	0-19	2N4058	0-13
AC113	0-22	AD162 0-22	BC152	0-19	BD135	0-44	BF185	0-44	MJE3440	0-55	2G308	0-21	2N1894	0-41	2N3054	0-19	2N4059	0-11
AC117	0-32	AD174 0-55	BC153	0-33	BD136	0-44	BF187	0-30	MFF104	0-41	2G309	0-21	2N1895	0-41	2N3055	0-45	2N1606	0-13
AC122	0-13	AF114 0-27	BC154	0-33	BD137	0-50	BF188	0-44	MFF105	0-41	2G306	0-44	2N1896	0-63	2N3056	0-16	2N1607	0-13
AC125	0-19	AF116 0-27	BC155	0-20	BD138	0-55	BF194	0-13	OC19	0-39	2G308	0-39	2N1897	0-39	2N3057	0-18	2N1608	0-13
AC126	0-19	AF117 0-27	BC156	0-13	BD139	0-61	BF195	0-13	OC20	0-70	2G309	0-39	2N1898	0-39	2N3058	0-16	2N1609	0-13
AC127	0-20	AF118 0-27	BC159	0-13	BD140	0-66	BF196	0-18	OC22	0-62	2G338	0-20	2N1899	0-39	2N3059	0-16	2N1610	0-13
AC129	0-20	AF119 0-27	BC160	0-50	BD155	0-88	BF197	0-16	OC23	0-54	2G339A	0-18	2N1900	0-24	2N3060	0-16	2N1611	0-13
AC128	0-20	AF124 0-33	BC161	0-55	BD175	0-66	BF200	0-50	OC24	0-62	2G344	0-20	2N1901	0-24	2N3061	0-16	2N1612	0-13
AC132	0-16	AF125 0-33	BC167	0-13	BD176	0-66	BF222	0-15	OC25	0-42	2G345	0-18	2N1902	0-24	2N3062	0-23	2N1613	0-13
AC134	0-16	AF126 0-31	BC168	0-13	BD177	0-72	BF227	0-50	OC26	0-32	2G371	0-18	2N1903	0-24	2N3063	0-23	2N1614	0-13
AC137	0-16	AF127 0-31	BC168	0-13	BD178	0-72	BF268	0-66	OC28	0-55	2G371B	0-13	2N1904	0-24	2N3064	0-23	2N1615	0-13
AC141	0-20	AF139 0-33	BC170	0-13	BD179	0-77	BF269	0-94	OC29	0-55	2G373	0-19	2N1905	0-22	2N3065	0-46	2N1616	0-13
AC141K	0-32	AF178 0-55	BC171	0-16	BD180	0-77	BF292	0-61	OC35	0-46	2G474	0-19	2N1906	0-19	2N3066	0-17	2N1617	0-13
AC142	0-20	AF179 0-55	BC172	0-16	BD181	0-77	BF293	0-61	OC36	0-56	2G477	0-19	2N1907	0-19	2N3067	0-17	2N1618	0-13
AC142K	0-28	AF180 0-55	BC173	0-16	BD186	0-72	BF270	0-39	OC41	0-82	2G378	0-18	2N1908	0-18	2N3068	0-16	2N1619	0-13
AC151	0-17	AF181 0-55	BC174	0-16	BD187	0-77	BF271	0-32	OC42	0-27	2G381	0-18	2N1909	0-18	2N3069	0-16	2N1620	0-13
AC154	0-22	AF186 0-55	BC175	0-24	BD188	0-77	BF272	0-83	OC44	0-17	2G382	0-18	2N1910	0-27	2N3070	0-23	2N1621	0-13
AC155	0-22	AF239 0-41	BC177	0-21	BD189	0-83	BF273	0-39	OC45	0-14	2G401	0-33	2N1911	0-27	2N3071	0-23	2N1622	0-13
AC156	0-22	AL102 0-72	BC178	0-21	BD190	0-83	BF274	0-39	OC70	0-11	2G414	0-33	2N1912	0-27	2N3072	0-23	2N1623	0-13
AC157	0-27	AL103 0-72	BC179	0-16	BD191	0-83	BF275	0-39	OC71	0-11	2G417	0-33	2N1913	0-27	2N3073	0-23	2N1624	0-13
AC165	0-22	ASV26 0-28	BC180	0-27	BD196	0-94	BF280	0-30	OC72	0-16	2N388	0-39	2N1914	0-23	2N3074	0-10	2N1625	0-13
AC166	0-22	ASV27 0-33	BC181	0-27	BD197	0-99	BF284	0-24	OC74	0-16	2N388A	0-61	2N1915	0-23	2N3075	0-13	2N1626	0-13
AC167	0-22	ASV28 0-28	BC182	0-16	BD198	0-99	BF285	0-38	OC75	0-17	2N404	0-22	2N1916	0-23	2N3076	0-13	2N1627	0-13
AC168	0-27	ASV29 0-28	BC182L	0-16	BD199	0-105	BF286	0-24	OC76	0-17	2N404A	0-21	2N1917	0-23	2N3077	0-13	2N1628	0-13
AC169	0-18	ASV30 0-28	BC183	0-18	BD200	0-105	BF287	0-27	OC77	0-28	2N524	0-46	2N1918	0-23	2N3078	0-13	2N1629	0-13
AC176	0-22	ASV31 0-28	BC183L	0-16	BD205	0-88	BF288	0-24	OC81	0-17	2N527	0-54	2N1919	0-23	2N3079	0-13	2N1630	0-13
AC177	0-31	ASV32 0-28	BC184	0-22	BD206	0-88	BF289	0-24	OC82	0-17	2N598	0-46	2N1920	0-23	2N3080	0-13	2N1631	0-13
AC178	0-31	ASV34 0-28	BC184L	0-22	BD207	0-105	BF290	0-22	OC82	0-17	2N599	0-50	2N1921	0-23	2N3081	0-09	2N1632	0-13
AC179	0-31	ASV55 0-28	BC186	0-31	BD208	0-105	BF292	0-22	OC82D	0-17	2N696	0-14	2N1922	0-23	2N3082	0-09	2N1633	0-13
AC180	0-22	ASV56 0-28	BC187	0-31	BDY20	0-10	BFY53	0-19	OC83	0-22	2N697	0-15	2N1923	0-16	2N3083	0-10	2N1634	0-13
AC180K	0-32	ASV57 0-28	BC187	0-12	BF115	0-27	BX19	0-17	OC139	0-22	2N698	0-27	2N1924	0-16	2N3084	0-10	2N1635	0-13
AC181	0-22	ASV58 0-28	BC188	0-12	BF117	0-50	BX20	0-17	OC140	0-22	2N699	0-17	2N1925	0-16	2N3085	0-10	2N1636	0-13
AC181K	0-22	ASV73 0-28	BC189	0-18	BF118	0-77	BX21	0-17	OC141	0-22	2N706	0-09	2N1926	0-16	2N3086	0-10	2N1637	0-13
AC187	0-24	ASZ31 0-44	BC212L	0-14	BF119	0-77	BX22	0-17	OC170	0-28	2N706A	0-10	2N1927	0-16	2N3087	0-10	2N1638	0-13
AC187K	0-25	BC107 0-9	BC213L	0-14	BF121	0-50	BX23	0-17	OC171	0-28	2N708	0-13	2N1928	0-11	2N3088	0-31	2N1639	0-13
AC188	0-24	BC108 0-9	BC214L	0-18	BF123	0-55	BX24	0-17	OC200	0-28	2N711	0-33	2N1929	0-11	2N3089	0-31	2N1640	0-13
AC188K	0-25	BC109 0-9	BC226	0-28	BF125	0-50	BX25	0-17	OC201	0-31	2N717	0-37	2N1930	0-11	2N3090	0-31	2N1641	0-13
AC176	0-22	BC110 0-12	BC226	0-28	BF127	0-55	BX26	0-20	OC202	0-31	2N718	0-37	2N1931	0-11	2N3091	0-31	2N1642	0-13
AC177	0-31	BC111 0-12	BC301	0-30	BF128	0-61	BX27	0-20	OC203	0-31	2N719	0-37	2N1932	0-11	2N3092	0-31	2N1643	0-13
AC178	0-31	BC112 0-17	BC302	0-27	BF130	0-60	BX28	0-20	OC203	0-31	2N720	0-37	2N1933	0-11	2N3093	0-31	2N1644	0-13
AC179	0-31	BC116 0-17	BC303	0-35	BF154	0-60	BX41	0-31	OC205	0-31	2N904	0-25	2N1934	0-11	2N3094	0-31	2N1645	0-13
AC180	0-22	BC117 0-20	BC304	0-40	BF155	0-77	BX45	0-14	OC309	0-44	2N743	0-22	2N1935	0-11	2N3095	0-31	2N1646	0-13
AC181	0-22	BC118 0-11	BC440	0-34	BF156	0-53	BSY95A	0-14	OC371	0-48	2N744	0-22	2N1936	0-11	2N3096	0-31	2N1647	0-13
AC182	0-22	BC119 0-33	BC460	0-40	BF157	0-61	BU105	0-20	ORP12	0-48	2N914	0-18	2N1937	0-11	2N3097	0-31	2N1648	0-13
AC183	0-22	BC120 0-33	BC370	0-29	BF158	0-61	BU106	0-20	ORP16	0-44	2N915	0-18	2N1938	0-11	2N3098	0-31	2N1649	0-13
AC184	0-22	BC121 0-33	BC371	0-28	BF159	0-66	BU107	0-20	ORP21	0-44	2N928	0-33	2N1939	0-11	2N3099	0-31	2N1650	0-13
AC185	0-22	BC122 0-33	BC372	0-28	BF160	0-44	CA24	0-28	ORP26	0-44	2N930	0-33	2N1940	0-11	2N3100	0-31	2N1651	0-13
AC186	0-22	BC123 0-33	BC373	0-33	BF162	0-44	CA24	0-28	P346A	0-22	2N1131	0-22	2N1941	0-11	2N3101	0-31	2N1652	0-13
AC187	0-22	BC124 0-33	BC374	0-28	BF163	0-44	CA26	0-55	P397	0-46	2N1132	0-24	2N1942	0-11	2N3102	0-31	2N1653	0-13
AC188	0-22	BC125 0-33	BC375	0-28	BF164	0-44	CA26	0-55	P397	0-46	2N1132	0-24	2N1943	0-11	2N3103	0-31	2N1654	0-13
AC189	0-22	BC126 0-33	BC376	0-28	BF165	0-44	CA28	0-28	P397	0-46	2N1132	0-24	2N1944	0-11	2N3104	0-31	2N1655	0-13
AC190	0-22	BC127 0-33	BC377	0-28	BF166	0-44	CA28	0-28	P397	0-46	2N1132	0-24	2N1945	0-11	2N3105	0-31	2N1656	0-13
AC191	0-22	BC128 0-33	BC378	0-28	BF167	0-24	CA41	0-33	TP129	0-48	2N1303	0-16	2N1946	0-11	2N3106	0-31	2N1657	0-13
AC192	0-22	BC129 0-33	BC379	0-28	BF173	0-24	CA42	0-33	TP130	0-58	2N1305	0-16	2N1947	0-11	2N3107	0-31	2N1658	0-13
AC193	0-22	BC130 0-33	BC380	0-28	BF174	0-28	CA44	0-39	TP131	0-58	2N1306	0-23	2N1948	0-11	2N3108	0-31	2N1659	0-13
AC194	0-22	BC131 0-33	BC381	0-28	BF177	0-39	CA44	0-39	TP132A	0-73	2N1307	0-23	2N1949	0-11	2N3109	0-31	2N1660	0-13
AC195	0-22	BC132 0-33	BC382	0-28	BF178	0-33	CA44	0-39	TP132A	0-73	2N1308	0-23	2N1950	0-11	2N3110	0-31	2N1661	0-13
AC196	0-22	BC133 0-33	BC383	0-28	BF179	0-33	CA44	0-39	TP142A	0-73	2N1309	0-26	2N1951	0-11	2N3111	0-31	2N1662	0-13
AC197	0-22	BC134 0-33	BC384	0-28	BF180	0-33	CA44	0-39	TP142A	0-73	2N1309	0-26	2N1952	0-11	2N3112	0-31	2N1663	0-13
AC198	0-22	BC135 0-33	BC385	0-28	BF181	0-33	CA44	0-39	TP142A	0-73	2N1309	0-26	2N1953	0-11	2N3113	0-31	2N1664	0-13
AC199	0-22	BC136 0-33	BC386	0-28	BF182	0-44	CA44	0-39	TP142A	0-73	2N1309	0-26	2N1954	0-11	2N3114	0-31	2N1665	0-13
AC200	0-22	BC137 0-33	BC387	0-28	BF183	0-44	CA44	0-39	TP142A	0-73	2N1309	0-26	2N1955	0-11	2N3115	0-31	2N1666	0-13

### DIODES AND RECTIFIERS

AA119	0-06	BY128	0-17	OA10	0-15
AA120	0-09	BY130	0-18	OA47	0-08
AA129	0-09				

# -the lowest prices!

**BRAND NEW TEAS & GERM. TRANSISTORS**  
Coded and Guaranteed

Pak No.	EQVT
T1	8 2G3713 OC71
T2	8 D1374 OC75
T3	8 D1216 OC81D
T4	8 2G381T OC81
T5	8 2G382T OC82
T6	8 2G344B OC44
T7	8 2G345B OC45
T8	8 2G378 OC78
T9	8 2G399A 2N1302
T10	8 2G417 AF117

All 54p each pak

**ND 120 MIXIE DRIVER TRANSISTOR.**  
Suitable replacement for BX X 21, C 407, 2N 1893 120vcb.

1	25	100+
0-19	0-17	0-16

Sil. trans. suitable for P.E. Organ. Metal TO-18 Eqvt. ZTX300 6p each. Any Qty.

**GP 100 T08 METAL CASE GERMANIUM VECO=80V. Vcco=50V. I.C.=10 amps. Plot=30W. hfe=30-170.**  
Replaces the majority of Germanium power transistors in the OC, AD and NKT range.

1	25	100+
0-47	0-44	0-40

**GP 800 T03 METAL CASE SILICON VECO=100V. Vcco=60V. I.C.=15 amps. Plot=115W. hfe=200. 100T=1MHz. Suitable replacement for 2N 3055, BDY 11 or BDY 20.**

1	25	100+
0-55	0-53	0-51

**NEW 9th EDITION 250 pages TRANSISTOR EQUIVALENTS BOOK.** A complete cross reference and equivalents book for European, American and Japanese Transistors. Exclusive to BI-PAK. £2.30 each.

**A LARGE RANGE OF TECHNICAL AND DATA BOOKS ARE NOW AVAILABLE EX STOCK. SEND FOR FREE LIST.**

**GENERAL PURPOSE NPN SILICON SWITCHING TRANS. TO-18 SIM. TO 2N708/BS. 27/28/95A.** All usable devices no open or short circuits. ALSO AVAILABLE in PNP Sim. to 2N709. When ordering please state preference NPN or PNP.

	20	For	5p
	50	For	1-08
	100	For	1-92
	500	For	8-25
	1000	For	14-30

**SIL. G.P. DIODES**

300mW	30	5p
40PIV(Min.)	100	1-65
Sub-Min.	500	5-50
Fully Tested 1,000	9-90	

Ideal for Organ Builders.

**ADI61/162**  
M/P COMP GERM. TRANS. OUR LOWEST PRICE OF 75p PER PAIR.

**LOOK FOR OUR AUDIO & ELECTRONIC COMPONENTS ADVERTISEMENTS PRACTICAL WIRELESS EVERYDAY ELECTRONICS AND RADIO CONSTRUCTOR**

**FULL RANGE OF ZENER DIODES VOLTAGE RANGE 2-33V. 400mW. (DO-7 Case) 9p ea. 14W (TOP-Hat) 18p ea. 10W (SO-10 Stud) 32p ea.**

**QUALITY TESTED SEMICONDUCTORS**

Pak No.	Description	Price 5p
Q1	20 Red spot transistors PNP	0-54
Q2	16 White spot P.C. transistors PNP	0-54
Q3	4 OC 77 type transistors	0-54
Q4	4 Matched transistors OC44/45/81/81D	0-54
Q5	4 OC 75 transistors	0-54
Q6	5 OC 72 transistors	0-54
Q7	4 AC 128 transistors PNP high gain	0-54
Q8	4 AC 128 transistors PNP	0-54
Q9	7 OC 81 type transistors	0-54
Q10	7 LC 71 type transistors	0-54
Q11	2 AC 127/128 Complementary pairs PNP/NPN	0-54
Q12	3 AF 116 type transistors	0-54
Q13	3 AF 117 type transistors	0-54
Q14	3 OC 171 H.F. type transistors	0-54
Q15	7 2N3926 Sil. Epoxy transistors mixed colours	0-54
Q16	5 NPN 2x 8T.141 & 3x 8T.140	0-54
Q17	4 MADD'S 2x MAT 100 & 2x MAT 120	0-54
Q18	3 MADD'S 2x MAT 101 & 1x MAT 121	0-54
Q19	4 OC 144 Germanium transistors A.F.	0-54
Q20	4 AC 127 NPN Germanium transistors	0-54
Q21	20 NKT transistors A.F. R.F. coded	0-54
Q22	10 OA 202 Silicon diodes sub-min	0-54
Q23	8 OA 81 diodes	0-54
Q24	15 IN914 Silicon diodes 75 PIV 70mA	0-54
Q25	8 OA95 Germanium diodes sub-min IN 89	0-54
Q26	2 10A PIV Silicon rectifiers 18425R	0-54
Q27	2 Silicon power rectifiers BYZ 13	0-54
Q28	4 Silicon transistors 2 x 2N696, 1 x 2N697, 1 x 2N698	0-54
Q29	7 Silicon switching transistors 2N706 NPN	0-54
Q30	7 Silicon switch transistors 2N708 NPN	0-54
Q31	3 PNP Silicon transistors 2x 2N1131, 1x 2N1132	0-54
Q32	3 Silicon NPN transistors 2N1711	0-54
Q33	7 Silicon NPN transistors 2N2369, 500MHz. (code P397)	0-54
Q34	3 Silicon PNP TO-5, 2 x 2N2904 & 1 x 2N2905	0-54
Q35	7 2N3646 TO-18 plastic 300 MHz NPN	0-54
Q36	3 2N3053 NEN Silicon transistors	0-54
Q37	7 NPN transistors 3x 2N3703, 2x 2N3702	0-54

**555 I.C. 65p each**

**All prices include V.A.T.**  
**MAMMOTH I.C. PACK**  
APPROXIMATELY 200 PIECES ASSORTED MANUFACTURERS FALL-OUT INTEGRATED CIRCUITS INCLUDING LOGIC 74 SERIES LINEAR AND AUDIO AMPLIFIERS MANY CODED also SOME UNKNOWN TYPES - YOU TO IDENTIFY  
**PAK NO. M.I.C. 200**  
**PRICE £1.25 per PAK including p & p & V.A.T.**

**INTEGRATED CIRCUIT PAKS**  
Manufacturers "Fall Out" which include Functional and Part-Functional Units. These are classed as "out-of-spec" from the maker's very rigid specifications, but are ideal for learning about I.C.'s and experimental work.

Pak No.	Contents	Price	Pak No.	Contents	Price	Pak No.	Contents	Price
UIC00	= 12 x 7400	0-54	UIC46	= 5 x 7448	0-54	UIC90	= 5 x 7490	0-54
UIC01	= 12 x 7401	0-54	UIC48	= 5 x 7448	0-54	UIC91	= 5 x 7491	0-54
UIC02	= 12 x 7402	0-54	UIC50	= 12 x 7450	0-54	UIC92	= 5 x 7492	0-54
UIC03	= 12 x 7403	0-54	UIC51	= 12 x 7451	0-54	UIC93	= 5 x 7493	0-54
UIC04	= 12 x 7404	0-54	UIC53	= 12 x 7453	0-54	UIC94	= 5 x 7494	0-54
UIC05	= 12 x 7405	0-54	UIC54	= 12 x 7454	0-54	UIC95	= 5 x 7495	0-54
UIC06	= 8 x 7406	0-54	UIC96	= 12 x 7460	0-54	UIC96	= 5 x 7496	0-54
UIC07	= 8 x 7407	0-54	UIC70	= 8 x 7470	0-54	UIC90	= 5 x 7490	0-54
UIC10	= 12 x 7410	0-54	UIC72	= 8 x 7472	0-54	UIC121	= 5 x 74121	0-54
UIC20	= 12 x 7420	0-54	UIC73	= 8 x 7473	0-54	UIC141	= 5 x 74141	0-54
UIC30	= 12 x 7430	0-54	UIC74	= 8 x 7474	0-54	UIC151	= 5 x 74151	0-54
UIC40	= 12 x 7440	0-54	UIC76	= 8 x 7476	0-54	UIC164	= 5 x 74164	0-54
UIC41	= 5 x 7441	0-54	UIC80	= 5 x 7480	0-54	UIC193	= 5 x 74193	0-54
UIC42	= 5 x 7442	0-54	UIC81	= 5 x 7481	0-54	UIC199	= 5 x 74199	0-54
UIC43	= 5 x 7443	0-54	UIC82	= 5 x 7482	0-54			
UIC44	= 5 x 7444	0-54	UIC83	= 5 x 7483	0-54	UICXI	= 25 Assorted	
UIC45	= 5 x 7445	0-54	UIC86	= 5 x 7486	0-54			74's £1-65

Packs cannot be split, but 25 assorted pieces (our mix) is available as PAK UIC XI.

**2 Amp. BRIDGE RECTS.**  
50 v RMS 35p each  
100 v RMS 40p each  
200 v RMS 45p each  
400 v RMS 50p each  
1,000 v RMS 55p each  
Size 16 mm x 16 mm.

**D1699 NPN SILICON DUAL TRANSISTOR**  
(Similar to 2N2060)  
1 25 100+  
0-28 0-26 0-23

**LINEAR INTEGRATED CIRCUIT PAKS MANUFACTURERS FALL-OUTS**

ULIC709	10 x 709	0-54
ULIC710	7 x 710	0-54
ULIC741	7 x 741	0-54
ULIC747	5 x 747	0-54
ULIC748	7 x 748	0-54

**KING OF THE PAKS Unequaled Value and Quality**

## SUPER PAKS NEW BI-PAK UNTESTED SEMICONDUCTORS

Money back refund if not satisfied

Pak No.	Description	Price 5p
U 1	120 Glass Sub-Min. General Purpose Germanium Diodes	0-54
U 2	60 Mixed Germanium Transistors AF/RF	0-64
U 3	75 Germanium Gold Bonded Sub-Min. like OA5, OA47	0-54
U 4	40 Germanium Transistors like OC8L, AC128	0-54
U 5	60 200mA Sub-Min. Silicon Diodes	0-54
U 6	30 Sil. Planar Trans. NPN like BSY95A, 2N706	0-54
U 7	16 Sil. Rectifiers TOP-HAT 750mA V.I.T.G. RANGE up to 1000 V	0-54
U 8	50 Sil. Planar Diodes DO-7 Glass 250mA like OA200/202	0-54
U 9	20 Mixed Voltages, 1 Watt Zener Diodes	0-54
U10	20 BAY56 charge storage Diodes DO-7 Glass	0-54
U11	25 PNP Sil. Planar Trans. TO-5 like 2N1132, 2N2904	0-54
U13	30 PNP-NPN Sil. Transistors OC200 & 2N 104	0-54
U14	150 Mixed Silicon and Germanium Diodes	0-54
U15	25 NPN Sil. Planar Trans. TO-5 like BFY51, 2N697	0-54
U16	10 x 3 Amp Silicon Rectifiers Stud Type up to 1000PIV	0-54
U17	30 Germanium PNP AF Transistors TO-5 like ACY 17-22	0-54
U18	8 x 6 Amp Silicon Rectifiers RYZ13 Type up to 600 PIV	0-54
U19	25 Silicon PNP Transistors like BC105	0-54
U20	12 x 1.5 Amp Silicon Rectifiers Top Hat up to 1000 PIV	0-54
U21	30 AF Germanium Alloy Transistors 2G900 Series & OC71	0-54
U23	30 MADD'S like Mhz Series PNP Transistors	0-54
U24	20 Germanium 1 Amp Rectifiers GJM Series up to 300 PIV	0-54
U25	25 300 MHz NPN Silicon Transistors 2N708, BSY27	0-54
U26	30 Fast Switching Silicon Diodes like IN914 Micro-Min.	0-54
U29	10 x 1 Amp BCR's TO-5 can, up to 800 PIV CR81/26-600	1-08
U32	25 Zener Diodes 400mW DO-7 case 3-18 volts mixed	0-54
U33	15 Plastic Case 1 Amp Silicon Rectifiers IN4000 Series	0-54
U34	30 Silicon PNP Alloy Trans. TO-5 BCFY26 28302/4	0-54
U35	25 Silicon Planar Transistors PNP TO-18 2N2906	0-54
U36	25 Silicon Planar NPN Transistors TO-8 BFY50/51/52	0-54
U37	30 Silicon Alloy Transistors SO-2 PNP OC200, 28322	0-54
U38	20 Fast Switching Silicon Trans. NPN 400 MHz 2N3011	0-54
U39	30 R.F. Germ. PNP Transistors 2N1303/5 TO-8	0-54
U40	10 Dual Transistors 6 lead TO-5 2N2060	0-54
U43	25 Sil. Trans. Plastic TO-8 BCFY26 28302/4	0-54
U44	20 Sil. Trans. Plastic TO-5 BC115/116	0-54
U45	7 3A SCR, TO66 up to 600PIV	1-08
U46	20 Unijunction transistors similar to T1848	0-54
U47	10 TO220AB plastic triacs 50V 6A	£1-08
U48	9 NPN Sil. power transistors like 2N3055	£1-08
U49	12 NPN Sil. plastic power trans. 60W like 2N5294/5296	£1-08

Code No's mentioned above are given as a guide to the type of device in the pak. The devices themselves are normally unmarked.

**FREE**  
One 55p Pak of your own choice free with orders valued £4 or over

**CADIUM CELLS**  
ORPI2 45p

**SIL. RECTS. TESTED**

PIV 300mA 750mA	1A	1-5A	3A	10A	30A
50 0-05 0-06	1N4001 0-05 0-08	0-15 0-21	0-21 0-30	0-10 0-17	0-23 0-75
100 0-05 0-07	1N4002 0-06 0-10	0-17 0-23	0-25 1-00	0-06 0-08	0-15 1N4004 0-08 0-15
200 0-06 0-10	1N4003 0-07 0-12	0-22 0-25	1-00	0-06 0-07	1N4005 0-10 0-18
400 0-08 0-15	1N4004 0-08 0-15	0-30 0-38	1-35	800 0-12 0-19	1N4006 0-11 0-20
600 0-06 0-17	1N4005 0-10 0-18	0-38 0-55	2-10	1000 0-14 0-30	1N4007 0-12 0-25
800 0-12 0-19	1N4006 0-11 0-20	0-38 0-55	2-10	1200 —	10-35
					0-80 0-88 0-75 3-00

**DIACS**  
FOR USE WITH TRIACS  
DR100 (D32) 25p each

**10 amp POTTED BRIDGE RECTIFIER on heat sink.**  
100PIV. 99p each

**TRIACS**  
VBOM 2A 6A 10A  
TO-5 TO-68 TO-48

	P	D	5p
100	33	55	83
200	55	66	99
400	77	83	1-21

Giro No. 388-7006  
Please send all orders direct to warehouse and despatch department

**BI-PAK**  
**P.O. BOX 6, WARE - HERTS**  
Postage and packing add 15p. Overseas add extra for airmail.  
Minimum order 55p. Cash with order please.  
**Guaranteed Satisfaction or Money Back**



# TRAMPUS ELECTRONICS LTD

58-60 GROVE ROAD,  
WINDSOR, BERKS.

WE HAVE MONEY BACK IF NOT SATISFIED.  
LARGE STOCKS. LOW PRICES.  
ALL BRAND NEW TOP GRADE FULL  
SPEC DEVICES. CALLERS WELCOME.

FAST SERVICE.

SEND C.W.O. ADD VAT TO ALL PRICES IN U.K. P&P 15P. EUROPE 25P. OVERSEAS 65P.

CATALOGUE/LIST FREE SEND S.A.B.

## Digital Displays



MINITRON 3015F  
0-9DP £1.15 ea  
LED 0.3" digit  
0-9DP £1.49 ea  
JUMBO LED 0.6"  
0-9DP £2.25 ea  
LIQUID CRYSTAL  
6 digit £18

## LEDS 14P.

MINI PIN SOURCE OR RED DIFFUSE  
LEDS. 209 STYLE. NO CLIP. 14P ea  
TIL209 RED LED & CLIP 17P ea  
BIG 1" RED LED & CLIP 18P ea  
ORANGE & GREEN LEADS:  
MINI 25P ea. BIG & CLIP 33P ea  
INFRA RED LED £1.2N5777 33P.  
PS12 PHOTO IC/amp/switch £1.

## DIGITAL CLOCK

MOS INTEGRATED CIRCUITS.  
AYS1224 4 DIGIT CLOCK supplied  
with 14pin socket & data 14.25  
MMS311/14 6 DIGIT CLOCK with  
28 pin socket & data £7.50  
3DIGIT DVM AY53500 £7.50  
4DIGIT COUNTER/DRIVER £7.50

## CASSETTE mechanics £12-50

STEREO CASSETTE MECHANISM.  
As used in imported types  
costing £100. Only requires  
a case & electronics heads  
supplied. Send for data 15p.

## IC's & Semiconductors

702 OPA 69p  
703 RF/IF 28p  
709 T099 71p  
709 DIL 14 29p  
710 DIL 14 36p  
720 Radio £1.39  
723 Regulator67p  
741 T099 29p  
741 D1L8 31p  
741 D1L14 31p  
741 Dual 741 89p  
748 DIL 8 36p  
1505 IC A/D  
Converter £7  
7805 IASV £1.59  
7808 IA8V £1.69  
7812 IA12V £1.69  
7815 IA15V £1.69  
76009 JW AF 75p  
76013 6W AF£1.39  
8058 Sig Gen £3  
CA3046 69p  
LM301 OPA 49p  
LM307 OPA 49p  
LM308 HiBoPa 95p  
LM309K Reg. £2.29  
LM371 RF/IF £2  
LM372N AF/IF £2  
LM373 £3  
LM377 2x2W £2.69  
LM380 2W AF 99p  
LM381 2xpre. £2  
LM382 amp £2  
LM3900 4XOPA 69p  
MC1303 £1.20  
MC1306 49p  
MC1310 & LED £2.69  
MC1312 5Qamp £2.50  
MC1330 69p  
MC1339 £1  
MC1350 55p  
MC1351 71p  
MC1352 71p  
MC1357 £1  
MC1358 £1  
MC1375 £1.25  
MFC4000 1W AF 35p  
MFC4060 54p  
MFC6030 52p  
MFC6040 90p  
MFC8010 £1.10  
MFC8040 £1  
NE531 35V/us £2  
NE536 FEI OPA£2  
NE540 Driver £1  
NE546 AM Rxl.50  
NE550 2v ref 79p  
NE555 TIMER 67p  
NE556 Dual" £1.30  
NE560 PLL £3.15  
NE561 PLL £3.15  
NE562 PLL £3.19  
NE566 LIL £2.69  
NE566 Gen £2.49  
NE567 code £2.69  
SN7709 709 29p  
SN72741 741 31p  
SN72748 748 36p  
SN76131 £1.20  
SN76660 FMIF £1  
SN76611 1F £1.25  
TAD 100 & 1F £2  
ZNA002 £3  
ZNA02T £1.75  
ZNA03 Servof2.50  
ZNA14 AM Rxl.09  
7400 etc gates 16p  
7413 schmitt 31p  
7447 driver £1.09  
7470/72 32p  
7473/74/76 39p  
7475 48p  
7490 Counter 65p  
7492 Counter 69p  
74121 mono 49p  
74141 driver 83p  
Full range in Cat.

### SPECIAL OFFERS

741 29p MFC4000 35p  
555 67p ZN414 £1.09  
BC107, BC108, BC109 9p ea  
2N3055 39p Three for £1  
115W/T03 or 90W plastic  
2N3819E 16p 2N3053 17p  
BFY50/51/52/53 all 18p  
IASOVrect 4p ea IN914 4p

### Price each:-

AC127/128 16p  
AC187/188 19p  
AD161/162 35p  
BC107/8/9 9p  
BC132/4/7 18p  
BC147/8/9 10p  
BC157/8/9 12p  
BC167/8/9 12p  
BC177/8/9 18p  
BC182/3/4\*11p  
BC212/3/4\*12p  
"A or L  
BCY70/1/2 15p  
BD131/2 39p  
BFY50/1/2 18p  
BFY53 17p  
BSX20 12p  
MJE2955 95p  
MJE3055 62p  
MPU131put 49p  
OA91 8p  
TIP29A 48p  
TIP30A 57p  
TIP31A 61p  
TIP32A 73p  
TIP41A 78p  
TIP42A 89p  
BZY88 400mw  
ZENERS 9p  
BRIDGE RECT  
1A 50V 20p  
GAS SENSOR £2  
GAS " KIT £5  
TIP2955 90p  
TIP3055 55p  
TIS43 UJT\*25p  
IN4001 4p  
IN4004 6p  
IN4148/914 4p  
2N697 13p  
2N706/8 10p  
2N2646 49p  
2N2640/5 20p  
2N2926royp 9p  
2N3053 17p  
2N3055 39p  
2N3614 49p  
2N3702/3 9p  
2N3704/5 10p  
2N3706/7 9p  
2N3708/9 8p  
2N3710/11 9p  
2N3563/64 16p  
2N3566/67 16p  
2N3641/2 16p  
2N3819E 16p  
2N3832E 17p  
2N3904/6 14p  
2N4249 16p  
TAG 1/400 55P  
C107/101 SCR  
4A/400V 55p  
SC146D TRIAC  
10A 400V 75p

## vero

VERO PINSx36 25p.  
COPPER CLAD VEROBOARD 0.1"  
21x5" 27p. 21x31" 24p. 31x31" 27p.  
31x5" 29p. 31x17" £1.50  
DIL IC's BOARDS 6x41" £1.50  
24 way edge connector 60p  
36way 90P. PLAIN 31"x17 £1  
FACE CUTTER 43p. FEC ETCHANT

## DALopen69p

PRINTED CIRCUIT BOARD KIT £1.69  
COPPER BOARD 6x4" 40p.  
DESOLDER BRAID reel 59p  
HEATSINKS  
5E/T05 & 18E/T018 5p ea.  
TV4 12p. TV3/T03 16p. 4Y1/T03 29p  
CAPACITORS  
22pf to 0.1uf 4p ea. ELECTROLYTIC  
25V 2/10/50/100uf 6p. 100uf 20p  
PRESSETS VERT: 5p. RESISTORS 11p

## POTS SWITCH OR EGIN

ROTARY: 12p. ABOR 13p. DIAL 38p.  
SLIDERS: SINGLE 26p. DOUBLE 48p.  
SWITCHES: SPST 18p. DPDT 25p.  
MINI 1" SPST 39p. PUSH 39p.  
BENCH POWER SUPPLY 3-12V £5.  
DIN PLUGS all 13p ea. Sockets 9p  
TRANSFORMERS 1A 6/12V £1.34  
BHA 0002 MODULE 15Watt AMP £5  
EA1000 4W AF MODULE £2.49  
8W/12V FLUORESCENT LIGHT £3.

## OIL sockets

PROFESSIONAL  
GOLD PLATED  
& GREY NYLON.  
8, 14 or 16 PIN  
ONLY 15p each.

## RECHARGEABLE BATTERIES

CAN SAVE YOU A FORTUNE!  
Bush & Meissner introduce two purpose-built battery chargers for the economy minded enthusiast:

The "KESTREL-DOWN" Charger for Alkaline rechargeable batteries, no-load voltage of 1.5-volts per cell, for the following sizes

Equivalent to	Type	Capacity	PRICE
U2 size	SA-13D	2Ah	£1-87
U11 size	SA-14C	1Ah	£1-22
U7 size (pencil)	SA-15AA	0.3Ah	£0-61p

The "DAIMON" Charger\* for Nickel-Cadmium batteries, no-load voltage of 1.25-volts per cell, for the following sizes

Type	Capacity	PRICE
NCC400	4Ah	£3-93
NCC200	2Ah	£2-68
NCC50	0.5Ah	£1-57

Each charger designed to give optimum results with a specific type of cell. You need never be without power, day or night.  
\*Note, under no circumstances must Alkaline batteries be used with the Daimon charger.

S.A.E. brings full details, write to



Importers & Distributors  
Dept. L5260  
275 West End Lane,  
London  
NW6 1QS  
01-794 9611



## Ex Gov Electronic Equipment.

all the equipment listed is untested and not guaranteed,  
Valve Voltmeter model No. 2 £4-50 pp 60p.  
Cintel Square wave generator £8-50 pp £1-50.  
Advance Signal generator £6-50 pp 60p.  
Radio type R361/GR ideal for spares £2-50 pp £1-00  
Vidio Oscillator type T.65A £6-50 pp £1-50.  
Furzhill Valve Voltmeter V200A £5-50 pp £1-00.  
Marconi Signal Generator Type TF 144G. £5-50 pp £1-00.  
24 volt DC motors 3 for £2-00 pp 60p  
G45 aircraft 16mm Gun Camera 24 volt £5-50 pp 60p  
New ex gov black telephones ideal as ext/intercom £1-00 pp 40p.  
Ex gov good condition working Pocket Watches 15 jewel £5-50 pp 20p.  
Intervalometer. Electric/clockwork makes good seconds timer £4-00 pp 40p.  
Cossor Oscillograph Cameras with motor and lens 35mm £6-50 pp 60p.  
Gents 12 volt buzzer 75p for two pp 20p.  
Transformers.  
12 volt 100 watt £3-50 pp 20p.  
24 volt 150 watt £4-50 pp 30p  
24 volt 250 watt £5-50 pp 40p.  
110 volt 1000 watt Auto £9-50 pp £1-00.  
35mm strip projector £4-50 pp 60p.  
12 inch loudspeaker type SRB £7-50, pp £1-00.  
Periscope Aircraft type £7-50 pp 60p.  
Aircraft lamps 24 volt 200 watt 4 for £1-00 pp 40p.  
Pump 24 volt DC £2-00 pp 60p.  
Projector incomplete £9-50 pp £3-50 (16mm sound & silent).  
Video Display indicators £4-50 pp £1-50.  
Cossor Oscilloscope £12-00 pp £2-00.  
Heavy duty 24 volt DC motors £2-50 pp 60p  
A. W. YOUNG, 251, High Road, Tottenham, London N15. 01 800 8627 or 01 800 8329 Ask for Mike.

## 4-STATION INTERCOM



£15-05  
Solve your communication problems with this 4-Station Transistor Intercom system (1 master and 3 Subs), in robust plastic cabinets for desk or wall mounting. Call/talk/listen from Master to Subs and Subs to Master. Ideally suitable for Business, Surgery, Schools, Hospital, Office and Home. Operates on one 9V battery. On/off switch. Volume control. Complete with 3 connecting wires each 66ft. and other accessories. P. & P. 50p

## MAINS INTERCOM NEW MODEL

No batteries-no wires. Just plug in the mains for instant two-way, loud and clear communication. On/off switch and volume control. Price £23.75 per pair P. & P. 60p

## INTERCOM/BABY ALARM



OUR PRICE ONLY £6.50  
Same as 4-Station Intercom for two-way instant communication. Ideal as Baby Alarm and Door Phone. Complete with 66ft. connecting wire and Battery. P. & P. 40p

## Transistor TELEPHONE AMPLIFIER

£6-45  
Why not boost business efficiency with this incredible Telephone Amplifier. Take down long telephone messages or converse without holding the handset. A useful office aid. On/off switch. Volume Control. Complete with Battery. P. & P. 30p. Full price refunded if not satisfied in 7 days.  
WEST LONDON DIRECT SUPPLIES (PW.9)  
189 KENSINGTON HIGH STREET, LONDON, W.8.

## SUPERSOUND 13 HI-FI MONO AMPLIFIER

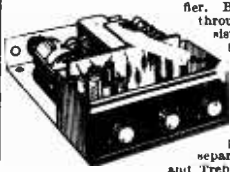

A superb solid state audio amplifier. Brand new components throughout. 5 silicon transistors plus 2 power output transistors in push-pull. Full wave rectification. Output approx. 13 watts r.m.s. into 8 ohm. Frequency response 12Hz-30KHz  $\pm$  3dB. Fully integrated pre-amplifier stage with separate Volume, Bass boost and Treble cut controls. Suitable for 8-15 ohm speakers. Input for ceramic or crystal cartridge. Sensitivity approx. 40mV for full output. Supplied ready built and tested, with knobs, escutcheon panel, input and output plugs. Overall size 3" high x 8" wide x 7 1/2" deep. AC 200/240V. PRICE £18.00. P. & F. 50p.

## DE LUXE STEREO AMPLIFIER

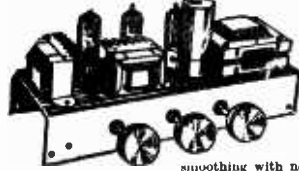

A.C. mains 200-240 v. Fully insulated heavy duty bolted mains transformer with full wave rectification giving adequate smoothing with negligible hum. Valve line up: 2 x ECL86 Triode Pentodes, 1 x EZ80 as rectifier. Two dual potentiometers are provided for bass and treble control, giving bass and treble boost and cut. A dual volume control is used. Balance of the left and right hand channels can be adjusted by means of a separate 'Balance' control fitted at the rear of the chassis. Input sensitivity is approximately 300mV for full peak output of 4 watts per channel (8 watts mono), into 3 ohm speakers. Full negative feedback in a carefully calculated circuit, allows high volume levels to be used with negligible distortion. Supplied complete with knobs, chassis size 11" x 4 1/2". Overall height including valves 5". Ready built & tested to a high standard. £10.75. P.&F. 50p.

**POWER SUPPLY UNIT 200/240v. A.C. Input.** Four switched fully smoothed D.C. outputs giving 6v, and 7.5v, and 9v, and 12v. at 1 amp on load. Fitted insulated output terminals and pilot lamp indicator. Hammer finish metal case overall size 6" x 3 1/2" x 2 1/2". Suitable for Transistor Radios, Tape Recorders, Amplifiers etc. etc. Ready assembled. PRICE £5.20 P. & F. 35p.

**VYNAIR & BEKINE SPEAKERS & CABINET FABRICS** app. 34 in. wide. Our price £1.80 yd. length. P. & F. 15p per yd. (min. 1 yd.). S.A.E. for samples.

### HARVERSON'S SUPER MONO AMPLIFIER

A super quality gram amplifier using a double wound fully insulated mains transformer, rectifier and ECL82 triode pentode valve as audio amplifier and power output stage. Impedance 3 ohms. Output approx. 3.5 watts. Volume and tone controls. Chassis size only 11" wide x 3 1/2" deep x 6 1/2" high overall. A.C. mains 200/240v. Supplied absolutely Brand New completely wired and tested with good quality output transformer. £4.20 P. & F. 40p BARGAIN PRICE

**FEW ONLY!** High grade mains transformer with grain orientated lamination. Primary 200/240 Secondary 18.5 volts at 0.6 amps and 4.6 volts at 0.3 amps. Size 2" h x 2 1/2" w x 2" d overall. £1.95 plus 25p P. & F.

**BRAND NEW MULTI-RATIO MAINS TRANSFORMERS** Giving 13 alternative Primary: 210-240V. Secondary combinations 0.5-10-15-20-25-30-35-40-50-60. half wave at 1 amp, or 10-0-10, 20-0-20, 30-0-30v. at 2 amps full wave. Size 3in. long x 3 1/2in. wide x 3in. deep. Price £2.60 P. & F. 40p.

**MAINS TRANSFORMERS.** For transistor power supplies. Pri. 200/240v. Sec. 9-0-9 at 60p. £1.25 P. & F. 25p. Pri. 200/240v. Sec. 12-0-12 at 1 amp. £1.40. P. & F. 25p. Pri. 200/240v. Sec. 10-0-10 at 2 amp. £2.00. P. & F. 35p.

**3 VOLT RELAY** 100 mA single pole normally closed. 2 for 60p + 15p P. & F.

### GENERAL PURPOSE HIGH STABILITY TRANSISTOR PRE-AMPLIFIER

For P.U. Tape, Mike, Guitar, etc. and suitable for use with valve or transistor equipment. 9-18v. battery or from H.T. line 200/300v. Frequency response 15Hz-20KHz. Gain 26dB. Solid encapsulation size 1 1/2" x 1 1/2" x 1". Brand new complete with instructions. Price 1.20p. P. & F. 15p.

### HANDBOOK OF TRANSISTOR EQUIVALENTS AND SUBSTITUTES

A must for servicemen and home constructors. Including many 1000's of British, U.S.A. European and Japanese transistors. ONLY 40p. Post 5p.

Reference Encyclopedias for Electronic Engineers and Designers, covering between them transistor characteristics, diode and transistor equivalents. Many thousands of up to date European types listed.

Diode Equivalents, 90p; Transistor Equivalents, £1.00; Transistor Characteristics, £1.30; POST FREE All three together, £2.90

### NEW ISSUE

Thyristor, Triac, Diac etc. encyclopedias 95p, Post Free 8 pole 3 way 2 bank low loss Yaxley type switches 1 1/2" sections. Standard spindle. 2 switches 64p + 10p P. & F.

Open 9.30-5.30 Monday to Friday, 9.30-5 Saturday Closed Wednesday. All prices and specifications correct at time of press and subject to alteration without notice.

## HARVERSONIC MAINS OPERATED SOLID STATE STEREO FM TUNER



Enjoy fabulous stereo radio at this fabulous low introductory price!

Designed and styled to match our 10 + 10 amplifier but will suit any other standard stereo amplifier. The design incorporates the very latest circuitry techniques with high-gain, low noise IF stages. Automatic frequency control to "lock-on" station and prevent drift. IC stereo decoder for maximum stereo separation. I.E.D. for stereo beacon indicator. Nominal output of tuner 100mV. Approximate size 12" wide x 8" deep by 2 1/2" high. Supplied ready built, fully tested and fully guaranteed (not available in kit form). Price £28.00 Post and Packing 50p.

**STEREO-DECODER** SIZE 2" x 3" x 1/2" ready built. Pre-aligned and tested. Sens. 20-500 mV for 9-16V neg. earth operation. Can be fitted to almost any FM VHF radio or tuner. Stereo beacon light can be fitted if required. Full details and instructions (inclusive of hints and tips) supplied. £5.00 plus 10p. P. & F. Stereo beacon light if required 40p extra.



**SPECIAL BARGAIN OFFER!** Limited number of BSE C123 Auto Changer De Luxe with lightweight tubular arm and stereo cartridge. Brand new, ONLY £8.00 + P. & F. 60p.

**LATEST Hi Sensitivity Uni-directional slim-line condenser microphone** as used by many professionals. Very low acoustic feedback, available in impedance or low impedance. State which required. £13.50 plus 25p P. & F.

**LATEST ACOS GP91/180** mono compatible cartridge with 1/4" stylus for LP/EP/78. Universal mounting bracket. £1.45. P. & F. 15p.

**CERAMIC STEREO CARTRIDGE.** Universal Mounting brackets and turnover stylus. 70mV per channel output. ONLY £1.75 + 15p P. & F.

**SONOTONE STEREO COMPATIBLE STEREO CARTRIDGE** T/O stylus Diamond Stereo LP and Sapphire 78. ONLY £3.27 P. & F. 10p. Also available fitted with twin Diamond T/O stylus for Stereo LP £3.75 P. & F. 15p.

**LATEST T/O STEREO/COMPATIBLE CARTRIDGE** for EP/LP/STEREO/78. £1.60 P. & F. 15p. **LATEST T/O MONO COMPATIBLE CARTRIDGE** for playing EP/LP/78 mono or stereo records on mono equipment. Only £1.47. P. & F. 15p.

**QUALITY RECORD PLAYER AMPLIFIER MK. II** A top quality record player amplifier employing heavy duty double wound mains transformer, EOC83, EL84, and rectifier. Separate Bass, Treble and Volume controls. Complete with output transformer matched for 3 ohm speaker. Size 7 1/2" wide x 3 1/2" deep x 6 1/2" high. Ready built and tested. PRICE £25.50. P. & F. 50p. **ALSO AVAILABLE** mounted on board with output transformer and speaker. PRICE £27.00. P. & F. 60p.

### HI-FI LOUSPEAKER SYSTEM MK II

Beautifully made, simulated teak finish enclosure with attractive slatted front. Size 16 1/2" high x 10 1/2" wide x 9" deep (approx.). Fitted with E.M.I. Ceramic Magnet 13" x 8" bass unit, H.F. tweeter unit and crossover. **AVAILABLE IN NOMINAL** 4 Ohm, 8 Ohm or 16 Ohm Impedance (state which). **OUR PRICE £9.50** each Carr. 90p Cabinet Available Separately £5.00, Carr. 90p Also available in 8 ohms with EMI 13" x 8" bass speaker with parasitic tweeter £9.00, Carr. 90p.

### LOUSPEAKER BARGAINS

5in. 3 ohm £1.25. P. & F. 15p. 7 x 4in. 3 ohm £1.40. P. & F. 20p. 10 x 6in. 3 or 15 ohm £2.10. P. & F. 30p. E.M.I. 8 x 5in. 3 ohm with high flux magnet £1.70. P. & F. 20p. E.M.I. 13 1/2 x 8in. with high flux ceramic magnet with parasitic tweeter 3, 8 or 15 ohm £3.50. P. & F. 30p. E.M.I. 13 x 8in. 3, 8 or 15 ohm with inbuilt tweeter and crossover network £4.05. P. & F. 30p. E.M.I. tweeter. Approx. 3 1/2". Available 3 or 8 or 15 ohms. £1.25 + 20p. P. & F.

**BRAND NEW, Bakerns Loudspeakers** at substantial discounts. 12in. 15w. H/D Speakers, 3, 8 or 15 ohms. State which. Current production by well-known British maker. Now with Hiflux ceramic ferrobar magnet assembly £7.50. Guitar models: 27" £6.80, 35w. £7.50. P. & F. 45p.

### "POLY PLANAIR" WATER-TYPE, WIDE RANGE ELECTRO-DYNAMIC SPEAKER

Size 11 1/2" x 14 1/2" x 1 1/2" deep. Weight 19oz. Power handling 20W r.m.s. (40W peak). Impedance 8 ohm only. Response 40Hz-20KHz. Can be mounted on ceiling, wall, doors, under tables, etc., and used with or without baffle. Send S.A.E. for full details. Only £6.60 each. P. & F. 34p.

**NOW ALSO AVAILABLE:** 8", 10 watts, r.m.s. 20 watt peak 40Hz-20,000Hz. Overall depth 1 1/2". Ideal for Hi-Fi or for use in cars. £4.22 + 25p P. & F.

## HARVERSONIC SUPER SOUND 10 + 10 STEREO AMPLIFIER KIT

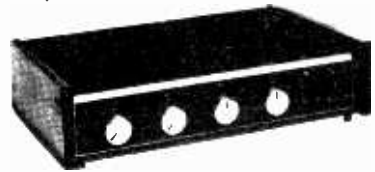

A really first-class Hi-Fi Stereo Amplifier Kit. Uses 14 transistors including Silicon Transistors in the first five stages on each channel resulting in even lower noise level with improved sensitivity. Integrated pre-amp with Bass, Treble and two Volume Controls. Suitable for use with Ceramic or Crystal cartridges. Very simple to modify to suit magnetic cartridge—instructions included. Output stage for 8 to 15 ohms. Compact design, all parts supplied including drilled metalwork high quality ready drilled printed circuit board with component identification clearly marked, smart brushed anodised aluminium front panel with matching knobs, wire, solder, nuts, bolts—no extras to buy. Simple step by step instructions enable any constructor to build an amplifier to be proud of. Brief specification; Power output: 14 watts r.m.s. per channel into 8 ohms. Frequency response  $\pm$  3dB 12-30,000 Hz. Sensitivity: better than 80mV into 1M $\Omega$ . Full power bandwidth:  $\pm$  3dB 12-15,000 Hz. Bass boost approx. to  $\pm$  12dB. Treble cut approx. to -16dB. Negative feedback 18dB over main amp. Power requirements 35v. at 1.0 amp. Overall size 12" w. x 8" d. x 2 1/2" h.

Fully detailed 7 page construction manual and parts list free with kit or send 15p plus large S.A.E.

**AMPLIFIER KIT** £18.96 P. & P. 30p (Magnetic input components 33p extra)

**POWER PACK KIT** £4.22 P. & P. 40p **CABINET** £4.22 P. & P. 40p (Post Free if all units purchased at same time)

Full after sales service Also available ready built and tested £28.08. Post Free.

*Note: The above amplifier is suitable for feeding two mono sources into inputs (e.g. mike, radio, twin record decks, etc.) and will then provide mixing and fading facilities for medium powered Hi-Fi Discotheque use, etc.*



### 3-VALVE AUDIO AMPLIFIER HA34 MK II

Designed for Hi-Fi reproduction of records, A.C. Mains operation. Ready built on anodised heavy gauge metal chassis, size 7 1/2" w. x 4 1/2" x 4 1/2" h. Incorporates EOC83, EL84, EZ80 valves. Heavy duty, double wound mains transformer and output transformer matched for 3 ohm speaker. Separate volume control and now with improved wide range tone controls giving bass and treble lift and cut. Negative feedback line. Output 4 1/2 watts. Front panel can be detached and leads extended for remote mounting of controls. Complete with knobs, valves, etc., wired and tested for only £6.50. P. & F. 45p.

speaker. Separate volume control and now with improved wide range tone controls giving bass and treble lift and cut. Negative feedback line. Output 4 1/2 watts. Front panel can be detached and leads extended for remote mounting of controls. Complete with knobs, valves, etc., wired and tested for only £6.50. P. & F. 45p.

**HSL "FOUR" AMPLIFIER KIT.** Similar in appearance to HA34 above but employs entirely different and advanced circuitry. Complete set of parts, etc. £5.50 P. & F. 45p.

### 10/14 WATT HI-FI AMPLIFIER KIT

A stylishly finished monaural amplifier with an output of 14 watts from 2 EL84s in push-pull. Super reproduction of both music and speech, with negligible hum. Separate inputs for mike and gram allow records and announcements to follow each other. Fully shrouded section wound output transformer to match 3-16  $\Omega$  speaker and 2 independent volume controls, and separate bass and treble controls are provided giving good lift and cut. Valve line-up 2 EL84s, EOC83, EF86 and EZ80 rectifier. Simple instruction booklet included with parts! All parts sold separately. ONLY £10.25 P. & F. 60p. Also available ready built and tested £14.00 P. & F. 70p.

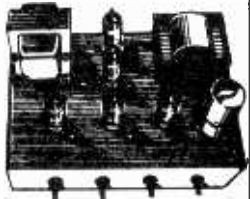

### HI-FI STEREO HEADPHONES

Adjustable headband with comfortable softfoam ear-cuffs. Wired and fitted with standard stereo 3 1/2 jack plugs. Frequency response 30-15,000Hz. Matching impedance 8-16 ohms. Easily converted for Mono. PRICE £3.50. P. & F. 25p.

### PRICES INCLUDE VAT

(Please write clearly) PLEASE NOTE: P. & F. CHARGES QUOTED APPLY TO U.K. ONLY. P. & F. ON OVERSEAS ORDERS CHARGED EXTRA.

## HARVERSON SURPLUS CO. LTD.

(Dept. P.W.) 170 HIGH ST., MERTON, LONDON, S.W.19 Tel.: 01-540 3985

A few minutes from South Wimbledon Tube Station. SEND STAMPED ADDRESSED ENVELOPE WITH ALL ENQUIRIES

# PE SCORPIO Mk 2 ignition system kit new from ELECTRO SPARES

- \* 6 OR 12 VOLT
- \* + VE AND - VE GROUND

Here's the new, improved version of the original PE Scorpio Electronic Ignition System—with a big plus over all the other kits—the PE Scorpio Kit is designed for both positive and negative ground automotive electrical systems. Not just +ve ground. Nor just -ve ground. But both! So if you change cars, you can be almost certain that you can change over your PE Scorpio Mk. 2 as well. Containing all the components you need, this Electro Spares PE Scorpio Mk. 2 Kit is simply built, using our easy-to-follow instructions. Each component is a branded unit by a reputable manufacturer and carries the manufacturer's guarantee. Ready drilled for fast assembly. Quickly fitted to any car.

When your PE Scorpio Mk. 2 is installed, you instantly benefit from all these PE Scorpio Mk. 2 advantages.

- ★ Easier starting from cold
- ★ Firing even with wet or oiled-up plugs
- ★ Smoother running at high speed
- ★ Fuel saving
- ★ More power from your engine
- ★ Longer spark plug life
- ★ No more contact-breaker burn

### Electro Spares prices:

De luxe Kit only £11.50 inc. VAT and p & p.  
Ready Made Unit £14.75 inc. VAT and p & p.  
State 6V or 12V system.

Send SAE now for details and free list.

### FM VARICAP STEREO TUNER

As featured in the May 1973 issue of 'Practical Electronics'. Superb Hi-Fi tuner Kit now available from Electro Spares. Including cabinet and all components - pre-set Mullard modules for R.F. and I.F. circuits. Motorola I.C. Phase Lock Loop Decoder for perfect stereo reception. No alignment needed. Guaranteed first time results - or send it back, and we'll return it in perfect order (for a nominal handling charge). Electro Spares price only £28.50 inc. VAT and p & p.

### 'GEMINI' STEREO AMPLIFIER

A superb unit with a guaranteed output of 30 watts RMS per channel into 8 ohms. Full power THD is a mere 0.02%, and frequency response is -3 dB from 20 Hz to 100 kHz into 8 or 15 ohms. Electro Spares have already sold 100s and 100s of these Kits. Get yours now! Depending on your choice of certain components, the price can vary from £50 to £60 inc. VAT and p & p.

- ★ All components as specified by original authors, and sold separately if you wish.
- ★ Full constructional data book with specification graphs, fault finding guides, etc. 55p plus 4p postage.
- ★ Price List only. Please send S.A.E. (preferably 9 x 4 minimum) for full details.

# ELECTRO SPARES



The Component Centre of the North  
288 ECCLESALL RD., SHEFFIELD S11 8PE (C)  
Tel: Sheffield (0742) 668888

# TECHNICAL TRAINING

*in radio television  
and electronics*

Whether you are a newcomer to radio and electronics, or are already engaged in the industry, ICS can help you. We can further your technical knowledge and provide the specialised training so essential to success, or prepare you for a recognised examination. ICS have helped thousands of ambitious men to move up into higher paid jobs - we can do the same for you. *Take one of these courses:-*

### CITY & GUILD CERTIFICATES:-

- Telecommunications Technicians
- Radio, TV and Electronics Technicians
- Electrical Installations Technicians
- Electrical Installation Work
- Technical Communication
- Radio Amateur

### MPT General Radio Communications Cert.

### DIPLOMA COURSES:-

- Electronic Engineering, Maintenance
- Radio, TV, Audio Engineering and Servicing (inc. Colour TV)
- Electrical Engineering, Installations
- Computer Engineering & Programming
- New Self-Build Radio Courses

## QUALIFY FOR A NEW CAREER

Home study courses for leading professional examinations and diploma courses for business and technical subjects:-

### G.C.E.

60 subjects at 'O' and 'A' levels

Accountancy	Engineering	Motor
Administration	Farming	Personnel
Advertising	Heating	Purchasing
Air Conditioning	Industrial	Sales
Building	Management	Secretarial
Construction	Marketing	Storekeeping
Catering	Mechanical	Work Study

### POST THIS COUPON TODAY

To: INTERNATIONAL CORRESPONDENCE SCHOOLS



Dept. 232D, Intertext House,  
LONDON SW8 4UJ  
or telephone 01-622 9911 (all hours)

Please send me full details of your courses for:-

(State Subject) .....

Name .....

Address .....

Occupation ..... Age .....

Accredited by the Council for the Accreditation of Correspondence Colleges



# NEW MULLARD & MAZDA VALVES

All individually boxed and guaranteed. Full trade discounts to bona fide companies. Price and availability lists on application.

## EXPRESS POSTAGE

5p for 1 Valve.  
Each additional Valve add 2p.

DM70 0-81	ECL83 0-86	GY501 1-18	PL82 0-48	30C1/PCF80 1-04
DY31 0-80	ECL86 0-84	GZ34 0-80	PL83 1-04	30C15/ 0-54
DY86/7 0-41	EF90 0-42	PC88 0-95	PL500 0-90	PCF800 1-01
DY802 0-46	EF83 0-98	PC89 0-42	PL504 0-90	PC317 1-01
EABCC80 1-03	EF85 0-42	PC800 0-57	PL508 1-24	30C18/ 1-00
EB91 0-64	EF86 1-16	PC855 0-60	PL509 1-56	PCF805 1-00
EBF81 0-79	EF89 1-14	PC880 0-64	PL802 1-40	30F5/FF818 1-03
EBF83 0-58	EF91 1-10	PC889 0-80	PY33 0-65	30FL1/ 1-03
EBF89 0-53	EF92 1-37	PC8189 0-80	PY82 0-57	PC8E800 0-80
EC86 0-73	EF183 0-83	PCF802 1-22	PY800A 1-02	30FL12 1-13
EC88 0-76	EF184 0-83	PCF85 0-84	PY800 0-49	30FL14 0-84
EC90 0-86	EF190 0-85	PCF200 1-00	PY801 0-49	30L1/PC84 0-84
EC97 0-60	EL34 0-92	PCF201 0-00	U26 0-88	
ECC81 0-47	EL35 1-01	PCF801 0-64	U91 0-88	
ECC82 0-44	EL84 0-47	PCF802 0-70	U193 0-54	
ECC83 0-47	EL85 0-86	PCF806 0-64	UABC80 0-90	PC8E805 1-03
ECC84 0-58	EL86 0-82	PCF82 0-58	UBC81 0-71	30L17 0-89
ECC85 0-71	EL89 0-90	PCF83 0-64	UF89 0-58	30F4MR 1-27
ECC88 0-84	EL95 0-72	PCFL84 0-61	UC88 0-49	30P12/ 1-00
ECC189 0-68	ELL80 2-50	PCL85 0-64	UJCH81 1-12	PC801 1-01
ECF80 0-60	EM81 1-10	PCL86 0-64	UJCH82 0-72	PC802 0-89
ECF82 0-68	EM84 1-19	PCL805/85 0-84	UF89 0-80	30PL1/ 1-00
ECF86 0-68	EM87 1-16		UL84 0-92	PCL801 1-00
ECF81 1-16	EY51 0-75	PD500 1-28	UA88 0-54	30P15/ 1-15
ECH83 0-94	EY86/7 0-40	PFL200 0-83	6/30L2/ 0-84	PCL500 1-15
ECH84 1-00	EY88 0-72	PL36 0-90	ECC804 0-98	30PL14/ 1-85
ECL80 0-67	EZ60 0-54	EL81 0-77	EF23/EF812 1-03	30PL15 1-13
ECL82 0-64	EZ81 0-38	PL81A 0-90		

# NEW VALVES

Individually boxed and guaranteed but of European or other origin at greatly reduced prices. Quotations for any valve not listed. Send SAE for lists.

AZ1 0-75	EF39 1-25	N78 3-50	PY500 1-10	6F28 0-75
AZ31 0-60	EF80 0-85	OA2 0-45	PY81/800 0-50	6J5M 0-65
CBL31 1-40	EF85 0-45	OB2 0-45	SP41 3-00	6J6 0-80
CL33 1-50	EF86 0-50	OC86 0-65	SP41 3-00	6J7G 0-80
CY31 0-60	EF89 0-35	PC88 0-85	T41 1-00	6J7M 0-85
DAF91 0-40	EF91 0-40	PC97 0-55	U14 0-75	6K6GT 0-80
DAF96 0-60	EF92 0-50	PC900 0-55	U25 1-00	6K7G 0-85
DC90 1-35	EF95 0-45	PC884 0-45	U26 0-85	6K7M 0-45
DF91 0-40	EF98 0-80	PC888 0-82	U191 0-75	6K8G 0-45
DF96 0-60	EF183 0-40	PC889 0-55	UA88 0-54	6K8M 0-70
DK91 0-50	EF184 0-40	PC8189 0-85	UF42 0-75	6K25 1-00
DK92 1-00	EL32 0-80	PCF80 0-40	UBC41 0-60	6L6G 0-55
DK96 0-75	EL33 2-00	PCF82 0-42	UBC81 0-50	6Q7G 0-40
DL92 0-50	EL34 0-70	PCF86 0-65	UBF80 0-50	6Q7M 0-60
DL94 0-48	EL36 0-60	PCF801 0-60	UBF89 0-50	6SL7GT 0-85
DL96 0-55	EL37 0-50	PCF802 0-65	UC85 0-60	6S7GT 0-85
DY86 0-42	EL41 0-90	PCF805 0-90	UCH42 0-60	68Q7GT 0-40
DY87 0-45	EL42 1-65	PCF806 0-90	UCH81 0-50	6V6GT 0-80
DY802 0-47	EL84 0-35	PCF808 0-90	UCL82 0-40	6V6G 0-80
EABCC80 0-38	EL95 0-60	PCL82 0-45	UCL83 0-79	6V6GT 0-80
EAF42 0-70	ELL80 2-00	PCL83 0-70	UF41 0-75	6X4 0-45
EB91 0-25	EM80 0-55	PCL84 0-60	UF89 0-50	6X6G 0-65
EB93 1-00	EM81 0-60	PCL85 0-60	UL41 0-85	6X6GT 0-55
EB94 0-75	EM84 0-40	PCL86 0-60	UL84 0-85	7B6 0-80
EB98 0-40	EM85 1-00	PCL805/85 0-60	UY41 0-50	7B7 0-80
EBF83 0-40	EY86 0-45	PD500 0-60	UY85 0-45	7C8 1-30
EBF89 0-32	EZ40 0-60	PEM45 0-85	VR105/30 0-40	7C8 1-30
EBL31 2-00	EZ41 0-75	PL36 0-85	VR150/36 0-45	7I7 0-80
ECC81 0-45	EZ80 0-30	PL81 0-45	OA2 0-45	7R7 0-80
ECC82 0-38	EZ81 0-31	PL82 0-50	OB2 0-45	787 2-25
ECC83 0-38	GY501 0-90	PL83 0-50	OR2 0-45	7Y4 0-40
ECC84 0-35	GZ30 0-85	PL84 0-80	1R5 0-50	12A76 0-45
ECC85 0-45	EZ82 0-65	PL85 0-85	1R4 0-40	12A77 0-45
ECC88 0-80	GZ34 0-75	PL504 0-85	3B4 0-50	12A78 0-50
ECH35 1-50	GZ37 1-25	PL508 0-90	3V4 0-95	12A79 0-88
ECH42 0-85	JIN309 1-50	PL509 1-55	5R4GY 1-00	12AX7 0-88
ECB81 0-35	KT61 2-00	PL802 1-00	5U4G 0-55	12BA6 0-60
ECB83 0-60	KT66 2-50	PX4 3-50	5Y3GT 0-85	12B6E 0-80
ECL80 0-60	KT81 (7C3) 1-30	PC85 3-50	5Y4G 0-60	30C1 0-40
ECL82 0-42	KT82 1-30	PY33 0-83	6Z4G 0-65	30C1E 1-00
ECL83 0-75	KT81 1-75	PY81 0-45	6/30L2 0-90	30C17 1-00
ECL86 0-55	KT88 2-90	PY82 0-45	6AK5 0-45	30C18 0-90
ECLL800 3-50	KTW61 1-50	PY83 0-50	6AM5 1-00	30F5 1-00
EF37A 1-20	MU14 1-00	PY88 0-50	6AQ5 0-60	30FL1 1-00

# TRANSISTORS-INTEGRATED CIRCUITS

## EXPRESS POSTAGE

5p for 1st Transistor, for each additional add 1p.

AA119 0-07	BD124 0-80	OA200 0-08	ZTX500 0-16	2N2904 0-20
AA127 0-10	BD131 0-45	OA202 0-10	ZTX501 0-15	2N2904A 0-25
AAZ15 0-10	BD132 0-50	OC16 1-00	ZTX503 0-18	2N2905 0-32
AC107 0-85	BF115 0-22	OC20 2-00	ZTX531 0-25	2N2906A 0-25
AC126 0-25	BF167 0-25	OC23 1-25	ZTX550 0-18	2N2906 0-20
AC127 0-25	BF173 0-28	OC28 0-70	IN4001 0-07	2N3053 0-20
AC128 0-20	BF179 0-33	OC35 0-55	IN4002 0-07	2N3055 0-60
AC176 0-25	BF180 0-35	OC36 0-65	IN4003 0-08	2N3055 0-60
AC178 0-25	BF181 0-35	OC42 0-40	IN4004 0-08	2N3624 0-80
AC188 0-20	BF194 0-35	OC44 0-18	IN4005 0-12	2N3616 0-65
ACY21 0-22	BF195 0-13	OC45 0-18	IN4006 0-10	2N3702 0-11
ACY39 0-65	BF197 0-16	OC72 0-25	IN4007 0-12	2N3703 0-12
AD140 0-60	BF200 0-32	OC76 0-20	IN4008 0-06	2N3704 0-14
AD149 0-60	BF561 0-25	OC77 0-25	IN4009 0-06	2N3705 0-15
AD161 0-60	BF808 0-25	OC81 0-25	18R21 0-07	2N3706 0-11
AD162 0-60	BFW10 0-61	OC81 0-25	18R23 0-07	2N3707 0-11
AF115 0-25	BFX29 0-28	OC81D 0-28	18R23 0-07	2N3708 0-07
AF116 0-25	BFX88 0-22	OC81Z 0-45	18R23 0-07	2N3709 0-10
AF117 0-20	BFY60 0-20	OC83 0-25	18R30 0-25	2N3710 0-11
AF186 0-40	BFY61 0-20	OC83 0-25	18R30 0-25	2N3711 0-11
AFY29 0-44	BFY92 0-20	OC83 0-25	18R30 0-25	2N3712 0-11
ABY27 0-80	BY126 0-14	OC140 1-00	2N695 0-15	2N3711 0-11
ABY28 0-80	BY127 0-15	OC170 0-25	2N696 0-15	2N3712 0-11
BA109 0-12	BZ X61 series 0-20	OC171 0-20	2N706 0-10	2N3820 0-60
BC107 0-12	BZY88 series 0-20	OC200 0-55	2N706A 0-12	2N3823 0-50
BC108 0-12	CR81-05 0-40	OC201 1-00	2N1131 0-25	2N3903 0-15
BC109 0-12	CR81-40 0-45	OC202 0-90	2N1132 0-25	2N3904 0-20
BC113 0-16	CR83-05 0-40	OC203 0-55	2N1302 0-18	2N3905 0-25
BC117 0-21	CR83-06 0-40	OC203 0-55	2N1302 0-18	2N3905 0-25
BC143 0-80	CR85-40 0-75	OC203 0-55	2N1302 0-18	2N3905 0-25
BC147 0-12	MJE320 0-80	OC203 0-55	2N1302 0-18	2N3905 0-25
BC148 0-10	MJE370 0-85	OC203 0-55	2N1302 0-18	2N3905 0-25
BC162C 0-14	MJE520 0-65	OC203 0-55	2N1302 0-18	2N3905 0-25
BC182 0-12	MJE2965 1-10	OC203 0-55	2N1302 0-18	2N3905 0-25
BC182L 0-12	MJE3055 0-75	OC203 0-55	2N1302 0-18	2N3905 0-25
BC184L 0-18	MPF102 0-40	OC203 0-55	2N1302 0-18	2N3905 0-25
BC187 0-12	MPF103 0-35	OC203 0-55	2N1302 0-18	2N3905 0-25
BCY32 1-20	MPF110 0-35	OC203 0-55	2N1302 0-18	2N3905 0-25
BCY83 0-88	MPF105 0-45	OC203 0-55	2N1302 0-18	2N3905 0-25
BCY84 0-45	NKT404 0-60	OC203 0-55	2N1302 0-18	2N3905 0-25
BCY70 0-18	OA5 0-60	OC203 0-55	2N1302 0-18	2N3905 0-25
BCY71 0-18	OA10 0-40	OC203 0-55	2N1302 0-18	2N3905 0-25
BCY72 0-18	OA11 0-10	OC203 0-55	2N1302 0-18	2N3905 0-25
BCY73 0-18	OA81 0-18	OC203 0-55	2N1302 0-18	2N3905 0-25
BD121 1-00	OA91 0-07	OC203 0-55	2N1302 0-18	2N3905 0-25

BN7400 0-80	BN7425 0-87	BN7478 0-44	BN74107 0-51	BN74107 1-09
BN7401 0-80	BN7427 0-87	BN7479 0-48	BN74110 0-51	BN74170 2-88
BN7402 0-80	BN7428 0-48	BN7475 0-58	BN74111 0-86	BN74174 1-80
BN7403 0-80	BN7430 0-80	BN7476 0-48	BN74112 0-86	BN74175 1-44
BN7404 0-80	BN7432 0-87	BN7480 0-80	BN74113 0-86	BN74176 1-44
BN7405 0-80	BN7438 0-48	BN7482 0-87	BN74114 0-86	BN74177 2-80
BN7406 0-40	BN7437 0-48	BN7483 1-20	BN74115 0-86	BN74178 2-80
BN7407 0-40	BN7438 0-48	BN7484 1-00	BN74116 0-86	BN74179 2-80
BN7408 0-28	BN7440 0-48	BN7485 0-80	BN74117 0-86	BN74180 2-80
BN7409 0-28	BN7441A 0-48	BN7486 0-75	BN74118 0-86	BN74181 2-80
BN7410 0-80	BN7442 0-85	BN7491A 0-85	BN74119 0-86	BN74182 2-80
BN7411 0-28	BN7442 0-85	BN7491A 0-85	BN74120 0-86	BN74183 1-44
BN7412 0-28	BN7443 0-85	BN7492 1-10	BN74121 0-86	BN74184 1-88
BN7413 0-80	BN7445 0-80	BN7493 0-78	BN74122 0-86	BN74185 1-88
BN7414 0-80	BN7446 0-80	BN7494 0-78	BN74123 0-86	BN74186 1-88
BN7415 0-80	BN7447 0-80	BN7495 0-85	BN74124 0-86	BN74187 1-88
BN7416 0-80	BN7448 0-80	BN7496 1-00	BN74125 0-86	BN74188 1-88
BN7417 0-80	BN7449 0-80	BN7497 4-32	BN74126 0-86	BN74189 1-88
BN7420 0-80	BN7450 0-80	BN7498 4-32	BN74127 0-86	BN74190 1-88
BN7422 0-28	BN7472 0-38	BN7499 2-16	BN74128 0-86	BN74191 1-88

# THIS MONTH'S

## OSCILLOSCOPE TUBES

Types CV 1526,  
DG 7-5, VCR 139A

All at £8.00 each, + p & p 25p.

# SPECIAL OFFER

TERMS OF BUSINESS: C.W.O. A/c's available to approved companies on application. Telephone and telex orders accepted. Export and trade enquiries welcomed. Lists, etc. on application. Open daily to callers 9 a.m.-5 p.m. Mon.-Sat. Closed Sat. 1-3 p.m. Prices correct when going to press.

# VALVE MAIL ORDER CO.

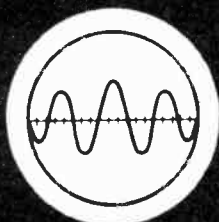

# TUAC

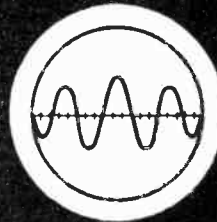

TRANSISTOR UNIVERSAL AMPLIFICATION CO. LTD.  
163 MITCHAM RD·LONDON SW17 9PG 01-672 3137/9080

## TUAC DISCOTHEQUE MIXER WITH AUTO FADE



Designed for the discerning D.J. of professional standard Offering a vast variety of functions. Controls; Mic Vol; Tone, over-ride depth; auto/Manual Sw; Tape Vol; L & R Deck Faders; Deck Volume; Treble and Bass; H. Phon Vol Selector; Master Vol On/Off Sw. Max output 1V RMS.

Specification: Deck Inputs—50mV into 1m $\Omega$ ; Deck Tone Controls—Treble +20 - 10dB at 12kHz. Bass +22 - 15dB at 40Hz; Mic input—200 ohms upwards. 2mV into 10k $\Omega$ ; Mic Tone Control—Total Variation Treble 15dB. Total Variation Bass 10dB; Tape input—30mV into 47k $\Omega$ ; Power Requirements—30-45 volts at 100mA.

**£26.50**

PANEL SIZE  
18 x 4½ in.  
DEPTH 3in.

### HOW TO ORDER BY POST

Make cheques/P.O.s payable to TUAC LTD (P.W.2). OR QUOTE ACCESS/BARCLAYCARD No. and post to TUAC LTD (P.W.2). 163, MITCHAM ROAD, LONDON S.W.17 9PG.

We accept Phone orders against ACCESS/Barclay Card Holders. Phone. 672 3137/9080.

### Stockists—Callers only

ARTHUR SALLIS LTD. 28 Gardner St., BRIGHTON, Sussex. Tel. 65806  
BRISTOL DISCO CENTRE 86 Stokes Croft, BRISTOL 1. Tel. 41666  
SOCODI 9 The Friars, CANTERBURY. Tel. 60948  
CALBARRIE AUDIO 88 Wellington St., LUTON. Tel. 411733  
A.I. MUSIC CENTRE 88 Oxford St., MANCHESTER. Tel. 236 0340  
DAMON ELECTRONICS 99 Carrington St., NOTTINGHAM. Tel. 53880  
MITCHELL ELECTRONICS 64 Winchester St., SALISBURY. Tel. 23689  
WEC LIGHTING 35 Northam Road, SOUTHAMPTON. Tel. 28102

## 3 CHANNEL LIGHT MODULATOR

- R.C.A. 8 Amp Triacs ● 1000W per channel ● Each channel fully suppressed and fused
- Master control to operate from 1W to 100W ● Full wave control—12 easy connections

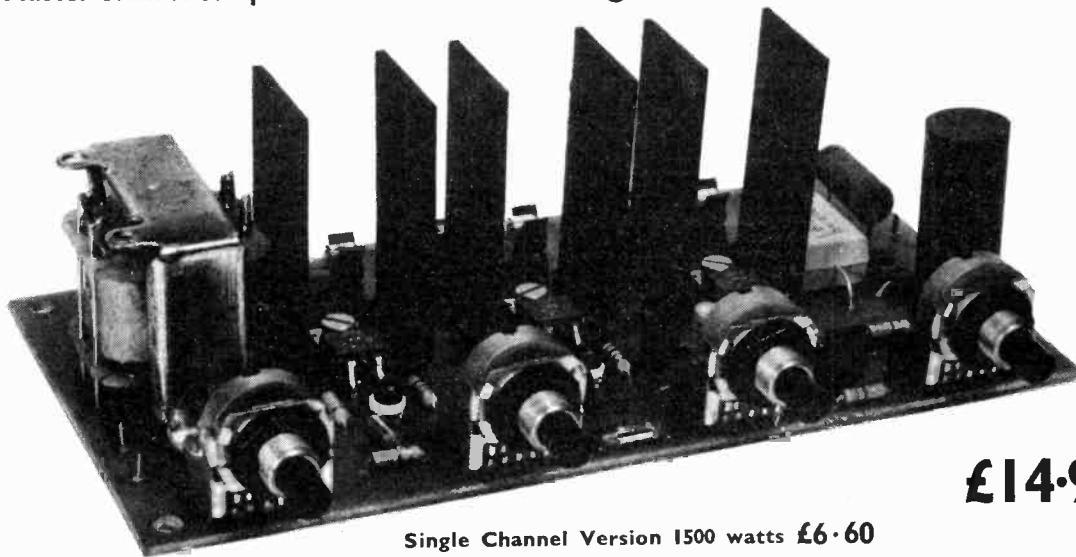

**£14.90**

Single Channel Version 1500 watts **£6.60**

MANUFACTURERS OF ELECTRONIC AND AMPLIFICATION EQUIPMENT  
SPECIALISTS IN QUALITY TRANSISTOR EQUIPMENT · OPEN 6 DAYS A WEEK 9.30am-6.00pm

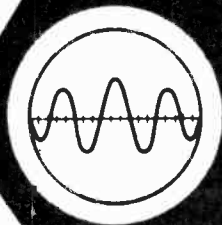

# TUAC

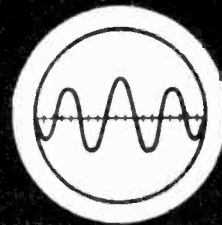

TRANSISTOR UNIVERSAL AMPLIFICATION CO. LTD.  
163 MITCHAM RD. LONDON SW17 9PG 01-672 3137/9080

## NEW TUAC POWER MODULES offering more power and quality than ever before.

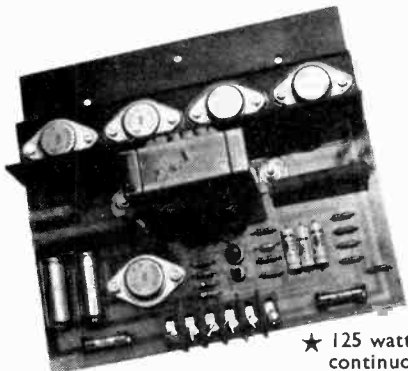

Specification on all power modules:  
All output power ratings  $\pm 0.5$ dB;  
Output impedance 8-15 ohms; THD at full power 2% typically 1%;  
Input sensitivity 60mV into 10k $\Omega$ ;  
Frequency response 20Hz-20kHz  $\pm 2$ dB; Hum and noise better than -70dB.

**TP125**

7 x 6 $\frac{1}{2}$  x 3in

**£17.00**

★ 125 watts RMS continuous sine wave output

★ 4 R.C.A. 150 watt 15 amp output transistors

**TL30**

4 x 5 $\frac{1}{2}$  x 2 $\frac{1}{2}$ in

**£7.90**

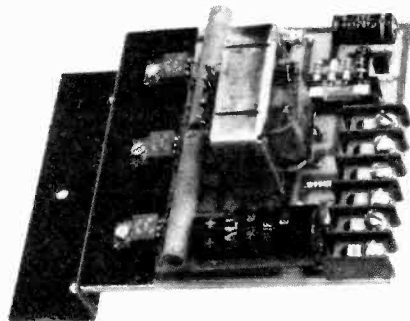

★ 30 watts RMS continuous sine wave output  
★ 2 R.C.A. 40 watt output transistor

★ Rugged layer wound driver transformer.  
★ Short—Open—and Thermal overload protection  
★ Only 6 connections

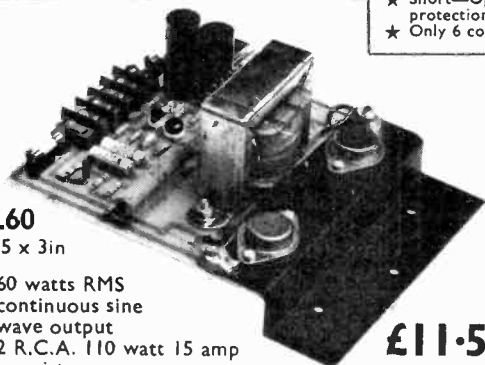

**TL60**

5 x 5 x 3in

★ 60 watts RMS continuous sine wave output  
★ 2 R.C.A. 110 watt 15 amp transistors

**£11.50**

**TL100**

5 x 5 x 3in

★ 100 watts R.M.S. continuous sine wave output  
★ 2 R.C.A. 150 watt 15 amp transistors

**£13.20**

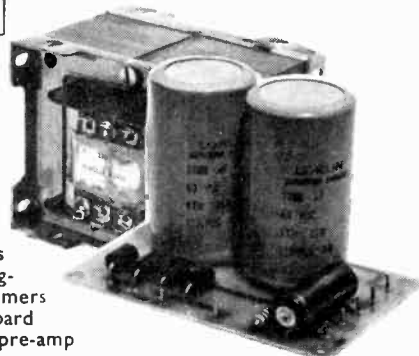

Power supplies vacuum impregnated Transformers with supply board incorporating pre-amp supply:

PS 125  $\pm$  50 volts for one TP125 ..... **£11.50**  
PS 100  $\pm$  45 volts for one TL100 ..... **£10.50**  
PS 60  $\pm$  40 volts for one TL60 ..... **£9.30**  
PS 30  $\pm$  50 volts for one TL30 ..... **£5.90**  
PSU 2 for supplying disco mixer ..... **£4.65**

## PREAMPLIFIERS

All TUAC audio modules are constructed on glass fibre P.C. board, are ready assembled and fully tested. Low noise silicon and FET transistors together with H.S. carbon film resistors are used throughout. Extensive research has gone into various wide range tone control circuits producing superb sound quality from any signal.

**VA08** Vol, Treble, Mid and Bass controls. Hi. IMP. FET, I/P suitable Mid, Guitar, Radio, Crystal/Ceramic P.U. Sensitivity 4mV. Treble +35dB at 16kHz. Mid +20-15dB at 1Hz. Bass +20-10dB at 40Hz. **£4.90**

**VA06** Vol, Treble and Bass controls. Sensitivity 8mV. Treble +28-15dB at 12kHz. Bass +18dB at 40Hz. **£4.15**

**SVA01 STEREO PRE AMP**; Vol, Treble, Mid and Bass controls. Hi. IMP. FET, I/P suitable Mid, Guitar, Radio, Crystal/Ceramic P.U. Sensitivity 4mV. Treble +35dB at 16kHz. Mid +20-15dB at 4kHz. Bass +20-10dB at 40Hz. Plus Full Balance Control **£10.00**

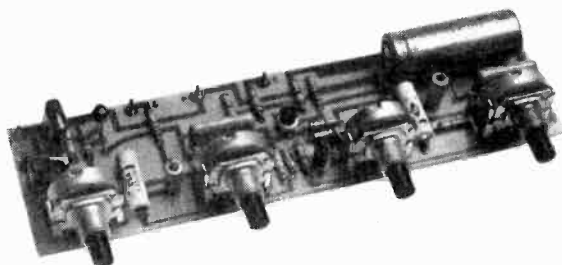

**ALL PRICES INCLUDE V.A.T. (8%) AND POSTAGE AND PACKING**

ACCESS & BARCLAY CARDS ACCEPTED · Just Send or Phone us Your Number · H.P. ARRANGED THROUGH PAYBONDS

# Marshall's

A. Marshall & Son (London) Limited Dept. PW  
42 Crickwood Broadway London NW7 3HD Tel: 01-452 0161  
& 85 West Regent Street Glasgow G2 2QD Tel: 041-332 4133

Everything you need is in our new 1975 catalogue. Available now price 25p

Trade and export enquiries welcome

## PW TELE TENNIS

As featured in PRACTICAL WIRELESS July - November 1974.  
Also on BBC Nationwide and in the Daily Mail October 2nd 1974.

This exciting new game is now available in kit form. Due to popular demand we are now able to offer a fantastic saving on list prices. Ideal game for whole family. No need to modify your TV set, just plugs in to aerial socket. Parts list as follows:

A Resistor Pack	£1.00	p.p.	20p
B Potentiometer Pack	£1.25	p.p.	20p
C Capacitor Pack	£3.10	p.p.	20p
D Semiconductor Pack	£14.50	p.p.	20p
E IC Sockets	£4.00	p.p.	20p
F Transformer	£7.50	p.p.	20p
G PCB's	£4.50	p.p.	20p
H Switches	£7.20	p.p.	20p
I UHF Modulator Kit			

Special Prices—complete kit (excluding case) £42.00 p.p. 50p Sections A-F incl. £23.50 plus 30p. Assembly instructions with complete kit of 75p on request.

SN7400	16p	SN7420	20p	SN7453	16p	SN7491	£1.10
SN7401	16p	SN7423	37p	SN7454	16p	SN7492	75p
SN7401AN	38p	SN7425	37p	SN7460	16p	SN7493	65p
SN7402	16p	SN7427	45p	SN7470	30p	SN7494	85p
SN7403	16p	SN7430	16p	SN7472	38p	SN7495	80p
SN7404	24p	SN7432	45p	SN7473	45p	SN7496	£1.00
SN7405	24p	SN7437	35p	SN7474	48p	SN74100	£2.16
SN7406	45p	SN7438	35p	SN7475	59p	SN74107	43p
SN7407	45p	SN7440	16p	SN7476	45p	SN74118	£1.00
SN7408	25p	SN7441	85p	SN7480	75p	SN74119	£1.92
SN7409	33p	SN7442	85p	SN7481	£1.25	SN74121	57p
SN7410	16p	SN7445	£1.59	SN7482	87p	SN74122	80p
SN7411	25p	SN7446	£2.00	SN7483	£1.20	SN74123	77p
SN7412	25p	SN7447	£1.30	SN7484	95p	SN74141	£1.00
SN7413	50p	SN7448	£1.50	SN7485	£1.58	SN74150	£1.44
SN7416	45p	SN7450	16p	SN7486	45p	SN74190	£1.95
SN7417	30p	SN7451	16p	SN7490	65p		

## TRY OUR NEW GLASGOW SHOP

Prices correct at October 1974, but all exclusive of V.A.T. Post and Package 20p postage and package charges

### Popular Semi-conductors

2N696	22p	2N3707	13p	AD142	59p	BC309	10p	LM709	48p
2N697	16p	2N3708	70p	AD143	45p	BC327	21p	TO99	38p
2N698	40p	2N3715	£1.50	AD161	50p	BC328	19p	8DIL	33p
2N699	45p	2N3716	£1.80	AD162	50p	BC370	17p	14DIL	10p
2N1302	19p	2N3771	£2.20	AD161 pr	BCY71		22p	LM723C	90p
2N1303	19p	2N3772	£1.80	AD162	£1.20	BCY72	13p	LM741	40p
2N1304	24p	2N3773	£3.20	AD109R	40p	BD123	82p	TO99	40p
2N1305	24p	2N3819	37p	AF115	24p	DB131	40p	8DIL	40p
2N1306	21p	2N3820	38p	AF124	30p	BD132	30p	14DIL	38p
2N1307	22p	2N3823	£1.45	AF125	30p	BD135	42p	LM747	£1.00
2N1308	25p	2N3904	27p	AF126	28p	BD136	49p	LM7805	£2.00
2N1309	36p	2N3905	24p	AF127	28p	BD137	55p	MC1310	£2.92
2N1671	£1.44	2N4036	63p	AF139	39p	BD138	63p	MJ480	90p
2N1671A	£1.54	2N4037	42p	AF178	55p	BD139	71p	MJ481	£1.14
2N1671B	£1.72	2N4216	20p	AF179	65p	BD140	87p	MJ490	98p
2N1671C	£4.32	2N4289	34p	AF180	58p	BF115	25p	MJ491	£1.38
2N2102	50p	2N4921	73p	AF239	51p	BF116	23p	MJE340	45p
2N2147	78p	2N4922	84p	AF240	72p	BF117	43p	MJE2955	£1.12
2N2148	94p	2N4923	83p	AF279	54p	BF154	16p	MJE3055	68p
2N2160	60p	2N5190	92p	AF280	54p	BF163	32p	MFC4000B	40p
2N2218A	22p	2N5191	95p	BC107	16p	BF180	35p	MFC4010A	49p
2N2219	24p	2N5192	£1.24	BC108	15p	BF181	34p	MFC4060	54p
2N2219A	26p	2N5195	£1.46	BC109	16p	BF184	30p	MFC6040	91p
2N2221	18p	2N5245	43p	BC147	12p	BF194	12p	NE555V	70p
2N2221A	21p	2N5457	49p	BC148	12p	BF195	12p	NE560D	£4.48
2N2222	20p	2N5458	45p	BC149	12p	BF196	13p	NE531	£4.48
2N2222A	25p	2N5459	49p	BC167B	13p	BF197	15p	NE565A	£4.48
2N2646	35p	4033	48p	BC168B	13p	BF198	18p	OC28	76p
2N2904	32p	40362	50p	BC168C	11p	BF200	40p	OC42	50p
2N2904A	32p	40363	88p	BC169B	13p	BF237	22p	OC71	20p
2N2905	24p	40406	44p	BC169C	13p	BF238	22p	OC72	25p
2N2905A	26p	40407	33p	BC182	12p	BFX29	30p	SL414A	£1.80
2N2906	19p	40408	50p	BC182L	12p	BFX30	27p	TAA263	£1.00
2N2906A	21p	40409	52p	BC183	12p	BFX84	24p	TBA800	£1.50
2N2907	22p	40410	52p	BC183L	12p	BFX85	35p	TBA810	£1.50
2N2907A	24p	40411	£2.00	BC184	13p	BFX87	28p	TIP29A	49p
2N2926	11p	40602	46p	BC184L	13p	BFX88	25p	TIP30A	58p
2N3053	25p	40604	56p	BC212K	16p	BFX89	45p	TIP31A	62p
2N3054	60p	40669	£1.00	BC212L	16p	BFY19	62p	TIP328	74p
2N3055	75p	AC117	20p	BC214L	21p	BFY51	23p	TIP33A	£1.01
2N3441	97p	AC126	20p	BC237	13p	BFY52	21p	TIP34A	£1.51
2N3442	£1.69	AC127	20p	BC183L	13p	BFY90	75p	TIP35A	£2.90
2N3415	10p	AC128	20p	BC239	13p	BR139	48p	TIP36A	£3.70
2N3416	15p	AC151V	25p	BC257	14p	CI06D	65p	TIP41A	79p
2N3417	21p	AC152V	17p	BC258	13p	CA3020A	1.80	TIP42A	90p
2N3702	11p	AC153K	25p	BC259	14p	CA3046	70p	TIP2955	98p
2N3703	12p	AC176	18p	BC300	36p	CA3048	£2.11	TIP3055	80p
2N3704	14p	AC176K	18p	BC301	34p	CA3095E	£1.96	ZTX300	13p
2N3705	12p	AC187K	23p	BC307	11p	CA3090	£4.23	ZTX302	20p
2N3706	9p	AC188K	34p	BC308	12p	LM1301A	46p	ZTX500	15p

12" LONG PERSISTENCE CRT. Full spec. Price £6.50 to include V.A.T. and Carriage.

MAKE YOUR SINGLE BEAM SCOPE INTO A DOUBLE WITH OUR NEW LOW PRICED SOLID STATE SWITCH. 2 Hz to 8 MHz. Hook up a 9 volt battery and connect to your scope and have two traces for ONLY £8.25, P. & P. 25p. (Not cased, not calibrated.)

WIDE RANGE WOBBULATOR. 5 MHz to 150 MHz up to 15 MHz sweep width. Only 3 controls, preset RF level, sweep width and frequency. Ideal for 10-7 or TV IF alignment, filters, receivers. Can be used with any general purpose scope. Full instructions supplied. Connect 6 3V A.C. and use within minutes of receiving. All this for ONLY £8.75, P.&P. 25p. (Not cased, not calibrated.) 20 Hz to 200 kHz WB.

SINE and SQUARE GENERATOR. Four ranges. Independent amplitude controls, thermistor stabilised. Ready to use, 9V supply required. £8.85 each, P. & P. 25p. (Not cased, not calibrated.)

GRATICULES 12cm x 14cm high quality plastic 15p each, P. & P. 5p.

Large quantity of good quality components — NO PASSING TRADE — so we offer 3lbs of ELECTRONIC GOODIES for £1.50. Post paid.

ROTARY SWITCH PACK—6 brand new switches (1 ceramic; 1 off 4pole 2 way etc.). 50p. P. & P. 20p.

P.C.B. PACKS S. & D. Quantity 2 sq ft—no tiny pieces. 50p plus P. & P. 20p.



PLEASE ADD V.A.T. AT 8%  
OPEN 9 a.m. to 6.30 p.m. ANY DAY

**CHILMEAD LTD**

7/9 ARTHUR ROAD, READING, BERKS.  
(near Tech. College) Tel.: Reading 582605/65916



CAPACITOR PACK—50 Brand new components, only 50p, P. & P. 20p.  
TRIMMER PACK. 2 Twin 50/200pF ceramic 2 Twin 10/60pF ceramic; 2 min. strip with 4 preset 5/20pF on each; 3 air spaced preset 30/100pF on ceramic base. ALL BRAND NEW. 25p the lot. P. & P. 10p.  
PHOTOCELL equ. OCP71, 13p each. MULLARD OCP70—16p each.

DELIVERED TO YOUR DOOR 1 out of Electronic Scrap chassis, boards, etc. No rubbish. FOR ONLY £4.00.

MODERN TELEPHONES type 706. Two-tone grey, £3.75 each. Two-tone green £3.75 each. Black £3.75 each. P. & P. 35p.

Ideal EXTENSION TELEPHONES with standard GPO type dial, bell and lead coding. £1.75 each, P. & P. 35p.

HANDSETS — complete with 2 inserts and lead 75p each, P. & P. 37p. DIALS ONLY 75p each, P. & P. 25p.

HIGH VALUE—PRINTED BOARD PACK. Hundreds of components, transistors, etc.—no 2 boards the same—no short leaded transistor computer boards £1.75 post paid.

Beehive Trimmer 3/30 pf Brand new. Qty. 1-913p ea. P. & P. 15p 10-99 10p ea. P. & P. 25p; 100-999 7p ea. P. & P. free.

HF Crystal Drive Unit. 19in. rack mount. Standard 240V input with superb crystal oven by Labgear (no crystals) £5 ea. Carr. £2.00

1000pf FEED THRU CAPACITORS only sold in packs of 10, 30p, P. & P. 10p.

ALWAYS some CHEAP SCOPES AVAILABLE—or build your own—send for our tube list with a S.A.E.

# YOUR CAREER in RADIO & ELECTRONICS ?

Big opportunities and big money await the qualified man in every field of Electronics today—both in the U.K. and throughout the world. We offer the finest home study training for all subjects in radio, television, etc., especially for the CITY & GUILDS EXAMS (Technicians' Certificates), the Grad. Brit. I.E.R. Exam.; the RADIO AMATEUR'S LICENCE; P.M.G. Certificates; the R.T.E.B. Servicing Certificates; etc. Also courses in Television; Transistors; Radar; Computers; Servo-mechanisms; Mathematics and Practical Transistor Radio course with equipment. We have OVER 20 YEARS' experience in teaching radio subjects and an unbroken record of exam. successes. We are the only privately run British home study College specialising in electronics subjects only. Full details will be gladly sent without any obligation.

To: British National Radio & Electronics School, Dept W.C. 35, P.O. Box 156, Jersey, C.I.

Please send FREE BROCHURE to

NAME ..... Block  
ADDRESS ..... Caps.  
..... Please

## BRITISH NATIONAL RADIO AND ELECTRONICS SCHOOL





# Newnes-Butterworths New Books

## AUDIO HANDBOOK

Gordon King

- ★ Deals fully with all aspects of audio recording and reproduction
- ★ Describes all the component parts of a sound system in detail
- ★ Gives full information on measurements and adjustments
- ★ Includes the parameters on all the four-channel systems currently available
- ★ Invaluable to the enthusiast, the audio dealer and student

304 pages 255 x 158mm Illustrated ISBN 0 408 00150 X £4.90  
March 1975

## 110 OPERATIONAL AMPLIFIER PROJECTS FOR THE HOME CONSTRUCTOR

R. M. Marston

- ★ Invaluable to electronics amateurs, students and practising engineers
- ★ Essential characteristics of the operational amplifier are outlined and followed by 110 useful projects
- ★ All projects are designed round internationally available components and every circuit has been fully evaluated by the author
- ★ Concise but comprehensive operating principles are given and constructional notes added where necessary

128 pages 216 x 138mm Illustrated Limp ISBN 0 408 00153 4  
£1.80. Cased ISBN 0 408 00149 6 £2.80 February 1975

## RADIO SERVICING POCKET BOOK—3rd Edition

Vivian Capel

- ★ Invaluable to radio servicemen and students working for the RTEB Examinations
- ★ Contains a wealth of information on radio components, the modern radio receiver and workshop planning and practice
- ★ Completely rewritten to include developments and trends since the 1962 edition . . . including Stereo Radio and Car Radios with more on various forms of interference
- ★ Incorporates for the first time in book form, a directory of Radio Manufacturers and Service Depots that will prove invaluable for obtaining spare parts and service data for particular models

232 pages 192 x 121mm Illustrated ISBN 0 408 00144 5 £1.95  
February 1975

## BEGINNERS GUIDE TO TRANSISTORS 2nd Edition

J. A. Reddihough, Revised by I. R. Sinclair

- ★ Provides an excellent and thorough introduction to the transistor in an easily understood form
- ★ Shows how the transistor is used in everyday practical circuits and explains the various techniques involved
- ★ A full revision has ensured that this second edition incorporates the latest developments in integrated circuits; logic principles have been introduced

160 pages 192 x 126mm Illustrated ISBN 0 408 00145 3 £1.80  
February 1975

## Order now from your local Bookseller



Teleplay incorporates all the refinements of television tennis games found in pubs, clubs and amusement arcades.

For the Do-It-Yourself enthusiast:  
Complete kit (if ordered in one consignment)  
**SPECIAL PRICE £68.50**  
COMPLETION KIT **PRICE £18.00**  
MODULATOR and  
VARIABLE OSCILLATOR KIT  
**PRICE £11.00**

### TELEPLAY EXCLUSIVE

Teleplay is the absolute ultimate in home TV games — no other company can offer so many features.

LOGIC LEISURE LIMITED  
KINGFISHER HOUSE, 68 PARK ROAD,  
NEW BARNET, HERTS.  
TEL: 01-440 9173/4. TELEX: 264397

Printed Circuit board ready drilled with diagram lay-out sheet and directions  
**PRICE £14.50**

PLEASE SEND S.A.E. FOR FULL DETAILS

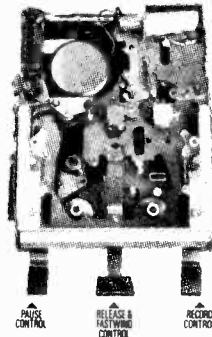

## GARRARD CT4'S' MK III STEREO CASSETTE PLAYER & RECORDER

has full facilities for record, play-back, pause, erase, rest, fast forward and

reverse wind, automatic tape end stop and cassette release.

Robust, precision engineered mechanism based on the "STARR" patented design. Ideal for use in Car stereo cassette players, HI-FI stereo cassette recorders, industrial and many other applications.

Send cheque or Postal Orders for **£19.98** (£18.50 + 8% VAT) (includes post and packing) to:

**BOTHWELL ELECTRIC SUPPLIES**  
(Glasgow) LIMITED  
431 Sauchiehall Street  
GLASGOW G2 3LG Tel: 041-332 6184  
Scotland's Leading Electronics Centre

# MAPLIN

# ELECTRONIC SUPPLIES

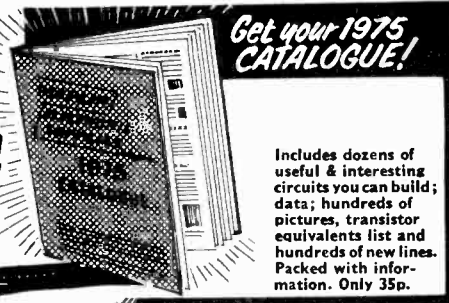

Includes dozens of useful & interesting circuits you can build; data; hundreds of pictures, transistor equivalents list and hundreds of new lines. Packed with information. Only 35p.

## SUPERSONIC SAME-DAY-SERVICE - MEANS QUALITY COMPONENTS - FAST!

**RESISTORS**  
**CARBON FILM**  
 1/4W 1Ω to 1M: 5% IM2 to 10M: 10% E12  
 1/4W 1Ω to 10Ω: 5%, 1M2 to 10M: 10%  
 E12 11Ω to 910k: 5% E12 & E24 1p each  
**METAL OXIDE**  
 1/4W 10Ω to 1M: 2% E12 & E24 4p each  
**WIREWOUND**  
 3W 0.25Ω, 0.27Ω, 0.33Ω, 0.47Ω:  
 10%, 1.05% 17p each  
 1.2Ω to 270Ω: 5% E12 13p each  
 Other ranges stocked. See our catalogue for details.  
 E12: 10, 12, 15, 18, 22, 27, 33, 39, 47, 56, 68, 82 and decads.  
 E24: 11, 13, 16, 20, 24, 30, 36, 43, 51, 62, 75, 81 and decads.

**POTENTIOMETERS**  
 Rotary miniature carbon track 1" spindle.  
 Values available: 5k, 10k, 20k, 50k, 100k, 250k, 500k, 1M, 2M.  
 Log. Single-gang 16p  
 Lin. Single-gang (+ 1k) 16p  
 Log. or Lin. Single-gang with switch 33p  
 Log. or Lin. Dual-gang without switch 49p  
 Slider 60mm track. Metal-cased: overall length 86-15mm (knob extra 7p)  
 (Log. or Lin. Single-gang 1k, 5k, 10k, 25k, 50k, 100k, 36p each  
 Log. or Lin. Dual-gang 1k, 5k, 10k, 25k, 50k, 100k, 45p each  
 Presets: 0-1W Vertical or Horizontal.  
 100Ω, 220Ω, 470Ω, 1k, 2k2, 4k7, 10k, 22k, 47k, 100k, 220k, 470k, 1M 7p each

**CAPACITORS**  
 Sub-miniature Axial lead electrolytic  
 Mid V Price Mid V Price  
 1-63 6p 68-63 6p  
 1-5 63 6p 68-18 6p  
 2-2 63 6p 68-63 14p  
 3-3 63 6p 100-4 6p Mid V Price  
 4-7 63 6p 100-10 6p 470-6.3 6p  
 6-8 40 6p 100-25 6p 470-10 14p  
 6-8 63 6p 100-40 6p 470-25 16p  
 10-25 6p 100-63 16p 470-40 25p  
 10-63 6p 150-6.3 6p 680-6.3 14p  
 15-16 6p 150-18 6p 680-16 16p  
 15-40 6p 150-25 6p 680-25 25p  
 15-63 6p 150-40 14p 680-40 28p  
 22-10 6p 150-63 18p 1000-4 14p  
 22-25 6p 220-4 6p 1000-10 16p  
 22-63 6p 220-10 6p 1000-16 25p  
 33-6.3 6p 220-16 6p 1000-25 28p  
 33-16 6p 220-25 14p 1500-6.3 18p  
 33-40 6p 33-40 6p 1600-10 25p  
 47-4 6p 220-63 25p 1500-16 28p  
 47-10 6p 330-4 6p 2200-6.3 25p  
 47-25 6p 330-10 6p 2200-10 25p  
 47-40 6p 330-16 14p 3300-6.3 28p  
 47-63 6p 330-63 28p 4700-4 28p

**MAINS CONNECTORS**  
 P380 3-pin 1.5A Chassis Plug with Line Socket 30p  
 SA2190 3-pin 5A Chassis Plug 25p  
 SA1862 Line Socket for SA2190 25p  
 P437 3-pin 5A Chassis Socket with Line Plug 55p

**TRANSISTORS & DIODES**  
 AC127 18p BY126 13p  
 AC128 18p BY127 13p  
 AC176 17p BY184 48p  
 AD161/162 MP BZY88 series 93p  
 BA100 9p MPF102 36p  
 BA145 22p OA91 6p  
 BC107 10p OA200 7p  
 BA108 10p OC71 20p  
 BC109 13p SCL46D 88p  
 BC109C 16p T1843 28p  
 BC142 23p W005 30p  
 BC143 26p W04 38p  
 BC147 10p 1N914 4p  
 BC148 10p 1N4001 6p  
 BC149 12p 1N4002 6p  
 BC168C 12p 1N4003 7p  
 BC169C 12p 1N4004 7p  
 BC178 17p 1N4005 8p  
 BC182L 10p 1N4006 8p  
 BC183L 12p 1N4007 9p  
 BC184L 12p 1N4148 4p  
 BC213L 14p 2N1302 20p  
 BC213L 15p 2N1303 20p  
 RC214L 18p 2N1304 30p  
 BCY71 22p 2N1711 24p  
 BD131 45p 2N2219 25p  
 BD132 54p 2N2646 48p  
 BD131/BD132 2N2905 33p  
 MP £1.20 2N2926 Or.  
 BD135 36p Ye. or Gn 10p  
 BD139 49p 2N3053 18p  
 BD140 69p 2N3065 49p  
 BF258 35p 2N3819 22p  
 BFX29 25p 2N4589 51p  
 BFX29 30p 7400 16p  
 BFX30 33p 7413 39p  
 BFX84 30p 7447 £1.10  
 BFX85 36p 7473 54p  
 BFX87 30p 7474 48p  
 BFX88 25p 7490 93p  
 BFFY50 20p 7493 93p  
 BFFY51 25p 74121 38p  
 BFFY52 20p  
 L.E.D. RED 2mcd only 15p  
 Panel m/c clip 5p  
 (Other colours and 7-seg. displays in our catalogue)

**INTEGRATED CIRCUITS**  
 CA3046 (14-pin DIL) 69p  
 LH0042CH (TO99) 24.25  
 MC1502 (14-pin DIL) £2.50  
 MC1496 (UA766) (14-pin DIL) 15p  
 MFC4000B 95p  
 MFC6040 83p  
 NE555V (8-pin DIL) 65p  
 SCL405 (14-pin DIL) 22.70  
 SG3402 (8-pin DIL) £1.98  
 MA741C (8-pin DIL) 36p  
 MA741C (14-pin DIL) 45p  
 MA747C (14-pin DIL) £1.05  
 MA749C (8-pin DIL) 38p  
 ZN414 (TO18) £1.20

**VOLTAGE REGULATORS**  
 MA7805 5V 1.5A (TO3) £1.75  
 MA7815 15V 1.5A (TO3) £2.30  
 MVR 5V, 12V, 15V, 500mA TO3 £1.60  
 MA78M05 5V 500mA (Plastic power) £1.30  
 MA78M15 15V 500mA (Plastic power) £1.30  
 MA7815 15V 100mA (TO92) 60p  
 MA7815 15V 100mA (TO92) 60p  
 MA782C Variable 2 to 27V (TO99 or 14-pin DIL) 75p  
 Our catalogue contains application circuits and data for all the above I.C.'s and many more

**DISCOUNTS**  
 Details in our catalogue. Start collecting MES Discount Vouchers NOW!

**SWITCHES**  
 Rotary adjustable stop 1 pole, 2 to 12 way; 2 pole, 2 to 6 way; 3 pole, 2 to 4 way; 4 pole, 2 or 3 way 36p each  
 Slide Sub-min DPDT 9p  
 Slide Min. DPDT 13p  
 Push to make Non-locking SPST 14p  
 Push-on, Push-off Locking DPDT 250V 4A 48p  
 Rocker White DPST 250V 10A 40p  
 Rotary Mains DPST 250V 2A 20p  
 Toggle with ON/OFF plate DPDT 250V 1.5A 25p  
**BCD OUTPUT SLIDE SWITCH**  
 Marks the end of the old-fashioned thumb-wheel switch. With 7-segment type read-out. Full details in our catalogue. £1.88

**PLUGS & SOCKETS**  

DIN	PLUG	CHASSIS SOCKET
2-pin	8p	6p
3-pin	9p	7p
4-pin	10p	7p
5-pin A (180°)	10p	7p
5-pin B (240°)	10p	7p
6-pin	10p	9p

**JACK PLUGS**  
 1/4 in. Std. Mono Plastic Barrel 13p  
 1/4 in. Std. Mono Metal Barrel 24p  
 1/4 in. Std. Stereo Plastic Barrel 15p  
 1/4 in. Std. Stereo Metal Barrel 30p  
 2.5mm Plastic Barrel 9p  
 2.5mm Metal Barrel 15p  
 3.5mm Plastic Barrel 9p  
 3.5mm Metal Barrel 15p  
**JACK CHASSIS SOCKETS**  
 2.5mm Open-type metal 5p  
 3.5mm Open-type metal 9p  
 1/4" Std. Mono Open-type metal 10p  
 1/4" Std. Mono Moulded with 2 break contacts 14p  
 1/4" Std. Stereo Open-type metal 15p  
 1/4" Std. Stereo Moulded with 3 break contacts 18p

**PHONO**  
 Plastic-topped Plug 5p  
 Screened Plug 12p  
 Chassis Socket Single 4p  
 Chassis Socket Twin 6p

**TRANSFORMERS**  
 LT700 min. output. Pri. 1k2; Sec. 5Ω 200mV 50p  
 Sub-min mains 6.0-6.0V 100mA 95p;  
 12-0-12V 50mA 95p  
 (Size both approx. 30 x 27 x 25mm)  
 Min. mains  
 0-6V 500mA, 0-8V 500mA £1.36  
 0-12V 250mA, 0-12V 250mA £1.36  
 0-20V 150mA, 0-20V 150mA £1.36  
 0-24V 125mA, 0-24V 125mA £1.36  
 Mains MT3AT: Sec: 12-15-20-24-30V 2A £3.60  
 Mains MT206AT: Sec: 0-15-20V 1A, 0-15-20V 1A £3.98

**ORGAN CONSTRUCTION**

A Full Scale Electronic Organ that you can Build to Your Own Specification.  
**FULL CONSTRUCTIONAL DETAILS IN OUR LEAFLETS**  
 Leaflet MES 51: Price 15p, describes a fully polyphonic basic organ which can later be used as the basis of a large sophisticated instrument.  
 Leaflet MES 52: Price 5p continues the description of the MES 50 series organs and shows you how to add a second keyboard with lots more stops.



**THE AMAZING DMO2**

A ready-built, tested and guaranteed digital master oscillator. Accurately generates the top 13 notes for your organ system and reduces the complete tuning of your organ to ONE SIMPLE adjustment. New design gives selectable C to C output ranges of (approx.) 4k to 8k (highest) or 2k to 4k or 1k to 2k, etc. right down to 16Hz to 32Hz! And this new compatible design is even smaller—only 3.5in x 3.7in including gold-plated edge connexion.  
 DMO2T includes built in variable depth and rate frequency shift tremulant.  
 DMO2 £18.25 DMO2T £14.25  
 SAJ 110: 7-stage frequency divider in 14-pin DIL package. Sine or square wave input. Square wave output may be converted to saw-tooth. £1.80 each or 6 for £9.94 or 12 for £18.16.  
 Keyboards high quality, fully sprung. £15.95  
 Flat-front 48-note F to E £15.95  
 Sloping-front 48-note C to C £20.44  
 Sloping-front 61-note C to C £20.44  
 Swell pedal with 10k log. pot £5.98  
 \*Spring Line Unit (Short) £3.05  
 \*Spring Line Unit (Long) £7.59  
 \*Reverberation Driver Module £5.84  
 \*S.A.E. pleaser for full details: leaflet MES 24. Gold-clad phosphor-bronze wire 30p per yd. Palladium earth bar 15p per octave length. Contact Blocks 2-make (GB2) 22p  
 Stop Tab rocker type not engraved (white, red, grey or black) with DPDT switch 49p

**SPECIAL OFFER**  
 5W Audio Amp 1C TBA 810S with Data and Circuits Price £11.00.

**"ELECTRONICS TODAY INTERNATIONAL" 4600 SYNTHESISER**

We stock all parts for this brilliantly designed synthesiser. This includes all the P.C.B.s, metal-work and drilled and printed front panel giving a truly professional finish. Authoritative opinions agree the E.T.I. International Synthesiser is technically superior to most of today's models. Complete constructional details in our booklet, available shortly. S.A.E. please for price list and specification.

We also stock all parts for the P.E. Synthesiser and Minisonic.



P.O. BOX 3, RAYLEIGH, ESSEX. Tel.: Southend-on-Sea (0702)44101

VAT Please add 8% to the final total. Post and packing FREE in U.K. (15p handling charge on orders under £1).

First-class post pre-paid envelope supplied free with every order.

# Thou shalt not listen!

**H**OW many of our readers have tuned their radio receivers over the long, medium, short and v.h.f. wavebands and have often paused to identify and listen to the many different transmissions that can be received?

There are many radio transmissions that can be picked up on domestic receivers that if received by you—and it is necessary to listen, to identify these transmissions—you would by listening, be committing an indictable offence under Section 5 of the 1949 Wireless Telegraphy Act.

Pause for a moment to think—how many of us have listened to either the police, fire brigade, taxis or aircraft transmissions that suddenly appear—often breaking through on top of other stations—as we tune our v.h.f./f.m. receivers or tuners? You are all GUILTY of the offence of LISTENING and the penalties for this offence are severe!

We have recently received, from a department of the Home Office, a letter which draws attention to the receiver design, *Low Frequency and Marine Receiver* by Charles Heath, that appeared in the January 1975 issue of this magazine. This receiver, if constructed and used for listening to transmissions from other than broadcast or licensed Amateur stations, render the listener liable for prosecution. It was requested that we should draw this interpretation of the 1949 Act to the attention of our readers.

Many of our wavebands—especially the Amateur bands are operated on a shared basis. This means that you—members of the public—may listen to licensed Amateur stations within these bands but not to the unending garble that emanates from the transmitters of the so-called “privileged” user. Take for example, one form of privileged transmission that litters the 80m Amateur band—not Amateur stations—they have no privilege: we refer to the never-ending “traffic” between North Sea oil rigs and their base stations. These stations, operating within the 80m Amateur band transmit without any identification for prolonged periods. Thou shalt not listen to them!

Quite recently, there was a spate of station closure notices, some served without prior warning, upon licensed Amateur stations (the non-privileged) by the Home Office—for what could only be, in the opinion of many, minor infringements of the regulations.

Licensed Amateur stations are required to identify themselves regularly during transmission times. Hands up anyone who has heard the station operators on oil rigs identify themselves? Remember, we are now discussing transmissions from “privileged” users in an Amateur band. These are but a few of the many “privileged” transmissions that, in the opinion of the Home Office, are entitled to a degree of privacy of transmission. These regulations are seeking to preserve the confidential nature of the messages which are not intended for reception by members of the public. There is no privacy or sanctuary for the licensed radio Amateur.

During a recent BBC television programme (Barlow, BBC-1, Jan. 8th, 1975) it was stated that it was *not illegal* to listen to public service broadcasts!! Poor Barlow—who will have whom on the carpet this time?

A recent report in the *Daily Express* (see Letters on page 1036 of this issue “Plane Spotters Beware”) brings forth comment from one of our readers.

Listeners, beware!!

LIONEL E. HOWES—Editor.

## NEWS...

### Frequency List from the United States

**T**HE most casual twirl of the dial of an all-band receiver reveals hundreds of radio signals that are neither broadcasters nor radio amateurs. Many of these signals are unintelligible meaningless sounds, and although your curiosity may be aroused to wonder who they are, finding out has, up to now, not been a simple or easy task. The purpose of this book is to shed some light on the question of identification of these many signals—predicated upon information not generally available in print.

The title of this book, *Confidential Frequency List*, is not intended to be facetious. In every country around the world there are prohibitions about “listening in” or “monitoring” the stations listed in this book. These prohibitions range from extreme to extreme: including outright forbidding (with penalties) to simple warnings that the content of the broadcasts must not be revealed to a third party. Although it is problematical how some of these prohibitions can be enforced—and what useful purpose they serve—it is NOT the desire, nor intent, of the author and/or the publisher to encourage circumvention.

This handbook is the distillation of various data from a great number of sources: private commercial, governmental and off-the-air monitoring. Although every effort possible has been made to verify these data, it is not to be expected that this book is 100% accurate. However, in the opinion of the author and publisher, it is the best that can be done without specifically violating some governmental radio security, although “classified” radio stations can frequently be overheard on many ordinary radio receivers.

Copies of the *Confidential Frequency List* are available from the publishers, *Ham Radio Magazine, Greenville, New Hampshire, U.S.A.* for £1.70. Payment may be made either by international money order or a British cheque.



### Calculator programmer

**A** NEW programming device, developed by Advance Electronics Limited for use with the 162P low-cost programmable calculator extends the capabilities of this machine for dealing with routine, repetitive calculations. Programmes are punched onto a plastic strip which is fed through a slot in the calculator to load the programme into the machine. Thus standard programmes of up to 40 steps in length can be held in permanent form. In addition, a simple mechanical "punch" is available for users to write their own programmes.

On the standard 162P calculator, programmes are fed into the machine directly from the keyboard, and the calculator can retain two programmes at any one time: one of up to 30 steps and one of up to ten steps in length.

Although these limitations are not significant for many applications, there are cases where users are continually carrying out several standard calculations, and clearly these users will benefit from having the programme in a permanent form ready to load into the machine.

In operation, the new pro-

gramming device bypasses the indentations on a sprocketed plastic strip, which is fed over a sensing device by a miniature drive motor. A novel principle is used in the patented sensing device; the indentations in the plastic strip are 'detected' by a row of miniature ball bearings which then depress a strip of electrically conductive rubber onto a row of contacts.

The plastic strips are about 30cm long (the exact length depends on the number of programme steps required), and are shaped so that pushing the strip into the slot on the calculator starts up the drive mechanism.

The 162P calculator fitted with the new programming mechanism and complete with the programming punch costs £249 (Plus V.A.T.). The mechanical punch for writing the programmes is available separately at a cost of £15. In addition, Advance Electronics is making available a series of commonly used programmes, as well as providing an advisory service to users who wish to write their own programmes. More information from: *Advance Electronics Ltd., Calculator Division, Raynham Road, Bishop's Stortford, Herts.*

### Pressure transducers

**S**E LABS, EMI's instrumentation and measurement company have added the EPI-080 series transducers to their range.

These miniature pressure transducers are capable of measuring static and dynamic pressures where small size and minimum pressure sensing area are of prime importance. The transducers incorporate semiconductor techniques which represents a significant advance in micro-circuitry.

#### Price increase

Like so many other magazines, *Practical Wireless* has become a victim of the ever-increasing world paper shortage resulting in large increases in the cost of raw materials. So that we can maintain our high standard of providing technical information and projects for readers, we have been forced to increase our cover price to 30p.

### "Exhibition madness" says APAE man

**T**HE President of the Association of Public Address Engineers, Keith Monks appealed recently to all interested parties to get together and sort out the "exhibition madness that is overtaking the audio industry".

He pointed out to members of the Press that in 1975 there are seven exhibitions of interest to everyone in the audio industry. All these shows take place within six weeks of one another.

Mr. Monks said that even if it was not possible to arrange a single venue, common dates should be arranged. If this were done, foreign visitors could make one visit to Great Britain and cover all the shows.

The APAE Exhibition, or "Sound 75 International Exhibi-

### Heathkit catalogue



**T**HE new Heathkit catalogue contains details of a great range of kits—many available for the first time in this country, like GR-1075 AM/FM Digital Electronic Alarm Clock-Radio; IC-2100 Desktop Slide-rule Calculator; GC-1093 Digital Electronic Car Clock/Timer; CI-1080 Exhaust Gas Analyser; CM-1073 Tune-Up Meter; IO-4510 Triggered, Dual-Trace Oscilloscope; IG-1271 Function Generator; SB-104 Solid-State SSB Transceiver with Digital Readout; HP-1144 AC Power Supply for the SB-104; SB-604 Station Speaker for the SB-104; SB-230 Linear Amplifier; SB-614 Station Monitor for the SB-104; SB-634 Station Console for the SB-104; SB-644 Remote VFO for the SB-104.

There is an article included which tells about kit building "The Heathkit Way" and shows how easy it is to construct a kit.

If you would like a copy of this new catalogue, which is free, write to *Heath (Gloucester) Limited, Bristol Road, Gloucester, GL2 6EE*. If you want to phone for one the number is Gloucester (0452) 29451.

tion" will take place from 11-13th March at the Bloomsbury Centre Hotel, London.

Among exhibitors there for the first time, will be firms from Japan and Finland.

# 2 VHF Converters

## PART 1

G. SEVERN

USED in conjunction with a communications receiver, either of these converters will give VHF reception, bringing in amateur and other transmissions and in some cases TV sound programmes, using only a simple dipole aerial. The simpler converter is tunable and the more complex converter is crystal controlled, so a few notes on the advantages and limitations of each method should prove helpful.

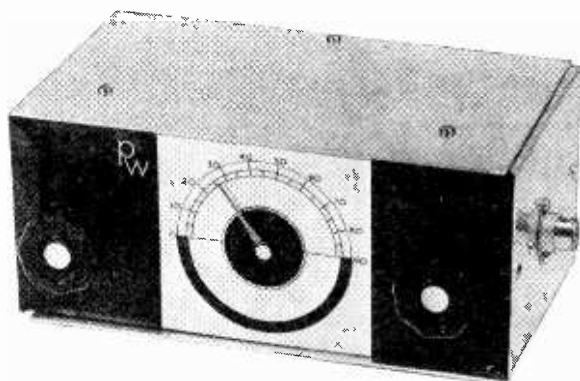

### TUNABLE CONVERTER

This is relatively simple, inexpensive and can be used over a wide band by adjusting the pre-set tuning. Though only two transistors are used, little gain is expected from an RF stage at these frequencies, so that sensitivity is quite good without this stage. An important advantage arises from the fact that the receiver can be tuned to a frequency where breakthrough of unwanted transmissions is minimal and tuning carried out on the converter. With the equipment used in this way, the receiver acts as a fixed tuned IF amplifier.

### CIRCUIT

This is shown in Fig. 1. The aerial feeder is connected to L1 while L2 is adjusted to the wanted band by trimmer TC1. As L2 tunes broadly TC1 need not be adjusted except when setting up for a different band. Tr2 is the local oscillator tuned by the 4.5pF variable capacitor VC1, operated by a cord drive. TC2 is a trimmer for the oscillator coil L5, with injection via C4 to gate 2 of the dual-gate mixer Tr1. (Gates 1 and 2 must not be reversed.)

Output from Tr1 goes to L3 which is tuned to about 10MHz. The coupling winding L4 provides a means of connecting a screened co-axial lead to the receiver, while the frequency of L3 can be adjusted by tuning its core for best signal strength

at around the receiver frequency to be used. The latter, of course, should be free from unwanted short wave signals.

### CIRCUIT BOARD

The components, with the exception of Tr1, are placed as shown in Fig. 2 and the board turned over so that their leads can be soldered. Two tags are bolted on at the point MC. All leads should be as short as reasonably practicable.

When wiring of this board is finished, with the exception of Tr1, take Tr1 and check that the collar, spring or binding of thin wire which shorts its four leads is present. Adjust the leads with a matchstick so that they come through the board as shown, and solder them. The means of shortening the four leads can then be removed. Touching the leads of Tr1 with a metal or plastic tool, or the fingers, can be expected to damage this transistor, until R1, R2 and R3 are connected, thereby protecting the insulated gates against static charges

### PANEL ASSEMBLY

The panel is a 7 x 3in flanged universal chassis member with VC1 mounted centrally. Fit the on-off switch and drive cord spindle at 2½in distance each

### ★ components list

#### TUNABLE CONVERTER

##### Resistors

R1 100kΩ	R5 1kΩ
R2 2.2kΩ	R6 10kΩ
R3 100kΩ	R7 10kΩ
R4 15Ω	All 5 or 10% ¼ or ½W

##### Capacitors

C1 22pF	C5 0.02μF
C2 1000pF	C6 1000pF
C3 39pF	C7 5pF
C4 5pF	C8 5000pF

All disc or tubular ceramic preferred  
 TC 1/2 30pF Philips type airspaced trimmer  
 VC1 4.5 pF variable (Jackson C804)

##### Semiconductors

Tr1 3N141	Tr2 BF200
-----------	-----------

##### Miscellaneous

L3, former ⅜in. dia. with core. Drum drive, 2½in. dia. with cord, spring and drive spindle (Home Radio). Casework, 7 x 4 x 3in. universal chassis with extra plate 7 x 4in. (Home Radio). Perspex 7 x 4in, approx ⅜in. thick. Knobs. Co-axial sockets (2). Veroboard 2 x ½in. 0.15in. Matrix. On-off switch. PP3 battery, terminal clips and holder.

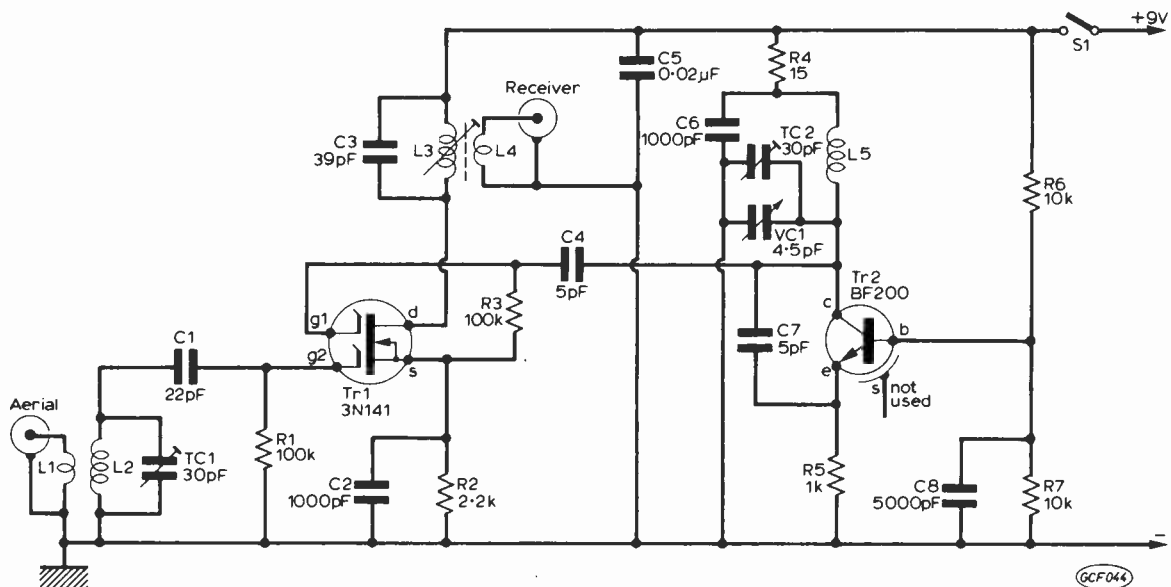

Fig. 1: Two transistors are the basis of this circuit for the tuned converter.

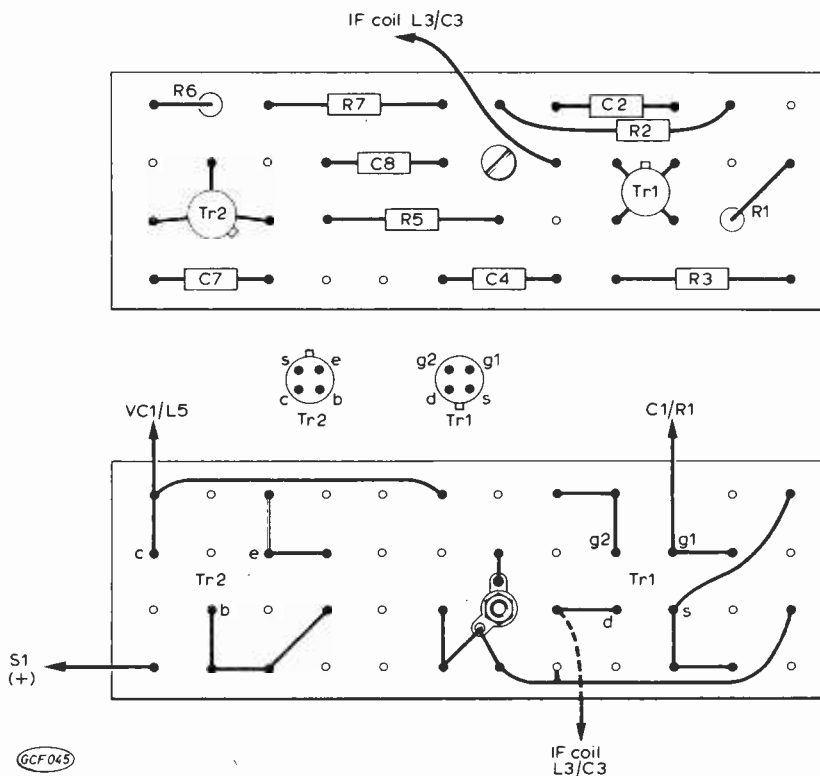

Fig. 2: Layout of components and wiring on the circuit board for Fig. 1.

from VC1. Set VC1 back by extra washers or an extra nut and the drive spindle forward by similar means. (If this is not done, insufficient spindle may project for the tuning knob.)

Solder TC2 directly to VC1 fixed plates and solder a stout wire about 1in long to the moving plates tag of VC1, letting it project backwards. Solder the MC tag of the board to this, as in Fig. 2 and make good other connections. Note that the board is horizontal, behind VC1 (as in the photograph of the

rear of the converter). The shortest possible leads are used to TC1, C1, L2, C6, L5 and TC2.

## COILS

L2 consists of 5 turns of 22 swg wire, formed by winding round an object  $\frac{1}{4}$ in in diameter, with its ends soldered directly to TC1. L1 comprises 2 turns of similar diameter, supported by taking one end to the co-axial aerial socket, and the other to a stout wire which runs from VC1 to MC, as shown in Fig. 3.

GCF046

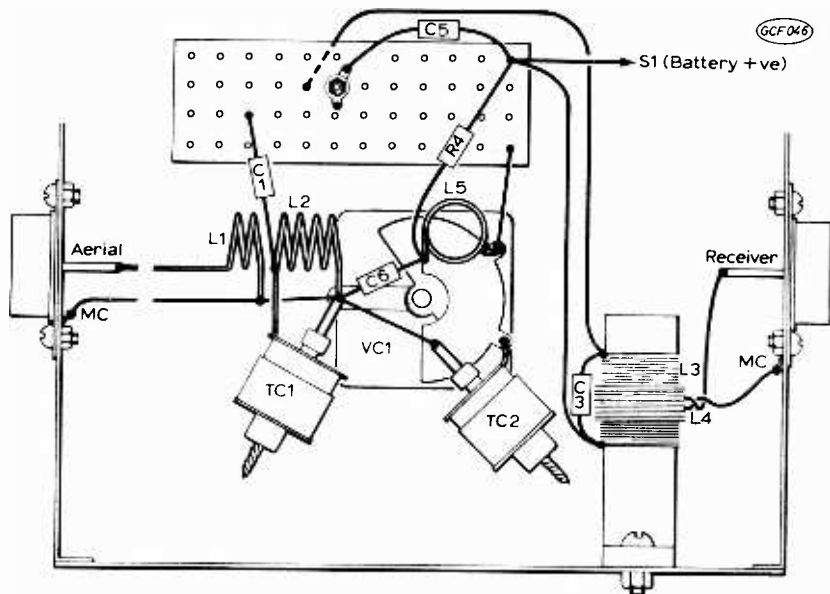
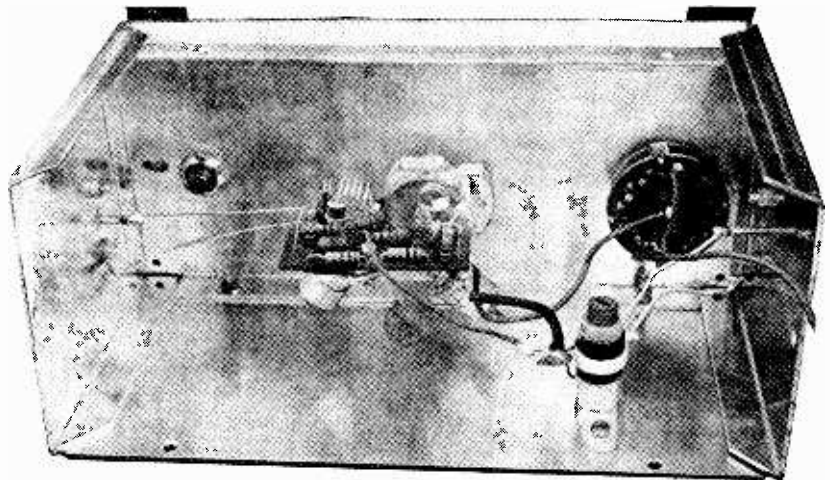

Fig. 3: Arrangement of components in the case. For clarity the circuit board is shown as being vertical. In fact, it is mounted horizontally over the tuning capacitor, as can be seen in the photograph below.

L5 is 13 $\frac{1}{4}$  turns, directly from VC1 to C6. Quite large changes in frequency can be obtained by TC1 and TC2, while for frequencies outside this limit of adjustment, L2 and L5 would have to be altered.

L3 consists of 21 turns, 24swg enamelled wire, close wound, near the top of the former. The ends only can be secured with thread or adhesive, noting that the whole winding should not be completely covered with adhesive. L4 is 4 turns of insulated connecting wire, wound on L3 as shown in Fig. 3.



## CASEWORK

Complete screening is required to avoid troublesome hand-capacity effects. The sides are each 4 x 3in flanged members; bottom and tops are 7 x 4in flat plates, the bottom being fixed with four 6BA bolts which also hold rubber feet. The top is secured with self-tapping screws. Note that the flanged member forming the panel is set back just sufficiently to give clearance for the drum and drive. The flanges have to be cut to allow for this.

Give the cord one complete extra turn round the driving spindle, take it round the drum and draw it tight, tying it with the drum spring under tension. The spindle of VC1 projects through a hole in a card, on which a scale is drawn. A pointer is fixed to VC1 by drilling a hole in the spindle and using a small self-tapping screw, although it could be fixed with adhesive.

A piece of Perspex, 7 x 3in, with holes to clear the switch and drive spindles, is bolted to the front flanges of the side members. The bottom, back and top of the case are not fitted until construction and wiring are finished.

## ADJUSTMENTS

TC2 is set to obtain the required band coverage with VC1 and TC1 adjusted for best volume with the receiver AGC switched off. L3 core is aligned for maximum output at the frequency to be used with the receiver. A co-axial lead with the outer braid earthed is used from converter to receiver and should be kept as short as possible.

A suitable aerial can be made from  $\frac{1}{4}$ in. to  $\frac{1}{2}$ in. diameter light alloy tubing. Two equal lengths are used, fixed with their inner ends about  $\frac{1}{2}$ in. apart in an insulated electrical junction box. A length of 75 $\Omega$  co-axial cable is taken from the box with the inner conductor connected to one element and the outer braid to the other element. A plug is then fitted to match the converter.

Such an aerial can be raised on a pole or mast, or otherwise fixed at a reasonable height. It will have little directivity, while giving reception over quite a wide band of frequencies. Length is not too important but if 2m reception is the primary aim, the aerial should be about 38in. to 39in. overall.

**Next month:—A crystal controlled converter**

# PW 'ASCOT' STEREO CASSETTE DECK

## PART 2

KEITH CUMMINS & TONY FRANCIS\*

### PLAYBACK

The input and equalisation stages of the playback amplifier are almost identical to those employed in the car cassette player described earlier in this magazine. Instead of driving an output stage, however, the equalisation stage feeds a noise limiting circuit, the output from which is taken to an external power amplifier at suitable level. The circuit of this section is shown in Fig. 5.

Incoming signals from the record/playback head are conveyed to the base of Tr10 by C20. R31 and R32 are the base biasing resistors. The input amplifier is of the complementary type, DC feedback being established by the network R34, R33, AC feedback is set by the ratio of R34:R35 and so the gain is defined at approximately 100. The signal is conveyed to the equalisation stage via C24 and the "set level" pot VR4. This pot is provided so that the gains of the channels can be equalised and set at the correct level for optimum operation of the noise limiter circuit.

The equalisation stage consists of Tr12, Tr13 and Tr14, the first two forming another complementary stage and the latter an emitter follower. DC feedback to stabilise the working point is applied via R40 and R39, following the same technique as before. The equalisation network consists of C26, C27 and R42, and feeds back from the emitter follower Tr14 to the emitter of Tr12.

Those who have read the previous articles referred to will recall that the equalisation network is necessary to correct the velocity characteristic of the tape



replay, that is, every time the frequency doubles, so does the output. This results from the fact that should the frequency double, twice as many molecular magnets are passing the replay head at a given instant, and consequently the rate of change of flux is doubled. As the induced voltage is directly proportional to the rate of change of flux, it follows that the voltage will also be double.

The process of recording and playback equalisation is actually somewhat more complex than this brief description would indicate; head losses at high frequencies result in the output first rising, then falling again. This is why we emphasise the highest frequencies during the recording process.

### NOISE REDUCTION

The output from Tr14 emitter is DC-coupled to the noise limiter circuit. The noise limiter employs transistors Tr16 and Tr15, the latter providing the output from the machine.

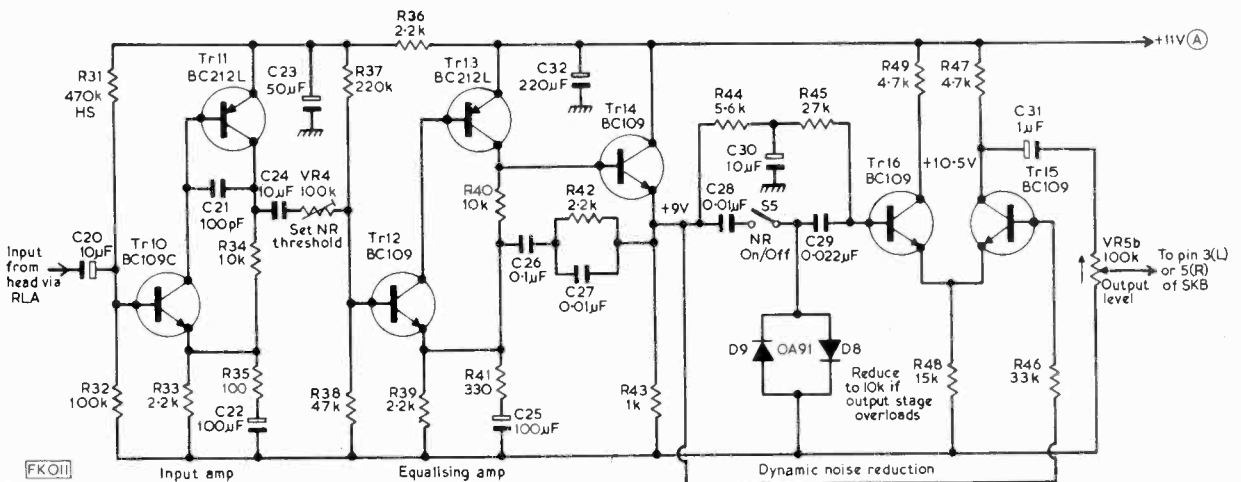

Fig. 5: One channel of the input, equalisation and noise limiting stages.

The noise limiter acts as a low pass filter which operates in the absence of high frequency signals. High frequency noise, which occurs in quiet musical passages, or between items, is therefore reduced. Before we discuss the operation of the circuit, we must first establish the principles involved, and the reader is referred to Fig. 6.

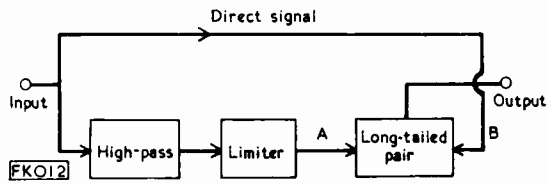

Fig. 6: Block diagram showing the linking of the stages of Fig. 5.

The signal is split into two parts, one containing high frequencies only. Each of these parts is taken to a long-tailed pair circuit, which in our application has two inputs and one output. If the same signal is applied to both inputs of the long-tailed pair no output occurs and the inputs are said to be in common mode. Antiphase signals, or signals appearing at one input only, appear at the output.

High frequency low level signals (principally tape hiss) are present in the direct signal applied to input B of the long-tailed pair. These signals are also present at the input A, since they come from the same source, and have passed through the high-pass filter. Because they are of low amplitude, they are unaffected by the limiter and so arrive at input A to produce the same signal at both inputs. As a result, no significant output is produced from the long-tailed pair and the hiss is effectively reduced.

Higher level high frequency signals are limited by the limiter circuit, after passing through the filter, and so cannot appear at their correct amplitude at input A to the long-tailed pair. Consequently, cancellation does not take place and the high frequency signals are present in the output. The circuit can be switched out by opening the signal path to the high-pass filter.

Now to the circuit in detail (Fig. 5). The long-tailed pair consists of Tr16 and Tr15. The non-processed direct signal is taken via R46 to the base of Tr15. The high-pass characteristic required for the input

to Tr16 base is achieved by inserting C28 and C29 in the signal path. The bias for Tr16 is provided via R44 and R45 (totalling the same value as R46), but the signal is decoupled via C30.

The junction of the capacitors C28 and C29 is taken to the limiter diodes D9 and D8. The diodes only start to have an effect when the applied signal exceeds about 200mV, so limiting takes place above this level. The halves of the long-tailed pair are basically identical, except that the collector of Tr15 is used to provide the source of output. The emitter circuit is common to both Tr16 and Tr15. It is essential, if a long-tailed pair is to have a high common-mode rejection, for the AC impedance of the emitter circuit to be high. This is achieved by using a large value resistor, but of course this implies that a high emitter voltage will be needed so that the rest of the circuit can operate correctly. For this reason, the output of Tr14 is centred on +9V.

The output signal is taken from Tr15 collector via C31 and applied to the output level control pot VR5. The signal is taken from VR5 slider to the output DIN socket [pins 3(L) and 5(R) for stereo]. The output is then adjusted to suit the amplifier being used.

Note that while the bias oscillator and power supply circuits are common to the two stereo channels, the record and playback circuits each have to be duplicated, hence two sets of components are needed for each of the circuits shown in Figs. 4 and 5.

## MOTOR CONTROL

The motor control board contains circuits for two basic functions, motor speed regulation and automatic stopping of the machine at the end of a cassette.

We shall deal first with the motor speed control. It will be seen from the circuit diagram (Fig. 7) that the motor is fed from the nominal 12V supply line via transistor Tr19 and resistors R55, R56 and R58. The base current for Tr19 is formed by the collector current of Tr18, the sensing transistor.

When power is supplied to the system, by inserting a cassette, a potential of just under two volts appears at the junction of resistors R53 and R54. This potential is applied, via diode D10, to the base of Tr18, so

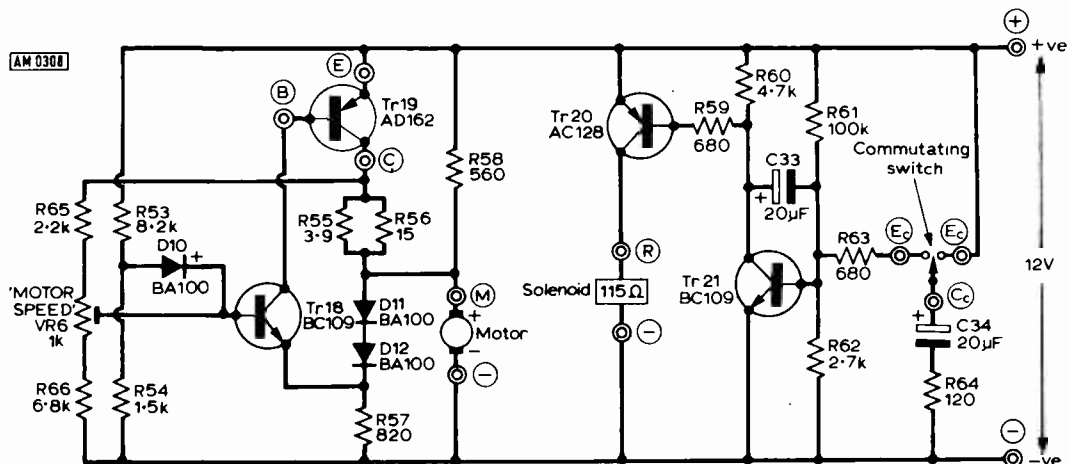

Fig. 7: Circuit of the motor control board. This is identical to that used in the 'Kempton' cassette player (Dec. 74).

turning this transistor on. Collector current flowing in Tr18 provides the base current to turn Tr19 on and the resultant current flows into the motor via R55 and R56 in parallel. The motor starts to turn and diodes D11 and D12 conduct, so clamping the emitter of Tr18 at a fixed voltage negative with respect to the positive side of the motor.

This action results in the emitter of Tr18 moving positive, but the base also moves positive since the collector of Tr19 is connected to Tr18 base via network R65, VR6 and R66. As a consequence, D10 becomes reverse-biased, so disconnecting the starting circuit, R53, R54 from Tr18 base. The emitter-base bias on Tr18 is now a function of the voltage developed across R55 and R56, since the top end of these resistors feeds the base circuit, while the bottom end is clamped to the emitter of Tr18 via D11 and D12.

If the motor load increases, so does its current drain. As a result, the voltage drop across R55 and R56 increases, so increasing the forward bias on Tr18. The increase in Tr18 collector current increases the flow of current in Tr19, so applying more power to the motor to compensate for its increase in load. If the load decreases, the process operates in reverse. Likewise, changes in the supply voltage are accommodated since the only reference required is the measure of current through the resistors in series with the motor, and the apparent DC resistance of Tr19 is adjusted accordingly.

The running speed of the motor is set by VR6 which varies the preset forward bias applied to Tr18. R58 provides a bleed current through the motor in the starting condition and also shunts Tr19, reducing its dissipation.

## ★ components list

### MOTOR CONTROL BOARD

#### Resistors

R53 8.2k $\Omega$	R58 560 $\Omega$	R63 680 $\Omega$
R54 1.5k $\Omega$	R59 680 $\Omega$	R64 120 $\Omega$
R55 3.9 $\Omega$	R60 4.7k $\Omega$	R65 2.2k $\Omega$
R56 15 $\Omega$	R61 100k $\Omega$	R66 6.8k $\Omega$
R57 820 $\Omega$	R62 2.7k $\Omega$	

R55 and R56 are  $\frac{1}{4}$ W, remainder  $\frac{1}{2}$ W 5%  
VR6 1k $\Omega$  miniature preset

#### Capacitors

C33 and C34 22 $\mu$ F 25V electrolytic

#### Semiconductors

D10, 11, 12 BA100 Tr18, 21 BC109 Tr19 AD162  
Tr20 AC128

#### Miscellaneous

Mounting kit for Tr19. Veroboard 3 x 1.4in. 0.1in. matrix

charging of the capacitor. Under these circumstances C33 would eventually become fully charged, and the current would stop flowing, so de-energising the solenoid and releasing the latch. However, this process is not allowed to complete.

## LATCHING

As soon as the cassette is inserted, the motor starts to move the tape, and the commutating switch commences operation. C34 is alternatively charged from the 12V supply, and discharged via R63 into

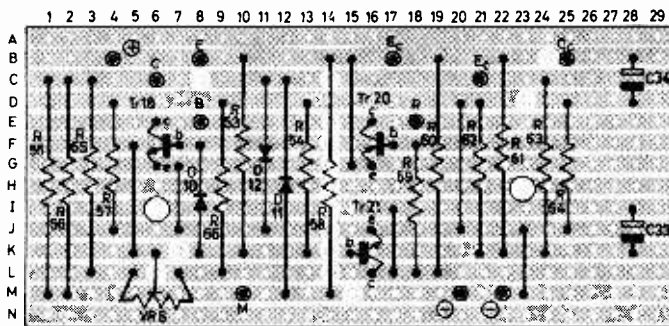

Track breaks required at:-  
B24; C8,14; D23; E14; F14; G14;  
H14; I14; J14; K7,14; L6,14; M15

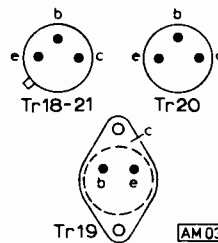

Fig. 8: Component layout of the motor control board, shown here larger than actual size.

## AUTO STOP

Now we come to the autostop mechanism. When the cassette is pushed in, it will only hold in provided the solenoid is energised, to operate the latch. The solenoid is controlled by transistor Tr20. Attached to the cassette feed-spool hub is a commutating switch, below the deck, which constantly switches a common contact between the others provided the hub is rotating.

When power is applied to the circuit by inserting a cassette, capacitor C33 charges via R60, R59 and the base circuits of both Tr20 and Tr21. The resultant collector current in Tr20 energises the solenoid to hold the latch. The flow of collector current in Tr21 reduces the charging voltage applied to C33, so forming a "Miller integrator" circuit linearising the

base of Tr21. The process is integrated by C33 so that a constant hold-in current flows through the solenoid. R64 is included to prevent excessive charging current in C34, with the attendant risk of contact wear and electrical interference.

When the cassette comes to the end, the feed hub stops rotating, and with it the commutating switch. As a result, no current pulses are fed into the base of Tr21, and C33 reaches its point of maximum charge. Current flow in the transistors then ceases, so de-energising the solenoid. The latch drops out releasing the deck mechanism and the cassette is ejected.

Obviously, any attempt to re-insert the cassette without turning it over will be fruitless, since the

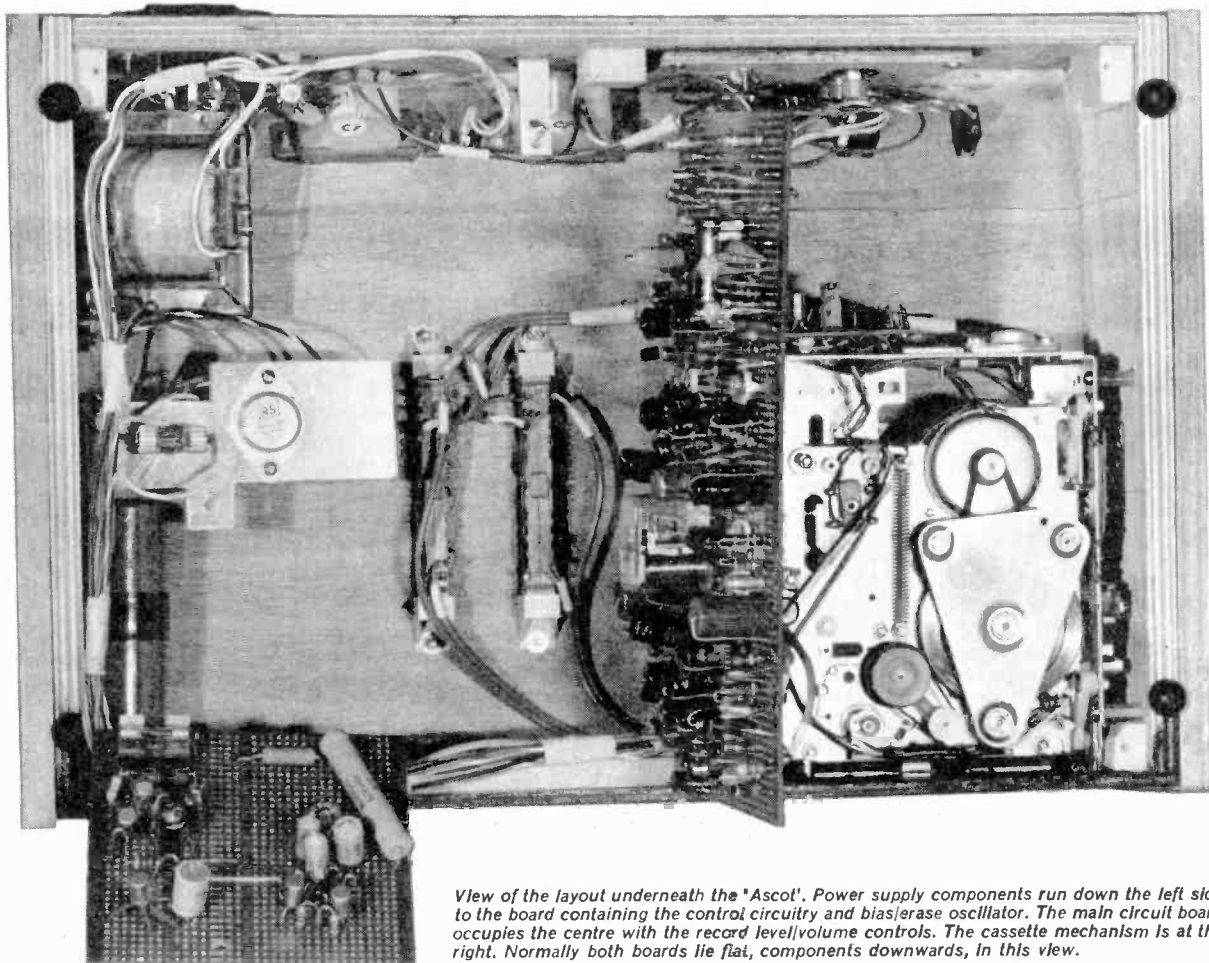

*View of the layout underneath the "Ascot". Power supply components run down the left side to the board containing the control circuitry and bias/erase oscillator. The main circuit board occupies the centre with the record level/volume controls. The cassette mechanism is at the right. Normally both boards lie flat, components downwards, in this view.*

commutating switch will be inoperative and the cassette will be promptly ejected again.

## CONSTRUCTION

The motor control board, Fig 8, is quite straightforward but take care to cut the tracks in the correct places. When completed, the board is mounted on the rear panel of the cassette mechanism in the position shown in the photograph. Nylon nuts and bolts should be used to avoid shorting or earthing any of the tracks.

The rear panel also acts as the heatsink for Tr19 and is supplied already punched with the necessary pattern of holes. An insulating mounting kit must be used for this transistor.

**Part 3, next month, will deal with the construction of the circuit boards, cabinet and general wiring.**

# points arising...

## ELECTRONIC HOME TELEPHONE EXCHANGE

Feb. 1975. In Fig. 6 page 895 the diode D10 is shown reversed. The bar (+) should go to the +7V line. Note:— the diode is shown correctly on the pcb layout, Fig. 10 page 898.

Also in Fig. 6 the line numbers 1 to 9 are in reverse order, should be 9 at top, down to 1. Relay contacts RLB1 to RLJ1 are in reverse order, should be RLJ1 at top, down to RLB1. The pcb layout is correct, Fig. 10, and these discrepancies do not affect the correct operation of the exchange.

In Fig. 10 C5 polarity is incorrect, the positive side should be at the right, pin 10 IC3. There should be a link between the two pads immediately left of IC2, pin 10 to earth.



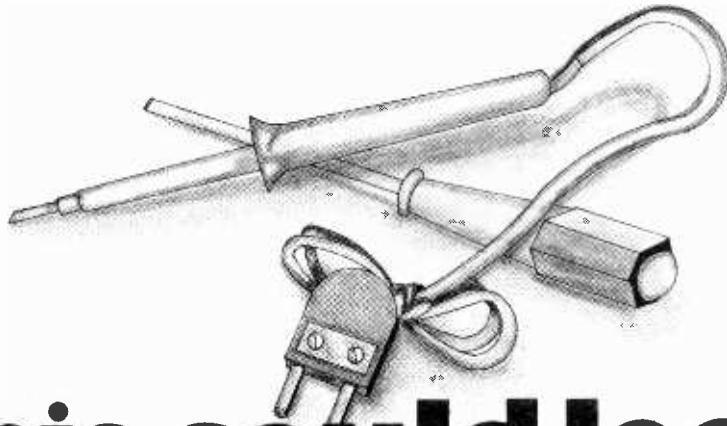

# This could lead to something big.

A soldering iron and a screw driver. If you know how to use them, or at least know one end from the other, you know enough to enrol in our unique home electronics course.

This new style course will enable anyone to have a real understanding of electronics by a modern, practical and visual method. No previous knowledge is required, no maths, and an absolute minimum of theory.

You build, see and learn as, step by step, we take you through all the fundamentals of electronics and show you

how easily the subject can be mastered and add a new dimension not only to your hobby but also to your earning capacity.

This course is accepted by and used in a large number of schools and colleges and forms an invaluable grounding for professional training in the subject. All the training is planned to be carried out in the comfort of your own home and work in your own time. You send them in when you are ready and not before. These culminate in a final test and a certificate of success.

**1**

## Build an oscilloscope.

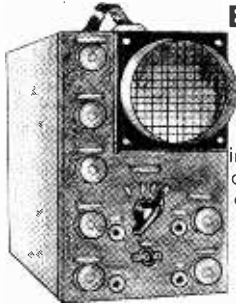

As the first stage of your training, you actually build your own Cathode ray oscilloscope! This is no toy, but a professional test instrument that you will need not only for the course's practical experiments, but also later if you decide to develop your knowledge and enter the profession. It remains your property and represents a very large saving over buying a similar piece of essential equipment.

**2**

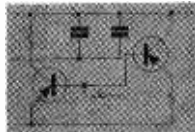

## Read, draw and understand circuit diagrams.

In a short time you will be able to read and draw circuit diagrams, understand the very fundamentals of television, radio, computers and countless other electronic devices and their servicing procedures.

**3**

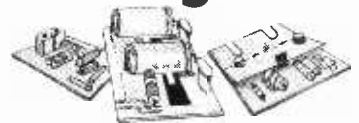

## Carry out over 40 experiments on basic circuits.

We show you how to conduct experiments on a wide variety of different circuits and turn the information gained into a working knowledge of testing, servicing and maintaining all types of electronic equipment, radio, t.v. etc.

**PLUS**



## FREE GIFT!

ALL STUDENTS ENROLLING IN OUR COURSES RECEIVE A FREE CIRCUIT BOARD ORIGINATING FROM A COMPUTER AND CONTAINING MANY DIFFERENT COMPONENTS THAT CAN BE USED IN EXPERIMENTS AND PROVIDE AN EXCELLENT EXAMPLE OF CURRENT ELECTRONIC PRACTICE

To find out more about how to learn electronics in a new, exciting and absorbing way, just clip the coupon for a free colour brochure and full details of enrolment.

WAA

Brochure without obligation to:  
**BRITISH NATIONAL RADIO & ELECTRONICS SCHOOL**, Dept WL35  
**P.O. Box 156, Jersey, Channel Islands.**

NAME.....  
 ADDRESS.....  
 .....

(Block caps please)



GIRO NO. 331 7056. Access accepted.  
C.W.O. only, P. & P. 10p on orders below £5  
Discount: £10-10%, £20-15% (except net items)  
Export Order enquiries welcome (VAT free)

Official Orders accepted from  
Educational & Government Departments  
ALL PRICES INCLUDE VAT AT 8%

**SPECIAL RESISTOR KITS** (Prices include post & packing)

10E12  $\pm$ W KIT: 10 of each E12 value, 22 ohms—1M, a total of 570 (CARBON FILM 5%), £3.58 net  
10E12  $\pm$ W KIT: 10 of each E12 value, 22 ohms—1M, a total of 570 (CARBON FILM 5%), £3.77 net  
25E12  $\pm$ W KIT: 25 of each E12 value, 22 ohms—1M, a total of 1425 (CARBON FILM 5%), £8.19 net  
25E12  $\pm$ W KIT: 25 of each E12 value, 22 ohms—1M, a total of 1425 (CARBON FILM 5%), £8.28 net  
5E12  $\pm$ W KIT: 5 of each E12 value, 10 ohms—1M, a total of 305 (METAL FILM 5%), £2.80 net  
Due to current world shortages, resistor kits may contain some wattage and value substitutions.

**MULLARD POLYESTER CAPACITORS C280 SERIES**  
250V P.C. Mounting: 0.01 $\mu$ F, 0.015 $\mu$ F, 0.022 $\mu$ F, 0.033 $\mu$ F, 0.047 $\mu$ F, 0.068 $\mu$ F, 0.1 $\mu$ F, 0.15 $\mu$ F, 0.22 $\mu$ F, 0.33 $\mu$ F, 0.47 $\mu$ F, 0.68 $\mu$ F, 1.0 $\mu$ F, 1.5 $\mu$ F, 2.2 $\mu$ F, 3.3 $\mu$ F, 4.7 $\mu$ F, 6.8 $\mu$ F, 10 $\mu$ F, 15 $\mu$ F, 22 $\mu$ F, 33 $\mu$ F, 47 $\mu$ F, 68 $\mu$ F, 100 $\mu$ F, 150 $\mu$ F, 220 $\mu$ F, 330 $\mu$ F, 470 $\mu$ F, 680 $\mu$ F, 1.0K, 1K5, 2K2, 3K3, 4K7, 6K8, (1 $\mu$ F) 0.01, 0.015, 0.022, 0.033, 0.047, 0.068, 0.1, 0.15, 0.22, 0.33, 0.47, 0.68, 1.0, 1.5, 2.2, 3.3, 4.7, 6.8, 10, 15, 22, 33, 47, 68, 100, 150, 220, 330, 470, 680, 1000, 1500, 2200, 3300

**MULLARD POLYESTER CAPACITORS C296 SERIES**  
400V: 0.01 $\mu$ F, 0.015 $\mu$ F, 0.022 $\mu$ F, 0.033 $\mu$ F, 0.047 $\mu$ F, 0.068 $\mu$ F, 0.1 $\mu$ F, 0.15 $\mu$ F, 0.22 $\mu$ F, 0.33 $\mu$ F, 0.47 $\mu$ F, 0.68 $\mu$ F, 1.0 $\mu$ F, 1.5 $\mu$ F, 2.2 $\mu$ F, 3.3 $\mu$ F, 4.7 $\mu$ F, 6.8 $\mu$ F, 10 $\mu$ F, 15 $\mu$ F, 22 $\mu$ F, 33 $\mu$ F, 47 $\mu$ F, 68 $\mu$ F, 100 $\mu$ F, 150 $\mu$ F, 220 $\mu$ F, 330 $\mu$ F, 470 $\mu$ F, 680 $\mu$ F, 1.0K, 1K5, 2K2, 3K3, 4K7, 6K8, (1 $\mu$ F) 0.01, 0.015, 0.022, 0.033, 0.047, 0.068, 0.1, 0.15, 0.22, 0.33, 0.47, 0.68, 1.0, 1.5, 2.2, 3.3, 4.7, 6.8, 10, 15, 22, 33, 47, 68, 100, 150, 220, 330, 470, 680, 1000, 1500, 2200, 3300

**MINIATURE CERAMIC PLATE CAPACITORS**  
50V: (PF) 22, 27, 33, 39, 47, 56, 68, 82, 100, 120, 150, 180, 220, 270, 330, 390, 470, 560, 680, 820, 1K, 1K5, 2K2, 3K3, 4K7, 6K8, (1 $\mu$ F) 0.01, 0.015, 0.022, 0.033, 0.047, 0.068, 0.1, 0.15, 0.22, 0.33, 0.47, 0.68, 1.0, 1.5, 2.2, 3.3, 4.7, 6.8, 10, 15, 22, 33, 47, 68, 100, 150, 220, 330, 470, 680, 1000, 1500, 2200, 3300

**POLYSTYRENE CAPACITORS 160V 5%**  
(PF) 10, 15, 22, 33, 47, 68, 100, 150, 220, 330, 470, 680, 1000, 1500, 2200, 3300, 4700, 6800, 10,000, 47p.

**RESISTORS**

CF—High Stab Carbon Film, 5%	MF—High Stab Metal Film, 5%	Size mm
W. Type Range	1-99	100-499
1	0.75	0.60
2	0.75	0.60
3	0.75	0.60
4	1.54	1.32
5	1.54	1.21
6	1.98	1.81
7	3.52	3.08
8	3.52	3.08
9	3.52	3.08

For value mixing prices, please refer to our catalogue. (price in pence each).  
VALUES AVAILABLE—E12 Series only. (Net prices above 100.)

**PRESET SKELETON POTENTIOMETERS**

MINIATURE 0-25V Vertical or horizontal 6p each 1K, 2K2, 4K7, 10K, etc. up to 1M  $\Omega$   
SUB-MIN 0-05V Vertical, 100  $\Omega$  to 220K  $\Omega$  5p each.

**B. H. COMPONENT FACTORS LTD.** (P.W.) 59 NORTH STREET, LEIGHTON BUZZARD, BEDS. Tel.: LEIGHTON BUZZARD 2316 (STD Code 05253) CATALOGUE No. 3 20p

**Miniature Mullard Electrolytics**

1.0 $\mu$ F 63V	61p	68 $\mu$ F 16V	61p
1.5 $\mu$ F 63V	61p	68 $\mu$ F 63V	12p
2.2 $\mu$ F 63V	61p	100 $\mu$ F 10V	61p
3.3 $\mu$ F 63V	61p	100 $\mu$ F 25V	61p
4.7 $\mu$ F 63V	61p	100 $\mu$ F 63V	14p
6.8 $\mu$ F 63V	61p	150 $\mu$ F 16V	61p
8.2 $\mu$ F 63V	61p	150 $\mu$ F 63V	15p
10 $\mu$ F 63V	61p	220 $\mu$ F 6V	61p
10 $\mu$ F 16V	61p	220 $\mu$ F 16V	61p
10 $\mu$ F 25V	61p	220 $\mu$ F 63V	21p
15 $\mu$ F 63V	61p	330 $\mu$ F 16V	12p
15 $\mu$ F 16V	61p	330 $\mu$ F 63V	25p
15 $\mu$ F 25V	61p	470 $\mu$ F 6V	9p
22 $\mu$ F 63V	61p	470 $\mu$ F 40V	20p
22 $\mu$ F 16V	61p	680 $\mu$ F 16V	15p
22 $\mu$ F 25V	61p	680 $\mu$ F 40V	25p
33 $\mu$ F 63V	61p	1000 $\mu$ F 16V	20p
33 $\mu$ F 16V	61p	1000 $\mu$ F 25V	25p
33 $\mu$ F 25V	61p	1500 $\mu$ F 6V	15p
47 $\mu$ F 63V	61p	1500 $\mu$ F 16V	25p
47 $\mu$ F 16V	61p	2200 $\mu$ F 10V	25p
47 $\mu$ F 25V	61p	3300 $\mu$ F 6V	26p

**VEROBOARD 0-1 0-15**

2 1/2 x 5"	36p	36p
2 1/2 x 5"	32p	32p
3 1/2 x 5"	42p	46p
3 1/2 x 3"	36p	36p
3 1/2 x 3"	9p	9p
2 1/2 x 5" (Plain)	—	19p
5 x 3 1/2" (Plain)	—	19p
Insertion tool	73p	73p
Track Cutter	59p	59p
Pins, Pkt. 25	22p	22p

**TRANSISTORS**

AC127	16p	BC212L	12p
AC128	21p	BC213L	12p
BC107	12p	BC214L	17p
BC108	12p	OC44	18p
BC109	13p	OC71	13p
BC148	12p	OC81	16p
BC149	12p	OC170	23p
BC182L	12p	TS143	33p
BC183L	12p	2N2926	11p
BC184L	13p	2N3702	11p

**POTENTIOMETERS**

Carbon Track 5K  $\Omega$  to 2M  $\Omega$ , log or lin (and 1K lin). Single, 16p Dual Gang 46p. Log single with switch 26p. Slider Pots. 10K, 100K, 500K, semi log 30mm, 34p, 45mm, 47p, 60mm, 55p.

**DIODES**

IN4001	61p
IN4002	71p
IN4003	9p
IN4004	90p
IN4005	12p
IN4006	14p
IN414	7p
IN916	7p
BA100	10p
OA5	42p
OA47	9p
OA81	11p
OA200	8p

**PLUGS**

DIN 3 Pin	12p
5 Pin 180°	20p
Std. Jack	26p
2.5mm jack	13p
Phone	6p

**SOCKETS**

DIN 2 Pin	10p
3 Pin	10p
5 Pin 180°	12p
Std. Jack	15p
2.5mm Jack	13p
Phone	6p

**ELECTROLYTIC CAPACITORS. Tubular & Large Cans**  
(1 $\mu$ F/V): 1/25, 2/25, 4/25, 4/710, 5/25, 8/25, 0/10, 10/50, 16/25, 22/6, 25/25, 25/50, 32/25, 50/25, 100/10, 100/25, 61p, 50/50, 8p, 100/50, 20/25, 11p, 250/50, 18p, 500/10, 11p, 500/25, 15p, 500/50, 18p, 1000/10, 20p, 1000/25, 22p, 1000/50, 40p, 2000/10, 20p, 1000/100, 88p, 2000/25, 30p, 2000/100, 93p, 2500/25, 38p, 2500/50, 61p, 5000/25, 65p, 5000/50, £1.08.

**HI-VOLT:** 4/350, 14p, 8/350, 19p, 100/100, 20p, 16/350, 22p, 16/450, 23p, 32/350, 33p, 50/250, 20p, 100/250, 30p.

**METALLISED PAPER CAPACITORS**  
250V: 0.05 $\mu$ F, 0.1 $\mu$ F, 6p, 0.25, 6p, 0.5 $\mu$ F, 71p, 1 $\mu$ F, 9p, 500V: 0.025, 0.05, 6p, 0.1, 6p, 0.25, 71p, 0.5, 9p, 1000V: 0.01, 0.025, 0.05, 0.1 $\mu$ F. £1.10 net.

**STOP PRESS**  
Our Retail Shop is now open at 59 North St., Leighton Buzzard

Screened Wire, Metre 61p  
Twin Screened Wire, Metre 12p  
Stereo Screened Wire, Metre 24p  
Connecting Wire, All colours, Metre 21p  
Neon Bulb, 90V Wire Ended 5 for 24p  
Panel Neon. 240V Red, Amber, Clear 20p

**NEW KIT**  
5E12  $\pm$ W Metal Film. 5 each value 10 $\Omega$ -1M, total of 305 £3.77

**MULTIMETER U4322**  
22 Ranges plus AF/IF Oscillator 20,000 $\Omega$ /Volt.  
Vdc—0.5—1000V in 7 ranges  
Vac—2.5—1000V in 6 ranges  
Idc—0.05—500mA in 6 ranges  
Resistance—5 $\Omega$ —1M $\Omega$  in 4 ranges.  
Accuracy—5% of F.S.D.  
OSCILLATOR—1 KHz and 465 KHz (A.M.) at approx. 1 Volt.  
Size—160 x 97 x 40mm.  
Supplied complete with carrying case, test leads and battery.  
PRICE £8.30 net p & p 25p.

**MULTIMETER U4341**  
27 Ranges plus Transistor Tester, 16,700 $\Omega$ /Volt. Overload protected.  
Vdc—0.5—1000V in 8 ranges.  
Vac—1.5—750V in 6 ranges.  
Idc—0.06—600mA in 5 ranges.  
Iac—0.3—300mA in 4 ranges.  
Resistance—2K $\Omega$ —2M $\Omega$  in 4 ranges.  
Accuracy—dc—2 1/2%, ac—4% of F.S.D.  
Hc—10—350 in 2 ranges.  
Size—115 x 215 x 90mm.  
Complete with steel carrying case, test leads, and battery.  
PRICE £11.30 net p & p 30p.

**NEW CAPACITOR KITS**  
C280 Kit—PC Mounting polyester 250V. 5 of each value: 0-01, 0-022, 0-047, 0-1, 0-22 $\mu$ F. 2 of 0-47, 1 $\mu$ F. £1.30 net.  
C296 Kit—Tubular polyester, 400V. 5 of each value: 0-01, 0-022, 0-047, 0-1, 0-22 $\mu$ F. 2 of 0-47 $\mu$ F. £1.30 net.  
Ceramic Kit—square plaquette 50V. 5 each value: 22, 33, 47, 100, 220, 330, 470, 1000PF, 2200, 4700PF, 0-01 $\mu$ F. £1.30 net.  
250V Paper Kit—Tubular metal case. 3 of each value: 0-05, 0-1, 0-25, 0.5, 1 $\mu$ F. 90p net.  
500V Paper Kit—Tubular metal case. 3 of each value: 0-025, 0-05, 0-1, 0-25, 0.5 $\mu$ F. 90p net.  
1000V Paper Kit—Tubular metal case. 3 of each value: 0-01, 0-025, 0-05, 0-1 $\mu$ F. £1.10 net.

**MULTIMETER U4324**  
34 Ranges. High sensitivity. 20,000 $\Omega$ /Volt. Overload protected.  
Vdc—0.6—1200V in 9 ranges.  
Vac—3—900V in 8 ranges.  
Idc—0.06—3A in 6 ranges.  
Iac—0.3—3A in 5 ranges.  
Resistance—25 $\Omega$ —5M $\Omega$  in 5 ranges.  
Accuracy—dc and R—2 1/2% of F.S.D.  
ac and dB—4% of F.S.D.  
Size—167 x 98 x 63mm.  
Supplied complete with storage case, test leads, spare diode, and battery.  
PRICE £9.95 net p & p 25p.

**MULTIMETER U4313**  
33 ranges. Knife edge with mirror scale. 20,000 $\Omega$ /Volt. High accuracy. mVdc—5mV.  
Vdc—1.5—600V in 9 ranges.  
Vac—1.5—600V in 9 ranges.  
Idc—60—120 microamps in 2 ranges.  
Idc—0.6—1500mA in 6 ranges.  
Iac—0.6—1500mA in 6 ranges.  
Resistance—1K $\Omega$ —1M $\Omega$  in 4 ranges.  
dB scale—10 to +12db.  
Accuracy—dc—1 1/2%, ac—2 1/2%  
Size—115 x 215 x 90mm.  
Complete with steel carrying case, test leads, and battery.  
PRICE £13.40 net p & p 30p.

**S-DeC**  
S-DeC £2.14  
T-DeC £3.92  
 $\mu$ DeC "A" £4.30  
 $\mu$ DeC "B" £4.30  
2 DeC £7.53  
£4.72

**ANTEX**  
CCN240 £2.43  
CN240 £2.01  
X25 £3.01

**MULTIMETER U435**  
32 Ranges, High Sensitivity 20,000 $\Omega$ /Volt.  
Vdc—75mV—1000V in 8 rgs.  
Vac—2.5—1000V in 7 rgs.  
Idc—0.01—2.5A in 6 rgs.  
Iac—0.005—2.5A in 5 rgs.  
Resistance—3-300K in 3 rgs.  
Capacitance scale 0-0-5 $\mu$ F  
Accuracy—dc and R—2 1/2% of F.S.D.  
ac and C—4% of F.S.D.  
Size—205 x 110 x 84mm  
COMPLETE WITH STEEL CARRYING CASE, TEST LEADS AND BATTERY  
PRICE £9.45 net p & p 25p

**FELSTEAD ELECTRONICS (PW89), LONGLEY LANE, GATLEY, CHESHIRE SK8 4EE**  
STYL. Replacements for virtually all ACOS, BSR, COLLARO, GARRARD, PHILIPS, RONETTE, BONOTONE. Single Tip: Sapphire 18p, Diamond 37p. Double Tip: Can be Stereo/LP +78 or ST/LP Sapphire 37p. Double Tip: Diamond ST/LP +Sapphire 78 68p. Diamond ST/LP +Diamond ST/LP £1.25. For GOLDRING Diamond 080H (800H) and 0850 at £2.10 each. (800E at £4.10. Charges 10p any quantity FREE LIST (FOR SAE) FULL DETAILS STYL and CARTRIDGE EQUIVALENTS including SHURE, PICKERING, AUDIO-TECH, B & O, AND MANY MORE STYL FOR MAGNETIC AND CRYSTAL PICK-UPS.  
CARTRIDGES. All with styl and fittings. Replacements for ACOS GP/91 8C (Stereo—mono compatible series) at £1.20, GP/93 Stereo at £1.80, GP/94 Stereo Ceramic at £2.20. Actual (P87-2, Front switch at £1.10, for BSR 23H, X5H and X5M at £1.50 each, NK5H and SK5M at £1.80 each. TCSH at £1.80. TCS Stereo, 3 pins £2.30; charges 10p any quantity.  
RECORDING TAPE. ALL FINEST BRITISH MYLAR 6" 600ft. 40p. 5" 900ft. 60p. 5 1/2" 1200ft. 84p. 7" 1800ft. £1.10. Charges for 6" and 6 1/2". 1-4 13p each; 5 and over, 35p the lot. Charges for 7". 1-3 15p each, 4-3 35p the lot, 6 and over 40p the lot.  
SPEAKERS 2 1/2", 3, 8 or 64 ohms (state which) 55p. Charges 10p each.  
CONNECTING WIRE. Pkts of 5 coils, ass't. coils each 5yds. Solid core 10p Flexible 21p (Charges 10p per pack).  
EARPIECES. Magnetic 2-5mm or 3-5mm plus (state which) 15p. CRYSTAL (3-5mm only) 35p (all 10p up to 6).  
VIBRATORS. 7 pin SYNCL (128R7 type) 75p. 4-pin NON-synch (121HD4) 45p (all 10p each).  
Send SAE for free styl, cartridge, accessories and components list. All prices include VAT.

**ELECTRONI-KIT**

"... educational kits of exceptional quality" (AUDIO mag. Dec. 1974)

**BUILD AND REBUILD ANY NUMBER OF TIMES:**  
Radios, microphones, burglar alarms, Inter-comms, ferrite detectors, solar cell, photoelectric cell, voice relay, electronic cats, birds, guns, organs, illuminometers, voltmeters, meters of all types, etc., etc., plus your own circuit designs.

**COMPLETELY SAFE—** suitable for all, from beginners on. 30 different projects £10-45, 100 £20-45, 150 £33-95.  
Prices include Manuals, Battery, p & p, VAT, etc. Cheque/PO (or 7p for catalogues) to DEPT. PW.

Satisfaction guaranteed  
**ELECTRONI-KIT LTD, 408 St. John's Street, London, EC1. [01-278 4579]**

# IC OF THE MONTH

Number 50

Fairchild  $\mu$ A720 AM Receiver

THE Fairchild  $\mu$ A720 device is a new integrated circuit designed for use in AM radio receivers at signal frequencies up to 30MHz. It is encapsulated in a 14 pin dual-in-line plastic package and includes an RF amplifier stage, oscillator, mixer, IF amplifier, AGC detector and a voltage regulator.

In order to make a complete radio receiver using this device, it is only necessary to connect suitable tuned circuits, a detector and an audio power amplifier.

## TYPICAL CIRCUIT

A typical  $\mu$ A720 circuit is shown in Fig. 1. It operates as a conventional receiver with an RF stage and an IF of about 475kHz. For simplicity no band switching is shown in the circuit of Fig. 1, but this can be added if a wide frequency coverage is required.

The aerial input is coupled to pin 12 of the device through the input coil L1, while pin 11 is decoupled

to ground by C1. After passing through the internal RF amplifier stage, the signal appears at pin 13 and is fed to the coil L2. The tuned circuit comprising VC2 and part of L2, and provides image frequency rejection before the signal is fed to the input of the mixer stage at pin 1.

The oscillator frequency is determined by the value of VC3 and the part of L3 across which this capacitor is connected. The capacitor C4 provides decoupling of the mixer while the output from this stage appears at pin 14. IFT1 provides much of the adjacent channel selectivity.

The IF signal passes to the input of the IF amplifier at pin 7 while the output of this amplifier is taken from pin 6 to the second IF transformer, IFT2. It is then detected by D1 and filtered by C8, R3 and C9 to provide the audio output. C10 is merely a DC blocking capacitor.

The IF amplifier output at pin 6 is also coupled back into pin 5 of the  $\mu$ A720 where it is demodulated

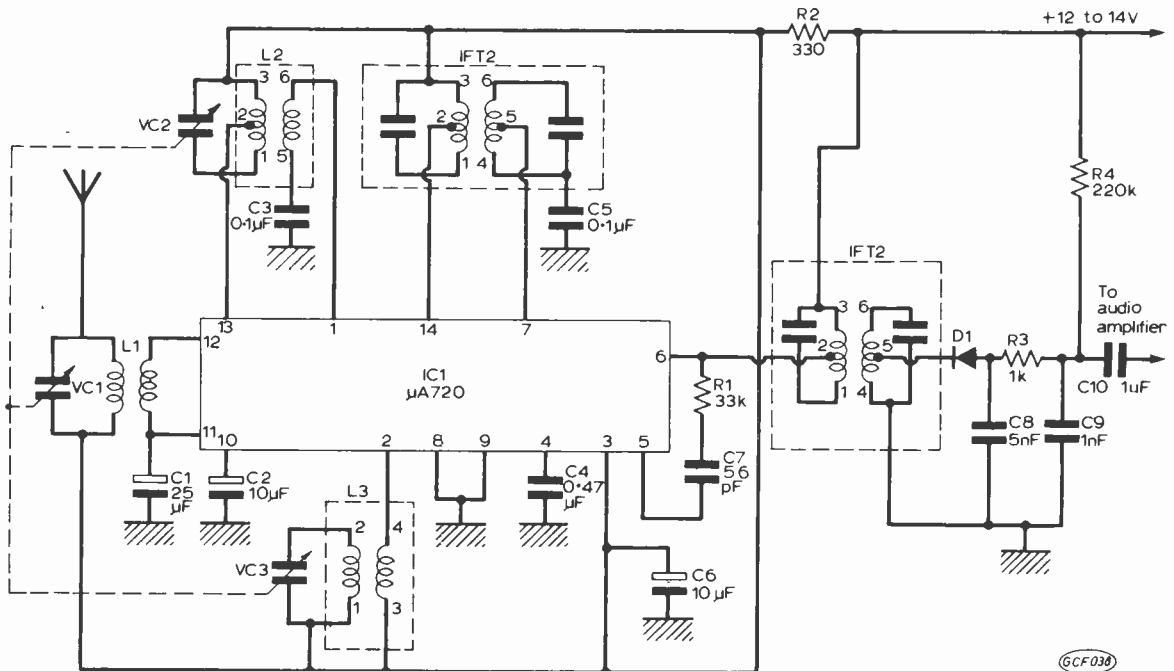

Fig. 1: Circuit of an AM radio receiver built round the  $\mu$ A720 integrated circuit and using variable capacity tuning.

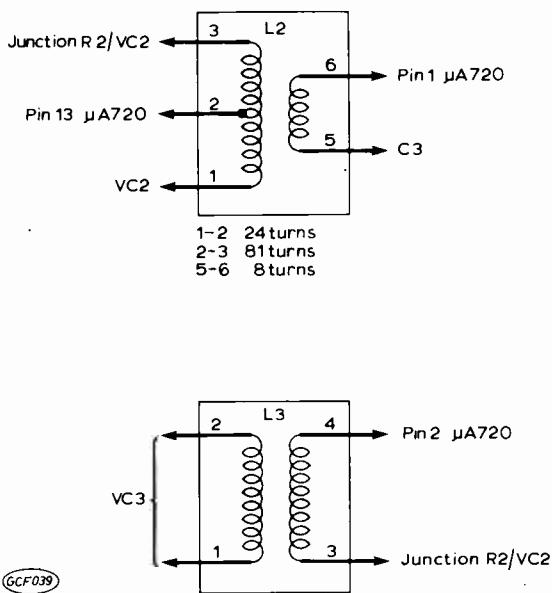

Fig. 2: Details of coils for use in Fig. 1.

by internal diodes and is used to provide the AGC signal.

The audio output from Fig. 1 may be used to drive a Fairchild  $\mu$ A706 IC audio power amplifier, although a somewhat simpler circuit can be made using the National Semiconductor LM380N power amplifier (see *Practical Wireless*, December 1973).

## POWER SUPPLY

The absolute maximum permissible voltage which can be applied to the  $\mu$ A720 circuit is 16V. It is wise however to operate the device from a supply of about

12V with a maximum of 14V to allow a reasonable margin of safety. It should be noted that there is no direct connection between any pin of the device, and the positive power supply line. The current required is in the order of 20mA.

## COILS

For medium and long wave coverage, the coil L1 may consist of a conventional ferrite rod aerial, but an outdoor aerial is essential for good short wave reception.

Suitable medium wave coils for the RF coil L2 and the oscillator coil L3 are shown in Fig. 2, the diameter of the coil formers being about  $\frac{3}{8}$ ". These coils are designed for a 190pF RF tuning capacitor ganged with an 80pF oscillator capacitor. However, it is more satisfactory to obtain the Toko type YXRS 18576 AQ coil of 100 $\mu$ H for MW use.

Conventional IF transformers may be employed for IFT1 and IFT2. However, it is difficult for the home constructor to wind such coils neatly and obtain the maximum Q factor for optimum selectivity. It is therefore advisable to purchase IF transformers, bearing in mind the writer prefers to use one of the miniature Toko ceramic filters between pins 14 and 7 of this IC.

These ceramic filters provide a selectivity curve with a flat bandpass characteristic and steep sides; this enables one to obtain the best audio quality from a fairly weak station adjacent to that of a much stronger one. The filters are obtainable with bandwidths of 8kHz (type CFT455B), 6kHz (type CFT455C) and 4.8kHz (type CFU60A), all these pass-bands being quoted at 6dB down. At 10kHz away from the centre frequency, the response is 22, 27 and 28dB down for these respective types. Each filter contains a special piezo-ceramic disc and an input and output transformer, both of which are tuned in a similar manner to that of an IF transformer.

—continued on page 1040

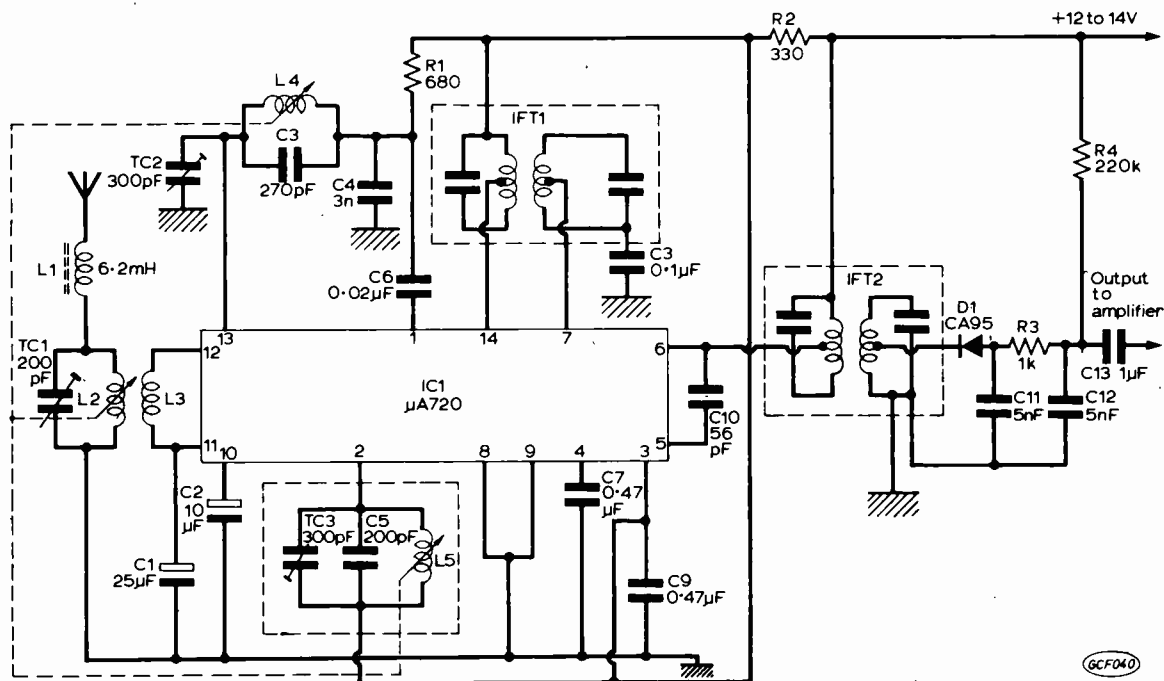
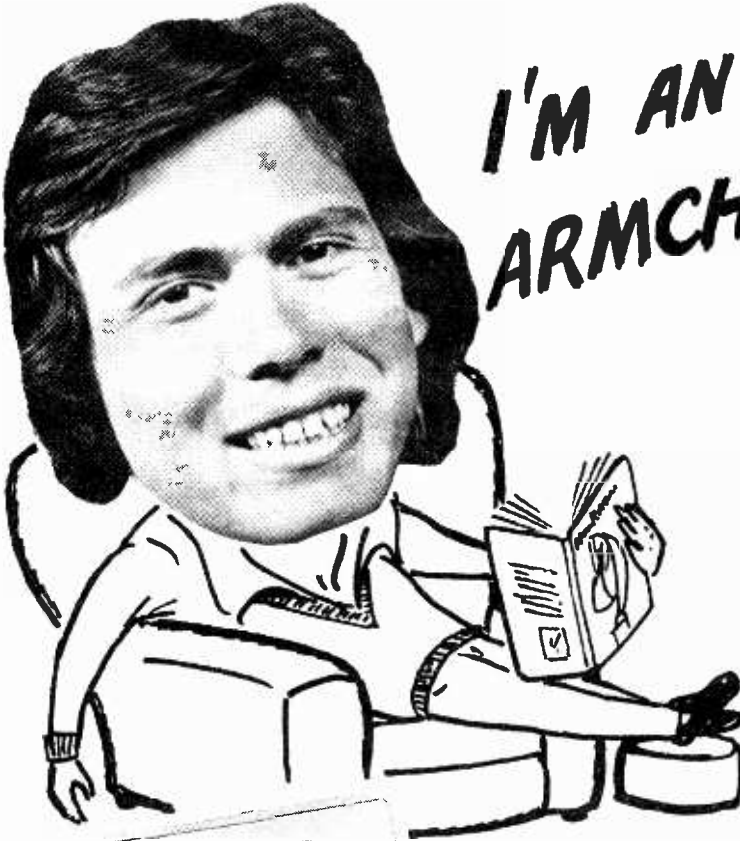

Fig. 3: In this version permeability tuning is employed in place of the capacity tuning of Fig. 1.

# I'M AN ARMCHAIR SHOPPER!



On a cold dark winter's evening, with the rain lashing down and the wind howling around, there's nothing I like better than to curl up in front of a fire, with tea and toasted scones at my side . . . and my catalogue on my lap. I then start choosing the bits and pieces for my next project. Home Radio Components had sent me one of their special order packs, so I had six order forms and six pre-paid addressed envelopes to simplify my job. I've now gone even one better. When I've written out my order, I pick up the phone and order direct. This was another thoughtful idea of Home Radio. They've made it easy for anyone to open a Credit Account without the delay and formality of references and all that fiddle faddle. Once you have an account, you can order anything, any time during the 24 hours! Just think what a boon that is, if you run out of wire or solder late at night.



## HOW ABOUT YOU?

I expect by now you're itching to know how to get in on this. It's really quite easy; but for a start you need the fabulous Home Radio Components Catalogue. It costs 65 pence, plus 33p post and packing; but with the catalogue you get 14 vouchers, each worth 5 pence when used as directed, so you can recover 70 pence of your investment. Why hesitate any longer? *Post off the coupon below today, with your cheque or PO for 98p, and join the merry band of Armchair Shoppers!*

**65p. plus 33p POST AND PACKING**

**Send off the coupon today. It's your first step to solving your component buying problems.**

The price of 98p applies only to customers in the U.K. and to BFPO Addresses.

*Please write your Name and Address in block capitals*

NAME .....

ADDRESS .....



HOME RADIO (Components) LTD., Dept. PW,  
234-240 London Road, Mitcham, Surrey CR4 3HD

(Regn. No.  
London 912966)



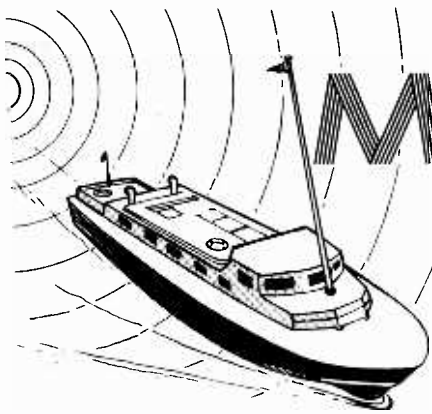

# MODEL CONTROL

## PART 3: ACTUATORS & MONITOR

# BY RADIO

F. G. RAYER G3OGR

**T**HE model control transmitter and receiver already described provide a radio link with the model. The equipment is designed for single channel operation which allows a relay in the model to be opened or closed at will. This, in turn, operates an actuator which is a device which moves the rudder of a model boat, switches on the propulsion motor or carries out other functions.

Complex mechanical actuators are not easily made but the simpler type of actuator is a straightforward device, quite easy to construct. In this case, it is intended for a model boat. Somewhat similar points apply to the guidance of other types of model.

### CONTROL PROVIDED

A model control system can begin in the simplest form, additions being made later. The simplest control provided is probably for steering only. This can be satisfactory with a yacht or other boat guided at will, or with a model plane adjusted to climb when flying straight, lose altitude when turning and glide to land when fuel is exhausted. Propulsion control is easily arranged with an electrical motor and the actuator described here allows turning to port or starboard, sailing straight ahead or stopping the main motor.

The simple type of actuator gives definite degrees of turn either way and this unit is of this type. Proportional and other methods of control are necessary for turns of any particular degree, or a small electric motor with a worm or screw drive to move the rudder can be used.

### ACTUATOR CONSTRUCTION

This actuator is based on a small Meccano clock-work motor (available from toy and model shops) though other motors could be used. It provides some hundreds of operations with each winding and is wound before starting the model.

In Fig. 1, the propulsion motor is off and the rudder is straight. End X of the rotating arm is held by A of the escapement. When the transmitter is keyed A is drawn to the core of the electro-magnet. The arm turns until Y engages B, the rudder link moving the rudder. Contacts Z-Z close, completing the circuit to the propulsion motor and battery. To sail straight, the key is released so that Y turns to engage A. To turn the other way, the key is pressed, causing X to engage with B. Any unwanted position can be passed almost immediately by momentary pressure on the key, any of the four positions being

held as long as required. Relay circuit current is only drawn when turning the model.

The rotating arm is about 2in long and filed from scrap metal. Several holes allow the crank throw of the rudder link to be adjusted. A short length of  $\frac{1}{4}$ in diameter rod is drilled to fit on the motor spindle and held with the screw which also opens contacts Z-Z. The rotating arm is soldered to this, high enough to clear the winding spindle. One contact Z is a spring brass strip, soldered to a bracket. The other is a small screw, fixed to a bracket which is in turn held to a paxolin strip by small screws. These contacts close firmly, except when opened by the screw as in Fig. 1.

The escapement is fashioned from a piece of metal about  $\frac{3}{8}$ in wide by  $3\frac{1}{2}$ in long. Catch A is formed by bending. Catch B is obtained by cutting away about  $\frac{1}{4}$ in from the strip. The narrow end continues, meeting a projection on the paxolin, to form a limiting stop. Elastic under tension keeps the escapement in this position until the magnet is energised. If the escapement is not ferrous metal, bolt or solder a

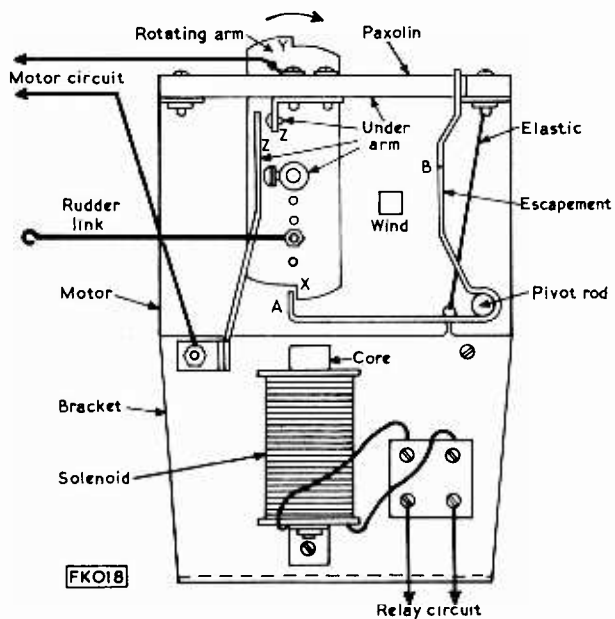
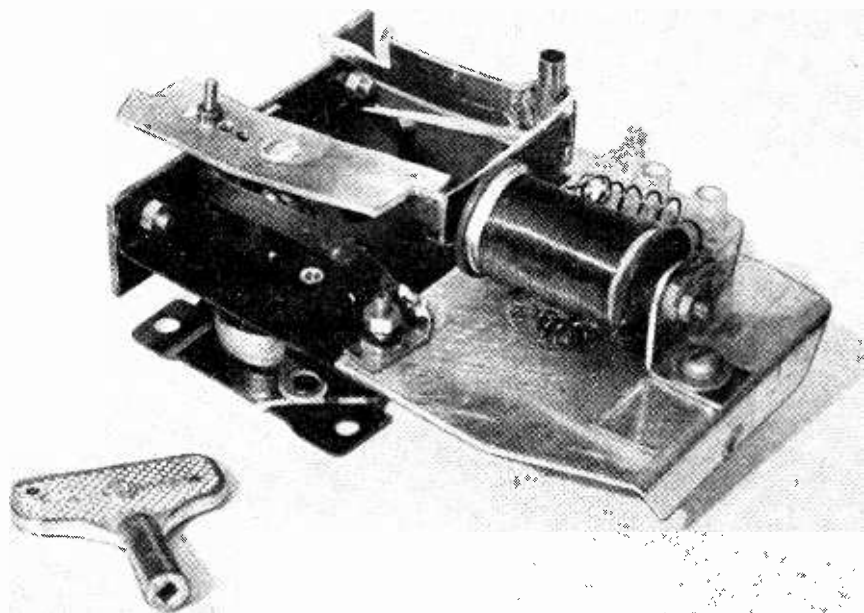

Fig. 1. Diagram showing the construction of a typical actuator, in this case to provide motor control and rudder steering on a model boat.



Actuator made by the author, based on Fig. 1. The motor control contacts are under the rotating arm but shown on top in Fig. 1, for clarity.

piece of iron or mild steel near the core of the solenoid.

The solenoid is fixed to a slotted bracket, to allow adjustment. It can be made from an old bell or buzzer, or it can be a few hundred turns of 26SWG or similar wire on an iron or mild steel core. The large bracket is 2½ x 2in cut from scrap metal, with a flange to allow mounting by a screw at this end, as well as by screws passing through the holes in the clockwork motor.

## RUNNING CHECK

Turn the rotating arm to see that ends X and Y project equally. If not, correct this by filing. Bend the escapement so that when A is moved slowly towards the magnet to release X,Y strikes B. Check that the meeting parts are reasonably smooth and that the elastic tension will return the escapement to the position in Fig. 1.

Position the magnet quite close to A. The mechanism should then operate reliably from a 4.5V or similar battery. Finally, with the mechanism mounted in the model, adjust the length of the rudder link so that the rudder is straight with X or Y engaging A. Adjust the crank throw so that a suitable turn is obtained with X or Y engaging B.

## ADDITIONAL CONTROL

Fig. 2 shows how the reversing function may be added. The rotating part of the escapement mechanism now has four arms. Its rotation operates the rudder as in Fig. 1. With this form of escapement, the spindle is allowed to move one-quarter of a turn each time the electro-magnet is briefly energised. To make this clear:— when the magnet is energised X is released and a very small rotation brings Y against Z. When the magnet releases, Y turns to the position formerly occupied by X, no holding current being necessary.

The reversing relay is connected to the same circuit. With no relay current present, battery A

drives the model forward. The escapement can thus take up any of four positions with the reversing relay not energised. However, if the transmitter key is held, the reversing relay is retained in the position bringing battery B into use, sailing the model astern. It is convenient to use an old or lower voltage battery for astern. For changing battery polarity with a single battery, a double pole relay is necessary for reversing.

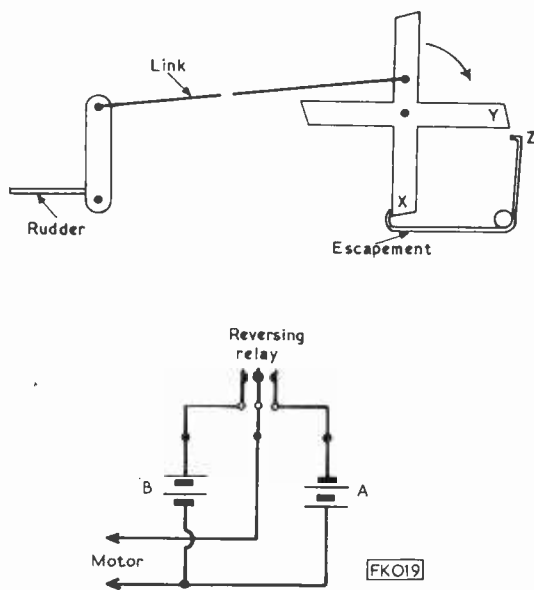

Fig. 2. Modifications to the rotating arm to provide reversing facilities on the propulsion motor.

Propulsion motors, except the larger types, are of permanent magnet construction and can be reversed by reversing the supply polarity. This type of motor gives best efficiency especially with dry cells. If a motor having a field winding is used, this will not be





# With the Doram catalogue, even the guarantee is guaranteed.

Doram is an entirely new way of buying electronic components.

So, to succeed, it's got to have something going for it, right?

We agree with you. And where Doram scores is in the security it gives the amateur buyer.

We'll give you peace of mind three ways.

## **No-quibble guarantee.**

Firstly, we guarantee to replace any component which arrives faulty. Absolutely free of charge.

And secondly, our guarantee is backed by the biggest electronics distribution Group in Britain.

## **7-day service.**

Thirdly, we guarantee you'll have your components within 7 days from our receipt of your orders.

We're so confident of our service that if we can't supply

the part you want within 7 days we'll give you an immediate refund.

So you'll never get a tedious wait.

You know just where you stand with Doram.

## **All branded goods.**

All goods supplied by Doram are made by big-name manufacturers. And they're all to manufacturer's specifications. They're the best money can buy.

In fact, Doram gives the amateur the sort of service only professionals have enjoyed before.

## **Millions of components.**

All in all, we're big enough to offer you stocks of millions of components, on over 4,000 product lines.

All you do is buy the Doram catalogue for 25p (that's a yearly reference book for the price of a pint of lager) and then take your pick from it.

Use the coupon now. Send today for the first-ever Doram catalogue. It can take a lot of worry out of amateur components buying.

And for 25p that's not bad, is it?

**I ENCLOSE 25p: PLEASE SEND ME THE NEW DORAM CATALOGUE.**

Name .....

Address .....

**Doram Electronics Limited,**  
PO Box TR8,  
Wellington Road Industrial Estate,  
Wellington Bridge, Leeds LS12 2UF.

\*This will be refunded on orders of £5 (less VAT) or more received by us before March 31st, 1975.

**DORAM**

PW 3/75

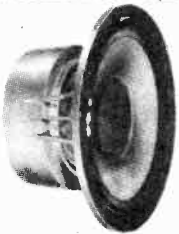

# WILMSLOW AUDIO

**THE Firm for speakers!**

## SPEAKERS

Baker Group 25 3, 8 or 15 ohm	£7-75	Goodmans 8P 8 or 15 ohm	£5-00
Baker Group 35 3, 8 or 15 ohm	£12-50	Goodmans 10P 8 or 15 ohm	£5-30
Baker Group 50/12 8 or 15 ohm	£12-50	Goodmans 12P 8 or 15 ohm	£12-95
Baker Deluxe 12" d/cone	£10-75	Goodmans 12P-D 8 or 15 ohm	£10-75
Baker Major	£8-50	Goodmans 12P-G 8 or 15 ohm	£15-75
Baker Regent	£7-75	Goodmans Audiomax 12AX 100 watt	£37-50
Baker Superb	£14-50	Goodmans Audiomax 15AX	£40-25
Baker Auditorium 12	£12-50	Goodmans 15P 8 or 15 ohm	£21-00
Celestion MH1000 horn	£10-95	Goodmans 18P 8 or 15 ohm	£36-00
Celestion PST8 for Unilux	£2-55	Goodmans Midax 750	£16-00
Celestion G12M 8 or 15 ohm	£12-00	Goodmans Axent 100 tweeter	£7-25
Celestion G12H 8 or 15 ohm	£15-00	Goodmans Audiom 100 12"	£12-00
Celestion G12 8 or 15 ohm	£24-00	Goodmans Axiom 401 12"	£17-25
Celestion G18C 8 or 15 ohm	£33-00	Goodmans TWINAXIOM 8	£8-25
Coral 6 1/2" d/cone roll surr. 8 ohm	£2-50	Goodmans TWINAXIOM 10	£9-00
Coral 8" d/cone roll surr. 8 ohm	£3-25	Kef T27	£5-25
EMI 13 x 8 3, 8 or 15 ohm	£2-25	Kef T15	£6-00
EMI 13 x 8 150 d/c 3, 8 or 15 ohm	£2-50	Kef B110	£7-25
EMI 13 x 8 450 t/w 8 ohm	£3-75	Kef B200	£8-25
EMI 13 x 8 type 350 8 or 15 ohm	£8-25	Kef B139	£14-25
EMI 13 x 8 20 watt base	£5-60	Kef DN8	£2-00
EMI 6 1/2" 93850 4 or 8 ohm	£3-00	Kef DN12	£3-30
EMI 5" 98132CP 8 ohm	£2-50	Kef DN13	£3-00
EMI 8 x 5 d/cone, roll surr 10 watt	£2-50	STC4001G super tweeter	£6-15
EMI 2 1/2" tweeter 97492AT	£1-65	Richard Allan CG8T 8" d/c r/surr.	£8-25
Eagle DT33 30 watt tweeter	£5-45	2 1/2" 64 ohm, 70mm 80 ohm, 70mm 8 ohm	£5
Eagle HT15 horn tweeter	£2-80	7" x 4" 3 or 8 ohm	£1-40
Eagle CT5 cone tweeter	£1-75	8" x 5" 3 or 8 ohm	£1-50
Eagle CT10 tweeter 8 or 16 ohm	£2-55	10" x 6" 3, 8 or 15 ohm	£2-30
Eagle MHT10 horn tweeter	£3-80		
Eagle crossover CN23, CN28, CN216	£1-50		
Eagle FR4	£1-35		
Eagle FR65	£5-30		
Eagle FR8	£10-65		
Elac 9 x 5, 59RM109 15 ohm, 59RM114 8 ohm	£2-80		
Elac 6 1/2" 6RM171 d/c roll surr.	£3-50		
Elac 6 1/2" 6RM220 d/cone	£2-85		
Elac 4" tweeter TW4	£1-25		
Elac 10" d/cone 10RM239 8 ohm	£2-65		
Elac 8" 8CS175 3 ohm	£2-50		
Fane Pop 15 watt 12"	£5-25		
Fane Pop 25/2 25 watt 12"	£7-25		
Fane Pop 40 watt 10"	£8-50		
Fane Pop 50 watt 12"	£12-00		
Fane Pop 55 12" 60 watt	£12-50		
Fane Pop 60 watt 15"	£13-25		
Fane Pop 100 watt 18"	£24-50		
Fane Crescendo 12A 100 watt 12"	£29-00		
Fane Crescendo 12B bass	£29-00		
Fane Crescendo 15" 100 watt	£36-00		
Fane Crescendo 18" 150 watt	£51-95		
Fane 801T 8" d/c roll surr.	£7-00		
Fane 807T 8" d/c roll surr.	£3-85		
Fane 808T 8" d/c	£2-75		
Fane 701 twin ribbon horn	£35-00		
Fane 910 horn	£12-75		
Fane 920 horn	£33-00		

## SPEAKER KITS

Baker Major Module	each £10-75
Goodmans Mezzo	pair £45-00
Goodmans DIN 20	each £9-75
Helme XLK 25	pair £22-00
Helme XLK 30	pair £14-95
Helme XLK 50	pair £39-95
Keffit 1	each £20-95
Keffit 3	each £36-75
Richard Allan Twinkit	each £8-95
Richard Allan Triple 8	each £13-75
Richard Allan Triple	each £19-95
Richard Allan Super Triple	each £23-75
Wharfedale Linton 2 kit	pair £18-25
Wharfedale Glendale 3 kit	pair £34-50
Wharfedale Dovedale 3 kit	pair £52-50

## PA/DISCO AMPLIFIERS

(carr. and ins. £1)	
Baker Major 100 watt	£40-75
Linear 30/40	£30-00
Linear 40/60	£35-00
Linear 80/100	£58-95
Linear 100 watt slave	£44-00

Eagle PA range in stock—ask for catalogue.

**Free with speaker orders over £7—**

"Hi-Fi Loudspeaker Enclosures" book. All units guaranteed new and perfect. Prompt despatch. Carriage and packing: speakers 38p each, speaker kits 75p each (£1.50 pair) tweeters and crossovers 20p.

**ALL PRICES QUOTED INCLUDE VAT.**

**WILMSLOW AUDIO (Dept. PW)**

Loudspeakers: Swan Works, Bank Square, Wilmslow, Cheshire. SK9 1HF

Discount Radio, PA, Hi-Fi: 10 Swan St. Wilmslow

Send stamp for free booklet "Choosing a Speaker"



## Agfa Cassettes

The best buy!

**Agfa Low Noise Cassettes AT LESS THAN HALF PRICE!**

	1	5	10
C60	37p	£1-30	£3-50
C90	50p	£2-48	£4-95
C120	63p	£3-10	£6-20

**AGFA HIGHDYNAMIC SUPER**

	1	5	10
C60+6	50p	£2-40	£4-70
C90+6	68p	£3-35	£6-80
C120	99p	£4-90	£9-80

**AGFA STEREO-CHROM CHROMIUM DIOXIDE**

	1	5	10
C60	85p	£4-20	£8-30
C90	£1-08	£5-35	£10-60

SAME DAY DESPATCH. P. & P. 15p per order

## WILMSLOW AUDIO

(DEPT. PW)

10 SWAN STREET, WILMSLOW, CHESHIRE, SK9 1HF

Cut-price prerecorded cassettes—send stamp for list

## H.A.C. SHORT-WAVE KITS

**WORLD-WIDE RECEPTION**

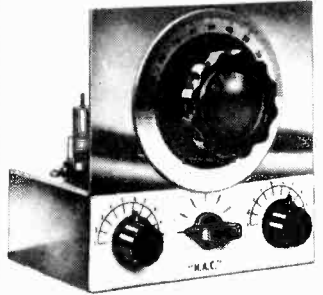

Famous for over 35 years for Short-Wave Equipment of quality. "H.A.C." were the Original suppliers of Short-Wave Receiver Kits for the amateur constructor. Over 10,000 satisfied customers—including Technical Colleges, Hospitals, Public Schools, R.A.F., Army, Hants, etc.

### 1974 "DX" RECEIVER

Complete kit—Price £4-60 (incl. p. & p. & V.A.T.). Customer writes: "Australia, India and America at loud volume."—"I have now heard over 300 stations including many Amateurs. I have received 32 Q.S.L. verified reports—from all continents. An amazing one-valve!" This kit contains all genuine short-wave components, drilled chassis, valve, accessories and full instructions. Ready to assemble, and of course, as all our products—fully guaranteed. Full range of other S.W. kits, including the famous model "K plus" (illustrated above). All orders dispatched by return. Send now for free descriptive catalogue of kits and components. Test Report available. **EXCITING COMPETITION** for Short-Wave listeners. Send stamped envelope for details.

**"H.A.C." SHORT-WAVE PRODUCTS**  
P.O. BOX No. 16, EAST GRINSTEAD,  
SUSSEX RH19 3SN

# VEROSTRIP

LENGTH 8'5"

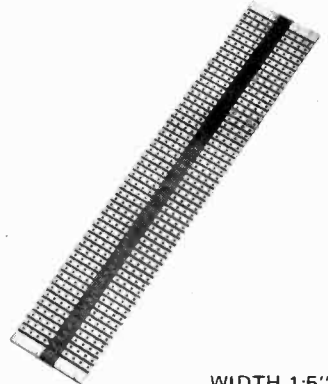

WIDTH 1'5"

Available from your Local Retailer

0.1 and 0.15 pitch Vero Strip is suitable for all applications where Tag Boards can be used.



VERO ELECTRONICS LTD.  
INDUSTRIAL ESTATE  
CHANDLERS FORD HANTS.

reversed when the supply polarity is changed. To reverse this type of motor, a double-pole relay is required, so wired that the supply is reversed to either the field or armature, but not to both.

A system of this kind can be modified by shortening arm Z so that the mechanism can come to rest in any one of eight equally divided positions. This gives half-port and half-starboard steering, as well as full-port and full-starboard. The reversing relay cannot then be held by the same circuit, but can be energised by contacts Z-Z in Fig. 1, giving straight astern as well as straight ahead and two degrees of turn each way.

The mechanism shown in the photograph of the boat is the Graupner Kinematic cascade switcher, which provides motor control by short blips and steering control by holding the transmitter keyed on. It is completely electric. A lightweight escapement suitable for small boats and planes, weighing only 1<sup>1</sup>/<sub>4</sub>oz and having four positions without holding, is the Rising & Schulz Mark I FR unit. Boat and other model kits, hulls, propulsion motors, steering and other control gear are available from model control equipment shops or large toy shops and model shops.

## INSTALLATION

It is convenient to use colour-coded leads to run through the model, for the receiver relay and other circuits. It is preferable to use separate batteries for the receiver and any other devices, as this helps avoid interference between the systems. A separate battery is generally required for the main motor. Interference problems can be reduced by keeping the receiver at the front of the model with electromagnetic control devices and motors towards the back. Suppressor capacitors of about 5000pF will usually be necessary across motor, electro-magnet or actuator circuits if interference upsets the receiver. Such interference may be shown by chattering or buzzing of a relay.

Plugs, terminals or other suitable means should be provided for connecting together the various parts of the whole system. On/off switches should be included for the receiver, etc. Fig. 3 shows the whole equipment for the boat illustrated which is typical of a straightforward model of this type.

The receiver, with battery and relay, occupies the forward section of the model. The actuator, with battery, is fitted in the stern near the rudder. Two propulsion batteries are placed forward of this with

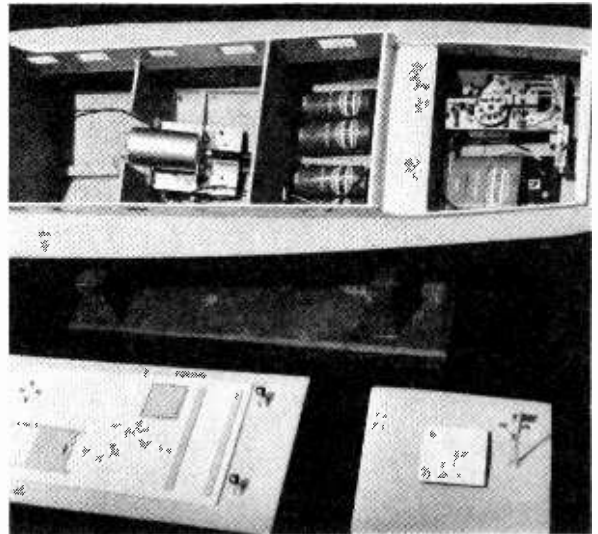

Hatches off to show the compartments for the propulsion motor, left main batteries, centre, actuator and auxiliary battery, right.

the propulsion motor near the middle driving the propeller shaft through a flexible coupling in the usual way. For convenience in reaching the equipment, front cabin and decks lift off.

## MODEL CONTROL MONITOR

This instrument is almost indispensable for tuning and testing model control transmitters for the 27MHz band. With such transmitters, some indication of the strength of the signal actually radiated is of great help when tuning oscillator and output circuits, or aerial loading coils, when provided. A receiver is not very suitable as an aid to tuning, as usually it gives only an indication that the equipment is in fact working.

If this monitor is placed a small distance from the transmitter adjustments can be made to the transmitter circuits while observing the reading on the monitor meter. The maximum monitor reading corresponds to the strongest radiated signal and thus to best operation of the transmitter and subsequent reliable range.

The monitor also incorporated a headphone socket so that a check can be made on the audio tone or tones produced by the transmitter.

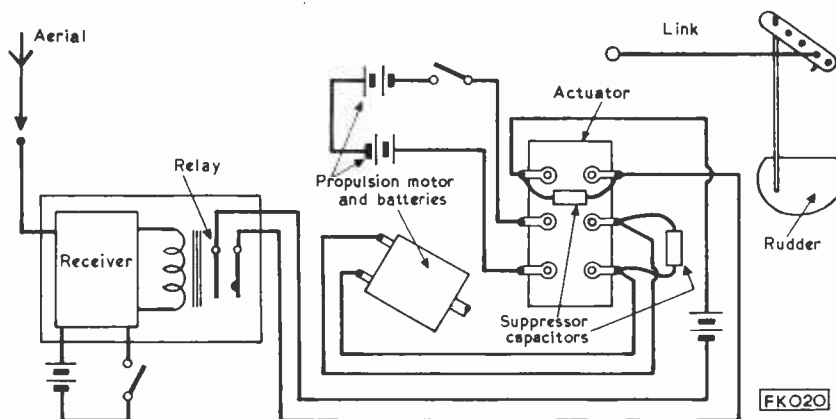
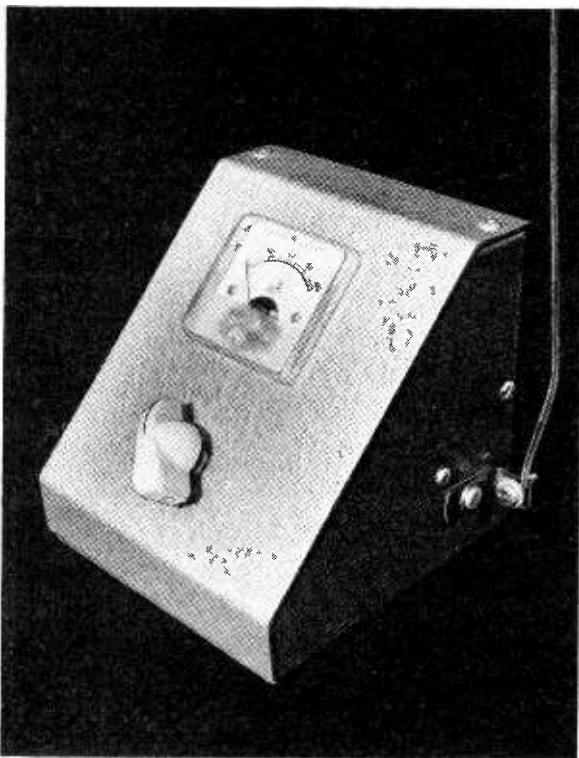

Fig. 3. Interconnection of the various units as arranged in a model boat. The link plate between the link and the rudder post enables the amount of rudder movement to be varied.



The monitor is an invaluable aid in setting up a transmitter for maximum output and hence maximum range of control.

## MONITOR CIRCUIT

The arrangement is shown in Fig. 4 and when trimmer TC1 is set so that the tuned circuit resonates at about 27MHz VC1 should be half closed. The required band is then tuned by VC1 which allows compensation to be made for changes in the aerial used. L2 is a coupling winding the diode D1 providing DC for the meter M1. The headphone jack socket is of a type normally closed until a plug is inserted.

## CONSTRUCTION

Component values and constructional details are not too important, provided the frequency coverage is suitable. A ready-made Wearite PHF3 coil may be used, or a coil may be wound. For a home-wound coil, use a  $\frac{5}{8}$ in diameter paxolin tube  $1\frac{3}{4}$ in long. Ten turns of 20SWG wire are required from points 1 to 2, spaced to occupy  $\frac{7}{8}$ in as in Fig. 5. The ends are passed through small holes in the tube, and the

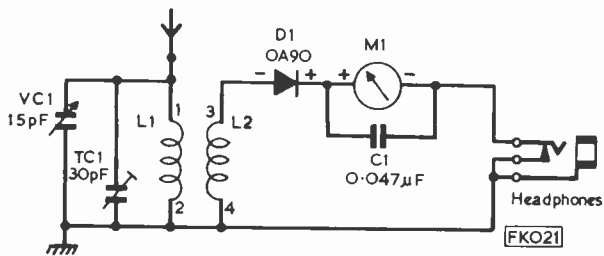

Fig. 4. Circuit of the monitor, in this case for the 27MHz model control band.

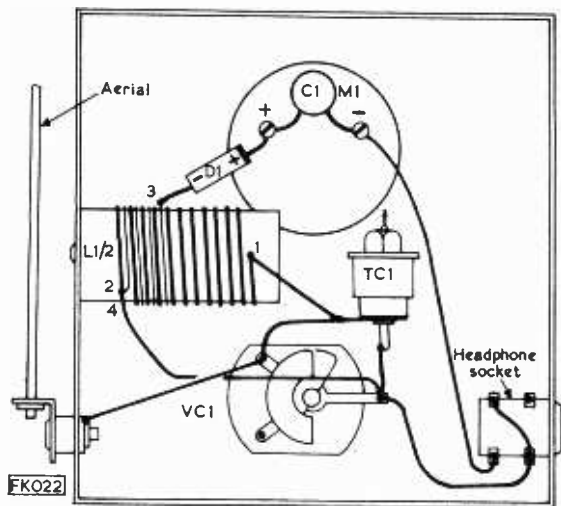

Fig. 5. Internal wiring of the simple monitor and details of the coil windings.

turns can be secured with Bostik 1 or similar adhesive. L2 has four turns of thin insulated wire, between the turns of L1, as shown.

A  $200\mu\text{A}$  indicating instrument is suggested, but if a more sensitive meter should be available it can be fitted which will allow the use of a smaller aerial on the monitor.

A sloping front case is used, as in Fig. 5. The coil is fixed with a bracket, or single 6BA bolt for the PHF3 while TC1 is supported by the wiring and VC1. A bracket is fixed to one side of the case, for the aerial, and insulated from the metal by adding insulating washers or any similar means. A telescopic aerial is ideal and some have a suitable bracket supplied. If so, this is fixed to the case.



## AERIALS

The aerial actually used may be a stiff wire from about 12 to 24in long, a telescopic receiver type aerial, a vertical rod, interlocking tubes or any other self-supporting aerial. When making a first

*continued on page 1010*



**I.L.P. (Electronics) Ltd**

# SHEER SIMPLICITY!

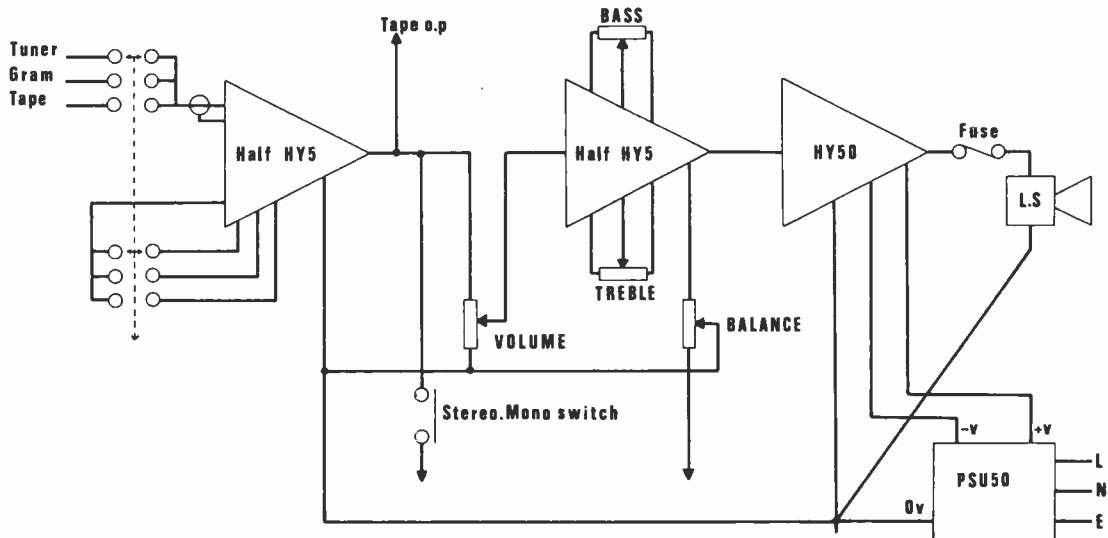

**MONO ELECTRICAL CIRCUIT DIAGRAM WITH INTERCONNECTIONS FOR STEREO SHOWN**

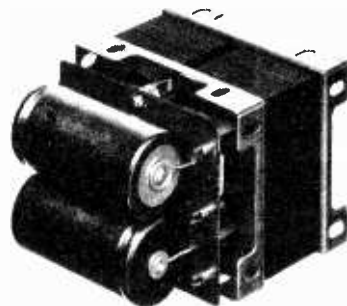
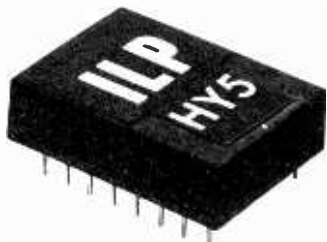

The HY5 is a complete mono hybrid preamplifier, ideally suited for both mono and stereo applications. Internally the device consists of two high quality amplifiers—the first contains frequency equalisation and gain correction, while the second caters for tone control and balance.

**TECHNICAL SPECIFICATION**

Inputs: Magnetic Pick-up 3mV RIAA; Ceramic Pick-up 30mV; Microphone 10mV; Tuner 100mV; Auxiliary 3-100mV; Input Impedance 47kΩ at 1kHz. Outputs: Tape 100mV; Main output 0db (0-775V RMS). Active Tone Controls: Treble ± 12db at 10kHz; Bass ± 12db at 100Hz. Distortion: 0.5% at 1kHz. Signal/Noise Ratio: 68db. Overload Capability: 40db on most sensitive input. Supply Voltage: ± 16-25V.

The HY50 is a complete solid state hybrid HI-FI amplifier incorporating its own high conductivity heatsink hermetically sealed in black epoxy resin. Only five connections are provided, input, output, power lines and earth.

**TECHNICAL SPECIFICATION**

Output Power: 25W RMS into 8Ω. Load Impedance: 4-16Ω. Input Sensitivity 0db (0-775V RMS). Input Impedance: 47kΩ. Distortion: Less than 0.1% at 25W typically 0.05%. Signal/Noise Ratio: Better than 75db. Frequency Response: 10Hz-50kHz ± 3db. Supply Voltage: ± 25V. Size: 105 x 50 x 25mm.

**PRICE £5.98 + 48p VAT**  
P. & P. free

The PSU50 incorporates a specially designed transformer and can be used for either mono or stereo systems.

**TECHNICAL SPECIFICATIONS**

Output voltage: 50V (25-0-25V). Input Voltage: 210-240V. Size: L.70. D.90. H.60mm.

**PRICE £6 + 48p VAT**  
P. & P. free

**PRICE £4.50 + 36p VAT**  
P. & P. free

## TWO YEARS' GUARANTEE ON ALL OUR PRODUCTS

**I.L.P. Electronics Ltd.**  
**Crossland House,**  
**Nackington, Canterbury**  
**Kent CT4 7AD**  
**Tel (0227) 63218**

Please supply, .....  
Total Purchase price .....  
I Enclose, Cheque  Postal Orders  Money Order   
Please debit my Access account  Barclaycard account   
Account number .....  
Name & Address .....  
Signature .....

# At Last... A Perfect Hi-Fi Match!



**our comprehensive matching hi-fi guide will start you assembling a quality system of your own choice to suit your needs and your pocket – and with no dud buys!**

Now at last you can see at a glance what components will match up mechanically, electrically – and financially – to produce the best possible sound for your money.

Basic specifications, recommended retail prices, generous discounts and the simplest classification will combine to help you make the best selection from the wide range of different makes available.

This authoritative 'map' of the hi-fi jungle will appear regularly as an updated section in Practical Hi-Fi and Audio every month, starting in the March issue with what makes a perfect match for setups costing less than £150.

**NO GUESSWORK! NO MISMATCHING!  
NO FRUSTRATION!**

**Plus our regular coverage of hi-fi developments and commonsense advice on hi-fi problems**

**PRACTICAL  
HI-FI & AUDIO**

March issue

OUT NOW 30p



# GOING BACK...

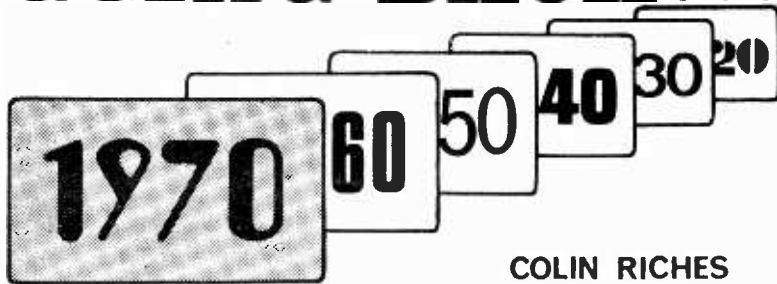

## Golden Oldies

ONE company that really believes in Going Back is Retrieval Recordings Ltd. which devotes itself exclusively to the reissue of vintage recordings, mainly from the ragtime and the Twenties periods. Using the archive material of the directors (themselves enthusiastic collectors), and employing special equipment of their own design, many historic and rare recordings of the early days of popular music have been preserved for all to hear—and with quite astonishing quality of reproduction.

Most of the LPs are of complete sets of recordings by particular performers arranged in chronological sequence and are backed by liner stories by specialist writers and include complete authenticated recording information. At the moment, the LPs cover vintage jazz, dance music, blues and popular music nostalgia, but other associated

idioms are under consideration.

The latest addition to the Fountain/Retrieval catalogue, Fountain FJ-109 (Curtis Hitch and Hoagy Carmichael) is a fine collection of Mid-West jazz from 1923 to 1927. The sub-title 'Indiana Summer' sets the mood for this album of bouncy music recorded in Richmond, Indiana.

Side 1 consists of the complete recorded output of The Happy Harmonists, a collection of lively foot-tapping numbers by a band organised by Curtis Hitch and featuring the spirited cornet playing of Fred Rollison. The last two tracks feature Hoagy Carmichael, who takes over the piano chair from Curtis Hitch.

Side 2 comprises recordings by groups led by Emil Seidel and Hoagy Carmichael. The highlight of this side is the recording of "Star Dust", which is not only the very first recording of the top pop of all time but includes a monumental and imaginative piano solo by composer Hoagy Carmichael. These recordings also include the complete output of Carmichael—cornettist extraordinary.

FJ-109 is presented in a gate-fold sleeve and contains full authenticated discographical information on the recordings. The fully packed LP includes no less than 19 titles. The r.r.p. is £2.44 including VAT.

Readers interested in the genuine article can obtain a copy of the latest catalogue of Fountain and Retrieval LPs on request (and enclosing a stamp for return postage) to: Retrieval Recordings Ltd., 48 Eversley Avenue, Barnehurst, Kent DA7 6RB.

## Who were they?

I have received numerous enquiries from many younger

readers who ask questions like, "who were Heinrich Hertz, Popoff, R. A. Fessenden, Nikola Tesla, Sir Oliver Lodge etc, etc.? When did they live and can you describe their contributions to wireless and explain some of their experiments?"

It is for this reason that I hope, from time to time to feature some of the great pioneers of wireless in the Going Back column.

## Nikola Tesla



Nikola Tesla was born in the town of Smiljan in Yugoslavia in 1857. He was educated at Prague and Graz Universities and studied "electricity". In 1882 he commenced the study of high frequency currents and developed the "Tesla Coil"—a loose-coupled air-cored high frequency transformer.

In 1883 he joined the Austrian Telegraphs department and shortly after emigrated to America. He became naturalized and managed to get himself a job as an assistant to Thomas A. Edison.

While working for Edison, Tesla made a special study of high frequency alternating currents and invented an alternator in 1890 which would develop 1kW at 10,000Hz. He patented a synchronous spark discharger in 1896. It was obvious from his patent that he had exhibited an exceedingly clear knowledge of the principle of tuning and a method of adjusting the phase of discharge by varying the position of the stationary electrodes of the spark gap. Like the Tesla Coil,



One of the sets of authentic recordings of historic popular music, Fountain FJ-101 includes the legendary sides made by the Original Dixieland Jazz Band in 1917, originally issued on 'hill-and-dale' 78s. This is jazz at the very beginning!

this device was not invented primarily to aid radio telegraphy but was designed to aid Tesla's research into high frequency currents.

A point to bear in mind is that a device similar to that patented by Tesla, was used by Marconi in 1907 when he used the "timed disc" in his spark transmitter.

The Tesla Transformer was used by the Marconi Company in the 1/2kW transmitting sets. It consisted basically of a primary of a few turns of thick copper wire and a secondary with a large number of turns of a much finer gauge wire. The primary and secondary were separated by an air-space, a glass or ebonite dielectric.

The Marconi version of Tesla's coupling transformer invention was often referred to as a "jigger". The type used for the 1/2kW spark transmitter had a primary of copper ribbon wound on edge as a sort of "square" spiral. It was mounted on an ebonite support. The secondary was wound outside the primary and a sheet of ebonite was fixed between them. The secondary

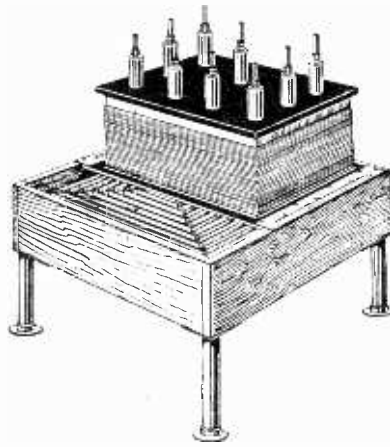

Tesla's transformer

winding comprised insulated copper stranded cable wound round a square wooden box. This had an ebonite panel mounted on which were the secondary tappings.

### A Clean Sweep

In Germany, the listening tax in 1932 had to be paid monthly. Its collection from the set owners

was made by the postman on his rounds. The annual broadcast licence was 24 Marks (then about 30/-).

Germany, at that time possessed roughly four and a quarter million registered listeners and radio pirates were discovered by the municipal chimney sweeps, who, in the course of their daily duties, visited all houses, flats and apartments. It was their duty to notify all wireless receivers to the local authority, thus allowing the latter to make the necessary investigations.

So, if you're naughty and have not paid your TV licence fee yet, keep a wary eye out for chimney sweeps—they may be detector van personnel in disguise.

#### J.S.T. — O.B.E.

We are very pleased to learn from the New Year's Honours List that Wing Commander John Scott-Taggart, M.C., Italian Order of Merit, has been appointed an officer of the British Empire 'for services to radio engineering'.

Among many other notable achievements 'ST' was the author of the famous ST series of receivers beginning in 1923, designed specifically for the home-constructor.

MODEL CONTROL—continued from page 1006

### ★ components list

#### ACTUATOR

Clockwork motor (Meccano No. 1 "Magic").  
Axle Rod (Meccano No.17 2in.)  
Collar with screw (Meccano No. 59)  
Rod connector (Meccano No. 213)  
Bell electromagnet (see text)  
Materials for bracket, escapement etc.

#### MONITOR

C1, 0.047μF. TC1, trimmer 30pF. VC1, 15pF variable (Jackson C804). D1, OA90. L1/2, coil (Wearite PHF3 or home-made). Case, 4 x 4 x 4in. or similar (H. L. Smith, Type U). Telescopic aerial (see text).

check, especially with a powerful transmitter, take care that the meter is not damaged. Should there be any sign that the reading will exceed full-scale, when tuning VC1, move the monitor to a greater distance or reduce the length of aerial.

### USING THE MONITOR

With the transmitter switched on VC1 is rotated for maximum reading on the meter and only needs re-adjustment if the monitor aerial is changed or the transmitter frequency changed. The monitor is placed so that a reading of about a quarter to half scale is obtained. With a low power transmitter, running possibly only a few hundred milliwatts, the monitor will only need to be at a short distance. But if the maximum permitted power is used, the distance will become inconveniently large, so a very short aerial wire should be used with the monitor.

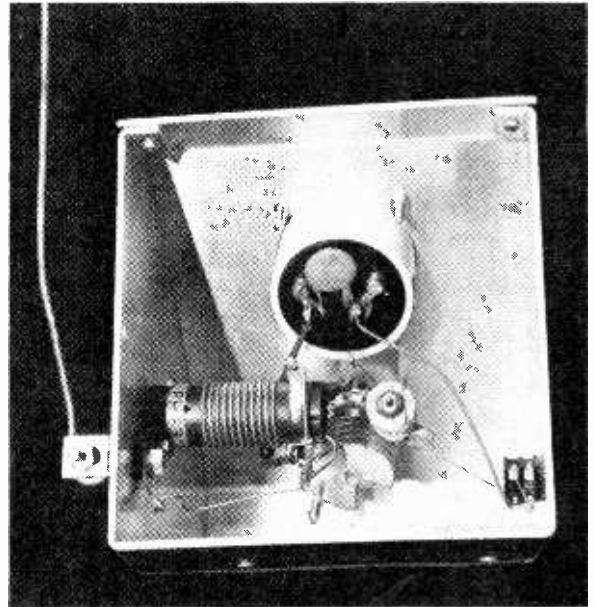

Inside the monitor. Compare with Fig. 5.

Provided transmitter and monitor remain in the same positions and other circumstances which could influence the field strength are also unchanged any modification to the transmitter which increases the power of the radiated signal can be seen. It will be found that quite small adjustments to transmitter tuning can have a considerable effect on radiated power. PW



# SPEED UP YOUR REFLEXES!

# IN NEXT MONTH'S PRACTICAL WIRELESS

## REACTION TIMER

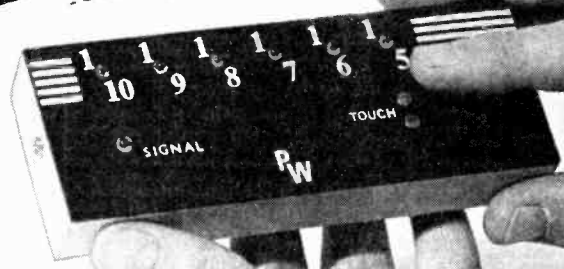

Here is an amusing device that will enable you and your friends to compare reaction times without any further argument! Full details given for the construction and calibration of the timer.

*and*  
*be first to 'hit the button' on our...*

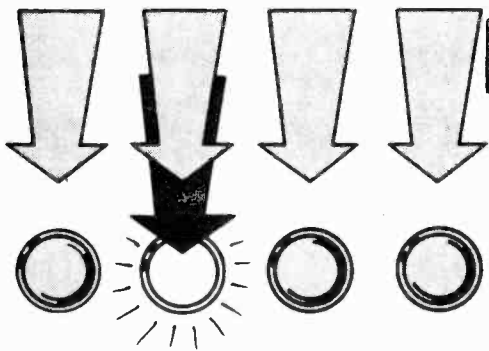

## QUIZ MONITOR

A 'must' for the quiz master . . . shift the responsibility of decision on to the Quiz Monitor. Sorts out the first contestant to push the button . . . and without fear or favour!

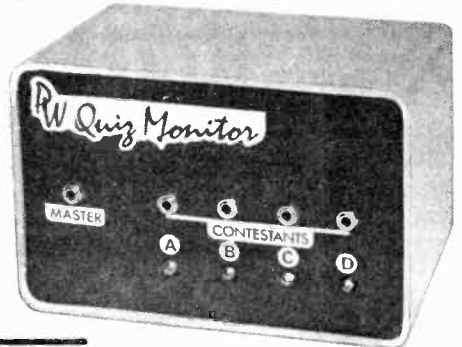

*plus*

**The 'IC+2' RECEIVER**

**The 'EASYBUILD'  
ELECTRONIC ORGAN part 2**

MANY OTHER CONSTRUCTIONAL  
ARTICLES, SPECIAL FEATURES  
AND REGULAR COLUMNS.

ON SALE IN MARCH



M. J. HUGHES M.A., C. Eng

★ performance

Audio output	1W
Output at external amplifier socket	100-500mV nominal
Output impedance at external LS socket	8-35Ω
Number of octaves	4
Notes available	60
Number of pitches	Two-8ft. and 16ft.
Master oscillator frequency	500kHz nominal.
Three voices each pitch	slider 1—triangular slider 2—square slider 3—spike
Supply voltages from internal power supply	-12V and -27V

IT must be the ambition of thousands of people to own and be able to play an electronic organ, failing to do so only because of the universal hurdle that has to be overcome—the price of a worthwhile instrument. In recent years however, a number of “Reed Organs” have appeared in the shops at more realistic prices but (apart from some near fraudulent claims) none of these, by any stretch of the imagination, can be classed as electronic organs, and of course, none of them get close to emulating the wide range of tone colours and effects that a true electronic organ is capable of producing.

The more adventurous amateur electronics enthusiasts have built their own instruments, but of these courageous people, probably very few have ever been able to complete their project either because time has been against them, or they have run up against the financial barrier. Those who have attempted making their own organ to conventional designs will be very much aware of the tremendous amount of time required to complete the job, caused simply by the number of components, interconnections and complex mechanical structure of the instrument.

The instrument to be described in this article has been designed with all the foregoing problems in mind and the resulting design is neat and extremely simple to make. Four or five evenings of work can

complete the electronic assembly, the cabinet is a straightforward carpentry job and the finished organ is small, compact, and light enough to carry around and produces a wide range of tone colours from rich church tones to bright crisp group sounds. It even features a few effects only found on the most expensive of commercial organs. All this is obtained for a comparatively low cost, about £50-£70 at current prices, but it depends, of course, on how one does the shopping and what work one is prepared to do at home.

To keep mechanical problems down to a minimum there are only two printed circuit boards; one of which houses the tone generating and tone forming circuits, including controls, and the other, a very simple board contains the power supply. Apart from these boards the only other wiring is a loom of wires to the keyboard and input and output lines to an external amplifier, if this is required.

Some sacrifices have had to be made to make it possible to meet the ultimate objective. The main one is the way tone colours are controlled. An organ purist will, no doubt, wince at the way these are generated because we have deliberately avoided the temptation of making a unit that will synthesise a pipe organ. The author feels that if one is making an electronic organ one ought to make the best possible use of electronic techniques to produce acceptable sounds, rather than to make an instrument sound like something it isn't!

INTERNAL AMPLIFIER

It is assumed that the instrument will be used either on the domestic scene, where high powers are not required, or for use with groups which are well catered for with dozens of watts of power from external amplifiers. There is, therefore, a built-in simple one watt audio stage which drives a small internal speaker; this provides ample power for the average room but lacks in bass response (more from the loudspeaker than the amplifier itself). It is for this reason that there are built-in options for headphone output and phono output which will plug into any high power or Hi-Fi amplifier system, for a truly high quality output.

# PW 'Easybuild'

# ELECTRONIC ORGAN

## MIERE

## PART 1

Anyone with some experience of soldering should be able to make this organ but, as one might expect, some care and patience is needed to prevent problems. The complexity has been removed from the hands of the constructor and transferred to the main printed circuit board. While assembly is simply a matter of putting the right components into the right place the right way round, the job of "soldering in" has to be done carefully to avoid bridging some of the narrowly separated conductors on the board. The organ also uses a large number of MOS (Metal Oxide Semiconductor) devices which have to be handled correctly to prevent damaging them. This may ring alarm bells in some areas but we shall explain exactly how to handle these devices when the time comes.

It is imperative that before embarking on this project that you obtain a good quality miniature solder-

ing iron. The bit diameter should, ideally, be  $\frac{3}{32}$ in. but under no circumstances should it exceed  $\frac{1}{8}$ in. diameter. Apart from this you will need normal tools i.e. side cutters, small pliers, a small screwdriver and resin cored solder. Use 22 gauge solder rather than the heavier 18 gauge to help keep connections neat. We recommend that you also have available a continuity tester (ohmmeter) to check for short circuits, any simple multimeter will suffice.

Armed with this equipment you should experience no problems, and, apart from being very pleased with the sound of the completed instrument, you should obtain great pleasure and satisfaction from the neat way it goes together. The only danger envisaged is that when the neighbours see and play it, you will find yourself embarking on it a second time round! A complete shopping list for all the components and hardware is given in this part together with the names and address of suppliers of the more unusual components.

## NOTE GENERATION

Before describing the circuitry in detail we will, for the benefit of those who have not encountered an organ before, go through the system in block form. The complete system is shown in Fig. 1.

A proper organ (unlike simple stylus organs) is a polyphonic device. This means that we can play as many notes as we like, all at the same time. Consequently it is necessary to have a large number of tone generators, each producing a frequency for every note on the keyboard. Using a 49 note keyboard (four 12 note octaves + top "C") we need, on the face of it, 49 separate tone generators. In practice more than these are needed for an organ because we have to provide the facility to play two notes (an octave apart) by depressing a single key which helps to generate the wide range of tone colours. To make this possible and to get the two pitch effect over the whole keyboard it is necessary to provide an extra octave of notes which extend below the bottom end of the normal keyboard. The tone generator in this circuit provides a total of 60 separate signals, each one of which has to have an exact frequency to keep the organ in tune. In the past this in itself has been an awesome task for the home constructor, but by making use of modern technology and integrated circuits this part of the system is now the simplest.

To generate the 60 different notes, we start off by

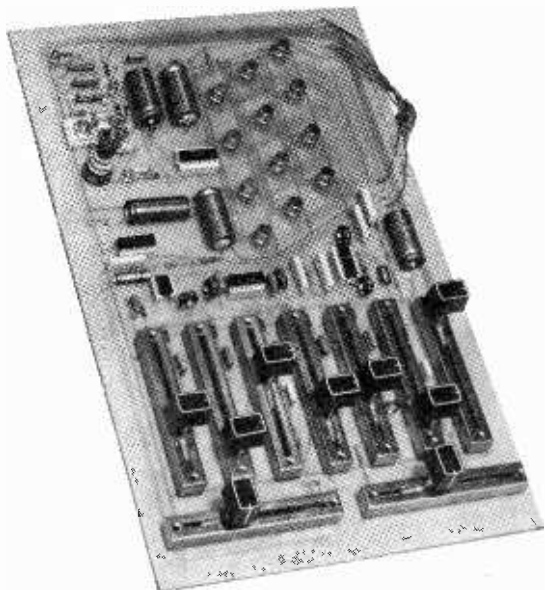

Main printed board containing tone generating and tone forming circuits, as well as all slider controls.

producing 12 tones that give the highest octave required on the keyboard. The notes occurring in octaves beneath this topmost one have an exact two to one relationship with each other. For example, if the frequency for the highest "C" on the keyboard is  $f$ , then the "C" an octave lower will be  $f/2$  and for the octave beneath that will be  $f/4$  and so on. The same applies to the other 11 notes in the top octave. To generate notes for sub-octaves it is only necessary to take the frequency of that note for the top octave and subject it to division by two for each successive octave lower. This is easily accomplished using divide-by-two integrated circuits. Operating with a top octave plus four other sub-octaves, for each note four divide-by-two circuits are needed. As it happens there are integrated circuits on the market which contain the four stages we require (for each note) all in the same package, so 12 such integrated circuits are required.

The problem remaining is to generate the 12 original notes for the top octave. In the past this has required 12 separate oscillators each of which needed

careful tuning. Apart from the tuning problem these oscillators required a lot of assembly time and proved quite costly. It is now possible to use a single oscillator and a special integrated circuit (which is, admittedly, rather costly) to produce the 12 notes in one operation. This means that there will no longer be any problems with tuning because every note will be precisely locked in an exact frequency relationship with its neighbour, so it is only necessary to set the master oscillator at the right frequency to tune the organ to the international pitch.

Again, the organ purists will wince at this because we are making use of the equal temperament scale which assumes an exact mathematical relationship between the frequencies of adjacent half tones within the musical scale. There is also the apparent drawback that it is virtually impossible to generate this relationship to perfection with simple electronics. Our organ will, intrinsically, be slightly out of tune from the equal temperament scale, but in fact the deviation is so small that it is impossible to discern the difference. It is worth remembering that many

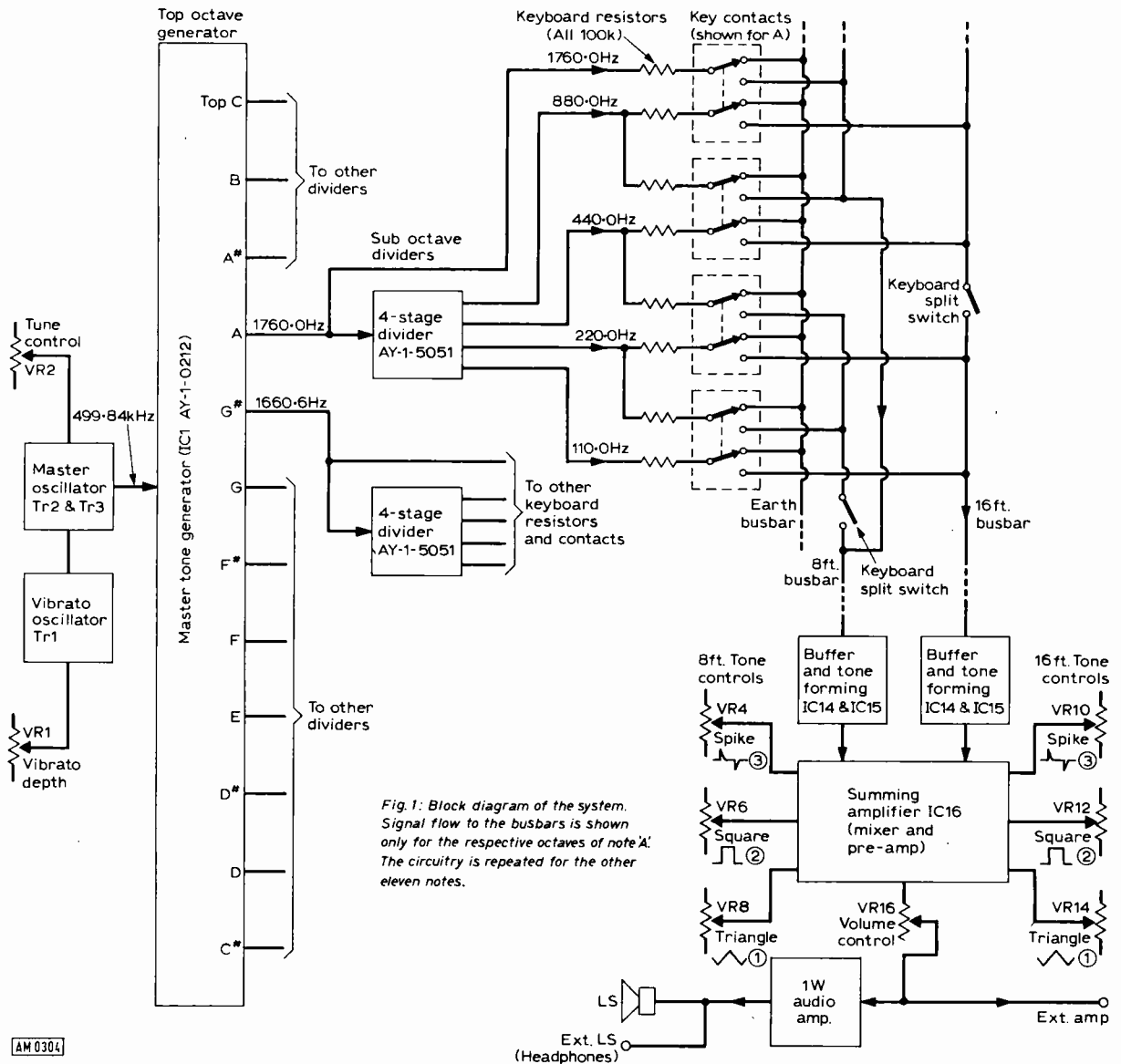

Fig. 1: Block diagram of the system. Signal flow to the busbars is shown only for the respective octaves of note 'A'. The circuitry is repeated for the other eleven notes.

highly priced commercial organs are now using exactly the same technique that we are advocating. This master tone generator IC produces the correct musical intervals by dividing down from an input frequency that is considerably higher than any of the notes required. The IC has 12 internal divisors, consequently there are 12 separate notes at the outputs. In our organ a master oscillator producing a nominal 500kHz output signal is used. The table shows the frequencies of the notes generated from the divisors for the top octave and for the subsequent four octaves beneath it. If the organ is to be tuned to International A (440Hz) the input frequency should be 499.840kHz and the figures in the table assume this as being the signal available from the master oscillator.

Even though the master oscillator may not be exactly on the stated frequency the organ will sound in tune with itself throughout its range because the tone intervals are locked. The only problem is that the organ, as a whole, would not necessarily be in tune with other instruments. This immediately presents two advantages in having an organ tuned this way: (1) there are absolutely no problems in setting up the basic tuning and (2) by adjusting one control only the organ can be brought into tune with any other instrument.

By voltage controlling the frequency of the master oscillator at low frequencies (approximately 6Hz) we can introduce frequency modulation of all the tones and this gives a very good vibrato effect. The vibrato is not ideal because all the tones are varying their frequencies in unison and this, to an organ purist, is not desirable, although the result is perfectly acceptable. By applying a DC shift to the voltage controlling the oscillator we can introduce a "tune" control to give Hawaiian guitar type sounds over about 1½ tones.

## THE KEYBOARD

The 60 tone lines from the dividers are fed through resistors to contacts on the keyboard. Each key has two contacts which have the true note fed to one contact (we call the genuine notes 8ft pitch) and the corresponding note an octave lower (16ft pitch) to the other contact. When the keys are not pressed the end of each resistor is connected to an earth rail and consequently the signal is shorted to earth. If a key is pressed the signals are fed to a line common to all the keys, called a busbar. There are two busbars in this organ; one for the 8ft pitch notes and the other for the 16ft pitch. The more keys that are pressed the more frequencies are superimposed on each other on each busbar, giving rise to the chords with

which we are all familiar. Using the series resistor on each line ensures that the signals superimpose additively which means that the volume will increase somewhat as more keys are pressed.

The signals impressed on the busbars are very much attenuated after the generators but they are in the same form, i.e. they are square waves that have been additively mixed. One could feed the busbar straight into an amplifier and listen to the sound of the square waves but the effect would be most uninteresting, being very much like a clarinet. The next step is to feed the output from each busbar into a circuit that will modify the wave shape of each set of signals. Such a circuit is called a tone forming circuit and there are two sets of these in the organ; one which operates exclusively on 8ft pitch notes while the other operates independently on 16ft pitch.

## TONE FORMING

Most organs carry out tone forming by feeding the busbar signals into complex filters, which is called subtractive tone formation because it simply filters out frequencies in various bands to "colour" the sound. The PW organ uses a totally different technique which is a form of additive tone colouration. The technique will be described in more detail later but basically the square wave signal is amplified and in turn forms one of the signals used in the additive process. It is then differentiated to produce a series of fast spikes. Such a signal maintains many of the characteristics of the original sound but becomes extremely "reedy". This signal is easy to produce and forms the second of the additive mixing signals. Finally the original square wave is fed to a two-ramp integrator which converts the square wave into a series of triangular waves. These triangular waves are more mellow in sound quality and closely resemble a flute. Ideally it would have been nice to produce sine waves rather than triangular waves but this would have required far too much circuitry.

These three modifications of the original busbar signals, "square", "spike" and "triangle" are fed via three slider potentiometers to a voltage summer. We can thus mix any proportion of one type of waveform with another and vary the colouration of the sound over a wide range. All the above is repeated for the other pitch (either 8ft or 16ft) and the output from the mixing sliders of the second pitch are also fed to the same summing point. One can therefore mix the spike waveform of, say, the 8ft pitch with the triangle waveform of the 16ft pitch and produce a totally different kind of sound. With the six controls an infinite number of sound patterns can be generated.

NOTE	Divisor	fHz (top octave)	fHz (next octave)	fHz (next octave)	fHz (next octave)	fHz (bot. octave)
Top C	÷ 239	2091.4	1045.7	522.9	261.4	130.7
B	÷ 253	1975.7	987.8	493.9	247.0	123.5
A#	÷ 268	1865.1	932.5	466.3	233.1	116.6
A	÷ 284	1760.0	880.0	440.0	220.0	110.0
G#	÷ 301	1660.6	830.3	415.2	207.6	103.8
G	÷ 319	1566.9	783.5	391.7	195.9	97.9
F#	÷ 338	1478.8	739.4	369.7	184.9	92.4
F	÷ 358	1396.2	698.1	349.1	174.5	87.3
E	÷ 379	1318.8	659.4	329.7	164.9	82.4
D#	÷ 402	1243.4	621.7	310.9	155.4	77.7
D	÷ 426	1173.3	586.7	293.3	146.7	73.3
C#	÷ 451	1108.3	554.2	277.1	138.5	69.3

## ★ components list

### Resistors

R1	1MΩ	R17	100kΩ
R2	4.7kΩ	R18	100kΩ
R3	38kΩ	R19	10kΩ
R4	38kΩ	R20	680Ω
R5	2.2kΩ	R21	100kΩ
R6	22kΩ	R22	100kΩ
R7	100kΩ	R23	10kΩ
R8	1kΩ	R24	100kΩ
R9	470kΩ	R25	100Ω
R10	1kΩ	R26	2.2kΩ
R11	100Ω	R27	2.2kΩ
R12	100Ω	R28	22kΩ
R13	10kΩ	R29	4.7kΩ
R14	680Ω	R30	680Ω
R15	10kΩ	R31-R128	100kΩ
R16	100kΩ		

All resistors 10% $\frac{1}{2}$ W	VR9	100kΩ min vert preset
VR1 5kΩ lin slider	VR10	10kΩ lin slider
VR2 5kΩ lin slider <sup>1</sup>	VR11	4.7kΩ min vert preset
VR3 100kΩ min vert preset	VR12	10kΩ lin slider
VR4 10kΩ lin slider	VR13	220kΩ min vert preset
VR5 4.7kΩ min vert preset	VR14	10kΩ lin slider
VR6 10kΩ lin slider	VR15	100kΩ min vert preset
VR7 10kΩ lin slider	VR16	10kΩ lin slider
VR8 10kΩ lin slider		

### Capacitors

C1	0.22μF	C16	0.33μF
C2	0.22μF	C17	0.047μF
C3	0.22μF	C18	0.1μF
C4	0.1μF	C19	0.33μF
C5	2200μF	C20	0.1μF
C6	1000μF (16V)	C21	0.1μF
C7	500pF (trimmer)	C22	0.1μF
C8	1000μF	C23	10μF (25V)
C9	0.33μF	C24	47μF (10V)
C10	0.033μF	C25	1000μF (16V)
C11	0.1μF	C26	0.33μF
C12	0.33μF	C27	1000μF (16V)
C13	0.1μF	C28	100μF (16V)
C14	0.1μF	C29	3000μF (35V)
C15	0.1μF		

All polyester 240V unless otherwise stated

### Semiconductors

Tr1	BCY71	D2	1N4004
Tr2	BCY71	D3	1N4004
Tr3	BCY71	D4	1N4004
Tr4	AD162	D5	1N4004
D1	1N4004	D6	1N4004
		D7	12V 400mW zener

### Integrated circuits

IC1	AY-1-0212	IC10	AY-1-5051
IC2	AY-1-5051	IC11	AY-1-5051
IC3	AY-1-5051	IC12	AY-1-5051
IC4	AY-1-5051	IC13	AY-1-5051
IC5	AY-1-5051	IC14	747 dual-in-line
IC6	AY-1-5051	IC15	747 dual-in-line
IC7	AY-1-5051	IC16	741 dual-in-line
IC8	AY-1-5051	IC17	LM380 dual-in-line
IC9	AY-1-5051		

### Miscellaneous

T1 240V prim. 18V  $\frac{1}{2}$ A sec. L1 and L2 Denco Maxi-Q aerial coil (blue) range T2. S1 240V  $\frac{1}{2}$ A mains slide. S2 single pole rocker. S3 single pole rocker. LS1 8Ω to 35Ω to suit cabinet. Sk1 switched jack. Sk2 switched jack. 49 note (C to C) keyboard. 49 two pole contact assemblies. Main PCB, power supply PCB, 16 circuit board pins, 98 way tag strip (tag separation approx.  $\frac{1}{2}$ in.) and approx. 50 yards fine insulated flexible connecting wire.

## ★ collated component list

### Resistors

3 off	100Ω	4 off	10kΩ
3	680Ω	2	22kΩ
2	1kΩ	2	38kΩ
3	2.2kΩ	105	100kΩ
2	4.7kΩ	1	470kΩ
		1	1MΩ

All resistors 10% $\frac{1}{2}$ W

### Potentiometers

7 off	10kΩ	} All linear sliders with three terminals (type TTC, PW organ)—from Radio Components Specialists or Henrys Radio
2 off	5kΩ	

### Presets

2 off 4.7kΩ min vertical, 3 off 100kΩ, 2 off 220kΩ

### Capacitors

1 off	500pF Compr. trimmer	3 off	0.22μF
		5	0.33μF
1	2200pF (polyester)	1	10μF (25V)
1	0.033μF	1	47μF (10V)
1	0.047μF	1	100μF (16V)
9	0.1μF	4	1000μF (16V)
		1	3000μF (35V)

### Transistors

3 off BCY71 and 1 off AD162

### Diodes

6 off 1N4004 and 1 off 12V 400mW zener

### Integrated circuits

1 off	AY-1-0212	1 off	741 dual-in-line
12	AY-1-5051	1	LM380
2	747 dual-in-line		

### Inductor

1 off Denco Maxi-Q aerial coil (blue) range T2

### Transformers

1 off 240V prim. 18V  $\frac{1}{2}$ A sec. type MT50 $\frac{1}{2}$

### Switches

1 off 240V  $\frac{1}{2}$ A mains slide, 2 off single pole rockers (miniature)

### Loudspeaker

1 off 8Ω to 35Ω to suit enclosure

### Miscellaneous

16 printed board pins. 3 x 14 pin DIL sockets. 1 x 16 pin DIL socket. 1 x 8 pin DIL socket. 50 yards fine insulated flexible connecting wire. 93 way tag strip comprising four separate strips holding 24,24,24 and 26 tags each, (these have to be constructed by the builder). Two switched jack sockets ( $\frac{1}{2}$ in.).

49 note (C to C) keyboard with 49 two pole contact assemblies, paxolin mounting plates and palladium earthing busbars; available as a kit from Maplin Electronic Supplies, PO Box 3, Rayleigh, Essex SS6 8LR priced £29.95 incl. p.p. & VAT.

Main printed circuit board and power supply printed circuit board available from Foresight Electronics, 62 High Street, Croydon CR9 2UT; price of both boards £7.20 incl. p.p. & VAT.

Integrated circuits, Transistors and Diodes available from Chromasonic Electronics, Dept. 1, 56 Fortis Green Rd., London N10; Henry's Radio, 404-406 Edgware Rd., London W2; Marshall's, Dept. PW, 42 Cricklewood Broadway, London NW2 3HD, Tel:01-452 0161 and Foresight Electronics.

### NOTE

Practical Wireless is offering a full size paper drawing of the main printed board showing track layout. For those who require one of these, please write, marking the envelope 'Easybuild Organ' to Practical Wireless, Fleetway House, Farringdon St., London, EC4A 4AD. and enclosing a PO or cheque for 25p and a 10x8in size S.A.E.

The output from the six input summer is fed to an internal integrated circuit power amplifier to give about one watt output from the internal loudspeaker. Alternatively the output from the summer can be taken to an external Hi-Fi amplifier if greater power and/or higher quality is required.

## SPLIT KEYBOARD

A drawback with a single manual organ is the lack of ability to emphasise the right hand or the left hand. An option in this system (which is included as standard but can be removed if not desired) is to "split" the keyboard. This allows us to use the 16ft pitch only over the bottom two octaves and the 8ft pitch only over the top two octaves. Thus, by means of a switch, it is possible to have 16ft operating over the whole keyboard but 8ft only over the top two octaves; this would make anything played by the right hand stand out over the accompaniment. Likewise 8ft can be operational over the whole keyboard with 16ft only over the bottom range, giving emphasis to bass notes. There is very little complication introduced to the electronics by doing this, all that is necessary is a series switch in each of the two busbars. The complications arise when trying to play in this mode, and only skilled organists are likely to be able to make the best use of this facility.

Due in part to the lack of pure sinewaves the organ tends to favour reed tones and although there are plenty of mellow tones to be produced, the tone colouration lacks variety. To overcome this drawback and increase the range considerably, it is suggested that the organ be connected to a Hi-Fi amplifier, where the treble and bass controls can be used to the best effect.

## CIRCUIT DETAILS

Fig. 2 shows the master oscillator and vibrato oscillator. The nominal 500kHz signal is generated by Tr3 which is a Hartley Oscillator using a standard medium wave tuning coil as the inductor. Making C7 500pF brings its tuning range well down to the frequency required. D1 and D2 are ordinary power rectifier diodes operating as varactor diodes and are, effectively, in shunt across C7. The more negative the potential of Tr2 emitter, the more reverse biased these diodes become, their junction capacitance reduces and the frequency of the oscillator rises.

The quiescent potential at Tr2's emitter is set over a limited range by VR2, the "tune" control already mentioned. On this quiescent potential one can superimpose a low frequency AC signal (about 6Hz) from the phase shift oscillator comprising Tr1. The amplitude of this vibrato signal can be varied from zero to maximum by VR1. There is no built-in preset control to the vibrato frequency but if desired it can be modified by changing the values of R3 and R4 (increasing them to 47kΩ will reduce the frequency and vice-versa). Do not use resistors outside the range of 22kΩ to 47kΩ.

The characteristics of the tuning diodes are by no means linear and it will be found that the vibrato has greater effect when VR2 is set to its earthy end (this corresponds to low frequencies). Values have been chosen to keep the variation to a minimum but in practice this should present no problems because for normal playing VR2 will not be altered once set—unless producing special "tune" effects and even then the "tune" will greatly over-ride the change in vibrato level.

The output from the collector of Tr3 is used to drive the master tone divider integrated circuit (IC1 in Fig. 3). This is an MOS integrated circuit in a 16 lead DIL encapsulation. It requires two negative supply rails of -12V and -27V as well as earth. Because of this, and the fact that other MOS devices having similar power requirements are used, the rest of the circuit is designed to operate from a -12V rail. Provided IC1 sees an input signal of 10V it will carry out its complex division with no problems. Each output is a square wave with unity mark space ratio for even divisions and a slight divergence from unity for odd divisions; this is mentioned purely for information and plays no part in the efficiency of the operation.

The output impedance of the master tone generator is 3-5kΩ. Being comparatively low there are no problems with interfacing it with the subsequent dividers and taking a parallel tapping from it to provide the tones for the topmost octave. Each output is fed to the input of a four stage divider, with 12 such circuits designated IC2 to IC13. These operate from the same supply rails as IC1 and are fully compatible. The only problem with these circuits is that they are in 10 lead TO-5 encapsulations which makes them slightly more difficult to handle. C8 and R12 are for decoupling and to prevent any breakthrough of the

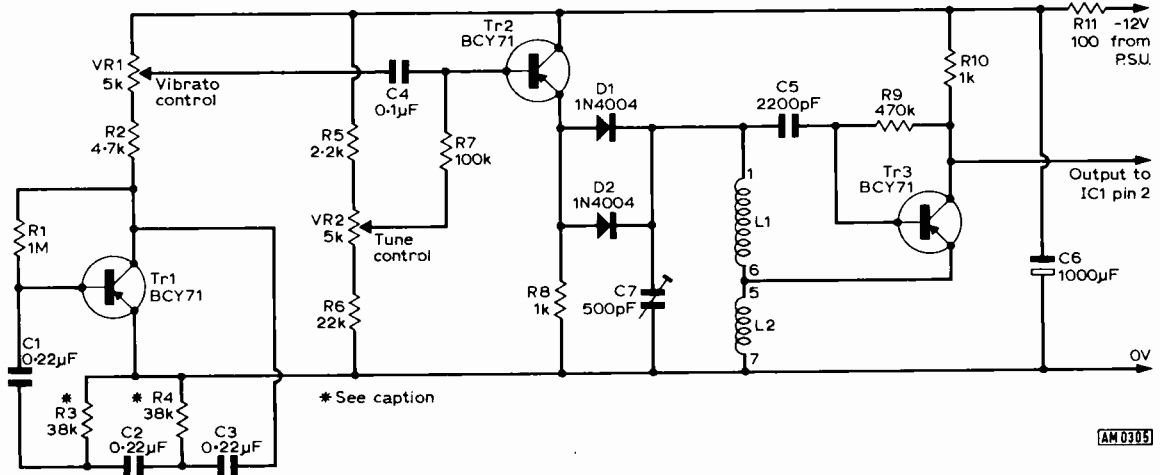

Fig. 2: Circuit diagram of Master oscillator, Vibrato and Tune circuits. R3 and R4 can be varied in the range 22kΩ to 47kΩ to preset vibrato speed to the desired value.

# NEW LOW PRICES!

## Sinclair Scientific kit

(Was £19.95 - save £5!)

**£14.95**  
(INC. VAT)

### Britain's most original calculator now in kit form

The Sinclair Scientific is an altogether remarkable calculator.

It offers logs, trig, and true scientific notation over a 200-decade range - features normally found only on calculators costing around £100 or more.

Yet even ready-built, the Sinclair Scientific costs a mere £21.55 (including VAT).

And as a kit it costs under £15!

### Forget slide rules and four-figure tables!

With the functions available on the Scientific keyboard, you can handle directly

- sin and arcsin,
- cos and arccos,
- tan and arctan,
- automatic squaring and doubling,
- $\log_{10}$ ,  $\text{antilog}_{10}$ , giving quick access to  $x^y$  (including square and other roots),
- plus, of course, addition, subtraction, multiplication, division, and any calculations based on them.

In fact, virtually all complex scientific or mathematical calculations can be handled with ease.

### So is the Scientific difficult to assemble?

No. Powerful though it is, the Sinclair Scientific is a model of tidy engineering.

All parts are supplied - all you need provide is a soldering iron and a pair of cutters. Complete step-by-step instructions are provided, and our Service Department will back you throughout if you've any queries or problems.

Of course, we'll happily supply the Scientific or the Cambridge already built, if you prefer - they're still exceptional value. Use the order form.

Components for Scientific Kit (illustrated)

1. Coil
2. LSI chip
3. Interface chips
4. Case mouldings, with buttons, windows and light-up display in position
5. Printed circuit board
6. Keyboard panel
7. Electronic components pack (diodes, resistors, capacitors, etc)
8. Battery assembly and on/off switch
9. Soft carrying wallet
10. Comprehensive instructions for use

Assembly time is about 3 hours.

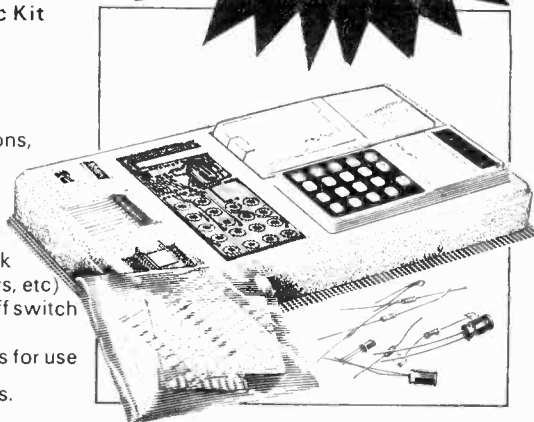

## Features of the Sinclair Scientific



- 12 functions on simple keyboard  
Basic logs and trig functions (and their inverses), all from a keyboard as simple as a normal arithmetic calculator's. 'Upper and lower case' operation means basic arithmetic keys each have two extra functions.

- Scientific notation  
Display shows 5-digit mantissa, 2-digit exponent, both signable.

- 200-decade range  
 $10^{-99}$  to  $10^{99}$

- Reverse Polish logic  
Post-fixed operators allow chain calculations of unlimited length - eliminate need for an button.

- 25-hour battery life  
4 AAA manganese alkaline batteries (e.g. MN2400) give 25 hours continuous use. Complete independence from external power.

- Genuinely pocketable  
4 1/3" x 2" x 11/16".  
Weight 4 oz. Attractively styled in grey, blue and white.



# NEW LOW PRICES!

## Sinclair Cambridge kit

(Was £14.95 - save £5!)

**Now only**  
**£9.95**  
 (INC. VAT)

At its new low price, the original Sinclair Cambridge kit remains unbeatable value.

In less than a year, the Cambridge has become Britain's most popular pocket calculator.

It's not surprising. Check the features below - then ask yourself what other pocket calculator offers such a powerful package at such a reasonable price.

### Components for Cambridge Kit

1. Coil
2. LSI chip
3. Interface chip
4. Thick film resistor pack
5. Case mouldings, with buttons, window and light-up display in position
6. Printed circuit board
7. Keyboard panel
8. Electronic components pack (diodes, resistors, capacitors, transistor)
9. Battery clips and on/off switch
10. Soft wallet

Assembly time is about 3 hours.

### Take advantage of this

**money-back, no-risk offer today**

The Sinclair Cambridge and Scientific kits are fully guaranteed. Return either kit within 10 days, and we'll refund your money without question. All parts are tested and checked before despatch - and we guarantee any correctly-assembled calculator for one year. (This guarantee also applies to calculators supplied in built form.)

Simply fill in the preferential order form below and slip it in the post today.

### Scientific

Price in kit form £14.95 inc. VAT

Price built £21.55 inc. VAT.

### Cambridge

Price in kit form £9.95 inc. VAT.

Price built £13.99 inc. VAT.

## Features of the Sinclair Cambridge



- Uniquely handy package. 4 1/3" x 2" x 11/16", weight 3 1/2 oz.
- Standard keyboard. All you need for complex calculations.
- Clear-last-entry feature.
- Fully-floating decimal point.
- Algebraic logic.
- Four operators (+, -, x, ÷), with constant on all four.
- Powerful constant with separate 'K' button.
- Constant and algebraic logic combine to act as a limited memory, allowing complex calculations on a calculator costing less than £10.
- Calculates to 8 significant digits.
- Clear, bright 8-digit display.
- Operates for weeks on four AAA batteries.

To: Sinclair Radionics Ltd,  
 FREEPOST St Ives,  
 Huntingdon, Cambs. PE17 4BR

- Please send me
- Sinclair Scientific kit at £14.95
  - Sinclair Scientific built at £21.55
  - Sinclair Cambridge kit at £9.95
  - Sinclair Cambridge built at £13.99

All prices include 8% VAT.

\*I enclose a cheque for £....., made out to Sinclair Radionics Ltd, and crossed.

\*Please debit my \*Barclaycard/ Access account. Account number

--	--	--	--	--	--	--	--	--	--	--	--	--	--	--	--	--	--	--	--	--

\*Delete as required.

Signed \_\_\_\_\_

Name \_\_\_\_\_

Address \_\_\_\_\_

Please print. FREEPOST - no stamp needed.

**sinclair**  
 Sinclair Radionics Ltd,  
 FREEPOST St. Ives,  
 Huntingdon, Cambs. PE17 4BR.

Reg. No: 699483 England. VAT Reg. No: 213 8170 88.

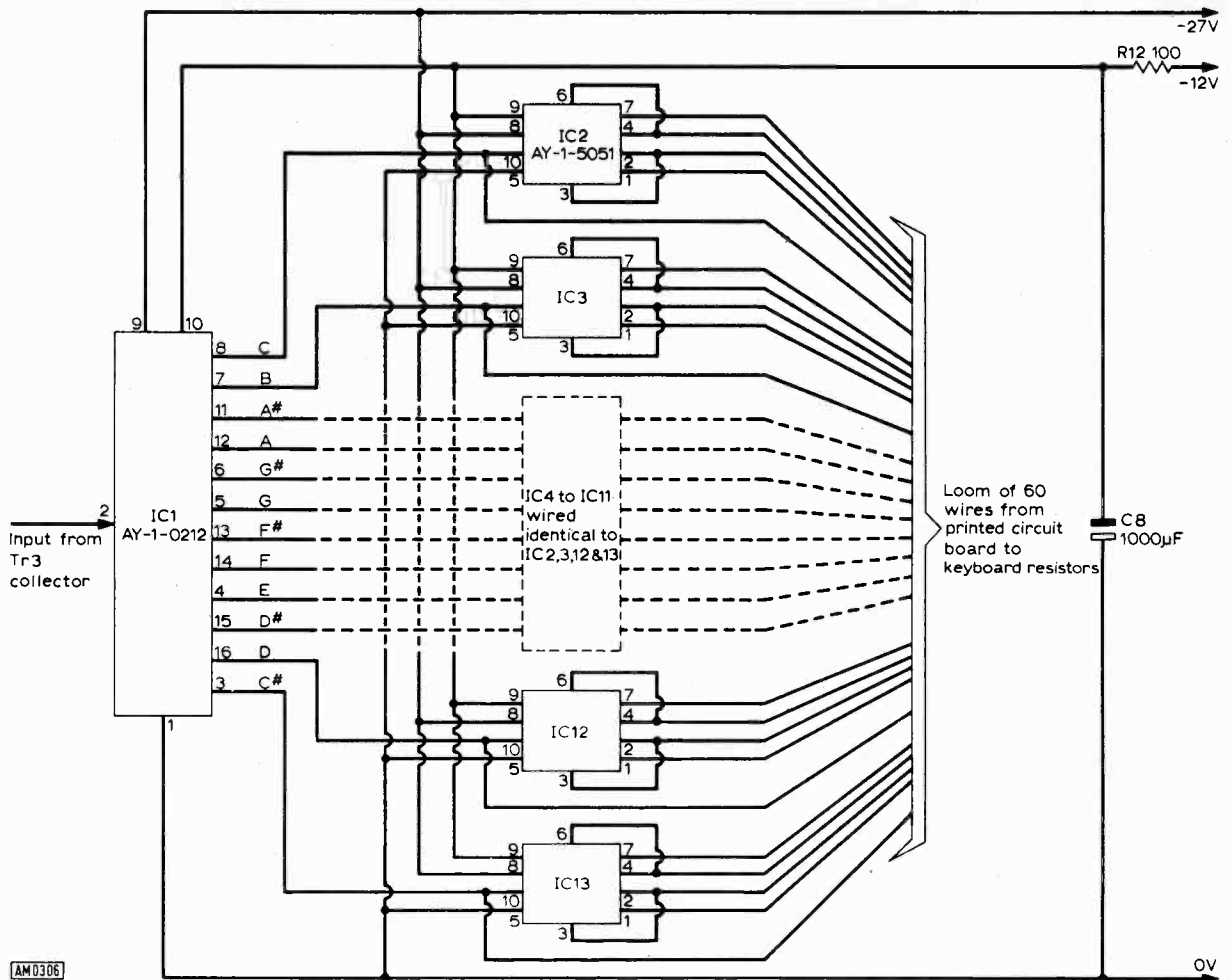

Fig. 3: Master tone generator and divider stages. The note 'C' is 'Top C' for each octave generated. Hence the lowest 'C' for 16ft pitch on the four octave keyboard is not available.

"chorus" from all the notes into the final audio stages of the organ which operates from the same -12V rail.

The four outputs from each divider together with a loop from its input are fed into a 60 wire loom which is routed to the keyboard resistors (mounted immediately adjacent to the key contacts).

## CONTROLS

The two wires from the 8ft and 16ft pitch busbars are routed back to the circuit shown in Fig. 4 which embraces the tone forming circuits, mixing stage and summing amplifier. The top portion and bottom section of Fig. 4 are identical apart from the values of C10 and C17. SW2 acts as the keyboard splitting switch at 8ft pitch. When it is closed the organ operates normally over its full range but when opened, only the top two octaves are fed through C9 to the input buffer amplifier ( $\frac{1}{2}$  of IC14). VR3 is used to preset the gain of this stage and its function will be explained during the setting up procedure. C10 with R14 differentiate the square wave signal from IC14 to produce the spikey waveform already described. Proportions of this are divided off by the manual control VR4 to be fed through C11 to the summing point of the six input mixer.

The preset VR5 taps off a proportion of the unmodified square wave signal which is fed via the control VR6 to the summing point. The preset is necessary to control, to a sensible level, the balance between the three tone colours. Without it the square wave signal would be grossly overpowering. C12 feeds the square wave signal to half of IC15 which operates as a two-ramp integrator. The rate of ramp is set by C14 with R15. The slope of the ramp remains constant for all input frequencies, resulting in higher frequencies being subjected to attenuation. Over the frequency range of the organ there is approximately a five to one amplitude variation in signals from the integrator but as it is the higher end that is attenuated this just about compensates for the ear's frequency response. In fact, although this ratio of five to one sounds dramatic there is very little difference on the ear!

The integrator by itself causes a very nasty keying "thump" and this is particularly noticeably at higher frequencies. To remove this effect the capacitor C14 is bypassed by VR7. On setting-up this is adjusted to the minimum value possible, consistent with a useful signal. The higher the value of VR7 the higher the gain of the integrating amplifier and hence the higher the overshoot, which causes the "thump". The

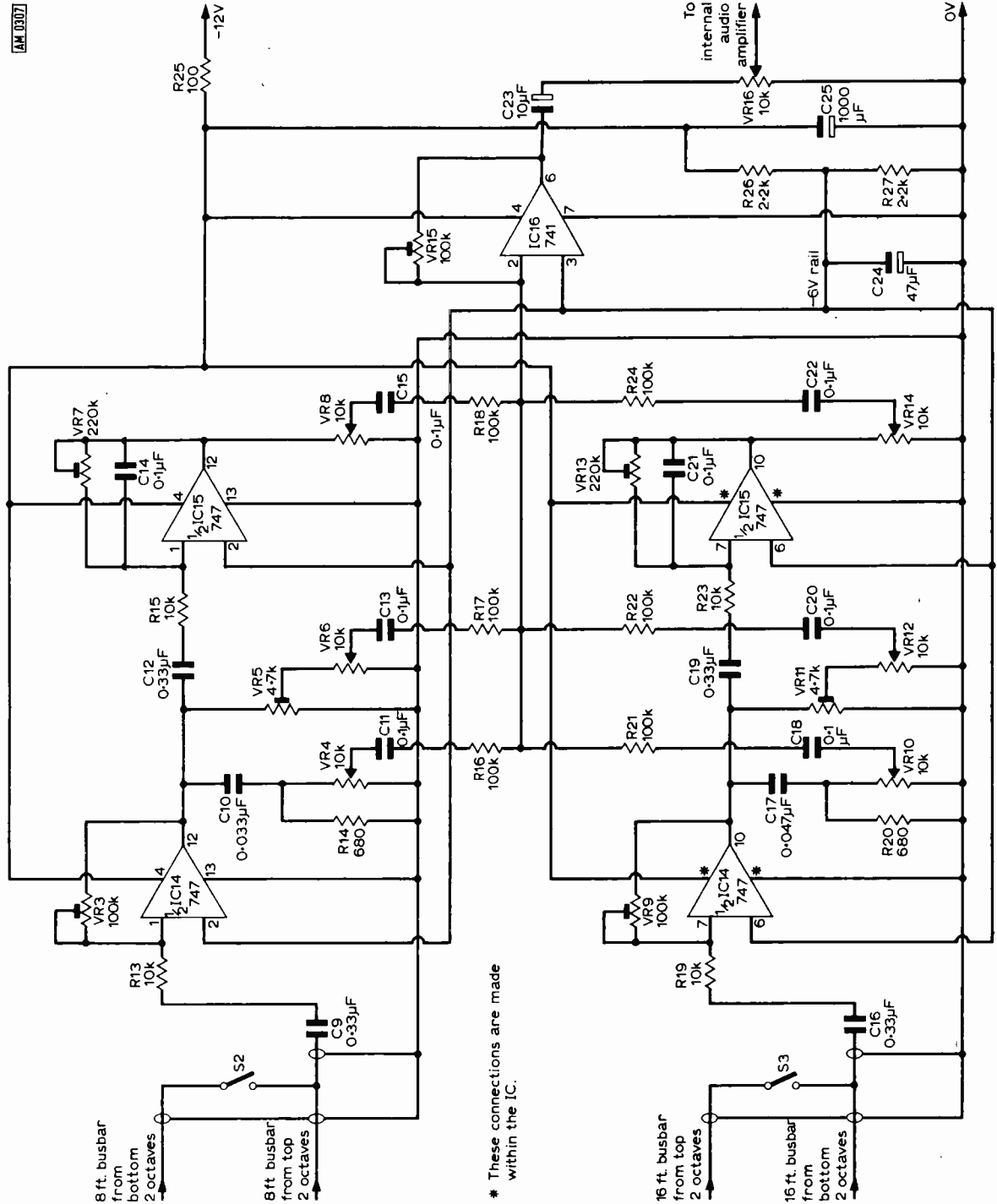

Fig. 4. Circuit diagram of the Tone forming circuits, the mixing stage and preamplifier.

triangular wave output from the integrator is now fed via the control VR8 to the summing point.

The tone forming circuit for 16ft pitch is identical except, of course, that the keyboard splitting switch operates on the bottom two octaves and in order to get a bit more power in the spike waveform, C17 has a slightly higher capacitance.

IC16 acts as a summing amplifier but perhaps ought to be called the pre-amplifier for the output signal. Its gain is set by the preset VR15 so that the

output from the wiper of VR16, the volume control, matches the input requirements of the external amplifier (probably in the range of 100 to 500mV). Remember that the output level depends very much on how many notes are being played and how the tone forming sliders are set. It is always better to have less gain than seems necessary in this stage to prevent overloading the other audio stage.

**PART 2 NEXT MONTH DEALS WITH BOARD ASSEMBLY, TESTING AND INITIAL SETTING-UP.**

# PRODUCTION LINES

colin riches

## 23CM CONVERTER

This SSM 23 converter uses schottky diodes in a balanced hybrid ring mixer. The secrets of its high performance lie in the balance of the mixer circuit, the image suppression stub, accurate matching into the i.f. amplifier and a clean, filtered oscillator injection signal. These features not only aid in the suppression of u.h.f. TV signals but also contribute to the final overall noise figure.

The crystal used in the oscillator chain is a close tolerance, low temperature co-efficient unit oscillating in the region of 100MHz. This is multiplied into the 1,200MHz region and the desired harmonic is selected in a *tuned* 2 pole resonator to provide a high rejection to unwanted harmonics.

In the hybrid ring mixer the signal input, the oscillator chain and the two diodes are each spaced  $\lambda/4$  apart, with the oscillator fed in between the two diodes. Therefore, the diodes see an *in phase* injection from the oscillator port and an out of phase signal from the aerial port. The injection is cancelled at the aerial and thus not radiated and the signal is cancelled at the oscillator port and not attenuated in the oscillator filter. Just like the balanced modulator in an SSB transmitter.

The i.f. amplifier employs two stages of amplification designed to have a very low noise figure and carefully matched into the diodes output.

Overall noise figure is 7dB, gain is 27dB and size 4in x 2½in x 1½in. Connectors for Standard converter—BNC co-axial socket input; Belling Lee co-axial output socket; 2mm colour coded supply terminals.

Price is £21.60 (this includes VAT and carriage). Converters are available for other frequencies (including satellite frequencies) or to customers' special requirements—up to the microwave region. Your enquiries are invited. If you would like further details, send a stamped, addressed envelope to: *S.S.M. Solid State Modules, 63 Woodhead Road, Solid, Lockwood, Huddersaeld, HD4 GER. (Tel. 0484 23991).*

## DUAL-DIGIT DISPLAYS

Litronix announce two new dual-digit red-lit numeric displays, believed to be the only displays of their type currently available. Designated DL-721 and DL-727, they have been created for a broad range of commercial and domestic applications, from digital clocks and t.v. tuner indicators to digital instrumentation and point-of sale systems. DL-721 contains a polarity indicator, and can register from 00 to 19; DL-727 incorporates two 7-segment digits, and can register from 00 to 99.

In both cases, the digits measure 0.5in. in height and have a right-hand decimal point. They are end-stackable on 0.5in. digit centres.

Typical electrical characteristics of these common-anode units include a forward voltage of 2V at 0.5 to 50mA, dynamic resistance of 6-ohm at 10mA, and luminous intensity of 3mcd at 20mA.

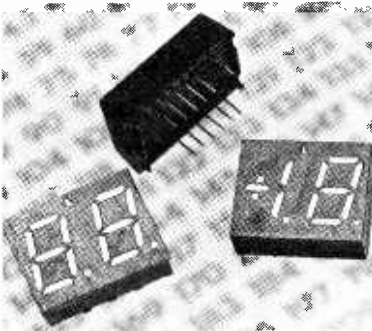

Both the -721 and the -727 are priced at £2.44 in quantities of 1,000. For further information and prices, contact *Litronix, European Headquarters—Bevan House, Bancroft Court, Hitchin, Herts SG5 1LW.*

## P.C.B.'s

W.K.F. Electronics tell us that they are able to offer any current circuit board published in *Practical Wireless* at 70p each, irrespective of size, complexity, etc.

If you would like further information on this service, contact: *W.K.F. Electronics, Welbeck Street, Whitwell, Worksop, Notts.*

## CASSETTE STORAGE

This excellent new cassette storage system is being sold direct from the manufacturers, Plastic Engineers Ltd. At a price of £2.50, it represents very good value for money.

The "Tape-Rax" holds 32 cassette cases on eight levels. Extra levels can be added and an extra four levels to hold another 16 cassette cases costs £1 plus 20p post and packing.

"Tape-Rax" may be obtained by sending £2.50 plus 30p postage and packing to *Plastic Engineers Limited, Treforest Industrial Estate, near Pontypridd, Glamorgan.*

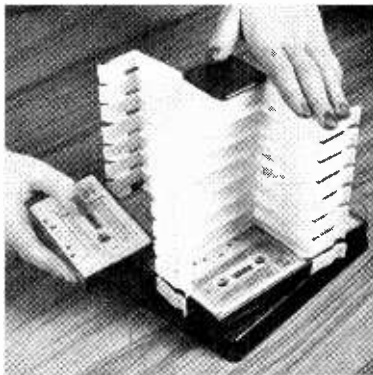

## THE CHANTICLEER

The "Chanticleer" is a new digital alarm clock from Bywood Electronics. The figures are shown as an orange display 0.7in. high. A brightness control dims the display for bedroom use.

It is very simple to set both time and alarm by two switches. At the time the alarm has been set for, a "beep" is emitted. This can be reset for five minutes simply by tilting the clock. This feature is jolly useful, for if you do doze off the alarm will wake you again in five minutes. The clock is mains operated and if the supply should fail, the display flashes to indicate that it may not be showing the correct time.

Recommended price of the "Chanticleer" is £19.95 plus VAT. It comes complete with case and 2-year guarantee. Further gen from: *Bywood Electronics, 181 Ebbens Road, Hemel Hempstead, Herts, HP3 9RD.*



## THE SWING S

Audio Workshops Ltd., have introduced a new Swing S indoor f.m. aerial. It has a low profile central body and two clear acrylic plastic "wings" along the edges of which there is an aluminium strip which acts as the aerial's element.

The aerial has a built-in tunable r.f. amplifier which can be tuned by turning the top of the body of the amplifier (white disc in picture) until the chosen optimum frequency is selected.

Audio Workshops tell us that the gain in signal strength is around 3-6dB and good stereo reception is possible under fringe conditions.

The aerial's tuning frequency range is 87-104MHz. It is supplied with two input cables, one for power and one for connection to the tuner. Retail price is £18.09 (including VAT). *Audio Workshops Limited, 29 High Street, Robertsbridge, Sussex.*

## 3M CASSETTE DECK

The Wollensak stereo cassette deck type 4766 from 3M employs beltless capstan drive, heavy-duty flywheel and Dolby noise reduction.

Features include sound mixing, peak overload indicators and 3-position bias switching.

Most "Dolbyised" decks have only a service-adjustable calibration system. The 4766 however, has a built-in calibration test tone which the user can adjust himself. Peak level recording indicators flash immediately over-modulation is reached.

Recommended retail price, excluding VAT is £231.48. Further information may be obtained from *3M United Kingdom Limited, Public Relations, 380-384 Harrow Road, London, W9 2HU.*

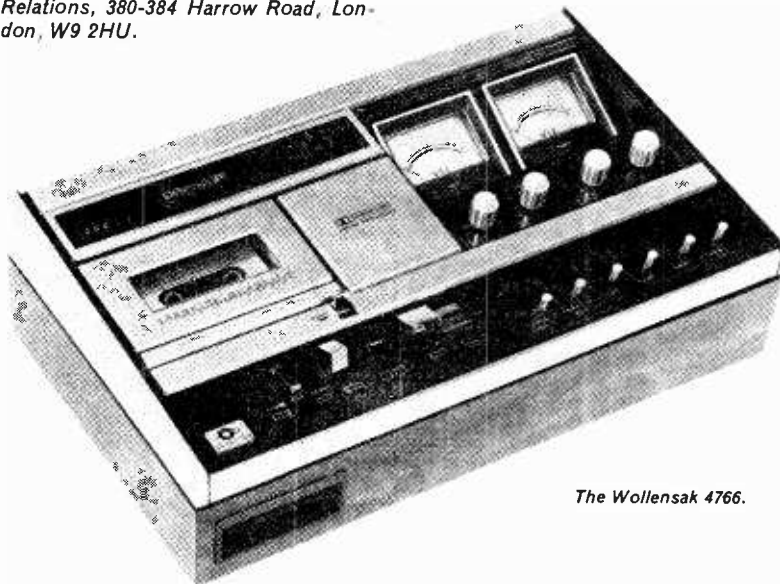

*The Wollensak 4766.*

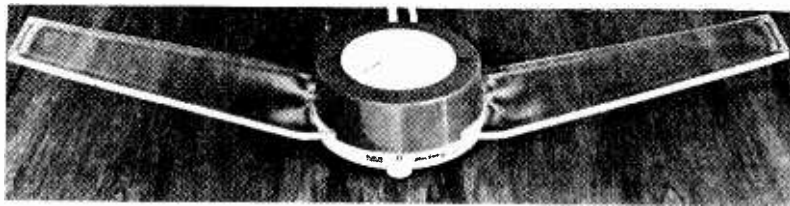

## ALPHANUMERIC NIXIE TUBES

Electronic Brokers Ltd., the electronic components and test equipment specialists of London NW1, are importing direct from the USA Alphanumeric Nixie tubes for digital or alphabetical displays.

The Nixie tube can display all the letters of the alphabet and the numerals from 0-9 in a single tube.

The tube has 13 or 15 cathode segments, with a common anode. By applying a negative voltage to the proper combination of cathode segments, the alphanumeric characters are formed.

Special features of the Nixie tube include, all DC operation, all characters uniform and of equal height, simple solid-state drive circuits for the memory, and maintenance free operation with long life and no loss of brightness.

Model B-7971 has  $2\frac{1}{2}$ " character heights and for quantities up to 1,000, the price is 99p each, with special prices beyond this figure. A numeric version—model B-5853 ST is also available with  $\frac{1}{2}$ " high characters, priced at £1.00 for a single unit, or 80p each for quantities over 100. *Electronic Brokers Ltd, 49/53 Pancras Road London NW1 2QB England Telephone 01-837 7781*

## AVAILABLE NOW!

### REPRINT OF PW'S TELE-TENNIS SERIES

July-November 74

Send 75p + 5p (post & packing) to:  
Chief Cashier (PW Tele-Tennis),  
IPC Magazines,  
Tower House, Southampton St.,  
London, WC2E 9QX

## BATTERY-POWERED ELECTRONIC THERMOMETER

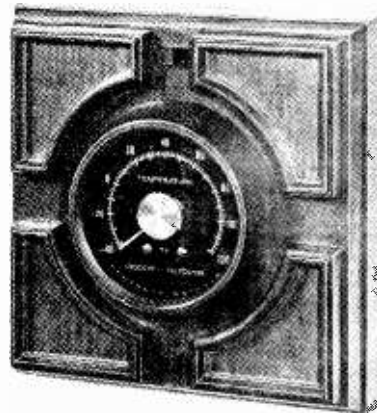

All solid-state circuitry provides reliable indoor/outdoor temperature readings in degrees Fahrenheit; from  $-40^{\circ}\text{F}$  to  $+120^{\circ}\text{F}$  on the same scale. Convenient front-panel selector-switch lets you choose indoor or outdoor scale. Touch the Push-to-Read button and the dial pointer swings up to indicate indoor or outdoor temperature. The thermometer is powered by a 9-volt battery (not included in kit) and housed in a simulated wood-grain plastic cabinet measuring  $7''\text{H} \times 7''\text{W} \times 2\frac{1}{2}''\text{D}$ .

Like every Heathkit the GD-1019 kit comes complete with a detailed Assembling and Instruction manual which leads you step-by-step through the construction of this kit.

Kit K/GD-1019 costs £16.20 (including 8% VAT and delivery within United Kingdom). *Heath (Gloucester) Ltd., Gloucester, GL2 6EE.*

A series of simple transistor projects, using not more than twenty components.

The circuit of this easily made Morse practice oscillator is shown in Fig.1 and it requires only two components in addition to the transistors, speaker and pitch control VR1. Current drain will depend somewhat on the transistors but is about 5mA from the 9V battery supply.

The OC42 and BSY95A are inexpensive surplus types but the circuit will operate with almost any small audio or similar type transistors. Tr1 must be PNP and Tr2 NPN transistors. Other suitable transistors are AC128 for Tr1 and BC108 for Tr2 and connections are the same as for Tr2 in Fig.2. Other transistors to hand could easily be tried.

The audio note or pitch obtained depends on the value of C1, speaker impedance and total value of R1 and VR1 in series. It is also influenced by the battery voltage. The exact values shown need not be used, provided the tone is satisfactory. Increasing the value of C1 lowers the frequency.

Fig.2 shows assembly inside a sloping front 4x4x4in. case, but any small box or case which would accommodate the parts would be quite satisfactory. Tr1, Tr2, C1 and R1 are supported on a 5-way tag strip and leads run from here to the speaker and other connecting points. The centre tag of the 5-way strip and negative line is in contact with the metal case, but this is not essential and an insulated box can be used if connections are made as in Fig.2.

A 2-way tag strip holds leads which run to the key. If the key is used with other equipment and is fitted with a jack plug, a suitable socket for this can be fitted to the case. No separate on-off switch is needed as the circuit is off when the key is open. Check that the battery connectors are not able to touch the metal case.

## Practicing the code

It is important to form letters and words correctly. A dash should equal three dots in duration and the spaces between dots and dashes forming a letter equal one dot each. Letters are separated by a space of three dots, and words by a space of five dots.

Practice with someone already experienced in the code is probably best. Two beginners, alternately sending and reading, need to take care to avoid habitual errors and is not recommended. This also applies to anyone trying to learn alone. Any learner will find a tape recorder very useful, both for checking sending and for obtaining some code practice for reading purposes. To avoid too much filling in from memory, material recorded to be read later will have to be random letters. These can be obtained by writing A to Y at random in a 5x5 block, to read vertically, horizontally, diagonally and backwards in any combination.

Records and tapes are available and the RSGB slow Morse transmissions on the amateur bands can be heard on a SW receiver, will also provide practice. After the code has been fully memorised, practice eventually brings speed in sending and reading. 

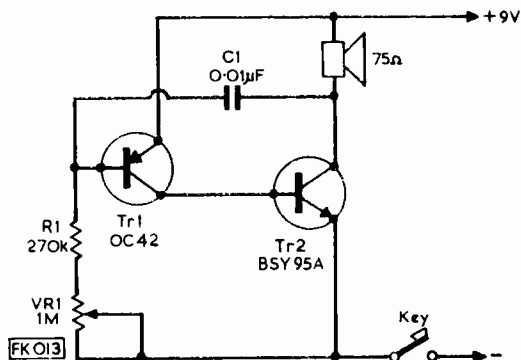
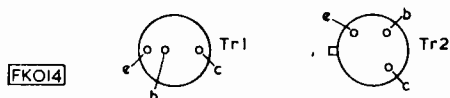
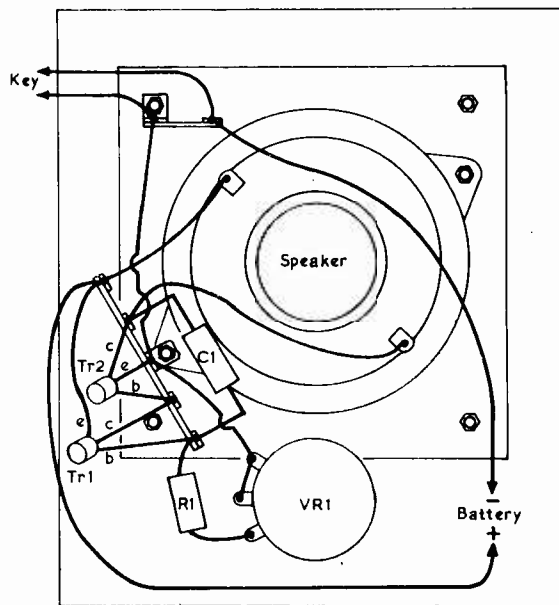

Fig. 1: above, gives circuit of the oscillator. Fig. 2: below, construction using a tag strip to mount components.



## ★ components list

- |  |  |
|--|--|
| R1   | 270kΩ 1/4W.                            |
| VR1  | 1 MΩ potentiometer.                    |
| C1   | 0.01μF.                                |
| Tr1  | OC42, AC128 or other audio PNP type.   |
| Tr2  | BSY95A, BC108 or other audio NPN type. |
| 75Ω speaker, 2 1/2" or similar.  |  |
| Tag strips, knob, 4 x 4 x 4in. sloping front case (H. L. Smith & Co. Ltd.) |  |
| PP3 or other 9V battery and clips.   |  |

## STEREO DECODER

When we set about producing a stereo decoder module, we were determined to see that it wasn't just another PLL MPX decoder. And this one isn't. It uses the unique CA3090AQ by RCA. A most sensitive, quiet and most versatile decoder is the result. The built-in TOKO pilot tone filter eliminates pilot tone problems—and the audio amplifier stages ensure enough output to drive your amplifier. The automatic stereo switch will defeat stereo on low level signals when driven from the meter output of the CA3089E

### Dynamic characteristics:

Input impedance 50k ohm  
Channel separation 40 dB (typ.)  
Mono channel balance 0.3dB (typ.)  
Minimum signal 40mV (Composite)  
Harmonic distortion 0.3% or better  
19kHz rejection 55dB  
38 kHz rejection 90dB  
Audio output 1400mV for 130mV input  
Automatic stereo muting with the CA3089E

<b>CA3090AQ</b>	<b>£3.75</b>
<b>2mH inductor</b>	<b>30p</b>
<b>Module kit</b>	<b>£5.40</b>
<b>Module built</b>	<b>£6.60</b>

## AUDIO AMPLIFIERS

The LM381 is a dual preamplifier expressly designed to meet the requirements of amplifying low level signals in low noise applications. Total equivalent input noise is typically 0.5µV rms. Each of the two amplifiers is completely independent, with an internal power supply decoupler—regulator, providing 120dB supply rejection and 60 dB channel separation. Other outstanding features include high gain (112 dB), large output voltage swing (Vcc-2V) p-p, and wide power bandwidth (75kHz, 20Vp-p). The LM381 operates from a single supply across the wide range of 9 to 40V. The amplifier is internally compensated and short-circuit protected.

### Price with datasheet £1.85

The LM380 is a two watt audio amplifier intended for low parts count consumer circuits employing a single supply voltage. The output has both short circuit current limiting and thermal overload current limiting to insure safe operation.

### Price with data booklet £1.00

## FM RADIO

**8319** This advanced FM tunerhead contains four tuned circuits—each controlled by a dual varicap diode. The RF and mixer stages employ dual gate depletion MOSFETs, allowing good AGC control and provision is made for simple oscillator only AFC, though the preferred method is to control by means of superimposing the AFC on the main tuning voltage.

Price £7.74

**EF5503 A** 'no compromise' tunerhead employing top quality techniques and components throughout. The MOSFET RF stage is followed by THREE tuned circuits, giving this head an exceptional immunity to adjacent channel and image interference. Following the mixer, an additional IF gain stage is included, enabling the use of common consumer IC IF amplification stages, such as the CA3089E/TDA 1200 etc

Price £8.40

**FM 1185** Ambient IF module with ceramic filter and CA3089E. Input direct from tunerhead; outputs audio, AFC, AGC, signal strength meter.

<b>CA3089E</b>	<b>£1.94 (8 page data)</b>
<b>CFS 10.7</b>	<b>40p</b>
<b>22µH inductor</b>	<b>15p</b>
<b>KACS K586 Quadrature coil</b>	<b>30p</b>
<b>FM 1185 Built and tested</b>	<b>£4.35</b>

The unique **LARSEN** FM tunerhead, type **7252**, combines a high quality tunerhead and IF, to provide an advanced VHF receiver module, with high gain and low distortion. Also included are features such as mute, AFC on all front end tuned circuits, and audio preamplification.

Sensitivity, Modulation 75 KHz 1µV  
S/N ratio 26dB  
Total harmonic distortion 0.1%  
Price £20.00

## CATALOGUE

Contains data and applications on our range of high technology integrated circuits and modules plus full details of the exclusive range of TOKO coils.

Price 25p inc. VAT and postage.

## DATA

Photocopied data is available for everything we sell, 6p per side. Data booklets free with ICL 8038, CA3089E, LM380, LM381, EF5603, 8319, 7252.

1 page free on request with everything we sell. **VAT** Please add 8% to all UK orders **Post and Packing 15p.**

## WAVEFORM GENERATOR

The **8038** Waveform Generator is a monolithic integrated circuit, capable of producing sine, square, triangular, sawtooth and pulse waveforms of high accuracy. The frequency (or repetition rate) can be selected externally over a range from less than 1/1000 Hz to more than 1 MHz and is highly stable over a wide temperature and supply voltage range. Frequency modulation and sweeping can be accomplished with an external voltage and the frequency can be programmed digitally through the use of either resistors or capacitors. The Waveform Generator utilises advanced monolithic technology, such as thin film resistors and Schottky-barrier diodes.

Supply voltage	+10 to +30V
Frequency range	0.001 Hz to 1 MHz
Sweep FM range	1000 : 1
FM linearity	0.2%
Square wave amplitude	0.9 x Vs
Triangle amplitude	0.33 x Vs
Triangle linearity	0.1%
Sine wave amplitude	0.22 x Vs
Sine wave THD	0.5%

Price with 8 page data and applications booklet **£3.10**

## 3 TERMINAL POWER SUPPLY

The **78** series of three terminal voltage stabilisers have revolutionised all power supply designs over the past year.

Two basic types exist:

**78L** series up to 100mA output

**78** series up to 1A output

Short circuit protection and thermal limiting are built-in.

By the addition of two resistors and a capacitor, the **7805** can give any regulated output voltage between 5 and 20V.

	<b>7805</b>	<b>78L12</b>
Output voltage	5V	12V
Tolerance	±0.2V	±0.6V
Regulation	15mV	20mV
Noise voltage	40µV	80µV
Ripple rejection	78dB	42dB

**7805** Available in TO3 Metal package **£2.05**  
or Plastic package **£1.75**

**78L12** Available in TO92 package **45p**

## VOLTAGE REGULATOR

NE550/µA 723 Price 80p

## INTEGRATED CIRCUITS

CA3053	40p	TBA120A	£1.00
CA3088E	£1.24	TBA651	£1.81
CA3089E	£1.94	TBA810S	£1.30
CA3090AQ	£3.75	TDA1200	£1.84
CA3123E	£1.40	SN7660N	£1.00
CT7001	£9.80	7400	20p
ICL8038	£3.10	7401	20p
LM309K	£1.90	7402	20p
LM380N	£1.00	7404	23p
LM381N	£1.85	7413	38p
LM1496	£1.02	7446	£1.20
LM1820	£1.40	7447	£1.20
LM3900	68p	7448	£1.25
NE546	£1.40	7473	31p
NE550	80p	7474	31p
NE555V	78p	7490	71p
NE560B	£3.19	7493	71p
NE561B	£3.19	7496	83p
NE562B	£3.19	74121	38p
NE565A	£2.75	74192	£1.57
NE566V	£2.55	74S00	74p
NE567V	£2.75	74S112	£2.30
µA720	£1.40	78L12	45p
µA723	80p	9368	£2.20
µA741	40p	9582	£2.50
µA753	99p	95H90	£9.90
µA7805UC	£1.75		
µA7805KC	£2.05		

## TRANSISTORS

BC109	12p
BC183L	14p
BC212	14p

BC318	14p
BF256L	34p
BSX20	25p
MEM614/5	38p
MEM616	20p
TIP2955	99p
TIP3055	60p
MJE340	45p
IN4004	10p
IN4143	7p
2N918	42p
2N2369	18p
2N3702	14p
2N3704	14p
2N4427	£1.53

## LED DISPLAYS

DLT04	95p
SLA1	£1.75
SLA7	£1.50
SLA9	£1.75
SLA11	£1.75
SLA21	£1.75
TIL209	30p

## TOKO FILTERS

455/470KHZ	
CFT455B	45p
CFT455C	45p
CFT470C	45p

CFU050D	50p
MFH41T	£1.35
MFH71T	£1.35

## TOKO FILTERS

10.7MHZ	
CFS 10.7	40p
CFK 10.7	60p

## TOKO IF COILS

455/470KHZ	
7mm	
LMC4200	27p
LMC4201	27p
LMC4202	27p
SET OF 3	60p
10mm	
YHCS590	27p
YHCS589	27p
YHCS11100	27p
SET OF 3	60p

## TOKO IF COILS

10.7MHZ	
KALS4520	30p
KACSK586	30p
TKACS34342/34343 (pair)	55p

## TOKO INDUCTORS

22µH	15p
2mH	30p
5.1mH	27p
43mH	27p

## MW OSC

(TBA651)	27p
(CA3123)	27p

## TOKO PILOT-TONE FILTERS

BLR2007	£1.50
BLR2011	£1.75

## MODULES

TOKO EF5603	£8.40
ET703	£3.30

## LARSEN

7252	£20.00
8319	£7.74

## AMBIT

CA3090AQ	£6.60
BUILT KIT	£5.40
CA3123E KIT	£3.50

## DIGITRONIC

III	£46.50
FM1185	£4.35

MC1310 KIT **£5.10**

NE561B **£5.00**

BASIC KIT **£5.00**

TBA810S **£2.75**

KIT **£5.90**

IMHZ XTAL **£3.50**

**HARDWARE**

TBA810S **15p**

HEATSINK **15p**

**IC SOCKETS**

8 PIN **15p**

14 PIN **16p**

16 PIN **16p**

28 PIN **£1.05**

**PUSHBUTTONS:**

0 to 9 **each 20p**

A to Z **each 20p**

'C' **each 20p**

'RUN' **each 20p**

'STOP' **each 20p**

'CLEAR' **each 20p**

'ENTER' **each 20p**

'AUTO' **each 20p**

'ON' **each 20p**

'OFF' **each 20p**

'SET' **each 20p**

'RESET' **each 20p**

# AMBIT INTERNATIONAL

37 HIGH ST., BRENTWOOD, ESSEX, CM14 4RH2

TEL. 0277 216029  
TLX.995194

# ADCOLA

ELECTRICAL SOLDERING INSTRUMENTS

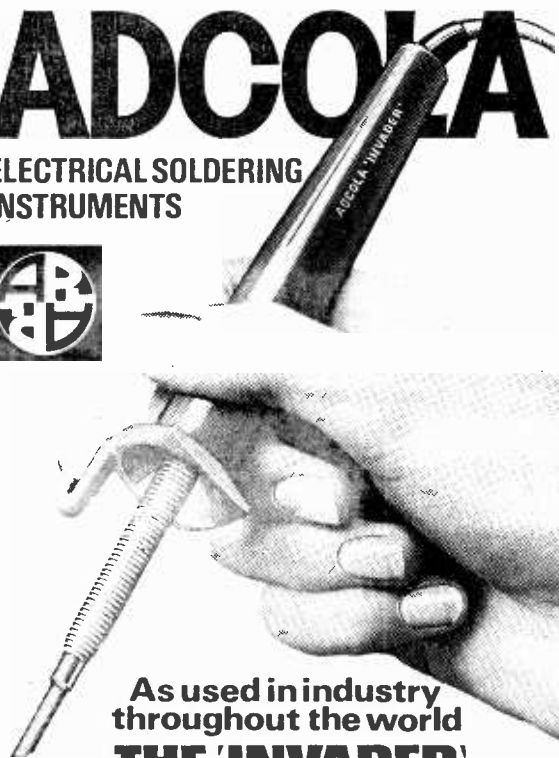

As used in industry throughout the world  
**THE 'INVADER'**

**BRITISH MADE, HAND BUILT, PRECISION INSTRUMENT**

'Invader' low leakage, high efficiency professional soldering instruments as used in industry worldwide, and why not you! Precision designed handle moulded of flame resistant material (SE1) and european safety standards. Stainless steel construction throughout with elements precision wound, earthed at two points, test run and finally flash tested at 2,000 v A/c. Low cost internally fitted bits with large range of bit faces for your future use. Can you afford not to have the 'Invader'.

MODEL 706 £2.88, 646 £3.13, 1076 £3.22  
 $\frac{1}{4}$ " Bit 19watt       $\frac{3}{16}$ " Bit 23watt       $\frac{1}{2}$ " Bit 27watt

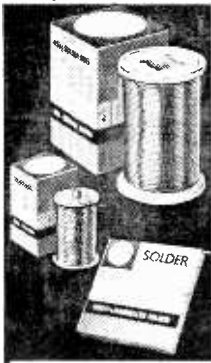

## ADCOLA MULTI-CHANNELLED SOLDER IN HANDY SIZES!

Adcola have designed solder packs to fulfil all your needs—manufactured to B S I. 44.1 60/40/18swg Multi channelled resin cored. If your need is small the dispenser or the three oz reel will do you if you are keener try the  $\frac{1}{2}$  kilo reel.

Dispenser 08p. 3oz 57p.  $\frac{1}{2}$  Kilo £2.58

**It makes sense to use the best! post your coupon now**

ADCOLA PRODUCTS LTD. GAUDEN RD.  
LONDON SW4 6LH  
VAT Regd No 235 6153 72      Regd No 442782

Please send me  
 MODEL 706      MODEL 646      MODEL 1076  
 SOLDER Dispenser      3oz. REEL       $\frac{1}{2}$  Kilo REEL  
 Price include V.A.T.      Add 10p for postage and packing  
 Inclosing P.O. cheque for £

NAME \_\_\_\_\_  
 ADDRESS \_\_\_\_\_

PW1

**PC ETCHING KIT**  
 Contains 1lb ferric chloride, 100 sq. ins copper clad board, DALO etch resist pen, abrasive cleaner, dish for etching and instructions. £3.30.

**RESISTORS & CAPACITORS**  
 500 asstd. resistors £1.40, 2500 £5, 200 poly, ceramic, mica capacitors £1. 15 different trimmers, air-spaced and compression up to 1250pF £1.

**VEROBOARD**  
 100 sq ins assorted sizes and pitches, about 8 bits £1.10.

**SPECIAL OFFER**  
**OF 741C DIL I.C.'s**  
 10 for £2.60  
 25 for £5.75  
 100 for £21.00

**FERRIC CHLORIDE**  
 Anhydrous technical quality in 1lb double sealed packs. 1lb 80p, 3lb £1.65, 10lb £4.45, 100lb £35.

**PO AMPLIFIER UNIT**  
 Contained in steel case 5 $\frac{1}{2}$  x 5 x 3 $\frac{1}{2}$ " are 2 x GET116 transistors on heat sinks, 3 pot cores, 2 30V zeners, 4 audio transformers, 1 $\frac{1}{2}$  R's & C's With circuit £1

**SEMICONDUCTORS**  
 All new full spec devices: AC127 AC128 AC176 AC177 AC187 AC188 all 20p; BC107, 8, 9 10p; 2N3055 38p. 723C 75p; 741C 35p; 1N914 4p; 1N4001 6p; 1N4004 8p; 1N4007 12p; 800V 11A 16p; 400mW zeners 16p; 400V 6A triac £1

All prices include VAT and postage. SAE list, enquiries. Computers, equipment and components always wanted for cash.

## GREENWELD ELECTRONICS (PW2)

Head office, mail-order dept, Wholesale/Retail shop: 51 SHIRLEY PARK RD. SOUTHAMPTON, SO1 4FX. Tel (0703) 772501. Also callers welcome at 21 Deptford Broadway SE8, Tel. 01-692 2009 & 38 Lower Addiscombe Rd., Croydon. Tel. 01-688 2950.

**71b BARGAIN PARCELS**  
 Hundreds of new components—pots, resistors, capacitors, switches, + PC boards with transistors and diodes. Also loads of odds and ends. Contents always changing as new goods come in. Amazing value at £2.30.

**COMPUTER PANELS**  
 Always thousands in stock, all sizes shapes and prices from 5p. 31bs assorted £1.40, 71bs £2.85, 561bs £15. 12 high quality panels with power transistors, IC's, trim pots etc £2.50. Pack containing about 500 components inc at least 50 transistors 95p. Pack of boards with 50 14 pin DIL DTL IC's £1.

**TRANSFORMERS**  
 All mains primary. 6-0-6V @ 100mA 85p; 9-0-9V @ 100mA 90p; 12-0-12V @ 100mA 95p; 16-0-16V with 9V tap @ 1 $\frac{1}{2}$ A £2; 24-0-24V @ 500mA £1.85; 3, 4, 5, 6, 8, 9, 10, 12, 15, 18, 20, 24, 30V @ 1A £2.45; The following are ex-equip: 22 $\frac{1}{2}$ -0-22 $\frac{1}{2}$ V @ 1A £2; 12V @ 15A £3.50; 18V @ 5A £3; 55V @ 5A £4.

**MULTIMETERS**  
 LT101: 0-10-50-250-1000V AC & DC. 0-1-100mA DC. 0-150K $\Omega$  Only £3.60. IT12: 20,000  $\Omega$  V, 0-5-25-50-250-500-2500V DC, 0-10-50-100-500-1000V AC, 0-50 $\mu$ A-2.5-250mA, 0-60k-6M $\Omega$ , -20 to +22dB. Protected meter movement £6.20

**POWER SUPPLIES**  
 G101. Contains mains transformer, 2A thermal cut-out and bridge rect. Will give 1.7-10.5V output with 2 extra capacitors (provided) £1.20. G102. These are stabilized power supplies giving  $\frac{1}{2}$ V @ 225mA. Voltage can be altered by changing zener. Not working, but only minor faults £1.

## NEW ALL SILICON! PRACTICAL WIRELESS



### ELECTRONIC IGNITION SYSTEM

This Capacitor-Discharge Electronic Ignition System was described in *Practical Wireless*, and has proved extremely popular.

The kit is supplied with a ready-drilled roller-tinned printed-circuit board and fully machined die-cast case with AMP Electrical Spade Connector Block together with a custom wound transformer, first grade components and full constructional details.

The original circuit employed Germanium Power Transistors for the negative earth version. WE OFFER SILICON P.N.P. POWER DEVICES AT NO EXTRA COST! All components are available separately. Case size 4 $\frac{1}{2}$ " x 3 $\frac{1}{2}$ " x 2". Complete assembly and construction manual free with kit, available separately 25p.

SUITABLE FOR 12V SYSTEMS WITH NEG. OR POS. EARTH.

PRICE: £9.50 U.K. ORDERS PLEASE ADD VAT

Quantity Discounts:  
 Trade and Overseas 1-5 Nett 6-9 less 10%  
 Enquiries Invited 10-49 less 15% 50-99 less 20%  
 Mail Order Only. 100-999 less 25% 1000 up less 30%

PLEASE STATE POS. OR NEG. EARTH WHEN ORDERING

**DABAR ELECTRONIC PRODUCTS**  
 98 LICHFIELD STREET  
 WALSALL, Staffs WS1 1UZ





**SPECIAL  
PRODUCT  
REPORT**



**KIT**

**'SCIENTIFIC'  
POCKET  
CALCULATOR**

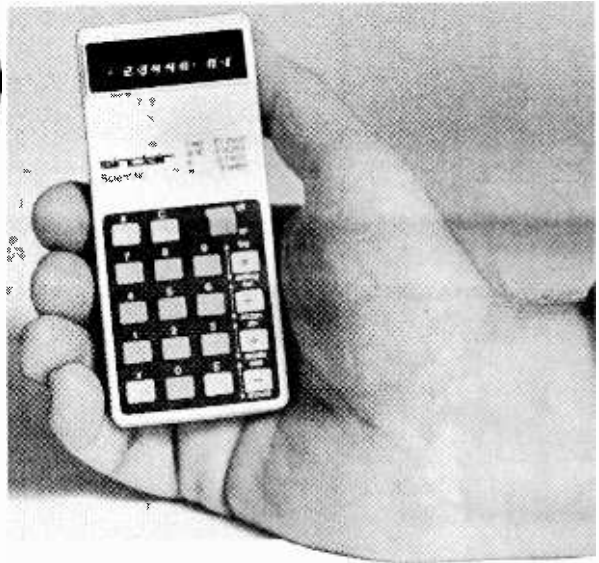

**T**HE kit is supplied in a protective pack of expanded polystyrene, and was complete, even down to two spare buttons for the keyboard. Also included were a small coil of fine gauge solder, a length of desoldering braid and a booklet "Hints on soldering".

The assembly instructions open with a summary of the construction steps and a components list to help you check and identify the various items in the kit. Then follow tips on soldering and assembly methods, a list of recommended tools and a very important and useful section on avoiding damage to the calculator chip from static electricity buildup.

A series of notes keyed to the list of construction steps give more detailed information on identifying each component and fitting it correctly to the printed circuit board.

The kit handbook is generally very good though it does contain a number of small inaccuracies. Two of these are very minor and should not cause too much head-scratching except to very inexperienced constructors.

The first occurs in the p.c.b. drawings which show two diodes called D1 and no D3. Since all diodes are the same type it doesn't really matter, of course. The second comes in the assembly instructions for the keyboard and case, where step 13—fitting the on/off switch blade—cannot be accomplished until after the p.c.b. has been located over the keyboard assembly in step 14.

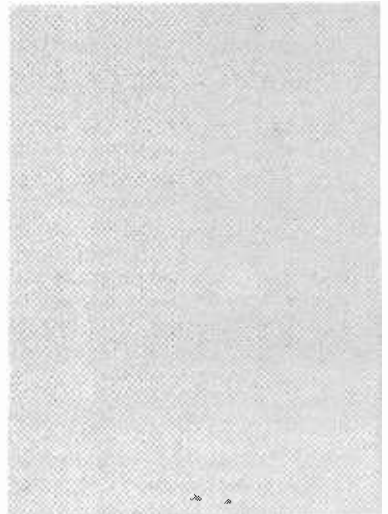
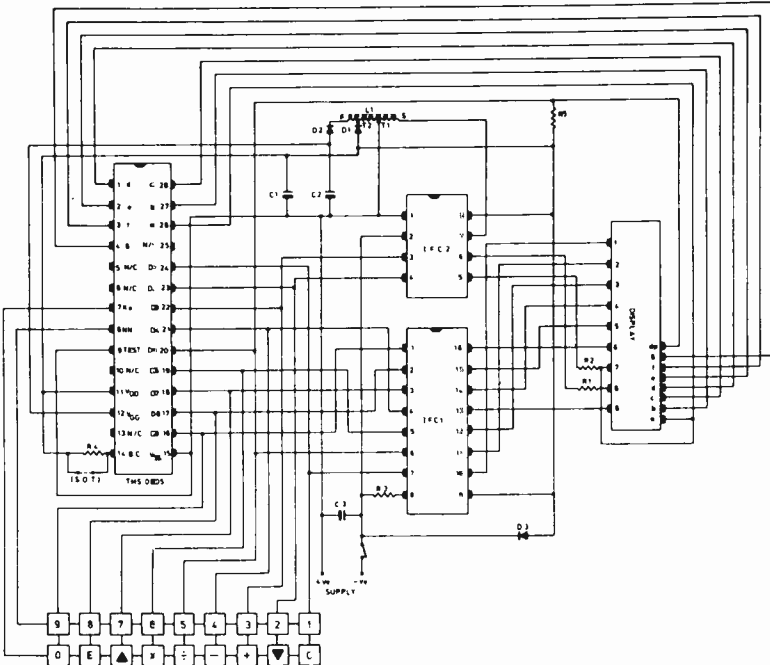

*Circuit diagram of the Scientific. The calculator uses three i.c.s plus twelve discrete components and a basic 9-digit i.e.d. display. The value of R4 is selected on test before despatch to match the particular calculator chip supplied. With some i.c.s it may be replaced by a wire link.*

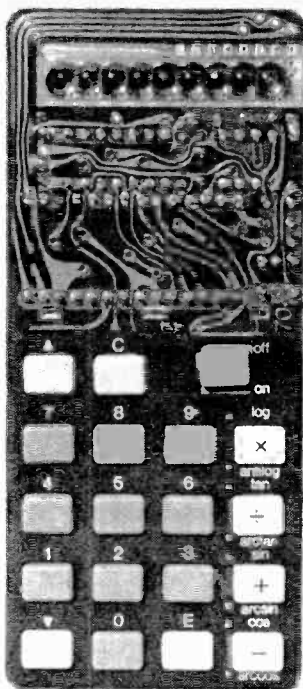

Front view of the p.c.b. and keyboard. All soldering, except for the battery clips and display, is done on this side of the board, which is double-sided fibreglass with plated-through holes. These ensure reliable connections between the two sides but also make removing a wrongly fitted component very difficult.



## Diode Polarity

The third is not so much an inaccuracy but rather a case of not allowing for all possibilities. In the section on determining diode polarity, the booklet says that the + end or cathode is identified by a band painted on the body of the diode, and this is normally true. In this particular kit the diodes supplied appear to have a black body with a blue band painted around one end. Meter checks revealed that the end with the blue band was the anode. Rather confusing for the uninitiated!

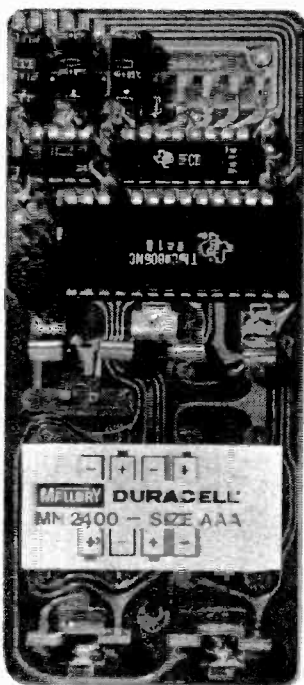

Rear view of the assembled p.c.b. The display drops into a slot in the board and is secured by the soldered connections to its edges.

Apart from these points, the instructions are clear and easily followed, and assembly was completed in under two hours. There are a total of 95 soldered joints to be made, half of them on the pins of the three i.c.s. For these the very small soldering iron (1/16" bit) recommended by Sinclair is really essential.

On fitting a set of batteries (four MN2400) the calculator worked right from switch-on. It has now seen considerable use over a period of three months and has just started on its second set of batteries. During that time one fault developed—a battery clip came adrift from the p.c.b. It seems that for this particular job a larger iron, say 25W, is advisable to get the solder to melt over the whole of the mating surfaces.

## Fault-finding

For those who suffer the traumatic experience of their calculator not working correctly when first tested, Sinclair thoughtfully provide a simple faultfinding guide. Since the components in each kit are tested before despatch, it is assumed that the most likely cause of any fault is a poor soldered joint, either open circuit or else shorted to an adjacent connection. In that event, the information provided should help the constructor to pinpoint the trouble.



The two case halves snap together to secure the p.c.b. A door in the back section covers the battery compartment.

In the last resort, you may return your calculator to Sinclair's Service Department for repair. They make a fixed charge of £2.50 unless a major component has been damaged during assembly, in which case the replacement may be charged for.

As a way of buying a truly pocket-sized calculator with more than just the four standard functions of addition, subtraction, multiplication and division, all for under £20, the Sinclair Scientific Kit would seem to take quite a lot of beating. Some prior experience of soldering on p.c.b.s is essential but otherwise you should not encounter any problems in assembly.

Undoubtedly the single most useful extra function on this calculator is log/antilog, which opens the door to a wide range of other functions. On the other hand the most annoying omission is a 'clear last entry' key. Having to repeat a lengthy calculation because you push a wrong button can be very frustrating. The lack of any memory is less of a drawback and can be overcome by using paper and pencil to note down intermediate results in more involved calculations.

**The Sinclair Scientific Kit is available from retailers or direct from Sinclair Radionics Ltd., London Road, St. Ives, Huntingdonshire PE17 4HJ. See their current advertisement for recommended retail price.**



**"I MADE IT MYSELF"**

*Imagine the thrill you'll feel! Imagine how impressed people will be when they're hearing a programme on a modern radio you made yourself.*

**Now! Learn the secrets of radio and electronics by building your own modern transistor radio!**

Practical lessons teach you sooner than you would dream possible.

What a wonderful way to learn—and pave the way to a new, better-paid career! No dreary ploughing through page after page of dull facts and figures. With this fascinating Technatron Course, you learn by building!

You build a modern Transistor Radio . . . a Burglar Alarm. You learn Radio and Electronics by doing actual projects you enjoy—making things with your own hands that you'll be proud to own! No wonder it's so fast and easy to learn this way. Because learning becomes a hobby! And what a profitable hobby. Because opportunities in the field of Radio and Electronics are growing faster than they can find people to fill the jobs!

**No soldering—yet you learn faster than you ever dreamed possible.**

Yes! Faster than you can imagine, you pick up the technical know how you need. Specially prepared step-by-step lessons show you how to: read circuits—assemble components—build things—experiment. You enjoy every minute of it!

You get everything you need. Tools. Components. Even a versatile Multimeter that we teach you how to use. All included in the course. **AT NO EXTRA CHARGE!** And this is a course anyone can afford. (You can even pay for it by easy instalments).

**So fast, so easy, this personalised course will teach you even if you don't know a thing today!**

No matter how little you know now, no matter what your background or education, we'll teach you. Step by step, in simple easy-to-understand language, you pick up the secrets of radio and electronics.

You become a man who makes things, not just another of the millions, who don't understand. And you could pave the way to a great new career, to add to the thrill and pride you receive when you look at what you have achieved. Within weeks you could hold in your hand your own transistor radio. And after the course you can go on to acquire highpowered technical qualifications, because our famous courses go right up to City & Guilds levels.

**Send now for FREE 76 page book—see how easy it is—read what others say!**

Find out more now! This is the gateway to a thrilling new career, or a wonderful hobby you'll enjoy for years. Send the coupon now. There's no obligation.

**Enough books are written about crime, this one stops it.**

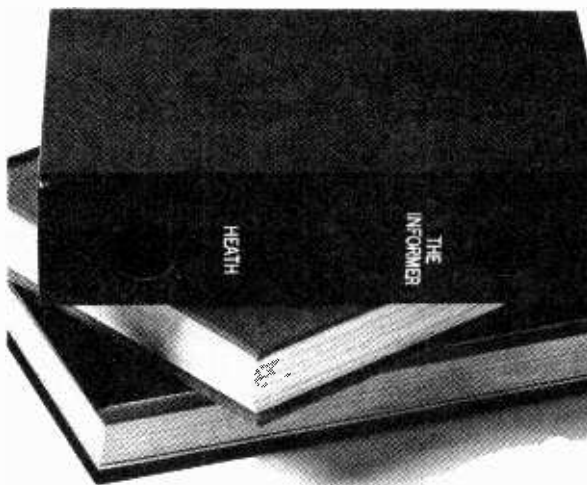

Outside it's a book. Inside it's an ingenious ultrasonic burglar alarm from Heathkit. The GD-39.

A complete kit that can be assembled in only a few enjoyable hours, with the help of a very easy to follow instruction manual.

The GD-39 works by transmitting a silent, ultrasonic signal throughout the room. And continuously monitoring it. Any movement made by an intruder in the room will then automatically produce a change in the signal. Which triggers off a lamp and, thirty seconds later, a remote buzzer, that just you hear, or a loud bell.

Enough to scare the living daylight out of a burglar.

For more details, and a bookful of other ideas, just post the coupon now for your free Heathkit catalogue.

Or, if you're in London or Gloucester, call in and see us. The London Heathkit Centre is at 233 Tottenham Court Road. The Gloucester showroom is next to our factory in Bristol Road.

Heath (Gloucester) Limited,  
Dept. PE124, Bristol Road,  
Gloucester GL2 6EE.  
Tel: (0452) 29451.

**The GD-39 Ultrasonic Burglar Alarm**

To: Heath (Gloucester) Limited, Dept. PE124, Gloucester GL2 6EE. Please send me a free Heathkit catalogue.

 Name \_\_\_\_\_  
 Address \_\_\_\_\_  
 \_\_\_\_\_  
 \_\_\_\_\_  
 Postcode \_\_\_\_\_

Remember easy terms are available with the Heathkit Monthly Budget Plan.



**POST TODAY FOR FREE BOOK**

To: ALDERMASTON COLLEGE  
DEPT. CPW 02  
READING RG7 4PF

CPW 02

Yes, I'd like to know more about your course. Please send me free details—plus your big, 76-page book that tells about all your courses.

NAME \_\_\_\_\_  
ADDRESS \_\_\_\_\_



HOME OF BRITISH INSTITUTE OF ENGINEERING TECHNOLOGY

for PW readers only....

# FREE COMPETITION!

## £500 to be spent with

### FIRST PRIZE £100!

Prizes for the amounts shown here will be in the form of vouchers for the purchase of, or deposit on, Heathkit equipment only. A small selection of Heathkit models is shown below. The vouchers, valid for three months from date of issue by Heathkit, cannot be exchanged by Heathkit for cash.

### 4 PRIZES OF £50! PLUS 8 PRIZES OF £25!



1



2

# HEATHKIT

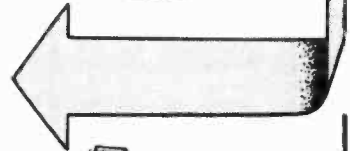

3

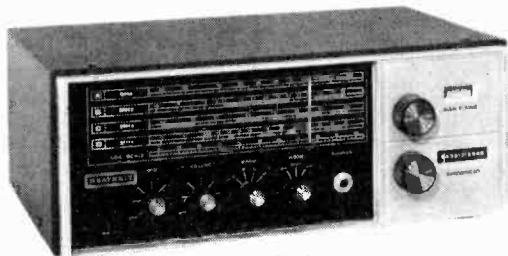

4



5



6



7

**FREE ENTRY COUPON**

1st	
2nd	
3rd	
4th	
5th	
6th	
7th	
8th	

**PRACTICAL WIRELESS  
Heathkit Competition**

My order of importance for the eight benefits is given on the left. I agree to the rules as final and legally binding.

(Signed)  
Mr./Mrs./Miss .....

Full  
Address .....

Post to: PRACTICAL WIRELESS Heathkit Competition,  
136 Long Acre, London WC2E 9QP.

**Closing date: March 14, 1975**

Please send FREE catalogue containing details of the wide range of over 250 electronic kits that may be chosen by winners.

Name .....

Address .....

Practical Wireless Heathkit Competition 1975.

*please cut out along this line*

- A** Imparts electronic knowledge and expertise.
- B** Gives personal control over quality of finished product.
- C** Gives pride of accomplishment and creative satisfaction.
- D** Keeps one up to date with the world of electronics.
- E** More value for money when comparing price and performance.
- J** Provides an enjoyable and practical hobby.
- K** Saves time and money by allowing the self-servicing of equipment.
- L** Range of kits includes products not always available in the shops.

**HOW TO ENTER:**

By building his own electronic equipment, the home- constructor has many advantages over those who buy ready-made units. Listed above are eight unique benefits which can be enjoyed by the average electronics enthusiast who prefers to "do-it-himself". All you have to do is place them in what you consider to be their order of importance to such an enthusiast. For example, if you think "Provides an enjoyable and practical hobby" is most important of them all, write J in the box marked 1st on your entry coupon. The letter of your next choice goes in the box marked 2nd, and so on for all eight.

Complete the coupon, all in ink (pen or ball-point) with your full name and address, then post in a sealed envelope to:—Practical Wireless Heathkit Competition, 136 Long Acre, London WC2E 9QP, to arrive not later than Friday, March 14th, 1975, the closing date.

If you would like a FREE copy of Heathkit's latest catalogue, also write your full name and address in the right-hand coupon. **DO NOT** detach this from the competition entry coupon.

- 1 AM/FM DIGITAL ELECTRONIC ALARM CLOCK/RADIO KIT K/GRI075
- 2 DIGITAL ELECTRONIC CAR CLOCK/TIMER KIT K/GC1093
- 3 DIGITAL MULTIMETER KIT K/IM1202
- 4 4-BAND RECEIVER KIT K/SW717
- 5 AM/FM STEREO TUNER-AMPLIFIER KIT K/AR1214
- 6 DELUXE MET/L LOCATOR KIT K/GD348
- 7 TUNE-UP METER KIT K/CM1073

**Nobody loses with PW! Fill in this coupon too, for a FREE copy of Heathkit's latest catalogue.**



**RULES**

There is no entry fee, but each attempt must be fully completed in ink on the proper printed coupon cut from PRACTICAL WIRELESS, and must bear the entrant's own full name and address.

**All accepted entries will be examined**, and the first prize, as described, awarded to the entrant who, in the opinion of the judges, has shown the greatest skill and judgement in listing the eight benefits in order of importance. Remaining prizes will be awarded for the next best entries in order of merit. No entrant may be awarded more than one prize. All prizes must be accepted as offered; there can be no alternative awards.

In the event of a tie or ties for any prize(s), a further eliminating test will be conducted by post between the tying competitors to determine such winner(s) or winning order.

Any entry received after the closing date will be disqualified, as will any received mutilated, illegible, incomplete, bearing alterations, with more than one key letter in each space or not complying fully with the instructions and rules. No responsibility can be taken for entries lost or delayed in the post or otherwise; proof of posting will not be accepted as proof of receipt.

The judges' decisions, and those of the Editor of Practical Wireless in all other matters affecting the competition, will be final and legally binding. No correspondence can be entered into.

The competition is open to all readers in Great Britain, Northern Ireland, The Channel Isles and Isle of Man, except employees (and their families) of IPC Magazines Ltd., the printers of Practical Wireless, and of Heath (Gloucester) Ltd.

All winners will be notified and the result published in the earliest possible issue of Practical Wireless.



## AMATEUR BANDS

by Eric Dowdeswell G4AR

IT seems strange to be writing this at the end of December for the March issue! I hope that many of you will be poring over the instruction manuals for a shiny new receiver, sent to you from the North Pole. Much more sensible than the eternal socks, shirts and racing cars! The trick is to let the word get around the family quite a few weeks before Christmas, coupled with hints dropped concerning filter bandwidths, sensitivity and desirable modes of operation. This invariably leads to veiled questions as to what you really mean and your prompt reply that the So-and-So receiver will fill the bill!

I managed to get a MFJ Enterprises CW filter this way this year and have since spent a lot of time sorting out signals with the three bandwidths available, down to 80Hz. It can be used at the output socket of a receiver thus avoiding having to dive inside the set! In my case I fitted it after the product detector in my much-modified HRO and coupled with the mechanical filter previously installed I have all the selectivity I need. If interested contact Hockley Audio Centre, Spa Road, Hockley, Essex.

Paul Barker BR334898 (Sunderland) sent in his usual immaculate log but bemoans the poor conditions on 20m which rather reduced his SSTV loggings. Tim Charles (Colchester) is having problems with his Satellite receiver but still managed to log a lot of DX. He comments on the many W stations above 3.8MHz who seem to want to work the DX but never listen below our end of the band at 3.8MHz. Tim's log for 40m shows what can be heard on this much neglected band.

Alan Rae (Glasgow) has been taking advantage of the problems which have beset schools in his part of the country by putting up some more aerials. One is a square loop, 12ft on each side, and tuned with a capacitor for the 15m band. Alan felt a little down-in-the-mouth when he subsequently passed by the Rugby transmitting site with its masses of fantastic aerial arrays. Makes our efforts in the amateur radio field seem a waste of time! Gary Edge (Warrington) is also A8740 and he writes to the column for the first time. As one would expect nowadays his best DX has been on 80m using a 9R59DS. More details of his set-up next time, I hope. Another newcomer is Stephen Budd, A8713 (Worthing) who has some

rather nice things to say about our column coupled with suggestions for more info on DXpeditions, contests etc. Stephen uses old favourite AR88 and pre-selector, with 150ft of wire.

Regular contributor Max France (Warrington) finds that his spare time, such as it is, coincides with best conditions on 80m, which is just as well, I suppose! With catches such as VR1AA and KS6DH he has not been idle. He's been listening to the 10m downlink from Oscar VII but his poor results would seem to suggest that his gear is not yet optimised for that band. Suggest, Max, that you look at a copy of *Radio Communication* each month which covers the Oscar programme very thoroughly.

Alan Doherty BR334968 (Portrush Co. Antrim) copied plenty on 80m and 20m but found DX sadly lacking on 40m. I think it is a matter of digging below the blanket of Euro QRM, as proved by the log of Tim Charles. Eric Carling (Lymington) managed another couple of countries to make it 229 for the year. KC6VE in the Eastern Caroline Is. and YJ8GS were good ones on 20m as were ZL3RB and 8P6ES on the 15m band. John Porter (Baslow, Derbys) has been airing his new FR50B (perhaps Christmas comes early in them parts!) and has consequently relegated his 9R59DS to the broadcast bands. You will find that it does a very good job there OM, the IF selectivity of about 4kHz being just right for the QRM and yet not too narrow for listening to a bit of music now and again while working in the shack!

Roger Trett (Norwich) apologises for the lack of reports but he has been busy taking his RAE and we can but wish him every success. He's added another long wire to his collection, mainly to pull in the VK's on his FR50B. Michael Green A8088 (Northwich) has been out of commission while getting his receiver's trimmers tickled, as he puts it. Bigger and better logs in future OM? Michael is full of praise for the Mid-Cheshire ARS which meets every Wednesday evening at the Verdin Comprehensive School, Winsford providing instruction for the RAE and Morse practice. I ought to mention that there are many such clubs around the country crying out for more members so make an effort to find your local club and join in the fun if you feel that you are a bit of a loner at the moment. The RSGB can usually help with info or see their callbook.

# Crescent Quality Components

**BARGAIN CAPACITOR 2,200MFD at 63v. DC wkg.**  
Size = 2" x 1 1/4" diameter. Tag ended. All new and unused. Our price 35p.

**STEREO/MONO HEADPHONE VOLUME CONTROL BOX**



**TWO WAY STEREO ADAPTOR**

Stereo Jack plug to two stereo free sockets, complete with 110mm cable. For connecting two stereo inputs into one.

A bargain at 65p.



**LIGHT EMITTING DIODES**  
TIL 209 (Red) With Clip 22p each  
TIL 209 (Green) With Clip 38p each  
TIL 209 (Yellow) With Clip 90p each  
Med 500 T092 Type 16p each

**LED READOUTS**

Litronix  
DL707 3 Character 14 Pin DIL 22-00  
DL701 as above but ± 1 22-00  
DL747 6 Character 22-62

**Minitron**

3015 7 Segment 16 Pin DIL 41-18  
3015G as above but ± 1 41-18

**Clock Chip**

CT7001 MOS/LSI Digital Clock/Calendar Chip Plus full Circuits and Information leaflet 42-95  
Circuits and Information sheet 15p  
Lit 704 Led Display for above 41-35  
Or 4 for 55-25

**WAFER SWITCHES**

1 Pole 12 Way 22p each  
2 Pole 2 Way  
2 Pole 3 Way  
2 Pole 4 Way  
2 Pole 6 Way  
3 Pole 4 Way  
4 Pole 3 Way



**POTENTIOMETERS**

All types 1" and less diameter  
Singles  
5K Log or 5K  
10K Lin Less 10K  
25K Switch 25K Less  
50K 15p each 50K Switch 45p each  
100K 100K  
250K Double 250K  
500K Pole 500K  
1M Switch 1M  
2M 80p each 2M

**PRE SETS**

Sub Miniature Skeleton Type 0-1 Watt Horizontal Mounting 100, 250 and 500 ohm, 1k, 2.5k, 5k, 10k, 25k, 50k, 100k, 250k, 500k, and 1M ohm 6p each

**MAINS TRANSFORMERS**

Open Type Double Wound Continuously Rated, two hole fixing clamp with colour coded flying leads, varnish impregnated. Approx. size: 1 1/2" x 1 1/4" x 1 1/4" high  
Fixing centres: 2 1/2"  
TR1 20-0-20v 100 m/A  
TR2 12-0-12 v 100 m/A All  
TR3 0-0-9 v 100 m/A 240 Volt  
TR4 6-0-6 v 100 m/A Primary  
TR5 3-0-3 v 100 m/A  
Our Price 41-28 each

**200/250v MAINS RELAY**

Heavy duty contacts 2-500 ohm coil. All new and unused D.P.D.T. mains relays 50p, Carr. Free. Special quantity 240 per 100 off.

**MINIATURE RELAYS**

Brand new range of British made Relays, Size 1 1/4" x 1" x 1/2". All two changecovers with 250v 1.5A contacts and suitable for fitting on 1m Veroboard.  
Type Volts Current Ohms All  
27/A 12v 17M/A 700  
21/A 12v 28M/A 430 41-30  
12/A 6v 33M/A 185 each

**DOUGLAS TRANSFORMERS**

All types are standard 240 volt primary.  
MT 102 ct. 0 - 18 - 25 - 33 - 40 - 50 at 500M/A 22-00 each  
MT237cs 20-0-20 at 150M/A 41-25  
MT241cs 20-0-20 at 30M/A 41-05  
MT240cs 15-0-15 at 30M/A 41-05  
MT239cs 12-0-12 at 50M/A 41-05  
MT238cs 3-0-3 at 200M/A 41-05

**POWER PACKS**

PP1 Switched 3 - 6 - 7 1/2 - 9 volt 400M/A Transistor and Zener Stabilised On/Off Switch and Polarity Reversal Switch, in a black metal case 25-25 each.  
PP2 Switched 6 - 7 1/2 - 9 volt Battery Eliminator. Approx. size 2 1/2" x 2 1/2" x 3 1/2". Ideal for cassette recorders 22-25  
PP3 Car converter. From 12v Pos. or Neg. to 6 - 7 1/2 - 9 volt. Easy to fit and transistor regulated 23-90



**VEROBOARD**

2 1/2 x 3 1/2	1	15	Plain 15
2 1/2 x 5	32p	24p	15p
3 1/2 x 3 1/2	34p	34p	18p
3 1/2 x 5	39p	45p	
17 x 2 1/2	1-08p	77p	80p
17 x 3 1/2	1-45p	1-16p	75p
17 x 5	1-85p		1-10p

Pin insertion tool 75p  
Spot face cutter 52p  
Pkt. 36 pins (state 1 or 15) 25p

**LOUDSPEAKERS**

2 1/2" 8 ohm 50p  
2 1/2" 40 ohm 50p  
2 1/2" 80 ohm 50p  
5" 8 ohm ceramic 41-25  
6" 8 ohm dual cone ceramic 22-50  
10" 8 ohm dual cone ceramic 23-75  
7" x 4" 8 ohm ceramic 41-60  
8" x 5" 8 ohm Permanent Magnet 41-60



\*EMI 13" x 8" 450 Kit 44-10  
3 - 3 - 15 ohm 27-50  
\*EMI 13" x 8" 350 Kit 27-50

**S. G. BROWN "DIPLOMAT" HEADSET**

Incorporates ceramic piezo electric transducers.  
Specifications—20-17,500 CFS.  
Frequency—20-17,500 CFS.  
Impedance—Predominantly capacitive, at .001MFD per earpiece can be regarded as 150K at 1kcs.  
Weight—3.5oz. (98 grams).  
A Bargain at 41-25 each set

**MAINS KEYNECTOR**

Keynector connects any Electrical Equipment to the mains supply in seconds. Ideal for beach, garage demonstrations, etc. Multi connections can be made (max. load 13A fused). 22-25p.



**ALUMINIUM BOXES**

Metal project boxes give you work a professional finish

	L	W	H	
AB7	2 1/2	4 1/2	1 1/2	54p
AB8	4	4	1 1/2	63p
AB9	4	2 1/2	1 1/2	54p
AB10	4	4 1/2	1 1/2	63p
AB11	4	2 1/2	2	54p
AB12	3	2	1	45p
AB13	6	4	2	89p
AB14	7	6	2 1/2	84p
AB15	8	6	3	99p
AB16	10	7	3	11-35
AB17	10	4 1/2	3	11-02
AB18	12	6	3	11-20
AB19	12	8	3	11-50

**ABS PLASTIC BOXES**

Handy boxes for construction projects. Moulded extrusion rails for P.C. or chassis panels. Fitted with 1mm front panels.  
1005 = 105mm x 73mm x 45mm = 51p  
1006 = 150mm x 75mm x 47mm = 68p  
1007 = 184mm x 124mm x 60mm = 96p  
1021 = 108mm x 74mm x 45mm (sloping front) = 50p

**BARGAIN BOARDS**

Components galore for the experimenter Ex Computer boards with Resistors, Capacitors and useful Transistors—at least 4 transistors per board. Five boards 41-00.

**CLEAR PLASTIC PANEL METERS**

Size 59mm x 46mm x 35mm these meters require a 38mm hole for mounting.

ME6 = 0 to 50 micro amp Full Scale  
ME7 = 0 to 100 micro amp Full Scale  
ME8 = 0 to 500 micro amp Full Scale  
ME9 = 0 to 1 m/A Full Scale  
ME10 = 0 to 5 m/A Full Scale  
ME11 = 0 to 10 m/A Full Scale  
ME12 = 0 to 50 m/A Full Scale  
ME13 = 0 to 100 m/A Full Scale  
ME14 = 0 to 500 m/A Full Scale  
ME15 = 0 to 1 amp Full Scale  
ME16 = 0 to 50 volts A.C. Scale  
ME17 = 0 to 300 volts A.C. Full Scale  
ME18 = "S" Meter  
ME19 = "VU" Meter

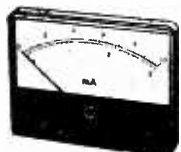

OUR PRICE 22-00

**"CRESCENT" 100 WATT R.M.S. ALL PURPOSE AMPLIFIER U. BUILD - IT**

**DECON DALO 33PC ETCH RESIST PEN**

The Decon Dalo 33PC is a unique instrument for the professional and amateur electronics engineer, enabling him to prepare in minutes a perfect printed circuit board

OUR PRICE 30p

**ADD LUXURY TO YOUR CAR**

with a motor driven car aerial  
SPEC: \* 5 section  
\* extended length 100cm  
\* Length under fender 40cm  
\* Cable length 120cm

Supplied complete with fixing bracket and control switch 27-50

We supply the three modules for you to build this Disco-Group-P.A. amplifier into the cabinet of your choice.

**\* THE POWER AMP MODULE**

170W r.m.s. sq. wave 300W instantaneous peak into 8 ohm (60W into 16 ohm).

**\* THE PRE-AMP MODULE**

Four control pre-amp. Vol. Bass, Treble, Middle controls. Designed to drive most amplifiers using F.M.T. first stage.

**\* THE POWER SUPPLY**

Is supplied complete with the mains transformer. Complete fixing instructions are supplied and no technical knowledge is required to connect the three ready wired modules. A fantastic bargain. 225. carr. 75p. Send S.A.E. for further details on this or our ready built amplifiers.

**STOP PRESSES**

BH A0002 16 watt Amp Module 22-60  
NE555 Timer I.C. 75p  
MC131QP Stereo Decoder I.C. 22-00  
7805 Regulator 41-48  
TIP 29A 55p  
TIP 30A 63p  
BC107 10p  
BC 108 10p  
RC109 10p



**I.C. SOCKETS**

D.I.L.  
8 pin  
14 pin 14p  
16 pin

**BARGAIN TRANSFORMERS**

12-0-12 volt 500m/A  
240 volt primary transformer bargain.  
approx size = 60mm x 40mm x 50mm  
fixing centres = 75mm  
Our Price = 41-20.

18 volt 500m/A  
240 volt primary transformer bargain.  
approx size = 60mm x 40mm x 50mm  
fixing centres = 75mm  
Our Price = 41-00.

**BARGAIN BOX**

Buzz buzzer mounted in a metal box complete with two U2 battery size holder.  
Designed and can be used as a fire alarm but is ideal as a door or Morse code practice buzzer.  
Approx. size—2 1/2" x 6 1/2" x 1 1/4".  
OUR PRICE—50p.

U.K. POSTAGE 15p  
UNLESS OTHERWISE STATED

V.A.T. Please add  
8% to all Totals

**CRESCENT RADIO LTD. P.W.**

All mail to 11 MAYES ROAD,  
WOOD GREEN, LONDON N22 6TL  
Phone: 01-888 3206

Callers Welcome at

15 Mayes Road & 13 South Mall, Edmonton N9.

If you construct  
You should  
own one.

CRESCENT  
CATALOGUE  
Price 30p.

# ESSENTIAL BOOKS FOR RADIO AMATEURS

NEW BOOK

**NBFM MANUAL**  
by  
**R. S. Hewes, G3TDR**  
and  
**G. R. Jessop, G6JP**

The use of frequency modulation by radio amateurs as a communication system has generally been confined to the vhf and uhf bands. When used for this purpose it is essentially a narrow band mode radically different from that used for high fidelity broadcasting. Until now references to narrow band frequency modulation equipment have been confined to articles appearing in various journals, but this manual is intended to present complete coverage of the subject from one source.

It is hoped that it will encourage the home construction of equipment which is truly narrow band, using the frequency or phase methods of modulation and taking full advantage of the mode by the use of the correct demodulator.

The relative freedom from interference to television, radio and audio equipment, and the excellent rejection of impulse noise, makes the mode attractive and economic for both fixed and mobile operation.

60 pages

Price: £1 inc p & p

NEW EDITIONS

**AMATEUR RADIO TECHNIQUES**  
(5th edition)

by **Pat Hawker, G3VA**

Basically an ideas and source book, this ever-popular work brings together a large selection of new circuits and devices and many constructional and fault-finding hints.

In this new edition some 50 pages of new material have been included and other sections have been revised and expanded.

304 pages Price £2.25 inc p & p Over 700 diagrams

**RSGB AMATEUR RADIO  
CALL BOOK 1975**

Incorporates new call signs and amendments notified between August 1973, when the previous edition closed, and August 1974.

Also includes valuable operating data such as band plans, beacons, amateur radio prefixes in country order, ITU zone list, beam headings and QSL Bureau sub-managers, and a list of RSGB affiliated societies, clubs and groups.

160 pages

Price £1.20 inc. p & p

These are just three of a complete range of technical publications, log books and maps for the radio amateur. Send a large s.a.e. for the complete list.

The RSGB is the national society representing all UK radio amateurs. Membership is open to all interested in the hobby: write to the General Manager and ask for full details.



## RADIO SOCIETY OF GREAT BRITAIN

35 DOUGHTY STREET, LONDON, WC1N 2AE TEL: 01-837 8688

# SPARKRITE Mk II

## Electronic Ignition... Better on all points



### Because you keep your points!

The SPARKRITE MK.2 is a full capacitive discharge electronic system. Specifically designed to retain the points assembly — with all the advantages and none of the disadvantages. No misfire because contact breaker bounce is eliminated electronically by a pulse suppression circuit which prevents the unit firing if the points bounce open at high rpm. Contact breaker burn is eliminated by reducing the current to about 1/50th of norm, thus avoiding arcing. But you can still revert to normal ignition if need be. In seconds. If points go (very unlikely) you can get replacements anywhere. All these advantages.

- Fitted in 15 minutes. ● Up to 20% better fuel consumption.
- Instant all weather starting. ● Cleaner plugs — they last 5 times longer without attention.
- Faster acceleration. ● Faster top speeds.
- Coil and battery last longer. ● Efficient fuel burning with less air pollution.

### The kit comprises everything needed

Ready drilled scratch and rust resistant case, metalwork, cables, coil connectors, printed circuit board, top quality 5 year guaranteed transformer and components, full instructions to make positive or negative earth system, and 6 page installation instruction leaflet.

WE SAY IT IS THE BEST SYSTEM AT ANY PRICE!

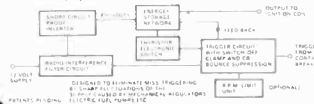

Sparkrite Mk II — full capacitive discharge electronic system — not just a transistorised inductive discharge booster.

### PRICES

D.I.Y. Kit only £10.93 incl. VAT and P & P  
Ready Built Unit £13.96 incl. VAT and P & P  
(Both to fit all cars with coil/distributor ignition up to 8 cylinders)  
We can supply units for any petrol engine vehicle (boat, motorcycle etc) with coil/contact breaker ignition.  
Details on request. Call in and see us for a demonstration.

### ORDER NOW TO:

ELECTRONICS DESIGN ASSOCIATES  
(Dept PW 3 ) 82 Bath Street,  
Walsall WS1 3DE Phone 33652

Please supply:

- Sparkrite Mk.2 D.I.Y. Kit(s) at £10.93 each incl. VAT and P & P (Will make pos. or neg. earth).
- Sparkrite Ready Built Neg. Earth Unit(s) at £13.96 each incl. VAT and P & P
- Sparkrite Ready Built Positive Earth Unit(s) at £13.96 each incl. VAT and P & P

NAME \_\_\_\_\_

ADDRESS \_\_\_\_\_

\_\_\_\_\_

\_\_\_\_\_

I enclose cheque/P.O. for £ \_\_\_\_\_  
Send SAE for brochure.





## Log extracts

**Michael Green:**—20m DU6BG FP8DH VE3CD/SU 80m UK1ADZ

**Roger Trett:**—20m HP9MC HV9VX HZ1TA VP1FF VP2MRA ZB2A 15m CE6EF VU2DK VK6KG ZS1WA

**John Porter:**—20m FL8DJ OH0NC VP2SV 5U7AG 15m VP8NP YS1MAE ZE3JU

**Eric Carling:**—20m FM7AQ HK0BKX KC6VE P29FV VS6BL YJ8GS 3D2AJ 15m AP2KS ZL3RB 8P6ES

**Alan Doherty:**—80m EA8CR KL7HNQ KP4AN VP2DM VS6DL ZL4KF 4S7PB 8R1AG 40m CT2BN 20m SV1IE VE6JD ZL2AIL 6W8FN 7X20A

**Max France:**—80m AP2KS KZ5JM KS6DH TR8DG VP7NX VP8NP VR1AA VS6FB ZD7FT ZK1DX (Cook Is.) plus 12 ZL's

**Stephen Budd:**—80m EL7D FP8FU 9M2DQ 20m VP2MRA ZL1BD ZL2WC 15m HS4AFD HZ1KE VK6QL VP2SM VP7DF 5N2ESH 9Y4CR

**Gary Edge:**—80m AP2KS DU1AU PJ2CW ZL2AW 40m VP2GMB 20m VK9YR VP8NS ZD7ST

**Alan Rae:**—80m A4GCV (Oman) A9ZBK (Bahrain) VP2VBU VP8FK 40m ET3DCO 15m H18HOG KG4AMI VP2MRA YS1WPE

**Paul Barker:**—20m (SSTV) I1NKT 12PET OE1SF 20m 9X5PT 15m CR7AF KV4AD ZD3R

**Tim Charles:**—80m CT2BP OJ0MA 40m CO2IP CT3AR DU1HKG FW8OR HH9LJ HP1BM KL7TY VK9WT XZ1OT YA1AL YB3CB YS3A ZL1AEA ZL2AKW 3V8AZ

All stations are SSB except those in bold which are CW.

knows only one other value either the frequency (MHz) or the wavelength (m). Taking an example:—

$$\text{Wavelength (metres)} = \frac{300,000}{6020} = 49.23\text{m.}$$

or as the station says "the 49 metre band". The equation also works by dividing metres into 300,000 to give the frequency in megahertz.

Another "crie de-coeur" from Glenn is that he is lacking traffic in the 60 metre band and he wonders if a special aerial is needed. Not at all, says I, try making a centre-fed aerial that is a half wave on 60 metres, using the formula in the P.W. Aerial Data Chart, that is  $468/f(\text{MHz})$  ft. Try cutting a length of copper wire to a quarter wave or about 45ft. which will also match a low input impedance.

One of the regular sounds on the 60 metre band is the atomic clock broadcast from Turin. There are many countries that put out these fixed standard frequency signals and the DXer will find them very handy for checking the calibration of his set since they are usually on a precise frequency, in this case 5MHz. Turin also will QSL if asked nicely.

A "first time" letter comes from **Michael Bridgewaters** of Shifnal, in Shropshire and he would like a feature on propagation popped in. Well, Michael, the fact is that printing and editorial deadlines would make the news stale, if not useless, by the time you got your copy of PW if you are referring to current conditions.

Twelve-year-old **Timothy James** from Basset was written in reporting Radio Australia at 0715 on 9570. He has not given a date for this but he must have heard it at the latter end of the summer season since Australia is now on from 0815 to 0915 on 9570 and they have registered I1760 with the ITU from 1845 to 2000 for this winter.

Someone who seems to have winkled out a few good signals is another youngster **Christopher Rowson** of Tittensor, Staffs., reporting as follows:—

11955 Voice of the Gospel (Ethiopia) at 1545  
15483 Radio Tanzania at 1930.

This thirteen-year-old pilots his Grundig Elite Boy and its long wire aerial and reports that he has pulled in the so-called "Paris calling Africa" programmes of ORTF. These are the "Afrique Inter" relays normally intended for French-speaking parts of Africa. By the way, these programmes are very good for French language practice, for those dreaded exams!

One of the many "giveaways" that stations are prone to send out is the pennant. News has been given to me of at least three more countries that have jumped on the bandwagon, namely Poland, Norway and Spain. Radio Nigeria sent out copper necklaces last year, but that did not last very long. Pennants, if you can get them, are fine to hang on the shack wall and those I have seen range from the large red, white and blue plastic of Radio Nederland to the exquisite pale-blue silky textured example from Adventist World Radio.

**Paul Heath** of Wednesfield informs us that HCJB Quito is at present sending out a form with its QSL card asking about the religion of their correspondent and how many times the said correspondent goes to church. This I think must rank, for sheer impertinence, alongside the penetrating questions that Radio Peking asks. For instance, they want to know one's occupation and how long one has held it. While touching on the subject of Gospel stations, **Rex**

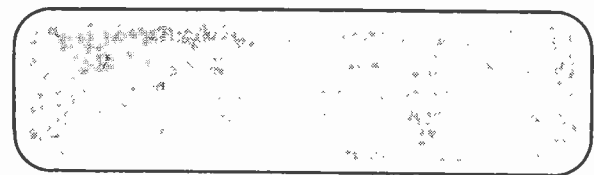

## SHORT WAVE BROADCASTS by Derek Bell

**G**lenn Tobin, aged 16, opens our box of goodies this month and he, on his Astrad VEF 204, has pulled in the following:—

7220 Voice of America at 1950 from Tangier  
9560 Radio Ghana External service (no time given)

not bad for a simple set with only an added length of wire for an aerial.

Glenn, however, mixes up metres and megahertz because, as he says, his set is only marked in metres and he has to rely on the frequencies announced by the station. The answer to this OM is the following formula, to get the old grey matter stirring! Frequency in metres equals 300,000 over frequency in megahertz. So there! It will make an equation if one



Cooper of Foulden, Norfolk reports having heard 15120 ETLF Addis Ababa at 1415, one of the more difficult loggings. To his Marconi CR150 Rex has added a preselector and a 33 foot vertical aerial. All I can say is, may the winds stay calm! Rex says that he bought the set in the local market and after "breathing on it" is getting reasonable results. One of his favourite stations was FEBA in the Seychelles and Rex would like anyone who knows what has become of it, to shout up.

From the horse racing scene round Yorkshire, Doncaster to be exact, **Jack Hanson** says that he has a couple of questions. The first is "who puts out the fixed-frequency signals on 2.5, 5, 10 and 15 MHz. If it is a beat at one second intervals it is probably one of the standard frequency stations mentioned earlier.

The way to check is to listen for a speech or morse announcement. His second query concerns the BBC World Service on 17700, broadcast on 8th Dec. at 1100. Jack reports that it had "a booming echo rather like two path propagation". Almost certainly it was a combination of sky and ground waves.

We must welcome a new station on the air. From Antarctica comes news that the American Forces Antarctic Network opened in December on 6012 using one kilowatt pumped into a vertical aerial. On that happy note comes time for me to close the shop and say "best 73s" to you and yours.

#### BROADCAST BANDS

**Short Wave** reports by the 15th of the month to **Derek Bell** c/o Practical Wireless, Fleetway House, Farringdon Street, London, EC4A 4AD.

**Medium Wave** Logs to **Charles Molloy**, 132 Segars Lane, Southport, PR8 3JG.

#### AMATEUR BANDS

Logs covering any amateur band/s in band/ alphabetical order by the middle of the month to **Eric Dowdeswell G4AR**, Silver Firs, Leatherhead Road, Ashted, Surrey, KT21 2TW.

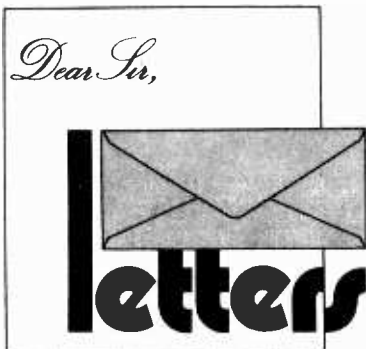

(P.W. April '69) without undue cramping. The quality of performance of this set is unbelievable and I'm sure puts the majority of commercial built pocket superhets to shame.

I would like to offer my humble thanks for all your efforts in making this possible, and providing so many hours of enjoyment for, I am sure, a great number of people. Thank you.—**John Bloxham** (Warwickshire).

#### Planespotters beware

On the 7th January this year a BAC One-Eleven was hijacked from Heathrow, and subsequently flown to Stansted. This you are all probably well aware of. What perhaps is news to a number of your readers is the fact that listening-in on the v.h.f. communications link between plane and control tower is illegal; as is listening to the Police, Fire Service and any other public service organisation.

Although the manufacturers are well aware of this fact, they persist in equipping their domestic v.h.f. receivers with full coverage of the 96-110 MHz band. It's possible to buy a receiver in any market place for £5, go to Heathrow, and eavesdrop on highly confidential communications between the aeroplane and ground stations.

The result of this latest hijack drama has finally brought home to those in high places the danger of allowing receiving equipment of this type to get into the hands

of the general public. It was disclosed recently, that during the drama, talks were going on between the plane's Captain, the Home Office and Scotland Yard, nearby 'plane spotters' heard the lot, apparently to the amazement of 'Security Chiefs'!!

The danger here of course, is in the definition of the word 'plane spotter'. If they are genuine enthusiasts, the dangers are not too great, but what's to stop would-be hijackers listening-in, or other undesirables? The complete procedure that Scotland Yard and the Home Office has worked out together with regards hijacks, could very soon become common knowledge, and as such a serious security risk.

The answers are many. Either put the public service communications on another frequency, scramble or code the messages, or stop making receivers capable of tuning over the present frequencies. The problem with the latter is the million or so radios already in public hands. What do we do?, tell those owners to report to their local friendly security centre to have their radios doctored?!

Maybe we ought to enforce the law already in existence, and punish anyone found listening to the Police, aeroplanes etc. You may well ask how does one do this? The answer is again simple—put microphones and cameras in everyones' homes, in the streets and the countryside,—ah well, 1984 here we come!—**Andrew Auger** (South London).

#### Thank you P.W.

Eighteen years ago a school friend showed me his home made one valve short wave receiver and introduced me to *Practical Wireless*, from then on I was hooked. Over the years I built numerous receivers and items of test gear from the pages of your magazine. In recent years with the aid of *Television* magazine I have progressed through the deeper mysteries of television and gained practical experience by repairing friends' equipment and with the 'five bobs' gained thereby have furnished a small workshop and acquired a supply of spares.

I must confess that in spite of the fascination of television I cannot resist constructional articles on pocket transistor radios. I recently made the "Mimi Pop" two I.C. radio (P.W. May '74) which I fitted into the 'Boots Soapdish Lid' case as described for the "Mite" radio

## AUTOMATIC EMERGENCY LIGHTING

Power cut days will soon be upon us. Our simple kit makes any light a fail-safe light. Kit containing relay and rectifiers and data, only 65p each. 10 or more 60p each. Suitable case 40p extra.

## PORTABLE CABINET OFFER

A nicely made portable cabinet, soft padded black finish intended for portable stereo system. Dimensions as sketch. With motor board cut out for Garrard SP 25. This was obviously a very costly cabinet originally made for a de-luxe record player. Offered at £1.95 plus £1 carriage, free if bought with the Garrard or BSR record decks



## LIGHT DIMMER KIT

For dimming up to 250w without heat sink or 750w with heat sink. This comprises, quadric variable control potentiometer, condenser, resistor, tag strip for mounting and data. Price £1.50. 5 amp Industrial Model £2.80.

## RELAY BARGAIN

Type 600 relay, 2 changeover one open and one closed contact. Twin 500 ohm coils make this suitable for closing off DC 6v, DC 12v, DC 24v or AC mains using resistor and rectifier, 33p each. Resistor and rectifier 20p extra.



## MAINS MOTOR

Precision made—as used in record decks and tape recorders—ideal also for extractor fans, blower, heaters, etc. New and all perfect. 81mp at 75p. Postage 20p for first one then 10p for each one ordered. 1" stackmotor £1.04. 1 1/2" stackmotor £1.20.

## TIME SWITCH

Smith's mains driven clock with 15 amp switch, also notes showing how you can wake up with music playing, kettle boiling or come home to a warm house, warn off burglars, keep pets warm, halve your heating bills, etc. £2.45.

## MACLAREN THERMOSTAT

Make and break 20A a.c. with the sensor probe coupled by a 2 feet capillary covering range of 10-100°C—complete with large engraved control knob. Price 88p.

## WINDSCREEN WIPER CONTROL

Vary speed of your wiper to suit conditions. All parts and instructions to make. £2.75.



## 6 DIGIT COUNTER

Resetable. 440 ohm coil up to 25 impulses per second. Ex-equipment but guaranteed perfect. £2.84 each. 4 digit counter as specified for telephone charge calculator 88p.



## PRESSURE SWITCH

Containing a 15 amp change over switch operated by a diaphragm which in turn is operated by air pressure through a small metal tube. The operating pressure is adjustable but is set to operate in approx. 10 in. of water. These are quite low pressure devices and can in fact be operated simply by blowing into the inlet tube. Original use was for washing machines to turn off water when tub has reached correct level but no doubt has many other applications £1.72, each.



## NUMICATOR TUBES

For digital instruments, counters, timers clocks, etc. Hi-vac XN.3. Price 99p each. 10 for £9.

## MULLARD AUDIO AMPLIFIERS

All in module form, each ready built complete with heat sinks and connection tags, data supplied. Model 1153 500mW power output 80p Model 1172 750mW power output £1.07 Model EP9000 4 watt power output £2.00 RP 9001 twin channel or stereo pr amp £1.41

## EXTRACTOR FAN

Cleans the air that rises from 10,000 cubic ft. per hour. Suitable for kitchens, bathrooms, factories, changing rooms, etc., it's so quiet it can hardly be heard. Compact, 5 1/2" casing with 5 1/2" fan blades. Kit, comprises motor, fan blades, sheet steel casing, pull switch, mains connector, and fixing brackets. £2.75 + 20p P. & P.



## CENTRIFUGAL BLOWER

Miniature mains driven blower centrifugal type blower unit by Woods. Powerful but specially built for quick running—driven by cushioned induction motor with specially built low noise bearings. Overall size 4 1/2" x 4 1/2" x 4". When mounted by flange, air is blown into the equipment but to suck air out, mount it from centre using clamp. Ideal for cooling electrical equipment or fitting into a cooker hood, film drying cabinet or for removing flux smoke when soldering, etc. etc. A real bargain at £2.50p.



## TANGENTIAL HEATER UNIT

This heater unit is the very latest type, most efficient, and quiet running. Is as fitted in Hoover and blower heaters. Comprises motor, Impeller, 2kW element allowing switching 1, 2kW, and with thermal safety cut-out. Can be fitted into any metal lined case or cabinet. Only needs control switch, £2.75. Don't miss this. Control Switch, 55p. P. & P. 50p.



## SHORTWAVE CRYSTAL SET

Although this uses no battery it gives really amazing results. You will receive an amazing assortment of stations over the 19.25-31.39 metre bands—Kit contains chassis front panel and all the parts. £1.25—crystal 50p.

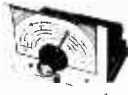

## DRILL CONTROLLER NEW IKW MODEL

Electronically changes speed from approximately 10 revs. to maximum. Full power at all speeds by finger-tip control. Kit includes all parts, case, everything and full instructions. £2.25 plus 25p post and insurance. Made up model also available. £3.25 plus 30p post & p.



## THIS MONTH'S SNIP

High compliance 8" round speakers suitable for 8-12 ohm outputs, these speakers have rubber mounted diaphragms and will handle up to 12.5 watts. Made originally for an expensive Decca hi-fi outfit, we offer at £3.75 each or £7.00 a pair plus 40p each postage.

## SMITHS CENTRAL HEATING CONTROLLER

Push button gives 10 variations as follows: (1) continuous hot water and continuous central heating (2) continuous hot water but central heating off at night (3) continuous hot water but central heating on only for 2 periods during the day (4) hot water and central heating both on but day time only (5) hot water all day but central heating only for 2 periods during the day (6) hot water and central heating on for 2 periods during the day time only—then for summer time use with central heating off (7) hot water continuous (8) hot water day time only (9) hot water twice daily (10) everything off. A handsome looking unit with 24 hour movement and the switches and other parts necessary to select the desired programme of heating. Supplied complete with wiring diagram. Originally sold, we believe, at over £15—we offer these, while stocks last, at £5.95 each, post 30p.



## TAPE DECK

In metal case with carrying handle, heavy fly wheel and capstan drive. Tape speed 3 1/2. Mains operated on metal platform with tape head and guide. Not new but guaranteed good working order. Price £1.95 plus £1 post and insurance.



## GENERAL PURPOSE SWITCH

Responds to moisture, heat, light, touch, time delays, etc. etc. Basic kit comprising relay, transformers, diodes, condensers, resistors, etc. and data—only £1.50 + 30p post.



## AMMETERS

—moving from 0 AC/DC—ideal for chargers etc. 2" sq. full vision 0-8 amp 85p. 1 1/2" round 0-2 amp 65p, 0-3 amp 65p, 0-4 amp 75p.

## DISTRIBUTION PANELS

Just what you need for work bench or lab. 4 x 13 amp sockets in metal box to take standard 13 amp fused plugs and on/off switch with neon warning light. Supplied complete with 6 feet of flex cable. Wired up ready to work. £2.75 plus 25p P. & P.

## SOIL HEATER

Or could be used on bench for seed trays. Comprises mains transformer to reduce to safe voltage also heater wire. £2.00 plus 25p p. & p.

## SPIT MOTOR

200-250V induction motor, driving a Carter gearbox with a 1 1/2" output drive shaft running at 5 revs p.m. Intended for roasting chickens, also for driving models—windmill, coloured disc lighting effects, etc. £2.50 plus 20p post and ins.



TERMS—  
ADD 8% V.A.T.  
Send postage where quoted—other items, post free if order for these items is £6.00, otherwise add 30p.

**J. BULL (ELECTRICAL) LTD.**  
(Dept. PW), 102/103 TAMWORTH RD.  
GROUDON GRO IXX

## NEW ITEMS THIS MONTH

The bargains in this column are just some of the items which appeared in the December supplement to our catalogue. You can receive this catalogue and the next 12 supplements by sending £1.

**Room Thermostat.** Mercury Switch type with thermometer for low voltage gas central heating systems etc. Made by a famous American Company, these are of very neat appearance, in plastic case, easily mounted but the most important feature is that they cut in and out quickly, thus maintaining a very steady temperature. Price £1.85

**12v Sealed Plug-in Relay** with two sets changeover contacts 10 amp rating. Fit into a standard octal valve base. Limited quantity. £1.50p.

**Constant voltage step down transformer.** American made 500w leading tap voltage can be either 115 + or - 20% or 250 + or - 20% for 50 c.p.s. mains output 115v or 250v. A real quality transformer, probably cost well over £100. Not new but guaranteed perfect. Our price £40. £110 to 750w £60. Carriage paid.

**Mercury Batteries.** Bank of 7 mercury cells. Type No. 625 which measure approx. 7" diameter by 1" thick in plastic tube with positive and negative ends marked giving a total of 10.7v. Only 5p per bank or £1 per carton of 25. With simple holder these will replace the PP3 and similar, or can be quite easily separated for operating simple pocket radios and instruments, dead aids, etc.

**Two circuit micro-switch.** Famous American Licon, maker's ref. 16-40411. Size approx. 1 1/2" long 1" wide 1" thick. Not necessarily suitable for switching the main supply breaks when using push rod is depressed. Circuit rating we estimate at 5 amps 250v. 12p each. Sound to light unit for enhancing your audio either with the addition of coloured lighting or white light responding to the music. Our unit, which will work up to three 150w lamps, is available as kit or parts at £6.95 or made up ready to work £7.95.

**Emergency lighting.** It would seem that once again there is a possibility of power cuts and black-outs. We hope it won't be as bad as last year, but the possibility of having to work off batteries is definitely with us. We can still offer 12v battery fluorescents. 24" uses the standard 24w tube and gives an excellent light, price £4.50 + 50p post and insurance. Also the 40", which uses the 40w tube, is now available, price £7 + 75p post and insurance. We also still have stocks of big inverters, ref. XB. This is a 500w 24v output inverter, unfortunately not 60 c.p.s. Its frequency, we believe, is 400 c.p.s. which means that whilst fluorescent lighting could be worked off it, special chokes would have to be used. Normal incandescent lamps can of course be used without any bother. The price of this unit is £11.50 + 50p post and insurance.

**Luminous rocket switch,** suitable for 13 amps at mains voltage, these are illuminated with neon through amber panel, snap-in fixing into hole size 1 1/2" x 1 1/2". Special bargain, 22p each.

**Chrome plated metal legs, heavy duty, really good quality, made originally for an expensive Decca outfit, height 12", £1.50 per set of 4 plus post 30p.**

**Experimenters Relay Parcel.** 10 type 600 relays all different coil values covering most experimenters needs. Also one mounting bracket. Total retail value £25.00—yours for £8.50 plus 30p post.

**Motor with fan blade—**if you want something to cool a cabinet or if you are making a cooker hood or a blower heater, this may be the answer. 1" stack induction motor with a set of Smith's fan blades, approx. 5" diameter. £1.50 + 30p post.

**Microswitch bargain—**Honeywell, brand new 10 amp 250v gold on silver contacts, standard fixing, normal operation. Price 10p each.

**Cooling fans—**heavy duty for TO8 type semi-conductors, extruded aluminium, size 4 1/2" x 3". Price 60p each.

**Full wave rectifiers** 4 x 1N3208 which we understand are rated at 25 amps mounted on cooling fins, these were intended for computers but were never installed. Price 88 each.

**Insulated terminals.** These are the popular type which will take a wire under the head or a 4mm plus in the top, fully insulated for mounting with metal panels, available in several popular colours—price 12p each.

**Delay Switch.** Depending on the amount of voltage applied, so this switch will delay making the circuit of up to 15 amps at normal mains voltage for up to 10 seconds, delay may be made or made variable with a suitable potentiometer. These can also be used as thermal relays as suitably connected a low current relay can switch up to 100 amps or more—these are glass tubes plus in a pin base—with base 75p each.

**Smiths 24 hr. timer heart, really the 'Autoset'** without its plastic case. This is a 24 hr. twice on, twice off, clock switch which will repeat until re-programmed. Switches rated at 15 amps. Limited supplies—£3.75 each.

**Smiths colour stat.** Customers will remember that we had a supply of these wall mounting thermostats last year. We were able to supply these at £1.65. A new batch has just arrived but like most other things these days they have gone up in price and we must now charge £2.25 each. However, this is still a very low price for such a thoroughly reliable wall thermostat.

**Panel meter with trip.** American made. These are fixed mounting, full vision, moving coil meters, face size 2 1/2" x 2 1/2" with two front settings which enable an external circuit to be tripped, a light lit or an alarm sounded, at pre-set voltages within the range of DC meters. We have meters covering the following DC voltages:—0 to 6; 0 to 15; 0 to 25; 0 to 45; 0 to +150. All £4.75 each.

# BIG Discounts

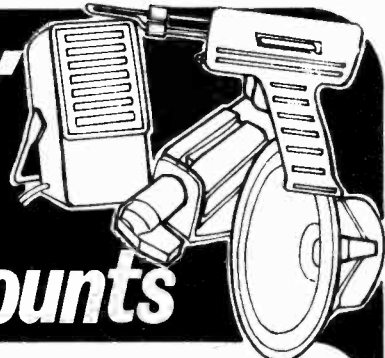

## ALL PRICES INCLUDE V.A.T.

SPEAKER BARGAINS		GOODMANS 6 1/2" 8 ohm	
	£		£
EMI 13" x 8" 3, 8 or 15 ohm		Dualcone	2.15
Plain	2.05	ELAC 6 1/2" 8 ohm Dualcone	2.15
With Co-Axial Tweeter		ELAC 8" 8 ohm Dualcone	2.30
8 ohms only	2.20	ELAC 10 ohm Dualcone 10 watt	3.50
Twin Tweeter	4.10	FANE 7" x 4" 3 or 8 ohm	1.00
Type 350 8 or 15 ohm,		ADASTRA 10" 8 or 15 ohm,	
20 watt	7.95	10 watt	3.55
6 1/2" 8 ohm, 10 watt	2.40	BAKER GROUP 25 12" 8 or	
8" 8 ohm, 10 watt	3.75	15 ohm, 25 watt	7.65
12" 8 ohm, 20 watt	6.70	P. & P.	
8" x 5" C/Mag. 5 watt	1.25	5" 8 ohm, C/Mag.	.85
8" x 5" Dualcone		2 1/2" 8 ohm or 84 ohm	.50
8 ohm, 10 watt	2.55	P. & P.	.15

TWEETER & CROSSOVER		Dome Tweeter 8 ohm, 30 watt	
	£		£
EMI 3 1/2" 3 or 8 ohm C/Mag	1.25	Crossovers CN23 (3 ohm),	5.40
Cone Tweeter 8 or 15 ohm,		CN28 (8 ohm), CN216 (16	
19 watt	2.60	ohm)	1.20
Cone Tweeter 8 ohm, 3 watt	1.45	P. & P.	.10
Horn Tweeter 8 ohm, 20 watt	6.40		

KIT FORM CABINETS TEAK VENEER		18 x 11 x 9 with 13" x 8" cutout	
	£		£
12 x 12 x 6 with 8" 8" x 5" or		for EMI 350	4.25
6 1/2" and 3 1/2" cut out.	3.30	P. & P. ea.	.45
17 x 10 x 9 with 8" or 13" x 8"			
cutout	3.80		

MICROPHONES		TW209	
	£		£
CM70 Planet stick metal,		CONDENSER MIKE 600 ohm,	5.75
switch crystal	1.55	uni-dir	0.35
DM180 Dynamic omni-dir.		Cassette Stick Mike with R.	
ball metal	4.75	Control on/off switch	1.45
UD130 50K/600 ohm, uni-dir		(2.5 & 3.5mm J/Pi)	.20
ball metal	6.40	P. & P.	

SOLDERING IRONS		X25 25 watt (low	
	£		£
ANTEX CN240 15 watt	2.15	leakage)	2.15
SK 1 KIT (15 watt Iron		P. & P.	.10
2 spare Bib etc.)	3.50		

CARTRIDGES & STYLLI		SONOTONE	
	£		£
ACOS GP91/2SC or 3SC ster.		9TAHC or 9TAHC/G Diam.	1.80
comp.	1.00	3509 Ster. ceram. Diam.	1.90
GP93/1 or 95/1 ster.		GOLDRING G850	2.95
cryst.	1.35	G800	3.95
GP94/1 or 96/1 ster.		G800E	6.90
ceram.	1.75	P. & P.	.10
GP101 cryst. comp.	0.80	D. Diamond Styll for above.	1.25
GP104 ster. ceram.	1.65	G800/G850	1.95
BSR X5M or X5H cryst. comp.	1.70	G800E	3.95
SX6M or SX6H cryst.		P. & P.	.05
comp.	1.90		
SC5M ster. ceram.	2.60		

CALCULATORS SINCLAIR		Scientific	
	£		£
Cambridge	19.95	6, 7.5 or 9 d.c. output at	2.30
		300mA	.15
		P. & P.	

BATTERY ELIMINATORS		PLASTIC LIBRARY CASES	
	£		£
240v input 6, 7.5 or 9	2.95	For 5" Reels	18p
12v d.c. input (specify output)		5 1/2" Reels	22p
		7" Reels	25p
		P. & P. 1-3, 9p ea. 4 or more, lot 30p	

TAPES		LP		DP	
	£		£		£
5 1/2"	50p	85p	1.00p		
7"	85p	80p	1.40p		
		1.10p	1.80p		

LOW NOISE CASSETTES		Cassette Cases	
	£		£
C60	1-5	6-10	11-20
C90	35p	33p	30p
C120	45p	43p	40p
	55p	52p	50p

BIB ACCESSORIES		WHARFEDALE SPEAKER BARGAINS	
	£		£
Tape Editing Kit Ref. 23	1.35	Linton 2 Kit (pr)	19.95 1.00
Recording Tape		Glendale 3 Kit (pr)	33.50 1.50
Splicer Ref. 20	1.15	Dovedale 3 Kit (pr)	52.00 1.50
Cassette Tape, editing Ref. 24	1.50	Denton 2 Speaker (pr)	30.90 2.00
Cassette Salvage Kit Ref. 29	.45	Linton 2 Speaker (pr)	39.50 2.00
12" Cassette Case Ref. 34	£1.50	Dovedale 3 Speaker	(each)
Stylus Balance Ref. 32A	1.20	(each)	42.00 2.00
Spirit Lever Ref. 46	.50	Glendale 3 Speaker (pr)	57.00 3.00
Hi-Fi Stereo Test Cassette	2.10	Kingsdale 3 Speaker	(each)
Groove-Kleen Record Cleaner	1.90	(each)	59.95 3.00
P. & P.	.10		

Send 25p for COMPLETE CATALOGUE, refundable upon first order. ALL OUR MERCHANDISE IS FULLY GUARANTEED. Subject to manufacturer increase and availability.

**Riversdale Electronics**  
Mail Order Department **PW3**  
P.O. Box 470, Manchester M60 4BU.

## TECHNOMATIC LTD. 54 SANDHURST ROAD, LONDON NW9

Tel: 01-204 4333

AC126/7/8	11p	TIS43	26p	DIODES		SCR-THYRISTORS	
AC176	12p	2N2648	35p	1N4001	5p	1A/500V	42p
AC187/8	11p	2N2926	8p	1N4007	7p	1A/400V	60p
AD161/2	36p	2N3053	18p	1N914	4p	3A/400V	75p
AF114/5/7	12p	2N3055	40p	OA200	6p	C106D	45p
BC107/8	9p	2N3442	140p	AEY11	50p	2N3525	95p
BC109C	10p	2N3702/3/4	11p	Z1J	65p	TRIAC	
BC182/3	10p	2N3705/6	10p	TIL209	16p	3A/400V	120p
BC212/3	11p	2N3773	220p			16A/500V	180p
BC214	13p	2N3819	20p	ZENERS		DIAC	20p
BFY50/1/2	15p	2N3823	60p	400mW	9p		
MPF102	31p	2N4871	31p	1-3W	20p		
MPF103/5	31p	2N5457	31p	1-5W	27p		
OC28	55p	2N5458	31p				
OC35	48p	3N128	79p				
TIP41A	65p	3N140/1	86p	BR. RECT.			
TIP42A	70p	40673	56p	1A/50V	20p		
TIP2955	70p			1A/600V	25p		
				2A/100V	35p		

TTL SERIES	Linear IC's	1 AMP REG (TO220)	MFC4000	CMOS LOGIC ICs by RCA
7400 14p	7473 36p	5V, 12V	40p	Gates (CD4001AE,
7401/215p	7474 34p	CA3046	TBA800	CD4011(AE etc) 37p
7403 22p	7475 32p	55p	100p	CD4013 67p
7404 18p	7476 37p	ICL8038	TBA810	CD4017 183p
7408 20p	7486 41p	290p	125p	CD4027 108p
7410 15p	7489 340p	MC1310	TBA820	CD4029 325p
7413 30p	7490 45p	240p	80p	CD4024 148p
7420 15p	7491 94p	MC1312	110p	CD4030 82p
7430 15p	7492 68p	LM3801	100p	CD4048 220p
7441 75p	7493 48p	DIL 8 or 14		CD4047 154p
7442 70p	74107 45p			(SAE for full list please)
7447 95p	74121 34p			
7448 90p	74141 85p			

OPTO-ELECTRONICS	LIT747	250p	5001 12 Digit Calculator
7 SEGMENT READ OUTS	"BLISDOR" LENS	250p	Chip 485p
OUTS	RED LENS	185p	5314 Clock chip 65p
3015F	LEDS		Clock chip with Alarm (Similar MM5316)
MAN3M	TIL209 (Red)	16p	750p
MAN4	Green/Yellow	35p	PC Keyboard
LIT704	LDR ORP12	50p	2.36" x 3.76" x 0.45"
LIT707			400p

FOR FULL LIST SEND SAE OR REFER OUR ADVERT IN P.E. OR W.W. Complete semiconductor kit for PW ASCOT STEREO CASSETTE DECK £4.85 + VAT.

MAIL ORDER ONLY P & P 15p. MINIMUM ORDER £2. Add 8% VAT on total.

## ENGINEERS

# FREE

YOURSELF FOR A BETTER JOB WITH MORE PAY!

This helpful guide to success should be read by every ambitious engineer. Send for this helpful 76 page FREE book now. No obligation and nobody will call on you. It could be the best thing you ever did.

Do you want promotion, a better job, higher pay? "New Opportunities" shows you how to get them through a low-cost home study course. There are no books to buy and you can pay-as-you-learn.

**CUT OUT THIS COUPON**

**CHOOSE A BRAND NEW FUTURE HERE!**

Tick or state subject of interest. Post to the address below.

Build-As-You-Learn PRACTICAL RADIO AND ELECTRONICS (with kit)	Electronic Engineering	CITY AND GUILDS Installations and Wiring
Electrical Engineering	Computer Electronics	CITY AND GUILDS Electrical Technicians
Electrical Installations and wiring	General Radio and TV Engineering	CITY AND GUILDS Telecommunications
Electrical Draughtsmanship	Radio Servicing, Maintenance and Repairs	Radio Amateurs' Exam etc. etc.
Electrical Mathematics	Transistor Technology	

To ALDERMASTON COLLEGE Dept. EPW-01 Reading RG7 4PF **EPW-01**

NAME (Block Capitals Please) \_\_\_\_\_

ADDRESS \_\_\_\_\_

Other subjects \_\_\_\_\_ Age \_\_\_\_\_

Accredited by C.A.C.C. Member of A.B.C.C.

**HOME OF BRITISH INSTITUTE OF ENGINEERING TECHNOLOGY**

# HOTLINES

ON RECENT DEVELOPMENTS

## TIME HAS COME

Timers are an evergreen idea in electronics and many ingenious circuits have been published using a variety of techniques. One of the latest ideas on the market isn't just an integrated circuit requiring a "few external components" to make an electronic timer unit. The latest is just a component and, apparently doesn't require any assistance at all, other than power.

It comprises a two-terminal cylindrical case measuring 0.75in. in diameter and 2in. long. With a wire from each end it looks rather like a capacitor.

Series connected, the module provides fixed delay times of 1, 5, 10, 30 and 60 seconds. It is accurate over its temperature range to within  $\pm 10\%$ . The temperature range is given as 32 to 125°F. The device comes in three input voltages; 12, 24 or 48V. The inductive output is rated at 500mA and the equivalent British price is about £3. Not available in the UK yet, as far as I know.

## REALLY WIRE-LESS!

One of the interesting events on the hi-fi market was the launch of a headset which isn't attached to the equipment by any wires of any sort. Just put these headphones on and out comes your stereo hi-fi. But it's not done by magic—just infra red. The system utilises photodiodes which emit a modulated IR beam. This in turn is detected by photosensitive diodes on the headset itself. It's thought that this system is almost ideal for the average hi-fi enthusiasts room since the type of emission is unaffected by surfaces and colours etc. The modulated light source itself is diffused throughout the room so it isn't necessary to wander round with the top of your head always pointing towards the IR transmitting diodes. The power output of the IR diodes is only 60mW to cover the average room so the system does not waste precious watts.

As a point of interest, Ginsberg confesses to remembering a similar system being shown at the SRDE

(Signals Research and Development Establishment) near Bournemouth some 6-7 years ago. The idea then was that a whole class could be fed with instructions from a single IR source located in the ceiling. Wonder what happened to that idea or if anyone ever took it up?

## FIBRE OPTICS

The coaxial cable has been with us for many years, and will doubtless be around for some time to come. But already there are serious rivals stirring. Fibre optics is one which has been quietly developing for some time. Thinking of the price of copper is one good reason for trying fibres for communications purposes. Pilkington Brothers is well known in the field of glass and this company has been carrying out a considerable amount of work on fibres. However the first demonstration given on short cables was given recently.

The company calls its cable Hytran and it can replace copper cable for short range applications. A most significant feature is that Hytran is said to cost only one tenth the price asked for low-loss fibres which were previously thought to be the "real McCoy" if one wanted to communicate. The current suggestion is that Hytran is eminently suitable for cables up to around 180 metres in length. Pilkington are also recorded as saying that the demand for short range cables of this kind is on the increase although long distance usage of fibres is still another decade away.

## NUCLEAR MAGNETICS

The Air Force Weapons Laboratory in the US is concerned about the effects that a huge electromagnetic pulse from a nuclear blast might have on the electronics systems in aircraft. So it's built a "little" gadget which simulates the effect—quite safely I'm told. The aircraft under test is held in a huge trestle structure made of wood and nylon. And just when it least suspects it, the US Airforce fires an 8MV pulse at it via a nearby antenna. The 8MV pulse is triggered in only 10nS. The electronics to

accomplish all this is quite horrendous and, just for interest, the entire complex should be completed by 1976—and each of the trestles can accommodate an aircraft the size of a jumbo jet.

## ALL BRITISH

Have you heard the name Godfrey Hounsfield? If you haven't, then you've missed something. He's British and a pioneer. His work, or rather the results of it have been described as the most significant thing in its field since Rontgen discovered X-rays. Hounsfield's work led to the EMI-Scanner manufactured by British company EMI Limited (Now you must of heard of His Masters Voice!).

The EMI-Scanner is a computerised brain examination system. It employs a computer to calculate the many thousands of readings which have been taken through various cross sections of the patients brain. The readings are obtained by using a narrow beam of X-rays which are rotated around the head for a short time while examination is in progress. The results of this are reproduced as detailed and very accurate pictures of brain tissue. These are projected onto a television screen. It is claimed that the system produces 100 times the amount of information on brain tissue compared to that obtained from normal skull Xray techniques.

Perhaps the most important question is, "Has it caught on or is it one of those laboratory wonders which has problems in practice?". Well, EMI introduced it just two short years ago and orders to date have amounted to £22 million (that's twenty two million pounds sterling) with £21 million being exports.

Can you think of anything that's gone from nothing to £22 million in two years. I think its a super achievement by a British man and exploited by a British company.



Miniature 3 gang tuning capacitors VC1, VC2 and VC3 in Fig. 1 are not readily available at the present time. The constructor can therefore either use a larger three gang type or make a simpler receiver using a miniature two gang type. In the simpler receiver, the RF stage of the  $\mu$ A720 is not used and the signal from the aerial coupling coil is fed directly to pin 1 (i.e. to the mixer input). The performance of such a simple receiver will not be so good as when an RF stage is employed, but will be perfectly

adequate for the reception of normal broadcasting stations which provide a reasonable signal strength at the location concerned.

In car radio receivers, one may wish to replace the variable tuning capacitor with a permeability tuning system in which iron dust cores move along the centre of the coils concerned. A circuit for this purpose is shown in Fig. 3.

AVAILABILITY

The  $\mu$ A720 is available from advertisers. At the time of writing the price is about £1.25 plus VAT, but this should be checked before ordering. **D.W.**

# TELEVISION

## IN THE MARCH ISSUE

ON SALE FEBRUARY 17th—25p

### COLOUR RECEIVER PRE-INSTALLATION CHECKS

Thorough pre-installation checking and setting-up contributes more to the quality of a colour picture than the actual design of the chassis—most of the poor quality pictures so often seen are due to this vital procedure having been ignored. Vivian Capel describes what is required and how to go about it.

### GREY-SCALE GENERATOR

The first essential in setting up a colour receiver is to obtain a first class monochrome display. After the purity and convergence have been set the next step is to adjust the conditions at the three c.r.t. guns for an accurate grey-scale from black through to white. For this purpose a video signal consisting of several discrete amplitude levels is invaluable. The generator to be described uses i.c.s. to generate eight levels from black to white and for simplicity is synchronised from the receiver.

### JELLY-POTS AND STICK RECTIFIERS

Jelly-pot line output transformers and selenium stick e.h.t. rectifiers have been widely used in Thorn/BRC sets from 1964 to the present time. John Law describes the various types employed over the years.

PLUS ALL THE REGULAR FEATURES

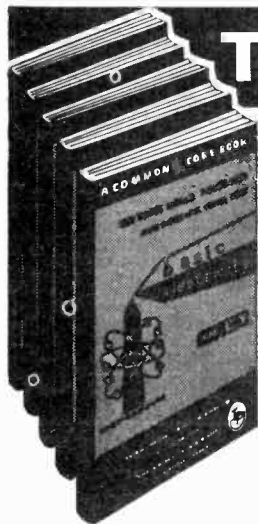

# The Pictorial Method

## BASIC ELECTRICITY (5vols) BASIC ELECTRONICS (6vols) BASIC TELEVISION (3vols)

You'll find it easy to learn with this outstandingly successful PICTORIAL METHOD. The essential facts are explained in the simplest language, one at a time, and each is illustrated by an accurate cartoon-type drawing. These clear and concise illustrations make study a real pleasure. The books are based on the latest research into simplified learning techniques. This easy-approach-to-learning method has proved beyond doubt that acquiring knowledge can be an enjoyable experience.

The series will be of exceptional value in training mechanics and technicians in Electricity, Radio and Electronics.

**YOUR 100% GUARANTEE**

Should you be, in any way dissatisfied with the MANUALS your money will be refunded by return of post.

### WHAT READERS SAY

... after studying them for a while, I came to the conclusion there is only one word to describe these manuals—BRILLIANT. *E. J. Southampton*

Their appeal is in their simplicity. *E. P. Basingstoke*

An ordinary person like me can soon acquire a first rate understanding of the subject. *G. B. Maidstone*

I have passed my theory exam, on electronics with the help of your manuals. *D. F. F. Eby*

To The SELRAY BOOK CO., 60 HAYES HILL, HAYES, BROMLEY, KENT. BR2 7HP

Please find enclosed P.O./Cheque value £.....

BASIC ELECTRICITY 5 parts £6.50

BASIC ELECTRONICS 6 parts £7.50

BASIC TELEVISION 3 parts £4.25

Tick Set(s) required. Prices include Postage and Packing.

**YOUR 100% GUARANTEE.** If after 10 days examination you decide to return the Manuals your money will be refunded in full.

NAME .....  
BLOCK LETTERS

FULL POSTAL.....

ADDRESS .....

**POST NOW FOR THIS OFFER!**

# Europe's Largest Hi-Fi Retailers



give you the greatest choice

## TMK 200 MULTIMETER KIT

Build yourself a quality 20000 opv. multimeter and save money. Complete kit with meter scale, movement and rotary range selector ready mounted in cabinet. All parts, batteries, test prods and instructions. Ranges: 0/0.6/6/30/120/600/1200V D.C. 0.6/30/120/600/1200V A.C. Current: 0/0.6/6/60/600mA Resistance 0/10/100K/10 Meg ohms. Decibels: -20 to +63dB. Size: 90 x 150 x 35mm



**OUR PRICE £7.95 P & P 30p**

## AUDIOTRONIC Model ATM1

Top value 1,000 opv pocket multimeter. Ranges: 0/10/50/250/1,000 volt AC and DC. DC current 0.1mA/100mA. Resistance: 0/150k ohms. Decibels: -10 to +22dB. Size 90 x 60 x 28mm. Complete with test leads.



**OUR PRICE £3.25 P & P 15p**

## AUDIOTRONIC Model ATM5

Jewel movement, attractively moulded case with edgewise ohms adjustment. Ranges: 0.3/1.5/15/300/1200V AC. (2500 opv), 0.3/30/300/600V DC. (5000 opv), 0-800 uA/0.300mA DC. Resistance: x 10 & x 100. -10 to +16dB. Supplied with battery test leads and data booklet. Size: 121 x 73 x 29mm.



**OUR PRICE £3.95 P & P 20p**

## HIKI 720X VOM

A versatile, accurate measuring instrument. 20,000 opv. AC. Mirror scale. Ranges: 0.5/2.5/10/50/100V DC. 0/10/50/250/500V AC. 0-50uA/250mA. 0-20k/2 Megohms.



**OUR PRICE £8.97 P & P 30p**

## MOEL C720ZEN

20,000 opv DC. 10,000 opv AC. Mirror scale. Ranges: 5/25/50/250/500/1000/2600V. DC 10/50/100/500/1000V. A.C. DC Resistance: x 10, x 1000 (30k) centre scale. DC Current: 500uA. 2.5mA/250mA. -20 to +68 dB.



**OUR PRICE £6.95 P & P 30p**

## MOEL PL436

20,000 opv DC. 8000 opv AC. Mirror scale. Ranges: 0.3/12/30/120/600V DC. 3/30/120/600V AC. 50/600uA/60/600mA. 10/100K/1 Meg/10 Meg Ohm. -20 to 46 dB.



**OUR PRICE £6.97 P & P 30p**

## HIKI 730X

30,000 opv. Overload protection. Ranges: 6/30/60/300/600/1200V DC. 12/60/120/600/1200V AC. 60 uA/30mA/300mA. 2K/200K. 2 Meg Ohm. -10 to 63 dB.



**OUR PRICE £7.50 P & P 30p**

## U4323 MULTIMETER

20,000 opv. Simple unit with audio/IF oscillator suitable for general receiver tuning. Ranges: 0.5/2.5/10/50/250/500/1000V DC. 2.5/10/15/250/500/1000V AC. 0.05/0.5/5/50/500mA DC. Resistance: x 10, x 100, x 1,000, x 10,000 (50k) 50k/1.5k/1.5k centre scale. Battery operated. Size: 160 x 97 x 40mm. Supplied in carrying case complete with test leads.

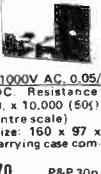

**OUR PRICE £7.70 P & P 30p**

## U435 MULTIMETER

20,000 opv. Ranges: 75mV/2.5/10/25/100/250/500/1000V DC. 2.5/10/15/100/250/500/1000V AC. Current: 50uA/1/5/25/100mA/0.5/2.5A DC. 5/25/25A AC. Resistance: 0.3/30/300k ohms. Size: 205 x 110 x 84mm. Supplied complete with leads, crocodile clips and steel carrying case.



**OUR PRICE £8.75 P & P 30p**

## MOEL C7208FM

30,000 opv DC. 15,000 opv AC. Ranges: 6/3/15/60/300/1200V DC. 6/30/60/300/600/1200V AC. DC Resistance: x 1, x 10, x 100, x 1000 (50k) centre scale. DC Current: 30uA. 3/30/600mA. 20 to +63dB.



**OUR PRICE £8.95 P & P 30p**

## U4324 MULTIMETER

High sensitivity, overload protected. 20,000 opv. Ranges: 0.6/1.2/3/12/30/60/120/600/1200V DC. 3/6/15/60/300/600/900V AC. Current: 0.06/0.6/6/60/600mA/3A DC. 0.3/3/30/300mA. 25A AC. Resistance: 35/500 ohms/0.5/5/50/500k ohms/5 Mohms. Decibels: -10 to +12dB. Size: 167 x 98 x 63mm. Supplied complete with test leads, spare diode and instructions.



**OUR PRICE £9.25 P & P 30p**

## U91 CLAMP VOLT AMPER

For measuring AC voltage and current without breaking circuit. Ranges: 300/600V AC. Current: 10/25/100/250/500A. Accuracy 4%. Size 283 x 94 x 36mm. Complete with carrying case, leads and fuses.



**OUR PRICE £13.50 P & P 30p**

## U4312 MULTIMETER

extremely sturdy instrument for general electrical use. 667 opv. Ranges: 0/0.3/1.5/7.5/30/60/150/300/600/900V DC & 75mV/0/0.3/1.5/7.5/30/60/150/300/600/900V AC. Current: 1.5/6/15/150/600mA/1/1.5/6A DC. 0/1.5/6/15/60/150/600mA/1.5/6A AC. 0/200/3k/30k ohms. DC accuracy 1%. AC 1.5%. Knife edge pointer, mirror scale. Complete with sturdy metal carrying case, leads and instructions.



**OUR PRICE £10.25 P & P 50p**

## HIKI 750X VOLT-OHM-MILLIAMETER

43 ranges. 0-0.3/0.6/1.5/3/6/12/30/60/150/300/600/1,200V DC. 0-3/6/15/30/60/120/300/600/1,200V AC. Current: 0-30/60uA/1.5/3/15/30/150/300mA/6/12A. Resistance: 0-3/300k/350Mohms. Decibels: -10 to +17dB. Output: -0.3/6/15/30/60/120/300V. Accuracy: ± 3% DC, ± 4% AC. Sensitivity: 50,000 opv DC, 5,000 opv AC. 4 inch meter. Built-in protection. Size: 57 x 102 x 153mm.



**OUR PRICE £11.95 P & P 40p**

## TMK MODEL TW50K

46 ranges, mirror scale. 50kV/DC. 500V/AC. DC Volts: 0.5/1.25/2.5/5/10/25/50/125/250/500/1000. DC current: 0.5/5/50/100/500/1000. AC Volts: 1.5/3/5/10/25/50/125/250/500/1000. DC Resistance: 10k/100k/1 Meg. 10 Meg ohms. -20 to +81.5dB.



**OUR PRICE £12.50 P & P 20p**

## MOEL C7080EN

Giant 6" mirror scale. 20,000 opv. 0/0.25/1.25/10/50/250/1000/5000V DC. 0/2.5/10/50/250/1000/5000V AC. 0/50uA/1/10/100/500mA/10A DC. 0/2k/20k/20 Meg. 20 to +50dB.



**OUR PRICE £19.95 P & P 35p**

## MOEL 500

30,000 opv with overload protection. Mirror scale. Ranges: 0/0.5/1/2/5/10/25/100/250/500/1000V DC. 0/2.5/10/25/100/250/500/1000V AC. 0/50uA/1/5/50/500mA/10A DC. 0/2k/20k/20 Meg/6 meg/60 megohms.



**OUR PRICE £13.95 Carr. paid**

## HIKI MODEL 700X

100,000 opv. Overload protection. Mirror scale. Ranges: 0/0.3/0.6/1.2/1.5/3/6/12/30/60/120/300/600/1200V DC. 1.5/3/6/12/30/60/150/300/600/1200V AC. 15/30uA/0.3/30/50/150/500mA/6/12A DC. 2k/20k/2M/20M Ohms. -20 to +63dB.



**OUR PRICE £14.95 P & P 30p**

## MODEL AS.1000 VOM

100,000 opv. Mirror scale. Built-in meter protection. 0/3/12/60/120/300/600/1200V DC. 0/6/30/120/300/600V AC. 0/10uA/6/60/300mA/12 Amp. 0/2K/200K/2M/200 Meg Ohm. 20 to 17dB.



**OUR PRICE £17.50 P & P 30p**

## KAMODEN HM720B FET VOM

Input impedance 10 Megohms. Ranges: 0/25/1/2.5/10/50/100V DC. 0/2.5/10/50/250/1000V AC. 0/25uA/2.5/25/250 mA DC. 0/5k/50k/500k/5M 500 Megohms.



**OUR PRICE £21.00 P & P 40p**

## KAMODEN 360 MULTIMETER

High sensitivity. DC 10k ohm/V. AC 10k ohm/V. 5" mirror scale, overload protected. Ranges: 0/5/2.5/10/50/250/1000V DC. 5/10/50/250/1000V AC. Current: 0.01mA/0.5/5/50/500mA/10A. Resistance: 0/1/1/10/100 ohms/1/10/100k ohms/10/100M ohms. Decibels: -20 to +62dB. Battery operated. Size: 180 x 140 x 80mm. Supplied complete with test leads etc.



**OUR PRICE £17.50 P & P 40p**

## Model HT1008A MULTIMETER

Overload protected shock proof circuits. 9.5uA Meter with mirror scale. Sensitivity 100kV. Polarity change switch. Ranges: 0.5/2.5/1.5/50/500/1000 Volts DC. 2.5/10/50/250/1000 Volts AC. DC Resistance: 0-20/200k/20 Meg ohms. DC current: -10/250mA/2.5/25/250 mA/1/10A. -10A, -20 to +62dB. Operates from 2 x 1.5V batteries. Size: 180 x 134 x 79mm.



**OUR PRICE £17.50 P & P 40p**

## 370WTR MULTIMETER

Features AC current ranges. 20,000 opv. 0/0.5/2.5/10/50/250/500/1000V DC. 0/2.5/10/50/250/500/1000V AC. 0/50uA/1/10/100 mA/1/10A DC. 0/100mA/1/10A AC. 0/5k/50k/500k/5 Meg/50 Meg Ohms. Decibels: -20 to +62dB.



**OUR PRICE £19.95 P & P 30p**

## U4317 MULTIMETER

High sensitivity instrument for field and laboratory work. Knife edge pointer. 96mm mirror scale. Overload protection. Ranges: 0.5/2.5/10/25/50/100/250/500/1000V DC. 0.5/2.5/10/25/50/100/250/500/1000V AC. Current: 50uA/0.5/1.5/10/250mA/1/5A DC. 0.25/0.5/1.5/10/250mA/1/5A AC. 0/5k/50k/500k/5 Meg/50 Meg Ohms. Decibels: -5 to +104dB. Battery operated. Size: 210 x 115 x 90mm. Supplied in carrying case complete with leads.

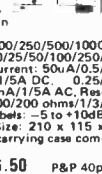

**OUR PRICE £16.50 P & P 40p**

## KAMODEN 72.200 Multitester

High sensitivity tester. 200,000 opv. Overload protected Mirror scale. Ranges: 0.06/3/3/30/120/600/1200V DC. 0/3/12/60/300/1200V AC. 0/5uA/1.2mA/120mA/600mA/12A DC. 0/1/2A AC. -20 to +63dB. 0/2k/20k/2 Meg/20 Megohms.



**OUR PRICE £22.50 P & P 30p**

## MOEL AF.105 VOM

50,000 opv. Mirror scale. Meter protection. 0/3/12/60/120/300/600/1200V DC. 0/6/30/120/300/600/1200V AC. 0/30uA/6/60/300mA/12 Amp. 0/10K/1m/10m/100 Meg Ohms. 20 to 17dB.



**OUR PRICE £12.50 P & P 30p**

## TMK MODEL 117 FET ELECTRONIC VOLTMETER

Battery operated. 11 Meg input, 26 ranges. Large 4 1/4" mirror scale. Size: 149 x 117 x 60mm. 0.3-1200kV DC. 3-300V RMS AC. 8-800V P.P. DC current 0.12-12mA. Resistance up to 2000Mohms. Decibels: -20 to +51dB. Supplied complete with leads and instructions.



**OUR PRICE £18.50 P & P 20p**

## TMK 100K LAB TESTER

100,000 opv. 6 1/2" scale. Buzzer short circuit check. Sensitivity 100,000 opv DC. 5kV AC. DC Volts: 0.5/2.5/10/50/250/1000V AC. 3/10/50/250/500/1000V DC. current 10/100uA/10/100/250mA. Resistance: 1k/10k/100k/10 Meg/100 Meg ohms. Decibels: -10 to +45dB. Plastic case with carrying handle. Size: 190 x 172 x 99mm.



**OUR PRICE £19.95 P & P 30p**

## LB4 TRANSISTOR TESTER

Tests PNP or NPN transistors. Audio indication. Operates on two 1.5V batteries. Complete with instructions etc.



**OUR PRICE £4.50 P & P 20p**

## KAMODEN TT35 TRANSISTOR TESTER

High quality instrument to test reverse leak current and DC currents. Amplification factor of NPN, PNP diodes, transistors, SCR's etc. 4" clear scale meter. Operates from internal batteries. Complete with instructions, leads carrying handle.



**OUR PRICE £17.50 P & P 40p**

## U4341 MULTIMETER & Transistor Tester

27 ranges. 16,700 opv. Overload protected. Ranges: 0.3/1.5/10/50/250/500/1000V DC. 1.5/7.5/30/150/300/750V AC. Current: 0.05/0.5/6/60/600mA AC. 0.3/3/30/300mA AC. Resistance: 0.06/0.6/6/60/600 ohms/2 Mohms. Battery operated. Supplied complete with probes, leads and steel carrying case. Size: 115 x 215 x 90mm.



**OUR PRICE £10.50 P & P 30p**

## STO0TR MULTIMETER TRANSISTOR TESTER

100,000 opv. Mirror scale. Overload protection. 0/0.12/0.6/1.2/30/120/600V DC. 0/6/30/120/600V AC. 0/12/60uA/12/300mA/12A DC. 0/10k/1 Meg/100 Meg. -20 to +60dB. 0.01-2 MFD Transistor tester measures Alpha, Beta and ICO. Complete with instructions, batteries and leads.



**OUR PRICE £19.95 P & P 25p**

## SWR METER Model SWR3

Handy SWR meter for transmitter antenna alignment, with built-in field strength meter. Accuracy 5%. Impedance 52 Ohms. 19dBm. Full scale 5 section collapsible antenna. Size 145 x 50 x 60mm.



**OUR PRICE £4.25 P & P 30p**

## C15 PULSE OSCILLOSCOPE

For display of pulsed and periodic waveforms on electronic circuits. VERT. AMP. Bandwidth: 10MHz. Sensitivity at 100kHz V RMS/mm: 0.1-25. HOR. AMP. Bandwidth: 500kHz. Sensitivity at 100kHz V RMS/mm: 0.3-25. Preset triggered sweep 1-300 usec. Free running 20-200 kHz in nine ranges. Calibrator pip. 220 x 360 x 430mm. 115-230V AC.



**OUR PRICE £43.00 Carr. paid**

## ALL PRICES EXCLUDE VAT

Also see following pages

### SINCLAIR DM2 DIGITAL MULTIMETER



Will measure AC and DC volts, AC and DC current, and resistance in a total of 20 ranges. The large light emitting diode display will read up to 1999 and automatically indicate polarity. Indication of positive and negative overloads is also provided. The instrument is fitted with a combined carrying handle and bench stand and sockets are provided for the connection of an external power supply RANGES:  
DC VOLTS 1v, 10v, 100v, 1000v  
AC VOLTS 1v, 10v, 100v, 1000v  
DC CURRENT 1mA, 10mA, 100mA, 1000mA  
AC CURRENT: 1mA, 10mA, 100mA, 1000mA  
RESISTANCE 1k, 10k, 100k, 1000k  
**OUR PRICE £59.95** P & P 50p

### RUSSIAN C116 Double Beam OSCILLOSCOPE

5 MHz pass band. Separate Y1 and Y2 amplifiers. Rectangular 5" x 4" CRT. Calibrated triggered sweep from 0.2µsec to 100 milli-sec/cm. Free running time base, 50Hz-1MHz. Built-in time base. Calibrator and amplitude Calibrator. Supplied complete with all accessories and instruction manual.  
**OUR PRICE £87.00** Carr. paid



### MODEL TE15 GRID DIP METER

Transistorised. Operates as Grid Dip Oscillator, Absorption Wave Meter and Oscillating Detector. Frequency range 440kHz-280MHz. In six coils, 500µA meter, 9V battery operation. Size: 180 x 80 x 40mm.  
**OUR PRICE £17.50** P&P 30p



### TRANSISTORISED L.C.R. A.C. BR/8 MEASURING BRIDGE

A new portable bridge offering excellent range and accuracy at low cost. Resistance: 6 ranges: 0.1 ohm-11.1 megohm ± 1% Inductance: 6 ranges: 1 microhenry-111 henries ± 2% Capacity: 6 ranges: 10pF-1110 mfd ± 2% Turns Ratio: 6 ranges: 1:1/1000-1:11000 ± 1% Bridge Voltage at 1,000cps. Operates from 9-volt battery. 100 micro-amp meter indication. Size 7 1/2" x 5" x 2"  
**OUR PRICE £27.50** P&P 30p

### TE16A TRANSISTORISED SIGNAL GENERATOR

5 ranges, 400kHz to 30 MHz. An inexpensive instrument for the handy man. Operates on 9V battery. Wide easy to read scale. 800kHz modulation. Size: 149 x 149 x 92mm. Complete with instructions and leads.  
**OUR PRICE £8.97** P&P 30p



### TE-20D RF SIGNAL GENERATOR

Accurate wide range signal generator covering 120 kHz-500 MHz on 6 bands. Directly calibrated. Variable RF attenuator audio output, Xtal socket for calibration. 220/240V a.c. Brand new with instructions. Size 140mm x 215mm x 170mm.  
**OUR PRICE £19.95** P&P 50p

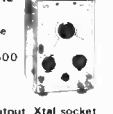

### MODEL TE20 RF SIGNAL GENERATOR

Six bands, 120kHz-260MHz. Dual output RF terminals. Separate variable audio output. Accuracy ± 2%. Audio output to 8V. Power requirements: 105-125V, 220/240V AC. Size: 193 x 265 x 150mm. Complete with test leads etc.  
**OUR PRICE £18.95** P&P 50p



### ARF 300 AF/RF SIGNAL GENERATOR

All transistorised compact fully portable. AF sine wave 18Hz to 220 kHz. AF square wave 18Hz to 100kHz. Output Square/Sine wave 10V. P.P. RF 100kHz to 200MHz. Output 1V maximum. 220/240V AC operation. Complete with instructions and leads.  
**OUR PRICE £37.50** P&P 50p



### MODEL MG100 SINE SQUARE WAVE AUDIO GENERATOR

Range 19 220,000Hz. Sine Wave 19-100,000 Hz Square Wave. Output Sine or Square wave 10V. P to P. Size 180 x 90 x 90mm. Operation 220/240V AC.  
**OUR PRICE £19.95** P&P 50p



### TE22 SINE SQUARE WAVE AUDIO GENERATOR

Sine 20cps to 200kHz on 4 bands. Square 20 cps to 30 kHz. Output impedance 5000 Ohms. 200/250V AC operation. Supplied brand new guaranteed, with instruction manual and leads.  
**OUR PRICE £24.95** P&P 50p



### BELCO AT201 Decade ATTENUATOR

Frequency range 0-200kHz. Attenuator 0-111dB, 0.1dB steps. Impedance 600 ohms. Input power maximum 30dBm. Size: 185 x 90 x 55mm.  
**OUR PRICE £12.50** P&P 50p



### DT 124 POWER UNIT

220 240V AC Input. Output 6, 7.5 or 9V DC 400mA.  
**OUR PRICE £2.20** P&P 50p



### PS200 Regulated POWER SUPPLY UNIT

Solid state. Variable output 5-20V DC up to 2 Amp. Independent meters to monitor voltage and current. Output 220/240V AC. Size: 190 x 136 x 98mm.  
**OUR PRICE £19.95** P&P 50p



### VU METER TYPE 3

Size 33mm 20mm  
**£1.25** P&P 15p



### SDH8V MOND/STEREO HEADPHONES

Volume control for each channel. 4/16 ohms impedance. Frequency response 20Hz-18kHz. Complete with 10ft. coiled lead and jack plug.  
**OUR PRICE £4.97** P&P 30p



### BH001 HEADSET and 800m Microphone

Moving coil. Ideal for language teaching, communications etc. Headphone impedance 16 ohms. Microphone impedance 200 ohms.  
**OUR PRICE £5.95** P&P 30p



### UNIPEX NT 100A

The unipex NT100A is a compact portable transistorised PA amplifier. This versatile unit has a maximum output of 10 watts RMS and operates on any 1.0-16V DC source, negative or positive ground and uses only 1.5A at rated output. Supplied complete with mounting brackets etc, plus full installation and operating instructions.  
**OUR PRICE £21.75** P&P 50p



### EA41 REVERBERATION AMPLIFIER

Self contained, transistorised, battery operated. Simply plug in microphone, guitar etc. and output to your amplifier. Volume control and depth of reverbation control. Bawlnut cabinet. 184 x 77 x 108mm.  
**OUR PRICE £7.50** P&P 30p

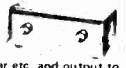

### RANK AUDIO RA 210T STEREO AMPLIFIER

7 1/2 watts rms. Inputs for magnetic phono, tuner, tape and aux. Separate base, treble, balance and volume controls. Headphone socket. Teak case. Unrepeatable offer.  
**OUR PRICE £17.50** P&P 50p

### VHF 105

This unit will give instant reception of the ground-air, air-to-ground waveband. Simply place beside any AM or FM Radio covering 535-1605 kHz. 88-108 MHz. No conversion or connection required. This converter is self powered by one 9-volt (PP3 Type) battery and comes complete with a full set of instructions and battery.  
**OUR PRICE £3.50** P&P 50p



### Just arrived - the sensational WIEN ET1008 CASSETTE RECORDER

A highly recommended cassette recorder at this really low Laskys price. **ONLY £8.95** P&P 50p. **FANTASTIC VALUE!**



### SPECIAL OFFER! CONVERT YOUR STEREO SYSTEM TO 4D SOUND

This clever unit enables you to add 4D sound to your existing system. Complete with simple connection details. Use this converter (together with 2 extra speakers) to achieve the fantastic 4D Quadrophonic sound! The effect of being immersed within the music becomes a thrilling new experience (2 year guarantee).  
**OUR PRICE £3.95** P&P 50p

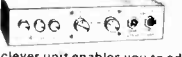

### FM TUNER CHASSIS

6 transistor high quality tuner. Size only 153 x 106 x 63mm. 3 IF stages. Double tuned discriminator. Ample output to feed most amplifiers. Operates on 9V battery. Covers 88-108MHz. Ready built, ready for use. Fantastic value for money.  
**OUR PRICE £8.95** P&P 20p  
Stereo Multiplex Adaptor £9.95 extra.



### WALKIE TALKIES SKYFON NV7

Super low cost transmitter receivers. 100MW with call buzzer and on/off volume control. 7 transistors. Telescopic rod antenna.  
**OUR PRICE £31.50** per PAIR P & P 50p. **NOT LICENSABLE IN THE U.K.**



### ELECTRONIC CALCULATORS

We carry a tremendous range of both pocket and desk calculators from as little as £8.95. Owing to the demand that is not possible to include them in this advertisement, so send for our latest price list or call into any branch.



### MINIATURE ORGAN MUSIC MASTER AM100

Spanning nearly two octaves, including semi-tones. This instrument will give hours of enjoyment to all the family. Beautifully finished. The keyboard range can be adjusted to be in tune with any instrument. Operates from internal 9V battery. Fitted with on/off switch, vibrato switch, earphone socket and external 9V D.C. socket.  
**OUR PRICE £7.95** P&P 50p

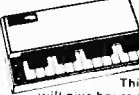

### BINATONE DIGITAL CLOCK

Attractive ivory case. Large clear numbers for hours, minutes and seconds. A.C. 240V operation. Size approx 6 1/2 x 3 x 3 1/2 inches.  
**OUR PRICE £4.50** P&P 50p



### SINCLAIR IC12 INTEGRATED CIRCUIT AMPLIFIER

complete with printed circuit mounting board.  
**OUR PRICE £1.50** P & P 15p.



### SINCLAIR Project 80 Modules

240 Power Amp. £5.95 P & P 15p  
260 Power Amp. £7.45 P & P 15p  
Stereo Clear Amp. £13.95 P & P 15p  
Active Filter Unit. £7.45 P & P 15p  
FM Tuner. £13.95 P & P 15p  
Stereo Decoder. £8.95 P & P 15p  
P25 Power Supply. £5.95 P & P 30p  
P26 Power Supply. £8.95 P & P 30p  
P28 Power Supply. £8.45 P & P 30p  
Transformer for P28. £4.05 P & P 50p

### SINCLAIR Project 80 Packages

2x240/Stereo 80/P25 £25.44 P & P 35p  
2x240/Stereo 80/P26 £27.84 P & P 35p  
2x260/Stereo 80/P28 £29.84 each

### TE1021 Stereo Listening Station

For balancing and gain selection of loudspeakers with additional facilities for stereo headphone switching. Two gain controls, speakers on-off side switch, stereo headphone socket.  
**OUR PRICE £2.25** P&P 15p



### AUDIOTRONIC LOW NOISE CASSETTES

TYPE	5	10	25
C60	£1.57	£3.00	£7.08
C90	£2.24	£4.25	£10.00
C120	£2.73	£5.17	£12.24

P&P 3p each. 10 and over Post Free

### MPT MIXER-PREAMPLIFIER

5 Microphone inputs each with individual gain control. Includes complete mixing facilities. Battery operated. Size: 235 x 127 x 76mm. Inputs: Mics. 3 x 3mV. 50k; 2 x 3mV 600 ohms. Phono. Mag. 4mV. 50k; Phono Ceramic 100mV. 100k.  
**OUR PRICE £8.97** P&P 20p



### AUDIOTRONIC AH401 Stereo Headphone Amplifier

All silicon, transistor amplifier. Operates from magnetic, ceramic or tuner inputs with twin stereo headphone outputs and separate volume controls for each channel. Operates from 9V battery. INPUTS: 50mV and 100mV. OUTPUT: 50mV per channel.  
**OUR PRICE £8.50** P&P 30p



### HIGH QUALITY CONSTRUCTION KITS

WE ARE APPOINTED STOCKISTS AT Oxford Street, 142 & 34 Lisle Street, 152, Fleet Street, 311 Edgware Road, CROYDON BIRMINGHAM KINGSTON LEICESTER NORTHAMPTON SOUTHEND TUNBRIDGE WELLS WOLVERHAMPTON branches or by Mail Order

All kits are complete with comprehensive easy to follow instructions and covered by full guarantee. Post and Packing 15p per kit.

AF20 Mono amplifier.....	£5.61
AF25 Mixer.....	£3.29
AF30 Mono pre amplifier.....	£3.30
AF35 Emitter amplifier.....	£2.42
AF80 50W mic. amplifier.....	£4.86
AF305 Intercom.....	£7.67
AF310 2 Mono Amplifier.....	£7.55
M160 Multi-vibrator.....	£2.18
M1302 Transistor tester.....	£8.33
M191 VU Meter.....	£5.37
M193 Stereo balance meter.....	£5.93
LF380 Guard amplifier device.....	£8.42
AT5 Automatic light control.....	£3.75
AT30 Photo cell switch unit.....	£6.68
AT150 400V triac light dimmer/speed control.....	£5.18
AT50 2 200V triac light dimmer/speed control.....	£6.75
AT60 1 channel light control.....	£10.82
AT65 3 channel light control.....	£16.52
GU330 Triac unit.....	£8.10
HF61 Diode detector.....	£3.87
HF65 FM transmitter.....	£3.21
HF75 FM receiver.....	£3.66
HF310 FM tuner.....	£16.32
HF325 Deluxe FM tuner.....	£26.33
HF330 Decoder (HF310/325).....	£10.55
GP310 Stereo pre-amplifier for use with AF310.....	£22.98
GP312 Circuit board.....	£10.02
GP304 Circuit board.....	£5.33
HF380 lw/hf aerial amplifier.....	£6.02
HF395 broadband aerial amp.....	£2.10
NT10 Stabilised power supply 100mA, 9V.....	£6.27
NT300 Stabilised s. supply.....	£13.16
NT310 Power Supply 240 V AC or 2, 15 V D.C. at 2 amps.....	£5.64
NT306 Voltage converter.....	£9.64
NT315 Power supply 240V AC to 4.5/15V DC, 500mA.....	£12.06

Amateur Electronics by Justy-Kit, the professional book for the amateur covers the subject from basic principles to advanced electronic techniques. Complete with circuit board for AE1 to AE10 listed below.  
**OUR PRICE £3.30** (No VAT) P&P 25p plus VAT

AE1 100mV output stage.....	£1.55
AE2 Pre-amplifier.....	£1.32
AE3 Diode receiver.....	£2.05
AE4 Flasher.....	£1.26
AE5 Adjustable multi-vibrator.....	£1.14
AE6 Monostable multi-vibrator.....	£1.11
AE7 RC generator.....	£1.08
AE8 Bass filter.....	£1.05
AE9 Treble filter.....	£1.05
AE10 CCIR filter.....	£1.05

Also see previous page  
**ALL PRICES EXCLUDE VAT**



# SEW PANEL METERS

SEW PANEL METERS ARE STOCKED AT OUR 3 LISLE ST., 311 EDGWARE RD., & 152 FLEET ST., BRANCHES or order by post.



USED EXTENSIVELY BY INDUSTRY, GOVERNMENT DEPARTMENTS, EDUCATIONAL AUTHORITIES ETC.

Over 200 ranges in stock—other ranges to order. Quantity discounts available. Send for fully illustrated brochure.

## CLEAR PLASTIC MODEL SD640

Size: 85 x 64mm

50uA	£3.90
100uA	£3.85
200uA	£3.80
500uA	£3.75
50-0-500uA	£3.85
100-0-1000uA	£3.80
1mA	£3.75
5mA	£3.75
10mA	£3.75
50mA	£3.75
100mA	£3.75
500mA	£3.75
1A DC	£3.75
5A DC	£3.75
10A DC	£3.75
5V DC	£3.75



10V DC	£3.75
20V DC	£3.75
50V DC	£3.75
300V DC	£3.75
15V AC	£3.75
30V AC	£3.85
VU Meter	£4.00

## CLEAR PLASTIC MODEL SW100

Size: 100 x 80mm

50uA	£4.70
100uA	£4.60
200uA	£4.40
50-0-500uA	£4.55
100-0-1000uA	£4.55
1mA	£4.40
5A DC	£4.40
10A DC	£4.40
20V DC	£4.40
50V DC	£4.40
300V DC	£4.40
5V DC	£4.40



150V AC	£4.55
300V AC	£4.55
VU Meter	£5.00

## EDGWISE MODEL PE70

Size: 90 x 34mm

50uA	£4.25
100uA	£4.20
200uA	£4.15
500uA	£4.20
50-0-500uA	£4.40
100-0-1000uA	£4.15
1mA	£4.05
300V AC	£4.05
VU Meter	£4.40



## MODEL E0107 EDUCATIONAL METER

Size: 100 x 90 x 150mm including terminals

50uA	£8.70
100uA	£8.10
50-0-500uA	£8.10
1mA	£7.80
1-0-1mA	£7.80
1A DC	£7.80
5A DC	£7.80
5V DC	£7.80
10V DC	£7.80
15V DC	£7.80



20V DC	£7.80
50V DC	£7.80
300V DC	£7.80
500mA/5A DC	£8.80
5V/15V DC	£8.80
1/5A DC	£8.80

## CLEAR PLASTIC MODEL MR 85P

Size: 120 x 110mm

50uA	£5.80
100uA	£5.85
200uA	£5.80
500uA	£5.40
50-0-500uA	£5.65
100-0-1000uA	£5.65
500-0-5000uA	£5.35
1mA	£5.35
1-0-1mA	£5.35
5mA	£5.35
10mA	£5.35
50mA	£5.35
100mA	£5.35
500mA	£5.35
1A DC	£5.35
5A DC	£5.35
15A DC	£5.35
30A DC	£5.35
10V DC	£5.35
20V DC	£5.35
50V DC	£5.35
150V DC	£5.35



300V DC	£5.40
15V AC	£5.45
30V AC	£5.45
S Meter 1mA	£5.35
VU Meter	£5.70
1A AC	£5.35
5A AC	£5.35
10A AC	£5.35
20A AC	£5.35
30A AC	£5.35

## \*Items with asterisk are Moving Iron type, all others are Moving Coil

### CLEAR PLASTIC MODEL SD830

Size: 110 x 83mm

50uA	£4.40
100uA	£4.35
200uA	£4.30
500uA	£4.25
50-0-500uA	£4.35
100-0-1000uA	£4.30
1mA	£4.20
5mA	£4.20
10mA	£4.20
50mA	£4.20
100mA	£4.20
500mA	£4.20
1A DC	£4.20
5A DC	£4.20
10A DC	£4.20
5V DC	£4.20



10V DC	£4.20
20V DC	£4.20
50V DC	£4.20
300V DC	£4.20
15V AC	£4.30
30V AC	£4.30
VU Meter	£4.50

### CLEAR PLASTIC MODEL MR 45P

Size: 50 x 50mm

50uA	£3.30
100uA	£3.25
200uA	£3.20
500uA	£3.10
50-0-500uA	£3.25
100-0-1000uA	£3.20
500-0-5000uA	£3.05
1mA	£3.05
5mA	£3.05
10mA	£3.05
50mA	£3.05
100mA	£3.05
500mA	£3.05
1A DC	£3.05
5A DC	£3.05
10V DC	£3.05
20V DC	£3.05
50V DC	£3.05
300V DC	£3.05
15V AC	£3.15



300V AC	£3.15
S Meter 1mA	£3.50
VU Meter	£3.50
1A AC	£3.05*
5A AC	£3.05*
10A AC	£3.05*
20A AC	£3.05*
30A AC	£3.05*

### CLEAR PLASTIC MODEL MR 38P

Size: 42 x 42mm

50uA	£3.20
100uA	£3.15
200uA	£3.10
500uA	£2.90
50-0-500uA	£3.10
100-0-1000uA	£2.85
1mA	£2.85
1-0-1mA	£2.85
2mA	£2.85
5mA	£2.85
10mA	£2.85
20mA	£2.85
50mA	£2.85
100mA	£2.85
150mA	£2.85
200mA	£2.85
300mA	£2.85
500mA	£2.85
1A DC	£2.85
2A DC	£2.85
5A DC	£2.85
10A DC	£2.85
3V DC	£2.85
10V DC	£2.85
15V DC	£2.85



20V DC	£2.85
50V DC	£2.85
150V DC	£2.85
300V DC	£2.85
500V DC	£2.85
750V DC	£2.95
15V AC	£2.95
30V AC	£2.95
50V AC	£2.95
150V AC	£2.95
300V AC	£2.95
S Meter 1mA	£3.10
VU Meter	£3.30

### CLEAR PLASTIC MODEL SD460

Size: 59 x 46mm

50uA	£3.50
100uA	£3.55
200uA	£3.50
500uA	£3.45
50-0-500uA	£3.55
100-0-1000uA	£3.50
1mA	£3.40
5mA	£3.40
10mA	£3.40
50mA	£3.40
100mA	£3.40
500mA	£3.40
1A DC	£3.40
5A DC	£3.40
10A DC	£3.40
5V DC	£3.40



10V DC	£3.40
20V DC	£3.40
50V DC	£3.40
300V DC	£3.40
15V AC	£3.55
30V AC	£3.55
50V AC	£3.55
150V AC	£3.55
300V AC	£3.55
VU Meter	£3.75

POSTAGE & PACKING 15p

## CLEAR PLASTIC MODEL MR 65P

Size: 86 x 78mm

50uA	£4.05
100uA	£3.95
200uA	£3.90
500uA	£3.85
50-0-500uA	£3.95
100-0-1000uA	£3.90
1mA	£3.80
1-0-1mA	£3.85
5mA	£3.80
10mA	£3.80
50mA	£3.80
100mA	£3.80
500mA	£3.80
1A DC	£3.80
5A DC	£3.80
10A DC	£3.80
15A DC	£3.80
20A DC	£3.80
30A DC	£3.80
50A DC	£3.80
5V DC	£3.80
10V DC	£3.80
15V DC	£3.80
20V DC	£3.80
50V DC	£3.80
150V DC	£3.80



300V DC	£3.80
15V AC	£3.90
30V AC	£3.90
50V AC	£3.90
150V AC	£3.90
300V AC	£3.90
500V AC	£4.00
S Meter 1mA	£3.90
VU Meter	£4.20
1A AC	£3.80*
5A AC	£3.80*
10A AC	£3.80*
20A AC	£3.80*
30A AC	£3.80*
50A AC	£3.80*
100A AC	£3.80*
200A AC	£3.80*
500A AC	£3.80*

## BAKELITE MODEL S80 Enlarged Window

Size: 80 x 80mm

50uA	£4.60
100uA	£4.55
500uA	£4.30
50-0-500uA	£4.55
100-0-1000uA	£4.50
1mA	£4.30
1A DC	£4.30
5A DC	£4.30
10A DC	£4.30
50V DC	£4.30
300V DC	£4.30
300V AC	£4.40
VU Meter	£4.80



## CLEAR PLASTIC MODEL MR 52P

Size: 60 x 60mm

50uA	£3.80
100uA	£3.80
200uA	£3.75
500uA	£3.60
50-0-500uA	£3.60
100-0-1000uA	£3.45
1mA	£3.40
5mA	£3.40
10mA	£3.40
50mA	£3.40
100mA	£3.40
500mA	£3.40
1A DC	£3.40
5A DC	£3.40
10V DC	£3.40
20V DC	£3.40
50V DC	£3.40
300V DC	£3.40
15V AC	£3.50
30V AC	£3.50



S Meter 1mA	£3.40
VU Meter	£3.90
1A AC	£3.40*
5A AC	£3.40*
10A AC	£3.40*
20A AC	£3.40*
30A AC	£3.40*

## BAKELITE MODEL MR 65

Size: 80 x 80mm

25uA	£5.40
50uA	£4.10
100uA	£4.05
500uA	£3.75
50-0-500uA	£4.05
100-0-1000uA	£4.00
500-0-5000uA	£3.70
1mA	£3.70
1-0-1mA	£3.70
5mA	£3.70
10mA	£3.70
50mA	£3.70
100mA	£3.70
500mA	£3.70
1A DC	£3.70
2A DC	£3.70
5A DC	£3.70
10A DC	£3.70
15A DC	£3.70
30A DC	£3.70
50A DC	£3.70
5V DC	£3.70
10V DC	£3.70
15V DC	£3.70
50V DC	£3.70
150V DC	£3.70



300V DC	£3.90
30V AC	£3.70*
50V AC	£3.70*
150V AC	£3.70*
300V AC	£3.70*
500V AC	£3.70*
S Meter 1mA	£4.20
VU Meter	£4.20
1A AC	£3.70*
5A AC	£3.70*
10A AC	£3.70*
20A AC	£3.70*
30A AC	£3.70*
50A AC	£3.70*
100A AC	£3.70*
500A AC	£3.70*
50mV DC	£3.85
100mV DC	£3.85

## 240° Wide Angle

1mA METERS	
MW1-6.60 x 60 mm	
£6.50 P & P 15p	
MW1-8.80 x 80 mm	
£6.90 P&P 15p	



## YAMABISHI VARIABLE VOLTAGE TRANSFORMERS

Excellent quality at low cost. Input: 230V 50/60Hz. Output 0-260V. MODEL S260 BENCH MOUNTING

1A	£10.50	50p
2.5A	£12.00	50p
5A	£17.50	50p
8A	£30.35	£1.00
10A	£33.75	£1.00
12A	£36.40	£1.00
20A	£85.00	£1.50
25A	£96.00	£1.50
40A	£120.00	£1.50



**ALL PRICES EXCLUDE VAT**



**FOR MAIL ORDER**

We offer a speedy and efficient service by mail order. Remember to add 8% VAT to total value of goods including post and packing.

TO LASKYS CUSTOMER SERVICES DIVISION  
Audiotronic House, The Hyde, London NW9 6JJ Tel 01-200 1321

Please send me the following items

TOTAL PURCHASE PRICE (inc P&P and VAT)

I enclose cheque postal order money order

I wish to pay by Barclaycard/Access and my number is

# CHROMASONIC electronics

Dept. 1  
56, Fortis Green Road, London, N10 3HN.  
telephone: 01-883 3705

## RESISTORS

The standard ranges of Resistors stocked are either E12 or E24 and the values are all in multiples of ten times the decade shown below. The E12 items are only those in bold type. The E24 items are both those in bold and light type.

10	1.8	33	56
11	20	36	42
12	22	39	68
13	24	43	75
15	27	47	82
16	30	51	91

CARBON FILM  $\frac{1}{2}$  watt  $\pm 5\%$  tol. 2p ea.  
E12 Series 10 $\Omega$  to 330K $\Omega$

CARBON FILM  $\frac{1}{2}$  watt  $\pm 5\%$  tol. 13p ea.  
E24 Series 10 $\Omega$  to 10M $\Omega$

CERMET THICK FILM  $\frac{1}{2}$  watt  $\pm 2\%$  tol. 8p ea.  
E12 series 56 $\Omega$  to 150K $\Omega$

METAL OXIDE FILM  $\frac{1}{2}$  watt  $\pm 2\%$  tol. 43p ea.  
E12 series 10 $\Omega$  to 1M $\Omega$

CARBON COMPOSITION  $\frac{1}{2}$  watt 43p ea.  
2.2, 2.7, 3.3, 3.9, 4.7,  $\pm 0.5$  tol.  
5.6, 6.8, 8.2  $\pm 10\%$  tol.

CARBON COMPOSITION 1 watt 53p ea.  
2.2, 2.7, 3.3, 3.9, 4.7,  $\pm 0.5$  tol.  
5.6, 6.8, 8.2  $\pm 10\%$  tol.

CARBON FILM 1 watt  $\pm 5\%$  tol. 33p ea.  
E12 series 10 $\Omega$  to 10M $\Omega$

CARBON FILM 2 watt  $\pm 5\%$  tol. 63p ea.  
E12 series 10 $\Omega$  to 10M $\Omega$

WIRE WOUND  $2\frac{1}{2}$  watt  $\pm 5\%$  tol. 0.22 to 0.47 $\Omega$  153p  
E12 series  $\pm 10\%$   $\pm 1$  to 270 $\Omega$  13p

WIRE WOUND 5 WATT 13p ea.

$\frac{1}{2}$	25	250	1.5K
1	30	270	1.8K
1.8	39	390	2K
2.2	50	330	2.2K
2.7	60	350	2.5K
3.3	68	400	2.7K
3.9	75	470	3K
4.7	82	500	3.3K
5	100	560	3.5K
5.6	125	600	3.9K
6.8	133	680	4.7K
8.2	150	750	5K
10	180	820	5.6K
15	200	1K	6.8K
21	220	1.2K	8.2K

WIRE WOUND 10 watt 14p ea.  
All the values shown in bold in the 5 watt range.

WIRE WOUND 10 watt  $\pm 5\%$  tol. 20p ea.  
10K, 15K, 20K, 25K

WIRE WOUND 15 watt 133p ea.  
All the values from 10 $\Omega$  upward shown in bold in the 5 watt range.

## POTENTIOMETERS



5K 250K Log or Lin Less Switch (and 1K Lin) 14p  
10K 500K Log or Lin with Switch 26p  
25K 1 Meg Dual Less Switch 46p  
50K 2 Meg 1 Meg Log only 57p  
100K 10K Log + 10K Antilog Less Switch

## Sliders

10K Single 33p  
50K DUAL 55p  
100K

## Presets

Vertical or Horizontal  
.1 Watt 53p .25 Watt 7p  
100 1K 10K 100K 1Meg  
250 2.5 25K 250K 2.5 Meg  
500 5K 50K 500K 5Meg

## Cerrets

100 2.5K 25K 250K  
500 5K 50K 500K  
1K 10K 100K 1Meg  
40p

## VDR's

### Thermistors

CZ1 17p  
CZ4 16p  
CZ13A 18p  
CZ19 18p  
E298CA258 13p  
E298DA258 13p  
E298DA260 13p  
E298DA262 13p  
E298DA265 13p  
E298DP268 13p  
E298Z05 13p  
E298Z06 13p  
E299DDP336 14p  
E299DDP338 14p  
E299DDP342 14p  
E299DDP348 14p  
GL16 E1.21  
GL23 E1.21  
R53 E1.49  
R54 E1.61  
VA1005 14p  
VA1026 14p  
VA1033 14p  
VA1034 14p  
VA1039 14p  
VA1040 14p  
VA1053 14p  
VA1055 14p  
VA1056 14p  
VA1066 17p  
VA1057 19p  
VA1067 19p  
VA1077 19p  
VA1098 21p  
VA1104 31p  
VA1107 29p

## CAPACITORS



Silvered Mica 350V.  
Tol.  $\pm 0.5\%$  11p each  
2.2 pf 18pf 30pf  
3.3 pf 20pf 33pf  
5 pf 22pf 39pf  
10 pf 25pf 47pf

Tol.  $\pm 1\%$  11p each  
50pf 150pf  
50pf 82pf 180pf  
68pf 100pf 200pf  
75pf 120pf 220pf

12p each  
250pf 330pf 560pf  
270pf 390pf 680pf  
300pf 470pf 820pf

17p each  
1000 pf 1500pf 220pf  
1800pf

26p each  
2700pf 3600pf 5000pf  
4700pf

33p each  
6800pf 8200pf 10000pf

Mixed Dielectric 600 Volts Wkg.  
0.01 uF 8p, 0.1 uF 9 p  
0.022 uF 8p, 0.22 uF 17 p  
0.033 uF 8p, 0.47 uF 26 p  
0.047 uF 8p, 1 uF 36 p  
0.068 uF 9p

Mixed Dielectric 1000 Volts Wkg.  
1000 pf 63p, 0.022 uF 11p  
2200 pf 63p, 0.047 uF 13p  
3300 pf 7p, 0.1 uF 13p  
4700 pf 7p, 0.22 uF 24 p  
0.01 uF 10p, 0.47 uF 33p

Solid Tantalum Beads  
all at 163p  
0.1 uF 35v, 10 uF 6.3v  
0.22 uF 35v, 10 uF 16v  
0.47 uF 35v, 10 uF 25v  
1.0 uF 35v, 22 uF 16v  
2.2 uF 35v, 47 uF 6.3v  
4.7 uF 35v, 100 uF 3v

Feed-through Ceramics  
1000 pf 350v 6p  
Disc Ceramics 750 Volt Wkg.  
all at 53p each  
470 pf, 1000 pf, 5000 pf, 0.01 uF

Metallised Polyester Film  
0.01 uF 33p, 0.22 uF 53p  
0.015 uF 33p, 0.33 uF 7p  
0.022 uF 33p, 0.47 uF 9p  
0.033 uF 33p, 0.68 uF 12p  
0.047 uF 33p, 1.0 uF 14p  
0.068 uF 4 p, 1.5 uF 22p  
0.1 uF 4p, 2.2 uF 26p  
0.15 uF 4p

Tubular H1-K Ceramics 750 Volts Wkg.  
1000 pf 53p 3000 pf 53p  
1500 pf 53p 5000 pf 53p  
2000 pf 53p 0.01 uF 53p

Pulse Ceramics all at 10p each  
12 kv D.C. Wkg. 8kv D.C.  
10pf 120pf 200pf  
22pf 140pf  
68pf 150pf 250pf  
82pf 120pf 270pf  
100pf 200pf 300pf

## CAPACITORS

Ceramic Plate  
Mullard C333 Series 63 Volts Wkg.  
all at 53p each  
0.025pf 1.8 pf  $\pm 2\%$  12 pf  $\pm 2\%$  48 pf  
2.2 pf 15 pf 82 pf  
3.3 pf 18 pf 100 pf  
3.9 pf 22 pf 120 pf  
4.7 pf 27 pf 150 pf  
5.6 pf 33 pf 180 pf  
6.8 pf 39 pf 220 pf  
8.2 pf 47 pf 270 pf  
10 pf 56 pf 330 pf

Mullard 630 series 40 volts  $\pm 10\%$  tol.  
\* 629 series 100 volts  
all at 53p each  
390 pf 1000 pf 3300 pf  
470 pf 1200 pf 3900 pf  
560 pf 1500 pf 4700 pf  
680 pf 1800 pf \* 10 nf  
820 pf 2200 pf \* 22 nf  
2700 pf

Erie Monolithic Ceramic 30 Volts Wkg.  
27 nf 11p, 47 nf 13p, 100 nf 17p

Low Voltage Disc Ceramics  
all at 53p each  
0.01 uF 18v, 0.1 uF 30v  
0.022 uF 18v, 0.22 uF 4v  
0.047 uF 18v, 0.47 uF 3v

Mylar Film 100 Volts Wkg.  
1000 pf 23p, 0.05 uF 33p  
2000 pf 23p, 0.068uF 5p  
5000 pf 23p, 0.1 uF 5p  
0.01 uF 33p, 0.2 uF 63p  
0.02 uF 33p, 0.47 uF 7p  
0.04 uF 33p

MULLARD C295 Series 63 volts  
Tolerance  $\pm 1\%$  Polystyrene  
6,800pf (6.8nf) C295 AH/D06K8 11p  
8,200pf (8.2nf) C295 AH/D08K2 11p  
13,000pf (13nf) C295 AH/D13K 15p  
18,000pf (18nf) C295 AH/D18K 15p  
20nf (.02uF) C295 AH/D20K 15p  
30nf (.03uF) C295 AH/D30K 18p  
39nf (.039uF) C295 AH/D39K 18p  
51nf (.051uF) C295 AH/D51K 25p

Polystyrene 160 volts Wkg.  
Tolerance  $\pm 1\%$  pf up to 33pf,  $\pm 5\%$  47pf up.  
10 pf to 10,000 pf (0.01 uF) in multiples of.  
10, 15, 22, 33, 47, 68.

Wima MKS 0.22uF  $\pm 5\%$  100v 11p

Mullard C280 Series 250 Volts Wkg.  
Metallised Polyester Film  
0.01 uF 33p, 0.22 uF 53p  
0.015 uF 33p, 0.33 uF 7p  
0.022 uF 33p, 0.47 uF 9p  
0.033 uF 33p, 0.68 uF 12p  
0.047 uF 33p, 1.0 uF 14p  
0.068 uF 4 p, 1.5 uF 22p  
0.1 uF 4p, 2.2 uF 26p  
0.15 uF 4p

Mullard C281 series 400 Volts Wkg.  
Metallised Polycarbonate Film  $\pm 10\%$   
0.01 uF 5p, 0.1 uF 8p  
0.015 uF 5p, 0.15 uF 9p  
0.022 uF 5p, 0.22 uF 11p  
0.033 uF 5p, 0.33 uF 15p  
0.047 uF 6 p, 0.47 uF 16p  
0.068 uF 6 p

**VAT INCLUSIVE PRICES AT 8%** OVERSEAS CUSTOMERS DEDUCT  $\frac{2}{27}$   
VAT INVOICES ON REQUEST  
P&P On U.K. Orders 15p Overseas Orders at Cost

# CHROMASONIC electronics

Dept 1  
56, Fortis Green Road, London, N10 3HN  
telephone: 01-883 3705

## INDUCTORS

### Denco Maxi-Q Coils

Ferrite Rod Aerials



FRA1 Long & Medium Wave band (300pf) 84p  
FRA2 Long & Medium (500pf) 84p

Tuning Coils in two series:

Range	150 kHz to 400 kHz
1	515 kHz to 1.545 MHz
3	1.67 MHz to 5.3 MHz
4	5 MHz to 15 MHz
5	10.5 MHz to 31.5 MHz
6	30 MHz to 50 MHz*
7	45 MHz to 78 MHz*

\* 50 pf tuning, all others based on 300 pf.

Series A Transistor - 48p each

Only available in ranges 1 to 5 inc.

4 Coils complete each range.

Blue	Aerial Coil
Yellow	R.F. Interstage
Red	Osc. Coil for 465 kHz I.F.
White	Osc. Coil for 1.6 MHz I.F.

give range number, letter 'T' and colour.

Series B Dual Purpose Coils 48p each

For FET or Valve Circuits

All ranges available

5 Coils complete each range.

Blue	Aerial
Yellow	Interstage R.F.
Green	R.F. plus reaction
Red	Osc. Coil for 465 kHz I.F.
White	Osc. Coil for 1.6 MHz I.F.

(Note use Red instead of White for ranges 6 & 7.)

### Chokes



We stock from 1 µH to 19 mH  
Check levels & prices when ordering

## TUNING CONDENSERS

TYPE E  
3 gang 310pf  
E3.99

TYPE OO  
208 + 176 pf with screen & trimmers  
E1.48

TYPE C804  
83p  
Slow Motion Drive Ratio 6:1 Ref. 4511

TYPE O  
365 pf  
365 x 365 pf E1.07

DILECON  
100pf 69p  
300pf 69p  
500pf 69p

### I.F. Transformers

IFT 13	465 kHz 1st & 2nd d/tuned	65p
IFT 14	465 kHz Final single tuned	65p
IFT 15	10.7 MHz d/tuned	65p
IFT 16	1.6 MHz 1st & 2nd d/tuned	65p
IFT 17	1.6 MHz Final d/tuned	65p
IFT 18	465 kHz or 1.6 MHz d/tuned	75p

## VEROBOARD

	COPPERCLAD	PLAIN	EXTRA
	0.1" 0.15"	0.15"	P&P
2 1/2" x 1"	7p	7p	-
2 1/2" x 3 1/2"	24p	21p	-
2 1/2" x 5"	30p	25p	13p
3 1/2" x 3 1/2"	30p	25p	-
3 1/2" x 5"	34p	34p	25p
1 7/8" x 2 1/8"	90p	69p	45p
1 7/8" x 3 1/8"	E1.21	75p	57p
1 7/8" x 5"	-	99p	10p

D.1 P. Breadboard 4.15" x 6.15" E1.40  
VEROSTRIP (State 1" or 1.5") 30p  
Pin Insertion Tool (State 1" or 1.5") 65p  
Spot Face Cutter 51p  
Terminal Pins in Pkts. of 50 (State 1" or 1.5") 22p

Details of I.C.'s, Rectifiers, Diodes, Bridges, Passive Components; LED's, Clocks, Triacs etc. can be seen on other pages and/or issues of Wireless World; Practical Wireless; and Practical Electronics.

## Electrolytics

UF	4V	6.3V	10V	16V	25V	40V	63V	100V	160V	450V
1							63p		83p	15p
1.5							63p			
2							63p		83p	
2.2							63p			
3							63p			
3.3							63p			
4							63p			
4.7							63p			
6.8							63p	83p		
8										21p
10										
15										24p (16uF)
22										
33										33p (32uF)
47	63p	63p	63p	63p	63p	63p	83p			8p
68										11p
100	63p	63p	59p	63p	63p	83p	14p	25p		
150										11p
220	63p	59p	8p	11p	14p	19p	31p			
330	63p	3p	11p				25p	44p		
470		8p	11p	14p	20p	26p	47p	59p		
680		10p		14p	20p	25p	44p	79p		
1000	13p		14p	19p	22p	25p	44p	79p		
1500		19p	19p	25p						
2200		18p	24p							
3300		26p								
4700		25p		44p	68p	79p	149p	25p		
6800				75p						

## DIODES

AA119	10p	BY103	22p	0A91	8p
AA120	10p	BY105	16p	0A200	11p
AA129	10p	BY126	16p	0A270	10p
BA100	10p	BY127	16p	Z5120	8p
BA102	27p	BY133	23p	Z5140	25p
BA110	44p	BY164	54p	Z5141	42p
BA115	19p	BY176	E1.62	Z5142	32p
BA144	25p	BY182	E1.62	Z5170	10p
BA145	22p	BY250	25p	Z5270	11p
BA148	22p	BZX70	27p	Z5271	14p
BA154	20p	Series		Z5278	36p
BA155	15p	BZY88	11p	IN914	8p
BA156	16p	Series		IN916	10p
BAX16	10p	0A47	11p	IN4009	7p
BB104	45p	0A79	10p	IN4148	5p
BB105B	41p	0A81	8p	IN4448	9p
BY100	16p	0A85	10p	I2S Series	18p
		0A90	8p		

## TRANSISTORS

AC107	16p	BC213L	13p	D13V	52p	ZTX301	13p	ZN3707	12p
AC126	13p	BC214L	13p	D40N3	59p	ZTX302	17p	ZN3708	10p
AC127	13p	BC268	13p	MJ480	93p	ZTX303	14p	ZN3709	10p
AC128	15p	BC407	16p	MJ481	E1.18	ZTX304	21p	ZN3710	11p
AC174	15p	BCY70	17p	MJ490	E1.93	ZTX310	10.1p	ZN3711	11p
AC187	22p	BCY71	17p	MJ491	E1.42	ZTX312	10p	ZN3722	E2.00
AC187K	20p	BCY72	17p	MJ500	E1.42	ZTX341	22p	ZN3791	E2.55
AC188	22p	BD115	73p	MJ100	E1.22	ZTX384	18p	ZN3819	27p
AC188K	25p	BD123	89p	MJ2955	E1.88	ZTX500	12p	ZN3821	81p
ACY17	39p	BD124	80p	MJ3055	E1.21	ZTX501	13p	ZN3823	9p
ACY17	38p	BD131	44p	MJ4000	E1.46	ZTX502	17p	ZN3903	15p
ACY20	74p	BD132	59p	MJ4010	E1.93	ZTX503	14p	ZN3904	15p
AD140	48p	BD131/2PR	E1.17	MJ340	45p	ZTX504	42p	ZN3905	22p
AD149	48p	BD135	41p	MJ350	97p	ZTX531	22p	ZN3906	25p
AD161	37p	BD136	43p	MJ2955	E1.20	ZTX550	17p	ZN4056	13p
AD162	38p	BD201	E1.95	MJ3055	72p	ZN697	16p	ZN4059	19p
AD161/62MP	74p	BD202	E1.46	MPF102	27p	2N706	13p	ZN4062	16p
AF114	17p	BF109	74p	MPF103	40p	2N708	16p	ZN4289	19p
AF115	17p	BF120	25p	MPF104	44p	2N714	24p	ZN4441	85p
AF116	17p	BF160	25p	MPF105	44p	2N930	22p	ZN4442	E1.04
AF117	17p	BF167	24p	MPF106	49p	2N1302	20p	ZN4443	E1.42
AF118	54p	BF173	24p	MPF111	22p	2N1303	24p	ZN4444	E2.04
AF124	32p	BF178	28p	MP5U06	63p	2N1304	24p	ZN4871	59p
AF139	34p	BF179	32p	MP5U56	77p	2N1305	24p	ZN4901	E1.13
AF172	25p	BF180	32p	OC28	49p	2N1306	24p	ZN5067	E1.07
AF179	40p	BF181	32p	OC35	45p	2N1307	27p	ZN5129	16p
ASV26	42p	BF184	32p	OC36	49p	2N1308	34p	ZN5172	11p
BC107	11p	BF185	27p	OC44	14p	2N1309	34p	ZN5191	77p
BC108	11p	BF194	15p	OC45	14p	2N1718	26p	ZN5194	91p
BC109	12p	BF195	17p	OC71	14p	2N1718	E4.37	ZN5295	52p
BC117	22p	BF196	10p	OC72	14p	2N1893	52p	ZN5447	10p
BC147	10p	BF197	10p	OC75	15p	2N1218	22p	ZN5449	16p
BC148	10p	BF200	31p	OC76	27p	2N1219	39p	ZN5457	46p
BC149	10p	BF244B	10p	OC81	14p	2N1246	54p	ZN5504	65p
BC157	13p	BF262	25p	OC83	25p	2N2894	97p	ZN5459	43p
BC158	12p	BF263	25p	OC170	27p	2N2904	32p	ZN5485	52p
BC159	14p	BF272	E1.19	OC171	32p	2N2905	30p	ZN5777	48p
BC167	17p	BF292	E1.54	OC771	E1.54	2N2924	16p	ZN6008	44p
BC168B	11p	BF597	23p	OMP12	65p	2N2925	18p	ZN6069	51p
CC169	12p	BF598	25p	TPP29	53p	2N2926	10p	ZN6070	57p
BC171	20p	BFW10	65p	TPP31	67p	2N3012	65p	ZN6401	65p
BC172	10p	BFX29	41p	TPP31A	67p	2N3054	50p	ZN6073	67p
BC177	22p	BFX88	26p	TPP32A	79p	2N3055	51p	ZN6075	E1.46
BC178	22p	BFY50	22p	TPP41A	79p	2N3375	E3.56	ZN6076	16p
BC179	24p	BFY51	22p	TPP42A	97p	2N3442	E1.19	ZN6111	54p
BC182L	11p	BFY90	E1.09	TS43	36p	ZN3566	18p	ZN6288	60p
BC183L	12p	BF100	42p	TS68A	39p	2N3638	20p	ZN6140	99p
BC184	12p	BFY39	43p	TS69	32p	2N3702	13p	ZN6401	65p
BC187	27p	BSX20	18p	ZTX107	10p	2N3703	12p	ZN153	87p
BC204	14p	BSX21	22p	ZTX108	10p	2N3704	13p	40321	54p
BC209	14p	BSY95A	14p	ZTX109	15p	2N3705	12p	40430	E1.39
BC212L	12p	BU105/02	E1.95	ZTX300	12p	2N3706	14p	40673	55p

## REGULATORS

# TRANSFORMERS

## SAFETY MAINS ISOLATING TRANSFORMERS

Pr. 120/240 V Sec. 120/240 V Centre Tapped and Screened

Ref. No.	VA (Watts)	Weight lb oz	Size cm.	Auto Taps	P & P
07	20	1 8	7.0 x 6.0 x 4.0	2.55	38
149	60	3 12	9.9 x 7.7 x 8.6	3.98	45
150	100	5 8	9.9 x 8.9 x 8.6	4.45	45
151	200	8 0	12.1 x 9.3 x 10.2	7.39	53
152	250	13 12	12.1 x 11.8 x 10.2	8.93	73
153	350	15 0	14.0 x 10.8 x 11.8	10.80	73
154	500	19 8	14.0 x 13.4 x 11.8	12.41	91
155	750	29 0	17.2 x 14.0 x 14.0	18.65	91
156	1000	38 0	17.2 x 16.6 x 14.0	26.50	*
157	1500	46 0	21.6 x 13.4 x 18.1	30.23	*
158	2000	60 0	21.6 x 15.3 x 18.1	33.70	*

## AUTO TRANSFORMERS

Ref. No.	VA (Watts)	Weight lb oz	Size cm.	Auto Taps	P & P	
113	20	1 8	5.8 x 5.1 x 4.5	0-15-210-240	1.42	30
64	75	2 4	7.4 x 6.7 x 6.1	0-15-210-240	2.64	38
4	150	3 4	8.9 x 7.7 x 7.7	0-15-200-220-240	3.75	45
66	300	6 4	9.9 x 9.6 x 8.6	"	5.29	53
67	500	12 8	12.1 x 11.2 x 10.2	"	8.02	67
84	1000	18 8	14.0 x 13.4 x 14.3	"	12.44	91
18	1500	24 4	14.0 x 15.9 x 14.3	"	16.65	*
95	2000	32 0	17.2 x 16.6 x 14.0	"	22.00	*
73	3000	40 0	21.6 x 13.4 x 18.1	"	31.90	*

## CASED AUTO TRANSFORMERS

115V mains lead input and U.S.A. 2-pin outlets. 20VA £2.85 pp 38p  
500VA £9.50 pp 80p 1000VA £15.92 via B.R.S.

## TRANSFORMERS

### PRIMARY 240-250 VOLTS 12 AND OR 24 VOLT RANGE

Ref. No.	Amps.	Weight lb oz	Size cm.	Secondary Windings	P & P	
111	0.5	0.25	4.8 x 2.9 x 3.5	0-12V at 0.25A x2	1.34	23
213	1.0	0.5	4.8 x 3.5 x 4.8	0-12V at 0.5A x2	1.58	30
71	2	1	6.1 x 6.4 x 6.1	0-12V at 1A x2	2.09	38
18	4	2	8.3 x 7.7 x 7.7	0-12V at 2A x2	2.60	38
70	6	3	8.9 x 8.0 x 7.0	0-12V at 3A x2	3.75	45
108	8	4	9.9 x 8.9 x 8.6	0-12V at 4A x2	4.15	45
72	10	5	9.9 x 9.6 x 8.6	0-12V at 5A x2	4.67	53
116	12	6	12.1 x 10.2 x 8.6	0-12V at 5A x2	5.02	63
17	16	8	12.1 x 9.9 x 10.2	0-12V at 8A x2	6.62	60
115	20	11	14.0 x 9.6 x 11.8	0-12V at 10A x2	9.45	73
187	30	15	15.8 x 12.1 x 11.8	0-12V at 15A x2	12.29	85
226	60	30	17.2 x 15.3 x 14.0	0-12V at 30A x2	15.30	*

### 30 VOLT RANGE

Ref. No.	Amps.	Weight lb oz	Size cm.	Secondary Taps	P & P	
112	0.5	1 4	6.1 x 5.8 x 4.8	0-12-15-20-24-30V	1.65	30
79	1.0	2 4	7.0 x 6.7 x 6.1	"	2.18	38
3	2.0	3 4	8.9 x 7.7 x 7.7	"	3.18	38
20	3.0	4 8	9.9 x 8.3 x 8.6	"	4.12	45
21	4.0	6 4	9.9 x 9.6 x 8.6	"	4.67	53
51	5.0	6 12	12.1 x 8.6 x 10.2	"	5.83	53
117	6.0	8 0	12.1 x 9.2 x 10.2	"	6.52	60
88	8.0	12 0	12.1 x 11.8 x 10.2	"	9.00	67
89	10.0	13 12	14.0 x 10.2 x 11.8	"	9.97	73

### 50 VOLT RANGE

Ref. No.	Amps.	Weight lb oz	Size cm.	Secondary Taps	P & P	
102	0.5	1 12	7.0 x 6.4 x 6.1	0-19-25-33-40-50V	2.35	30
103	1.0	2 12	8.3 x 7.4 x 7.0	"	3.08	38
104	2.0	5 8	8.9 x 8.9 x 8.6	"	4.26	45
105	3.0	6 12	9.9 x 10.2 x 8.6	"	5.28	53
106	4.0	10 0	12.1 x 10.5 x 10.2	"	6.91	67
107	6.0	12 0	14.0 x 10.2 x 11.8	"	11.00	67
118	8.0	18 0	14.0 x 12.7 x 11.8	"	11.80	85
119	10.0	25 0	17.2 x 12.7 x 14.0	"	15.45	*

### 60 VOLT RANGE

Ref. No.	Amps.	Weight lb oz	Size cm.	Secondary Taps	P & P	
124	0.5	2 4	7.0 x 6.7 x 6.1	0-24-30-40-48-60	2.12	38
126	1.0	3 4	8.9 x 7.7 x 7.7	"	3.10	38
127	2.0	6 4	9.9 x 9.6 x 8.6	"	4.62	45
125	3.0	8 12	12.1 x 9.9 x 10.2	"	6.84	60
123	4.0	13 12	12.1 x 11.8 x 10.2	"	7.96	67
40	5.0	12 00	14.0 x 10.2 x 11.8	"	8.87	73
120	6.0	15 8	14.0 x 12.1 x 11.8	"	10.27	85
121	8.0	25 00	14.0 x 14.7 x 11.8	"	13.64	*
122	10.0	25 0	17.2 x 13.7 x 14.0	"	15.93	*
189	12.0	29 00	17.2 x 14.0 x 14.0	"	18.16	*

### MINIATURE TRANSFORMERS WITH SCREENS P & P

Ref. No.	MA	Weight lb oz	Size cm.	VOLTS	P & P	
238	200	2	2.8x2.6x2.0	3-0-3	1.40	10
212	1A 1A	1	4.6x1.5x8x4.8	0-6-0-6	1.67	30
13	100	1	4.3x2.6x2.9	9-0-9	1.28	13
235	330 330	4	4.8x2.9x3.5	0.9-0.9	1.42	19
207	500 500	1	6.1x5.4x4.8	0-8.9-0-8.9	1.75	30
308	1A 1A	1	12.7x0.6x4x6.1	0-8-0-8-9	3.00	38
339	200 200	4	4.8x2.9x3.5	0.15-0.15	1.30	19
214	300 300	1	4.6x1.5x8x4.8	0-20-0-20	1.76	30
221	700 (D.C.)	1	8.7x0.6x1x6.1	20-12-0-12-20	1.98	38
206	1A 1A	2	12.8x3.7x7.0	0.15-20-0.15-20	3.15	38
203	500 500	2	4.8x3.7x7.0	0.15-27-0.15-27	2.73	38
204	1A 1A	3	4.8x9.7x7.7	0.15-27-0.15-27	3.50	38

PLEASE ADD 8% FOR V.A.T. INCLUDING P. & P.

## BARRIE electronics

3, THE MINORIES, LONDON EC3N 1BJ

TELEPHONE: 01-488 3316/8

NEAREST TUBE STATIONS: ALDGATE & LIVERPOOL ST.

## VALVE BARGAINS

Any 5 50p, 10 75p, 50 £3.30, 100 £6.40. Your choice from the following list:

ECC82, ECL80, EB91, EF80, EF183, EF184, PC86, PC88, PC97, PC900, PCC84, PCC89, PCC189, PCF80, PCF802, PCF805, PCL82, PCL84, PCL85, PCL805, PCL86, PF1200, PL36, PL504, PY581, PY81, PY800, PY881, EH90, 30EL1, 30FL2, 30PL14.

Colour Valves 25p each  
PL508, PL509, PY500/A

Press 4 Button UHF Tuners £2.50.

## AERIAL BOOSTERS

We make three types of Aerial Boosters all for set top fitting, with Co-ax Plugs and Sockets.

B11—For Stereo and Standard VHF Radio

B12—For the older VHF Television, please state BBC1 and ITV Channels.

B45—For mon. or colour this covers the complete UHF band.

All Boosters are complete with Battery and take only minutes to fit.

Price £3.40 each

## BARGAIN PACKS

All Components in the Bargain Packs are unused and marked.

Pack 1—Polyester (C280) Axial Leads Capacitors—250V/W & 400V/W, very good mixed selection from 0.01 UF to 2.2 UF. Price 100 £1, 1000 £8 (our choice).

Pack 2—Electrolytic Capacitors—complete mix selection from 1 UF to 1000 UF, and from 10V/W to 63V/W. Price 100 £1.50, 500 £6 (our choice).

Pack 3—Transistors—any 10 80p, any 100 £7 (your choice). AC128 - AC176 - BC113 - BC115 - BC135 - BC153 - BC171 - BC172.

Pack 4—15 Mixed Plugs, mixed selection of co-ax, din2-3-5 pins, jack standard—3.5mm-2.5mm. Price £1.

Prices include V.A.T. P. & P. under £1/10p, £1 to £3/15p, above £3/20p. Overseas at cost. Money back guarantee on all orders.

ELECTRONIC MAILORDER LTD., 62 BRIDGE ST., RAMSBOTTOM, BURY, LANCS. Tel. Rams. 3036.

# Train for television

Course commences Autumn 1975

This is your opportunity to train as a television and radio engineer on our full-time Two-Year College Diploma Course specially designed to cover the examinations of the City and Guilds Radio, Television and Electronics Technicians' Certificate. Full theoretical and practical instruction on all types of modern receivers—including the latest colour sets.

Minimum entrance requirements are Senior Cambridge or 'O' Level, or equivalent in Mathematics and English.

Please send free prospectus to:

Name \_\_\_\_\_

Address \_\_\_\_\_  
 \_\_\_\_\_  
 \_\_\_\_\_

THE PEMBRIDGE COLLEGE OF ELECTRONICS

(Dept. PW1) 34a Hereford Rd., London W2 5AJ

# SAXON

Money saving high performance audio equipment DIRECT FROM OUR OWN FACTORIES.

## GUARANTEED TESTED HIGH PERFORMANCE MODULES—now better value than ever

- |   |                                |   |
|---|--------------------------------|---|
| <b>SA35</b><br>35W RMS 25-50V<br>7 transistors, 7 diodes    | <b>£5-45</b><br>Carriage free  | ★ 25Hz-25kHz<br>★ 0.2% distortion<br>★ Noise-80dB<br>★ 500mV into 20K<br>★ 4-16 ohms<br>★ Simple wiring<br>★ Short and open circuit proof<br>★ Continuously rated<br>★ Top-grade components |
| <b>SA50</b><br>50W RMS 25-65V<br>7 transistors, 7 diodes    | <b>£6-90</b><br>Carriage free  |   |
| <b>SA100</b><br>100W RMS 45-70V<br>10 transistors, 7 diodes | <b>£12-50</b><br>Carriage free |   |



THE SA100 MODULE

## POWER SUPPLIES

### UNSTABILISED—READY WIRED

- |                   |                                 |              |               |
|-------------------|---------------------------------|--------------|---------------|
| <b>PU45</b>       | Suits 2 SA35 or 1 SA50 (4 ohm)  | <b>£5-45</b> | Carriage 30p  |
| <b>PU70</b>       | Suits 2 SA50 (8 ohm) or 2 SA100 | <b>£8-45</b> | Carriage 40p  |
| <b>STABILISED</b> |                                 |              |               |
| <b>PS45</b>       | Suits 2 SA35 or 2 SA50 (4 ohm)  | <b>£4-45</b> | Carriage free |
| <b>MT45</b>       | Transformer for above           | <b>£3-50</b> | Carriage 30p  |
| <b>PS70</b>       | Suits 2 SA100                   | <b>£5-45</b> | Carriage free |
| <b>MT70</b>       | Transformer for above           | <b>£4-90</b> | Carriage 40p  |

N.B. PS70 is not suitable for the SA50

120 watt module complete with built-in supply—extra heavy duty **£22-50** Carr. 60p

## Mk II STEREO DISCO MIXER £22-50

This well tried unit mixes two decks, handles any ceramic cartridge, and features mic over-ride plus separate full range bass and treble controls on both mic and deck inputs. Ample headphone power is available for P.F.L. May be used for mono and is mains operated. Fitted with sturdy screening case. Controls: Mic vol, base, treble. Left/Right fade, deck volume, bass, treble, h/phone select, vol, Mains. Size 17½in x 3in x 4in deep.

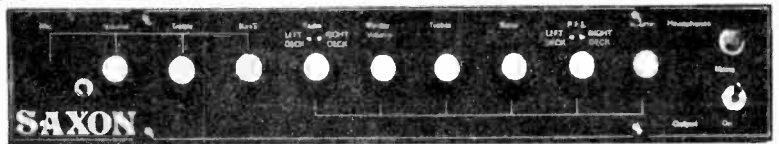

## DISCO MODULE £9-50

Thousands sold of this extremely popular mono version. A mic input may be fitted using the VA30 (see below). Low consumption from a 9V battery. Features the same high standards of reproduction as the Stereo version. Controls: H/phone select, vol, Left deck vol, Right deck vol, bass, treble, master vol. Size 12½in x 3in x 2in deep.



## 3-CHANNEL SOUND-LITE £22-50

Only SAXON can supply such incredible value for money. This unit features 3kW power handling, full-wave control, bass, middle, treble AND master controls. Twin loudspeakers for "through" connections. It may be used free standing or will panel mount next to either of the above. Also features unique CUT-BACK circuitry for extra wide range response. Size 12in x 3in x 2½in deep. Professional standards at a price you can afford!



**SINGLE CHANNEL VERSION £7-50** Carr. free  
Recently reduced in price due to increasing sales, handles 1kW. Full wave operation.

ADD 8% VAT TO ALL ORDERS

## MULTI-PURPOSE MIXERS

**M4HL £19-50** Carr. 50p  
**M6HL £29-50** Carr. 50p  
Featuring multiples of our VA30 module, the M4HL and M6HL fulfil the requirements of all clubs, groups, etc. where a high quality mixer is required. Each channel has one high and one low impedance input, plus volume, treble and bass controls. Input impedances may, if required, be easily changed. The M4HL has four channels, and one output, and the M6HL six channels (12 inputs) and a master control and two outputs. Either unit may be used free-standing or panel mounted. These mixers will feed all types of amplifier. Recommended for their versatility and high performance, and excellent value for money.

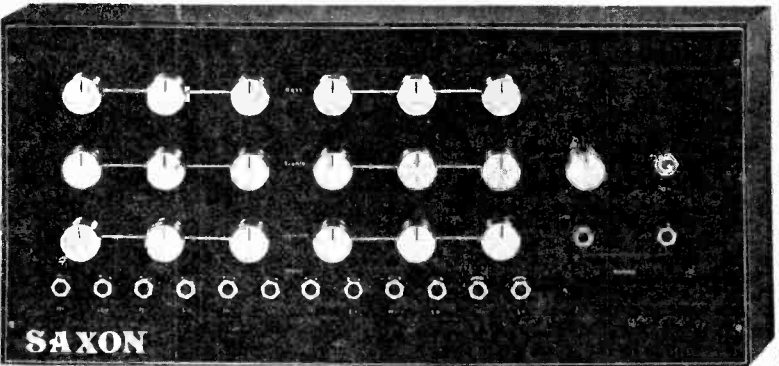

**VA30 CHANNEL MODULE £3-50** Carr. free  
This is the basic channel module in the above mixers and may also be used for extra inputs on either the mono or stereo mixers. Fitted with volume, bass and treble controls, requires just a jack and supply (9-100V)

## SAXON CSE 100

### COMPLETE AMPLIFIER

**£39-90**  
Carr. free

100W of speech and music—Two separately controlled inputs. Wide range bass and treble controls. Sturdy and attractive vinyl case. Twin outputs. Ideal for groups, discos, etc. Fully tested and guaranteed. 50W version identical in appearance.



**CSE50 £29-50** Carr. free

## NEW !!

### SAXON MULTIMIX 100 £57-00

100W rms four inputs slider controls plus master slider. Wide range bass and treble controls. Fantastic value, ideal for complete disco's, groups, clubs etc. SAXON MULTIMIX 50—Exactly as above but 50W rms. £45-00

CALLERS AND MAIL ORDER  
**SAXON ENTERTAINMENTS LIMITED**  
327-333 WHITEHORSE ROAD CROYDON CR0 2HS

(Please quote magazine when ordering)  
SHOP HOURS: 9 a.m.-5 p.m. — LUNCH 12.30-1.30 p.m. MAIL ORDER DESK: 10 a.m.-3 p.m.  
24-HOUR ANSWER SERVICE. TEL. 01-684 6385. TECHNICAL ENQUIRIES: 01-684 0098.

SEND 10p FOR OUR 26 PAGE MANUAL—full circuits & details.  
TERMS OF BUSINESS: C.W.O. C.O.D. or ACCESS (just send in card number). Send 50p for C.O.D.  
Please send S.A.E. with all enquiries.  
VAT @ 8% must be added to all orders including carr. charges.

# R T V C

# FOR AUDIO AT A BUDGET

## COMPLETE STEREO SYSTEM **System 1. £51-00**

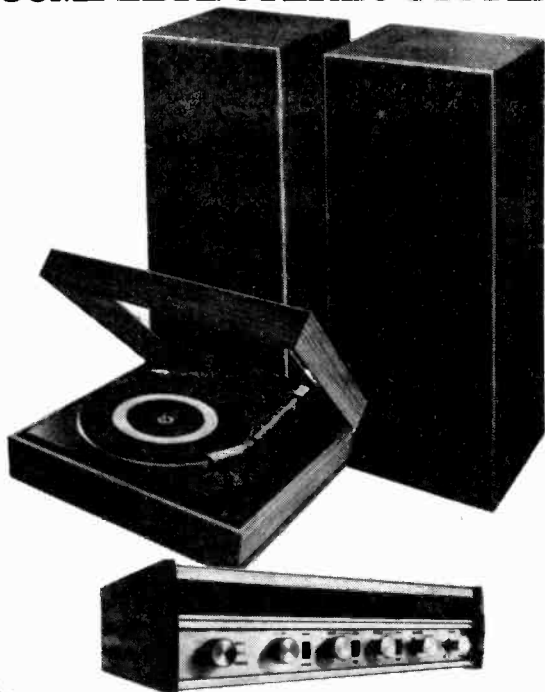

**40 Watt Amplifier**, Viscount III - R102 now 20 watts per channel.

**System 1 includes:**  
 \* **Viscount III amplifier** - volume, bass, treble and balance controls, plus switches for mono/stereo on/off function and bass and treble filters. Plus headphone socket.  
**Specification**  
 20 watts per channel into 8 ohms. Total distortion @ 10W @ 1kHz 0.1%, *P.U.1* (for ceramic cartridges) 150mV into 3 Meg. *P.U.2* (for magnetic cartridges) 4mV @ 1kHz into 47K. Equalised within  $\pm 1$ dB R.I.A.A. *Radio* 150mV into 220K. (Sensitivities given at full power). Tape out facilities: headphone socket, power out 250mW per channel. *Tone controls and filter characteristics:* Bass: +12dB to -17dB @ 60Hz. Bass filter: 6dB per octave cut. Treble control: treble +12dB to -12dB @ 15kHz. Treble filter: 12dB per octave. *Signal to noise ratio:* (all controls at max.) -58dB. Crosstalk better than 35dB on all inputs. Overload characteristics better than 26dB on all inputs. Size approx. 13 $\frac{1}{2}$ " x 9" x 3 $\frac{1}{2}$ ".  
**Garrard SP 25 Mk III deck** with magnetic cartridge, de luxe plinth and hinged cover.  
**Two Duo Type II matched speakers** - Enclosure size approx. 17 $\frac{1}{2}$ " x 10 $\frac{1}{2}$ " x 6" in simulated teak. Drive unit 13" x 8" with parasitic tweeter. 10 watts handling.

**Complete System £51-00**

## **System 2. £69-00**

Viscount III amplifier (As System 1)  
 Garrard SP 25 Mk III deck (As System 1)  
**Two Duo Type III matched speakers** - Enclosure size approx. 127" x 13" x 11 $\frac{1}{2}$ "  
 Finished in teak veneer. Drive units 13" x 8" bass driver, and two 3" (approx.) tweeters. 20 watts R.M.S., 8 ohms frequency range - 20 Hz to 18,000 Hz.

**Complete System £69-00**

### PRICES: SYSTEM 1

Viscount III R102 amplifier	£24.20 + £1 p & p
2 Duo Type II speakers	£14.00 + £2.20 p & p
Garrard SP 25 with Mag. cartridge de luxe plinth and hinged cover	£21.00 + £1.75 p & p
<b>total:</b>	<b>£59.20</b>

Available complete for only: **£51-00**  
 + £3.50 p & p

### PRICES: SYSTEM 2

Viscount III R102 amplifier	£24.20 + £1 p & p
2 Duo Type III speakers	£39.00 + £4.00 p & p
Garrard SP 25 with Mag. cartridge de luxe plinth and hinged cover	£21.00 + £1.75 p & p
<b>total:</b>	<b>£84.20</b>

Available complete for only: **£69-00**  
 + £4.00 p & p



## STEREO **21**\* QUALITY SOUND FOR LESS THAN **£20-00**

Stereo 21, easy to assemble audio system kit. No soldering required. The unit is finished in white P.V.C. and the acrylic top presents an unusually interesting variation on the modern deck plinth.

Includes: - **BSR 3 speed deck**, automatic, manual facilities together with stereo cartridge.  
**Two speakers** with cabinets.  
**Amplifier module**, ready built with control panel, speaker leads and full, easy to follow assembly instructions.

**Specifications:** For the technically minded: -  
 Input sensitivity 600mV. Aux. input sensitivity 120mV. Power output 2.7 watts per channel. Output impedance 8-15 ohms. Stereo headphone socket with automatic speaker cutout. Provision for auxiliary inputs - radio, tape, etc., and outputs for taping discs. **Overall Dimensions.** Speakers approx. 15 $\frac{1}{2}$ " x 8" x 4". Complete deck and cover in closed position approx. 15 $\frac{1}{2}$ " x 12" x 6".

**Complete only £19.55 + £1.60 p & p.** Extras if required. Optional Diamond Styli **£1.37**.  
 Specially selected pair of stereo headphones with individual level controls and padded earpieces to give optimum performance. **£3.85**.

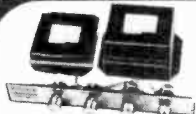

## **BUILD YOUR OWN\*** STEREO AMPLIFIER

For the man who wants to design his own stereo - here's your chance to start, with Unisound - pre-amp, power amplifier and control panel. No soldering - just simply screw together. 4 watts per channel into 8 ohms. Inputs: 120mV (for ceramic cartridge). The heart of Unisound is high efficiency I.C. monolithic power chips which ensure very low distortion over the audio spectrum. 240V. AC only. **£7-64 + 55p. p & p**

## **8 TRACK HOME CARTRIDGE PLAYER\***



Elegant self selector push button player for use with your stereo system. Compatible with Viscount III system. Unisound module and the Stereo 21. Technical specification Mains input, 240V, Output sensitivity 125mV. Comparable unit sold elsewhere at £24.00 approx. Yours for only **£11.95 + 90p p & p.**

# PUSH BUTTON CAR RADIO KIT \* The Tourist II

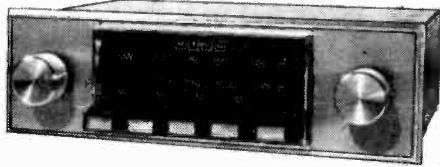

**NO SOLDERING REQUIRED!**

**NOW BUILD YOUR OWN PUSH BUTTON CAR RADIO**  
Easy to assemble construction kit comprising fully completed and tested printed circuit board on which no soldering is required. All connections are simple push fit type making for easy assembly. Fine tuning push button mechanism is fully built and tested to mate with printed circuit board.

Technical specification: (1) **Output** 4 watts R.M.S. output. For 12 volt operation on negative or positive earth. (2) **Integrated circuit output stage, pre-built three stage IF Module.** **Controls** volume manual tuning and five push buttons for station selection, illuminated tuning scale covering full, medium and long wave bands.

Size chassis 7" wide, 2" high and 4 3/4" deep approx **£7.70** +55p p & p

**Speaker** including baffle and fixing strip **£1.65+23p. p & p.**

**Car Aerial** Recommended — fully retractable **£1.37+20p. p & p**

**The Tourist I Kit** For the experienced constructor if you can solder on a printed circuit board you can build this model.

Same technical specification as Tourist II **Price £6.60 + 55p p & p.**

## EMI SPEAKERS AT FANTASTIC REDUCTIONS

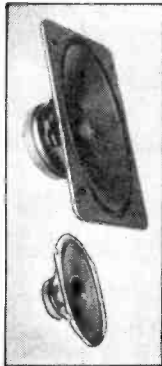

### 20 WATT SPEAKER SYSTEM \*

System consists of a 13" x 8" (approx) elliptical woofer unit with a 8" x 5" (approx.) mid range unit incorporating parasitic tweeter and crossover components. Circuit Diagram

#### Technical Specification:

##### Bass Unit

Flux density—100 K, speech coil—1 1/2", Cone, Triple laminated paper with P.V.C. surround.

Mid Range Unit  
Flux density—33K, speech coil—1" with parasitic tweeter.

Power Handling  
20 watts R.M.S., impedance—8 ohms, frequency response—20 Hz to 18,000 Hz.

**OUR PRICE  
£6.60. Complete**  
+ 90p p & p.

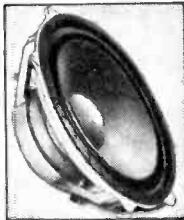

### 15" 14A/780 BASS UNIT

Bass unit on a rigid diecast chassis Superior cone material handles up to 50 watts RMS, and is treated to give a smooth frequency response. Resonance 30 Hz. Flux density 360,000 Maxwells. Impedance at 1 kHz is 8 ohms. 3" voice coil.

Recommended retail price **£40.80.**

**OUR PRICE £18.70**

+ £1.50 p & p

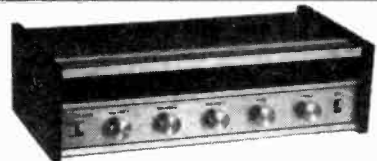

## DISCO AMPLIFIER\*

Reliant Mk IV Mono Amplifier, ideal for the small disco or house parties. **Outputs** 20 watts R.M.S. into 8 ohms (suitable for 15 ohms).

**Inputs** \*4 electrically mixed inputs. \*3 individual mixing controls.

\*Separate bass and treble controls common to all 4 inputs.

\*Mixer employing F.E.T. (Field Effect Transistors) \*Solid State circuitry.

\*Attractive styling.

**INPUT SENSITIVITIES** —Input - 1.) Crystal mic. guitar or moving coil mic, 2 and 10mV. (Selector switch for desired sensitivity).

—Inputs - 2), 3), 4). Medium output equipment — ceramic cartridge, tuner, tape recorder, organs, etc. — all 250mV sensitivity. AC Mains, 240V operation. Size approx: 12 1/2" x 6" x 3 1/2". **£15.00 + 60p. p & p**

## PORTABLE DISCO CONSOLE\*

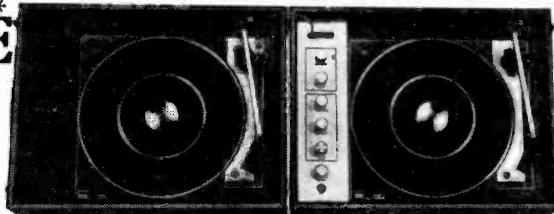

**INCORPORATES:** Pre-Amp with full mixing facilities, including switched input for mic with volume control, switched input for auxiliary with volume control, bass and treble controls, volume control and blend control for turntables.

Two B.S.R. single play professional series decks, fitted with crystal cartridges.

The turntables are designed and precision engineered. They combine clean modern styling with superb reproduction. Their many special features include square section aluminium tonearms, (high precision low mass design fully counterbalanced, with calibrated stylus pressure control for perfect tracking), and conveniently grouped easy to read linear controls. The turntables have viscous cueing devices which allows the tonearms to be placed or lifted at any point on the record.

The two lightweight cartridge shells have slide-in-holders to facilitate easy inspection of needles and cartridges.

### TECHNICAL SPECIFICATION:

**Pre-amp** — Output — 200mV.

**Auxiliary inputs** — 200mV and 750mV into 1 meg.

**Mic input** — 6mV into 100K. 240 volt operation.

**Turntables capacity** — 7", 10" or 12" records.

**Rumble, wow and flutter** —

Rumble Better than —35dB. Wow Better than 0.2%.

Flutter Better than 0.06% (Gaugmont kaloe meter).

**Finish** — Satin black mainplate with black turntable mat inlaid with brushed aluminium trim. Tonearm and controls in black and brushed aluminium.

**Console size** —

Unit Closed — 17 1/2" x 13 1/2" x 8 1/2" (approx.)

Unit Open — 35 1/2" x 13 1/2" x 4 1/2" (approx.)

This disco console is ideally matched for the Reliant IV and Disco 50 or any other quality amplifier.

The unit is finished in black PVC with contrasting simulated teak edging diamond spun control knobs with matching control panel.

**Yours for only £45.00 + £3.50 P. & P.**



**DO NOT SEND CARD**

Just write your order giving your credit card number

Mail orders to Acton. Terms C.W.O. All enquiries stamped addressed envelope. Goods not despatched outside U.K. Leaflets available for all items listed thus \* Send stamped addressed envelope. All items subject to availability. Prices correct at 1st Jan. 1975 and subject to change without notice. All prices include V.A.T. at 8% rate.

**Personal Shoppers 9a.m.-5.30p.m. Half day Thurs. 9.30a.m.-5p.m. Closed all day Wed.**



Radio and TV  
Components  
(Acton) Ltd.

21c High Street, Acton, London W3 6NG  
323 Edgware Road, London W2

**SPOT FREQ OSC UNITS** suitable for testing A.F. Amps etc., these give a low distortion Sine Wave O/P of 1 volt RMS into 1K, with Thermistor stabiliser, reqs supply of 9 to 12v DC, contained in Ali case  $4\frac{1}{2} \times 1\frac{1}{2} \times 1\frac{1}{2}$ " fitted standard coax sk plug supplied, available in the following freqs 100, 500c/s, 1, 2, 5, 10, 20, 50 & 100Kc. Price £4 other freqs in this range 25p extra. See Feb. P.W. for Sq Wave Osc units.

**INDICATOR UNIT 266** contains 6" VCR97 tube, 18 valves, slow motion dial, tuning conds etc in case 11 x 9 x 18" with cover £7-50.

**BLOWER MOTORS.** Small double ended blower for use on 6 to 28v DC new boxed £2-55.

**AERIAL LOOP CONTROLLER** were used for R1155 loops consists of handwheel & 360' Indicator new £2.

**ELECTRONIC MULTIMETERS** AV0 type CT38 bench unit for 200/250v 50c/s covers AC/DC volts, AC/DC Amps, Res, Watts, with copy of H/B tested £24.

**DUAL GANG POTS** 10K ohm ea section  $2\frac{1}{2}$ " dia okay for AF osc with knob & dial £1-35.

**CODER UNIT** with 10 min valves, 13 min relays 12v, 12 min micro swts in case with cover £3-75.

**REED RELAYS** coils 12 v DC as 2 N.C. & 3 N.O. reeds 55p.

**TEST SET 502** contains meter 2-5 Ma FSD, 3x Yax swts, close tol res etc in neat case 8 x 12 x 4" okay for portable meter £2-32.

**POWER UNITS** mains operated & stabilised made to operate BC221 freq meter. Fits in battery compartment. Tested with circ. £7-16.

**CRYSTAL FILTER UNITS** 100Kc SSB Rx filter contain 4 xtals, coils, trimmers etc with connectors £2-30.

**SANTON TYPE SWT** 2p 4w rated 250v/10a new 75p.

**LARGE INST TYPE SWTS** 8p 12w 8b & 2p 23w 2b both £1-30. ea. 7p 23w 7b £1-60 all new.

**COAX CABLE** 75 ohm 15 mts for £1-20 also low loss type 10 mts for £1-90.

**MAINS CABLE** 3 core 3 amp 10 mts for 86p.

**METER UNIT** X pointer type dual 110 Ua for use with R1155 £1-79.

**INDICATOR UNIT.** 6" display, module construction with min & sub valves, int RF type EHT unit 3 counter dial linked to CRT cursors, thought to be Sonar Ind first MOD release £12-50 new, £10-50 S/H.

**SCOPES.** American service general purpose bench scopes 115v 50c/s I/P, single beam, 3" tube, Y amp 2c/s to 11 Mc/s at 50 Mill/V per inch, Time & Voltage Calibrators, with probes & Accs tested with copy of Inst Book. £40.

**SILICON DIODES** 200 PIV 8 amps 4 for 75p also 800 PIV 750 Ma new 15 for £1-10.

**VALVES.** Ex equip 5U4, 6X5, 6SN7, 12AT7, 12AU7, 12AX7, 6BH6, EL85, 6H6, 6Y6, 6SK7, 6N7, 6J6, 6AK6, 6X4, CV173, EF50, OB2, 12SJ7, 12J5, 12A6, 6BE6, 5R4, 6CH6, CV286 95v stab, CV284 75v stab, 85A2, any 3 for 65p.

**METER** 1 Ma FSD scale knots  $2\frac{1}{2}$ " dia £1.

**CRYSTAL OVEN** with 12 type Hc6/u holders can be removed oven 24v 76p.

**MIKES** American type T17 carbon with swt new £1-35.

**DYNAMOTOR UNITS** American 12v DC I/P O/P 440v at 200 Ma £2-65.

**TAG STRIPS** solder type 24 way new 10 for 40p.

**LAMPS** double filament type with silvered reflector 28v 14w new 5 for 65p.

**SPEAKERS** p.m. type 4 x 4" coil 3 ohm with trans to match o/p pentode 80p.

**I.F. TRANS** double wound 100Kc 2 for 60p.

**NUTS & BOLTS** etc in 2, 4, 6 & 8 Ba assorted 250 items new £1.

**FLAME STATS** operate about 90' C new £1.

**INVERTOR UNITS** rotary type I/P 28v DC, O/P 115v 400c/s 6-5 amps 1 phase, with V.R. & circ. American Surplus. £18.

**VEEDER COUNTERS** 4 digit with reset coil 230v DC new £2.

**Copies of Manuals & circs available** List on request

Above prices inc carr & VAT. SAE for list or enquiry.

Goods are ex equipment unless stated otherwise.

**A. H. SUPPLIES** 57 MAIN RD, SHEFFIELD S9 5HL 444278 (0742)

# ELECTROVALUE

## IMPORTANT ANNOUNCEMENT ON PRICES

**1975** is the year of challenge. Rather than sit back and wait for things to happen, we have produced our own policy to help stabilize price structure and maintain the services which have made **ELECTROVALUE** pre-eminent.

**PRICES** as shown in our latest catalogue (No. 7, issue 3) will be maintained at least until March 31st next (except in severe cases of market fluctuation) and then held after review for further 3-month periods instead of day to day price changes.

**CATALOGUE No. 7, ISSUE 3** is now ready with 108 pages of bargains and information. Price—30p post paid, including 25p refund voucher for use on orders for £5 or more.

**DISCOUNTS** apply on all items except the few where prices are shown NETT. 5% on orders from £5 to £14-99; 10% on orders value £15 or more.

**FREE POST AND PACKING** in U.K. for pre-paid mail orders over £2 (except Baxendall cabinets). If under there is an additional handling charge of 10p.

**QUALITY GUARANTEE.** All goods are sold on the understanding that they conform to maker's specification. No rejects, seconds or sub-standard merchandise.

**SUPPLIERS OF QUALITY COMPONENTS AND SEMI-CONDUCTORS AT COMPETITIVE PRICES.**

### ELECTROVALUE LTD

All communications to Dept. PW3, 28, ST. JUDES ROAD, ENGLEFIELD GREEN, EGHAM, SURREY TW20 0HB Telephone Egham 3603, Telex 264475 Shop hours: 9-5.30 daily, 9-1 pm Sats.

**NORTHERN BRANCH:** 680, Burnage Lane, Burnage, Manchester M19 1NA Telephone (061) 432 4945 Shop hours: Daily 9-5.30pm; 9-1pm Sats.

## poly-planar

### 20-Watt Full Range Speaker

Completely replaces the conventional cone speaker  
Super-thin construction  
permits new installation ideas.



Power capability: 40 watts peak. Frequency range: 40 Hz-20 KHz  
Sensitivity: 85 dB/M for 1 watt electrical input. Input Impedance: 8 ohms. Operating temperature range: -20°F to +175°F. Size (WxDxL): 1-7/16" x 11-3/4" x 14-11/16". Weight: 19 ounces.

£8-00 each Stereo pair £15-50

INCLUSIVE OF VAT AND POSTAGE

## web europa

P.O. Box 9, Ruthin Clwyd

## VHF MODULATOR

Which enables the use of a standard TV as a monitor for CCTV and Video games (TV Tennis). Operates from 8V-12 VDC. Tuneable over VHF Channels 27-40. Input—Standard 1V poss Video. Output—7.5mV into 75ohm at 600 MHZ. Dimensions  $2\frac{1}{2}$ " x 2" x  $\frac{1}{2}$ "—6' Coax.

Price—Fully Assembled and Tested £6-50 inc. VAT and postage.

Please send cheque or P.O. with order to:

## STRONG ELECTRONICS LIMITED

Bourne Works, Whyteleafe, Surrey CR3 0YD





### SINCLAIR CALCULATORS

Sinclair Scientific £22.45 (£2.05)  
Cambridge Assembled £15.95 (£1.55)  
Cambridge Memory £20.95 (£1.95)

### FERRANTI ZN414

IC radio chip with data £1.20 (22p). Also available kit of extra parts to complete a radio £2.55 (43p). Send sae for free leaflet.

### SINCLAIR PROJECT 80

AFU £6.38 (73p)  
Z40 £5.12 (63p)  
Z60 £6.38 (73p)  
Q16 £7.21 (80p)  
PZ5 £5.11 (63p)  
PZ8 £7.79 (84p)  
PZ8 £7.36 (80p)  
Decoder £7.75 (84p). Trans for PZ8 £3.85 (50p).  
Tuner £11.62 (£1.37). Stereo 80 £11.62 (£1.37).  
Project 80S £29.95 (£2.80).  
Project 80S SQ £33.95 (£3.10).  
Project 80 SQ Quad Decoder £15.95 (£1.18)



### ECONOMICAL QUADROPHONICS

Introducing the Napalex QA10 self contained matrix quadrophonic synthesizer. Just feed the output of any stereo system (Including Project 80 or 60) into it and hook on 4 speakers to obtain the latest experience in sound. Send sae for free leaflet. Only £10.15 (£1.10).



### SINCLAIR SUPER IC12

6 watt IC power amp and preamp. With 44 page booklet and printed circuit £1.80 (40p).

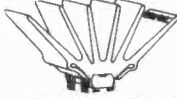

### NEW SINCLAIR IC20

High power IC audio amplifier £6.95 (82p).

### DELUXE KIT FOR THE IC12

Includes all parts for the printed circuit and volume, bass and treble controls needed to complete the mono version £4.80 (28p). Stereo model with balance control £3.90 (46p).

### IC12 POWER KIT

Supplies 28V 0.5 Amps £3.07 (52p).

### LOUDSPEAKERS FOR THE IC12

Mono model £1.50 (27p). Stereo model £1.75 (47p).  
5" x 8 ohm £1.40 (39p). 5" x 8" 8 ohm £1.75 (47p).

### PREAMP KITS FOR THE IC12

Type 1 for magnetic pickups, mics and tuners Mono model £1.50 (27p). Stereo model £2.70 (35p). Type 2 for ceramic or crystal pickups. Mono 80p (20p). Stereo £1.60 (27p).

SEND SAE FOR FREE LEAFLET ON KITS

### BATTERY ELIMINATOR BARGAINS

The most versatile battery eliminator ever offered. Switched output of 3, 4, 6, 7, 9 and 12V at 500 mA £3.90 (70p).  
Other eliminators stocked:—  
250mA:—3 way switched model giving 6, 7½ and 9V £2.50 (50p).

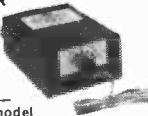

50mA:—  
4½V £2.40 (40p). 6V £2.40 (40p). 9V £2.40 (40p). 7½V cassette type £2.80 (50p). Double 4½V + 4½V £2.95 (50p). 6V + 6V £2.95 (50p). 9V + 9V £2.95 (50p).  
500mA:— Heavy duty deluxe models 6V £2.78 (55p). 7½V £2.78 (55p). 9V £2.78 (55p).

### S-DECS AND T-DECS

S-DeC £1.98 (31p)  
T-DeC £3.63 (47p)  
µ-DeC A £3.99 (51p)  
µ-DeC B £5.99 (81p)  
IC carriers:—  
16 dil: plain 81p (15p) with socket £1.77 (25p).  
10 TO5: plain 78p (15p). With socket £1.88 (24p).  
Experiment guides:—A £1.59 (30p), E £1.77 (39p), C 90p (28p), D £2.40 (45p), E £4.20 (63p).



## SWANLEY ELECTRONICS

PO BOX 68, SWANLEY,  
KENT BR8 8TQ.

Please add the sum shown in brackets after the price to cover the cost of post and new VAT. Official credit orders from schools etc. welcome. No VAT charged on overseas orders.

## MAINS UNITS for all types of TRANSISTOR EQUIPMENT

RUN YOUR TRANSISTOR RADIO OR CASSETTE RECORDER FROM YOUR CAR BATTERY (Similar to illustration)

This unit enables you to run your cassette tape recorder from the car whilst travelling. It is easily fitted and comes complete with fitting instructions. Please state make of cassette, voltage and type of plug required.

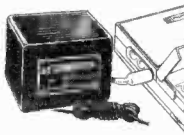

ONLY £2.86

RUN YOUR TAPE RECORDER OFF AC MAINS

Mains unit supplied complete and ready to plug into your cassette recorder. (State voltage, make and type of plug required, if in doubt send diagram of recorder socket.)



ONLY £3.40



RUN YOUR TRANSISTOR RADIO OFF AC MAINS

For single outputs, 6v, 9v £2.86

For two separate outputs, 6v + 6v, 9v + 9v £3.52 per unit. (Please state outputs required.)

All units are completely isolated from mains by double wound transformer ensuring 100% safety. All British Made. All Prices inc. V.A.T. and P. & P. R.C.S. PRODUCTS (RADIO) LTD. (Dept. P.W.M.)

31 Oliver Road, Walthamstow, London, E17

Full refund if not completely satisfied.

## TELEVISION CAMERA KITS

Complete kits are available for both "Mullard" and "P.E." design. Each kit includes a comprehensive construction manual, and a completely FREE technical back up service to ensure your success. VHF and UHF Modulator kits also available to allow standard domestic T.V. to be used as monitor.

All parts available separately, including a wide range of lenses, vidicon tubes and focus/scan coil assemblies. Ready built cameras also available. Complete kits available for P.W. tele-tennis game. Send 5" x 7" S.A.E. for full details, or come along for a demonstration and a chat with our technical staff.

## CROFTON ELECTRONICS

124 Colne Road, Twickenham, Middlesex, TW2 6QS  
Tele: 01-898 1569  
Telex 934642  
Cadanac LDN



Wire Wound Resistors. Our selection of mixed values. 30 for £1.50. 100 for £4.00.

Audio Amplifier Module. Mullard LP1173, output power, nominal 10 watt, supply voltage +24 volt, with data and circuit, £2.50.

Ferguson Stereogram chassis Model 3357, all transistor, medium long, VHF/FM, 3 watts per channel S/M, with connection data, less tuning scale, £20. Post paid.

Crystals HC6U: £2 03333 MHz: 52-02500 52-01667: 51-56667: 51-58330: 37-76250 37-75000: 12-895 8: 12-891 6: 12-700-0 9-458-33: 9-456-25: 9-455-55: 9-533-33: 9-531-94: 9-530 55: 9-090-62: 9-087-5 50p each.

Electrolytics. 32/32/32µF, 325v. 2" x 1½" 35p; 80µF 150vt 1" x 1" 20p; 2000µF 30v 2½" x 1" 25p; 2000µF 35v 3" x 1" 30p; 470µF 100v 3" x 1½" 25p; 2000µF 25v 2" x 1½" 35p; 30000µF 25v 4½" x 2½" 50p; 700µF 200v 3½" x 1½" 30p; 16/16µF 275v 1½" x 1" 20p; 40 40; 20µF 275v 3" x 1" 20p; 4500 300/900µF 30v 2½" x 1½" 50p; 4000µF 35v 3" x 1½" 40p; 4000µF 35vt 3" x 1½" 35p; 2500µF 40vt 2½" x 1½" 40p; 4300µF 18v 2" x 1" 20p; 470µF 25v 1½" x 1" 15p.

Matched pair of bookshelf speakers. Teak fin sh, size 12" x 3" x 5". 8x5 8" ohms ceramic, 5 watts RMS. Complete with din leads. £1.00 pair.

Thorn TV IF chassis, 950 series (less valves), £1.75.

UHF 625 transistor push button tuner (NSF Telefunken) as used on Decca MS2400. Brand new and boxed, £3.25. Light Dependent Resistors (RCA sq3536) 30p each 4 for £1.00.

P-C Boards (not computer panels) 1 off 6 transistor single wave band. 1 off 4 transistor audio 1 off 3 transistor £1.60, three boards.

Rank EVR Teleplayer colour transistor panels, type and components on new panels listed as follows, £2.50, each panel. Z605—14 off BC148: 2 RCA ca3064 (ic): 1 crystal 4-433618 MHz—Z607—12 off BC148: 1 BC108: 1 BC158: 1 RCA ca3046 (ic), 1 RCA ca3045 (ic): Z608—23 off BC148: 2 BC158—Z612—12 off ME4103: 2 BC-251B: 1 BFY50.

Mains Droppers, 10 mixed values, £1.00.

Edgewise level meters, 200µA, size 2" overall, 50p.

Chrome Plastic knobs, 3 types, 4 off each with spring clip, £1.25.

Aluminium Chassis, 7½" x 5½" x 2½" 70p; 10" x 7½" x 2" 85p; 11" x 7½" x 2½" 95p.

BSR P128, similar to HT70 single play, with heavy die cast turntable, less cartridge, £11.00.

Transistorised FM tuner head, with A.M. gang slow motion drive 88-108 Mics, with circuit diagram, £2.30.

Ferguson Stereogram Chassis. MW/LW/VHF with tuning scale (5+5 watts sine wave) 15 ohms £28.50. Post paid 15 ASSORTED SWITCHES £2.00.

50-3 way to 7 way TAG STRIPS, £1.25. ALMA RIEDEL RELAY TYPE DRH. 3 VOLTS, 55p.

REPAO & DENCQ COILS. NEW/BOXED OUR SELECTION—5 FOR £1.25

Goods not despatched outside UK 15p Handling charge on orders under £1.00. Please add 10% for post and packing on all items except gram chassis. All items include VAT.

## SURPLECTRONICS

216 LEAGRAVE ROAD,  
LUTON, LU3 1JD, BEDS.

## "SLO-SYN" 3-LEAD SYNCHRONOUS STEPPING MOTOR



Type SS15. These fine motors are easily reversed, starting and stopping in less than 50 without electrical or mechanical braking. Simple relay circuit can be applied to give DC., to winding for a maximum holding torque of 3000z/in with 35v at 0.35 amps through winding. For AC. (synchronous) operation at 120r., 50Hz. Speed 60 rpm at 60Hz., 72 rpm. STEPPING. Holding torque at 50 steps per second—100 oz/in. Can be wired to give 100 or 200 steps per revolution with accuracy of 0.1° per step non-cumulative. Torque characteristics can be modified by simple R.C. circuits. Dimensions: dia. 4", body length 4 1/2", spindle length 2 1/2" x 3/8" dia. Weight 6 1/2 lbs. BRAND NEW in maker's packing. Offered at less than 1/2 maker's price. **OUR PRICE ONLY £15 P & P £1-00**

### UNISELECTORS

12 Bank 25 way double sweep 48v. D.C. ex-computer in 1st class condition. £8 plus 50p. P & P.

### SHADED POLE MAINS MOTOR

A quality shaded pole motor. Open frame, 3" high x 2 1/2" x 2". Spindle 1" x 3/8". 1,420 r.p.m. £1.95 P & P 20p

### CARTER ELECTRIC

Similar to above with alloy gear case, 60 r.p.m. This item is ex-equipment but perfect. £1.95. P & P 30p.

### "LABGEAR ELIMINAC"

P.S.U. 200-250v. 40/60Hz. Alternative outputs fully variable (variac incorporated). Output 1. 12v at 5a D.C. fully smoothed. Output 2. 12v at 8a D.C., with ripple content. Output 3. 20v at 10a A.C. 2 1/2" x 2 1/2" flush 0-20v D.C. m.c. meter. In attractive grey hammer finish case. In maker's carton £27.50. Carr. & Pkg. £1.50.

### SPECIAL OFFER

## LIGHT DEPENDENT RESISTORS

Matched pairs Pioneer Type 174 similar to OPR 12. Resistance 1K to 40K Dia 1/2" with 1/2" flange. £1.50 for two pairs (minimum) 10 or more pairs, 50p. per pair Incl. P & P.

### MAINS SOLENOID

This little unit gives vertical lift of approximately 1" through hinged "elbow". Bracket incorporates 2 fixing screws. Length of arm, 2 1/2". 240V AC. Pull at coil is approximately 1lb. £1. FREE P. & P. Special quotes for quantities.

### SOLENOIDS by WESTOOL

240 AC type MM6. 3lb. pull, 2 1/2" x 1" x 1 1/2". Travel 1". £1 each. P. & P. 20p.  
240 AC type MM4. 2lb. pull, 1 1/2" x 1 1/2" x 1". Travel 3/4" 80p each. P. & P. 20p. Quantity discounts: 10-50 10%, 50 upwards 25%.

### OPEN FRAME shaded pole GEARED MOTORS

240 AC, 110rpm. NEW HIGH TORQUE, approx. overall size: 3 1/2" x 3 1/2" x 2 1/2" + spindle 1/2" dia. £3. P. & P. 50p.  
110rpm with pressed steel gear case (similar to above but slightly smaller). £2.70. P. & P. 30p.

## SILVANIA MAGNETIC SWITCH

Now complete with reference magnet!



A magnetically activated switch, vacuum sealed in a glass envelope. Silver contacts, normally closed. Rated 3amp at 120v; 1amp at 240v. Size: (approx.) 1 1/2" long x 1/2" dia. Ideal for burglar alarms, security systems etc., and wherever non-mechanical switching is required. 10 for £2.10; P. & P. 15p. 50 for £8.80; 100 for £15.50. FREE P. & P. over 10.

## AMPEX 7.5v. D.C. MOTOR

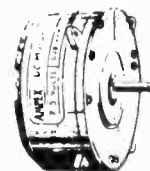

An ultra precision tape motor designed for use in the AG20 portable recorder. Torque 450GM/CM. Stall load at 500ma. Draws 60ma on run. 600rpm ± speed adjustment. Internal AF/RF suppression. 1/2" dia. x 1" spindle, motor 3" dia. x 1 1/2". Original cost £16.50. **OUR PRICE £4.25. P. & P. 25p.** Quantity available. Mu-metal enclosure available 75p each. FREE P. & P.

### FAN/BLOWER



Precision-built in Germany. Dynamically balanced mains unit (200/240) continuous rated, reversible 60MA on run. Size: 5 1/2" dia. x 2 1/2" deep. Back plate is tapped for 4 fixing screws (supplied). Well under maker's price at £3. P. & P. 40p.

### ALL PRICES INCLUDE V.A.T.

Whilst we welcome official orders from established companies and Educational Departments, it is no longer practical to invoice goods under £5. Therefore, please remit cash with orders below this amount.

# ELECTRO-TECH COMPONENTS LTD.

315/317, EDGWARE ROAD, LONDON, W2.  
Tel: 01-723 5667 01-402 5580

### MASSIVE CLEARANCE BARGAINS

Bargain component parcels contain Resistors, Potentiometers, Knobs, Rotary and Slide Switches, IF's, Tag Strips, Drive Drums, Coil Formers, Wire, Grommets, Relays, Pulley Wheels, Magnets, Transistor Panels, etc. Save yourself £'s on these well selected parcels, 6lb net weight £1-00, p.p. 50p.  
Brand New Wire-wound Resistors 1-7 watts, mostly Plessey GWS-1.3-5-7. Good selection. 100 for £1-00, p.p. 20p.  
Mullard Ferrite Cores LA3 50p, LA4 75p, LA2100 50p.  
SPECIAL OFFER. Metallised Polyester Capacitors by Erie, Mullard, etc. Values include -01/160V, -01/250V, -015/160V, -022/160, -033/160, -047/160V, -068/160V, -1/160-250V, -22/160V, etc. This is a bargain not to be missed. 100 for £1-50, p.p. 20p.  
Assorted Capacitors, Silver Mica, Tubular and Disc Ceramics, Polystyrene, Tremendously good selection. 300 for £1, p.p. 20p.  
Please add 8% V.A.T.

Mail Order Only.

**XEROZA RADIO,**  
1, EAST STREET, BISHOPS TAWTON, DEVON.

Newest, nearest system ever devised for storing small parts and components: resistors, capacitors, diodes, transistors, etc. Rigid plastic units, interlock together in vertical and horizontal combinations. Transparent plastic drawers have label slots. 1D have space dividers. Build up any size cabinet for wall, bench or table top.

## INTER-LOCKING PLASTIC STORAGE DRAWERS

NEAT! NEATLY!  
TIDY!

DISCOUNT PRICES

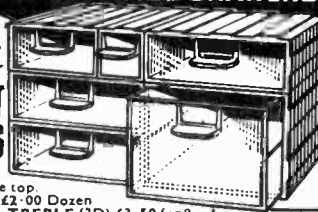

SINGLE UNITS (5" x 2 1/2" x 2 1/2") £2-00 Dozen  
DOUBLE UNITS £3-50 Dozen. TREBLE (3D) £3-50 for 8  
DOUBLE TREBLE £4-90 for 8  
EXTRA LARGE SIZE (6D) £4-50 for 8.  
Carrage 40p. Orders over £10 post free  
QUANTITY DISCOUNTS! 5% in £1 for orders over £15  
7 1/2% for orders over £30. Quotations for large quantities.  
PLEASE ADD 8% VAT TO TOTAL REMITTANCE.

FLAIDLINE SUPPLIES

(Dept. PW3), 124 CRICKLEWOOD BROADWAY, LONDON N.W.2 01-450 4844



## PRACTICAL PAPERBACKS FROM FOULSHAM-TAB

- TV SERVICING GUIDEBOOK by Art Margolis £1-55
- TAPE RECORDING FOR FUN AND PROFIT by Walter G. Salm £1-70
- HI-FI TROUBLES by Herman Burstein £1-40
- BEGINNER'S GUIDE TO COMPUTER LOGIC by Gerald F. Stapleton £1-60
- FIRE AND THEFT SECURITY SYSTEMS by Byron Wels £1-55
- HOME-CALL TV REPAIR GUIDE by Jay Shane £1-35
- HOW TO USE TEST INSTRUMENTS IN ELECTRONIC SERVICING by F. Shunamam £1-80
- POPULAR TUBE/TRANSISTOR SUBSTITUTION GUIDE £1-80
- ELECTRONICS SELF-TAUGHT WITH EXPERIMENTS AND PROJECTS by James Ashe £1-85
- BASIC ELECTRONICS PROBLEMS SOLVED by Donald A. Smith £1-60

- WORKING WITH THE OSCILLOSCOPE by A. C. W. Saunders £1-50
- WALKIE-TALKIE RADIO OPERATOR'S GUIDE by Bob Brown & Paul Lawrence £1-70
- 64 HOBBY PROJECTS FOR HOME & CAR by Bob Brown & Mark Olsen £1-80
- PULSE & SWITCHING CIRCUITS by Harvey F. Sweaver £1-95
- ELECTRONIC MUSICAL INSTRUMENTS by Norman H. Crowhurst £1-80
- MAJOR APPLIANCE REPAIR GUIDE by Wayne Lemons & Billy L. Price £2-10
- PRACTICAL TEST EQUIPMENT YOU CAN BUILD Edited by Wayne Green £1-80
- QUESTIONS & ANSWERS ABOUT TAPE RECORDING by Herman Burstein £2-05



**FOULSHAM-TAB LTD.**  
YEovil ROAD, SLOUGH, BERKS



## Situations Vacant

# ELECTRONIC ENGINEER

required in an expanding electronic services company in the Sultanate of Oman, specialising in commercial/industrial television and radio installations, also the installation and servicing of electronic security systems. Applicants should have a minimum of either Ordinary National Certificate or City & Guilds Final.

Salary £3,500 pa nett, free furnished accommodation supplied, limited free utilities, i.e. electricity and water, company car and petrol supplied free, annual paid leave of one month with air fares provided, initial contract period minimum of two years. Applications should be made to P.O. Box 1000, Muscat, Sultanate of Oman.

**MEN!**  
**£70p.w.**  
**can be yours**

Jobs galore? Tens of thousands of new computer personnel needed over the next few years alone. With our revolutionary, direct-from-America, course, you train as a Computer Operator in only 4 weeks! Pay prospects? £3500 + p.a.

London Computer Operators Training Centre subscribes to the British Government backed National Computing Centre code of practice for Computer Training Schools so you know your training will be second to none.

After training, our executive appointments bureau—one of the world's leaders of its kind—introduces you FREE to world-wide opportunities. Write or 'phone TODAY, without obligation.

London Computer Operators  
Training Centre  
Y22, Oxford Hse.,  
9-15 Oxford St. W1. Tel: 01-734 2874

## Aerials

**GENUINE FULL SIZE**  
**18 element TV aerial**  
as used by leading  
TV companies

FOR ONLY  
**£2.20**  
+43P CMT

1TV, 8BC1, 528/W & Colour Guaranteed Perfect Pictures. Save ££s. We supply this genuine U.H.F. aerial for only £2.20, can be used outside or inside. Quality made technically advanced design. Precision grid/reflector eliminates ghosting. Complete with clamp, instructions advice. Money Back Refund. Wall/Caravan Bracket 25p. Best Cable 12P per yard. Plug 100P & FREE with order maps & channel reference of Radio & TV Transmitters. SEND DIRECT TO DEPT. PW10 219 Mansfield Rd, Nottingham.

**IMPERIAL TRADING AERIALS LTD.**  
Dix Quality Aerial Specialists

J. and A. TWEEDY  
(Electronic Supplies) Limited  
Full range of Jaybeam Aerials available  
We supply High Gain Multibeam aerials.  
Carriage and VAT included in the quoted price.  
**MULTIBEAM UHF TV AERIALS** MBM 28 £5.00,  
MBM 48 £8.00, MBM 70 £11.00,  
**PARABEAM UHF TV AERIALS** PBM 12 £4.00,  
PBM 18 £5.00.  
**STEREOBEAMS FM AERIALS** SBM 2 £3.00,  
SBM 3 £4.00, SBM 5 £5.00, SBM 6 £8.00.  
SAE for full list of accessories available—Low  
Loss Co-ax 12p/m.  
79 Chatsworth Road, Chesterfield, Derbyshire  
Tele: 34982

## Educational

GO TO SEA as a Radio Officer. Write: Principal, Nautical College, Broadwater, Fleetwood FY7 8JZ.

### C AND G EXAMS

Make sure you succeed with an ICS home study course for C and G Electrical Installation Work & Technicians Radio/TV/Electronics Technicians. Telecomms Technicians and Radio Amateurs.

### COLOUR TV SERVICING

Make the most of the current boom! Learn the techniques of servicing Colour and Mono TV sets through new home study courses, approved by leading manufacturers.

### TECHNICAL TRAINING

Home study courses in Electronics and Electrical Engineering, Maintenance, Radio, TV, Audio, Computer Engineering and Programming. Also self-build radio kits. Get the qualifications you need to succeed.

Free details from:

INTERNATIONAL  
CORRESPONDENCE SCHOOLS,  
Dept 732, Intertext House, London SW8 4UJ.  
Or Phone 01-422 9911 (All Hours)

## Service Sheets

# LARGE SUPPLIER OF SERVICE SHEETS

(T.V., RADIO, TAPE RECORDERS,  
RECORD PLAYERS, TRANSISTORS,  
STEREOGRAMS, RADIOGRAMS,  
CAR RADIOS)  
ALL AT 50p EACH

**"PLEASE ENCLOSE LARGE S.A.E  
WITH ALL ENQUIRIES & ORDERS"**

Otherwise cannot be attended to

(Uncrossed P.O.'s please, original  
returned if service sheets not available.)

### PLEASE NOTE

We operate a "by return of post" service. Any  
claims for non-delivery should be made within  
7-days of posting your order.

## C. CARANNA

71 BEAUFORT PARK  
LONDON, N.W.11 6BX

We have the largest supplies of Service  
Sheets (strictly by return of post). Please  
state make and model number alternative.  
Free TV fault tracing chart or TV list on  
request with order.

Mail order or phone 01-458 4882

**BELL'S TELEVISION SERVICES** for Service Sheets, Manuals, Books on Radios, TVs, etc. Service Sheets 40p plus s.a.e. Free booklists on request. Back issues of PW, PE, EE, TV available 25p plus 7p post. S.a.e. with enquiries.—B.T.S. (Mail Order Dept.), 190 Kings Road, Harrogate, Yorks. Telephone (0423) 55885.

**SERVICE SHEETS** for over 6,000 models of Televisions, Radios, Transistors, Stereo, Tape Recorders, Record Players, etc., at only 30p plus SAE with free Fault-Finding Guide. Over 50,000 sheets in stock for 10,000 models. SAE enquiries. Catalogue 20p plus SAE. Hamilton Radio, 47 Bohemia Road, St. Leonards, Sussex. Telephone Hastings 429066.

**SERVICE SHEETS.** Radio, TV etc., 8,000 models. Catalogue 20p. S.A.E. enquiries. Telray, 11 Maudland Bank, Preston.

## Books and Publications

**ELECTRONICS MEN.** You are worth more than a measly £40 or £50 a week. Last year I earned £3,600 for six months' work, the other six I had off. You could do similar, my booklet explains how. It's 65p from Alben, 3 Church Street, Diss IP22 3DD.

## Technical Books - Radio & Electronics

World's Radio & TV Stations (International Edit)	£0.60
Audio Amplifiers	£0.53
Boys Book of Crystal Sets & Simple Circuits	£0.25
Television Timebase Circuits	£1.00
Radio TV and Industrial Tube & Valve Equip	£0.60
How to get the best out of your Tape Recorder	£1.50
Modern Electronic Troubleshooting	£1.30
Jack Darr's Service Clinic	£1.35
Transistor Circuits for Modern Test Equipment	£0.60
Rad & Elect Colour Codes and Data Chart	£0.15
Handbk of Transistor Equip. and Substitutes	£0.40
Hi Fi, PA & Disco Amplifier Design Hndbk.	£0.75
Radio Servicing Problems	£0.60
Electronic Circuits for the Amat Photographer	£0.60
Handbook of Simple Transistor Circuits	£0.35
How to build Solid State Audio Circuits	£1.75
Sound and Loudspeaker Manual	£0.50
TV Technicians Bench Manual	£2.50
Radio Amateur Operator's Handbook	£0.70
Television Servicing Vol. No. 1	£0.85
Television Servicing Vol. No. 2	£1.10
Television Servicing Vol. No. 3	£0.60
Television Servicing Vol. No. 4	£0.85
Radio Technicians Bench Manual	£3.00
Servicing Transistor Radio Receivers	£0.75
1st Book of Hi Fi Loudspeaker Enclosures	£0.60
2nd Book of Hi Fi Loudspeaker Enclosures	£0.60
Manual of Electronic Circuits for the Home	£0.50
Modern Crystal Set Circuits for Beginners	£0.35
Electronic Novelties for the Motorist	£0.50
2nd Book of Transistor Equip. & Substitutes	£0.95
Handbook of Electronic Musical Novelties	£0.50
Transistorised Novelties for Hi Fi Enthusiast	£0.35
Fault Location Exercises in Rad. & TV Vol. 1	£0.80
Fault Location Exercises in Rad. & TV Vol. 2	£1.35
Colour TV Picture Faults	£2.50
Practical Transistor Novelty Circuits	£0.40
Boys Book of Practical Radio & Electronics	£0.60
Radio Receiver Construction using ICs & Transis.	£0.60
ICs & Transistor Gadgets Construction Handbk	£0.60
Integrated Circuits Equip. & Substitutes Hbk.	£0.75
Audio Technicians Bench Manual	£3.00
Improving your Hi-Fi	£3.00
Guide to Printed Circuits	£2.50
Receiving Pal Colour Television	£5.00
World Radio TV Handbook 1975	£3.50

PLEASE ADD 10% FOR POSTAGE & PACKING

## RADIO BOOK SERVICE

40 Elwill Way, Beckenham BR3 2RZ

**UFO CHARTS:** Wave Prediction 54p; Daily Flight Pattern, 50p; Map, 50p; TV UFO Detection, 2 Optical Circuits, 63p; Propulsion Theory, 55p; "Anti-Gravity" 55p. Circuits: Transistor Optical Detector, 66p; Radiation/Optical, 44p; Microdetectors, memory, auto-record, 80p. Sighting Recorder, 55p. R. & E. Highlands, Needham, Suffolk.

## For Sale

### COPPER CLAD LAMINATE FOR PRINTED CIRCUITS

Single sided 1/16" paper base—1.0p/sq. inch.  
Single sided 1/16" glass-epoxy—1.5p/sq. inch.  
Any rectangular sizes cut to your requirements.  
Please send cash with order.  
Price includes postage and packing.  
From: **SIMTECH ENGINEERING LTD**  
**VOLUNTARY PLACE**  
**WANSTEAD**  
**LONDON E.11. 01-530-4240.**

**MICROPHONES:** AKG D109, £12.65; AKG D202E1, £43.45; AKG D190C, £18.70; AKG D190E, £20; AKG D224 £55; Sennheiser MD211N, £49.50; Sennheiser MD415N, £29.70. All brand new and boxed. Send CWO to J. J. Francis, (Wood Green) Ltd., Manwood House, Matching Green, Harlow, Essex. Tel: Matching 476.

**SOUNDLIGHT CONVERTORS.** 3 channel 1.5 kW £17; 3kW £25; 1 channel 1kW £9. **STROBES:** from £21. **SEQUENCERS (Chasers):** £3, etc. Call or catalogue sent. Aarvak Electronics, 98A (P), West Green Road (side door), London N15 5NS. Tel. 01-800 8656.

**VALVES, VALVES & MORE VALVES.** Large stocks 1930-1974, many obsolete. Also available many types of transistors and stylis. Price lists available. JSP. Cox Radio, The Parade, East Wittering, Sussex. West Wittering 2023.

**JSCILLOSCOPES:** Telegquipment 720; damaged Cossor 1049 Mk. III, £30 pair. 0628 21268 (Maidenhead) evenings.

**B.B.C. GECOPHONE** crystal set with loading coil and headphones. Morgan, 13 Devon Place, Mumbles, Swansea.

## Miscellaneous

### MINI ACCUMULATORS

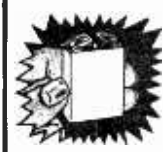

2 volt **MULTI-USE**  
Sealed Lead Acid Rechargeable Cells.  
Size L450-1.4" x 1.1" x .44" 3 for £1.85 inc. P. & P.  
Size GA2-1.7" x 1.3" x .5" 3 for £2.35 inc. P. & P.  
**GARFIELDS, 269 Rye Lane, London, S.E.15**

**LOWEST COST IC SOCKETS.** Use Soldercon IC socket pins for 8 to 40 pin DIL's. Make 8 pin sockets for 4p, 14 pin for 7p (at 300 pin price). 70p for strip of 100 pins, £1.50 for 3 x 100 £4 for 1000, 10p p&p for orders under £2. Add 8% VAT. Instructions supplied—send sae for sample. SINTEL, 53n Aston Street, Oxford. Tel: 0865 43203.

**12 VOLT 21" 13 Watt Fluorescent Lighting** (by Thorn/AEI) with diffuser & on/off switch. Ideal caravan, boat, emergency lighting, etc. Guaranteed.



£5.50 inc. VAT & Post. List price £7.02 inc. VAT  
**SALOP ELECTRONICS 23 Wyle Cop, Shrewsbury, Shropshire Tel. 53286**

**"VINTAGE RADIO 1887-1929"** £3.15 soft cover, £4.15 hard cover. "Gernsbacks 1927 Radio Encyclopaedia", £5.65 soft cover, £7.15 hard cover. All post paid. These two brilliant American publications about early radio are now available in the U.K. from: Tudor Rees's, Antique Wireless Service, 64 Broad Street, Staple Hill, Bristol. Tel: 0272 565472.

**HEADPHONES:** 8 ohms. Suitable communications receivers, £3.39. Partridge Electronics Ltd., Broadstairs, Kent.

BUILD THE STEREO FM TUNER

P W SANDOWN  
LOOK

- PCB & Cmpnts inc. TR & BOX \_ £ 26.32
- Push Button Unit. 6 Position \_ \_ £ 2.97
- METERS, Tuning & Level \_ \_ each £ 1.50
- Subminiature Switches \_ set of 4 £ 2.62
- Cabinets & Front Panels \_ \_ \_ to order
- VAT INCLUSIVE PRICES P & P 25p

S.A.E. for further details

**FW ELECTRONICS, 40 TUDDENHAM RD, IPSWICH, SUFFOLK IP4 2SL. Mail Order only**

**SUPERB INSTRUMENT CASE** by Bazelli, manufactured from heavy duty PVC faced steel. Hundreds of Radio, Electronics and Hi-Fi enthusiasts are choosing the case they require from our range of over 200 models. Generous trade discount. Fast despatch. Free literature, Bazelli, Department No. 25, St. Wilfrids, Foundry Lane, Halton, Lancaster LA2 6LT.

## Synthesiser "Sounds Supreme" by Dewtron (VAT extra.)

Famous kits, e.g. waa-waa complete kit £3.50; Fuzz kit £5.50. P & P 25p under £10. Ring Modulator modules £9. "Mister Bassman" Bass Pedal Units and whole range of synthesiser modules, musical novelties, etc. Catalogue 15p from D.E.W. Ltd., 254 Ringwood Road, Ferndown, Dorset.

**EX-EQUIPMENT COMPONENTS.** Indicators modifiable to aerial direction monitors, chokes, relays, switches, instruments, fuse holders, push buttons, caps, etc. SAE for list. Eldun Electronics, 16 Raven Road, Timperley, Cheshire.

SIMPLE TO FORM  
NON-MAGNETIC RUST PROOF  
MILL FINISH

## ALUMINIUM

FLAT MINI SHEETS

10ins. x 14ins. 20 swg (0.90mm.)

6 sheets for £2 incl P&P

OTHER SIZES AVAILABLE

For general car repairs, trims, kick plates, etc.

**BAYKIN ENGINEERING LTD.**  
GREVILLE ROAD, BEDMINSTER, BRISTOL, BS3 1LL

**LOUD 6v SIRENS.** For Burglar Alarms, etc. (new and boxed), £1.20; add 10p P.P. List 6p. Grimby Electronics, 64 Tennyson Road, Cleethorpes, South Humberside. (Callers to Lambert Road, Saturdays only.)

**HAVE YOU HAD YOUR CHIPS?** AY-5-1224 Digital Clock chip now £3.95 inc. VAT, post free. Circuit and details s.a.e. **GREENBANK ELECTRONICS (Dept. 322), 94 New Chester Road, Wirral, Merseyside L62 5AG.**

## DON'T LOOK

unless you can resist the temptation to get these super 'attention-getters'!

★ Pocket-sized **MAXI-VOLT** Big 1inch Spark Generator (instant 15,000 volts!). Ready-made, needs no batteries. Carry it around anywhere. Only weighs about 3 oz. (89g.) send £1.90 for your Maxi-Volt now!

★ Unique **TRANSMITTER/RECEIVER** Kit. No licence examinations or tests required to operate this transistorised equipment. Easy to build. Get transmitting. Send £6.90 for yours now!

★ Psychedelic **MINI-STROBE** Kit. Take a pocket-sized lightning storm to Disco's & parties. "Brain-freeze" 'em with vari-speed stop-motion flashes. Includes super case too. Send £2.90 now! (all prices include V.A.T., packing & postage.)

Send remittance to:

**BOFFIN PROJECTS,**  
**4 CUNLIFFE ROAD,**  
**STONELEIGH, EWELL, SURREY**  
(Mail order U.K. only)

Or for more details, send 20p for list s

**PRINTED CIRCUIT MANUFACTURERS OFFER, PCBs for All PE and PW projects published after June '74, at one price. 70p each. Any 5, £2.85. PCB sets for: PW Tele-tennis, £3.50. Sandown Tuner with screens, £2.20. PE CCTV, £1.45. Power Slaves, £1.35; Scorpio Ignition, 'WW' Ferret Metal Locator, 65p each. CWO Prices inclusive. PRODUCTION SPACE AVAILABLE FOR: PCB production, PCB and electronic design, electroplating, silk-screening, roller tinning, photography and all artwork. Estimates by return post or phone. WKF Electronics Wellbeck Street, Whitwell, Worksop, Notts. Tel: 695.**

BUILD THE **TREASURE TRACER MK III Metal Locator**

- Varicap tuning
- Britain's best selling metal locator kit
- Weighs only 22oz.
- Speaker and earphone operation
- Knocks down to only 17in.
- Prebuilt search coil assembly
- Ministry approved design
- As seen on BBC1 and BBC2 TV
- You only need soldering iron, screwdriver, pliers and snips
- Five transistor circuit

Send s.a.e. for leaflet

Complete **£9.80** Built, tested and guaranteed **£13.75**  
K11 P & P 60p | 78n VAT P & P 60p, £1.19 VAT

**MINIKITS ELECTRONICS,**  
**14 CLEVELAND ROAD,**  
**LONDON, E16 2AN (Mail order only)**

**HARDWARE.** Comprehensive range of screws, nuts, washers, etc. in small quantities, and many useful Constructors' items. Sheet aluminium to individual requirements, punched, drilled, etc. Fascia panels, dials, nameplates in etched aluminium. Printed circuit boards for this magazine and other individual requirements, one-offs and small runs. Machine engraving in metals and plastics, contour milling. Send 2 x 4 1/2p stamps for catalogue. Ramar Constructor Services, Masons Road, Stratford on Avon, Warwicks., CV37 9NF.

# FANTASTIC NEW MICROTEST 80

MEASURES  
ONLY

90×70×18 mm

Amazing Value at **£11.95**

8 fields of measurement  
and 40 ranges

Volts D.C. 6 ranges: 100mV - 2V. - 10V. - 50V. - 200V. - 1000V. (20kΩ/V)  
Volts A.C. 5 ranges: 1.5V. - 10V. - 50V. - 250V. - 1000V. (4kΩ/V)  
Amp. D.C. 6 ranges: 50μA - 500μA - 5mA - 50mA - 500mA - 5A  
Amp. A.C. 5 ranges: 250μA - 2.5mA - 25mA - 250mA - 2.5A  
Ohms 4 ranges: LowΩ - Ω x 1 - Ω x 10 - Ω x 100 (da 1/10 dΩ fino a 5 MegaΩ)  
V Output 5 ranges: 1.5V. - 10V. - 50V. - 250V. - 1000V  
Decibels 5 ranges: + 6dB, +22dB, +38dB, +50dB, +82dB  
Capacity 4 ranges: 25μF - 250μF - 2500μF - 25,000μF



**SUPRTESTER 680R ICE**  
20,000 Ohm per Volt/sensitivity • Fully screened against external magnetic fields • Scale width and small case dimensions (128 x 85 x 32mm) • Accuracy and stability (1% in D.C. 2% in A.C.) of indicated reading • Simplicity and ease of use and readability • Full ranges of accessories • 1000 times overload • Printed circuit board is removable without de-soldering • More ranges than any other meter. Ask for free catalogue

**£18.50**  
Accessories (extra) available to convert Microtest 80 & Supertester 680R into following: SIGNAL INJECTOR, GAUSS METER, ELECTRONIC VOLTMETER, AMPERCLAMP, TRANSISTOR TESTER, TEMPERATURE PROBE, PHASE SEQUENCE INDICATOR—Send for details.

**MORE RANGES FOR LESS MONEY!**  
AC/DC Multimeter type U4324  
A-DC 0-08-3A - 8 Ranges.  
A-AC 0-3-3A - 5 Ranges.  
V-DC 0-6-1200 V - 9 Ranges.  
V-AC 3-900 V - 8 Ranges.  
Freq.: In the range of 45 to 20kHz  
Resistance: 500 Ohm to 5 MOhm - 5 Ranges. Decibel: -10 to +12dB  
Accuracy: ± 2.5% O.C. ± 4% A.C.  
Dimensions: 187 x 98 x 83 mm.

Only **£8.85**



## ALPHANUMERIC NIXIE TUBES B7971

The Alpha numeric NIXIE tube has the ability to display all the letters of the alphabet, numerals 0 thru 9 and special characters in a single tube. From the standpoint of both readability and electrical characteristics, the Alphanumeric NIXIE tube provides many unique benefits including ★ 170v-21mA ★ All d.c. operation ★ Uniform, continuous line characters of equal height ★ Memory with simple solid state drive circuits ★ Readability in high ambient light - 200 footcandle brightness ★ Long life with no loss of brightness ★ Character height 2 1/2 in.



Price only **99p** each plus 16p P.P.  
Bases for above 60p each.

## JUST ARRIVED !! NUMERIC INDICATOR TUBES

Ultra-long life, high quality, 0-9 and 2 Independent decimal points. Supply voltage 200V D.C. Current 14mA, Pulse duration 100μs. Character height 0.51, overall size 1.4. Brand new, guaranteed. Surplus to manufacturers requirements. Type B5853at  
1-25 £1.00 25 99p 100+ 80p  
1000+ price on application  
Add 8% VAT to all items + 35p P & P

ELECTRONIC BROKERS LTD.  
49-53 Pancras Road, London NW1 2QB  
Tel: 01-837 7781

## NEW YEAR BONANZA!

**B.B. SUPPLIES offer:-**  
**LEVER** key switch, 4-pole, lock-off-lock, in black plastic stackable case app. 120mm x 120mm x 25mm. Brand new **75p**  
**PUSH** button switching unit, 3 two-pole c/o units, one cancels others, room for one more unit. App. 75mm x 60mm x 35mm. Brand new (wired and numbered) **50p**  
**RELAY**, 24 volt, 3600 ohms, 4 c/o contacts. Size: 40mm x 33mm x 15mm (wired and covered). Brand new **50p**  
**LAMP** fitting, 6 volt—contained in hammer finished, grey steel box on wood plinth. Ideal case for small projects. Six app. 75mm x 75mm x 70mm. Brand new **50p**  
**SPECIAL** price until 31-3-75 for all 4 above items + useful accessory. **£2.00**  
4T (energising earpieces (salvaged) **20p**  
All prices include VAT and p. & p. Many other Govt. surplus, new and shand items at bargain prices, S.A.E. for New Year Catalogue of teletronic parts to:  
**38 HEATHWOOD GARDENS, SWANLEY KENT BR8 7HN**

**AERIAL WIRE**. High quality PVC covered multi-strand copper, 50ft 60p (10p); 75ft 87p (13p); 100ft £1.20 (15p); 150ft £1.80 (24p); 200ft £2.39 (26p); 250ft £2.96 (28p); 300ft £3.54 (31p). P & P in brackets. Longer lengths available. SAE all enquiries.  
A1 Radio Components, 14 The Borough, Canterbury, Kent CT1 2DR.

## FLUORESCENT LIGHT KIT

12v  
8w

You can build this reverse polarity proof light for use in homes, garages, caravans, for camping, or emergency lighting. Everything is supplied: the tube, white enameled metalwork, first quality components, P.C.B., instructions, etc.  
Price only **£3-19** Inc VAT post & packing  
Ready built **£3-78**  
Diffuser only 59p extra

## ALUMINIUM BOXES

Prices include lid, screws and V.A.T.  
Post and packing 10p extra on all orders

1	2	3	4	5	6	7	8	9	10	11	12	13	14	15	16	17	18	19	20
1	2	3	4	5	6	7	8	9	10	11	12	13	14	15	16	17	18	19	20

Order now to -

ELECTRONICS DESIGN ASSOCIATES  
DEPT. PW  
82 Bath St., Walsall, WS1 3DE. Phone 33652

**LOW COST I.C. MOUNTING.** Lengths of 100 I.C. pin sockets, 60p (p & p 5p). Quantity rates, SAE details & sample. L.E.D. (MLED500), 20p each. (post paid). P.K.G. Electronics, "Oak Lodge", Tansley, Derbyshire.

**FERRIC CHLORIDE ETCHANT.** 100g 15p, 6p postage; 500g 60p, 25p postage. DYMOTT, 15 Langthorn Close, Frampton Cotterell, Bristol.

**P.W. CRATA F.M. TUNER.** Set of five P.C. boards £3, p&p 20p. Other components available. S.A.E. for lists. Teleradio, 325 Fore Street, Edmonton, London N9 0PE.

## P.W. EASY-BUILD ORGAN

SET OF TWO P.C.B.'s **£7-20**  
SET OF THIRTEEN MOS I.C.'s **£21-85**  
SET OF ALL SEMICONDUCTORS **£26-70**  
SET OF ALL SEMICONDUCTORS PLUS THE P.C.B.'s **£32-00**  
ALL INCLUDE P & P AND V.A.T.  
SEND FOR DETAILS OF PASSIVES OFFER

FORESIGHT ELECTRONICS  
62 HIGH ST., CROYDON, SURREY

TV, Audio, Radio Servicing. Most spares 1930-1975. Equipment designed, tested and maintained.

Technical Services (Luton) Ltd.,  
111 Cutenhoe Road, Luton, Beds.  
LU1 3NG. Tel. 0582 29673/27601

## SEND NOW!

We offer our own kits for these exciting new projects:

**PW Electronic Organ**  
**PW Ascot Cassette Recorder**  
and we still supply the famous  
**PE Rondo full Quadraphonic System**

Our new catalogue is FREE, but postage or S.A.E. would be appreciated.

# Studio Electronics

PO BOX 18 HARLOW  
CM18 6SH ESSEX

Tel: HARLOW (STD 0279) 25457

## TRANSISTORS (p. & p. 8p.)

All new and full spec.  
BC107/8/9, BC147/8/9, BC157/8/9 all 9p  
BF180 25p, BF182/3 40p, BF184 17p,  
BF187 13p, BFW10 55p, 741 8DIL 34p,  
BF336 35p, 2N3771 £1-10, 2N3441 50p,  
BD131 40p, 2N3055 45p, NE555 67p.

## EX COMPUTER PC PANELS

4 x 2in packed with semiconductors and top quality resistors, capacitors, diodes etc. Guaranteed min. 35 transistors, plus data 25 boards £1 (30p)

## ELECTROLYTICS

2,200μ 63v **35p (8p)**  
2,000μ 50v with clip **35p (8p)**  
4,700μ 63v **50p (12p)**  
15,000μ 30v, 68,000μ 16v **65p (22p)**  
30,000μ 25v **65p (22p)**  
4,000μ 70v, 3,600μ 40v 4 x 2" **55p (15p)**  
5,000μ 35v **40p (12p)**  
20A 100 piv Si recs 4 for **£1 (12p)**  
3A 100 piv Si recs 4 for **50p (8p)**  
250 mixed resistors **60p (13p)**  
250 mixed capacitors **60p (11p)**  
150 mixed HI-STABS **60p (11p)**  
200 Si planar diodes **60p (8p)**  
QH bulbs 12v 55w **50p (7p)**  
2N3055 EQUIV 4 for **£1 (10)**

## SMALL ELECTROLYTICS

2.2μ 10/16v, 10μ 35v, 50μ 40v, 100μ 40v, 100μ 6v, 150μ 10v, 64μ 10v 12 for **45p.**

## PRESETS 100mW

220Ω 470Ω 1k 4k7 10k 100k 12 for 50p.  
Postage and packing shown in brackets  
ADD 8% VAT to TOTAL

## KEYTRONICS

(Mail Order only)

44 EARLS COURT ROAD  
LONDON W8. 01-478 8499

# WATFORD ELECTRONICS

35 CARDIFF ROAD, WATFORD, HERTS, ENGLAND  
MAIL ORDER. CALLERS SATURDAYS ONLY

C.W.O. Please P. & P. add 15p to orders under £3. Prices exclusive of VAT

## Send 10p postage for our comprehensive catalogue

TRANSISTORS (less 10% for 25+ of one type)									
AC125 13p	BC149C 8p	BF181 33p	OC82 15p	2N1132 20p	2N3819 24p				
AC126 11p	BC157 8p	BF184 22p	OC83 20p	2N1301 20p	2N3820 38p				
AC127 11p	BC158 11p	BF185 22p	OC140 20p	2N1302 20p	2N3823 60p				
AC128 11p	BC159 13p	BF194 10p	OC201 70p	2N1303 20p	2N3904 15p				
AC176 11p	BC167 12p	BF195 10p	OC202 80p	2N1304 20p	2N3905 17p				
AC187 12p	BC168 12p	BF196 12p	TIP29 43p	2N1305 24p	2N3906 17p				
AC188 11p	BC169 12p	BF197 15p	TIP29A 45p	2N1306 24p	2N4037 35p				
AC171 35p	BC170 11p	BF257 32p	TIP30 48p	2N1307 24p	2N4547 30p				
AC191 25p	BC171 11p	BF595 18p	TIP30A 51p	2N1893 20p	2N4548 30p				
AC192 24p	BC172 11p	BFX86 21p	TIP31 54p	2N1900 45p	2N4549 30p				
AC221 29p	BC177 16p	BFX88 22p	TIP32 64p	2N2217 23p					
AC272 16p	BC178 16p	BFY50 15p	TIP33 95p	2N2303 25p					
AD140 48p	BC179 18p	BFY51 15p	TIP34 130p	2N2483 30p					
AD149 48p	BC182 10p	BFY52 15p	TIP41A 68p	2N2646 31p					
AD181 78p	BC183 10p	BFY53 17p	TIP42 70p	2N2906 15p					
AD182 78p	BC184 10p	BFY54 17p	TIP43A 74p	2N2907 14p					
AF114 13p	BC212 12p	BU105 £2.20	TIS43 26p	2N2926R 9p	OA81 8p				
AF115 13p	BC213 12p	MJE370 63p	TIS44 17p	2N2926G 9p	OA85 13p				
AF116 18p	BC214 12p	MJE371 78p	ZTX107 10p	2N2926Y 9p	OA91 6p				
AF117 13p	BC215 12p	MJE520 62p	ZTX108 10p	2N2926G 9p	OA9 9p				
AF118 40p	BC243 28p	MFP102 30p	ZTX109 12p	2N3053 18p	OA79 10p				
AF121 33p	BC258 18p	MPF103 30p	ZTX300 12p	2N3054 42p	OA79 10p				
AF124 30p	BC259 18p	MPF104 30p	ZTX301 14p	2N3055 45p	OA81 8p				
AF125 30p	BC270 15p	MPF105 35p	ZTX302 18p	2N3614 59p	OA85 13p				
AF126 30p	BC271 18p	OC26 40p	ZTX303 22p	2N3615 65p	OA90 6p				
AF127 30p	BC272 12p	OC28 48p	ZTX311 10p	2N3702 12p	OA91 6p				
AF139 33p	BC131 40p	OC35 48p	ZTX341 19p	2N3703 12p	OA200 6p				
AF181 45p	BD132 40p	OC36 52p	ZTX500 12p	2N3704 12p	OA202 6p				
AF186 48p	BD137 45p	OC41 45p	ZTX502 18p	2N3705 12p	PL4001 6p				
AF239 38p	BD145 55p	OC42 15p	ZTX504 42p	2N3706 10p	PL4004 6p				
BC107 9p	BDY60 59p	OC44 11p	ZTX531 23p	2N3707 10p	PL4007 6p				
BC108 9p	BDY61 52p	OC45 11p	ZTX550 18p	2N3708 8p	1N914 5p				
BC108B 11p	BF115 23p	OC70 11p	2N706 11p	2N3709 8p	1N4001/2 5p				
BC109 10p	BF177 26p	OC71 11p	2N708 16p	2N3710 9p	1N4003 6p				
BC109C 11p	BF178 28p	OC72 11p	2N918 40p	2N3771 140p	1N4004/5 6p				
BC147 7p	BF179 33p	OC74 28p	2N930 18p	2N3772 160p	1N4006/7 7p				
BC148 7p	BF180 33p	OC81 24p	2N1131 20p	2N3773 240p	1N4148 5p				

### DIODES

AA120 10p	BY100 18p
BY100 18p	BY164 35p
BY211 25p	OA5 38p
OA5 38p	OA9 9p
OA79 10p	OA79 10p
OA81 8p	OA85 13p
OA90 6p	OA91 6p
OA200 6p	OA202 6p
PL4001 6p	PL4004 6p
PL4007 6p	1N914 5p
1N4001/2 5p	1N4003 6p
1N4004/5 6p	1N4006/7 7p
1N4148 5p	

### TTL 74 DIGITAL ICs

Part No.	Price	Part No.	Price	Part No.	Price
7400 15p	7428 35p	7473 33p	7471 32p	7490 8 pin	27p
7401 15p	7430 15p	7474 32p	7472 33p	723C 14 pin	50p
7402 15p	7432 25p	7475 47p	7471 41p	741C 8 pin	26p
7403 15p	7433 38p	7476 32p	7451 69p	748C 8 pin	26p
7404 18p	7437 27p	7480 44p	7453 69p	TBA 800	95p
7405 18p	7438 27p	7481 99p	7455 69p	ZN 414	105p
7406 18p	7439 27p	7482 70p	7456 70p		
7407 38p	7441 75p	7483 83p	74160 101p		
7408 15p	7442 65p	7484 90p	74166 143p		
7409 15p	7443 120p	7485 125p	74167 315p		
7410 15p	7444 105p	7489 334p	74170 215p		
7411 20p	7445 86p	7490 47p	74172 540p		
7412 20p	7446 105p	7491 48p	74173 103p		
7413 35p	7447 100p	7492 48p	74180 106p		
7414 60p	7448 86p	7493 47p	74184 160p		
7416 35p	7450 15p	7495 63p	74185 169p		
7417 35p	7451 15p	7496 72p	74190 180p		
7420 15p	7453 15p	74100 135p	74191 160p		
7422 15p	7455 15p	74104 40p	74192 128p		
7423 27p	7460 15p	74105 40p	74193 128p		
7425 27p	7470 30p	74107 33p	74198 210p		
7426 27p	4772 26p	74110 43p	74199 210p		

### SPECIAL OFFER

While stocks last  
709C 8 pin 27p  
723C 14 pin 50p  
741C 8 pin 26p  
748C 8 pin 26p  
TBA 800 95p  
ZN 414 105p

### OPTO ELECTRONICS

Minitrans 3105F  
7 seg display 110p  
OCPT7 40p  
OCPT1 85p  
ORP12 58p  
ORP60 45p  
ORP61 46p

### LED TIL 209 (Red)

(with socket) 18p  
2N5777 40p

### LINEAR IC'S (less 5% 20+ mixed)

709C 27p	LM300 170p
723C 50p	LM380 100p
741C 26p	MC724 60p
747C 80p	MC1303L 130p
748C 26p	MC1304P 360p
7805 (Reg.) 160p	MC1310P 240p
AY-1-0212 5 50p	MC1710CG 60p
AY-1-5015 1 15p	MFC4000B 39p
CA-3018 72p	MLM309K 158p
CA-3020 140p	NE555 55p
CA-3035 135p	NE582 310p
CA-3036 90p	PA263 195p
CA-3046 55p	TBA810 150p
CA-3048 210p	SL403D 150p
CA-3075 150p	SL414A 150p
CA-3081 150p	SN76603 250p
CA-3089E 199p	SN76115 250p
CA-3090Q 310p	TAD100 140p
	TBA800 95p
	ZN414 150p

### BRIDGE RECTIFIER

(plastic case)	1A 50V 38p
	1A 100V 42p
	1A 100V 52p
	1A 200V 70p
	2A 50V 30p
	2A 100V 35p
	2A 200V 45p
	4A 80V 58p
	4A 100V 58p
	6A 100V 99p
	6A 400V 99p

### SCR (Thyristor)

1A 50V 38p	8 pin 14p
1A 100V 42p	14 pin 14p
1A 100V 52p	16 pin 15p
1A 200V 70p	24 pin 75p

### DIL SOCKETS

400V 3A 85p	78p
500V 3A 120p	78p
400V 6A 120p	80p
500V 6A 150p	80p

### ALUM. BOXES

2 1/2 x 5 1/2" 45p
4 x 4 1/2" 45p
4 x 2 1/2" 45p
4 x 5 1/2" 45p
4 x 2 1/2" 50p
3 x 2 1/2" 18p
7 x 5 1/2" 78p
10 x 7 3/8" 118p
10 x 4 1/2" 99p
12 x 5 3/8" 120p
12 x 8 3/8" 150p

### TRIACS

400V 3A 85p	78p
500V 3A 120p	78p
400V 6A 120p	80p
500V 6A 150p	80p

### DIAC

ST2 25p
---------

### FUSES AND HOLDERS

20mm 150mA-5A  
1" 2A-13A mains  
1 1/2" 250mA-15A  
Panel Holder Single  
Chassis Holder 20mm  
Chassis Holder 1 1/2"

### ENAMEL COPPER WIRE (2oz reel)

16, 18, 20, 22 SWG 32p  
24, 26, 28, 30 SWG 39p  
32, 34, 36, 40 SWG 48p

### FERRITE RODS: 1/8" diam.

2" - 8p; 5 1/2" - 12p; 6 1/2" - 16p

### STEREO JUNCTION BOXES

Provides multiple output to your Amplifier.  
JB31: 4 outputs. 2 for two sets of stereo headphones and 2 for two speakers.  
Price: £1.48 only.  
JB11D: Has output for two sets of stereo headphones, 2 speakers and 3 position switch for headphones, loudspeakers or both.  
Price: £1.95 only.

### AIRCRAFT BAND CONVERTOR

Mod. VHF 105  
Enjoy listening to Aircraft band by merely placing it beside a radio.  
Price: £4.75 p & p 15p.

### STEREO HEADPHONES

Light weight, 8 ohm impd. attractive, Dynamic.  
Price: £3.00 p & p 15p.

ALL DEVICES BRAND NEW AND FULLY GUARANTEED. ORDERS DESPATCHED BY RETURN OF POST. TERMS OF BUSINESS: CASH/CHEQUE/P.O.s OR BANKERS DRAFT WITH ORDER. GOVERNMENT AND EDUCATIONAL INSTITUTIONS OFFICIAL ORDERS ACCEPTED. TRADE AND EXPORT INQUIRY WELCOME. P & P ADD 15p TO ORDERS UNDER £3.00. OVERSEAS ORDERS POSTAGE AT COST, AIR/SURFACE PRICES EXCLUSIVE OF VAT.

**POLYESTER CAPACITORS:** Axial lead type. (Values are in µf).  
400V: 0.001, 0.0012, 0.0015, 0.0018, 0.0022, 0.0033, 0.0047, 0.0068, 0.01 3p; 0.015, 0.022, 0.033, 0.047, 0.068, 0.1 4p; 0.15, 0.22, 7p; 0.33, 10p; 0.47, 13p; 160V: 0.1, 0.15, 4p; 0.22 5p; 0.33 6p; 0.47 9p; 0.68 10p; 1.0 13p. 250V: 0.22 6p; 0.33 8p; 0.68 12p; 0.47 9p; 2.2 18p.

**RADIAL LEAD P.C. TYPE (Values are in µf).**  
250V: 0.01, 0.015, 0.022, 3p; 0.033, 0.047, 0.068, 3 1/2p; 0.1 4p; 0.15 4p; 0.22, 0.33 5p; 0.47 7p; 0.68 10p; 1.0 11p; 1.5 20p; 2.2 22p.

**ELECTROLYTIC CAPACITORS:** Axial lead type (Values are in µf)  
63V: 0.47, 1.0, 1.5, 2.2, 3.3, 4.4, 7, 6.8, 10, 15, 20, 22, 47, 68, 6p, 100, 12p. 40V: 100, 6p 30V: 3500, 35p. 25V: 68, 150, 6p; 220, 11p; 470, 13p. 25V: 680, 18p; 1000, 24p; 2200, 34p, 3000, 33p. 16V: 40, 125, 250, 6p. 16V: 1000, 1500, 16p. 10V: 4, 100, 5p; 640, 10p; 1000, 14p; 2200, 18p.

**POTENTIOMETERS (AB) Carbon**  
Tack, 0.25W Log & 0.5W Linear values  
1KΩ-2MΩ single gang 14p  
5KΩ-2MΩ single gang D/P switch 23p  
2KΩ-2MΩ dual gang stereo 42p

**SLIDER POTENTIOMETERS**  
0.25W log and linear values  
5KΩ-500KΩ single gang 35p  
10K-500K ohm Dual gang 50p  
KNOBS for above Black or Silvered 8p

**PRESET POTENTIOMETERS**  
0.1W 50Ω-1MΩ 5p  
0.25W 100Ω-2MΩ 8p  
0.25W kΩ-2MΩ 8p

**QUALITY RESISTORS. ERIE MAKE**  
Small Size, High Stability, Low Noise  
Type Pwr Tol. Range Val. 1-49 50-100 100+  
Carbon 1/2W 5% 2-2Ω-10M E24 1p 0.8p 0.7p  
Carbon 1/4W 5% 2-2Ω-10M E12 1p 0.8p 0.7p  
Carbon 1W 5% 2-2Ω-10M E24 2.5p 2p -  
WW 4W 10% 2-2Ω-100 E12 8p 7p -

Quantity price applies to resistors of each value not mixed.

JACK PLUGS	SOCKETS	PANEL METERS
Screened chrome 10p	Plastic body 8p	Open metal 8p
3mm 14p	10p	Moulded with break contacts 17p
Standard Mono 17p	13p	15p
Standard Stereo 30p	18p	25p

**DIN 2PIN LOUDSPEAKER**  
TYPE 3, 4, 5 (180° & 240°) 6PIN 12p 8p 15p

**CO-AXIAL (TV)** 10p 8p 15p (f.f.)

**PHONO** assorted colours 6p 5p (sgl.) 7p (dbl.) 10p (trpl.) 9p

**BANANA** 7p 7p -

**SWITCHES**  
TOGGLE: SPST 12p DPDT 28p  
PUSH BUTTON: Miniature push to make or break non locking 15p  
ROCKER (white): 10A 250V SP changer centre off 25p  
ROCKER: Illuminated (white) incorporates neon lights when on 45p

**ROTARY SWITCH:** 1 pole/12way 2p/6w, 2p/2w, 2p/4w, 3p/3w 3p/4w, 1A DP 250V 12p 1A DP 250V 9p 1A DP 250V 9p

**TRANSFORMERS MAINS**  
Primary 220-240V  
6-0-6 (miniature) 100mA 90p  
9-0-9 (miniature) 100mA 90p  
12-0-12 (miniature) 100mA 90p  
18-0-18 also 24V 100mA 90p  
20-0-24V 500mA 220p  
30-24-20-15-12



"VFA 5ft BELOW GROUND, same as dipole; elevated 15ft, one 'S' point UP on dipole".  
(Report by well-known station W70E, retired U.S. Govt. Electronics Engr.)

# ABOVE ALL RIDGE SYSTEM

It's the antenna system that counts! However good your equipment, if a PART-

return it (in re-saleable condition) for a cash refund.

**PARTRIDGE** have a complete **VFA SYSTEM**, correctly terminated for your equipment ranging from modern communications gear to a modest solid state radio. Don't be satisfied with anything less than the **PARTRIDGE WORLD RECORD ANTENNA SYSTEM!** Make your selection from the list below:-

(Each **SYSTEM** consists of the elegant gold stove enamelled 7' 6" VFA and a matching finish **JOYMATCH A.T.U.**, despatched direct by parcel post—our risk). (All prices delivered—our risk)

**SYSTEM 'A'** for modern Communications Receivers ..... £29 58

**SYSTEM 'D'** for other S.W. and M.W. receivers, all types ..... £20 84

**SYSTEM 'J'** for TXs and TCVRs up to 500w PEP 160 thru 10m (pa Inpt) ..... £33 59

**JOYMATCH A.T.U.** kit (1-6 continuous to 30 mHz) ..... £6 24

**JOYMATCH A.T.U.** kit (500 kHz continuous to 30 mHz) ..... £6 24

Either kit fully assembled ..... £7 55

**JOYMATCH "Aerial Bandswitch"** tuned aerial. MW & SW ..... £6 24

**SUPER SENSITIVE** general coverage DX-CRYSTAL SET that REALLY WORKS, not a toy, complete with Aerial and a sensitive matching Earpiece ..... £3 92

**COMMUNICATIONS HEADPHONES**, 8 ohms, matches most modern Comm. Rxs. ..... £3 39

VFA Stack Lashing (Massive VFA support on chimney stack) ..... £2 51

VFA Heavy duty Wall Bracket (18" stand off) ..... £2 51

**JOYMATCH** Artificial Earth (ground) switch tuned ..... £6 24

A.G.T.U. Artificial Earth D.I.Y. add on unit for your A.T.U. ..... £0 60

Radials for the A.G.T.U. cut to required band, each ..... £0 60

"INVISIBLE AERIAL" wire, tough PVC covered tinned copper 22swg per 10m ..... £0 60

A.G.T.U. supplied fitted to **JOYMATCH A.T.U.'s** (less radials) ..... £0 80

Coax cable, RX type, 75 ohms, per 10 metres ..... £0 88

**AERIAL WIRE**, heavy duty 16swg enamelled aluminium, per 10 metres ..... £0 59

**VALVES**, complete set for 9R59DS & 9R59DE, including OA2 stabiliser ..... £4 75

Send 41p stamp for details and expert advice.

## BOX 5 PARTRIDGE SUPER PACKAGE £157'58



Phone 0843 62535

or 62839

(after office hours)

G3CED G3VFA



## INDEX TO ADVERTISERS

A. H. Supplies	1050
Adcola	1026
Allard Electronics	1054
Ambit International	1025
Arrow Electronics	1051
A.S.P. Ltd.	973
B. B. Supplies	1057
Barrie Electronics	1046
Baykin Engineering Ltd.	1056
Bentley Acoustics	970
Beta Devices	1054
B. H. Component Factors Ltd.	996
Bi-Pak Semiconductors	974-975
Bi-Pre-Pak Ltd.	971
Bib Hi-Fi Accessories Ltd.	972
Boffin Projects	1056
Bothwell	984
British Institute of Engineering Technology	1029, 1038 cover iii
British National Radio & Electronics School	968, 982, 995
J. Bull (Electrical) Ltd.	1037
Bush & Meissner	976
C. Caranna	1055
Chillmead Ltd.	982
Chromasonic Electronics	1044-1045
C. J. L. Ltd.	970
Codar	972
Colomor (Electronics) Ltd.	1000
Crescent Radio Ltd.	1033
Crofton Electronics	1052
Dabar Electronic Products	1026
D.E.W. Ltd.	1056
Doram Electronics Ltd.	1003
Electronics Brokers	1057
Electronic Design Associates	1034-1057
Electronic Mail Order Ltd.	1046
Electron-kit	996
Electrospares	978
Electro-Tech	1053
Electrovalue Ltd.	1050

Felstead Electronics	996
Flairline	1053
Foresight Electronics	1057
Foulsham Tab	1053
F. W. Electronics	1056
Galleon Trading	1054
Garfields	1056
Greenweld Electronics	1026
H.A.C. (Shortwave) Products	1004
Harversons Surplus Co. Ltd.	977
Heath (Gloucester) Ltd.	1029
Henry's Radio Ltd.	cover iv
Home Radio	999
I.L.P. (Electronics) Ltd.	1007
Imperial Trading	1055
Interface International	973
Intertext (I.C.S.)	978, 1055
Jones, J. C.	973
Kensington Supplies	1054
Keytronics	1057
Lasky's	1041-1042-1043
Lewis Radio	970
Light Soldering Ltd.	968
Linear Products Ltd.	1000
Logic Leisure Ltd.	984
London Computer Operators Training Centre	1055
Maplin Electronic Supplies	985
Marco Trading	1054
Marshall, A.	982
Milward, G. F.	1060
Minikits Electronics	1056
Muscat	1055
Newmart Electronics	969
Newnes-Butterworth	984
Partridge Electronics Ltd.	1059
Pembridge College	1046

Radio Book Services	1053
Radio Component Specialists	98 i
Radio Exchange Ltd.	cover i
Radio Shop, The	968
Radio Society of Great Britain	1034
R.C.S. Products Ltd.	1052
R.S.C. (Hi-Fi) Centre Ltd.	966-967
R.S.T. Valve Mail Order Co.	979
R. & T.V. Components Ltd.	1048-1049
Riversdale Electronics	1038
Salop Electronics	1056
Saxon Entertainment Specialists	1047
Selray Book Co.	1040
Sinclair (Cambridge) Ltd.	1018-1019
Simtech Engineering Ltd.	1056
Sound Systems of Suffolk	1054
Strong	1050
Studio Electronics	1057
Surpltronics	1052
Swanley Electronics	1052
Technical Services (Luton) Ltd.	1057
Technomatic Ltd.	1038
Trampus Electronics Ltd.	976
T.U.A.C.	980-981
Tweedy (J. & A.)	1055
Vero Electronics	1004
Watford Electronics	1058
Web Europa	1050
West London Direct Supplies	976
Wilmslow Audio	1004
Young, A. W.	976
Xeroza Radio	1053
Z & I Aero Services	1060

Head Office and Warehouse  
44A WESTBOURNE GROVE  
LONDON W2 5SF  
Tel: 727 5641/2/3

# Z & I AERO SERVICES LTD.

Please send all correspondence and Mail-Orders to Head Office  
Our new 1975 Catalogue/Price list of valves, tubes, semiconductor, Test Equipment  
and passive components is now ready. Please send £0.20 for your copy.  
No C.O.D. orders accepted

Retail Shop  
85 TOTTENHAM COURT ROAD  
LONDON W1  
Tel: 580 8403  
Open all day Saturday

## AC/DC MULTIMETER TYPE U4324



33 ranges up to  
3 Amps AC/DC;  
1200V DC, 900V  
AC, 500kΩ, +12  
db.

Sensitivity:  
20kΩ/V DC;  
4kΩ/V AC

Accuracy:  
±2.5% DC;  
±4% AC

Movement is protected by silicon diodes.

Dimensions 167×98×63 mm. Weight: 1.5lb.

PRICE: complete with test leads, instruction manual and fibre-board storage case £9.85. Packing & carr. £0.50.

## MULTIMETER TYPE U4323

Sensitivity: 20,000Ω/V.

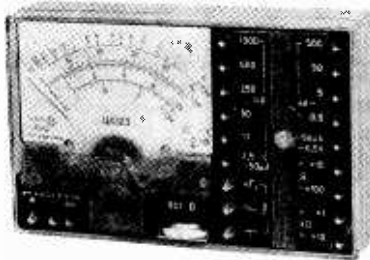

7 D.C. Voltage ranges 0.5-1000V  
6 A.C. Voltage ranges 2.5-1000V  
5 D.C. Current ranges 0.05-500mA  
4 Resistance ranges 1kΩ-1mΩ

Built-in oscillator providing AF output of 1kHz and I.F. output of 465kHz with an amplitude of 1 volt minimum.

Dimensions: 140×87×40 mm. Weight 0.5kg

PRICE complete with leads and plastic storage case £8.00. Packing & postage £0.50

## AC/DC MULTIMETER TYPE U4313

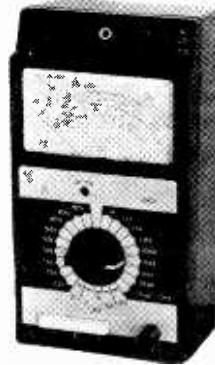

39 ranges:  
600μA to 1.5A  
AC  
60μA to 1.5A DC  
75mV to 600V  
DC  
1.5V to 600V AC  
1MΩ, 0.5μF, 12db

Accuracy: 1.5%  
DC; 2.5% AC  
Sensitivity: 20k  
Ω/V DC; 2kΩ/V  
AC

Mirror scale 86mm long.

Dimensions: 115×215×90 mm, Weight 3.3lb.

PRICE, complete with test leads, service manual and steel carrying case £13.80. Packing & carriage £0.50.

**ALL THE ABOVE INSTRUMENTS FEATURE TAUT SUSPENSION MOVEMENTS  
PRICES ARE EXCLUSIVE OF V.A.T.**

## G. F. MILWARD, 369 Alum Rock Road, Birmingham B8 3DR. Tel. 021-327 2339

We are glad to say that it is now possible to supply from stock the following integrated circuits.  
**ALL ARE BRANDED, FULL SPECIFICATION** devices offered at unbeatable prices

	1/99	100/499	500/1000		1/99	100/499	500/1000		1/99	100/499	500/1000
7400	£0.15	£0.125	£0.10	7442	£0.645	£0.537	£0.43	7494	£0.495	£0.412	£0.33
7401	£0.15	£0.125	£0.10	7443	£1.275	£1.062	£0.85	7495	£0.63	£0.525	£0.42
7402	£0.15	£0.125	£0.10	7445	£0.855	£0.712	£0.57	7496	£0.72	£0.60	£0.48
7403	£0.15	£0.125	£0.10	7446	£1.05	£0.875	£0.70	74104	£0.315	£0.262	£0.21
7404	£0.18	£0.15	£0.12	7446A	£1.05	£0.875	£0.70	74105	£0.315	£0.262	£0.21
7405	£0.18	£0.15	£0.12	7447	£1.05	£0.875	£0.70	74107	£0.315	£0.262	£0.21
7406	£0.375	£0.312	£0.25	7447A	£1.05	£0.875	£0.70	74121	£0.315	£0.262	£0.21
7407	£0.375	£0.312	£0.25	7448	£0.855	£0.712	£0.57	74122	£0.45	£0.375	£0.30
7408	£0.15	£0.125	£0.10	7450	£0.15	£0.125	£0.10	74123	£0.83	£0.525	£0.42
7409	£0.15	£0.125	£0.10	7451	£0.15	£0.125	£0.10	74141	£0.75	£0.625	£0.50
7410	£0.15	£0.125	£0.10	7453	£0.15	£0.125	£0.10	74151	£0.60	£0.575	£0.46
7412	£0.195	£0.162	£0.13	7454	£0.15	£0.125	£0.10	74153	£0.60	£0.575	£0.46
7413	£0.345	£0.287	£0.23	7480	£0.15	£0.125	£0.10	74155	£0.60	£0.575	£0.46
7416	£0.345	£0.287	£0.23	7472	£0.255	£0.212	£0.17	74156	£0.60	£0.575	£0.46
7417	£0.345	£0.287	£0.23	7473	£0.315	£0.262	£0.21	74160	£1.005	£0.837	£0.67
7420	£0.15	£0.125	£0.10	7474	£0.315	£0.262	£0.21	74161	£1.005	£0.837	£0.67
7423	£0.27	£0.225	£0.18	7475	£0.485	£0.387	£0.31	74182	£1.005	£0.837	£0.67
7425	£0.27	£0.225	£0.18	7476	£0.315	£0.262	£0.21	74183	£1.005	£0.837	£0.67
7426	£0.27	£0.225	£0.18	7480	£0.435	£0.352	£0.28	74186	£1.425	£1.187	£0.95
7427	£0.27	£0.225	£0.18	7482	£0.75	£0.625	£0.50	74174	£1.20	£1.00	£0.80
7430	£0.15	£0.125	£0.10	7483	£0.825	£0.687	£0.55	74175	£0.975	£0.812	£0.65
7432	£0.27	£0.225	£0.18	7485	£1.275	£1.062	£0.85	74192	£1.275	£1.062	£0.85
7437	£0.27	£0.225	£0.18	7486	£0.315	£0.262	£0.21	74193	£1.275	£1.062	£0.85
7438	£0.27	£0.225	£0.18	7490	£0.485	£0.387	£0.31	74198	£2.10	£1.75	£1.40
7440	£0.15	£0.125	£0.10	7492	£0.485	£0.387	£0.31	74199	£2.10	£1.75	£1.40
7441A	£0.825	£0.687	£0.55	7493	£0.485	£0.387	£0.31				

To secure the above prices, all orders for these devices must exceed £10 in total value. Price rating is established by TOTAL NUMBER OF DEVICES ORDERED. Any mix may be made. For special quotations for large orders ring 021-327 2339 NOW!

## BRAN TUB!!!

- ★ Resistors, Wire-wound and Carbon
- ★ Capacitors, Silver-mica, Paper, Ceramic, Polyester and Electrolytic
- ★ Controls, Volume, Pre-set, Carbon, Wire
- ★ Diodes, Silicon, Germanium, Zener
- ★ Transistors, Silicon, Germanium

All the above are new and unused stock.

We have made up packs of 2lb gross weight, all are different in content, and contain a mixture of components from the above list. This is a fantastic unrepeatable offer that will enable you to get a good stock of spares at a tiny fraction of normal price!

To make things even more interesting — TWENTY OF THESE BAGS ALSO CONTAIN A POUND NOTE! TWENTY CUSTOMERS WILL BE VERY PLEASED INDEED!

Rush your order now! This offer is only made to reduce our surplus stock! It is unlikely that in these days of rising prices we shall ever be able to repeat!

And the price that we are asking? Only £1.50 including both postage and VAT!

## NEW! NEW! NEW! NEW!

An aerosol spray providing a convenient means of producing any number of copies of a printed circuit both simply and quickly.

Method: Spray copper laminate board with light sensitive spray. Cover with transparent film upon which circuit has been drawn. Expose to light. (No need to use ultra-violet.) Spray with developer, rinse and etch in normal manner.

Light sensitive aerosol spray .. .. . £1.00  
Developer and Etchant .. .. . 50p

PLUS POSTAGE

## FIBRE-GLASS COPPER LAMINATE

Single-sided .. .. . 75p sq. ft.

Double-sided .. .. . £1 sq. ft.

Cut in any multiple of 6"

To a maximum size of 3' x 4'

POSTAGE 30p

NOTE: ALL GOODS PLUS 8% VAT (EXCEPT OVERSEAS)

POSTAGE 30p

# FREE!

## Over 150 ways to engineer a better future

HIGHER PAY

A BETTER JOB

SECURITY

### find out how in just 2 minutes

That's how long it will take you to fill in the coupon. Mail it today and we'll send you full details and a free book. We have successfully trained thousands of men at home—equipped them for higher pay and better, more interesting jobs. We can do as much for YOU. A low-cost home study course gets results fast—makes learning easier and something to look forward to. There are no books to buy and you can pay-as-you-learn.

Why not do the thing that really interests you? Without losing a day's pay, you could quietly turn yourself into something of an expert. Complete the coupon (or write if you prefer not to cut the page). No obligation and nobody will call in on you . . . but it could be the best thing you ever did.

Others have done it, so can you

"Yesterday I received a letter from the Institution informing that my application for Associate Membership had been approved. I can honestly say that this has been the best value for money I have ever obtained, a view echoed by two colleagues who recently commenced the course". Student D.I.B., Yorks.

"Completing your course, meant going from a job I detested to a job that I love, with unlimited prospects"—Student J.A.O. Dublin.  
 "My training quickly changed my earning capacity and, in the next few years, my earnings increased fourfold". Student C.C.P., Bucks.

**FIND OUT FOR YOURSELF**

These letters and there are many more on file at Aldermaston College, speak of the rewards that come to the man who has given himself the specialised know-how employers seek. There's no surer way of getting ahead or of opening up new opportunities for yourself. It will cost you a stamp to find out how we can help you. Write to

**ALDERMASTON COLLEGE**

Dept. RPW02, Reading RG7 4PF.

**HOME OF BRITISH INSTITUTE OF ENGINEERING TECHNOLOGY**

Practical Radio & Electronics Certificate course includes a learn while you build **3 transistor radio kit.**

Everything you need to know about **Radio & Electronics** maintenance and repairs for a **spare time income** and a **career** for a better future.



**CUT OUT THIS COUPON**  
 Tick or state subject of interest.  
 Post to address below.

<input type="checkbox"/> MECHANICAL	<input type="checkbox"/> DRAUGHTSMANSHIP	<input type="checkbox"/> Construction Surveyors Institute I.C.S.I.
<input type="checkbox"/> Society of Engineers—	<input type="checkbox"/> Institute of Engineering Designers (A.M.I.E.D.)	<input type="checkbox"/> City & Guilds (all branches)
<input type="checkbox"/> A.M.S.E. (Mech)	<input type="checkbox"/> General	<input type="checkbox"/> Heating & Vent.
<input type="checkbox"/> Institute of Engineer & Technicians (A.M.I.E.)	<input type="checkbox"/> Draughtsmanship	<input type="checkbox"/> Inst. Clerk of Works
<input type="checkbox"/> CITY & GUILDS	<input type="checkbox"/> Elec. Draughtsmanship	<input type="checkbox"/> Site Surveying
<input type="checkbox"/> Gen. Mech. Eng.	<input type="checkbox"/> Architectural	<input type="checkbox"/> Health Engineering
<input type="checkbox"/> Maintenance Eng.	<input type="checkbox"/> Draughtsmanship	<input type="checkbox"/> Road Construction
<input type="checkbox"/> Welding	<input type="checkbox"/> Technical	<input type="checkbox"/> Quantities
<input type="checkbox"/> Gen. Diesel Eng.	<input type="checkbox"/> Drawing	<input type="checkbox"/> Estimates
<input type="checkbox"/> Sheet Metal Work		<input type="checkbox"/> Hydraulics
<input type="checkbox"/> Eng. Inspection		<input type="checkbox"/> Structural Eng.
<input type="checkbox"/> Eng. Metallurgy		
<input type="checkbox"/> ELECTRICAL & ELECTRONIC	<input type="checkbox"/> RADIO & TELECOMMUNICATIONS	<input type="checkbox"/> GENERAL
<input type="checkbox"/> CITY & GUILDS	<input type="checkbox"/> City & Guilds	<input type="checkbox"/> Agricultural Eng.
<input type="checkbox"/> Gen. Electrical	<input type="checkbox"/> Telecons	<input type="checkbox"/> Council of Eng. Institutions
<input type="checkbox"/> Engineering	<input type="checkbox"/> Gen. Radio & TV	<input type="checkbox"/> Farm Science
<input type="checkbox"/> Electrical	<input type="checkbox"/> Eng.	<input type="checkbox"/> Plastics
<input type="checkbox"/> Installations	<input type="checkbox"/> Radio Amateurs	
<input type="checkbox"/> Electrical Maths	<input type="checkbox"/> Exam	<input type="checkbox"/> Supplementary courses for Nat. Certificates.
<input type="checkbox"/> Computer	<input type="checkbox"/> Radio Servicing	
<input type="checkbox"/> Electronics		
<input type="checkbox"/> Electronic Eng.	<input type="checkbox"/> AUTOMOBILE & AERONAUTICAL	
<input type="checkbox"/> Practical Radio & Electronics (with kit)	<input type="checkbox"/> Institute of the Motor Industry A.M.I.I.	
<input type="checkbox"/> MANAGEMENT & PRODUCTION	<input type="checkbox"/> MAA/IMI	
<input type="checkbox"/> Institute of Cost & Management	<input type="checkbox"/> City & Guilds	
<input type="checkbox"/> Accntns.	<input type="checkbox"/> Auto Eng.	
<input type="checkbox"/> Computer	<input type="checkbox"/> Gen. Auto Eng.	
<input type="checkbox"/> Programming	<input type="checkbox"/> Motor Mechanics	
<input type="checkbox"/> Works M'nt	<input type="checkbox"/> Auto Diesel Eng.	
<input type="checkbox"/> Work Study	<input type="checkbox"/> Garage M'nt	
<input type="checkbox"/> Gen. Production	<input type="checkbox"/> AEC Aero	
<input type="checkbox"/> Eng.	<input type="checkbox"/> Engineering Exams	
<input type="checkbox"/> Estimating & Planning	<input type="checkbox"/> Gen. Aero Eng.	
<input type="checkbox"/> Storekeeping	<input type="checkbox"/> CONSTRUCTIONAL	
<input type="checkbox"/> Management	<input type="checkbox"/> Institute of Building	<input type="checkbox"/> Coaching for many exams, including C & G
<input type="checkbox"/> Skills	<input type="checkbox"/> L.I.O.B.	
<input type="checkbox"/> Quality Control	<input type="checkbox"/> A.B.T. Clerk of Works	

**G.C.E.**  
 —choose from 58 'O' & 'A' level subjects

**POST TODAY FOR A BETTER TOMORROW**

To Aldermaston College,  
 Dept. RPW02, Reading RG7 4PF.

NAME.....  
 Block capitals please  
 ADDRESS.....  
 .....  
 ..... POSTCODE.....  
 OTHER SUBJECTS.....  
 ..... AGE.....

Accredited by C.A.C.C. Member of A.B.C.C.

Published on approximately the 7th of each month by IPC Magazines Limited, Fleetway House, Farringdon Street, London EC4A 4AD. Printed in England by Index Printers, Dunstable, Beds. Sole Agents for Australia and New Zealand—Gordon and Gotch (Asia) Ltd.; South Africa—Central News Agency Ltd. Publisher's subscription rate (including postage): for one year UK £3.85, Overseas £4.95 (\$13.50 USA/Canada) International Giro facilities Account No. 5122007. Please state reason for payment "message to payee". PRACTICAL WIRELESS is sold subject to the following conditions, namely that it shall not, without the written consent of the Publishers first having been given, be lent, resold, hired out or otherwise disposed of by way of Trade at more than the recommended selling price shown on the cover, excluding Eire where the selling price is subject to V.A.T., and that it shall not be lent, resold, hired out or otherwise disposed of in a mutilated condition or in any unauthorised cover by way of Trade or affixed to or as part of any publication or advertising, literary or pictorial matter whatsoever.

# Henry's Radio

LARGEST SELECTION OF ELECTRONIC COMPONENTS AND EQUIPMENT. LOW PRICES - MEAN LESS VAT.



## You can build the Texan and Stereo FM Tuner

### TEXAN 20 + 20 WATT IC STEREO AMPLIFIER

Features glass fibre PC board, Gardners low field transformer 6-IC's, 10-transistors plus diodes, etc. Designed by Texas Instruments engineers for Henry's and, P.W. 1972. Supplied with full chassis work, detailed construction handbook and all necessary parts. Full input and control facilities. Stabilised supply. Overall size 15 1/2" x 22 1/2" x 6 1/2" mains operated. Free teak sleeve with every kit. **£31.00 (Carriage 50p).** (also built and tested £37.50)



**HENELEC Stereo FM Tuner** Features capacity diode tuning, led and tuning meter indicators, stabilised power supply—mains operated. High performance and sensitivity with unique station indication IC stereo decoder. Overall size in teak sleeve 8" x 22" x 6 1/2". Complete kit with teak sleeve **£21.00 (Carriage 50p).** (also built and tested £24.95)

## JOIN THE LARGE BAND OF HAPPY CONSTRUCTORS!

### TRANSISTORISED MODULES



**Tuners - Power Supplies - Amplifiers**

**AMPLIFIERS (All single channel unless stated)**

		£ p
4-300	9 volt 300 MW	1.75
2004	9 volt 250 MW	2.70
104	9 volt 1 watt	3.10
304	9 volt 3 watt	3.95
555	12 volt 3 watt	4.10
555ST	12 volt 1 1/2 + 1 1/2 watt	5.10
E1208	12 volt 5 watt	4.95
608	24 volt 10 watt	4.95
410	28 volt 10 watt	4.95
620	45 volt 30 watt	9.95
Z40	30/35 volt 15 watt	3.45
260	45/50 volt 25 watt	6.95
SA6817	24 volt 6 + 6	10.20

**Amplifiers with controls**

E1210	12 volt 2 1/2 + 2 1/2 watts 8 ohms	8.25
R500	Mains 5 watts 4-16 ohms	6.30
SAC14	Mains 7 + 7 watts 8 ohms	11.75
SAC30	Mains 15 + 15 watts 8 ohms	14.95
CAO38	9 volt 1 1/2 + 1 1/2 watts 8 ohms	6.95
CAO68	12 volt 3 + 3 watts 8 ohms	10.50

**AM/FM Modules**

Mullard LP 1186 FM tuner (front end) with data 10.7 MHZ O/P	4.85
LP1157 Am/Module	£2.50
LP1171 Am/FM Module	£4.50
LP1179 Am/FM Front End	£4.85
Mullard LP 1185 10.7 MHZ IF unit with data	4.50
Gorler Permeability FM tuner (front end) 10.7 MHZ O/P	4.20

**FM and AM Tuners and Decoders**

FM5231 (2) 6 volt fm tuner	7.95
TU312 volt version (FM use with Decoder)	7.95
SD4912 Stereo Decoder for Tu 3-12 volt	7.95
SP62H 6 volt Stereo FM tuner	14.80
A1007 9 volt MW-AM	4.95
Sinclair 12/45 volt FM tuner stereo recorder for above	7.45
AI018 9 volt FM tuner in cabinet	13.95
AI005M (S) 9-12 volt Stereo decoder FM for above	7.50
106Z 12 volt Stereo decoder general purpose	6.50

**Preamplifiers**

Sinclair Stereo 60 Preamplifier	6.75
E1300 Cart/Tape Mic Inputs 9 volt	2.85
E1310 Stereo 3-30 mV mal cart 9 volt	4.75
F373 Stereo 3 mV tape head 9 volt	4.95
3402 Stereo 5-20 mV Mag. cart. mains	5.95
EQ25 Mono 3-250 mV Tape/Cart/Play 9 volt	1.95

**Power Supplies Mains Input** (chassis-rest cased)

470C6 7 1/2 9V 300 MA with ad/ps	2.25
P500 9 volt 500 MA	3.20
HC244R 3/6 7 1/2 9V 400 MA stabilised	5.50
*P11 2v 1/2 amp. 3-30	3.30
*P15 28V 1/2 amp	3.30
*P1080 12V 1A 4.7	4.45
*P1081 45V 0.9A	7.80
P12 4v-12V 0.4-1 amp	7.15
SE107 S 3/6 9/12V, 1 amp stabilised	12.75
PI076 3/4 6/7 9/12V, 1/2 amp	4.20
SE800A 1-15 VOLT 0-1A stabilised	17.50

### EMI SPEAKERS SPECIAL PURCHASE

13 in. x 8 in. chassis speakers £3.85 each  
 \*150 TC 10 watts 8 ohms twin cone £2.20  
 \*450 10 watts 4, 8, 15 ohm with twin tweeters and crossover £3.85 each  
 EW 15 watt 8 ohms with tweeter £5.25  
 350 20 watt 8, 15 ohm with tweeter £7.80 each  
 \*Polished wood cabinet £4.80 carr., etc. 35p each or 50p pair.

### UHF TV TUNERS

625 line receiver UHF transistorised tuners UK operation. Brand new. (Post/packing 25p. each).  
 TYPE C variable tuning £2.50  
 TYPE B 4-button push-button (adjustable) £3.50

### PA-DISCOQUE LIGHTING EQUIPMENT

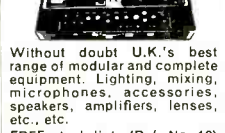

Without doubt U.K.'s best range of modular and complete equipment. Lighting, mixing, microphones, accessories, speakers, amplifiers, lenses, etc., etc.

FREE stock lists (Ref. No. 18) on request CALL IN AND SEE FOR YOURSELF AT  
**HENRY'S DISCO CENTRE,**  
 309 EDGWARE ROAD,  
 TEL. 01-723 6963

**NOW OPEN SUPERMARKET**  
 Come and browse round the new components supermarket at 404, Edgware Road. Bargains galore. Goodie Bags. Components, etc.  
**WATCH FOR FURTHER DEVELOPMENTS!**

EP27 Low Cost Seven Segment Led. Digit Height 1/2 inch. £1.35 pp 15p  
 L450 RECHARGEABLE BATTERY 2v 400mA/HR 50p pp 15p.

**PHILIPS 12V FLUORESCENT INVERTER**  
 for 8w fluorescent tube. Supplies with instr. and tube £3.50 p.o. 30p.

**STC & ITT MINIATURE RELAYS**

150R 6v	2p c.o.
180R 6/12v	2p c.o.
185R 12v	2p c.o.
430 1250R 12/55	2p c.o.
780 1700R 18/24v	2p c.o.
715 1800R 24v	4p c.o.
1275 2500R 18/24v	2p c.o.
420 4000R 24v	2p c.o.
BRAND NEW 60p p.p. 15p	

### TEST EQUIPMENT MULTIMETERS

Carr/packing 35p)	£ p
J4324 20kΩ/V with case	9.25
J435 20kΩ/V with steel case	8.75
J4313 20kΩ/V with steel case	12.50
J4317 20kΩ/V with case	16.50
J4341 33kΩ/V plus transistor steel case	10.50
U4323 20kΩ/V plus 1kHz OSC with case	7.70
ITI-2 20kΩ/V slim type	5.95
THL33D (L33DX) 2kΩ/V	
Robust TP55N 20kΩ/V (Case £2)	7.50
TP10S 20kΩ/V	6.25
TW20S 20kΩ/V	10.00
TW50K 50kΩ/V	11.25
EP10KN 10kΩ/V	9.95
AF10S 50kΩ/V Deluxe (case £1.90)	12.50
S100T 100kΩ/V plus transistor tester	22.50



### NEW REVOLUTIONARY SUPERTESTER 680R

	£ p
680R Multi-tester	18.50
TE40 AC Multivoltmeter 175	
TE15 Grid dip meter 440Hz-28MHz	19.50
TE65 28 Range valve voltmeter	22.50
TE20D RF Generator 120Hz-500MHz	18.95
TE22D AF Generator 20Hz-200kHz	19.95
*HM350 in circuit transistor tester	19.50
*C200 De-luxe meter 1-300mHz	6.95
*TT145 Compact transistor tester	14.75
SN7426N 20Hz-200Hz	19.75
*C3042 S/R Meter	5.75
*SE350A De-luxe signal tracer	12.95
*SE400 Mini-lab all in one tester	15.50
C1-5 Scop 500,000KHz (carr. £1.00)	43.00
*C3043 5 CH F/A meter 1-300mHz	5.75
R'stance sub box J P'stetc	2.40
Capacitor 20p 2.10	
SN7483N 100kΩ/V formers (carr. £1)	6.55
SN7484N	1.00
Radio activity counter 0-10r (carr. £1)	9.97
Mains unit for above (carr. 50p)	3.75

### TAPE HEADS

Marriot XRPS/174 Track High	2.50
Marriot XRPS/18 1/2 Track Med.	3.50
Marriot XRPS/36 1/2 Track Med.	5.00
Marriot XRPS/63 1/2 Track High	1.75
Marriot Erase Heads for XRSP 17/18 (XES11)	75p
Marriot BX1ZE 343 1/2 Track eraser	75p
R/R/P1 Rec'd/Play 1 Track HRP S'gle Trk Rec/Play 35p	
Bogen Type UL290 Erase 1-50	
Miniature Stereo Cassette Rec/Play	2.25

### EXCLUSIVE 5 WATT IC AMPLIFIERS

Special purchase 5 watt output 8-15 ohm load. 30 volt max. DC operation. complete with data. Price £1.50 each or 2 for £2.85.  
 Printed Circuit Panels 50p.

### CALCULATORS

Sinclair Cambridge Kit	£13.50
Sinclair Cambridge (Build)	£17.50
Sinclair Memory	£22.50
Sinclair Scientific	£26.95
Sinclair Scientific Kit	£18.50

### ALL PRICES SUBJECT TO 8% VAT

**EXTRA DISCOUNTS**  
 Semiconductor—Any one type or mixed SN74 Series 'IC', 12—extra 10%; 25—extra 15%; 100—extra 20%.  
**74 SERIES & LINEAR**

£ p	£ p	£ p
SN7400N 0.16	SN7485N 1.63	SN74191N 2.00
SN7401N 0.16	SN7486N 0.47	SN74192N 2.00
SN7402N 0.16	SN7489N 3.87	SN74193N 2.00
SN7403N 0.16	SN7490N 0.55	SN74194N 1.30
SN7404N 0.22	SN7491N 1.38	SN7495N 1.10
SN7405N 0.26	SN7492N 0.70	SN7496N 1.20
SN7406N 0.42	SN7493N 0.70	SN7497N 1.20
SN7407N 0.42	SN7494N 0.80	SN7498N 2.77
SN7408N 0.28	SN7495N 0.80	SN7499N 2.52
SN7409N 0.28	SN7496N 0.95	RCA
SN7410N 0.16	SN7497N 3.87	CA3012 1.32
SN7411N 0.25	SN74100N 1.89	CA3014 1.80
SN7412N 0.30	SN74101A 0.58	CA3018 1.12
SN7413N 0.36	SN74105N 0.53	CA3019 1.02
SN7414N 0.72	SN74107N 0.45	CA3020 1.80
SN7416N 0.36	SN74110N 0.58	CA3022 1.93
SN7417N 0.36	SN74111N 0.86	CA3028A 1.03
SN7420N 0.16	SN74112N 0.86	CA3036 1.08
SN7421N 0.33	SN74118N 0.90	CA3046 0.70
SN7422N 0.25	SN74119N 1.68	CA3048 2.11
SN7423N 0.37	SN74120N 0.95	CA3075 1.75
SN7425N 0.37	SN74121N 0.50	CA3081 1.80
SN7426N 0.32	SN74122N 0.70	CA3089E 2.94
SN7427N 0.25	SN74123N 1.00	CA3090 4.23
SN7428N 0.40	SN74125N 0.65	Signetics
SN7430N 0.16	SN74132N 0.72	NE555 0.65
SN7432N 0.37	SN74141N 0.90	NE660B 4.50
SN7433N 0.37	SN74145N 1.26	NE561B 4.50
SN7437N 0.37	SN74150N 1.75	NE562B 4.50
SN7438N 0.37	SN74151N 0.00	NE563B 2.65
SN7440N 0.22	SN74153N 0.95	Motorola
SN7441A 0.92	SN74154N 2.00	MC1301L 1.42
SN7442N 0.79	SN74155N 1.00	MC1304P 1.79
SN7443N 1.27	SN74156N 1.00	MC1301P 2.91
SN7444N 1.27	SN74157N 0.95	MC1358CF 0.77
SN7445N 1.60	SN74158N 0.95	MC1711CC 0.60
SN7446N 1.89	SN74161N 1.38	MC14000P 0.45
SN7447A 1.60	SN74162N 1.38	MF4010P 0.55
SN7448N 1.27	SN74163N 1.38	MF6040P 1.00
SN7449N 0.16	SN74164N 1.76	Others
SN7451N 0.16	SN74165N 1.76	TBA801 1.50
SN7454N 0.16	SN74166N 1.76	TA0303N 1.50
SN7455N 0.16	SN74167N 3.00	SN72741P 0.62
SN7460N 0.16	SN74170N 2.52	SN72748P 0.61
SN7470N 0.36	SN74173N 1.66	702C 0.75
SN7472N 0.38	SN74174N 1.57	709C 0.39
SN7473N 0.41	SN74175N 1.10	723C 0.90
SN7474N 0.45	SN74176N 1.42	725C 0.45
SN7475N 0.59	SN74177N 1.26	741C 0.60
SN7476N 0.45	SN74180N 1.26	747C 1.00
SN7480N 0.60	SN74181N 1.35	748C 0.61
SN7481N 1.10	SN74182N 1.26	LM309K 2.00
SN7482N 0.87	SN74184N 1.80	TA3950 1.75
SN7483N 1.10	SN74185N 1.80	Sinclair IC12
SN7484N 1.00	SN74190N 2.00	6w amp 2.20

### Cosmos Integrated Circuits. Full Range in Stock

AAZ13 0.12	BLY36 6.00	TIP42A 0.90
AC107 0.51	BSX20 0.13	TIS43 0.26
AC128 0.15	BU105 2.20	VA05A 4.02
AC187 0.21	BY100 0.27	ZTX108 0.18
AC197 0.40	BY127 0.12	ZTX300 0.13
ACY29 0.78	BYZ13 0.78	ZTX302 0.45
AD149 0.50	CO160 0.54	ZTX500 0.13
AD161 0.44	GET111 0.12	2N697 0.16
AD162 0.44	GET115 0.60	2N705 0.12
AF117 0.24	GET880 0.90	2N930 0.18
AF118 0.57	LM309K 2.00	2N987 0.42
AF149 0.25	MA121 0.25	2N102 0.25
AF186 0.48	MJE340 0.47	2N1304 0.28
AF239 0.44	MJE520 0.63	2N1613 0.21
ASY27 0.33	MJE3055 0.77	2N1771 0.20
BA115 0.10	MJE2955 1.27	2N1214 0.78
BAX13 0.05	MPF105 0.66	2N1216 0.78
BCY07 0.14	MPF107 0.66	2N2925 0.42
BC108 0.13	OA5 0.12	2N3053 0.18
BC109 0.14	OA81 0.78	2N3054 0.18
BC109C 0.16	OA200 0.08	2N3055 0.45
BC113 0.15	OA202 0.06	2N3440 0.58
BC147 0.10	OC28 0.66	2N3442 1.30
BC148 0.08	OC35 0.66	2N3525 0.81
BC149 0.10	OC36 0.60	2N3614 0.65
BC169C 0.15	OC44 0.20	2N3702 0.11
BC182 0.12	OC45 0.20	2N3714 1.41
BCY32 0.85	OC71 0.18	2N3771 1.77
BCY39 1.50	OC72 0.28	2N3773 0.40
BCY55 0.40	OC73 0.54	2N3792 2.10
BCY70 0.18	OC81 0.29	2N3819 0.38
BCY71 0.22	OC83 0.27	2N3886 0.72
BCY72 0.12	OC140 1.14	2N3903 0.15
BD124 0.65	OC170 0.30	2N4002 0.15
BD131 0.42	OC200 0.54	2N4126 0.45
BF185 0.90	OC202 0.90	2N4871 0.34
BF190 0.36	OCPT7 1.20	2N5457 0.30

# **FREQUENCY ALLOCATION CHART**

This frequency allocation chart is based on information taken from International Telecommunication Union documents for one or more of the three ITU Regions. There are many subdivisions within the allocations shown resulting in many frequencies being shared by various services or allotted on a secondary basis. The amateur service allocations shown here are those for the UK. Only Aeronautical Mobile allocations above 118MHz have been shown on this chart.



# FREQ ALLO CHA

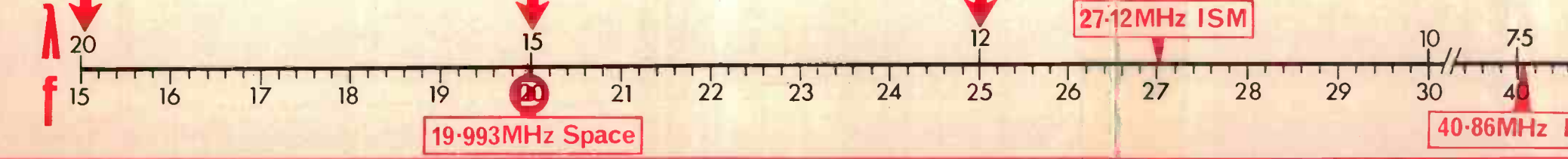
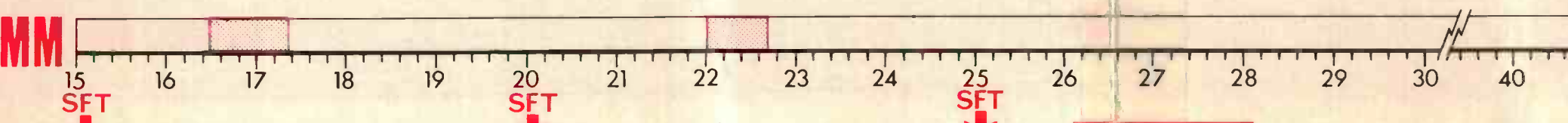
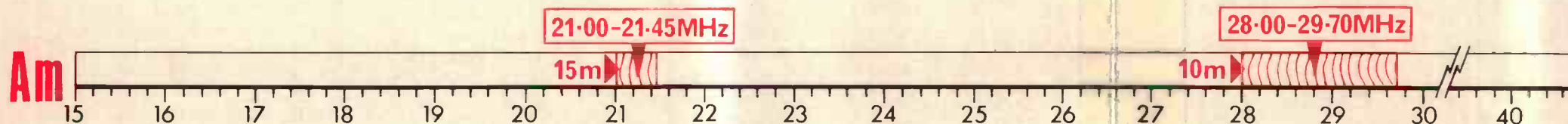
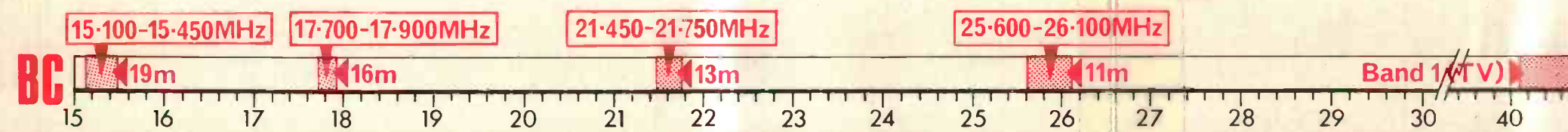
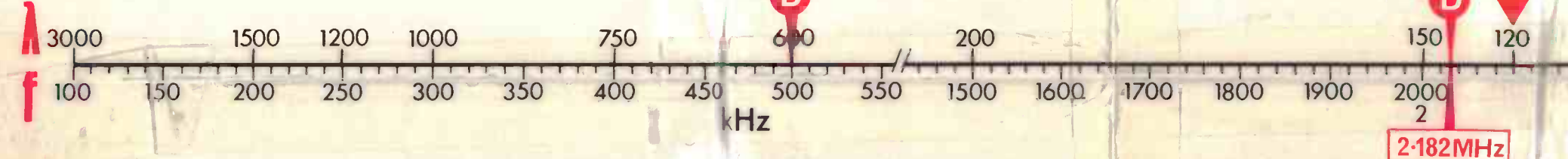
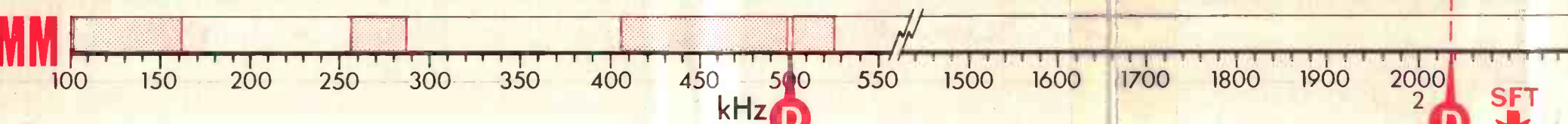
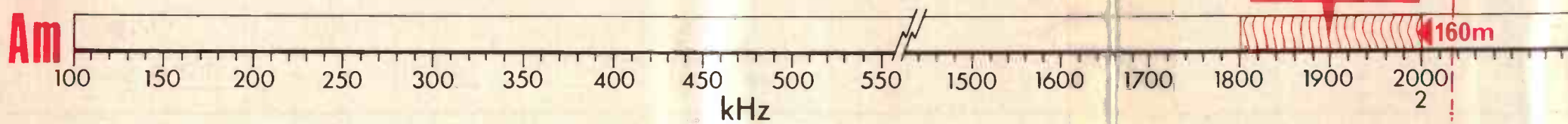
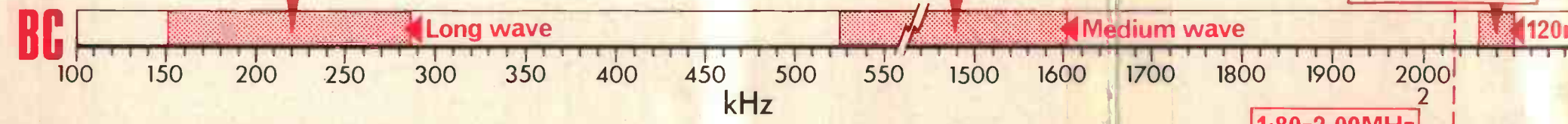
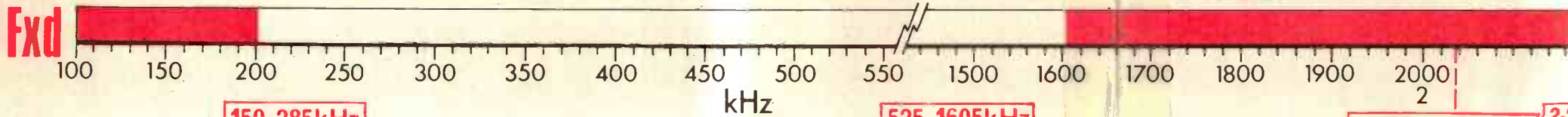

# FREQUENCY LOCATION CHART

PRESENTED  
FREE WITH  
PRACTICAL  
WIRELESS  
MARCH 1975

Fxd	Fixed Services	AM	Aeronautical Mobile Service
BC	Broadcasting Services	D	Distress Frequencies
Am	Amateur Service	SFT	Standard Frequency Transmissions
MM	Maritime Mobile Service	ISM	Industrial, Scientific and Medical

