

219
A BEGINNER'S CONSTRUCTIONAL COURSE

PRACTICAL 13

WIRELESS

APRIL
1958

EDITOR: F.J. CAMM



A NEW SERIES

COMMENCING IN THIS ISSUE IS A SERIES OF CONSTRUCTIONAL ARTICLES PREPARED ESPECIALLY FOR THE BEGINNER. THE ILLUSTRATIONS ABOVE SHOW THE FIVE STAGES IN THE CONSTRUCTION OF A MULTI-VALVE MAINS RECEIVER, EACH STAGE COMPLETE IN ITSELF, AND IN THIS ISSUE THE FIRST STAGE — A COMPLETE ONE-VALVE, SHOWN ON THE RIGHT — IS DESCRIBED.

SUB-MINIATURE ELECTROLYTIC CONDENSERS

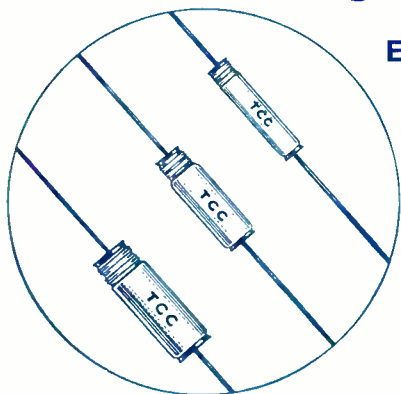

Tolerance of capacity : -20% +50%
Temperature range : -30°C. to +60°C.

Since we introduced this range, the use of transistors has become more widespread with the result that the range of capacities has been increased to keep pace with current design. The condenser element is hermetically sealed in an aluminium tube with rubber bungs (T.C.C. Patents 578487, 587072 and 578409) and the general assembly has been modified to permit the wire terminations to be flexed right up to the body of the condenser. Any slight increase in length of some ranges is more than offset by the advantage gained in the reduction of overall space required.

Capacity In μ F	Pk. Wkg. Volts	Dimensions in inches		T.C.C. Type Number	List Price Each
		Length	Diameter		
6	1.5	1.18"	1.18"	CE58	5/-
4	4		CE58AA	5/-	
2	8		CE58A	5/-	
6	3		CE68AA	4/-	
10	3		CE68AA	4/-	
4	6		CE68A	4/-	
2	12		CE68B	4/-	
1	25		CE68C	4/-	
8	6		CE69A	4/-	
2	25		CE69C	4/-	
1	50		CE69D	4/-	
32	1.5		CE67	4/-	



THE TELEGRAPH CONDENSER CO. LTD.
RADIO DIVISION NORTH ACTON, LONDON, W.3 Telephone: ACO rn 0061

**WITHOUT DOUBT—THE FINEST
VALUE IN HIGH FIDELITY!**



Stentorian
MODEL H.F.1012

● *The speaker with the
unique specification*

10" Die-cast unit, incorporating 12,000 gauss magnet. Fitted with the patented cambric cone and universal impedance speech coil providing instantaneous matching at 3, 7.5 and 15 ohms. Handling capacity, 10 watts. Frequency response, 30 c.p.s.-14,000 c.p.s.
Bass resonance, 35 c.p.s.

£4. 19. 9
including P.T.

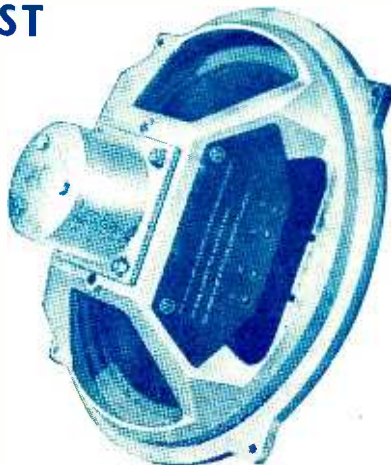

Stentorian High Fidelity Units are regularly specified by the leading designers where the maximum performance in relation to price is required. The range of speakers available is from 2½" to 15". Write for illustrated leaflets, or see and hear all Stentorian products at our London Office, 109 Kingsway, any Saturday between 9 a.m. and 12 noon.

WHITELEY ELECTRICAL RADIO CO. LTD • MANSFIELD • NOTTS

Tel: Mitcham 5201
Open Daily to Callers



All Valves Brand New
and Fully Guaranteed

211, STREATHAM ROAD, MITCHAM, SURREY

Special 24 Hour Express Mail Order Service

OZ4 5/9	6CH6 7/6	12AT7 8/9	150B2 15/-	CBL1 23/6	EGH81 9/6	HL23 13/6	PCC84 9/-	UJ47 9/9
1A5 6/6	6ESGT 10/-	12AU7 9/-	150B3 15/-	CBL31 21/-	ECH35 12/6	HL23DD 12/6	PCF80 12/6	U153 9/6
1A7 12/6	6F1 19/6	12AX7 9/-	7B7 8/6	CCH35 21/-	ECL80 12/6	HL4 14/6	PCF82 12/6	U191 18/6
1D5 15/6	6F6 10/6	12BA6 8/9	7C5 8/6	CL4 17/6	ECL82 13/6	HL41 12/6	PCF83 12/6	U251 21/-
1D6 10/6	6F7 10/6	12BE6 9/3	7C6 8/6	CL33 18/6	EF9 21/-	HL41DD 17/6	PL33 8/6	U281 18/6
1H5 9/9	6F12 8/6	12E1 20/-	7D5 21/-	CY1 15/6	EF22 16/-	HL42DD 10/6	PL82 23/6	U282 20/-
1L4 6/6	6F13 18/6	12JFGT 7/-	7D6 21/-	CY31 15/6	EF36 6/6	HL42DD 10/6	PL81 16/6	U301 21/-
1LNS 5/6	6F14 23/6	12JGT 10/-	7D8 21/-	D41 9/6	EF37 9/6	HY90 7/6	PL82 9/6	U329 21/-
1N5 9/9	6F15 15/6	12K7GT 10/6	7H7 8/6	D42 9/6	EF37A 10/3	IW4/350 10/-	PL83 11/6	U339 18/6
1RS 8/9	6F17 12/6	12K8GT 12/3	7K7 17/-	D63 6/-	EF39 7/6	IW4/500 10/-	PL820 21/-	U403 9/6
1S5 8/9	6F33 7/6	12Q7GT 8/6	7S7 12/7	D77 5/9	EF40 15/-	EF41 9/6	PEN4A 21/-	U404 10/6
1T4 8/1	6H6 3/-	12SA7 8/6	7Y4 7/6	D152 5/9	EF41 9/6	EF42 12/-	PEN4A 22/-	U801 27/6
1U5 10/6	6ISGT 6/6	12SC7 8/6	9BW6 14/9	DAC32 9/9	EF42 12/-	KBC32 10/-	PEN4DD 23/6	U4020 15 6
2D13C 10/-	6J6 7/6	12SG7 8/6	11D3 23/6	DAF91 8/9	EF80 8/6	KF35 10/6	PM2A 10/-	UABC80
2D21 10/6	6J7GT 10/-	12SH7 5/6	11D5 23/6	DAF96 9/6	EF85 7/6	KL32 10/6	PM2HL 14/6	UAF42 10/-
2X2 4/6	6K7GT 10/-	12S7 8/-	13D3 12/6	DAF96 9/6	EF86 12/6	KL32 10/6	PM22A 18/6	UB41 12/7
3A5 12/6	6K8GT 12/3	12S7 8/6	12Z3 12/6	DF33 -9/9	EF86 12/6	KL32 10/6	PM24M 19/6	UBC41 8/6
3D6 14/6	6K25 18/6	12SQ7 10/6	14H7 7/6	DF91 8/6	EF89 10/-	KL35 10/6	PM202 15/6	UBF80 9/6
3Q4 10/6	6L1 17/6	12SN7 15/6	15A2 23/6	DF92 6 6	EF91 8/6	KT2 7/6	PM202 15/6	UBF89 10/6
3Q5 9/9	6L6 7/6	14R7 16/-	15D2 23/6	DF97 9/6	EF92 9/6	KT32 9/6	PM202 15/6	UBF89 9/6
354 8/6	6L18 12/6	14S7 16/-	40SUA 15/9	DH63 10/6	EF93 8/6	KT33C 12/6	PM202 15/6	UBF89 9/6
3V4 8/6	6L19 21/-	19AQ5 9/-	41STH 23/6	DH76 8/6	EF95 14/-	KT36 23/6	PM202 15/6	UBF89 9/6
5R4G5 15/9	6L34 8/9	19BGG6G 21/-	61BT 15/-	DH77 7/6	EL31 14/-	KT41 23/6	PM202 15/6	UBF89 9/6
5V4G 8/6	6J30L2 13/-	20D1 14/6	61SPT 15/-	DH107 10/6	EL32 5/6	KT44 12/6	PM202 15/6	UBF89 9/6
5V4 12/-	6LD3 9/-	20D2 23/6	62BT 25/-	DH719 9/6	EL33 18/3	KT55 18/6	PM202 15/6	UBF89 9/6
5Y3GT 8/6	6LD20 15/3	20F2 23/6	161 8/6	DK91 8/9	EL35 15/-	KT61 18/6	PM202 15/6	UBF89 9/6
5Z3 13/6	6N7GT 8/-	20L 23/6	185BT 30/-	DK92 11/6	EL37 21/-	KT63 10/6	PM202 15/6	UBF89 9/6
5Z4G 10/-	6M1 16/-	20PL 23/6	25A6G 18/6	DK96 9/6	EL38 23/6	KT66 17/6	PM202 15/6	UBF89 9/6
6A7 13/6	6M2 16/-	20P3 21/-	303 8/6	DL33 9/9	EL40 10/-	KT71 10/6	PM202 15/6	UBF89 9/6
6A8 10/6	6P1 18/-	20P4 23/6	304 8/6	DL35 13/6	EL42 10/-	KT74 10/6	PM202 15/6	UBF89 9/6
6A8B 12/6	6P25 18/6	20P5 21/-	305 8/6	DL92 8/-	EL81 17/6	KT76 12/6	PM202 15/6	UBF89 9/6
6AJB 8/6	6P28 23/6	25L6GT 9/-	328 9/6	DL94 8/-	EL84 9/-	KT101 30/-	PM202 15/6	UBF89 9/6
6AK5 6/6	6Q7GT 10/6	25Y5 10/6	329 9/6	DL96 8/9	EL85 10/6	KTW61 9/-	PM202 15/6	UBF89 9/6
6AK8 10/6	6SA7GT 8/6	25Z4 9/-	807 8/6	EAS0 2/-	EL90 8/6	KTW62 9/-	PM202 15/6	UBF89 9/6
6AL5 5/9	6SG7 9/6	25Z5 10/-	955 3/-	EABC80 9/6	EL91 8/6	KTW63 9/-	PM202 15/6	UBF89 9/6
6AM5 8/6	6SH7 8/6	25Z6 9/6	9002 5/6	EAC91 10/-	EM80 10/-	KTZ4 9/-	PM202 15/6	UBF89 9/6
6AM6 8/6	6S7 8/6	30 7/6	9003 5/6	EAF42 10/-	EM81 11/-	KTZ63 10/6	PM202 15/6	UBF89 9/6
6AN5 5/-	6SK7 9/6	32 8/6	5763 12/6	EB41 10/6	EY81 10/-	L63 6/6	PM202 15/6	UBF89 9/6
6AQ5 7/6	6SL7GT 7/6	30C1 12/6	AC4/PEN 15/-	EB91 5/9	EY86 13/-	LN309 12/6	PM202 15/6	UBF89 9/6
6AQ8 10/6	6SN7GT 8/6	30F5 12/6	AC5/PEN 15/-	EB91 5/9	EY91 9/-	LZ319 12/6	PM202 15/6	UBF89 9/6
6AT6 7/6	6U4GT 11/6	30FL1 12/6	AC5/PEN 15/-	EBF80 9/6	EZ35 9/-	M44 8/6	PM202 15/6	UBF89 9/6
6AU6 15/6	6U5 8/6	30L1 11/-	AC6 15/-	EBF89 9/6	EZ40 8/-	MHL4 12/6	PM202 15/6	UBF89 9/6
6B7 10/6	6U7 8/6	30P4 23/6	AC6 15/-	EFL21 21/-	EZ41 10/6	MKT4(5) 7/1	PM202 15/6	UBF89 9/6
6B8 4/3	6V6G 9/-	30P12 12/6	AC7 29/6	EFL31 21/-	EZ80 8/-	MS48 21/-	PM202 15/6	UBF89 9/6
6BA6 8/6	6V6GT 7/6	30P16 10/-	ACHL 11/6	ECL91 8/9	EZ81 8/-	MS48 21/-	PM202 15/6	UBF89 9/6
6BE6 8/3	6X4 7/6	30PL1 20/-	AC/PEN 21/6	EC90 12/6	EZ90 7/9	MS48 21/-	PM202 15/6	UBF89 9/6
6BG6G 21/-	6X5GT 8/6	35A5 10/6	ACTH1 29/6	ECC31 13/6	FC2 14/6	MU14 10/-	PM202 15/6	UBF89 9/6
6Bj6 7/6	7Q7 9/-	35L6GT 10/-	ACVPI 23/6	ECC32 16/-	FC13 14/6	MX40 23/6	PM202 15/6	UBF89 9/6
6BR7 12/-	7R7 15/-	35W4 8/-	ACVPI 23/6	ECC33 8/6	FC13C 14/6	N18 11/6	PM202 15/6	UBF89 9/6
6BV6 8/6	8D3 8/6	35Z3 10/-	AC2/PEN 15/-	ECC34 14/6	FW4/500 12/6	N19 8/-	PM202 15/6	UBF89 9/6
6BV7 9/6	10C1 18/6	35Z4 8/6	AC2/PENDd 23/6	ECC35 8/6	FW4/800 12/6	N37 8/3	PM202 15/6	UBF89 9/6
6BX6 8/6	10C2 18/6	35Z5 10/6	AC2/PENDd 23/6	ECC40 17/6	GZ30 10/-	N78 11/6	PM202 15/6	UBF89 9/6
6BY7 7/6	10F1 23/6	50C5 10/6	AZI 15/6	ECC81 8/6	GZ32 11/6	N108 16/6	PM202 15/6	UBF89 9/6
6C4 6/6	10F3 21/-	50CD6G 27/6	AZ31 15/6	ECC82 9/-	GZ34 11/6	N142 9/6	PM202 15/6	UBF89 9/6
6C5GT 7/6	10F9 12/6	50L6GT 10/-	B36 15/6	ECC83 9/-	H30 4/9	N153 11/3	PM202 15/6	UBF89 9/6
6C6 7/6	10LD3 8/6	50L6GT 10/-	B65 8/6	ECC84 10/-	H63 10/-	N150 10/-	PM202 15/6	UBF89 9/6
6C9 16/6	10LD11 15/3	75 10/-	B152 8/6	ECC85 10/6	HBC90 8/-	N329 9/6	PM202 15/6	UBF89 9/6
6C10 12/6	10P13 21/-	77 10/6	8309 9/-	ECC91 7/6	HL92 11/6	N727 7/6	PM202 15/6	UBF89 9/6
6CD6G 27/-	10P14 18/6	80 9/6	8339 9/-	ECC92 12/6	HL133DD 11/6	N729 8/-	PM202 15/6	UBF89 9/6
6D1 5/9	12A6 6/6	80 9/6	8339 9/-	ECC91 7/6	HL133DD 11/6	P2 11/6	PM202 15/6	UBF89 9/6
6D2 5/9	12AH8 10/9	84 14/6	85A2 15/-	ECC92 12/6	HL133DD 11/6	P2 11/6	PM202 15/6	UBF89 9/6
6D3 5/9	12AT6 8/9	85A2 15/-	B719 10/6	ECC91 7/6	HL133DD 11/6	P2 11/6	PM202 15/6	UBF89 9/6

METAL RECTIFIERS NEW AND GUARANTEED

RMI 7/6	18RA 1-1-8-1, 4/6	16RE2-1-8-1, 8/6
RM2 8/-	18RA 1-1-16-1, 6/6	18RA 1-2-8-1, 11/6
RM3 10/-	16RC 1-1-16-1, 9/2	14A86, 18/6
RM4 21/-	14RA 1-2-8-2, 19/6	14A97, 26/6
RM5 25/-	14RA 1-2-8-3, 24/-	14A100, 28/-

BRAND NEW FULLY GUARANTEED
CATHODE RAY TUBES.

(NOT RECONDITIONED).

Type 43/69 at £16.10.0
Type 36/44 at £15.0.0

TERMS OF BUSINESS C.W.O. or C.O.D.
2/9 PACKING CHARGE ON ALL C.O.D.
ORDERS. POSTAGE 3d. PER VALVE.

OBsolete VALVES A SPECIALITY
QUOTATIONS GIVEN ON ANY TYPE
NOT LISTED.

AND NOW THERE ARE TWO

Stern's "fidelity" TAPE RECORDERS



PRICE . . . Including CRYSTAL MIKE and 1,200ft. reel of PLASTIC TAPE. **£49.10.0** OR £32.10.0 WITH REV. COUNTER

CREDIT SALE: Deposit £12 8/- and 9 monthly payments of £4 10/8.
HIRE PURCHASE: Deposit £24 15/- and 12 monthly payments of £2 5 11.

(Plus £1 10/- carriage and insurance of which

IT INCORPORATES: THE NEW TRUVOX MK. IV TAPE DECK together with the "fidelity" MODEL HF/TR2 TAPE AMPLIFIER (both fully described on this page), and a Rola 10in. x 6in. P.M. Speaker.



PRICE . . . Including CRYSTAL MIKE and 1,200ft. reel of PLASTIC TAPE. **39 GNS.**

CREDIT SALE: Deposit £10 5/- and 9 monthly payments of £3 15 2.
HIRE PURCHASE: Deposit £20 10/- and 12 monthly payments of £1 18 -.

£1 is refunded on return of Packing Case.)

IT INCORPORATES: THE TRUVOX MK. III TAPE DECK together with correctly matched HF/TR1A TAPE AMPLIFIER and a 7in. x 1in. Speaker.

BEFORE CHOOSING YOUR TAPE RECORDER YOU SHOULD HEAR THESE MODELS—TRULY "HI-FI" RECORDINGS ARE OBTAINABLE and they are comparable to much higher-priced Recorders. Alternatively send S.A.E. for ILLUSTRATED LEAFLET.

The NEW TRUVOX MKIV TAPE DECK

ONE OF THE BEST DECKS ON THE MARKET.

PRICE (Plus 10/- carr. and ins.) **£27.6.0.**

CREDIT TERMS: Deposit £6 17/- and 9 monthly payments of £2 10/-.
H.P. TERMS: Deposit £13 13/- and 12 monthly payments of £1 5 4.

WE ALSO HAVE A FEW DECKS WITH REV. COUNTERS. Price £30 9/- Send S.A.E. for details.

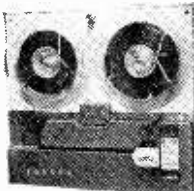

The "fidelity" TAPE AMPLIFIER MODEL HF/TR2

With POWER SUPPLY UNIT PRICE

H.P. TERMS: Deposit £8 and 9 months of £1.
CREDIT TERMS: Deposit £4 and 9 monthly payments of £1 9 4. When ordering, please advise make of deck in use. Send S.A.E. for full details.

£16.0.0. (Carr. and ins. 6/-)

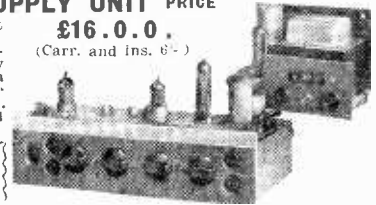

Can be supplied to correctly operate with Colliaro and Truvox Decks.

A TAPE PRE-AMPLIFIER and ERASE UNIT

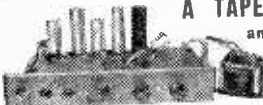

STERN'S MODEL HF/TR1.—A completely assembled Pre-amplifier with own Power Supply. Can be supplied correctly matched for use with Truvox or Colliaro Decks and incorporates Recording Level Indicator and Monitoring facilities. Please send S.A.E. with any enquiry. **PRICE £11.10.0.** (Plus 5/- carr. & ins.)

SPECIAL PRICE REDUCTION WHEN PURCHASED WITH TAPE DECK.

HOME CONSTRUCTORS

We can supply a COMPLETE KIT OF PARTS to build this TAPE AMPLIFIER for £12 (plus 5/- carr. and ins.). The Assembly Manual, Practical Diagrams, etc., are available for 2/6. WE MAKE SPECIAL PRICES TO PURCHASERS OF TAPE EQUIPMENT (i.e., buyers of Deck and Amplifier together, etc., etc.). SEND YOUR ENQUIRY TO US . . . H.P. and CREDIT SALE TERMS ARE AVAILABLE.

"FRUSTRATED EXPORT ORDER"

The Corsor Model 527X 4-Valve "All dry" Battery Portable. Offered for **£6.15.0.** (Plus 5/- carr. & ins.)



Consists of a 4-valve Superhet Receiver covering Medium Waveband 197-375 metres, and two Short Wavebands, 13.5 to 136 metres. The new low consumption valves are incorporated and the whole is accommodated in an attractive robustly made case. Battery required is 90 volts and 1.4 volts (price 19/6) and is external to case.

MODERNISE YOUR OLD RADIOGRAM

The NEW ARMSTRONG PB. 409 A.M./F.M. Radiogram Chassis

"A chassis for those who want the highest quality." ● A 9-valve line up employing the latest MULLARD preferred-type valves ● Provides complete coverage of the V.H.F. F.M. Transmissions plus the Short, Medium and Long Wavebands. ● Has Push-Pull Output with Negative Feedback for 6 watts peak Output. ● Quick Action "Piano Key" Selectors and separate Bass and Treble Controls ● Has "Magic Eye" Tuning Indicator. ● Dimensions 13in. x 9 1/2in. x 8in. high. Dial size 1 1/2in. x 5 1/2in.

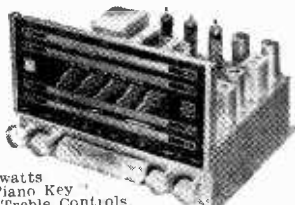

PRICE **£29.8.0.** Credit £7.7.0 and 9 monthly payments of £2.14.0. (Plus 6/- carr. & ins.) H.P. £14.14.0 and 12 monthly payments of £1.7.3. SEND S.A.E. FOR ILLUSTRATED LEAFLET.

WE HAVE THE FULL RANGE OF DULCI CHASSIS IN STOCK

THE MODEL H.4. is illustrated but all Chassis and Tuners are similar—send S.A.E. for leaflets. H.P. and CREDIT SALE TERMS are available. SEND S.A.E. for details.



RADIOGRAM CHASSIS These two Chassis are really well designed and reproduce most excellent quality on both Radio and gram. **£20.17.0.**

MODEL H.3. A 3 Waveband AM-FM CHASSIS **£24.6.6.**
MODEL H.4. A 4 Waveband AM-FM CHASSIS **£20.17.0.**
TUNER with self-contained POWER SUPPLY **£20.17.0.**

STERN'S "F.M." TUNING UNIT

A 5-valve Tuner incorporating the latest Mullard Permeability Tuning Heart and a "Magic Eye" Tuning Indicator. **PRICE ASSEMBLED £14.10.0.**

READY FOR USE (Plus 7/6 carriage and insurance).
TERMS: (a) Hire Purchase: Deposit £7.5.0 and 9 monthly payments of 18/4. (b) Credit: Deposit £3.12.6 and 9 monthly payments of £1.6.7.



HOME CONSTRUCTORS—You can build this unit for Full Assembly Instructions are available for 1/6.

£10.0.0.

STERN RADIO LIMITED (Dept. P.W.)
PLEASE SEND S.A.E. WITH ALL

COMPLETE KITS of PARTS for the "Hi-Fi" ENTHUSIAST

STERN'S REMOTE CONTROL UNIT

Designed in particular for use with the MULLARD 5-10 Main Amplifier

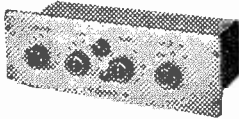

Ideally suited for simple domestic installation as an alternative to the more elaborate Pre-amplifier (shown and described opposite). Tone Control facilities are really excellent and in conjunction with the "5-10" Main Amplifier reproduction is of very high quality. Perfectly suitable for use with all the popular Record Players (B.S.R., Collaro, Garrard) and the modern Radio Tuner Units. Front Panel contains: (a) Coloured Indicator, (b) Separate BASS and TREBLE CONTROLS, (c) 3 position Selector Switch, (d) Volume control. Inputs on back for Radio and Gram. and Gram. equalising is incorporated. FULL DATA is contained in the 5-10 MAIN AMPLIFIER MANUAL, at 1.8.

RECORD PLAYERS

THE VERY LATEST MODELS ARE IN STOCK

MANY AT REDUCED PRICES!!!

TRANSCRIPTION UNITS - AUTO-CHANGERS - SINGLE RECORD PLAYERS

Send S.A.E. for ILLUSTRATED STOCK LIST

SPECIAL CASH OFFERS!!

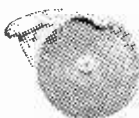

The Latest Collaro 4-Speed Single Record Player.

Incorporating the very popular STUDIO "O" CRYSTAL PICK-UP. For £5.19.6

(Plus 5/- carr. and ins.)

Incorporates Auto-Stop and Plays 7 1/2 r.p.m. and all types of L.P. Records.

The Collaro "Junior" Rim Drive 4-Speed Record Player



Offered complete with Collaro Crystal Pick-up. For £4.10.0

(Plus 4/- carr. and ins.)

We also offer Gram Motor and Turntable at £3.2.6. Crystal Pick-up only, £1.12.6. (carr. and ins. 2/6 extra.)

THIS LATEST BRAND NEW B.S.R. MONARCH 4-SPEED AUTOCHANGER

£7.19.6

(Plus 5/- carr. and ins.)

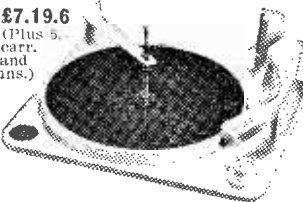

Minimum base-board size required 11in x 12 1/2in. with height above 5 1/2in., & height below baseboard 2 1/2in.

WE ALSO HAVE A FEW ONLY

COLLARO 4-Speed "Mixer" Auto-changers. The Units are BRAND NEW and incorporate the STUDIO "O" Pick-up. PRICE, £8.15.0 (Plus 5/- carr. and ins.)

109 & 115 FLEET ST., LONDON, E.C.4.

Telephone: FLect 5312 3,4.

CORRESPONDENCE

The MULLARD "5-10" MAIN AMPLIFIER

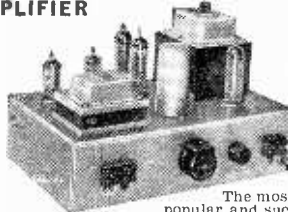

The most popular and successful Amplifier yet designed and certainly needs no recommendation from us. Our kit is complete to MULLARDS specification including the latest PARMERKO ULTRA LINEAR OUTPUT TRANSFORMER and the recommended Mullard Valve Line-up. PRICE OF COMPLETE KIT OF PARTS (Plus 5/- carr. & ins.) £9.10.0 or alternatively we supply - FULLY ASSEMBLED and TESTED for £11.10.0 (Plus 5/- carr. & ins.)

THE ASSEMBLY MANUAL containing FULL SPECIFICATION is available for 1/6. We also offer the "5-10" incorporating the latest PARTRIDGE ULTRA LINEAR OUTPUT TRANSFORMER for an extra £1.6.0

SPECIAL PRICE REDUCTIONS... WE OFFER YOU...

PRICES ARE SUBJECT TO £1.6.0. EXTRA IF PARTRIDGE TRANSFORMER IS PREFERRED.

(a) THE COMPLETE KIT OF PARTS to build both the MULLARD 5-10 and the REMOTE CONTROL UNIT for £11.11.0

(b) THE COMPLETE KIT OF PARTS to build both the MULLARD 5-10 and the "Fidelity" PRE-AMPLIFIER TONE CONTROL UNIT for £15.15.0

ALTERNATIVELY WE WILL SUPPLY ASSEMBLED and FULLY TESTED, as follows -

(a) THE MULLARD 5-10 and the REMOTE CONTROL UNIT for £14.0.0

CREDIT SALE TERMS, £3.10.0 Deposit and 9 monthly payments of £1.5.3. H.P. TERMS, £7 Deposit and 9 monthly payments of 17/9.

(b) THE MULLARD 5-10 and the "Fidelity" PRE-AMPLIFIER-TONE CONTROL UNIT FOR £18.18.0

CREDIT SALE TERMS, £4.15.0 Deposit and 9 monthly payments of £1.14.7. H.P. TERMS, £9.9.0 Deposit and 12 monthly payments of 17/6.

WHEN ORDERING PLEASE INCLUDE 7/6 to cover cost of carriage and insurance.

THE NEW MULLARD "3-3"

PROVIDING EXCELLENT REPRODUCTION AND HAVING AN ATTRACTIVE PERSPEX FRONT PANEL. Price - For complete Kit of parts: £7.10.0

(plus 6/6 coverage and insurance). Alternatively supplied ASSEMBLED and FULLY TESTED - £8.19.6

(plus 6/6 coverage and insurance). The complete specification is available for 1/6. Developed from the very popular 3-valve 3-watt Amplifier designed in the Mullard Laboratories. Our kit is complete to the Mullard specification, including supply of specified components, valves and a PARMERKO OUTPUT TRANSFORMER.

We also include switched inputs for 78 and L.P. records, plus a radio position. Extra power to drive a Radio Tuning Unit is also available.

THE IDEAL AMPLIFIER FOR A SMALL HIGH QUALITY INSTALLATION

WE ALSO SUPPLY SEPARATELY - (a) The 2-Stage (plus Rectifier) AMPLIFIER £4.2.0

(b) THE PORTABLE CARRYING CASE £3.17.6

(c) P.M. SPEAKER 18/9

We also have carriage and insurance, 4/- extra. Carriage and insurance, 4/- extra. Ideal for Record Players. PRICE ONLY £3.3.0 (plus 3/- carr. & ins.)

STERN'S "fidelity" PRE-AMPLIFIER TONE CONTROL UNIT

"A design for the Music Lover"



This unit can be used with any Main Amplifier. Briefly it has inputs for all types of MICROPHONES, HIGH and LOW GAIN PICK-UPS and a RADIO TUNING UNIT. It incorporates (a) GRAM EQUALISING CONTROL, (b) STEEPCUT FILTER, (c) Continuously variable BASS and TREBLE CONTROLS, a variable OUTPUT CONTROL which enables its use with any type of Amplifier, and Jack Sockets on Front Panel for TAPE RECORD and TAPE PLAYBACK.

Used with the "5-10" the reproduction is comparable to that normally associated only with the very expensive commercially made High Fidelity Amplifiers. PRICE OF COMPLETE KIT OF PARTS £6.16.0

WE ALSO OFFER IT ASSEMBLED READY FOR USE, £8.10.0 (plus 5/- carr. & ins.)

THE ASSEMBLY MANUAL contains full specification and is available for 1/6.

STERN'S "HIGH QUALITY" 8-10 WATT AMPLIFIER

Has power supply for Radio Tuning Unit



PRICE OF COMPLETE KIT OF PARTS (Plus 5/- carr. & ins.) £7.10.0

SUPPLIED ASSEMBLED and READY FOR USE £9.10.0

Proved one of the most popular models yet offered to the HOME CONSTRUCTOR. Provides excellent reproduction up to 8 watts, employing 6V6's in push-pull, incorporating negative feedback. Provides for use of both 3 and 15 ohm speakers.

SPECIAL CASH ONLY OFFER !!

This very attractive PORTABLE AMPLIFIER CASE together with a good quality GRAM AMPLIFIER and a P.M. SPEAKER.

ALL for £8.7.6 ONLY (plus 7/6 carr. & ins.)

The Amplifier consists of a 2 Stage design incorporating 3 modern B.V.A. valves and has separate BASS and TREBLE CONTROLS. The Portable Case will also accommodate almost any make of Autochanger, and is attractively finished in Maroon and Grey colour Deline.



SIGNAL GENERATORS

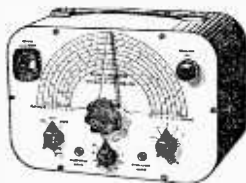

25/- deposit and 6 monthly payments of 21/6. Cash £8.19.6. Post and Packing 5/- extra. Coverage 100 Kc/s-100 Mc/s on Fundamentals and 100 Mc/s to 200 Mc/s on harmonics. Metal case 10in. x 6in. x 5 1/2in., grey hammer finish. Incorporating three miniature valves and Metal Rectifier. A.C. Mains 230/250 v. Internal Modulation of 400 c.p.s. to a depth of 30%. Modulated or unmodulated R.F., output continuously variable 100 millivolts. C.W. and mod. switch, variable A.F. output. Incorporating magic eye as output indicator. Accuracy plus or minus 2%.

25/- deposit plus P. & P. 5/- and 4 monthly payments of 21/6. Cash £4/19/6 plus P. & P. 5/-.

Coverage 120 Kc/s, 84 Mc/s. Metal case 10in. x 6in. x 4 1/2in. Size of scale, 6 1/2in. x 3 1/2in. 2 valves and rectifier. A.C. mains 230-250 v. Internal modulation of 400 c.p.s. to a depth of 30%, modulated or unmodulated R.F., output continuous variable 100 millivolts. C.W. and mod. switch, variable A.F. output and moving coil output meter. Grey hammer finished case and white panel. Accuracy plus or minus 2%.

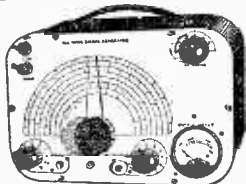

CONVERT TO I.T.A. FOR ONLY 25/- deposit plus P. & P. 5/- and 4 monthly payments of £1/5/6. Cash £5/17/- plus P. & P. 5/- ANY T.V. (except Philips or Valley Area, Wales)

WITHIN 35 MILES OF I.T.A. TRANSMITTER. ALL CHANNELS NO ADJUSTMENTS TO SET.

Complete with built-in power supply, 230-250 v. A.C. mains. Crackle finish case 5 1/2in. long, 3 1/2in. wide, 4 1/2in. high incorporating gain control and band switch. Illus. with cover removed. Complete installation comprises "Converter," Wolsey 3-element I.T.A. outside or loft aerial, 36ft. I.T.A. lead, two plugs, (Wolsey 5-element 10' extra.)

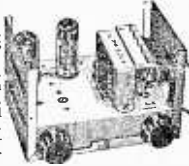

AC/DC POCKET MULTI-METER KIT

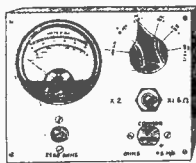

Comprising 2in. moving coil meter, scale calibrated in AC/DC volts, ohms and milliamps. Voltage range AC/DC 0-50, 0-100, 0-250, 0-500. Milliamps 0-10, 0-100. Ohms range 0-10,000. Front panel, range switch, wire-wound pot. (for ohms zero setting), toggle switch, resistors and rectifier. In grey hammer finish case. Plus Built and tested 19/6 P. & P. 1/6. 7/6 extra.

Point to point wiring diagram 1/-. free with kit.

4-VALVE ALL-DRY SUPERHET PORTABLE KIT

Incorporating Ferrite rod aerial, Medium and long waves. In grey leatherette. Size 9in. x 7in. x 6in. Valve line-up: 1F4, 1R5, 1S5, 3V4. Complete kit of parts (less batteries).

£5.19.6 Plus Post & Packing .3/6.



COMPLETELY BUILT PORTABLE AMPLIFIER

approx. size 6 1/2in. x 2 1/2in., incorporating 2 valves, contact-cooled metal rectifier, 145 and 100k bit crystals 59/6 Plus P. and double wound mains transformer 230-250 v. £3/6 & P. 3/6. 5" P.M. SPEAKER & O.P. TRANSFORMER, if purchased with the above. 18/6. Plus P. & P. 1/6.

COLLARO 4-SPEED AUTOMATIC CHANGER

Model 457 (suitable for use with above amplifier). A.C. mains. 270-250 v., turnover crystal her'd. Brand new, fully guaranteed. £8.19.6 Plus or 25/- deposit, plus P. & P. 5/- and P. & P. 5/-, 7 monthly payments of £1/5/0.

RADIO & T.V. COMPONENTS (Acton) LTD.
23 HIGH STREET, ACTON, LONDON, W.3

All enquiries S.A.F. GOODS NOT DISPATCHED OUTSIDE U.K.

SPUTNIK SPECIAL

SHORT-WAVE RECEIVER 10-60 Mc/s (5-30 Metre-) RECEPTION SET TYPE 208



Complete with 6 valves, 2-5K8G, 2-EF39, 6Q7G and 6V6G. Internal mains power pack and 6 v. vibrator pack. Built-in 6 1/2" speaker, Muirhead slow-motion drive. B.F.O. and R.F. stage. Provision for 'Phones and Muting and 600 ohm. Dual Input 100/250 v. A.C. and 6 v. D.C. Size 24 x 18 x 12. Weight 7 1/2 lbs. In metal transit case. All sets in new condition and air tested. I.F. Frequency 2 Mc/s.

£6.19.6. Carr. 15/6.

BE PREPARED TO LISTEN TO THE SATELLITES

"TRANSISTOR-8"

Push-Pull Portable Superhet (can be built for £11/10/-)

This Portable 8 Transistor Superhet is tunable for both Medium and Long Waves and is comparable in performance to any equivalent Commercial Transistor Set. Simplified construction enables this set to be built easily, and quickly into an attractive lightweight cabinet supplied.

Send for circuit diagrams, assembly data, illustrations and instructions, and full shopping list, 3d. in stamps.

We can supply all these items including Cabinet for £11/10/- All parts sold separately.

"EAVESDROPPER"

THREE TRANSISTOR POCKET RADIO (No Aerial or Earth required)

Variable Tuning. Total cost, as specified including Transistors, Transformers, Coils, Condensers and Battery, etc., with circuit and plastic case. 77/6 POST FREE. With Balanced Armature, 81/-, With Acos Mike, 90/-, With Min. Hearing Aid, 90/-.

MINI-TWO

TWO-TRANSISTOR MINIATURE POCKET RADIO

The smallest Transistor set offered on the market. Variable Tuning, Drilled Chassis, Plastic Case size 3 1/2 x 2 1/2 x 1 1/2 in., Miniature Hearing Aid, 2 Transistors and all components including 1) volt Battery. Circuits and full practical layout diagrams. All items sold separately.

Total Cost 49/6 Complete

"HOMELIGHT" 2-TRANSISTOR PERSONAL PORTABLE

Variable Tuning

We can supply all components including 2 Transistors, Diode-Resistors, Condensers and Miniature Hearing Aid and Plastic Case size 4 1/2 x 2 1/2 x 1 1/2 in. Battery. FOR 52/6 All items sold separately.

TRIPLET A.C./D.C. POCKET TEST-METER TYPE 666H

15 Ranges 1,000 ohm p.volt. A.C./D.C. 10-50 250/1,000/5,000 volts. Milliamps, 0-10 10 50 m/a. Ohms, 0-300 250,000 ohms.

£5/10/-

In new condition with Prods and Internal Battery.

USA TEST-METER TYPE "834-S"

A.C./D.C. 15- RANGES F.S.D. 1,000 o.p.v.

A.C./D.C. Volts, 12/60/300 v./1,200/6,000 v. Milliamps, 1.2/12/60/600 m/a. Ohms, 0-5,000 meg.

£6/19/6

Complete in wooden carrying case with leads and internal batteries.

SEND STAMPS FOR NEW 1958 58-PAGE CATALOGUE OPEN MONDAY TO SAT. 9-5. THURS. 1 o'clock.

HENRY'S RADIO LTD.

6 HARROW ROAD, EDGWARE ROAD, LONDON, W.2 TEL.: PADDINGTON 1063-9

EMI "HIS MASTER'S VOICE" MARCONIPHONE · COLUMBIA

Announce NEW PRACTICAL WAY OF LEARNING AT HOME

NEW — completely up-to-date methods of giving instruction in a wide range of technical subjects specially designed and arranged for self-study at home under the skilled guidance of our teaching staff.

NEW — experimental outfits and lesson manuals are despatched on enrolment and remain the student's property. A tutor is allotted to each student for personal and individual tuition throughout the course.

Radio and television courses, with which specially prepared components are supplied, teach the basic electronic circuits (amplifiers, oscillators, detectors, etc.) and lead, by easy stages, to the complete design and servicing of modern Radio and T/V equipments.

If you are studying for an examination, wanting a new hobby or interest, commencing a career in industry or running your own full-time or part-time business, these practical courses are ideal and may be yours for moderate cost. Send off the coupon to-day for a free Brochure giving full details. There is no obligation whatsoever.

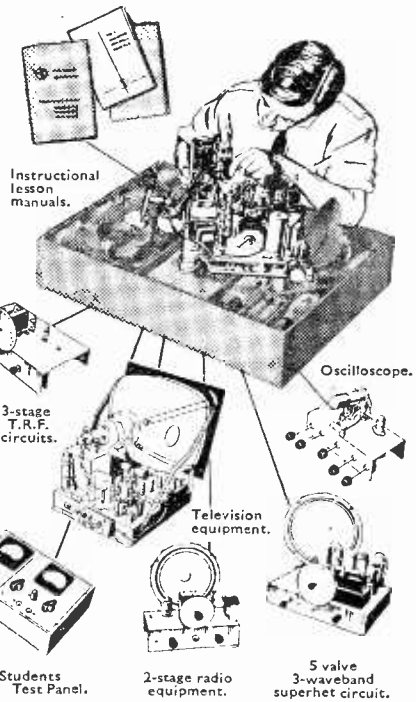

- Courses with Equipment**
- RADIO · SHORT WAVE RADIO
 - TELEVISION · MECHANICS
 - CHEMISTRY · PHOTOGRAPHY
 - ELECTRICITY · CARPENTRY
 - ELECTRICAL WIRING · 'HI-FI'
 - DRAUGHTSMANSHIP · ART etc.

E.M.I. Factories
at Hayes
England.

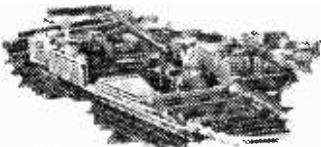

EMI INSTITUTES

Fill in for **FREE BROCHURE**
E.M.I. INSTITUTES, Dept. 32 X, London, W.4.

Name Age
 (If under 21)

Address

I am interested in the following subject(s) with/
 without equipment

(We shall not worry you with personal visits)

1C107



BLOCK
CAPS
PLEASE

APR. '58

The only Home Study College run by a World-wide industrial organisation.

PREMIER RADIO COMPANY

Tel.: AMBassdor 4033

B. H. MORRIS & CO. (RADIO) LTD.

Tel.: MUS. 3451

207 EDGWARE RD., LONDON, W.2 & 23 TOTTENHAM COURT RD., LONDON, W.1



The "Petite" PORTABLE

A completely new design with the all star feature from the firm with 45 years of experience in the supply of designs for the home constructor.

MAY BE BUILT FOR

£7.7.0

Plus p. & p. 3/-.

Batteries Extra. H.T. 10/- (type B128) or equivalent. L.T. 1/6 (type AD35) or equivalent.

* Size only 8in. x 8in. x 4 1/2in. * Instruction Book 1/6
MAINS UNIT NOW AVAILABLE FOR ONLY 37/6 plus 2/- p.p.

THE NEW MERCURY SWITCHED F.M. TUNER

by Jason

Complete set of parts available with built and tested front end.

Price **£9.19.6** plus 2/6 pkg. & carr.

Power Pack requirements 35 ma.

The NEW De - Luxe TAPE RECORDER TR3



for **£6.5.0**
DEPOSIT & 8 MONTHLY PAYMENTS OF £5.17.11
OR CASH 45 GNS.
plus 21/- post & pkg.

TRADE ENQUIRIES WELCOMED

Case finished in Red and Cream with gilt styling and fittings.
Size 19 1/2in. x 15in. x 9in. for A.C. Mains 200/250 v. 50 cycles.

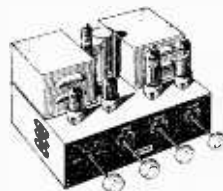

BUILD THE 1-VALVE BATTERY RECEIVER

As shown on B.R.C. T.V. This receiver contains a DAF93 valve and a pair of 4,000 ohm headphones, and is powered by a combined 67 1/2 and 11 volt battery. Price complete with headphones but less battery 45/-. Send for free diagram.

THE STAAR "GALAXY"

4-speed mixture Auto-Changer. Finger-tip stop, start and speed change control. Size 11 1/2in. x 12 1/2in. A.C. mains 110-250 v. Price £9.15.0, plus 4/6 pkg. & carr. Credit Terms £15.0 & 8 monthly payments of £15.9.

2-Volt 18Ah bakelite-cased ACCUMULATOR by Oldham, Dagenite, Exide. New and unused, unspillable. 7 1/2 x 4 x 2. Price 8/6, plus 1/6 p. & p.

THE TELETRON "COMPANION" 3 TRANSISTOR POCKET RECEIVER

This receiver may be built for **89/6** complete. Postage and packing 1/3.

COMPACT GRAM AMPLIFIER

Complete ready to connect to any type of Pick-up and Speaker (3 ohms). A.C. Mains 200/250 v. Volume and tone control on 9" extended leads. 1 valve. Overall size 7 1/2in. x 6" wide x 3 1/2" high.

Plus packing and postage 2/6. **£2.19.6**

Visit our New
HI-FI SHOWROOM
at
23 TOTTENHAM COURT RD.
The best HI-FI Showroom
in the district
(2 minutes from Tottenham Court Road Underground Station)
Tel.: MUS. 3451

WRITE FOR DETAILS OF PREMIER TAPE RECORDER KIT FOR ONLY £33.15.0.

4-WATT AMPLIFIER

MAY BE BUILT FOR **£4.10.0** Plus 2/6 Pkg. & Carr. Instruction Book 1 - post free.

A steel case is now available, complete with engraved panel, for 15/6 extra. The amplifier may be supplied complete for £5.5.0 plus pkg. and post 3/6, or fitted in case at 88 plus pkg. and post 3/6.

2-BAND T.R.F. RECEIVER

MAY BE BUILT FOR **£5.15.0** Plus 3 - Pk. & Post.

3-Band Superhet Receiver may be built for £7.19.6 plus pkg. & carr. 3/-. These two receivers use the latest type circuitry and are fitted into attractive cabinets 12in. x 6 1/2in. x 5 1/2in. in either walnut or ivory bakelite or wood. Individual instruction books 1/- each. Post free.

8 WATT AMPLIFIER

This design includes 5 miniature valves of the latest types, an ultralinear output transformer suitable for Speakers of 3 and 15 ohms and a very attractive perspex front panel with gold lettering, complete set of parts.

Postage & packing **£8.8.0** 5/- extra. or £10.19.6 built and tested. Send 1/6 for Booklet.

B.S.R. T.U.S 3-speed Record Player £3.19.6 plus 2/6 post and packing. P.U. complete with arm, 38/-.

THE LATEST COLLARO 4-SPEED SINGLE PLAYER UNIT COMPLETE WITH PICK-UP AND TURNOVER CARTRIDGE £4.12.6, PLUS 2/6 PKG. & CARR.

Why not make the best! MULLARD AMPLIFIER KIT

Now supplied with ultralinear output transformer.

All the components for Model 510, plus pre-amplifier, on one chassis (total six valves), chassis gold hammer finished. May be purchased for £12.12.0 plus pkg. and post 7/6. This version complete and tested £15.15.0. Or pre-amplifier and tone control in a separate unit £14.14.0, plus pkg. and post 7/6.

ADDRESS ALL MAIL ORDER ENQUIRIES TO: (Dept. P.W.) 207 EDGWARE RD., LONDON, W.2

BENDIX RECEIVER RA 10.

A 4 waveband superhet covering 150 kc/s-10 mc/s. Valves 6SK7 1st R.F. 6K8 Mixer. 6SK7 1st and 2nd I.F. 6R7 2nd Det. 6C5 B.F.O. 6K6-output. Size 6 1/2 x 15 1/2 in. Easily converted to mains operation as described on page 453 of the September "Practical Wireless." £5/10/-, carr. 7/6.

HIGH RESISTANCE HEADPHONES. 4,000 ohms. Brand new 11/6 each, P. & P. 2/-.

INDICATOR UNIT SLC No. 5. Ideal for conversion into an Oscilloscope using a 139A or ACR 10 tube. Unit consists of 2-VR65, 1-VR66, various resistors, condensers and pots. Size 11 x 6 x 3 in. Brand new, complete with modification circuit. 20/-, P. & P. 3/- each.

COLVERN WIRE WOUND POTENTIOMETERS. 25 watts 50k and 100k. Price 6/- each.

LEAD ACID ACCUMULATORS. 2 volts 16 A.H. Ideal for 6 volts and 12 volts supply. Brand new original cartons. Size 4in. x 7in. x 2in. 5/6 each. P. & P. 2/6. 3 for 15/-, P. & P. 3/6. 6 for 27/6. P. & P. 5/-.

AMERICAN THROAT MICROPHONES. Type T.S. 30. 3/- each. Post paid.

VIBRATOR PACKS
12 VOLT input, 300 volts output at 150 mA. As a bridge rectifier will handle 450 volts RMS at 120 mA. Pack consists of 12 volt vibrator, 4 metal rectifiers, chokes and smoothing condensers. ONLY 30/-. Carriage 5/-.

6 VOLT input, 230 v. output at 100 mA. complete 4-pin vibrator. OZ4 rectifier. Fully smoothed. 25/6 each. P. & P. 2/6.

PYE 45 mc/s I.F. STRIPS. Complete with seven valves, 6-EF50, 1-VR92, 6 tunable I.F. transformers. 30/-. Post paid.

DYNAMIC SOUND POWERED HEADPHONES. Type D.L.R. 5. 60 ohms. Individual earpieces can be used for room-to-room communication. No Batteries required—just connect up. Can also be used as miniature speakers. ONLY 7/6 pair. P. & P. 2/6.

CONVERTERS

Easily the most useful units released by the Ministry. Within minutes you can extend the frequency of any receiver to cover the following :-



R.F.26. 50-65 Mc/s., 20/- each.
 R.F.25. 40-50 Mc/s., 8/6 each.
 R.F.24. 20-30 Mc/s., 12/6 each.
 R.F.24. Shop soiled, 7/6 each.
 Complete with valves and circuit. 3/6 Postage on each.

COMMUNICATION RECEIVER R.1155

This magnificent receiver covers 5 ranges: 75-200 Kc/s. 200-500 Kc/s. 600-1.500 Kc/s. 3-7.5 Mc/s. 7.5-18.5 Mc/s. Fully tested before despatch. Complete with N type drive circuit and instruction booklet. £8.10.0. Carr. 10/-.

OSCILLOSCOPE !!

Latest Ministry release of Test Set type 43. Employs 3 1/2 in. CRT type VCR138A, 4-6J7, 4-VR54, 1-5Z4, 1-VU120. Panel controls: X shift, Y shift, Focus, Brilliance, External or internal sync., Four speed time base, Internal H.T. & E.H.T. Mains power pack. Size 17in. x 9in. x 18in. Complete with leads. Brand New and Unused.

£8.10.0

Carr. 15/-.

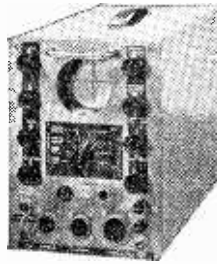

SIGNAL GENERATOR AND WAVEMETER

Type W.1649. Frequency of Signal generator: 140 to 240 Mc/s. Accuracy -0.5 Mc/s. Frequency of Heterodyne Wavemeter: 155-255 Mc/s. Accuracy -0.2 Mc/s. Containing VR.135 and 4-VR915 meg. crystal. Retractable aerial. Power requirements: 6.3 volts and 120 volts. Unit housed in copper lined wooden case. Size 15 1/2 in. x 13in. x 14 1/2 in. 45/- Plus 10/-.

TRANSMITTER RECEIVER No. 19.

Two transmitter-receivers and an intercom amplifier in one case. "A" set covers 2-8 mc/s, RT and CW. and "B" set 240 mc/s, RT only. Complete with 15 valves and 500 Micro amp. check and Tuning Meter. Complete with circuit and instruction booklet. Only 60/-, plus 10/- carr.

SPECIAL VALVE LIST

New Original		Cartoned American Valves			
2C25	3/6	6AG7	9/6	6X5GT	8/6 9006 3/6
2X2	2/6	6H6	2/6	807	6/- 12J5GT 6/-
3924	7/6	6SH7	6/-	830-B	40/- 1625 5/-
5U4G	7/6	6SL7GT	7/-	955	1/9 446B 25/-
6AC7	5/-	6SN7GT	6/6	956	1/9 464A 25/-
6AG5	5/6	6V6GT	7/6	9004	1/9 464A 25/-

All brand new and fully tested. Please add postage.

SIGNAL GENERATOR TYPE 52A

Frequency 6-52 Mc/s. in four ranges. Internal mains pack, extensively filtered. 50 ma. amp. R.F. Meter. Internal or external modulation. Calibrated coarse and fine (in μ V.) attenuator, output impedance 70 or 100 ohms. minimum output 0.5 μ Volts, maximum output 100 mV. Complete with all leads, calibration charts and circuit. Brand new in original manufacturers' cases. £8.10.0. Carr. 10/-.

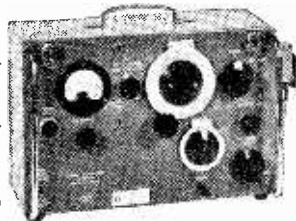

Relda Radio Ltd.

(Dept. "P") 32A, Coptic Street, London, W.C.1. Phone: MUSEum 9607. Tottenham Court Road Underground. Fourth turning on the left down New Oxford Street.

WHEATSTONE BRIDGE.

Consisting of four stud switches: 0-10 ohms, 0-100 ohms 0-INIF. Galvanometer centre zero F.S.D. 2.5 mA. Ranges easily extended. Housed in oak cabinet 16 x 7 1/2 x 6 in. Complete with instructions, 40/- P. & P. 4/-.

MUIRHEAD VERNIER SCALED 0-180 deg. Ratio 25 to 1. 3in. dia. 10/6. P. & P. 1/6.

R.C.A. MAINS TRANSFORMERS. Input 110-240 v., output 345-0-345 at 150 mA. 6.4 v. at 4.5 amps. 5 v. at 2 amps. Brand new, fully shrouded. Limited quantity. Write now. Only 35/-, P. & P. 3/-.

WESTON 1 Amp. H.F. METERS. 2in. circular. Brand new, 5/6. P. & P. 1/-.

AMERICAN ROTARY CONVERTERS. With cooling fan. Input 12 v. D.C. Output 250 v. at 90 mA. Completely suppressed. Brand new. 19/- each. Plus P. & P. 3/-.

COMMAND RECEIVERS. 1.5-3 mc/s, fully valued, with circuit, 65/-, P. & P. 3/6.

LUMINOUS MAGNETIC MARCHING COMPASS. Pocket size. Brand new with instructions. ONLY 12/6. P. & P. 1/-.

POCKET VOLT METERS. Read 0-25 volts and 0-250 volts D.C. Brand new. Only 12/6. P. & P. 2/6.

PUSH BUTTON COIL PACKS. 465 Kc/s. I.F. Gram., long, medium and 6 short waveband spread. 8/6. Post 1/6.

RELAYS. 6,500 ohms and 3,500 ohms. 8/- pair. Post paid.

WAVEMETER TYPE W1433. Frequency 154-260 mc/s., with crystal check and calibration chart. Mains 50 cycle. 50/-. Carriage 10/-.

BENDIX RECEIVER MN26.C.

Covering 150-1,500 kc/s in 3 bands. Valves used 5-6K7, 2-6N7, 2-6J5, 1-6F6, 1-6L7. Complete with switching motor and



dynamotor. This superb unit has been modified for 12 v. operation. With circuit. Only 80/-, Carr. 8/6.

R.S.C. BATTERY CHARGING EQUIPMENT

ASSEMBLED CHARGERS

6 v. 1 amp.....	19/9
6 v. or 12 v. 1 amp.....	27/9
6 v. 2 amps.....	33/9
6 v. or 12 v. 2 amps.....	33/9
6 v. or 12 v. 4 amps.....	56/9

Above ready for use. Carr. 3/6. With mains and output leads.

SELENIUM RECTIFIERS F.W. BRIDGE TYPES

6/12 v. 1 a. 4 1/2 L.T. Types H.W.	1/11
6/12 v. 2 a. 9/3 2-5 v. 1 a. H.W.	2/9
6/12 v. 3 a. 11/9 6-12 v. 1 a. H.W.	2/9
6/12 v. 4 a. 14/9 H.T. Types H.W.	
6/12 v. 6 a. 19/9 150 v. 40 mA. 3/9	
6/12 v. 10 a. 27/9 250 v. 50 mA. 5/9	
6/12 v. 15 a. 35/9 250 v. 80 mA. 7/9	
6/12 v. 15 a. 35/9 250 v. 250 mA. 11/9	

BATTERY CHARGER KITS

Consisting of Mains Transformer, F.W. Bridge, Metal Case, Fuses, Fuse-holders, Grommets, panels and circuit. Carr. 2/9 extra.

3 v. or 12 v. 1 amp.....	22/9
6 v. 2 amps.....	25/9
6 v. or 12 v. 2 amps.....	31/8
6 v. or 12 v. 4 amps.....	53/9

BATTERY CHARGER KIT

Consisting of F.W. Bridge Rectifier, 6/12 v. 5 a. Mains Trans., 0-9-15 v. 6 a. output and Ammeter. 49/9. Post. 3/6.

ASSEMBLED CHARGER

6 v. or 12 v. 2 amps.

Fitted Ammeter and selector plug for 6 v. or 12 v. Louvred metal case, finished attractive hammer blue. Ready for use. With mains and output leads. Double Fused. Only **49/9** Carr. 3/6.

All for A.C. Mains: 230-250 v., 50 c/s. Guaranteed 12 months.



Assembled 6 v. or 12 v. 4 amps.

Fitted Ammeter and variable charge rate selector. Also selector plug for 6 v. or 12 v. charging. Louvred steel case with stoved blue hammer finish. Fused **75/-** and ready for use with mains and output leads. Carr. 4/6. Credit Terms: Deposit 30/- and 4 monthly payments, 13/-.

R.S.C. MAINS TRANSFORMERS (FULLY GUARANTEED)

Interleaved and Impregnated. Primaries 200-230-250 v. 50 c/s. Screened.

TOP SHROUDED DROP THROUGH

250-0-250 v. 70 mA. 6.3 v. 2 a. 5 v. 2a.	16/9
350-0-350 v. 80 mA. 6.3 v. 2 a. 5 v. 2a.	18/9
250-0-250 v. 100 mA. 6.3 v. 4 a. 5 v. 3 a.	23/9
350-0-350 v. 100 mA. 6.3 v. 4 a. 5 v. 3 a.	23/9
350-0-350 v. 100 mA. 6.3 v. 4 a. 5 v. 3 a.	23/9
350-0-350 v. 100 mA. 6.3 v. 4 v. 4 a. C.T. 0-1-5 v. 3 a.	23/9
350-0-350 v. 150 mA. 6.3 v. 4 a. 5 v. 3 a.	23/9

FULLY SHROUDED UPRIGHT

250-0-250 v. 60 mA. 6.3 v. 2 a. 5 v. 2 a.	17/6
250-0-250 v. 100 mA. 6.3 v. 4 a. 5 v. 3 a.	23/9
250-0-250 v. 100 mA. 6.3 v. 6 a. 5 v. 3 a.	31/-
300-0-300 v. 100 mA. 6.3 v. 4 a. 5 v. 3 a.	23/9
350-0-350 v. 100 mA. 6.3 v. 4 a. 5 v. 3 a.	23/9
350-0-350 v. 130 mA. 6.3 v. 4 a. 6.3 v. 1 a.	35/9
350-0-350 v. 100 mA. 6.3 v. 4 a. 5 v. 3 a.	33/9
350-0-350 v. 150 mA. 6.3 v. 2 a. 6.3 v. 2 a. 5 v. 3 a.	35/9
425-0-425 v. 200 mA. 6.3 v. 4 a. C.T. 6.3 v. 4 a. C.T. 5 v. 3 a. Suitable Williamson Amplifier, etc.....	49/9

FILAMENT TRANSFORMERS

All with 230-250 v. 50 c/s. primaries 6.3 v. 1.5 a. 5/9; 6.3 v. 2 a. 7/6; 0-4-6.3 v. 2 a. 7/9 12 v. 1 a. 7/11; 6.3 v. 3 a. 8-11; 6.3 v. 6 a. 17/6; 12 v. 3 a. or 21 v. 1.5 a. 17/4.

JUNCTION TRANSFORMERS.

Brand new R.F. Type 17/6.

ELIMINATOR TRANSFORMERS

Primaries 200-250 v. 50 c/s.

120 v. 40 mA. 5-0-5 v. 1 l.	15/9
90 v. 15 mA. 4-0-1 v. 50 mA.	9/9

CHARGER TRANSFORMERS

All with 200-230-250 v. 50 c/s. Primaries:

0-9-15 v. 11 a. 11/9; 0-9-15 v. 3 a. 16/9;	
0-9-15 v. 5 a. 19/9; 0-9-15 v. 6 a. 23/9.	

SMOOTHING CHOKES

250 mA. 5 H 300 ohms.....	12/9
150 mA. 7-10 H 250 ohms.....	11/8
100 mA. 100 H 230 ohms.....	8/9
80 mA. 10 H 350 ohms.....	5/9
60 mA. 10 H 400 ohms.....	4/11

OUTPUT TRANSFORMERS

Midget Battery Pentode 68:1 for 351, etc..... 3/9

Small Pentode. 5,000 Ω to 3 Ω 3/9

Small Pentode 7/8,000 Ω to 3 Ω 3/9

Standard Pentode 5,000 Ω to 3 Ω 4/9

Standard Pentode. 7/8,000 Ω to 3 Ω 4/9

10,000 Ω to 3 Ω 4/9

Push-Pull 10-12 watts 6V6 to 3 Ω or 15 Ω 15/9

Push-Pull 10-12 watts to match 6V6 to 5-5-3 or 15 Ω 16/9

Push-Pull EL34 to 3 or 15 Ω 16/9

Push-Pull 15-18 watts. 6L9, KT66..... 22/9

Push-Pull 20 watts, sectionally wound 6L6, KT66, etc., to 3 or 15 Ω 47/9

EX-GOVT. SMOOTHING CHOKES

300 mA. 20 H 200 ohms.....	19/9
350 mA. 5 H 50 ohms.....	12/9
150 mA. 10 H 100 ohms.....	11/9
150 mA. 10 H 150 ohms Trop.....	6/9
120 mA. 12 H 100 ohms.....	9/9
100 mA. 5 H 100 ohms.....	3/11

EX-GOVT. E.B.T. SMOOTHING CONDENSERS. .02 mfd. 5,000 v. Cans. 2/9.

THE SKYFOR T.R.F. RECEIVER.

A design of a 3-valve Long and Medium wave 250-250 v. A.C. Mains receiver with selenium rectifier. It consists of a high gain H.F. stage and low distortion anode bend detector. Power pentode output is used. Valve line-up 6K7, SP61, 6V3c. Selectivity and quality are well up to standard, and simplicity of construction is a special feature. Point-to-point wiring diagrams, instructions and parts lists, 1/9. Maximum building costs 24/9/6, including attractive Brown or Cream Bakelite or Walnut veneered wood cabinet 12 x 6 x 5 1/2 in.

EX-GOVT. DOUBLE WOUND STEP UP/STEP DOWN TRANSFORMERS.

10-0-100-220-220-240 v. to 5-0-75-115-135 v. or REVERSE. 80-100 watts. Only 11/9, plus 2/9 post. 10-0-100-220-220-240 v. to 9-0-110-122-136-148 v. or REVERSE. 200 watts. 35/9, plus 7/6 carr. Both 50 c.p.s.

EX-GOVT. MAINS TRANSFORMERS.

Primary 0-10-120-200-210-220-230-240-250 v. 50 c.p.s. Secs. 275-0-275 v. 100 mA. 6.3 v. 7 a. 5 v. 3 a. Govt. ratings. 22/9. Following with 230-25 v. primaries, 400-0-400 v. 200 mA. 5 v. 3 a. 5 v. 2 a. 19/9; 230-0-230 v. 100 mA. 12.6 v. 1.5 a. 5 v. 2 a. 11/9; 12 v. 3 a. 5 v. 3 a. 9/9. Postage 2/9 on any type.

Primary 200-250 v. Sec. 0-16-18-20 v. 60amps Suitable Welding or Soil Heating. 79/6. Carr. 7/6.

EX-GOVT. CASES. Size 14-10-8 1/2 in. high. Well ventilated, black crackle finished, undrilled cover. IDEAL FOR BATTERY CHARGER OR INSTRUMENT CASE. OR COVER COULD BE USED FOR AMPLIFIER. Only 9/9, plus 2/9 postage. Size 8 1/2 x 13 1/2 x 6 1/2 in. with undrilled well ventilated cover, finished in stoved grey enamel. Suitable for charger or instrument case. 7/8, plus 2/9 post.

EX-GOVT. VALVES (NEW)

1T4	7/9	6J6	4/9	ECC91	4/9
1S5	7/9	6V6G	7/9	EF80	7/9
3S3	8/9	6X4	6/9	EB91	4/9
5Y3G	8/9	6X5CT	8/9	EF91	8/9
5U4G	8/9	6L6G	11/9	EF96	4/9
3Z4G	9/9	6Z5	8/9	6X4	8/9
6K7G	5/9	12A6	7/9	KT44	8/9
6S7GT	6/9	15D2	4/9	EZ90	6/9
6SL7G	8/9	35Z4GT	8/9	EL84	10/6
6SN7GT	8/9	MH4	4/9	FW4500	9/9
6AT6	7/9	ECC83	9/9	SP61	2/9

ELECTROLYTICS (current production) NOT EX-GOVT.

Tube Types	Can Types
8 μ F 450 v. 1/9	16 mfd. 350 v. 1/11
8 mfd. 500 v. 2/8	16 mfd. 500 v. 2/9
16 μ F 350 v. 2/3	16 μ F 450 v. 2/9
16 μ F 450 v. 2/9	32 μ F 350 v. 2/11
16 μ F 500 v. 2/9	32 mfd. 450 v. 4/8
32 μ F 350 v. 2/9	100 mfd. 450 v. 9/9
25 μ F 25 v. 1/3	8-16 μ F 450 v. 2/9
50 μ F 12 v. 1/3	8-16 μ F 450 v. 3/11
50 μ F 25 v. 1/6	16-16 μ F 450 v. 4/11
50 μ F 50 v. 1/9	32-32 μ F 350 v. 4/9
100 mfd. 12 v. 1/9	32-32 μ F 450 v. 5/9
100 mfd. 25 v. 2/3	100-100 mfd. 350 v. 4/9
1,500 mfd. 6 v. 1/8	64-120 mfd. 350 v. 7/9
3,000 mfd. 6 v. 3/9	100-200 mfd.
6,000 mfd. 6 v. 3/9	275 v. 6/9

Many others in stock.

VOLUME CONTROLS with long (1 1/2 in.) spindle all values less switch, 2/3; with S.P. switch, 3/9; with D.P. switch, 4/6.

H.T. ELIMINATOR AND TRICKLE CHARGER KIT. Input 230-250 v. A.C. Output 120 v. 40 mA. Fully smoothed and rectified supply to charge 2v. accumulator. Price with louvred metal case and circuit. 23/9, or ready for use, 8/3 extra.

SPECIAL OFFERS: Electrolytics, 32-32-32 mfd. 250 v. Dubilier small can, 2/9 ea. 150 mfd. 450 v. 3/9. Small 0.005 mfd. 2-zanz. 4/9 ea. Westinghouse Rectifiers 250 v. 250 mA. 7/9. CO-AXIAL CABLE. 75 ohm. 1/2 in. 8d. yd. Twin-Screened Feeder 11d. yd.

R.S.C. BATTERY TO MAINS CONVERSION UNITS

Type BMI. An all-dry battery eliminator. Size 5 1/2 x 4 1/2 in. approx. Completely replaces batteries supplying 1.4 v. and 90 v. where A.C. mains 20-250 v. 50 c/s is available. Suitable for all battery powered radio receivers, requiring 1.4 v. and 90 v. This includes latest low consumption types. Complete kit with diagrams. 39/9. or ready to use, 46/9.



Type BM2. Size 9 x 5 1/2 x 2 1/2 in. Supplies 120 v. 90 v. and 60 v., 40 mA. and 2 v. 0.4 a to 1 amp. fully smoothed. Therefore completely replacing both H.T. batteries and H.F. 2 v. accumulators. When connected to A.C. mains supply 200-250 v. 50 c/s. **SUITABLE FOR ALL BATTERY RECEIVER NORMALLY USING 2 v. ACCUMULATOR.** Complete kit of parts with diagrams and instructions. 49/9. or ready for use, 59/6.

MINIATURE MOTORS. 24/28 v. D.C. or A.C. made by Hoover Ltd., Canada. Size only 2 1/2 x 1 1/2 in. Spindle 1/4 in. long, 1/4 in. diam. Brand New. 9/9.

HEADPHONES. Brand new. Low resistance. Only 6/9 pr.

EX-GOVT. 50 WATT SPEECH AMPLIFIERS. For normal 200-250 v. A.C. mains. Complete with hand mike and good length of lead and all valves. Ready for use, in wood transit cases. Only 9 Gns., carr. 15/-.

FANNOY RE-ENTRANT 8 WATT SPEAKERS. For use with above, 27/6 ea.

EXTENSION SPEAKERS

Ready for use in walnut veneered cabinet.

8in. 23 ohms, 35/9. Very limited number.



EX-GOVT. METAL BLOCK (PAPER) CONDENSERS.

4 mfd. 350 v. 2/9;	4 mfd. 1,000 v. 4/9;
8 mfd. 500 v. 4/9;	10 mfd. 500 v. 3/9;

R.S.C. A8 ULTRA LINEAR 12 WATT AMPLIFIER

High-Fidelity Push-Pull Amplifier with Built-in Tone Control. Pre-amp stages, High sensitivity. Includes 5 valves (807 outputs). High Quality sectionally wound output transformer, specially designed for Ultra Linear operation, and reliable small condensers of current manufacture. INDIVIDUAL CONTROLS FOR BASS AND TREBLE. "Lift" and "Cut." Frequency response 3 db., 30-30,000 c/s. Six negative feedback loops. Hum level 71 db. down, ONLY 70 millivolts INPUT required for FULL OUTPUT. Suitable for use with all makes and types of pick-ups and practically all microphones. Comparable with the very best designs.

£7-15-0

FOR STANDARD or LONG-PLAYING RECORDS. For MUSICAL INSTRUMENTS such as STRING BASS, GUITARS, etc. OUTPUT SOCKET with plug provides 300 v. 20 mA. and 6.3 v. 1.5 a. For supply of a RADIO FEEDER UNIT. Size approx. 12.9-7in. For A.C. mains 200-230-250 v. 50 c/s. Outputs for 3 and 15 ohm speakers. Kit is complete to last nut. Chassis is fully punched. Full instructions and point-to-point wiring diagrams supplied. Unapproachable value at £7 15- for factory built 45- extra. Carriage 10-
If required laminated metal cover with 2

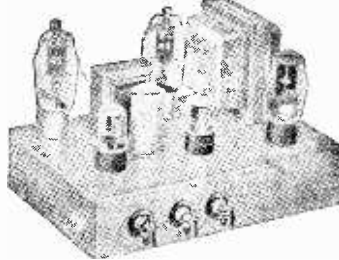

carrying handles can be supplied for 18/9. Additional input socket with associated Vol. control so that two different inputs such as Gram and 'Mike' or Tape and Radio can be mixed, can be provided for 13/- extra. Guaranteed 12 months.
Kit on assembled two input model: DEPOSIT 25/6 and nine monthly payments 25/6.
HIGH-FIDELITY MICROPHONES and SPEAKERS in stock. Cash keep prices or Credit terms if supplied with amplifier.

R.S.C. 30 WATT ULTRA LINEAR HIGH-FIDELITY AMPLIFIER A10

A highly sensitive Push-Pull high output unit with self-contained Pre-amp. Tone Control Stages. Certified performance figures compare equally with most expensive amplifiers available. Hum level 70 db. down. Frequency response 3 db. 30-30,000 c/s. A specially designed sectionally wound ultra linear output transformer is used with 807 output valves. All components are chosen for reliability. Six valves are used, EF86, EF86, ECC83, 807, 807, GZ33. Separate Bass and Treble Controls are provided. Minimum input required for full output is only 12 millivolts so that ANY KIND OF MICROPHONE OR PICK-UP IS SUITABLE. The unit is designed for CLUBS, SCHOOLS, THEATRES, DANCE HALLS or OUTDOOR FUNCTIONS, etc. For use with Electronic ORGAN, GUITAR, STRING BASS, etc. For standard or long-playing records, OUTPUT SOCKET PROVIDES L.T. and H.T. for a RADIO FEEDER UNIT. An extra input with associated vol. control is provided so that two separate inputs such as Gram and Mike' can be mixed. Amplifier operates on 200-250 v. 50 c/s. A.C. Mains and has outputs for 3 and 15 ohm speakers. Complete kit of parts with fully punched chassis and point-to-point wiring diagrams and instructions. If required cover as for parts with 10/- extra.
ONLY

£10-19-6

Carr. 10-
Kit can be supplied for 18/9. The amplifier can be supplied factory built with 12 months' guarantee, for £13.15. C. TERMS: DEPOSIT 36- and 9 monthly payments of 31-.

COLLARO RC54 3-SPEED AUTO-CHANGERS with Studio Pick-up. Brand new. For 110 v. 50 c.p.s. A.C. mains. Price with 110 to 250 v. Auto Trans. only 7 Gns. Carr. 5/6.

COLLARO CONQUEST 4-SPEED AUTO-CHANGERS with high fidelity Studio Pick-up. Latest model. Brand new. Cartridge. For 200-250 v. 50 c.p.s. A.C. mains. Our price £8 19/6. Carr. 5.1. Credit Terms. Deposit 3 gns. and 6 monthly payments of 21/6.

COLLARO 4-SPEED SINGLE PLAYER with separate pick-up, as fitted RC457. For 200-250 v. A.C. mains. £4.12.6. Post 3/9.

LG3 MINIATURE 2-3 WATT GRAM AMPLIFIER. For use with above or any other single or auto-change units. Output for 2-3 ohm speaker. For 200-250 v. 50 c.p.s. A.C. mains. Overall size 6 1/2 x 4 1/2 in. Controls: Vol. and Tone with switch. Guaranteed 12 months. Only 55/9.

SUPERHETEROFEDERUNIT. Design of a high quality Radio Tuner Unit (especially suitable for use with any of our Amplifiers). Delayed A.V.C. employed. The W.Ch. Sw. incorporates Gram position. Controls are Tuning, W.Ch. and Vol. Only 250 v. 15 mA. H.T. and L.T. of 6.3 v. 1 amp. required from amplifier. Size of unit approx. 9-8-7in. high. Simple alignment procedure. Point-to-point wiring diagrams, instruction and priced parts list with illustration. 2/6. Total building cost, £4 15-.. For descriptive leaflet send S.A.E.

LINEAR L45 MINIATURE 4.5 WATT QUALITY AMPLIFIER. Suitable for use with Collaro, B.S.R. or any other record-playing unit, and most microphones. Negative feedback. 12 db. Separate Bass and Treble Controls. For A.C. mains input of 200-250 v. 50 c/s. Output for 2-3 ohm speaker. Three miniature Mullard valves used. Size of unit only 6.5-5.3in. high. Output for 2-3 ohm speaker. Guaranteed for 12 months. Only £5 19/6. Send S.A.E. for illustrated leaflet. Credit Terms. Deposit 22/6 and 5 monthly payments of 22/6.

LINEAR "DIATONIC" 10-14 WATT HIGH FIDELITY PUSH-PULL ULTRA LINEAR AMPLIFIER. For 200-230-250 v. 50 c/s. A.C. mains. Valve line-up ECC83, ECC83, EL84, EL84, EZ81 miniature Mullard. The unit has self-contained Pre-amplifier Tone Control stages and separate Bass and Treble Controls. Independent 'Mike' and Gram input sockets are provided. Size is only 9-7-6in. Output Matchings for 3 and 15 ohm speakers. Only 12 GNS. ; or Deposit 25/9 plus 10 c/s. monthly payments of 26/9. Send S.A.E. for leaflet.

R.S.C. 4-5 WATT A5 HIGH-GAIN AMPLIFIER

A highly sensitive 4-valve quality amplifier for the home, small club, etc. Only 50 millivolts input is required for full output so that it is suitable for use with the latest high-fidelity pick-up heads, in addition to all other types of pick-ups and practically all 'mikes'. Separate Bass and Treble Controls are provided. These give full long-playing record equalisation. Hum level is negligible being 71 db. down. 15 db. of negative feedback is used. H.T. of 300 v. 25 mA. and L.T. of 6.3 v. 1.5 a. is available for the supply of a Radio Feeder Unit, or Tape Deck pre-amplifier. For A.C. mains input of 200-250-250 v. 50 c/s. Output for 2-3 ohm speaker. Chassis is not alive. Kit is complete in every detail and includes fully punched chassis (with base-plate) with Blue Hammer finish and point-to-point wiring diagrams and instructions. Exceptional value at only £4/15-.. or assembled ready for use 25/- extra, plus 3/6 carr.; or Deposit 22/6 and 5 monthly payments of 22/6 for assembled unit.



LINEAR L45 HIGH QUALITY TAPE DECK AMPLIFIER. With "built in" power pack and output Ready for stage. For Tape Decks use ONLY with High or Low Impedance, Playback and Erase Heads, such as Lane, Truvox, Aspden, Collaro, Carr. 7/6 Brennell, etc. For A.C. Mains 230-250 v. 50 c/s. Linear frequency response of +3 db., 50-11,000 c/s. Negative feedback equalisation. Illustrated leaflet 6d.

12 GNS.

STAR GALAXY 4 SPEED MIXER AUTO-CHANGER. Attractive two tone finish. A precision manufactured unit with a motor which virtually eliminates "wow" and rumble. The only changer with exclusive finger tip control. Playing Desk size 11 x 10in. Depth below base-board 2in. Above 5in. Fitted pick-up with dual sapphire tipped stylus. For 200-250 v. 50 c.p.s. A.C. mains. A limited number of these luxury units available at only 9 GNS. Carr. 4/6. Brand New.

Terms: C.W.O. or C.O.D. NO C.O.D. under £1. All goods supplied subject to terms and guarantee as detailed in current catalogue. Open 9 to 5.30; Sats. until 1 p.m. Catalogue 6d. Trade list 6d. S.A.E. with all enquiries.

R.C.A. 90 WATT RE-ENTRANT SPEAKERS. 15 ohms or 600 ohm matching. For Outdoor work. Only 4 GNS. P.M. SPEAKERS. All 2-3 ohms, suitable for use with LG3, L45, A5, or A7 amplifiers, 6in. Goodmans, 17/9. 7 x 4in. Elliptical Elec. 18/9. 6in. Goodmans, 17/9. 8 in. Rola 19/9. 6in. Goodmans, 27/9. 10 x 6in. Elliptical Goodmans, 27/9. 12in. Plessey, 29 11. 10in. W.B. "Stentorian" 3 or 15 ohms type HF1012 10 watts, hi-fidelity type. Recommended for use with our A8 Amplifier, £4 10/9. 12in. Plessey 3 ohms 10 watts. (12,000 lines), 59/6.

PLESSEY DUAL CONCENTRIC 12in. 15 ohm HIGH FIDELITY SPEAKER with built-in tweeter (completely separate elliptical speaker with choke, condensers, etc.), providing extraordinarily realistic reproduction when used with our A8 or similar amplifier. £4 10/9. 10 watts. Price complete, only £5/17/6.

M.E. SPEAKERS 2-3 ohms, 8in. R.A. Field, 600 ohms 11/9.

R.S.C. 3-4 WATT A7 HIGH-GAIN AMPLIFIER

For 230-250 v. 50 c/s. Mains input. Appearance and Specification, with exception of output wattage, as A5. Complete Kit with diagrams, £3 15-.. Assembled 22/6 extra, Carr. 3/6.

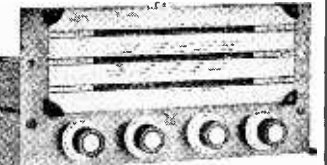

AM/FM RADIOGRAM CHASSIS HIGH QUALITY 8-WATT PUSH-PULL OUTPUT

For 200-250 v. Mains. Long wave, Medium, F.M. and Gram. Complete with 6 B7A valves. Guaranteed 12 months. Only 22 GNS. Or Deposit £2/12/- and 9 monthly payments of £2/12/-.

Post 19 extra under £2; 2/9 extra under £5. As detailed in current catalogue.

TOP QUALITY FULLY GUARANTEED VALVES

ALL GOODS LISTED ARE ACTUALLY IN STOCK

EXPRESS SERVICE !!!

C.O.D. ORDERS RECEIVED BY 3.30 P.M., EITHER BY LETTER, PHONE OR WIRE, DESPATCHED THE SAME AFTERNOON. ALL ORDERS RECEIVED BY FIRST POST DESPATCHED SAME DAY.

FOR ONLY 6d. EXTRA PER ORDER WE WILL INSURE YOUR VALVES AGAINST DAMAGE IN TRANSIT. ALL UNINSURED PARCELS AT CUSTOMER'S RISK.

IA3	3/- 6AT6	8/6 6K8GT/G	11E3	15/- 30P4	15/- CV85	12/6 ECC35	8/6 EZ8D	9/6 PCF8D	14/- U3C41	9/6		
IA5	6/- 6AU6	10/6I	11/- 12A6	6/6 30P12	13/6 CV271	10/6 ECC81	9/- EZ81	10/- PCF82	12/6 UBFB0	9/6		
IA7	15/- 6B4G	6/6 6L6G	9/6 12AH7	8/- 31	7/6 CV428	30/- ECC82	9/- FW4 200	10/- PCL82	12/6 UBFB9	10/6		
ID5	10/6 6B7	10/6 6L18	13/- 12AH8	10/6 33A/158M	D1	3/- ECC83	9/-	12/6 PEN40DD	UCC85	10/6		
IH5	11/- 6B8G	4/6 6N7	8/- 12AT6	10/6I	30/- D42	10/6 ECC84	10/- GZ30	10/6I	25/- UCH42	11/-		
IL4	6/6 6B8M	5/- 6Q7G	10/- 12AT7	10/- 12A17	10/6I	5/- ECC85	9/6 GZ32	12/6 PEN45	19/6 UCH81	11/6		
ILD5	5/- 6BA6	7/6 6Q7GT	11/- 12AU7	10/- 35A5	11/- D77	6/6 ECC91	5/6 GZ34	14/- PEN46	7/6 UCL82	15/6		
ILN5	5/- 6BE6	7/6 6R7G	10/- 12AX7	9/- 35L6GT	10/- DAC32	11/- ECF80	13/6 H30	5/- PL82	10/- UCL41	9/-		
IN5	11/- 6BJ6	8/- 6SA7GT	8/6 12BA5	9/- 35W4	8/6 DAF91	8/- ECF82	13/6 H63	12/6 PL83	11/6 UF80	10/6		
IR5	8/6 6BR7	11/6 6SC7	10/6 12BE6	10/- 35Z3	10/6 DAF96	10/- ECH35	9/6 HABC80	10/6I	12/6 UF85	10/6		
ISS	8/- 6BV6	9/6 6SG7GT	8/- 12E1	30/- 35Z4GT	8/- DF33	11/- ECH42	11/-	13/6 PM12	6/6 UF89	10/6		
IT4	7/- 6BW7	12/6 6SH7	8/- 12J5GT	4/6 35Z5GT	9/- DF91	7/- ECH81	9/- IHK90	10/- PM12M	6/6 ULA11	11/-		
1U5	10/- 6BX6	12/6 6S17	8/- 12J7GT	10/6 41MTL	8/- DF96	10/- FCL8D	14/- HL23	10/6 PY80	9/- UL46	15/-		
2A3	12/6 6C4	7/- 6SK7GT	8/- 12K7GT	7/6 50C5	12/6 DH63	10/- ECL82	14/- HL41	12/6 PY81	9/- UL84	11/6		
2A7	10/6 6C5	6/6 6SL7GT	8/- 12K8GT	50L6GT	9/6 DH76	7/6 EF36	6/- HLI33DD	10/6I	9/6 UY41	8/6		
2C26	4/- 6C6	6/6 6SN7GT	7/6 14/- 72	4/6 DH77	8/6 EF37A	9/6 EF39	6/- HVR2	20/-	OP21	7/- V1507	5/3	
2D13C	7/6 6C8	12/6 6S57	8/- 12Q7GT	7/6 77	8/- DK32	15/- EF39	6/- HVR2	20/-	OP25	15/- VLS492A	2/6	
2X2	4/6 6C9	12/6 6U4GT	14/- 12SA7	6/6 78	8/6 DK91	8/6 EF40	15/- HVR2A	6/-	OP25	15/- VMP4G	15/6	
3A4	7/- 6C10	12/6 6U5G	7/6 12SC7	8/6 80	9/- DK92	12/6 EF41	9/6 KL35	8/6	Q5150/15	10/6 VP2(7)	15/-	
3A5	12/6 6CH6	12/6 6U7	8/6 12SG7	8/6 83V	12/6 DK96	10/- EF42	12/6 KT2	5/-	10/6 VQ04/7	VP4(7)	15/-	
3B7	12/6 6D5	6/6 6V6G	7/- 12SH7	8/6 85A2	15/- DL2	15/- EF50(A)	7/- KT33C	10/6I	15/-	VP13C	7/-	
3D6	5/- 6E5	12/6 6V6GT	8/- 12S17	8/6 150B2	15/- DL33	9/6 EF50(E)	5/- KT44	15/-	7/-	VP41	7/6	
3Q4	9/- 6F6G	7/- 6X4	7/- 12SK7	8/6 807	7/6 DL92	8/- EF54	5/- KT63	7/-	R12	12/6 VP41	7/6	
3Q5GT	9/6 6F6GT	8/- 6X5GT	6/6 12SQ7	8/6 956	3/- DL94	9/- EF73	10/6 KTW61	8/-	SD6	12/7 VR105/30	9/-	
3S4	8/- 6F8	12/6 6Z4/84	12/6 12SR7	8/6 1203	7/- DL96	10/- EF80	8/6 KTW62	8/-	SP4(7)	15/-	9/-	
3V4	9/- 6F12	7/- 6Z5	12/6 12Y4	10/6 4033L	12/6 DLS10	10/6 EF85	9/- KTW63	8/-	SP41	3/6 VR150/30	9/-	
3V4	8/6 6F13	13/- 6/30L2	12/6 14R7	10/6 5763	12/6 DM70	8/6 EF86	14/6 KTZ41	8/-	SP42	12/6	9/-	
5V4	12/6 6F16	9/6 7A7	12/6 14S7	17/- 7193	5/- EA50	2/- EF89	10/- KTZ63	10/6I	SP61	3/6 VT61A	5/-	
5X4	12/6 6F17	12/6 7B7	9/- 19AQ5	11/- 7475	7/6 EA76	9/6 EF91	9/- L63	6/-	SU61	12/6 VT501	5/-	
5Y3G	8/- 6F32	10/6 7C5	8/- 19H1	10/- 9002	5/6 EABC8D	9/- EF92	6/6 LNI52	14/-	TP22	15/- W76	7/6	
5Y3GT	8/6 6F33	7/6 7C6	8/- 20D1	16/- 9003	5/6 EAC91	7/6 EL32	5/6 LZ319	14/-	U16	12/6 X61	12/6	
5Y4	12/6 6G6	6/6 7H7	8/- 20L1	13/6 9006	6/- EAF42	10/6 EL41	11/- MH4	7/-	U18/20	12/6 X65	12/6	
5Z3	12/6 6H6GT/G	7/6 7Q7	9/- 220P	10/6 AC6PEN	7/6 EB34	2/6 EL42	11/6 MHL4	7/6	U22	8/- X66	12/6	
5Z4G	10/6I	3/- 757	10/6 25L6GT	10/- AC/HL	EB41	8/6 EL41	15/- MHLD6	12/6	U31	10/- X79	12/6	
5Z4GT	12/6 6H6M	3/6 7V7	8/6 25Y5	10/6 DDD	15/- EB91	6/6 EL84	10/6 ML4	12/6	U43	12/6 XD(1.5)	6/6	
6A8	10/- 6J5G	5/- 7Y4	8/- 25Y5G	10/- AC/P4	8/- EBC33	7/6 EL91	5/- ML6	6/6	U50	8/- XFV10	6/6	
6AB7	8/- 6J5GTG	5/6 8D2	3/6 25Z5	10/6 AL60	10/- EBC41	10/- EM34	10/- MU14	10/-	U52	8/6 XFY12	6/6	
6AB3	14/- 6J5GTM	6/- 8D3	9/- 25Z4G	10/- AP4	7/6 EBF80	10/- EM80	10/6 OA10	12/6	U76	8/- XH(1.5)	6/6	
6AC7	6/6 6J6	5/6 9D2	4/- 25Z6G	10/- ATP4	5/- EBF89	9/6 EY51	5/-	OA70	5/-	U78	7/- XSG(1.5)	6/6
6AG5	6/6 6J6	6/- 10C1	15/- 28D7	7/- AZ31	12/6 EC52	5/6 (Small)	12/6 OA71	5/-	U251	15/- Y63	7/6	
6AJ8	9/- 6J7G	6/- 10F1	19/6 30	7/6 BL63	7/6 EC54	6/- EY51	OC72	30/-	U404	10/6 Z63	10/6	
6AK5	8/- 6J7GT	10/6 10F9	11/6 30C1	14/- CK505	6/6 EC70	12/6 (Large)	12/6 P61	3/6	UABC80	Z66	20/-	
6AL5	6/6 6K7G	5/- 10F18	12/6 30F5	12/6 CK506	6/6 ECC31	15/- EZ35	6/6 PABC80	15/-	10/6	Z77	9/-	
6AM6	9/- 6K7GT	6/- 10LD3	9/6 30FL1	12/6 CK523	6/6 ECC32	10/6 EZ4D	8/- PCC84	10/-	UAF42	10/6 Z719	14/-	
6AQ5	7/6 6K8G	8/- 10P13	17/6 30L1	12/6 CV63	10/6 ECC33	3/6 EZ41	10/6 PCC85	12/6	UB41	12/7 Z729	14/6	

TERMS OF BUSINESS:—CASH WITH ORDER OR C.O.D. ONLY. POST/PACKING CHARGES 6d. PER VALVE; ORDERS VALUE £3 OR MORE POST FREE. MINIMUM C.O.D. FEE AND POSTAGE 3/-. EACH ADDITIONAL VALVE 6d. EXTRA. WE ARE OPEN FOR PERSONAL SHOPPERS MON.-FRI 8.30-5.30. SATS. 8.30-1 P.M.

ALL VALVES NEW, BOXED, TAX PAID, AND SUBJECT TO MAKERS' GUARANTEE. FIRST GRADE GOODS ONLY, NO SECONDS OR REJECTS. GOODS ARE ONLY SOLD SUBJECT TO OUR TERMS OF BUSINESS, OBTAINABLE FREE ON REQUEST. CATALOGUE OF OVER 1,000 DIFFERENT VALVES 3d.

When comparing our prices, remember just what we offer. Bentley valves are not only "GUARANTEED NEW AND BOXED," and "GUARANTEED TESTED AT TIME OF DESPATCH," Bentley valves are NEW, BOXED, AND SUBJECT TO THE MAKERS' STANDARD GUARANTEE AS WELL. Only our enormous turnover enables us to select the products of the world's finest manufacturers at lowest prices and pass the benefits on to YOU.

BENTLEY ACOUSTIC CORPORATION LTD.

THE VALVE SPECIALISTS

38 CHALCOT ROAD, LONDON, N.W.1

PRImrose 9090
PLEASE ENQUIRE FOR ANY VALVE NOT LISTED 3d. STAMP. PLEASE.

SHORT WAVE COMMUNICATIONS RECEIVER

R.208. ONLY £6-19-6

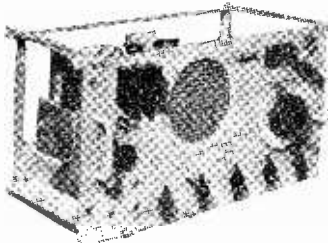

This is a super short-wave receiver covering 5-30 metres (10-60 Mc/s). Uses 6 valves. Has R.F. stage, 2 I.F. stages, B.F.O., etc. Muirhead instrument drive, two internal power packs, mains and battery vibrator pack. Complete with own P.M. speaker. Provision for phones

and speaker muting. Complete in metal transit case; size approx. 24 x 18 x 12in.; weight 70lb. Suitable A.C. mains 100-230 and 6 volt battery. In perfect condition, practically unused. Tested before despatch and guaranteed. Handbook free with each. Price £6.19.6, carriage and insurance 15/-.

Famous Transmitter virtually given away

The famous R1154N — unused but slightly soiled and not tested. Covers 210-500 Kcs. 3-5.5 Mc/s and 5-10 Mc/s. Has unique "click stop" mechanism (7 stops) and permits selected frequency to be held, returned to, etc. Hartley Oscillator, Power Amplifier, Keying and Speech. Wonderful breakdown value, meters, relays, switches. Complete with valves — real bargain at 29/6 plus 10/- carriage.

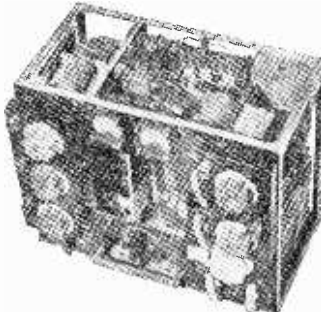

STOP PRESS ITEMS

R. & C. SUBSTITUTION BOX

As described in last month's issue — author describes this as second most used instrument on his bench. Kit of components with full instructions. £2.10.0, plus 2/6 post and insurance.

SIMPLETONE

electronic organ described in February issue. Kit of components as specified complete with valves but not chassis or case. £2.10.0, plus 3/6 post and ins.

FOUR EXCEPTIONAL BARGAINS

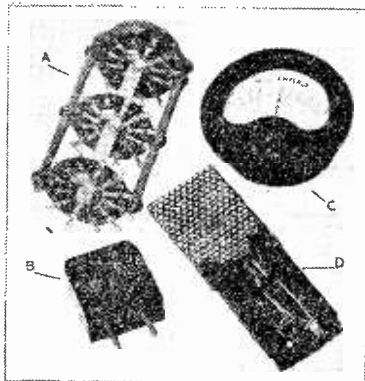

- A Yaxley Switch, 5-position, 6 pole, 1/2in. spindle of reasonable length. Price 2/3 or 24/- per doz.
- B 500KC Crystal, plug-in type, 6/6.
- C 5-0-5 Centre Zero Mill-amp Meter, 2 1/2in. moving coil, 17/6, plus 1/6 post and insurance.
- D Thermal Delay Unit, 6.3 operated. Switches on or off, 3 s.

FOR THOSE EXTRA PLUG POINTS

Three-core cable 7.029 (15 amps) 500 v. grade — a big purchase enables us to sell this at 37.6 per coil (50 yards). Carriage 3.6.

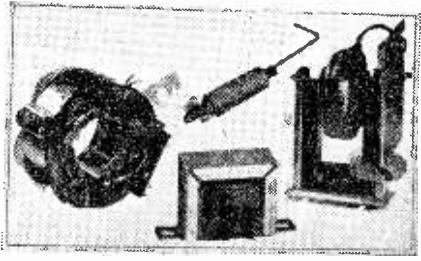

FOUR ITEMS FOR THE PRICE OF ONE

This set of modern T.V. parts is equally suitable for modernising an old television or for building into a new one. Suitable for wide angle 14in. or 17in. tubes using EHT or 12-14 kV. The four items comprise: (1) Line output EHT transformer (2) 70" scanning coils on ferrite yokes, (3) Width control with ferrite core, (4) Frame output transformer. With these parts we also give free, complete circuit diagram of a modern television which uses them. We offer the whole lot at the price of the Line output transformer only, namely 57 6, plus 2 6 post and insurance.

TABLE RECEIVER CABINET

Fine walnut veneered table receiver cabinet complete with metal chassis, three colour glass scale-back plate and scale mounts, as illustrated but less knobs. Offered at less than the price of the cabinet, namely 39.6 plus 5-/- carriage and insurance.



HI-FI SNIP

Infinite Wall Baffle

Nicely veneered and polished. Corner fitting (attaches to picture rail). Takes up no floor space. Gives really fantastic results with only low-priced 8in. speaker. Fitting for tweeter. Only 45/- each, carriage and insurance 3.6.



Yours for 10/- down and 17 weekly payments of 10/- or cash price £8.10.0

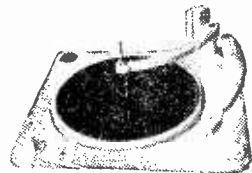

The latest most up-to-date Record Player made by the famous B.S.R. company. Using Hi-Fi Crystal Pick Up and fitted with every modern device. Definitely a record changer which will give years of trouble-free music. Not surplus but the current model. Price £8.10.- or 10/- deposit and 17 weekly payments of 10.-, carriage and insurance 5.-.

ELECTRONIC PRECISION EQUIPMENT LTD.
66 GROVE ROAD, EASTBOURNE

For Shop Address see Double Page Advertisement

Tube Tester and Re-Activator

We can supply all the main components for making this unit which will not only test Cathode Ray Tubes but also will re-activate them, supplied complete with full instructions. Price £3. plus 2/6 post and ins.

Transistor Timer

All the parts for making transistorised Enlarging or Process Timer with constructional details. £2/10/- plus 2/6 post and pks.



Beginner's Superhet



All the components including metal chassis, valves, metal rectifier, coils, tuning condenser, etc., etc., required, to build the "Beginner's Superhet" as described in the January Issue, are available as a parcel. Price £3. plus 3/- post and ins.

Condenser Tester and Re-Activator

This unit tests condensers under correct working conditions at proper voltages, it can also be used for "reforming" electrolytics. All basic parts and full instructions, 50/- plus 2/6 post and ins.

Band III Converter

Suitable for Wales, London, Midlands, North, Scotland, etc. All the parts including 2 EF80 valves, coils, fine tuner, contrast control, condensers, and resistors. (Metal case available as an extra). Price only 19/6, plus 2/6 post and insurance. Data free with parts or available separately 1/6.



Making a Solder Gun

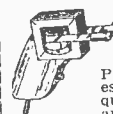

A 7-second solder gun of the type costing £3-£4 was described in Prac. Mech. Only two essential parts are required—(a) transformer and (b) push switch. These we can supply at 13/6, plus 2/- post. The rest of the parts you will have in your own "junk" box. Copy of the article concerned given free with the kit.

A.C./D.C. Multimeter Kit
15 Basic Ranges

Measures A.C./D.C. volts, D.C. current and ohms. All the essential parts including metal case, Zn. moving coil meter, selected resistors, wire for shunts, range selector, switches, calibrated scale and full instructions—price 19/6, plus 2/6 post and insurance.



AM/FM Chassis

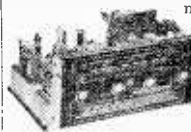

made by the famous McCarthy Radio. This employs a printed circuit in the F.M. Tuner section. It uses 8 valves and has a very attractive three colour dial, size approximately 12 x 5 1/2 in., covers four wavebands: 1000-2000 m., 230-550 m., 45-50 m., and 80-100 mc/s. This is a precision made chassis with four controls, tuner, volume, wavechange and tone. Fully guar. Price £22/10/-, post and ins. 5/-.

19 RANGE TESTMETER



Can be yours for only 10/- deposit and 19 payments of 10/- weekly. Like all IVO meters it is a very fine instrument: it has a sensitivity of 10,000 ohms per volt and 19 most useful ranges as follows: D.C. volts 0-1,000 (seven ranges), A.C. volts 0-1,000 (five ranges), 0-1 amp. (5 ranges), resistance 0-2 megohms. (2 ranges) (complete with test leads). Immediate delivery. Cash price £9.10.0—non-callers please add 3/6 post & ins.

FREE GIFT.—All purchasers of the above item this month will receive the M.M. Range Extender which adds: capacity 0.1 m.f. in two ranges—inductance 0-100 henrys and decibel -20 to +36.

TAPE DECK SNIP—LAST CHANCE

TAPE DECK.—Made by the famous Truvox Company. This contains exactly the same essentials as the current model. Only the styling is different. It also takes the stereophonic head.

SPECIFICATION.—3 B.T.H. shaded pole motors with silent friction drive eliminating wow and flutter. Push button controls, electrically and mechanically interlocked. Patent electric type push button controlled brake. Tape loading on the drop in principle, accommodation for reels of 7 in. diameter. Tracking sense to British and American standards. Playing times: up to 3 hours with L.P. Tape or 2 hours with Standard Tapes. Two tracks side by side with safety gap. Positive Azimuth adjustment of Record/Player head. High Impedance Heads. Overall size 14 1/2 x 12 1/2 x 5 in. approx. 120 only of these fine decks offered at non-repeatable price of £17/10/-. Non-callers add 10/- carriage and ins.

NOW 2 MODELS Turret Tuner

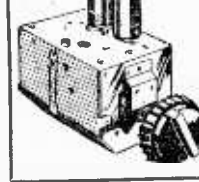

Brand new stock, not surplus, with coils for Band I and III complete with valves. Model 1 I.F. output 55-35 Mc/s. Series heaters. Model 2 I.F. output 16-19 Mc/s. Parallel heaters. With instructions and circuit diagram, 79/6. With knobs 3/6 extra, post and insurance 2/6.

THIS MONTH'S SNIP
Complete Walkie-Talkie for £1

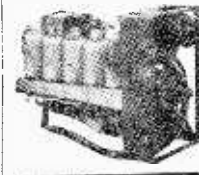

Complete Walkie-Talkie Radio Transmitter has a range of approx. 5 miles. Just right for search parties, fire brigades, etc. Operates on dry batteries. Complete with five valves and in metal case. Size approx. 9 x 6 x 3 1/2 in. Unused but not tested or guaranteed. £1 only, plus 2/6 post and insurance.

Big stocks of all types of components are kept at all depots. Some special component bargains are also listed below.

Morganite Potentiometers

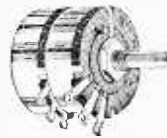

Single and 2 gang types available. standard size with good length spindle, all new and boxed. Gang type 3/6 each—values available: 5K+5K, 100K, 100K, 1 meg. Single types 1/- each, values available: 10K, 20K, 50K, 100K, 250K, 1 meg., 2 meg.

Ceramic Switches

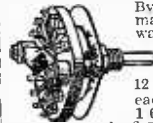

By one of our best makers, 3 pole, 3 way, 2/6 each, also standard type switches 12 pole, 2 way, 1/6 each, 6 pole, 3 way, 1/6 each, 3 pole, 6 way, 2/6 each, 6 pole, 4 way, 2/6. 50 assorted resistors. Well mixed and useful values, 1 and 1 watt. Price 5/- per 50. 50 assorted resistors. Well mixed

Fine Tuners

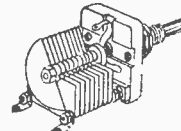

Ceramic trimmers all with 3 in. spindle of fair length. 5, 10, 15, 30-P.F. at 2/3 each or 24/- per dozen.

Transistors



A good range of transistor parts, miniature transformers, electrolytics, etc., available at all branches. Red Spot and audio ... 10/- Blue Spot 1.6 Mc/s. ... 15/- White Spot 2.5 Mc/s. ... 20/-

Filament Transformer

Suitable 200-250 input, output 6.3 volts 1 1/2 amps. Price 6/6.



Connecting Wire

P.V.C. covered in 100ft. coils—2 1/2 g a coil or four coils different colours. 10/- post free. Mains Transformer, 250-0-250, 60-80 mA, 6.3 v. standard mains input. Half shrouded, 15/-, post and insurance 2/6. 1 mfd. 350 v. Small Tubular Metal cased Condensers. Made by DuBilier, 2/6 per dozen. Germanium Diodes, B.T.H., with wire ends, 10d. each or 9/- dozen. Midget I.F. Coils. Dust cored, size 11 x 1 1/2 in., 465 Kc/s. 6/6 pair. Standard Size I.F. Coil. Dust cored, 465 Mc/s. 6/6 pair. 0.0005 twin gang tuning condensers, 4/9, post 9d. Bakelite 5 Amp. Electric Wall Switch, "Hicraft" 9d. each, or 8/- per dozen. Series, parallel and off-electric wall switch made by Crabtree. Price 1/3 each, or 13/6 per dozen.

BAND III PRE-AMP



In difficult areas it will be necessary to increase the signal level and this is the ideal unit for this purpose. It is A.C. mains operated and is fitted with input and output coax. plugs. Price £4. post and packing 3/6.

FLUORESCENT LIGHTS



These are complete fluorescent lighting fittings. Built-in ballast and starters—stove enamelled white and ready to work. Ideal for the kitchen, over the work-bench and in similar locations. Single 40. 4ft. 3in. long, uses a 40-watt tube. Tw in 20. Uses 2 20-watt standard tubes. Price for either type 39/6, with tubes. Carriage and ins. up to 150 miles 5/6, up to 250 miles 7/6.

T.V. SERVICE SHEETS

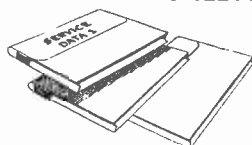

100 sheets covering the most popular post-war Televisions by leading makers—Cossor, Ekco, Ferguson, Pye, etc., etc. Give circuit diagrams, component values, I.F. frequencies, etc., £1 post free.

CRYSTAL MICROPHONE

Miniature crystal type has high gain and is suitable for all purposes—tape recorders—amplifiers. Price 4/9. post and ins. 9d.



MAINS-MINI



Uses high-efficiency coils, covers long and medium wave-bands and fits into the neat white or brown bakelite cabinet—limited quantity only. All the parts, including cabinet, valves, in fact, everything. £4/10/0, plus 3/6 post. Constructional data, free with the parts, or available separately 1/6.

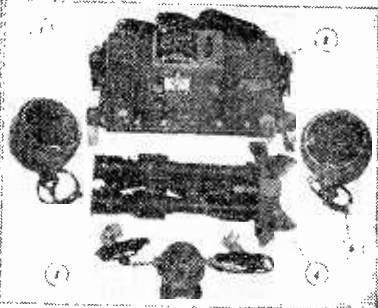

TABBY EQUIPMENT COMPLETE

Complete equipment for seeing in the dark, as fitted to Army vehicles for night driving, etc. Complete working equipment comprises: 2 Infra Red Radiators, adjustable binoculars, powerpack for 6 or 12 volts, control units and inter-connection cables. Original cost—£10, plus 10/- carriage and insurance. Mains power pack 4/extra.

PUBLICATIONS FOR CONSTRUCTORS

Title	Short Description	Price of data
Car Starter Charger	A 6-12 volt 5 amp battery with overcharge position.	1/6
Chimelite	Door chimes and hall light combined.	2/-
I.T.A. Converter	A two valve unit suitable for converting any type of television.	1/6
Crispian	Four valve all dry battery portable.	1/6
Economy Amplifier	Cheapest possible 3 valve mains amplifier.	1/6
Skysearcher	Cheapest possible £3 valve mains receiver for medium wave.	1/6
Economy Three...	Three valve battery version of the Skysearcher.	1/6
F.M. Tuner	Good unit quality tuner based on the original Radio Constructor circuit.	1/6
Mini Radio	Four valve mains T.R.F. medium and long wave.	1/6
A.C./D.C. Multi-meter	15 range test meter for A.C. and D.C. volts, ohms and milliamps.	1/6
Simplex	The simple transistor receiver for headphones.	9d.
Transistor Timer	For photographic and process timing.	9d.
Easy to Build T.V.	A modern set suitable for wide angle 14" or 17" tubes which can be assembled in an evening (only 24 solder joints to make).	3/6
Condenser Tester	Tester for all types of condensers, can also be used for reforming electrolytics.	9d.
C.R.T. Tester	A device for testing and re-activating television picture tubes.	9d.
Beginners' Super-het	A 4 valve mains operated receiver, simple to make and align.	9d.
Two Way Switch	Describes how to control a light from two points.	9d.
Moisture Operated Switch	Describes a switch which is operated by moisture.	9d.
Electric Blanket	Describes how to make a foolproof, waterproof electric blanket.	9d.
Anti-burst	Describes how pipes in lofts can be prevented from freezing.	9d.
Thermal Delay Switch	Gives circuits of process timer, sequence switch, overload relay, smoke control, etc.	9d.
Solder Gun	Shows how to make a second solder gun.	9d.
Special Offer	All the above booklets and pamphlets, 12/6 or any ten at half price.	

Guitar Amplifier operates directly from A.C. mains—high-fidelity.



3-valve 4.5 watt with frequency response better than 40-15,000 c.p.s. Control panel size 8in. x 2 1/2in. comes fixed to chassis but is intended for independent mounting. Separate bass and treble controls giving fullest variation of cut and lift. Separate switch, absolutely no mains hum. Remarkable value at £4/10/6.

500 WATT STEP DOWN TRANSFORMER

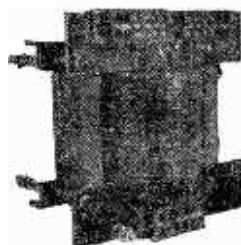

With output tapped from 110 v.-155 v. in 3 volt steps, massive transformer which will withstand considerable overloading. Price 45/- plus 5/- carriage (up to 250 miles).

The "ESTRONIC" Band III Converter

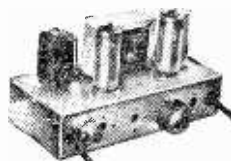

To-day's best value in Band III converters suitable for your TV, or money refunded. Complete ready to operate 49/6 non-mains, or 79/6 mains, post and insurance 3/6.



TV Masks
Latest type grey crystalline
11in. 10/-, 14in. 12/-
14in. 1/- post

ELECTRONIC PRECISION EQUIPMENT, LTD.

Post orders are dealt with from Eastbourne, so for prompt attention please post your orders to 66 Grove Road, Eastbourne, marked Department 7.

42-46, Windmill Hill, Ruislip, Middx. 66, Grove Road, Eastbourne, Sussex. 29, Stroud Green Rd., Finchbury Park, N.4. 286, London Road, Croydon.
Phone: RUISLIP 5780. Half day, Wednesday. Phone: ARCHWAY 1049. Half day, Thursday. Phone: CRO 6558. Half day, Wednesday.

Just a line to say **ALIGN!**

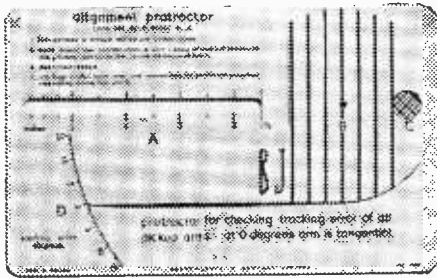

TEST YOUR TRACKING

BJ introduces the first **ALIGNMENT PROTRACTOR** in plastic ivoryine for measuring the tracking accuracy of all pickup assemblies.

A vital measuring instrument. Send P.O. for 7/- today.

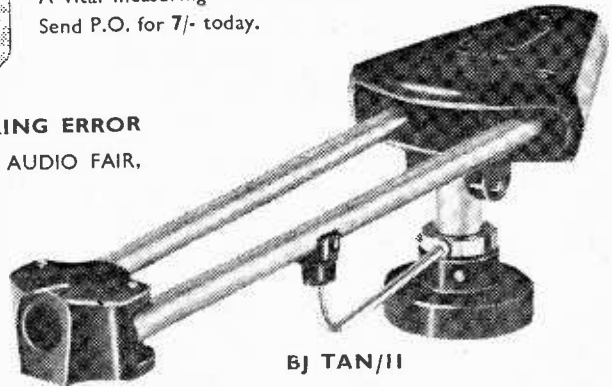

BJ TAN/II

ONLY BJ ARMS OVERCOME TRACKING ERROR

See your dealer today and visit us at the **AUDIO FAIR**, April 1958 in Room No. 130.

BJ	BJ TAN/II ARM ...	£3.30
	P.T. ...	£1.53
	BJ SUPER 90 MARK II	£11.11.0
	P.T. ...	£4.12.5

BURNE-JONES (DEPT. D.) SUNNINGDALE ROAD CHEAM SURREY

data for **AUDIOPHILES** *

	
EF86	ECC83
	
EL34	GZ34
	
EL84	EZ81

Audiophiles all over the world are demanding Mullard audio valves for their high quality sound equipment. And who can blame them when they know that the Mullard World Series of Audio Valves is the finest in the world. Fill in the coupon below for free data on Mullard World Series Audio Valves.

* *Audiophile—Enthusiast for high quality sound reproduction who is satisfied with nothing but the best.*

This popular book is available now from most dealers, price 3.6d. It contains designs and full constructional details of the new Mullard EL34 High Quality 20 Watt Amplifier, a Mullard Band II F.M. Tuner, pre-amplifiers for the Mullard EL34 Amplifier and for the popular Mullard 5 Valve 10 Watt Amplifier, together with other useful technical information.



Mullard

WORLD SERIES
AUDIO VALVES



Mullard Ltd., Publicity Division,
Mullard House, Torrington Place,
London, W.C.1.

COUPON

To Mullard Ltd., Publicity Division

Please send me, free of charge, leaflets on the Mullard World Series of Audio Valves, and details of "High Quality Sound Reproduction".

NAME

ADDRESS

.....

MVM 349

PRACTICAL WIRELESS

EVERY MONTH
VOL. XXXIV, No. 616, APRIL 1953
COMMENTS OF THE MONTH

EDITOR : F. J. CAMM

26th YEAR
OF ISSUE

BY THE EDITOR

ADVICE TO CONTRIBUTORS

DURING the course of the year large numbers of manuscripts are submitted to us, but a proportion of them have to be rejected for various reasons. It will be helpful to contributors if they bear in mind the following points. Preference is given to constructional articles, not necessarily of complete receivers, but also of components and test gear. The articles must actually have been made and tested, and they must be original. Articles which should be from 1,500 to 2,000 words in length, typewritten on one side of the paper only, using double spacing, and 1 in. margins, should contain the name and address of the contributor on the top left-hand corner of the first folio. They should be accompanied by a list of components, with values, and sources of supply. All of the components must be readily available. Articles describing a piece of apparatus designed round some old components "found in the junk box" are not required, since all readers' junk boxes may not contain such components. A circuit diagram, should accompany the list of the components, and be marked to coincide —V1, V2, etc.; R1, R2, etc.; C1, C2, etc. A wiring diagram should also be included as well as photographs. Negatives should also be supplied. We pay on a generous scale for all such articles. In the first place you should write a letter to us, outlining the proposed article so that we can ascertain whether the subject appeals.

—AND ADVICE TO QUERISTS

MAY we once again remind readers that our Query Service is only available to those who provide evidence of their readership by enclosing the query coupon cut from the current issue. It appears at the foot of page iii of the cover each month. A stamped and addressed envelope must also be enclosed. We are receiving so many letters from those who are obviously not readers of the paper that we are compelled to insist upon rigid adherence to our rules. We cannot undertake to answer questions aroused by articles in contemporaries, nor can we undertake to modify circuits to suit individual requirements. Purchasers of ex-Government apparatus should address queries relating to such to the suppliers.

HOME CONSTRUCTION ON THE INCREASE!

IT is pleasant to be able to record in this 26th year of our existence that the sales of this journal continue to increase and that more sets are being built than has been the case since 1939. Each year sees a new generation come along anxious to learn the fundamentals by the practical instruction which set building provides.

THE 1958 RADIO SHOW

THE 25th National Radio and Television Exhibition will be held at Earls Court, London, from Wednesday, August 27th to Saturday, September 6th, with a preview on Tuesday, August 26th.—F.J.C.

Our next issue, dated May, will be published on April 2nd.

Editorial and Advertisement Offices :
PRACTICAL WIRELESS

George Newnes, Ltd., Tower House,
Southampton Street, Strand, W.C.2.

© George Newnes Ltd., 1958.

Phone : Temple Bar 4363.
Telegrams : Newnes, Rand, London.
Registered at the G.P.O. for transmission by Canadian Magazine Post.

SUBSCRIPTION RATES

including postage for one year
Inland - - - 19s. per annum.
Abroad - - 17s. 6d. per annum.
Canada - - - 16s. per annum.

CONTENTS :

	Page
Editorial	95
Round the World of Wireless	96
Making a Simple Geiger Counter	58
Converting The 19 Set	102
A Condenser Condition Tester On Your Wavelength	106
Servicing Radio Receivers	
Alba Models 3211, 6221, 6231, 6241, 6251	111
A Two-valve Portable Radiogram	115
Transistors in Practice	119
A Beginner's Constructional Course	121
The Application of Rectifiers	126
Transmitting Topics	133
Hum Troubles	141
Programme Pointers	146
Open to Discussion	149
News from the Trade	153

The Editor will be pleased to consider articles of a practical nature. Such articles should be written on one side of the paper only, and should contain the name and address of the sender. Whilst the Editor does not hold himself responsible for manuscripts, every effort will be made to return them if a stamped and addressed envelope is enclosed. All correspondence intended for the Editor should be addressed: The Editor PRACTICAL WIRELESS, George Newnes, Ltd., Tower House, Southampton Street, Strand, W.C.2. Owing to the rapid progress in the design of wireless apparatus and to our efforts to keep our readers in touch with the latest developments, we give no warranty that apparatus described in our columns is not the subject of letters patent.

Copyright in all drawings, photographs and articles published in PRACTICAL WIRELESS is specifically reserved throughout the countries signatory to the Berne Convention and the U.S.A. Reproductions or imitations of any of these are therefore expressly forbidden. PRACTICAL WIRELESS incorporates "Amateur Wireless."

Round the World of Wireless



Broadcast Receiving Licences

THE following statement shows the approximate number of Broadcast Receiving Licences in force at the end of December, 1957, in respect of wireless receiving stations situated within the various Postal Regions of England, Wales, Scotland and Northern Ireland. The numbers include Licences issued to blind persons without payment.

Region	Total
London Postal	1,083,676
Home Counties	1,087,938
Midland	809,336
North Eastern	1,056,632
North Western	789,236
South Western	678,336
Wales and Border Counties	424,468
Total England and Wales	5,929,622
Scotland	779,274
Northern Ireland	184,087
Grand Total	6,892,983

Receiver Sales Top Million

THE monthly retail survey for November, published recently by the British Radio Equipment Manufacturers' Association, shows that retail sales of radio receivers (excluding car radios) for the first eleven months of the year was over one million, compared with 982,000 for the whole of 1956.

A comparison of sales during the eleven-month periods January-November, 1957 and 1956, shows that television receiver sales have declined by 3 per cent.; sales of radio receivers have increased by 20 per cent.; and sales of radiograms by 24 per cent. (It should be noted that the statistics cover retail sales only and do not include rental or relay transactions.)

Orkney V.H.F.

AS already announced, the BBC proposes to build a combined Television and V.H.F. Sound broadcasting station in Orkney to serve the Orkney Islands and the north coast of Caithness. Consideration of the method of conveying the sound and vision signals from the main network to the area to be served has shown that the signals can best be relayed from a point

By "QUESTOR"

near Wick and thence to Orkney. It has been decided, with the approval of the Postmaster General, that the installation at Wick will be designed in such a way as to provide the radio link to Orkney and at the same time to provide V.H.F. Sound and Television services in Caithness.

V.H.F. Multichannel Radio Link

THE capacity of the Salisbury-Umtali V.H.F. multichannel radio link in Southern Rhodesia operated by the Ministry of Posts is to be extended by a purchase of additional Marconi radio equipment and a rearrangement of the existing units. The route, covering a distance of some 135 miles, will be completed in four hops, with terminals located at Salisbury and Umtali, and repeater stations at Marandellas, Castle Beacon and Rusape.

A single path system will be employed using the well-tried Marconi Type HM100 V.H.F.

multichannel terminal units at all the sites except Rusape, where a Marconi Type HM150 V.H.F. multichannel repeater will be installed. The repeater stations at Marandellas and Castle Beacon will have back-to-back HM100 terminals, so that provision is made for a number of channels to be taken off at these sites when required at a future date.

Music by Wire

THE Postmaster General announces that he is prepared to consider applications from private persons and companies for licence to distribute music by wire. The Postmaster General's consent is required for such music services, for they would otherwise infringe his telegraphic monopoly.

The licence will allow persons and companies to operate music distribution centres and wire networks for sending their own programmes of recorded music to business premises such as shops, restaurants, offices and factories but not to private homes. Live or recorded radio broadcast programmes, advertise-



Tuning forks are used by the Police to check the new radar speed traps. Five forks are used to check at 20, 30, 40, 50 and 60 m.p.h.

ments and propaganda will not be permitted. The area over which music may be distributed will be defined in the licence.

Licensees will themselves have to provide the wires from the music distribution centres to their customers' premises but where the Post Office has spare wires these may be rented for linking music distribution centres one with another.

Ekco Search Radio

THE Vickers "Viscount" airliners now operated by the Iraqi Airways are being fitted with Ekco Airborne Search Radar.

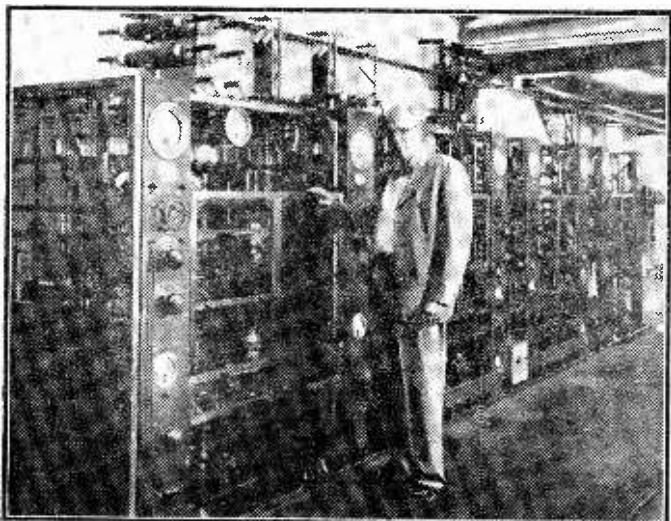

The 30-year-old transmitter in South Africa.

This Ekco radar equipment, which is already installed in the B.O.A.C. Bristol "Britannia" fleet and is specified for many other modern airliners, detects turbulent cloud formations ahead of the aircraft, thus enabling the pilot to take avoiding action. Ekco Search Radar also gives an accurate indication of high ground in the path of the aircraft and provides facilities for "map painting" the land below.

B.I.R.E.

THE following meetings will take place during March, 1958:

London: London School of Hygiene and Tropical Medicine, Keppel Street, Gower Street, London, W.C.1, Tuesday, March 18th, at 6.30 p.m. A Discussion

on the Technical Committee's Report "Recommended Method of Expressing Electronic Measuring Instrument Characteristics. I:—A.M. or F.M. Signal Generators." Wednesday, March 26th, at 6.30 p.m. "Electronics in Medicine."—R. F. Farr, B.Cs.

North Eastern: Wednesday, March 12th, at 6 p.m. Institution of Mining and Mechanical Engineers, Neville Hall, Westgate Road, Newcastle-upon-Tyne. "Industrial Television."—S. G. Gobbi.

West Midlands: Wednesday, March 12th, at 7.15 p.m. Wolverhampton and Stafford-

advise the Postmaster General on the broad aspects of radio frequency planning with a view to the efficient use of the radio frequency spectrum and the economic development of equipment for that purpose by the radio industry."

International Microwave Convention

AMONGST the many post-war developments in the field of engineering science, those in radar, communications and navigational aids have been outstanding. They have all been made possible by the evolution of valves working at microwave frequencies, a field which is expanding so rapidly, and with so many new departures in concept and technique, that regular international conferences must be held to enable scientists in every part of the world to get together and exchange ideas. The latest of these conferences has been arranged by The Institution of Electrical Engineers, which is organising an International Convention on Microwave Valves to be held at The Institution in London from the 19th to 23rd May, 1958. The Convention will survey present knowledge and discuss future trends, with particular attention to work in progress or recently completed.

30-year-old Transmitter

A SHORT-WAVE transmitter supplied by Marconi's in 1926 for the Klipheuveld radio station of the South African Post Office Administration is still used to provide a radio link between Klipheuveld and Somerton in England. The transmitter, a Type SWB 1, 20 kW equipment, was installed to initiate the beam service between the United Kingdom and South Africa which began in 1927. Originally designed to operate in the 11 and 5 Mc/s bands, the transmitter and aerial system were subsequently altered to operate in the 18 and 9 Mc/s bands.

This is the oldest working short-wave transmitter in southern Africa and it is intended to preserve it as a reminder of the first stages in the development of point-to-point radio communication.

shire Technical College, Wulfruna Street, Wolverhampton. "Analogue Computers"—K. C. Garner.

Frequency Allocation Committee

THE Postmaster General announces that the members of the Frequency Allocation Committee have been appointed following the recent announcement that Sir Lawrence Bragg would be its Chairman. The Committee will be representative of the radio industry, users' organisations and Government departments and it is expected that its meetings will provide opportunity for industry and users to be associated more closely with frequency planning. The terms of reference are "to

Making a Simple Geiger Counter

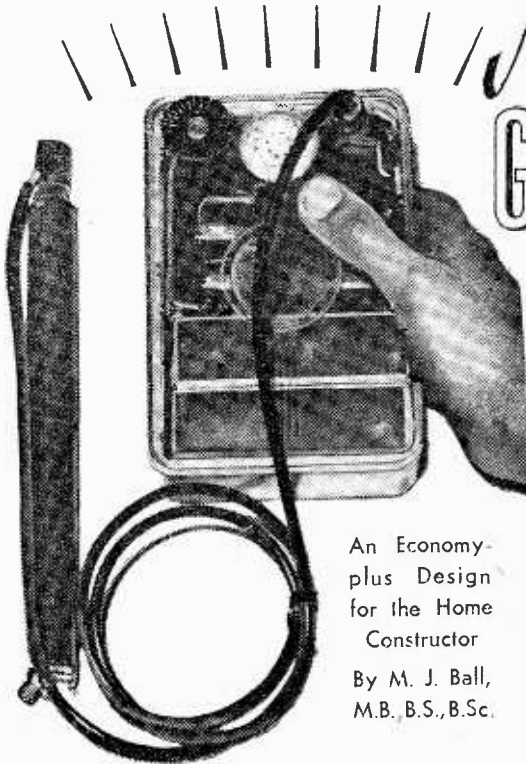

An Economy-
plus Design
for the Home
Constructor

By M. J. Ball,
M.B., B.S., B.Sc.

IN this country, unlike the United States, the general public has not yet become "atom conscious," which is a surprising fact considering that we are well to the fore in the field of industrial and scientific nuclear development, and in research utilising radioisotopes.

In this country, practically all that are available in the way of geiger counters are large mains-driven items of bench equipment, or rather bulky portable instruments containing a field-strength meter and involving the wearing of headphones in areas of low radiation intensity.

At the other end of the scale are the attractive sounding "pencil size" geiger counter units— attractive, that is, until one learns that one must

carry a boxful of high tension batteries and wear headphones which only give a faint clicking. It was with this in mind that the author designed this geiger counter which, although not incorporating any radically new principles, supplies a long felt need in the amateur constructor's equipment.

It is a very easily constructed and inexpensive four-valve circuit, made of components that are readily obtainable new or on the surplus market, and the whole unit is contained complete with batteries in a transparent plastic sandwich box such as can be seen in any chain store. No cumbersome headphones are necessary since two methods of registration are employed. Every charged particle or ionising radiation hitting the Geiger-Mueller (G.-M.) tube gives rise to a loud click in the crystal insert which is easily heard across a room. There is also a visual indicator in the form of a miniature neon lamp which flashes at a scaled down logarithmic rate proportional to the radiation intensity.

When the G.-M. tube is plugged in and the set is turned on, it provides a highly sensitive detector of radioactivity, on account of the large size G.-M. tube that is used. Whether the radiation arises from natural deposits of uranium or thorium ore, the luminous dial of your watch or even the increase in the background radiation following the fall-out in this country of a hydrogen bomb test somewhere in the world, the set is able to record it both qualitatively and, with the aid of a stop watch, quantitatively (Fig. 6).

As well as its use for amateur prospectors (the Stationery Office publishes several pamphlets and detailed memoranda on the deposits of uranium in the British Isles, including the price the

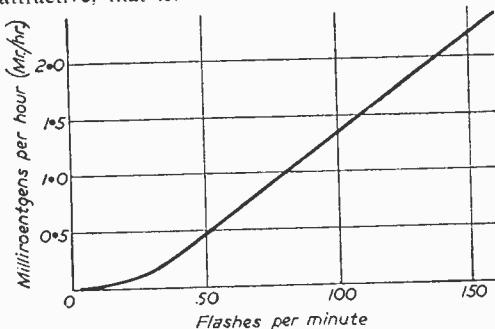

Fig. 6.—Typical calibration curve of the instrument with a value of .01 μ F for C6.

LIST OF PARTS

- R1—22k Ω
- R2—1 Meg Ω
- R3—4.7k Ω
- R4—470k Ω
- R5—2.7 Meg Ω
- R6—1 Meg Ω
- R7—120k Ω
- R8—see text
- M.R.—Metal rectifier type K.8.40.
- Ne—neon, midget wire-ended.
- Coax. socket moulded polythene Belling Lee type.
- Geiger-Mueller tube '20th Century Electronics Type G24.
- Choke—(See text) Teletron Type EH10.
- Batteries—H.T. two type OL230 or equivalent.
- Batteries—L.T. type OL 250 or equivalent.
- Box 'Hygienic Food Pack' or equivalent.
- C1—2, 5, 6—.01 μ F tubular ceramic
- C3—.01 μ F mica
- C4—.001 μ F mica
- Xtal—1 $\frac{1}{2}$ in. diam. Acos or
- Cosmocord deaf aid Microphone
- V 1, 2, 3, 4—Type CK 50S AX
- Wire-ended deaf aid pentode.

Government pays per ton of ore!) this counter could be used in Civil Defence training and around laboratories and hospitals where radio-isotopes are in use for industrial, diagnostic and therapeutic purposes, both for tracing lost sources and for checking personal radiation hazards.

The Circuit

For convenience in interpretation, the circuit is best considered in two parts: the high voltage

Underview of chassis showing the choke which is described in Fig. 4 on page 101.

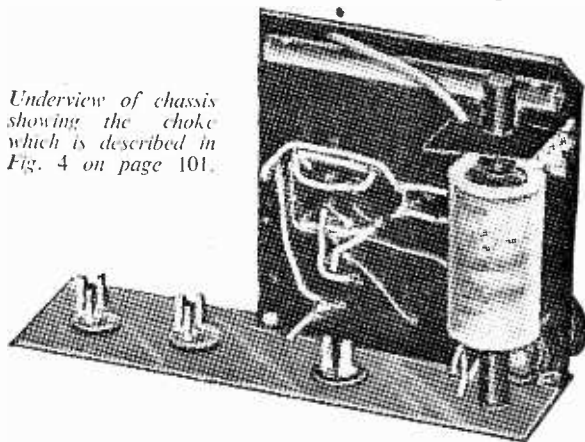

oscillator (which produces up to 1,400 volts) and the amplifier.

The circuit uses four wire-ended deaf aid valves of a type which has become abundant and cheap since deaf aids are being transistorised, and which have extremely low filament and H.T. consumption ratings. Three of the valves are used in the oscillator and one in the amplifier.

The oscillator is a conventional multivibrator

with the first valve V1 coupled as a triode by strapping the screen-grid and anode, and with two pentodes, V2 and V3 in parallel as the output stage. This is necessary to obtain sufficient power for the high voltage pulse and permits a standardisation of the type of valve in the circuit, and is in the long run cheaper than buying a single valve rated as an output valve in place of these two which are listed as voltage amplifiers. The arrangement also permits the fractional voltage filaments to be connected in series-parallel, as is explained later.

The output stage screen-grids are used as the multivibrator "anode" whilst their anodes "proper are fed with 90 volts H.T. through the "ringing choke." A high voltage is developed across the choke by the sudden collapse of magnetic flux with each cycle of oscillation, and these pulses of voltage are rectified by the metal rectifier M.R., smoothed by the reservoir condenser C3, and the steady high voltage is applied across the G.-M. tube via the neon circuit and R5.

As each ionising particle enters the tube, the resultant cascade of electrons causes a voltage drop across R5 which is fed as a pulse to the grid of the amplifier valve V4 via C4 and is registered as a click in the crystal insert in the anode circuit of this valve. Now each cascade of electrons also serves to charge the condenser C6 and, when the striking potential of the neon is reached, a flash occurs and the charging cycle starts again.

The minimum rate of flashing is around four per minute, and is dependent on the background count of cosmic rays and local radioactivity, and on the leakage resistance across the G.-M. tube.

The flashing rate increases as the radiation intensity rises till at the maximum (to which one

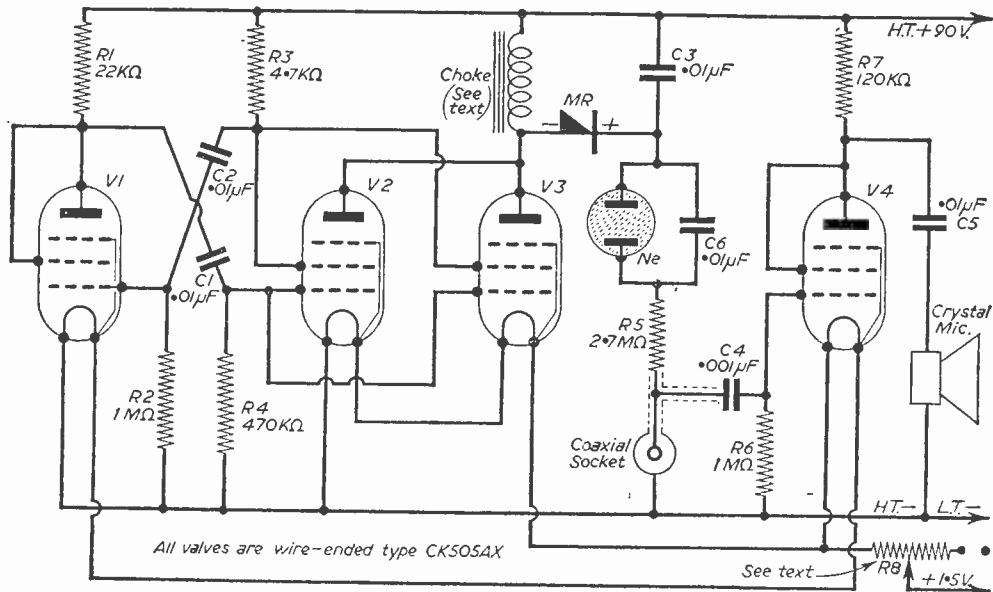

Fig. 7. —Theoretical circuit of the geiger counter. Parts are listed on page 98.

should never expose oneself!) the rate is uncountable and is a function of the time constant of R5C6.

Several finer points about the circuit are worth noting. The component values have been chosen to give a frequency of oscillation high enough to allow a small value of C3, yet low enough not to give a troublesome whistle from the crystal unit whose size makes it relatively inefficient in radiating low frequencies.

The residual buzz is due to stray capacities and can be reduced if desired by shielding the coax socket and its associated wire from the generator anode circuit by means of earthed copper foil or tinplate bent to shape and soldered into place. Some buzz should remain, however, to indicate when the set is switched on, and to develop grid bias for V4 across R6. In some crystal units the buzz can be minimised by cover-

ing the central holes with Sellotape, leaving the peripheral holes open. This does not affect the loudness of the click.

The H.T. supply is 90 volts. In the model illustrated, two 45 volt layer type deaf-aid batteries were used. The H.T. current drain is about 2 milliamps.

The L.T. supply is 1½ volts and the valves are wired in series-parallel, their individual filament voltages being listed as 0.625. The current is adjusted to a figure somewhere between 50 and 60 milliamps by means of R8.

This component is a midgeit wirewound potentiometer of about 25 ohms or less, from which part of the wire should be unwound so that an "OFF" position is provided, and so that sufficient current flows to allow an immediate start of oscillation when switching on (see Fig. 1). This avoids unbiassed valves receiving the full 90

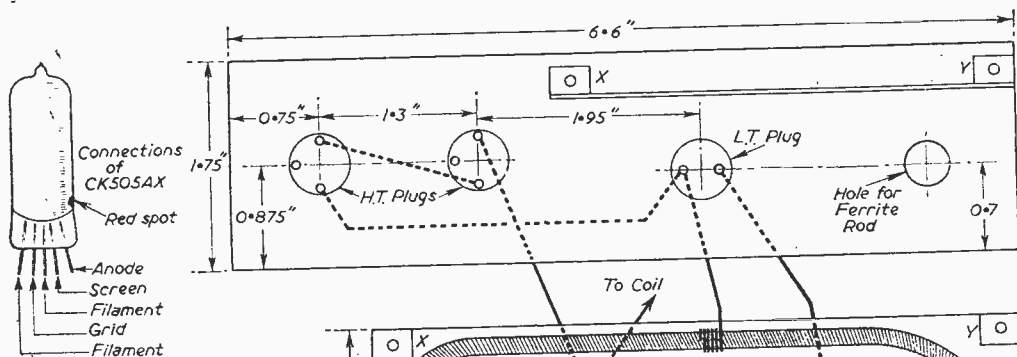

Fig. 1 (Below).—The modified potentiometer.

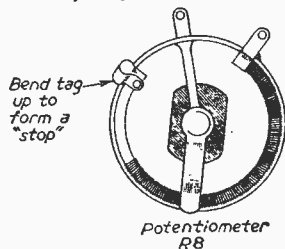

Fig. 2 (Right).—Main layout and wiring with principal dimensions. The heavy lines indicate wiring on the front of panel, and the broken lines the wiring behind panel.

volts H.T. which might damage them. The method of adjusting to the tube operating voltage is described in a later paragraph.

Construction

It is to the simplicity of construction that the unit owes its cheapness—furthermore, it can easily be built in an evening.

The "chassis" consists of three pieces of pavinol joined by small metal brackets (Fig.2). On one piece are mounted the battery plugs and one end of the ferrite rod, on the second is the

circuit, polythene-covered wire should be used when piercing the panel. The core of good quality coaxial cable is quite suitable. The condensers are of the midget ceramic variety but mica types individually selected for absence of internal leaks are used at the high voltage end. Part of the circuit can be used to this end (see Fig. 3). After the initial charging current has passed, the neon will stop flashing if the condenser is satisfactory.

The box is a polystyrene sandwich box cut down to the depth of the H.T. batteries to economise in space. The box was chosen not only for its availability, but also for the excellent insulating properties of this plastic. Insulation

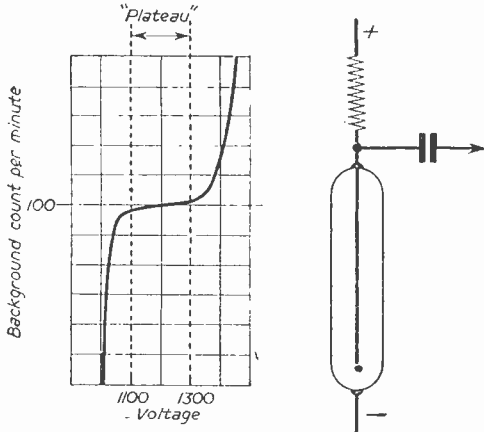
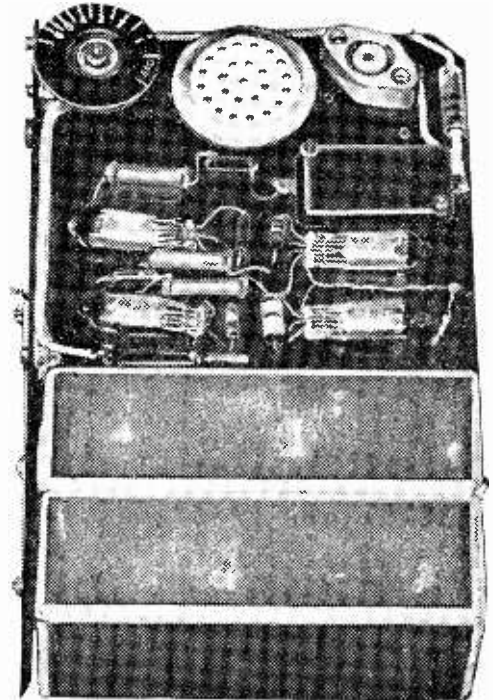

Fig. 5.—Characteristics and connections of a typical tube.

valve circuitry, and the third piece supports the other end of the ferrite rod.

The method of wiring is exceedingly simple and merely entails pricking fine holes where required with an awl, bending the wire ends of the components at right angles (caution! care needed) and pushing the wires through holes. Very little connecting wire is necessary if these component wires are sleeved and bent into position. At the high potential side of the



The completed instrument.

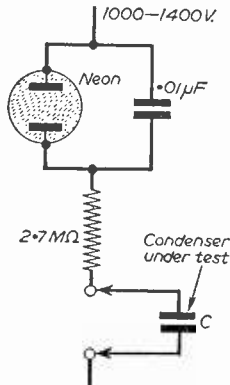

Fig. 3.—Checking condensers for leakage.

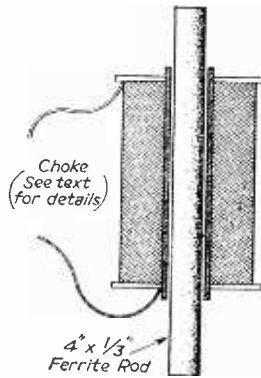

Fig. 4.—Details of the special choke.

is so important at the high voltages and small currents involved that merely breathing on the "hot" end of the G.M. tube will set the neon flashing at an alarming rate.

Should any constructor care to diverge from the details of this design to the extent of fitting miniature deaf aid batteries, the actual size of the set could be reduced to less than a half of that illustrated, but the battery life would be proportionately shortened and one would have to search for another polystyrene box of a suitable shape.

Holes in the box for the voltage control, crystal insert and Belling-Lee plug are best cut with a soldering iron or hot poker and trimmed up with a file, since polystyrene is rather too brittle for drilling large holes.

(Concluded on page 150)

Converting the 19 Set

HOW TO MODIFY
THIS POPULAR EX-ARMY
RECEIVER FOR AMATEUR
USE

By K. E. Marcus

THERE is now available on the surplus market an ex-army receiver-transmitter, the W.S.19 MK II, which can be modified at practically no cost to a highly efficient communication receiver.

It should, however, be borne in mind that this modification is a major engineering effort which should only be undertaken by readers who are patient enough to carry it through.

The sets on the market are either of British, Canadian or American manufacture. During the war contracts were placed in Canada with two or three firms and then sub-contracted in U.S.A.

These Canadian and American sets are by far the better engineering efforts. For this description a Canadian Marconi has been used as basis. As sets of American manufacture are not easily obtainable it is suggested to use either a Canadian Marconi or a R.C.A. for this conversion.

General

The 19 Mk II contains a transmitter-receiver for two ranges (8-4½ Mc/s plus 4½-2 Mc/s), a transmitter-receiver for 240 Mc/s, and an intercom-amplifier. This and the 240 Mc/s affair as well as the transmitter portion of the main set ("A" set), are not required, though good use will be made of part of the components in the course of this conversion.

After conversion the new set will cover 3.3-15.5 Mc/s in two ranges, be equipped with a B.F.O. and will be highly sensitive.

As will be seen 66 modifications which are well within the capacity of an amateur will produce the new set.

The following description refers throughout to the official diagram, which should be obtained, if possible, before an attempt at conversion is made.

First Phase (Front Panel "B" Section, "I/C" Section)

For a start the front panel is to be removed, cutting off all the leads to the components fitted to it.

Then remove all components in the screened partition to the left, only leaving the valve base V7A (horned triode).

After that remove both sender-receiver relays under the chassis.

These operations leave one with the main ("A") set proper.

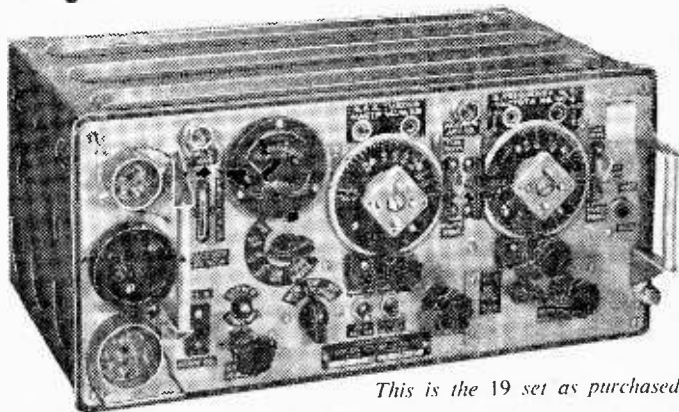

This is the 19 set as purchased.

Second Phase (R.F. Portion Modifications)

To the right of the four-gang condenser are three valves: starting from the rear of the chassis they are the mixer valve 6K8, the R.F. amplifier 6K7, and a sender-mixer 6K8.

The sender-mixer valve (V2B) is now removed.

To the left of the four-gang condenser are two valves; near the I.F. transformer a 6H6 (V6A), which is to be removed including the valve base. Further to the front is the EF50 (V5A) which will be used as a first R.F. amplifier in front of the 6K7 (V1A). To achieve this the following operations have to be carried out.

(A) Unsolder the connection to the anode of V2B (sender-mixer); this wire goes to the range switch S11A, segment 1. Disconnect this wire from the switch, likewise the capacitor C2C (100 pF) fixed to the same spot. Mark this spot: the EF50 anode will be connected here later.

(B) On coils L7 and L21 remove the connecting wire between the tags 5 (bottom of the coil) and solder off C4T (0.1 μF to earth) and R5E (2,200 Ω to H.T.).

(C) Cut off from segment 2 on S11A the old connection to tags and disconnect the trimmer C10E.

(D) Transfer the two wires from S11A, segment 2, from their present position, namely the common-to-both windings tags 3 (top of the coil) to tags 5 (bottom of the coil).

(E) Interconnect both tags 3 and solder back to this spot C4T and R5E, further, connect to it the wafer point where the old connection to tags has been taken off in operation C.

(F) Remove C5C (.01 mF) from S11A, segment 2, and transfer the line to the main gang from the far end of C5C to this wafer point. Mark it: this is where the grid lead to V1A (R.F. amplifier) will be connected to later.

(G) Unsolder the connection to anode of V5A (EF50); this wire goes to range switch S11A, segment 3. Disconnect this wire from the switch, likewise the capacitor C2E (100 pF) fixed to the same spot. Mark this spot: the aerial lead will later be connected here.

(H) On coils L4 and L6 remove the connecting wire between the tags 5 (bottom of the coil) and remove C4R (.1 μ F to earth) and R5D (2200 Ω to H.T.).

(I) Cut off from segment 4 on S11A the old connection to tag and disconnect the trimmer C10F.

(K) Transfer the two wires from S11A, segment 4, from their present position, namely the common-to-both windings tags 3 (top of the coil) to tags 5 (bottom of the coil).

(L) Connect both tags 3 together to the wafer point where the old connection to tag 5 has been taken off in operation I, and earth it.

(M) Remove C5B (.01 μ F) from S11A, segment 4, and transfer the line to the main gang from the far end of C5B to this wafer point.

(N) Bring to this wafer point capacitor C2C (100 pF) which was left afloat in operation A. To do this this condenser has to be taken off the grid pin of the EF50, where it will go back to at the end of the next operation.

(O) Now take out the valve base of the EF50 and refit it with a 180 deg. turn-about and reconnect the screen grid—and cathode components. The grid leak R1E (470 K Ω) will be connected between EF50 grid and earth and the coupling condenser from the aerial-circuit (C2C) can now be brought back to the grid of EF50.

(P) On top of the chassis there is a wire coming out of the gang which is soldered to a tag on the tank coil. This wire is now taken through a hole through the chassis and connected via a capacitor, 100 pF, to the wafer point mentioned in operation F.

(Q) Finally, connect the anode of EF50 (V5A) to the wafer point S11A segment 1 marked in operation A.

These 16 operations complete the R.F. modifications, apart from the changes to the coils and the gang.

The sender-mixer base, the B.F.O. can near it.

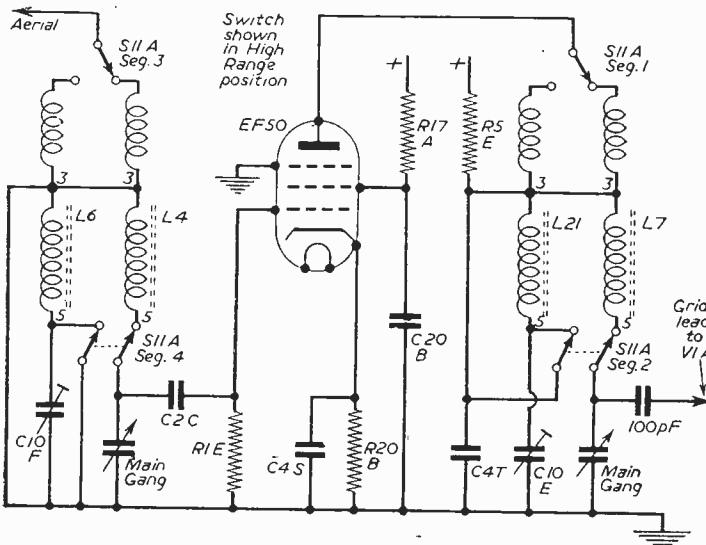

Fig. 1.—The R.F. circuit.

the P.A. valve 807 and its base, and the tank coil, can now be removed. So can be a great deal of wiring afloat.

Thereafter it is advisable to check over the work done with Fig. 1, and to remove all components not required any more round the sender portion of the set.

Finally make sure that in the high range

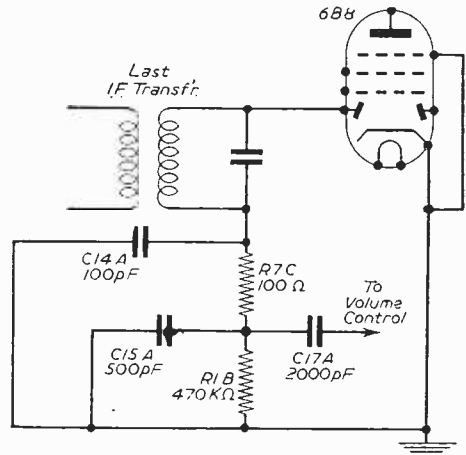

Fig. 2.—The detector stage.

position the low range tuning coil is now shorted (ref. to operations E and L).

Third Phase (Detector)

There are no modifications at present on either the R.F. amplifier, the mixer or on the 2 I.F. amplifiers.

The next stage of the conversion concerns the detector-stage.

(A) Cut off all connections to valve base V3A (6B8) except, (1) the direct lead from the I.F. transformer to one of the diodes, (2) the two heater lines.

(B) Earth, provisionally, the cathode (pin 8) of V3A.

(C) Fit, provisionally, the B.F.O. can which has been removed in phase 2, to where the tank coil used to be. Do not connect up yet, it needs modification to be described in phase 9.

(D) Earth the cold end of diode load resistor R1B (470 k Ω) and remove all components and wiring of this stage except, (1) capacitor C17A (2,000 pF), and (2) the old grid lead of the 6B8, which will be used for a new Audio Amplifier valve 6K7 in Phase 5.

It is advisable again to check the work done by Fig. 2, and to remove all surplus wiring and components thereafter.

Fourth Phase (Engineering)

- This is mainly an engineering stage.
- (A) Into the rear left corner goes the mains transformer (350-0-350v 100 mA).
- (B) The smoothing choke goes under the chassis beneath the mains transformer.
- (C) The valve base V7A is used for the new rectifier 5U4.
- (D) The reservoir and smoothing condensers go where the valve VID used to be.
- In fitting these components it should be kept in mind that the 3in. loudspeaker has to go on

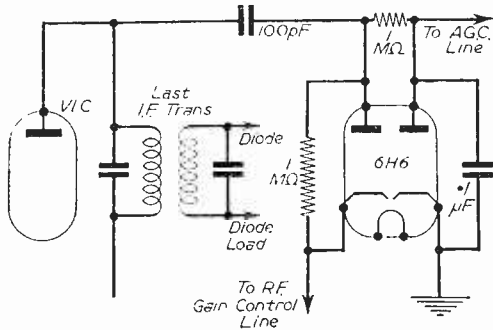

Fig. 3. The A.G.C. stage.

- to the new front plate and clearance for it has to be allowed.
- (E) Two new valve base holes have to be drilled: one to the left of the third I.F. transformer and close to it, where the double-output transformer T5A/T6A used to be; the other one just behind the 807 base hole. These holes are to be fitted with salvaged octal bases.
- (F) A third octal base is to be fitted over the 807 hole.
- (G) Finally, the transformer T2A (which was fitted sideways to the screen surrounding the B-1/C section) goes underneath the chassis near, but to the front of, the newly drilled hole, about where the tank condenser used to be above chassis.

Fifth Phase (Wiring of Power and Output Stages)

- Throughout the following four operations reference should be made to the relevant diagram.
- (A) Plug into the new base next to the last I.F. transformer the salvaged 6K7 and connect up according to Fig. 3.
- (B) Plug into the new base behind the old 807 a salvaged 6K7, and into the new base replacing the 807 a salvaged 6V6 and connect up according to Fig. 4.
- (C) Plug into the old E1148 (V7A) base a 5U4 and connect up according to Fig. 5. The choke should be able to dissipate 10W without undue heating; it should be rated at least 10H for 100mA, and if its ohmic resistance is less than 950Ω the difference from the recommended 1,000Ω should be made up by putting a resistor in series with it. The 1K25W resistor should be of the wirewound vitreous variety.
- (D) The valves in the WS19 Mk II were all in series-parallel. The last operation of this phase

is to rewire them for 6v A.C. parallel heating. Pin 2 on the octal bases and pin 1 on the EF50 should always be earthed: pin 7 on octal bases and pin 9 on EF50 goes to the 6v A.C. busbar.

Sixth Phase (Front Plate)

- This phase concerns itself with the fitting of the new front plate.
- (A) The spindle of the 4-gang condenser determines the position of the tuning mechanism which is a Muirhead drive.
- (B) The spindle of the range-switch determines the location of the range handle.
- (C) The R.F. gain control (5kΩ) goes to the right in line with the range switch. As soon as the front-plate is in position it is connected up according to Fig. 6.

R4A is the screening grid bleeder resistance of the mixer, the cold end of which has to be taken off chassis. R2A (220 Ω) is the cathode resistor of the 6K7 and R9A (1 KΩ) that of the first I.F. amplifier; both have to be taken off chassis. These three resistors are connected to the R.F. gain control line

- (D) One of the salvaged toggle switches goes to the left in line with the range switch. It will be labelled "A.G.C. on/off" and earths the A.G.C. line when operated. As soon as the front plate is in position it is connected up according to Fig. 7. L10A is the "grid leak" of 6K7 R.F. amplifier, which is already connected to L8A, the first I.F. transformer grid coil (A.G.C.-line). On the corresponding point on L8B the old wire is taken off, a resistor 100 KΩ and a capacitor .01 μF soldered on, and the other side of this condenser earthed. On the base of V5A (EF50) the earth connection of pin 4 (suppressor grid) is broken and this pin earthed through a parallel combination of 47 KΩ and .01 μF. A resistor, 100 KΩ, is then taken to the A.G.C. line.

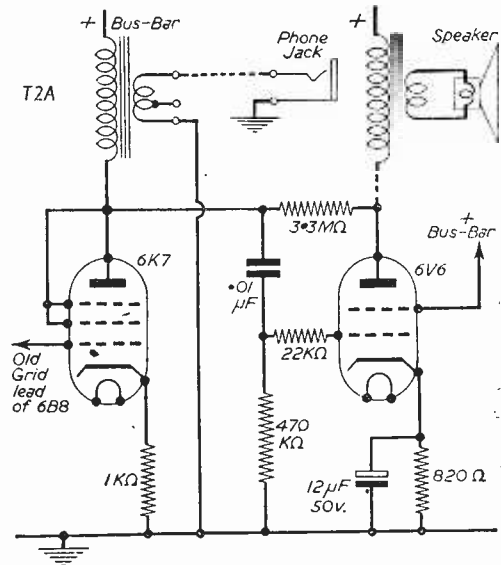

Fig. 4.—The output stage.

(E) About where the old system switch used to be the audio gain control R13A will be fitted. After fitting the front plate a screened lead will be taken from the hot end of the control to C17A (2000 Ω) in Fig. 2; on to the slider goes the screened lead to the new audio amplifier 6K7, and the cold end is earthed.

(F) Again, further to the left in line with the

(C) The following components, which originally transferred part of the oscillator voltage to the sender-mixer, should now be removed: C21A + R42G + R7L and the lead to sender-mixer grid.

(D) Capacitor C39A which injected the B.F.O. voltage into the second I.F. transformer can likewise be removed.

(E) The set is now ready for test. It should be receiving on its old ranges, 8 to 4½ Mc/s and 4½ to 2 Mc/s. If it works, no attempt should be made to realign it. If not, the usual trouble shooting should be carried out.

It is strongly recommended not to skip operation E.

Eighth Phase (Modification of Range Coverage)

This again is a major operation and great care should be exercised.

(A) Remove each of the three R.F. coils, L6, L21, L23 on the lower range in turn. Each has 23 turns as tuner; take off four turns, but leave the coupler windings unmodified except on L23 (mixer grid coil) where seven turns should be taken off the coupler winding.

(B) Remove each of the three R.F. coils, L4, L7, L22, on the higher range in turn. Each has 14 turns as tuner; take off five turns. Leave coupler windings on L4 unmodified. On L7 take four turns off the coupler winding. On L22 take six turns off the coupler winding.

(C) Remove the two oscillator coils L24 and L25 at the same time. L24 goes back unmodified into position L25 (low range). The old L25 has 25½ turns as tuner and 15½ turns as tickler. Rewind to 8½ turns as tuner and 5½ turns as tickler.

(D) Solder a trimmer 50 pF across the tuner windings of each of L24 and L25 (the two bottom lugs opposite each other)

(E) Remove padders C8A (3100 pF), C12A (1780 pF), trimmer C11A (140 pF max.) and fit new padders (2000 pF from the low frequency oscillator coil to earth, 4000 pF from the high frequency oscillator coil to earth), instead to the same lugs where the old ones have been taken off, i.e., as the common tuner-tickler lug No. 4 of the coils. C12A can be re-used with 250 pF ± 5 per cent. in parallel for the 2000 pF padder. C8A can be re-used with 800 to 1000 pF ± 5 per cent. in parallel for the 4000 pF padder if required.

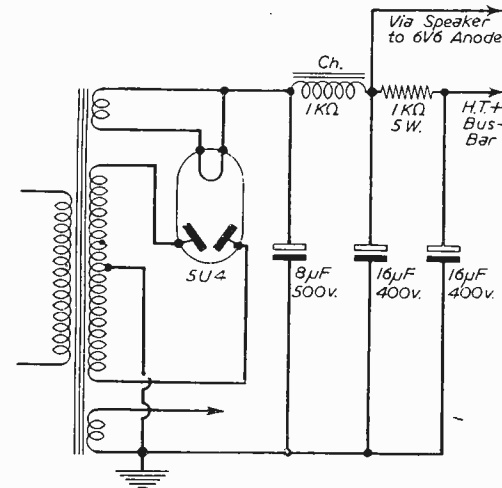

Fig. 5.—The power supply section.

controls fitted, goes the salvaged key-jack, which is connected up according to Fig. 4 as a telephone line (600 Ω) jack.

(G) Finally in this line goes the mains on/off switch, and above it a 6v. pilot of the P.O. telephone type.

(H) A salvaged Pye-plug will be fitted to the top right-hand corner of the front plate and connected up via a capacitor, 300 pF, and a short length of coax through the hole through the chassis to range-switch S11A, segment 3, i.e., the spot marked in operation G of the second phase for aerial.

(I) To the left of the Muirhead-drive and near the top edge of the front plate the salvaged set-meter will be fitted. It will be connected up in the ninth phase, operation G.

(K) To the left of the Muirhead-drive near the deck, about half way up the front plate, the salvaged tuning condenser of the B-set will be fitted. Its modification and connection will be described in the ninth phase, operation F.

(L) Again further to the left the hole for the 3in. loudspeaker will be drilled. The loudspeaker and its transformer should be fitted and connected up according to Figs. 4 and 5 when the front plate is in position.

Seventh Phase (Final Connections and Test)

(A) Complete now the H.T. line. The set had originally two H.T. lines, one the receiver H.T. and the sender H.T. They can now be combined and taken to the H.T. end of the smoothing chain (refer to Fig. 5).

(B) The mains lead can now be connected up.

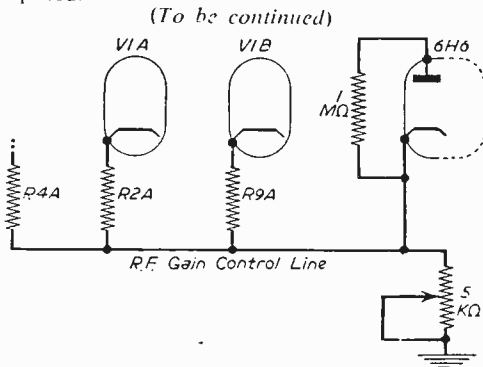
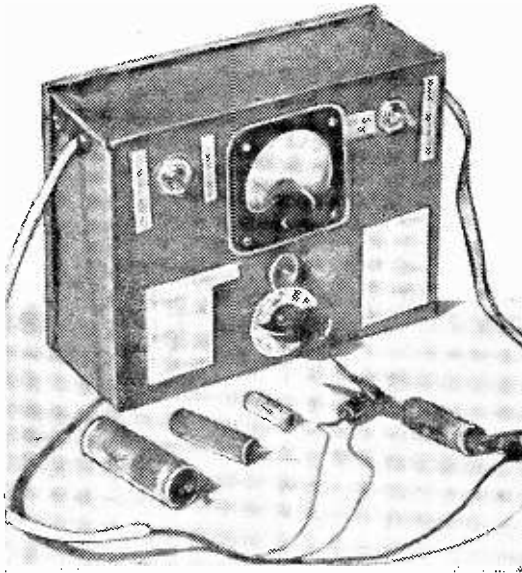

Fig. 6.—How the R.F. gain control is connected.

A Condenser Condition Tester

A MODIFIED FORM OF THE INSTRUMENT DESCRIBED IN THE FEBRUARY ISSUE

By J. BROWN



THE article "Condenser Condition Tester" that appeared in the February issue of PRACTICAL WIRELESS has caused quite a controversy, judging by the letters from readers. These were of all different natures, so the whole unit has been modified with hopes that most readers will possibly be now pleased to see some more protection of the meter. Also S3A has been modified and a different idea for the method of procuring the required voltage for tests. We should like to clear up some points first re the original article.

(1) The voltages given on page 866 were measured at the junctions of the chain by a valve voltmeter. This possibly explains the difference in other figures when measured with other meters.

(2) Meter protection. Originally one section of S3 was allocated for a meter protection device which still has to be proved to be efficient.

Having had experience with test gear, British, American, Continental, even Japanese, the writer has yet to see an infallible protection circuit.

Either they work and are very hard to reset, or they do not work at all.

When the idea of the tester materialised, it was automatically thought that each individual had his own pet ideas re the test of condensers.

The writer prefers to test with a multirange meter on the highest ohms range first. As the test meter is so arranged that the battery power supply is adjusted to read full scale, very little damage may be done, so the suggestion is to test with an ohmmeter first before any other tests are carried out.

However, in this modified design it is so arranged that on each position of S2 the meter reads just on full scale even with a S/C condenser. The only damage to meter that can be now done is when a capacitor is connected with the wrong polarity, so at all times *observe correct polarity*.

Going back for a brief moment, the statement

re meter protection devices is said with all good faith regards manufacturers. We realise that a meter in the wrong hands is subject to abuse at all times, so the golden rule is "If in doubt, switch off, think and look."

Capacitors or condensers can be reformed by applying to them, in correct polarity, the working voltage via a limiting resistor. This limits the current to a safe value. In the modified circuit our working voltage is obtained via the resistor chain R3 to R12.

The 600 volt range current is obtained from its own resistor R2. After being selected by S2, it is passed to the meter via the limiting resistor used on all settings, R13, then to the positive terminal. S3 has been modified to any two position single-pole switch. The power supply is the same, as is the neon leakage side. R1 is the smoothing and dropper resistor to ensure we have 600 volts at the junction of R1, R14, R2 and 3. Carry out the reforming by selecting the correct voltage or a little under would be better, connect the condenser, *correct polarity*, and reform till the lowest figure is obtained on the meter. This was quoted at one-tenth of a milli-amp per μF . There seems to be some query at this.

In another reference work we see quoted "The maximum leakage for a 8 μF condenser should be between .4 and .5 mA." Other readers have

LIST OF COMPONENTS for original model (see also P.107)

T1—One 2½ : 1 ratio L.F. transformer.

One metal rectifier 10C/13186 (surplus).

MRI or 4-RM2 in series.

C1—One 4 μF 600 volt condenser.

R1—18 K.

R2-R12—1 megohm

R16—2.2 meg.

R15—4.7 meg.

R13—1 meg.

R14—1 K 3 watt

C2—.25 μF 500 volts working.

One 5 mA meter Govt. surplus. Meter.

S2—One 12-way single-pole Yaxley switch.

S1A and S1B—Double-throw changeover.

S3A and S3B—Double-throw changeover.

Two terminals.

1 Neon Lamp. The original was a surplus type CV988 or GE991, although any type can be used if the resistor which is incorporated in some neons is removed. If a commercial neon is going to be used, inquire if it is fitted with a resistor to limit the current.

had various figures. The basis of the tester was as aforementioned. "the voltage equal to the working voltage is applied to the condenser via the limit current resistor." This is illustrated as below, Fig. 2, the only difference being that we have an indicator of the amount of leakage.

The values of the divider resistors are changed. we now have a series chain, the voltage required is taken from the preceding resistor. Hence the values are given below.

There was a suggestion that the position 12 be connected to the negative side of meter, but the safest way is to leave this with no connection. Hence the capacitor under test cannot discharge through the meter. All these above resistors are different from the original circuit and are all normal values except R12, this may be easily made up by putting in series a 2.5 K plus a 1 K. The wattage of these should be 2-3 watts, but 1 watt resistors have been used.

Resistor Number	Value	Position Voltage from Chassis	S2 position for operation
R2	120 K	L 600	Position 1
R3	20 K	A 500	" 2
R4	20 K	B 400	" 3
R5	20 K	C 300	" 4
R6	10 K	D 250	" 5
R7	10 K	E 200	" 6
R8	10 K	F 150	" 7
R9	10 K	G 100n	" 8
R10	10 K	H 50	" 9
R11	25 K	I 25	" 10
R12	2.6 K	J 12	" 11
Nil	Nil	Nil	No connection

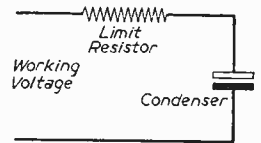
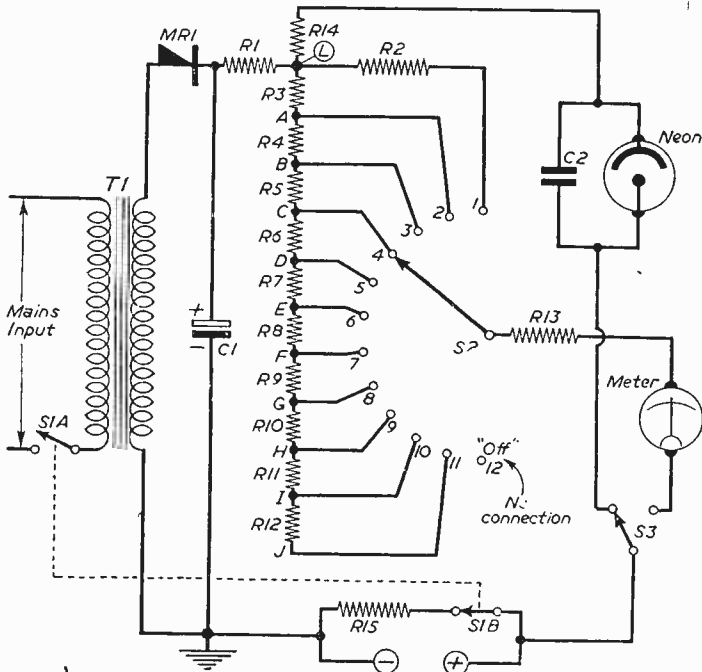

Figs. 1 (left) & 2 (above). The modified circuit and basic arrangement.

Value of R13

The value of R13 was chosen as a compromise between the required values. However, during the operation of reforming, the meter will momentarily exceed the full scale. This does not seem to damage the meter in any way, but should any reader think it will be injurious, a 100K resistor (variable wirewound) may be inserted between the meter connection of R13 and the meter. We now have a Maximum to Minimum control to safeguard the meter during the initial stages of reforming. The operation would then be: Connect the condenser, polarity correct, set the 100K to Minimum, the maximum amount of resistor in circuit, switch S2 to correct position, and then switch on. After a short period, the 100K pot may be increased.

- COMPONENTS**
for the modified version described in this issue.
- T1 as original.
 - R15 as original.
 - S1A and S1B as original.
 - R13 is limiting resistor for ranges 2-11-10 K.
 - R2 is limiting resistor for range 1.
 - Neon and C2 as original.
 - Meter as original.
 - C1 as original.
 - S2 as original.
 - R1-3 K 3 watt.
 - MR1 as original.
 - R14 is 1 meg.
 - S3 changed to single pole.
 - 2 position or change-over S/P.

Constructing a Direct-coupled A.C./D.C. Amplifier

IN the March issue an article appeared under the above title in which the two circuits, Fig. 1 and Fig. 2 were shown with the usual theoretical symbol for an earth connection. As the apparatus described in that article is of the so-called "Universal" type it should be remembered that a direct earth should not be connected to any equipment constructed according to those details.



On Your Wavelength

BY THERMION

Improved Recording Technique

I HAVE, on very good authority, learned that a well-known gramophone record company has made a revolutionary advance in recording on records. The idea is to put on the disc a composite recording made by both lateral and hill and dale methods in the same groove. For reproducing, a player amplifier is required that has a single stylus. The two recordings are passed through two crystals and then go to two separate amplifiers. The output from these is combined in a final output stage. I have been given to understand that the results are fantastic.

The development of the photoelectric cell and the sound track on film led to the belief some years ago that the gramophone disc, which developed from the old Edison type cylindrical record, would eventually vanish, and instead we should have a machine consisting of a photoelectric cell and amplifiers which would run for several hours from a recording on celluloid tape. It was estimated that the complete recording of an opera could be accommodated on a coil of celluloid no larger than the present discs. As I have mentioned before, such a machine was actually marketed and indeed exhibited at one of the early radio shows, but it was bought up and "killed" by a rival concern. I still think that that is the inevitable development of recorded music.

The plain fact must be faced, however, that gramophone discs are selling in far larger numbers than ever before and the gloomy forebodings of the gramophone industry who in the early days thought that radio would kill the demand for discs have not been fulfilled. As with L.P.R., the transition from gramophone discs to celluloid tape must be gradual, and it would take place over a long period of years. All of the recorded music could not be re-recorded in less than, say, 10 years.

Dens

I HAVE had a small response to my request to readers for photographs of their dens. Those which have come to hand so far are, however, extremely interesting and I shall shortly hope to publish the first group. Remember I shall pay one guinea for every photograph published and there is no time limit.

A Spring Clean

THE annual urge to go through one's documents, papers and periodicals and throw away those which are of no further interest possessed me the other day. Like most other amateurs I found it a slow process, for you start reading old catalogues and find that a large

amount of time has passed and the waste paper basket is still empty. Finally, you find that you can't throw this away or that away and you end up with a pile as before. There is a fascination about browsing through old catalogues. My collection goes back to the beginning of radio. I carefully file all of the catalogues collected at exhibitions and sent to me by manufacturers, and even to-day I find it necessary to refer to them. I know that the proper procedure is to keep a carefully indexed register, extract what you want from the literature, and then throw it away. I, however, prefer to keep the lot. And there have been many occasions when I have been glad that I did so.

The Late F. H. Robinson

I DEPLORE the passing in February of my old friend, F. H. Robinson (Robbie to his friends). His death came suddenly. He had a long connection with radio journalism and was editor of the "Broadcaster" (now "Electrical and Radio Trading"). That was in the early '20s, the days of fierce competitive radio journalism, and although Robbie remained on the trade side of journalism he took a keen interest in all branches of it, and particularly in the social side. He was honorary social secretary of Radio Industry Club, president of the Radio Industry's Golfing Society, and just before his death had finished an historical souvenir which was issued at this year's annual R.I.G.S. ball. He was known to everybody in the radio trade, and he will be missed by that wide circle of friends.

M.P.R.

I HAVE received a large number of letters from readers who are interested in making or purchasing one of those really midget printed circuit transistorised pocket receivers which do not require a battery four times the size of the receiver. I wonder if any of the manufacturers will take the hint and put such receivers on the market? I suggest that they might usefully experiment with some of the long-life pellet batteries now being used in place of mainsprings in American wrist watches. Although no larger than sixpence in diameter and thickness they operate the watch for a year, develop a full voltage of 1.5v., although their discharge rate is comparatively low, being in the order of a milliamp or so. They would, however, solve battery space problems, and used in conjunction with special low consumption peanut valves they should provide the answer to the problem. Unfortunately, such batteries are not at present available to the general public, although they are available to manufacturers. I understand that at least one Swiss manufacturer is also producing them.

HOME RADIO OF MITCHAM

187 LONDON ROAD, MITCHAM, SURREY.

MIT 3282

London and Home Counties distributors for Panda Transmitters.

HIGH STABILITY RESISTORS

We are pleased to announce that we now stock a complete range of 97 different preferred values of $\frac{1}{2}$ watt 5% high stability resistors. PRICE only 9d. each. Add post 3d. on order.

MULLARD 5 VALVE 10 WATT QUALITY AMPLIFIER

Full constructional details including separate pre-amplifiers, F.M. tuner, etc., in "High Quality Sound Reproduction," price 3/6, plus 6d. post. We stock all the parts for these kits and also the "3-3" amplifier, tape amplifiers, and new 2 valve pre-amplifier.

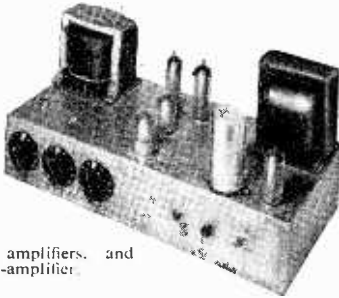

The most successful home constructor design ever produced. Enjoy crystal clear Hi-Fi reception NOW. All parts standard and available from stock. Many thousands in daily use throughout the country. Full constructional data, point-to-point diagram and price list, 2/4, post paid. Complete kit down to last nut and bolt. £7.7.6.

JASON F.M. TUNER KIT

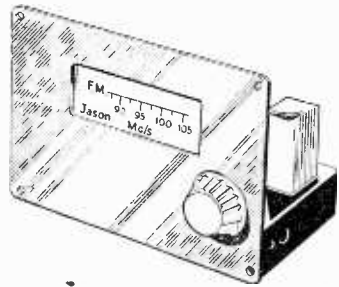

A NEW JASON F.M. TUNER—THE "MERCURY"

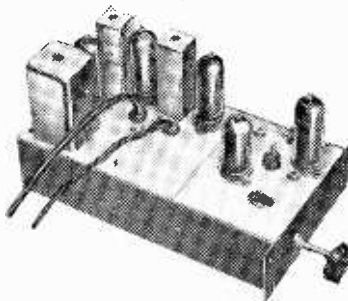

F.M. at its simplest and best. Enjoy crystal clear high fidelity reception with the programme you want always spot-on tune at the turn of a switch. Foster Seeley discriminator and A.F.C. incorporated. Full constructional data, point-to-point diagram and price list, 2/4, post paid. Complete kit down to last nut and bolt. £10.0.0.

"TRANSEVEN" PORTABLE



7 transistor portable radio. Superhet circuit, push-pull output with 7in. x 4in. speaker. 4 pre-set stations (1 long and 3 medium). Low running costs from 7½ volt battery. Full constructional data with point-to-point diagram and price list, 1/9, post paid. Complete kit including cabinet 9in. x 7in. x 4in., £10.15.0. Make one now for the summer.

THE "THREE DEE"

Dual range radio with band-pass tuning using germanium diode and three transistors. Loudspeaker reception and low running costs from 7½ volt battery. Designed for local station reception and ideal for bedroom, workshop, caravan, or second radio set. Chassis size 6in. x 4in. x 2in. Full constructional data with point-to-point diagram and price list, 1/-, post paid.

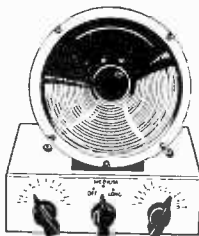

THE "HIWAYMAN" ALL-DRY PORTABLE



A well tried portable using latest high efficiency ferrite rod aerial, 2 wavebands, 4 valve in straightforward superhet circuit. Build one NOW ready for the summer and holidays. Full constructional data, point-to-point diagram and price list, 1/9, post paid. All parts standard and from stock. Building cost £7.10.0.

COMING SHORTLY!

Available shortly the new Repanco MINI-SEVEN 7 transistor superhet pocket portable with loudspeaker and guaranteed results on internal aerial. A real winner. Send 1/9, now for full constructional data as soon as released and be the first with this wonderful little set.

LORENZ LPH 65

This amazing tweeter brings sparkling life and realism to your reproduction, whether you like rock 'n' roll or the classics. Only 39/6, complete with easy instructions for connecting to your present speaker through 2 mfd condenser (3-).

We are stockists for:—EDDYSTONE, PANDA, DULCI, ARMSTRONG, STENTORIAN, DENCO, JACKSON, REPANCO, TELATRON, WHARFEDALE, GOODMAN'S, etc., etc.

SPECIAL
Stock up now!
Brand new 16 mfd
350 v. tubular
condensers by
T.C.C. ONLY
1/6 EACH or 6/-
for 7/6, post 6d.

I VALVE ALL-DRY BATTERY SET

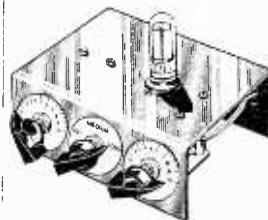

Ideal constructional kit for boy. Gives excellent results. Complete kit of parts with valve, 33/6. Combined H.T. and L.T. battery, 8/3. Headphones 15/-.

Full constructional data with point-to-point diagram and price list, 1/-, post paid.

MAXI-Q

I.F. TRANSFORMERS

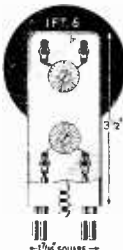

Price A, 9/-
B, 9/4

IFT. 11/465 Kc/s and 1.6 Mc/s.

Miniature IF Transformers for 465 Kc/s or 1.6 Mc/s giving excellent performance at low co-t. Coils are litz wound and permeability tuned with high-grade iron dust cores and s.m. condensers. Screening Can 1 1/2" x 13/16" sq. PRICE 6.6.

IFT. 11 10.7 Mc/s.

Nominal frequency 10.7 Mc/s. For IF stages of F.M. receivers and converters. The Q of each winding is 90 and the coupling critical. Construction and dimensions as above. PRICE 6.6.

IFT. 11/10.7/L.

As above but with secondary tap for limiter input circuits. PRICE 6.6.

IFT. 6A and B 465 Kc/s or 1.6 Mc/s.

A superior IF Transformer for use in high quality receivers and tuners. Permeability tuned, litz wound coils, high-grade iron dust cores and silver mica condensers. Termination is made by four coloured flexible leads. Coupling is optimum at 465 Kc/s and slightly sub-optimum for increased selectivity at 1.6 Mc/s. IFT.6A has all leads brought out at the bottom, while IFT.6B has a top screened grid lead. Screening can 3 1/2" x 1 7/16" square.

PRICE: TYPE 'A', 9-. PRICE: TYPE 'B', 9/4.

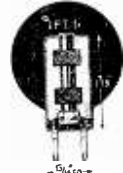

Price 6/6

IFT. 12/85 Kc/s.

A narrow band 85 Kc/s IF Transformer for use in double super-het communications receivers. The overall response of one transformer is approx. 3.5 Kc/s at -6 db. Dynamic resistance 500,000 ohms. Wound on a polystyrene former with iron dust core tuning and silver mica condensers. Screening can 2 1/2" x 1 13" square.

PRICE 16/-.

ALL I.F. TRANSFORMERS ARE ALIGNED BEFORE LEAVING THESE WORKS.

For full details of these and many other components send 1/- in stamps for GENERAL CATALOGUE. Please send S.A.E. with all enquiries. Trading terms for direct postal orders, C.W.O. plus appropriate postal charges.

DENCO (CLACTON) LTD. (Dept. P.W.), 357/9 Old Road, Clacton-on-Sea, Essex.

STOP PRESS: MAXI-Q PRE-SET F.M. TUNER, completely assembled and valued, £12. VARIABLE VERSION, £11. COMBINED POWER PACK AND AMPLIFIER, £5.10.0, or in comprehensive kit form, £5.

VALVES • SAME DAY SERVICE

All Guaranteed New and Boxed

1.4v. midget, 1R5, 1S5, 1T4, 3S4, 3Q4, 3V4, DAF91, DF91, DK91, DL92, DK92, DL94; ANY 4 for 27.6.

1A7GT	13 6	6V0GT	7 6	DAC32	11-	EF35	9 6	PL33	22 6
1C5GT	15 6	6X4	7 6	DAF36	8 6	EF39	8 6	PL81	19 6
1H5GT	11-	6X5GT	6 9	DF93	11-	EF43	7 6	PL82	19 6
1N5GT	11-	7B7	8 6	DF96	8 6	EF46	13/-	PL93	10 6
1R5	8 6	7C5	8 6	DH76	7 6	EF89	9 6	PY89	8 6
1R5	7 6	7C6	8 6	DH77	8 6	EF41	6/-	PY81	8 6
1T4	3 6	7HT	8 6	DK32	13 6	EF82	5 6	PY82	8 6
3Q4	8 6	7ST	9 6	DK32	8 6	EL32	16 9	PY83	8 6
3Q5GT	9 6	7Y4	9 6	DK93	9 6	EL31	16 9	PZ33	18/-
3S4	7 6	12AH5	8 6	DL33	9 6	EL38	22 6	R19	13 6
3V4	8 6	12AT6	8 6	DL33	15 6	EL41	9 9	SP41	3 6
5U4G	8 6	12AT7	8 6	DL96	8 6	EL42	11 6	SP61	3 6
5V4G	11 9	12AU7	8 6	RABC90	7 9	EL84	9 9	TH41	13 6
5Y3GT	7 6	12AX7	8 6	EF42	10 6	EM34	10 6	U26	12 6
5Z4G	9 6	12BA6	8 6	EB91	6 6	EM80	10 6	U58	7 6
6AL5	5 6	12CTGT	10 6	EBC33	7 6	EY51	12 6	U76	7 6
6AM5	5 6	12K7GT	7 6	EBC41	9 6	EY85	17 6	UB39	9 6
6AM6	6 6	12K8GT	14 6	EBF83	8 9	EZ40	8 6	UAF42	10 6
6A05	7 6	12Q7GT	7 6	EBF93	8 6	EY41	7 6	UBC41	8 6
6AT6	8 6	12SN7GT	7 6	ECC81	8 6	EZ81	9 6	UBF80	9 6
6BA6	7 6	12X7	18 6	ECC82	8 6	PW4 500	13 6	UCH42	9 6
6BE6	7 6	12Y3	7 6	ECC83	8 6	GZ32	11 6	UCH81	9 6
6BH6	9 6	14S7	12 6	ECC84	10 6	GZ32	11 6	UGL93	17 6
6BJ6	7 6	19AQ5	9 6	ECC85	9 6	KT32	8 6	UF41	8 6
6BR7	8 6	25Z4G	9 6	ECC86	10 6	KT44	6 6	UF42	15 6
6BW6	7 6	33L8GT	9 6	ECC87	11 6	KT63	6 6	UP89	10 6
6BW7	8 6	35Z3	9 6	ECH21	16 9	MH4	6/-	UL41	9 6
6CD6G	25 6	35Z4GT	7 6	ECH35	10 6	MU11	9 6	UL81	9 6
6F6G	6 6	35Z5GT	9 6	ECH42	9 6	N18	8 6	UX21	16 6
6F12	6 6	43	13 6	ECH81	8 6	N18	8 6	UY41	7 6
6K7G	4 6	50CD6G	18 6	ECL80	10 6	PCC80	10 6	UY85	7 6
6K7GT	6 6	50L8GT	8 6	EF37A	8 6	PCF60	10 6	VP41	7 6
6K8G	7 6	AC TP	20 6	EF39	6 6	PCF82	10 6	VP1321	21 6
6L8G	12 6	AZ31	11 6	EP41	9 6	PCL82	12 6	WV6	7 6
6Q7GT	9 6	B36	18 6	EF42	11 6	PCL83	12 6	WV7	5 6
6SN7GT	7 6	CL33	16 9	EF30	6 6	PEH46	6 6	WV7	5 6
6U4GT	11 6	D77	6 6	SYL 6/6	PL36	17 6	Y63	6 6	
6V6G	7 6					Z77	6 6		

Postage 6d. per valve extra. Any Parcel Insured Against Damage In Transit Ed. extra.

READERS RADIO

24, COLBERG PLACE, STAMFORD HILL, LONDON, N.16 STA. 4587

FREE TO AMBITIOUS ENGINEERS!

This 148-page Book

Have you sent for your copy?



'ENGINEERING OPPORTUNITIES'

is a highly informative guide to the best-paid Engineering posts. It tells you how you can quickly prepare at home on "NO PASS—NO FEE" terms for a recognised engineering qualification, outlines the widest range of modern Home-Study Courses in all branches of Engineering and explains the benefits of our Employment Dept. If you're earning less than £20 a week you cannot afford to miss reading this unique book. Send for your copy to-day—FREE.

--- FREE COUPON ---

Please send me your FREE 148-page "ENGINEERING OPPORTUNITIES"

NAME
ADDRESS

Subject or Exam. that interests me.....

British Institute of Engineering Technology
409 B, College House, 29-31, Wright's Lane, Kensington, W.8.

WHICH IS YOUR PET SUBJECT?

- Mechanical Eng.
- Electrical Eng.
- Civil Engineering
- Radio Engineering
- Automobile Eng.
- Aeronautical Eng.
- Production Eng.
- Building, Plastics, Draughtsmanship, Television, etc.

GET SOME LETTERS AFTER YOUR NAME!

- A.M.I.Mech.E.
- A.M.I.C.E.
- A.M.I.P.E.
- A.M.I.M.I.
- L.T.O.B.
- A.F.R.Ae.S. B.Sc.
- A.M.Brit.I.R.E.
- CITY & GUILDS GEN. CERT. OF EDUCATION etc., etc.

BIET

Servicing Radio Receivers

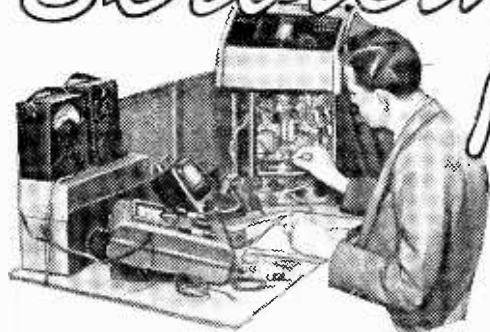

ALBA RADIO—MODELS 3211, 6224, 6231, 6241 AND 6251

By Gordon J. King, A.M.I.P.R.E.

AT the finish of the last series under this title, it was promised that a new series would be commenced dealing with radio receivers of more modern styling, and in particular with sets featuring V.H.F.-F.M. and transistorised circuits. With co-operation from leading manufacturers this series can now be launched, and since new models will be under the spot-light readers will be kept up to date with regard to the latest developments and circuit techniques.

The seven-valve Alba chassis, the complete circuit of which is given in Fig. 1, forms the basis of five models: a table model (Model 3211) and four radiograms. The chassis can be switched over four bands—L.W., M.W., S.W. and V.H.F.-F.M.—and the band-selector switch has provision for switching in a pick-up (the latest crystal type eminently suitable), the switch thus has five positions. The remaining three controls are ganged A.M./V.H.F.-F.M. tuning, volume and tone. There is also a "magic eye" tuning indicator which functions on both A.M. and V.H.F.-F.M.

The Circuit

Looking first at the A.M. sections of the circuit V2 is a fairly conventional heptode frequency changer stage, whose aerial and oscillator tuned circuits are selected by ganged switch sections in the usual manner. At this point it should be noted that only when the main ganged band-selector switches are themselves switched to the "F.M." position are the A.M./F.M. changeover switches in the "F.M." position. On all other positions of the "band-selector" the A.M./F.M. changeover switches are in the "A.M." position. This is common practice, and the changeover switches themselves are ganged to the "band-selector" switches, thereby facilitating the use of a common control knob.

Dual I.F. Transformers

In the anode circuit of the heptode section of the frequency changer valve are placed the A.M. and F.M. I.F. transformers in series, L9/L10 being the A.M. section and L11/L12 the F.M. section. It will be seen that a changeover switch serves to short out the primary of the transformer

not in use. In the secondary circuit the F.M. winding is shorted out when the chassis is switched to "A.M." but when switched to "F.M." both windings remain in series and the A.G.2 line is shorted to chassis. Switching of the I.F.s is not essential owing to the considerable difference between the A.M. and F.M. intermediate frequencies, and is not always adopted in combined receivers. The "standard" I.F.s being 470 Kc/s on A.M. and 10.7 Mc/s on F.M., as in the Alba chassis.

The selected I.F. is thus conveyed to the common I.F. amplifier valve (V3), and the signal is developed in amplified form across the appropriate second I.F. transformer. Again it will be seen that the I.F. transformers are connected in series, but that the secondary windings convey the selected I.F. signals to the appropriate detectors for demodulation.

On A.M. the signals across L17 of T2 are applied direct to the A.M. diode in V4B. At this stage it should be noted that V4 is one of the new multi-electrode valves (Mullard EABC80), in which are incorporated three diodes and a triode—two of the diodes having separate cathodes and the cathode of the other one being common to the triode. It is usual practice to employ as A.M. detector the diode whose cathode is common to the triode, as shown in Fig. 1 (V4B).

The A.M. detector load is formed by R20, R26 and C40 being the detector filter components. The

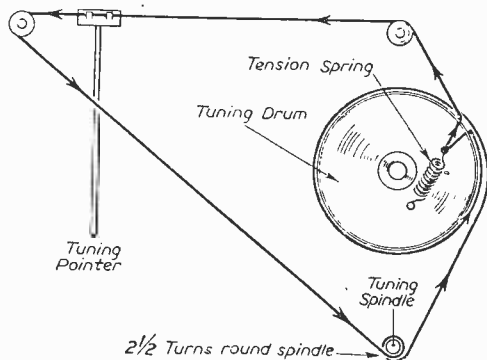

Fig. 2.—Details of the tuning drive.

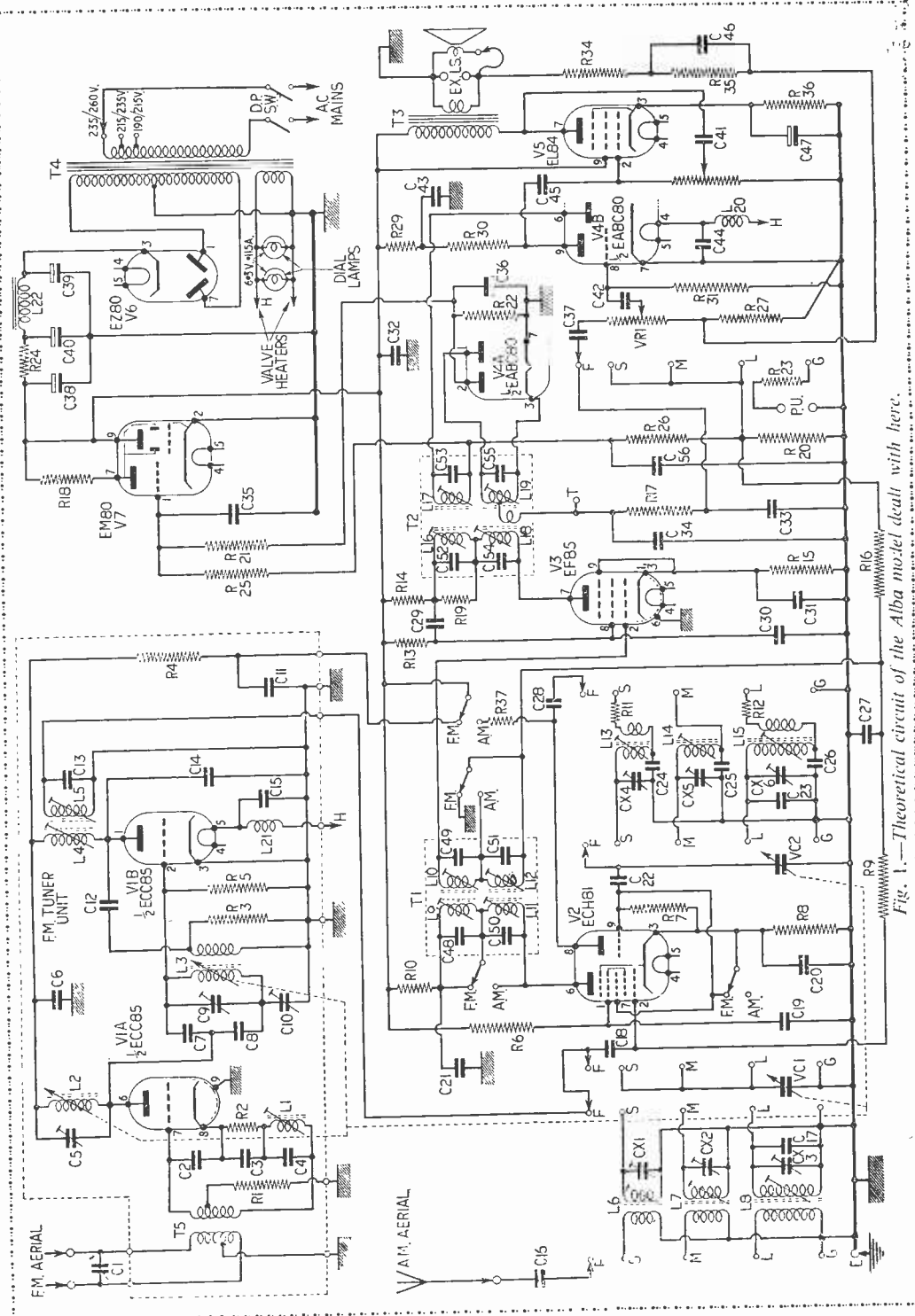

Fig. 1.—Theoretical circuit of the Alba model dealt with here.

A.F. content of the signal across the load is fed to the grid of the triode section of V4B by way of the band-selector switch, C37, the volume control (VR1) and C42. From hereon the circuit follows conventional practice. The amplified A.F. signal appearing across the load resistor (R30) of the A.F. amplifier triode is capacitively coupled through C45 to the control grid of the output valve (V5), the anode circuit of which is loaded by the loudspeaker. A degree of negative feedback is applied over the two A.F. stages from the secondary of the output trans-

The F.M. Tuner Unit

The F.M. tuner is an independent unit whose permeability tuning is ganged by means of a cam to the main A.M. tuning mechanism. A single double-triode valve (V1) is featured, section V1A arranged as an R.F. amplifier and section V1B as a self-oscillating frequency changer. Although it may not appear so from first glance, the R.F. stage is connected in the earthed-grid mode, the grid being connected to chassis by way of a section of the grid winding of T5 and R1. In this way the internal electrode capacitances of V1A are neutralised and any tendency for positive feedback is avoided. A 300 ohms balanced aerial input circuit is adopted and impedance matching and coupling of the signal to the tuned cathode circuit (L1) are accomplished by the flatly tuned aerial transformer T5. The cathode coil L1 is also flatly tuned to embrace the whole of Band II, but the R.F. stage generally is tuned over the band by the anode coil L2 and its associated slug.

The amplified R.F. signal is applied to the grid of the frequency changer at the point of zero oscillator voltage which exists at the junction of C7 and C8. In this way oscillator radiation by way of the aerial, due to feedback through the R.F. stage, is kept to a minimum, since the voltage

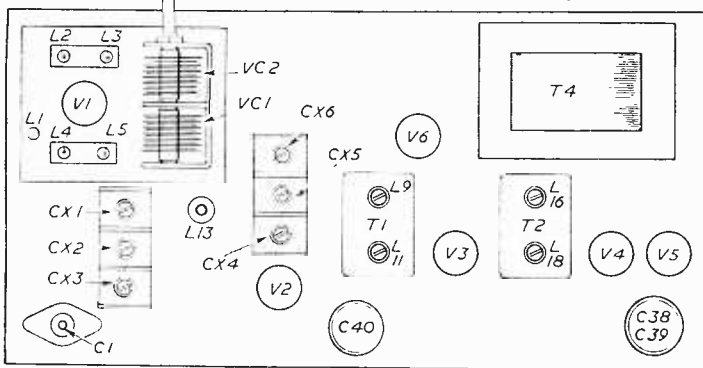

Fig. 3.—Top view of chassis, showing trimmer adjustments and major components.

former to the grid of V4B. A selective feedback tone control circuit is given by C41 and the tone control (VR2).

A.G.C. and Tuning Indicator

The D.C. content of the signal at the A.M. detector is used as an A.G.C. bias, being fed to stages V2 and V3 by way of R16 and R9, C27 acting as decoupler, and also as a bias for operating the magic eye tuning indicator (V7). In this latter function the bias, whose magnitude is dependant upon the I.F. carrier signal at the A.M. diode, is applied to the grid of V7 through R25, C35 filtering any residual I.F. component. The tuning indicator is connected in the normal manner across the H.T. line.

F.M. Operation

Apart from the operations already mentioned, when the receiver is switched to F.M. the A.M. oscillator is muted by the band-selector switches disconnecting the oscillator coils and removing the oscillator anode from the H.T. line. At the same time H.T. is applied to the F.M. tuner unit, the triode/heptode coupling link is shorted to V2 cathode and the 10.7 Mc/s I.F. output from the tuner is connected to the control grid of the heptode by way of C18. Under this condition the heptode operates as an additional F.M. I.F. amplifier.

at the R.F. coupling point is maintained at zero as long as the bridge circuit comprising C7, C8, C10 and the valve capacitances is balanced. The trimmer T10 is provided to adjust for optimum balance which is indicated by the smallest oscillator signal at the aerial terminals.

The F.M. I.F. signal appears in V1B anode circuit, and is coupled to the heptode by way of L5, as already described. Tuning of the oscillator circuit is also performed by a slug in the oscillator coil L3, which is also ganged to the slug in L2 and the A.M. tuning system. On F.M. the F.M. I.F. signal travels through

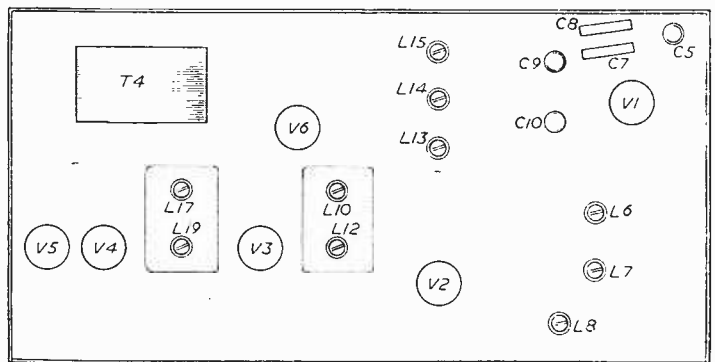

Fig. 4.—Under-chassis view, showing trimmer adjustments and major components.

the circuits and appears in amplified form across the secondary of the ratio detector transformer L19. The ratio detector is completed by the two diodes in V4A, by the stabilising capacitor C36 and associated load resistor R22. The A.F. F.M. signal appears across C34 from whence it is conveyed to the volume control by way of the de-emphasis network R17 and C33, the band-selector switch and C37. The signal from here follows the same course as already described. A source

II and then retuning the set to the local Band II station.

A modulation hum occurring on F.M. when the tuning is adjusted slightly either side of the optimum tuning point is invariably the result of a defect in V4. Substituting the valve with one in good condition quickly proves this possibility.

Distortion on F.M. but not on A.M. is sometimes caused by unbalance of emission of V4A diodes. If valve replacement does not cure the trouble, however, misalignment of the ratio detector transformer, L18/L19, should be suspected. This trouble is also revealed on the tuning indicator by the tuning point for minimum distortion not coinciding with maximum deflection of the "eye."

Distortion on both services should lead to a check of C45 (for insulation resistance), R30 and R31 (for open-circuit or high value).

As an aid to fault finding, the voltages to be expected on the electrodes of the various valves, when the receiver is switched both on A.M. and F.M., are given in the table on the left.

Details for restringing the drive are given in Fig. 2. A fine nylon cord is suitable for this purpose.

VOLTAGES

Valve	Set on F.M.			Set on M.W. A.M.		
	Anode	Screen	Cath.	Anode	Screen	Cath.
ECC85.	a" 165	—	—	—	—	—
ECC85	a' 170	—	2.4	—	—	—
ECH81	230	90	1.9	250	75	2
	Oscillator			Oscillator		
	—	—	—	at 150	—	—
EF85	120	85	1.85	130	95	2
EABC80	at 50	—	—	at 50	—	—
EL84	215	240	7.1	230	255	7.7
EM80	—	—	—	—	—	—
EZ80	295 volts each anode		300	295 volts RMS each anode		305

Readings taken on a AVO 7 with gang at Max.

of bias for operating the tuning indicator is available across the load resistor R22, and is fed from here to the grid of V7 through R21.

The Power Circuit

The receiver uses a mains transformer which isolates the mains from the chassis, a full-wave rectifier and a two-stage choke/resistive filter, comprising L22 and R24, capacitors C38, C39 and C40 being the associated smoothing elements. A single L.T. winding on the mains transformer energises the valve heaters, including the rectifier, and the 6.3 volt 0.115 amp MES spherical dial lamps.

Servicing Notes

A sudden cutting off of F.M. signals after the set has been working for a while is usually caused by failing emission of the frequency changer section of V1. When this is the case, the F.M. section can usually be brought back to life by tuning to the high-frequency end of Band

A.M. Alignment

The receiver should first be aligned on A.M., and the following procedure adopted. Short-circuit the oscillator tuning gang (VC2), inject a 470 Kc/s modulated signal across VC1, switch the receiver to M.W. and close the tuning gang. After allowing about five minutes for the receiver and signal generator to become frequency stable, adjust the cores in L9, L10, L16 and L17, in that order, for maximum indication on an output meter connected to the extension loudspeaker sockets. Repeat until no further increase in output can be obtained.

Remove the short-circuit from VC2, inject a 600 Kc/s modulated signal by way of a dummy aerial across the A.M. aerial and earth sockets, tune the receiver to 500 metres and adjust L14 and L7 for maximum indication on output meter. Repeat for best results. Retune the generator to 1,500 Kc/s and the receiver to 200 metres and adjust CX5 and CX2 for maximum output.

(To be continued)

LIST OF VALUES FOR FIGURE 1

C1—30 pF.	C17—100 pF.	C33—2,500 pF.	C49—100 pF.	R9—1 MΩ.	R25—2.2 MΩ.
C2—8.2 pF.	C18—100 pF.	C34—330 pF.	C50—27 pF.	R10—1.5 KΩ.	R26—220 KΩ.
C3—1,000 pF.	C19—2,000 pF.	C35—.005 μF.	C51—27 pF.	R11—220 Ω.	R27—100 Ω.
C4—47 pF.	C20—.05 μF.	C36—5 μF.	C52—100 pF.	R12—10 KΩ.	R28—
C5—30 pF.	C21—.005 μF.	C37—.02 μF.	C53—100 pF.	R13—56 KΩ.	R29—220 KΩ.
C6—570 pF.	C22—100 pF.	C38—32 μF.	C54—10 pF.	R14—10 KΩ.	R30—220 KΩ.
C7—39 pF.	C23—190 pF.	C39—32 μF.	C55—50 pF.	R15—150 Ω.	R31—10MΩ.
C8—39 pF.	C24—5,343 pF.	C40—8 μF.	C56—100 pF.	R16—1 MΩ.	R32—
C9—30 pF.	C25—600 pF.	C41—200 pF.	R1—120 Ω.	R17—12 KΩ.	R33—
C10—30 pF.	C26—270 pF.	C42—.02 μF.	R2—220 Ω.	R18—470 KΩ.	R34—1.5 KΩ.
C11—2,200 pF.	C27—.1 μF.	C43—.1 μF.	R3—2.2 KΩ.	R19—68 KΩ.	R35—10 KΩ.
C12—18 pF.	C28—100 pF.	C44—1,000 pF.	R4—4.7 KΩ.	R20—220 KΩ.	R36—150 Ω.
C13—15 pF.	C29—.05 μF.	C45—.01 μF.	R5—1 MΩ.	R21—2.2 MΩ.	R37—27 KΩ.
C14—12 pF.	C30—3,900 pF.	C46—.1 μF.	R6—47 KΩ.	R22—56 KΩ.	VR1—500 KΩ.
C15—2,200 pF.	C31—.1 μF.	C47—25 μF.	R7—47 KΩ.	R23—100 KΩ.	with D.P., S.W.
C16—200 pF.	C32—.25 μF.	C48—100 pF.	R8—220 Ω.	R24—600 WW.	VR2—500 KΩ.

A Two-Valve Portable Radiogram

UTILISING ONLY TWO VALVES, THIS PORTABLE RADIO WILL ALSO FORM A USEFUL RECORD REPRODUCER

By M. L. Michaelis

(Continued from Page 43, March issue)

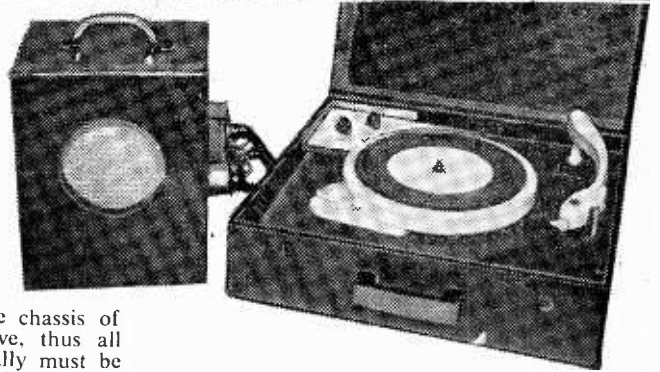

IT should be remembered that the chassis of this receiver is liable to be live, thus all earthed points projecting externally must be insulated. Pay particular care to grub screws of control knobs, and isolation of any metal masses of the record player.

Adjustments of Radio-amplifier

After completing the construction, check all wiring carefully. Then disconnect R2 from the grid cap of V1.

Advance the reaction control, after allowing sufficient time to warm up, on medium-wave radio setting. If it is not possible to obtain oscillation, reverse connections 5 and 6 on the tuning coil (Fig. 6). Oscillation should then be possible by sufficient advance of the reaction control at all positions over the tuning range of both wavebands.

Now reconnect R2 to grid cap of V1 and switch to gramophone. Set VR2 to about the middle of its range with a small screwdriver. If a medium-frequency loud howl is now heard with the radio-amplifier volume control at maximum, remove lead 1 from contact A of VR2 and connect it to contact B (Fig. 7). But if nothing, or only a very high-pitched whistle, was heard with

the volume control VR1 at maximum, then leave the lead 1 as it is.

Now, leaving VR1 at full volume, turn VR2 fully anticlockwise (or fully clockwise if lead 1 had to be altered). Then slowly advance VR2 until a high-pitched whistle just starts. Then turn it back about 30 degrees past the point where the whistle stops. The negative feedback is now correctly set up.

The Record Player

The exact design and layout of the record player, on the mechanical side, is largely a question of carpentry and, apart from the points discussed below, can be executed according to individual taste. A suggested overall appearance is shown in Fig. 9, this being that adopted in the author's equipment.

The position of the pickup foot in relation to the centre spindle of the turntable is a critical matter, and some care paid to it will be amply rewarded. If the pickup foot is incorrectly positioned, we get what is called "tracking distortion," which has the following characteristics. Reproduction tends to be more or less normal on the outer grooves at the start of a record, and then progressively deteriorates towards the centre of the record. High notes especially are affected, becoming woolly and muffled, giving a rasping noise getting worse and worse as the end of the side is approached.

In the absence of specific instructions from the makers, the following procedure should be used for positioning a loose pickup in relation to the turntable (see Fig. 7). It will be noticed that the only critical distance is that from the exact centre of the turntable spindle to the exact centre of the swivel-pivot about which the pickup turns in the horizontal plane. This swivel-pivot usually coincides with the centre of the foot, but should it not be found to do so, appropriate correction must be made.

Measure the distance from the swivel-pivot to

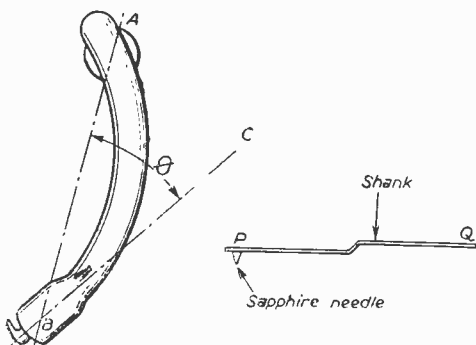

Fig. 7.—The pickup mounting is critical, see details on the right.

the needle-tip, to the nearest twentieth of an inch. Call this L inches. The best way to do this is to hold the pickup horizontally over a piece of drawing paper and make small dots exactly below the swivel-pivot (A) and the needle-tip (B).

Next, without moving the pickup after the previous stage, draw a line BC through B parallel to the shank, PQ, of the needle.

Finally, it is necessary to adjust the counterbalance device in order to obtain correct stylus pressure on the record. The adjustment is usually some form of spring tensioning device underneath the pickup near the foot. Or it may be a sliding weight. If no device at all is found, yet the stylus pressure does not check correct, suitable pieces of lead foil will have to be attached.

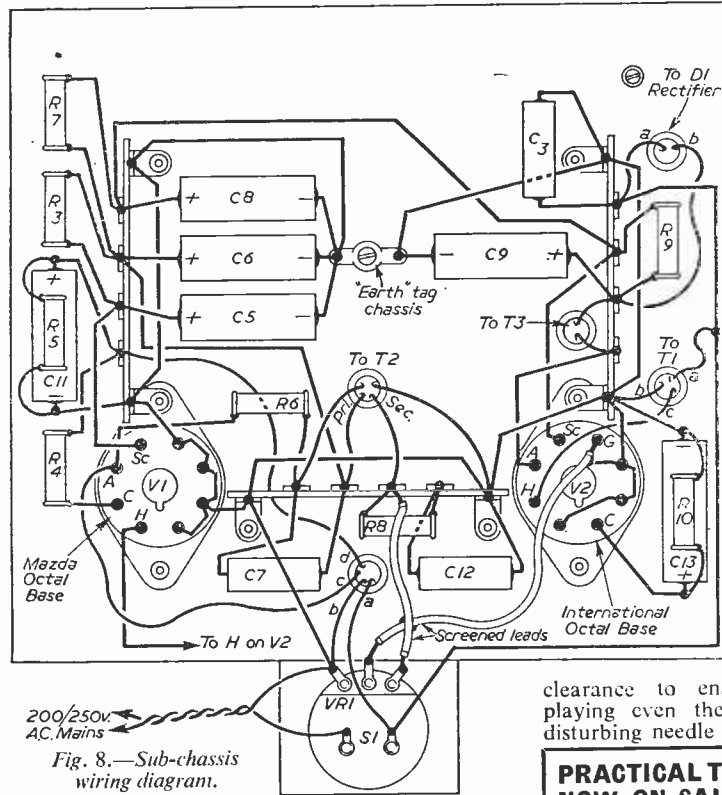

Fig. 8.—Sub-chassis wiring diagram.

Measure the angle ABC (θ) in degrees as accurately as possible by means of a protractor on the drawing paper.

Then: Required distance from turntable spindle centre = $(L - 0.021\theta)$ inches
to swivel-pivot = R inches

Assuming that the swivel-pivot coincides with the centre of the foot, the latter may now be placed anywhere on the circumference of a circle of radius R inches centred on the turntable spindle axis.

The second point to take care of is the height of the pickup in relation to the turntable. If a pickup and motor unit are purchased as a matched kit this point will most likely have been catered for during manufacture, so that the correct level is obtained simply by fixing the motor unit and pickup foot on a level board by means of the existing screw-holes or other attachment devices. However, if a pickup and motor unit are purchased separately, one or the other must be raised on its fixing device until the pickup arm runs true horizontal whilst playing a record.

Obtain a calibrated depression-type letter balance, as sensitive as possible. Prop up the record player and the balance on suitable books until, upon swinging out the pickup arm, the needle just touches the pan when the arm is horizontal. Adjust the counterbalance step by step until the balance registers between 6 and 8 grammes when the needle is gently rested on the pan. If the pressure is too small (below 6 grammes), the needle is liable to jump grooves on loud recordings; whilst if the pressure is too high (over 8 grammes) unnecessary record and needle wear result.

To avoid introducing motor rumble, the motor unit and the pickup should be attached to the board by resilient rubber or spring mountings.

When making the record player case, allow sufficient clearance to enable the lid to close whilst playing even the largest records. This avoids disturbing needle chatter noises.

PRACTICAL TELEVISION MARCH ISSUE NOW ON SALE PRICE 1s. 3d.

The really keen amateur prefers to make all his own parts so far as possible, although there are a number of items in the modern television receiver which are, perhaps, beyond the scope of the amateur. Scanning coils, for instance, are often regarded as the type of component which should be purchased, but it is possible to construct them at home, in a design which will give the highest performance. This is the main feature of this month's issue of our companion paper, PRACTICAL TELEVISION, and in addition to telling you exactly how to make them we have described in past issues suitable frame and line transformers to work with them.

Instructions for fitting Multi-tuners to standard one-channel sets is another important feature in this issue, whilst other articles deal with Scanning & Synchronisation, Servicing the G.E.C. 6145/6541, Coaxial Cable Hints, A Remote Control Unit, Linearity Faults, and the usual features.

LASKY'S RADIO

BARGAIN OFFER OF POCKET VOLT TEST METERS

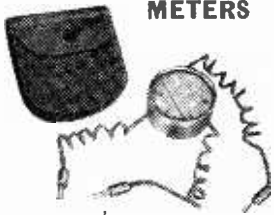

Two ranges, D.C. 0-250 v. and 0-25 v. Complete with leads in leather case. LASKY'S PRICE 12/6 Post free. Few only left. Send NOW.

4-SPEED SINGLE PLAYER BARGAIN

COLLARO "JUNIOR" 4-spd. motor and pick-up with HGP39 cartridge. 92/6 Post 3/6. Motor only, 59/6. Post 2/6. Pick-up only, 33/6. Post 2/6.

TRANSISTORS

Hermetically sealed and unaffected by temperature variations. Tested and guaranteed efficient.

R.F. P.N.P. Junction Type, suitable for medium and low freq. oscillators, freq. changers and I.F. amplifiers 21/- (1.5 to 8 Mc/S).

(Double spot—yellow and red.)

AUDIO P.N.P. Junction Type, suitable for high gain and low freq. amplifiers, and for output stages up to 250 10/- milliwatts.

(Double spot—yellow and green.)

Post free.

Full operating data and circuit diagrams for receivers, oscillators, amplifiers, etc., supplied.

TRANSISTOR AMPLIFIER KIT

200 milliwatts. Output impedance 5 ohms. Operates from 6 v. battery. Miniature size: 3 1/2 in. x 3 1/2 in. height can be under 1 in. COMPLETE KIT including 4 Transistors, PRINTED CIRCUIT, full instructions. 79/6 Post 3/6. Full details on request.

TRANSISTOR S/HET TUNER

For construction on Printed Circuit. Uses 3 R.F. Transistors, 1 germanium diode, 3 I.F. transformers, Ferrite rod aerial. Operates from 6 v. battery and 1.5 v. cell. Size of Printed Circuit, 3 1/2 in. x 3 1/2 in.

CAN BE BUILT FOR 15/12/9 Post 3/6.

Full details on request.

Demonstrations at both addresses.

LASKY'S (HARROW ROAD) LTD.

42, TOTTENHAM COURT ROAD, W.1.
370, HARROW ROAD, PADDINGTON, W.9.

Telephone: MUSEum 2605.

LAD 4075 and CUN 1979.

Open all day SATURDAY. Half-day Thursday.

PLEASE ADDRESS ALL MAIL ORDERS TO HARROW ROAD.

MINIATURE MOTORS

Will work on any voltage from 6 to 12. Complete with gearbox. Overall size 2 1/2 in. long x 1 1/2 in. x 1 in. Ideal for model remote control, etc. Original cost over £2.

LASKY'S PRICE 12/6 Post 1/6.

RADIOGRAM CHASSIS

Large selection—Dulci, Armstrong, Imperial, etc.

AM..... from 7 guineas
AM FM..... from 14 guineas



COLLARO

4-SPEED MIXER AUTO-CHANGER

Latest model RC.456 incorporating auto and manual control enabling records to be played singly or automatically. Complete with Studio crystal p.u. and sapphire stylus. List 13/17/-

LASKY'S PRICE 18/19/6

Post 3/-

ELECTRIC PAINT SPRAYER

New model for up and down spraying of all painting jobs in & out-doors, 3-down only units. Price of 9/6 or Cash Price Reduction Offer at 67/6.



.001-1" MICROMETER

Invaluable to engineers, apprentices, model makers, Precision Instrument for Schools, Garages, Work shops, Students, Handymen, Engineers. Valuable Micrometer Bargain. 2 in. Model 143.

This New Blowlamp

Post 9d. is 5 1/2 in. high, weighs only 7 ozs. and is sturdily made from solid brass tube. No working parts to go wrong. Ideal for tinning and sweating, silver soldering, glass bending and drawing. Uses methyated spirits only. 14/7

MAJOR Model 6 times stronger Flame, 30/-

Chass's Cutters with Keys

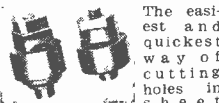

The easiest and quickest way of cutting holes in sheet metal. The cutter consists of three parts: a die, a punch and an Allen screw. The operation is quite simple. Prices incl. key: Size in. 13/9; 3/4 in. 14/9; 1 in. 14/-; 1 1/4 in. 17/6; 1 1/2 in. 18/-; 1 3/4 in. 19/6; 2 in. 22/-; 2 3/4 in. 25/9; 3 in. 29/-; 4 in. 35/9; 5 in. 40/9; 6 in. sq. hole. 27/- Post 1/-

All prices are with keys

PIFCO

All-in-one Radiometer A.C./D.C.

- ★ Circuit Test.
- ★ I.T. and H.T. Tests.
- ★ mA, Test.
- ★ Valve Test.

Continuity and Resistance Tests. Complete with Test Leads. Post 1/- Guaranteed 32/6



SERVICE SHEETS

The one you require enclosed if available in a dozen assorted of our best choice 10/6

O1A	1/-	12SF5	5/-
OZ4	5/-	12SH7	6/-
1B4	2/-	12SJ7	6/-
1B5	3/-	12SK7	6/-
D8	10/-	12TL7	6/-
1E5	5/-	12Z5	11/-
1F1	5/-	13SPA	8/-
1F5	5/-	14B3	8/-
1F6	5/-	17	7/-
1G4	7/6	18	7/-
1H4	5	23	12/-
1H6	5/-	31	2/-
1J6	5/-	32	3/-
1LN5	3/-	34	2/-
2A3	10/-	35L5	10/-
2A6	2/-	43	12/-
2A7	2/-	45	10/-
2D4A	8/-	46	8/-
2D4B	7/-	50Y6	6/-
6A6	6/-	57	8/-
6AC5	7/-	58	4/-
6AC5	6/-	75	15/-
6AG7	15/-	81	8/-
6AK5	8/-	240QP	8/-
6AK6	7/-	954	3/-
6AK7	15/-	956	2/-
6AQ5	10/-	1290A	5/-
6C4	6/-	1904	1/-
6C8	9/-	2351	15/-
6F5	5/-	9001	5/-
6F32	6/-	9074	6/-
6F33	7/-	9003	6/-
6H6	2/-	KT241	6/-
6N7	7/-	LP220	5/-
6SK7	6/-	MSPEN	EL2
7B8	5/-	4-	EL50
7V7	5/-	NSP1	15/-
8D2	8/-	O1A	1/-
12A	1-	H83	5/-
12A6	7/-	OZ4	5/-
12AH7	10/-	PD223	11/-
12AT7	9/-	PENDD	HP21C
12H3	4/-	2330	10/-
12J5	6/-	QP233	5/-
12SC7	10/-	R1	9/-

RADIO BULLS VALVES

246, HIGH ST. HARLESDEN ROAD

DEMOBBED VALVES MANUAL 2/6

Giveing equivalents of British and American Service and Cross Reference of Commercial Types with an Appendix of B.V.A. Equivalents, and Comprehensive Price List. We have still some Valves left at very old Budget Rates (33 1/2%) which are actually sold at the old price (1951).

Also ready our new comprehensive BVA List.

SALE

of VALVES both RADIO and TV Types.

As listed on left

From 1/- to 15/-

METAL RECTIFIERS

Westinghouse					
18RA	1-1	8-1	4 6	14A8	20 9
18RA	1	16	1 6 9	14A9	23 10
16R	1-1	16	1 9 7	14A10	26 1
14RA	1-2	8	2 20 9	14A12	28 4
14RA	1-2	8	2 28 5	14B13	33 9
16RE	2-1	8	1 9 7	14V7	24 10
18RA	1-2	8	1 12 4	14V9	28 9
				WX6	3 11



TRANSISTORS

in Practice

5.—R.F. AMPLIFICATION

By R. Hindle

(Continued from page 48, March issue)

IT was pointed out in a previous series dealing with valve amplifiers that there is no difference between the amplification of audio and radio frequencies if all the factors are taken into consideration. In practice, however, reactive effects, i.e., stray capacitance and inductance, are ignored when considering simple audio design, but most certainly have to be taken into consideration when working with radio frequencies because their effect is no longer negligible. This is equally true of transistors. These have been considered, quite conveniently but sufficiently accurately up to now, as being purely reactive at both input and output, giving exactly 180°

higher frequencies is indicated by the parameter called the "alpha cut-off" and designated by the symbol f_a . This is the frequency at which the current amplification factor falls by 3db, compared with the low frequency amplification factor a , not the frequency at which it stops amplifying in spite of its name. The word "cut-off" should not be taken too literally. This particular way of specifying the upper frequency is adopted to make the life of the mathematician as easy as possible—we ordinary folk use it as a basis for comparing one transistor with another and it serves that purpose quite well.

The symbol f_a refers to the common base circuit; as usual a dash indicates a symbol referring to the common emitter circuit, so f^1_a is the alpha cut-off frequency using the common emitter circuit. Sometimes f^1_β is used—it means the same. f^1_a is lower than f_a , and the relationship is approximately $f^1_a \approx \frac{f_a}{a}$

in words, the cut-off frequency using a common emitter circuit is equal, or more or less, to the cut-off frequency base working (the figure usually quoted in transistor literature) divided by the current gain with common emitter circuit.

The transistors available until recently had a comparatively low f_a and attempts at R.F. amplification generally used the common base circuit. Though, under these circumstances, the current gain of the transistor itself is less than one, power gain was obtained by virtue of the higher output impedance, and transformer coupling gave, from emitter to emitter of two transistors, the current gain looked for. The higher gain claimed previously in audio cases for the common emitter circuit was lost at R.F. due to the low cut-off frequency of the earlier transistors and the lower input/output resistance ratio of the common emitter circuit made this circuit less effective.

The basic circuit of a transistor amplifier with two stage working with common base is given in Fig. 30(a). A step-down inter-transistor transformer is used to match the higher resistance output to the lower resistance input of the follow-

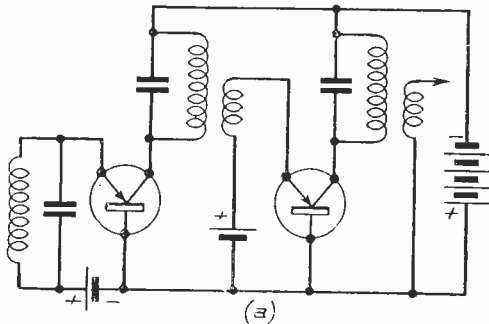
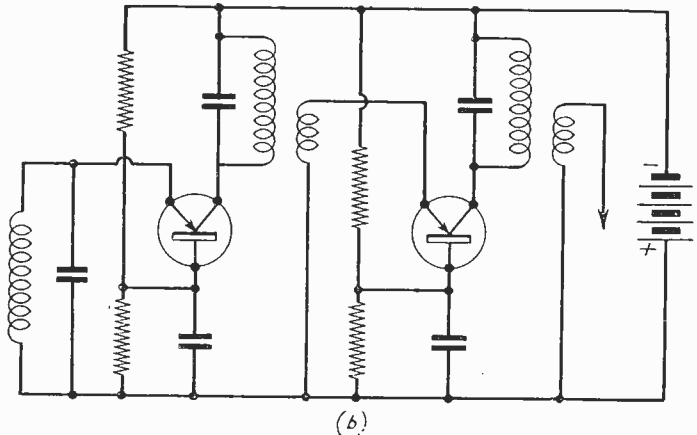

Fig. 30 (a—above, and b—below).—Basic circuit of the common-base R.F. amplifier.

phase shift or zero shift depending on whether the common base or common emitter circuit is used. At R.F., this is no longer a fair assumption. Transit time effects are present because of the sluggish passage of carriers across the base from emitter to collector. As with valves, this effect sets an upper limit to the frequency that can be effectively handled, and in the case of transistors commonly available at present that limiting frequency is lower than in the case of valves.

Cut-off Frequency

Transistors vary, of course, and their effectiveness at



ing transistor. The transistor output reactance is absorbed in the tuned circuit.

Separate emitter batteries would not be used in practice, and can be avoided by using base bias from a potentiometer as indicated in Fig. 30 (b).

The common emitter circuit is preferred at R.F. as at A.F. if the f_{α} of the transistor is suitable for the frequency to be worked. The cut-off frequency for common base operation, that is usually quoted in transistor data, should be ten times the frequency that it is intended to work in the common emitter circuit to get optimum gain and so, a R.F. amplifier intended to work on the medium waves with a common emitter circuit should preferably use a transistor with a cut-off at 10 Mc/s. Quite significant gain can be obtained with transistors of somewhat inferior frequency performance.

Feedback

It will be remembered that one of the characteristics of a transistor that is responsible for a complication in circuit technique is that the output circuit is directly coupled to the input circuit internal to the transistor and not isolated as in the case of a valve used in an audio circuit. But of course, the old hands will remember that input and output is far from being isolated when a triode valve is used for R.F. amplification. The transistor, or at least those now available, are triodes and the problem presented is much like the one involved in designing a triode valve R.F. amplifier. Subsequently valves with more electrodes were developed to avoid the coupling between anode and grid and similar developments are now taking place in the field of transistors. Sooner or later the tetrode transistors with means of accelerating the passage of current carriers and reduced coupling from output to input will be made available and these will operate at much higher frequencies than those now offered.

Meanwhile the triode type of transistor has to be used, and so we are just where we were when only triode valves were made. Experiences of those earlier days can be drawn upon for

the solution to the transistor problem now being contemplated.

The way out, for the benefit of those who have not experienced the earlier valve problems, is to neutralise the effect of unwanted feedback by providing a second feedback loop exactly like the unwanted one, but feeding it from a

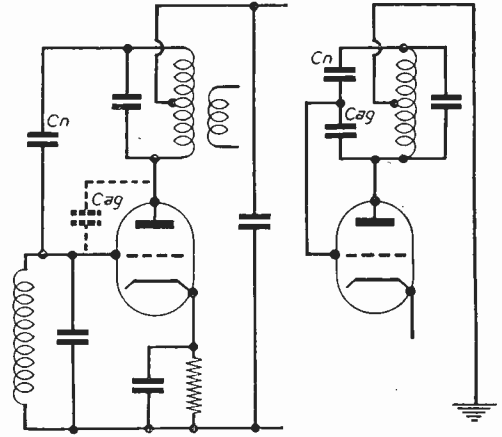

Fig. 32.—Triode valve neutralised R.F. amplifier. Fig. 33.—Neutralised R.F. amplifier. Circuit redrawn as bridge.

point where there is a signal 180° out of phase with that from which the spurious feedback arises.

There is no D.C. path from anode to grid of a triode valve and the feedback that takes place is via the anode to grid stray capacitance. This stray capacitance is represented in Fig. 32 by Cag, shown dotted. Normally the top of the anode tuned circuit goes to H.T. positive, but if, instead, the coil is centre-tapped and the centre-tap is connected to H.T. positive (which so far as signals are considered is equivalent to earth) as shown in this illustration, the valve is just as effectively fed with current but only a half of the signal across the tuned circuit is now fed on to the following circuit. A signal also exists between the centre-tap and the upper end of the tuned circuit and this is 180° out of phase with the anode signal. It is necessary, now, only to add to the circuit Cn in Fig. 32, which is made equal to Cag (in practice a variable is provided) to provide satisfactory neutralisation, the signal is fed back through Cn being equal and opposite to that via Cag, which is thereby cancelled out.

Maybe some readers will find it easier to think in terms of a bridge circuit, and so the circuit of Fig. 32 is redrawn in Fig. 33 to show the bridge effect more clearly.

(To be continued)

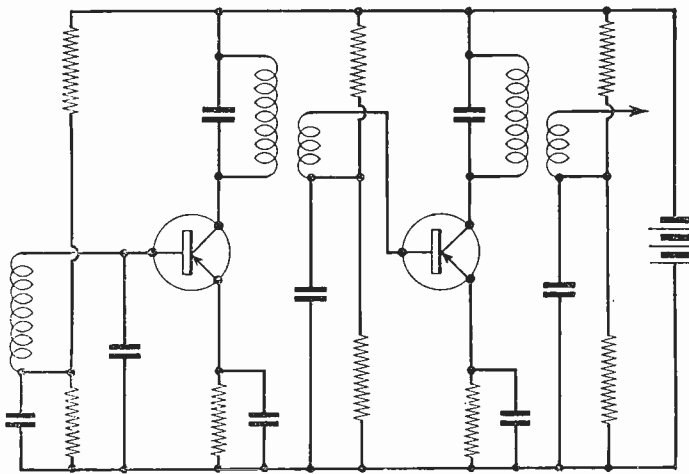

Fig. 31.—Basic circuit of common-emitter R.F. amplifier.

A Beginner's CONSTRUCTIONAL COURSE-III

A NEW SERIES WRITTEN ESPECIALLY FOR
THE AMATEUR

By E. V. King

1.-A 1-VALVE A.C. SET

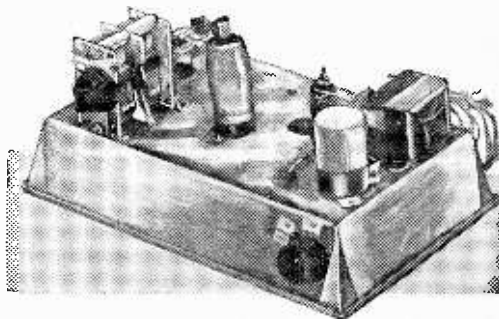

The Chassis

It is possible to build this receiver on quite a small chassis but the beginner must not do this as many mechanical and electrical difficulties are introduced. Soldering in small places can only be done after much practice and electrical feedback due to interaction of close components causes oscillations which it is difficult for the beginner to get rid of. The chassis thus measures approximately 10in. X 5½in. X 2in. high, the measurements are not important and can vary by about 10 per cent. either way without harm.

Making a chassis is not easy unless you have a well equipped workshop and so the author used baking tins from a popular store for the demonstration prototypes photographed with the series. Oil drum metal straightened, cleaned and aluminium painted makes a good chassis. aluminium, copper or tinplate can also be used. The baking tins used by the author were old ones so they were made to look better with aluminium paint, this is scraped away where tags connect to the chassis.

If you wish to make your own chassis the shape required is given in Fig. 1.

Cutting the Holes

The valve and condenser holes must be cut

THERE have been numerous requests for a course for beginners, and with this in mind the author set out to design a receiver in such a way that each stage could be built and got working before the next was attempted. The beginner often has limited finances and it was decided to build the receiver round three SP61 or SP41 valves, both of which are obtainable very cheaply. The total cost of the receiver when it is completed comes to a maximum of £2 10s. without the speaker, and many who go in for careful selective buying from advertisements in this magazine will cut down on that quite a lot.

The circuit used is a well tried 3-valve T.R.F. arrangement, but the practical wiring is arranged to give the beginner confidence in sorting out the various wires and parts. In some cases the experienced man may wonder why a certain thing has been done, i.e., it will be seen that H.T. is taken to pin 7 of each valve, this is not the easiest arrangement for one with experience, but it is for the beginner.

The prototype of the receiver, when completed received scores of continental stations on a short aerial at loudspeaker strength and the output, though not large, is ample for the ordinary living-room. A larger output stage will be detailed at the end of the course for those who wish to have a louder output.

Theoretical and Practical

The beginner is advised to use the theoretical circuits in conjunction with the practical layouts given. The author has made a complete circuit (for each section) with which the beginner should check his modifications for the month. This circuit has been purposely set out in a slightly different way from subsidiary circuits given earlier.

It is proposed firstly to make up an L.T. power unit, an H.T. power unit, and a one valve receiver for use with phones.

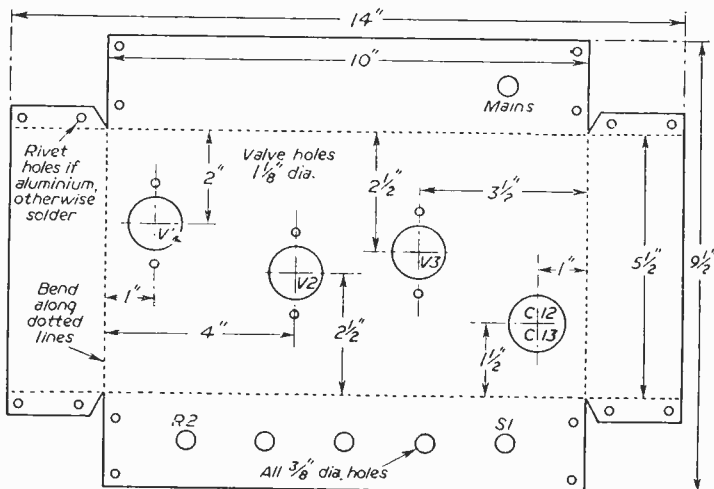
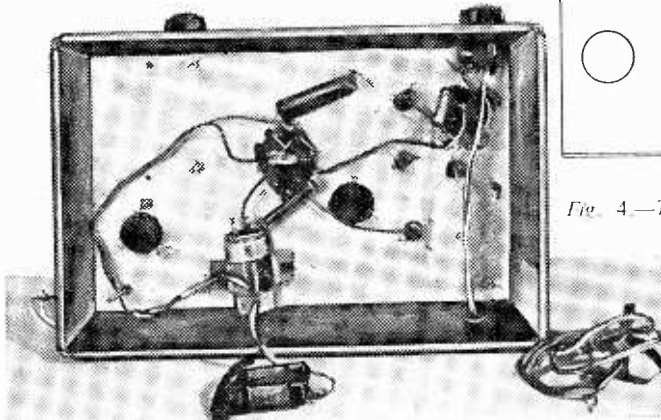

Fig. 1.—Details of the chassis. This may be made from tinplate, copper or aluminium. You can also make use of an ordinary baking tin.

out. There are various ways of doing this. Special valve hole cutters may be bought at radio dealers, or variable tank cutters may be purchased much more cheaply at an ironmongers or borrowed from a plumber. They need, however, to be used with great care or they will tear the tin and spoil the chassis. A quite satisfactory, though rather longer method, is to drill a series of $\frac{1}{16}$ in. holes round the edge of the one to be cut out, and the centre is then loosened either with small tinsnips or a chisel. The burred edges are then carefully filed with a fine mesh half round file. The holes are all to be exactly $\frac{1}{16}$ in. in dia., do not make the holes smaller in any event, and not larger by more than $\frac{1}{16}$ in. It is best, if making a chassis, to cut the holes out before bending the metal to shape.

When the holes have been cut out hammer the metal chassis flat on a smooth surface.

A top view of the chassis with approximate dimensions to centres is given in Fig. 1 and Fig. 2a, a front view in Fig. 2b.



Under side view of Stage 1.

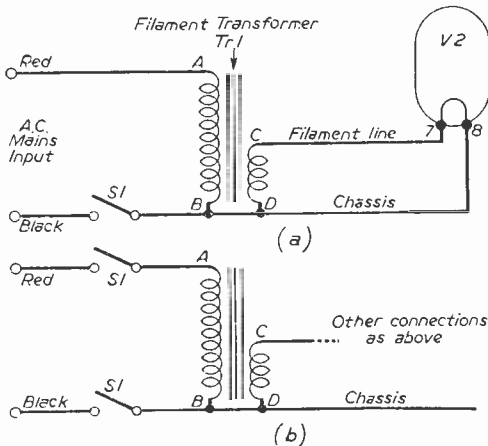

Fig. 3.—Details of the heater circuit.

The L.T. Power Unit (Filament Supply)

Since the receiver requires 4 or 6.3 volts to

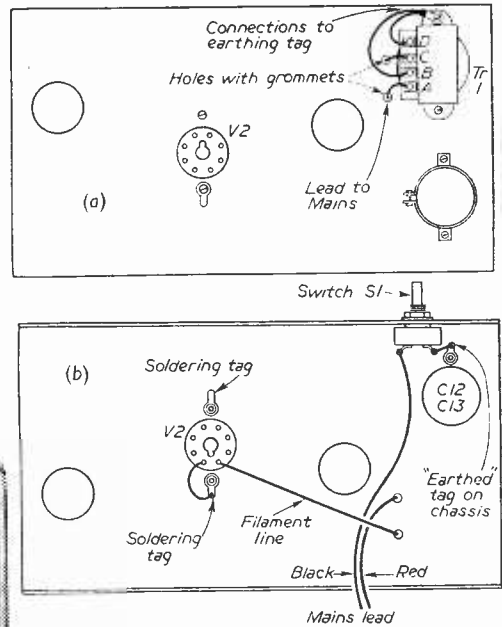

Fig. 4—Top and underside views of the heater circuit.

light the valve filaments, the available mains voltage has to be reduced by a suitable transformer and an on/off switch incorporated.

The L.T. supply shown in Figs. 3 and 4 uses a transformer TR1 for filament supplies. The beginner may use either SP41 or SP61 valves. The following points may

LIST OF COMPONENTS

Components used for first stage (their function will be explained in the next issue.)

- Baking tin or chassis.
- Grommets.
- Nuts, bolts, soldering tags, push back insulated wire, solder, flux, etc.
- V2—SP41 (VR65A) or SP61 (VR65).
- Mazda Octal valve base and top cap connector.
- MR1—Metal Rectifier, any type rated at 240 v. and 30 mA or more.
- C1—500 pF ceramic or mica, 500 v. working.
- C7—100 pF ceramic or mica 300 v. working.
- C10—.1 μ F paper 350 v. working.
- C15—100 μ F mica or ceramic 500 v. working.
- C9—One half of a double electrolytic condenser, 8-8 μ F, 350 v. working.
- C12 and 13—Another double electrolytic, 16-16 or 32-32 μ F 350 v. working.
- R4—1 Megohm $\frac{1}{2}$ watt. (Brown, Black, Green.)
- R7— ditto. ditto.

enable him to decide which to buy. SP41 valves require 4 volts and SP61 require 6.3 volts for the heaters. A six volt filament transformer is more likely to be useful to the experimenter if he ever strips this receiver to make another. SP41 valves are just as good as SP61's but are somewhat cheaper. It is quite possible to use a standard speaker transformer for lighting the 4 volt filaments if you have 240v. A.C. mains. Suitable transformers are obtainable from an advertiser at Is. 9d. These were used on the prototypes shown.

Fix your transformer, valve-holder and rotary (not toggle) on/off switch as shown in Figs. 2a and 2b and Fig. 4.

If you are not sure about the connections to the tags on the transformer use a torch battery and flash lamp bulb as shown in Fig. 5, noting that when tags are found which will light the

lamp, then those tags are the filament connections. It does not matter which way round each pair are connected.

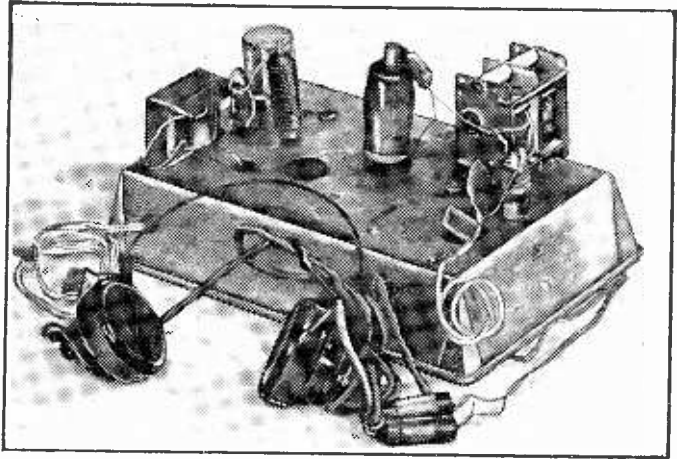

A general view of the finished Stage 1.

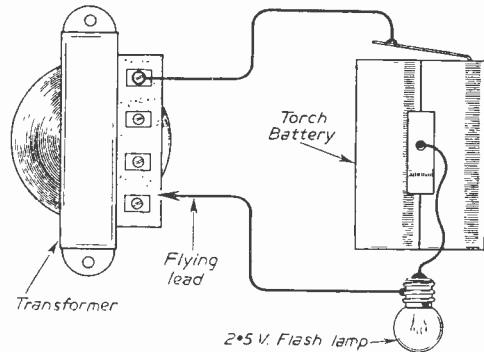

Fig. 5.—How to check an unmarked transformer.

Fix the valve base under the chassis with the locating lug to the rear when viewed from underneath (Fig. 4 (a and b)). If your holders are paxolin make sure that they are mounted so that the valve pins, when inserted, do not short to chassis. Fix soldering tags (home-made ones of cocoa tin metal will do) with the nuts and bolts fixing each valveholder. Only one holder need be purchased and fitted this month. Note that the base is known as a Mazda Octal and is quite different in size from the International Octal. Do not try and force the valve in if you have the wrong base. If the holders are old surplus stock scrape them clean in the sockets and on the soldering tags.

Wiring the L.T. Supply

Here is a suggested plan for the beginner to

COMPONENTS

- R8—470k $\frac{1}{2}$ watt. (Yellow, Violet, Yellow.)
- R6—10k $\frac{1}{2}$ watt. (Brown, Black, Orange.)
- R11—3k 3 watt. (Orange Black, Red or printed letters.)
- TR1—Filament transformer or output transformer used as such. See Text. 240-200 v. to 4 or 6.3 volts.
- L1—Wearite PA2 coil.
- S1—Single-pole single-way rotary switch with insulated knob.
- C5 and C6—Double variable 500 pF condenser fitted with trimmers and a tuning knob (large one or slow motion drive).
- Phones fitted with two .05 μ F 500 v. condensers as stated in text.

(Note.—The beginner may always use condensers of higher rated voltage than stated and resistors of higher wattage provided there is room for them in the receiver.)

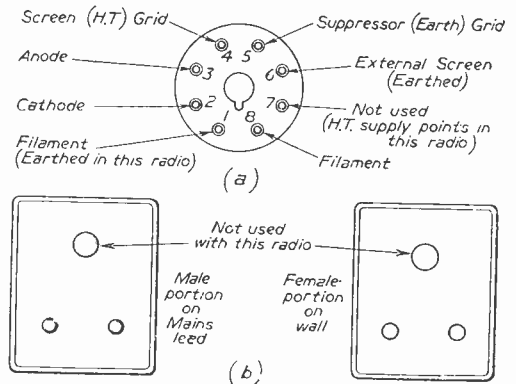

Fig. 6.—The top illustration shows the valve base identification, and the lower illustration gives the standard mains 3-pin plug details.

follow. Take the twin mains lead through a hole in the back using a grommet to avoid the wire insulation cutting and shorting to chassis and connect the black wire to one tag of the on/off switch S1, Figs. 3 and 4. Take the red lead through another grommet to the top of the chassis and solder it to one mains tag of the filament transformer. Join the other mains tag of the transformer to earth i.e., to chassis, using a soldering tag where the bolt holds the transformer in position (Fig. 4a). Earth also one of the filament tags or wires. Join the other tag of the switch to chassis again using a tag. Now take a coloured wire to take the filament current and connect it to the other filament wire or tag on the transformer, feed it through a grommet to pin 8 on V2 (Fig. 4b). Join pin 1 V2 to earth by a tag mounted with the holder. The L.T. circuit is now complete for our one-valver.

The following points may be helpful for the beginner:

1. The bases are numbered as shown in Fig. 6 when viewed from underneath in a clockwise direction starting at the lug. In his early days the author built a similar receiver and made the common learner's error and viewed them from on top.

2. The mains switch must be a type which uses an insulated knob or there is a danger of shock if the unit is incorrectly connected to the mains. A two-pole type could be used, the other two contacts being inserted in the lead going to TR1 (see Fig. 3b). If the cheaper single pole type is fitted a always disconnect from mains plug when working on the receiver.

3. Do not work on a mains receiver when standing on a garage, shed, concrete, or other damp floor. If you do your work in such a place use a good rubber mat in perfect condition. Do not work near water taps or other earthed objects. Provided the user is not himself wet he is not likely to do himself harm, but he certainly will drop a chassis or valve when 240v is applied to his body! Never touch a mains radio with wet hands or feet.

4. On this receiver if you connect the mains the wrong way round the chassis becomes live, so be sure to connect the lead going via S1 to chassis to the neutral or black wire and connect correctly to the 3-pin socket (Figs. 6a and 6b).

5. If in doubt connect a small mains lamp or

neon lamp between chassis and any earth (i.e., water pipe). If the lamp does not light all is well. If it does then the chassis is connected to the live side of the mains and the plug connections must be reversed.

Testing the Filament Circuit

Plug in the valve, locating the lug correctly and holding it by the bakelite portion. Connect

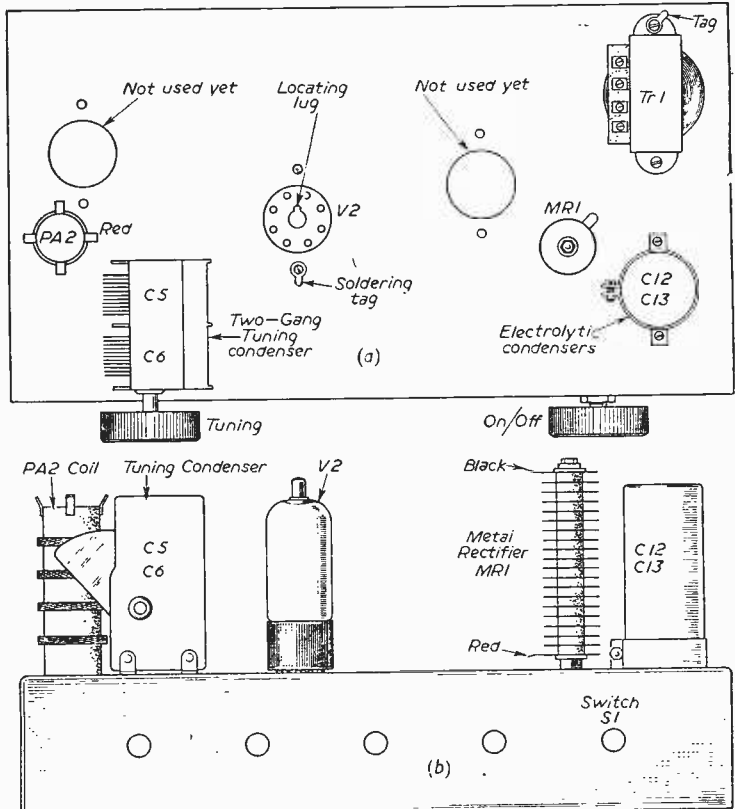

Fig. 2.—(a) above and (b) below. Top and front views of the receiver showing component positions.

the mains as detailed above. Switch on at the mains and set by means of S1. A slight hum will be heard coming from the transformer. If it is excessive it is probably not screwed down tightly but if it is getting very warm then you have caused a short by incorrect wiring and you will have to recheck. In 30 seconds V2 filament, viewed around the top cap, should be alight. Do not leave it on for longer than necessary.

Transformer Temperature Rise

The transformer should never get hotter than can be tolerated by the fingers, if it does and no short is present, then the transformer is not capable of supplying the current required, which this month is just under 1 amp. Do not proceed until you have this part of the circuit functioning perfectly.

The H.T. Power Unit

Here the mains is taken as an A.C. source at 200v to 250v and is rectified and smoothed to D.C. and then fed to each valve in turn. The theoretical circuit in Fig. 7 should be compared with the practical layout in Figs. 8a and 8b. The rectifier may be any metal type capable of having 240v across it and supplying 30 mA or over: it is mounted on one end and above the

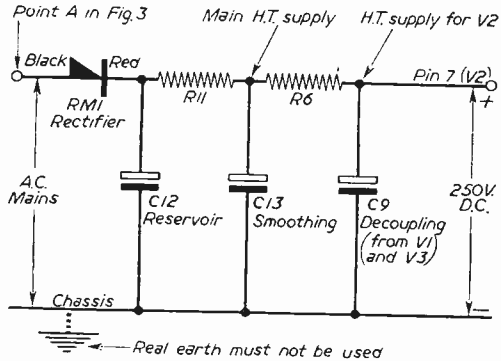

Fig. 7.—Circuit of the mains unit.

chassis to allow adequate cooling of its fins. Do not alter the tightness of the nuts which hold the rectifier together or it will be ruined. It is mounted with the black tag uppermost and the red tag adjacent to the chassis. C12 and C13 are the smoothing condensers made in one largish can. they are rated at 16 or 32 μ F and 350v working (or 450v for added safety). If you examine this can. you will notice three tags, one tag is common to both condensers and is usually coloured black. This has to be earthed to chassis. Sometimes there are only two tags in which case the can itself is the other connection and it must be so attached to the chassis that it makes a perfect connection. Often too. one of the condensers is able to take more A.C. (ripple) than the other, this is noted on the case, is usually coloured red. and should be used for C12. The smoothing resistor R11 is of large wattage and is rated at 300 ohms (sometimes written 3k) and 3 watts or over. It gets quite hot in operation and is mounted directly on to the tags of C12 and C13 with leads at least one inch long at each end. It is suspended "in air" and care should be exercised so that no wires go near to it or they may have their insulation burnt off.

In this stage we are only concerned with V2 so the output from R11 is fed through a decoupling resistor R6 (this is very necessary when more stages are added) to one tag of another double electrolytic condenser C9 (the other half. C8 is not used yet). The remarks given about the other double electrolytic apply here too: no ripple is present however.

Electrolytic condensers must be new. they will not keep on the shelf indefinitely but keep better when in use. If they are connected the wrong way round (or the rectifier is the wrong way round) they are ruined beyond repair.

Wiring the H.T. Supply

Here is a suggested plan for the beginner to

follow. Study Tr1 and you will notice that one mains tag is earthed. the other goes to the mains (red) lead. take a short wire from this tag and solder it on to the black tag of the metal rectifier MR1. Do not overheat the rectifier in so doing. Now take a lead from the red tag of MR1 through a grommet to the positive tag of C12. Prepare R11 and solder in position between C12 and C13. Now take a lead from C13 to pin 7 on V2 base. fixing to this tag one end of R6. The other end of R6 is then connected to tag of C9. Remember to earth the black tag of the two electrolytics if necessary as already detailed. The junction of R6 and C9 is the feed point for the valve we are using at this stage.

Testing the H.T. Supply

Plug in. switch on at mains and by S1. Observe that no resistors get hot (there is no load on them yet). If they do then there is a short circuit. a condenser is faulty or the rectifier is not doing its job. After one minute switch off. Unplug from mains. Hold an insulated screwdriver in such a way that it shorts junction of R6 and C9 to chassis. A big fat blue spark should jump across. Always discharge electrolytics in this way when servicing the receiver. If you wish to play safe you may wire a 1k $\frac{1}{4}$ watt resistor in one of the leads to RM1. this resistor

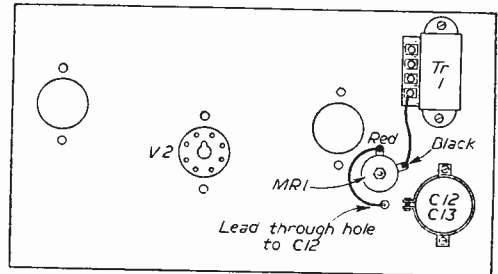

(a)

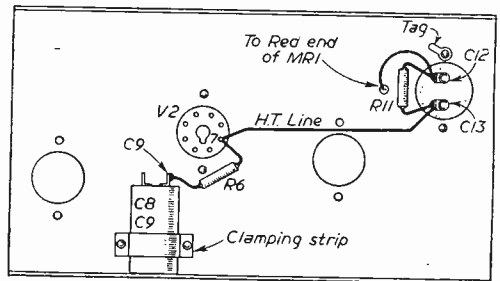

(b)

Fig. 8.—Additional wiring to complete the H.T. circuit of Fig. 7.

will act as a fuse and burn out if you have made an error in the wiring. This resistor is much cheaper than another RM1. If you are lucky enough to have a meter check between chassis (negative) and junction R6 and C9, it should be about 300 volts since no load is being applied. Do not proceed with the radio until this circuit is in order.

(To be continued)

The Application of Rectifiers

METAL RECTIFIERS MAY BE USED FOR A VARIETY OF PURPOSES AS EXPLAINED HERE

By "Serviceman"

ANY device which enables an electrical current to pass more readily in one direction than in another can act as a rectifier, and modern metal rectifiers are among the most robust and convenient units of this kind. They have a very wide field of application, and suitable circuits can usually be connected up without any undue difficulty. They may be used with models, or in plating, charging and spark-suppression circuits, as will become apparent when their application is considered in detail, and usually have very long and useful lives.

The ratings of such rectifiers should first be considered, and are expressed in terms of the maximum voltage and current they can safely handle. For example, a 12v. 2 amp rectifier would have a maximum current rating of 2 amps, and could be used in a circuit where the voltage does not exceed 12. It would also be suitable for use on any lower voltage or current, and this fact considerably increases the usefulness of any rectifier obtained. When a rectifier is operated at or near its maximum ratings, reasonable ventilation should be allowed and the fins should preferably be situated vertically. With lower ratings, heating may be extremely slight and ventilation is less important. A number of holes should, however, be drilled in any type of case containing a rectifier and its associated components, unless operation will be for short periods only.

Such rectifiers consist of specially prepared metal plates or discs usually secured together by a long bolt or threaded rod, and in no circumstance should they be dismantled. They are available in half-wave, full-wave and bridge types, and this should always be kept in mind when a

rectifier is to be purchased for any particular circuit.

A half-wave rectifier has two tags only and is shown at "A" in Fig. 1. It allows current to flow in one direction, but not in the reverse direction. When alternating current is applied to it, as with the transformer secondary illustrated, a pulsating direct current flows in the external circuit. This form of rectification is suitable for many purposes, but full-wave rectification has the advantage that both positive and negative pulsations of the A.C. supply are used. The type of rectifier shown at "B" uses a centre-tapped transformer, and has three tags. For a given output voltage, the transformer secondary will have to be of twice the voltage rating of the secondaries in "A" or "C." The last type of rectifier shown at "C," is often most convenient, for full-wave use, for this reason. For given outputs "A" or "C" could use a secondary of, say, 12v. rating, "B" would require a 12-0-12v. secondary, the "0" being, in effect, a centre-tap on a winding delivering 24v. in all.

Before considering actual working circuits, the output voltage desired from any piece of equipment using a rectifier should be considered. Some voltage drop arises in a rectifier, according to its type and loading. If charging is in view, it should also be remembered that a normal 2v cell rises to 2.8v on charge. Because of these factors, allowance must be made for possible voltage drop. To avoid insufficient output, the transformer secondary should provide up to 50 per cent. more voltage than will be required, or 100 per cent. when low voltage charging is in view. Should the voltage eventually prove a trifle high, a wire-wound resistor will drop it to the required level. On the other hand, if insufficient output is encountered, no simple way of increasing it exists. For example, a 6v transformer and 6v rectifier would be quite inadequate for charging a 6v. accumulator. When

(Continued on page 129)

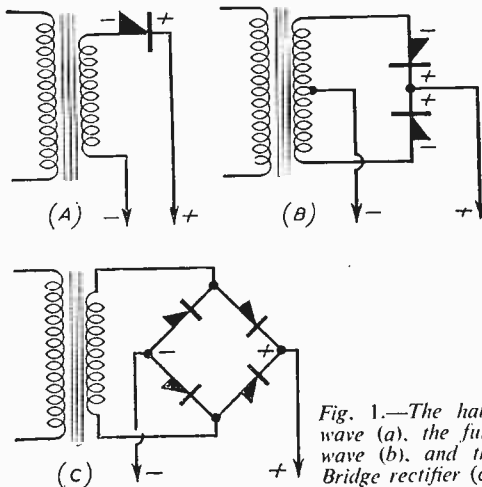

Fig. 1.—The half-wave (a), the full-wave (b), and the Bridge rectifier (c).

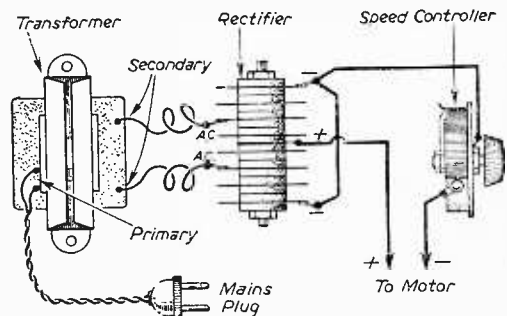

Fig. 2.—Operating a D.C. type motor.

RETURN-OF-POST SERVICE

JASON FM TUNER KIT

We can wholeheartedly recommend this tuner as being one of the most satisfactory of all the FM Kits. Construction is easy and results first class. Our Kit is really complete, the Instruction Book, all components, valves and small items such as wire, nuts, bolts and solder being included. Definitely nothing else to buy.

COMPLETE KIT, £6.19.6. Post free. Credit Terms. Deposit 19/6 and seven monthly payments of £1.0.0. All parts are available separately and our fully detailed list is available free upon request. Instruction Book can be supplied for 2/- plus 3d. postage.

MICROPHONES

ACOS—All crystal.

- MIC35. Hand. 25/-.
- MIC36. Table. With stand and switch. 68/-.
- MIC22. Ball type with table stand. 84/-.
- MIC39. Latest "Stick" type. Table stand also included £5.5.0.

COLLARO

Studio. Hand. Crystal. 45/-.

CADENZA

Fine Ribbon microphone with table stand in presentation case. A mu-metal shielded transformer is built into the base. High impedance. £10.10.0.

LUSTRAPHONE

Ribbonette. Latest ribbon type. Complete with table stand. High impedance. 17.17.6.

LOUD SPEAKERS

GOODMANS

- Axlom 150 12". 15 ohm. £11.5.9.
- Audion 60 12". 15 ohm. £9.12.9.
- Axlette 4" 3 or 15 ohm. £6.18.6.
- Tretax Tweeter. £6.4.0.
- Cross-over Unit N5500 for Tretax. 39/-.
- ARU 172. Acoustical resistance Unit. 55/3.

WIARFEDALE

- GOLDEN FSB 10". 15 ohm. £8.14.11.
- BRONZE FSB 10". 3 or 15 ohm. £5.11.3.
- SUPER 3". Tweeter. £6.19.11.

GEC

- Metal Corp. £9.5.0.
- Presence Unit for Metal Cone speaker. 79/6.

WHITELEY

- HF1012 10". Universal speech coil. 99/6.
- HF816 8". " " " " £6.17.0.
- HF812 8". " " " " 83/6.
- HF811 8". 3 ohm or 15 ohm. 62/-.
- T816. Cone Tweeter. 8". 15 ohm. £6.10.0.
- T10. Tweeter. 15 ohms. 64/-.
- Cross-over Unit CX3000 for T10. 30/-.
- Cross-over Unit CX1500 for T816 36/6.

ELAC

- Elliptical 9" x 5". Hi-Fi Series. 28/2.
- Elliptical 7" x 4". Hi-Fiux. 25/-.
- Square 3 1/2". 25/-.
- Tweeter 4" square. 29 10.

NEW MULLARD 2 VALVE PRE-AMP

Constructional details for this appear in the March issue of Radio Constructor. We can supply all items, write for list.

CREDIT TERMS

Any of the above items can be supplied on Credit Terms. Details are as follows:—

SEVEN MONTHLY PAYMENTS. Deposit 3/- in the £ and balance plus a small service charge (10% of balance, but minimum charge 1/-) payable in seven monthly payments.

THREE MONTHLY PAYMENTS. Deposit 6/- in the £ and balance plus a small service charge (5% of balance, but minimum charge 10/-) payable in three monthly payments.

TERMS OF BUSINESS.—Cash with order or C.O.D. Postage extra under £3. We charge C.O.D. orders as follows. Up to £3, postage and C.O.D. fee, minimum 2/8. Over £3 and under £5, C.O.D. fee only 1/6. Over £5 no charge.

MULLARD TAPE AMPLIFIER TYPE "C"

THE MULLARD TAPE AMPLIFIER TYPE C is a new version of the Type B Amplifier. It comprises a recording amplifier and a play-back Pre-amplifier, and is intended to use an existing amplifier for play-back. It uses a Ferroxcube Inductor in the treble boost circuit and has a switch for the speed equalising circuits in place of the plug-in unit on the Type B Amplifier. The circuit gives details for use with Brenell, Collaro, Tuxox and Lane Tape Decks.

INSTRUCTION MANUAL is available from us free of charge. Please send 4d. in stamps to cover cost of postage. **COMPLETE KIT** containing all components, valves and sundries kit.

KIT A.—With alternative valves. £14.0.0.

KIT B.—With Mullard valves. £15.15.0.

All items available separately. Detailed list free.

POWER PACK KIT. £4.0.0. Items available separately. Send for list.

CREDIT TERMS.—**KIT A.** Deposit £2.1.6 and seven monthly payments of £1.17.6. **KIT B.** Deposit £2.7.0 and seven monthly payments of £2.2.0.

NEW JASON "MERCURY" FM SWITCHED TUNER KIT

This fine new switched tuner provides all three BBC programmes at the turn of a switch. The front end unit is supplied ready wired and tested. See our advertisement in December PRACTICAL WIRELESS or send for full details. Instruction book 2/3 post free.

COMPLETE KIT. £9.19.0 **POST FREE**

CREDIT TERMS. Deposit £1.10.0 and seven monthly payments of £1.7.0.

LATEST AVO TEST METERS

AVO METER MODEL 8 MARK II

The latest version of this finest of all test meters is now available from stock. 50 microamp movement (20,000 ohms per volt). Eight DC Voltage, Seven DC Current, Seven AC Voltage, Four AC Current and three ohms ranges. Fully detailed literature available free. Price £23.10.0. Credit Terms. Deposit £3.9.0 and seven monthly payments of £3.2.0. Leather carrying case, £3.0.0.

AVO MULTIMINOR

A new and very attractive pocket size instrument at a modest price. Movement is 100 microamps (10,000 ohms per volt). Six DC Voltage, Five AC Voltage, Five DC Current and two ohms ranges. Descriptive leaflet available free upon request.

Price £9.10.0 Credit Terms. Deposit £1.8.0 and seven monthly payments of £1.6.0. Leather carrying case, £2 6

MULLARD 510 and GEC 912 PLUS AMPLIFIERS
We carry full stocks for all versions of these popular Amplifiers and our price lists are available free.

TRANSISTORS

SURPLUS TYPES

Special offer of the famous Red Spot. 7/6 each. Four for 27/0. RF Junction Type. Freq. 100 Mc. 21/-.

AF Junction Type. Yellow/Green Spot. Pair in push-pull give 250 mW. 10/- each.

MULLARD TYPES

OC70, 21/- OC71, 24/- OC72 Matched Pairs, 60/-.

All transistors post free.

WATTS RADIO (MAIL ORDER) LTD.

54 CHURCH STREET, WEYBRIDGE, SURREY.

Telephone: Weybridge 4556

PLEASE NOTE. POSTAL BUSINESS ONLY FROM THIS ADDRESS.

HIGH GAIN BAND 3 T.V. CONVERTERS

NO ALTERATIONS REQUIRED TO YOUR SET

RETURN OF POST SERVICE. All new goods.

Posted orders to Camberley, please. All 3/- each extra post (4/- for 2), 2/- extra C.O.D. Following apply to all converters: full instructions supplied. Can be fitted in 10 mins.; free from drift: fitted with co-axial plug: fully wired ready for use: with power pack, including metal rectifier; double wound transformer: 2 valves: mains on-off switch: fine tuner; B.B.C. to I.T.A. at turn of switch: 12 months' guarantee (B.V.A. valves 90 days): Terms available, one-third down and balance plus 7/6 in four equal monthly payments; postage with first payment. **FOR ALL SETS EXCEPT PHILIPS WITH TWIN FEEDER.**

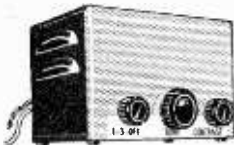

£4.7.6

ECC81 valves.
With metal cabinet as illustrated. Stove enamel grey hammer finish. 5in. x 7 1/2in. x 4 1/2in.

State local B.B.C. station. Walnut wood cabinet. £4/17/6. Chassis less cabinet. £3/17.6. Variable attenuator, 7/6 (1/- p. & p.). Aerial splitter, 8/- (1/- p. & p.). External crossover unit. 7/6 (post 1/6). Genuine low-loss co-axial, 8d. yd.

Postal charges in brackets.

Ex-U.S. Army Valves 6K6 GT/G 5/6 (9d.).
I.F. Transformers by Gorler AM/FM (10.7 Mc and 465 Kc), 15/- pair (1/-).
Screens for T.V. PERSPEX, tinted, 14in. x 11in., 5/- (2/-); White 14 1/2in. x 11in., 5 - (2/-); 17 1/2in. x 15in., 7/6 (2/6).
LAMINATED GLASS, tinted, 14 1/2in. x 11in., 5/- (3/-); 17in. x 13 1/2in., 7/6 (3/6).
Battery eliminator for 4 low consumption valves 90v. 15 ma. and 1.4v. 125 ma., 35 - (2/6). 200-250v. A.C. (Size 5 1/2in. x 3 1/2in. x 2in.).

13 CHANNEL CONVERTER

Switch positions, off-I.T.A.-B.B.C. Valves PCF80 and PCC84. Moulded cabinet 8 1/2in. x 4 1/2in. x 6in.



£5.5.0

Don't confuse with similar article being offered without power pack.

Robust Band 3 AERIALS. for 1in. to 2in. diam. mast or for loft. 3-element, 27 -; 5-element, 35/-; 9-element, 55 -; carr. pd. Belling-Lee 6-el., 37.6.

AUTOMATIC RECORD

CHANGERS are in short supply. Collaro RC457 Studio turnover crystal pick-up. 4-spezJ mixer. A.C. mains 200-250 v., see illus. ALSO Collaro single player AC3/554. 3-speed, turnover crystal, pick-up with "T" head. £6.16/6 (3/6 p. & p.).



£8/16/6 (5/- p. & p.)

GLADSTONE RADIO

82B, High Street, Camberley, Surrey. 3, Church Road, Redfield, Bristol.

Tel. 51207.

Taylor

POCKET SIZE UNIVERSAL METER MODEL 122A



Size: 4 1/2" x 3 1/2" x 1 1/2".
Weight: 14 oz.

A small 21-range instrument ideal for the enthusiastic amateur.

Sensitivity is 5,000 o.p.v. A.C. and D.C. Accuracy: 3% D.C. 4% A.C.
A high sensitivity moving coil centre pole type meter with 2 1/2" scale is fitted.

RANGES

Volts D.C.: 0-3-15-30-150-300-1,500.
Volts A.C.: 0-15-30-150-300-1,500.
Milliamperes D.C.: 0-15-30-150-300-1,500.
Amperes D.C.: 0-15. Resistance: 10 ohms-1 megohm.
Automatic overload protection fitted to meter movement.

PRICE: **£9.5.0** PROMPT DELIVERY

Or on Credit Sale Terms: 1st payment of £13.2 and 8 further monthly payments of £13.2.
ALL TAYLOR Instruments available on HIRE PURCHASE and 7 DAYS' APPROVAL.

Write for full details and Catalogue.

TAYLOR ELECTRICAL INSTRUMENTS LTD.

Montrose Avenue, Slough, Bucks

Telephone: Slough 21381—Cables: Taylins, Slough

REPANCO HIGH GAIN COILS

Dual Range Crystal Set Coil, Type DRX1	2/6
Dual Range Coil with Reaction, Type DRR2	4/-
Matched Pair Dual Range T.R.F. Coils, Type DRM3 pair	8/-
Pair Dual Range Superhet Coils, Type SH4, pair	8/-
Miniature Iron Dust Cored Coils, Type "R" —			
Range	Aerial	H.F. Osc.	
800-2,000m.	RA1	RHF1	RO1
190-550m.	RA2	RHF2	RO2
70-230m.	RA3	RHF3	RO3
15-50m.	RA4	RHF4	RO4
Ferrite Rod Aerial, Dual Range Type FR1	12/6
Miniature I.F. Transformers, Type MSE (465 Kc/s), pair	12/6
Standard I.F. Transformers, Type TCG (465 Kc/s), pair	13/6

EASY-TO-BUILD TRANSISTOR RECEIVERS

Repanco "Three Dee."—A new dual range radio with band pass tuning using a crystal diode and 3 transistors. Easy wiring plans and instructions. 1 - post free.

Repanco "Transveen."—Latest portable superhet 7 transistor receiver with preset tuning for 4 stations. Easy wiring plans and instructions. 1 9 (post free).

Repanco "Mini-7." The amazing new Pocket Transistor Radio. Size only 5 1/2in. x 3 1/2in. x 2 1/2in. A seven transistor Superhet circuit fully tunable over medium wave. Uses 3 White Spot and 4 Red Spot transistors. Attractively housed in a plastic case. Comprehensive plans and component price list 1 9 (post free).

RADIO EXPERIMENTAL PRODUCTS LTD.

33 MUCH PARK ST., COVENTRY

Tel. 62572.

the exact output required is not known, it is helpful to have a transformer with a number of tappings, so that various voltages may be chosen.

For Permanent-magnet Motors

Motors of this type are used in quite a number of models, especially trains, so that reversing is possible by changing the polarity of the supply. Motors with wound fields and armatures may be run from A.C., but this is not so with permanent-magnet motors, and a rectifier is required. One suitable circuit is shown in Fig. 2, though the other forms of rectification indicated in Fig. 1 may be used, if components for these are to hand.

With the type of rectifier shown, positive and negative tags are marked with red and black, or with the usual positive and negative signs. These must be observed in any circuit where the polarity of the output is important. The rectifier input

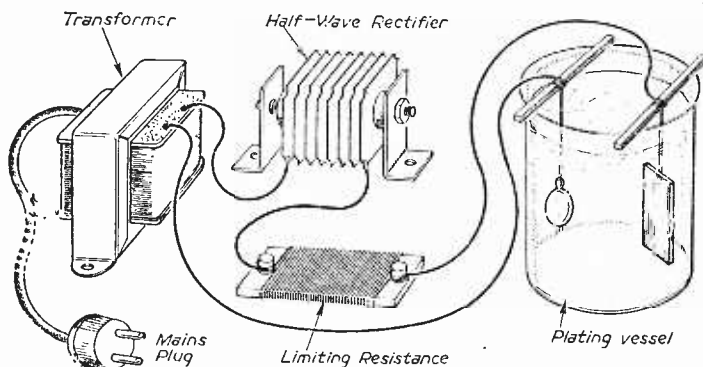

Fig. 3.—A simple circuit for electroplating.

tags are marked "A.C." in Fig. 2, and may be thus indicated on the rectifier; in other cases, green may be used, or a sign similar to the letter "S." The centre bolt is usually insulated from all the plates.

To avoid troublesome experiment in obtaining the exact output voltage required, a wire-bound resistor or speed controller can be added in one lead with advantage. For most purposes a value of about 0 to 5 ohms will be satisfactory. Or a controller may be constructed from spirals of resistance or iron wire fixed between studs or bolts contacted by a rotating arm.

If the transformer is sound, all secondary connections will be safe to handle. The primary connections, being at mains voltage, should be of good flex, with no bare joints, and a proper mains plug. If joints are necessary at the transformer, they should be adequately covered, or the components enclosed in a wooden box. As a further safeguard it is recommended that a fuse of low rating (about 1 amp) be included in each mains lead, and that the frame, core and secondary of the transformer be wired to earth on the mains plug. If this is done, any breakdown in the transformer insulation will cause the fuses to blow and the secondary circuit will not become alive at mains voltage. The usual 5, 13 or 15 amp house fuses are not adequate protection against this.

Plating and Charging

When electroplating objects where a fairly heavy current is required for a long period, batteries are not very satisfactory, and may be replaced by a transformer and rectifier, when A.C. mains are available. A simple circuit of this type is shown in Fig. 3, but full-wave rectification could be used. The rating of the transformer and rectifier will, of course, depend upon the type of plating and the current which must flow. A meter may be included in one lead to show the current flowing, just as with battery circuits.

A simple charging circuit is shown in Fig. 4. Here, again, a full-wave rectifier circuit can be used. A transformer with a tapped secondary is indicated, so that batteries of different voltages can be handled. The variable resistor also enables the output to be adjusted, and permits control of the charging rate. When first using this circuit, the lowest voltage tapping should be used and the resistor set at maximum value. If the charging current is too low, the resistor may be turned towards zero, or a tapping chosen which gives more voltage.

No current can flow unless an accumulator is actually connected. To guard against possible damage due to shorting of leads or connecting the battery in the wrong polarity, a fuse may be wired in series with the meter, or a fixed resistor of about 2 ohms may be included, to limit the current. The correct charging current is usually indicated on the accumulator. Lower currents may be used, if necessary, though the accumulator will then require to be left on charge for a longer period. After charging has been in progress some time, the current will tend to fall, due to an increase in battery voltage. This is normal, and does not indicate any fault or deterioration in the rectifier or other parts.

Other Applications

In addition to making available a ready source of D.C. from A.C. mains, rectifiers have several applications of a rather different nature. One of these is shown in Fig. 5, and is very useful for relays or other inductive loads controlled by

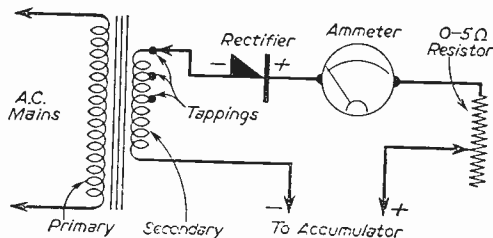

Fig. 4.—A circuit for accumulator charging.

contacts of low current-carrying capacity. With such inductive loads, a high voltage surge arises when the contacts are opened, causing a spark to pass. This voltage is usually many times that of the voltage of the operating source, and of reversed polarity. Such sparking may be suppressed by wiring a rectifier in parallel with the coil winding or other inductive load, as shown. The rectifier presents an infinite resistance to the normal applied voltage, but acts as an effective short circuit to back E.M.F. generated when the contacts are opened. As the load is only momentary, the rectifier need usually have a voltage rating only equal to that of the applied operating voltage. This kind of circuit is recommended by some relay manufacturers, especially when a relay with very light contacts is used to control a larger relay. Sparking at the contacts of the first relay can thus be avoided.

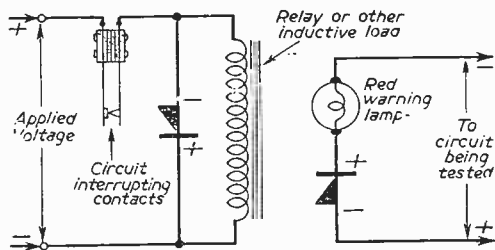

Fig. 5 (Left).—A spark-quenching circuit.
Fig. 6 (Right).—Polarity reversal warning circuit.

A second application of interest is shown in Fig. 6, and useful in any instance when it is desired to know that an applied polarity is correct or when equipment may be connected to a D.C. source in the wrong polarity (e.g., with D.C. mains). When polarity is correctly applied, the lamp does not light because no current flows. If, however, the polarity is reversed, current flows and the warning lamp is illuminated. This is particularly useful with any equipment which would be damaged if switched on when connected in the wrong polarity (e.g., D.C. mains operated amplifiers), or when any indication is at once required if the polarity is wrong (as, for example, when connecting up a number of accumulators). For mains voltages a 250v rectifier and low-consumption mains-voltage lamp or neon is required; for low voltages a low-voltage rectifier and bulb will be suitable.

Dry-cell Activator

A directly-operated circuit for dealing with batteries up to 150v. is shown in Fig. 7, and may be made up at extremely low cost. Here the fuses are to safeguard the equipment in the event of any short circuit. The double-pole switch isolates the cells, etc., when in the "Off" position, and is essential when operation directly from the mains is undertaken. It can in no circumstance be replaced by a single-pole switch unless the mains plug is always withdrawn before touching any bare connection.

The 100 ohm resistor limits the peak rectifier current, and the 16 μ F condenser provides a

measure of smoothing and acts as a reservoir for the pulses received from the rectifier. The current adjusting potentiometer requires to be of the wire-wound type, and can be of 10,000 ohms. A further resistor, of about 1,000 ohms, limits the battery current.

If torch batteries and other low voltage batteries only are to be dealt with, a charging circuit such as that in Fig. 4 may be used. The current is, however, very small, compared with that required for an accumulator. The circuit in Fig. 7 can deal with radio H.T. batteries, but is not very suitable for batteries of very low voltage. The actual charging current will depend upon the size of the cells, and will usually be about 10 to 30 mA (.01 to .03 amp). Batteries which have been discharged in a reasonably short period are particularly suitable for re-charging.

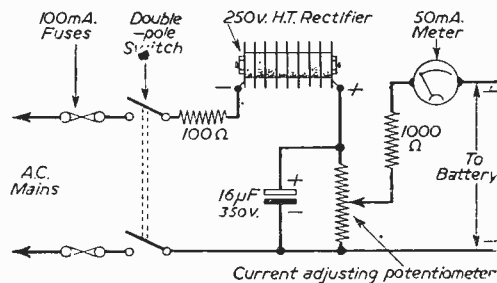

Fig. 7.—Circuit of a dry-battery reactivator.

and can give a new period of long service. Corroded cells are not satisfactory, and it is usually necessary to abandon the battery after it has been charged a few times.

Finally, it will have been noticed that transformers are used for isolating the low-voltage side of the circuits given, and to reduce the voltage. Users not familiar with circuits of this type should not overlook that transformers cannot be used with D.C. mains, and this should be kept in mind when making up equipment for the first time.

JOIN THE PRACTICAL GROUP

Edited by F. J. CAMM

PRACTICAL HOME MONEY MAKER	1/3
PRACTICAL WIRELESS	1/3
PRACTICAL TELEVISION	1/3
PRACTICAL HOUSEHOLDER	1/3
PRACTICAL MECHANICS	1/3
PRACTICAL MOTORIST & MOTOR CYCLIST	1/3

They are all published monthly

CASH OR TERMS

17in. T.V. CHASSIS TUBE & SPEAKER £19.19.6

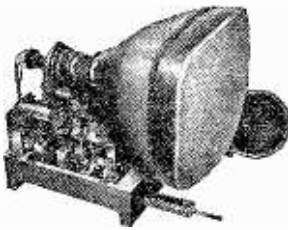

Latest improved circuits. Higher E.H.T. (brilliant picture). Improved sensitivity (for greater range). Chassis easily adapted to any cabinet. 17in. rectangular tube on adapted reconditioned chassis. Channels 1-5. 12 months guarantee on tube, 3 months guarantee on valves and chassis. Less valves. Valve line-up: (5 valves): 6SN7GT, 6V6, EY51, 2-6D2s. Others: 6L18, EL33, 7-6F1s. Turret tuner 50/- extra. Chassis size 11 1/2in. x 14 1/2in. x 1 1/2in. With 5 valves, £21.19.6. With all valves, £25.19.6. (Ins. carr. 25/- incl. tube). State B.B.C. channels and I.T.A. if Turret Tuner (incl. cd).

14in. T.V. CHASSIS TUBE & SPEAKER £13.19.6

As above with 14in. round type tube, 3 months guarantee. With 5 valves £15.19.6. With all valves, £19.19.6. (Ins. carr. 25/- incl. tube). Turret Tuner, £C/- (extra).

DENCO RADIOGRAM CHASSIS, 97/6

3 and 4 waveband turret tuned. Superhet A.C. D.C. chassis with 6in. or 8in. speaker. Size 8 1/2in. x 10in. x 12in. Valve line up: CCH35, EF39, EBCC3, CL33 and CY31. (C1C or dropper). Ins. carr. 7/6.



SUPER CHASSIS, 99/6

5 valve superhet chassis including an 8in. speaker. 4 control knobs (T.C.C., Volume, Tuning, W.C. Switch), 4 waveband with position for gram. P.U. and for extension speaker. A.C. P. & P. 5/6.

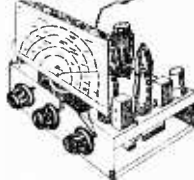

CONSTRUCTOR T.V. CHASSIS

POWER PACK & AMPLIFIER, 19/6. O.P. stage 6V6 with O.P. Trans. Smoothed H.T. 250 v. 250 mA 3 v. 5 a., 22 v. 3 a., 6.3 v. 4 a. 4 v. centre tapped. Less valves. FREE drawing. Carr. 5/6.

TIMEBASE 4/9. Including scanning coil, focus unit, etc. Less valves. FREE drawing. P. & P. 2/6.

SOUND & VISION STRIP 9/6. S'het. Complete vision strip. Less valves. FREE drawing. P. & P. 2/6.

HEADPHONES, 1/9



Single earphone and band. C-LR type. Ideal for crystal sets, extension on radio, etc. P. & P. 1/3. **SIMULATOR UNITS, 19/6.** Complete with valves. Telescopic aerial. Instruction booklet FREE with each order. Ideal for Walkie-Talkie conversion. Test set 172A. Ex-W.D. P. & P. 4/6.

HOME RADIO 79/6

5 valve (octal) superhet. 3 waveband receiver. A.C. D.C. Universal mains can be adapted to gram. P.U. In wooden cabinet. 18 1/2in. x 11 1/2in. x 8 1/2in. Ins. carr. 7/6.

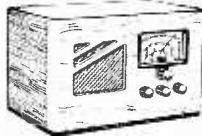

SELF FEED SOLDERING TOOL, 19/3. 6-12 volt, 110-125 volt. Made for the American market. Car battery or mains, export quality. Complete in light carrying case. Reel of solder and spare parts. P. & P. 2/9. A few of the above in 6-12 volts, 220-240 volts, 2E, 6.

5 VALVE MIDGET RADIO, 79/6. Superhet octal valves: 12K8, 12K7, 12G7, 351A, and 332A. 5in. speaker included. 2 wavebands, 3 control knobs, 100-240 volts. Universal supply. Wooden cabinet, size 17in. x 8 1/2in. x 6in. Ins. carr. 3/6.

T.V. CHASSIS, 49/6. Complete chassis by famous manufacturer R.F. EHT unit included. Drawing 2/6 or FREE with order. Chassis in 3 separate units (power, vision, timebase interconnected). These chassis can easily be fitted into existing console, cabinets. Less valves and tube. Channels 1-2-3-5. Easily converted to I.T.A. Ins. carr. 10/6.



ELECTRIC CONVECTOR HEATER, 99/6

Cleaner, cheaper, safer than paraffin. A.C. D.C. Switched for 1 or 2 kw. watts. Illuminated grille. 200-250 volt. Ins. carr. 10/6.

CO-AX CABLE, 6d. yd. Good quality. Cut to any length. 10 Post on 20 sds. 45-per 100 yds. Post 3/6.

CAR AERIALS, 6/9. Whip antennae, 50in. long, collars to 1 1/2in. one hole fixing. Post 1/-.

RECTANGULAR T.V. TUBES

17in. £7. 10. 0.

14in. £5. 10. 0.

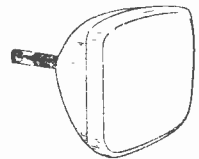

12 MONTHS GUARANTEE

6 months full replacement, 6 months progressive. Made possible by the high quality of our tubes. Ins. carr. 15/6. Convert your 9in., 10in., 12in. to our special offer of 14in., 15in., 16in. T.V. TUBES £5. 3 months guarantee on all round tubes. Details on how to "Do-It Yourself" in our FREE catalogue. 12in. T.V. TUBES £4/- 3 months guarantee, 15/6 ins. carr. on all tubes. TUBES WITH BURNS £1 including carriage. Perfect picture. 14in. and 17in. rectangular. This low price owing to slight screen burns. Ideal for stand-by or for testing.

BEAUTIFUL EXTENSION SPEAKER, 29/9

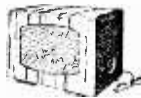

Complete, fitted with 8in. P.M. Speaker "W.B." or "Goodmans" of the highest quality. Standard matching to any receiver (3-5 ohms). Flex and switch included. Unrepeatable at this price. Money refunded if not completely satisfied. Ins. carr., 3/6.

8in. P.M. SPEAKER, 8/9. Let the lady of the house listen to that Radio or T.V. programme. Complete with O.P. trans. 10/- P. & P. 2/8.

P.M. SPEAKER, 12/9. 8in. Elac or Goodmans. High quality. 2-5 ohms. Complete with O.P. trans. 14/- P. & P. 2/9.

T.V. AERIALS, 25/6. For all I.T.A. channels. For outdoor or loft. 3 elements. Famous manufacturer at half the normal price. Post 2/6.

T.V. MASKS, 14/9. 17in. Halo lighting. New. Post 2/-.

T.V. MASKS, 10/9. 17in. White plastic. New. Post 2/-.

T.V. MASKS, 7/9. 17in. Grey plastic. Brand new. Post 2/-.

TORCH LANTERNS, 6d. each. X.W.D. Includes 2 bulbs uses 800 battery. P. & P. 1/- Crate of 48 with 22 bulbs extra 22/- (118 bulbs in all). Ins., carr., 10/-.

POPULAR RADIO OR RADIOGRAM CHASSIS, 39/6

3 w/and and gram. S'het. 5 valve. International octal. Ideal table gram, but still giving high quality output. 4 knob control. 6in. P.M. Speaker. 7/9 extra. Set of knobs 2/- Chassis size 12in. x 6in. x 6in. Less valves. Ins., carr., 4/6.



Boxed VALVES 3 MONTHS' GUARANTEE

6L19	8/9	741	8/9	SP61	3/9	EF37	4/9
451U	10/9	6SG7	3/9	DF66	5/9	EF68	5/9
EZ40	8/9	77	3/9	EB34	1/9	PEN36	6/9
4D1	2/9	8D2	3/9	6P28	10/9	ET32	6/9
6B8	3/9	8D3	7/9	ECC81	8/9	EL11	3/9
6F12	7/9	12A7U	5/9	ECH42	8/9	PEN45	6/9
EF22	3/9	12EF6	6/9	EP39	6/9	TT11	6/9
6HG6	1/9	12AF42	8/9	EP41	8/9	KTW61	6/9
SP41	3/6	12SJ7	1/9	EP91	7/9	Z77	7/9

American Types. U.X. All at 1/9 each.

18	75	1D3	6A7
42	38	1D6	6C6

Carretors 201 also at 1/9 each.

HEATER TRANSFORMERS, 12/9. 1-20-250 v. Primary 12 v. Heater 1 amp. P. & P. 1/9.

HEATER TRANSFORMERS, 9/9. 2-1 ratio auto trans. for heater winding up to 6 v. P. & P. 1/9.

R.F. E.H.T. COIL, 19/6. 6-10 Kv. Drawing and Data FREE with each order. Post 2/6.

Liverpool St. to Manor Park Station.—10 mins. Send for free 1958 Catalogue. Open all day Saturday. **DUKE & CO.** (Dept. 4), 621/3, ROMFORD ROAD, MANOR PARK, E.12. Tel.: ILF 6001-3.

THE LINEAR 'DIATONIC'

A 10-WATT HIGH FIDELITY ULTRA LINEAR AMPLIFIER WITH INTEGRAL PRE-AMP

A special feature is the compactness of the unit. Full advantage has been taken of latest component miniaturisation developments to produce a 10-watt Hi-Fi push-pull amplifier incorporating tone control pre-amplifier stages within the measurements of 9 x 7 x 6½ ins. In addition two high impedance input sockets are provided for microphone and gram, etc. Each input has its associated vol. control, five B.V.A. valves are employed ECC83, ECC83, EL84, EL84, EZ81, H.T. and L.T. Power supply point is included for a radio tuner.

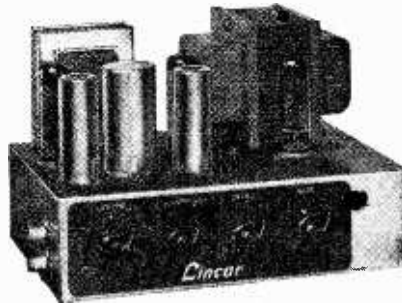

FREQUENCY RESPONSE
± 2 d.b., 30-20,000 c.p.s.

MAXIMUM POWER OUTPUT
In excess of 14 watts.
RATED OUTPUT 10 WATTS.

SENSITIVITY
Volume (1) 22 millivolts for rated output.
Volume (2) 220 millivolts for rated output.

TREBLE LIFT CONTROL
Continuously variable + 6 d.b. to -13 d.b. at 12,000 c.p.s.

BASS CONTROL
Continuously variable + 13 d.b. to -18 d.b. at 15 c.p.s.

HUM LEVEL
Referred to maximum output and including integral pre-amp -60 d.b.

HARMONIC DISTORTION
0.19% measured at 6 watts.

NEGATIVE FEEDBACK
Total 32 d.b. including 24 d.b. in main loop.

Weight 12½ lbs. Power consumption 90 watts. For 200-230-250v. 50 c.p.s. A.C. mains. Outputs for 3- and 15-ohm speakers. Chassis finish stoved Blue-Grey hammer. **HIGHEST QUALITY!** Retail price **MAXIMUM RELIABILITY!** **AT A PRICE YOU CAN AFFORD.** Available through your local dealer, leading mail order firms, or direct from us. Send S.A.E. for descriptive literature.

12 GNS.

L45 MINIATURE 4/5-WATT QUALITY AMPLIFIER
Size only 6 x 5 x 5¼ in. high. 12 d.b. Negative Feedback. Sensitivity 30 m.v. for full output. 3 Mullard valves. ECC83 Twin Triode. EL84 Power Output. EZ90 Rectifier. Separate Bass and Treble Controls. Mains switch incorporated in control. For 200-250 v. 50 c.p.s. A.C. Mains. An ideal unit for use with Gram. or 'Mike.' Output matching for 2-3 ohm speakers. Retail Price **£5-19-6**
Also available: LG3 3-watt Gram Amplifier, 49 9. LT 45 Complete Tape Amplifier, 12 gns. "Conchord" 30-watt Amplifier, 15 gns.

TRADE ENQUIRIES to

LINEAR PRODUCTS LTD. ELECTRON WORKS, ARMLEY LEEDS.

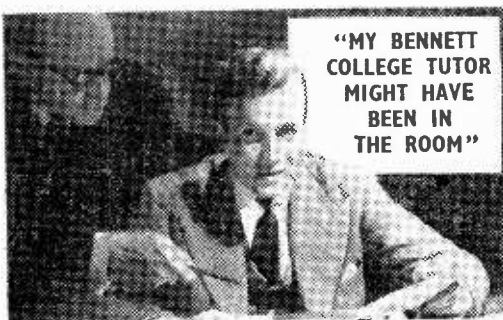

"MY BENNETT COLLEGE TUTOR MIGHT HAVE BEEN IN THE ROOM"

PERSONAL POSTAL TUITION

- WHAT CAREER DO YOU WANT?**
- Architecture
 - Building
 - Carpentry
 - Commercial Art
 - Diesel Engines
 - Draughtsmanship
 - Electrical Eng.
 - Electric Wiring
 - Forestry
 - Locomotive Eng.
 - Machine Drawing
 - Mechanical Eng.
 - Motor Engineering
 - Plumbing
 - Quantity Surveying
 - Radio Engineering
 - Sanitary Science
 - Surveying
- OR WHY NOT OBTAIN A QUALIFICATION?**
- A.M.I.C.E.
 - A.M.I. Mech. E.
 - A.R.I.B.A.
 - A.N.I. Struct. E.
 - GEN. CERT. OF EDUCATION & R.S.A. Exams.
 - Telecommunications
 - Television
 - Wireless Telegraphy and Telephony
 - Book-keeping
 - English
 - Geography
 - Journalism
 - Languages
 - Mathematics
 - Modern Business Methods
 - Police Subjects
 - Salesmanship
 - Shorthand
 - Short Story Writing and many others

Every Bennett College student enjoys this friendly, intimate coaching right through his Course. A few of the Courses are listed opposite. Tell us your subject. We will send you The Bennett College Prospectus and the famous FREE book "I ran your mind to SUCCESS". This will show you how you can advance to a better, finer future by Personal Postal Tuition. Fill in and post the coupon today.

BENNETT COLLEGE
(Dept. D.104 PT.) SREPFIELD

Please send me the Prospectus on..... and my free copy of "I ran your mind to SUCCESS".

NAME.....
ADDRESS.....
TOWN.....

(Age under 21) Please write in BLOCK letters

Post this coupon NOW!

Best Buy at Britain's

AMERICAN MULTIMETERS. by Precision, U.S.A. 400 micro-amps basic. A.C. and D.C. volts to 6,000 D.C., milliamps to 900, Ohms to 5 megs., 20 ranges in all. In polished wooden case, 7½ x 7½ x 5½. Complete with leads, batteries and instructions. Tested and guaranteed, £6 19/6.

AVO BRIDGES.—34 range Universal Meter, for A.C. and D.C. volts, A.C. and D.C. current and Ohms. Large easy-to-read 5 in. mirror scale, B.S.I. standard. Complete with batteries and guaranteed in first-class working order. £8 19 6. P. & P. 4.

AVO BRIDGES.—Measures capacity to 50 mfd., resistance to 50 megohms, meter indicates balance, and reads 0.1 to 15 v. as valve voltmeter. Leakage test and power factor scale. Full instructions. Tested and guaranteed. A.C. mains operation. £7 19 6.

MULLARD GM4140 1 C. & R. BRIDGES.—0.1 Ohm to 10 Megohms in 4 ranges; 10 pPd. to 10 mFd. in 3 ranges. For 50 c/s A.C. mains. In perfect working order. £7 10. P. & P. 3/6.

W.C.A. SPEAKERS.—0 to 50 Megohms at 500 v. BRAND NEW in leather case. With leads and instructions. £12 10. Ditto, but 100 v., £8/10.

MINIATURE 373 I.F. STRIPS.—For F.M. tuner described in April and May P.W. Complete with 3 of EF91, 2 of EF92 and EB91. A fresh release enables us to offer these once again. BRAND NEW with circuit, 42.6. OR less valves. 12/6. Post either, 2/6.

SPEAKERS.—3 Ohms, 6½ in. diam. In grey wrinkled steel cabinet, 9 x 9 x 5 in. Complete with volume control and transformer for 500 Ohms line. Brand new, 27 6. P. & P. 3/6.

VIBRATOR PACK.—Input 6 v. D.C. Output approx. 100 v. at 50 m/amps. D.C. Fully smoothed and R.F. filtered. Size 6½ x 5 x 2 in. Fitted with Mallory 629C vibrator. BRAND NEW, 12/6.

VIBRATOR PACK.—Input 6 v. D.C. Output 200 v. D.C. 100 m/amps Fully smoothed and R.F. filtered. Size 9 x 5 x 6½ in. Complete with 024 and vibrator. Brand new, 25. P. & P. 2/6.

W.C.A. ISOLATING TRANSFORMERS (Vortexion).—For testing A.C./D.C. sets in safety. 230 v. input, output 230 v. 100 watts, 22 6. P. & P. 2/6.

MAINS TRANSFORMERS.—Input 200-250 v. A.C. Outputs 275-0-275 v. 100 m/amps; 6.3 v. 7 Amps; 5 v. 3 Amps. (Govt. rating.) 4 x 4½ x 4 in. high. Upright mtg. Brand new, 25. P. & P. 2/6.

R.C.A. OUTPUT TRANSFORMERS.—Pri. push-pull 6L6 s. Secs. 600 Ohms, tapped at 15, 7.5 and 5 Ohms. Tertiary winding for NFB. Handles 20 Watts. Potted. Circuit of R.C.A. amplifier supplied FREE. Brand new, 27 6.

AVOMINOR LEATHER CASES.—Brand new, with strap, 7 6.

PLEASE ADD POSTAGE OR CARRIAGE ON ALL ITEMS

CHARLES BRITAIN (RADIO) LTD.
11 Upper Saint Martin's Lane, London, W.C.2
TEMPle Bar 0545
Shop hours 9-6 p.m. (9-1 p.m. Thursday). Open All Day Saturday

TRANSMITTING TOPICS

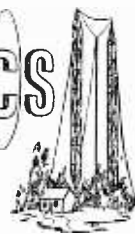

THE SIMPLEST TRANSMITTER

By O. J. Russell, B.Sc.(Hons.), G3BHJ

FROM time to time, the simplest set has been recommended in this feature as a standby or training arrangement for the newcomer. No apology is given therefore for repeating the circuit of Fig. 1, showing a simple tetrôde crystal oscillator. Incidentally, "almost any" valve may be used in such a circuit. "Almost any" is, indeed, correct, for practically any small triode, tetrode or pentode valve may be used. Thus the triodes 6J5, 6C5, 6C4, 7193, etc., may be used, and some of these valves may be picked up for a few shillings on the surplus market. Moreover, in the pentodes and tetrodes, types such as the QV-04-7, EF91, EF50, 6AM5, 6AM6, 6F6, 5763, 6Y6, 6K6, 6V6, 6L6, 6AG7, 6AK7, 807, 6146, KT66 and a host of other such valves as the 6BW6 and so on may be used.

There is little difficulty, therefore, in selecting a valve for such a circuit. Indeed, even a battery pentode or triode will give a watt or so up to a few watts according to type in such a circuit. Small dry battery valves such as the 3V4 and 3Q4 indeed will give a respectable output in such a circuit, and enable DX contacts to be made. Reference to QRP exploits with transistors will convince any sceptic that a watt or so of R.F. will enable DX contacts to be achieved. This is necessary, as after recent experiences it is clear that many imagine that large amounts of power are necessary. This extends up to all levels. As a W contact worked regularly on a ten metre schedule, when the W was using 300 watts as "low power" input to his Viking KW set he was most apprehensive that he would not make the schedule when a fault entailed his using a low power exciter "with only 65 watts." I was able to reassure the W that he was still audible, and refrained from pointing out that I had always employed a power of 75 watts throughout the schedule of transmissions. In fact as an analysis of W stations worked shows that the average input is around the 100 watt mark, a fact confirmed by other sources such as QST, a kilowatt is not an essential to DX working. However, a simple crystal oscillator is capable of ten watts or so of R.F. and under good conditions will cover the world. Despite the fact that VFOs are used to a very great extent, there are still many DX stations using crystal control. We can quote, of course, the "rarest" of rare DX JT1AA as a prime example, but many "non-DX" stations are working DX with crystal controlled sets. Thus W9QHR can be heard on a remote controlled crystal set, and this is a consistent signal over here worked by the author many times, even under poor or crowded band conditions, while "ERV" has consistent QSOs with DX stations such as ZS9G, helping G3BHJ to con-

tact a "new one" incidentally! Further, the much sought after UR2BU is crystal controlled, and in fact requests DX stations to QSY off his frequency after the QSO for that reason.

Some Pitfalls

However, while it has been stated that a newcomer will gain useful experience with a simple crystal controlled outfit, it is necessary to point out some of the pitfalls that can arise even from such a simple arrangement as a plain crystal oscillator. This is borne out by observing a number of "new hams" struggling with crystal oscillator sets. Despite their simplicity, it is necessary to use skill in extracting satisfactory results. This despite the sophisticates who consider a crystal oscillator beneath them, and plunge straight into a multi-stage set-up. Usually it appears that to get these sophisticates operational requires a large amount of effort on the part of some experienced amateur, which does not give the neophyte experience in operating and adjusting his station. Once some Good Samaritan has tuned up the set, adjusted aerial arrangements and loading taps so that the set can be put on the air, the neophyte is then happy just to operate, oblivious of the fact that a new aerial or some other alteration may leave him with no idea whatsoever on how to get good results. Attention to basic principles that could have been acquired by a simple set would save such embarrassments. Indeed, a number of promising operators have given up amateur radio because the simple "know-how" necessary for taming a transmitter has been lacking. Rather than "humble" themselves by calling in a

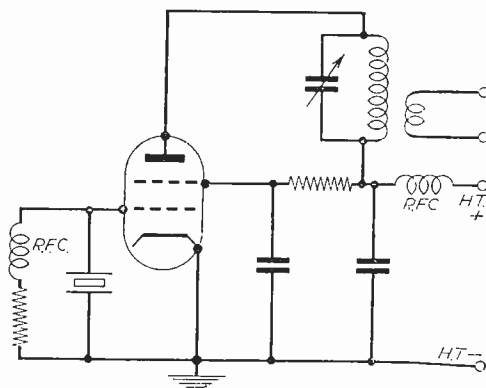

Fig. 1.—A basic crystal oscillator circuit that makes a useful simple transmitter.

handy and experienced ham time after time they have tried a series of random fiddlings, to no avail, and finally given up. The fact is that the basic necessity for sorting things out for oneself is not necessarily inborn, but may be developed by the right training. However, in some cases the would-be ham never acquires this training, and is lost when faced with a chirpy topband VFO feeding a buffer stage that has parasitics feeding a P.A. stage of apparently zero efficiency. It is too much all at once, despite the fact that many such "quitters" when in the Services were able to adjust complicated sets by following "the book." However, proper ham radio experience provides a higher training than this . . . it teaches—or should teach—by experience to go "beyond the book." In other words the true amateur is able to deal

despite this, commercial sets are here to stay. One solution that preserves the personal participation of the amateur is the "kit" set, and is a good solution where time is limited, as metal drilling operations are all done at the factory leaving the amateur assembly and wiring up operations to complete the transmitter.

Using the Set

Nevertheless, for an amateur faced with using a set, home built or commercial, there is the necessity of acquiring "know-how" in adjustment and use of the gear. The simplest crystal oscillator set offers quite a few opportunities in this direction. Let us consider the mythical case of a new and inexperienced and wholly imaginary new amateur who is using such a set. The complete circuit is given in Fig. 2, together with the associated aerial tuning unit in Fig. 3. It would seem that first-class results should be expected. However, our hypothetical neophyte, flushed with the success of passing the R.A.E. exam, is soon face to face with problems that the R.A.E. syllabus is no help at all in solving. The first problem was a fabulous chirp. This had to be heard to be believed, and at times "dots" were "lost" due to the violence of the chirp. Moreover, local amateurs on the watch to have a QSO with the new hand could sometimes hear him at a modest RST 539 to RST 559 when QRM from distant stations permitted. In some cases he was not heard at all, despite the fact that he was known to be transmitting, as more distant stations could be heard working him with very unflattering signal reports. Despite this, no amount of searching could pull the local signal through the Sunday QRM on 3.5 Mc/s! It was clear, particularly as the new hand could hear local amateurs at S9 plus, that all was not in order. A new aerial some hundred feet long was installed, in the hope that the aerial was at fault. This boosted signals to a RST 559 locally to RST 569 "under favourable conditions" —the favourable conditions being a more charitable frame of mind of the reporting amateurs, or possibly a growing skill in sorting out a weak and chirpy signal from the more distant QRM.

Inspection of the outfit revealed that some 80 mA of anode current were being drawn at some 400 volts input by the 6L6G oscillator. Moreover, hardly any aerial loading was in evidence, despite the fact a bulb in series with the aerial was glowing (Fig. 4). Despite this the operator had had a few QSOs outside England, and was apparently resigned to his fate, or at a loss as to how to proceed. Refraining from the obvious reference to transistor DX on a few milliwatts, it was clear that radiation efficiency was tragically low.

The way in which such faults can be overcome is simple—if one has the necessary technical training for a reasoned approach. However, no doubt the modern educational tendency to concentrate on non-essentials has unduly discouraged an enquiring and adventurous frame of mind. Technically speaking the use of over 30 watts

(Continued on page 137)

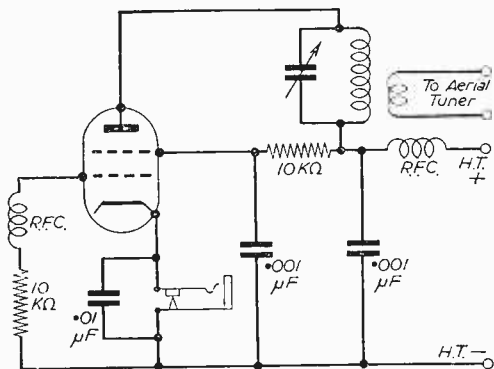

Fig. 2.—Simple crystal oscillator circuit with component values used originally.

with all sorts of circuit and adjustment, and if necessary to improvise workable gear. Moreover, his own rig will depart "from the book" in many particulars in order to achieve greater efficiency, and will in fact be altered from time to time for better results. This mental flexibility is to be prized today, despite the factory made sets that are available. A spoon-fed amateur is unlikely to arise to emergency as did the Dutch amateur who wound a tank coil on a beer bottle and used the output valve of a broadcast set to improvise an emergency set-up during the catastrophic floods a year or so ago. That is being an amateur as opposed to operating on the amateur bands. Not, of course, that we object to using factory built sets; what we object to is not acquiring the amateur "know-how" that enables the true amateur to keep on the air despite all difficulties, and to improvise his own gear if necessary rather than buy a ready made item. In an emergency one may not be able to run out to a shop. The British amateur who was instrumental in saving a ship during severe gales was only able to do this by swinging his VFO out of the amateur band—a feat more difficult with a packaged commercial set. Also, of course, running repairs can be cheerfully made upon a set one has built oneself, whereas a commercial unit may require some close study to find one's way around the wiring. However,



FOR VALUES—
Guaranteed New and Boxed

Table listing various electronic components and their prices. Columns include component names (e.g., AC/PE 6 6, ATTP 34 9), values (e.g., KT55 13 8), and prices (e.g., 15 0). The table is organized into several columns and rows.

Bulgin Type P322 Anode Cap. Insulated for high voltage... Terminal Block, Ref. No. 5X/234, 20-way 6 volts Top Quality Maroon Plex, 2in. core twisted with 2in. pin plug... 2.9 ea.

Studio "E" Kit, complete with Headphones, Battery, Valve, and all other parts to build this Popular Kit, 45.4.

A NEW HIGH FIDELITY AMPLIFIER Type K.C.1, 2 Stage. For use with a 3 ohm speaker, A.C. mains, 230-240 v., recommended for use with any record player.

NYLON DRIVE CORE. Non stretch. 6d. yd.

FOCUS UNIT For 14in. or 17in. tubes, center adjustment by famous manufacturer, 15/- ea.

W.B. "STENTORIAN" HIGH FIDELITY UNIT, MODEL H.F. 1012 10in. Die-cast unit, incorporating 12,000 gauss magnet. Handling capacity, 10 watts. Frequency response, 30 c.p.s. - 14,000 c.p.s. Base response, 35 c.p.s., £4.19.9.

MODELS H.F. 810 and H.F. 812 Sin. unit incorporating 10,000 gauss magnet. Handling capacity, 5 watts. Frequency response 50 c.p.s.-12,000 c.p.s. Base response, 65 c.p.s. Steel chassis, £3.2.0. Die-cast chassis (12,000 gauss), £4.3.8.

Attractive cabinets for 3 valve TRF Kit, complete with chassis, dial, backplate, Dial Drum, Pointer, etc., etc., 27.6.

Complete Range of Metal Rectifiers. Compare the Prices. RM1, 4 6; RM2, 5 6; RM3, 7 6; RM4, 10 6; RM5, 16 6. 14.97, 25/-; 14.25, 19 6 & 14.10, 15/-.

Isolation Transformers. - Mains Input NR20A, 2 volt, NR20B, 4 volt, NR20C 6.3 v. all with 25% boost. All one price, 10.6 ea.

Full range of Omron, Teletron, Weatite, Repanca Coils, Ferrite Coils, Coil Packs, etc., etc. See our catalogue for full details.

Aerialite Co-Axial Plugs ... 14 ea. Aerialite Co-Axial Sockets ... 11d. ea. Aerialite Back to Back Sockets ... 16 ea.

Miniature I.F. Transformers 465 Kc/s ... 8/- pair RCA 50 ohms wire wound Piezoelectric var. Control ... 2/- ea.

Full range of carbon controls, 1/2in. spindle length, all values ... 13 ea. Collaro Studio "O" Cartridge 22 6 ea. Bulgin Mains 2-pin Plug & Socket ... 2 6 ea.

Pile wound chokes R.F., 1.6 ea. Resistors T.S.L. 1 watt 10% Tolerance Full range of Preferred Values, 6d. each. Also good selection of 1/2 watt 1% types 2.6 each. Order forms available on request.

Ceramic condensers by Top Manufacturers. Good selection in stock Price 9d. ea.

Aerialite Loft Aerials, 3 Element, 27 6; 5 Element, 37 6; Suitable for Channels 8, 9, 10.

We hold large stocks of Control Knobs, Brass X-tube and Bolts, Toggle switches, wavechange switches, tag boards and panels. All are listed in full detail in our current Catalogue. Send 1/- in stamps for your copy.

CYLDON "TELETUNER" All types available. Stations of your choice. Fit this Converter and your troubles are over, £7.7.0 ea. Aerials and Oscillator Coils (All Channels—all frequencies), 7/6 pair. Also available from stock, complete range of spares.

Teleton Companion, complete kit of parts for this 3 Transistor Pocket Radio, Ferrite Rod, Case, etc., 80.6.

CONTROL KNOBS Long knucked knobs for T.V. Receivers in walnut, black and cream, 1/- ea.

SUPPRESSORS Duplicator kits of condensers and chokes for Interference Suppression. 1 amp kits, 5/6; 2 amp kits, 6/-; 3 amp kits, 6/6.

REVISED SECOND EDITION "POINTS ON PICK UPS" A Replacement Guide to pick-up heads, cartridges, stylus. Over 193 illustrations, 5/- ea.

Omron Coils for Collaro Type Deck Transmitter QT6 Bias Filter coil, 7 6 ea. QT7 Treble Boost coil in Mu Metal can, £1.7.6 ea. QT9 Bias Osc. coil, 7 6 ea.

Omron Coils for the Beginner's Short wave Receiver Radio Constructor, Aug., 1957. SW Q1 31.4 Mc/s, 6/- ea. SW Q2 12.45 Mc/s, 6/- ea.

SCRATCHOFF Removes scratches from Radio & T.V. cabinets in Polythene Disperser Tubes, 3/- ea.

OUR 1957 58 ILLUSTRATED CATALOGUE IS AVAILABLE NOW Send 1/- in stamps for your copy.

MAINS TRANSFORMERS 3-WAY MOUNTING TYPE

M.T.1. Primary 200-220-240 v. Secondaries, 250-0-250 v., 80 mA, 0-6.3 v., 4 A, 0-4 v., 2 A, both tapped at 4 v., 21 9 each. Postage and Packing please add 2/- per transformer.

M.T.2. Primary 200-220-240 v. Secondaries 350-0-350 v., 80 mA, 0-6.3 v., 4 A, 0-5 v., 2 A, both tapped at 4 v., 21 9 each. Postage and Packing please add 2/- per transformer.

M.T.3. Primary 200-220-240 v. Secondaries 300 v., 2 A, taps at 3 v., 4 v., 6 v., 8 v., 9 v., 10 v., 15 v., 18 v., 20 v., 24 v., 21 9 each. Postage and Packing please add 2/- per transformer.

TERMS: Cash with order or C.O.D. Postage and Packing charges extra, as follows: Orders value 10/- add 1/-; 20/- add 1/6; 40/- add 2/-; £5 add 3/- unless otherwise stated. Minimum C.O.D. fee and postage 3/-. All single valves postage 6d. Personal Shoppers Monday-Friday 9 a.m. to 5 p.m. Saturday 10 a.m. to 1 p.m.

ALPHA RADIO SUPPLY CO. 103 LEEDS TERRACE WINTON STREET LEEDS 7

FROM THE HOME OF HI-FI

DULCI

High Fidelity at its finest

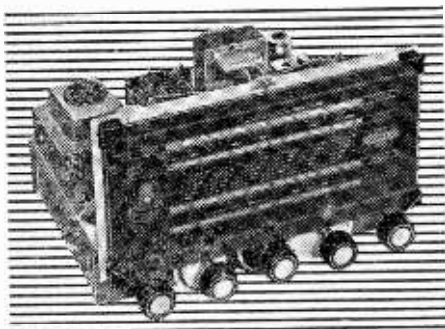

Model H4PP. (Illustrated) NEW! A complete Dulci High Fidelity radiogram chassis, combining sensitivity, selectivity and stability to delight the most discerning listener. Outstanding record and VHF reproduction, 4 wavebands. Ultra linear amplifier gives ample power output. Push-pull system, wide frequency response, bass and treble controls. Fits easily into any existing cabinet. The perfect chassis for modernising your radiogram.

AM/FM Model H4PP. Price **£29.3.10.** inc. P.T.

Model H4. AM/FM Radiogram chassis. 7 valve, 4 waveband superhet with FM (VHF). Magic eye tuning indicator. High sensitivity. Dial size 11½" x 5½". Sockets for speaker (3 and 15 ohm.) Mains sockets for motor.

£24.6.6. inc. P.T.

Model H3. Three waveband model (inc. VHF), 6 valves. For 3 ohm. speaker. Chassis immensely sensitive and stable, giving highest quality reproduction. Wide range Tone Control, with pick-up, extension speaker and gram motor sockets. **£20.17.0.** inc. P.T.

Write for full details

DISTINCTLY

DULCI

QUALITY PRODUCTS

THE DULCI COMPANY LTD. 97-99 VILLIERS ROAD LONDON N.W.2.

TELEPHONE: WILLESDEN 6678/9

FIRST-CLASS RADIO COURSES...

(GET A CERTIFICATE!)

QUALIFY AT HOME—IN SPARE TIME

After brief, intensely interesting study—undertaken at home in your spare time—YOU can secure your professional qualification. Prepare for YOUR share in the post-war boom in Radio. Let us show you how!

FREE GUIDE

The New Free Guide contains 132 pages of information of the greatest importance to those seeking such success-compelling qualifications as A.M.Brit.I.R.E., City and Guilds Final Radio, P.M.G., Radio Amateurs, Exams., Gen. Cert. of Educ., London B.Sc. (Eng.), A.M.I.P.E., A.M.I.Mech.E., Draughtsmanship (all branches), etc., together with particulars of our remarkable Guarantee of

SUCCESS OR NO FEE

Write now for your copy of this invaluable publication. It may well prove to be the turning point in your career.

FOUNDED 1885—OVER
150,000 SUCCESSES

NATIONAL INSTITUTE OF
ENGINEERING

(Dept. 461), 148, HOLBORN,
LONDON, E.C.1.

TELETRON TYPE FX. 25



Self-tuned, Dual-wave Ferrite Rod Aerial, 15/- each.

Designed for use in pocket Transistor receivers. Descriptive folder with circuit-component layout, and wiring instructions for a three-Transistor regenerative receiver. Price 6d. NO aerial, earth or tuning condenser required. Operates speaker from 3 Penlight cells. All parts, including cabinet and chassis, available from component stockists.



Miniature Transistor IFI's & Osc coil for 315 kc/s, 6/6 ea. FRM/2 Transistor Ferrite Rod Aerial, 10/-. Available from component stockists.

Stamp for complete lists and circuits.

THE TELETRON Co. Ltd.
266 Nightingale Rd., London N.9
HOW 2527

FIELD ELECTRIC

51, Gt. Tichfield Street,
London, W.1.

Tel.: MUSEum 6591.

MUIRHEAD SLOW MOTION DRIVES. Cal. 0-180 DG. Ratio 25-1. 10/- Post 1/-.

MINIATURE RELAYS. 4½ volt. 3 makes. 4/6. Post 9d.

ALKALINE CELLS. 1½ volt. 3½" x 2½" x 1". 4/6. Post 1/-.

AMERICAN SHUNT MOTORS. 24 volt. 5,000 r.p.m. 3½" x 1½" dia., spindle ¼". 8/6. Post 1/-.

TELESCOPIC AERIALS. 3 ft. 4 in. long in five sections. 6/6. Post 1/-.

BLOCK CONDENSERS. 8 mfd., 400 v. D.C. 4/6. Post 1/-.

AMERICAN TANK PERISCOPES. 5/6. Post 2/-.

SELENIUM RECTIFIERS. Full wave bridge. 12 volt. 4 amp. 12/6. Post 1/6.

AMMETERS. 0-1 a. 2in. D.C. 8/6. Post 1/-.

MAINS TRANSFORMERS. 350-0-350 80 m/a, 4 volts at 4 amps. 6.3 v. at 3.5 amps. 0.4-5 volts at 2 amps. 25/- Post 2/-.

of input to produce very unflattering signal reports from far and near is obviously a point to query. Furthermore, operating at such high power levels in a crystal oscillator is a potent source of chirp. However, the set was running virtually unloaded at 30 watts, so that the most elementary step would seem to alter the circuit parameters to reduce this unduly high "unloaded" level of power. The simplest and most efficacious step is to increase drastically the grid-leak value to at least 47,000 ohms and preferably 100,000 ohms. This immediately stabilises operation and ameliorates chirp to vanishing point. A further change is to alter the screen

a small coil of three turns shorting the bulb it still lit. Moreover, an original bulb of higher current rating and hence lower resistance had been replaced by this bulb because "it lights better." In fact the high resistance bulb was lighting to only a fraction of its 0.15 watt rating, indicating a radiated power probably way down in the milliwatts originally. However, the parallel coil of a few turns effectively shorts out the resistance of the bulb, while allowing enough light to indicate well. In fact the probable aerial current had increased many times, so that the bulb light now represented only a fraction of the actual aerial current, instead of all of it as previously. In fact the proud owner now started to face a new peril, as on pressing the key T.V.I. reared its ugly head through a faint grille on the TV receiver, a further proof that much more power was percolating skywards.

However, even with this improvement, it was clear that coupling was still infinitesimal. A quick survey of the aerial tuning and output system revealed why. Links had been wound and positioned as shown in Fig. 5. No attempt had been made to alter or adjust the links, and it can probably be assumed that because they "looked like" a circuit drawing of a linked assembly, they could be expected to work. Indeed, one factor may have been a "fear" that the chirp would be increased. However, the chirp that originally existed was quite independent of the microscopic degree of loading that existed, and was in fact due to the incorrect circuit parameters that were originally used.

Of course the degree of coupling with the arrangement as shown is infinitesimal, a fact that the writer has stressed before. The coupling of an end link rises sharply if it is actually over the winding it is coupled to, so that it was not surprising that pulling the link at the transmitter end a little way toward the tank coil "cold" end produced a dramatic increase in bulb brilliancy, and the T.V.I. grille became much stronger, while key thumps became audible on the TV sound channel! However, it was not possible to move the link very much, as it was firmly tied down at the earthy end, the reason being given as "so I can't overcouple." No mathematical evidence of elaborate calculations of coupling factors and power transfer coefficients was forthcoming to support what was presumably a superstitious belief in overcoupling beginning

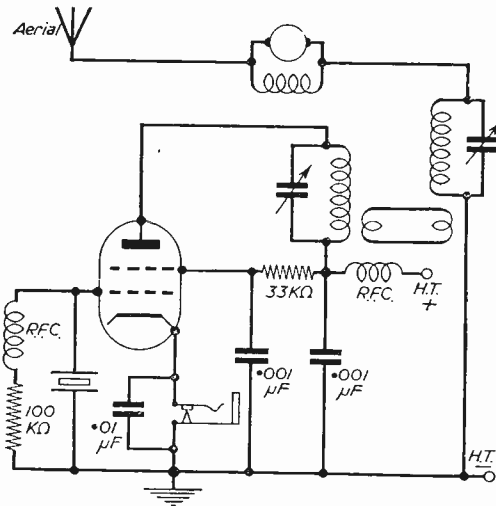

Fig. 4.—The crystal oscillator with revised component values.

resistor to a higher value also, say, 22,000 or 33,000 ohms, with a similar beneficial effect upon oscillator performance. Furthermore, use of such "realistic" values of resistance for screen and grid resistor operation will provide a healthy oscillation dip in plate current and reveal the efficacy or otherwise of aerial loading. In its original form, there was scarcely any change between oscillating and non-oscillating current due to the low value of grid resistor, and the rather low screen resistor.

The Aerial System

Having thus ameliorated the operating parameters of the "simple" set, attention was turned to the aerial system. The writer recoiled with a shrill scream of pure horror as he observed that the "series bulb" used as a current indicator was a special low current 0.04 amp bulb. As the hot resistance of such a bulb is something like 100 ohms, it is scarcely the thing to place in an aerial circuit. No one interested in an efficient aerial inserts a 100 ohm resistor, or for that matter constructs an aerial of resistance wire totalling 100 ohms of resistance. Yet here was a resistance of approximately that value deliberately inserted! It was quickly demonstrated that with

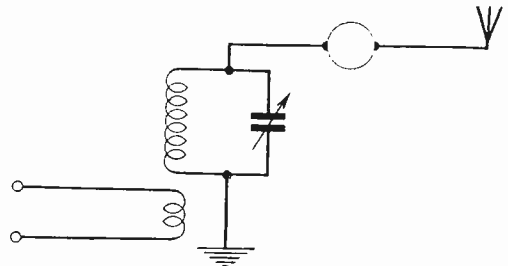

Fig. 3.—Aerial tuner for link coupling to a transmitter.

very early on in the approach of one coil to another. In fact, of course, the actual coupling was indeed infinitesimal, and a rearrangement of the links so as to be "overwound" with the lower ends of the aerial and oscillator tank coils provided a suitable amount of coupling (Fig. 6). It again does not seem to be appreciated that with a link coupled tuner of this kind, unless a marked reaction of the aerial tuner with the transmitter loading can be obtained, the coupling available is inadequate. Putting up longer aerials will have little effect.

Afraid to Touch It

The trouble in such cases is that the proud owner is afraid to touch his set "in case I stop it working." In such cases the solution is to do something. Try various values of grid leak. Alter link coil spacings and number of turns, and consider what next to adjust. Naturally don't adjust at random. If coupling seems inadequate, or if local reports are very low, try a tighter coupling, search for high resistance bulbs used as "series aerial bulbs," and if the link coils do not seem to help loading, try various numbers of turns. However, only too often one finds operators running with negligible efficiency, afraid to alter anything because the "set is working," and seem to imagine that even if a grid leak is changed disaster will result. The fact that the original grid leak or component may again be replaced never seems to enter their heads. The cure is for such faint hearts to rapidly wire in a series of components of varying value and check how this affects operation. Also, of course, they might reflect that loading down a crystal oscillator with, say, a 10 K grid leak is after all

of thing that the writer actually encounters and has encountered many times in the past few years. It is, of course, true that some newly licensed hams

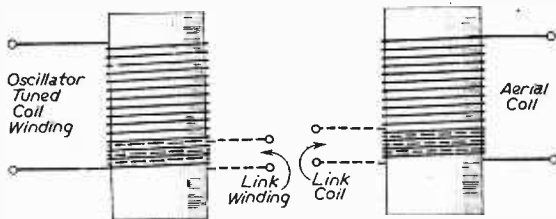

Fig. 6.—Interwound link coils for the aerial coupling and tuner circuit, which give a much higher degree of coupling.

rather foolish, due to the heavy damping caused by the grid drawing high grid current, so that it is no wonder a chirp results, whereas with a value like 100 K the damping is ten times less and hence it is no surprise that chirp disappears almost completely. Moreover, although with the new grid leak and one or two other changes the rig may only run, say, 10 watts input, this, if efficiently coupled, gets out with fine signal reports, whereas the 30 watts input with inefficient coupling never did get a good report.

While this sort of experience is not the inevitable experience of amateurs, many of whom have a good experimental sense, it is one that the writer encounters quite often. While our quoted experience is mythical in that it does not apply to any specific amateur it represents the sort

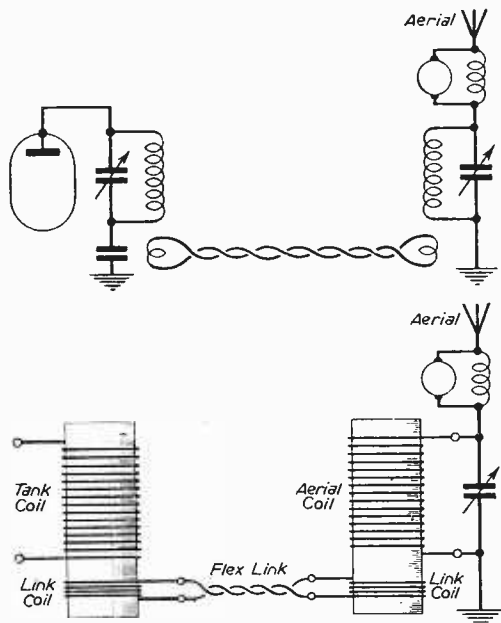

Fig. 5.—The theoretical circuit, and the too literal practical disposition of the actual output coupling and aerial tuner.

have never had to find their own way in situations of this type. Hams with some school training in science can automatically apply experimental principles, but the products of certain educational systems seem incapable of such rational behaviour, and are content to sit waiting for a miracle to happen, or even to blame local conditions for poor results. With a little reconsideration, they may realise that the R.A.E. does not cover all aspects of amateur radio, and that practical experimentation is a different matter to memorising the simple tricks demanded by the R.A.E. exam. With a little adventuring and a little reconsideration of all the factors involved a solution may be found. Even their struggling with a "simple" set will then provide a useful lesson in technique, which will serve in good stead when experimenting with new circuit arrangements, aerials and so on. Experienced hams will know what is meant.

A NEW HANDBOOK
RADIO CONTROLLED MODELS
 By F. J. CAMM Price 12/6, by post 13/4d.
 From
GEORGE NEWNES, LTD.,
 Tower House, Southampton Street, Strand, W.C.2

NO EXPERIENCE NEEDED TO MAKE THESE RADIOS

LOOK!



BUILD THIS POCKET RADIO FOR ONLY 37/6

AT LAST! In response to many requests we now present the **HIGH EFFICIENCY PENTODE SKYPOCKET**—a beautifully designed precision **POCKET RADIO**. No radio knowledge needed—**EVERY SINGLE PART TESTED BEFORE DESPATCH**; our simple, pictorial plans take you step-by-step. This set has a remarkable sensitivity due to painstaking design. Covers all medium waves 200 to 550 Metres. Size only 5 1/2 in. x 3 in. x 2 in. in Strong, Transparent case with panel, cover and ivorine dial. A really personal phone pocket-radio **WITH DETACHABLE ROD AERIAL**. Self-contained all-dry battery operation. Average building time 1 hour. **Total Building Cost—including Case, High Efficiency Pentode Valves, etc., in fact, everything down to the last nut and bolt—ONLY 37/6, with plans, Postage, etc., 2/-**. C.O.D. 16 extra. (Parts sold separately. Priced Parts List, etc., 1/6.) Demand is certain to be heavy—**SEND TODAY!**



47/6

Build this exceptionally sensitive high efficiency Pentode radio. Uses unique assembly system and can be built by anyone without any radio knowledge whatever in 45 minutes. Handsome black-crackle steel case with specially made black and gold dial with stations printed. Size of radio only 6 1/2 in. x 3 in. x 3 in. Covers all Medium and Long waves—uses only one all-dry battery. I.F.T. consumption only 1 to 1.5 mA. Uses personal phone. Ideal for Bedroom, Garden, Holiday, etc. Many unsolicited testimonials. *Mr. Norton, of Oxford writes: 'Yesterday evening on the Medium waveband, I counted 32 separate stations. I am very pleased with the set, which is well worth the money. BILLY THE SKYROMA' NOW!* Total building cost—everything down to last nut and bolt—**47/6** (Postage, etc., 2/-) with full set of clear, easy-to-follow plans. (Parts sold separately. Priced Parts Lists, etc., 1/6.)

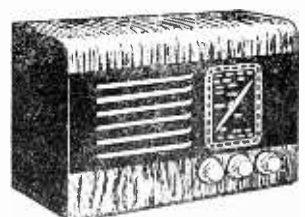

107/6

Total building cost including choice of beautiful walnut veneered cabinet or ivory or brown bakelite. This is the lowest possible price consistent with high quality. No radio knowledge whatever needed—can be built by anyone in 2-3 hours, using our very simple easy-to-follow diagrams. The terrific new circuit of the **“OCEAN-HOPPER”** covers all medium and long waves with optional negative feedback, has razor-edge selectivity, and exceptionally good tone. Price also includes ready drilled and punched chassis, set of simple easy-to-follow plans—in fact, everything! All parts sparkling brand new—no junk! Every single part tested before despatching. Uses standard octal-base valves: 6XG6 high-frequency pentode leading into 6J5C audio-bend detector triode, coupled to 6V6GT powerful output beam-power tetrode, led by robust rectifier. For A.C. Mains, 200-250 Volts (low running costs—approximately 18 Watts!). Size 12 in. x 6 in. x 5 in. **Build this long range powerful midset NOW!** All parts and set of plans, **65/6**. (Post and packing 3/6.) Parts sold separately. Priced Parts List, 1/6.

Build This TRANSISTOR POCKET SET For Only 49/6!



FEW ONLY AT 95/-!

NEW in maker's sealed cartons. Limited quantity of the famous 3-speed record player units, exceptionally easy to fix, with lightweight pick-up, incorporating "Acos" crystal turnover head and separate sapphire stylus for Standard and Long-Playing. With full instructions and fixing plans. Unbeatable price 95/-, plus 3/6 Post, Packing, etc. C.O.D. 2/- extra. **RUSSY ORDER NOW—BEFORE IT'S TOO LATE!**

WE'VE DONE IT AGAIN! . . . our design department in response to a great many requests have designed this **“SKY PINE”** Vest-Pocket **TRANSISTOR RADIO** which gives a superb performance. It is highly sensitive. Size only 4 1/2 in. x 3 1/2 in., the weight under 7 ozs.—yet it is a **TWO-STAGE** receiver covering all medium waves, working entirely off a tiny "pen-light" battery, which costs 6d.—fits inside the case—and lasts many months. Uses personal phone and has push-button **LUMINOUS** On Off Switch. Every part tested before despatch. **SPECIAL STEP-BY-STEP PLANS FOR ABSOLUTE BEGINNERS.** Total building cost including case, transistors, etc.—everything etc., 2/- C.O.D. 16 extra. (Parts sold separately. Priced parts list, etc., 1/6.) As the building cost is absolutely rock-bottom (it must increase later) **DEMAND WILL BE VERY HEAVY—RUSH YOUR ORDER TO-DAY!**

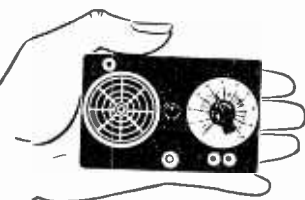

ONLY £8-12-6

BRAND NEW—NOT SURPLUS! In maker's sealed cartons. Latest UAS "Monarch" 4-speed record player complete with high-fidelity turnover" head. Type HGP 37-1. Capacity of 10 Records, plays 12 in., 10 in. and 7 in. intermixed in any order. 78, 45, 33 and 16 r.p.m. For A.C. mains 100 to 250 volts. Exclusive "magdisk" selector gives quickest and quietest change ever. With full instructions and fixing plans. Limited quantity at **£8-12-6, plus 4/6 Post, Packing, etc. WHY PAY MORE! SEND NOW WHILE STOCKS LAST!**—modernise your radiogram and increase its value.

BUILD THIS TRANSISTOR SET FOR ONLY 35/-
VERY SPECIAL OFFER WHILE STOCK OF PARTS LASTS!—The "Sky-Scout" Pocket two-stage transistor set, size only 5 in. x 3 1/2 in. x 4 1/2 in. Covers all medium waves and works entirely off tiny "pen-light" battery which costs 6d., and fits inside case. All parts tested before despatch. Can be built for 35/-, plus 2/- post and packing, including Case, Transistor, STEP-BY-STEP PLANS FOR ABSOLUTE BEGINNERS, nuts, bolts, etc. (C.O.D. 1/6 extra.) Parts sold separately, priced parts list, etc., 1/6. **VERY SIMPLE TO BUILD.**

CONCORD ELECTRONICS
 69 PRESTON STREET, BRIGHTON Dept. PWT

Orders receive prompt attention Cheques accepted. Cash on delivery 1/6 extra. I lease print name and address in block. All orders Suppliers to Schools, Universities, Government and Research Establishments. Complete range of components and valves stocked. CALLERS WELCOME. Shop Hours: 9 a.m. to 6 p.m. (1 p.m. Thursday). Regret no C.O.D. abroad.

CABINETS AND EQUIPMENT

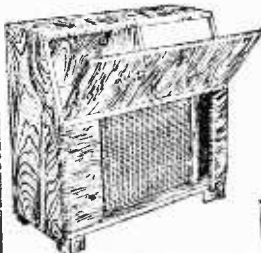

This popular Walnut Bureau Cabinet is veneered with the finest selected Walnut and beautifully polished. It is designed to accommodate any equipment with generous storage compartments.

Walnut £16-16-0
Natural Oak £18-18-0



This beautifully made cabinet is Oak veneered with Mahogany interior and is satin finished. This cabinet can be fitted with any of the latest Hi-Fi units.

CONTEMPORARY £10-15-0

We can supply and fit these cabinets with equipment of any absolutely free. Fitting

- 5v. AM Chassis ... £14. 5.0
- 5v. FM Tuner ... £13.15.0
- 5v. Switched FM Tuner ... £15.12.9
- 6v. AM/FM Chassis £20.17.0
- 7v. AM/FM Chassis £24. 6.6
- 9v. AM/FM Chassis £27. 6.0
- Motek K8 Tape Deck £15. 0.0

- Motek K9 Tape Deck £22. 1.0
- Truvox Mk. IV Tape Deck ... £30. 9.0
- 4-speed B.S.R. Changer ... £8.15.0
- 4-speed Collaro Changer ... £9.19.6
- Speakers ... from £1.12.0

Send for comprehensive illustrated catalogue of cabinets, auto-changers, speakers, etc., all available on easy H.P. terms.

LEWIS RADIO

120 (PWA), GREEN LANES, PALMERS GREEN, (N.R. Cock), LONDON, N.13. Tel. Bowes Park 1155/6.

MAKE SOUND JOINTS SIMPLY BY USING Multicore

ERSIN MULTICORE

Contains 5 cores of extra-active, non-corrosive Ersin Flux. Prevents oxidation and cleans surface oxides.

SIZE 1 CARTON

5/-

HANDYMAN'S CARTON

Suitable for 200 average joints. 6d.



Wherever precision soldering is essential, manufacturers, engineers and handymen rely on MULTICORE. There's a MULTICORE SOLDER just made for the job you have in hand. Here are some of them.

ARAX MULTICORE

FOR METAL FABRICATION (Not wire-to-tag joints)

Contains 2 cores of Arax flux. Flux residue is easily removed with water.

SIZE 8 CARTON

5/-

Handymans Carton 6d.



HOME CONSTRUCTORS 2/6 PACK

In addition to the well-known Home Constructors Pack (containing 19ft. of 18 s.w.g. 60/40 alloy) a similar pack is now available containing 40ft. of 22 s.w.g. 60/40 alloy especially suitable for printed circuits



BIB WIRE STRIPPER AND CUTTER

Strips insulation without nicking wire, cuts wire cleanly, splits extruded flex 3/16 each



MULTICORE SOLDERS LTD.,

MULTICORE WORKS, HEMEL HEMPSTEAD, HERTS. (BOXMOOR 3658)

LYONS RADIO LTD.

Dept. M.P., 3 GOLDHAWK ROAD, SHEPHERDS BUSH, LONDON, W.12 Telephone: SHEPHERDS Bush 1729

RECEIVERS TYPE R.1155 "B."—One of the most popular and best known of ex-Government communications receivers. This model is fitted with the latest type of improved slow-motion drive and has a B.F.O., A.V.C., etc. Frequency range is 75-230 Kc/s (1,500-4,000 metres), 200-500 Kc/s (600-1,500 metres), 3-7.5 Mc/s (40-100 metres) and 7.5-18.5 Mc/s (17-40 metres). Power requirements are: H.T. approx. 250 v. smoothed D.C. and L.T. 6.3 v. A.C. Supplied with circuit diagram and instruction leaflet (containing Power Pack construction data) in good condition and working order. PRICE ONLY £8.10.0. carriage 10/-.

SIEMAN'S HIGH-SPEED RELAYS.—Resistance 2,000 ohms. single contact change-over. Ex-Gov., as new. PRICE ONLY 9/6. post 9d.

ADAPTORS MONITORING No. 1.—The exact purpose of this Unit is not clear to us but they contain many useful components, including 8 valves (2 VR78, 4 VR65A, 1 VU120 and 1 VU39) and an A.C. Power Pack for 200/250 v. 50 cps. A.C. mains input and with an output of 1.5 kV, 1 kV, smoothed D.C., H.T.; 4 v. A.C. and 4 v. tapped at 2 v. A.C. Supplied with circuit diagram of P.P. in condition as new. PRICE ONLY 25/-, carr. 8/6.

APN. 1 UNITS.—Radio altimeters which in effect are Transmitter Receivers. Operational frequency is 67.42 cm. (445Mc/s). Can be converted for use in the 70 cm. band for model control. Fitted with 14 valves (4-12SH7, 3-12SJ7, 2-12HG, 2-900A, 2-955, 1-VR150-30) and many useful components, including relays and Dynamotor for 21/28 v. D.C. input and having an output of 285 v. D.C. at 75 mA. In good condition. PRICE ONLY 29/6 or less Dynamotor 25/-, carr. 7/-.

CHASSIS

UNDRILLED ALUMINIUM CHASSIS

- | | |
|-----------------------------|-----|
| 4 Sided Chassis | ca. |
| 8in. x 4in. x 2 1/2in. | 6/- |
| 8in. x 6in. x 2 1/2in. | 6/6 |
| 8in. x 8in. x 2 1/2in. | 7/- |
| 10in. x 8in. x 2 1/2in. | 7/6 |
| 11in. x 7in. x 1 1/2in. | 6/6 |
| 12in. x 8in. x 2 1/2in. | 8/- |
| 14in. x 8in. x 2 1/2in. | 8/6 |
| 16 1/2in. x 8in. x 2 1/2in. | 9/- |

2 Sided Only

- | | |
|---------------------------------|-----|
| 7in. x 4in. x 2in. | 3/- |
| 10in. x 8in. x 2 1/2in. | 4/9 |
| 16 1/2in. x 8 1/2in. x 2 1/2in. | 6/9 |

One minute hole punches and screw-up type hole punches available from 1/4in. dia. to 2in. dia. in 1/16in. steps. Send for price list. Postage and packing charged extra 1/9. Send sketch of your requirements for prices by return to:

Oliver & Randall LIMITED
40 Perry Hill, London S.E.6

THE BARGAIN OF THE YEAR



BEREC (EVER-READY) BATTERY RADIO

4 Mullard Valves

MW 200-550 m SW 20-75 m
Brand New in Sealed Cartons.
BELOW COST £5.19.6

While they last.

CASH ONLY CARRIAGE PAID
Cancelled Export Order.

Not a kit. A factory built Super-sensitive All Dry Battery Receiver. Uses Ever Ready B136 or B103 obtainable everywhere.

H. P. RADIO SERVICES LTD.,

51, County Road, LIVERPOOL, 4.
Tel.: AIntree 1445. TELEX 62-244
Established 1935

Hum Troubles

THE CAUSES AND CURES FOR ONE OF THE MOST COMMON OF SET FAULTS

By Gordon J. King, Assoc. Brit. I.R.E.

BY far the most frequent of symptoms encountered by the experimenter and service technician in all ranges of electronic equipment is that of mains hum. It has been estimated that some three-quarters of all hum complaints can be traced to defective reservoir and smoothing capacitors associated with the equipment's power supplies, and that the remaining quarter of complaints demand real investigation in order to bring to light the faulty component or circuit section.

The section of search can be narrowed down by making a few simple tests with the receiver switched on. For example, if the hum is still present with the volume control backed off, the front part of the circuit up to and including the detector stage is free from defect. Why this is so can be realised by studying the circuit diagram on page 142 (McMichael Model 153).

Here the demodulated signal appearing across the detector load resistor R22 is coupled, via C57 and switch S2—front, to the top of the volume control R23. The A.F. signal is thus developed across this control, and the required level is tapped off by the slider and applied to the grid of V3 by way of C51, the triode section of V3 serving as A.F. amplifier and the diodes as detector and A.G.C. rectifier. With the volume control at minimum, the slider is at the earthy side of the control and is thus at the point of zero signal. Should the hum level increase as the volume control is advanced, then the hum signal is accompanying the required A.F. signal across the resistive track of the volume control.

Let us suppose that the hum level remains constant irrespective of volume control setting. In order to discover whether or not it is being introduced by V3 itself, the next best move would be to short-circuit the control grid of V4 (output valve) to chassis.

Faulty Power Circuits

If this action results in little difference in hum level, then there is small doubt that the disturbance is the result of trouble in the power supply circuits. If the hum level is high and the reproduction of low volume is distinctly modulated by the ripple, the reservoir capacitor (C60A Fig. 1) being open-circuit or of low value is the most likely cause. The reservoir capacitor is that electrolytic whose positive side is connected direct to the cathode of the rectifier (or to the positive—red—terminal in the case of a metal rectifier). Such a fault may well reduce the H.T. line voltage by as much as 40 per cent., thereby promoting reduced volume as well as excessive hum.

A disturbing heavy hum, though less prone to modulate the reproduction with ripple and cause low volume, results from low value or open-circuit of a filter electrolytic, such as C60B (Fig. 1).

The quickest and most effective method of checking for suspect electrolytics is by shunting with a capacitor known to be in good condition. The value and voltage working should be approximately the same as those of the suspect. It is a good idea to keep in the tool kit a capacitor of some 8 μ F or 16 μ F (500 volts working) solely for test purposes. The capacitor can be connected to fly-leads, and the negative lead terminated by a crocodile clip for connection to the receiver chassis or negative point, while the positive lead is best terminated by an insulated test-prod. It is then a simple and convenient matter to make the negative connection and run round the positive tags of suspect capacitors with the test-prod. It is important, however, to discharge the capacitor after each test—this should be done through a 5,000-ohm resistor to avoid an instantaneous discharge which would be liable to damage the test component.

In the remote event of the electrolytics being in good condition, and hum still present with the control grid of the output valve shorted to chassis, attention should be given to the output valve itself. In A.C./D.C. receivers a heater-to-cathode leak or short in this valve reflects a strong ripple voltage into the control grid circuit and thus promotes the symptom. To be on the safe side it is most desirable to check the valve by substitution.

Unbalanced Rectifier

Unbalanced emission or failure of one side of a full-wave rectifier circuit is sometimes the cause of a slight ripple effect on the reproduction, possibly accompanied by reduced volume as the result of low H.T. voltage. In the circuit at Fig. 1, for example, open-circuit of either R43 or R44 would disconnect one anode of the H.T. rectifier (V5)—the possibility is well worth bearing in mind. Unbalanced emission resulting either in the valve itself or in the associated circuit can usually be discovered quite easily by comparing the voltage at each anode with respect to chassis (with the test meter switched to A.C., of course). If the voltage is greater at one anode than at the other, the anode on which the greater voltage exists is passing less current than the other anode, this being indicated by the smaller volts drop across the resistance of the appropriate half winding of the transformer secondary and surge limiting resistor (if used). Such a test would, of course, reveal mismatch of surge limiting resistors and transformer secondary resistance, relative to the centre-tap, as well as unbalanced valve emission.

Shorting turns in the H.T. secondary windings may well promote unbalanced voltages at the two anodes, and also result in hum, but the trouble would not be long in revealing itself more drastically in the form of serious overheating of

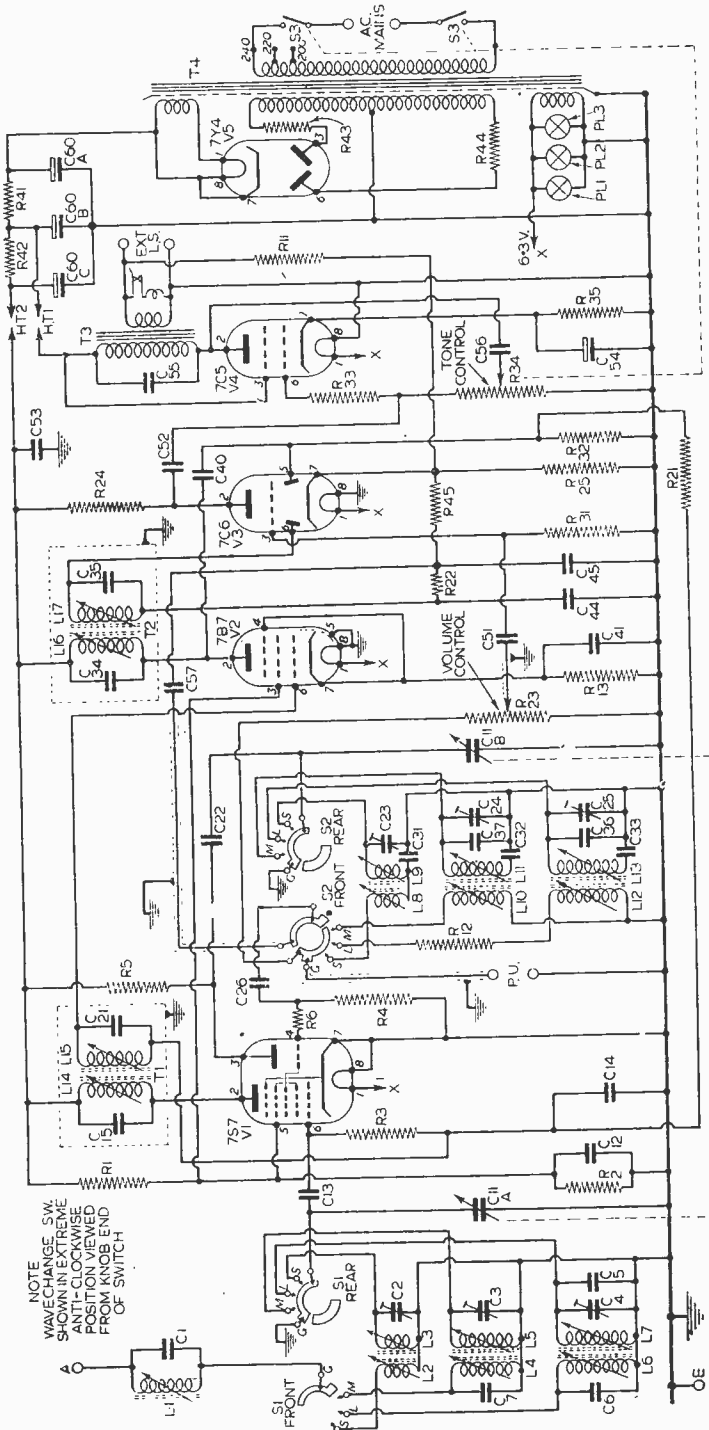

NOTE
WAVECHANGE SW.
SHOWN IN EXTREME
ANTI-CLOCKWISE
POSITION VIEWED
FROM KNOB END
OF SWITCH

Fig. 1.—Circuit of the McMichael Model 153 which is used in this article by way of explanation.

the mains transformer. If transformer trouble of this nature is suspected, the rectifier valve should be removed and the voltages at the anode tags of the valve holder compared. If the voltages differ by more than 5 to 10 per cent., the transformer is almost certainly in need of replacement.

Check the A.F. Amplifier Stage

If the hum disappears on shorting the control grid of the output valve to chassis, and is unaffected by operation of the volume control, the trouble lies somewhere in stage V3 of the circuit in Fig. 1. A high ripple content on H.T.2 line is a possible cause, and this would result from open-circuit or low value of the filter electrolytic C60C. A heater-to-cathode leak in V3 may introduce a ripple voltage across the cathode resistor R25 and thus cause it to be reflected into the grid circuit through R31. This trouble happens more often, however, in A.C./D.C. equipment in which the valve heaters are series-connected.

Pre-detector Troubles

In cases where the hum increases when the volume control is advanced, it will nearly always be found that the hum is present only when the aerial is connected and the receiver is tuned to a station. This manifestation of the symptom is usually referred to as modulation hum, since the hum actually modulates the signal on its way through the receiver to the detector.

Frequent causes in this connection are poor H.T. filtering in the R.F., frequency changer and I.F. stages (check decoupling capacitors), impaired heater-to-cathode insulation in the pre-detector valves (the best test is by

(Continued on page 145)

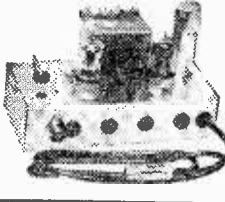

BAND 3 T/V CONVERTER—185 Mc/s - 199 Mc/s

Suitable for London, Birmingham, Northern and Scottish ITA Transmissions.

Mk. 2 Model as illustrated. Latest Cascode circuit using 6X5A1 and 6F80 valves, giving improved sensitivity (1400 over standard circuits). Built-in Power supply 100-240v. Dimensions only $4\frac{1}{2} \times 3\frac{1}{2} \times 4\frac{1}{2}$ in. H. 4 in. simple and easy to build—only external plug-in connections, wired, aligned and tested ready for use. State Channel required. Guar. Bargain Offer good results or full refund only £3.19.6. Carr. & Pack 2.6.

Mk. 1 Model using 2 6X5A1 or 6F80's. Full constructor's Kit of Parts including drilled chassis 7 in. \times 4 in. \times 2 in.

Diode/pent. valves and all components, etc., excluding Power supplies to modified W design. Bargain Offer only 2 gns. P. & P. 2.6. Power Supply Kit. Complete 20-. P. & P. 1.6. Band 1-Band III Switch Kit. 6.6.

CONVERTER ACCESSORIES
 Band I-Band III Cross-over Unit, 7.6. Var. Attenuators 640-3640. 6.9. BBC Pattern Filter, 8.6. Band III Aerials-outside Single Dipole with 4 yds. coax, etc., 13.9. 3 Element Beam, 27.6. 5 Element, 35.4, etc.

Volume Controls **80 ohm COAX**

Log. ratios, 10,000 ohms - 2 Megohms. Long windings, your guarantee. Midget Edison type.

No Sw. S.P.Sa. D.P.Sw. 3/- 4- 40
 Linear Ratio, 0.0099 ohms - 2 Megohms. Less switch, 3- each. Coax plugs, 12. Coax sockets, 1-. Couplers, 1.3. Outlet boxes, 4.6.

TWIN-FEEDER, 80 ohms. 6d. vol. 1,500 ohms. 8d. vol. **TWIN SCREEN FEEDER**, 80 ohms. 1.3 yd. 100 pf. 1.3. 250 pf. 1.6. **PHILIPS Beehive Type** - 2 to 8 pf. or 3 to 50 pf. 1- each. **RESISTORS**. Pref. values 10 ohms 10 megohms.

CARBON

20% Type, 1 w. 3d. 1/2 w. 5d. 1 w. 8d. 2 w. 9d. 10% Type, 1 w. 9d. 1/2 w. 1 w. 1.1. 1% Hi-Strib. 1 w. 2.-

WIRE-WOUND POTS Pre-set Min. T.V. Type Knurled Slotted Knob. All values 25 ohms to 20 K. 3/- ea. 50 K. 4.-. Ditto Carbon Track. 50 K. to 2 Mca. 3.-.

CONDENSERS. Mica or S. Mica. All pref. values 3 pf. to 650 pf. 6d. ea. Ceramic types, 2.2 pf. 3,000 pf. 9d. each. Tubulars, 450 v. Hunts 4 T.C.C. .0005, .001, .002, .01 and 1.50 v. Hd. .02, .05, 1.500 v. Hunts T.C.C. 1 - 25 Hums. 1.6. .05 Hums. 1.9. 1/2 2Kv. T.C.C. (50plex). 3.6. .0016 K.V. T.C.C., 5.6. .001 20 Kv. T.C.C., 9.6.

SPEAKER FRET.—Expanded Bronze anodized metal 8 in. \times 8 in. 2.3; 12 in. \times 8 in. 3.-; 12 in. \times 12 in. 4/8; 12 in. \times 16 in. 6.-; 24 in. \times 12 in. 9.-, etc.

TYGAM FRET (Murphy pattern). — 12 in. \times 12 in. 2.-; 12 in. \times 16 in. 3.-; 12 in. \times 24 in. 4.-, etc.



RECORD PLAYER CABINETS

Contemporary style, velveteen covered cabinet in mottled red with cream interior. Size 14 1/2 x 13 x 11 in. fitted with all accessories, including speaker, baffle beam and plastic fret. Space available for all modern amplifiers and autochangers, etc. (Open record player mounting board 14 x 13 in).

Cabinet Price, **£3. 3. 0.** Carr. and Ins., 6.6.
2 VALVE AMPLIFIER (to fit above cabinets) modern circuit with EL84 output, ready built, with 6in. speaker and output transformer, **£12.12.6.** Carr. and Ins., 2.6.

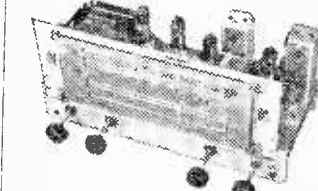

ALL-WAVE RADIOGRAM CHASSIS

3 WAVEBANDS S.W. 14 m. 50 m. LATEST MIDGEET M.W. 200 m. - 500 m. B.V.A. L.W. 800 m. - 2,000 m. SERIES

Brand new and long. A.T. 200-250 v. 4 pos. High sw. short-medium-long-gram. P.F. socket. High AVC and neg. feedback. O.P. 4 watts. Chassis size 13 1/2 x 5 1/2 x 2 1/2 in. Dial 10 in. Hor. or Vert. station names. Walnut or ivory knobs to choice. And quality at Low Cost.

Chassis isolated from mains. **BARGAIN 9 1/2 gns.** Carr. and Ins., 4.6.
 9 or 10in. speakers to match. 20 - and 25.-
7 Valve De Luxe, push-pull EL41 version, 7 watt output, with H Duty Output Transformer, £12.10.0. Carr. & Ins., 2.6

RECORD PLAYER BARGAINS
 4 sp. BSR (T19). 99.6. 4 sp. COLLARO, 5 gns. 4 sp. GARRARD (4 S.P.). 57.10.0. Carr. & Ins. 3.6.
AUTO CHANGERS. 4 sp. BSR (DAS). 28.15.0. 4 sp. COLLARO (RC45B). 29.10.0. 4 sp. BARGAIN RARD (RC120 4B). 9/ gns. Carr. & Ins., 4.6.
 All above units are latest models and are fitted with modern stylized Light Xtd. P.F. with turnover head and twin sapphire styli.

SCOTCH ROY, EMITAPE, etc., 1,200ft., 27.-. Long playing, 1,200ft. reels, 45/- . Paper tape, good quality, 1,200ft., 12.8. Reels only, 3in., 3 -; 5in., 3.8; 7 1/2 in., 4 -; 7 in., 4.3.

SPECIAL OFFER
 Recording tape by famous manufacturer, 1,200ft. on standard 7in. plastic spool (superior quality).
Special Price, 22/6
 (normal price, 35/-)

NEW BOXED VALVES ALL GUARANTEED

1R5, IT 17 8 DP96	9- 9E41	10 6 PF72	10 6
1N5, 184 7 8 DK96	9- 9E90	10 6 PL62	12 6
384, 3V4 8 - DL96	9- 9E91	10 6 PL82	10 -
324 9 8 53L6	10 6 EP91	8 6 PL82	11 6
4V4 6 8 LABC80	9 8 EL41	10 6 PY80	9 6
6K7 6 6 EB91	6 6 EL84	11 6 PY81	9 6
6K8 8 6 EB41	10 6 5M85	11 6 PY82	9 6
907 8 6 EC83	9 6 EY51	12 6 PY83	10 6
6X7 8 6 EL784	12 6 EY86	14 6 122	8 6
6Y6 7 8 8 196	12 6 6Z40	8 6 U25	12 6
6X4 7 8 EC82	12 6 6Z80	8 6 UCH-42	10 6
6X5 7 8 6 3042	10 6 6Z80	8 6 UCH-42	10 6
754 9- 9ECH81	10 6 M713	9 6 U41	10 -
705 8 6 PCL80	10 6 PM84	10 6 U41	10 6
DAP96 9- 6 PL82	12 6 PF80	10 6 V11	9 6

SPECIAL PRICE PER SET
 1R5, IT 17 8 DP96, 9E41 or 9V4 27 6
 DK96, DP96, DAP96, DL96 35/-
 6K8, 6K7, 907, 8V6, 5Z4 or 6X5 35/-

ELECTROLYTICS ALL TYPES NEW STOCK

Tubular Wire Ends	32 x 32 350 v. B.E.A. 5 6
25 25 v., 50 12 v.	1 9
30 50 v., 4 500 v.	2
100 25 v., 2 450 v.	2 2
8 450 v. B.E.C.	2 2
8 500 v. Dub.	2 9
8 5 500 v. Dub.	4 6
8 14 150 v. T.C.C.	5
16 450 v. B.E.C.	3 6
16 500 v. Dub.	4
16 16 450 v. T.C.C.	5 6
32 500 v. Dub.	4
32 500 v. Dub.	5
30 30 350 v. B.E.A.	6 6
32 x 32 350 v. T.C.C.	2 6
8 x 16 450 v. T.C.C.	4 6
16 x 16 450 v. T.C.C.	5 6
8 x 16 450 v. T.C.C.	5 6
80 x 16 250 v.	11 8
60 x 60 275 v.	12 6
100 x 250 275 v.	12 6

Many other types in stock.
TRANSISTOR.—Midget Electrolytics.
 2 mfd., 4 mfd., 8 mfd., 6 v. 3 6
 6 mfd., 16 mfd., 16 mfd., 3 v. 3 6
SENTECEL RECTIFIERS.—M.H.T. Type. Phys. Back Voltages, K3 25 2 kv., 5 -; K3 40 3.2 kv., 6.9; K3 45 3.6 kv., 7.3; K3 50 4 kv., 7.8; K3 100 8 kv., 13.6. **MAINS TYPES**.—RM1, 125 v. 60 mA.; 4.9; RM2, 125 v. 100 mA.; 5.6; RM3, 125 v. 125 mA.; 7.6; RM4, 250 v. 250 mA., 16 -; RM4B type 250 mA., 17.6; RM5, 250 v. 300 mA., 21 -.

I.F. TRANSFORMER 465 kc/s
 Brand new ex-manufacturer's midget I.F.T., size 2 1/2 in. \times 7 in. dist. core tuning. Litz wound coils, High Q. Bargain offer, 7/6 pair.

MAINS TRANSFORMERS.—Made in our own Workshops to Top Grade spec. Fully interleaved and Impregnated. **RADIO AND AMPLIFIER**
 Type. —250 v. 60 mA. F.W. sec. 5 v. or 0.3 v. 1.4 amp. rect. 6.3 v. 2.5 amp. H.T. 25/6 etc. C.R.T. H.T. **ISOLATION TYPE**.—Low leakage with or without 25%, sec. boost voltage. Ratio 1:1 or 1:1.25. 2 v. 4 v. 9 v. or 13 v. 10 6 ea. Ditto with mains primaries 20 v. 250 v. 12 6. SDX 11A8 to order.

L.F. CHOKES.—In H. 100 mA., 5 -; 15 H. 100 mA., 10 6; 10 H. 120 mA., 10 6; 20 H. 150 mA., 15 6.
OUTPUT TRANS.—Standard pentode, 4 8; push-pull 12 watt, 13 6. Small pentode, 3/9. Midget battery pentode (184, etc.), 4 6.
SPEAKERS.—Patented 8 in. \times 8 in. Blac., 16 6. 3 1/2 in. Goodmans, 18 6; 5 in. R. & A., 17 6; 5 in. Clifton, 18 6; 7 x 4 in. Goodmans, 18 6; 8 in. Rola, 20 -; 8 in. Special C.M. Goodmans, 21 6; 10 in. R. & A., 25 -.

8 in. P.M. SPEAKER (3 ohm)
 Ex-Mfrs. units, Rola, W.B. Celeston, etc. All reconditioned and guaranteed. Ideal ext. unit. 7.6. P. & P. 1.6. Ditto with 0 P Trans., 9 6.

F.M. TUNER UNIT (87 mc s-105 mc s) by Jason. As described in Radio Constructor. Designer Approved Kit of parts to build this modern highly successful unit, drilled chassis and superior type lit. glass dial, coils, cans and all quality components, etc., for only 5 gns., post free. Set of 4 specified min. valves, 30 -, post free. Illustrated handbook, with full details, 2 - post free. 2-day alignment service now available. 7 6 plus P.A.P.

TRS RADIO COMPONENT SPECIALISTS (Est. 1946)

70 BRIGSTOCK ROAD, THORNTON HEATH, SURREY (THO 2188)



50 yards Thornton Heath Station.
 Listed above are only a few items from our very large stock.
 Hours: 9 a.m.—5 p.m. 1 p.m. Wed.
 See 1 3d. stamp to lay for Complete Bargain List. OPEN ALL DAY SAT.

TRANSFORMER & COIL/WINDING CAPACITY AVAILABLE FOR PROTOTYPE & SMALL RUNS.

Terms C.W.O. or C.D.F. K.L.G. and C.L.G. (P.A.), etc., payable to T.R.S. Post/Packing up to 1lb. 7d., 1lb. 1, 1, 1lb. 1, 6, 5lb. 2, - 10/5. 2/9.

Let I.C.S. Train YOU!

● **COURSES ON :—**

**RADIO and TELEVISION
SERVICING · ELECTRONICS**

● **EXAMINATION COURSES FOR :—**

P.M.G.'s CERTIFICATE (Marine Radio Operators)

C. & G. RADIO AMATEURS' EXAM.
(Amateurs' Transmitting Licence)

C. & G. RADIO SERVICING CERTIFICATE (RTEB)

BRITISH INSTITUTION OF RADIO ENGRS., etc.

Whether you plan to have your own business, to become an electronics engineer or to take up a career in industry, an I.C.S. Course will help you to success. You learn at home in your own time, under expert tuition. Moderate fees include all books.

● **LEARN - AS - YOU - BUILD
Practical Radio Course**

A basic course in radio, electronic and electrical theory backed by thorough practical training. You build a T.R.F. and a 5-valve superhet radio receiver, signal generator and multi-tester.

Other Learn-as-you-Build radio courses are available

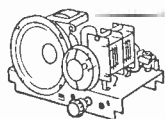

5-VALVE SUPERHET RECEIVER

MULTI-TESTER
(sensitivity
1,000 ohms per volt)



RF/AF SIGNAL GENERATOR

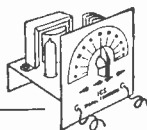

● **POST THIS COUPON TODAY** for FREE book on careers in Radio, etc., and full details of I.C.S. Courses.

**INTERNATIONAL CORRESPONDENCE
SCHOOLS**

Dept. 170H, International Buildings, Kingsway, London, W.C.2.

Name..... Age.....
(Block Letters please)

Address.....

Occupation..... 4.58

**INTERNATIONAL
CORRESPONDENCE SCHOOLS**

EXCLUSIVE OFFER OF THE R. 107

THE ARMY'S FINEST COMMUNICATIONS RECEIVER

Just purchased from the Ministry of Supply, this magnificent 9 valve 3 Wave-band receiver gives World Wide Reception over a coverage of 1.2-17.0 Mc/s (18-250 metres), taking in several important Amateur Bands, Shipping Band, and part of the Medium Wave Band, including the B.B.C. Light Programme, sensitivity is 1 micro-volt on CW, and 2-6 micro-volts on RT. The controls include a Bandwidth Switch ("Wide" or "Narrow"), choice of A.V.C. and B.F.O., Audio Filter, R.F. Gain, Aerial Trimmer. Has built-in Output Stage with Internal Speaker, which can be switched out to use Headphones. Uses normal international Octal Valves. Incorporates A.C. Mains Power Unit for 100-250 volts, and Vibrator Pack for 12 volts D.C. In Grey Metal Case size 24" x 13" x 17". These sets are slightly used, but in first class condition, thoroughly checked and aerial tested before despatch.

COMPLETE, READY TO SWITCH ON

£8-19-6

(Carriage 2/- England and Wales, rest of U.K. extra).
S.A.E. for Illustrated Leaflet.

COLLINS TCS TRANSMITTERS. Special offer of these famous American Transmitters. Frequency Range 1.5-12.0 Mc/s in 3 bands. Employs 7 valves, 2 of 1625 in P.A. Stage, 1625 buffer and 1625 modulator stage, 3 of 12A6 in Oscillator stage. Radio Tele- phone or Radio Telegraph. Provision for VFO or Crystal Control 4 Crystal positions. Has Plate and Aerial Current meters. IN BRAND NEW CONDITION. ONLY £12.10.0 (carriage, etc., 15/-).

WIRELESS SET NO. 19Mr. II.—The famous Army Tank Transmitter-Receiver, incorporates "A" Set (TX/RX covering 2.0-8.0 Mc/s, i.e. 37.5-150 metres). "B" Set (VHF, TX/RX covering 230-240 Mc/s, i.e. 1.2-1.3 metres) and intercommunication Amplifier. Complete with 15 valves as follows : 6 of 6K7G, 2 of 6K9G, 2 of 6V6G, and 1 ea. 6B3C, 6H6, E1148, EF50, 807 and booklet giving circuits, notes, etc. Size 17 1/2 in. x 8 1/2 in. x 12 in. Magnificently made by famous American firms. IN BRAND NEW CONDITION. ONLY 65/- (carriage, etc., 10/-).

12 VOLT POWER UNIT for the above available, 25/- (carriage, etc. 5/-).

6 v. VIBRATOR PACKS. Output approx. 130 v. at 30 mA., fully filtered and smoothed. Complete. ONLY 12/6.

R1155 SUPER SLOW-MOTION TUNING ASSEMBLY. As used on all late model 1155s. Easily fitted to "A" sets, etc. ONLY 12/6.

E111 TRANSFORMERS. 5.5 kv. (Rect.) with 2 v. 1 a., 79/8. 7 kv. (Rect.) with 2 v. 1 a., 89/6. 2.5 kv (Rect.) with 2.0-2 v. 1.1 a., 2.0-2 v. 2 a. (for VCR97 tube, etc.). 42/6 (postage 2/- per trans.).

POCKET VOLTMETERS.—Read 0-15 volts and 0-300 volts A.C. or D.C. BRAND NEW AND UNUSED. ONLY 18/6.

CRYSTALS. British Standard 2-pin 500 kc/s. 15". Miniature 200 kc/s and 465 kc/s 10" each.

ROLA 6 1/2 in. P.M. SPEAKER. Mounted in grey crackled metal cabinet 9 in. x 9 in. x 4 1/2 in., with volume-control. Ideal for use with receiver, or as extension. BRAND NEW. ONLY 27/6. (Post 2/6).

MAINS ISOLATING TRANSFORMER. Manufactured by Vortexion. Fully shrouded. Will provide true 1 : 1 ratio from nominal 230 v. Primary. Rated at 100 watts. BRAND NEW. ONLY 22/6. (Post 2/6).

HARRIS ELECTRONICS

(LONDON) LTD.

138 Gray's Inn Road, London, W.C.1.

(Phone TERMINUS 7937).

Please include carriage costs on ALL items.

(Open until 1 p.m. Saturdays. We are 2 mins. from High Holborn (Chancery Lane Station) and 5 mins. by bus from King's Cross).

substitution) and feedback of harmonics of the mains frequency to the aerial input circuit of the set. In the latter case the effect may be aggravated by a considerably distorted mains waveform applied to the set. Sharp charging pulses at the input of the mains filter circuits are also responsible for the production of interfering harmonics which result in modulation hum.

The cure is sometimes difficult to find, particularly if the disturbance is present only on a heavily loaded mains circuit. However, the fol-

lowing from some other equipment connected to the mains supply near by. Television receivers are frequent offenders in this respect. Mains filters connected to both the affected and offending receivers are often called for, while a good aerial and earth system at the affected end invariably pays dividends.

Points to Watch

When making a substitution test with an electrolytic, as described earlier, it sometimes happens that the sudden surge due to the connection of

LIST OF COMPONENTS

C1—500 pF.	C24—4.40 pF.	C52—0.1 μ F.	R21—1 M Ω .
C2—4.40 pF.	C25—4.40 pF.	C53—0.1 μ F.	R22—47 K Ω .
C3—4.40 pF.	C26—100 pF.	C54—3.5 μ F.	R23—2 M Ω .
C4—4.40 pF.	C31—6,770 pF.	C55—.001 μ F.	(Volume control)
C5—20 pF.	C32—503 pF.	C56—500 pF.	R24—390 K Ω .
C6—1,000 pF.	C33—150 pF.	C57—.01 μ F.	R25—33 Ω .
C7—250 pF.	C34—100 pF.	R1—18 K Ω .	R31—10 M Ω .
C11a and b—13.5—528 pF.	C35—180 pF.	R2—47 K Ω .	R32—1 M Ω .
C12—0.1 μ F.	C36—60 pF.	R3—1 M Ω .	R33—100 K Ω .
C13—100 pF.	C37—10 pF.	R4—47 K Ω .	R34—0.5 M Ω .
C14—0.1 μ F.	C40—50 pF.	R5—18 K Ω .	R35—390 Ω .
C15—100 pF.	C41—0.1 μ F.	R6—100 K Ω .	R41—750 Ω .
C21—100 pF.	C44—100 pF.	R11—680 Ω .	R42—1 K Ω .
C22—100 pF.	C45—100 pF.	R12—680 Ω .	R43—100 Ω .
C23—4.40 pF.	C51—.01 μ F.	R13—270 Ω .	R44—100 Ω .
			R45—470 K Ω .

lowing dodges are well worth trying: connect an 0.1 μ F 300-volt A.C. capacitor across the mains supply to the receiver; connect an 0.01 μ F A.C. capacitor (of suitable voltage) between the anode of the rectifier valve and chassis—both anodes should be so decoupled where a full-wave rectifier is used; reverse the mains plug in its socket; check on the efficiency of the aerial and—most important—the earth system; check the H.T. rectifier by substitution; connect an R.F. choke across the aerial and earth terminals of the set.

It often happens that modulation hum, or a very similar symptom, is caused by interference

the test part temporarily “heals” the faulty capacitor. This can be avoided, however, if the substitution capacitor is charged before being connected to the circuit.

Watch out for poor chassis connections during the course of investigating for hum troubles. A high resistance connection sometimes develops between the tags riveted to the chassis and used as common earthing points. If the tag happens to be associated with the power circuits as well as decoupling points for the A.F. and I.F. stages a high hum level invariably results, possibly accompanied by instability at high volume settings.

News from the Clubs

THE AMATEUR RADIO CLUB OF NOTTINGHAM (G3FKW)
Hon. Sec.: F. V. Farnsworth, 32, Harrow Road, West Bridgford, Nottingham.

NOTTINGHAM Amateur Radio Club continues to meet every Tuesday and Thursday at Woodthorpe House, Mansfield Road, Nottingham and welcomes new members. Top-band is being worked regularly from the club room, which has good facilities for construction work. Morse practice and discussions on all aspects of amateur radio. Details from hon. sec.

WELLINGBOROUGH AND DISTRICT RADIO AND T.V. SOCIETY (G3KXS)
Hon. Sec.: P. E. B. Butler, 84, Wellingborough Rd., Rushden, Northants.

AT the A.G.M. held on January 9th the chairman, Mr. G. Wilford, said that a full winter programme, now half way through, had provided interesting and instructive lectures.

The equipment officer, Mr. R. Tilley (G3KSC), reported that a modulator had been constructed for the club T.X., which would be going on the air, on phone, in the near future.

The following officers were elected for the coming year.
Mr. G. A. Wilford, chairman; Mr. P. E. B. Butler, secretary; Mr. N. Seabrooke, treasurer; Mr. R. Tilley (G3KSC), equipment officer.

On Saturday, March 8th the society visits Northampton Power Station, and on March 12th Mullard Ltd. presents a film and lecture on the “History and Development of the C.R.T.” April 3rd, Mr. R. Marriott will answer TV queries and on April 17th a junk sale will be held.

Meetings are held every Thursday evening, 7.30 p.m., at the club room above the C.W.S. fruit shop, Silver St., Wellingborough.

Visitors and new members welcome. Details from hon. sec

THE BOURNEMOUTH AMATEUR RADIO SOCIETY
Hon. Sec.: C. R. Davies (G3JAU), 107, Talbot Road, Winton, Bournemouth.

AT the A.G.M. held on January 3rd the following were elected for 1958:

Chairman: D. A. Pilley (G3HLW).

Secretary: C. R. Davies (G3JAU).

Treasurer: J. Glass.

Membership is now 45 of which 24 are licensed amateurs. Meetings are held regularly on the first Friday of every month at our headquarters, The Cricketers Arms, Windham Road, Bournemouth, and a warm welcome is extended to new members and visitors.

Programme Pointers



Our Critic, Maurice Reeve, Reviews Some Recent Programmes

THE hundred and fiftieth programme in the "Music to Remember" series affords the opportunity for choosing it to open this month's notes. They are given on Monday evenings at 7 p.m., before an invited audience, in all parts of the country, and last for one hour. Mostly they are provided by the regional orchestras—though by no means always—and frequently they contain a soloist. Though occasionally the programmes contain a number which would best be forgotten, most items are well worth remembering. Furthermore, the choices can seldom offend the general body of unsophisticated music lovers for whom they are presumably meant to cater—the "others" won't be listening, anyway. The performances are always average to good.

But perhaps their chief feature is that each item is "introduced" by a well-known music critic or pedagogue, which is, perhaps, the point where the highbrow listener dons his hat and mutters to himself, "I've heard those dashed remarks so many times before that I'll throw a flowerpot at somebody if I'm forced to endure, them again."

Hasn't everybody, for that matter?

For thirty years now the BBC has given us every single work in the repertoire dozens and hundreds of times and nearly always with historical and biographical details. As these are very circumscribed even for the largest and most complicated work, the public has long since wearied of them past the point of satiety. Whilst the gentlemen performing this task do so with delightful and *saue* erudition, it is high time that the listener was relieved of the boredom of their endless repetition, especially by announcers from legitimate symphony concerts. I respectfully suggest a twelve months truce, during which time the public can express their wish for their return if they want them.

Topical Affairs

The monthly programme "Radio Link" is one of the most vital and forceful of all the periods devoted to topical affairs. This, doubtless, is because it is either unscripted, or less inhibited, than any of the others; one cannot hear the speakers "turning the pages." It is very breezy, forthright and refreshing. The last issue I heard featured Mr. Aneurin Bevan being interviewed from London, Paris, Washington and Moscow respectively and simultaneously. Robert McKenzie was the admirable chairman. "At Home and Abroad," as well as some of the others, have become very stilted, stuffed-shirted and announcer-ridden. "Radio Link," so far, is like

standing on Hastings promenade in the teeth of a good sou'-wester coming up the Channel.

The late Richard Tauber had a magnificent tenor voice which was heard far too often in light, and not nearly often enough in serious, classical opera. An hour's programme honoured the tenth anniversary of his death. Though the script of Roy Plomley made him out as never putting a foot wrong—they never do!—the many excerpts from his various successes showed just the wrong turnings his—artistic—career took. It was a well-balanced if conventional feature, contributed to by many well-known personalities and including some of Tauber's own recordings.

"Don't Do It Yourself"

The name of the editor of this and his numerous other "Practical" journals is known to tens of thousands up and down the land. But his voice is naturally known to fewer, among whom his present correspondent is happy to number himself. It came over in its familiar tones in a telling talk, on Network Three, which he styled "Don't Do It Yourself." To do or not to do, electrocute yourself or play safe, let the baby suck the lead paint off his pram or his fingers; all this, and much more besides, was in this tightly packed *quart d'heure*.

Adapted Novel

Richard Hurdall, Marjorie Westbury, Norman Shelley and Deryck Guyler headed a very long cast in an adaptation for radio of the novel by Gilbert and Margret Hackforth-Jones, "Fish Out of Water." An exciting war-time story of the chase, successful, of course!, after some deliberately-made sub-standard mines.

Some of these stories would do more good in a staff college or cadet school than many of the instructors one meets with at such places; no one ever puts a foot wrong or says anything but the right thing on the instant. The power of command is overwhelming, heroism is instructive and the villains are doomed from before the curtain rises. With beautiful women thrown in for good measure and love equally triumphant with duty, what a syllabus they would furnish. The recruiting queues might reach Cup Final proportions. It made a good radio play.

A repeat hearing of Dame Peggy Ashcroft in "Hedda Gabler" was worth most of the Monday night pieces rolled up into one.

Wanted!

QUALIFIED MEN AND WOMEN

Industry and Commerce offer their best posts to those with the qualifications—appointments that will bring personal satisfaction, good money, status and security. As part of a modern industrial organisation, we have skilled knowledge of what is required and the best means of training personnel for present day and future requirements. We specialise also in teaching for hobbies, new interests or part-time occupations in any of the subjects listed here. Write to us to-day for further information. There is no obligation of any kind.

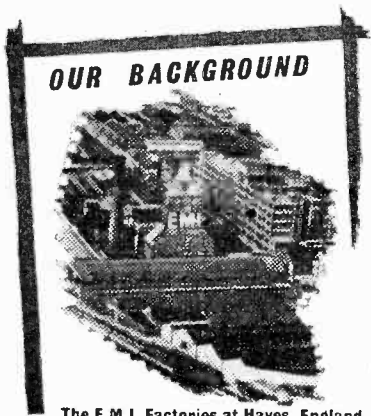

OUR BACKGROUND

PERSONAL & INDIVIDUAL TRAINING IN —

- | | | | |
|---------------------------------------|-------------------------|------------------------------|---------------------|
| Accountancy | Draughtsmanship | Mathematics | Sales Management |
| Advertising | Economics | M.C.A. Licences | Sanitary |
| Aeronautical Eng. | Electrical Eng. | Mechanical Eng. | Engineering |
| A.R.B. Licences | Electrical Instal. | Metallurgy | Salesmanship |
| Art (Fashion, Illustrating, Humorous) | Electronics | Motor Eng. | Secretaryship |
| Automobile Eng. | Electronic | Painting & Decorating | Servo Mechanisms |
| Banking | Draughtsmanship | Photography | Shorthand & Typing |
| Book-keeping | Eng. Drawing | P.M.G. Certs. | Short Story Writing |
| Building | Export | Police | Short Wave Radio |
| Business | Gen. Cert. of Education | Production Eng. | Sound Recording |
| Management | Heat & Vent. Eng. | Production | Telecommunications |
| Carpentry | 'Hi-Fi' Equipment | Planning | Television |
| Chemistry | High Speed | Radio | Time & Motion Study |
| City & Guilds Exams | Oil Engines | Radio Amateur | Tracing |
| Civil Service | Industrial Admin. | (C & G) Licence | Transistors |
| Commercial | Jig & Tool Design | Radio Engineering | Welding |
| Subjects | Journalism | Radio & Television Servicing | Workshop Practice |
| Commercial Art | Languages | Refrigeration | Works Management |
| Computers | Management | | etc., etc. |
| Customs Officer | Maintenance Eng. | | |

Also courses for GENERAL CERTIFICATE OF EDUCATION, A.M.I.H.&V.E., A.M.S.E., A.M.Brit.I.R.E., A.M.I.Mech.E., A.M.I.E.D., A.M.I.M.I., A.F.R.Ae.S., A.M.I.P.E., A.M.I.L.A., A.C.C.A., A.C.I.S., A.C.C.S., A.C.W.A., City & Guilds Exams., R.T.E.B. Servicing Certificates, R.S.A. Certs., etc., etc. Moderate fees.

The E.M.I. Factories at Hayes, England.
The only Home Study College
 operated by a world-wide
 manufacturing organisation

EMI

INSTITUTES

NEW! Courses with **PRACTICAL EQUIPMENT**

in **RADIO · TELEVISION · MECHANICS**
CHEMISTRY · ELECTRICITY
DRAUGHTSMANSHIP · PHOTOGRAPHY etc., etc.

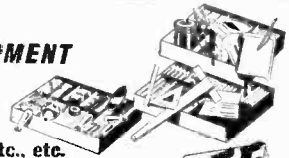

POST THIS TODAY

To: E.M.I. INSTITUTES, Dept. 32K, London, W.4.
 NAME _____ AGE _____
 (if under 21)

ADDRESS _____

I am interested in the following subject(s) with/without equipment _____

APR/58 (We shall not worry you with personal visits)



BLOCK
CAPS
PLEASE

IC92

-part of "His Master's Voice" Columbia, etc., etc.

FUN TO BUILD AND A THRILL TO OWN!



BUILD THIS SHOULDER/POCKET SET FOR 38/-

It's fun to build this "POCKETPAL" shoulder or pocket radio. So easy to build—it covers all the medium waveband with exceptional sensitivity and selectivity. Features a high efficiency pentode valve in well tested, powerful circuit. Personal phone ALL DRY battery operation (Batteries fit inside) slings over the shoulder—AERIAL IS INSIDE THE SLING LEAD!—or slips into pocket. Minisize 3" x 2" x 5 1/2". Build in about 40 minutes WITHOUT ANY EXPERIENCE, using our "STEP-AND-CHECK" INSTRUCTION MANUAL WHERE EVERYTHING YOU DO IS SPELLED OUT FOR YOU IN PICTURES SO YOU CAN'T GO WRONG! This "POCKETPAL" radio can be built for only 38/- including Case, Valve, Manual, Nuts, etc. Post & Packing is 2/- (C.O.D. 2/-). PARTS SOLD SEPARATELY—shopping list, etc., 1/6. HEAVY DEMAND CURRENT—DON'T PUT IT OFF—SEND NOW!



BUILD THIS FOR ONLY 35/-!

It's fascinating to build this "fantabulous" "TOM-TITUMB" transistor radio—only the size of a small cigarette packet, yet a marvel of clarity giving unexcelled transistor reception over all the medium-waves. Personal phone circuitry gives loud and clear tone. Can be built by absolute novice in 30 minutes providing endless listening pleasure the moment building is completed. Uses only one small 8d. penlight battery lasting months. Absolute beginners are assured of error-free building because of our SPECIAL INSTRUCTION MANUAL—WHERE EVERYTHING IS SPELLED OUT FOR YOU IN PICTURES—SO YOU CAN'T GO WRONG! It costs only 35/- to build the "TOM-TITUMB" including Case, Transistors, Manual, Nuts, etc. Postage & packing amount to 2/- (C.O.D. 2/-). PARTS SOLD SEPARATELY—shopping list, etc., 1/6. EASY TO BUILD, THRILLING TO OWN—SEND AT ONCE!

BUILD THIS MAINS "FRYING-PAN" RADIO FOR ONLY 68/6!



Build this MAINS "FRYING-PAN" SPECIAL, uses highly sensitive twin-triode valve circuit and normal size speaker. Covers all Medium and Long Waves giving amazing performance and tone. Costs only 1d. for about 75 hours use! Excellent for KITCHEN, bedroom, garden hut, etc., etc. Robust design.

ANYONE CAN FOLLOW. Can be built for 68/6d. including valves, speaker, step-by-step plans, etc. Postage and packing 3/- (C.O.D. 2/-). PARTS SOLD SEPARATELY—shopping list, etc., 1/6. WILL PAY FOR ITSELF AGAIN AND AGAIN!—RUSH YOUR ORDER TODAY.

NOTE: Complete range of components stocked, regret no orders sent abroad, cheques gladly accepted. Sorry no callers at present.

MERLIN LABORATORIES (Dept. PW2). 167a PORTLAND ROAD, HOVE, SUSSEX

"D I Y"

Yes! YOU can DO IT YOURSELF with the aid of our RADIO HOME CONSTRUCTION HANDBOOK! Over 100,000 enthusiasts already have earlier issues of this famous publication which gives full parts lists, circuits, etc., of many receivers, tape recorder, oscilloscope feeder units, communications set, hi-fi amplifiers, power pack, crystal set, etc. It is also packed with data, construction, soldering and servicing hints, facts, formulae, colour code, etc. Our latest "Easy-as-A.B.C." FULL SIZED p.p. Construction sheets are available FREE with orders so that even the beginner gets professional results first time! This claim is confirmed by many hundreds of genuine testimonials received. Send 3/- to-day for your copy. (Worth much more!) NOWHERE IS THERE A BOOK SO VALUABLE TO THE NOVICE CONSTRUCTOR AND EXPERT!
RODING LABORATORIES
Hurn Airport, Christchurch, Hants

TELEVISION TUBES

RECLAIMED GUARANTEED :
12"—£6 14"—£5 17"—£7.10.0
CARRIAGE AND INSURANCE 15/6 EACH TUBE.
FULLY GUARANTEED HIGH QUALITY REBUILT
10"—£8.10.0 12"—£9 14"—£10.10.0 15"—£12.10.0
17"—£12.10.0
CARRIAGE AND INSURANCE INCLUSIVE
PRIME ELECTRICS (Dept. W/3)
36, QUEENSDALE ROAD, W.11
Phone: PARK 1131
CALLERS 10.30-3 MON.-SAT. CLOSED WED.

TRANSISTORS ARE OUR SPECIALITY FULL TECHNICAL ADVICE SERVICE ALL PRICES ARE POST PAID

Transistors. Red Spot, 8/-, Red Yellow Spot (R.F.), 21/-. Green (Audio), 10/-. Crystal Diodes, 1/3.
7-Transistor Portable Circuit, 1/6.
3-Transistor Radio Circuit, 11d.
Complete kit £3.17.6. Speaker extra.

ELECTROLYTICS—GUARANTEED
15 mfd. 450 v. 150 mA. 1 1/2" x 1 1/2" 2 4 each.
8-9 mfd. 450 v. 100 mA. 1 1/2" x 1 1/2" 2 9.
8-16 mfd. 450 v. 100 mA. 1 1/2" x 1 1/2" 2 9.
50 mfd. 50 v. 1 6. 25 mfd. 25 v. 1 8.
Condensers : .01 mfd. 1,000 v. 6d.
.1-350 v. 8d. .002 150 v., 6d. .005 150 v., 6d.
Resistors: All Values 10% 1 watt, 6d. ea.

HEADPHONES, Low Res. Ex.W.D. 9 11
TERMS : C.W.O. or C.O.D. (over £25)
FULL COMPONENT LIST, 6d.

OAKFIELD RADIO
44 OAKFIELD ROAD, STOKPORT

Fidelia HAND BUILT

Fidelia genuine hand built real high fidelity equipment for those people who desire the finest.
Major AM/FM 12 valves, £44.
De-Luxe AM/FM 11 valves, £34/10/0.
Imperial, high fidelity amplifier and VHF tuner, £34.
Full details willingly but 6d. in stamps is appreciated.

ELECTRO ACOUSTIC DEVELOPMENTS
2, Amhurst Road, Telscombe Cliffs, Sussex.

PULLIN SERIES 100 HIGH RESISTANCE TEST METER A.C./D.C. 10,000 ohms/volt 21 RANGES 100 microamps to 1000 v.

Complete in die-cast case with test leads, clips & prods.
FULLY GUARANTEED

CASH PRICE or Deposit £2-10-0 & nine further monthly payments of £1-4-6.
£12-7-6
Illustrated brochure free on request

FRITH RADIACRAFT LTD
69-71 CHURCH GATE LEICESTER
& 28 HIGH ST NEWPORT PAGNELL Bucks

Open to Discussion



The Editor does not necessarily agree with opinions expressed by his correspondents

Converting the Command Receiver

SIR.—Mr. Coulson's interesting articles on the above-mentioned subject appeared in issues of PRACTICAL WIRELESS for November/December 1957, and he closed his helpful directions with the comment that he is unable to suggest any further modifications in the case of this particular receiver.

I have taken matters a stage further in the modification of the B.C.455 and in the thought that your readers may find the conversion of interest, I give a circuit diagram using the same part numbers as Mr. Coulson.

Very briefly, what I have done is to take out the last two valves in the B.C.455—that is, the 12SR7 and the 12A6. After removing the wiring from the 12A6 base except the heater leads, I replaced the 12A6 with a 12K8 using the B.F.O. oscillator coil to convert the I.F. frequency of the 455 to 200 Kc/s. The output from the 200 Kc I.F. transformer is taken to the aerial lead of a B.C.453 and the latter receiver is tuned to 200 Kc/s. I have three R.F. 24s working on 10, 15 and 20 metres respectively, coupled to the B.C.455 and thence to the B.C.453.

This conversion has been working for more than a year and the result is greatly improved selectivity and remarkably quiet reception when one thinks that there are four frequency conversions involved.

Good luck to your interesting magazine which I have enjoyed regularly for years.—A. D. Forsyth (Pretoria).

A Reader's Satisfaction

SIR.—Perhaps there are many in my circumstances who cannot afford to keep paying out for the meters used in these handy little gadgets described in PRACTICAL WIRELESS, for instance the "Simple One Meter Transistor Tester" and the "Condenser Condition Tester" in the February 1958 issue, which would have cost me over a

pound (£1), just for these two items. However, being the owner of an Avo F, I made up the components as described, but where the leads to the meter ran, I led to two holes through tin, finished them off with two spade plugs and coupled them to Avo meter set to appropriate range.

Now I merely couple AVO up to whichever unit I require to use.—R. J. PIERRE (Southend-on-Sea).

Amateur Transmitting

SIR,—I should like to say how much I agree with "Old Timer's" encouragement to budding amateurs; I am a classified C.C.F. operator, and am seventeen and a half years old. Yet, despite the fact that I have access

to a large amount of equipment, I cannot take the R.A.E./morse exams, for apart from the fact that I have very little time to study, I calculate that the all-in expenses, taking a cheap R.A.E. course,

Whilst we are always pleased to assist readers with their technical difficulties, we regret that we are unable to supply diagrams or provide instructions for modifying commercial or surplus equipment. We cannot supply alternative details for receivers described in these pages. WE CANNOT UNDERTAKE TO ANSWER QUERIES OVER THE TELEPHONE. If a postal reply is required a stamped and addressed envelope must be enclosed with the coupon from page iii of cover.

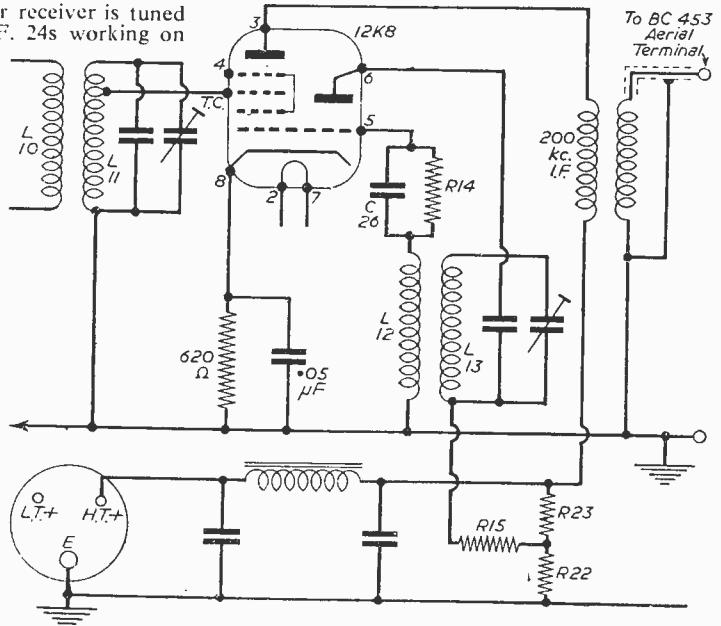

The Command receiver modification referred to in Mr. Forsyth's letter above.

would be around £12, which is quite a considerable sum for a student in his busiest year or two; and when I am settled in a job, I may have little time for radio work (or play).

I am in full support of a high-frequency band, licence free, for amateurs, and would suggest that possibly one might only be allowed to use it for, say, nine months, before taking one's exam.—
J. ANDERSON (Bramhall).

Midget Sets

DEAR THERMION.—Your remarks about midget transistor-operated sets interested me. I, for one, would be most interested in seeing one for home-making. I have had pocket sets in the past—the earliest used two Weco peanuts—the (the One Volt Wonder!) They fairly galloped up the L.T. at $\frac{1}{2}$ amp each. The biggest bugbear with miniature sets is batteries. Either they are small, and easily exhaustible, or the set becomes bulky. I have been toying with the idea of making a little set to take away on holiday, using hearing-aid valves in the early

stages and a normal B7G 1.4-volt output pentode. I haven't started to dabble with transistors yet. And printed circuits are not easily available.—
P. C. JONES (N.10).

Restrictive Practices

SIR.—Valves with no manufacturers' names and the type number printed on in light green or grey are manufactured on the continent, mostly Germany and Holland. They carry purchase and import tax, which has been duly paid. The writer's experience over the last four years, or so, is that they are just as reliable as B.V.A. valves, and, if bought from a reputable supplier, carry the usual guarantee. B.V.A. valves offered at cheap prices are often "rejects" and should be treated with suspicion unless the purchaser knows, personally, that the dealer concerned will change faulty ones. (Note: "reject" does not infer of itself that the valve is faulty, as it may have been rejected from a "special purpose" circuit).—
S. F. H. (N.W.3).

MAKING A SIMPLE GEIGER COUNTER

(Continued from page 101)

The Choke

For those who prefer to wind their own coils, these dimensions give a good result (see Fig. 4).

The former is a rolled paper tube with paxolin end checks well smoothed with sandpaper, spaced at 1.8in. and held in place with Durofix. 40 s.w.g. double silk-covered wire is wound on, to an outside diameter of 1 $\frac{1}{2}$ in. Wavewinding is essential to reduce the internal capacitance. End connections may be made either by small copper strips cemented in place or by lengths of multi-strand wire. The completed coil may be immersed in good quality wax and the windings protected with a layer of Cellotape if desired. The coil is mounted by pushing the ferrite rod through holes in the paxolin "chassis." Teletron Products have recently made the author a prototype production model of the ringing choke, which works very well; its type number is EH.10.

Operation

The set is designed for use with a 10in. long gamma counter tube with an operating voltage of around 1200. These are considerably cheaper than the latest halogen quenched tubes. 3ft. to 5ft. of coaxial cable with a Belling-Lee plug connect the tube to the set. No excuse is tendered for the following explanation of the principle of the G.-M. tube.

There is basically a tube of metal or graphite-coated glass forming the cathode, and a centrally positioned fine wire which is the anode. (N.B.—Though similar in appearance, this has the opposite polarity to a thermionic diode.) The tube is filled with an ionisable gas such as argon under low pressure, and a smaller quantity of an inert gas such as alcohol vapour or a halogen. The tube operates as follows: a particle such as a beta particle or a meson, or an ionising radiation such as X-rays, gamma rays or cosmic

rays cause an atom of argon to ionise and the released electron is accelerated towards the central wire by the applied voltage, causing a shower of electrons by secondary emission on the way. This causes a single pulse of current in the wire. Any tendency for a chain reaction to spread through the tube, or for an ionising glow to persist is "quenched" by the presence of the large clumsy alcohol molecules, and by the fact that the pulse current through the series resistor causes the applied voltage to drop below the critical point.

The characteristics of a typical tube are shown in the graph (Fig. 5). The "plateau" or operating range in a good tube is fairly flat over about 200 volts and the figures are often marked on the tube.

If the operating voltage is exceeded for any length of time, or if the polarity is reversed accidentally, the tube may be permanently damaged by decomposition of the alcohol vapour, so care must be exercised in switching on the set.

If an electrostatic voltmeter is not available, the routine is as follows: the knob of R8 is rotated until the sporadic clicking is first heard (about 80 to 100 per minute normally, but this has risen by 15 per cent. since nuclear tests were started), then the knob is slowly advanced until the background count starts to rise a little. The position half-way between these two points is then marked. In the model illustrated a flat calibrated disc was used instead of a pointer knob and dial, since it could not be easily turned on by accident in the pocket.

Most home constructors will find many of the components and materials used in this geiger counter lying around their workshops, but if one starts from scratch and purchases all the components, and winds the choke oneself, the total cost of construction will be found to lie between £3 and £4—and this includes the cost of the G.-M. tube.

THE "WEYRAD" SIGNAL GENERATOR

AN INSTRUMENT OF HIGH ACCURACY AT LOW COST

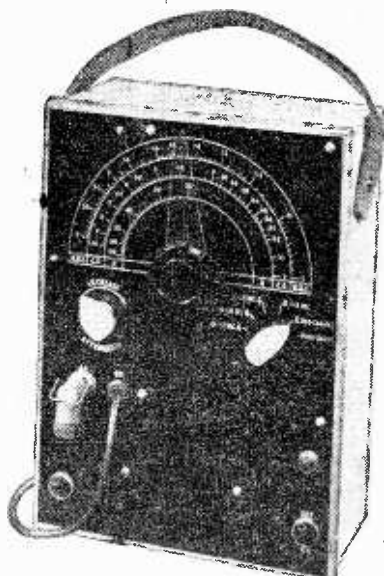

- Coverage 100 Kc/s-70 Mc/s (on fundamentals).
- Accuracy better than $\pm 2\%$ on all ranges.
- Large, clearly calibrated scale.
- Modulated or C.W. output.
- 500 c/s A.F. source.
- S.G.M.I.—A.C. mains operation. Double wound, varnish-impregnated transformer, tapped 210/225/250 volts.
- S.G.B.I.—All dry battery operated.
- All components are by well-known manufacturers ensuring maximum reliability.
- Both types in quantity production.
- Illustrated leaflet available, price 2d.

WEYMOUTH RADIO MANUFACTURING CO., LTD.
CRESCENT STREET, WEYMOUTH, DORSET

EXPRESS ELECTRONICS

ROSEDENE LABORATORIES
KINGSWOOD WAY, SELSDON, SURREY

VALVES NEW, TESTED AND GUARANTEED

IAC6	8/6	6BR7	10/6	12AU7	7/6	EBF80	9/6	N17	7/6
IC1	7/6	6BW6	7/6	12AX7	8/-	ECC35	7/6	N18	7/6
IC2	8/6	6BW7	8/-	12K7GT	8/-	ECC81	8/6	N19	7/6
IC3	9/-	6CH6	7/-	12K8GT	12/5	ECC82	7/6	PCC84	9/-
IF1	8/6	6C10	9/-	12Q7GT	8/-	ECC83	8/6	PCF8C	10/6
IF3	7/6	6D1	1/6	25L6GT	8/6	ECC84	10/6	PCF82	10/6
IFD1	8/6	6D2	6/9	25Z4G	8/6	ECC80	10/6	PL81	14/6
IFD9	7/6	6F12	6/-	35L6GT	9/-	ECC82	10/6	PL82	9/-
IPI	9/-	6F15	9/-	35W4	8/6	ECH42	10/-	PY81	8/6
IPI0	7/6	6J5G	5/6	35Z4GT	7/-	ECH81	9/-	PZ30	17/6
IPI1	7/6	6K7G	5/6	5763	10/6	ECL80	10/-	U52	8/-
IRS	7/6	6K8GT	9/6	D77	6/9	EF37A	9/-	U76	8/-
IT4	7/6	6L6G	10/6	DAF71	7/6	EF39	5/-	U78	7/-
IS5	7/6	6Q7GT	8/6	DF91	7/6	EF41	9/-	UBC41	8/5
IU5	7/-	6SA7	8/-	DF96	8/6	EF80	5/6	UCH42	10/-
3Q4	7/6	6SL7GT	7/6	DH75	8/-	EF91	6/-	UF41	8/6
3S4	7/6	6SN7GT	8/-	DH77	7/6	EF92	5/6	UL41	10/-
3V4	7/6	6V6G	7/6	DH142	8/6	EL37	19/6	UY41	7/6
SU4G	8/6	6V6GT	7/6	DH150	10/-	EL38	20/-	W76	8/6
5Y4G	7/-	6X4	7/-	DK91	7/6	EL41	10/-	W142	8/6
Z24G	9/6	6X5GT	7/6	DK92	8/6	EY51	12/6	X17	7/6
6AL5	6/9	757	8/6	DK96	9/-	EZ35	7/6	X18	8/6
6AM6	6/-	8D3	6/-	EA50	1/6	EZ40	8/-	X142	6/6
6AT6	7/6	12AH9	10/6	EABC80	8/6	EZ80	8/-	X150	10/-
6BA6	7/6	12AT6	8/6	EB91	6/9	KT33C	8/5	Z77	5/-
6BE6	8/-	12AT7	8/6	EBC41	10/-	KT66	11/-	ZD17	7/6

MATCHED PAIRS

ELR4 23/- 6V6G and GT 17/-, 6BW6 18/- per pair.
Push Full O.P. Transformers for above 3-15 ohm 14/6.

SETS OF VALVES

DK91, DF91, DAF91, DL92 or DL94.....	27/6
IRS, IT4, IS5, 354 or 3V4.....	27/6
6K8, 6K7, 6Q7, 6V6, 5Z4G.....	35/-
12K8, 12K7, 12Q7, 35L6, 35Z4.....	35/-

Postage and packing, 6d. Over £1 post free. C.O.D. 2/6.

"ASPDEN" TAPE RECORDER KITS

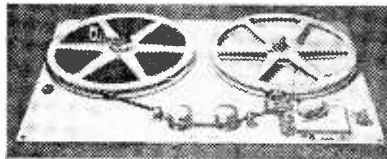

TAPE DECKS. 2-speed, twin track, easy to assemble kits with finest motor, Ferroxcube heads and full instructions.

MODEL 582 for 5in. spools, kit £8.5.0.

MODEL 782 for 7in. spools, kit £9.5.0.

Either model assembled and tested, 30/- extra.

AMPLIFIER kit, 2½ watt, record-replay, 2 recording positions, neon indicator, etc., £5.18.0. Power pack kit for above. £2.18.6 (both without valves). Carr. and packing extra.

YOU CAN BUILD A QUALITY TAPE RECORDER

R.C.W. of Co. Durham writes:—

"... I have been using this equipment very successfully for some months now. Many people who have heard it have been staggered that such quality can be obtained for such a low price."

This tape deck and amplifier is being used in the Antarctic by an Expedition member.

Send stamp for full particulars to:—

W. S. ASPDEN Stanley Works, Back Clevedon Rd., BLACKPOOL, Lancs.



PIFCO

**ALL-IN-ONE
RADIOMETER**

- ★ Circuit Test
- ★ L.T. & H.T. Tests
- ★ mA Test
- ★ Valve Test

Use the PIFCO All-in-One RADIOMETER for the practical testing of all types of radio and electrical apparatus. You can carry out continuity and resistance tests, check H.T., L.T., and G.B. voltages, also Household Appliances, Car Lighting Systems, Bell Circuits, etc. May be used on A.C. or D.C. mains.

Obtainable from your local dealer.

Write for informative folder to:—

ONLY
32/6
COMPLETE

PIFCO LTD., WATLING ST., MANCHESTER, 4
36-37, UPPER THAMES ST., LONDON, E.C.4

INFRA-RED VIEWING EQUIPMENT

See in the dark with equipment specially developed for night driving, reconnaissance, sniping, etc.

BINOCULARS £3.10.0 Carriage 7/6

Focusing and adjustable. Complete with 6 (or 12) volt power unit, brand new in transit case with carrying bags and cleaning fluids. Carriage 7/6.

MONOCULAR £1.0.0. Carriage paid

Sealed unit incorporating push button operated zamboni pile. Focusing eyepiece. Brand new in stout hide (binocular type) case.

MONOCULAR £1.10.0. Carriage paid

Larger, all plastic model, with bigger caesium cell. Brand new in superb hide shoulder strap carrying case.

VIEWING LAMP 17/6 Carriage paid

Weatherproof car spotlight providing a powerful source of infra-red rays through easily removable filter. Takes standard 12 v. bulb. Swivelling single-point bumper fitting. Brand new.

PROOPS BROS. LTD.,

Dept. P. 52 Tottenham Court Road, London, W.1
Tel.: LANgham 0141. Shop hours: 9-6. Thurs. 9-1

A MATCH BOX TRANSISTOR RECEIVER

This tiny two-stage transistor receiver gives outstanding performance, covering the B.B.C. Programmes on the medium waveband. It is built around a specially designed coil, and fits completely inside a matchbox. Only a short indoor aerial is required in most districts, and the self-contained battery lasts several months.

The receiver is supplied in kit form together with clear instructions, and can be assembled in 30 minutes, no cutting, drilling, or soldering being required.

PRICE **25/-** POSTAGE AND PACKING 6d. EXTRA.

RETURN OF POST SERVICE.

This offer applies only to Gt. Britain and Northern Ireland.

CENTRAL RADIO SALES

Central Chambers, Small Street, Bristol, 1

FOUR-SIDED BLANK CHASSIS

Made in our own works from Commercial Quality half-hard Aluminium of 16 s.w.g. thickness (approx. 1/16") these chassis will carry components of considerable weight and normally require no corner strengthening.

THIRTY SIZES TO CHOOSE FROM!

We can now supply on the SAME DAY as your order is received the exact size to the nearest half-inch and in depths of 1", 1 1/4", 1 1/2", 1 3/4", 2", 2 1/4", 2 1/2", 2 3/4", 3", that you require.

—AT NO EXTRA CHARGE. Maximum length 17". To arrive at the cost of any chassis, you need only add twice the depth to the length and the width, multiply the two and refer to the table below.

Sq. ins.	Price	Post	Sq. ins.	Price	Post	Sq. ins.	Price	Post
10	3/-	1/3	176	8/-	1/6	336	13/-	1/9
40	4/-	"	208	9/-	"	368	14/-	"
80	5/-	"	240	10/-	"	400	15/-	"
112	6/-	"	272	11/-	"	432	16/-	"
144	7/-	"	304	12/-	"	464	17/-	"

Full particulars on request.
PANELS.—Cut to any size up to 3ft. x 3ft. at 4/6 per square foot. Postage should be added at the rate of 1 oz. for each 9 sq. ins.
H. L. SMITH & CO. LTD. (Metalwork Dept.)
287-288, EDGWARE ROAD, LONDON, W.2. PAD 5891

REPANCO

HIGH GAIN TRANSISTOR COMPONENTS

STANDARD RANGE

Ferrite Slab Aerials Type FS2. Designed for Long and Medium Wave reception with transistor portable superhet receivers. Slab size 5 1/2 in. x 3 in. x 5/32 in. Complete with fixing brackets. 13/6.
Combined Oscillator and 1st. I.F. transformer Type OT1. 1 3/16 in. sq. x 1 1/2 in. I.F. Frequency 315 Kc/s., 11/5.
2nd I.F. Transformer (315 Kc/s.) Type TT2. 5/-.
3rd I.F. Transformer (315 Kc/s.) Type TT3. 5/-.

I.F. Transformers enclosed in iron dust pots with slug tuning.
Push Pull Interstage Transformer Type TT4. Ratio 1 : 1 C.T. Stack size 1 1/2 in. x 1 1/16 in. x 7/16 in.. 8/6.
Push Pull Output Transformer Type TT5. Ratio 15 : 1 C.T. Size as TT4 Matched to 3 ohm speaker, 8/-.

MINIATURE RANGE.—For pocket receivers.

Ferrite Slab Aerial Type FS3. Medium Wave only. With fixing grommets. Size 3 in. x 3 in. x 5/32 in., 7/6.
Oscillator Coil Type XO8. Medium Wave only. Overall size 3/4 in. dia x 1 in. Enclosed in Ferrite pots, 5/-.
I.F. Transformer Type XT6. Suitable for 1st and 2nd I.F. 455 Kc/s. Size 3/4 in. sq. x 1 1/16 in., 10/-.
I.F. Transformer Type XT7. Designed for 3rd I.F.T. or detector I.F.T. 455 Kc/s. Size as XT6, 10/-.
Push Pull Interstage Transformer Type TT9. Ratio 1 : 1 C.T. Radiometal Core. Size 3/4 in. x 3/4 in. x 13/32 in., 12/6.
Push Pull Output Transformer Type TT10. Ratio 8 : 1 C.T. Matched to 3 ohm speaker. Size as TT9, 12/6.
Practical and Theoretical circuits enclosed with each Repanco Transistor Component.

JUST RELEASED. "THE MINI-7" a new personal portable transistor receiver. Size 5 1/2 in. x 3 1/2 in. x 1 1/2 in. Send 1/9 P.O. for instructions.

Mail Order and Trade:
RADIO EXPERIMENTAL PRODUCTS, LTD.
33 Much Park St.
COVENTRY
Tel.: 62572

Wholesale Enquiries and Export:
REPANCO, LTD.
O'Brien's Buildings
203-269 Foleshill Rd.
COVENTRY
Tel.: 40594

News from the Trade

SILVER EXIDE BATTERY

A NEWCOMER to the extensive range of Exide batteries is a portable 6 volt unit, the 3EN5, which has a wide potential use in radio and communications equipment, portable tape recorders, instrumentation equipment and similar applications.

This portable unit weighing only 3 lbs., filled, is completely unspillable in any position. It is assembled in a multi-compartment container moulded in translucent high impact polystyrene

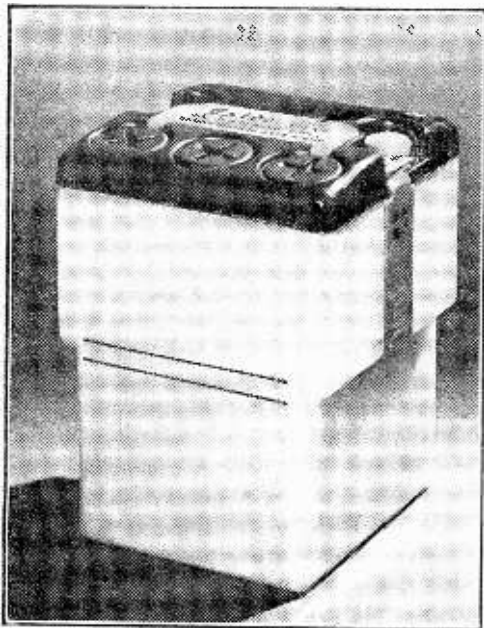

The Silver Exide battery.

which is capable of withstanding mechanical abuse either in handling or in transit. The level of electrolyte can be seen through the material of the container—the maximum and minimum acid levels being marked by two red lines. Unspillability is obtained by a special built-in device through which gas is allowed freely to escape from the cell, while the electrolyte is completely retained in whatever position the battery may be placed.

Filling holes are of sufficient diameter to permit easy topping up which can be carried out without removing the cover and the screwed ebonyite plugs have coin slots for easy removal.

Inter-cell connections are made internally through the cell partitions, reducing the weight of the battery and providing the shortest possible path for current and therefore, the lowest internal voltage drop.

The terminals are screwed steel studs which have been cadmium plated and situated as far as possible from the gas vent so as to reduce

the possibility of corrosion. That part of the terminal assembly not forming the contact area is protected by a cover against accidental short circuits. The terminal studs are themselves anchored in the lid moulding so that the strain of connecting leads is not transferred to the internal cell assembly.

Double separation consisting of sheets of microporous Porvic and glass wool is used. These separators provide complete immunity from short circuiting and help to retain the active material in the plates.

The dimensions are 3 11/16 in. long (3 5/23 in. at base) × 3 9/16 in. wide × 5 in. tall and this 6 volt battery type 3EN5 has a capacity of 5 ampere hours at the 20 hour rate of discharge.—Chloride Batteries Limited, Exide Works, Clifton Junction, Manchester.

NEW COSSOR BOOKCASE RADIOGRAM

COSSOR RADIO AND TELEVISION LTD., announce a completely new radiogram, Model 570, with a novel approach in design. Known as the "Melodygram," Model 570 has unique attributes, being a combination of radio, record reproducer and bookcase with sideboard top. The bookcase shelf can hold a considerable library of record albums, books or magazines. The cabinet is finished in light oak veneer.

A two wave-band printed circuit radio receiver is incorporated and a 4-speed automatic record changer with alternative manual control, and turn-over high-fidelity pick-up. Three Cossor "multiple" valves plus rectifier and an internal Ferrodyne rod aerial are used. There is continuously variable tone-control and the output is fed to a 7 in. × 4 in. elliptical speaker. Model 570 is for A.C. mains operation. 200/250v., 50c/s.

Dimensions: Height, 27 1/2 in., width, 29 1/2 in., depth, 13 1/2 in., at top broadening to 15 1/2 in. at base. Price 39 gns. tax paid.—Cossor Radio and Television Ltd., Highbury Grove, London, N.5.

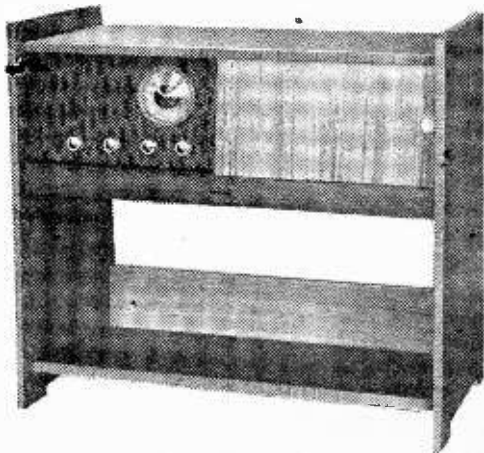

The Cossor Bookcase radiogram.

PHILIPS TAPE RECORDERS

A PROGRAMME indicator (three-digit revolution counter), designed to clip on to the edge of the carrying case of the AG8109 tape recorder is a new accessory now being marketed by Philips Electrical Limited. It can also be used, by clipping to the carrying handle of the case, with models AG8105 and AG8107. A programme indicator is already available for model AG8106.

Known as Type EL 3979-17, the new indicator is finished in grey plastic to match the AG8109 and the digits are in white. There is a plastic cap at the end of the drive cable, and this is pushed over the top of the spool spindle. The accessory can therefore be very quickly and easily fitted and removed as required. It sells at £3 7s. 6d. (free of tax).—Philips Electrical Limited, Century House, Shaftesbury Avenue, London, W.C.2.

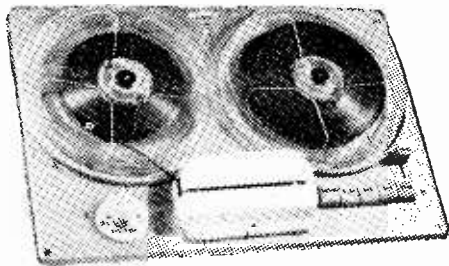

The new motor tape deck.

LOUDSPEAKER FOR PORTABLE RECEIVERS

THE latest addition to the range of loudspeakers produced by The Plessey Company Limited is a 3in. shallow unit which has been specially developed for use in the smaller types of portable receivers.

The overall depth and volume of the speaker have been reduced to the minimum proportions that are consistent with obtaining high sensitivity and maximum value from a very small input. It can be supplied, either with a circular chassis for mounting with a clamp around the magnet yoke, or with a square chassis which has four fixing holes.

Features of the unit are the flat chassis and the window cut-outs, which are shaped to facilitate maximum use being made of the space behind the speaker for mounting other components.

Overall depth of the standard model is 1in. and the flux density is 8,500 gauss; it also employs a magnet with a $\frac{3}{4}$ in. diameter pole. In instances where a greater depth can be accommodated, a magnet with the value of 10,000 gauss can be supplied.

The standard voice coil is 3 or 5 ohms impedance, but high impedance coils up to 80 ohms may be fitted if required.—The Plessey Co., Ltd., Hford, Essex.

THE MOTEK TAPE DECK

THE Motek K9, a new and entirely British tape deck, is manufactured and introduced by Modern Techniques who have a wide experience

in this field. Designed to enable easy fitment by the manufacturers of tape recorders, this particular deck offers simplicity of control and operation. Patents are pending on the many outstanding features of this fine deck and include: Choice of three speeds, $7\frac{1}{2}$, $3\frac{3}{4}$, $1\frac{7}{8}$ inches per second at the turn of a knob. Built-in revolution counter for precise tape location. Continuous playing time range from $1\frac{1}{2}$ to six hours. Pause control switch. Fully automatic press-button controls. Eight two-way change-over switches available on record and play wafers on push-button unit, allowing for possible amplifier wiring. Foolproof interlocking system. Price 21 gns.—Modern Techniques, Wedmore Street, London, N.19.

TAPE RECORDING BOOKLET

TWENTY-FIVE ideas for widening the use of tape recorders are contained in a new 12-page give-away booklet published by the 3M Company, makers of Scotch Boy magnetic tapes.

The ideas range from the suggestion of a "snapshots in sound" album for a growing family to a tip that businessmen can use tape recorders to improve their own speech and that clergymen can enlist their aid to rehearse sermons.

The booklet goes on to explain what one should do to obtain best quality recordings and then gives advice on splicing tapes and other aspects of the use of a tape recorder.—Minnesota Mining and Manufacturing Company, Ltd., of 3M House, Wigmore Street, London, W.1.

HIGH-FREQUENCY TRANSISTORS

THE R.C.A. 2N370, 2N371 and 2N372 are drift transistors of the germanium p-n-p type designed for use in all-wave battery portable receivers. The 2N370 is intended for R.F. amplifier service, the 2N371 oscillator service, and the 2N372 for mixer service. These three transistors provide the designer of such receivers with a complete transistor complement for high-gain R.F. tuners.

Excellent stability and exceptional uniformity of characteristics both initially and throughout life are features of these transistor types.

They are controlled during manufacture for input and output values and for power gain characteristics to insure unit-to-unit interchangeability.

In addition, low values of base resistance and collector transition capacitance made possible by the unique design of these transistors permit the design of R.F. circuits having superior high-frequency performance.

The 2N370, 2N371 and 2N372 look alike. They are hermetically sealed in metal cases, have a diameter of 0.360in., a body height of 0.375in., and four flexible leads. One of the leads provides shielding to minimise interlead capacitance and to minimise coupling to adjacent circuit components—a feature of primary importance in high-frequency applications.—R.C.A. Great Britain Ltd., Lincoln Way, Windmill Road, Sunbury-on-Thames, Middlesex.

PRECISION-BUILT COMPONENTS

JACKSON LGP GEARED DRIVE



This geared drive gives a 9in. pointer travel with only a 3/4in. diameter pulley. The LGP geared drive can be fitted to the standard range of L type condensers. Price LGP2 complete 18/9. LGP3 complete 24/-.

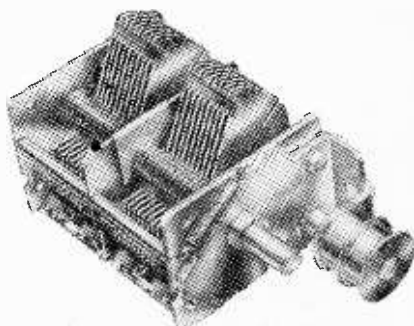

IT'S RELIABLE IF IT'S MADE BY JACKSONS!

Please write for illustrated catalogue.

JACKSON BROS. (London) LTD.

KINGSWAY . WADDON . SURREY

Telephone : CROydon 2754,5

**E
D
D
Y
S
(
N
O
T
T
I
N
G
H
A
M
)
L
T
D.
(
D
E
P
T.
P
W
)**

This Month's Special Offers

- 6L6G VALVES 5/11 each
- 807 " " " " " " " " 4/11 each
- 6K7G " " " " " " " " 2/11 each
- EL32 (4-pin) VALVES ... 3/11 each

ACOS CRYSTAL MIKE INSERTS, 4/11 each. High quality, can be used for Tape Recorders, Baby Alarms, Musical Instruments, etc. Post, etc., 6d. each.

MIDGET BATTERY ELIMINATORS

To convert all types Battery Portables. (Please state make and model number.) 5/7/6, plus 2/6 postage and packing.

All new and Guaranteed.

Any parcel insured against damage in transit.

SURPLUS NEW AND GUARANTEED VALVES

All Tested before Despatch.

Post, etc., 6d. per valve extra. Over £3 post free.

1R5	7/11	6SK7	7/11	12K7	7/6	EB91	6/6	EF42	12/6
1S5	7/3	6SN7	7/11	12Q7	7/6	EBC41	9/6	EF80	9/11
1T4	7/3	7B7	8/11	25L6GT		EBF80		EF91	7/11
3V4	8/6	7C5	8/11		9/-		9/6	EL41	9/11
5U4G	6/6	7C8	8/11	25Z4G	9/-	ECC81	8/11	EL84	9/11
5Z4G	9/6	7H7	8/11	35A5	10/11			EL94	9/11
6B6	6/6	7S7	8/11	35W4	7/6	ECC82B	11	PCC84	8/6
6B8G	3/11	7Y4	7/11	35Z4G	7/6	ECC83B	11	PY80	8/6
6BJ6	7/-	10P1	15/11	954	1/6	ECC8410	6	PY81	8/6
6P1	13/11	10P9	11/6	955	3/11	ECC85	8/6	PY82	8/6
6P13	13/11	12AH7		956	2/6	ECH35		UCH42	
6P15	13/11		7/11	956	2/6	ECH42	10/6	UL41	9/11
6J5G	3/11	12AT6		958	3/11			UL41	9/6
6K8G	7/11		9/11	AZ1	12/11			UY41	7/6

CRYSTAL CALIBRATOR

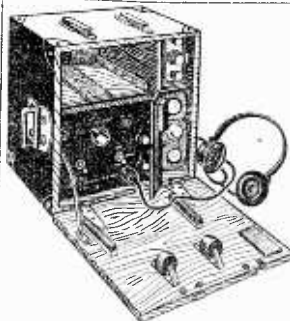

Just the job for the ham or short wave enthusiast. Check points every 10, 100, and 1,000 kc/s. Contains 1,000 kc/s crystal. 6 valves in multi-vibrator circuit, accuracy plus or minus 0.025%. Brand new. Size 12in. x 8in. x 7in. Complete in transit case with all accessories including phones and spare valves, £3.19.6, plus 7/6 carr.

A.C. mains power pack 350 volts 100 Ma. 6.3 volts, 4 amps. 5 volts 3 amps completely smoothed and in attractive grey enamel case size 12in. x 8in. x 6 1/2in. Brand new, ideal for amplifiers, receivers, etc. Contains 5 in line octal holders, wired for 5Z4 rectifier. Brand new, 25/-, plus 3/6 carriage.

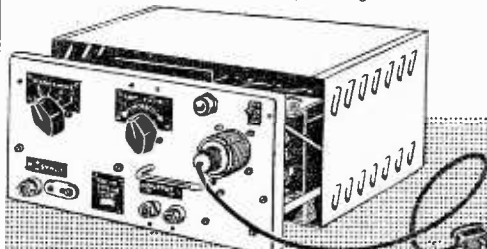

FIELD'S RADIO, 85, Snow Hill, Birmingham, 4. Please print your name and address.

172, ALFRETON RD., NOTTINGHAM

RECEIVERS & COMPONENTS

TELEVISIONS, 12in. 5 channel. £14; 14in. £18; 17in. £27; Faulty Sets from £2. WILKINSON'S, 146, Goldhawk Rd., W.12. (SHE 4379.) Callers only.

MIDDLESBROUGH. Largest stocks on N-East coast. Radio, TV components, PM Kits, Gram. Cabinets, Tape Decks, Leak Amplifiers, Valves, etc. Callers only. PALMERS, 106, Newport Road. (Phone: 3096.)

TELEVISIONS NEEDING ATTENTION, 9in.-10in. models, £4/10/- each. 12in. models, £6/6/- each. 15in. models and Philips Projection models £11/10/- each; immediate despatch, carriage paid. BARKERS, 325, Brockley Road, S.E.4. (TID 6752.)

"OSMOR NEWS" Components lists for "P.W.", "Consul Car Radio", "P.W.", "The Chorister" and "R. Constructor" "Beginner's S. Wave 1 Valve" on request. OSMOR, 418, Brighton Rd., S. Croydon. (CRO 5148.)

VALVES from 1/6. Radio, T.V. Components: low prices. Lists 3d. J. PALMER, 32, Neasden Lane, N.W.10.

BRAND NEW MILLIAMMETERS, 0-1 M.A. M/C 2 1/2in. sq./h. 10/6 each; brand new Thermostats, 0-250v., 15A, adjustable, 40-200 Far., 2/6 each; postage extra. Lists free. N. R. BARDWELL & CO., Sellers Street, Sheffield, 8. (Phone: 52886.)

POWER IN PACKETS. Owing to Defence cuts we are low in stock of certain H.T.s. but have plenty of the following: 145v. Kallium, 4/-; 120v. small, 2/4; £4 x 87 x 4 1/2, 10/9; 671v. 4/6; 224v., 2/4; 41v. heavy duty, 2/3. Stamp for Battery List. Now for a further bargain. 12 assorted Files from 14in. downwards. 16/8. A few scopes remaining at £5/15/-, inc. post. 6d. for full mod. booklet. DIGGINS, 129/133, Radnor St., Hulme, Manchester, 15. (MOS 2419.)

UNREPEATABLE OFFER.—12in. 5 Channel T.V., £15; 14in., £22, good working order. C. EDWARDS, 1070, Harrow Rd., London, N.W.10. (Phone: LADBroke 1734.)

T.V. TUBES, 33%, with cathode heater shorts; 15/ with burn; carr. extra; ideal for testing; good picture. Please enquire for types and sizes required. DUKE & CO., 623, Romford Road, Manor Park, E.12. (H.F. 6031.)

RADIO & TELEVISION COMPONENTS

of guaranteed performance and long life. We have a most extensive range to offer—Example: **MAINS TRANSFORMER, SHIELDED PRIMARY, 195/250 VOLTS, SECONDARY 230-0-280 VOLTS 100 MVA, LT. 6.3 VOLTS 3.7 AMPS & 6.3 VOLTS 0.95 AMPS, MOUNTED TWIN FUSE HOLDER AND TAG PANEL FOR SWITCH AND MOTOR. 27/6 EACH, POST 2/6.**

The quality of our Components cannot be excelled. Send S.A.E. for latest list of our bargain offers.

J. E. SEXTON LTD.
162, Gray's Inn Rd., London, W.C.1.
Tel.: TERminus 0228-9.

RATES: 5/6 per line or part thereof, average five words to line, minimum 2 lines. Box No. 11—extra. Advertisements must be prepaid and addressed to Advertisement Manager, "Practical Wireless," Tower House, Southampton St., Strand, London, W.C.2.

MULTIMETERS, Ohms, Volts, Milliamps, new, 12/6; Rotary Transformers, 12v. in., 300v. out., 12/6; Indicator Units, complete with C.R.T. and valves, new, Type 95, £3; 168A, £5. Switches, Condensers, Resistors, Potentiometers, Relays, Cut-outs, Switchboards, Meters, etc. AMATEURS PARADISE, 155, Humberstone Rd., Leicester.

HALT!

Have you seen our latest illustrated list? It contains Radio Receivers, Components, Test Equipment, Tape Recorders and accessories, valves and C.R.T.s, tools and many other items too numerous to mention here. Send 6d. (P.O. or stamps) for your copy, from:

G. M. JONES (Dept. PW),
453, SOUNDWELL ROAD,
KINGSWOOD, BRISTOL.

PHILIPS Mains Transformers, 200/250, 250-0-250, 80ma. 6.3V 3A, 8/6. p. & p. 2/6. Philips Smoothing Chokes, 3/6, p. & p. 2/-. Philips Output Transformers, 3/6, p. & p. 2/-. ELECTROSURE, 118, Fort Street, Exeter. 56687.

F.M. AERIAL offers from manufacturers. Indoor Dipole, with mast and base, 12/6; "H" ditto, 22/6, post free. Send 1/- P.O. for our full T.V. Aerial Lists with illustrated parts catalogue and aerial data. Build your aerials from our fully machined parts and save money. SKYLINE WORKS, Burnhall Road, Coventry.

TELEVISIONS, 9in. models, £7/10/-; 12in. models, £13/10/-; 12in. 5-channel models, £19/10/- each; all working, carriage paid. Send for list. TOMLINS, 127, Brockley Rise, Forest Hill, S.E.23. (FOR 5497.)

TAPESPONDING. Exchange tape recorded messages home overseas. Details EWART, 87, Terrace, Torquay.

LOUDSPEAKERS repaired promptly. MODEL LOUDSPEAKER SERVICE, Bullingdon Rd., Oxford.

GUARANTEED TELEVISION, 12in. 5-Channel models, first-class picture. £26 each, carriage paid. THE GRAMOPHONE SHOP, 19-21, Brockley Rise, London, S.E.23.

R.E.P. One valve chassis, 2/6. Coil, 4/-; 3 Dial Plates, 2/3. 3095 Mtd, tuning, 3/2 003, 3/10. Instructions, 6d. Chassis 3D Transistor, 3/- Instructions, 9d. Seven Transistor superhet portable Instructions 1/8. **TRANSISTORS**, Audio, 10/-. R.F., 21/- **THREE** Waveband prealigned superhet coil pack, 26/- plus P.T. 10/-. T.R.F. coil set, 8/- Superhet coil, pair 8/-. ALL coils complete with circuits. High Resistance earphones, 12/-. Resistors, 6d. **TELETRON** pocket 3 TRANSISTOR "COMPANION." Complete Kit, 88/6. p.p. 1/6.

ELECTRADIO

18, Broadlands Avenue,
Keynsham, Som.

Hi-Fi TEST TAPE. Check your recorder with the B.R. Test Tape Frequency response check, 50-10,000 cycles; transit and quality test 500ft. reel recorded at 7 1/2 or 3 1/2 in. per sec.; 20/-, post free. BISPHAM RADIO LTD., 153, Red Bank Rd., Blackpool.

METERS (NEW, BOXED, M.O.S.)

Ammeters, Moving Coil, scaled 0-20, complete with shunt, 5 mA Basic Movement, 10/6, Postage 1/6. **Ammeters**, 6in. round, moving iron, 50 cycles A.C. 0-50, switchboard mounting, £4, Postage 3/6. **Voltsmeters**, moving coil, 2in. round, 10,000 ohms resistance, 0-50, 10/6, Postage 1/6.

SPEED ELECTRICS, EASTWOOD, NOTTS.

ANNAKIN

Sound Reproducing Unit No. 6.—Has 2-635G, 1-616G, 1-5Z4G, 230 v. A.C. Power Pack. Vol. and Bass controls. Easily converted to 10 watt amplifier. Scaled, £2, Carr. 10/-.

Receiver Unit R. B APNA.—Has 1-6SN7, 1-6SL7, 1-6H6, 4-6SK7, 1-6SA7, 1-5U4G, 3-6B4G, 2-2X2, 1-6SJ7, 1-VR105/30. Power Pack for 115-80 v. 12 coils, 7 IFT, U.S.A. make. New. Boxed, £25.0. Carr. 10/-.

Assault Cable, Single steel, PVC insul., 8/6 per 1,000 yds. New, Post 3/6.

Single L.T. Phones.—Headbands. Used, 2/- Post 1/3.

AF Transformers.—1 to 200 ohm. New. Boxed, 1/- ea. Post 9d. 6/- doz. Post 2/9.

Fuel Gauge Meters.—Cal 0-45, Moving Iron. New. Boxed, 2/6 each. Post 1/3.

Above prices England and Wales only. A.A.E. for Lists and enquiries. Money Back Guarantee if not pleased with goods.

25, ASHFIELD PLACE, OTLEY, YORKS.

FOR SALE

AMERICAN MAGAZINES. Year's subscription "Audio" 35/-. "High Fidelity" 50/-. Spec. copies 4/- & 5/- ea. Cat. free. WILLEN LTD. (Dept. 40), 9, Drapers Gdns., London, E.C.2.

TAN IN 24 HOURS.—Super-tonic Sunray Lamps, Ultra-violet Infra-red combined; automatic exposure; controlled emission; all mains. Listed £7/10/-, our price 80/-. S.A.E. illustrated brochure. Dept. 100, SCIENTIFIC PRODUCTS, C.veleys, Lancs.

SLEEVING, cheap, black fabric (soiled in store). Polythene inside, 1 1/2 m.m. (few 1 m.m.), 1,000 yds., 15/-. or 3 m.m. 400 yds., 12/6; p. & p. 4/-. Post only. STREATFIELD, 26, Wood Lane, London, N.6.

VALVE CARTONS, ex-stock. Minatures 10/5. "G.T.s" 12/-. "G's" 14/- per 100, plus postage 2/-. Ask for our valve list and Hi-Fi list. 3d. stamp. RHS, Dept. RP, 151, Swan Arcade, Bradford, 1.

CABINETS for EQUIPMENT, SPEAKERS, PYE BLACK BOX & RECORDS.

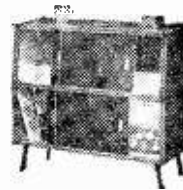

Write for Catalogue
A. L. STAMFORD (Dept. S19),
10, College Parade, Sa'isbury Road,
London, N.W.6

WANTED

GLASGOW. Cameras bought for cash or taken part exchange for Tape Recorders, Players, or Amplifiers. **VICTOR MORRIS, 406, Argyle St., Glasgow, C.2.**

813 VALVES wanted for prompt cash. **MODO, Inverkeithing, Fife.**

WANTED, Transmitter T.59, Trans-receivers TR.1520, 1934, 1935, 1936, 1987, Receivers BC.312 and type 100, P.S.U. type 381; Dynamotors DM.21 and DM.28. GILFILLAN, 7, High St., Worthing. (Tel.: 8719.)

WANTED VALVES

All types for prompt cash. Must be new. State quantity.

WILLIAM CARVIS LTD., 103, North Street, Leeds, 7.

NEW VALVES WANTED: ECL80, EY51, EY86, PL81, PCL83, PCF80, or similar types. A prompt offer and prompt cash awaits. Also interested in good Meters. **RHS, Dept. RP. 155, Swan Arcade, Bradford, 1.**

MISCELLANEOUS

THE TAPE RECORDER SPECIALISTS offer wonderful bargains in Tape. Famous British make. 7in., 1.200ft., 22/6; 5 1/2in., 1.200ft. (L.P.), 22/6; 5 1/2in., 850ft., 19/6; 5in., 850ft. (L.P.), 19/6; 5in., 400ft., 14/6; each plus p. & p. 1/6. Send now, only 500 reels available. Tape Recorders bought for cash; all makes stocked; no interest terms; free offers; specialised repair service. **E. C. KINGSELEY & CO. (G.), 132, Tottenham Court Road, London, W.1. (Euston 6560.)**

TRANSISTOR PUSH-PULL AMPLIFIER

Mullard 6 v. 200 Mw. circuit. Complete kit of parts on prefabricated miniature chassis, with four transistors, etc. (less speaker/battery). 90/-, Circuit and assembly data only. 1/6.
TRANSISTORS, tested, guaranteed. Audio 10/-, R.F. 8 M.c. 21/-.
TRANSISTOR transformers for Mullard P.P. circuit, 16/- pair.
COILS, T.R.F. m/w with circuit, 7/6.
MAINS transformer, 200/250 v. A.C. output, 200 v., 25 mA, 6.3 v. 1 amp., 10/6.
AERIALS, Band II (F.M.) dipole, 10/6. Band III, dipole, 7/6. 3 element array, 25/-, Combined I & III, 33/9.
CHARGERS, 6 v., 2 amp., or 12 v. 1 amp., 35/-.
HEADPHONES, H.R. (4,000 ohms), new, boxed, 17/6.
CHOKES, new, boxed, 85 mA. 5 1/6; 85 mA., 7/6; 150 mA. 13/6.
SWITCHES, midget, all combinations single wafer, 4/- each.
VALVES, new, boxed. 174, 8/-; 154, 8/-; 5U4, 8/6; 6K7, 5/6; 6K8, 8/-; 6V6G, 7/6; MU14, 7/6; PCL82, 10/6; PCF80, 10/6; PL82, 10/6; PY80, 10/6; PY81, 10/6; PY82, 10/6; S781, 5/6; ECC81, 8/-; ECC82, 8/-; ECC83, 8/-; ECC84, 10/6; ECC84, 10/6; ECC85, 9/6; ECF80, 10/6.
 Postage on all orders. Trade and Mail Order

OSMABET LTD.

14, HILLSIDE ROAD, TOTTENHAM, LONDON, N.15.

SERVICE SHEETS

SERVICE MANUALS/SHEETS, Tel./Radio for hire, sale and wanted. Mixed Manuals and Sheets. 12 for 10/-; s.a.e. enquiries. **W. J. GILBERT (P.W.), 24, Prithville Gdns., London, W.12.**

SERVICE SHEETS for sale and hire. Radio/T.V. S.A.E. enquiries. **J. PALMER, 32, Neasden Lane, N.W.10.**

SITUATIONS VACANT

THERE IS a national shortage of Mercantile Radio Officers. Why not make Communications your career? You can be assured of a sea-going appointment after qualifying at The School of Marine Radio and Radar (A.S.T.), Hamble, Southampton. For details, apply Commandant, quoting A.12

RADIO (METEOROLOGICAL) TECHNICIANS required by Meteorological Office. Qualifications: Basic knowledge of radio and radar and experience in maintenance/operation of radar equipment including oscilloscopes. Successful applicants serve in United Kingdom and overseas. Commencing London salary £600 at age 25 or over, rising annually to £705 subject to deductions for each year below age 25. Provincial salary £28 to £30 lower. Overtime, night duty allowance, etc. Apply at any **EMPLOYMENT EXCHANGE,** quoting King's Cross 2468/066 93.

A BRAND NEW

300 WATT TRANSMITTER

For Only £15 Down and 8 monthly payments of £15. Delivery after 1st payment. Cash Price £120.

LOOK AT THE SPECIFICATION !!

Power Output—300 watts all services.
 Power Input—180/250 volt 50 cycle A.C. mains.
 Hand or High Speed Keying.
 Crystal or MO Control with temperature compensated MO circuit.
 Types of wave—C.W., M.C.W. and R/T.
 Frequency Range—1.5 Mc/s. to 20 Mc/s.
 Modulation—100 per cent.
 Output Impedance—50 ohms coaxial Feeder.
 Audio Input Impedance—600 ohms.
 Remote Control facilities if desired.

ALSO:

Halicrafters S-27 Communications Receivers
 Wireless Sets 62—1 1/2 to 10 Mc/s. Send and Receive.
 Wireless Sets 88 Walkie-Talkies—40 to 42 Mc/s.
 Wireless Sets 19 with all operating equipment.
 Collins T.C.S. Sets complete 1 1/2-12 Mc/s with Power Supply Units for 12 volt, 24 volt or Mains Supply.

H.P. or Credit Facilities on all Goods.

R. GILFILLAN & CO., LTD.

7 High Street, Worthing, Sussex
 Tel.: Worthing 8719 or 30181.

PUBLIC APPOINTMENTS

RADIO TECHNICIANS IN CIVIL AVIATION.—A number of appointments are available for interesting work providing and maintaining aeronautical telecommunications and electronic navigational aids at aerodromes and radio stations in various parts of the United Kingdom.

Applications invited from men, aged 19 or over, who have a fundamental knowledge of radio or radar with some practical experience. Training courses are provided to give familiarity with types of equipment used. Salary £600 at age 25, rising to £705. The rates are somewhat lower in the provinces and for those below age 25. Prospects of permanent pensionable posts. Opportunities for promotion to Telecommunications Technical Officer are good for those who obtain O.N.C. in Electrical Engineering or certain City and Guilds Certificates. The max. salaries of Telecommunications Technical Officers are Grade III £970, Grade II £1,030, Grade I £1,250.

Apply to **MINISTRY OF TRANSPORT AND CIVIL AVIATION (ESB 1, RT), Berkeley St. House, London, W.1,** or any Employment Exchange (quoting Order No. Westminster 2109.)

AERONAUTICAL INSPECTION SERVICE. Radar and Wireless Divisions. Vacancies exist for Examiners (unestablished) at R.A.F. Units at Carlisle, Stafford, Handforth, Henlow, Bedfordshire, and the Gloucestershire and Wiltshire area. City and Guilds Intermediate Group Certificate in telecommunications engineering or equivalent theoretical knowledge with experience in industry or Services required. Salary range £625-820 (men). Prospects of promotion and establishment. Age up to 55 years. Application forms from **AIR MINISTRY, C.E.4h, Cornwall House, Stamford Street, London, S.E.1,** or from any Ministry of Labour and National Service office (quoting Borough Order No. 111 066.41).

(Continued overleaf)

ELECTRADIX FOR BARGAINS

A.C. MOTORS 230 volts 50 c/s, 1 h.p., capacitor start, brand new, 4-hole mounting, 95/-, carr. 5/-.

VACUUM PUMPS. 7 cu. ft. per min. 10lbs. per sq. inch at 1,200 r.p.m. Rotary vane type, 30/-, post 2/9.

SYNCHRONOUS MOTOR. 200/250 volts 50 c/s 1 r.p.m., clockwise rotation; totally enclosed, with spindle 3" long by 1/2" dia. 40/-, post 1/9.

MINIATURE MOTORS for model work. 4 1/2 volts D.C., weight 1 oz., size 1 1/2" x 1 1/2" thick. Ideal for up to 18" motor boats, model aircraft or remote control. 10/9, post free.

D.C. DYNAMOS. 14/32 volts, 9 amps. Shunt wound, 2,500 r.p.m., foot mounting. £7/10/-, Control Panel, 65/-, 12 volt, 5 amp. high-speed, with 70% reduction gear to 60 r.p.m. With smoothing unit, totally enclosed. 35/-, carr. 5/-.

PARALEX HOLE CUTTERS. Capacity 1-4", 32/6; 1 1/2-6 1/2", 35/-; 2-10 1/2", 95/-; 2-12 1/2", 105/-, Morse Taper shank; brand new—write for special Leaflet.

ELECTRADIX RADIOS

Dept. P. 214, Queenstown Road, Battersea, S.W.8. **MACaulay 2159**

EDUCATIONAL

FREE! Brochure giving details of Home Study Training in Radio, Television, and all branches of Electronics. Courses for the Hobby Enthusiast or for those aiming at the A.M.Brit.I.R.E., City and Guilds, R.T.E.B., and other Professional Examinations. Train with the college operated by Britain's largest Electronics organisation. Moderate fees. Write to: E.M.I. INSTITUTES, Dept. PW23, London, W.4.

11 + EXAMINATION

Write for **FREE** 24-page **GUIDE** and Test stating age of child, to: **THE REGISTRAR** (Dept. M8), Mercer's Correspondence College, 69, Wimpole St., London, W.1.

LEARN IT AS YOU DO IT—we provide practical equipment combined with instruction in Radio, Television, Electricity, Mechanics, Chemistry, Photography, etc. Write for full details to: E.M.I. INSTITUTES, Dept. PW47, London, W.4.

THERE IS a national shortage of Mercantile Radio Officers. Why not make Communications your career? You can be assured of a sea-going appointment after qualifying at The School of Marine Radio and Radar (A.S.T.), Hamble, Southampton. For details, apply Commandant, quoting A.12.

A.M.I.P.R.E.—For details of suitable study courses (only a limited number of students accepted) send for free Syllabus of Instructional Text I.P.R.E. Conditions of Membership Booklet. 1/- The Practical Radio Engineer Journal, sample copy, 2/3. 6,000 Alignment Peaks for Superhets. 6/-. All post free from **SECRETARY, I.P.R.E.**, 20, Fairfield Rd., London, N.8.

A.M.I.Mech.E., A.M.Brit.I.R.E., City and Guilds, etc., on "no pass—no fee" terms; over 95% successes. For details of exams, and courses in all branches of engineering, building, etc., write for 144-page handbook free. **B.I.E.T.** (Dept. 242B), 29, Wright's Lane, London, W.8.

CITY AND GUILDS (Electrical, etc.) on "no pass—no fee" terms. Over 95% successes. For full details of modern courses in all branches of Electrical Technology, send for our 144-page handbook free and post free. **B.I.E.T.** (Dept. 242A), 29, Wright's Lane, London, W.8.

T.V. and RADIO.—A.M.Brit.I.R.E., City and Guilds, R.T.E.B., Cert., etc., on "no pass—no fee" terms. Over 95% successes. Details of exams, and home training courses in all branches of radio and T.V., write for 144-page handbook free. **B.I.E.T.** (Dept. 242C), 29, Wright's Lane, London, W.8.

ASTRAL RADIO PRODUCTS

HOME RADIO. 32-page illustrated booklet. Simple wiring instructions for Crystal Set, 1/2, 3 Valves, 2/-, post 3d. **TRF COILS.** Specified for Bedside Push-button 4, etc., 7/- pr. post 6d. Push-button Unit with modification data 7/- **DUAL WAVE HIT Coils.** Specified for Summer All Dry Portable. Modern 1 Valver. Modern 2 Valver. A.C. Double Triode 1, etc., 4/6, post 3d. **IFT's.** Miniature, 1" x 1 1/2" x 2 1/2" in cans. Extra high Q. Special offer 9/- pr. post 6d. **K COILS.** A.C. B pass 3/3 each, post 3d. **FRAME AERIALS.** M.W., 5/-, post 4d. **COIL PACKS.** L.M.S. 36/-, post 1/- **Crystal Set Coils.** L. & M.W., 2/6, post 3d. **82, Centurion Road, Brighton.**

WIRELESS. See the world as a Radio Officer in the Merchant Navy; short training period; low fees; scholarships, etc., available. Boarding; and Day students. Stamp for prospectus. **WIRELESS COLLEGE,** Colwyn Bay.

H.A.C. SHORT-WAVE EQUIPMENT

Noted for over 18 years for S.W. Receivers and Kits of Quality.

Improved designs with Denco coils:
One-Valve Kit, Model "C" Price 25/-
Two " " " " " " " " 50/-

All kits complete with all components, accessories, and full instructions. Before ordering call and inspect a demonstration receiver, or send stamped, addressed envelope for descriptive catalogue.

"H.A.C." SHORT-WAVE PRODUCTS
(Dept. TH), 11, Old Bond Street, London, W.1.

SPARKS' DATA SHEETS THE "SEAFARER"

Battery Two-valve offering New Interests and Thrills on Trawler, Ship-to-Shore, Aeronautical and 60/160 m. Amateur Bands. Plus normal Med. and Long-waves. A great Little Set. Data Sheet, etc., etc., 3/3. All Components and Chassis available. **L. ORMOND SPARKS (P), VALLEY ROAD, CORFE CASTLE, DORSET**

TV SPARES

41, CALL LANE, LEEDS 1.

Tel. 28559.

We specialise in exact replacement components, e.g.

Mains Droppers for Ultra twin R6, 1,690Ω + 1,450Ω, 5/3; R7, 175Ω - 340Ω; 410Ω, 5/3. For Phillips: R1, 150Ω + 250Ω + 170Ω + 100Ω, 6/5. R3, 430Ω; 200Ω; 180Ω, 4/10, etc.

Line Output Transformers: LOP4 fits Pye V4, VT4, V7, VT7, 55/2. LOP6 fits FV2, FV4, 50/9.

TSL HI-STAB 1/2 watt Resistors. 10Ω to 10MΩ, 5d. each. 4/- per 12 mixed.

Crystal Diodes, 1/3. Red Spot Transistors, 7/6.

Service Sheets. 6 for 5/-. 12 for 9/-. P. & P. free. These are all mixed. No enquiries for sheets, they are sold just as they come.

New type AVO Multimeter Meter. £9/10/- P. & P. free by registered post.

Please enclose postage. No lists available yet.



COLLARO AC.3 554. Three-speed, single player for A.C. mains 200/250 v., cream finish, complete with turn-over crystal pick-up. "T" type head. Strictly limited quantity at £8.10.0, plus 5/6 cart. **CRYSTAL PICK-UPS** fitted Acos HIGP47 cartridge. Ultra lightweight. Our price 37/6, plus 2/5 cart. **3-SPEED RECORD PLAYERS** fitted with Acos turnover HIGP59 pick-ups with twin sapphire styl, revolve case with lid, fitted clasp and handle. Worth 10 gns. Our price £7.15.6, plus 5/6 cart. **3-SPEED GRAM MOTORS,** complete with crystal Pick-up. Our Price 79/6, plus 5/6 carriage. **REXINE COVERED CABINETS,** single player size, suitable most auto units, including transcription motors. (Motor heard uncut.) Our price 46/6, plus 5/6 carriage. **PORTABLE RECORD PLAYER CABINETS** to house Monarch, Collaro or Gramard 120 Changers, with space for Amplifier and Speaker. REXINE finish in attractive colours, fitted catches and handles. Our price £3.5.0, plus 6/6 carriage. Send stamp for complete bargain lists.

RONALD WILSON & CO.

(DEPT. P.W.), 12 BRIDGE STREET, WORCESTER

TELEVISION

The advance of Radio Technique will offer unlimited opportunities of high pay and secure posts for those Radio Engineers who have had the foresight to become technically qualified. How you can do this quickly and easily in your spare time is fully explained in our unique handbook. Full details are given of **A.M.Brit.I.R.E., City & Guilds Exams.,** and particulars of up-to-date courses in **Wireless Engineering, Radio Servicing, Short Waves, Television, Mathematics, etc., etc.** We guarantee "NO PASS—NO FEE." Prepare for to-morrow's opportunities and future competition by sending for this very informative 144-page guide **NOW—FREE** and without obligation. **BRITISH INSTITUTE OF ENGINEERING TECHNOLOGY** (Dept. 242), COLLEGE HOUSE, 29-31, Vrieght's Lane, Kensington, W.8

TRANSISTOR SPECIALISTS

To introduce you to **TRANSISTORS**
Send 8d. Stamps for Our **ELEMENTARY NOTES ON TRANSISTORS**

We Claim **MORCO REFLEX RECEIVER**
TO BE THE BEST TWO-TRANSISTOR CIRCUIT. LOUD SPEAKER RESULTS ALL DISTRICTS. SOME DISTRICTS WITHOUT AERIAL OR EARTH.

MORCO EXPERIMENTAL SUPPLIES,
8 & 10, Granville St., Sheffield, 2.
Tel.: 27461.

ALFRED PADGETT

40, MEADOW LANE, LEEDS, 11

Tel.: CLECKHEATON 99

BRAND NEW WESTON U.S.A. MODEL 688 SOCKET SELECTOR.—Complete with Octal UX 4, 5, 6, 7, Octal B.7G, Valve selectors and valve data chart for more than 230 valves. If you have a meter it is a must. Price, 12/6. Post 2/6.
ONLY 300 TO OFFER

PAPER CONDENSERS.—2 mfd. or 1 mfd. 450 volts working, 6d. each. Post 1/-, 4 mfd., 1/-, post 1/3.

NEW METAL RECTIFIERS.—250 volts at 60 mills, 2/6, post 1/3. 150 volts at 40 mills, 1/-, post 1/3.

NEW EF50 VALVES.—Four on a strip with valve holders and locking rings, 10/- complete, post 2/-. With Red Sylvanina valves, 12/6, post 2/.

MIXED B.A. NUTS AND BOLTS.—1 6 half lb. 2/6 lb., post 1/6.

NEW INSULATOR HALF WATT RESISTORS.—Box of 50, 1 meg only, 7/6, post 9d.

CELLULOSE CEMENT.—Will soon fix that loose base. 1/6 bottle, post 1/3.

NEW RECEIVERS, TYPE 3645.—The cleaned up 1355, complete with 7 VR65 valve loss 5U4 and 6X5, but otherwise complete. 12/6. Less valves, 6/6. Carriage 2/.

NEW POT METERS.—250 K. and 500 K. Good spindle length. 6d. each, post 9d.

NEW T.V. COAX CABLE.—Any band. Worth 1/3 per yard. My price, 6d. per yd., post free. Also Milk Cable, 4d. per yard, post free.

NEW STOCK OF G.E.C. GERMANIUM DIODES.—9d. each, post 9d.

NEW VALVES, EX. EQUIPMENT.—All at 1/- each, Post 9d. VR65, VR137, 8D2, QP23, VU111, VR86, 12SH7, 12SJ7, DLS10 ML6, PT15 (post 1/6).

All at 6d., post 9d. 6H6, VR52, VR51, 12H16. All at 2/-, post 9d. 6J5, 696, 6K7.

ORDER YOURS NOW!



... is in great demand

Cash Price **40 GNS.**

or Credit Sale Terms of 93/4 Deposit and 8 equal monthly payments of 104.6. (Delivery after first payment.)



The most compact, lightweight and small, 3-speed tape recorder with simple push-button automatic controls. Up to 3 hours playing time possible. The Sound 777 incorporates the latest Collaro Mark IV tape transcriptor with digital footage indicator, pause control and instantaneous track reversal. Piezo-electric desk microphone, £2.15.0 optional extra.

The E. & G. **RADIO CENTRE** Ltd.



33, Tottenham Court Rd., London, W.1.
Tel.: MUSeum 6667

A WONDERFUL MONEY-SAVING OPPORTUNITY FOR READERS OF PRACTICAL WIRELESS!



Now's the time to join the SCIENTIFIC BOOK CLUB

You **BUY** Books published at 12/6, 15/- and more—for **ONLY 4/-**

FULL LENGTH FULL SIZE

This Scientific Book Club is owned and controlled by Foyles, the world-famous booksellers.

LOOK AT THESE GREAT TITLES!

Recent and forthcoming selections include:

INSIDE THE ATOM

By Isaac Asimov
Published at 12s. 6d.
4s. TO MEMBERS

THE MEN BEHIND THE SPACE ROCKETS

By Heinz Gertmann
Published at 21s.
4s. TO MEMBERS

THE MOUNTAINS OF PHARAOH

By Leonard Cottrell
Published at 18s.
4s. TO MEMBERS

SCIENCE UNFOLDS THE FUTURE

By J. G. Crowther
Published at 18s.
4s. TO MEMBERS

Each month, the Scientific Book Club brings to its members the fascinating story of the march of modern science, told in thoroughly dependable books by the front-rank scientific writers of our time—vivid, vital, constructive contributions to Man's unceasing struggle to solve the problems of the Universe. And although the ordinary editions of these books are sold to the general public at 10/6, 12/6, 15/- or more, THE PRICE TO MEMBERS OF THE SCIENTIFIC BOOK CLUB IS ONLY 4/-. Remember, too, that Scientific Book Club selections are full-length and unabridged. They are printed on good quality paper, well bound, with an attractive picture jacket. These are, we say with certainty, books that you will be glad to read, proud to own. The Scientific Book Club brings these great books to you each month: helping you to build up, at remarkably low cost, a first-class collection of scientific books. *Now is the time to join!*

FREE! You can obtain the famous **PEARS CYCLOPAEDIA** (published at 15s.) FREE if you enrol a friend in the Club. Send your friend's name and address with 5s. (4s. plus 1s. postage) for first book, mentioning this offer, and your gift will be sent to you.

---FILL IN THIS ENROLMENT FORM TO-DAY!---

To The Scientific Book Club 121 Charing Cross Road, London, W.C.2
I wish to join the Scientific Book Club, and agree to purchase the book issued each month to members at a cost of 4s. (postage 1s.). I agree to continue my membership for a minimum of six books and thereafter until countermanded.

- ★ I will pay for selections on receipt.
- Or if you wish to save time, postage and postal-order costs you may send an advance subscription. 6 months 30s.; 12 months 60s.
- ★ I enclose 30s./60s. (Strike out amount not applicable.)
- ★ Place ✓ in the space above, as required.

Prac. Wireless, Apt. '58.

NAME.....
(Block letters, please)

ADDRESS.....

Overseas enrolments should be accompanied by an advance subscription. Prices as for inland (except S. Africa, Australia, New Zealand).

Years of experience and technical skill combined with many outstanding features including three speed control knob make this a truly fine deck.



Patents pending.
Details on request.

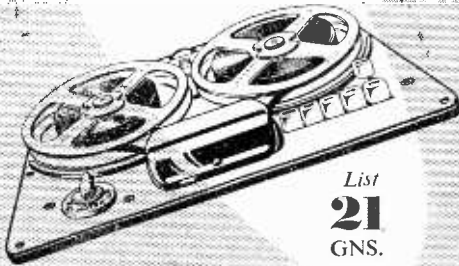

List
21
GNS.

MODERN TECHNIQUES

Wedmore Street, London, N 19. Tel: ARCHWAY 3114

TRANSISTORWISE

"RECO" ALL-WAVE 1 TRANSISTOR KIT

A low cost beginner's radio. Kit includes all parts, transistor, diode, and super sensitive ex G.P.O. Phone for private listening, neat plastic case and 1.5V. battery for months of dependable listening. Only 22/6. P. & P. 2/6.

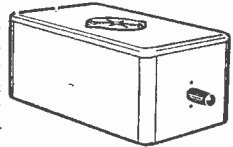

"RECO" TRANSISTOR 2 PORTABLE

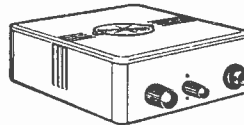

Receives home and Continental stations. Ferrite rod aerial. Attractive plastic case, 4 1/2" x 4 1/2" x 1 1/2", balanced armature output unit and all parts. 55/- inc. battery.

"RECO" PORTABLE TRANSISTOR 3

Similar specification to the "Reco" 2, but uses high gain frame aerial mounted on metal chassis. Has variable gain control. 65/- buys all parts, case and battery.

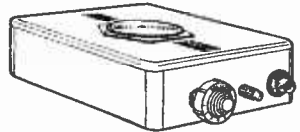



Parts Price List, Wiring Diagram and Circuits for all the above, 2/6

All parts sold separately

RADIO EXCHANGE CO.

(Dept. P.W.), 27, HARPER STREET, BEDFORD

 <p>"Q Coils" Iron dust cores 4/- Amazing efficiency</p>	 <p>Potted Coils 5/- Superhet, T.R.F. modern technique</p>	<p>Coils for Collaro Tape Officially recommended Transcriptor pre-amp. O.S.C. 7/6</p>	<p>STATION SEPARATOR —A positive answer HOME, THIRD, LIGHT, Etc. 10/6</p>	<p>STOP! T.V. Patterning SIMPLE REMEDY 10/-</p>
<p>SCRATCH FILTER COIL 6/9 Whistle Filter 10/-</p>	<p>DUAL RANGE COILS T.R.F. S'HET } 7/6 ea.</p>	<p>OSMOR Mini-Magic F.M. Tuner Kit Complete £1-10-0</p>	<p>B.B.C. 1 VALVER Components 27/6 (Valve 10, ex.) including diagrams</p>	<p>Also B.B.C. (T.V.) Filter Choke 7/6</p>
<p>FERRITE ROD AERIALS MW 8/9 M-L 12/9</p>	<p>I.T.A. Converter To fit inside T.V. FOR ALL SETS KIT Complete 65/- Very efficient! £4</p>	<p>Dial 24/6 complete ASSEMBLY</p>	<p>The World on a 1 Valve Short Wave Coil & Circuit 6/-</p>	<p>Experimental & Development Dept.</p>
<p>Special Coils for HAMS DESIGNERS MANUFACTURERS</p>	<p>OSMOR Satellite Switch-tuned F.M. Dimensions 4 1/2" x 4 1/2" A completely stable drift-free unit for adding to existing radio or Hi-Fi amplifier Circuit & wiring diagram on request.</p>		<p>F.M. COILS For Osmor C'ts & Many Designs</p>	

Thank "Q"



FREE! Send 1/- (stamps) for fully descriptive literature AND OSMOR DESIGNS—5-Valve S'Het, Miniature ditto, Battery and Battery/Main, Receiver, Mains T.R.F. S'Het and T.R.F. Freders, Band 3 Converters, F.M. Tuners, Wiring Diagrams, Chassis Templates, Coil and Coilpack information and price lists and information on circuits in "Wireless World," "Practical Wireless," "Radio Constructor." Full Circuits included. See also classified Advt's. on page 156.

(Dept. P.W. 21) **418 BRIGHTON ROAD SOUTH CROYDON, SURREY**
CROYDON 5148/9

Train for a Wonderful future in RADIO & TELEVISION...

Radio and Television techniques are continually advancing and their applications ever increasing. These fields offer to the trained technician a career with an assured and remunerative future.

Here is your opportunity to enter for:—

1 YEAR COURSE Full-time day course in the Principles and Practice of Radio and Television. Designed for the training of Radio and Television Servicing Engineers and others similarly engaged in the Electronics Industry. Next course commences May 28th, 1958; others in September and January.

The E.M.I. College of Electronics, Dept. 32,
10, Pembridge Square, London, W.2.
Telephone: BAYswater 5131/2.

The College is part of the E.M.I. Group... Britain's foremost electronic engineers... Pioneers of the world's first public television service.

THE E.M.I. COLLEGE OF ELECTRONICS



IA.62



THE SUPEREC "55" BATTERY PORTABLE

BUILDING COST £7.15.0

Plus 5/- P.P.

- 4-VALVE SUPERHET.
- LONG/MEDIUM WAVES.
- 7in. x 4in. SPEAKER.
- B7G 1.4 v. VALVES.
- SIMPLE CONSTRUCTION.

SEND 1/6 FOR BOOKLET.

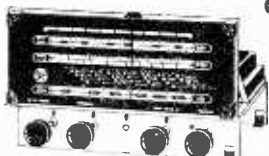

CHASSIS ASSEMBLY

CONTAINING:
DRILLED CHASSIS AND
BACKPLATE, SIZE
12 x 7 x 8in., GLASS DIAL
L.M.S.G., DRIVE DRUM
AND SPINDLE, KNOBS.
PRICE 22/6 PLUS 2/6 P.P.

ALWAYS IN STOCK

RESISTORS, CONDENSERS, TRANSFORMERS, VALVES,
AMPLIFIERS, AUTOCHANGERS, RADIO CHASSIS,
SPEAKERS, CABINETS, PICK-UPS, SPEAKER FABRIC,
RECORDING TAPE, MICROPHONES, ETC.

Shop Open : 9 a.m.—6 p.m. Early Closing : Thursday, 1 p.m.

SUPERIOR RADIO SUPPLIES

37, HILLSIDE, STONEBRIDGE N.W.10
PHONE: ELGAR 3644

1958 EDITION RADIO AMATEUR'S HANDBOOK

32/6 by The A.R.R.L. Post. 1/9

QUALITY AMPLIFIERS For A.C. Mains. A Data Publication. 4/6. Postage 4d.

ELEMENTS OF TAPE RECORDER CIRCUITS. By Burstein & H. C. Pollak. 23/-. Postage 9d.

MODEL ANSWERS TO C. & C. TELECOMMUNICATIONS (PRINCIPLES), Vol. 1, 2, 5/- each. Postage 6d. each.

RADIO, Vol. 1, 2, 5/- each. Postage 6d. each.

HIGH FIDELITY SOUND REPRODUCTION, by E. Molloy. 20/- Postage 1/-.

HI FI YEAR BOOK, 1957, by M. Henslow. 10/6. Postage 1/-.

RADIO VALVE DATA "WW," 5/- Postage 8d.

THE A.R.R.L. ANTENNA BOOK, 18/- Postage 1/3.

THE MODERN BOOK CO.

BRITAIN'S LARGEST STOCKISTS
of British and American Technical Books
19-23 PRAED STREET,
LONDON, W.2.

Complete catalogue 6d.
Phone : PADdington 4185.
Open 6 days 9-6 p.m.

W. B. SUPPLIES

Mail Order Dept.

22, Swan St.,
Manchester, 4.

Terms : Cash with Order. Orders under 20-
add 9d.

Postage, over 20/- add 13.

RED SPOT TRANSISTORS. 6 11 4M H.V. chokes for cross-overs, 4.6. Loopsticks, 4.6. Morse Tappers, 2/-. Control Unit with 2-24 volt Dimmers, 2/6.

BALANCED AMATEUR EAR PIECES ideal transistor speakers, 5/-.

T.V. CIRCUITS AND SERVICE DATA. No. 2, containing Ferranti T1215, T1415, G.E.C. BT2147C, BF5144C, B70A1C, Pye FV1, FV1C, Regentone T15, Mark 2, L, B and H, "Big 12" L, B and H, 3 10 the lot, post paid.

HOW TO MAKE AERIALS for Bands 1 and 2 and VHF. 2/10, post paid. Correct-acting photographs, 3/11, post paid. Colour Code Chart for Resistors, 1.6. BF50 valves (tested), 2.9. Speaker Fret (Tygan) 12in. x 12in., 3.6. 18in. x 12in., 5.9. Metal (gold), 12in. x 12in., 4.6. 18in. x 12in., 6.9. Coaxial Cable (new), 50 Yds. Drum, 25/-.

A.S.V. AMPLIFIERS. High gain, output 2 to 3 watts, ready to connect to any type of pick-up and speaker, 30. Volume and Tone Controls, 200/240 volts A.C. Fully Guaranteed, £3.19.6.

TYANA ELECTRIC SOLDERING IRONS 230/250 volts, 16.9. Rempyco Irons with warning light in handle, 230/250 volts, 22.6.

OSCILLOSCOPE TUBES, CV1523 (3EG1). Filament 4 volts, anode 3 KV max., complete with screen, base and cover, 15.6 plus 1.6 postage.

PLASTIC TWIN FLEX 230 volts, 20-
per 100 yds.

E.N.W.D. TEST METERS, 0-500 0, 0-5,000 0, 0-5 M.A. 0-300 v, 0-1.5 v., moving coil, only 17/6 plus 1.6 postage.

BENSON'S BETTER ARGAINS

TEST SET 127U (1055M). U.S.A. Microwave Frequency Meter, 375-725 mc/s. 3 valve hot-operated. Brand New £7.10s. **CERAMICONS** — N750k, etc. 1, 1.5, 3.3, 5.6, 8.2, 10, 12, 15, 22, 27, 33, 40, 47, 75, 100, 150, 180, 200, 250, 270, 330 pfs. 6d. each. **Midjet mica 50mpf. 3d.** **COMM. RECEIVERS,** brand new, 6 valves, metal wave (0.32-1.5 mc/s.), 97.6; used 82.6 (post 3.6). Conversion data & etc. to CAR RADIO, 1.6. **RECEIVERS,** battery, 60-220 metres, 4 valves het. 2 volt. New 60 — (p.p. 3.6). I.F. STRIP 373, new, with valves, 42.6. **RELAYS,** coaxial, 3/4" x 12 v., 10 — set 3 plugs, 1.6. **TYPE 85, 5 pole 0 heavy-duty :** 6/12 v., 7.6 (p.p. 2.6). **RK78, 2.4 13 mc/s.** with 5 valves, 100k. x Xtal. Good cond., 35 — (p.p. 3.9). **TEST SETS :** 74A with 10 valves, VCR 133A and faulty power pack, fair condition, 40 — (corr. 8.6). **BC1068 VHF Receiver,** valves 2.357. 1 100G, new, 15 — (p. 3.6). **VIBRAPACKS,** 4 v. D.C. to 250 v. 80 mA., smoothed, cased, 22.6 (post 3.6). **RESPONDER ZC8931, 160 190 mc/s.** New, with valves, 15 — (corr. 7.6). **VIBRATORS,** Maltory 6229/12 v. 4 pin., 7.6. **BRAND NEW R.F. 25, 25 — R.F. 27, good cond., 20 — (p.p. 6.6).** **DYNAMOTORS** (post 3.6) : 12 v. to 250 v., 65 mA. and 5.3 v. 2.5 A., 11.6 : 6 v. to 250 v., 80 mA., 12.6. **METAL RECTIFIERS :** 240 v. 100 mA., 4 — : 240 v. 30 mA., 3.6 : 1,000 v. 30 mA., 7.6. **RL155 3 M.** Tuning Drives "N" type, brand new, 10.6. **CHOKES, I.F., 30H, 12u mA., Screened 7.6 ; 3H, 200 mA., 4.6. SWITCHES,** water. 1p 6w. 5b, 2.6 : 1p 11w. 2b, 6p 2w. 4b, 3/6. Stud type, Muirhead 12442B, 7.6. **TEST METERS,** New, 4 — : 2 pin. Read 1.5 and 3 v., 60 mA. and 5k 1, 12.6. **TS347** contains 10 mA. 3 pin. meter, res., etc., 8.6. **TS350** with 1 mA. 3 pin. meter, valve TP25, etc., 30 —. **METERS,** contain 2 separate micro-amp movements and 2 neon, new, 7.6. **MOTORS** 200 220 v. enclosed, 5/1. 3 pin. dia. D.R. 3 pin. spindle, (AC DC) interlocked, 12.6 (post 3.6). **RL155B.** Good condition, valued, aerial tested £7.10s. (Rail 10/-).

LIST AND ENQUIRIES : S.A.E. please ! Terms C.W.O. Postage extra. Immediate despatch.

(Call s & post : W. A. BENSON (P.W.)
136 Rathbone Road, Liverpool 15. SEP 0533.
Calls : S. SUBERADIO (Whitechapel) LTD,
118 Whitechapel, Liverpool 2. ERY 1180.

SOUTHERN RADIO'S WIRELESS BARGAINS

TRANSRECEIVERS. Type 38 (Walkie Talkie) complete with 5 valves, etc. New condition, untested by us, but serviceable. No guarantee. £1.2.6 each.

ATTACHMENTS for Type "38" Transreceivers. ALL BRAND NEW. Headphones, 15/6; Throat Microphones, 4/6; Junction Boxes, 2/6; Aerials No. 1, 2/6; No. 2, 5/-; Webbing, 4/-; Haversacks, 5/-; Valves—A.R.P.12, 4/6; A.T.P.4, 3/6. Set of FIVE VALVES, 19/- the set.

TRANSRECEIVERS. Type "18" Mark III. Two Units (Receiver & Sender). Six Valves, Microammeter, etc., in Metal Carrying Case. Untested, without guarantee but COMPLETE. £2.18.6.

ATTACHMENTS for "18" Transreceivers. ALL BRAND NEW. Phons, 15/6; Microphones, 12/6; Aerials, 5/- . Set of SIX VALVES, 30/-.

RECEIVERS R109. S.W. Receiver in Case. 8 valves. Speaker and 6-v. Vibrator Pack. Untested. No guarantee but COMPLETE, £2.18.6.

RESISTANCES. 100 Assorted useful values. New wire end, 12/6. **CONDENSERS.** 100 Assorted. Mica, Tubular, etc., 15/-.

BOMBSIGHT COMPUTERS. EX-R.A.F. NEW. Hundreds of Components. Gears, etc. Ideal for Experimenters, £3. **LUFBRA HOLE CUTTERS.** Adjustable 1/4 in. to 3/4 in. For Metal, Plastic, etc., 7/-.

QUARTZ CRYSTALS. Type F.T.241 and F.T.243. 2-pin, 1/2 in. Spacing. Frequencies between 5,675 kcs. and 8,650 kcs. (F.T. 243). 20 Mc/s and 38.8 Mc/s (F.T.241, 54th Harmonic), 4/- each. ALL BRAND NEW. TWELVE ASSORTED CRYSTALS, 45/- . Holders for both types, 1/- each. Customers ordering 12 crystals can be supplied with lists of frequencies available for their choice.

MORSE TAPPERS. Standard type, 3/6; Extra Heavy on Base, 5/6; Midget, 2/9.

TRANSPIRENT MAP CASES. Plastic, 14in. x 10 1/2 in. Ideal for Maps, Display, etc., 5/6.

STAR IDENTIFIERS. Type 1 A-N covers both Hemispheres, 5/6. **CONTACTOR TIME SWITCHES.** 2 impulses per sec., in case, 11/6.

Postage or Carriage extra. Full List of RADIO BOOKS, 3d.

SOUTHERN RADIO SUPPLY LTD.
11 LITTLE NEWPORT ST., LONDON, W.C.2. GERrard 6553

BUILD THIS AUTHENTIC JASON SWITCHED F.M. TUNER

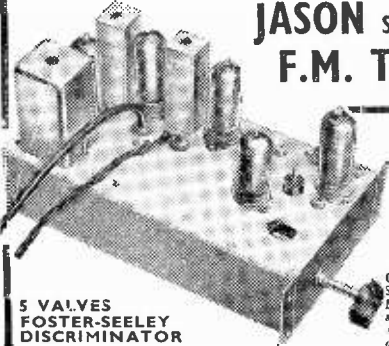

JASON MERCURY

5 VALVES FOSTER-SEELEY DISCRIMINATOR

This British-designed F.M. Tuner provides choice of the three B.B.C. programmes at the turn of a switch, with a fourth position for "OFF." It is a stable unit, free from drift and of high quality. The Switch Tuned Front End is supplied wired, tested and aligned, complete with 2 valves and station-indicating plate. Chassis ready punched. In conformity with all Jason F.M. Units, this model is completely stable and offers the highest possible standards of reproduction.

CONSTRUCTOR'S SWITCH-TUNED MODEL with assembled Front End with two valves and all parts as specified cost to **£9.0.0**

SWITCH-TUNED FRONT END with two valves, complete. **£6.5.0** (incl. £1 15.0 P Tax)

Data Publication Book of the Tuner (Post Paid 2/-)

JASON POWER PACK £2.1.9 Parts count to

FROM LEADING STOCKISTS, or in cases of difficulty: **THE JASON MOTOR & ELECTRONIC CO.**

3-4 Gt. Chapel Street, Oxford Street, London, W.1

COPPER WIRE

ENAMELLED, TINNED, LITZ. COTTON AND SILK COVERED. RESISTANCE WIRES. 1 oz., 2 oz. & 4 oz. REELS. All gauges available. B.A. SCREWS, NUTS, WASHERS, soldering tags, eyelets and rivets. EBONITE AND BAKELITE PANELS. TUFNOL ROD, PAXOLIN TYPE COIL FORMERS AND TUBES. ALL DIAMETERS. Latest Radio Publications. SEND STAMP FOR LISTS.

SPECIAL OFFER GERMANIUM CRYSTAL DIODES

1/- each. Postage 3d.

Diagrams and three Crystal Set Circuits Free with each diode. A large purchase of these fully GUARANTEED diodes from the manufacturers enables us to make this attractive offer.

CRYSTAL SET

INCORPORATING THE SILICON CRYSTAL VALVE

Adjustable Iron Cored Coil. RECEPTION GUARANTEED. Polished wood cabinet, 15/-, post 1/6. A REAL CRYSTAL SET, NOT A TOY

POST RADIO SUPPLIES
33 Bourne Gardens, London, E.4

COVENTRY RADIO

Component Specialists since 1925

We have now trebled the size of our premises in order to supply a larger range of Components, Amplifiers and Hi-Fi Equipment.

Send your enquiries to :

189-191 Dunstable Road, Luton, Beds.

New Telephone No. : LUTON 7388-9

1-Finger Pianists

Build your own electronic keyboard and play everything! Send for free leaflet. Guitar, cello, flute and trumpet are all easy. Write now...

C & S, 10 Duke St., Darlington, Co. Durham

Build your own POCKET RADIO

ALL PARTS NECESSARY TO BUILD YOURSELF A COMPLETE 5-TRANSISTOR POCKET RADIO (Size less than 5 1/2" x 3 1/2" x 1 1/2") CAN BE SUPPLIED FOR AS LITTLE AS £9.18.2. (MEDIUM WAVE) or £10.6.8. (LONG AND MEDIUM WAVES). Send now for free price list and/or 3/- for instruction booklet.

Components available include :
Miniature 3 ohms. Loudspeaker 27/6.
Jackson O.O. Twin Gang with intersection screen ... 10/6.
Oscillator and I.F. Coils ... 8/-.
Output transformers matching single OC72 to 3 ohms ... 10/-.
Battery packs to give 9 volts from 1 1/2 volt slim-pen-light cells 5/-.
(Also available to give 3, 6 or 12 volts.)

Resistors ... from 4d.
Capacitors ... from 6d.

Special Offer—Transistor Radio Batteries (1.5 v.) Size 1 1/2" x 1 3/16", 3d. each.

S. E. C. Ltd.,

9-11 Monmouth St., London, W.C.2.

RADIO AND TELEVISION COMPONENTS

We operate a prompt and efficient MAIL-ORDER Service. 3d. stamp (only) for Catalogue.

JAMES H. MARTIN & CO.
FINSTHWAITE, NEWBY BRIDGE, ULVERSTON, LANCs.

We Have Pleasure to Announce the Opening of Our New Retail Shop

AT
85, TOTTENHAM COURT ROAD,
LONDON, W.1.

(Open all day Saturday)

Here are only a few of the bargains:

- TRANSMITTER-RECEIVERS No. 19 Mk. 2, complete with valves, good condition ... **£2. 0.0**
 - Ditto without valves ... **£1. 0.0**
 - EDDYSTONE 358X RECEIVERS, with 10 coils, overhauled and aligned ... **£12.10.0**
 - RECEIVERS R-1155B, working ... **£8.10.0**
 - HEADSETS: CLR, low impedance ... **£0. 5.6**
 - DLR, balanced armature, low impedance ... **£0. 7.6**
 - CHR, high impedance ... **£0.10.0**
 - HS30 U American lightweight headset with miniature ear-plug type earpieces ... **£0.12.6**
 - METERS: 2 1/2 in. Rd. Fl. 300 v. A.C. M.I. ... **£1. 0.0**
- Comprehensive stock of meters, valves, components, transformers, etc.

Please visit our shop and inspect other bargains in Radio Aircraft Equipment, Test Equipment, etc.

Z & I AERO SERVICES LTD.

Head Office: 14, South Wharf Road, London, W.2.

Tel.: AMBassador 0151.

Retail Shop: 85, Tottenham Court Road, London, W.1.

The VIKING tape recorder

Uses the MOTEK K9 deck. 3-speeds, "Pause," counter. Hatfield oscillator. Switch for Amplifier. 2 inputs. Vol. control scale. Unique method of super-imposing recording. Accessibility for service. C.C.I.R. linked equalisation. Detachable lid.



Send now for leaflet to:—

HATFIELD RADIO

78, STROUD GREEN ROAD, LONDON, N.4

Tape specialists since 1952.

Solder with

LITE SOL

"PERMATIP"
AND
"PERMABIT"
INSTRUMENTS
FOR
GREATER
SOLDERING
EFFICIENCY

The soldering bit which maintains its face indefinitely without attention. 25 models available for mains or low voltage supply. Bit sizes 3/32 to 3/8 inch. Full details in booklet S.P.10 from sole manufacturers:—

LIGHT SOLDERING DEVELOPMENTS LTD.,
106, GEORGE STREET, CROYDON,
SURREY. Tel. CROYdon 8589.

Morse Code Operating as a PROFESSION

45 years of teaching Morse Code is proof of the efficiency of the Candler system. Send 3d. stamp for Payment Plans and Full Details of all Courses.

CANDLER SYSTEM CO. Dept. 510
52b, Abingdon Road, London, W.8.
Candler System Co., Denver, Colorado, U.S.A.

High Fidelity Sound Reproduction, by E. Molloy. 20". postage 1/3.
Elements of Tape Recorder Circuits, a new American Gernsback Book. 23". postage 1/3.
F. M. Radio, by Sturley, 2nd Edition, 15" postage 9d.
Radio Servicing, Vol. 3. Final year radio theory by Fozard, 5". postage 6d.
Fun with Radio, by Gilbert Davey, 10 1/2" postage 1/3.
Amateur Radio Call Book R.S.G.B., 3 1/2" postage 6d.
High Fidelity Loud-speaker Enclosures, by Babani, 5". postage 6d.
We also have a full range of Slide Rules and Drawing Instrument Sets. Send for list.

UNIVERSAL BOOK CO.

12 Little Newport Street, London, W.C.2
(adjoining Lisle Street)

VALVES—Guaranteed

EA50	2-1VR65	3 1/8-6BE8	7-6U7	5-
EB41	7-6VR85A	3 1/8-6BH6	5-7B6	8-
EB91	7-6VR91	4-6BW8	6-6TD6	7-6
EC33	8-6VR137	4-6CSM	6-6D2	4-6
EF36	4-6VT20	3 1/8-6D2	7-6D2	5-
EF37	7-6VT50	4-6BF6	7-6D6	5-
EF39	5-6VT51	4-6BF13	11-610F1	11-6
EF50	5-6VU111	2-6GJ5	6-12BA6	7-6
EF69	8-6W77	5-6GJ8	6-12BE6	6-
EL32	5-0Z4	5-6KT6	4-612J7	8-6
PEJ	4-2152	8-66KT7M	5-612K7	8-
DY31	9-01D5	8-66SA7	8-15D2	6-
PV81	10-1LN35	6-6SN7GT	18	7-6
SP41	4-43D1	4-	8-620D1	12-
SP61	6-6AK6	7-66U5	7-635W4	7-6
TT11	3-66AL5	7-66U5(UX)	50C5	7-6
WR21	4-6B8	6-	7-678	8-6

Postage 6d. per valve, orders over £1 post free. Also all components) TV Tubes, Perfect Condition (callers only) MW22 16, MW 22/18, £4.0.0 each. Also all Transistor Components.

TELEKIT SUPPLY

104 High Street, Beckenham, Kent.
Phone: BEC 3720

WIRING ACCESSORIES

Return of Post Service. Lowest possible prices consistent with high quality. Money back guarantee.

PVC Cable Flat Twin Twin with E. 3 Core

1.044	£2. 9. 2	£3. 1. 9	£3.10. 5
3.029	£3. 5. 7	£3.17.11	£4.16. 5
5.036	£4. 9. 6	£5. 2.11	£6.11. 4
7.029	£5.12. 6	£7. 0. 7	£8. 4. 7

FRS CABLE

1.044	£2.10. 0	£3. 1.10	£3.10. 3
3.029	£3. 3.11	£3.16. 4	£4.19. 4
3.036	£4. 3. 5	£5. 1. 7	£6. 5. 6
7.029	£5.10. 5	£6.16.11	£7.18.10

Prices per 100 yds. All sizes stocked. Supplied in 25, 50, 75 or 100 yd. lengths. 7.029 and above cut to length—no cutting charge. Carriage paid on all orders over £2. Full range of accessories available. Send for complete lists.

F. HUNT & CO.
STEPCOTE HILL, EXETER
Phone: Exeter 56827

GUESSING?—DON'T!

PIN-POINT THOSE FAULTS WITH A RES. CAP BRIDGE, 35/- (P. & P. 1/6)
READY CALIBRATED

Stamp for details of this and other kits.
RADIO MAIL (Dept. N)

Raleigh Mews, Raleigh Street, Nottingham

LOOK!

Specially made for
YOUR Home Workshop . . .

New improved construction from one of the toughest imported hardwoods . . . top boards specially kiln-dried, joints through bolted. Top and bottom rails morticed into the legs and front legs let into front board provide absolute rigidity. 3-Way bench top by simple adjustment.



30" DOWN or 40" - with vice

'Woden' Woodworker's Quick Release Vice, illus 23.10.0 extra fitted free.

£7.10.0
Carr. pd

Length 4 8
Width 2 0
Height 2 9

To: J. POWELL & SON (Dept. C), TIMBER MERCHANTS, PENSNETT, BRIERLEY HILL, STAFFS.

Please forward fully comprehensive price lists, including full details of the bench illustrated and the model which incorporates drawer and cupboard.

NAME

ADDRESS

G2AK This Month's Bargains

HI-FI EQUIPMENT

AVAILABLE FOR IMMEDIATE DELIVERY. Amplifiers, speakers, pick-ups by Gramplan, Leak, Quad, Rogers, R.C.A., Spectone, W.B., Wharfedate, etc.

AMERICAN OCTAL BASED XTALS. 1000KC Precision Type. Replacements for BC221. Only 30/- ea. post free.

100 Kc/s XTALS. by famous American makers. 3-pin base holder. New condition, worth £3.10.0. Only 25/- post free.

PLUG IN NOISE LIMITERS. 3 Position Limiting No Rewiring. Best with H.R. Phones. Only 8/6. P. & P. 1/6.

HEADPHONES. H.R. Type 4000 ohms, very sensitive. Only 12/6 pr. Post 1/6. C.L.R. type (low res.) 8/6. Post 1/6.

SEMI-MIDGET COMBINED I.F. TRANSFORMERS. 10.7 Mc/s and 465 kc/s (can be used on 10.7 Mc/s or 465 kc/s only). 9/11 per pair, postage 9d.

CHOKES. 2.5 mH, 120 mH pie-wound R_F chokes. 2/- each. 3 or more post free.

AERIAL WIRE. Copper. 7-25 stranded: 140ft., 10/-; 70ft., 5/-; Hard Drawn 14g.: 140ft., 17/-; 70ft., 8/6. P. & P. 2/-.

RIBBED GLASS 3in. AERIAL INSULATORS. 1/6 ea., or 6 for 7/6. P. & P. 1/6.

CONDENSERS. 8 μ F 600 v. Trop. 750 v. normal condensers. NEW. ex W.D. stocks. 5/6. P. & P. 1/6.

ABSORPTION WAVEMETERS, 3 to 35 Mc/s in 3 switched bands. Complete with indicator bulb. 17/6 post free.

No C.O.D. on orders under £1.

Please Print Your Name and Address.

CHAS. H. YOUNG LTD.

Dept. 'P' 110, Dale End, Birmingham, 4. (CEN. 1635)

The "TYANA" Standard Soldering Iron



- Adjustable Bit.
- Weight approx. 4 oz
- Heating Time 3 min.
- 40 Watt economy Con- sumption.
- Standard Voltage Ranges.

Replacement Elements and Bits always available.

"DIPLOMA" HEADPHONES



Lightweight High Resistance (4,000 ohms). Complete with cord. 17/6

Ideal for CRYSTAL SETS and also for use with TAPE RECORDERS.

KENROY LIMITED
152/297 UPPER ST., ISLINGTON, LONDON, N.1.

Telephone: Canonbury 4905-4663

B.B.C. - I.T.V. - F.M. - AERIALS

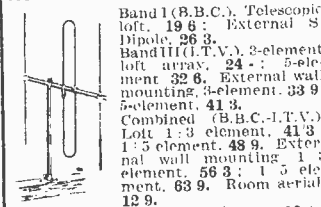

Band I (B.B.C.). Telescopic loft. 19 6; External S Dipole. 26 3.
Band III (I.T.V.). 3-element loft array. 24; 5-element mounting. 32 6; External wall mounting. 4-element. 33 9; 5-element. 41 3.
Combined (B.B.C.-I.T.V.). Loft 1: 3 element. 41 3; 1: 5 element. 48 9. External wall mounting. 1: 3 element. 56 3; 1: 5 element. 63 9. Room aerial. 12 9.
Band II (F.M.). Loft S Dipole. 12 6; Loft "H." 28; External S Dipole. 28 3. Postage and Packing all types. 2 6. Co-axial. 30. yd.: Co-axial plugs 1 3. State channel when ordering. S.A.E. for Price List. Trade enquiries invited.
KVA ELECTRONICS (Dept. 11)
189, Kent House Rd., Beckenham, Kent
SYD 2488

AC/DC MULTIMETER 45/-

See last month's advert. Part B now available at 19/6. P. & p. 9d.
1%. High Stability Resistors. Any value 100 ohms to 1 Megohm, including non-standard values: 1 w., 2 3.
Precision Wirewound Resistors. Eureka wound on strip. 1 to 1,000 ohms, 0.5%, 3 -; 0.2%, 0.01 ohm, 4 3; 1.001K to 5K, 0.5% -; 3 6; 0.2%, 4 9; 5.001K to 20K, 0.5%, 4 3; 0.2%, 6 -. Your value wound to order.
Shunt for 1 mA 100 ohm Meter. Ranges 10, 100, 1,000 mA. 1%, accuracy, 8/6.
Shunt for 500 μ A 500 ohm Meter. Ranges 5, 50, 500 mA. 1%, accuracy, 9/6.
Precision Condensers. 1 μ F 2%, 0.01 μ F 2%, 100 pF 1%, 6 6 per set. 100 ohms 1%, 10 K 1%, 1 Meg. 1%, 5/9 per set.
S.A.E. with enquiries, please. Post extra.

PLANET INSTRUMENT CO.
25, DOMINION AVE., LEEDS 7.

THE WAVEMASTER TRANSISTOR PORTABLE

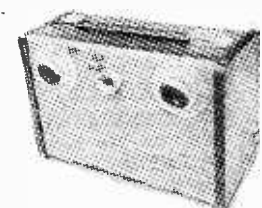

AN OLYMPIC WINNER
Pick of the World's Stations at your finger-tips.

Long and Medium Wavebands. Comprehensive assembly data and Components Lists, 1/6. Complete Receivers Available.

OLYMPIC RADIO COMPONENTS, LTD.
224, Hornsey Road, Holloway, N.7.

FM and HI-FI Components

DENCO F.M. TUNER circuits 1s. 6d.
RADIO CONST'R. F.M. " 2s. 0d.
MULLARD AMPLIFIERS " 3s. 0d.
G.E.C. 912 PLUS AMPLIFIER " 4s. 0d.
G.E.C. F.M. PLUS TUNER " 2s. 6d.
Separate price lists available on request to
J. T. FILMER 82, DARTFORD RD., DARTFORD, KENT. Tel. Dartford 4057.

Forrest
Transformer for Quality Equipment
H. W. FORREST (Transformers) Ltd.
349, Haslucks Green Road, Shirley, Solihull, Warwicks. Tel.: Shirley 2483.

Practical Wireless

BLUEPRINT SERVICE

PRACTICAL WIRELESS

No. of
Blueprint

CRYSTAL SETS

2/- each	
1937 Crystal Receiver ...	PW71*
The "Junior" Crystal Set	PW94*
2/6 each	
Dual-Wave "Crystal Diode"	PW95*

STRAIGHT SETS

Battery Operated

One-valve : 2/6 each	
The "Pyramid" One-valver (HF Pen) ...	PW93*
The Modern One-valver	PW96*

Two-valve : 2/6 each	
The Signet Two (D & LF)	PW76*

3/6 each	
Modern Two-valver (two band receiver) ...	PW98*

Three-valve : 2/6 each	
Summit Three (HF, Pen, D, Pen)	PW37*

The "Rapide" Straight 3 (D, 2 LF (RC & Trans))	PW82*
---	-------

F. J. Camm's "Sprite" Three (HF, Pen, D, Tet)	PW87*
--	-------

3/6 each	
The All-dry Three	PW97*

Four-valve : 2/6 each	
Fury Four Super (SG, SG, D, Pen)	PW34C*

Mains Operated

Two-valve : 2/6 each	
Selectone A.C. Radiogram Two (D, Pow) ...	PW19*

Three-valve : 4/- each	
A.C. Band-Pass 3	PW99*

Four-valve : 2/6 each	
A.C. Fury Four (SG, SG, D, Pen)	PW20*

A.C. Hall-Mark (HF, Pen, D, Push Pull) ...	PW45*
--	-------

SUPERHETS

Battery Sets : 2/6 each	
F. J. Camm's 2-valve Superhet	PW52*

Mains Operated : 4/- each	
"Coronet" A.C.4	PW100*
AC/DC "Coronet" Four ...	PW101*

Published on the 7th of each month by GEORGE NEWNES, LIMITED, Tower House, Southampton Street, Strand, London, W.C.2, and printed in England by W. SPEIGHT & SONS, Exmoor Street, London, W.10. Sole Agents for Australia and New Zealand: GORDON & GOTCH (A sia), LTD. South Africa and Rhodesia: CENTRAL NEWS AGENCY, LTD. Subscription rate including postage, for one year: Inland 19s., Abroad 17s. 6d. (Canada 16s.). Registered at the General Post Office for the Canadian Magazine Post.

No. of
Blueprint

SHORT-WAVE SETS

Battery Operated

One-valve : 2/6 each	
Simple S.W. One-valver ...	PW88*

Two-valve : 2/6 each	
Midget Short-wave Two (D, Pen)	PW38A*

Three-valve : 2/6 each	
Experimenter's Short-wave Three (SG, D, Pow)	PW30A*

The Perfect 3 (D, 2 LF (RC and Trans)) ...	PW63*
--	-------

The Band-spread S.W. Three (HF, Pen, D (Pen), Pen)	PW68*
---	-------

MISCELLANEOUS

2/6 each	
S.W. Converter-Adapter (1 valve)	PW48A*

The P.W. 3-speed Auto-gram	(2 sheets), 8/-*
-----------------------------------	------------------

The P.W. Monophonic Electronic Organ (2 sheets), 8-	
---	--

TELEVISION

The "Argus" (6in. C.R. Tube), 3/-*	
The "Simplex"	3/6*

The P.T. Band III Converter	1/6*
-----------------------------	------

All the following blueprints, as well as the PRACTICAL WIRELESS numbers below 94, are pre-war designs, kept in circulation for those amateurs who wish to utilise old components which they may have in their spares box. The majority of the components for these receivers are no longer stocked by retailers.

AMATEUR WIRELESS AND WIRELESS MAGAZINE

STRAIGHT SETS

Battery Operated

One-valve : 2/6	
B.B.C. Special One-valver	AW387*

Mains Operated

Two-valve : 2/6 each	
Consoelectric Two (D, Pen), A.C.	AW403

SPECIAL NOTE

THESE blueprints are drawn full size. The issues containing descriptions of these sets are now out of print, but an asterisk denotes that constructional details are available, free with the blueprint.

The index letters which precede the Blueprint Number indicate the periodical in which the description appears. Thus P.W. refers to PRACTICAL WIRELESS, A.W. to Amateur Wireless, W.M. to Wireless Magazine.

Send (preferably) a postal order to cover the cost of the Blueprint (stamps over 6d. unacceptable) to PRACTICAL WIRELESS, Blueprint Dept., George Newnes, Ltd., Tower House, Southampton Street, Strand, W.C.2.

No. of
Blueprint

SHORT-WAVE SETS

Battery Operated

One-valve : 2/6 each	
S.W. One-valver for American	AW429*

Two-valve : 2/6 each	
Ultra-short Battery Two (SG, det Pen)	WM402*

Four-valve : 3/6 each	
A.W. Short Wave World-beater (HF, Pen, D, RC, Trans)	AW436*

Standard Four-valver Short-waver (SG, D, LF, P)	WM383*
--	--------

Mains Operated

Four-valve : 3/6	
Standard Four-valve A.C. Short-waver (SG, D, RC, Trans)	WM391*

MISCELLANEOUS

Enthusiast's Power Amplifier (10 Watts) (3/6)	WM387*
---	--------

Listener's 5-watt A.C. Amplifier (3/6)	WM392*
---	--------

De Luxe Concert A.C. Ictrogram (2/6)	WM403*
---	--------

QUERY COUPON

This coupon is available until April 6th, 1958, and must accompany all queries sent in accord with the notice on our "Open to Discussion" page. PRACTICAL WIRELESS, APRIL 1958

THE

MULTIMINOR

This splendid new AVO Instrument has been developed to meet a definite demand for a sturdy pocket-size multi-range test meter at a modest price, suitable for use on modern electronic apparatus as well as for radio and television receivers, motor vehicles, and all kinds of domestic appliances and workshop equipment.

Readings are obtainable quickly and easily on a very open scale, and range selection is by means of a robust clearly marked rotary switch of the characteristic AvoMeter type. Measurements of A.C. and D.C. Voltage, D.C. Current, and Resistance are made by means of only two connection sockets.

Designed and Manufactured by

AVO Ltd.

19 RANGES

D.C. Voltage	A.C. Voltage
0—100mV.	0—10 V.
0—2.5V.	0—25 V.
0—10 V.	0—100 V.
0—25 V.	0—250 V.
0—100 V.	0—1,000 V.
0—250 V.	
0—1,000 V.	
	D.C. Current
	0—100μA
	0—1mA
	0—10mA
Resistance	0—100mA
0—20,000 Ω	0—1 A
0—2M Ω	

List Price:

£9' 10s.

complete with Test Leads and Clips.

A new pocket-size instrument for the Radio and T.V. constructor.



Pocket size: 5½ x 3½ x 1½ ins.
Weight: 1 lb. approx.



Leather Case if required 32/6

Sensitivity:
10,000 Ω/V on D.C. voltage ranges.
1,000 " " " " A.C. " " " "

Accuracy:
3% of full scale value on D.C.
4% " " " " " " " " A.C.

To meet special requirements, instruments can be supplied to a higher degree of accuracy for a small additional charge.



Telephone: VICTORIA 3404 (9 lines)

AVOCET HOUSE • 92-96 VAUXHALL BRIDGE RD. • LONDON • S.W.1

M.M.2.

YOU can build any of these at Low Cost!

A MINI TRANSISTOR RADIO

AN IDEAL PRESENT

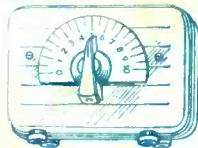

A two-stage highly sensitive circuit uses a new super high gain transistor coil and mini tuning Total building condenser. Gives remarkable performance. With step-by-step instructions. Beginners can't go wrong. Get your order in while prices are low. Send 2/- for wiring diagram and component price list.

37/6

Includes Plastic Case mini ear-piece. Batteries etc. All parts sold separately.

Ideal for:

- Late night listening.
- Children's nursery, etc.

1v. WORLD WIDE SHORT-WAVE RADIO

EXPLORE THE WORLD ON SHORT WAVES!

Can be built for from our list of components which can all be purchased separately, covers 10-100 metres and is capable of receiving speech and music from all over the world. Price includes the famous 954 acorn valve and one coil covering 40-100 metres. Provision is made to increase to two or three valves and all components are colour coded. Send 2/- for point to point wiring diagram, layout and price list.

30/-

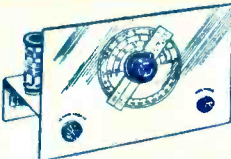

Post and packing: Under 10/- add 9d. under 40/- add 1/6 over POST FREE.

TRANSISTOR POCKET RADIO

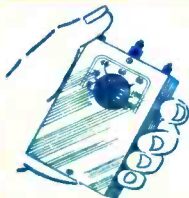

The ideal low cost transistor pocket radio for the beginner. The Two-Stage circuit utilises the new R.C.S. VARILOOPSTICK transistor coil. A specially designed miniature .0005 tuning condenser permits the receiver to be in a case which fits in the palm of your hand. Works for months off small battery costing 7d. Can be built in 30 minutes. PRICE

30/-

full construction data, including plan to parts for 2/-.

PERSONAL PORTABLE RADIO

THE SET FOR PERSONAL LISTENING

This little set was designed to give you a real personal portable radio that you can listen to anywhere without disturbing others. Use it on camping trips, in bed, in your office. Supplied with detachable rod aerial, it covers all the medium waves 200-500 metres. Average building time one hour. PRICE

30/-

Send 2/- for specification, point to point circuit and parts price list



R.C.S. PRODUCTS (RADIO) LTD., 11, OLIVER ROAD, LONDON, E.17. (Mail Order only)