

# CRYSTAL DIODES

1/-

Vol. 28... No. 554  
DECEMBER, 1952

EDITOR:  
F.J. CAMM

# PRACTICAL WIRELESS

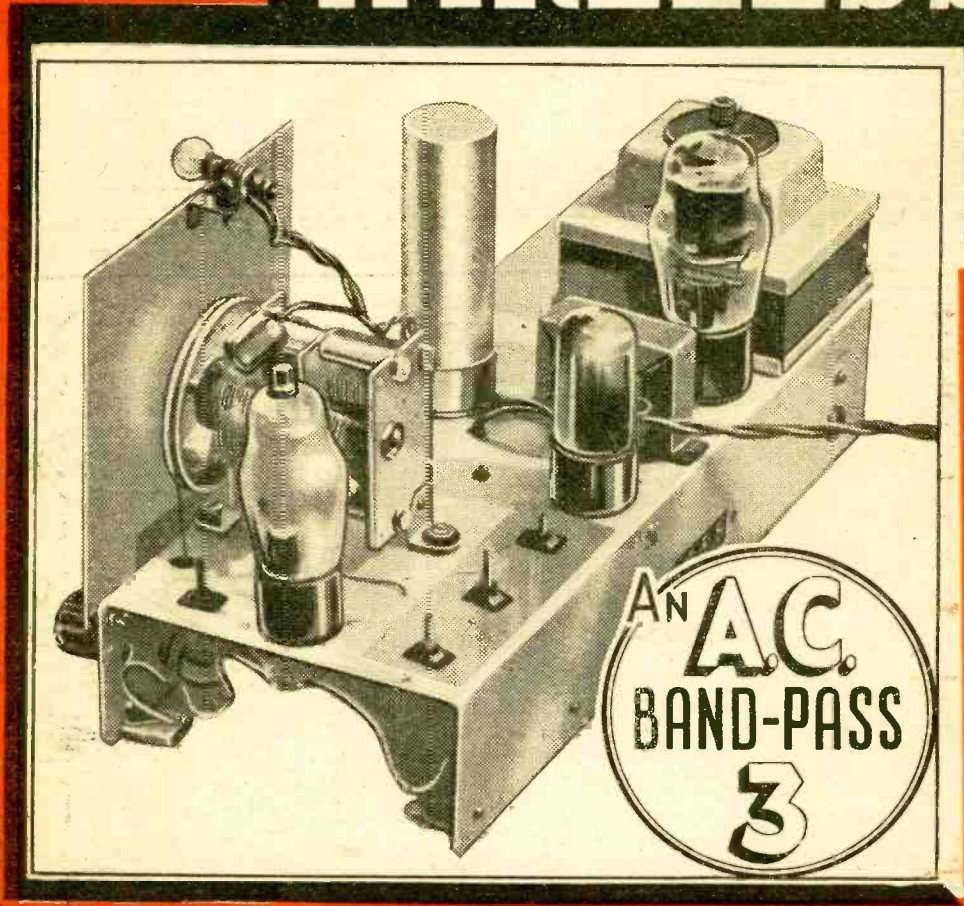

## IN THIS ISSUE :

PREDICTING AMPLIFIER RESPONSE  
ELECTRONIC ORGANS  
THE DECIBEL

FREQUENCY MULTIPLICATION  
AN 1155 CONVERTER  
SURPLUS C.R. TUBES

# EVERY AMATEUR CONSTRUCTOR

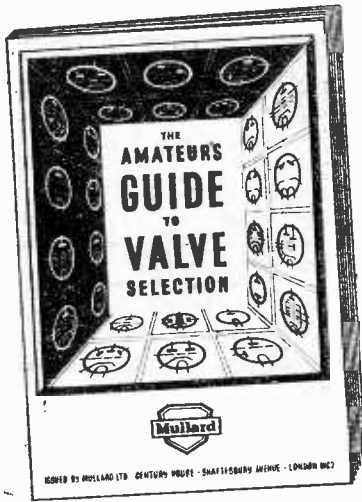

## NEEDS THIS <sup>new</sup> BOOK

For the first time Mullard have compiled a Valve and C.R.T. reference specially for the amateur constructor. "The Amateur's Guide to Valve Selection" contains essential information on valves for AC, AC/DC and battery operated radio receivers, for television receivers, and for audio amplifiers:

1. Instructions for the correct use of the Mullard "Preferred" Range of Valves and of Mullard "Long Life" Television Picture Tubes.
2. Full operational data for each application.
3. Simple valve selection table for quick reference.
4. Mullard Valve and C.R.T. nomenclatures.
5. Typical circuit diagrams for the various applications.

## Mullard

OBTAINABLE FROM YOUR LOCAL DEALER, OR DIRECT FROM MULLARD LTD., BY FORWARDING YOUR NAME AND ADDRESS, TOGETHER WITH A 1/9 P.O., TO THE ADDRESS BELOW.



**1/6**  
Per copy (packing & postage 3d. extra);

MULLARD LTD., VALVE SALES DEPT., CENTURY HOUSE, SHAFTESBURY AVENUE, LONDON, W.C.2.

MVM 212



As Specified for Conversion of the 21 Receiver TR1196, Type 18, Wartime Utility and others.

**SUPERHET and T.R.F.**  
The OSMOR "Q" Coilpack does not "whistle while it works" but gives you perfect performance in every way. And it saves time, money and hours

of wasted effort puzzling over complicated wiring circuits. Just 5 connections, 5 minutes' work and the job is done—and well done!

**COILS.** A full range of separate midjet coils is available, fitted with tag rings for easy connection. **PRICE 4/- each.** Send 5d. stamp for **FREE** circuits and new illustrated lists of Coils, Coilpacks, and all Radio Components, also details of parts for construction of an inexpensive tape recorder.

**OSMOR RADIO PRODUCTS, LTD. (Dept. P30),** BOROUGH HILL, CROYDON, SURREY Tel.: CROYDON 5148/9

## TECHNICAL BOOK SERVICE



### for the Radio Industry

For all your technical books and periodicals you need go no further than the nearest shop or bookstall of W.H.S. Whilst it is not practicable to maintain a big stock of such books at every branch—the Daily Supply Service from Head Office will quickly deliver the books you want to your local branch. We will gladly supply lists of the standard works on any subject and welcome inquiries from students and librarians.

★ Our Postal Service can send technical books and periodicals to any address at Home or Overseas.

## W. H. Smith & Son

TECHNICAL BOOK SERVICE

HEAD OFFICE: STRAND HOUSE, LONDON, W.C.2

# SOLDERING COSTS CAN BE CUT...

# Wolf

**BEST VALUE FOR MONEY!**

★ **SOLDER TWICE AS FAST - AT FAR LESS COST!**

**TRIGGER-FEED**

**SOLDERGUN**

The Wolf Type 51 Soldergun with its trigger feed action is indispensable to all modern assembly.

**SOLDERGUNS**

Off-straight easy-grip handle. Perfect balance. Solid construction. Low current consumption. Model for every purpose. Rapid constant heat.

**SOLDERING IRONS**

Identical as regards elements and bits to Wolf Solderguns but with round hard wooden handle with heat-deflecting skirt.

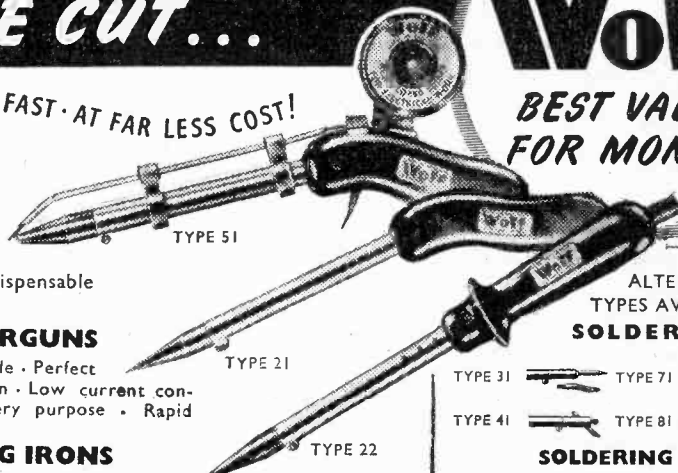

ALTERNATIVE TYPES AVAILABLE  
**SOLDERGUNS**



**SOLDERING IRONS**

★ Obtainable at all high-class stockists and ironmongers  
**WOLF ELECTRIC SOLDERGUNS AND SOLDERING IRONS**

**WOLF ELECTRIC TOOLS LTD., PIONEER WORKS, HANGER LANE, LONDON, W.5 - TELEPHONE: PERIVALE 5651-4**

The new **ARMSTRONG** Television Chassis Model T.V.15 incorporating a 12in. C.R.T., is now available for distribution.

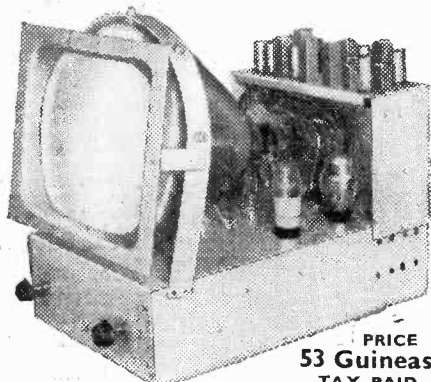

**PRICE 53 Guineas TAX PAID**

Also available in a beautifully veneered two-toned walnut Console cabinet. 63 Guineas Tax Paid. Installed free. Comprehensive Maintenance Service available.

Please send for Radiogram and T.V. list, post free.

**ARMSTRONG WIRELESS & TELEVISION CO., LTD.,**  
WARLTERS ROAD, HOLLOWAY, LONDON, N.7.  
Telephone: NORTH 3213

## The solder for all HOME TELEVISION CONSTRUCTOR SETS

Designers of television constructor sets know that the efficiency of their equipment depends on the solder used by the constructor—that's why they recommend Ersin Multicore for trouble-free, waste-free soldering. Ersin Multicore, the only solder containing three cores of extra-active, non-corrosive Ersin Flux, is obtainable from all leading radio shops. Ask for Cat. Ref. C.16018, 18 S.W.G. 60/40 High Tin Television and Radio Alloy. The size 1 Carton contains 37 feet of solder, costs 5/-.



## Ersin Multicore Solder

In case of difficulty in obtaining supplies, please write to:

**MULTICORE SOLDERS LTD., MULTICORE WORKS, MAYLANDS AVE., HEMEL HEMPSTEAD, HERTS** • Boxmoor 3636 (3 lines)

## ANNOUNCING THE

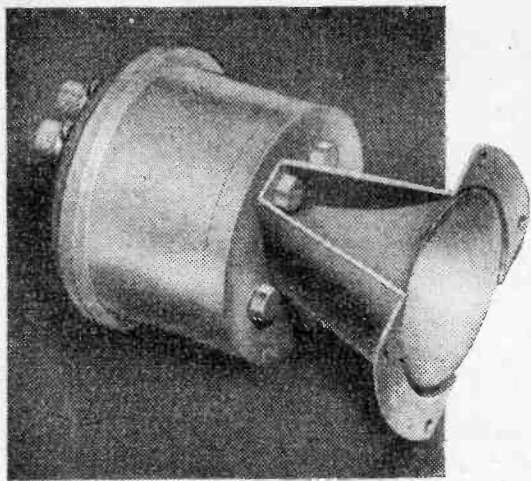
*Stentorian*PRESSURE TYPE  
TWEETER UNIT

In response to the demand evidenced at the Radio Show, we introduce a unit for use with any cone speaker, providing very high quality reproduction at remarkably low cost.

The Unit is of the moving coil pressure type and is similar to that embodied in the 10" and 12" Concentric Duplex Loudspeakers. The speech coil is of aluminium wire, wound on an aluminium former which is rigidly fixed to an aluminium diaphragm. The speech coil and diaphragm is situated at the rear of the magnet and the centre pole hollowed out to form the commencement of the Horn, in the centre of which is located the phase equalizer.



Full range of chassis models is available from 2½" to 18", full details gladly sent on application

Speech coil impedance 15 or 30 ohms. Flux Density: 14,000 gauss. Response: 2,000/14,000 c.p.s. Power handling capacity: 3 watts. Price: 75/6. It is recommended that a suitable cross-over network of between 2,000/3,000 c.p.s. be used.

WHITELEY ELECTRICAL RADIO CO. LTD · MANSFIELD · NOTTS

## GARLAND BROS. LTD.

CHESHAM HOUSE, DEPTFORD BROADWAY, S.E.8.  
5 OBELISK PARADE, LEWISHAM, S.E.13.

TEL: TIDEWAY 4412/3  
TEL: LEE GREEN 4038

THE 'GARLAND'  
TAPE  
RECORDER

£37/10/0

including a 1,200ft. reel of Scotch Boy Tape and a spare spool. Carriage, etc., 15/-. Crate £1 (not charged if you undertake to return carriage paid to us). No wiring or soldering to be done. Incorporating the new Lane Tape Table and the UE7 Amplifier, housed in a de luxe walnut veneered cabinet. GARLAND KIT £32/5/-, plus carr. and crate. TRADE SUPPLIED.

## AMPLIFIER A.C.11

This popular amplifier is still available for those who desire good quality at a low cost. Output is 4 watts, and volume and tone controls are incorporated. High grade output transformer. H.T. and L.T. supplies are from mains transformer. Amplifier-wired and tested £6/2/6. Plus 5/- carriage. GARLAND KIT £5/2/6, plus 5/- carr. TRADE SUPPLIED.

## RONETTE MICROPHONES

B110 Crystal, in ivory plastic, £2/12/0. HM7, filter-cell, die-cast case; designed for magnetic tape recording, £3/7/6.

## TAPE RECORDER OSCILLATOR COILS

Inductance 6.3 mH., resonating at 45 Kc/s., with a .002 mfd. condenser. For use with high impedance heads. Made for us by a leading manufacturer. Price 6/9 each.

TRADE SUPPLIED.

## VALVES

The following are a few examples from our stocks of new boxed valves: 6SH7, 6/6; MS/PEN, 6/6; 6Q7G, 10/6; NGT1, 6/6; RL18, 5/-; VU133, 5/-; VU111, 5/-; KT66, 13/6; 6J7G, 10/6; 6K7G, 10/6; 6V5G, 9/6.

## AERIAL ROSDS

Useful copper-plated steel tubes, fit end to end to enable any length of aerial to be made: ideal for T.V. Length 12in. Price 2/6. per dozen; 21/- per gross.

**GARLAND KITS.**—All main components already mounted on chassis. Only wiring and soldering to be completed. Circuits, diagrams, instructions supplied.

## LANE TAPE TABLE

Now incorporating the following features: 3 motors; very fast wind-on and re-wind; automatic braking; high impedance, half-track heads; tape speed 7 1/2 in./sec. Price £16.10.0, plus 10/- carriage, etc.

TRADE SUPPLIED.

**GARLAND BROS.**—Please send Post Orders to Deptford Branch

## THE UE7 RECORD-PLAYBACK AMPLIFIER

High Gain Amplifier designed for use with the Lane Tape Table, incorporating bias and erase oscillator, power supplies, and 8in. loudspeaker. For full details see previous advertisements or send 2d. stamp. Price £12.12.0, plus 7/6 carriage, etc.

**GARLAND KIT** for this Amplifier, £9.15.0, plus 7/6 carriage, etc. TRADE SUPPLIED.

## DE LUXE TAPE RECORDER CABINETS

Veneered walnut, to take UE7 Amplifier and Lane Tape Table. £6.

## MULTI-PURPOSE TOOL

Bends, shears, punches and threads sheet-strip and rod. For all the little construction jobs that waste your time. Tool price 10/-. Jig, gauge and protractor for accurate repetition work. Price 7/6.

## ENGRAVING TOOL

Operates direct from 200-240 volt A.C. mains for engraving on metal and plastic. Price 12/6.

## TYANA SOLDERING IRONS

Lightweight, 40 watt irons with easily replaceable elements and bits. Voltage ranges, 100/110v., 200/220v., 230/250v. Price 16/9. "The iron that makes soldering a pleasure."





# CONDENSERS

The abbreviated ranges of two popular types given here are representative of the wide variety of T.C.C. Condensers available.

## SUPER TROPICAL "METALPACKS" (in Aluminium Tubes)

Capacity (μF)	Wkg. Volts D.C.		Dimensions		Type No.
	at 71° C.	at 100° C.	Length	Dia.	
.005	1,000	750	1 1/2 in.	1/2 in.	CP45W
.02	750	600	1 1/2 in.	1/2 in.	CP45U
	350	200	1 1/2 in.	1/2 in.	CP45N
.25	500	350	2 1/2 in.	1/2 in.	CP47S
.5	500	350	2 1/2 in.	1 in.	CP91S
1.0	350	200	2 1/2 in.	1 in.	CP91N

## SUPER TROPICAL MINIATURE "METALMITES" (in Aluminium Tubes)

Capacity (μF)	Wkg. Volts D.C.		Dimensions		Type No.
	at 71° C.	at 100° C.	Length	Dia.	
.0002	500	350	1/8 in.	.2 in.	CP110S
.0005	500	350	1/8 in.	.2 in.	CP110S
.001	350	200	1/8 in.	.2 in.	CP110N
.002	350	200	1/8 in.	.22 in.	CP111N
.005	200	120	1/8 in.	.22 in.	CP111H
.01	350	200	1/8 in.	.34 in.	CP113N

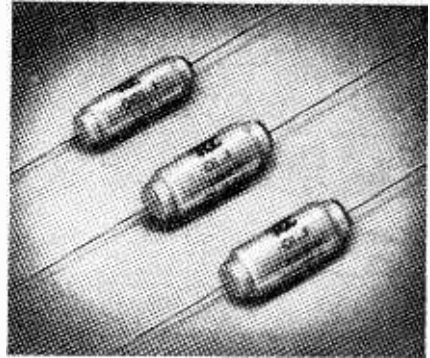
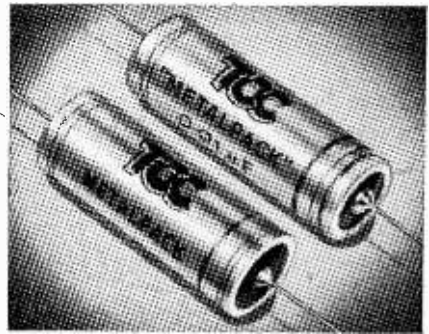

### THE TELEGRAPH CONDENSER CO. LTD.

Radio Division: North Acton, London, W.3. Tel: Acorn 0061

- MAINS DROPPERS**  
 Welwyn 708Ω with 3 taps ... 2/6 ea.  
 .. 751Ω with tap at 40Ω ... 1/9 ea.  
 Erie 717Ω with tap at 600Ω ... 1/3 ea.  
 Zenith 358Ω with 5 taps ... 2/3 ea.  
 Standard 2amp. 950Ω variable 2/9 ea.
- ENAMELLED COPPER WIRE**  
 1 lb. reels 26 S.W.G. ... 3/3 ea.  
 1 lb. .. 38 .. ... 2/9 ea.  
 1 lb. .. 16 .. ... 3/3 ea.  
 1 lb. .. 16 .. ... 1/9 ea.  
 1 lb. .. 14 .. ... 3/3 ea.  
 1 lb. .. 14 .. ... 1/9 ea.
- THROAT MICROPHONES**  
 2 Units in box ... 2 - ea.
- BIAS CONDENSERS**  
 T.C.C. 25 mfd. 25 v. D.C. ... 1 1/3 ea.  
 Daly 60 mfd. 50 v. D.C. ... 2 6 ea.  
 Dubilier 50 mfd. 12 v. D.C. ... 1/9 ea.  
 Hunts 25 mfd. 50 v. D.C. ... 1/9 ea.  
 T.C.C. 12 mfd. 50 v. D.C. ... 1/- ea.  
 T.C.C. 50 mfd. 12 v. D.C. chassis mounting ... 9d. ea.  
 T.C.C. 50 mfd. 12 v. D.C. Micro-pac ... 1 9 ea.

- THIS MONTH'S OUTSTANDING BARGAINS**  
 T.C.C. 8 mfd. 350 v. ... 1 1/3 ea.  
 B.E.C. 32 mfd. 350 v. ... 1 6 ea.  
 Metal Rectifiers 12 v. 1 amp. 1 ea.  
 T.C.C. 25 mfd. 25 v. D.C. ... 1 1/3 ea.  
 Octal Grid Caps ... 6d. doz.  
 Jack Sockets ... 6d. ea.  
 Morganite 1 Meg. S.P.S. ... 2 9 ea.  
 .. 4 Meg. less switch ... 1 6 ea.  
 Wire Wound Controls. 200Ω, 5Ω, 10 KΩ, 25 KΩ, 50 KΩ 2/- ea.
- EX. GOV. VOLUME CONTROLS**  
 200Ω, 500Ω, 600Ω, 5 KΩ, 10 KΩ, 20 KΩ, 25 KΩ, 50 KΩ, 100 KΩ, 150 KΩ, 200 KΩ, 1 Meg. Ω, 1 Meg. Ω, 1 Meg. Ω, 2 Meg. Ω, All 1/- ea.
- ERIC CERAMICS**  
 5 pF 6.8 pF, 27 pF ... 4 doz.

# ALPHA RADIO SUPPLY CO.

## VALVES

GUARANTEED NEW AND BOXED SOME GOVERNMENT SURPLUS

X76M	10/-	573G	9/6	80	9/6
PEN383	10/-	6AC7	7/3	807	10/6
7D5	10/-	524G	9/6	954	2/9
U19	9/-	6B4	8/6	12A6	7/9
TH30C	10/-	6C6	7/6	12C8	9/-
EBC3	10/-	6F6G	9/-	12K3	9/6
TSP4	9/-	6H6	4/6	25A6G	9/6
FL35	10/6	6J7M	8/6	35L6GT	10/-
12Z3	9/-	6K7G	6/6	35Z4GT	9/6
6SS7	9/-	6K8G	12/6	ECL80	12/6
6L5	5/6	6L7	8/-	E1148	8/-
MS4B	12/6	6N7	7/6	HL23DD	8/6
12AT7	10/-	6Q7G	10/6	KT61	10/6
12J5	8/-	6SA7GT	9/6	KT66	11/6
90Z2	6/6	6SG7	7/9	KTZ41	6/9
305GT	8/6	6SHT	7/-	MH4	8/-
VR150.30	9/-	6SL7	9/6	MSPen	5/-
OZ4	8/-	6SK7	7/-	Pen25	8/6
1R5	8/9	6SL7	9/6	TP25	8/6
154	8/9	6SW7GT	11/6	UL41	11/6
155	8/9	6SQ7	9/6	UY41	10/6
354	8/9	6V6G	9/-	EF39	7/6
2A3	7/9	6V6GT	9/-	EBC33	8/-
215SG	4/-	6X5GT	7/9	EF36	7/6
2X2	5/6	6AM6	10/6	SP61	4/-
304	9/6	6AL5	8/9	SP41	4/6
354	10/6	7B7	9/-	EF50	6/6
3V4	9/6	7C5	8/-	EA50	7/6
42	9/6	7C6	9/-	EF8	7/6
5U4G	9/-	7Y1	9/-	VU39	9/-

- COLLARO AC37 VARIABLE SPEED MOTOR, 4 pole shaded pole**  
 100/125v.  
 200/250v.  
 1" shaft suitable for recording.  
 32/6 each

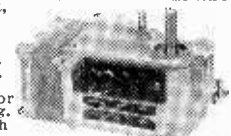

- CHOKES**  
 Cast Iron Case, pitch dipped, 5 H. 250 mA. ... 8/9 ea.  
 Midget type, 10 h. 250Ω, 10 mA. 1/8 ea.
- STANDARD VOL. CONTROLS**  
 Centralab 1 MegΩ, 1 MegΩ, 1 MegΩ, S.P.S. ... 3/9 ea.  
 Centralabs 1 Meg. D.P.S. ... 5/- ea.  
 25 KΩ less switch ... 1/6 ea.  
 Morganite 1 MegΩ, 1 MegΩ, 2 MegΩ, S.P.S. ... 3/9 ea.  
 Morganite 1 MegΩ, less switch 2/6 ea.
- STANDARD CAN ELECTROLYTIC**  
 T.C.C. 16 mfd. 450 v., 3/3 ea. ; Hunts 16 mfd. 450 v., 3/3 ea. ; T.M.C., 16 mfd. 450 v., 3/- ea. ; T.M.C., 8 x 8 mfd. 450 v., 3/6 ea. ; B.E.C. 8 x 16 mfd. 350 v., 3/6 ea. ; B.I. 16 mfd. 500 v., 3/9 ea. ; B.E.C. 16 mfd. 450 v., 3/3 ea. ; B.E.C. 16 x 16 mfd. 450 v., 4/9 ea. ; Dubilier 32 x 16 mfd. 350 v., 5/9 ea. ; Dubilier 24 x 16 mfd. 350 v., 5/9 ea. ; Dubilier 32 x 8 mfd. 350 v., 4/3 ea. ; T.C.C. 16 x 24 mfd. 350 v., 5/9 ea. ; B.E.C. 32 x 32 mfd. 450 v., 7/- ea.
- COIL FORMERS**  
 Aladdin with iron core slugs  
 8/- and tin. ... 9/- doz.  
 Paxolin 3in. x tin. ... 4d. ea.  
 Ceramic Coil Formers ... 5d. ea.
- SPEAKERS**  
 4" in. Elac. 13/6; 5in. Goodmans, 13/9; 5in. Plessey, 12/9; 8in. Goodmans, 17/6; 7in. Rola, 16/6; 10in. Plessey, 22/6; 10in. Rola, 32/6; 12in. TruVox, 57/6.

TERMS: Cash with order or C.O.D. MAIL ORDER ONLY. Full List available; send 3d. stamp. Postage, 6d. to 10/-; 1/- to 20/-; 1/6 to 2/-; 2/- to 5/- Minimum C.O.D. and postage charge 2/3.

## 5/6 VINCES CHAMBERS, VICTORIA SQUARE, LEEDS, 1

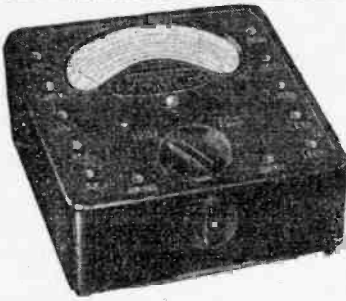

# 'AVO' Precision ELECTRICAL TESTING INSTRUMENTS

Registered Trade Mark

A dependably accurate instrument for testing and fault location is indispensable to the amateur who builds or services his own set.

## The UNIVERSAL AVOMINOR

(as illustrated) is a highly accurate moving-coil instrument, conveniently compact, for measuring A.C. and D.C. voltage, D.C. current, and also resistance: 22 ranges of readings on a 3-inch scale. Total resistance 200,000 ohms.

Size: 4½ ins. x 3½ ins. x 1½ ins.  
Nett weight: 18 ozs.

Complete with leads, interchangeable prods and crocodile clips, and instruction book.

Price: £10 : 10 : 0

D.C. Voltage  
0—75 millivolts  
0—5 volts  
0—25 " "  
0—100 " "  
0—250 " "  
0—500 " "

A.C. Voltage  
0—5 volts  
0—25 " "  
0—100 " "  
0—250 " "  
0—500 " "

D.C. Current  
0—2.5 milliamps  
0—5 " "  
0—25 " "  
0—100 " "  
0—500 " "

Resistance  
0—20,000 ohms  
0—100,000 " "  
0—500,000 " "  
0—2 megohms  
0—5 " "  
0—10 " "

**GUARANTEE:** The registered Trade Mark "Avo" is in itself a guarantee of high accuracy and superiority of design and craftsmanship. Every new Avominor is guaranteed by the Manufacturers against the remote possibility of defective materials or workmanship.

## The D.C. AVOMINOR

is a 2½-inch moving coil meter providing 14 ranges of readings of D.C. voltage, current and resistance up to 600 volts, 120 milliamps, and 3 megohms respectively. Total resistance 100,000 ohms.

Size: 4½ ins. x 3½ ins. x 1½ ins.  
Nett weight: 12 ozs.

Complete as above  
Price: £5 : 5 : 0

Sole Proprietors and Manufacturers —  
**AUTOMATIC COIL WINDER & ELECTRICAL EQUIPMENT CO., LTD.**  
Winder House, Douglas Street, London, S.W.1. Phone: VICTORIA 3404-9

Here it is...

## THE ACOS G.P. 30 TURNOVER CRYSTAL PICK-UP

STANDARD-LENGTH PLANNING



Price in Great Britain  
**£2 . 10 . 0**  
plus P.T. 21/5.

The G.P. 30 crystal turnover pick-up is intended to provide the largest number of record enthusiasts with the best possible reproduction of standard and microgroove records.

So this pick-up satisfies four all-important requirements: ★ It will reproduce both standard and microgroove records. ★ It is simple to operate; a turn of the front knob brings either stylus into use. ★ The output characteristics give balanced, distortion-free reproduction with minimum surface noise when used in conjunction with commercial equipment such as the normal radio set. ★ It is extremely kind to the record—giving long record life. The careful design gives exceptional tracking capabilities at the low stylus pressure of ten grammes.

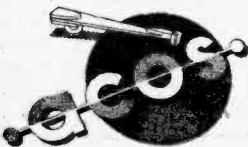

... always well ahead

COSMOCORD LIMITED, ENFIELD, MIDDLESEX

# Practical Wireless

EVERY MONTH  
VOL. XXVIII, No. 554 DECEMBER, 1952

Editor F. J. CANN

20th YEAR  
OF ISSUE

COMMENTS OF THE MONTH

By THE EDITOR

## The BBC and Copyright

THE Copyright Committee which was set up in April, 1951, to consider copyright law has recommended "with some reluctance" that a new performing right should be given to broadcasting authorities, especially in relation to their television programmes. We can understand the reluctance with which this recommendation has been made, for we, too, are opposed to vesting in the BBC any further powers which would still further increase their monopoly.

The recommendation has been made with the object of ending the deadlock between sporting promoters and the BBC over the televising of sporting events. The recommendation does not, therefore, affect ordinary sound broadcasts of commentaries of sporting events; but we must remember that long before television became a serious competitor the same deadlock existed between the BBC and the promoters of sporting events. It is true that the Committee rejects the claim of sports promoters for a performing right, and it equally rejects the suggestion that the BBC should be given compulsory powers to televise events on terms agreed by arbitration.

The BBC has had a difficult time with promoters for many years, and it is possible that the frustration which the attitude of these promoters has created resulted in the suggestion being made in a spirit of desperation. We must remember that the BBC has no inherent right to provide its listeners with programme material which has been prepared for them by somebody else; and the fees which they have offered to promoters in the past have not been particularly generous. At the same time the BBC has been quite right in turning down offers to permit broadcasts on fantastic terms. The promoters rightly think that with the advance of television fewer people will be encouraged to pay for seats at, say, a boxing match and that they will suffer thereby.

Much fuss has been made about sporting broadcasts, such as boxing matches and cup finals. It is doubtful whether the public would complain if such topics were entirely removed from the programme. The compulsory powers which it was suggested should be given to the BBC would

necessarily involve the recognition of a statutory right to enter other people's premises.

"We are no more prepared to recommend that the BBC should have a legal right to take its television cameras into private places than we should be to give a right of access to a newspaper man or a newsreel photographer."

The recommendation that only one performing right should be recognised would enable the broadcasting authority to control the public performance of the spectacle and to satisfy the reasonable requirements of the organisers. Compulsion, one way or another, would undoubtedly do more harm than good and that is why the Committee was not prepared to give sports promoters and others a statutory right additional to their present right to refuse admission.

The Committee also recommends that no performing rights should be given in a purely sound broadcast and it suggests that the device of first recording the commentary has opened the way to safeguarding the interests of sports promoters and others. The Committee does not accept the proposal that performing rights should be given to performers in the presentation of their recorded performances.

The most important recommendation made is that a permanent tribunal should be set up to decide disputes between organisations controlling performing rights and the users. Other recommendations are that a broadcasting authority should have the right to prevent the copying of its programmes either by re-broadcasting or the making of records for sale; the performing rights in gramophone records should be maintained; the Dramatic and Musical Performers' Protection Act could be extended to prohibit clandestine broadcasting of performances, and the Government should accede to the revised Convention signed at Brussels in 1948.

Briefly, the deadlock over the televising of sporting events is because the sports associations require fees the BBC is unwilling or is unable to pay and also because it is felt that control should be exercised over the exhibition or performance. A performing right could not be restricted to sport promoters but would have to be granted widely.—F. J. C.

# ROUND the WORLD of WIRELESS

## New Marconi Director

**SIR NOEL ASHBRIDGE, B.Sc.**, Director of Technical Services, BBC, since 1948, has joined the board of directors of Marconi's Wireless Telegraph Co., Ltd., the Marconi International Marine Communication Co., Ltd., Marconi Instruments, Ltd., and the English Electric Valve Co., Ltd.

Sir Noel, who was knighted in 1935, was born on December 10th, 1889. Educated at Forest School

## Munich Exhibition

**THE** German Communication and Transport Exhibition will take place in Munich from June 20th to October 11th, 1953, and will offer the first comprehensive survey since the war, an impressive summary of conditions and problems facing communication and transport to-day.

The Bavarian capital is already preparing for this exhibition; the Munich Exhibition Park is being

## Broadcast Receiving Licences

**THE** following statement shows the approximate number of sound licences issued during the year ended August, 1952. The grand total of sound and television licences was 12,806,012.

Region	Number
London Postal	1,818,120
Home Counties	1,512,453
Midland	1,401,682
North Eastern	1,831,594
North Western	1,490,913
South Western	1,063,500
Welsh and Border	725,017
<b>Total England and Wales</b>	<b>9,843,279</b>
Scotland	1,151,058
Northern Ireland	213,728
<b>Grand Total</b>	<b>11,208,065</b>

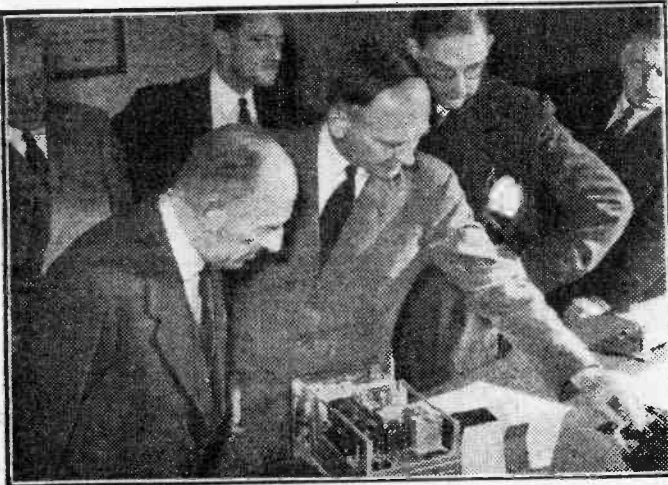

Senior officials from the Ministry of Supply recently made a special visit of inspection to Marconi's Wireless Telegraph Co., Ltd., at Chelmsford, to examine new types of equipment. Left to right:—G. M. Wright, Engineer-in-chief; L. A. Sweny, Manager, Aeronautical Division; R. R. Stanford-Tuck, Sales Manager of the Aeronautical Division; S. S. C. Mitchell, C.B., C.B.E., Controller of Guided Weapons and Electronics, Ministry of Supply; F. S. Barton, Principal Director of Electronics Research and Development, Ministry of Supply; F. S. Mockford, Commercial Manager.

and King's College, London, his early training was acquired with Yarrow and Co., Ltd., and British Thomson-Houston Co., Ltd. In 1920 he joined Marconi's, being head of their experimental broadcasting station at Witle for several years. In 1926 he joined Captain Eckersley (then chief engineer of the BBC) as his assistant. He took over as chief engineer in 1939 and later was appointed Controller, Engineering Division, and Deputy Director-General.

modernised, new halls and a congress hall are being erected. The exhibition ground covers a total area of 470,000 sq. yds., including 14 halls covering 42,000 sq. yds. and open ground extending over 170,000 sq. yds.

The exhibition will cover all sections of modern transport and communications, including road and rail transport, navigation, aviation, postal services, telegraphy, telephony, radio, forwarding agencies, storage and tourist traffic.

## EKCO Assists Education

**MR. G. W. GODFREY**, executive director, radio sales, of E. K. Cole, Ltd., and Mr. E. W. Shepherd, service manager, participated in the recently concluded radio and TV Teachers' Vacation Course organised by the Ministry of Education in conjunction with the R.I.C. Mr. Shepherd's lecture dealt with "Wound Components as Applied to TV," and a final talk was given by Mr. Godfrey on "The Future of Television and its Industrial Possibilities." This is the third year that Ekco have taken part in the course.

Mr. Shepherd has also been invited to deliver the opening lecture of the season at the Leicester College of Technology, and he will deal with the Ekco T164 television receiver and "spot-wobble."

## New Appointments

**TO** meet with the increasing demand on its specialised wireless equipment for aeronautics, Marconi's Wireless Telegraph Co., Ltd., has found it necessary to expand and reorganise its Aeronautical Division into three distinct sections: Technical, Sales and Contracts.

The division was formed as a separate unit of the company after the first world war, its object being to design radio to meet the growing



needs of civil aviation. Mr. L. A. Sweny (with the exception of war service between 1942 and 1946) has been its manager since 1936.

To meet with the present re-organisation, Dr. B. J. O'Kane has been appointed chief air radio engineer and joined the company on October 1st.

Former Battle of Britain pilot R. R. Stanford-Tuck, D.S.O., D.F.C., who joined the company in 1949, is now appointed sales manager of the division, and Mr. F. Wheeler, who has been with the company since 1928, is appointed contracts manager.

**International Telegraph Conference**

**MR. CHARLES CARPENTER**, traffic manager of Cable and Wireless, Ltd., sailed from Southampton recently for Buenos Aires to join the British delegation to the International Telecommunications Plenipotentiary Conference, of which he is a member.

The object of the conference, at which more than 70 countries will be represented, is to revise the current International Telegraph Convention, drawn up at Atlantic City in 1947. Mr. Carpenter is an authority on international telegraph affairs. When the conference ends in December he will return to London by air via Washington and New York for talks with the U.S. State Department, the Federal Communications Commission and the American telegraph companies.

**Local Authority Aids Exports**

**A** PROTOTYPE of the Ekco airfield radar approach aid has been ordered for evaluation purposes by the U.S. Air Navigation Development Board. Mr. Bernard Collins, manager of Southend Airport, will go with the equipment to the U.S. to demonstrate its capabilities throughout America. His journey is the result of a unique act of co-operation between a municipal authority and an industrial organisation.

E. K. Cole, Ltd., has arranged with the corporation, whose municipal airport was used for development and testing of the approach aid, for the granting of leave for Mr. Collins to make this trip at the express request of the U.S. authority.

**Treatment by Wireless**

**I**N Italy, a service has been put into operation for aeroplane passengers taken ill. Doctors are

always available on the ground, ready to advise treatment by means of a radio link with the aircraft.

**Price Control Suspended**

**A** REPORT from America states that the price control on gramophones, wireless and television receivers has been suspended.

**Modern Radio and Television Laboratory**

**I**T is stated that the radio and television laboratory at the Oldham Technical College, Ascroft Street, is equipped with the most modern servicing and testing apparatus in the country.

The laboratory was designed by the staff of the electrical engineering department.

**Sir Ian Jacob**

**T**HE new Director-General of the BBC, Lieut.-General Sir Ian Jacob, who takes over his new position from Sir William Haley on December 1st, was once Controller of the BBC European Service before becoming Director of the BBC's Overseas Service.

It is understood that Sir Ian's salary will be in the region of £7,000 a year. At least £4,000 of this, however, will be taken as tax.

There is a strong possibility that one of the first moves of the new Director-General may be the raising of licence fees.

**Amateur Licence Interchange**

**O**N May 13th this year a treaty became effective between Canada and the U.S.A. under which certain mobile and amateur radio stations licensed by the respective countries are permitted to operate across the border in each other's territory. Amateurs have to apply for a permit to avail themselves of this privilege, and when operating are subject to the regulations of

the country in which they are operating.

**Microwave Radiation**

**DR. JOHN P. HAGEN** and N. Hepburn, of the American Naval Research Laboratory, have reported that tests have proved that sun spots and activity around the sun are definitely responsible for radio blackouts and noises on various frequency spectra. Work with a highly directional beam have shown that the intensity of the sun's radiation at 35,000 Mc/s was much more constant than at a lower frequency. The latest equipment, however, showed that the changes in the intensity of the radiations nowhere lasted more than five minutes.

**Radar Guard**

**T**HE G.E.C. research laboratory at Schenectady is now provided with a radar-like device which detects cars as well as pedestrians approaching the area. The radiated wave is only 5in. in length and is focused by an 18in. parabolic reflector. A pedestrian is detected at about 100ft., and a car approaching rings a bell. The device is particularly valuable at night as it relieves the security guards.



*Lt.-General Sir Ian Jacob, who at 53, has recently succeeded Sir William Haley as Director-General of the BBC.*

# Calibrating a Home-built Signal Generator

USING KNOWN TRANSMISSIONS IN PLACE OF LABORATORY EQUIPMENT

By Angus D. Taylor (G8PG)

**D**UE to the high initial cost of the commercially-built article, there is an increasing tendency for experimentally-minded amateurs to build their own signal generators. While the home-built article may lack some the refinements of the commercial product it is usually adequate for the requirements of the experimenter, but, particularly in the case of the beginner, the great snag appears to be accurate calibration—especially over the 300 to 500 kc/s range where accurate calibration is so important if successful superhet alignment is required. The great majority of amateurs do not own a receiver covering this range, and even those who do will be little better off unless they are reasonably expert at reading morse, as the only available stations for use as calibration markers are telegraphy stations of the ship-to-shore service. At first sight the above would seem to indicate that the amateur who has no access to an accurately calibrated oscillator might give up the idea of building his own signal generator, but in actual fact there is a simple solution to the problem which only requires the use of a simple broadcast receiver together with a sheet of graph paper and a list of the frequencies of the more easily identified broadcasting stations. This method will be described in detail later in the article, but first, in order to help readers who have not previously attempted to calibrate an oscillator, the method of obtaining a calibration chart for the ordinary medium- and long-wave broadcast bands will be briefly described. Once again the required equipment comprises a broadcast receiver, a sheet of graph paper and a list of broadcasting station frequencies.

## Procedure

The procedure is as follows: First carry out the calibration during the evening hours so that the more distant broadcasting stations will be audible. Having assembled the required apparatus, switch on the signal generator with the wave-range switch set to the medium-wave position and allow it to run for half an hour. This allows the components to warm up to their normal working temperature and ensures that the oscillator will be reasonably stable during the calibration. During the half-hour wait, bring the receiver into operation and identify accurately fifteen or so broadcast transmitters spaced throughout the medium-wave band—as many as possible of the BBC transmitters, Athlone, A.F.N., Luxembourg and so on. At the end of the half-hour, tune the receiver to the highest frequency transmitter which has been identified (say the Third Programme on 1,546 kc/s), switch the signal generator modulation on and tune up from the high-frequency end of the signal generator dial until the modulated note is heard in the receiver. As soon as the modulated note is heard switch off the modulation. A whistle will then be heard as the unmodulated

oscillation heterodynes the Third Programme transmitter carrier wave. If the signal generator tuning is swept across the third programme frequency, this whistle will start off at high pitch, gradually drop to inaudibility and then rise again. The correct setting is the centre position where the whistle is completely inaudible, as at this point the frequencies of the signal generator and the Third Programme transmitter are exactly the same. Carefully adjust the signal generator tuning to this point, then note on a sheet of paper the dial reading of the signal generator and the frequency of the Third Programme. Having done this, tune the receiver to the next known transmitter (say Luxembourg) and repeat the procedure, noting the dial reading obtained and the Luxembourg frequency. Repeat the process on all the known stations until some ten or fifteen calibration points have been obtained throughout the tuning range of the signal generator.

Once these calibration points have been obtained, they can be permanently recorded on a graph as shown in Figs. 1 and 2. The points for plotting the graph are obtained by running a horizontal line out from the frequency of the known station and a vertical line up from the equivalent signal generator dial reading. At the point where these two lines intersect, make a dot on the graph paper. Repeat the process for each calibration point obtained and, when all have been plotted, carefully sketch in a line to join all the dots together. Once this is done, the frequency-dial reading relationship of the signal generator has been plotted and it is a simple matter to find the dial reading for any given frequency or

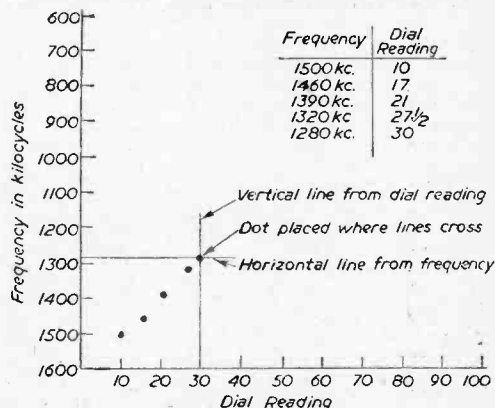

Fig. 1.—Method of recording the frequency and dial readings of the calibration points together with the methods of plotting them on the graph paper. The plotting of the 1280 kc/s calibration point is shown in detail.

the frequency represented by any given dial reading. If the dial reading for a given frequency is required, lay a straight edge horizontally from the desired frequency to the line on the graph. Note where the straight edge cuts the graph and run it down vertically from this point through the dial readings scale. The point at which it cuts the dial readings scale indicates the dial reading for this particular frequency. To find the frequency corresponding to a given dial reading reverse the process—run the straight-edge vertically upwards from the dial reading scale then horizontally across to the frequency scale. Once the medium-wave calibration is drawn up in this way carry out the same process for the long waves, where, of course, there are fewer stations and therefore fewer calibration points.

Having calibrated the two broadcast bands, the next operation is to calibrate the 300 to 500 kc/s range. To do this, we make use of the property possessed by an oscillator of generating, besides the frequency to which it is tuned, multiples of this frequency known as harmonics. As an example, an oscillator tuned to say 300 kc/s will also generate oscillatory energy at  $300 \times 2$  kc/s,  $300 \times 3$  kc/s and so on. As the multiplier increases the amount of energy generated drops rapidly, but the second harmonic ( $300 \times 2$  kc/s) will be quite strong and easily audible in a nearby receiver tuned to  $300 \times 2$  which is of course 600 kc/s. If we use this property of the oscillator, therefore, we can use it to calibrate itself! The method is as follows: With the aid of the medium-wave calibration graph, set the oscillator to 600 kc/s with the modulation turned on and tune in the signal from the oscillator accurately on the receiver. Switch the signal generator to the uncalibrated 300-500 kc/s range and tune from the low-frequency end of the dial until a signal is heard in the receiver. Adjust the signal generator, tuning carefully for maximum volume from the receiver. The signal generator is now tuned to 300 kc/s as we are listening to the second harmonic, the fundamental frequency of which is equal to  $\frac{600}{2} = 300$  kc/s.

Having obtained and noted this point, switch the signal generator back to medium wave and tune it

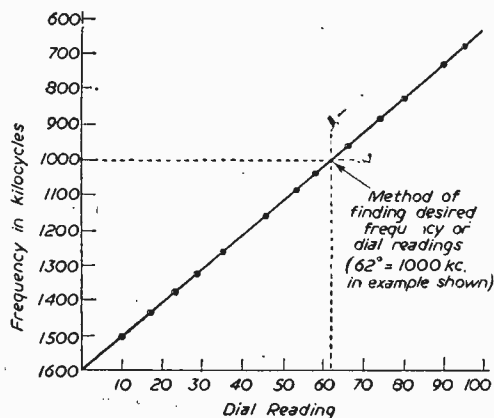

Fig. 2.—Completed calibration graph together with the method of reading off frequency from dial reading or vice-versa.

to 620 kc/s, locate this point on the receiver, switch back the signal generator to the uncalibrated range and adjust the tuning for maximum signal in the receiver. The signal generator is now tuned to  $\frac{620}{2} = 310$  kc/s. Note this point and continue the calibration in 20 kc/s steps from 600 kc/s up to 1,000 kc/s which will, of course, equal 10 kc/s steps from 300 to 500 kc/s on the uncalibrated range of the signal generator. Once all the calibration points are obtained they should be plotted into a permanent graph as already described. The process may sound a little laborious, but it is fairly simple in practice and provides an ideal means of calibration where other means are not available.

In conclusion, a word of warning. When calibrating the 300-500 kc/s range make sure that the coils in use do not tune as low as 150 kc/s as the fourth harmonic of this frequency is also equal to 600 kc/s, the calibration setting used on the receiver. This can be simply checked by switching the receiver over to 150 kc/s and making sure that nothing can be heard from the signal generator on that frequency. If this is the case, the signal generator can be taken as being on the desired 300 kc/s frequency. If signals do happen to be audible on 150 kc/s, it means that the coils are too large and turns will have to be removed until 300 kc/s comes near the maximum capacity setting of the signal generator tuning condenser.

## Philips Competition Result

WINNERS of the Philips Competition held during the National Radio Show are announced by Philips Electrical, Ltd., Century House, Shaftesbury Avenue, W.C.2. They are:

**FIRST PRIZE**—a Philips Projection Television Set, value 89 gns.—Mrs. H. B. Collett, 11, Heaton Avenue, Romford, Essex.

**SECOND PRIZE**—a Philips Radiogram, value 65 gns.—Mr. R. Lakeman, Caravan Site, c/o R.A.F. Medmenham, Marlow, Bucks.

**THIRD PRIZE**—a Philips Radio Set, value 30 gns.—Mr. R. Merrett, 11, Avondale Rise, Peckham, S.E.15.

In addition, 68 other prizes have been awarded. These include: Philips "Philishave" electric dry shavers, decoration lighting sets, and parcels of the famous Philips "Argenta" lamps.

Competition forms were handed to the public during the radio show, and entrants were asked to do the following:

- (1) Decide the best three designs in a range of seven radio receivers.
- (2) Place in order of importance four features of Philips radiograms.
- (3) Choose an original and descriptive name for Philips projection television.

A total of 13,000 entries were received.

In accordance with regular practice in such cases, the three main prize-winners will receive their sets through a local Philips dealer.

Mr. Eric Robinson kindly consented to make a formal presentation in the head office showrooms of Philips Electrical, Ltd., at Century House, to the first three winners.

# SHORT-WAVE SECTION

A ONE-VALVE TOP-BAND CONVERTER FOR THE R.1155

By T. Griffin (G3GUV)

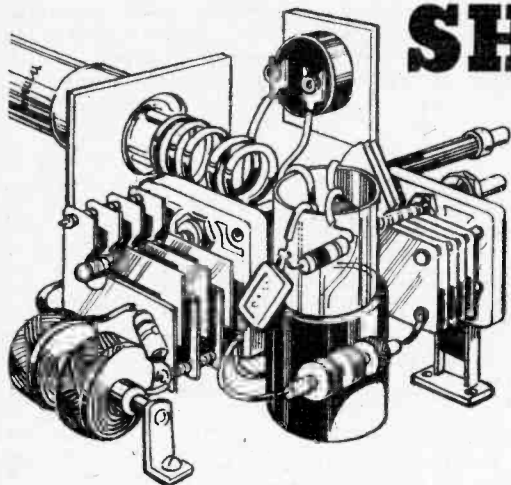

At the present time many of the firms advertising in this magazine are offering the R1155 communications receiver in brand new condition at prices varying from £10 to £15. The types advertised, however, do not include the R1155N model. This is the only one of the series which covers the 160-metre amateur band. The other models cover the following frequency ranges:

- Range 1: 18 to 7.5 Mc/s.
- Range 2: 7.5 to 3.0 Mc/s.
- Range 3: 1,500 to 600 kc/s.
- Range 4: 500 to 200 kc/s.
- Range 5: 200 to 75 kc/s.

It will be noted that there are two gaps in the frequency coverage: from 500 to 600 kc/s and 1.5 to 3.0 Mc/s. The first gap is unimportant to the average short-wave enthusiast and is understandable, as the intermediate frequency of the receiver (560 kc/s) falls within this range. The second gap, unfortunately, deprives the S.W.L. of one of the most interesting of the amateur bands, not to mention the trawler band with its attendant well-seasoned vocabularies! It is to those who feel attracted by the low price of these fine receivers, but who are deterred by the above disadvantage, that this article is directed.

A few months ago, the writer obtained one of these sets (type R1155E) and decided to rectify the omission by making the converter herein described in two easy stages—easy on the pocket as well as easy in construction. The first stage was to build the simplest possible one-valve mixer stage, the output of which would fall within one of the ranges covered by the receiver. The next stage was the improvement of the converter by substituting an I.F. transformer for the original choke-capacity coupling. The

improvement proved well worth while. The mixer output frequency (first I.F.) chosen was the obvious one of the 465 kc/s, and it was chosen for two reasons. First, it falls conveniently at the "high-Q" end of Range 4 on the receiver and, secondly, because the necessary coils are easily obtainable. The unit was designed around the EK32 valve (VR57 is the Service type number), obtainable very cheaply from suppliers of war-surplus equipment. In the interests of economy and simplicity of adjustment the first unit built used choke-capacity coupling from converter to receiver.

## Circuit

The circuit, Fig. 1, follows normal mixer stage practice, except that the anode circuit is untuned. In spite of this a fair degree of gain is obtainable from the stage and it allows plenty of latitude in tuning-in the output from the converter on the main receiver. The coils used will produce in the output a frequency of 465 kc/s. When the main receiver is tuned to this frequency and the unit connected, the set and converter function as a double superhet with the first I.F. 465 kc/s and the second, that of the receiver, 560 kc/s. The selectivity of this arrangement is quite high and, due to the low ratio of signal frequency to first intermediate frequency, no trouble is experienced from image interference.

The coils used in the writer's unit are "OSMOR"

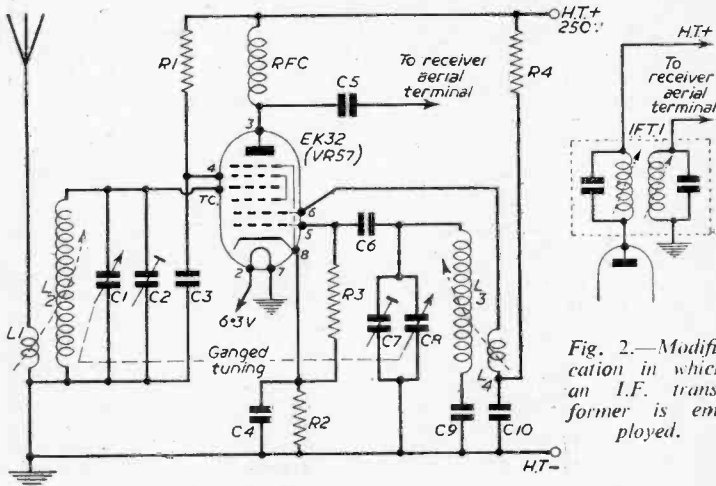

Fig. 1.—Circuit of the converter stage.

Fig. 2.—Modification in which an I.F. transformer is employed.

type "T.B." (Trawl band) and give a coverage of 1.3 to 4.3 Mc/s (70 to 230 m.)—more than sufficient to bridge the gap between ranges 2 and 3 on the R1155. "Supacoils" and "Wearite" P-type coils have been used on other units of a similar nature and both these types give excellent performance. If coils other than those specified are used, care must be taken to adhere to the maker's circuit recommendations, particularly regarding the value of the oscillator padding condenser C9. Any gross departure from the recommended value will certainly result in great difficulty in making the oscillator cover the range required, and in consequent tracking difficulties. The oscillator and H.F. tuning capacitors are shown ganged in the circuit, but they may with advantage be separately tuned. Separate tuning greatly simplifies tracking, enabling a signal to be readily "peaked up" at any point on the band, and obviates the necessity for the trimmers, C2 and C7. The disadvantage of separate tuning, having to adjust two controls simultaneously, has not proved to be so great as was at first thought. With a little practice they may be kept near enough "in line" from one end of the band to the other when searching broadly. When a signal has been tuned with the oscillator control only slight readjustment on the H.F. control is necessary to peak the signal.

**Power Supplies**

The power requirements of the EK32 are very modest; 6.3 volts at 0.2 amp. and 250 volts at 4.3 mA. Power for the converter may thus be taken from the power pack supplying the main receiver. If this is done certain precautions must be taken to safeguard the correct working of the R1155 bias circuits, because H.T.—on the receiver is *not* connected to earth. No direct connection must be made between the chassis of the converter and the chassis of the receiver. A 0.1  $\mu$ F condenser should be connected between the two chassis, and the lead connecting the output of the converter to the receiver should have its outer braid earthed only at the receiver end. If the extra load on the power supply causes

the H.T. voltage to drop slightly, this is no great disadvantage as the converter valve will perform quite well on 200 volts or less. In point of fact the writer has heard such a combination working with just over 100 volts on both receiver and converter!

**Construction**

Any small chassis will do and layout diagrams are given (Figs. 3 and 4) for either separately tuning H.F. and oscillator circuits, or ganging the tuning. The chassis on the prototype measures 7in.  $\times$  5in.  $\times$  2in., is of thin aluminium and fits inside a slightly larger metal cabinet and there is much room to spare on the chassis. In order that the danger of I.F. break-through be minimised it is strongly recommended that the unit be placed in a metal box or cabinet.

**LIST OF COMPONENTS**

- C 1, 8, 500 pF variable.
- C 2, 7, 50 pF trimmer.
- C 3, 4, 5, .01  $\mu$ F.
- C 6, 100 pF mica.
- C 9, 2,500 pF silver mica.
- C 10, .1  $\mu$ F.
- R 1, 250 k $\Omega$ .
- R 2, 470 $\Omega$ .
- R 3, 47 k $\Omega$ .
- R 4, 20 k $\Omega$ .
- R.F.C., M.W. R.F. choke.
- I.F.T. 1, 465 kc/s I.F. transformer.
- L 1, L 2, "OSMOR" coil "T.B. Ae."
- L 3, L 4, "OSMOR" coil "T.B. Osc."

**Adjustment and Operation**

Connect the output of the converter, via shielded lead or coaxial cable, to aerial and earth terminals of the receiver, and apply power to both units. Adjust the dust cores of the coils until they are level with the top of the coil formers. If separate tuning is employed no further adjustment is necessary to the converter. Just tune the R1155 to a "quiet spot" around 465 kc/s and carry out main tuning on the oscillator capacitor, "peaking-up" with the H.F. capacitor. If ganged tuning is employed tune in a station on the converter near the H.F. end of the band (several medium-wave broadcast stations will be heard in the evenings). Adjust C7 until the station occupies the desired position on the main tuning scale by setting the main tuning dial to the desired setting and tuning the station with C7. If no exact frequency coverage is desired, C7 may be left at half-mesh. Now peak the signal by adjusting C2. Tune towards the L.F. end of the band (main tuning capacitor vanes almost fully in mesh) until a signal is heard. Its position on the scale may be set by adjusting the core of L3, L4. If this adjustment is not required, leave the core level with the top of the coil former. To obtain maximum signal strength

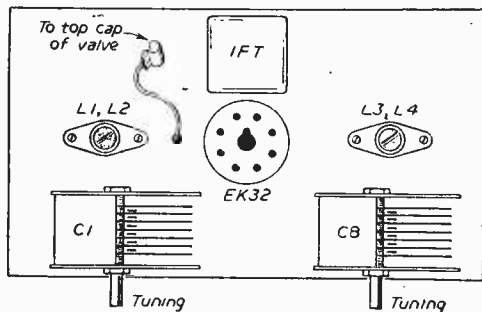

Fig. 3.—Suggested layout for separate tuning.

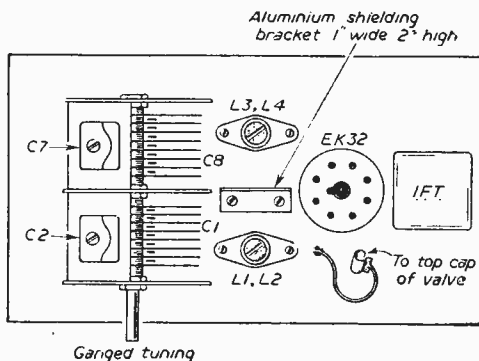

Fig. 4.—Suggested layout for ganged tuning.



adjust the core of L1, L2. The converter should now give a fairly good response over the complete tuning range.

The substitution of an I.F. transformer for the choke and coupling capacitor C5 brings about a marked improvement in stage-gain and selectivity. Fig. 2 shows the circuit of the modification. Any 465 kc/s I.F. transformer will do in this position, preferably one having iron dust cores. (A 460 kc/s transformer from an old type 25 set was tried with one unit and gave excellent results.) To align the transformer tune the converter until a steady signal is picked up on the receiver and adjust the cores of the I.F. transformer for maximum signal strength.

The converter, both in its original and its modified form have been in use at the writer's station and at the station of a friend for some months. The

performance is undoubtedly good. The sensitivity and selectivity compare most favourably with a well-aligned civilian communications receiver of well-known and reputable make, although the signal/noise ratio, a weak point of the R1155, is not as good.

A further modification to the R1155, carried out by the writer, was the removal of all the range 5 coils and alteration of the unit to cover 1.2 to 4 Mc/s. If any readers may be toying with the idea of a similar conversion, let them be warned that the mechanical difficulties, though by no means insuperable, are great. A thorough familiarity with the circuit of the receiver and an exact knowledge of placement of all components in the coil box are essential prerequisites, plus a steady hand and a stout heart.

## News from the Clubs

### WELLS AND DISTRICT AMATEUR RADIO AND TELEVISION SOCIETY

Hon. Sec.: W. L. Woodcraft (G3HUE), Haversham House, New Street, Wells.

THIS society, which is associated with the Wells Evening Institute, meets every Wednesday evening in its own premises in Milton Lane, Wells. During the past few months members have been building up, decorating and equipping the club's workshops and meeting rooms in preparation for the long winter nights.

A club TX is in course of construction. Talks by G3AWZ, G4DA and G3HUE also appear on the programme.

### THE SOUTH SHIELDS AND DISTRICT AMATEUR RADIO CLUB

Hon. Sec.: W. Dennell (G3ATA), 12, So. Frederick Street, South Shields.

THE above club held their annual meeting last month and election of officers took place.

It was resolved that the club shall now be known as The South Shields and District Amateur Radio Club.

A number of new members enrolled and a programme was arranged for the year which includes lectures, film shows and socials.

Meetings are held every Friday evening at the "Trinity House Social Centre," Laygate, South Shields, commencing at 7.30 p.m.

Anyone interested please write or call on the secretary.

### MIDLAND AMATEUR RADIO SOCIETY

Hon. Sec.: G. W. C. Smith (G3HDK), 84, Woodlands Road, Birmingham, 11.

THE annual general meeting of the above society was held on September 16th, when the officers and committee for the ensuing year were elected.

At the Sutton Coldfield and North Birmingham Model Engineering Society's exhibition on October 2nd, 3rd and 4th, a combined M.A.R.S./Slade stand was on view and attracted much attention from the visitors. The Lord Mayor and Lady Mayoress of Birmingham, who opened the exhibition, spent some time on the stand and obtained first-hand experience of "ham radio" by speaking to a well-known "old timer" over the air. Meetings of the society are held on the third Tuesday in the month at the Imperial Hotel, Birmingham.

### WELLINGBOROUGH AND DISTRICT RADIO AND TELEVISION SOCIETY

Hon. Sec.: N. M. Seabrooke, 85, The Drive, Wellingborough.

MEETINGS are held fortnightly on Thursdays, at the British Railway Sports and Social Club, Wellingborough, and an enterprising programme has been planned for the winter months ahead.

### DERBY AND DISTRICT AMATEUR RADIO SOCIETY

Hon. Sec.: F. C. Ward (G2CVV), 5, Uplands Avenue, Littleover, Derby.

THE winter session having now commenced, meetings are held weekly on Wednesdays at 7.30 p.m. Permanent installation of the club transmitter is nearing completion and in the near future it is hoped that an "on the air" night will be a regular feature of the society's programme. A copy of "Future Events" can be obtained from the hon. sec. New members and visitors are welcome at any society function.

### CLIFTON AMATEUR RADIO SOCIETY

Hon. Sec.: T. Arch, 11, Boyson Road, S.E.17.

THE Junk Sale, as reported last month, which was held on October 3rd, was very well attended and some very useful gear was sold.

The club TX G3GHN will very shortly be on the air again, having been under the process of rebuilding.

The Xmas Party will be held this year on December 12th, when the programme that everybody enjoys will be put into top gear. Preparations for the event have been in hand for three months, so everybody will have a swell time. The Clifton extend to visitors and prospective members a cordial welcome any Friday evening at 225, New Cross Road, S.E.14, or enquiries to be written to the secretary.

### IXWORTH RADIO CLUB

Hon. Sec.: P. G. Wright, Thurston Road, Gt. Barton, Bury St. Edmunds, Suffolk.

ANYONE who is in any way interested in experimental radio or television is welcome at this club.

They are putting on a demonstration at the Handicrafts Exhibition, at The Art Gallery, Bury St. Edmunds (November 17-22), when it is hoped to have an 80-metre phone TX running, and they will be pleased to meet any local readers.

### THE LOTHIAN'S RADIO SOCIETY

Hon. Sec.: I. Mackenzie, 41, Easter Drylaw Drive, Edinburgh 4.

THE opening meeting of the 1952-53 session was held on Thursday, September 18th, at 25, Charlotte Square, Edinburgh.

A comprehensive programme has been arranged covering receivers, transmitters, V.H.F. and H.F., tape recorders and amplifiers, television, etc. Classes covering the Radio Amateurs examination syllabus have also been arranged, together with Morse code instruction. These classes are available to all members of the society.

A cordial invitation is extended to prospective members to attend these meetings. The hon. sec. will be glad to supply further information, together with a copy of the 1952-53 programme.

### THE ROCHDALE RADIO AND TELEVISION SOCIETY

Hon. Sec.: J. Riley, 1, Darley Bank, Britannia, Bacup.

DECORATION of the club-room is now completed and electricity is installed. Morse classes are starting on the first Friday in November.

Meetings are held in the club-room at 1, Law Street, Sudden, Rochdale, on Friday evenings at 7.45, visitors being welcome.

The winter season should be very interesting as RX, TX and test gear is to be constructed.

### BRIGHTON AND DISTRICT RADIO CLUB

Hon. Sec.: R. T. Parsons, 14, Carlyle Avenue, Brighton, 7.

ATTENDANCES on club nights have improved, perhaps helped by a very interesting programme organised by the hon. sec. G2CMH is rebuilding the club TX and hopes to have the club station QRO on 80 metres soon. Forthcoming events include:

November 11th.—The Williamson amplifier, by Mr. Goodsell.  
November 25th.—Aerial Fundamentals, by G6QB.  
December 2nd.—The Germanium Diode, by the General Electric Co.

# On your Wavelength

by THERMION

## Patents

**A** PROPOS my comments on Patents in the October issue, I have received a letter from a patent agent disagreeing with my statement that readers may build anything which is described in PRACTICAL WIRELESS or our associated journals without fear of prosecution, provided that they do not offer for sale what they build. The patent agent says that this is not a true statement of the law (with which I profoundly disagree) "though it may be true in practice." The position as I have stated it is the law and there is plenty of case law to support my statement. Indeed, my views represent the views of eminent patent counsel given in a written opinion to me.

My correspondent goes on to say if a reader were to make a patented article other than for experimental use he would infringe the patent and could be sued for that infringement, and that it is quite immaterial in such circumstances whether or not the article is offered for sale.

In practice it is highly improbable that any patentee would consider it worth while bringing an action for infringement against someone who makes only one infringing article. As it would be impossible for any patentee to prove that a person had made a patented article for any other purpose than experiment I quite fail to see the drift of my correspondent's remarks.

He also disagrees with my statement that the most an inventor can do as regards an invention on which a patent application has been filed is to mark goods embodying the invention with the words "Patent applied for." I went on to say that if subsequently it is found that the idea has been anticipated, and in the meantime the applicant has commenced to market, the maker may be and probably will be sued for damages. I should have thought that statement was crystal clear, but not so to my correspondent. He says that it is true that if an inventor's idea is covered by the claims of a prior dated patent which is still in force, the patentee of the latter could sue for infringement, and this would be irrespective of any marking with the words "patent applied for." He says that an invention may be anticipated without there being any risk of infringement.

The gravamen of my comments on this latter subject was that in order to warn the public against infringement it was necessary to mark goods "patent applied for," as the absence of such marking might lead some to presume that anyone could make the article.

## World's Illiterates Increasing

**I** WAS very surprised to read in a recent UNESCO report that half the world's population cannot read or write, a condition which it describes as a denial and travesty of human rights. The total as well as the percentage of illiterates is rising, says the report with the comment: "It is impossible to stand

by and do nothing. The situation grows worse as the population of the world rapidly increases."

This is a damning indictment of present educational methods and it also implies that the educational broadcasts throughout the world have failed. The school-leaving age has been raised, there are State-sponsored scholarships, education is free, there are evening classes and unceasing educational broadcasts. Now that States tend to become mass-thinking machines and people prefer to listen rather than to learn it may mean that illiteracy will increase. As all children are compelled to go to school it is astonishing that they can leave school without learning the most important two of the three R's.

## Components for Constructors

**A**S a result of my comments on the manner in which certain firms who built their businesses on the constructor market have deserted it, I am glad to be able to say that some of them intend to return to the fold. It is noteworthy that at the R.S.G.B. Amateur Radio Exhibition, many more components were available than hitherto. If this exhibition gives the impression that it caters more for the transmitter than the man interested in receiving, it must be remembered that it has been organised by the Radio Society of Great Britain whose main interest is in amateur transmitters.

Several readers have suggested that this journal should undertake the organisation of a constructors' exhibition, and I should like to have the views of other readers on this subject so that I can pass along a consensus of opinion to the proper quarters. Obviously at present such an exhibition could not be made to pay on gate money alone, for there are far too few firms catering entirely for constructors who could exhibit and help to make the exhibition of interest.

## Aerials

**D**RIVING round suburbia the other day I was struck by the large number of different types of television aerials and my mind was carried back to the early 'twenties when every conceivable variety of receiving aerial was erected, each of which had its adherents and for which the wildest and widest claims were made. We know to-day how false some of those claims were, for outside receiving aerials have practically disappeared. I prophesy that television aerials will go the same way. I strongly suspect a large amount of bunkum has been written about aerials and the advantages of the various types.

## NEWNES SHORT-WAVE MANUAL

6/-, or 6/6 by post from

GEORGE NEWNES, LTD. :: Tower  
House, Southampton Street, London, W.C.2

# Germanium Crystal Diodes

SOME DETAILS OF THESE MODERN  
CRYSTALS WITH SOME CIRCUITS  
FOR THE EXPERIMENTER

By B. L. Morley

**R**ADIO has developed rapidly since the "crystal" days, and valve has superseded valve, new types being developed to keep pace with the ever-widening range of frequencies which were made available for reception.

The wheel has now turned full circle, and electronic devices, which can no longer be called valves, produce radio waves of such high frequencies that they cannot be successfully handled at the receiving end by accepted valve technique, and so the crystal (though a much more robust and efficient crystal) has come back into its own, and is being used where its erst-while usurper is much less efficient.

The ultra-high frequencies such as are generated by the magnetron cannot be amplified by thermionic valves, and the procedure is to convert them to a much lower frequency by the superheterodyne principle, using diode mixers. A circuit of this nature is shown in Fig. 1.

Under these conditions it has been found that the silicon crystal diode is superior to the thermionic diode, as it has a much lower shunt capacity and covers a much wider frequency range, using less power from the oscillator.

The development of this technique during the war led to intense research work on crystals and has resulted in the present mass production of highly efficient germanium diodes, which can be used to construct amazingly sensitive crystal receivers, and to perform functions previously considered to be the exclusive field of the valve.

## Mainly Historical

In the early part of the war, silicon diodes were used for micro-wave mixers in oscillators. The method was first developed in Britain and it was

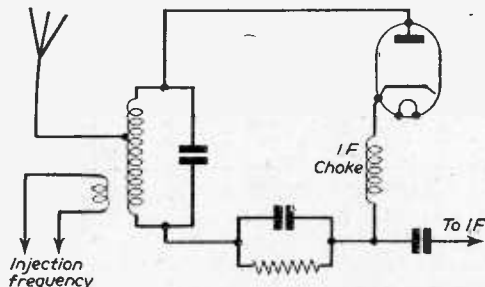
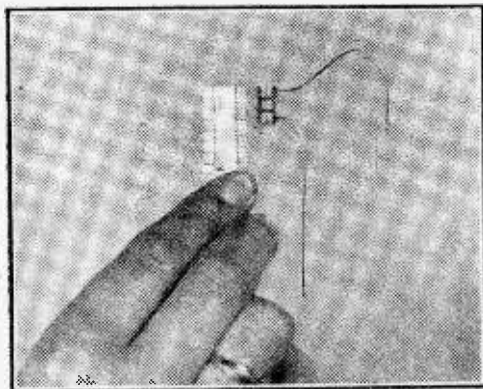

Fig. 1.—A diode in a superhet circuit.



found that these crystals could handle efficiently frequencies which were beyond the capabilities of valves. The circuit of such a mixer is shown in Fig. 2.

Although a very efficient frequency converter at ultra-high frequencies, it was found that the silicon crystal was very easily destroyed if subjected to overloads, and this limited its use in electronic pulse systems such as radar. The result was the investigation of other materials suitable for use as diode mixers, and eventually led to the development of germanium.

In the early stages of production the germanium crystal was able to withstand quite heavy overloads, but it was not as efficient as silicon and its noise factor was rather higher. However, as it could handle quite a wide frequency range it began to replace thermionic diodes.

Extensive research was carried out by British manufacturers and in 1946 the British Thomson-Houston Company (B.T.H.) had reached the stage where actual production on a marketable scale could be undertaken. The main source of supply of germanium was the U.S.A. and even her production was only 2,000 lbs. per annum. It was difficult and expensive to obtain really pure metal.

The G.E.C. laboratories succeeded in extracting germanium from the flue dust in the chimneys of gas works. This method was further developed by John Matthew and Company to produce the germanium in economical quantities. A pure and ample supply of the metal was thus made available to British manufacturers, and resulted in the development of mass production methods to supply crystals to the public at a low price.

Further research in the U.S.A. resulted in the

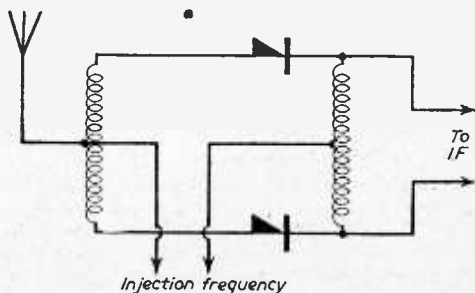

Fig. 2.—The crystal has replaced the valve in this circuit.

discovery that, by adding a second electrode (or cat's whisker) to the crystal, a triode was formed which would amplify signals in a similar manner to the thermionic triode. In 1948 a valveless loudspeaker radio receiver was demonstrated in the Bell Laboratories in New York, the driving current of only a few milliamps being obtained from a small dry battery.

British manufacturers were working on the same lines and later the same year a crystal triode was produced by B.T.H. and a valveless loudspeaker radio receiver was successfully demonstrated in their laboratory.

Research work and the exploration of the possibilities of germanium crystals is being pursued vigorously. The latest development is the discovery of a new method of making contact with the crystal. This is by forming the rectifying barrier (or junction as it is called) *inside* instead of on the surface of the germanium to render the contact extremely robust and stable. This method of construction enables crystals to be produced whose power-handling capabilities range from less than one microwatt, to water-cooled rectifiers which will carry 100 amps. in an area of one square centimetre.

**Construction of the Diode**

There are three main firms which manufacture germanium crystal diodes in Britain. They are the B.T.H., the G.E.C., and Westinghouse.

The construction of the B.T.H. crystal is shown in Fig. 3. The crystal is actually a flake of germanium which is fixed inside the glass tube. The "cat's whisker" is a tungsten wire contact which is soldered into the negative end. The actual contact is made during manufacture and requires no adjustments whatsoever. The crystal is equipped with two wire ends 2in. long which can be soldered directly to the other components in the receiver. The robust construction makes it no longer necessary to "tickle" the cat's whisker to find the best position.

When soldering, care should be taken to avoid excessive heat getting to the diode. The connecting wire should be gripped with a pair of pliers between the soldering tag and the diode, at the point where

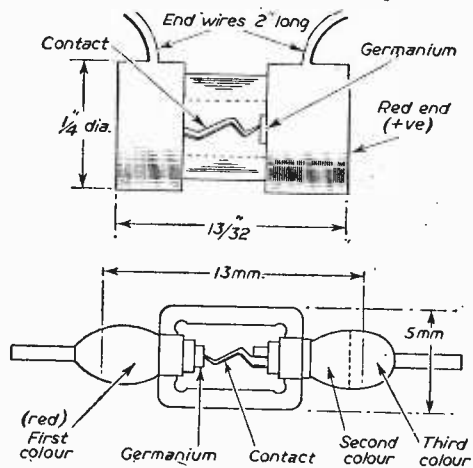

Fig. 3 (Above).—Dimensioned outline of B.T.H. type, and Fig. 4 (below).—Dimensioned outline of G.E.C. type.

the connection is being made, so as to divert the heat. This precaution should be taken with all crystal diodes.

The construction of the G.E.C. type is shown in Fig. 4, and it will be observed that the principle is similar to that of the B.T.H.

**Polarity Markings**

The general practice is to mark one end in red; this is the cathode end. If A.C. is applied to the other end (the anode) a positive potential will appear at the red end.

Different types have differently coloured anodes. With the B.T.H. the following colours are used:

Type	Colour of anode
CG1-C	Green
CG4-C	Blue
CG5-C	White
CG6-C	Black
CG8-C	Brown

The G.E.C. use a two-colour code at the anode as follows:

Type	Colour of anode
GEX33	Orange/Orange
GEX44	Yellow/Yellow
GEX45	Yellow/Green
GEX55	Green/Green

**Equivalent Table**

The following table indicates types which can be substituted for each other, for general use:

B.T.H.	G.E.C.	Westinghouse
CG4-C	GEX55	WG7A
CG5-C	GEX45	WG7B
CG6-C	GEX45	WG5A

It must be borne in mind that these equivalents are only approximate and the serious experimenter should study the characteristics of the type he intends to use.

**Characteristics**

As with valves, each manufacturer has produced his own types of diodes with their own particular characteristics, and it is not possible to give here a complete list of all the characteristic curves available. However, the graph in Fig. 5 shows a curve indicating the performance to be expected.

An example of the performance ratings is given overleaf for a crystal detector.

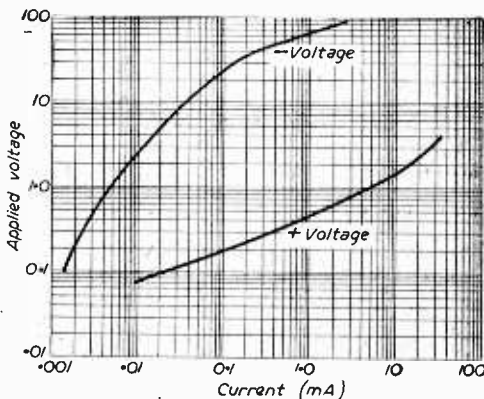

Fig. 5.—D.C. characteristic curves of typical rectifier.

Characteristic	CG6-C	GEX45	WG4B
Max. voltage (peak reverse) ...	50	60	40
Max. input current continuous (mA.) ...	50	50	50
Transient surge (mA.) ...	400	500	500
Min. forward current at + 1v. (mA.) ...	2	5	5
Max. reverse current at -10v. ( $\mu$ /a.) ...	100	33	100

The average figure for resistance taken at plus 1 volt is 500 ohms and the minimum back resistance taken at minus 10 volts is 100,000 ohms. These figures will, of course, vary from one type to another. The capacity is less than 1 pF.

**Advantages of Germanium Crystals**

This modern version of the crystal has many advantages over the thermionic valve for many radio and electronic devices. A summary of these is given below :

- (a) Great sensitivity. (They make really super crystal receivers.)
- (b) Long life. (Shelf life 10 years ; operating life more than 10,000 hours.)
- (c) No adjustments to be made.
- (d) No current consumption. (This means no heater current and therefore no heater wiring.)
- (e) Low self-capacity. (One of the disadvantages of the small metallic oxide type was its comparatively high self-capacity, making it unsuitable for VHF work.)
- (f) Superior frequency response.
- (g) Wide frequency range.
- (h) Robustness.
- (i) Can be soldered directly into the circuit.
- (j) Can handle high voltages.
- (k) Able to withstand heavy transient overloads.

**Practical Uses**

A short list of the practical uses to which the crystals can be put is given below. This list is not intended to be fully comprehensive, but is given merely as a guide, and doubtless the experimenter will be able to find many other uses for them.

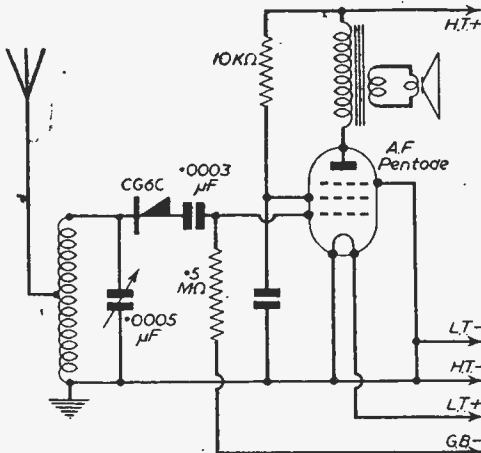

Fig. 7.—Crystal plus pentode loudspeaker crystal set.

Application	Suggested types		Westing-house
	B.T.H.	G.E.C.	
Narrow band V.H.F. detector ...	CG5-C	GEX44	WG5A
Interference limiter ...	CG6-C	GEX44	WG6A
Medium frequency detector ...	CG6-C	GEX44	WG7A
Detector for crystal Rx ...	CG6-C	GEX45	WG4B
Instrument rectifier	CG5-C	GEX55	WG7B
Discriminator FM receivers ...	CG5-C	GEX55	WG7A
Ratio detector (FM)	CG5-C	GEX55	WG7A
H.F. indicator (standing wave) ...	CG5-C	GEX55	WG4A
Medium frequency A.V.C. circuit ...	CG5-C	GEX45	WG6A
General purpose diode ...	CG6-C	GEX45	WG6A

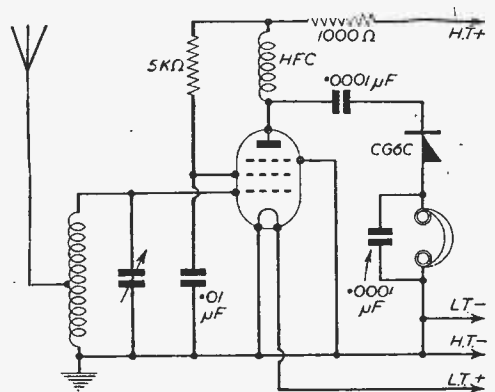

Fig. 8.—H.F. stage followed by crystal detector.

**Circuits**

Figures 6 to 9 give some circuits for experimental purposes, which the beginner can build. Battery type valves have been shown, though mains type can, of course, be used. No particular valve types are specified as the circuits are purely for experiment, and the constructor will doubtless wish to use any he may have on hand. Each circuit given is a working circuit and will give good results.

Some more circuits for the advanced worker are given later.

Figure 6 shows the basic crystal detector circuit. The coil can be home-made and one consisting of 50 turns 26 S.W.G. wire enamelled, silk and cotton covered close-wound on a 2½ in. diameter former will cover the medium wave-band. The tap is made 15 turns from the earthy end of the coil. High-resistance headphones should be used.

If desired, a commercial type of coil can be used with switching to cover the long and medium wave-bands.

Used with an outdoor aerial the results are sur-

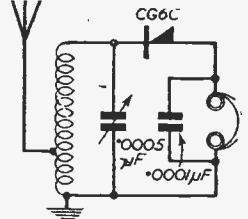

Fig. 6.—Single crystal receiver circuit.



prising, due to the highly sensitive crystal. The B.T.H. type is indicated on the diagram.

In Fig. 7 we have a circuit which employs a crystal for the detector and a pentode valve to provide sufficient amplification to work a loudspeaker on the local station.

Figure 8 shows a circuit using an H.F. valve before

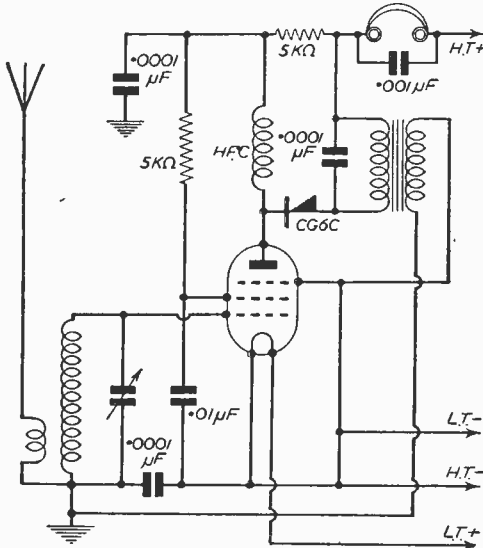

Fig. 9.—One-valve reflex circuit.

the crystal detector. It may be found that extra selectivity is required with this circuit and, if desired, the coil can be given an extra winding to couple the aerial loosely.

Figure 9 gives a circuit of the reflex type which was very popular at one time. The valve not only acts as an H.F. amplifier but also as an L.F. amplifier, the output from the crystal detector being fed back into the grid circuit of the H.F. valve.

These circuits are worth experimenting with, and provide a good knowledge of the capabilities of the modern crystal.

For the more advanced worker, the circuit shown in Fig. 10 is a tested working circuit, which will not only provide second detection, but A.V.C. voltages as well. This circuit, and also those in Figs 11 and 12, are given by courtesy of B.T.H., Ltd., and use the CG5-C crystals. Fig. 10 is suitable for V.H.F. working.

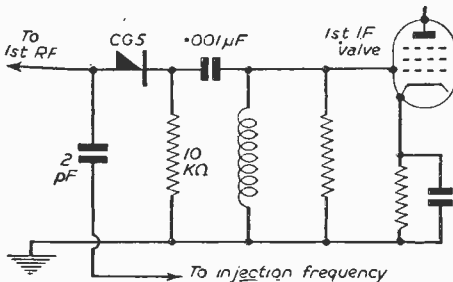

Fig. 12.—Discriminating circuit in F.M. receiver.

Figure 12 shows two CG5-C crystals used in the discriminating stage of an F.M. receiver and can replace the usual duo-diode valve.

The germanium crystal used as a mixer is shown in Fig. 12, and this circuit can be used for V.H.F. working.

A combined detector and noise limiter for short-

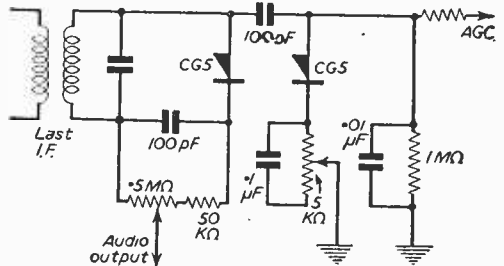

Fig. 10.—Detector and A.V.C. circuit.

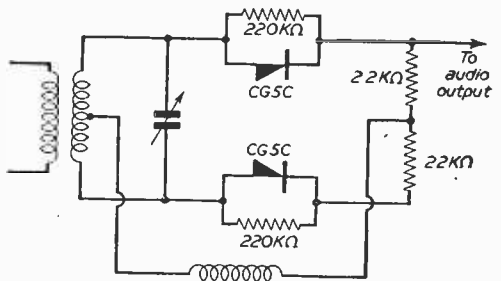

Fig. 11.—A B.T.H. circuit.

wave and V.H.F. receivers is given in Fig. 13. The limiter portion acts as an effective suppressor of car ignition interference.

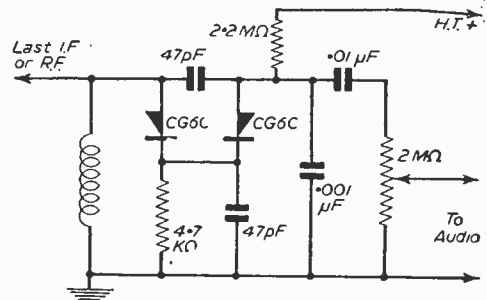

Fig. 13.—Noise limiter in a S.W. receiver.

**NEWNES' RADIO ENGINEER'S  
POCKET BOOK**

By F. J. CAMM

5/-, or by post 5/6

Obtainable from booksellers, or by post from George Newnes, Ltd. (Book Dept.), Tower House, Southampton Street, Strand, W.C.2.

# Testing Condensers

**Q**UITE a large number of beginners, and even some that have been in radio for a number of years, have no means of measuring capacity at low frequencies, and absolutely no means of measuring insulation. One of the most useful measuring devices and perhaps one of the cheapest is the neon indicator, and there are many types available on the surplus market at the moment; some can be obtained for a matter of one shilling.

It will be remembered that there is a phase difference of 90 degrees between the voltage across the condenser and a resistor in series. The formula for the

combined impedance is  $Z = \sqrt{R^2 + \left(\frac{1}{\omega C}\right)^2}$  and since the voltage developed across either the resistor or the condenser is dependent on the ratio of the two impedances, if the capacity of the condenser is reduced then the resistor must be increased to maintain the voltage ratio.

## Simple Circuit

Fig. 1 shows a simple capacity tester circuit; the resistance is adjusted with the condenser connected so that the neon is only just struck; the variable resistor can quite easily be a potentiometer and it is a simple matter to calibrate it in terms of capacitance, by the simple expedient of connecting a condenser of known value to the device and "balancing," then marking the scale at the appropriate point. It is as well to use close tolerance condensers in order that the calibration shall be accurate. The disadvantage with using a potentiometer is that the higher capacitances are all cramped at one end; it is a better idea to find the resistance to be placed in series with, say, a 0.1  $\mu\text{F}$  for balance. The value of this will depend on the neon used, as the striking voltage of neons varies from about 75 to over 250 volts, and wiring a series of multiples and sub-multiples of this resistance to a wafer switch. If, say, a resistor of 30,000 ohms is required, then the resistors required for the range would be: 3,000 for 1  $\mu\text{F}$ , 6,000 for 0.5, 12,000 for 0.25, 30,000 for 0.1, 60,000 for 0.05, and so on; in this way it is possible to build up quite a range of capacities that can be measured. With condensers it is not usually essential that the capacity be measured to a high degree of accuracy. For decoupling condensers the value is not particular to 200 per cent. above, but lower values cannot be tolerated. As A.C. is used for the testing, this device is not suitable for the testing of electrolytics, as there is no polarising voltage and the large current drawn would burn out the mains transformer, the most

suitable type of which is one of the numerous little Pre-Amp transformers manufactured by quite a number of reputable firms. The instrument can, of course, be used direct off the mains, but the use of a transformer greatly improves the factor of safety.

## Insulation

Insulation is another thing that is very important. How often does the user of surplus or second-hand condensers make an amplifier or receiver and find that the output valve

is running very hot, and the mains transformer seems to be overloaded? The most likely cause of this is a condenser of doubtful insulation value between the anode of the drive valve and the grid of the output valve. A simple insulation test on the condenser before use would prevent numerous troubles of this type.

## An Improvement

The circuit shown in Fig. 2 is an improvement on the capacity-measuring device, so that insulation can also be measured. The rectifier is shown as being of the metal type, but almost any six-volt valve with all the spare electrodes strapped to the anode can be used. If size is of consequence, then a 6H6 is indicated, although the writer prefers the Mullard EZ41, as it is of small diameter and of much lower impedance. The condenser can be almost anything over 1  $\mu\text{F}$  in either paper or electrolytic and as small 8  $\mu\text{F}$  electrolytics are readily available one of these was chosen. The 1 M $\Omega$  resistor acts as a bleeder to bleed away the charge from the condenser when the unit is not in use.

The operation of the unit is to connect the condenser or component under test between the insulation test terminal and the common, and if there is a permanent light, the insulation of the condenser is at fault. There should be a flash when the condenser is connected and then a flash every several seconds if the condenser is a good one; if the condenser is exceptionally good, it may be a flash every several minutes. One point here is that the terminals must be very well insulated, I might even say exceptionally well insulated.

*An article dealing with the construction of a very simple condenser testing and capacity measuring instrument. The components can for the most part be found in the average spares box.*

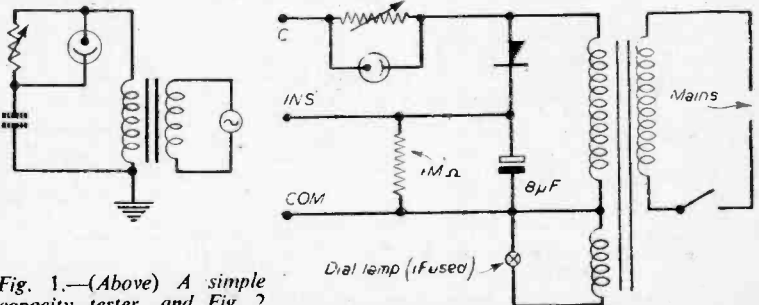

Fig. 1.—(Above) A simple capacity tester, and Fig. 2 (right) the final circuit adopted. A neon should be included in the INS lead.

# TAYLOR MULTIRANGE UNIVERSAL METER



Model

## 120A

A precision made compact instrument, versatile, sensitive, but sturdy enough to give long service under the most exacting conditions. 19 ranges provide a wide range of measurements and the convenient pocket size makes it an ideal instrument for service engineers and many other users. Supplied with all necessary leads and instructions for use. A canvas carrying case with shoulder strap is available to order.

An accurate moving coil movement with a 2½ in. scale length. Sensitivity is 1,000 ohms per volt on both A.C. and D.C. volt ranges. Knife edge pointer and clearly marked scales give ease in reading.

### Ranges

**VOLTS D.C. :** 0-.25, 0-10, 0-50, 0-250, 0-1,000, 0-2,500.

**VOLTS A.C. :** 0-10, 0-50, 0-250, 0-500, 0-2,500.

**MILLIAMPS D.C. :** 0-1, 0-10, 0-50, 0-500.

**RESISTANCE :** 0-2,000 ohms, 0-200,000 ohms; these ranges can be extended by using external battery.

### Price £9

For full details of the complete range of Taylor products, please write for New 16 page catalogue.

**TAYLOR ELECTRICAL INSTRUMENTS LTD.**

MONTROSE AVENUE, SLOUGH, BUCKS.

Slough 21381

# FREE

## THIS VALUABLE BOOK



which details the wide range of Engineering and Commercial courses of modern training offered by E.M.I. Institutes —

*the only Postal College which is part of a world-wide Industrial Organisation.*

Courses include training for :

City and Guilds Grouped Certificates in Telecommunications; A.M. Brit. I.R.E. Examination, Radio Amateur's Licence, Radio & Television Servicing Certificates, General Radio and Television Courses, Radar, Sound Recording, etc. Also Courses in all other branches of Engineering.

**EMI** INSTITUTES  
 associated with  
**MARCONIPHONE** **H.M.V.**  
**COLUMBIA &** (His Master's Voice)

COURSES FROM  
**£**  
 PER MONTH

### POST NOW

Please send, without obligation, the FREE book.  
 E.M.I. Institutes, Dept. 32  
 43 Grove Park Road, Chiswick, London, W.4

Name .....

Address .....

IC108

## B.A. SCREWS, NUTS, WASHERS, ETC.

	Prices per gross		Brass Washers
	Full	Lock	
Assd. Screws 2/6	6/9	6/-	Assd. 1/6, 2BA 2/-,
Assd. Nuts 2/6	5/6	5/-	1BA 2/-, 2BA 1/10,
Screws and Nuts	4/4	4/-	3BA 1/9, 4BA 1/8,
1/2 gr. each 2/6	5/4	4/-	5BA 1/6, 6BA 1/6,
Brass Screws,	4/-	3/9	8BA 1/6
Assorted	6/4	3/6	
2BA 5/6, 4BA 5/-,	7/4	4/6	
6BA 4/-, 8BA 4/6	6/4	4/-	

Soldering Tags, Assd. 2/-, 2BA 2/3, 4BA 2/-, 6BA 1/10, 8BA 1/10  
 Eyeless and Rivets, assd. 1/6. Aluminium Rivets, assd. 1/6.  
 Br. Knurled Terminal Nuts. 6BA 8d., 4BA 1/-, 2BA 1/6 doz.  
 Br. Terminals, w/nuts, heavy type, NP, 6d. each, 5/6 doz.  
 GRUB SCREWS, Assd. 1/6, 6BA 1/3, 4BA 1/4, 2BA 1/6 per 3 doz.

A SELECTION FROM OUR HUGE STOCK OF SCREWS

### PRICES PER HALF-GROSS.

ABBREV.: Heads. CH., Cheese. RH., Round. CS., Counter-sunk. NP., Nickel Plated. CP., Cadmium Pl. SC., Self-colour.

6BA		BRASS		STEEL	
CH	NP 1/6	RH	NP 1/5	CH	NP 1/-
"	" 1/6	"	" 1/6	RH	SC 1/-
"	" 1/7	"	" 1/7	CS	CP 1/-
"	" 1/9	"	" 1/9	RH	SC 1/2
"	" 1/10	"	" 1/11	CS	CP 1/1
"	" 1/11	"	" 2/-	"	" 1/2
"	" 2/-	SC	2/1	RH	SC 1/2
"	" 2/1	"	" 2/3	CS	CP 1/4
"	SC 1/11	"	" 1/4	"	" 1/5
"	NP 2/3	CS	NP 1/6	RH	SC 1/5
"	" 2/6	"	" 1/7	CS	CP 1/7
"	" 1/9	"	" 1/8	CH	" 1/9
Insc/H	NP 1/9	"	" 1/9	"	" 2/6
"	" 2/-	"	" 1/10	H/H	" 2/9

4BA		BRASS		STEEL	
CH	NP 2/-	RH	NP 1/10	CS	CP 1/2
"	" 2/1	"	" 2/3	"	" 1/3
"	" 2/1	"	" 2/9	RH	" 1/4
"	" 2/2	"	" 3/-	"	" 1/2
"	" 2/6	CS	" 1/8	"	" 1/4
"	" 3/3	"	" 2/-	CS	CP 1/4
"	Hex/H.. 2/6	"	" 2/3	RH	SC 1/6
"	" 3/6	"	" 1/10	"	" 1/9

8BA		BRASS		STEEL	
CH	NP 2/-	CH	SC 2/-	CH	CP 2/-
"	" 2/6	RH	NP 2/2	CS	" 2/-
"	" 1/8	"	" 2/6	CH	" 2/2
"	" 2/3	"	" 2/9	RH	" 2/2
"	" 1/9	Hex	" 2/9	CH	NP 2/3
"	" 2/6	"	" 2/10	RH	CP 2/3

ALL ABOVE POSTAGE EXTRA.

## G.E.C. & B.T.H. GERMANIUM CRYSTAL DIODES

G.E.C. GLASS TYPE 3/8in. x 3/16in.  
 B.T.H. LATEST TYPE MOULDED IN PLASTIC  
 Both Wire Ends for Easy Fixing. 4/6 each, postage 2 1/2d.

### B.T.H. SILICON CRYSTAL VALVE

3/6 each, postage 2 1/2d. Fixing Brackets 3d. Extra.  
 Wiring instructions for a cheap, simple but high quality  
 Crystal Set included with each Diode and Crystal Valve.

Large stocks of Copper and RESISTANCE WIRES: Paxolin  
 type TUBING; Laminated Bakelite and Ebonite PANELS;  
 TUFNOL and EBONITE TUBES and ROD; ERIE and  
 DUBILIER RESISTORS; GERMANIUM and SILICON DIODES.

POST ORDERS ONLY PLEASE.

Send stamp for comprehensive lists. Trade supplied.

**POST RADIO SUPPLIES**  
 33, BOURNE GARDENS,  
 LONDON, E.4

## PREPARE NOW

FOR WINTER TV

The NEW 1355 Conversion data for all five Channels. Sound, Vision, T.B.'s, Power, on one 1355 chassis without expensive RF units. NEW EDITION, 3/- per copy.

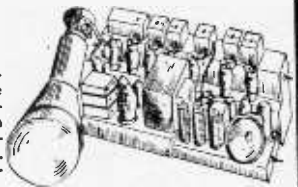

NEW 1355's in original cases, 45/-.

VIBRATOR PACK 21,	TRANSMITTER 21	RECEIVERS
delivering 140v at 40 mA from 6v in p u c. New. 17/6	for speech, MCW or CW on 4.2-7.5 or 18-31 mc/s; PA coils and relays, stripped by Ministry, may be replaced with our data. With circuit, control box and key. First class condition. (Less valves) 12/6	S450B, 4 EF54's (RF. mixer, LO multipliers) 2 EF39's (2.9 mc/s IF's) EB34 (dec) EC52 (xtal osc.) 6J5 and 6V6 (audio). 6S/85 mc/s. NEW with circuit. (Post 2/-) 49/6

ACCUMULATORS	INDICATOR 182A	NEW 1155's
multiple, unspillable, 7AH. 3 1/2 x 1 1/2 x 4ins. (1/- post) 6/6	with 6in. C.R.T. 3 EF50's, 4 SP61's, SU4, dozens of resistors and condensers, 9 W/W pots, these are suitable for conversion to 'scope or TV. BRAND NEW (less relay) in original cases. Only 79/6	Most famous ex-R.A.F. communications Receiver — AIR TESTED, BRAND NEW in original cases. Only £10 15s.

**RADIO EXCHANGE CO.**  
 9 CAULDWELL STREET, BEDFORD  
 Phone 5568

# PRIVATE

## OPINIONS

- "... it is everything you say, in fact even more: on every range it is accurate... after about half an hour from receiving it I had it working."—A. P., Longton.
- "... I am very pleased with kit, especially the instructions—so clear!"—K. T., Cleethorpes.
- "... I felt I had to write and congratulate you for putting on the market a R.C. bridge of such high accuracy at a phenomenally low price. Construction is remarkably easy..."—D. G. R. L., Cheam.
- "... I am very pleased with same and think it remarkably good value for such a low cost..."—W. E. C., Hove.
- "... when one of your bridges was tried out against Laboratory Standards and everyone present was amazed at the very high degree of accuracy..."—J. R., Fulham.

## THE RADIO MAIL 30/- RES./CAP. BRIDGE KIT IS THE BEST RADIO VALUE OBTAINABLE TO-DAY

5 megohms—50,000 ohms 50 mfd.—2 mfd.  
 100,000 ohms—1,000 ohms 1 mfd.—.01 mfd.  
 1,000 ohms—10 ohms .01 mfd.—.0005 mfd. (500 pF.)

NO CALIBRATING. An accurately calibrated panel with each kit.

NEW COMPONENTS. Specially selected for accuracy. EASILY ASSEMBLED. Instructions, circuit and diagrams.

Part post & packing 1/6. Cash with order or C.O.D.

**RADIO MAIL, 4, RALEIGH ST., NOTTINGHAM**  
 Stamp for list and with all enquiries, please

# Predicting Amplifier Response

FACTORS USED IN WORKING OUT FREQUENCY AND GAIN VALUES

By N. J. Wadsworth, B.Sc.

**A**N amplifier is often required which will give a stated voltage gain between certain frequency limits and provide a certain output voltage. Examples of this are audio frequency amplifiers of various kinds and amplifiers for oscilloscopes, the latter having the more stringent specifications. Many people can calculate the gain of an amplifier from the valve data and the component values using the formulae: (1) gain of a pentode =  $g \cdot R_1$  where  $g$  is the mutual conductance and  $R_1$  the anode load, and (2) gain of a triode =  $\mu R_1 / (R_1 + r_a)$  where  $\mu$  is the amplification factor of the valve and  $r_a$  is the anode impedance with  $R_1$  as before. They do not know, however, how to calculate the frequency response curve, i.e. how the output will vary with frequency. Thus, while it is well known that the larger the coupling capacitor the better the low-frequency response, it is not always known how large to make it for a given low-frequency cut off. Other questions which arise are—how large should the screen decoupling capacitor be? Is  $25\mu\text{F}$  sufficient to by-pass the cathode bias resistor? What will be the high-frequency limit of the amplifier? How much phase shift will there be at 50 c/s? These and related problems will be covered in this article.

The first point to consider is the response curve necessary for various types of amplifier. For quality audio work the gain should be reasonably constant from about 30 c/s to 15 kc/s although, if it is constant between 50 c/s and 10 kc/s, the reproduction is still good. In audio work, small phase shifts have very little effect. An amplifier for an oscilloscope must have zero phase shift over a wide range of frequencies, say from 30 c/s to 50 kc/s or perhaps up to 200 kc/s. This needs much more careful design.

There are a number of different ways of presenting the response curve of the amplifier. For audio work the gain is usually expressed in "db." Here db is interpreted as

$$20 \log \left( \frac{\text{output volts at } f}{\text{output volts at a standard frequency}} \right)$$

and is not a power ratio at all. This is a very convenient, although not strictly correct, use of db. In this system, each halving of the gain appears as a 6 db drop whether the gain is reduced from 2 to 1 or from 1,000 to 500. Phase is normally unimportant and a 1 or 2 db drop is inaudible.

For C.R.O. amplifiers, since the output is presented visually, it is more usual to use the actual voltage gain rather than its log, and to keep it as accurately constant as possible; even a 2 per cent. drop being readily visible. Also, if complex waveforms are to be presented unaltered, it is essential

that the phase shift in the amplifier be very small over the working range. This is also necessary when using X and Y amplifiers to plot external variables such as the anode voltage and current of a valve.

In television video amplifiers, and C.R.O. amplifiers when square waves are used for testing, the "transient response" is of importance. This is the output waveform when a square wave of very rapid rise time and long duration is applied to the input.

We will now consider a single valve amplifier in detail and discuss the response of each portion in turn and then discuss the effect of using more than one valve and also of various gain control circuits.

## Low Frequency Response

The most well-known cause of loss of output at low frequencies is the coupling capacitor. The basic circuit is shown in Fig. 1. The response of this

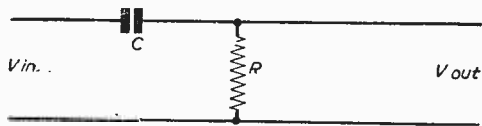

Fig. 1.—Basic circuit of L.F. input arrangement.

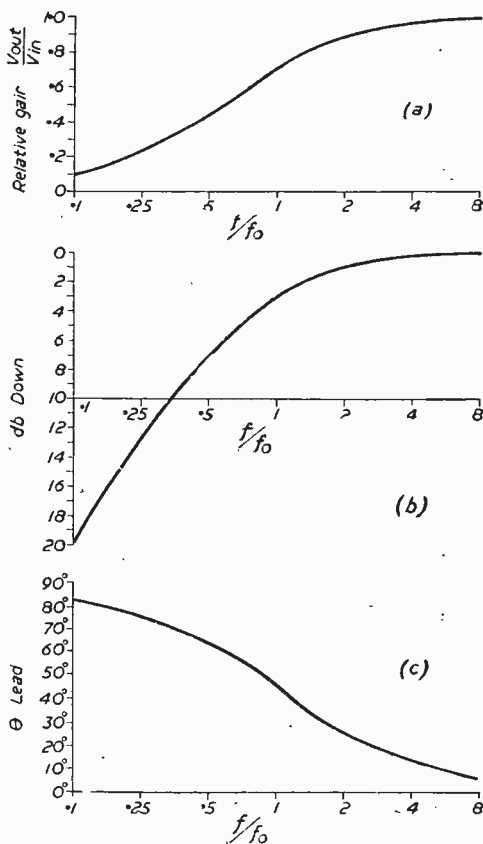

Fig. 2.—Graphs showing gain, frequency response and phase shift.



circuit is given by Fig. 2. To use these curves, which apply for all values of C and R, first calculate  $f_o = \frac{1}{2\pi RC}$  and then for any frequency, f, the response may be read off opposite the appropriate value of  $f/f_o$ .

In all formulæ in this article all frequencies are in cycles per sec., all resistances in megohms, all capacities in  $\mu F$ , all conductances in  $\mu A/V$  and all times in seconds.

For example, to find the response of the circuit of Fig. 1 at 30 c/s if  $C = 0.05 \mu F$  and  $R = 500 K \Omega$  we calculate  $f_o = 1/(2\pi \times \frac{1}{2} \times 0.05) = 6.36$  c/s. Therefore at 30 c/s  $f/f_o = 30/6.36 = 4.78$  and from the curve 2a the output 0.975 is ofmax, from 2b it is 0.17 db down and from 2c the phase shift is 12 deg. leading. Thus while the drop in amplitude is very small the phase shift is not negligible. Since

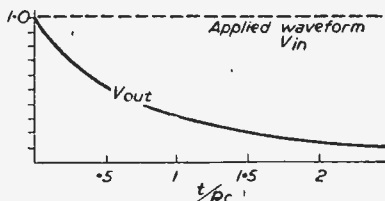

Fig. 3.—Response to a square wave.

it is the start of the output drop and phase shift that is often of importance, Table I is provided giving the relative output, the db drop, and the phase shift  $\phi$  for various values of  $f/f_o$ . The table or the curves may of course be used in reverse. Thus, if a phase shift of less than 5 deg. is wanted at 50 c/s we see that at this frequency  $f/f_o$  must be at least 12, so  $f_o$  is about 4 c/s. Therefore  $RC$   $0.04 M \Omega - \mu F$  and a  $0.04 \mu F$  capacitor and a  $1 M \Omega$  resistor will do. In practice, a  $0.05 \mu F$  capacitor would be used. The response of this circuit to a square wave is given

by the formula  $V_{out} = V_{in} \cdot e^{-\frac{t}{CR}}$  where the time after application of the voltage is t. This is plotted in Fig. 3 and, as will be seen, the voltage has dropped about 10 per cent. after a time  $CR/10$  and is down to 37 per cent. of its maximum after  $t = CR$ .

To keep phase shift low at very low frequencies, R is made as large as the valve manufacturers allow, normally about  $2 M \Omega$ , and C is made as large as possible consistent with low leakage.

If the load resistance of the preceding valve is comparable with R, for high accuracy in calculating  $f_o$ , R in the formula should be replaced by  $R + \frac{Rl \cdot ra}{Rl + ra}$

where Rl is the anode load and ra the anode impedance of the preceding valve. In almost all practical cases this correction is negligible.

A lesser known cause of drop in output at low frequencies is the capacitor, Ck, across the cathode bias resistor, Rk, in the circuit of Fig. 4. As the frequency falls this becomes less effective and the output drops. The shape of the curve is shown in Fig. 5 where G1 is the gain calculated

assuming the capacitor has zero impedance, i.e. the usual valve gain, and G2 is the gain with no capacitor, that is  $G1/(1 + gRk)$  where g is the mutual conductance as before. The upper part of this curve is similar

to that of Fig. 2 putting  $f_o = \frac{1 + gRk}{2\pi Ck Rk}$  and this may be used with reasonable accuracy till the loss of gain is about half the maximum. For frequencies below this, the phase shift returns to zero and the gain slowly drops to G2. As an example, consider

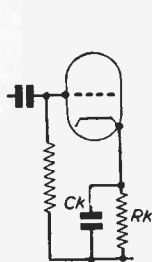

Fig. 4.—Cathode circuit of an L.F. stage.

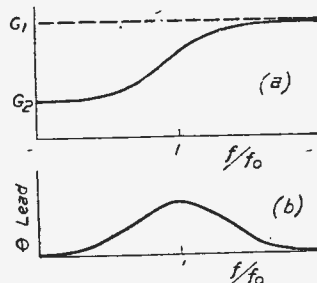

Fig. 5.—Curves for L.F. stage as at Fig. 4.

the circuit of Fig. 4 with  $Ck = 25 \mu F$ ,  $Rk = 150 \Omega$ ,  $g = 7$  ma/V, typical values for an SP61 or an EF50.  $f_o$  is about 80 c/s and from Table I the phase shift is about 19 deg. at 250 c/s. This shows one cause of phase shift that is often unsuspected in oscilloscope amplifiers. The square-wave response of the circuit is shown in Fig. 6 where  $V1/V2 = G1/G2$ . It is often impracticable to make Ck large enough to cause little phase shift at the lowest frequencies wanted in an oscilloscope amplifier, and it is then necessary to leave it out all together, thus reducing the gain to G2 at all frequencies and improving the valve linearity by the negative feedback.

A third cause of drop in response at low frequencies is the screen decoupling capacitor Csg in Fig. 7. This has much the same effect as the cathode capacitor just described. To keep the phase shift and drop in gain low, either the resistance of R1 and R2 in parallel must be much less than the screen grid impedance rsg (analogous to anode impedance) of the valve, in which case Csg may be dispensed with, or the reactance of Csg at the lowest wanted frequency must be very small compared with R1, R2 and rsg in parallel.

(To be continued.)

TABLE I

$f/f_o$	Relative output	db down	$\phi$
0.5	0.44	7.2	64°
1.0	0.71	3.0	45
2.0	0.89	1.0	26
5.0	0.98	0.16	10.5
10.0	0.995	0.05	5.5
20.0	1.0	0.01	2.9
50.0	1.0	0	1.0
100.0	1.0	0	0.4

TABLE II

$f/f_1$	Relative output	db down	$\phi$
0.01	1.0	0	0.4°
0.02	1.0	0	1.0
0.05	1.0	0.02	2.9
0.1	0.995	0.05	5.5
0.2	0.98	0.16	10.5
0.5	0.89	1.0	26
1.0	0.71	3.0	45
2.0	0.44	7.2	64

# Making a Tape Deck

HINTS ON THE CONSTRUCTION OF TAPE-RECORDING MECHANISMS

By R. Bissett, M.A.

**A**N essential part of most tape recorders is a capstan whose function is to drive the tape at a constant speed. The spooling of the tape may be on shafts driven by the capstan motor or, more simply, each spool may be mounted on its own motor shaft. The making of the capstan and its associate flywheel presents a real difficulty, almost an impossibility, to those with no facilities. Only the machining expert can approach the standards of wow-free and flutterless traverse claimed for commercial machines.

It occurred to the writer from a study of wire-recording mechanisms that constant speed is not a pre-requisite. In many designs the take-up spool

wheel, and this acts as a mechanical filter which, together with the inertia of the turntable, ensures that the speed is very regular indeed. The two-speed collar should be removed from the motor shaft and a thin piece of rubber sleeving slipped over the shaft in its place. By choosing a suitable thickness of sleeve, the turntable may be made to revolve at any speed from about 40 r.p.m. down to 26 r.p.m. In order that the turntable may revolve in an anti-clockwise direction (for rewind), a thin flexible wire should be fixed to the nut below the idler wheel spindle. A soldering tag is a good way of fixing the wire if the tag is soldered to the underside of the nut. The other end of this wire is attached to the switch controlling the motors and it pulls away the idler from the turntable when rewind is in progress. There is sufficient adhesion between the spool and the rubber mat to carry the spool round without slip.

## Rewind Motor

For the rewind motor the writer uses a Hoover model SP 202 running anti-clockwise at 950 r.p.m. with a shaft  $\frac{9}{32}$  in. diameter, the same size as the turntable spindle. Any shaded-pole motor of reasonable torque made to run anti-clockwise and preferably not less than four poles will serve if the shaft is made up to  $\frac{9}{32}$  in. by a sleeve. To this shaft must be fitted a disc about 1½ in. to 2 in. in diameter on which the spool is carried. The disc must be a tight fit on the shaft (or sleeve) or it may be held by a grub-screw. It is important that the centre hole be drilled truly vertical. The writer uses a bakelite disc ¼ in. thick, but a flat surface radio knob might serve. A 6 B.A. pin is screwed into this disc and engages with a hole

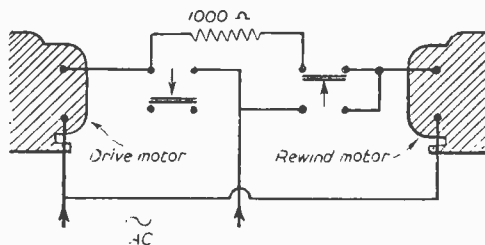
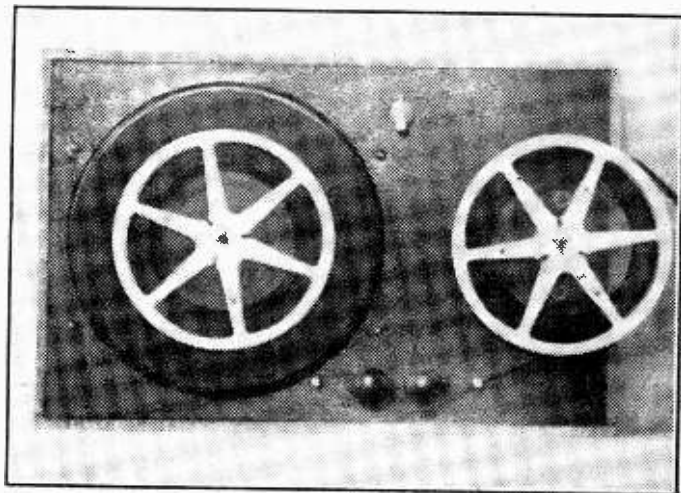

Fig. 1.—Mains supply to motors—switch set off. Cam operates one or other of the micro-switches.

supplies the drive to the wire, and the speed of the wire varies as it winds on to a larger diameter. Admittedly the change in speed of the wire from start to finish may only vary 10 per cent. or less. The mechanism to be described here employs the take-up spool as a drive for the tape and the spools used are non-standard. It will be appreciated that the standard 7 in. spool with inner diameter of 1½ in. would cause a variation in tape speed of more than four to one between start and finish. This has two objections. First, if the slower speed is high enough to make a recording, there is excessive waste of tape as the speed increases. Secondly, the frequency corrections would have to be changed during the course of the recording. With the arrangement here, however, the speed variation is less than one and a-half to one.

## Drive Motor

The drive motor is a BSR MU-10 gramophone motor complete with rubber-covered turntable. These motors employ between the driving shaft and the turntable a spring-held idler



A tape deck constructed by the author.

in the spool to give a positive drive. When the tape is driven forward the rewind motor is partially energised via a resistance of about 1,000 ohms. (A mains dropper from A.C./D.C. radio is suitable.) This is the usual method of ensuring that sufficient drag is applied to the tape to keep it taut as it winds off.

### The Spools

These are the only parts which call for machining. Two discs  $\frac{1}{8}$  in. thick and  $4\frac{1}{2}$  in. diameter are required, and they must be true to a  $\frac{9}{32}$  in. centre hole. The material may be a close-grained wood, ebonite or one of the plastics. Some firms will supply plastic items ready made. These form the spool centres. For the cheeks, 7 in. plastic spools were cut (Scotch Boy type). The centre drum should be sawn through and the remains of the drum filed away, taking care not to split the cheeks in the process. These cheeks were first cemented to the centre discs. Holes were then drilled through alternate spokes  $1\frac{1}{4}$  in. from the centre and tapped 6 B.A. to take short countersunk brass screws from both sides. Such a spool can hold 600 ft. of tape. Two spools were made in order to use double-track recording. Storage of tape, of course, should be on standard spools.

### The Heads

The writer prefers heads to which the tape makes contact on the "wrap round" principle as these obviate the use of pressure pads and their mechanism. Those wishing to make their own heads may, as the writer did, procure mumetal and radiometal laminations (ready cut and stacked if desired). The shape preferred is shown in Fig. 2. A housing may be made from thin-walled brass tube about 1 in. in diameter. A length of  $\frac{3}{4}$  in. is cut off for each head and an extra ring  $\frac{1}{4}$  in. wide to provide tape guides. A slot is filed so that the laminations peep through the circumference of the tube and make contact with the tape, but not so far through as to push it away from the guides. A brass or copper disc with a centre hole should be soldered into the lower end of the tube. Two arcs about  $\frac{3}{4}$  in. long are cut from the ring and soldered to the outside making a  $\frac{1}{4}$  in. channel for the tape. The head is held in place inside the housing by a rubber pad. An extra refinement consists of two discs and a band of mumetal to line the inside of the housing, the lower disc having a hole so that the screened lead may pass down through the mounting bush, which is soldered to the underside of the mount. A metal or bakelite cap cemented into the top of the housing completes the head except for smoothing off with 00 glasspaper and metal polish.

### The Switch

The switch uses the locking mechanism of a three-way rotary. A cam makes or breaks micro-switches for the motors and carries the flexible wire to pull off the idler on rewind. The length of this wire should allow the idler to engage as soon as the switch is turned to the central "off" position, thus braking the turntable and preventing spilling of the tape. No brake is required on forward drive. With suitable wafers on the switch spindle a four-way rotary may be used to make appropriate amplifier connections as well as controlling the motors; record—playback—off—rewind.

### Mounting the Parts

The drive motor should be mounted on a small sub-baseboard about 11 in. x 7 in. The deck is most readily made from  $\frac{1}{2}$  in. plywood with a hole  $10\frac{1}{2}$  in. diameter cut so as to leave  $\frac{1}{2}$  in. of deck at the back, front and left-hand side. The motor board is fixed to this by four  $3/16$  in. bolts with  $\frac{1}{2}$  in. spacers so that the surface of the turntable lies  $\frac{1}{4}$  in. to  $\frac{3}{8}$  in. above the deck. The rewind motor has two metal tags fitted within the clamping bolts and these tags may be used to bolt the motor to the underside of the deck after a  $\frac{1}{2}$  in. hole is made to let the shaft through. Other types of motor will require other methods. The distance separating the two shafts and the minimum

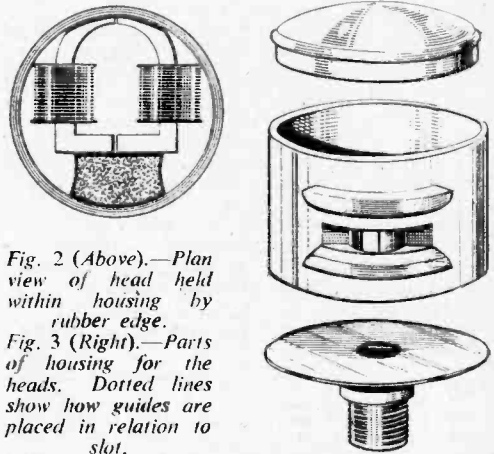

Fig. 2 (Above).—Plan view of head held within housing by rubber edge.

Fig. 3 (Right).—Parts of housing for the heads. Dotted lines show how guides are placed in relation to slot.

length of the deck depend on the size of the spools to be used (see below). Two pieces of  $\frac{1}{4}$  in. brass rod about 1 in. long should be fixed to act as tape guides, so that the tape approaches and leaves the heads always at the same angle irrespective of the amount on the spools.

### Playing Time

Assuming 30 r.p.m. the 7 in. spool takes on 600 ft. in  $13\frac{1}{2}$  minutes and the tape speed varies between 7.2 in. and 10.4 in. per second. By making larger spools, say 9 in. flanges with centre hubs  $5\frac{1}{2}$  in. diameter, 1,200 ft. may be accommodated and at the slowest turntable speed (26 r.p.m.) a playing time of 25 minutes may be obtained, with a speed variation from  $7\frac{1}{2}$  in. to  $11\frac{1}{2}$  in. per second.

One special application of this tape drive is used for office dictation. A normal 5 in. spool carrying 600 ft. is used for the feed. The take-up spool is 7 in. with a 4 in. centre hub and full track heads are used, giving about 18 minutes running time.

The limitations of this drive mechanism should be apparent to every reader, but it is very suitable for many uses that an amateur may require from a recorder.

## REFRESHER COURSE IN MATHEMATICS

8/6, by post 9/-

by F. J. CANN

GEORGE NEWNES, LTD.

Tower House, Southampton Street, London, W.C.2

# Electronic Organs

ANSWERS TO SOME QUERIES REGARDING OUR OWN ORGAN DESIGN, AND DETAILS OF SOME OTHER PRINCIPLES

By W. J. Delaney (G2FMY)

**A** VERY large number of queries were received concerning the organ design which has recently been published in these pages, and many of these showed that the general principles of electronic organ design are not realised. Quite a large number of readers could not understand why the organ only played one note at a time and could not see why chords could not be played; others wanted to know whether the design could be extended to include more octaves; still others wanted to change the range of the instrument to another part of the musical spectrum.

Dealing first with the design as published, it should be stated right away that experiments were made over a considerable period of time and that the range and design, as given, are the very best which can be obtained with the minimum of cost. If expense is no object, the design can, of course, be modified in various directions, but with a small additional outlay very little can be done. If much is to be spent, then it would undoubtedly be worth while to build a polyphonic instrument.

## Pitch

The instrument was suggested with a two-octave keyboard (actually 24 notes), and this may be modified by taking the lower C to the top of the keyboard, or moving the entire keyboard up or down two or three semitones *only*. This will answer those queries who wanted to know whether it would be practicable to make it a three-octave range. As indicated in Fig. 3 on page 414 of the September issue, the relationship between adjacent half-tones is by no means constant, and it will be found, if the keyboard is extended, that at extremes of the range the notes will not bear the same relationships and accordingly, although it could be tuned up on one range of the octave switch, when switched to the other ranges it would go out of tune on certain notes. The differences may be slight, but to anyone with a musical ear the notes will sound unnatural, being very slightly sharp or flat. For this same reason, the octave switching condensers C4, C5 and C7 should not be increased to widen the range of the instrument. It has been suggested that each value could be four times that of the lower, so that the shift would be by the entire range of the keyboard. On the face of it this should work, and actually it will in one part of the piano keyboard, but in general it is not a practical proposition.

## Chords

With regard to the playing of more than one note at a time, it should be realised that the note is formed by the valve V2 being set into oscillation, the frequency of this type of oscillator being dependent upon the values of the anode condenser, the grid resistance, and/or both. Thus, the frequency may be changed by changing the value of either the condenser, the resistance or both. In playing, the grid resistors are changed by the action of the keys, and obviously the pressure of more than one key at a time will merely mean that the value of the grid resistance is that between grid and the highest key pressed, all keys lower than that merely being on the earth side and having no effect whatsoever on the grid circuit. Thus the highest note always sounds, and there is no way of arranging that two separate notes can be produced at the same time in that stage. One reader thought that a duplicate range of switches could be wired into circuit so that two notes could be played at once, but a little thought will show that if another range of resistors is wired across the grid circuit, pressing two keys would merely place two resistors in parallel and still produce only one note.

## Polyphonic Arrangements

Whilst on this subject of playing two or more notes, it may be explained that in an electronic organ

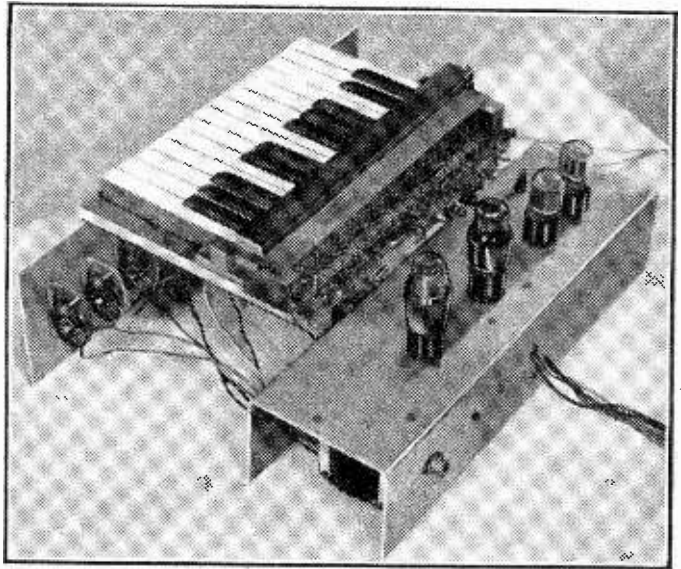

Only two octaves were specified in the "P. W." organ, but multipliers increased this to five. It is not recommended that a three-octave basis be used.

designed for the playing of chords each note of the scale must be produced by a separate generator. This may be a triode or double-triode valve, with arrangements similar to that used in the present design, but there will have to be 12 of these to produce a single octave. Therefore, the minimum number of valves which can be used in a polyphonic organ is 12, plus at least a further 12 for each additional octave, which can only be obtained by using a frequency multiplying circuit. For a normal five-octave keyboard, therefore, the customary arrangement is to make a note generator with three frequency multipliers, giving four valves per note for five octaves, which means that for the 61-note keyboard there would be  $4 \times 12$  or 48 valves, plus those used for vibrator, tone and amplification.

### Pedals

Two ambitious readers wanted to know whether a pedal attachment could be added, the idea being to use the instrument in conjunction with another electronic organ to produce a fuller tone. This could most simply be done by adding another oscillator on the lines of V2, with a  $.1 \mu\text{F}$  anode condenser and appropriate grid resistors for one octave only. The output could be taken from the anode of the oscillator

through a  $.05 \mu\text{F}$  condenser to the grid of V3. This has been tried and works without pulling, provided that the lower notes are at least one octave below the lowest note produced on the instrument as designed. If there is any pulling, the only satisfactory solution will be the inclusion of a buffer stage between the pedal note generator and V3, and this may easily be arranged by making C3 a double triode.

### Simplified Tuning

To simplify the work of selecting correct values for Ra to Rx variables may be used, but in view of the critical values which are needed it will be found that the best plan is to obtain a length of paxolin and punch along its edges small holes to accommodate the wire ends of resistors. For each note you would then need a 1,000-ohm variable—one of the Egen banked type components pre-set being ideal and the fixed resistors being selected as already explained, but with the slider of the variable in its central position. The resistor is then selected to be nearly correct, final adjustment being carried out on the variable. As already explained, however, this will only save time in the initial setting up and the variable factors will have no future use as they cannot be separately adjusted without upsetting the entire keyboard.

## New Premises for Schools Broadcasting Department

**F**ROM September 22nd, when the new schools broadcasts term began, programmes have been originating from the new building recently taken over by Schools Broadcasting Department, Nos. 1 and 1A, Portland Place. This is conveniently situated just across the road from Broadcasting House and replaces the temporary accommodation at Film House, Wardour Street, which the department has occupied since 1945. The new building contains, in addition to offices, five studio suites designed and constructed to meet schools broadcasts requirements. There are three general purpose studios, two talks studios, their associated control cubicles, an "echo room" for the production of artificial reverberation, and an apparatus room.

The technical equipment, built to the latest BBC design, enables each studio suite to function as a self-contained unit. Each studio has its own control cubicle containing a desk on which are mounted all the necessary operational controls. In accordance with modern practice each microphone has its own amplifier. The outputs of these amplifiers are fed first to a mixer unit on the control desk where they can be selected individually, or combined, as required, and then to a main amplifier, which is also controlled on the desk, so that the general level of the programme can be maintained within the appropriate limits. Provision is made for adding artificial echo in varying amounts to any of the microphone or gramophone points.

Means are also provided to link the outputs of three of the other studios to the control desk in the cubicle of Studio 5, which then acts as a master control position, and has its talk-back, cue light controls, and similar facilities extended to them. Such linking arrangements augment the usefulness of the studios and permit of more ambitious productions.

The installation is of special interest in that once the studio equipment has been set up ready for use it can be switched on and off as required from the main control room in Broadcasting House.

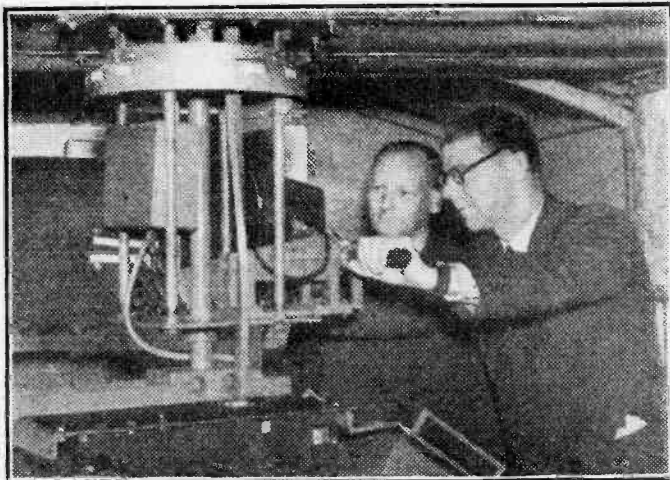

*Mr. Bernard Collins, manager of Southend Airport, who is to demonstrate the Ekco airfield radar approach aid in America, is seen with the equipment watched by Mr. A. W. Martin, technical director of E. K. Cole, Ltd., who was responsible for developing the approach aid.*



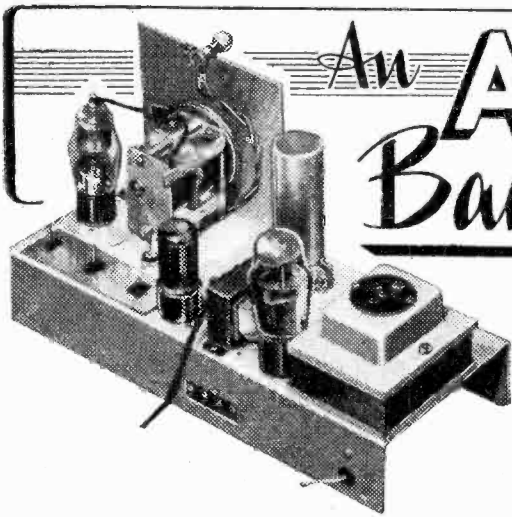

# An A.C. Band-Pass 3

A DETECTOR-L.F. CIRCUIT WITH VALVE RECTIFIER AND HIGHLY SELECTIVE TUNING. AN R.F. STAGE WILL BE DESCRIBED LATER

**S**OME constructors who have built a number of battery-operated receivers seem hesitant about attempting a mains receiver, and this design should be of particular interest to them. It employs a pentode detector followed by a beam tetrode output stage, the third valve being the rectifier, which is of full-wave type. This type of circuit is very much less complicated than the usual superhet output stage, but can, nevertheless, give good results. Reaction is provided, and this considerably increases sensitivity to weak transmissions. For listening to the local stations, under average conditions, this control need not be used, and a volume control, combined

with the on/off switch, is provided. In order to achieve a good degree of selectivity, two tuned circuits are employed, with top-capacity coupling. This avoids the flat tuning which can be so troublesome with simple "straight" receivers.

Such a circuit provides good volume and range, but selectivity and sensitivity equal to that obtained with a larger receiver using more valves must not, of course, be expected. Nevertheless, very powerful reception of local stations is possible, and quite a number of more distant transmitters can be picked up at good volume. Accordingly, the receiver should prove of real utility, and quality of reproduction is fully up to the general standard of ordinary receivers.

A fairly large chassis is used so that wiring and components are not unduly cramped, and this allows space for either a 6in. or 8in. speaker to be mounted

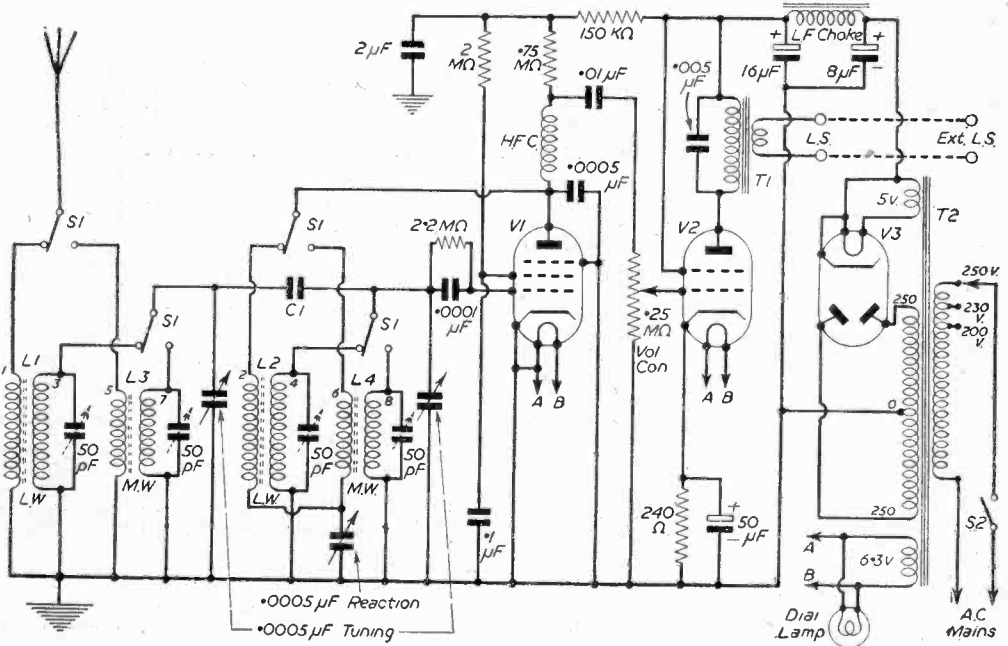

Fig. 1.—Theoretical circuit of the A.C. Band-Pass 3.

opposite to the tuning dial. The size of speaker fitted can depend upon personal preference. The larger type of speaker does give slightly improved reproduction, especially at the lower frequencies, but the improvement is not very significant. With the smaller speaker, the overall size of the receiver is reduced.

**Tuning System**

Four separate dust-cored coils are used, two for medium waves and two for long waves. The pairs of coils are quite separate, and are selected by a 2-way 4-pole rotary switch. The primary windings of the aerial coils are used for aerial coupling, to avoid excessive damping which would otherwise be imposed by the aerial. Coupling between the two circuits is provided by C1, and this condenser can be adjusted between quite wide limits. When the capacity is very small, selectivity (sharpness of tuning) will be high, but volume will be reduced. As the capacity is increased volume increases but selectivity is to some extent reduced. Because of this, it is best to adjust the capacity of C1 by trial, initially, as will be explained.

In addition to the adjustable cores of the coils, a small pre-set condenser is wired in parallel with each tuned winding. These enable correct alignment to be obtained, and the initial adjustment of them is very simple.

An illuminated tuning dial with stations and wavelengths indicated is specified, the gang condenser being driven by a cord reduction arrangement from the outer, right-hand control knob. The adjacent knob is for wave-changing, and the next for reaction. The left-hand knob provides on/off switching and volume control.

**Practical Construction Details**

The positions of all the components will be seen from the diagrams. The valveholders may be secured

either above or below the chassis, the key-ways being positioned as illustrated. It is most convenient to leave the speaker and tuning dial to be fitted later, otherwise it will be difficult to work with the chassis in an inverted position.

The heaters may be wired first with advantage, using twin flex. One length of flex is taken from the 6.3 v. secondary of the mains transformer to tags 2 and 7 on the 6V6 holder. A further length goes to tags 2 and 7 on the 6J7 holder, from which additional

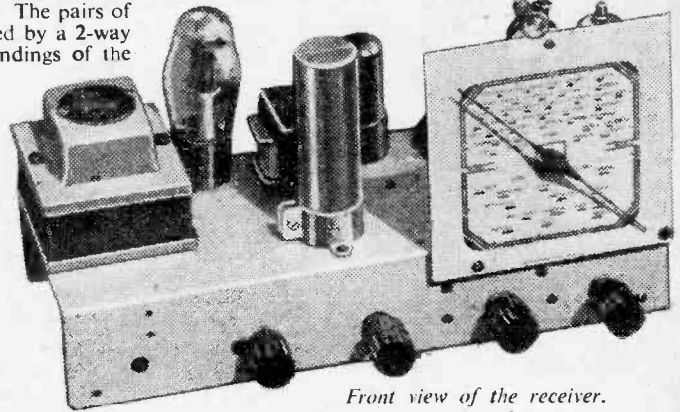

leads pass up to the dial lamp-holder. The 5 v. secondary feeds the rectifier heater, the heater tag 8 is also the cathode, and goes to the 8μF section of the smoothing condenser, and smoothing choke.

The smoothing condenser consists of 8μF and 16μF values in a common tubular can, the negative connection being obtained by bolting the retaining clip to the chassis. In the

- LIST OF COMPONENTS**
- 2-gang .0005 μF condenser dial. (Osmor.)
  - H.F. choke, Type QCT
  - 4-pole 2-way rotary switch
  - "K" type coils No. (T. G. Howell.)
  - Four .00005 μF pre-Electronics.)
  - 20 henry, 250 ohm, (Osmor.)
  - 8 plus 16 μF smoothing (Osmor.)
  - .0005 μF reaction condenser
  - 25 megohm volume control
  - Radio.)
  - 250-0-250, 5 v., 6.3 v. former. (Osmor.)
  - Four 1 1/4 in. dia. control knobs etc.)
  - 13 in. by 5 1/2 in. by 2 1/2 in. (Osmor.)
  - Three McMurdo octal
  - 2.2 MΩ 1/2 watt resistor
  - 2 MΩ ditto.
  - .75 MΩ ditto.
  - 150,000 MΩ ditto.
  - 240 MΩ 1 watt resistor
  - .0001 μF fixed condenser
  - .1 μF ditto.
  - .0005 μF ditto.
  - 2 μF ditto.
  - .01 μF ditto (mica).
  - .005 μF ditto.
  - 50 μF bias condenser
  - 6J7, 6V6 and 5Z4 valve
  - 6.3 v. .3 a. dial light
  - 6 in. to 8 in. P.M. speaker
  - 6 B.A. nuts, bolts, con

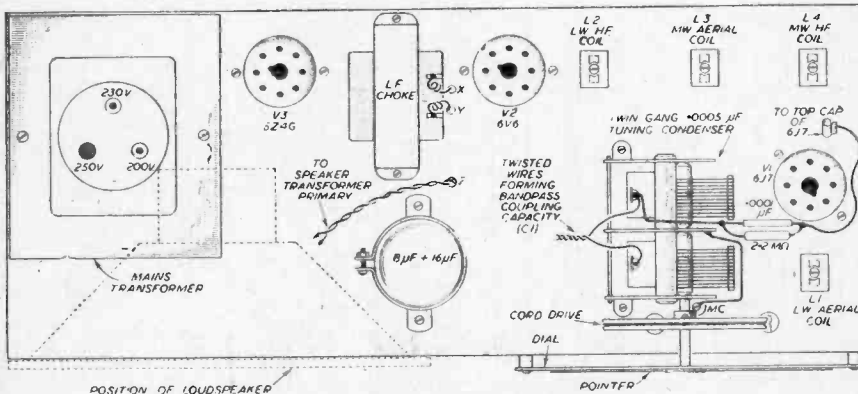
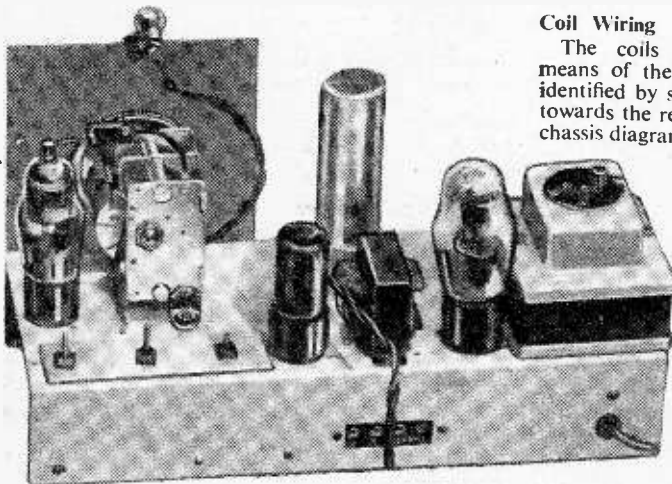

Fig. 2.—Above chassis view showing wiring.

specified type the 8 $\mu$ F tag is marked red. The mains input leads pass through a rubber grommet in the back runner of the chassis, and are soldered to a small 2-way tag board. If this is not done these leads should be otherwise made secure to

sequently connected to the primary of the speaker transformer. The second pair of sockets at the rear of the chassis provide extension speaker connections. Two leads from these are taken to the secondary of the speaker transformer.



Rear view of the receiver.

**Coil Wiring**

The coils are secured in  $\frac{1}{2}$  in. dia. holes by means of the spring clips provided. The tags are identified by small notches, and these are positioned towards the rear of the chassis, as shown in the sub-chassis diagram. Both primary and secondary of both aerial coils are connected to the chassis; so are the secondaries of the two H.F. type coils. The two reaction windings are returned to the reaction condenser. This leaves eight tags to be connected, and these are numbered to show how the wave change switch is wired to them. When the switch is in one position, both medium-wave coils are connected. In the second position, both long-wave coils are switched in. The receiver will operate correctly on one waveband before the coils for the other band are added, and this should be remembered if any confusion in the coil wiring arises.

The four pre-sets are bolted directly to the chassis. In each case the tag bolted to the chassis should be that adjacent to the head of the adjusting screw. It should be noted that the 50 $\mu$ F condenser must be connected in the correct polarity as shown.

**Drive and Dial**

The large drum is placed on the condenser spindle and the cord passed through the small slot on its rim, and hooked by the spring which maintains tension. The cord is then taken down through one hole in the chassis, round the tuning knob drive, up through the second hole, and given a complete turn round the drum. Both ends are then tied

withstand any pulling which may arise.

All leads should be reasonably short and direct, and kept clear of each other. A number of points are marked "M.C." and these are wired to the chassis. A lead from the moving plates tag of the tuning condenser to chassis is necessary, as the condenser specified has rubber-bushed feet. Two flexible leads pass up through the chassis from tags 3 and 4 of the output valve; these are sub-

- COMPONENTS
- with drive and metal
- (Osmor.)
- (Coventry Radio.)
- 1, 151, 122 and 152.
- condensers. (Sussex
- mA smoothing choke.
- condenser with clip.
- 50 $\mu$ F. (Coventry Radio.)
- 1 with switch. (Alpha
- through mains trans-
- s. (Sussex Electronics,
- chassis, with socket strip.
- holders. (Osmor, etc.)
- Dubilier
- T.C.C., etc.
- 10 v.)
- Or G/GT types.)
- holder.
- with 6V6 transformer.
- ing wire, etc.

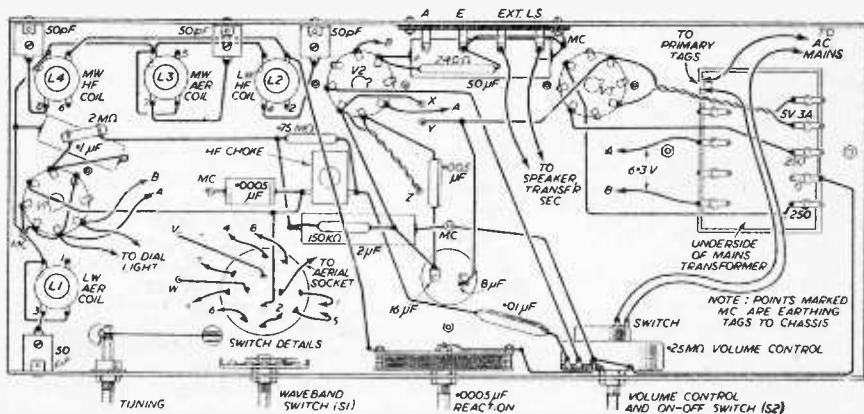

Fig. 3.—Under chassis view and wiring.

together, the cord being pulled tight to stretch the spring. The dial is bolted to the front runner of the chassis, the condenser vanes are closed, and the pointer set at a horizontal position. The dial may be spaced out slightly from the chassis to bring it near to the pointer.

The lamp-holder is bolted to the top of the dial, and fitted with a 6.3 v. .3 A. bulb. If the holder is of the type with one tag common to the fixing bracket then a single lead from tag 7 of the 6J7 holder is all that will be required.

#### Circuit Adjustments

The mains transformer is equipped with a screw which may be inserted in one of three holes, for 200, 230 and 250 v. mains. Where the actual voltage is not of these figures, it should be inserted into the next highest hole, and tightened down.

Only a very small capacity is required for C1, and this is provided by twisting together two *insulated* wires which have been soldered to the top tags of the condenser, as illustrated. The capacity will depend upon the thickness of the insulation and the length twisted together, in addition to the gauge of wire. Connecting wire with very thick insulation is unsuitable. In cases of doubt, a .00005 $\mu$ F pre-set can be used. However, the capacitance of the twisted wires can be adjusted in a few moments by actual trial.

The four pre-sets below the chassis are set approximately half open, and the coil core-screws turned until about 10 or 12 threads project above the chassis. A station of high wavelength in the medium-wave band should then be tuned in, and the BBC Third Programme transmitter on 464 metres will probably be most convenient. The cores of the medium-wave coils are then adjusted for maximum volume, and also to obtain a correct pointer indication of the station. As the cores are unscrewed it will be necessary to close the tuning condenser slightly, to keep the station in tune, and vice versa. In this way the inductance

of the coils can be adjusted to the correct value. A station of low wavelength is then tuned in, and the medium-wave trimmers are adjusted. A little further adjustment of the cores may then be required. Adjustment to the trimmers should be made at the low-wavelength end of the scale; the cores should be adjusted only when a high-wavelength station is being tuned in.

Actually, the procedure is very straightforward, but maximum volume will only be obtained when both circuits tune accurately together. The long-wave band is then similarly treated.

Low volume and very sharp tuning will indicate that C1 is of too small a capacity. This can then be increased as explained.

#### Aerial, Earth and Speaker

Best range and volume will naturally be obtained with a good outdoor aerial and a sound earth. However, satisfactory results are obtainable with an indoor aerial, though range is reduced, due to the lower signal pick-up of such aerials. In the event of an *extremely* short indoor aerial being used, this may be taken directly to the fixed plates tag of the rear section of the gang condenser, if desired.

For proper reproduction the loudspeaker must be enclosed in a cabinet or secured to a baffle board. If the receiver is to be inserted into a suitable cabinet from behind, the speaker may be secured to the chassis by means of a stout bracket. When required, a 2-3  $\Omega$  extension speaker may be plugged into the extension sockets at the rear of the chassis. The receiver should not be switched on without the usual output transformer being connected to provide an anode load for the 6V6.

The Marconi/Osram U50 and Mullard GZ30 are equivalents of the 5Z4G. The Z63 and KTZ63 may be used instead of the 6J7; a 6K7 or equivalent type will also give quite good results here. The 6V6 will handle a little over 4 watts, with average screen grid and anode voltages of 250.

## British Sound Recording Association

LECTURE details for London for the first half of the 1952/53 season, to be held at the Royal Society of Arts, John Adam Street, W.C.2, at 7 p.m.

*November 21st.*—"Problems of Sound Recording and Reproduction." A discussion, to be opened by a prominent engineer who will be joined by others in the "Brains Trust" which will follow the main discussion. It is hoped that members will take an active part in the "open" discussion following the opening remarks. The Brains Trust will afford an opportunity for members to submit questions on any recording or reproducing problem which they have.

*December 19th.*—"Equalisers, filters and tone control systems," N. H. Crowhurst, A.M.I.E.E. The lecturer will discuss the design of equaliser circuits to be used with high quality amplifiers; between stages at high impedance; at line impedance; the question of termination; the significance of constant resistance types; various configurations and equivalents; methods of achieving desired response shaping; factors influencing design—response, distortion, possibilities, etc.

## Political Education in Malaya

PRIVATE enterprise has played a large part in assisting the Malayan Government to bring the Community Broadcasting Service within reach of the indigenous population in the remoter parts of the country.

This programme which enables them to keep abreast of Malayan news and views was planned to meet a situation in which individually owned radio receivers were a rarity. Village communities gather at stated times to hear the programmes from Singapore and Kuala Lumpur—at no cost to themselves.

The General Electric Company has been given a 10-year contract to provide, install and maintain all the battery operated receivers. Since the G.E.C. started installing receivers in Malaya some 720 equipments have been put into operation, the last State to be served being Perak, which has 140, the largest number in any State.

Each radio equipment can and usually does serve a village group of from 100 to 250 people. Special listening hours have been arranged for Community Broadcasts whose programmes are put out in three languages: Chinese, Malay and Tamil. Three dialects of Chinese are used in the Chinese programmes.

**DESIGNS FOR THE HOME CONSTRUCTOR**



**THE "MINI FOUR".**—A 4-valve Battery Superhet Receiver, designed by "Practical Wireless" to receive 4 Pre-Set Stations, no tuning being necessary. The complete Receiver can be built for £9/10/0 (plus case, 15/6). Send 1/6 for Assembly Instructions, Layouts and Component Price List.

**THE "MINI TWO-THREE."**—Complete diagrams and layouts from which either a T.R.F. 3-valve set or a 2-valve set (afterwards easily converted to the 3-valve) can be made for £5/3/0 or £4/3/6 respectively (plus case, 15/6). Full instructions, layouts and Component Price List, 2/-.

**THE "MINI TWIN."**—The ideal set for the beginner! A simple 1-valve 2-stage Battery Set covering Long and Medium Wavebands. Can be built for 37/6, plus 9/6 for attractive Plastic Case and 14/9 for suitable headphones. Complete instructions, layouts and price list 1/3.

Complete instructions, layouts and price list 1/3.

**A QUALITY "PUSH-PULL" AMPLIFIER KIT**

A Kit of Parts to build a 6-8 watt Push-Pull Amplifier for operation on A.C. mains 200-250 volts.

Incorporates a simple arrangement to enable either a magnetic crystal, or lightweight pick-up to be used.

A 10-watt Output Transformer is designed to match from 2 to 15 ohm speakers. Tone control is incorporated. The overall size of the assembled chassis is 10in. x 8in. x 7 1/2in. high. Price of kit complete in every detail, including drilled chassis and valves, £6/12/6. Component list is supplied.

Price of assembled chassis, supplied ready for use, £8/2/6. Instructions, layouts and price list 1/-.

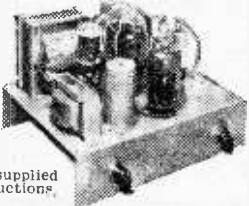

**THE "WIRELESS WORLD" 3-VALVE SET**

A Midget 3-valve T.R.F. Receiver for operation on A.C. mains, covering long and medium wavebands.

We are able to supply all of the components to build this set, as designed, and specified in the Feb. 1950 issue, including the drilled chassis, valves and moving coil speaker, etc., at the following prices—

To construct complete chassis, less dial and drive assembly, £5/5/0. Ditto, including dial and drive assembly, 2/6.

To construct the complete Set, including dial and drive assembly and cabinet, £7/3/6.

Overall size of cabinet is 7 1/2in. x 5 1/2in. x 1 1/2in.

A reprint of the designer's article, giving Circuit and Assembly Instructions (this is available separately for 9d.), together with a Practical Component Layout is included with each of above assemblies.



**"PERSONAL SET" BATTERY ELIMINATOR**

A complete kit of parts to build a Midget "All-dry" Battery Eliminator, giving approx. 69 volts and 1.4 volts.

This Eliminator is for use on A.C. mains and is suitable for any 4-valve Superhet Receiver requiring H.T. and L.T. voltage as above, approx. to 69 volts.

The kit is quite easily and quickly assembled and is housed in a light aluminium case, size 4 1/2in. x 1 1/2in. x 3 1/2in. Price of complete kit, with easy to follow assembly instructions, 42/6.

In addition we can offer a similar COMPLETE KIT to provide approx. 90 volts and 1.4 volts. Size of assembled Unit 7in. x 2 1/2in. x 1 1/2in. Price 47/6.



\* Send 9d. P.O. for our STOCK LIST, showing many KITS OF PARTS for Sets and Battery Chargers and "hundreds" of Wireless Components. When ordering please include 1/6 to cover cost of postage and packing.

**STERN RADIO LTD., 109 & 115, FLEET STREET, E.C.4.**

Telephone: CENTRAL 5814 & 2280

**ARMY CARBON MICROPHONES** complete with switch, 5/9. Matched transformer, 4/6.

**NEW UNSPILLABLE EXIDE PO-2 accumulators**, 11 A. H. 4 1/2 x 3 1/2 x 2 1/2in., 18/6.

**TRI96 CIRCUIT AND CONVERSION DATA**, 1/3. 1147A or B, 1/6. Any CRT Unit to Oscilloscope, 2/9.

**GERMANIUM DIODES**, 3/9.

**P.M. SPEAKERS**, 8in., 20/-; 10in. Goodman, 32/6. 5in. Goodman, 14/6. 6in., 16/6. 10in. Plessey, 29/6.

**SELENIUM RECTIFIERS**. F.W. 6 or 12v. 4 A., 26/-; 24v. 2 A., 30/-; 3 A., 14/6; 1/2 A., 5/6; 250v. 120 mA. H.W., 9/-.

**TRANSFORMERS**, 200-240 volts, tapped 3.4-5.6-8.9-10-12-15-18-20-24 and 30 volts at 2 A., 21/6. One year guarantee.

**TYPE 18 TRANS. CHASSIS**, clean condition, partly stripped, 8/6 to clear.

**10H./120 mA. BRASS SHROUDED CHOKES**, 7/6.

**T.C.C. TYPE CP58QO**, .1 mfd. 7 kv. Condensers, 10/6. 2.5 kv., 5/6.

**M/C MICROPHONES**, 7/6. Trans. to match, 5/-.

**PRACTICE MORSE KEY AND BUZZER SETS**, 7/6.

**VCR97 C.R. TUBES**, picture tested, new and crated. 45/-; base, 3/6.

**PHONES**, High Resistance, 12/6; Low, 8/6.

**TYPE IN34 GERMANIUM CRYSTAL DIODES**, 5/6.

**STILL AVAILABLE.—MULTIMETER KITS**, 24/6.

**MINIATURE VALVES**. New. CK512AX, 9/-; 9001, 9002, 9003, 7/6; 6AG5, 10/6.

**NEW VALVES**. 35Z4, 35L6, 25Z4, 25L6, U281, VP4B, U50, 5Y3GT, 6K7GT, 11/-.

**NEW 2 VOLT II A.H. EXIDE ACCUMULATORS**, 7/-  
2-volt Battery Operated 3-valve Mine Detector Amplifiers. Complete with Headphones and Magnetic Crystal Microphone, 30/-.

ALL POST PAID.

**THE RADIO & ELECTRICAL MART**

253b, Portobello Road, London, W.11

Phone: Park 6026

**ANNOUNCING THE NEW BURGEOYNE MKIII TAPE TABLE**

Following our policy of constant improvement in design and performance we are now distributing the NEW BURGEOYNE MK. III TAPE TABLE.

This unit incorporates a brand new feature which will make an immediate appeal to all tape recording enthusiasts . . .

**INSTANTANEOUS BRAKING**

Hitherto a feature found only on the most costly Tape Tables, the new Burgoyne Mk. III Tape Table incorporates a positive and instantaneous brake mechanism which operates under all conditions. With the tape running at maximum speed forward or back, application of the brakes brings it to an immediate standstill, giving instant location of any section of tape, with no slack and no possibility of breakage. Another invaluable aspect is the fact that the Tape reels are held rigid when loading and unloading.

This new feature is the greatest single advance in the famous range of Burgoyne Tape Tables!—and represents a MUST for all serious recordists. The new Table employs three motors, thus avoiding the transmission weakness invariably associated with single motor units.

- \*Fast forward and rewind.
- \*Two High Impedance Heads.
- \*Tape speed 7 1/2 in. per sec.
- \*Spare Tape Reel.
- \*Heavy Balanced flywheel.

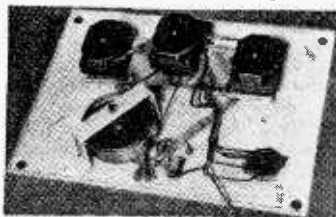

(Underside View of Burgoyne Tape Table)

**£16.10.0 CASH** (7/6 carr. and pkg.)  
OR H.P. terms: £6.10.0 deposit and 12 monthly payments of £1.

Come to the Radio Centre for a demonstration of the New Burgoyne Recorder incorporating the above tape table.

**E & G MAIL ORDER SUPPLY CO.**

The Radio Centre  
33, Tottenham Court Road,  
London, W.1



# CLYDESDALE

Bargains in Ex-Service Radio and Electronic Equipment

### SPEECH MODULATOR BC 456



Employing screen modulation complete with valves 1B25, 12J5 and stabiliser VR. 159/30. modulation transformer, R.F. choke, mic. transformer, three relays, plus various condensers and resistors, etc. In metal case, 10 1/2 x 7 1/2 x 4 1/2 in., chassis depth 2 1/2 in. (Less Dynamotor)

ASK FOR **37/6** each CARRIAGE PAID  
NO. P/E42  
Circuits available at 1/3.

### METAL (MINE) DETECTOR NO. 4 Ref. ZA24238

Of Cdn. design and construction, using 1T4 pentodes. Comprising TC. Amplifier, Search Coil, Sweep Pole, Control Box, Headphones, Test Unit and Rucksack. Complete less batteries in fitted transit case.

ASK FOR **£6.19.6** CARRIAGE PAID  
NO. P/H179

### DUMMY AERIAL ZA10798/1 For Wireless Senders S.3.3

Comprises : 2 Morganite type 7101 Carbon Resistors, 800 ohms, 6 volts, 10 in. long by 1 in. dia., connected in parallel by heavy brass clamps with connecting Lugs. Overall dimensions 10 1/2 x 3 in.

ASK FOR **5/-** each POST 1/-  
NO. P/H971

**MONITOR CRYSTAL TYPE 2 10T/11390**  
As used with R1116 and R1082. Less valves and crystals. Unit has controls, input and output points, etc., on front panel, shock-mtd. sub-chassis. Housed in Plastic case 7 1/2 x 5 1/2 x 3 1/2 in.

ASK FOR **10/-** each POST PAID  
NO. P/H972 In Transit Case.

### 192 PAGE CATALOGUE. NEW LIST No. 80

Giving details and illustrations of ex-Service items and cancelling all previous lists and supplements. Now Ready—Price 1/6. Price credited on first purchase of 10/- or over.

### FOR INEXPENSIVE TELEVISION

**I.F./A.F. AMPLIFIER UNIT R.1355**  
The popular T.V. Sound and/or Vision Unit 5 I.F. stages, 10 valves : 3 VR85 (SP61), 5U4G, VU120A, etc., etc. In metal case 18 in. x 8 1/2 x 7 1/2 in. Used, good condition.

ASK FOR **67/6** CARRIAGE PAID  
NO. P/E770  
2nd Grade in Transit Case. 59/6 Carr. Paid. 3rd Grade, loose stored. 42/6 Carr. Paid. Circuit of R.1355 available at 1/3.

Transformers for T.V. E.H.T. 55/-, 57/6, 59/6 or 65/- each. Mains (Morley), 55/-, 60/- (Argus), 69/6 each.

Order direct from :

## CLYDESDALE SUPPLY CO., LTD.

2 Bridge Street, Glasgow, C.5. Phone : SOUTH 2706/9  
Visit our Branches in Scotland, England and N. Ireland

### FOR INEXPENSIVE TELEVISION INDICATOR UNIT TYPE 62A

Containing VCR97 CRT with mu-metal screen. 12 VR91's (EF50), 4 VR85's (CV118-SP61), 3 VR92's (EA50), 2 VR54's (EB34). Plus Pots., Switches, H.V. Cond., Resistors, etc., etc. Built on metal chassis to fit box size 18 x 8 1/2 x 1 1/2 in. All controls brought to front panel beside viewing screen.

Used Good Condition.  
ASK FOR **£7.19.6** CARRIAGE PAID  
NO. P/H868

### INDICATOR UNIT TYPE 62

(in maker's original case)  
Containing VCR97 C.R.T. with mu-metal screen. 100 Kc Crystal unit 10XC/2, 16 VR65's, CV118 (SP61), 2 VR54's (EB34), 2 VR92's (EA50) plus pots., switches, H.V. conds., resistors, etc. Built on metal chassis to fit box 18 x 8 1/2 x 1 1/2 in. All controls brought to front panel beside viewing screen.

ASK FOR **£5.9.6** CARRIAGE PAID  
NO. P/H526

### INDICATOR UNIT TYPE 61H

(in maker's original case)  
Containing a VCR97 Cathode Ray Tube, with mu-metal screen. 4 VR91's (EF50), 3 VR54's (EB34), various w.w. pots, switches, H.V. cond., resistors, etc., built in metal chassis to fit into metal box 18 in. x 8 1/2 in. x 7 1/2 in. All controls are brought to front panel beside viewing screen.

ASK FOR **89/6** CARRIAGE PAID  
NO. P/E777

# HENRY'S

**INDICATOR UNIT TYPE 182A.** This unit contains VCR517 Cathode Ray 6in. Tube, complete with Mu-metal screen, 3 EF50, 4 SP61 and 1 5U4G valves, 9 wire-wound volume controls and quantity of Resistors and Condensers. Suitable either for basis of Television (full picture guaranteed) or Oscilloscope. Offered BRAND NEW (less relay) in original packing case at 79/6d. Plus 7/6 carr. "W.W." Circuit supplied Free.

**PYE 45 Mc STRIP.** Size 15in. x 8 in. x 2in. Complete with 45 mc's Pye Strip, 13 valves, 10 EF50, EB34 and EA50. Volume controls and hosts of Resistors and Condensers. Sound and vision can be incorporated on this chassis with minimum space. New condition. Modification data supplied. Price 25. carriage paid.

### ★ A COMBINED SIGNAL TRACER AND AUDIO OSCILLATOR ★

An easy-to-build unit that can be used for I.F. and Audio signal tracing, without any switching or tuning, including variable output oscillator, for amplifier checking. Highly sensitive, responds to signals picked up from an ordinary receiving aerial. The circuit is that of a high-gain 2-stage, resistance-coupled audio frequency amplifier, employing 3 miniature 1.4 valves, with a 3in. speaker in the output of the Power Amplifier Stage. An added advantage being that as this Unit is "All-Dry" it can be used with safety on A.C. or A.C. D.C. mains and Battery sets. The complete Kit with portable cabinet (size 6in. x 7in. x 6in.) and battery weighs only 4 lbs. We shall be pleased to supply a complete Kit for the construction of the above, right down to the last nut and bolt, including 2-1T4 and 1-1S4 Valves, 3in. Speaker and instructions only can be supplied for 1/6. If required this Unit will be assembled and tested for an extra charge of 15/-. This is a highly efficient instrument, and a MUST for every radio man.

**WALKIE-TALKIE TYPE "46"** (case removed) complete with 6 valves, 2VP23, HL23, DD, QP25, TP25 and ATP4, aerial rods, I.F. trans., 1.8 mc/s. mtk trans. in new condition, but less transmitting components and coils removed by M.O.S., 35/- carr. paid. (Less Valves, 12/6.)

**RECEIVER UNIT TYPE 159.** Size 8in. x 6 1/2 in. x 4 1/2 in., containing VR91, VR92, CV66, VR65 and 24 v. selector switch. New condition, 15/-.

### TAPEMASTER

All the components, motors and Microphones suitable for the above NOW IN STOCK.

### EXCEPTIONAL VALUE OFFER

Ten EF50 Brand New (Ex-Units) ... ..	55/- Set.
6K9C, 6K7G, 6Q7G, 5Z4G, 6V6G (or KT61) ... ..	42/6 "
1R5, 1S5, 1T4 or (3S4 or 3V4) ... ..	32/6 "
TP25, HL23/DD, VP23, PEN25 (or QP25) ... ..	27/6 "

**STROBE UNITS.** Brand New, in sealed cartons, these contain SIX EF50s, five EA50s, one SP61, a host of condensers, resistors, transformers, chokes, relays, switches, seven pots and five smoothing condensers. Size 18in. x 8 1/2 in. x 7 1/2 in. Only 67/6, plus 5/- carriage.

### VIEWMASTER AND TELE-KING

Full comprehensive stocks of the above now available, manufactured by reputable manufacturers. Viewmaster booklet, 7/6. Tele-King booklet, 6/- post free.

**CATHODE RAY TUBES :**  
VCR97. Guaranteed full picture. 40/-, carr. 5/-.  
VCR517. Guaranteed full picture. 40/-, carr. 5/-.  
3BP1. Suitable for scopes. 25/-, carr. 3/-.

9in. ESCUTCHEON. Brown bakelite. Suitable plate glass and mask for 9in. tube. Price 7/6 each.

SEND POSTAGE FOR NEW 1953 COMPREHENSIVE 28 PAGE CATALOGUE.

5 HARROW ROAD, PADDINGTON, LONDON, W.2. TEL : PADDINGTON 1008/9, 0401.

# TRANSMITTING TOPICS

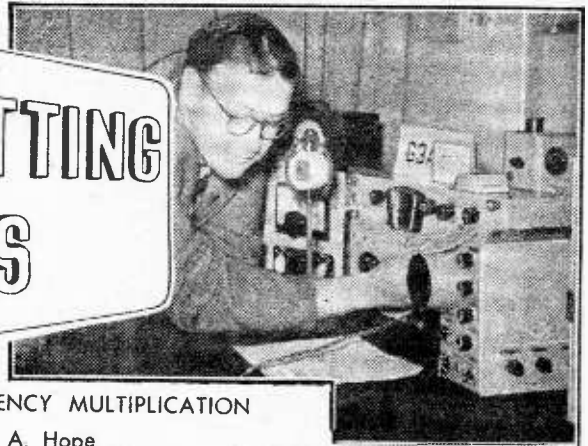

## PRINCIPLES OF FREQUENCY MULTIPLICATION

By Wm. A. Hope

**T**HERE appears to be a widespread belief that the multiple of any given frequency is obtained by the "selection" of the required "harmonic," using a rejector circuit in the anode circuitry of the multiplier valve. It all depends what one means by the word "selection."

This article was written to clear up any wrong ideas on this subject, and to give, briefly, the basic principles of the frequency multiplier.

### Pendulum Analogy

This analogy makes use of the well-known pendulum/escapement system, where the escapement represents the anode current variation of the multiplier valve; whilst the pendulum represents the anode tuned circuit. Let us suppose that the escapement actuates the pendulum once in every four cycles; therefore, we can say that the frequency of oscillation of the pendulum is four times that of the escapement. If the escapement frequency is considered as the "fundamental," the frequency of oscillation of the pendulum represents the fourth "harmonic" of the "fundamental" frequency.

The normal frequency multiplier operates in roughly the same manner as the P.A. stage of a transmitter, except that the control grid is biased further beyond the valve "cut-off" point and the R.F. input to the multiplier is considerably increased. This results in increased intensity of the  $I_a$  pulses, which last for a much shorter period of time.

These short  $I_a$  pulses cause the tuned circuit (which is tuned to a multiple of the fundamental frequency) in the anode circuit of the multiplier to be driven into oscillation at its predetermined frequency. As the fundamental frequency is multiplied, the efficiency of the stage is reduced; i.e., the

power output from the multiplier stage is reduced. Fig. 1 shows graphically how the  $I_a$  pulse is produced using the normal  $I_a/V_g$  characteristic of the valve in question. As will be seen, the widths of the grid swing curve (marked "A" in Fig. 1) and the  $I_a$  pulse are the same, but there are two cycles of oscillation in the anode circuit for each cycle of R.F. input to the multiplier control grid. This is shown in Fig. 2, where  $F_1$  is the fundamental frequency and  $F_2$  represents one cycle of the R.F. output. In this case we have

$$F_1 = F_2 + F_2 = 2 \times F_2$$

$\therefore F_1 = n \times F_2$ , where  $n$  is the multiplying factor.

In this case,  $n$  is equal to 2, thus satisfying the conditions for frequency doubling. Lastly, a word on suitable valves. Beam power tetrodes and pentodes, of the 6V6 and the EF50 class respectively,

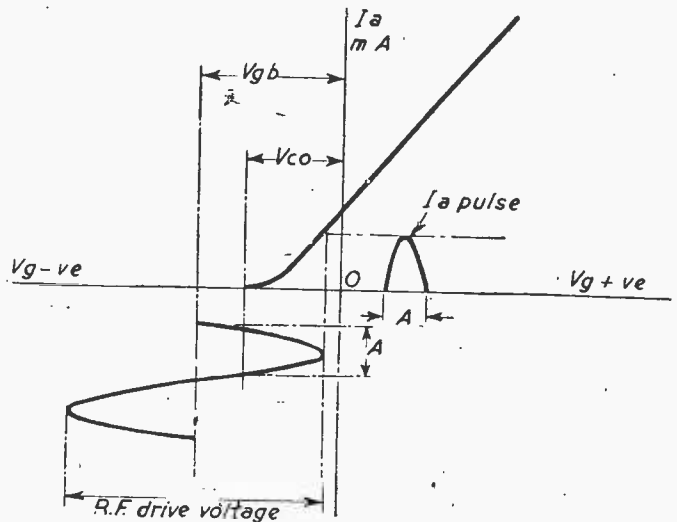

Fig. 1.—Relation between  $I_a$  pulse and drive input.



are very suitable for frequency multipliers since they have a high grid/plate amplification and provide ample R.F. output. As stated previously, however, a further stage of amplification may be necessary, bearing in mind that the higher the multiplied frequency, the lower the stage efficiency.

**WIRELESS TRANSMISSION**

By F. J. CANN

A comprehensive work on all aspects of the subject.

Price 6/-

**GEORGE NEWNES, LTD.,**  
Tower House, Southampton St.,  
Strand, W.C.2.

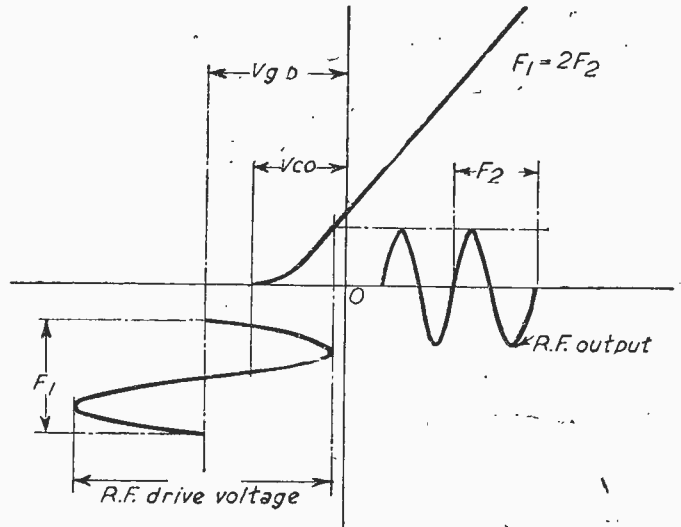

Fig. 2.—Frequency doubler operation.

# Converting D.C. Sets for A.C. Mains

By H. S. Thorpe

THE Mullard PZ30, having an output of 400 mA. as a half-wave rectifier, lends itself as an ideal method of running D.C. sets from A.C. mains, especially when the speaker field is in the heater chain, or the series current of the valve heaters is such that a rectifier could not be run in series with them.

The circuit used is as shown in Fig. 1.

V is a Mullard PZ30.

The two anodes are strapped, as shown, as well as the two cathodes, for operation as a half-wave rectifier. The dropper is a normal .3 amp. type in series with the PZ30 heater and the 230v. mains, dropping the surplus voltage, in this case 178 volts, at .3 amp. The condenser is a good reliable type with a high ripple rating, such as Hunt's J42 (max. ripple, 225 mA).

The valve, dropper and condenser can be mounted

on the radio chassis, taking care to isolate all components from direct contact with chassis, or they could be mounted on a small sub-chassis screwed to the side of the cabinet above the set. The condenser should be mounted away from the dropper or any source of direct heat.

The normal on-off switch in the set must be disconnected and the leads joined together and taped. The switch is then connected to the live lead going to pin 7 on the valve.

If the set fails to operate on switching on, reverse the polarity of the leads marked Set + and Set -.

The set must be treated as a universal set, as if the A.C. supply is reversed the chassis could be alive to E.

A practical layout is shown in Fig. 2.

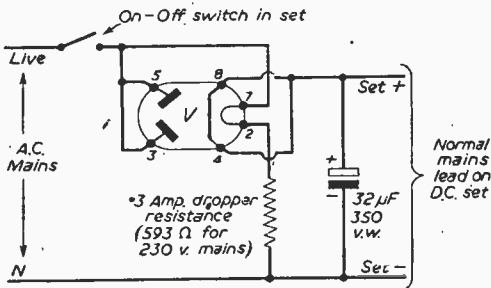
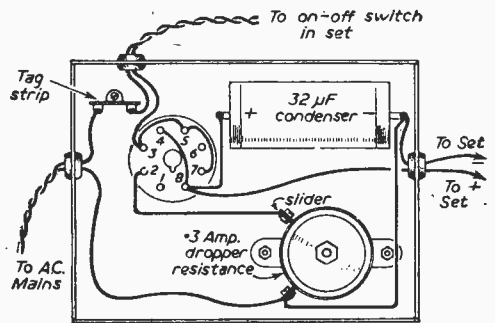

Fig. 1.—Theoretical circuit which is recommended by the author. A 30Ω 5w. resistor should be included in each anode lead.



View underneath chassis

Fig. 2.—Underside view of chassis, which may be of steel or aluminium.

**INTRODUCING the £25 RADIOGRAM**



Console Type Cabinet. With full grained walnut finish, will take standard type auto change gram unit. Price £11.10.0. H.P. Terms, £3.17.0 deposit and 12 monthly payments of 15/-, plus 15/- carriage. Radio Chassis to Suit, £8.19.6. H.P. Terms, £3.0.0 deposit and 12 monthly payments of 11/6, carriage and insurance 7/6. Collaro Gram Unit. For standard 10in. to 12in. records with hi-fi pick-up. £4.19.6, carriage and insurance 3/6. Special Offer. Cabinet, Radio Chassis and Collaro Unit, £25 or £8.7.0 deposit and 12 monthly payments of £1.12.6. Non-callers add £1 carriage and insurance. Data-photographs-wiring diagrams, etc., 2/6, refunded if returned.

**THE P.T. "ARGUS" TELEVISION RECEIVER**

Although this television costs only about £20, it does not involve the conversion of ex-Government units, and had been designed for construction by the novice. The circuits have been kept straightforward and devoid of "frills" though nothing has been sacrificed which would assist in its efficient and stable operation.

We can supply the 21 valves, C.R. Tube and all the parts for £20 10. 0. H.P. terms are available, deposit being £6.17.0, balance 12 monthly payments of £1.6.6 each. Carriage and packing 10/- extra.

A reprint of the data, by permission of the Editor of "Practical Television," together with some additional diagrams and notes produced by our Television engineers are available as a constructor's envelope. Price 5/-, post free.



**BUILD THIS FINE INSTRUMENT FOR 29/6**

**T.V. SIGNAL AND PATTERN GENERATOR**

This generator has been carefully designed and although it can be built and used by any beginner it is at the same time a most useful instrument for the more advanced worker.

It can be tuned to the Vision channel and will produce a pattern on the face of the C.R. tube. Alternatively, if tuned to the sound channel it will produce an audible signal in the loudspeaker.

Thus its owner will become independent of B.B.C. transmissions and can fault find or test at any time. It operates entirely from A.C. mains and is quite suitable for use with superhet or straight receivers.

A complete kit of parts (in fact everything except the cabinet), with full constructional and operational data will be supplied for 29/6, plus 2/6 post and insurance; alternatively data is available separately, price 2/6 (credited if you buy the kit later). NOTE.—Cabinets as per the illustrated prototype will be available shortly.

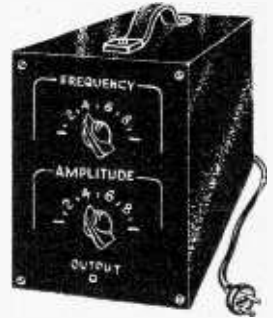

**THIS MONTH'S SNIP**

15in. Magnetic Television Tube' by very famous maker, as used in many Popular Television Receivers (list on request). New, with written guarantee; offered at approximately half price: £12-10 each, plus 10/- carriage and insurance. Limited quantity so order immediately.

(SMALL DEPOSIT SECURES.)

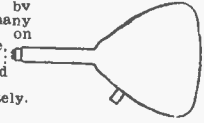

**ELECTRONIC PRECISION EQUIPMENT DEPT. 7**  
42-46 WINDMILL HILL RUISLIP MIDDLESEX 152-3 FLEET ST. LONDON E.C.4.

**RADIO SUPPLY CO. 15, WELLINGTON ST., LEEDS, 1.**

Post Terms C.W.O. or C.O.D. No C.O.D under £1. Postage 1/- charged on orders up to £1; from £1 to £3 add 1/6; over £3 post free. Open to callers 9 a.m. to 5.30 p.m. Sats. until 1 p.m. S.A.E. with enquiries, please. Full list 5d. Trade list 5d.

**R.S.C. MAINS TRANSFORMERS (FULLY GUARANTEED)**  
Interleaved and Impregnated. Primaried 200-230-250v. 50c/s Screened.

<b>TOP SHROUDED DROP THROUGH</b>	220 ma 3 h 50 ohms	8/9
260-0-260 v 70 ma. 6.3 v 2 a. 5 v 2 a	250 ma 5 h 50 ohms Potted	10/9
260-0-260 v 80 ma. 6.3 v 2 a. 5 v 2 a	100 ma 10 h 200 ohms	7/6
350-0-350 v 80 ma. 6.3 v 2 a. 5 v 2 a	90 ma 10 h 100 ohms	5/9
250-0-250 v 100 ma. 6.3 v 4 a. 5 v 3 a	80 ma 10 h 350 ohms	5/9
350-0-350 v 100 ma. 6.3 v 4 a. 5 v 3 a	60 ma 10 h 400 ohms	4/9
0-4.5 v 3 a	40 ma 5 h 150 ohms	3/9
350-0-350 v 150 ma. 6.3 v 4 a. 5 v 3 a	1 amp. 25 h. L.T. type	4/9
350-0-350 v 150 ma. 6.3 v 2 a. 6.3 v 2 a. 5 v 3 a	<b>ELIMINATOR TRANSFORMERS</b>	
<b>FULLY SHROUDED UPRIGHT</b>	Primaries 200-250 v 50 c/s. 120 v 40 m. 7/11	
250-0-250 v 60 ma. 6.3 v 2 a. 5 v 2 a	120-0-120 v 30 ma. 4 v 1 a	12/9
Midget type 21-3in.-3in.	<b>OUTPUT TRANSFORMERS</b>	
250-0-250 v 100 ma. 0-4-6.3 v 4 a.	Small Pentode. 8,000 ohms to 3 ohms	3/6
0-4.5 v 3 a	Standard Pentode. 5,000 to 3 ohms.	4/9
250-0-250 v 100 ma. 6.3 v 6 a. 5 v 3 a	Push-Pull 10-12 watts 6V6 to 3 or 15 ohms	15/11
<b>FOR R1355 CONVERSION</b>	Push-Pull 10-12 watts to match 6V6, etc., to 3-5-8 or 15 ohms	16/9
300-0-300 v 100 ma. 0-4-6.3 v 3 a. 0-1.5 v 3 a	Push-Pull 15 watts to match 6L6, etc.	22/9
350-0-350 v 100 ma. 0-4-6.3 v 4 a. 0-4.5 v 3 a	Push-Pull 20 watt 6L6, KT68, etc., to 15 ohms. High Quality, Sectionally wound	51/9
350-0-350 v 150 ma. 6.3 v 4 a. 5 v 3 a	Williamson type exact author's spec. 85-	
350-0-350 v 250 ma. 6.3 v 6 a. 4 v 3 a.	<b>BATTERY SET CONVERTER KIT.</b>	
0-2-6 v 2 a. 4 v 3 a. for Electronic Eng. Televisor	All parts for converting any type of Battery Receiver to A.C. Mains 200-250 v 50 c/s	
425-0-425 v 200 ma. 6.3 v 4 a. C.T. 6.3 v 4 a. C.T. 5 v 3 a. suitable Williamson Amplifier, etc.	Supplies 120 v, 90 v or 60 v at 40 ma. Fully smoothed, and tully smoothed L.T. of 2 v or 1.4 v at 4 a. Price, including circuit, 45/9	
325-0-325 v 20 ma. 6.3 v 0.5 a. 6.3 v 1.5 a for Williamson Preampifier... 17/6	As above but with L.T. 2 v 1 amp. 47/9. Please state voltages required when ordering.	
<b>FILAMENT TRANSFORMERS</b>	<b>SPECIAL OFFERS. Mains Trans., Midget type 2-3-2-1 in. Primary 220-240 v, Secs. 250-0-250 80 ma. 6.3 v 2.5 a. 10/9. Small fl. trans. 220-240 v input. 6.3 v 1.5 a output. 5/9. .0005 mfd. 2 sangs. 4/9. Vol. controls. 25 k with D.P. switch, 1in. spindle/2/11. P.M. SPEAKERS. All 2-3 ohms. 5in. Goodmans, 13/9; 6in. F.W. 14/11; 8in.</b>	

Plessey, 15/11; 8in. Rola, 17/11; 10in. Goodmans, 31/-; 10in. Plessey, 19/9. **M.P. SPEAKERS.** (All 2-3 ohms) 4in. E.M.I. with Trans. Field 750 ohms, 14/9; 6in. Rola Field 700 ohms, 12/9; 8in. R.A. Field 600 ohms, 12/9; 10in. R.G.D., Field 600 ohms, 23/9.

**VOL. CONTROLS** (standard spindles). All values, less switch, 2/9; with S.P. switch, 3/11; with D.P. switch, 4/6.

**NEW GUARANTEED VALVES (EX-GOV'T.)**

	Each	Each	Each
1T4	9/6	6XSGT 8/9	EF50 6/6
1S4	9/11	7D8	6/9
1R5	9/6	807	10/11
1R5	9/11	8D2	2/11
354	10/6	80	9/11
5Y3G (USC)	9/6	9D2	2/11
6	9/6	954	1/11
5Y4G	10/6	12K7GT	10/6
5V4G	11/6	12K8GT	10/6
5Z4C	9/6	12K7GT	10/6
6J5GT	5/9	12SK7	6/11
6J5Met.	6/11	12SC7	6/11
6J7G	6/11	12SQ7	7/9
6K7G	6/11	15D2	5/3
6K7Met.	7/11	16Z5	5/9
6X8C	12/9	25L6GT	10/6
6Q7G	9/11	50L6GT	10/6
6SN7GT 12/9	35Z4GT	10/6	UF42 10/11
6SL7GT 11/9	DA1	1/3	UL41 10/6
6SK7	6/11	EA50	2/9
6SG7	6/9	EF96	6/9
6V6G	9/6	EF99	9/9
6V6Met.	9/6		X78 12/9

**ELECTROLYTICS.** Tubular 3 mfd. 350 v. 1/9; 8 mfd. 450 v. 1/11; 16 mfd 450 v. 2/11; 25 mfd 25 v. 1/3 CAN; 8-8 mfd 450 v. 3/11; 8-16 mfd 450 v. 4/6; 12-12 mfd 350 v. 3/3; 16-16 mfd 450 v. 4/11; 32 mfd 350 v. 2/11; 32 mfd 450 v. 4/11; 32-32 mfd 350 v. 4/9; 32-32 mfd 450 v. 5/9; 32-32 mfd 350 v. plus 25 mfd 25 v. 5/6; 32-32 mfd 350 v. 6/6; 50 mfd 350 v. 3/11; 16-16 mfd 475 v. 5/9; 16-32 mfd 350 v. 4/6; 16-32 mfd 450 v. 5/3; 24-24 mfd 450 v. 3/11.

# OBTAIN YOUR PLANS OF THE "MAXIMITE"

A SUPER MODERN MINIATURE TRANSPORTABLE RADIO RECEIVER USING LATEST HIGH PERFORMANCE MIDGET VALVES AND COMPONENTS

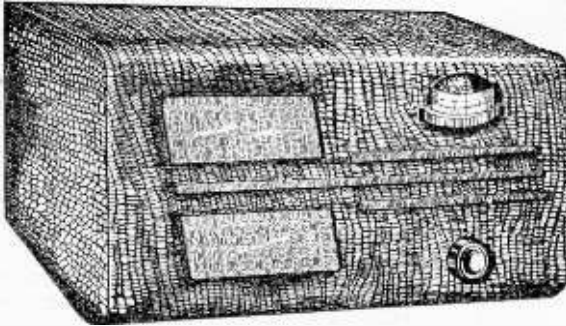

SIZE ONLY : 6in. long, 3½in. high, 2½in. wide.  
AC/DC SUPERHET WITHOUT LINE CORD  
LARGE MAINS DROPPERS  
EXTERNAL AERIAL OR EARTH  
CORD DRIVES, etc.

FULL PLANS (including detailed point to point wiring) printed on art paper. **1/- POST FREE**

This Receiver is a three valve superhet plus rectifier, of very small dimensions using the latest improved post-war midget components, giving—

- GREAT SENSITIVITY ● GOOD SELECTIVITY ● HIGH STABILITY ● POWERFUL OUTPUT

### NEW LINES THAT MAY INTEREST YOU—

Polished Aluminium Chassis, 4-sided, plus angle brackets. Size: 10in. x 7in. x 2½in., 7/6; 12in. x 8in. x 2½in., 8/9. 1/- Post/Packing.  
VALVES. 6K8GT—10/6; 5Z4G—9/6; 5V4G—10/-; 12AX7—6/-; 6SN7—10/-; 6SL7—8/6; 6K7G—8/-; 12K8—8/6; EL33—10/-; 6F6—7/6; 1S4—9/-; Many more—ask for Quote.  
T.C.C. VISCONOL .001, 6Kv—6/-; .001 12Kv—10/-; .01 6Kv—10/-; .001 15Kv—15/-.  
LT52—12v. 1½A. 19/6; 36 E.H.T. 45. 23/-; 36 EHT, 40, 21/6; 36 EHT 50, 26/-; K3/100 (9 Kv. 1 m/a)—14/8; 36EHT 100—29/4; Metal Rects. MINIATURE PANEL LIGHTS. Green, Red or White, 2/-.  
COLVERN 6 ohm G.T. Wire-Wound Pot. (Electronic), 8/- All Viewmaster Parts Stocked.

**RADIO SERVICING CO.** 444, WANDSWORTH ROAD, CLAPHAM, LONDON, S.W.8. Telephone MACaulay 4155.

Our No. 11 Catalogue, price 6d., Post Free. Postage: 77, 77A, 168, 169 Buses. S.R. Station: Wandsworth Road. Open till 6.30 p.m. 1 o'clock Wednesday. Over £2 free, below 10/-, 6d.; £1, 9d.; £2, 1/-.

EX-GOV. and Standard Types subject to Stock. Many at old price.



Please mark envelope PW12

Order C.O.D. or ask for quotation. Also enquire for types not listed.

AC/HL	DCC30	EBL1	EM34	KT61	MH4	MVS Pen	PL81	SU2150A	UF41
AC/HLDD	DD41	EBL21	EN31	KT63	MH41	7 pin	PL82	T41	UF42
AC/HLDD	DD41	EBL21	EX51	KT65	MHD4	MVSPenB	PL83	TDD2A	UL1
AC/HLDD	DD207	EBL31	EY91	KT71	MHD4	met	PM2HL	TDD4	UL44
AC/HLDD	DD207	EBL31	EZ35	KT74	MH4	N15	Clear	TDD13C	UL46
AC/HLDD	DD207	EBL31	EZ40	KT76	MKT1	N19	met	TH4B	UM34
AC/HLDD	DD207	EBL31	EZ41	KT78	MKT4	N37	PM12M	TH21C	UR1C
AC/HLDD	DD207	EBL31	EZ41	KT78	MKT4	N78	PM22A	TH30C	UR3C
AC/HLDD	DD207	EBL31	EZ41	KT78	MKT4	N78	PM22D	TH41	U8
AC/HLDD	DD207	EBL31	EZ41	KT78	MKT4	N78	PM24A	TH233	U6
AC/HLDD	DD207	EBL31	EZ41	KT78	MKT4	N78	PM24M	TH2321	U7
AC/HLDD	DD207	EBL31	EZ41	KT78	MKT4	N78	PM202	TP22	U8
AC/HLDD	DD207	EBL31	EZ41	KT78	MKT4	N78	PT10	TP23	U9
AC/HLDD	DD207	EBL31	EZ41	KT78	MKT4	N78	PT41	TP25	UY1N
AC/HLDD	DD207	EBL31	EZ41	KT78	MKT4	N78	PK3	TP2620	UY41
AC/HLDD	DD207	EBL31	EZ41	KT78	MKT4	N78	PK25	U10	V914
AC/HLDD	DD207	EBL31	EZ41	KT78	MKT4	N78	PK25	U14	VMP4G
AC/HLDD	DD207	EBL31	EZ41	KT78	MKT4	N78	PK25	U16	VP2B
AC/HLDD	DD207	EBL31	EZ41	KT78	MKT4	N78	PK25	U18/20	VP4 5 pin
AC/HLDD	DD207	EBL31	EZ41	KT78	MKT4	N78	PK25	U22	VP4 7 pin
AC/HLDD	DD207	EBL31	EZ41	KT78	MKT4	N78	PK25	U24	VP4A 7 pin
AC/HLDD	DD207	EBL31	EZ41	KT78	MKT4	N78	PK25	U25	VP4B
AC/HLDD	DD207	EBL31	EZ41	KT78	MKT4	N78	PK25	U27	VP13A
AC/HLDD	DD207	EBL31	EZ41	KT78	MKT4	N78	PK25	U31	VP23
AC/HLDD	DD207	EBL31	EZ41	KT78	MKT4	N78	PK25	U143	VP41
AC/HLDD	DD207	EBL31	EZ41	KT78	MKT4	N78	PK25	U147	VP133
AC/HLDD	DD207	EBL31	EZ41	KT78	MKT4	N78	PK25	U149	VP1322
AC/HLDD	DD207	EBL31	EZ41	KT78	MKT4	N78	PK25	U156	VR75/30
AC/HLDD	DD207	EBL31	EZ41	KT78	MKT4	N78	PK25	U151	W17
AC/HLDD	DD207	EBL31	EZ41	KT78	MKT4	N78	PK25	U152	W21 4 pin
AC/HLDD	DD207	EBL31	EZ41	KT78	MKT4	N78	PK25	U201	W21 7 pin
AC/HLDD	DD207	EBL31	EZ41	KT78	MKT4	N78	PK25	U281	W61M
AC/HLDD	DD207	EBL31	EZ41	KT78	MKT4	N78	PK25	U282	W76
AC/HLDD	DD207	EBL31	EZ41	KT78	MKT4	N78	PK25	U403	W77
AC/HLDD	DD207	EBL31	EZ41	KT78	MKT4	N78	PK25	U404	W81
AC/HLDD	DD207	EBL31	EZ41	KT78	MKT4	N78	PK25	U401	W101
AC/HLDD	DD207	EBL31	EZ41	KT78	MKT4	N78	PK25	U402	W107
AC/HLDD	DD207	EBL31	EZ41	KT78	MKT4	N78	PK25	U403	W142
AC/HLDD	DD207	EBL31	EZ41	KT78	MKT4	N78	PK25	U404	W143
AC/HLDD	DD207	EBL31	EZ41	KT78	MKT4	N78	PK25	U405	W144
AC/HLDD	DD207	EBL31	EZ41	KT78	MKT4	N78	PK25	U406	W145
AC/HLDD	DD207	EBL31	EZ41	KT78	MKT4	N78	PK25	U407	W146
AC/HLDD	DD207	EBL31	EZ41	KT78	MKT4	N78	PK25	U408	W147
AC/HLDD	DD207	EBL31	EZ41	KT78	MKT4	N78	PK25	U409	W148
AC/HLDD	DD207	EBL31	EZ41	KT78	MKT4	N78	PK25	U410	W149
AC/HLDD	DD207	EBL31	EZ41	KT78	MKT4	N78	PK25	U411	W150
AC/HLDD	DD207	EBL31	EZ41	KT78	MKT4	N78	PK25	U412	W151
AC/HLDD	DD207	EBL31	EZ41	KT78	MKT4	N78	PK25	U413	W152
AC/HLDD	DD207	EBL31	EZ41	KT78	MKT4	N78	PK25	U414	W153
AC/HLDD	DD207	EBL31	EZ41	KT78	MKT4	N78	PK25	U415	W154
AC/HLDD	DD207	EBL31	EZ41	KT78	MKT4	N78	PK25	U416	W155
AC/HLDD	DD207	EBL31	EZ41	KT78	MKT4	N78	PK25	U417	W156
AC/HLDD	DD207	EBL31	EZ41	KT78	MKT4	N78	PK25	U418	W157
AC/HLDD	DD207	EBL31	EZ41	KT78	MKT4	N78	PK25	U419	W158
AC/HLDD	DD207	EBL31	EZ41	KT78	MKT4	N78	PK25	U420	W159
AC/HLDD	DD207	EBL31	EZ41	KT78	MKT4	N78	PK25	U421	W160
AC/HLDD	DD207	EBL31	EZ41	KT78	MKT4	N78	PK25	U422	W161
AC/HLDD	DD207	EBL31	EZ41	KT78	MKT4	N78	PK25	U423	W162
AC/HLDD	DD207	EBL31	EZ41	KT78	MKT4	N78	PK25	U424	W163
AC/HLDD	DD207	EBL31	EZ41	KT78	MKT4	N78	PK25	U425	W164
AC/HLDD	DD207	EBL31	EZ41	KT78	MKT4	N78	PK25	U426	W165
AC/HLDD	DD207	EBL31	EZ41	KT78	MKT4	N78	PK25	U427	W166
AC/HLDD	DD207	EBL31	EZ41	KT78	MKT4	N78	PK25	U428	W167
AC/HLDD	DD207	EBL31	EZ41	KT78	MKT4	N78	PK25	U429	W168
AC/HLDD	DD207	EBL31	EZ41	KT78	MKT4	N78	PK25	U430	W169
AC/HLDD	DD207	EBL31	EZ41	KT78	MKT4	N78	PK25	U431	W170
AC/HLDD	DD207	EBL31	EZ41	KT78	MKT4	N78	PK25	U432	W171
AC/HLDD	DD207	EBL31	EZ41	KT78	MKT4	N78	PK25	U433	W172
AC/HLDD	DD207	EBL31	EZ41	KT78	MKT4	N78	PK25	U434	W173
AC/HLDD	DD207	EBL31	EZ41	KT78	MKT4	N78	PK25	U435	W174
AC/HLDD	DD207	EBL31	EZ41	KT78	MKT4	N78	PK25	U436	W175
AC/HLDD	DD207	EBL31	EZ41	KT78	MKT4	N78	PK25	U437	W176
AC/HLDD	DD207	EBL31	EZ41	KT78	MKT4	N78	PK25	U438	W177
AC/HLDD	DD207	EBL31	EZ41	KT78	MKT4	N78	PK25	U439	W178
AC/HLDD	DD207	EBL31	EZ41	KT78	MKT4	N78	PK25	U440	W179
AC/HLDD	DD207	EBL31	EZ41	KT78	MKT4	N78	PK25	U441	W180
AC/HLDD	DD207	EBL31	EZ41	KT78	MKT4	N78	PK25	U442	W181
AC/HLDD	DD207	EBL31	EZ41	KT78	MKT4	N78	PK25	U443	W182
AC/HLDD	DD207	EBL31	EZ41	KT78	MKT4	N78	PK25	U444	W183
AC/HLDD	DD207	EBL31	EZ41	KT78	MKT4	N78	PK25	U445	W184
AC/HLDD	DD207	EBL31	EZ41	KT78	MKT4	N78	PK25	U446	W185
AC/HLDD	DD207	EBL31	EZ41	KT78	MKT4	N78	PK25	U447	W186
AC/HLDD	DD207	EBL31	EZ41	KT78	MKT4	N78	PK25	U448	W187
AC/HLDD	DD207	EBL31	EZ41	KT78	MKT4	N78	PK25	U449	W188
AC/HLDD	DD207	EBL31	EZ41	KT78	MKT4	N78	PK25	U450	W189
AC/HLDD	DD207	EBL31	EZ41	KT78	MKT4	N78	PK25	U451	W190
AC/HLDD	DD207	EBL31	EZ41	KT78	MKT4	N78	PK25	U452	W191
AC/HLDD	DD207	EBL31	EZ41	KT78	MKT4	N78	PK25	U453	W192
AC/HLDD	DD207	EBL31	EZ41	KT78	MKT4	N78	PK25	U454	W193
AC/HLDD	DD207	EBL31	EZ41	KT78	MKT4	N78	PK25	U455	W194
AC/HLDD	DD207	EBL31	EZ41	KT78	MKT4	N78	PK25	U456	W195
AC/HLDD	DD207	EBL31	EZ41	KT78	MKT4	N78	PK25	U457	W196
AC/HLDD	DD207	EBL31	EZ41	KT78	MKT4	N78	PK25	U458	W197
AC/HLDD	DD207	EBL31	EZ41	KT78	MKT4	N78	PK25	U459	W198
AC/HLDD	DD207	EBL31	EZ41	KT78	MKT4	N78	PK25	U460	W199
AC/HLDD	DD207	EBL31	EZ41	KT78	MKT4	N78	PK25	U461	W200
AC/HLDD	DD207	EBL31	EZ41	KT78	MKT4	N78	PK25	U462	W201
AC/HLDD	DD207	EBL31	EZ41	KT78	MKT4	N78	PK25	U463	W202
AC/HLDD	DD207	EBL31	EZ41	KT78	MKT4	N78	PK25	U464	W203
AC/HLDD	DD207	EBL31	EZ41	KT78	MKT4	N78	PK25	U465	W204
AC/HLDD	DD207	EBL31	EZ41	KT78	MKT4	N78	PK25	U466	W205
AC/HLDD	DD207	EBL31	EZ41	KT78	MKT4	N78	PK25	U467	W206
AC/HLDD	DD207	EBL31	EZ41	KT78	MKT4	N78	PK25	U468	W207
AC/HLDD	DD207	EBL31	EZ41	KT78	MKT4	N78	PK25	U469	W208
AC/HLDD	DD207	EBL31	EZ41	KT78	MKT4	N78	PK25	U470	W209
AC/HLDD	DD207	EBL31	EZ41	KT78	MKT4	N78	PK25	U471	W210
AC/HLDD	DD207	EBL31	EZ41	KT78	MKT4	N78	PK25	U472	W211
AC/HLDD	DD207	EBL31	EZ41	KT78	MKT4	N78	PK25	U473	W212
AC/HLDD	DD207	EBL31	EZ41	KT78	MKT4	N78	PK25	U474	W213
AC/HLDD	DD207	EBL31	EZ41	KT78	MKT4	N78	PK25	U475	W214
AC/HLDD	DD207	EBL31	EZ41	KT78	MKT4	N78	PK25	U476	W215
AC/HLDD	DD207	EBL31	EZ41	KT78	MKT4	N78	PK25	U477	W216
AC/HLDD	DD207	EBL31	EZ41	KT78	MKT4	N78	PK25	U478	W217
AC/HLDD	DD207	EBL31	EZ41	KT78	MKT4	N78	PK25	U479	W218
AC/HLDD	DD207	EBL31	EZ41	KT78	MKT4	N78	PK25	U480	W219
AC/HLDD	DD207	EBL31	EZ41	KT78	MKT4	N78	PK25	U481	W220
AC/HLDD	DD207	EBL31	EZ41	KT78	MKT4	N78	PK25	U482	W221
AC/HLDD	DD207	EBL31	EZ41	KT78	MKT4	N78	PK25	U483	W222
AC/HLDD	DD207	EBL31	EZ41	KT78	MKT4	N78	PK25	U484	W223
AC/HLDD	DD207	EBL31	EZ41	KT78	MKT4	N78	PK25	U485	W224
AC/HLDD	DD207	EBL31	EZ41	KT78	MKT4	N78	PK25	U486	W225
AC/HLDD	DD207	EBL31	EZ41	KT78	MKT4	N78	PK25	U487	W226
AC/HLDD	DD207	EBL31	EZ41	KT78	MKT4	N78	PK25	U488	W227
AC/HLDD	DD207	EBL31	EZ41	KT78	MKT4	N78	PK25	U489	W228
AC/HLDD</									

# Resistor Tolerances

THE MEANING OF TOLERANCES, AND THEIR IMPORTANCE IN MODERN CIRCUITS

IT mystifies beginners to find that many resistors which are sold as, say,  $10K\Omega$  may in fact be anything between  $8K\Omega$  and  $12K\Omega$ , and they wonder why this is and how much difference it will make to the performance of the circuit in which they are interested.

Why are not all resistors marked with their actual resistance? The reason is that manufacturers cannot make resistors all of which are exactly a predetermined value. If they try to make  $10K\Omega$  resistors some of them turn out to be  $9K\Omega$  or even  $8K\Omega$ , and others  $11K\Omega$  or  $12K\Omega$  or perhaps even further from the desired value. The salesman, on the other hand, cannot stock every conceivable value of resistor— $10K\Omega$ ,  $10.1K\Omega$ ,  $10.2K\Omega$ ,  $10.3K\Omega$ ,  $10.4K\Omega$ , etc., not to mention  $10.01K\Omega$ ,  $10.02K\Omega$ , etc., so they compromise by classifying groups of values together and putting one label on them all. These groups must be so arranged that any value of resistance falls into one or another of them. The obvious starting point is a group centred about a number beginning with 1, such as  $10K\Omega$ , and for simplicity there must be groups centred round  $1K\Omega$  and  $100K\Omega$  as well. The next point to be considered is how large these groups shall be. Obviously the larger the range of values each group takes in the smaller will be the number of groups needed. The largest and most common size of group used in practice is the 20 per cent. tolerance group in which any resistor will be within 20 per cent., or one part in five, of the marked value. Thus resistors marked  $10K\Omega$  may be between  $(10-2)K\Omega$  and  $(10+2)K\Omega$ , i.e. between  $8K\Omega$  and  $12K\Omega$ . The lower limit of the next group must be  $12K\Omega$  so as to leave no gap, and its centre value is therefore  $15K\Omega$ , with  $18K\Omega$  as its top limit. At this point trouble starts, as if the lower limit of the next group is made  $18K\Omega$  its mean value becomes  $22.5K\Omega$ , which is inconvenient. Also, if this process continues the seventh group centres on  $110.6K\Omega$ , whereas it is convenient that the series should repeat with the seventh term  $100K\Omega$  and the 13th  $1M\Omega$ . So we see that a slight overlap between groups is in fact desirable. The centre of the third group is therefore made  $22K\Omega$ , the fourth group is centred on  $33K\Omega$ , the fifth on  $47K\Omega$  and the sixth on  $68K\Omega$ . In this way every actual resistor may be put in one of the groups and there is very little overlap. If  $\pm 10$  per cent. groups are used each group is smaller and other nominal values are put between the  $\pm 20$  per cent. ones. Thus the  $10K\Omega \pm 10$  per cent. group covers up to  $11K\Omega$  and a new group centred on  $12K\Omega$  has to be introduced to bridge the gap between this and the lower limit of the  $15K\Omega \pm 10$  per cent. group. Actually a very small gap is left between  $13.2K\Omega$ , the upper limit of the  $12K\Omega$  group, and  $13.5K\Omega$ , the lower limit of the  $15K\Omega$  group, but this may be ignored in practice. This halving process is repeated for the  $\pm 5$  per cent. groups.

## Importance

We now come to the second question: how much does this matter? It is obviously important to know the answer to this as  $\pm 20$  per cent. resistors are

cheaper than the more accurate ones and so must be used wherever possible. The first point to be realised in considering this question is the very large variation of characteristics between one valve and another of the same type. As a typical example the anode current of a certain type of R.F. pentode may vary between  $6mA$ . and  $15mA$ . from one valve to another under identical conditions, and the mutual conductance from  $6mA/V$ . to  $9mA/V$ . If a pentode is being used as an audio voltage amplifier its gain is given by  $G = gm.R1$ , where  $R1$  is the anode load and  $gm$  the mutual conductance. Thus if  $R1$  is 20 per cent. low, the outside limit, and in practice it will probably be less than this, the gain  $G$  will also be 20 per cent. low. This corresponds to a reduction in output of less than 2 dB, which will be undetectable by ear and even with a perfectly accurate resistor the gain may vary more than this from one valve to another. Thus in this application a  $\pm 20$  per cent. resistor is quite accurate enough. If a triode is used as a voltage amplifier with an anode resistor equal to or greater than its anode impedance the variation in gain will be even less. If the resistor is used as the cathode resistor in an automatic bias circuit the anode current will only increase by about 10 per cent. if the resistor is 20 per cent. low, and this is again no bigger than the variation from one valve to another. Thus in almost all valve circuits the variation in gain due to using  $\pm 20$  per cent. resistors is smaller than that due to changing valves.

If, however, two equal output voltages are required, as in a phase splitter such as that shown in Fig. 1, it is important that  $R_a$  and  $R_c$  should be equal although their actual value is not very important. If the constructor has no way of matching the resistors himself then his only way of getting them equal may be to buy high accuracy ones.

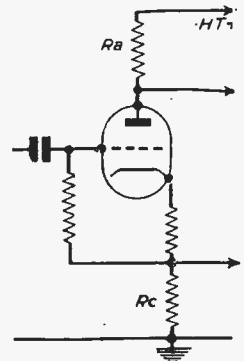

Fig. 1.—A typical phase-splitter circuit to illustrate the effect of resistor tolerances.

There are a few cases where it is essential to have resistors of the exact value required, such as in carefully calculated tone corrector circuits. In these the product of a resistance and a capacity must be accurately a predetermined value, and it is quite common to use  $\pm 1$  per cent. resistors and capacitors. Another example where it is specially important to have the resistors right is in bridge circuits and voltmeters where they must act as standards.

### Accuracy

We will now consider arrangements for getting an accurate resistor of a non-standard value. This is important as high stability  $\pm 1$  per cent. resistors are only made of a few values and not in overlapping ranges as  $\pm 5$  per cent. resistors are. Consider the case of two resistors connected in series. If the combination is to be  $\pm 1$  per cent. and one resistor is  $\pm 1$  per cent. the other must be  $\pm 1$  per cent. also; but if it is permissible for the combination to be 1.1 per cent. out then the second may be less accurate. Consider a typical case. It is desired to connect a  $100K\Omega$  and a  $5K\Omega$  in series to make a  $105K\Omega$  resistor and 1.1 per cent. tolerance is permissible. In this case a  $100K\Omega \pm 1$  per cent. must be used and at the worst will only be  $1K\Omega$  out. But a total error of 1.155K $\Omega$  is allowed so we see that the  $5K\Omega$  may be up to 155 $\Omega$  out. This is over 3 per cent. and if a  $\pm 5$  per cent. resistor is used the total value will still be within 1.2 per cent. of the desired amount, which for most purposes is good enough. Thus as long as the larger resistor is accurate a cheap lower accuracy resistor may be used for the second.

The same thing happens if resistors are connected

in parallel. Thus if a  $100K\Omega$  and a  $2M\Omega$  are so connected to give a resistance of  $95K\Omega$  and the  $100K\Omega$  is a  $\pm 1$  per cent. resistor the  $2M\Omega$  can be  $\pm 5$  per cent. without making the total resistance more than 1.2 per cent. out at the most. In calculating this case it is easiest to work in conductance, that is the reciprocal of resistance. The conductance of a  $100K\Omega$  resistor is  $1/100,000$  mhos or  $10\mu$ mho, while that of a  $2M\Omega$  resistor is  $0.5\mu$ mho, and the problem is the same as before with new units. Of course the errors in the two resistors may cancel each other out and it is unlikely that they will both be at the limit of their tolerance, but this is possible and must be considered as it is the worst case.

Exactly the same reasoning applies to capacitors. A  $100pF \pm 1$  per cent. capacitor may be connected, in parallel this time, with a  $5pF \pm 5$  per cent. one and the combination will be within 1.2 per cent. of its nominal value, or a  $2,000pF$  5 per cent. may be connected in series with the  $100pF \pm 1$  per cent. with the same accuracy.

The method outlined above should enable constructors to calculate the effect of connecting two resistors of different tolerances in series or parallel with each other.

## The Tuned Circuit

FURTHER TO THE ARTICLE ON THIS SUBJECT IN LAST MONTH'S ISSUE, THE FOLLOWING NOTES MAY PROVE OF INTEREST

### Applications of the Tuned Circuit

AS applied to a radio receiver, the tuned circuit is fundamentally employed for the selection of a desired transmission. The resonant frequency of which is adjustable, usually by a variable tuning capacitor. Although some receivers incorporate a mechanical method of traversing the axis of the tuning coil with an iron dust core, thereby altering the inductance of the coil.

Whether L or C be rendered variable the result is the same: a means is created by which the resonant frequency of the circuit may be adjusted from the cabinet front. The "rejector circuit" is normally employed for this function, since it has the ability to develop across it a large signal potential and acts as a short circuit to unwanted carrier voltages. The (full line) curve of Fig. 8 (a) shows a typical response curve which may be expected from a rejector circuit of fairly high Q, while the broken line curve illustrates the effect of heavy damping, producing low Q characteristic. The curves at (b) indicate similar conditions in conjunction with the "acceptor circuit."

Owing to the present overloaded state of the medium and short wave bands, the tuned circuit should be as selective as possible, thereby attenuating the possibilities of adjacent channel interference. Unfortunately a single tuned circuit of high selectivity gives rise to poor quality reception owing to its restricted pass-band. However, by employing a combination of two or more tune circuits in a bandpass arrangement the sides of the overall response curve are made fairly vertical, while the top is flat within its pass-line limits.

Numerous and varied are the applications presented for the tuned circuit, not only on the R.F. side of the receiver, but also in connection with the A.F. side. Whistle filters, scratch filters, tone compensator circuits, to mention just a few. All of these take the form of either the "acceptor" or "rejector circuit," according to the mode of application.

In conclusion it should be mentioned that the subject of tuned circuits is indeed a vast one, but it is hoped that this brief account will be of assistance to constructors and servicemen, and will enable them to understand more clearly the function of this important circuit.

## Book Received

"Electronic Measurements," by Termán and Pettit. 707 pages. Second Edition. Price 72s. 6d. From McGraw-Hill Publishing Co., Ltd.

THIS is an important contribution to electronics, and published at a time when electronics is penetrating almost every known activity. It is exhaustive in its content, very completely illustrated, and very adequately covers the whole field from Voltage and Current, Power, Circuit Constants, Frequency Measurements, Waveform Measurements, Characteristics of Valves, Amplifier Measurements, Receiver Measurements, Aerials, Radio-waves, Oscillators, Generators, to Reactance and Resistance Standards and Devices, and Attenuators and Signal Generators.



# introducing our latest kit

## The *Skyway* TAPE RECORDER AND RECORDING AMPLIFIER

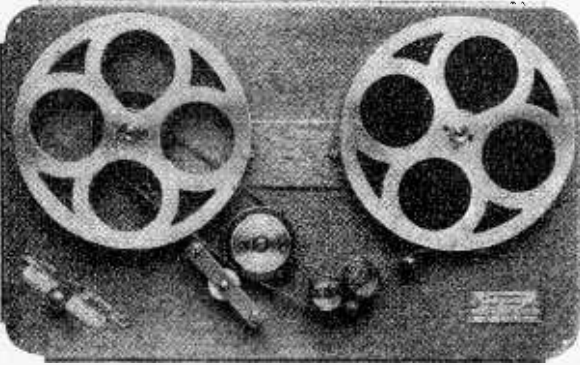

RECORDER UNIT  
KIT  
PRICE **18 GNS.**  
Less tape and reels.

COMPLETE  
wired and tested  
with tape and reels. **£25**

De Luxe AMPLIFIER  
KIT with 8-stage  
wiring diagram. **14 GNS.**

Available as a kit of machined parts ready for assembly or as a complete unit ready for use. Many desirable features are incorporated including 2-speed operation for 3 $\frac{1}{2}$ in. or 7 $\frac{1}{2}$ in. per second; HI-FI record/playback and R.F. erase heads of the half-track type giving over 2 hours playing time on one reel of tape. Completely automatic operation with ONE-KNOB CONTROL for stop, rewind and forward; instant rewind without unthreading. Ball-bearing capstan, oilite self-lubricating bushes to all other bearings. Attractive blue mottle hammered finish.

Illustrated leaflet free on request



# WIDE ANGLE TV

Smith's of Edgware Road stock ALL the components—Allen, Denco, Colvern, Dubilier, Elac, McMurdo, Morgan, STC, TCC—

for the

**“TELEKING”**  
**“VIEWMASTER” CONVERSION**  
**and “MAGNAVIEU”**  
**(Radio Constructor)**

Also Tubes, Valves, Cabinets, etc.  
Price lists on receipt of S.A.E.

**H. L. SMITH & CO. LTD.**  
287/9, EDGWARE ROAD, LONDON, W.2.  
Tel: Paddington 5891. Hours 9 till 6 (Thursday 1 o'clock).  
Near Edgware Road Stations, Metropolitan and Bakerloo.

## THE FAMOUS BENNETT COLLEGE

can help your career through personal postal tuition

in any of these subjects:

- Accountancy Exams. ★ Aircraft Eng. & Radio ★ Architecture ★ Auditing ★ Book-keeping ★ Building ★ Carpentry ★ Chemistry ★ Civil Service ★ Commercial Art ★ Commercial Arithmetic ★ Company Law ★ Costing ★ Diesel Engines ★ Draughtsmanship ★ Electric Wiring ★ Engineering (Civil; Electrical; Mechanical; Motor; Steam; Structural) ★ Jigs, Tools & Fixtures ★ Journalism ★ Languages ★ Mathematics ★ Mining ★ Modern Business Methods ★ Plumbing ★ Police ★ Press Tool Work ★ Quantity Surveying ★ Radio ★ Salesmanship ★ Secretarial Exams. ★ Shorthand ★ Surveying ★ Telecommunications ★ Television ★ Textiles ★ Works Management ★ Workshop Practice

and GENERAL CERTIFICATE OF EDUCATION

SUCCESS WILL BE YOURS

As a Bennett College Student your own Personal Tutor will coach you until you qualify, at your pace, with no time wasted. You will learn quickly, easily.

SEND TODAY FOR A FREE PROSPECTUS

TO THE BENNETT COLLEGE, DEPT. L. 104, SHEFFIELD.

Please send me your prospectus on..... (Subject)

NAME .....

ADDRESS .....

..... AGE (IF UNDER 21).....  
PLEASE WRITE IN BLOCK LETTERS

# PRATTS RADIO

1070 Harrow Road, London, N.W.10

Tel.: LADbroke 1734.

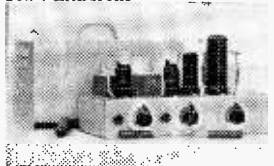

(Nr. Scrubbs Lane)  
AMPLIFIERS READY TO USE.

MODEL AC10E (as illustrated). 10-watt, 4-valve unit, neg. feedback, separate mike stage and separate mike and gram inputs. 2 faders and tone control. Input volts mike .002, gram 2lv. £10-7-6.

MODEL AC18E. 6-valve unit with p/pull output of 18! watts, separate mike stage and separate mike

and gram inputs, 2 faders and tone control. Feedback over 3 stages. Input volts, mike .003, gram 3v. £15-5-0. MODEL AC32E. Specification as AC18E, but with a larger output stage giving 32 watts output. £18-18-0. MODEL U10E. D.C./A.C. mains, p/pull output of 10 watts. Spec. as AC18E, £12-19-6. All the above amplifiers are complete with metal case, chrome handles and outputs to match 3, 8, 15 ohm speakers. All have H.T. and L.T. connectors for supplying power to tuning units (as have AC3C and AC4C, but not U10E and U4C). See tuning units below. MODEL AC8C. 5-valve chassis with p/pull output of 10 watts. Feedback over 3 stages. For record or radio reproduction. Output to 3, 8 or 15 ohms, inputs for radio/LP/standard records £10-10-0. MODEL AC4C (A.C.) or MODEL U4C (A.C./D.C.). 3-valve 4-watt amplifier chassis for radio/records. Output to 3 ohms. £5-15-0. All prices include inland carriage. Remember that College amplifiers have been in production since 1945 and used by hundreds of domestic and commercial operators throughout the world. Demonstrations daily 8.30 to 6.0 p.m., on both microphone and records.

We recommend the following equipment for use with our amplifiers: MICROPHONES, Rothermel 2D35, 59 1/2; Rothermel D104, £5-5-0; Acos 22-1 or 22-2 models, £6-6-0. Stands available. TUNING UNITS, College TU2. Medium-wave Superhet circuit, complete with valves ready for use. £4-19-6, post 1/6. Model TU1, 3 waveband superhet, £10-9-6. These units plug straight into our A.C. amplifiers.

PICK-UPS, Acos GP20, with standard head. £3-11-5. GRAMOPHONE UNITS, Collaro A.C. units with rim drive motor, pick-up, turntable, cut-out diagram, etc., Crystal model. £6-15-6; Magnetic, £6-9-6. For those who require motor and turntable only (for use with G.P.20 pick-ups) we offer the following: E.S.R. MU10 gram unit. £3-17-6; Collaro AC47 gram unit, centre drive. £4-15-6.

SPEAKERS, W.B. 10in. Speakers, 12,000 lines. £3-14-0. All goods are brand new and contain no surplus components. Send 3d. stamp for fuller details.

## faithful reproduction

from 50 c/s to 10 Kc/s at 7½ in/sec using



High-quality recorder reproducers demand high-quality tape to produce results that will satisfy the discriminating listener.

### "SCOTCH BOY" MAGNETIC TAPE HAS:

- High, uniform sensitivity
- High fidelity at low speeds
- High signal/noise ratio
- Medium coercivity, easy erasure
- Low distortion and transfer
- Special cellulose acetate base giving strength and durability.

in 1200', 600', 300' reels and other sizes.

If you want advice on any tape-recording problem, our entire technical knowledge is at your disposal.

MINNESOTA MINING & MANUFACTURING Co., Ltd  
167 Strand, London, W.C.2. Telephone: TEMple Bar 6363

### THE OSCILLOSCOPE BOOK

88 pages. 43 diagrams. 5/-

Full details of how to make and how to use an oscilloscope. 2nd impression.

### MAGNETIC RECORDING: WIRE & TAPE

72 pages. 73 diagrams. 4/6

Deals with theory, construction and use of both types. 2nd edition.

### TELEVISION FAULTS

72 pages. 29 diagrams and half-tones. 5/-

Gives a detailed explanation of probable faults in all sections of the receiver. Also a supplement giving circuit diagrams (10in. x 8in.) of six commercial televisions.

### AUDIO HANDBOOKS

No. 1: AMPLIFIERS. 64 pages. 38 diagrams. 3/6

A trouble shooting guide for the constructor who has built an amplifier, but then finds it doesn't work.

No. 2: FEEDBACK. 64 pages. 40 diagrams. 3/6

"The chapter dealing with 'Charts and Examples' is worth the price of the book twice over."—

I.P.R.E. JOURNAL.

## NORMAN PRICE (PUBLISHERS) LTD.

283, City Road, London, E.C.1.

### THE BARGAIN OF THE YEAR

## LOOK! FIVE BOB THE LOT!

One Doz. International Octal Valveholders.

One Doz. English (Mazda) Octal Valveholders.

One Doz. Mica and Silver Mica Condensers:

2 at 10 pf, 2 at 20 pf, 4 at 30 pf, 2 at 1,000 pf, 1 at 1,300 pf, 1 at 1,600 pf.

One Doz. .1 mfd. x 350 v. Tubular Condensers.

Two Doz. Assorted Resistors.

Two Gross (approx.) i.e., 6 ozs. Assorted B.A.

Screws, Nuts and Washers.

One Alum. Can Electrolytic Cond., 100 mfd. x 6 volt.

The above are ex new equipment and are in perfect condition.

THE LOT FOR 5/- (Plus 1/- postage).

— IMMEDIATE DESPATCH —

### MAKE YOUR OWN RECEIVER

and save pounds. Our new edition of "Universal Radio Construction" at 1/6 post free gives full working diagrams with point-to-point wiring for the construction of a SUPERHET for £6 and a T.R.F. for £5 5s. Prices include all valves and cabinet in either polished wood or moulded bakelite (3 colours available).

Other previously advertised bargains still available:—3 mfd. x 500 v. Alum. Can Electrolytics, 1/9 each, 18/- doz.; .1 x 500 v. Tub. 4/- doz.; 18 SWG Multicores, 2/6 doz. yds.; Midget I.F.T.'s., 465 kc., 8/6 pr., etc., etc., etc.

Latest list 3d. stamps. Min. P. and P. all orders. 1/-.

## SUSSEX ELECTRONICS LTD.

PRINCES STREET, BRIGHTON, SUSSEX.

Tel.: 24446.



# Surplus Cathode-ray Tubes

DETAILS OF TUBES SUITABLE FOR OSCILLOSCOPES

By E. G. Bulley

**T**HE availability of cathode-ray tubes on the surplus market has provided the experimenter and amateur with the means by which he can construct a piece of measuring equipment at reasonable cost.

Prior to the war, the construction of such gear was in most cases out of reach of one's pocket, the main reason being that the price of the tube was quite high. However, many constructional articles have in the past appeared in PRACTICAL WIRELESS, and will no doubt continue to do so.

This article is therefore written so as to provide the reader with data appertaining to the smaller diameter tubes that are available, and which are considered suitable for the construction of small bench type oscilloscopes.

### Function

The cathode-ray tube is perhaps described best as a device whereby two dimensions can be plotted, one dimension as a function of the other. However, the basic construction of such tubes does not differ from one manufacturer to another, so to enable the new reader to appreciate their action the following description is included.

The description deals only with those available upon the surplus market, namely those of the electrostatic types which are tabulated in the table. The tube itself consists of a heater element assembled within an oxide coated cathode sleeve, thus, as in radio valve practice, the heater raises the temperature of the cathode to a specific temperature resulting in electron emission. Now this emission is drawn into

a narrow beam from the cathode by the action of what may be termed an electric field which is created by such electrodes as the grid and anode number one.

As this beam, which is fairly small in cross-sectional area, leaves anode number one, it has a tendency to spread or diverge. This diverging beam, however, is immediately corrected by the electric field created by anode number two. In other words, the beam converges after leaving anode number two and thus reaches the fluorescent screen as a small spot.

It is as well to mention, however, that the second anode also increases the kinetic energy of the beam, and it is this potential that causes the beam to strike the screen with sufficient force to cause the spot to fluoresce and so give a visible indication of what is happening.

### Several Anodes

The reader will notice by referring to the table that some of the tubes have three or four anodes. This need not in any way confuse the issue, because their purpose is to create additional kinetic energy to the beam of electrons, either before or after deflection. Nevertheless, it may be as well to mention that in some tubes these anodes consist of an aquadag coating upon the interior walls of the glass envelope. If the coating is located after the deflector plates its purpose is to increase the kinetic energy of the beam, after it has been deflected. This enables the spot on the screen to be more intense and much sharper, which is essential in making some observations.

The deflector plates do not really require much description because as their name indicates, they are

TABLE OF EX-SERVICE TUBES

Surplus No.	Comm. No.	VF	IF	VA1	VA2	VA3	VA4	Beam Current	Screen Diameter
CV279...	—	4	1.1	1,500	250	1,500	—	—	70m/m
NC16 ...	—	4	1.1	1,500	250	1,500	—	—	70m/m
CV320...	4053A	4	1.1	800	135	800	—	3μA	38m/m
VCR155.	4053A	4	1.1	800	135	800	—	3μA	38m/m
CV967...	4053A	4	1.1	800	135	800	—	3μA	38m/m
NC19 ...	4053A	4	1.1	800	135	800	—	3μA	38m/m
CV389...	—	4	1.1	3,500	75	1,700	3,500	40μA	40m/m
VCR521	—	4	1.1	1,800	700	4,000	—	50μA	90m/m
VCR522	—	4	1.1	800	135	800	—	4μA	38m/m
VCR221	—	4	1.1	2,000	340	2,000	4,000	4μA	90m/m
*2AP1...	2AP1	6.3	0.6	250	1,000	—	—	—	2in.
*2BP1 ...	2BP1	6.3	0.6	500	2,000	—	—	—	2in.
*CV602	3AP1	2.5	2.1	1,000	1,500	—	—	—	3in.
*3AP4...	3AP4	2.5	2.1	1,000	1,500	—	—	—	3in.
*3BP1 ...	3BP1	6.3	0.6	575	2,000	—	—	—	3in.
*3EP1 ...	3EP1	6.3	0.6	430	1,500	—	—	—	3in.
*3JP1 ...	3JP1	6.3	0.6	500	2,000	4,000	—	—	3in.
*3KP1...	3KP1	6.3	0.6	320 appx.	2,000	—	—	—	3in.
*3MP1...	3MP1	6.3	0.6	500	2,000	—	—	—	3in.
*3RP1...	3RP1	6.3	0.6	600	2,000	—	—	—	3in.

\* American manufacture.

there to deflect the beam. They consist of two pairs of parallel plates, each pair located so that they are 90 deg. to each other. One pair is used for horizontal deflection, whereas the other pair is for vertical deflection.

It can therefore be said that the field created between these plates will deflect the beam accordingly and so reproduce a visible result upon the screen of the tube. The anodes and focusing arrangement of any tube, plus that of the emitter, is commonly known as the electron gun and is the means by which the beam can be controlled, focused and accelerated at will.

The potential applied to the final anode is much higher than that of the preceding anode, that is to say in the case of a tube having three anodes, anode number three is operated at a much higher potential than that of number two, but in many cases anode number one has applied to it the same potential as that of anode number three. Furthermore, some oscilloscope circuits have anode number two at earth potential; this naturally depends upon circuit design and requirements.

To-day, the C.R.O. is an essential piece of equipment and enables the experimenter to investigate waveforms, valve characteristics, electrical and

mechanical equipment as well as a host of others which are too numerous to mention.

#### Layout and Screening

In the design of any oscilloscope special attention should be paid to the design and layout of the power pack, because the presence of any ripple voltages will undoubtedly cause modulation of the electron beam. One must, therefore, give plenty of thought to the filter section of such a pack.

Another important factor is that of screening, because the tube is extremely sensitive to magnetic or electric fields. Ample screening must therefore be provided, not only for the tube, but if possible to such components as transformers and chokes. Suitable screens for these surplus tubes can still be obtained from various dealers who have in the past broken down equipments for their components. It is of importance not to forget to earth the screens, otherwise the screening effect will be lost and interference to the beam will still prevail.

To conclude, it is not out of place to mention to the reader, whether new or old, that cathode-ray tubes are usually operated at high potentials and great care must therefore be taken when using them.

## From Our American Correspondent

### First Records on Tape

THE first full-range recorded tapes for commercial sale featuring major orchestras with noted conductors and soloists were introduced by MaVo-Tape, Incorporated, at the October 29th-November 1st Audio Fair, in New York City. Distribution of the recordings, to be sold as "Magnecordings by Vox," is to follow the New York introduction.

The "Magnecordings" will be recorded on half tracks of standard recording tape at  $7\frac{1}{2}$  in. per second tape speed, presenting a full hour programme on a professional 7 in. reel. Special equalisation in recording will give high-fidelity reproduction up to 15,000 c.p.s.

The "Magnecordings" will be made by Magnecord, the world's oldest and largest manufacturer of professional magnetic tape recording equipment for MaVoTape, Inc., from the "master" tapes of the Vox Productions, Inc., library, and will be distributed initially through Magnecord distributors. "Magnecordings by Vox" will offer all the advantages of tape recording; no surface noise, no loss of quality through wear, and the accurate liveness and range of full frequency reproduction, 50 to 15,000 c.p.s.

"Magnecordings" will be sold by "time segments"; the length of the selection will determine the price of the tape. An hour programme, 7 in. reel of 1,200 ft. (2,400 ft. of recorded programme), will sell for \$9.95.

Plans call for six releases per month. Initial releases will include *Shostakovich*—Fifth Symphony by the Vienna Symphony Orchestra, Jascha Horenstein conductor; *Mahler*—Symphony No. 2 in C Minor, "The Resurrection," by the Vienna Symphony Orchestra, Otto Klemperer conductor, with Ilona Steingruber soprano; and, *Tchaikovsky*—Piano Concerto in B Flat by Monique de la Brouchellerie and the Vienna Symphony Orchestra.

Distribution of "Magnecordings by Vox," throughout Latin America will be handled by Magnecord Western Hemisphere, Inc., 89, Broad St., New York, 4, N.Y., and to all other countries by Magnecord International, Ltd., of the same address.

### New Model of Eicor Tape Recorder

EICOR, Inc., announces a newly-styled model of their famous tape recorder which retains the same basic trouble-free mechanism with the following improvements:

A pressure tape roller that engages automatically.

An easier method of changing recording speed, consisting of merely removing the  $7\frac{1}{2}$  in. speed sleeve which is fitted over the  $3\frac{1}{2}$  in. speed shaft.

The amplifier is equipped with an equalisation switch for the frequency change between the low and high speeds.

Self-aligning plug-in recording heads are provided as standard equipment. This gives a quick change from single- to dual-track recording and enables a new head to be installed without servicing.

A locking system is built into the record-listen switch to guard against accidental erasure.

A more easily operated system of mechanical and electrical switching makes the recorder extra easy to operate.

A red indicating light for "record" and a green light for "play" give extra-visible indication of the position of the record-play switch.

Four standard type-gramophone jacks—two for input and two for output—have been provided. The outputs have cut-out switches.

The case has been re-styled and strengthened, and the lid will close on the unit while loaded with 7 in. reels, ready for operation. Storage of the microphone and A.C. supply cord, which plugs into the unit, is in the lid of the case.

Eicor tape recorders are exported exclusively by Ad. Auriema, Inc., 89, Broad Street, New York, 4, N.Y.

**CITY & RURAL**

Immediate delivery  
from stock.

**"VIEWMASTER"**

SPECIFIED COMPONENTS

SEND FOR STAGE I NOW—  
price £3.2.3 post free.

Complete Kits, Stage-by-Stage  
and Single Components Supplied.  
"VIEWMASTER" ENVELOPES, 7/6

COMPLETE SET OF GUARANTEED  
VALVES FOR "VIEWMASTER"  
£6.15.0

Television Explained, by W. E. Miller, 5/-.  
6in. CRT Magnifier Lens, 22/6.  
Belling 72-ohm Twin Feeder, 7id. yard.  
Electrolytics, Tubular, 8 mfd. 450v.,  
2/3; 32-32 mfd. 275v., 3/6.  
Multi-Ratio O/P Transformers, 5/11.  
Speakers P.M., 3in., 13/6; 5in., 14/6;  
6in., 16/6; 8in., 19/6.  
6V6GT, 10/6. VR81, 8/6. 5Z4G, 10/6.  
Heater Transformers, 6.3v. 1.5A., 7/6.  
2.5 Kv. Transformer, 45/-.  
Smoothing Chokes, 10H 100 mA., 8/3;  
15H 60 mA., 5/11.

Extensive Stocks New & Surplus  
Components & Valves

For Attention—Advice—Service write

**CITY & RURAL RADIO**  
101, HIGH STREET,  
SWANSEA, GLAM.

Telephone: Swansea 4677

**EDDYSTONE**  
**COMMUNICATION**  
**RECEIVERS**  
OF  
**SURPASSING EXCELLENCE**



MODEL '740'

A Robust 8-valve Communications  
Receiver at a moderate price.  
Frequency range 30.6 Mc/s to  
1.4 Mc/s and 205 to 220 metres.  
Mechanical bandsread. A.C.  
mains (110-240 volts) with provision  
for 6-volt battery operation.

Price: **£38.15.0**  
(Exempt from P.T.)

**HIGHSTONE UTILITIES**

Soldering Irons, streamlined iron, with  
curved Pencil Bit, 200/250 v. 50 w., 11/6.  
Standard Iron, with adjustable bit 200/250  
v. 60 w., 13/6. Heavy Duty Iron, 150 w.,  
16/6. all post 8d. Meters, small ex 2in.  
meters 1/- each, post 3d. Telephone Hand  
Generator, with handle, 9/6, post 1/6.  
Bell Transformers, for use on 200/250 v.  
A.C. Mains. Output 3, 5 or 8 volts at 1 amp.  
9/-, post 8d.

Crystal Sets, which are fitted with a permanent  
crystal detector. Why not have a set  
in your own room—12/6, post 8d. De Luxe  
receiver in polished oak cabinet, 18/6,  
post 1/- Spare Permanent Detectors, 2/-  
each. When ordered separately, 2/6. With  
clips and screws, 2/10, post 3d.

Headphones, in good order, 6/-; better  
quality, 7/6. New Headphones, 10/- a  
pair. Balanced armature type (very sensi-  
tive), 12/6 a pair, all post 8d. New Single  
Earpieces, 3/6. Bal. armature type, 4/6;  
ex-R.A.F. earpieces, 2/6, post 4d. All  
headphones listed are suitable for use  
with our crystal set. Hand Microphones,  
with switch in handle and lead, 4/6. Similar  
instrument, moving coil, 7/6, post 9d.

Sparkling Plug Neon Testers, with vest  
pocket clip, 3/3, and with gauge, 3/6, post 3d.  
Ex-R.A.F. 2-Valve (2-volt) Amplifiers,  
can be used to make up a deaf aid outfit,  
intercommunication system, or with  
crystal set, complete with valves and fitting  
instructions, 20/-, post 2/-. Ditto, less  
valves, 10/-. Wooden box to hold amplifier,  
2/- extra. One valve amplifier, complete  
with valve, 10/6, post 1/3.

Meters, 10 v., 2in. Rectifier (a.c.) in  
wooden carrying case, 14/6 + 15 v., 2in.  
m.c., 8/6; 150 v., 2in., m.c., 10/-; 0.5 amp.  
2in., T.C., 6/-; 4 amp., 2in., T.C. in case  
with switch, 7/6; 100 mA 2in. m.c./7/6. All  
meters post extra. Money refunded if not  
completely satisfied.

**HIGHSTONE UTILITIES,**

58, New Wanstead, London, E.11.  
Letters only. New Illustrated List sent on  
request with 1d. stamp and s.a.e.

**VALVES BY RETURN**

1G6	4/6	6SC7	7/6	EL32	7/6
1G8GT	5/6	6SG7	8/6	EL81	10/6
1LD5	6/6	6SH7	5/6	KT61	10/6
1LN6	6/6	6SQ7	9/6	KT63	7/6
1R5	9/6	6SN7	10/6	KT66	10/6
1S4	9/6	6SS7	7/6	OZ4	7/6
1S5	9/6	6U7	6/6	PEN46	7/6
1T4	9/6	6V8G	9/6	QP25	7/6
16Z5	5/6	6XSGGT	7/6	RK34	3/6
215SG	4/6	7193	3/6	RL37	4/6
25A6	9/6	77	7/6	RR72	2/6
2D07	2/6	7B6	6/6	SP4	7/6
2C34	3/6	7R7	7/6	SP41	3/6
35L6	11/6	854	2/6	SP61	3/6
3D6	5/6	9D2	3/6	TP25	8/6
3S4	10/6	12A6	7/6	U21	10/6
50Y6GT	7/6	12J5	5/6	U404	9/6
5U4G	9/6	12SG7	5/6	VR21	3/6
5Y3-5Z4	8/6	12SH7	5/6	VR53	6/6
6AC7	7/6	12SL7	7/6	VR54	2/6
6BB	7/6	A015	5/6	VR65	3/6
6F6	8/6	ARP12	5/6	VR85A	3/6
6F8	5/6	CV6	2/6	VR66	3/6
6G6GT	9/6	D1	2/6	VR78	2/6
6H6	5/6	E1148	2/6	VR150	10/6
6J5GT	5/6	EAS0	2/6	VS110	7/6
6J6	10/6	EP36	6/6	VT82	5/6
6J7G	7/6	EP50	6/6	VU39	10/6
6K6	8/6	EP54	4/6	VU111	3/6
6K7G	6/6	EP91	10/6	VU102A	3/6
6N7	8/6	EK32	6/6	VU133	3/6

All the above are Boxed and Tested and  
carry my guarantee.

Money back if dissatisfied.  
Please include a small amount for  
postage.

MAIL ORDER ONLY

**E. MINETT (P.W.)**

VALVE SPECIALIST

54, RETREAT STREET  
WOLVERHAMPTON



MODEL '750'

An outstanding 11 valve Double-  
Superheterodyne with excellent  
signal to noise ratio.  
Voltage stabiliser, separate  
oscillator.  
Frequency range 32 Mc/s to  
480 kc/s.

Price: **£68**  
(Exempt from P.T.)

Please write for Technical  
Specification and address  
of your nearest Eddystone  
Agent to:

**STRATTON & CO LTD**  
EDDYSTONE WORKS  
ALVECHURCH ROAD  
WEST HEATH BIRMINGHAM.

**SAMSONS**

PAINTON ATTENUATORS.—5,000  
ohms in 75 ohm steps, 1in. spindle,  
10/6. P.P., 1/-.

DESYNN TRIMMERS.—No. 167, with  
Desynn potentiometer, 10/6. P.P., 1/-.  
4in. W.W. POTS.—2,000 ohm each  
half, 15/-, P.P., 1/6.

U.S. ARMY INTERPHONE AMPLI-  
FIERS.—BC-347C, complete with  
6F6G valve, 15/-, P.P., 1/-.

MINIATURE ALKALINE CELLS.—  
204 volts, 8-10 A.H., size to top of ter-  
minals, 4in. x 1 1/2in. x 3in., 7/6. P.P., 1/-.  
24 volts, 15-20 A.H., size 6in. x 4in. x  
3in., 17/6. P.P., 1/6.

HEAVY DUTY TRANSFORMERS.—  
Prim. 200/230. Sec. 10 volts 15 amps,  
32/6. P.P., 2/6. Prim. 200/240 volts,  
Sec. 6.3 volts 15 amps, 25/-, P.P., 2/-.  
Prim. 230 volts, sec. 12 volts 10 amps,  
22/6. P.P., 2/-.

6 MED. 1,500 VOLTS WKG. CON-  
DENSERS.—Size 5 1/2in. x 4 1/2in. x 3in.,  
5/6. P.P., 1/6. 2,250 mfd. 2,000 volts  
wkg., size 6in. x 5in. x 3in., 7/6. P.P., 1/6.  
4 mfd. 800 volts wkg., 160 P.F., size 5 1/2in. x  
3in. x 2in., 5/6. P.P., 1/-; 8 mfd. 400  
volts wkg., size 5 1/2in. x 3in. x 1 1/2in., 6/-,  
P.P., 1/-.

MINIATURE LIGHTWEIGHT 4J  
VOLT REVERSIBLE MOTORS.  
—Ideal for models. Size 1 1/2in. x 1 1/2in. x  
1in., 7/6. P.P., 10d.

34ft. AMERICAN SURPLUS TELE-  
SCOPIC STEEL AERIAL MASTS.  
—Length closed, 6ft. 6in. Dia. of first  
section 1 1/2in., top section 1in., complete  
with base guy, insulated assembly  
and metal pegs. £8/10/0. Carr. 7/6.

169/171 Edgware Road  
London, W.2. Tel. PAD. 7851

125 Tottenham Court Road, W.1  
Tel. EUS. 4982

All orders and enquiries to our Edgware Road  
branch, please. Open all day Saturday at  
the Edgware Road Branch.

**DUAL RANGE POCKET  
-VOLTMETER-**

**0-12 v. 0-250 v. A.C./D.C.**



Robustly constructed in Black Lacquered Brass Case, this accurate and well-finished instrument has many uses in the workshop and the home. The Dual Range makes possible the accurate testing of Car, and all L.T. and H.T. Batteries, and house and workshop wiring. The moving Iron System permits considerable overload without damage to the instrument. Particular attention has been paid to Scale Clarity. DIAMETER 2ins. DEPTH 1in.

**THE TECHNICAL SERVICES CO.**  
Shrubland Works, Banstead, Surrey.

Price 19/- each.  
Plus postage and packing 1/-.

**“TYANA”  
SOLDERING IRON 16/9**



*The Perfect Small Soldering Instrument*

- Adjustable Bit. ● Easy to handle. ● Weight approx. 4 ozs. Overall Length 11in. and the Diameter of the Bit is 1/4in.
- Heating Time 3 min. ● 40 Watt economy Consumption. ● Standard Voltage Ranges (other Ratings Available on Request).
- Long Life and Efficiency. ● Replacement Elements and Bits always available.

Just the Convenient Iron Required for Intricate and Fine Soldering.  
Maintenance Service for Industrial users.

British made by:—  
**KENROY LIMITED**  
152/297, Upper Street, Islington, London, N.1.  
Telephone: Canonbury 4905-4663

**SPARKS' DATA SHEETS**  
are the Safest and Finest Constructional Sheets of Guaranteed and Tested Radio Designs.

**MEET THE "BOSUN"**  
After the phenomenal success of my "Middy" design, I wish to introduce the "Bosun" to those who want a Simple, Economical and More Powerful All-Dry battery Receiver.

**WHO IS THE "BOSUN" ?**  
The "Bosun" represents my Latest Design. It has been tried under the most difficult conditions in Dorset, and has passed all tests with flying colours.

The "Bosun" is a 3-Valve "Straight" design, covering Ship-to-Shore Transmissions and Medium and Long-waves. Tests have proved it to be outstanding in its performance.

**CONSTRUCTING THE "BOSUN"**  
My Data Sheet No. LO/34 covers, in every detail, the building and wiring of this design. Price 3/2d Post Paid.

The "Bosun" uses the same Coil, Valves, Switch, Condensers and Resistors, etc., as the "Middy". **STAMP FOR LIST**

**L. ORMOND SPARKS (P), 49A, HIGH STREET, SWANAGE, DORSET**

**A REALLY SMALL RADIO  
RECEIVER**

This radio receiver is only half the size of a matchbox but gives loud, clear reception of the BBC Home, Light, and Third Programmes on the medium waveband, about 180-550 metres. No catwhiskers, crystals, or batteries are required, and the set works off a short indoor aerial in many districts. By the addition of a small, simple, and cheap loading coil the set can be made to tune the Light Programme on 1,500 metres.

**PRICE  
9/-  
POST FREE**

**SWIFT RADIO (W)**  
137, COTHAM BROW, BRISTOL, 6  
Orders by Post Only.

**SPECIAL OFFER  
COMPARE THESE PRICES**

EA50, 1/6; 954, 6H6, 12H6, MIL6, 2/-; ATP4, 3D2, 3/6; 12SG7, 12SC7, 12SJ7, KTZ41, MS/PBN, PEN220A, 15D2, 4/-; 6J5, 90B1, VP23, 4/6; 801A, 843, 954V, W63, SP4, 6B4, 6J7, 12CB, EF36, 2A3, 8B8, 9D2, 6G6, 2X2, 8S87, 6F5, KTZ63, 2D7, 5/-; 0Z1, 1LA, 6F50, 6/-; OA4, SP4, EK32, EB33, 6J7GT, 7F7, 7T, KT3, 6K6, 6A5, 12A3, 6SK7, 16I6, PEN25, PEN46, HL133D, VP133, 6F7, 6F8; EF92, VP41, 7/-; TP26, MHLDS, UF41, 3Q4, 7C5, 25L6, 41, 42, 1622, PEN393, 7/8; KT66, X41, MH4105, EZ40, 6BA6, 6L9G, 8B5, EF41, KT33C, TP22, 834, TH233, 8/6; 6A8, 6F41, KT33C, TP22, 834, TH233, 8/6; 6A8, 6F41, KT33C, TP22, 834, TH233, 11/6; 6L6M, 9/6; EL33, 3A8, 10/-; TH23C, 11/6. ONE ONLY of each of the following to each customer.—6K8, 6A5, 8/6; 807, 6V6, 17/4; 7/6; 6SF3, 7/-; VR150, 6/6; 6AG3, 6/-; 6K7, 6X5, 6L7, 6N7, 3A4, 5/-; MINIMUM ORDER 2d, post free. Order early to avoid disappointment. Send S.A.E. for full list.

**ELECTRAD RADIO  
69, HIGH ST., BELFAST, N. IRELAND**

**—THE MODERN BOOK CO.—**

**Electronic Measurements**, by Terman and Pettit. 72s. 6d. Postage 1/-.

**The Practical Electrician's Pocket Book, 1953.** 5s. 0d. Postage, 6d.

**Television Receiving Equipment**, by W. T. Cocking. 18s. 0d. Postage 6d.

**Radio Data Charts**, by R. T. Beatty. 7s. 6d. Postage 6d.

**Practical Wireless Encyclopedia**, by F. J. Camm. 21s. 0d. Postage 9d.

**Radio Engineers' Handbook**, by F. E. Terman. 50s. 0d. Postage 1/-.

**Amplifiers**, by G. A. Briggs and H. H. Garner. 15s. 6d. Postage 6d.

**Radio Interference Suppression**, by G. L. Stephens. 10s. 6d. Postage 6d.

**Magnetic Recording**, by S. J. Begun. 25s. 0d. Postage 9d.

**Sound Recording and Reproduction**, by J. W. Godfrey and S. W. Amos. 30s. 0d. Postage 6d.

**The Radio Amateur's Handbook**, by A. R. R. L. 30s. 0d. Postage 1/-.

**Television Faults**, by N. Stevens. 5s. 0d. Postage 3d.

**Radio Servicing Equipment**, by E. Lewis. 25s. 0d. Postage 9d.

**The Williamson Amplifier.** 3s. 6d. Postage 3d.

**The Radio Valve Data**, compiled by Wireless World. 3s. 6d. Postage 3d.

We have the finest selection of British and American radio publications in the Country. Complete list on application.

**19-23, PRAED STREET,  
(Dept. P.12) LONDON, W.2  
Paddington 4185.**

**TWO NEW UNIQUE SERVICES!**

Are you (1) Making your own chassis? (2) Wondering where you can get that valve that doesn't seem to be on anyone's list (even ours!) at ex. (govt. price)? If so, we think we can help you. Send S.A.E. for our latest list and NEW SUPPLEMENT.

**NEW CONDENSERS.—**British moulded mica: 75, 100, 150, 200, 400, 450, 500, 540, 600, 700, 1,000, 2,000, 4,000, 5,000, 10,000 pf. Silvered mica: 10, 15, 20, 30, 50, 75, 100, 120, 200, 3,000, 4,000, 4,700 pf. All 3/6 doz. (minimum). U.S.A. moulded mica: 50, 220, 1,200, 2,000, 2,200, 5,000, 4/6 doz.; 10,000 pf. (short-wire ends); 2/6 doz. (minimum).

**CONDENSER BARGAIN.**—Our selection. 50 of above. 10/-.

**RESISTORS.**—All preferred values: 1 w, 6d.; 1 w, 9d.; 4 w. (most values). 41d. 41s. 5 w. 700, 3K, 4K, 5K, 6K, 12K, 20K, 30K, 500K, 8d.; 10 w. 3.5, 56, 10K, 15K, 20 w. 6.3, 5, 40, 44 (tap 15), 1/-.

16in. HOME-BUILT TELEVISION I.—Superhet, 5-channel. Lab. tested. Full constructional details, 6/-.

**VALVES.**—All types advertised last month.

**SPEAKERS.**—5in. makers' cartons, 13/9, post 1/6. 6MED. 2,000v. TEST metal condensers, 4/9, post 11d. GO-AX. Standard, 4in. 75/80 ohms, 10d. yd.

**POST FREE ON ORDERS OVER 21/-**

**(E.S. & F.F.R.I.)**

**2A, BURNLEY ROAD, AINSDALE, SOUTHPORT**

**H.A.C. SHORT WAVE  
EQUIPMENT**

Noted over 18 years for S.W. Receivers and Kits of Quality.

Improved designs with Denco coils  
**One-Valve Kit, Model "C" Price, 25/-**  
**Two " " " " "E" " " " 50/-**

All kits complete with all components, accessories, and full instructions. Before ordering call and inspect a demonstration receiver, or send stamped, addressed envelope for descriptive catalogue.

**"H.A.C." SHORT-WAVE PRODUCTS**  
(Dept. TH), 11, Old Bond Street, London, W.1.

# THE DECIBEL

## • THE APPLICATION OF THIS UNIT, WITH WORKED EXAMPLES

ONE of the most useful and most abused units in communications calculations is the decibel, or db as it is known for short. It is a logarithmic quantity and is a ratio of two powers. To get an idea of the unit, it is essential to have an idea of the function of logarithms. There are two types of these in general use, the log to the base  $e$  or natural log and the log to the base 10; the latter is used in most calculations. A log (the abbreviation of logarithm) is defined as the power to which one number must be raised to produce another number. For example, 1,000 is 10 multiplied by itself three times, and is often written as  $10^3$ . Now if  $\log_{10}$  is used, then  $\log_{10}$  1,000 would equal three, i.e., the power to which 10 had to be raised to produce 1,000. This looks simple, so we must look for a catch. Take, then, 3.16. This is the square root of 10; then how many times must 10 be multiplied by itself to produce this number? Obviously less than 1, but in algebra from the law of indices, a square root can be written as  $X^{\frac{1}{2}}$  so then root ten can be written as  $10^{\frac{1}{2}}$  or to keep the log as a decimal number,  $10^{0.5}$ . No snag there. Another example: 316 is equal to 100 multiplied by root 10. The logs of the numbers are added, i.e.,  $10 \times 10 \times 3.16$  would give a  $\log_{10}$  of  $1+1+0.5$ , so log to the base 10 316 would be 2.5. How about  $316 \times 316$ ? The answer on working out by arithmetic comes very near to 100,000, and the log of this number is five. The log of 316 is 2.5, so that log  $316 \times 316$  would be  $2.5+2.5$ , which equals 5. The answer is, then, the same whether we work forward or backwards.

In communications work, the ratio of two powers to the base 10 is called the Bell, but as this involves the use of decimals, the decibel is used. This is one-tenth the ratio of the Bell, and is obtained by multiplying the ratio to the  $\log_{10}$  by 10; this then gives a number in which the unit represents the log of a number, whilst the tens and hundreds figures represent the number of 0s. The formula for the number of db is given as  $10 \log_{10} P1/P2$ , where P1 is the larger power and P2 the smaller. If the power put in is larger than that got out, then there is a loss or negative gain, i.e., if there is a loss on calculation of 5db it can also be regarded as a gain of -5db; alternatively, a gain is a negative loss. Again the term so many db up is a gain whilst so many db down is a loss.

Very often in calculations it is a ratio of voltages that have to be dealt with. Now these cannot be converted to db ratios, unless the resistance is known, as the formula  $E^2/R$  gives the power dissipated by a voltage in a resistance.

The number of db will be  $10 \log_{10} \frac{E^2/R}{e^2/r}$ .

Only if the input resistance is equal to the output resistance can the formula  $20 \log_{10} E/e$  be used, as the two Rs cancel out.

There is also another formula for calculating the db from resistance and current. The power dissipated by a current in a resistance is  $I^2R$ , so the formula  $10 \log_{10} I^2R/i^2r$  can be used. But if

R and r are of the same value, the formula can be simplified to  $20 \log_{10} I/i$ .

### Examples

One or two examples of the use of these calculations will be of use. A certain aerial gives into a transmission line of 80 ohms, an output of 10 mV. at a certain frequency, and another gives 20 mV. into the same load. The power delivered is thus four times. Applying the formula  $20 \log_{10} E/e$ , we get  $20 \log_{10} 20/10$ .  $\log_{10} 2$  is from our tables 0.3; this multiplied by 20 gives 6 db. On the other hand, if two aerials gave the same voltage output, but one delivered it to a 100 ohm load and the other to a 50 ohm load, the second would have an output that was 6 db. higher than the other. Another example. An amplifier requires an input of 1 volt to give an output of 5W. With an input of 1M this would give a gain of  $10 \log_{10} 5/0.000,000,1$ , equals  $10 \log_{10} 5,000,000$ , equals  $10 \times 6.7$  or 67 db, but if the input resistance was 1,000 ohms the gain in db would only be 37 although the input voltage had not altered.

Another use of the db is in calculating the frequency response of amplifiers. In this case the response is given at a certain power at a certain frequency, say, 5 watts at 1,000 cycles for a certain input voltage. If the output power is measured at another frequency, the ratio of the powers is given in db, i.e., if there is only half the power at 300 cycles the response would be said to be 3 db down at this frequency. It is usual to plot the response on graph paper that has a straight law on the vertical and logarithmic on the horizontal.

### A Table of $\log_{10}$ of Useful Numbers

Log 1 is 0.00	Log 10 is 1.0
Log 2 is 0.30	Log 100 is 2.0
Log 3 is 0.48	Log 1,000 is 3.0
Log 4 is 0.60	Log 10,000 is 4.0
Log 5 is 0.70	Log 100,000 is 5.0
Log 6 is 0.78	
Log 7 is 0.85	
Log 8 is 0.90	
Log 9 is 0.95	

## REFRESHER COURSE IN MATHEMATICS

By F. J. CAMM

8/6, by post 9/-

GEORGE NEWNES, LTD.,

Tower House, Southampton Street, Strand, W.C.2

# Programme Pointers

By MAURICE REEVE



## Attack on BBC

**D**URING September the *Daily Telegraph*—and doubtless other papers—quoted excerpts from a speech made to a Mothers' Union Festival, at Lowestoft, by Canon Stather Hunt, Rector of Pakefield, Lowestoft, in which the Canon roundly denounced the dramatic fare provided by the BBC and, more particularly, its selection of plays for "the popular feature, 'Saturday Night Theatre.'" "Ninety per cent. of these plays," the Canon said, "hinge on the adulteries or would-be adulteries of the characters."

Other points from Canon Hunt's address were that the plays "were a menace to the moral health of the country"; "Sexual sin is apparently regarded as not being merely normal but sometimes almost glorious . . ." and "Why not portray pure love and the happiness of married life."

With all due respect, it is difficult to imagine a more ridiculous or inaccurate condemnation. I have often felt obliged, on this page, to pass my own strictures on "Saturday Night Theatre" choices, but invariably from the exactly opposite avenue of approach to the Canon's. To me they more often fail for the very want of those elements which, had they been present, would have enhanced them both as dramatic vehicles and pictures of real life. "Rupert of Hentzau" and "Quiet Week-end" are much more typical than, say, "Autumn Crocus."

Coast erosion in East Anglia has made sad havoc of Pakefield in recent years, and parts of it that were a respectable distance from the coast, when I was on holiday there as a child, are now no more. As the mothers of those fast-departing acres listened to the "Voice on Sinai" the other night, they must have wondered whether they were going to be allowed to listen at 9.15 on the following Saturday. It is utterly absurd to say that 90 per cent. of these plays are hinged on the adulteries, or would-be adulteries, of the characters, and I would recall to Canon Hunt the ever-true words of Dean Inge that "the soul is dyed the colour of its leisure thoughts."

## "Saturday Night Theatre"

Of the two "Saturday Night Theatres" I "attended" this month one, "Autumn Crocus," would certainly justify the Canon's moral strictures. But the other, "The Heiress," has not the slightest elements of adultery or sex in it. Both were huge West End successes, the former before the war and the latter very recently.

Dodie Smith's beautiful play deals with an idyllic story of an English school-teacher, on holiday in Switzerland, having her first love affair with the proprietor of the hotel where she and her friend are staying—a married man with a family. But as virtue is triumphant and the young lady returns home to her duties and the path of duty, Canon Hunt should not be too squeamish over it. Martyn

C. Webster's production captured the essential spirit of the piece which, as the part of Fanny—excellently played by Marjorie Westbury—was idealized love; and Albert Leiven, as the hotel proprietor, caught the more mundane and material side of the affair to a T.

"The Heiress," based on Henry James' novel of the same name, by Ruth and Augustus Goetz, is a most delicate and entralling story. Catherine is the daughter of a Boston doctor. Her mother, apparently a beautiful and gracious woman, died when she was a child. Because her father believes her to have grown up without any of her mother's beauty and charm—rather like himself, presumably! he visits her with a cold and cynical brutality and makes of her life little better than hell on earth. To complete her wretched lot, she falls in love with a young scoundrel who, after proposing to her for her prospects, deserts her for learning that those prospects are not likely to be as much as was hoped. Returning a complete failure, from the Californian gold rush and renewing his base suit, the heroic girl rises to her full stature and tells both her worthless father and lover just where they get off.

Although Cecil Trouncer as Dr. Soper and Patricia Hilliard as Catherine didn't quite rise to the heights of their prototypes at the Haymarket, they gave a completely satisfactory performance, as did Peter Cotes, Gladys Young and the rest. Frederick Bradnum's production was equally satisfactory.

## "The Lady from the Sea"

In spite of these two first-class shows, I think Ibsen's "The Lady from the Sea" in the Monday World Theatre series was even better. The old master at his favourite theme, of releasing woman from her age-old shackles and giving her a chance to breathe the air of "freedom" and "liberty," writes a most moving play, even though it is not quite the masterpiece that "Ghosts" and some of the others are. Peter Watts's production and translation were powerful and William Fox, Marie Ney, Heron Curvic, Valentine Dyal, etc., formed an excellent cast.

## Piano Concerto

E. Sackville West gave another of his absorbing and erudite analyses of piano concertos, this time with the great Brahms B flat. It may have "claims" to being the greatest, as Mr. West said, but it definitely is not. Of all the records used as illustrations, no mention was made of easily the finest, and probably the finest of all discs, that of Horowitz and Toscanini.

**SALVAGE RADIO-GRAM CHASSIS.**—5 valve, superhet. 1952 model. Made to sell at three times this price. Latest pin-type midget valves (B8A series). 4 watts A.F. output. Incorporating own O.P. transformer and smoothing circuit for use on any P.M. speaker. Three wave-bands, and gram position. Price, complete, but without speaker, £9-17-6 for front-drive (as illustrated), and £7-17-6 for end drive. Post and packing, 4s. 6d.

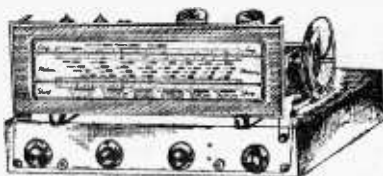

**SLASHED PRICES**

**RECORD-CHANGERS.**—Brand new but superficially damaged by foam extinguisher. All thoroughly reconditioned and tested before despatch. Can be used with our radio-gram chassis to enable you to build your own radio-gram at a fraction of today's costs. Three-speed models, £8-17-6, single-speed, £5-17-6. Collaro and Garrard.



**EXTENSION SPEAKERS.**—Brand new 5in. P.M. Speaker on latest type baffle stand, polished, gold-sprayed metal fret, 5ft. lead, 19/9. Also available in totally enclosed polished cabinets, 25/9, packing and post, 1/9.

**TRANSFORMERS.**—Mains (Salvage). 260-0-260, 6.3 v.; 3 A., tapped for 250, 210, 110 v. Price, 12/6. Post 2/-. Also standard O.P. Trans. at 2/9. Post 1/1-.

**CONDENSERS.**—Two - rang. .0005 mfd. (salvage). 2/9; single cond. .0005 mfd., 2/6; Electrolytics —16-16 mfd. 500 VDC. 4/9; 12-12 mfd. 350 VDC. 3/9; 30-20 mfd. 450 VDC. 3/9.

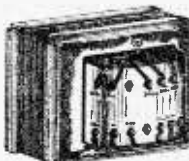

**T.R.F. RADIO SET.**—Ideal for the bedroom. Choice of ivory or walnut brown plastic cabinet. Complete kit of parts, with full instructions and points to point wiring diagrams, £6-7-6. Assembled ready for use, 35/- extra. Please state whether A.C. or A.C./D.C. required. Postage and packing, 3/6.

**GRAM MOTOR.**—Clockwork type, by E.M.I. Double mainspring. No handle. Working order, 13/9. Postage and packing 2/3.

**SOLDER.**—Ersin multicore (salvage), 4d. a yard. **INSULATING TAPE.**—New and wrapped, 1/6 per 4 lb. roll (jin.). **WIRE.**—Spring steel at 1/- per reel, and Nichrome at 4/6. Two sizes in each kind, .032in. (25 yards), and .014in. (50 yards). **CABINETS.**—Polished wood, with gold-sprayed metal fret, 12/9.

**VALVE CLEARANCE OF SALVAGE STOCKS**

11/9	10/9	8/9	6/9	5/9	3/9
3525	5U4G	1S4	3D6	6J5	4D1
3524	EF41	1S5	6L7	6J7	6C5
GTIC	EL41	1R5	77	12S-37	AR6
PM25	U50	1T4	757	12S-37	CC2
EY51	6V6G	EF91	EB91	12SH7	EB34
ECL80	EF90	10F1	EF92	UY41	E1148
V160	6C6	12SG7	SP41	UF41	PEN383
607	6B8	DCC90	ARP12	15D2	855
524	PT41	KTW61	EF50	TT11	9004

STAMP FOR CATALOGUE.

C.W.O. OR C.O.D.

**DUKE & CO.,**

621, ROMFORD ROAD, LONDON, E.12.  
GRA 6677 Money back guarantee

**SMOOTHING CHOKES**

20 mA 40 H	3/11
40 mA 8 H	3/11
40 mA 10 H	4/3
100 mA 10-20 H	7/3
150 mA 3 H	3/6
120 mA 10 H	18/6

**OUTPUT TRANSFORMERS**

40 mA Multi ratio	6/11
80 mA Multi ratio	14/11
80 mA Pentode	12/6
60 mA Plessey, 6,000 ohms	5/11
Standard pentode	4/11
Pentode	3/6
Midget pentode	4/3
Miniature pentode, 3S4	4/6
1B4	8/6
PX1 intervalve	8/6
5:1 intervalve	5/11

**SPECIAL OFFER**

4 Valves, 1 each —U50, EL33, EF3, ECH33, 39/6. POST FREE.

**TWO-GANG TUNING CONDENSERS .0005MFD.**

No. 1. Miniature. With Perspex dust cover and trimmers. Size: 1 1/2 x 2 x 1 1/2in. 4in. spindle ..... 8/6  
No. 2. Midget. With trimmers. Size: 2 1/2 x 1 1/2 x 1 1/2in. 4in. spindle ..... 8/6  
No. 3. Midget. With one trimmer. Size: 2 1/2 x 1 1/2 x 1 1/2in. 4in. spindle ..... 7/6  
No. 4. Standard type. Size: 2 1/2 x 2 1/2 x 1 1/2in. 4in. spindle ..... 6/6

**THREE-GANG TUNING CONDENSER**

.0005 mfd. Size 3 1/2 x 2 1/2 x 1 1/2in. 4in. spindle 7/6

**SUPERHET COILS**

Aerial and oscillator. For 465 Kc/s. I.F. Supplied with circuit. Size, each coil:—1 1/2in. high. 1 1/2in. diam.

No. 1. Long and medium wave. 2/11 per pair.  
No. 2. 10-30 metres. 1/11 per pair.  
No. 3. 25-95 metres. 1/11 per pair.  
Postage 9d. per pair extra.

**SPECIAL OFFER**

1 Pair of each range. 6/9. POST FREE.

**TEST PRODS.**

Fused, with fully retractable contact points. 4/11 per pair.

**SPEAKERS. No Tax On Our Stock Yet**

All 3 ohms. P.M. Less o. trans. 3in., 12/6, 3 1/2in., 12/11, 5in., 12/6, 6in., 13/6, 8in., 15/-, 8in. Closed field, 17/6, 10in. light weight, 19/6, 10in. Goodmans, 25/-, 10in. Wharfedale Bronze 15 ohms, 89/6, Goodmans, Audiom 60, 15 ohms, £8.12.6.

**I.F. TRANSFORMERS**

**MIDGET TYPE.** 465 Kc/s. Iron dust cores. In can size 1 1/2in. x 1 1/2in. x 2 1/2in. high. 12/6 per pair.

Wearite type 550. Permeability tuned, 445-520 Kc/s. In cans. size 3 1/2in. high, 1 1/2in. square. 12/6 per pair.

**SPEAKER FRET**

Expanded metal. Finished silver.	
12in. x 12in.	3/11
12in. x 18in.	5/11
Plastic. Finished bronze or cream.	
12in. x 5in.	2/-
12in. x 6in.	2/9
12in. x 16in.	6/6

**TRIMMERS AND PADDERS**

All values up to 100 pF. Pakolin 6d. each. 5/- per doz. Ceramic 6d. each. 7/6 per doz. 350 pF and 550 pF, 1/- each. 10/6 per doz.

**CONDENSERS ELECTROLYTICS**

32+32 mfd. 350 v.w. and 25 mfd. 35 v.w. in single aluminium can. Latest fixing, 4/11 each.	
8 mfd. 450 v.w.	2/3
8 mfd. 500 v.w.	2/11
16 mfd. 350 v.w.	2/6
16 mfd. 500 v.w.	3/6
32 mfd. 275 v.w.	2/6
50 mfd. 350 v.w.	3/11
60 mfd. 350 v.w.	3/11
250 mfd. 12 v.w.	2/-
250 mfd. 350 v.w.	4/11
8+8 mfd. 450 v.w.	4/6
8+16 mfd. 500 v.w.	5/3
12+12 mfd. 350 v.w.	3/6
16+16 mfd. 500 v.w.	4/6
16+24 mfd. 450 v.w.	5/11
32+32 mfd. 150 v.w.	2/6
32+100 mfd. 450 v.w.	7/6

**BIAS**

25 mfd. 25 v.w.	1/6
50 mfd. 12 v.w.	1/6
50 mfd. 50 v.w.	1/6
75 mfd. 12 v.w.	1/-

A large selection of record players and auto-changers, single and three-speed models available from stock. Collaro and Garrard.

**GARRARD AUTO CHANGERS.** Single speed, with magnetic pick-up. FROM £8.19.6.

**LASKY'S RADIO**

LASKY'S (HARROW ROAD), LTD.,  
370., HARROW ROAD, PADDINGTON,  
LONDON, W.9.

Telephones: CUNningham 1979-7214.

MAIL ORDER AND DESPATCH DEPARTMENTS: 485-487, HARROW ROAD, PADDINGTON, LONDON, W.10. Telephone: LADbroke 4075.

Hours: Mon. to Sat. 9.30 a.m. to 6 p.m.; Thurs., half day, 1 p.m.

Postage and packing charges (unless otherwise stated): on orders value £1—1s. 0d. extra; £5—2s. 0d. extra; £10—3s. 6d. extra; over £10 carriage free. All goods fully insured in transit.



**NEW VALVES ALL BOXED GUARANTEED**  
 SEE LAST MONTH'S ADVERT (page 536)  
 FOR SPECIAL SALE BARGAINS

**80 OHM COAX CABLE**  
 Standard dia. diam. Polythens insulated  
 Not ex-Govt., 10d. per yd.

**VOLUME CONTROLS.**—Midget Edison type. All values, long spindles, guaranteed 1 year. Less sw., 3/-; S.P.Sw., 4/-; D.P. Sw., 4/9.

**RESISTORS.**—All Values. 1 w. 4d.; 1 w. 6d.; 1 w. 8d.; 2 w. 1/-.

**WIRE-BOUND RESISTORS.**—Best makes Miniature Ceramic Type.—5 w., 15 ohm to 4 K., 1/9; 10 w., 20 ohm to 6 K., 2/3; 15 w., 30 ohm to 10 K., 2/9; 5 w. Vitreous, 12 K. to 25 K., 3/-.

**W/W POTS.**—T/V Type Pre-set. Miniature. Fitted knob is knurled and slotted. 200, 500 ohm. 1 K., 2 K., 2.5 K., 5 K., 10 K., 15 K., 20 K., 25 K., ea., 3/-.

**SOLDBES.**—60/40 Grade 16G, 4d. yd. 1 lb. reels 5/8d.

**COILS.**—Wearite "P" type, 2/8 each. Midget—Osmor "Q" type, 3/8 each. All ranges in stock.

**O/P TRANSFORMERS.**—Standard pentode, 3/9; Heavy duty 70 ma., 4/6; Universal tappped primary, 4/9; Midget 3/4 ea., 3/9; L/P, chokes 10 h. 65 ma., 4/8; 20/25 H. 150/100 ma., 12/6.

**ELECTROLYTICS.**—New stock. Best makes. 8/450 v. B.E.C., Midget 8-18/450 v. B.E.C., Tub. ... 2/8 Med. Can. ... 5/- 8/450 v. T.C.C., Small 16+16/450 v. B.E.C., Can ... 2/6 Med. Can. ... 5/6 16/450 v. T.C.C., Med. Can ... 3/6 Tub. ... 1/8 8+8/450 v. B.E.C., 50/50 v. B.E.C., Ins. Midget Tub. 4/- Tub. ... 2/- 60 mfd. 350 v. T.C.C. 250 mfd. 350 v. B.E.C. ... 6/8

**BARGAIN CORNER.**  
 Twin Gang .0005 mfd., 5/8; 2 v. Accumulator  
 10 A.H. 4/9; 6 v. Vibrator Pack (less vtr.), 12/6; 12 v. Vibrator Transformer, 7/6; Plessey I/F Transf., 465 kc/s, dust core tuning, HI-Q semi-midget, cans slightly soiled, 8/6 pair. I.F. Filter Coils, Litz Wire, Dust Core Tuning, 465 kc/s., 1/9.

**T.R.S. 307, WHITEHORN ROAD, WEST CROYDON.**  
 Telephone: THORNTON ROAD 1665  
 Mail Order: 71, Medvale Road, East Croydon.  
 Bargain Lists, 3d. Terms C.W.O. or C.O.D.  
 Over 21 post free. P. & P. 6d. extra.

**S.E. LONDON CONSTRUCTORS**  
 We hold good stocks of new and guaranteed  
**COMPONENTS AND VALVES**  
 Rewinds, loudspeaker repairs, communication and TV receiver alignment, etc.  
**GLYNDON RADIO SERVICE**  
 68, Wellington St., Woolwich.  
 WOO 2749.

**WALTON'S of WOLVERHAMPTON**  
**INSULATION TAPE,** tin. x 1lb. Ex A.M. Each Cellophane wrapped. To clear, 18/- dozen, 27/10s. Od. per gross, carriage paid.  
**RELAYS,** Super Sensitive High Speed, 7/6 each, postage 6d.  
**MAP CASES,** Plastic, 14in. x 10in., 3/6 each, postage 1/6.  
**10in. ROLA P.M. EXTENSION SPEAKERS,** 25/- each, postage 1/-.  
**SPECIAL 8+8+3 mfd. ELECTROLYTIC, 500V. D.C. working, 1/6 each** (only supplied with other goods).  
**Boxes of NUTS, BOLTS & WASHERS,** mainly B.A. sizes, each box contains approx. 1,000 items. 3/6 each, postage 1/-.  
**SPECIAL VALVE OFFER,** 6 brand new U.S.A. Valves (in original boxes) comprising—2 off VU111 High Voltage Rectifiers, 2 off RK34 V.H.F. Low Power Transmitters, 2 off 951 V.H.F. acorn Pentodes, 12 6 the 6, post paid Great Britain.  
 Send s.a.e. and 3d. in stamps for our latest list.  
**WALTON'S WIRELESS STORES**  
 48, Stafford St., Wolverhampton



**DEPT. P.W.**  
**18 TOTTENHAM CT. RD. LONDON, W.1.**  
**MUSEum 4539/2453**

**Ronette Microphone.** The latest Ronette XTAL mic. B10 Freq. 30,750 cps. Only 52/-  
**A.D.S. Hi. Fidelity Amplifier.** This is our latest gramophone amplifier which you MUST hear.

P.P. 6V6 output. Freq. 25-18,000 cps. + 1-lbt. Hum—60db at 61 watts. Treble boost and cut—Bass boost—L.P. correction. Provision for Feeder Unit. Max. UNDISTORTED OUTPUT 84 watts. Price **£15.0.0.** Send S.A.E. for leaflet.

**THIS AMPLIFIER WILL BE AVAILABLE AN AN EASY TO BUILD KIT AT A LATER DATE.**

**Gramophone Equipment.** B.S.R. 331—73 RPM Motor Unit, 78/7, plus 1/6. B.S.R. 3-speed Motor Unit, 26.8.8, plus 1/6. Collaro 3-speed Unit, XTAL Heads, £13.0.6. Collaro 78 RPM Changer, £12.3.3. Collaro 3 REG11, 3 speed, XTAL Heads, £18.10.0.

**Decca XMS PUP, 27, plus 1/-.** Connoisseur HTD PUP, 24.11.8, plus 1/6. Slight weight, one head, 26.9.0. LP Head, 71/8. Trans., 15/-.  
 Fibre PUP, 24.3.2. Trans., 25/-. Chaucery XTAL PUP, 54/-, plus 1/6. LP Insert, 31/8. Collaro AC514 Player Unit MAG Head, 26.10.5, plus 2/-.

**Garrard Heads.**—Hi Fi. 59/11. Miniature, 54/4. Standard, 26/8, plus 1/- post. Adaptors, Type A, 9/8. B, 6/7. C, 4/6, plus 1/- post.

**Collaro AC/DC Motor,** 12in. Table, 210.8.11, plus 2/6. Garrard AC8 Speed Controlled 78 RPM 2in. Table, 25.10.0, plus 2/6. Garrard AC72A 3-speed Turnover MAG Head, 216.6.8, plus 3/6.

**Denco Coil Pack.**—For P.W. Mini Four, 42/10, plus 1/6. M800 Wearite I.F.S., 21/-, plus 1/6. 3in. Flac Speaker 15/-, plus 1/6. Miniature O/P Trans. 4/-. Min. 1/6 neg. Pot. OP sw., 5/-.

**Metal Rectifiers,** RM2, 125 v., 100 ma., 5/9. R.M.1., 125 v., 60 ma., 5/-, plus 1/6. Type 280 STC 280 v., 80 ma., 10/-, plus 1/6.

**Denco "C" T.R.F. Coils.** Medium and Long wave, 8/- pair, plus 1/6.

**Variable Condensers.**—Midget 2-gang 500 pf. 7/8, with dust cover, 10/6. Standard, 7/6— with Trimmers, 8/6. 3-gang 500 pf., 7/8. All plus 1/6 postage.

**Speakers.**—3 1/2" FLAC, 15/-. 5in. FLAC, 15/-. 8in. ROLA, 19/8. 10in. Goodman, 27/8. 12in. Truvox, 32/2, 59/8, plus 1/3 postage.

**BRANDENBURG E.H.T. UNIT.**—6-9 kv. 6 gas. Coil only, 39/-. Coil with C22 Rectifier, 69.6. 10/15 KV Coils, 55/-.

**Qualtape "New Principle" 2-Speed Recorder** now available 16 gas. plus 3/6.

**Collaro Tape Deck Motors.**—Left and right hand drive, 38/6 each plus 1/6.

**Scotch Boy.**—EMI-GEC Tape, 35/-, plus 6d. Resine Player Case.—Cut for BSR Motor, 39/6, plus 3/6.

**EMI 30w. Public Address Amplifier.**—KT60 Output, Rack Mounting, all Valves Metered. Brand New, 225. A few only.

**Transformers.**—4.3 v., 1.5 a., 7/6, plus 9d. 4 v., 2 a., 7/6, plus 9d. 12 v., 1 a., 8/6, plus 9d. 6.3 v., 6 a., 19/6, plus 1/6. Williamson Output, 24.10.0. Choke, 27/9, plus 1/6.

**Chokes.**—10 h. 150 ma., 15/3, plus 1/3. CH5, 10 h 60 ma. 300Ω, 4/9, plus 1/6. CH4, 10 h 75 ma. 150Ω, 4/9, plus 1/6. 50 h. 30 ma. 1,500Ω, 6/6, plus 1/6. 50 h. 20 ma. 1,100Ω, 6/6, plus 1/6. 70 h. 20 ma., 6/6, plus 1/6. 29 h. 10 ma. 5.6, plus 1/6.

**FULL MAIL ORDER FACILITIES**  
 (Please Add Postage)  
 Shop Hours, Monday to Friday, 9-5.30 p.m.  
 Saturday, 1 p.m.

**LYONS RADIO LTD.**  
**3 GOLDHAWK ROAD Dept. M.P. SHEPHERDS BUSH, LONDON, W.12**  
 Telephone: SHEPHERDS Bush 1729

**MINE DETECTORS.**—This detector gives warning of the presence of metal objects under ground, in timber, water, etc., and there are probably many applications for which this equipment can be used in addition to its original one. We supply them complete in strong wood transit case. The principal items being an A.F. amplifier employing 3-AR12's (VP23) valves mounted with battery case in metal case 11 x 11 x 4 1/2 ins., search coils, control box pole front and rear sections, various canvas satchels, headphones, etc. Power requirements are 60 v. or 90 v. H.T. battery and 6 "S" type 11 v. cells (not supplied). Condition is as new and unused. Price **£3.12.6.** carr. 12/6.

**POWER UNITS TYPE 13E.**—This is a rotary converter unit for 6 v. D.C. input and having a fully smoothed and filtered output of 300 v. D.C. at 100 ma. Originally designed to operate Receivers types R.148L, 1182 and 1392. The whole is housed in a metal cabinet, for rack mounting, 19 x 10 1/2 x 10 1/2 ins. The rotary converter itself (Type 57) occupies a space of only 2 1/2 x 5 x 5 ins. so that if required the power unit could be made up very much reduced in size. Condition apart from internal metal work, which may be slightly store soiled, is new and unused and in good working order. Price, 55/-, carriage 3/6.

**COAXIAL CABLE.**—Standard 75.80 ohms. 1 in. outside dia. Price 11d. per yard. (Postage under 10 yards 1/-).

**THIS MONTH'S BARGAIN OFFER.—RECEIVERS TYPE R.1155.**—These popular communications receivers in "used" condition, complete with their seven valves. They are in working order although this might not be perfect. "W.W." data leaflet and circ. diagram supplied. (Separately 1/3.) Price **£6.17.8.** carriage 7/6, plus 2/1 for transit case which we refund when this is returned.

**TELEVISION COMPONENTS**  
 for the  
**"Practical Television Receiver" VIEWMASTER, E.E. TELEVISOR and HAYNES TP38 in STOCK**  
 Price Lists available on request.  
**J. T. FILMER,**  
 Maypole Estate, Bexley, Kent.  
 Tel.: Bexley Heath 7267

**NEW HOME CONSTRUCTORS HANDBOOK**  
**15 TRIED AND TESTED CIRCUITS**  
 T.R.F. SETS  
 4, 5 AND 6 VALVE SUPERHETS  
 A.C. A.C./D.C. and BATTERY SETS  
 TESTED FULLY  
 FEEDER UNITS  
 AMPLIFIERS  
 ETC.  
 WITH FULL CONSTRUCTIONAL DETAILS FOR AN EFFICIENT CRYSTAL SET AND A SUPERHET COIL PACK  
 Lots of Technical information, too!  
**PRICE 2/6 POST FREE**  
**SEND FOR YOUR COPY TO-DAY AS FOR A SHORT TIME ONLY WE ARE GIVING FREE**  
**WITH EVERY HANDBOOK AN EXTRA CIRCUIT AND FULL CONSTRUCTIONAL DETAILS OF OUR ECONOMY SUPERHET**  
**SUPACOILS MAIL ORDER OFFICE**  
 98 Greenway Avenue, London, E.17

# OPEN TO DISCUSSION

The Editor does not necessarily agree with the opinions expressed by his correspondents. All letters must be accompanied by the name and address of the sender (not necessarily for publication).

## Importance of Layout

SIR,—I have been interested in the comments about Mr. Kemsey-Bourne's amplifier circuit. Last term at school one of my pupils (Elementary Radio) constructed his circuit and was very disappointed in it. After spending much time with it at his home, he brought it to a practical session of the class. The amplifier was duly put through its paces. The first thing noticed was that the grid of the output valve was getting very hot; a grid stopper was applied with some measure of success. Various measurements were made and they were hay-wire! Having had considerable experience with amplifiers, I suspected that the very bad layout that the student had used was at fault. This entailed long leads to the valve electrodes put in to keep the valves well spaced—to keep things stable and reduce feed-back. These long leads were, in fact, acting as tuned circuits, and oscillations were occurring at very high frequencies. The chassis layout was revised and the grid leads were made as short as possible. The amplifier was then rebuilt and worked perfectly, with the circuit exactly as the writer had specified. I mention this because very often good circuits get a bad name because the constructor makes—not deliberately—a mess of the layout.—JAMES S. KENDALL (Birmingham).

## Modifying MCRI

SIR,—Readers who own ex-Service receiver MCRI may be interested in obtaining sufficient output to work a small speaker.

This can be done by substituting a 3V4 for the final valve. No alteration in wiring is needed, since the 3V4 has a tapped filament; one half only being in use; nevertheless, output is ample for a small speaker.

The screen should be fed at 90 volts instead of 67 volts which it will receive, but no ill effects have been noted using 67 volts.—A. ASHCROFT (Ormskirk).

## Re 6-volt Circuits

SIR,—I am a regular reader and am very keen on 6-volt battery-operated circuits of receivers and audio-amplifiers. I have tried to build some of the circuits in PRACTICAL WIRELESS with a vibra-power-pack, but found their drain on my 6-volt battery far in excess of the commercial receivers.

I am sure there are many like me who would be

very grateful if you could include a discussion on 6-volt circuits.

Our nearest A.C. power is 34 miles away, and so we must rely on our 6-volt wind chargers for power.—G. JOHANNES (Darling, S. Africa).

## Recording Results

SIR,—May I reply to the letter in your October issue of PRACTICAL WIRELESS, of Mr. L. C. Phillipps, who is experiencing great trouble in recording the violin.

As he states that his tape recorder will record this instrument when played over his radio set, but not when he is recording a "live" solo, the trouble is most certainly an acoustic one.

I suggest that he stands with his back to the microphone when playing a violin solo. For my part, when recording music, I place a bowler hat over the rear part of the mike to dampen echo.

Has your correspondent tried a ribbon mike? This, with its directional properties, in a damped room (heavy curtains, etc.), should rid him of those unwanted echoes.—KEITH H. YOUNG (Alkington).

## D.C. Supplies

SIR,—I have made up the A.C. H.T. eliminator and trickle charger described and circuited in PRACTICAL WIRELESS, November, 1951, pp. 501-502. As I applied to the "junk box" for spares, the unit differs a little in some respects.

It is housed in the tuning deck of a former R1196, the four tuning capacitor holes providing for a mains "on-off" switch, a DPDT switch for the 6 volt 2.5 amp. side and the 12 volt 1.5 amp. side of the composite mains transformer to be switched in and out of the charging circuit, the mains lead access, and the charging lead exit.

I have seven wander plugs arranged on a bakelite panel (Woolworth wander plugs), so that I have the following combinations:

6.3 volt heaters } For Mains set.  
12 volt heaters }

H.T. 30-90 (3 watt 50 K. pot. through 15 K. resistor.

H.T. 120 volt } For battery set.  
H.T. 150 volt }

H.T. 180 volt }  
H.T. 240 volt (for mains set).

+ leads to charge 2-volt accumulators at 1 amp.

I have two large metal rectifiers 280 volt 60 m/a in circuit for FW rectification smoothed by 2 chokes

*Whilst we are always pleased to assist readers with their technical difficulties, we regret that we are unable to supply diagrams or provide instructions for modifying surplus equipment. We cannot supply alternative details for constructional articles which appear in these pages. WE CANNOT UNDERTAKE TO ANSWER QUERIES OVER THE TELEPHONE. If a postal reply is required a stamped and addressed envelope must be enclosed with the coupon from page 111 of cover.*

in series with 32  $\mu$ F. + 16  $\mu$ F. 350 volt working electrolytics—absolutely no hum.

Instead of a wander plug to various tappings via resistor chain, I have used one side of a two-pole, six-way wafer switch.

L.T. rectifier 6 volt 1 amp. ex Premier radio.

L.T. dropping resistor as per your diagram, etc.

Earthing via  $\frac{1}{2}$   $\mu$ F. condenser through third pin of mains socket plug, i.e., three-core cable.

On battery work (1935 Mullard MB3) this unit is simply grand. (The mains trans. ex Radio Supply Co., Leeds, 10/9) (260-0-260 60 m/a. 6.3 volt 2.5 amp. and 12 volt 1.5 amp.)

You will see that I have left myself the opportunity of using the unit as a mains RX power pack as well when need arises. I hope to try this soon.—J. RODGER (Old Meldrum).

### An Electrolytic Tester

SIR.—There seems to be several points that do not appear to be clear in my article on the electrolytic tester. (1) The polarity of the test lead. This is negative and should be taken to the negative end of the condenser under test. (2) The positive connection is that marked 50 in the diagram and is situated at the rectifier cathode. (3) The total resistance of the chain of resistors should be 60,000 ohms, and for this particular circuit, should, starting from the positive end, be 10,000, 15,000, 10,000, 5,000, 10,000 and 10,000. (4) The centre tap of the mains transformer should not, on any account, be connected to anything. (5) The "fail" lamp is just a 6-volt dial bulb. (6) The use of the 2-way switch is to measure the ratio of the voltage drops for the calculation of the capacity of the condensers. (7) The contacts A1 and A2 are contacts mounted on the top of the relay. (8) The resistance in series with the meter can be any value between 200 and 500 ohms—200 is best for a large reading on the meter whilst a higher value gives a better protection.—JAMES S. KENDALL (Birmingham).

### Balanced Speakers

SIR.—May I once again crave space in order to amplify my previous letter? First, let me tell our friend Mr. Waterworth that I am not concerned with tone controls. I suppose in my long experience I have dealt with every form of tone control ever devised, "his," by the way, was described in another journal very fully, some three years ago. Too often tone control circuits cause more troubles than they cure. Next, crossover networks, to be really efficient, are too costly and cumbersome for the ordinary amateur. I am not concerned with these either.

A simple frequency discriminating network from the volume control of the feeder, or gram. pre-amplifier, feed three distinct circuits, each through another volume control. Each circuit is designed for its job, High, mid and low, and each output feeds a speaker designed for its job, too. One does not want cinema output in a room 16 ft. by 18 ft., where three one watt outputs are plenty, so pressure units are superfluous. The top speaker can be a 5 in., or even a 3 in., it should be mounted high in one corner of the room, sloping slightly downward; a small flare will give better distribution. The middle and low speakers may be mounted in a corner cabinet, with a division between them. The low

should be within 1ft. of the floor. The middle may be an ordinary 8 in., the low can also be an 8 in., but must have a flexible spider and surround; for the latter I prefer "chamois" leather. The speakers should be situated in opposite corners of the same wall, i.e., at an angle of about 90 deg. Single ended outputs are sufficient for domestic purposes and the whole equipment will not be as costly as most modern amplifiers alone. With this arrangement one can build up high and low at will, and also retain as much low as desired at very low volume.

In conclusion, I regret I have neither the time nor facilities to provide circuit diagrams for the many readers who have written to me, but perhaps P.W. will allow me the space to publish details of the equipment at some future date. Further, I have developed an entirely new single ended output which is particularly suitable for this type of amplifier. I will describe this when opportunity permits.—R. H. COWTAN (Rickmansworth).

### Organ Details

SIR.—In the October, 1952, issue "Thermion" draws attention to the patent law and refers particularly to your current articles on the construction of a simple electronic organ. This has prompted several readers to inquire if this company had raised any objection.

As manufacturers of the "Clavioline," which was the forerunner of various simple electronic organs developed during the past two or three years, we would like your readers to know that, far from objecting, we welcome any such article which stimulates an interest in this absorbing field of electronics.—B. DAVIS (Managing Director, Henri Selmer and Co., Ltd.).

### The Radio Show

SIR.—I have read with great interest the article which appeared in the November issue of PRACTICAL WIRELESS, by the Marquis of Donegall, concerning a visit to the Radio Show. Due probably to an oversight, the reference at the end of the first column on page 513 to the assembly of television cameras on our stand should not, of course, refer to the Electrical Trades Union. This Union had a small stand on the first floor and was in no way connected with the activities which were undertaken jointly on our stand by Pye, Ltd., and ourselves.—H. F. GILLARD (Multicore Solders Ltd.).

### A CHRISTMAS GIFT PROBLEM?

If you are still undecided what to give your friends for Christmas and they share your interest in radio, why not solve your difficulties by letting us send them from you PRACTICAL WIRELESS every month for a year.

It is so easy to arrange. Just write to The Subscription Manager (G.2), PRACTICAL WIRELESS, Tower House, Southampton Street, Strand, London, W.C.2, enclosing the names and addresses of your friends, with remittance to cover, and we will do the rest. We can send the magazine to any address at home or abroad at the annual rate of 13/6 (Canada 13/-). An attractive greetings card will be sent in your name with the first Gift Copy.

Remember a Christmas Subscription for PRACTICAL WIRELESS is a gift which will give pleasure and is a reminder of your good wishes the whole year through.



**The "Fluxite Quins" at Work**

"There'll be the dickens to pay,  
Nice time to sweep chimneys I'll say,  
We're in a fine plight,  
And we're out of FLUXITE,  
Undoubtedly our blackest day."

See that **FLUXITE** is always by you—in the house—garage—workshop—wherever speedy soldering is needed. Used for over 40 years in Government works and by leading engineers and manufacturers. Of all ironmongers—in tins, from 1/- upwards.

**FLUXITE**  
**SIMPLIFIES ALL SOLDERING**

Write for Book on the Art of "SOFT" Soldering and for details on CASE-HARDENING STEEL and TEMPERING TOOLS with FLUXITE. Price 1/d. each.

**FLUXITE Ltd.**  
Bermondsey Street, London, S.E.1.

**HI-FI R/G EQUIPMENT**

**N.R.S. "SYMPHONY" AMPLIFIERS**, fitted with the patent "three channel system" giving independent control of Bass, Middle and Top, thus affording the maximum possible control of tone and compensation for recording deficiencies. Especially essential when mixing the playing of old and new 78s with the new LP records. Scratch control and negative feedback also incorporated. Woden transformers. 5-watt model only 10 gns. 10-watt model (Pushpull triodes), 15 gns., carr. 5/-.

**N.R.S. No. 2 P.A. AMPLIFIER**, 12 watts output. Radio/Gram/Mike input, separate volume controls for fading in and out. Woden power components, price £11/19/6, carr. 5/-.

**GARRARD 3-Speed AUTOCHANGER**, model RC72A WITH NEW TYPE LONG ARM for better tracking and two separate Decca XMS heads (not to be confused with autochangers with turnover pickups). Price £19/13/0. Or fitted with the Acos GP19 and GP19LP hi-fi crystal heads. £18/5/6. Carr. 5/-. Limited number only.

**COLLARO 3-Speed AUTOCHANGER** RC3/521 for 33 $\frac{1}{2}$ , 45 and 78 r.p.m. £12/8/2. COLLARO 3-Speed MIXER CHANGER, £14/19/2.

**BASS REFLEX CABINET KITS**, 30in. high, consist of fully cut patent acoustic non-resonant timber, deflector-plate, felt, all screws, etc., and full instructions. 8in. speaker model 15in. wide x 12in. deep, 85/-; 10in. speaker model (larger), 97/6; 12in. speaker model (larger), 107/6. Carr. 7/6. Ready built, 7/6 extra.

**NORTHERN RADIO SERVICES** 16, Kings College Road, London, N.W.3 Phone: PR1mrose 8314. Tubes: Swiss Cottage and Chalk Farm. Callers welcome. Full Bargain Catalogue 2jd.

**THE A.C. MAINS R1155 COMMUNICATIONS RECEIVER.**—This famous Bomber Command Receiver now available complete with power pack, output stage and speaker, ready to operate. Just plug in and receive the world, with a receiver of the £100 class. Wave ranges covered are 18.5-7.5 mcs., 7.5-3.0 mcs., 1500-800 kcs., 600-200 kcs., 200-75 kcs. Every set is thoroughly tested and checked before despatch, and is BRAND NEW AND UNUSED IN THE MAKER'S TRANSIT CASE. ONLY £18 19s. 6d. complete (carriage etc. 1s. 6s.) OR BRAND NEW RECEIVER ONLY £11 19s. 6d. (carriage 10/6). POWER PACK, OUTPUT STAGE AND SPEAKER ready to plug on to any R1155, ONLY £5 10s. (carriage etc. 5/-). BUY THE COMPLETE RECEIVING STATION AND SAVE 10/-.

**INDICATOR UNIT TYPE G.**—Contains 6in. C.R. Tube, VCR97, 4 valves EF50, 1 of 6B34, and 1 of EA50. The unit recommended for conversion to the "Wireless World" General Purpose Oscilloscope, full details supplied (or available separately 1/2). ONLY 7/6 (carriage etc. 7/6).

**POTENTIOMETERS.**—Less switch, 3/- With switch 4/6.

**VALVEHOLDERS.**—I.O. or M.O., 6d. B9G.10d. Diode, 6d.

**RESISTORS.**—1w. 4d. 1w., 5d. 1w., 6d. 2w., 8d. 15w., 2.5k., 2/-.

**CONDENSERS.**—Mica and Silver Mica. 6d. Tubulars: 1mfd., 9d. .01mfd., 9d. .05mfd., 9d. .005mfd., 9d. 5mfd., 2/- .03mfd., 2.5kv., 2/6. 1mfd., 2.5kv., 4/6.

**ELECTROLYTICS.**—8mfd. 450v., 2/8. 8 x 8mfd. 450v., 4.9. 16 x 16 mfd. 450v., 7/- 25mfd. 25v., 1/6. 50mfd. 12v., 1/6.

**P.M. SPEAKERS (With Transformer).**—5in. Goodmans, 15/- 6in. Goodmans, 17/6.

**P.M. SPEAKERS (Less Transformer).**—5in. Rola, 16/6. 6in. Plessey, 14/6. 10in. Rola, 27/6. (Postage 1/6 per speaker).

**PENTODE OUTPUT TRANSFORMER.**—Goodmans, 5/-.

**CHOKES.**—20H 80ma., 9/6. 30H, 100ma., 12/6. 5H, 200ma., 6/- (Postage 1/- per choke.)

**TRANSFORMERS.**—Manufactured to our specification, and fully guaranteed. Normal Primaries. 425v.-0-425v. 200ma. 6.3v. 6a. 6.3v. 6a. 5v. 3a. 0.4-6.3v. 3a. ONLY 72/6. 425v.-0-425v. 200ma. 6.3v. 6a. 6.3v. 4a., 5v. 3a. ONLY 50/- 350v.-0-350v. 160ma. 6.3v. 6a., 6.3v. 3a., 5v. 3a. ONLY 42/6. 250v.-0-250v. 100ma., 6.3v. 6a., 5v. 3a. ONLY 32/6. The above are fully shrouded, upright mounting. Universal Mounting 350v.-0-350v. 80ma., 0.4-6.3v. 4a. 0.4-5v. 2a. ONLY 18/6. 250v.-0-250v. 80ma., 0.4-6.3v. 4a. 0.4-5v. 2a., ONLY 18/6. The following are upright mounting. EHT for VCR97 Tube, 2.5v. 5ma. 0.5v. 0.2v. 1.1a. 2v.-0-2v. 2a. ONLY 37/6. EHT 1.500v. 5ma. 2v. 1a., 2v. 1a. ONLY 72/6. EHT 7,000v. 5ma. 4v. 1a. ONLY 52/6.

**PLEASE ADD 1/6 PER TRANSFORMER POSTAGE.**

**TRANSFORMER**, for a variety of uses, giving outputs of 3v., 4v., 5v., 6v., 8v., 9v., 10v., 12v., 15v., 18v., 20v., 24v., 30v., at 2 amps., from normal mains input. ONLY 17/6 (postage 1/-).

**TRANSFORMERS**—Ex W.D. and Admiralty, built to more than 50% safety factor, with normal A.C. Mains Primaries. All Brand New and Unused. 300v.-0-300v. 200ma., 5v. 3a., 6.3v. 5a. C.T., 20v. 75ma., 70v. 100ma. Weight 12lb. ONLY 62/6 (postage, etc., 2/6). 330v.-0-330v. 100ma. 4v. 2a. Weight 7 lb. ONLY 22/6 (postage, 1/6). L.T. 5v.-0-5v. 5a., 5v.-0-5v. 5a., 5v.-0-5v. 5a. By using combination of windings will give various voltages at high current. Weight 11 lb. ONLY 35/- (postage, etc., 2/6). L.T. 6.3v. 7.7a., 4.2v. 2.5a. 4v. 1a. ONLY 19/6 (postage, 1/6). EHT 1,900v. 2ma., 520v. 10ma., 300v. 10ma., 2v. 1.5a. ONLY 21/- (postage, 1/6).

**U. E. I. CORPORATION**

**THE RADIO CORNER**  
138 Gray's Inn Road, London, W.C.1  
(Phone TR6minus 7937)

Cash with order, please, and print name and address clearly.  
Open until 1 p.m. Saturdays, we are 2 mins. from High Holborn (Chancery Lane Station), 5 mins. by bus from King's Cross.

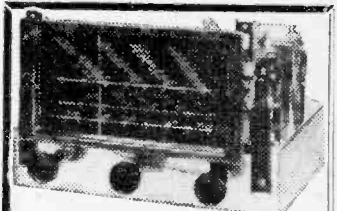

**BUILD THIS RADIO & SAVE POUNDS!**

As a reader of this magazine you obviously are keen to build your own equipment—so why not make a really super job while you are about it? And save money! Our time-proved circuits utilise standard interchangeable components (many of which you probably already have), which, together with our ALIGNED UNITS, punched chassis, and "Easy-as-A-B-C" point-to-point construction blueprints, makes failure impossible!!

No radio enthusiast can afford to be without our famous "HOME CONSTRUCTOR'S HANDBOOK," which not only contains all of our popular circuits, but full technical descriptions, parts lists, hints and tips, formulae, resistance colour code, symbols, etc., etc. SEND 2/6 NOW for the latest 44-page issue, which comes complete with Catalogue.

**RODING LABORATORIES (PW12)**  
301, Hurn Airport, Christchurch, Hants.

**YOU can become a well-paid RADIO ENGINEER**

Our Home-Study Courses in Radio, Television and Mathematics are a proved success. We train men to earn good money in their spare time, start businesses of their own, or get bigger salaries. Post coupon for free details.

**T. & C. RADIO COLLEGE**

Post in unsealed envelope, 1/d. postage.

To: T. & C. RADIO COLLEGE,  
36, Northfield Road,  
Ringwood, Hants.

NAME .....

ADDRESS .....

P12/52

# WILCO ELECTRONICS

**VALVES.**—Guaranteed Govt. surplus.

2X2	6/6	4074B	5/-	KT61	10/8
5U4G	8/6	7193	5/-	KT96	11/6
5Z4G	8/6	7475	10/6	KTW63	8/6
6AC7	5/6	ATP4	7/6	LE3	6/6
6BG6G	12/6	EB36	10/6	MI4	7/6
6CG8	6/6	CV54	6/6	MS PEN 10	
6H6	4/-	CV67	25/-	MS/PEN B	
6J5G	6/6	CV174	25/-	PEN46	10/-
6J6	12/6	CV1001	6/6	SI90	10/6
6K7G	8/6	CV1582	10/6	SP41	7/6
6K8GT	12/6	DI	2/6	SP61	5/-
6L6C	11/6	DHT7	10/-	STV290 40	
6N7GT	10/6	EL148	5/-	SU2150 A	12/6
6SH7	5/6	EL171	25/-	U19/20	9/6
6SL7GG	9/6	EL1320	10/6	V372	6/-
6SN7GT 10/6		EL1498	10/6	V960	6/6
6SUG	10/6	EA50	3/6	V1130 B 12/6	
6V6GT 8/6		EB34	2/6	V197	5/-
6X5GT	9/6	EC52	6/6	VR105/30	
12K9CT 12/6		EC54	6/6	VR150/30	
12SH7	5/6	EC180	12/6	W77	10/6
25L6GT 10/6		EF36	7/6	Z77	11/6
2BD7	9/6	EF38	7/6		
807	10/6	EF54	6/6		
954	6/-	EL35	11/6		
955	6/-	EZ40	10/6		
955	6/-	H83	6/6		

**RECEIVER R.1355.**—As specified for Inexpensive Television. Complete with 10 valves. 38/8. Carriage, 7/6.

**AMPLIFIERS.**—50 watt "Tannoy" Rack Mounting, less valves, only £8 10/- Carr. 10/-.

**AMPLIFIERS.**—15 watts, using 2—PX25, MU14, MBL4, rack mounting, with power pack, 200/250V. Carriage, 10/-.

**SLIDING-MOTION DIAL.** with vernier 200-1 reduction, front of panel mounting, 5in. diam., calibration 0-100, 5/6 each. Post 1/-.

**MILLIAMMETERS.**—0-200 or 0-250, 2 1/2 in. flush, 12/6.

**MOVING-COIL METER** with a 1 mA. movement 2 1/2 in. flush. Rectifier type, scaled 0-100 volts A.C., resistance 100K ohms, a very useful basic meter, only 30/- post free.

**POWER PACK.**—input 230v., output 350-0-350v., 80 mA. with 5Z4 valve, 2-8.3v. windings, 40/- Carriage 2/6.

204, Lower Addisonvale Road, Croydon. Tel.: ADD 2027

# LONDON CENTRAL RADIO STORES

**UTILITY SETS.**—Superhet, Medium Waveband only, 4-valve P.M. Speaker in Pinewood Cabinet, 13 1/2 in. x 12 in. x 6 1/2 in. A.C. only. Very fine tone and volume, £24.10.0, post. and carriage, 3/6.

**VIBRATORS.** Type G. 650 12-volt 4-pin. American base, 7/6. Type V5123, 4-pin, 12-volt. American base, 7/6.

**INFRA RED Image Converter Photo Electric Cell.** Type CV143, suitable for all kinds of purposes, 14/6 each, 1/- post and packing.

**NIFE ACCUMULATORS.**—Ex-Naval, slightly shaped for container. Size: 7 in. x 4 in. x 1 1/2 in. 1.5 volt, approx. 25 amp. Size 8 x 4 x 1 1/2 in. 1.5 P. & P. NIFE ACCUMULATORS.—Size: 6 in. x 1 1/2 in. x 1 1/2 in. approx. 10 amp. 8/6.

**NEW ALUMINIUM INSTRUMENT** or Screening Box 6/6, post and packing, 9d.

**MOVING COIL INSERTS.**—Suitable for Miniature Loudspeakers or Microphones, 30 ohm 2 in. diameter, 1 1/2 in. deep, 2/9, 6d. post and packing.

**INERT CELLS.**—1.5 volts, new, suitable for Electric Bells Set, etc., etc. Size: 5 in. x 2 in. x 2 in. 2/6, 4d. P. & P.

**WIRE WANTS TO BUY**

**RADIO EQUIPMENT — AMPLIFIERS — TAPE RECORDERS — TELEVISION TEST EQUIPMENT — COMPONENTS.**

**TELEPHONE HANG SET,** 8/6 each, post. and packing 9d.

**TELE F.**—Complete with Amplifier, Desk Type Telephone incorporating Bell, etc., in Transit Case, £26.10.0. 10/- carriage, etc.

**UNREKABLE METAL REFLECTORS.**—10 in., 4ft, 6in. focal length, 8 1/2 P.M. SPEAKERS, 2 in., 3 ohm, 8/6, 9d. post. and packing.

For Other Bargains See Last Issue.

**LONDON CENTRAL RADIO STORES**  
23, LISLE STREET, W.C.2  
Phone/Grams: GERard 2963

**VALVES.**—6J6, 6SN7GT, 6K8GT, 6V6GT, 5Y3GT, 6BW6, 6BE6, 6BA6, 6A6, 12BA6, 12BE6, EF92 (W77, 9D6), 9/6, VR105, 717A, V570, VU508, 8/6, 6AM6 (8D3, EF91, 277, 6F12), 6AT6 (DH77), 6N7GT, 6EN46, 1T4, 1R5, 1S5, 1U5, 3A4, 354, 3V4, 8012, CV18, 12SC7, 6B8, 7/6, 6AL5 (EB91, D77, 6D2, DD6), VR136, 12SL7GT, 12J5GT, 12SH7, 6K7GT, RKR72, RKR73, JAN-CRP-72, 8/6, 1A5GT, VGT128, 1289A, VT501, 1625, VR135, VR137, CV189, VR56, VR68, 5/-, VR54, VR65, 1T4, 3/6, VR92, 2/6, 6G7, 2/6, 6U7GT, 12/6, CV7, 15/-, V1906 17/6, 7F8, 20/-, VR91, Tested O.K. 10/- for 4.

**VALVEHOLDERS.**—Mazda octal 2/6 for 6. EF50 Ceramic, 2/6 for 6. B7G Amphenol, 4/6 for 6. BBA Amphenol, 5/6 for 6. British 4-pin Ceramic, 1/- for 2. UX 7-pin Ceramic, 2/6 for 2. VCR97 Base, 2/6 each.

**SMALL UNIT** containing 2 Toggle Switches, brand new, 1/3.

**CHOKE,** 20 hy., 10 ma. approx. 2 x 1 x 2 in., 2/6 for 2. Bargain Price.

**HEADPHONES,** balanced armature, brand new, 8/6 pair.

**WESTERTONS, WX6,** 1/3 each, 6 for 6/-.

**MAINS DROPPER,** 717 ohms, tapped at 100 ohms, 2 amp., 2/-.

**THERMAL DELAY SWITCH,** 5 volt, 5/6.

**POST OFFICE JACK SOCKETS,** 2/6 for 2.

**CONDENSERS,** Erie, Ceramic, Mixture Tubular, 50 pF., 2 for 2. 50 pF., 2012, 2 for 2.

**COIL FORMERS,** Polystyrene, 1 in., with iron dust core, 1/- each, 5/- for 6.

**MORSE KEYS, A.M. type** on Bakelite Base, 2/6.

**SWITCHES,** Rotary, stud type, 2 pole 36 way, containing 42 high stability resistors in metal case, approx. 3 1/2 x 3 1/2 x 5 1/2 in. deep, 1/- only.

**SIGNAL GENERATOR,** Type 22, with 6 v. vibrator pack, 35/- only.

**ADMIRALTY S.M. DIALS,** white ivorine dial, 100-1 ratio, 3 1/2 in. diameter, 7/6.

Compare our Prices. Remember We pay postage.

**J. B. SERVICE (Bexleyheath) LTD.**  
5 MAYLACE ROAD WEST, BEXLEYHEATH, KENT.

# RADILTD

**SPEAKERS.**—L/make. 2-3 Ohms. Less/tr. 5 in., 12/6; 8 in., 15/6; 10 in., 23/6; 3 in. 5 Ohm 11/6.

**CONTROLS.**—Semi-midget, 2 1/2 in. Spindle. Range 10K to 2 Meg. 3/6. SP/sw. 5/-, DP. 6/- Standard size, same range, 3/- SP/sw. 4/6.

**A.C. MAINS GRAM AMPLIFIER.** Complete kit of parts, incl. Valve and Speaker. With Circuit Data, Instructions. 57/6. Post Free.

(Wired and Tested, 12/- extra.)

**New Boxed VALVES** Post Free.  
1T4, 1S4, 1R5, 1S5, 354, 6V6, 6K6, 6Q7, EL32, 6F6, 5Z4, 5Y3, 6X5, 787, 6SN7, EF91, 9/3 each, 6D6, 6K7, 6J7, EB91, EF30, EF36, SP41, SP61, 12SN7, 12SL7, 6C5, 6S57, 6B8, 7/6 each, ECH35, CCH35, 25A, AZ33, CL33, EL33, KT91, 12/6, 12Q7, 35L5, 35Z4, DAC32, 11/6 each, SNIP.—New stock I.F. trans., 465 Kcs. Guaranteed, 9/9 pair.

ELM ROAD, LONDON, E.17. (KEY 4813.)

# LAWRENCE SLASHES PRICES

Amazing Bargains List of Transformers, Selenium Rectifiers, Rotary Converters, Milliamp and Ampmeters, Voltmeters, Wireless Valves, Testing Gear, R.A.F. Gear, Second-hand Radio Sets. Experimenters Try our 10/- Post Paid Bumper BOX of Radio Parts worth £5. Your Money Back if Not Entirely Satisfied. We also cater for Model Railways Fans. S.A.E for Bargains List.

# LAWRENCE FRANKEL

Mail Order  
134 Cranley Gardens, London, N.10  
Tel.: TUDOR 1404

# TELEVISION

The advance of Radio Technique will offer unlimited opportunities of high pay and secure posts for those Radio Engineers who have had the foresight to become technically qualified. How you can do this quickly and easily in your spare time is fully explained in our unique handbook.

Full details are given of A.M.B.R.I.R.E. (City & Guilds Exams), and particulars of up-to-date courses in Wireless Engineering, Radio Servicing, Short Waves, Television, Mathematics, etc., etc.

We guarantee "NO PASS—NO FEE." Prepare for to-morrow's opportunities and future competition by sending for this very informative 144-page guide NOW—FREE and without obligation.

**BRITISH INSTITUTE OF ENGINEERING TECHNOLOGY**  
(Dept. 242)  
17, Stratford Place, London, W.1.

# RADIO G200 ANNOUNCES

**VALVES** at 1/9: CV6, RK34, 2C34; at 2/3: EA50, DI, VR78, VR92; at 2/6: 954, 956, 2X2; at 4/6: 615gt, 6H6gt, 12H6, 65H7; at 5/6: 6K7gt, 12S7, 4D1, 6AC7, 617g, 65S7, 65G7; at 6/9: 6K7gt, 65K7, 12C8, 12S7C, 6U5gt, EC52, 12SK7, U76, 12SL7; at 7/6: 12SN7, B36, 787, 7C5, 7C8, 7C7, 7H7, 7R7, 757, 7Y4, DH77, W77; at 8/6: 154, 1T4, 3A4, 6X5gt, 35L6gt, 25L6gt, 50L6gt; at 9/6: 1R5, 354, 3Q4, 3V4, 1D5, 6V6gt, 6F6gt, 6C6, 6D6, DF92, 1G6gt, 6CH6, 68G6, 25Z4, 35Z4gt, D77, 1G6gt, 12AU7, 12AU7, 12AX7, X79, X78, 6N7gt, 12AT7, 6L6, 6L6g, 65L7, 65N7, 6L7, KT81, 807, 6L6, 6L6g, 65L7, 65N7, 6L7, 6A8gt, 12K8gt, 65A7, 2A3; at 10/6: 12K8Y, 6K8gt, 6V6, 6F6, 6N7, 6Q7gt, 65Q7, 12SQ7gt, X61, X76, 5Z4G, 83V.

**ARTHUR HOILE**  
55 UNION STREET, MAIDSTONE, KENT  
Phone: 2812

# Amateur Radio Enthusiasts THE INCOMPARABLE GLOBE-KING

**SINGLE VALVE S.W. RECEIVER**  
• WORLD-WIDE RANGE 11-100 METRES • CRYSTAL-CLEAR NOISE-FREE RECEPTION • ELECTRICAL BAND SPREAD TUNING • EXTREMELY LOW RUNNING COSTS  
Catalogue Free. Stamp for postage.

**JOHNSONS (RADIO)**  
48, FRIAR STREET, WORCESTER

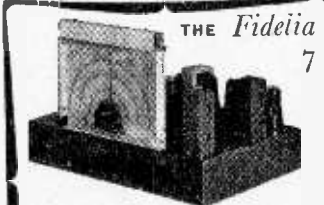

All models have variable selectivity, high quality detector, triode output stages, 7 valve model illustrated £21-15-0. De-luxe 9-valve, £25-5-0. Major 10-valve, £31-10-0. Minor 6-valve, £17-10-0. Data sheets on request.

**Fidelia Equipment**  
2 Amburst Road, Teacombe Cliffs, Sussex

The Astral Dual Wave H.F. Coil, as used in the original model, Modern 1-Valver, The Summer, All-Dry Portable, B7G Battery Miniatures, all published in this Journal, 4 3/4. postage 3d. 1, 2, 3-valve circuits, 3d. extra. TRF Coils, A.D. 3-Band 3 (Aug. 1951 Issue), A.C. Mains Midget (Oct. '50 Issue), 6/6 post. 3d. postage. \*0005 Variable Reaction Cond. 3/6. Astral "P" type coils 2/6 each. "Q" type 2/6 each. Trade enquiries invited. Mail Order only.

**T. G. HOWELL,**  
29, McWilliam Rd., Brighton, 7.

# News from the Trade

## A New Solder Company

H. J. ENTHOVEN & SONS LTD., 89, Upper Thames Street, London, E.C.4, have formed a new company which was operative as from the 15th October of this year.

The new company will be known as "Enthoven Solders Ltd." who will have their head office at Upper Thames Street. It will be divided, for ease of administration and customer service, into two divisions.

One of the divisions, concerned with marketing of solid solders, is to be under the control of Mr. W. J. Myers, who is appointed to the board of the new company. The other is under the direction of Mr. F. C. Thompson, a comparative newcomer to Enthovens, but an executive with great experience in marketing and one having a fine general business background.

## Enfield Speed Changer

A NOVEL instrument to enable a standard (78 r.p.m.) motor to be used for playing 33½ and 45 r.p.m. discs is illustrated on the right and is marketed by the British Distributing Company. Three hinged limbs are provided with rubber feet and it may thus be placed firmly upon the motor-board of any size of turntable. The limbs are threaded and the main mechanism may be raised so that it just clears the turntable, with the spindle end of the motor fitting into a hole in the centre of the changer. Indications show the setting for either 33½ or 45 discs, and loosening a screw enables the setting to be found very simply. Three rubber rollers then come into operation, one being driven by a record placed on the turntable to act as a driver and the other two rotating the slow-speed disc which rests upon them and is centred by a short projecting spindle as in a normal motor. Friction is adequate for all normal discs which are, of course, played with lightweight pick-ups and the device works very well indeed. It is sold upon a large card carrying stroboscopes for the three speeds and the price is 13/6 plus P.T. British Distributing Co., 591, Green Lanes, London, N.8.

## "Emidicta" Portables

SINCE its inception in 1950 the "Emidicta" system has been adopted on an increasingly large scale by all manner of industrial organisations and commercial undertakings, including banks,

insurance companies and Government departments.

Now the system has been made completely comprehensive by the introduction of two "Emidicta" portable machines specially designed for use by travellers or by executives on prolonged business trips.

One of the new "Emidicta" portables (Model 2401) is for A.C. mains operation, the other (Model 2402) works from internal dry batteries and caters for circumstances where no mains supply is available.

Recordings made on either of the portable machines may be used on the office type "Emidicta" and vice-versa and thus a complete "Emidicta" link is formed between the traveller and his headquarters. E.M.I. Sales and Service, Hayes, Middlesex.

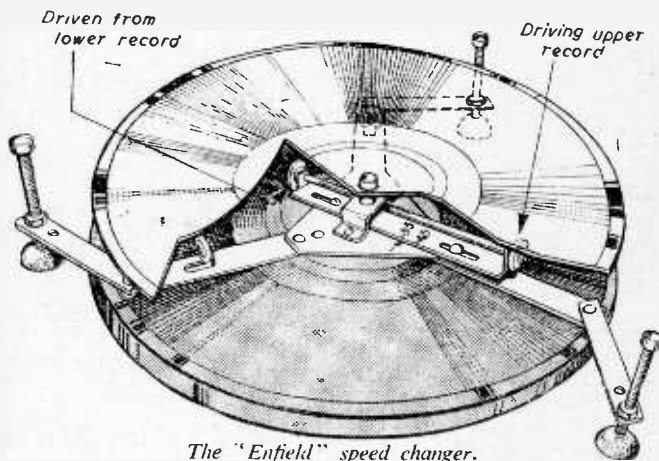

The "Enfield" speed changer.

## Plessey "E" Series I.F. Transformer Type 19

A RESULT of improved techniques in winding and assembly, the new E/19 I.F. transformer introduced by The Plessey Company, Ltd., is an all-purpose unit of inexpensive construction.

Permeability tuned in the normal manner, the "E" type transformer has a Q factor of 85 and an overall bandwidth for two stages of 7.7. Kc/s at 6 db, and 15.4 Kc/s at 20 db. The standard coils are tuned by 100 pF capacitors, and both stages are identical. Other values of tuning capacity, coupling, etc., can be supplied to meet manufacturers' special bandwidth requirements.

A further advantage offered by this unit, for use in portable receivers, is a 50 per cent. reduction in weight over previous designs of iron pot cored miniature I.F. transformers. The Plessey Co., Ltd., Ilford, Essex.

Editorial and Advertisement Offices:

"Practical Wireless," George Newnes, Ltd., Tower House, Southampton Street, Strand, W.C.2. Phone: Temple Bar 4363.

Telegrams: Newnes, Based, London.

Registered at the G.P.O. for transmission by Canadian Magazine Post.

The Editor will be pleased to consider articles of a practical nature suitable for publication in "Practical Wireless." Such articles should be written on one side of the paper only, and should contain the name and address of the sender. Whilst the Editor does not hold himself responsible for manuscripts, every effort will be made to return them if a stamped and addressed envelope is enclosed. All correspondence intended for the Editor should be addressed: The Editor, "Practical Wireless," George Newnes, Ltd., Tower House, Southampton Street, Strand, W.C.2. Owing to the rapid progress in the design of wireless apparatus and to our efforts to keep our readers in touch with the latest developments, we give no warranty that apparatus described in our columns is not the subject of letters patent. Copyright in all drawings, photographs and articles published in "Practical Wireless" is specifically reserved throughout the countries signatory to the Berne Convention and the U.S.A. Reproductions or imitations of any of these are therefore expressly forbidden. "Practical Wireless" incorporates "Amateur Wireless."





**SOUTHERN RADIO'S** Wireless bargains: Transmitter-receivers (walkie-talkie), type 38 Mark II, complete with 5 valves, microphone, phones, aerial, etc.; guaranteed ready for the Air; less batteries, £6/12/6, plus 2/6 post. Transmitter-receivers, type 38 Mark III, later model, complete, crystal controlled, £8/10/-; Transmitter-receivers, type "18," 6.9 Mcs., perfect, £7/10/-; Receivers R109, complete with enclosed Speaker and Vibrator Pack for 6-volts, 1.8 to 8.5 mcs., complete with 8 valves in metal case, £7/15/-, plus 7/6 carriage; Miniscopes, G.E.C., type M861b, miniature cathode ray, oscilloscopes, 1 1/2 in. tube, time base, etc., etc., brand new in maker's sealed cartons with leatherette carrying case, £15/10/-, plus 5/- carriage; Lubbra Hole Cutters for use on wood, metal, etc., etc., adjustable from 1/4 in. to 3/4 in.; 5/9; Throat Microphones, complete with long lead and plug, magnetic, 4/6; Plastic Transparent Map Cases, 14 in. by 10 1/2 in.; ideal for charts, photos, display, etc., etc., 5/6; Star Identifiers, with hydrographic office mods., A-N type, new in cases, 5/6; Westectors, W x 6 and W32, 1/- each, 11/- per doz.; Marconi Aerial Plier, U15, type, complete in conformity with I.C. specifications, full fixing instructions, 4/6; Contactor Time Switches, 10-hour movements, 2 impulses per second, thermostatic control; in soundproof case, 11/6; Remote Controls for above, 7/6; Visual Indicators, type 3 (10Q4), contains 2 moving coil microamp meter movements, neons, etc.; easily convertible to efficient M.C. meters, 11/-; conversion fully described in "W.W." Sept., 1951; Resistances, 100 assorted values, with ends 1 to 2 watts, 12/6 per 100; Condensers, 100 assorted Tubular and Mica Condensers, all useful values, 15/- per 100; Control Cables for Command Receivers B.C. 453/4/5, 14ft. with adaptors at either end, 10/-; Full list of Radio Books, 2/4d. Hundreds of more lines for callers. **SOUTHERN RADIO SUPPLY LTD.**, 11, Little Newport St., London, W.C.2. (GERARD 6653.)

**HIGH GAIN** Dual Range Coils for 1 and 2 valve sets. Polystyrene formers. With circuits 4/- (post 3d.). Trade supplied. **R.E.P. LTD.**, 33, Much Park St., Coventry.

**P.W. ORGAN**, Autogram, Fault-finder, etc.; complete part lists; close tolerance Resistors for organ. Viewmaster, Resistors 37/-; Condensers £7/4/-. Please send s.a.e. to **JACKARDINE**, 78, Shadsworth Rd., Blackburn.

**WINDCHARGERS**, 12v electric lighting plants, s.a.e. for folder. "AMELITE," Midtaphouse Works, Liskeard, Cornwall.



**"AUTOMAT" CHARGER KITS**  
This shows the No. 1 kit assembled into its case. Built in one hour, it is simple, foolproof and troublefree. All new material with full guarantee. Generous size components. No. 1 kit 6/12v. 2 amp. metal rectifier, 45 watt transformer ballast bulb for 2v., 6v., 12v. charger, 38/6d., post 1/6d., or with handsome steel case, 52/- plus postage 2/-.  
Ditto but 3 amp. rect. and 65 watt. trans. 46/- or with case 58/6d., postage 2/-.  
Eliminator Kit, trans. 135v. 30 ma. h.t. rect., 2v. 1a. trickle rect., 2 x 10 mfd. condensers, case, screws, grommets for 15v., 20/30 ma. eliminator with trickle charge, 42/-, postage 1/4d., or less case. 35/-, postage 1/4d.  
**CHAMPION PRODUCTS**,  
43, Uplands Way, London, N.21.  
Phone: LAB 4457.

**WALNUT** E. Wiskam Cabinets. Stamp details. **R. WISKER**, 501, Hale End Rd., Highams Park, E.4.

**REQUIRED**, Tanoid or similar Loud-speaker equipment. Write, **PETER LACROIX & SON, LTD.**, Arundel Place, Brighton.

**VALVES**

**NEW VALVES** wanted, small or large quantities, 6K8, 6V6, 5Z4, KT33C, 1R5, 1S5, FW4/500, 6Q7, 12K8, 80, UV39, EBC33, 354, etc., etc. Prompt cash. **WM. CARVIS**, 103, North Street, Leeds, 7.

**AMATEUR'S** stock of over 60 Valves. Many new. First offer of £4 secures. **Ferguson**, 6 Oxford Rd., Renfrew.

**VALVES**, types 6K7, 6K8, 6Q7, 5Z4, 5U4G, 1R5, 1S5, 1T4, 354, 807, 813, 829, 832, 723, A/B, etc., wanted urgently; immediate collection. Write or phone: **PYPE HAYES RADIO**, 606, Kingsbury Rd., B'ham., 24. (ERD. 4942.)

**WINWOOD** for value: V/master Coils, complete set with choke 19/-; V/master Valves, set of 12, £6/4/6, incl. post; O/trans; Std Pent, 4/3; H/diud, 5/9; P/pull, 7/9; Crystal Diodes, 2/9; 0005 and 0003 S/di/c cond., 3/3; Mains drprs., 2 and 3; 4/6; I.F.T.s, Std, 465 Kcs., 9/6 pr.; P.M. Spkrs., 5ln., 2-3 ohms, 11/9; Valves, new, boxed, 6V6G, 8/6; 5Z4, U50, 5Y3, EP91, 9/3 each; EB91, 6K7, 6J7, EL32, 7/6 each; 6K8, 6Q7, 6V6, 6K7, 5Z4, set of 5 valves, 45/-; Controls, 47K, 100K, 500K, all DP/Sw. 9 each. Stamp list. **WINWOOD**, 12, Carnarvon Rd., London, E.10. (Mail only.)

**"VIEWMASTER"** Valves, exact to specification, guaranteed new and boxed, comprising 5 EF50, 1 6P25, 1 KT61, 1 EBC33, 1 EB91, 2 6K25, 1 6P28, set of 12 £6/2/6 including tax (post and insurance 2/-). "Teleking" 15ln. Receiver, complete set of 17 valves exact to specification, £9/9/- including tax. 6AM6, EF91, 6P12, 277, DH77, 6AT6, 6V6G, 5Z4G, EBC33, 1S5, 1R5, 1T4, 3V4, 1S4, 8/6; 3S4, 9/-; 6AL5, EB91, 7/6; PZ30, PL38, 17/6; 6P25, 13/6; EY51, OCH35, ECH35, U22, 6P15, 6C9, 12/-; 6K8GT, CL33, PL33, 10F9, 10LD11, 10C1, 10P13, PL82, 11/-; PY80, UCH42, UL41, UF41, UB41, X78, N78, 10/6; 2526GT, DL33, UY41, U28, ECH42, DAC32, DL33, 10/-; ECL80, EF60, KT61, 6SN7GT, 6Q7G, 12K8GT, 9/6; MU14, U50, 5Y3G, 80, 35L6GT, 50L6GT, 3524GT, 6V6GT, AZ31, 9/-; EF39, EF8, EF50, 7Y4, 7C5, 7C6, 7B7, 7H7, 7S7, 7/6; HVR2A, 6K7G, 6/3. All new and boxed. Postage 4d. per valve extra. **READERS RADIO**, 24, Colberg Place, Stamford Hill, London, N.16.

**STAN WILLETT'S**  
43, Spon Lane, West Bromwich, Staffs.  
**R1155 COMMUNICATION RECEIVERS**—complete with 10 valves in wooden transit case, all tested and guaranteed before dispatch, £7/19/6, carriage 8/6.  
**V.C.M.97** (full size picture)—Guaranteed brand new and boxed 29/6, post 4/6.  
**32 MFD. CONDENSERS**, 450 V.—Guaranteed brand new, 4 for 5/11, post extra.  
**VOLUME CONTROLS**—1 1/2 in. spindle, 1 and 2 meg., 1/6 each, 100 k. S.P. S.W., 1/6; 1 meg. with S.P. S.W., 2/6, post 4d.  
**VALVES** (all guaranteed)—At 1/6: 2C4, R34, EA50, SP41, VU111, 864, 8D2, At 3/8: 3D6, 1LD5, ATP4, SP61, At 5/9: 6J7, 6K7, 6K7, 7H7, 7R7, 14R7, 12S7J, 12U5, VR50-30. At 7/11: 5Z4, 6V6, 6X5, 7C5, 7C6, 7S5, A, 8/6. 6AM6, 6SL7, DH63, MU14, U50, At 10/6: 5U4, 6SN7, ECH33. At 12/6: UCH42, 6J6. At 4/9: EC52, post extra.  
**CRYSTAL MONITOR**—Type 2, less valves and crystal, but full of useful components. Size, 7 1/2 in. x 5 1/2 in. x 5 in. As new, 6/8, post 1/6.

**SITUATIONS VACANT**

The engagement of persons answering these advertisements must be made through a Local Office of the Ministry of Labour or a Scheduled Employment Agency if the applicant is a man aged 18-64, inclusive, or a woman aged 18-59, inclusive, unless he or she, or the employment, is exempt from the provisions of the Notification of Vacancies Order, 1952.

**RADIO (METEOROLOGICAL) MECHANICS** required by Meteorological Office. Qualifications: Basic knowledge of radio and radar and experience in maintenance/operation of radar equipment, including oscilloscopes. Successful applicants serve in U.K. and overseas. Commencing London wage £7/17/6 at age 25 or over rising annually to £9/10/6. Deduction of 3/- for each year below 25. Overtime, night duty allowances, etc. Promotion prospects. Apply to: Borough Employment Exchange (Dept. P.W.), 236, Walworth Rd., London, S.E.17.

**EDUCATIONAL**

**RADIO OFFICERS** urgently reqd. We train most in shortest period. Training fees payable after appointments secured. Scholarships available. Boarders accepted. 2d. stamp for Prospectus. **Wireless College**, Colwyn Bay.

**MERCHANT NAVY and Air Radio**—Here is an opportunity to train as Radio Officer. The big liners are open to you, but you must qualify for the P.M.G. Certificate. Day, Evening and "Radiocerts" postal courses. Estd. 30 years; s.a.e. for prospectus from Director. **THE WIRELESS SCHOOL**, 21, Manor Gardens, London, N.7. (Tel.: ARC. 3694.)

**A.M.I. MECH.E.**, A.M.Brit.I.R.E., City and Guilds, etc., on "no pass—no fee" terms; over 95% successes. For details of exams, and courses in all branches of engineering building etc., write for 144-page handbook free. **B.I.E.T.** (Dept. 242B), 17, Stratford Place, London, W.1.

**WIRELESS**—Evening Class instruction for P.M.G. Certificate of Proficiency and Amateur Wireless Licence. Morse instruction only, if required, also postal courses. Apply **B.S.T.**, LTD., 179, Clapham Rd., London, S.W.9.

**THE INSTITUTE of Practical Radio Engineers** Home Study Courses are suitable coaching text for I.P.R.E. and other qualifying examinations. Fees are moderate. Syllabus of seven modern courses post free from **SECRETARY, I.P.R.E.**, 20, Fairfield Rd., London, N.8.

**NUTS, BOLTS, SCREWS AND WASHERS**

**ALL CADMIUM PLATED**  
**SET 305 (Size 2BA)**. Assorted screws and bolts from 3/16 in. to 1 1/2 in. long, with plain hex. nuts, Finnic nuts, double anchor nuts, lock washers and plain washers. All rust proof. Average Contents, 450 Pieces 7/6, plus 6d. post.  
**SET 306 (Size 4BA)**. Assorted screws and bolts from 1/4 in. to 1 1/2 in. long, with plain hex. nuts, Finnic nuts, and plain washers. All rust proof. Average Contents, 600 Pieces, 7/6, plus 8d. post.  
**SET 307 (Size 6BA)**. Assorted screws from 1/4 in. to 1 1/2 in. long, with plain hex. nuts, Finnic nuts, shake proof washers, and plain washers. All rust proof. Average Contents, 750 Pieces, 7/6, plus 6d. post.  
By post, air-freight or ship, anywhere in the world. Overseas post extra.  
All sets well packed in compartmented boxes.  
**BERNARD F. WADE LTD.**  
ILKLEY, YORKS, ENGLAND  
Tel.: Ilkley 1767.

**Special Xmas Offer**

**G.F.C. "Miniscope,"** the well-known mains-operated oscilloscope, 100 volts and 200/250 volts 50 cycles. Uses hard valve time base, two valve amplifier for Y plates. Has all the usual controls—shift, sync, brilliance, focus, time base frequency, etc. This 'scope was specially designed for the radio and television engineer. **BRAND NEW** in manufacturer's sealed carton with leatherette carrying case, complete with all leads, valves, tube and complete Instruction Manual with circuit. The manual includes 40 pages devoted to the use of the 'scope by Miller. List price £21, yet we offer this complete 'scope for **ONLY \$9.19.6.** carr. and pkg. 4/6. Send S.A.E. for illustrated brochure. 'Scopes demonstrated to all callers. **Communication Receiver R1155**—for world reception. For those not familiar with the receiver we can supply the authoritative "Wireless World" circuit and descriptive booklet for 1/3 post free. All air-tested before despatch. Complete with ten valves. **ABSOLUTELY BRAND NEW** for **£11.19.6.** plus 10/6 carriage in original transit case. Demonstrations given any time. Come and hear the receiver you buy. We have a few only, slightly used, air-tested and aligned where necessary for only **£7.19.6.** plus 10/6 carriage in original case. **A.C. Mains Power Pack & Output Stage** enables the R1155 to be operated from 200/250 volt A.C. mains without any alteration whatever to the receiver. Just plug in and connect low impedance speaker (speaker not included). Manufactured by ourselves from first class components in a black metal case size 9 1/2 in. x 6 1/2 in. x 4 in. Guaranteed **FOR SIX MONTHS.** Complete with all valves, Jones plug and lead for **£4.10.0.** carr. 3/6. **££ SAVE MONEY ££.**—We offer a brand new R1155, Power Pack and output stage for only **£15.19.6.** carr. and pkg. 12/6.



**CHARLES BRITAIN (RADIO) LTD.**

11, Upper Saint Martin's Lane, London, W.C.2  
Shop hours, 9-6 p.m. (9-1 p.m. Thursday)

**MORSE CODE Training**

Send for the Candler **BOOK OF FACTS**

It gives details of all Courses which include a Special one for securing Amateur Licence. **CANDLER SYSTEM CO.** Dept. 5LO 52b, Abingdon Road, London, W.8. Candler System Co., Denver, Colorado, U.S.A.

**COVENTRY RADIO**

Component Specialists since 1925

**189, DUNSTABLE ROAD · LUTON**

Phone: LUTON 2677

New Catalogue Available early December

WE SEND COMPONENTS ALL OVER THE WORLD. LET US KNOW YOUR REQUIREMENTS. NO ORDER TOO SMALL. QUOTATIONS GIVEN.

**FIRST-CLASS RADIO COURSES . . .**

**GET A CERTIFICATE!**

**QUALIFY AT HOME—IN SPARE TIME**

After brief, intensely interesting study—undertaken at home in your spare time—**YOU** can secure your professional qualification. Prepare for **YOUR** share in the post-war boom in Radio. Let us show you how!

**FREE GUIDE**

The New Free Guide contains 132 pages of information of the greatest importance to those seeking such success-compelling qualifications as **A.M.Brit.I.R.E., City and Guilds Final Radio, P.M.G. Radio Amateurs, Exams., Gen. Cert. of Educ., London B.Sc. (Eng.), A.M.I.P.E., A.M.I.Mech.E., Draughtsmanship** (all branches), etc., together with particulars of our remarkable Guarantee of **SUCCESS OR NO FEE** Write now for your copy of this invaluable publication. It may well prove to be the turning point in your career.

**FOUNDED 1885—OVER 150,000 SUCCESSES**

**NATIONAL INSTITUTE OF ENGINEERING**

(Dept. 461) 148, HOLBORN, LONDON, E.C.1

**TWIN TRACK TAPE RECORDING**

Complete Kit, £24.10.0 (Carr. Paid)

**LANE MK II. TAPE TABLE**

Only, £16.10.0 (Carr. 10/- extra)

Detailed Plans & Instructions, 2/6.

Demonstrations daily at our Shop. Open 8.30 a.m.-6 p.m., including Sats. Send 6d. for our new 24-page Catalogue of Radio and Engineering Supplies.

Tel.: St. Albans 5951.

**BOLD & BURROWS, 12/18 VERULAM ROAD (A5), ST. ALBANS, HERTS.**

**IT'S NEW—SENSATIONAL POCKET-SIZE—"FLICK-A-DISC"—VALVE CHART**

(Copyright reserved)

**FLICK O' THE DISC AND YOUR VALVE EQUIVALENT IS AT YOUR FINGERTIPS**

Instant Equivalents to over 300 British, American, and Ex-W.D. Valves. All types from 1.4 to 40 volts. **A MUST for the Service Engineer**

From **2/6** EACH Post 3d. **RICHARD EDEN, LTD.** 93, Westbourne Grove, London, W.2. Trade enquiries invited.

**VALVES**

All Guaranteed.		24 hours' Service.	
41MP	5/-	MSPEN (7-pin)	4/6
4TSP	4/-	VR66	1/6
DDL1	4/6	SP41	2/6
MH4	4/6	2X2	4/6
MH4 (Metal)	6/-	EF50 (VR91)	5/6
42SPT	4/6	EF50 (RED SYL)	7/6
V65	6/-	6Q7	10/-
CV9	4/6	6K7	6/6
8D2	4/6	6V6	9/6
9D2	4/6	6SH7	5/-
15D2	5/-	APV1 (4v-Rec)	10/-
LP2	3/6	5Z4	9/6
KT44	4/6	VU111	4/6
KTZ41 (VP4B)	4/6	1R5	9/6
AR6 (2v-Triode)	4/9	FW4/500	9/6
KT24 (2v-Pen)	4/9	EA50	2/6
EF80	11/-	954	2/6
EF91	10/-	155	9/-
807	9/-	1T4	9/-
6J7 (Z62)	4/6	ECL80	10/-
6J5	5/6	6H6	4/-
6SN7	10/6	5U4C	9/-

**TELEVISION.**—Mark 17 Set. 2-valve Battery Transmitter and Receiver. Will receive TV sound without modification. Instruction Book and Circuit—Free. 29/6. **TELEVISION TUBE.**—ACR2K (Mu Metal Screen). 4-v. heater. Max. H.T. 4,000 kV. Work on 2.5. 28/6.

**COLVERN W.W. POTS.**—Boxed 1 kΩ. 2 kΩ 2/9.

**PANELS.**—Complete with 18 Cond., 22 1-watt Resistors, 3 W. resistors. 4/9.

**DOUBLE FUSE HOLDERS.**—2/3. **PAPER BLOCK COND.**—8 mfd., 500 v.w. 3/6.

**BULGIN RED LAMP HOLDERS, 2/3.** **G.E.C. NEON TUNING INDICATOR** with base.—2/3.

**11-v. DRY CELL.**—8d. **JONES 8-WAY PLUG.**—1/- **ADHESIVE TAPE.**—4in., 50 yds. 1/6.

Mail Order Only. Postage Over £2 FREE.

**REX RADIO**

37, LOUIS ST., CHAPELTOWN RD., LEEDS. 7



Accurately tests High, Low and Grid Bias Batteries. Write for leaflet 29 M.



**RUNBAKEN MANCHESTER**

1952

**CRYSTAL SET**

The **LESDEX NEW 1952 CRYSTAL SET** in bakelite case 8 1/2" x 3" x 5", fitted litz-wound coil, variable condenser, everset Diode Detector, telephone transformer, headphones, with headband, cord and plug, aerial and earth terminals, all aerial tested. Maroon or Mottled Brown, 30/- each, postage 2/6.



**DYNAMOS.**—Shunt wound D.C. 14/32 volts 9 amps; 2,500 r.p.m. for charging 12, 18 or 24-volt batteries, £3 10s As new and guaranteed. Carr. 5/- extra. 12 volts 6 amps, 4-brush type, compound wound by Smith with pulley, 55/-. Carriage 5/-. D.C. generators, 24 volts, 28/30 amps, shunt wound, 900 r.p.m., new condition, £25. Carriage extra.

**MORSE PRACTICE SET.**—A.M. Morse Key with twin-coil buzzer, space for battery, all on base, wired, 6/6, post 1/6.

**ELECTRADIX RADIOS**

Dept. G.214, Queenstown Road, Battersea, London, S.W.8.

Telephone: MACaulay 2159

Practical Wireless

**BLUEPRINT SERVICE**

**PRACTICAL WIRELESS**

No. of  
Blueprint

**CRYSTAL SETS**

- 1s. each.  
1937 Crystal Receiver... PW71\*  
The "Junior" Crystal  
Set ... .. PW94\*

**STRAIGHT SETS**

Battery Operated

- One-valve : 2s. each.  
The "Pyramid" One-  
valver (HF Pen) ... PW93\*  
Two-valve : 2s. each.  
The Signet Two (D &  
LF) ... .. PW76\*  
Three-valve : 2s. each.  
Summit Three (HF Pen,  
D, Pen) ... .. PW37\*  
The "Rapide" Straight  
3 (D, 2 LF (RC &  
Trans)) ... .. PW82\*  
F. J. Camm's "Sprite"  
Three (HF, Pen, D,  
Tet) ... .. PW87\*  
Four-valve : 2s. each.  
Fury Four Super (SG,  
SG, D, Pen) ... .. PW34C\*

Mains Operated

- Two-valve : 2s. each.  
Selectone A.C. Radio-  
gram Two (D, Pow)... PW19\*  
Three-valve : 2s. each.  
Double - Diode - Triode  
Three (HF Pen, DDF,  
Pen) ... .. PW23\*  
Four-valve : 2s. each.  
A.C. Fury Four (SG, SG,  
D, Pen) ... .. PW20\*  
A.C. Hall-Mark (HF  
Pen, D, Push-Pull) ... PW45\*

**SUPERHETS**

- Battery Sets : 2s. each.  
F. J. Camm's 2-valve  
Superhet ... .. PW52\*

No. of  
Blueprint

**SHORT-WAVE SETS**

Battery Operated

- One-valve 2s. each.  
Simple S.W. One-valver PW88\*  
Two-valve : 2s. each.  
Midget Short-wave Two  
(D, Pen) ... .. PW38A\*  
Three-valve : 2s. each.  
Experimenter's Short-  
wave Three (SG, D,  
Pow) ... .. PW30A\*  
The Perfect 3 (D, 2 LF  
(RC and Trans)) ... PW63\*  
The Band-spread S.W.  
Three (HF Pen, D  
(Pen), Pen) ... .. PW68\*

**PORTABLES**

- Four-valve : 2s.  
"Imp" Portable 4 (D,  
LF, LF, Pen) ... PW86\*  
1s.  
The "Mini-Four" All-  
dry (4 valve superhet) PW

**MISCELLANEOUS**

- 2s. each.  
S.W. Converter-Adapter  
(1 valve) ... .. PW48A\*  
(2 sheets), 7s. 6d.  
The P.W. 3-speed Auto-  
gram.

**TELEVISION**

- The Practical Television Receiver,  
(3 sheets) 10/6  
The "Argus" (6in. C.R. Tube) 2/6

**AMATEUR WIRELESS AND  
WIRELESS MAGAZINE**

**STRAIGHT SETS**

Battery Operated

- One-valve : 2s.  
B.B.C. Special One-  
valver ... .. AW387\*  
Two-valve : 2s. each.  
A modern Two-valver ... WM409\*

Mains Operated

- Two-valve : 2s. each.  
Consoelectric Two (D,  
Pen), A.C. ... .. AW403

**SPECIAL NOTE**

THESE blueprints are drawn full size. The issues containing descriptions of these sets are now out of print, but an asterisk beside the blueprint number denotes that constructional details are available, free with the blueprint.

The index letters which precede the Blueprint Number indicate the periodical in which the description appears. Thus P.W. refers to PRACTICAL WIRELESS, A.W. to Amateur Wireless, W.M. to Wireless Magazine.

Send (preferably) a postal order to cover the cost of the Blueprint (stamps over 8d. unacceptable) to PRACTICAL WIRELESS Blueprint Dept., George Newnes, Ltd., Tower House, Southampton Street, Strand, W.C.2.

No. of  
Blueprint

**SHORT-WAVE SETS**

Battery Operated

- One-valve : 2s. each.  
S.W. One-valver for  
America ... .. AW429\*  
Two-valve : 2s. each.  
Ultra-short Battery Two  
(SG, det Pen)... .. WM402\*  
Four-valve : 3s. each.  
A.W. Short Wave World-  
beater (HF Pen, D, RC,  
Trans) ... .. AW436\*  
Standard Four-valver  
Short-waver (SG, D,  
LF, P)... .. WM383\*

Mains Operated

- Four-valve : 3s.  
Standard Four-valve A.C.  
Short-waver (SG, D,  
RC, Trans) ... .. WM391\*

**MISCELLANEOUS**

- Enthusiast's Power Am-  
plifier (10 Watts) (3/-) WM387\*  
Listener's 5-watt A.C.  
Amplifier (3/-) ... WM392\*  
De Luxe Concert A.C.  
Electrogram (2/-) ... WM403\*

**QUERY COUPON**

This coupon is available until Dec. 1st, 1952, and must accompany all Queries, sent in accord with the notice on page 601.  
PRACTICAL WIRELESS, Dec., 1952



OPEN TILL 6 P.M. SATURDAYS

TELEPHONES: AMBASSADOR 4033 &amp; PADDINGTON 5271/2

# PREMIER RADIO Company

(REGD.) B. H. MORRIS &amp; CO (RADIO) LTD. EST. 40 YRS.

THIS IS OUR ONLY ADDRESS (Dept. PW.) 207 • EDGWARE ROAD • LONDON • W2 THIS IS OUR ONLY ADDRESS



NOW BEING DEMONSTRATED AT THE ADDRESS ABOVE

Introducing ... THE PREMIER De Luxe

## PORTABLE

### MAGNETIC TAPE RECORDER

THIS UNIT COMPARES MORE THAN FAVOURABLY WITH ANY OTHER MAKE OF TAPE RECORDER AT DOUBLE THE PRICE.

THE 7 VALVE AMPLIFIER has been specially designed for high quality reproduction.

#### Brief Specification:—

**VALVE LINE UP:—**EP37A First Stage; 6SL7 Second Stage and Tone Control; 6V6 Output; 6X5 Rectifier; VT501 Bias and Erase Oscillator; 7193 Rechrud Level Amplifier; 6U5 Magic Eye Record Level Indicator.

**OUTPUT:—**4 Watts. **FREQUENCY RANGE:—**50 cps to 9,990 cps.  
**CONTROLS:—**Volume; Record/Playback Switch; Treble Boost; Base Boost—on/off. A VISUAL MAGIC EYE Record Level Indicator is incorporated.

The unit is housed in a superbly finished rexine covered portable cabinet which incorporates a compartment for the Microphone when not in use. Weight complete 35 lb. Dimensions—21in. long; 12 1/2in. deep; 9 1/2in. high.

The Recorder incorporates the NEW LANE TAPE TABLE.

#### Brief Specification:—

Made to high standards and incorporating features ensuring low level of "Wow" and "Flutter" throughout the full length of tape

**FAST REWIND.** Provision for fast rewind and forward run in less than 1 min. in either direction. THREE MOTORS obviating friction drive.

**HIGH FIDELITY RECORD PLAYBACK (1 HOUR APPROX. PLAYING).** The Table is fitted with high fidelity record playback head of new design wound to high impedance and a separate A.C. Erase Head. The Heads are half track size, allowing approx. 1 hr. playing from standard 1,200ft. Reel of Tape.

**TAPE SPEED** 7 1/2 in. sec. For use on A.C. 200/250, 50 cycles mains only.

**MICROPHONE—**ROTHERMEL 2D56 Crystal—Specially designed for Premier.

★ SUPPLIED COMPLETE WITH MICROPHONE, REEL OF 'SCOTCH BOY' TAPE AND REWIND SPOOL **39 Gns.** (Pkg. Carr. 1gn.)

This Recording Outfit has been designed for use with M.C.-1-111 'SCOTCH BOY' Magnetic Tape. With this high quality tape a frequency range of 50 cps. to 9,990 c.p.s. at tape speed of 7 1/2 in. sec. can be readily achieved. Additional reels of 1,200ft. can be supplied at 35/-

Separate Units are available as follows:—

Built Amplifier complete with portable Cabinet. Plus Speaker. Plus 7 1/2 in. Pkg. Carr. 14Gns. 3/- Pkg. Carr. **£4.19.6**

The Lane Tape Table **£16.10.0** Plus 7 1/2 in. Pkg. Carr.

**CONSTRUCTOR'S POLISHED CABINET.** Size 10 x 8 1/2 x 5 1/2 in. approx., supplied in flatted form. Frovood and ready to glue together. Complete with plastic front, 5 valve chassis, cadmium plated, size 8 1/2 x 4 x 1 1/2 in., tuning scale, knob and back, 10/- post and packing, 1/6.

**Twin-gang and Pair of L. and M. T.R.F. Coils** with circuit to suit above, 8/6.

**Standard Wave-change Switches.** 6-pole 3-way, 2/-; 4-pole 3-way, 1/9; 5-pole 3-way, 1/9. Miniature 3-pole 4-way, 5-pole 2-way, 4-pole 3-way 2/6.

**Valveholders.** Paxolin octal, 4d. Moulded octal, 7d. EP50 ceramic, 7d. Moulded BTG slightly soldered, 6d. Local amphonel 7d. Local pax., 4d. Mazda Amps, 7d. Mazda pax., 4d. B9A, B9A amphonel 7d. BTG with screening can 1/6.

**Trimmers.** 5-40 pf., 5d.; 10-110, 10-230, 10-450 pf., 10/4.

**Twin-gang .0005 Tuning Condensers.** 5/- With trimmers, 7/6. Midget .00037 dust cover and trimmers, 8/6.

P.M. SPEAKERS		with trans.	less trans.
2 1/2 in.	...	15/6	13/6
3 1/2 in.	...	16/6	12/6
5 in.	...	16/6	12/6
6 1/2 in.	...	15/-	15/-
8 in.	...	18/6	15/-
10 in.	...	25/-	25/-

Post and packing on each of the above, 1/- extra.

**EX-GOVT. MARCONI CR100 COIL UNIT.**—6-band, 10-5,000 metres approx., complete with 5 I.F.s and 4-gang tuning condenser, 27/6. post and packing 3/-.

**Constructor's Parcel,** comprising chassis 8 1/2 x 4 1/2 x 1 1/2 in., with speaker and valveholder cut-outs, 5in. P.M. speaker with transformer, twin gang with trimmers, pair T.R.F. coils long and medium, iron cored, four valveholders, 20 K. volume control and wave-change switch, 23/-, post and packing 1/6.

**Mains or Battery Superhet Portable Coils.** Comprising medium-wave frame aerial and long-wave loading coil, used as aerial coils. Midget iron-cored screened L/M osc. coils, complete with circuit I.F. frequency 455 Kc., 9/6.

**465 Kc. Midset I.F.s.** Q.129, size 1 1/2 in. long, 1 1/2 in. wide, 1 1/2 in. deep, by very famous manufacturer. Pre-aligned adjustable iron-dust cores. Per pair, 12/6. Coils and I.F.s. £1. post paid.

Terms of business:—Cash with order. Dispatch of goods within three days from receipt of order. Where post and packing charge is not stated, please add 1/- to 10/-, 1/6 up to £1. and 2/- up to £2. All enquiries and Lists, stamped, addressed envelope.

**D. COHEN** RADIO AND TELEVISION COMPONENTS 23, HIGH STREET, ACTON, W.3. (Opposite Granada Cinema)

Hours of Business: Saturdays 9-6 p.m. Wednesdays 9-1 p.m. Other days 9-4.30 p.m.

**Output Transformers.** Standard type 5,000-ohms 1mp., 2-ohms speech coil, 4/9. Miniature type 42-1-3/3. Multifratio 3,500, 7,000 and 14,000 2 ohms speech coil, price 5/6. 10-watt push-pull 6v6 matching 2 ohms speech coil, 7/-.

#### MAINS TRANSFORMERS

These transformers are all famous radio manufacturers' surplus and are fully interleaved, impregnated and guaranteed.

**Mains transformer.** primary 200-250 v. 230-0-230, 250 mA., 6 v. 6 amp. 5 v. 3 amp., drop-through, 29/6. P. & P. 3/-.

**Mains Trans. Pri.** 200-250 v. Sec. 3, 4, 5, 6, 8, 9, 10, 12, 15, 18, 20, 21 and 30 volt at 2 amp., 13/- P. & P. 1/6.

**350-0-350 100 mA., 4 v. 4 amp., 4 v. 2 amp., upright or drop-through, 16/-.**

**300-0-300 100 mA., 6 v. 3 amp., 5 v. 2 amp., 25/-.**

**Drop-thru, 350-0-350 v. 70 mA., 6 v. 2.5 amp., 5 v. 2 amp., 14/6.**

**230-0-230, semi-shrouded drop-through, 80 mA., 6 v. 3 amp., 5 v. 2 amp., 16/6.**

**Semi-shrouded, drop-through, 230-0-230, 80 mA., 4 v. 6 amp., 4 v. 2 amp., 12/6.**

**Auto-wound, H.T. 230 v. at 350 mA., 4 v. 3 amp., 2 v. 3 amp., or 6 v. 3 amp. Separate 1 v. 3 amp. rectifier winding (upright or drop-through), 10/6.**

**350-0-350, 120 mA., 4 v. 4 amp., 4 v. 3 amp., drop-through, 21/-.**

**Auto-transformer, various combinations of voltages including 110 v., 70 watts, and 3 1/2 v. windings at 1 amp., 2 v. 1 amp., drop-through or upright mounting, 10/6.**

**250-0-250, 60 mA., 6 v. 3 amp., 12/8.**

**250-0-250, 80 mA., 6 v. 4 amp., 14/-.**

**Pri. 230 v. Sec. 200-0-230 35 mA., 6 v. 1 amp., 1 amp. 5/6.**

**Heater Transformer, Pri. 230-250 v. 6 v. 11 amp., 8/-; 2 v. 2 1/2 amp., 5/- P. & P. each 1/-, 2, 4 or 6 volt 2 amp. 7/6.**

**Primary, 200-250 v. P. & P. on each, 1/6 extra.**

**Kit of parts for Signal generator. Coverage 110 Kcs.-320 Kcs., 320 Kcs.-900 Kcs., 900 Kcs.-27 Mcs., 275 Mcs.-25 Mcs., 8.5 Mcs.-2 Mcs. Metal case 10 1/2 x 6 1/2 x 4 1/2 in., size of scale 6 1/2 x 3 1/2 in. 2 valves and 1 rectifier valve. A.C. mains 230-250. Internal modulation 400 cps. to a depth of 30 per cent. Frequency calibration accuracy plus or minus 1 per cent. Modulated or unmodulated R.F. output continuously variable 100 millivolts. £3 10/0. P. & P. 4/-. This includes the return to us for checking and calibration.**