

**FREE INSIDE! "MAINS VALVES" DATA SHEET!**

# Practical Wireless

**3<sup>rd</sup>**

Published every Wednesday by  
**GEORGE  
NEWNES  
LTD.**

Vol. 1. — No. 24.  
MARCH 4th, 1933.

Registered at the G.P.O. as a Newspaper.

**BUILDING THE**

# Q.P.P.

**THREE-  
FOUR**



*Completing*

**THE A.C.  
"FURY FOUR"**

by

**F. J. CAMM.**

**FREE** WE WILL CONVERT YOUR PRESENT  
BATTERY SET TO Q.P.P.

SEND FOR FULL DETAILS TO :-

**PILOT REPAIR SERVICE, 77, CITY ROAD LONDON, E.C.1**

Proprietors: Prio-Scott Co., Ltd.  
ADVT.

# SPECIFIED



## FOR THE

# FURY FOUR

### MIDGET TRANSFORMER

is specified by Mr. F. J. Camm for the "Fury Four" . . . yet another famous set designer who pays tribute to the quality and reliability of Igranic Radio Components. If there is one component more than any other in which you must have unquestioning faith, it is the Transformer . . . follow the specification.

A masterpiece in miniature—it weighs only 6½oz., and its size is 2½in. by 1½in. by 1½in. Primary inductance over 60 henries. Beautifully finished in brown bakelite. Ratios: 3-1 and 5-1. Price 10/6.

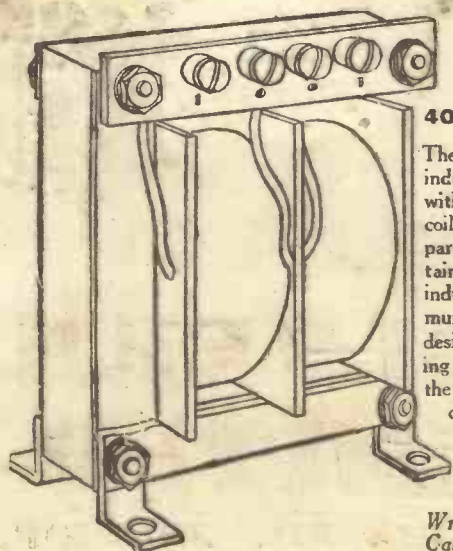
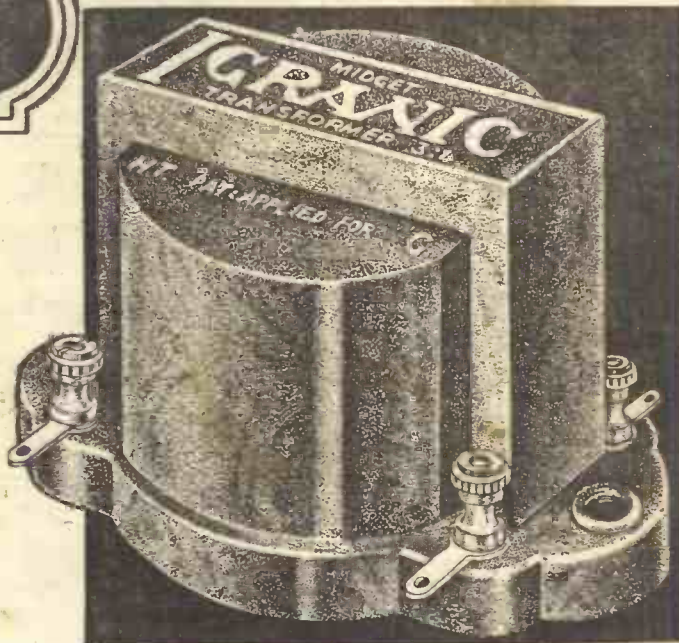

### TYPE C.H.2 CHOKE

40 henries, 40 m/A.

The type C.H.2 constant inductance choke is fitted with four terminals to enable coils to be put in series or parallel. This choke maintains a constant value of inductance up to the maximum current for which it is designed, so that the smoothing remains consistent up to the maximum carrying capacity of the choke. Price 9/6

Write for fully illustrated Catalogue No. J. 3244 of Igranic Quality Components.

# IGRANIC

# COMPONENTS WILL

# BE THE MAKING

# OF YOUR SET.

**IGRANIC ELECTRIC CO., LTD.,**  
149, Queen Victoria Street, London, E.C.4.

**THE  
CONSISTENT PERFORMANCE**

OF THE

**FURY FOUR A.C.  
RADIOGRAM**

depends, to a very large extent, on the high tension supply.

No matter how good the circuit, or how excellent the components used, a wavering high tension supply spoils all. That is why the designer chooses a WESTINGHOUSE METAL RECTIFIER. He knows that it will deliver a constant and non-deteriorating high tension supply for years: and that its proved performance of 45,600 hours output on full load cannot be approached by any other form of rectification. He has chosen Westinghouse. . . . and ensured his high tension supply.

"The All Metal Way, 1933," tells you more about the world's most reliable rectifiers—Westinghouse Metal Rectifiers. Post the coupon and get a copy TO-DAY!

**COUPON**

I enclose 3d. in stamps, as I am desirous of knowing more about the Westinghouse Method of Reliable Rectification.

NAME.....

ADDRESS.....

..... PRAC. 4-3-33



**WESTINGHOUSE  
METAL  
RECTIFIERS**

The Westinghouse Brake & Saxby Signal Co., Ltd.,  
82, York Road, King's Cross, London, N.1.

*You must have a*  
**TD Coil**  
*for the*  
**"Q.P.P.**  
**Three-Four"**

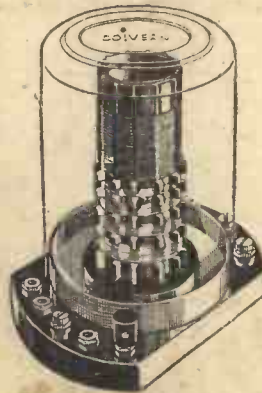

*Selectivity and quality combined in this receiver.*

Super Selectivity is vitally necessary under present-day broadcasting conditions. This is achieved with the Colvern TD Screened Coil.

Four Alternative Tappings are provided. They are arranged as sockets with a wander plug, giving varying degrees of selectivity. The first two tappings give aerial couplings similar to those normally employed but with greatly increased selectivity. Nos. 4 and 5 give a high degree of selectivity with weak aerial coupling, suitable for use in a swamp area.

There is no break through on the long wave band from B.B.C. stations.

PRICE
<b>8/6</b>
EACH

*Send for the Colvern circuit booklet, RL 10.*

**COLVERN  
LIMITED**

**MAWNEYS RD., ROMFORD,  
ESSEX.**

**LONDON WHOLESALE DEPOT:  
150, KINGS CROSS ROAD, W.C.1.**

**Build with your  
own hands  
this better set  
save pounds**



**success a certainty!**



**GET YOUR  
FREE COPY  
OF MOST SUCCESSFUL  
CHART  
EVER PUBLISHED  
enabling you to build  
MOST SUCCESSFUL  
SET EVER  
BUILT!**

NEVER before was there such a set within the reach of the home constructor. Never before such power from a battery set. Never before so many enthusiastic letters from constructors or so much talk about any radio set as this Lissen "Skyscraper" Kit has elicited. 50-60-70 loud-speaker stations—everybody who builds a "Skyscraper" gets results like that! Lissen have published a 1/- Construction Chart, giving the most detailed instructions ever printed for the building of a wireless set. You can't go wrong—every part, every wire, every terminal is identified by photographs. Everybody, without any technical knowledge or skill, can safely and with COMPLETE CERTAINTY OF SUCCESS undertake to build this most modern of radio receivers from the instructions given and the parts Lissen have supplied. This new Lissen "SKYSCRAPER" Kit Set is the only one on the market that you can build yourself employing a Metallised Screened Grid Valve, High Mu Detector and Economy Power Pentode. Around these three valves Lissen have designed a home constructor's kit the equal of which there has never been before. Why be satisfied with whispering foreign stations when you can BUILD WITH YOUR OWN HANDS this Lissen "SKYSCRAPER" that will bring in loudly and clearly distant stations in a profusion that will add largely to your enjoyment of radio?

**YOU ARE TOLD EXACTLY WHAT TO  
DO WITH EVERY SINGLE NUT & SCREW  
YOURS FOR ONLY 8/6  
DOWN**

**COMPLETE IN  
CABINET WITH  
LOUDSPEAKER £6.5s**  
*or 11/6 down and twelve  
monthly payments of 10/6*

**THE ONLY KIT YOU CAN  
BUILD YOURSELF EMPLOYING  
METALLISED SG HIGH MU  
DETECTOR & ECONOMY  
POWER PENTODE VALVES**

To-day you can buy the LISSEN "SKYSCRAPER" KIT on Gradual Payment Terms. "Skyscraper" Chassis Kit, complete with Valves, CASH PRICE, 89/6. Or 8/6 down and twelve monthly payments of 7/6. "Skyscraper" Kit complete with Walnut Cabinet and in-built Loud-speaker, as illustrated, £8 5s. cash. Or 11/6 down and twelve monthly payments of 10/6. You can get the Lissen "Skyscraper" Chart FREE from any radio dealer, or by posting the COUPON below direct to factory.

**LISSEN  
"SKYSCRAPER"  
KIT 3**

**COUPON**  
To Lissen, Ltd., Publicity Dept., P.R.39, Worples Road, Isleworth, Middlesex.  
Please send me FREE copy of your 1/- Skyscraper Chart.  
Name: .....  
Address: .....

**ASK YOUR  
DEALER OR  
POST COUPON**

SPECIAL PUSH-PULL NUMBER!

Practical Wireless



EDITOR: Vol. 1. No. 24 || F. J. CAMM || March 4th, 1933 Technical Staff: H. J. Barton Chapple, Wh. Sch., B.Sc. (Hons.), A.M.I.E.E. Frank Preston, F.R.A., W. J. Delaney, W. B. Richardson.

ROUND the WORLD of WIRELESS

Broadcasts from Japan A SHORT-WAVE transmitter is being erected in the neighbourhood of Tokio; it will operate on a short wavelength and will be used solely for broadcasts destined to Europe.

Another High-power Station for China THE central committee of the Kuomintang, the present governing party in China, has decided to erect a high-power transmitter at Shanghai, which will be used mainly for military purposes.

Poland Loses 18,000 Listeners IN the course of two years, notwithstanding the installation of the Warsaw super-power station, the Polish broadcasting system has lost 18,000 listeners, the total number of licences in December, 1932, reaching only 296,255 for the entire country.

Radio Telephony for Belgian Police SINCE the beginning of the year, experiments have been carried out with pocket wireless receiving apparatus, with which it is hoped to equip many members of the Brussels Police Force.

Further Development of American Relay System BOTH the National Broadcasting Company of America and the Columbia Corporation have recently relayed transmissions from Bangkok, Tokio, Manila and the Philippine Isles.

Experimental Relay Station for Roumania TO improve the broadcasting service a new relay station has been temporarily installed at Blaj; its wavelength is

1,930 metres (156 kc/s), and power 750 watts (aerial). The station rebroadcasts the Bucharest programmes.

Summer Time THE date fixed for the annual change-over from Winter to Summer time does not, unfortunately, coincide in the various countries adopting this principle. British Summer Time this year is fixed for April 9th, and from that date our clocks will correspond with those of such countries as Scandinavia and other countries working to Central European Time and in which no alteration is made throughout the year.

Alternative Programmes for Milan FOLLOWING the inauguration of the 50-kilowatt station at Milan, the E.I.A.R., with a view to giving local listeners alternative programmes, propose to utilize the old Vigentino transmitter (7 kW.) for the relay of entertainments from Rome and Naples. Tests are to be carried out on about 421 metres.

Short-wave Link Between Belgium and the Congo

A GREATER number of short-wave transmitters are being daily used for the relay of wireless programmes from European countries to their respective colonies. The Brussels broadcasts are to be relayed for the benefit of white residents in the Belgian Congo; they will be transmitted on 30 metres through the Ruysselde (Bruges) station.

A Pleasure Cruise

UNDER the title of Fourteen Days' Sunshine, the B.B.C. will broadcast "Nationally," on March 20th, and "Regionally" on the following day, another John Watt production, revolving around the people who meet on board a liner on one of these much advertised cruises. But no advertising will be allowed! On a recent occasion, when a well-known Vaudeville artist broadcast a skit, he told of his projected attempt to swim the channel at its widest point, stating that he would do so at the end of a tow-line hitched to the . . . and he mentioned the name of a well-known trans-Atlantic liner.

Weather Forecasts for the Masses

NOTWITHSTANDING the fact that German studios broadcast weather reports and forecasts at least four times daily it would appear that the inhabitants of some cities are so interested in climatic changes that special services may be estab-

Specials in This Issue!

- COMPLETING F. J. CAMM'S A.C. FURY FOUR - Page 1144 THE Q.P.P. THREE-FOUR Page- 1130 THE PUSH-PULL DETECTOR THREE - Page 1148 WHAT IS WRONG? Page 1125 BEGINNER'S SUPPLEMENT Page 1153 SHORT-WAVE SECTION Page 1155

the change-over at an earlier date, and will advance one hour, in the night of March 25th-26th. This must be taken into consideration by British listeners to French programmes. Belgium, it is stated, will make her change simultaneously with the United Kingdom. On the other hand, Holland, which, in the usual way is twenty minutes ahead of G.M.T., may alter at a later date and, consequently, for the period between that of our alteration and hers, British Summer Time will be ahead of Amsterdam by forty minutes. It is a pity that these various countries cannot come to an agreement to start Summer Time on the same day, as these differences in dates are a source of puzzle to listeners.

# ROUND *the* WORLD of WIRELESS (Continued)

lished to supply their wants. At Frankfurt-am-Main, a company has been started to supply printed weather forecasts for delivery through slot-machines. In exchange for 10 pfennigs (at par, one penny) the inhabitants of that city will be able to obtain a printed slip giving a forecast for the ensuing twenty-four hours. Although it is thought that the novelty of the service may appeal to the public, it is doubtful whether the charge will be warranted, as in no case will the company hold itself responsible for the accuracy of its reports.

## Development of Broadcasting in U.S.A.

ACCORDING to a recently-published report, during 1932 the National Broadcasting Company of America increased its network to a total of eighty-seven transmitters. The cable used to link up these stations now reaches over 20,500 miles. In the course of twelve months, the letters received by the company's studios amounted to 4,800,000 and the gross income derived from publicity was represented by twenty-nine million dollars. One year's working compelled the organization of 51,900 network programmes or over 500,000 appearances of announcers and artists before the microphone. It is expected that 1933 will show an increase on these figures.

## New American Super-power Station

WITHOUT doubt this winter has proved peculiarly favourable to the reception of trans-Atlantic transmissions and listeners on the medium wavelengths have nightly captured broadcasts from stations of as low a power as 250 watts. Within a year's time, logging U.S.A. may be a matter of nightly occurrence as the power of the transmitters on the other side is being steadily increased. W.L.W. Cincinnati, as an example, which has already been heard on 700 kc/s (428.3 m), on many occasions, is now erecting a 500 kilowatt transmitter, which is to serve as a practical laboratory for experiments in the field of super-power broadcasts. Up to the present, the highest power allowed to any station in the United States by the Federal Radio Commission has been 50 kilowatts. With a few more stations of that calibre on the air, signals from the New World should prove as easy to capture as those emanating from the nearer Continentals.

## Contradictory Views!

IN Germany, with a view to improving the technical education of the unemployed, they are granted free listening licences and are encouraged to construct wireless receivers; in Holland, several municipalities have decreed that persons receiving the dole may not be in possession of a wireless set! On the other hand, the Belgian Government has assured the Workmen's Unions that members who are totally unemployed will not be required to pay the radio tax levied from listeners during 1933.

## Radio Diffusion in Belgium

NOTWITHSTANDING the fact that this small country possesses two powerful broadcasting transmitters, a law recently

## INTERESTING and TOPICAL PARAGRAPHS

### SWEDEN'S MOST NORTHERN WIRELESS STATION



This little building at Kiruna, Lapland, represents Sweden's most northern wireless station.

passed by the Belgian Chamber of Deputies encourages the installation of wired wireless distributors. The first one to be opened is that of Deurne, near Antwerp; others are to follow in Flanders, and the province of Hainaut and Liège. The charge made is exceedingly low, having been fixed at one franc per day; the subscriber is given a choice of four programmes.

## Dutch Colonial Transmitter

THE 40 kilowatt short-wave station PHOHI, which has been carrying out tests of broadcasts destined to Java, Sumatra, etc., resumed its broadcasts on February 21st. It has been decided to adopt two wavelengths, namely, 25.57 m. (11,730 kc/s) during the winter and 16.88 m. (17,770 kc/s) during the summer months.

## A Princely Announcer

IT is reported from Sweden that Prince Lennart Bernadotte, a grandson of the King of Sweden, has been appointed announcer to the Stockholm studio.

## Short-wave Transmissions from the Polar Regions

A SERIES of broadcasts is being carried out daily by a scientific expedition directed by Professor Mercanton, of the University of Lausanne (Switzerland). These transmissions are made through a 50-watt station (TF3B) situated at Snaefellsjockul (Iceland) on the 40-metre amateur band between 4.0 and 7.0 p.m. G.M.T.

Under the call-sign LMZ and on 21.40 metres transmissions are also being made on Sundays between 7.0 and 8.0 a.m. and again from 7.0 to 8.0 p.m. G.M.T. by the Norwegian Riiser-Larsen expedition to the Antarctic circle. The power is 80 watts (aerial). Should experimental amateurs pick up any of these signals, in the case of Iceland they are asked to report to *Le Réseau des Emetteurs Français*, 17, rue Mayet, Paris (6e), and in respect to the Antarctic messages, to the Norwegian Radio Relay League, Post Box 2253, Oslo (Norway).

## Another Frequency for Radio Algiers

IN view of the fact that French listeners are complaining that the broadcasts from Radio Alger (Algiers), on most evenings are swamped by the Mühlacker transmissions the Government General of Algeria proposes to effect a change in the wavelength of the station and at the same time to increase its power.

## "When We Come to the End of the Dance"

LISTENERS who have heard Henry Hall and his B.B.C. dance orchestra broadcasting the new waltz "When We Come to the End of the Dance," may be interested to know that this was composed by a woman, Mrs. Marjorie Crocombe, who, although trained as a "high-brow" musician in Milan and Brussels, had never previously thought of writing a popular tune. The chance remark of a friend, to the effect that women rarely succeed as composers of dance music, set her thinking. Just to prove him wrong she composed this liting waltz, which looks like being the most popular "last dance" of the season.

## SOLVE THIS!

### Problem No. 24.

Jackson has a four valve A.C. mains receiver, employing a high-efficiency 8.G. valve in the first stage. This was provided with bias in the ordinary manner by a resistance in the cathode lead, and worked admirably. Owing to an accident, the valve got broken, and he decided to replace it with a better valve, but of the metallized type. This was carried out, but the receiver was unstable, and thinking that the screening may not have been efficient, he twisted some bare wire round the bulb and joined this direct to earth. The set was even more unstable with this arrangement, and he found that the anode current of the complete receiver was higher. Why? Three books will be awarded for the first three correct solutions opened. Address your solution to the Editor, PRACTICAL WIRELESS, Geo. Newnes, Ltd., 8-11, Southampton Street, London, W.C.2, to reach us not later than March 6th, 1933. Mark your envelope Problem No. 24, and do not enclose any other correspondence with your solution.

### SOLUTION TO PROBLEM No. 23.

The current of 18 millamps, passing through the 2,000 ohm winding of the loud-speaker, resulted in a voltage drop of 36 volts. Consequently, as only a 120 volt H.T. battery was in use, the output valve was overloaded and working in a very inefficient manner on 84 volts.

The following three readers received books in connection with Problem No. 22:

Mr. A. Freeman, 43, Netherfield Road, Everton, Liverpool 5; Mr. J. Pickard, 24, Birklea Street, Bradford, Yorks; Mr. R. Waghorn, 33, Westcliffe Parade, Westcliff-on-Sea.

# WHAT IS WRONG?—3

In His Third Article of the Series, the Author Continues His Remarks on Anode Voltage and Current Tests.  
By FRANK PRESTON, F.R.A.

### Anode Current Indications

As was explained at an earlier stage, the values of anode current give a very good idea as to how the valves are performing, but before we can make use of

either with the valve, valve holder or low tension circuit, so the next thing to do is to test the valve filament by means of the "Filament Tester" referred to last week. If the bulb glows (the light will be quite dim due to the resistance of the valve filament) the L.T. circuit and valve holder will be exonerated from blame, but failure of the bulb to light can point to any of the faults enumerated above. The valve can be eliminated by substituting another one, and if the bulb then shows a light the previous valve was faulty or making bad contact with the holder. The question of contact can be verified by cleaning the valve pins with fine emery cloth and carefully opening them out with a sharp knife, if they are of the split type. When there is no indication of filament current whatever valve is tried in the holder, it will be known that the holder itself, or the L.T. wiring, is at fault. Check the wiring by applying a voltmeter across the filament terminals of the valve holder. "No voltage" shows a break in the L.T. circuit and so the wires must carefully be traced back to their source. The on-off switch might be wrong, but if so there will be no L.T. current (and consequently no anode current) to any of the valves. When a voltage reading

is obtained at the filament terminals the fault is obviously concerned with the valve holder, which should be replaced or removed for examination. In the case of a mains receiver, or one fed from a high tension eliminator, it can safely be assumed that the power supply or its connections are defective if the latter tests fail to reveal a fault, and yet there is no sign of anode current. This point will be dealt with when we discuss mains receivers.

(2) *Too low a current indicated:* Shows that the valve is wrong, the grid bias voltage too high, the grid is disconnected, the valve is oscillating, some component in the anode circuit is of too high a resistance, or that there is a resistance in the L.T. circuit. The tests mentioned in respect to (1) should be applied, especially that of measuring the voltage across the filament terminals of the valve holder. If it is suspected that an anode circuit component has developed a high resistance, the component may be replaced by a similar one, if available, or by a variable resistance. By adjusting the resistance until the anode current is the same as before a good indication of the resistance of the suspected component can be gathered—the effective value of the variable resistance can be estimated by the position of the slider. To test for oscillation in any type of valve the anode terminal should be touched with a moistened finger; a change in anode current will take place if the valve is oscillating. Do not forget that, in the case of an S.G. or pentode valve, the screening grid voltage will have a pronounced effect on anode current.

(3) *Too high a value of anode current:* This might point to too little G.B. voltage, grid disconnected, valve oscillating, leaky grid or coupling condenser, short circuit through a component in anode circuit. Apply tests as in (2) and if a leaky grid condenser is suspected the wire from it to the anode circuit of the previous valve should be disconnected as shown in Fig. 15.

this information we must understand what the readings indicate. We will consider these under different headings, bearing in mind that "high" and "low" readings are purely comparative terms, and are given in respect to the normal currents specified by the valve manufacturers and shown on the characteristic curves.

(1) *No current indicated:* This points to a faulty valve, a break in the anode circuit or a broken connection in the low tension circuit. A method of testing valves will be given later, but the anode circuit components can be tested by short circuiting each in turn as shown in Fig. 14. If a current reading is obtained when any component is short-circuited it will be obvious that that component is faulty, and should be replaced. There is just one possible complication which might arise in respect to this particular test and which would be caused by a "leaky" by-pass or coupling condenser. If the condenser were joined from a point in the anode circuit to earth or to G.B.—it would pass a certain amount of current if any leakage occurred across it, and in consequence it would "rob" the valve of its anode current. If there is reason to suspect a fault of this kind the wire going to one terminal of the condenser should be disconnected whilst making the tests; the wire concerned is indicated in Fig. 14.

Should the latter test fail to disclose the fault it will be clear that the trouble lies

but if so there will be no L.T. current (and consequently no anode current) to any of the valves. When a voltage reading

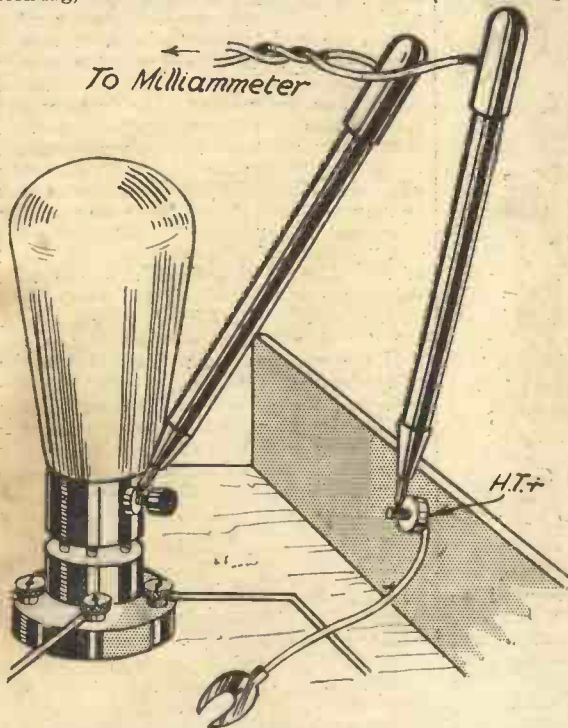

Fig. 13.—Measuring the priming grid current to a pentode.

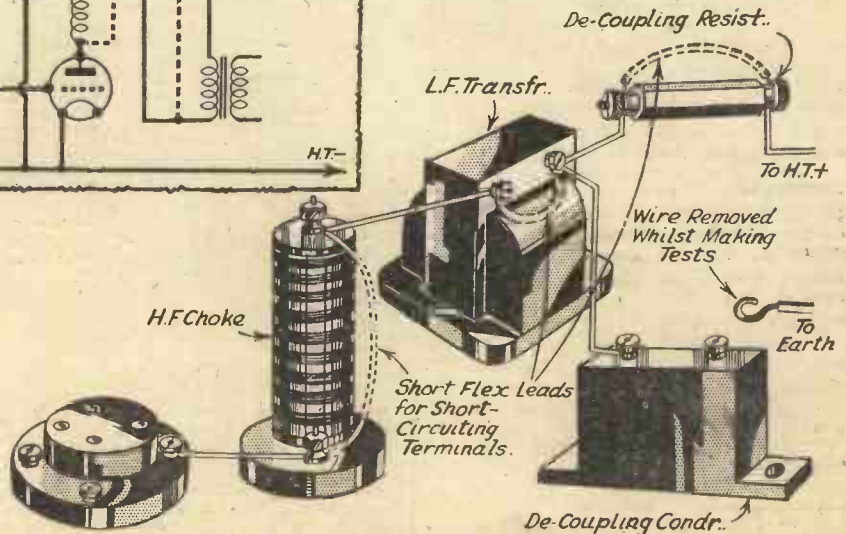
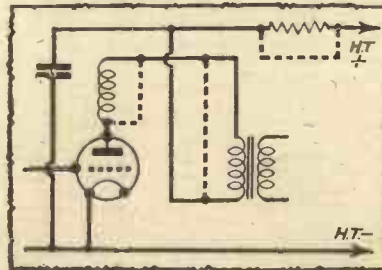

Fig. 14.—Showing how various components in a typical anode circuit should be short-circuited in turn to find which is faulty.

If automatic grid bias is obtained through a voltage dropping resistance, replace the resistance by the variable one and adjust it until a normal reading is obtained. Should this be impossible it will be clear that the bias resistance was not at fault or that its by-pass condenser is broken-down and causing a "short"; disconnect and repeat the tests.

(4) *Anode current fluctuating*: A continual variation in anode current when the set is not tuned to any signal will generally prove to be due to a bad connection which might be either in the grid, filament or anode circuit. First examine carefully all the wiring, see that the valve is firmly in its holder and short-circuit the on-off switch with a short length of wire. Short-circuit each component in the anode circuit as shown in Fig. 14 and apply all the tests mentioned under heading (1). If the fault still persists disconnect the wire going to the grid terminal of the valve holder, if the valve concerned is an S.G. or detector. This should *not* be done in the case of an L.F. valve because the removal of the grid bias voltage might result in damage to the valve. Instead, the grid should be connected directly to the grid bias battery as shown in Fig. 16. If the current becomes steady on applying the latter test it will be obvious that the component(s) in the grid circuit (tuning coil or condenser, transformer, secondary or grid leak) is at fault. In the case of an S.G. or V.-M. valve where a potentiometer is used for volume control, this component should be replaced if a spare is available. Otherwise the connection to the slider should be removed and replaced by a wire going direct to the high tension or grid bias battery. When the current fluctuation occurs only when a signal is tuned-in, there is probably a bad contact in the aerial-earth or tuning system, or in the grid circuit of the valve concerned is an S.G. or detector. To locate the fault, all connections should first be checked and, when possible, other tuning coils substituted. Where the fluctuation is in respect to an L.F. valve it might, or might not, indicate a fault. A certain amount of variation in anode current is inevitable, and it will vary in degree with the delicacy of the meter. But where the current change is so much that the needle "kicks" violently it is likely that the valve is faulty, is receiving incorrect H.T. and G.B. voltages, or is being overloaded. The former points can be checked by trying other voltages and the latter by reducing volume. In any case, if there is anything seriously wrong the fault will previously have made itself conspicuous in the form of distortion.

(5) *Anode current normal to every valve*: When every valve is found to pass the correct amount of H.T. current and yet the set fails to operate in the desired manner, a different series of tests must be applied and these will be dealt with in the next article of this series.

After taking the anode current measurements, as explained above, you will have located most of the likely sources of trouble that exist in your set, but you might still be baffled by some peculiarity which has not yet been brought to light. I will, therefore, explain a few further experiments which should enable you to clear up the difficulty. You will remember that we classified the probable faults under five headings,

which I repeat below in order to refresh your memory. They are:—

1. Entire absence of signals.
2. Weak reception.
3. Reception accompanied by noises or crackling.
4. Distortion, or poor "quality."
5. Instability.

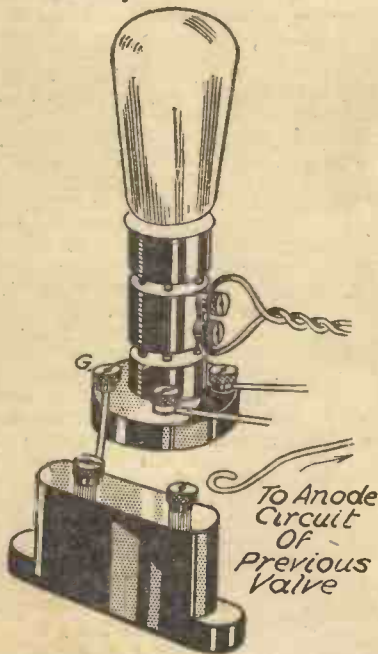

Fig. 15.—If it is suspected that the grid condenser is leaking, it should be disconnected whilst taking anode measurements.

The previous tests were intended to apply chiefly to faults (1) to (3), but they will have helped in the location of (4) and (5) also. In our previous tests we were principally concerned with isolation of the grid, filament, and anode circuits, but now I am going to suggest that we split up the valve stages and check each in turn. There are three ways in which we can do this; one is to start at the loud-speaker "end" of the circuit and work backwards; another is to commence with the tuning

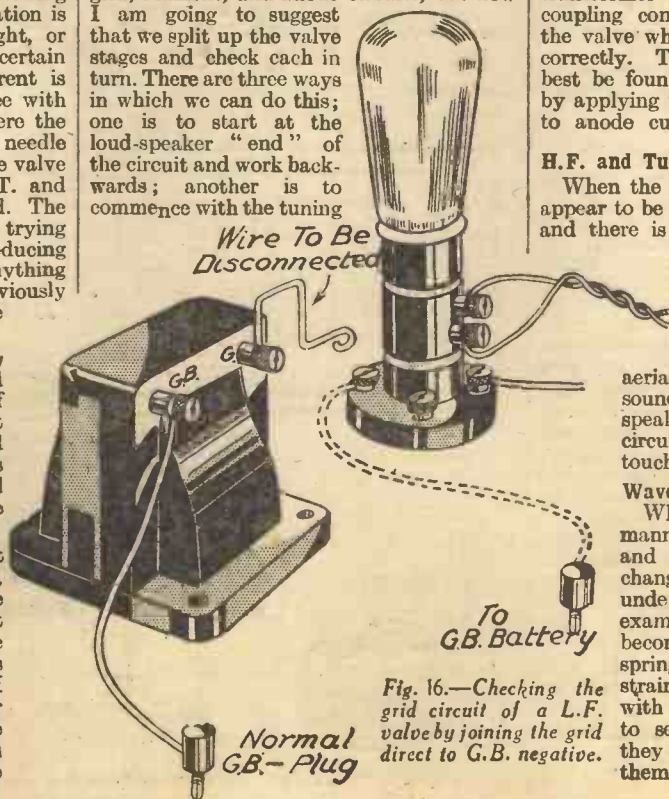

Fig. 16.—Checking the grid circuit of a L.F. valve by joining the grid direct to G.B. negative.

circuits and proceed towards the low-frequency amplifier, whilst the third is to start at the detector-valve and work outwards towards the aerial and loud-speaker "ends." Each method has its application to different types of set, and since these remarks must be of a general character, and applicable to any kind of instrument, I shall try to combine the three methods and show how, by following a logical sequence, any set or any fault can be tackled.

When the set appears to be quite "dead," and signals are absolutely non-existent, it is best to commence work on the most vital part of the receiver—the detector-valve. Touch the grid terminal with a moistened finger, either direct or through the agency of a short length of wire; a sound should be heard in the speaker if the detector and L.F. stages are operating correctly. I cannot say what kind of a sound should be heard, because it will vary with every set, but it should be fairly loud. It might be merely a "plop," it might take the form of a terrifying "howl," or it might be a dull "groan." But if there is a loud sound of any kind it will show that the L.F. valves are at least doing something, and so the fault is probably at some point of the circuit preceding the detector.

If the set does not respond, touch the grid terminal of the valve following the detector; if there is still no sound, try the next valve after that. Of course, the sound will be weaker as the last valve is approached because of the lesser degree of amplification before the speaker. When a point is first arrived at where a sound is heard, it will be obvious that the fault is in the stage immediately preceding, and tests can therefore be applied to the anode circuit of that valve. It will probably be found that the coupling component is either short-circuited, open-circuited, or disconnected, but it might be that a similar fault occurs in respect to the transformer secondary, grid-leak, or coupling condenser in the grid-circuit of the valve which appears to be functioning correctly. The defective component can best be found by testing each in turn, or by applying the tests mentioned in respect to anode current measurements.

**H.F. and Tuning Circuits**

When the circuits following the detector appear to be operating in a normal manner, and there is still no trace of signals, the fault must be confined to the H.F. amplifying and tuning circuits. A preliminary test will consist of touching the grid terminal of each high-frequency valve and then the aerial terminal. In each case a sound should be heard from the speaker; if not, the fault is in the circuit of the valve whose grid is touched.

**Wavechange Switches**

When the set behaves in a normal manner on one wavelength range and not on the other, the wave-change switches will first come under suspicion. They should be examined to see that no wires have become detached and that the spring contacts are not dirty or strained. If, in the case of tuners with built-in switches, it is difficult to see the switch contact springs, they should be operated by pushing them with the end of a pencil.

(To be Continued.)



# The DESIGN of LOUD-SPEAKERS

Some Points about Sound Reproduction, and how the Loud-speaker may Make or Mar the Fidelity of the Received Signals

By W. J. DELANEY



**B**EFORE we can discuss the question of the design of loud-speakers it is necessary to have a clear idea of just what a sound wave is. For the purpose of this article, I am going to deal with the reproduction of a note produced by a large bass drum, and the following description should be read in conjunction with Fig. 1. The figure at the left of this illustration represents a drum head at rest, and the thin wavy lines at the left are representative of the air in front of the vellum (or skin) of the drum. When the drum is struck the vellum is driven inwards, the actual distance of its travel being governed by the tautness of the vellum. When it has travelled its maximum distance inwards, the air, which will obviously have followed it, will be rarefied, and there will consequently be a movement of the air in the direction of the drum. As soon as the momentum of the vellum has been overcome it will tend

shows us, then, that the note, which is actually the speed of vibration, is governed by the size, and the drum, which we are using as our illustration, we will imagine to be of such a size that the note produced by it is a 50-cycle note. This means that the vellum of the drum will, if struck, vibrate backwards and forwards fifty times in a second. (Actually, of course, it only does this for a fraction of a second as it quickly comes to rest.) The large bass drum used in some dance bands does, in fact, have, roughly, this note, and this point should be borne in mind. To sum up what has already been said, therefore, a drum with a 50-cycle note will have a vellum which will vibrate backwards and forwards fifty times in a second, and the air will consequently be alternately rarefied and compressed in the same proportion. We can now study the method of reproducing sounds by means of a loud-speaker, and see

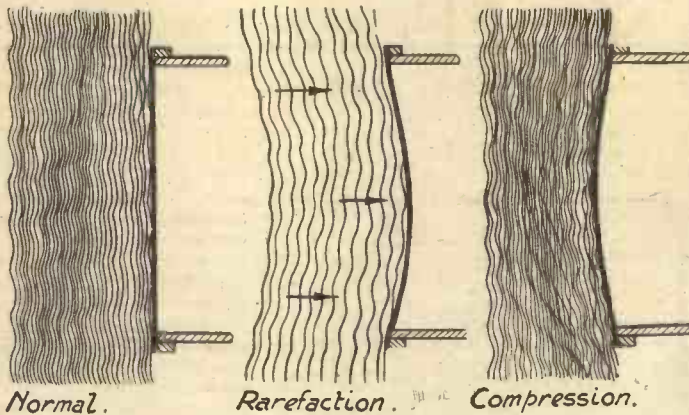

Fig. 1.—A diagrammatic representation of a drum-head, and the condition of the air surrounding it.

to spring back to its normal position, but due to the force of the original blow and the springiness of the vellum it will overshoot the mark and bulge outwards slightly, as shown in the next illustration. On its outward travel it will push the air in front of it, and owing to the rapidity of its travel the air will be compressed, as shown diagrammatically in this illustration. The beat of the drum may, therefore, be considered as a rarefaction and compression of the air, and although this is not scientifically correct, it will serve to enable the non-technical reader to understand the remainder of this explanation.

### Frequency

If you take a piece of elastic 12in. long, and, without stretching it, pluck it slightly, it will give off a musical note. Now reduce the length of the elastic to 6in., and, again without stretching it, pluck it as you did at first. The note will be different. This

how difficult it is to actually reproduce some musical frequencies.

### Moving-iron Loud-speakers

Loud-speakers are divided, roughly, into two classes—moving-iron and moving-coil. The names are really self-explanatory, and mean that in one type a piece of iron moves to produce the sound and in the other type a coil of some sort is caused to move. Although the iron and the coil are not the actual producers of the sound, they are the means to the end, and must, therefore, be considered, for the moment at least, independently from the cone, trumpet or

other apparatus with which they are used. The simplest type of loud-speaker, which is, incidentally, obsolete to-day, but is employed in principle in the headphones, consists of a flat disc of metal clamped round the edge, and fixed just in front of an electro-magnet. It has already been explained in these pages how the sound is converted into electrical impulses, and how these are passed through the magnet windings of the loud-speaker, so we will not discuss this part of the problem here. Fig. 2 shows this type of movement, and it is obvious, if you remember the difference between the two lengths of elastic, that this disc cannot vibrate at the slow rate of the large bass drum. Not only is it too small to do so, but it is so thick, comparatively, that even if the magnet drew it inwards at the correct rate, the tension of the diaphragm would pull it back to normal so quickly, that the frequency would be very much higher than 50 cycles. We can, therefore, dismiss this type of reproducing unit, and it is as well to remember that loud-speaker manufacturers do not now make this movement.

### Reed Type Reproducers

We have just noted that the *tension* of the disc, or diaphragm, was the cause of the inability to reproduce the slow vibration, and it will be obvious, therefore, that to obtain this 50-cycle note we have got to do away with tension. The reed-type of loud-speaker is, therefore, the next movement to consider. In Fig. 3 is shown the magnet with a thin strip of iron in place of the disc of Fig. 2, and, in addition, this strip is attached only at one end. This strip of iron, or, as it is more correctly called, the reed, will obviously have less restoring force than the disc which is clamped all round its edge, and we may consequently expect it to answer more easily to the 50-cycle note. As, however, the end of the reed must be firmly attached to something, there is some restoring force, and this will naturally prevent a faithful following of the slow vibration. In addition, the attachment of the cone or other means of setting the air in vibration will have an effect on

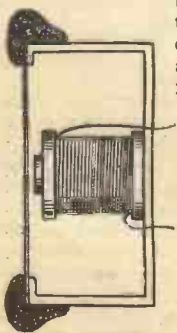

Fig. 2.—A simple diaphragm movement.

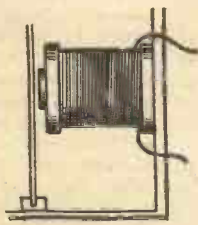

Fig. 3.—A simple reed type movement.

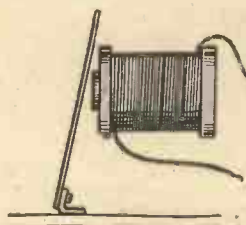

Fig. 4.—A patented reed arrangement.

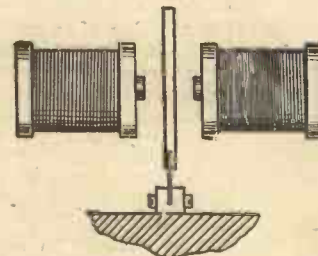

Fig. 5.—A balanced armature arrangement.

(Continued on page 114.)

# ARM-CHAIR VOLUME CONTROL

By "ELECTRODE"

**M**ETHODS of volume control are many and varied, and some sort of volume control is an essential part of any set. Typically, a three-valve set of, say, a year or two ago had its volume control in some form of reaction or something practically equivalent to it, and this still represents quite a good method for a three-valve set. In particular, it has the advantage of leaving the set, when at the lowest gain, in the best condition for quality, and increases the gain of the detector stage, giving the requisite improvement on normal sensitivity even with a slight deterioration of quality.

Within the last year or so the variable- $\mu$  valve has made its appearance, providing an excellent method of volume control which has notable advantages—in particular that, in the control of gain, it also gives some control of selectivity. It has not, however, been much used in the H.F. stages of three-valve sets, but has been more employed in sets using two H.F. stages, where there is much less need for pushing the gain of the detector stage by reaction. It is also, of course, being much used in the super-heterodynes for the same reason.

### Cutting Down the Local Stations

In a good modern set, however, apart from one using variable- $\mu$  valves, it is often difficult to get a volume-control that is wide enough in its scope to suit all conditions. Thus with a three-valve mains set quite a small aerial is adequate for relatively local-station reception, but if we want a modicum of foreign reception a moderately good outdoor aerial is necessary. In this case, at a distance of twenty-five or thirty miles from one of the twin-wave B.B.C. stations the outdoor aerial gives a local-station strength which it may not be possible to cut down sufficiently.

Some sets provide an abrupt "local-distant" switch which puts a relatively low resistance across the aerial-earth terminals and reduces the overall level. The "sweetness" of this in practice sometimes—indeed, mostly—leaves a lot to be desired; and a smooth change, instead of the abrupt jump, is much preferable. This can easily be added if the user desires, and, in particular, it can be added externally, as herein described, without making any change whatever to the set.

### External Volume Control

Apart, however, from any volume control belonging to the set, it is often a great convenience to have a control accessible from the chair—especially from the fireside arm-chair—without the need for rising to go to the set. Most listeners must have experienced cases when this would have been a very definite advantage. When listening to a serious programme or one demanding continuity, it is mostly undesirable to make changes of volume or otherwise to meddle with the volume. But, on the other hand, certain varied

types of programme can often do with varied volume. Personally, I can never get the "crooner" or "syncopated harmonists" reduced to sufficiently low volume, but then, "chacun à son goût." In other cases, also, reduction of volume

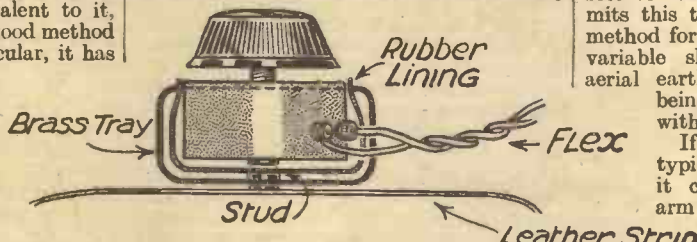

Fig. 1.—Small volume control in arm-chair ash-tray as volume control.

may be desirable for some point of discussion or conversation. Domestic listeners can readily imagine such a need. In these cases it is a great advantage to be able to control it from the arm-chair. Very few sets provide for a permanent volume control for remote operation, but such a device is neither expensive nor difficult to apply.

Quite a well-known device is a resistance across the loud-speaker, either as a shunt or as a potentiometer controlling the actual supply to the loud-speaker. At least one commercial set makes provision for additional terminals for the attach-

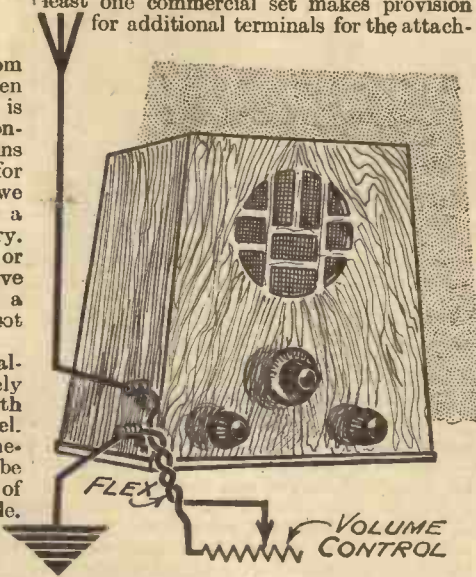

Fig. 2.—Application of remote volume control to set.

ment either of an extra loud-speaker or for a shunt volume control of the type just mentioned. Any method, however, which controls the volume on the loud-speaker itself has naturally the disadvantage that all the circuits before the speaker, from input to output terminals, have to be working at the highest signal level. This is, of course, the condition in which distortion is most likely to occur, and, apart from distortion due to the speaker itself, reduction of volume at the speaker is not going to be of any help in reducing distortion already existing in the set.

### Control at the Input

An obviously better method is to do the control right at the beginning of the set, so that at low volumes the signal through the whole receiver is at a low level. Many sets contain a series condenser which permits this to be done, but a very suitable method for external application is to put a variable shunting resistance across the aerial earth terminals of the set. This being external, it can be added without any alteration to the set.

If a small-sized resistance of the typical volume-control variety is used it can be accommodated on the arm of the arm-chair, with a flex of suitable length joining it to the set. The accompanying illustrations show one of these resistances used in this manner. The resistance is housed in one of those arm-chair ash-trays, in which a small brass cup is fastened by a stud on to a band of suede leather, with end weights which keep it taut over the arm of the chair. Many people—I will not exclude myself—have found these a delusion and a snare as ash-trays, waiting till they get comfortably full of ash, stubs, and matches to get knocked over on to the floor. As arm-chair volume controls, however, I find them delightful. The first illustration, Fig. 1, shows the general housing. The resistance is one of the small bakelite variety; the terminals had to be cut short to get it into the ash-tray, but this was easy. Rubber lining—cut from an old hot-water bag—keeps all the metal of the resistance off the metal of the tray, as well as providing a means of tight packing. A small hole drilled through one side of the tray permits entry of the flex. The second illustration, Fig. 2, shows diagrammatically the method of applying this to the set.

### Resistance Value

The best value of the resistance will depend on a number of things—for example, it will depend on the particular arrangement of the aerial circuit of the set itself. It will also depend on the efficiency of the aerial, and of the set itself, as well as the variation of volume-control that is desired. Generally, however, a resistance of about 25,000 ohms will be found fairly suitable. A test for the best resistance is to ensure that, with the resistance all in, the presence or the absence of the resistance across the set terminals makes no detectable difference. It can then be inferred that the resistance when at its maximum value is causing no loss of efficiency, while it will, of course, serve as a regulator of volume as the value of resistance is cut down.

Apart from being an inherently good method as regards keeping down distortion, this arrangement is also particularly useful in sets with built-in speakers, where access to the speaker itself is often not easily obtained. The writer has used this arrangement with complete success on several different sets, e.g., a 3-valve battery set (detector, L.F., power), a commercial 3-valve A.C. set (H.F., detector, power-pentode), and also on an eight-valve super-heterodyne.

# PUSH-PULL DETECTION

READERS will be more or less familiar with push-pull amplifiers, these having been the subject of various articles in PRACTICAL WIRELESS, but the push-pull system may also be applied to

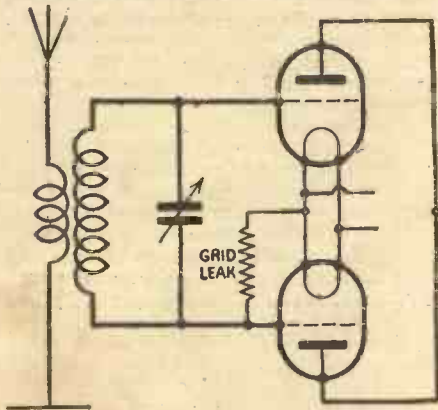

Fig. 1.—The essential connections of a push-pull detector circuit.

the detector circuit in a comparatively simple manner. The present article is intended for those who wish to understand something of the "why and wherefore," but for the severely practical readers whose demand is "something to make," the specification and construction of a three-valve push-pull detector set is described elsewhere in this issue.

The essentials of the circuit are shown in Fig. 1. The tuning arrangement consists of an aperiodic aerial coil closely coupled to a tuned grid coil. In the ordinary way the lower end of the grid coil would be earthed, but in the present case this end is connected to the grid of another detector valve. The grid system is thus entirely isolated except for the grid leak.

The high-frequency currents which flow through the aerial coil are reproduced by induction in the grid coil which is, of course, tuned to the required wavelength in the usual manner by means of a variable condenser. When the top end of the coil is negative the bottom end is positive, and vice versa, and as each end is connected to a grid, each valve is always half a cycle out of step with its companion. Let us look into this rather more closely.

### Cycle of Voltage

Fig. 2 shows diagrammatically a single complete cycle of voltage as it would arrive on the grids of the two valves; this is the radio-frequency wave which is repeated about one million times per second. The top diagram shows the grid voltage rising to a positive value in the top valve at the same time that the voltage is falling to a negative value, as shown in the bottom diagram, in the bottom valve. (The dotted vertical lines represent the same instant of time in both diagrams.)

For the sake of simplicity, we will disregard the detector action for the present and consider what happens in the anode circuit. Each valve will, of course, reproduce the grid voltage fluctuations in its own anode circuit, though the anode cur-

An Important, Informative and Interesting Article dealing with Push-Pull in the Detector Stage

By S. J. GARRATT

rent will not be an alternating one (i.e., the anode current increases or decreases with change of grid voltage, but always flows in one direction). Now the anodes of both valves are connected to a common output connection, so the total output will, of course, be the sum of the two individual outputs. This is shown diagrammatically in

Fig. 3, where the full line represents the output from one valve and the dotted line that of the other valve. It will be seen

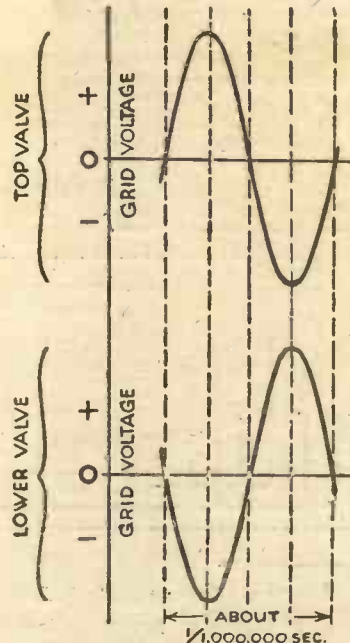

Fig. 2.—The signal variations of the two valves.

that at any instant the output of one valve is always as much above a straight line drawn through the middle as the other

output is below it, or, in other words, the combined output is constant in value and the high frequency fluctuations have entirely disappeared. This is a most important point, for it means that no decoupling is required provided the valves are well matched.

Now let us see what happens to the audio-frequency component when a broadcast wave is received. The full lines in Fig. 4 show, in the usual diagrammatic form, the main characteristics of such a signal wave as it arrives at the grid of one valve, while the dotted lines show what is happening simultaneously in the other valve, the two valves being, as already explained, exactly half a cycle out of step.

In Fig. 4, both valves must be considered to have the high-tension battery disconnected for the moment, when it will be seen that the mean grid voltage remains constant at zero; or, to put it another way, the radio-frequency currents surge to and fro through the tuned grid coil (shown in Fig. 1), from one grid to the other and back again, but the total charge on the whole of the isolated grid circuit remains unaltered at zero.

### Grid Current

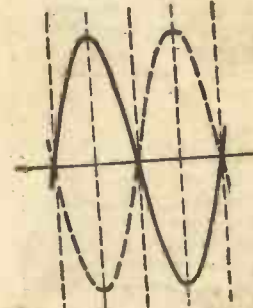

Fig. 3.—The anode components of the two valves.

some few of the electrons being attracted to the grid instead of the anode, but only when the grid is positively charged. This grid current charges up the whole of the isolated grid system of Fig. 1 negatively. Now the greater the amplitude in Fig. 4, the greater becomes the grid current and the greater the corresponding negative charge on the grid system, with the result that the positive half of Fig. 4 is depressed as shown in

(Continued on page 1163.)

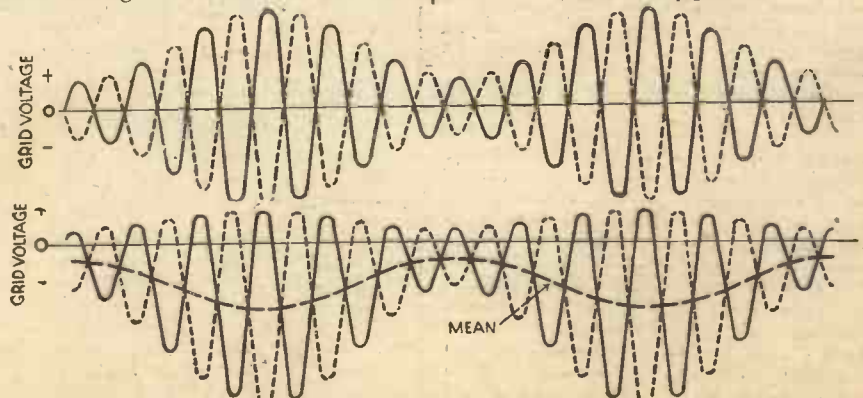

Fig. 4 (above)—the two oscillations of the push-pull detectors, and Fig. 5 (below)—the result of the rectification of the dual oscillations.

# BUILDING THE Q.P.-P.

## Constructional Details of the Latest Receiver Employing Two



Rear view of the Q.P.-P. Three-Four, showing the slide-in frame and the R. and A. moving-coil speaker.

PRELIMINARY details were given last week concerning the latest receiver to be produced by us, employing the now popular Quiescent Push-pull principle. Photographs were given last week showing that the receiver was of the self-contained type, having the receiver situated on a shelf in the upper portion of the cabinet, and the loud-speaker being screwed into the lower portion. The batteries may also be incorporated in this part of the cabinet. Sufficient has already been said in our pages to enable our readers to understand the benefits of this form of L.F. coupling, and it will be found that this particular receiver will deliver an output usually only obtained with a mains-operated receiver employing the very largest of output valves.

### Constructional Details

The actual constructional work will be found extremely simple, and should occupy only a few hours. The cabinet will be found to contain an inner section, which is fitted with a removable baseboard. This is held in place by small nails, and should be removed for the constructional part of the work. Mount the components as shown in the various illustrations, leaving the under-baseboard components until part of the wiring has been completed on the upper surface of the baseboard. Wire those parts which you have now fixed, carrying out the wiring with Glazite. There are no difficulties to be met with in this receiver, so that there is very little that can be said about the actual wiring. Next drill the panel from the details given in Fig. 2, and attach the condensers, switches and tone control. Be careful when handling this latter component that the fine wire winding is not broken by coming into contact with the screw-driver, etc. Now attach the panel, and carry out any further wiring that is possible and then mount the condensers and output choke on the undersurface of the baseboard. It will now be found that the baseboard with the panel attached may be stood on the table or work-bench on its side, and there will be no risk of damage to the wiring or components which would be

occasioned if the baseboard was handled without the panel attached. The Ohmite resistances are held in position by the wiring, and their position is clearly shown in the wiring diagrams. Next screw the loud-speaker to the back of the lower section of the cabinet, using either wood screws driven in from the rear, or bolts passed through from the front of this part of the cabinet and nuts employed to hold the speaker rim in position. It must be borne in mind that the speaker must be very rigidly held, otherwise with the volume which is produced by this receiver the cabinet will set up most distressing rattles. A further point which may be of interest here is the fact that the volume of the lower notes in the musical scale may be

the front of the baffle. This may be carried out by using small distance pieces, such as strips of wood, between the baffle and the speaker. The distance pieces should only be about 1 in. long, so that there is an air space between the baffle and the speaker of about  $\frac{1}{4}$  in. However, this is a point which must be left to individual taste. The grid-bias battery is accommodated at the rear of the upper part of the cabinet, and it may be stood behind the valves, or if preferred, a Bulgin grid-bias clip may be attached in the centre of this part of the baseboard and the battery held firmly in this. The remaining batteries, namely, the H.T. and L.T., are stood in the lower compartment behind the loud-speaker, and it will be found that the back of the cabinet may then be

### COMPONENTS FOR THE Q.P.-P. THREE-FOUR.

- |   |   |
|---|---|
| 1 Colvern T.D. Coil.                        | 2 Clix 4-pin Valve-holders.                     |
| 1 J.B. .0005 Slow Motion Condenser, Type D. | 2 Clix 5-pin Valve-holders.                     |
| 1 J.B. .0003 Differential Condenser.        | 3 Clix Wander Plugs, G.B.+ , G.B.1, G.B.2.      |
| 4 T.C.C. Fixed Condensers.                  | 1 Belling-Lee 6-way Battery Cord.               |
| .0001 mfd. (Type S) .05 mfd. (Type 50).     | 1 Becol Panel, 12in. by 7in.                    |
| .01 mfd. (Type S) .1 mfd. (Type 50).        | Speaker.—R. & A. Bantam.                        |
| 6 Graham Farish Ohmite Resistances.         | Cabinet.—Clarion Q.P.-P.                        |
| 2.1 megohm, 2-100,000 ohms.                 | Valves.—Mazda, L.2, H210 and 2 Pen. 220A.       |
| 1.5,000 ohms, 1-30,000 ohms.                | Batteries.—Drydex Special Q.P.-P. H.T. Battery. |
| 1 Watmel 20,000 ohm Variable Resistance.    | Drydex 16 volt G.B. Battery.                    |
| 1 R.I. Q Type Transformer.                  | Accumulator. 2 volt Block Battery.              |
| 1 Varley Transchoke D.P. 39.                |   |

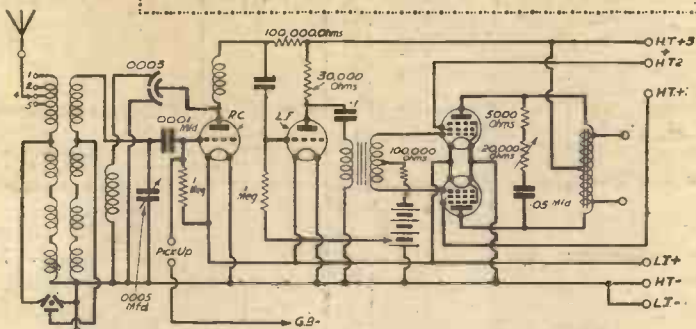

Fig. 1. The circuit diagram of the Q.P.-P. Three-Four.

reduced in intensity by attaching the speaker so that the felt rings surrounding the framework do not press against

screwed in place making the whole receiver self-contained.

### The Cabinet Back

It will be noted that the terminals for this receiver project a short distance to the rear of the baseboard and cabinet back, and it will be necessary, therefore, to cut away part of the fretted back. It will not be found difficult to carry out this part of the work, and the utility of the cabinet is in no way destroyed by this small alteration, and the appearance is maintained by the two oval holes being run in to the fretted pattern. The battery

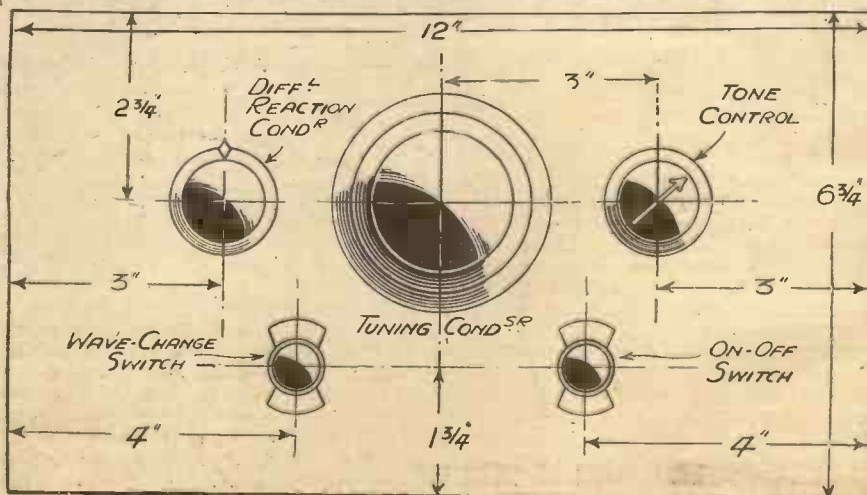

Fig. 2. Panel lay-out for the Q.P.-P. Three-Four.

# THREE-FOUR

## Output Valves Working on the Quiescent Push-Pull Principle

leads are attached direct to the valve sockets, the filament switch, and the other respective components, and to prevent them being pulled away by accident, a small bracket or other device should be attached to the undersurface of the baseboard to firmly clamp the multi-cord in its position. The grid-bias lead for the first L.F. valve is passed through a hole in the baseboard, after tying a knot in it. This prevents the lead from being pulled through and so breaking the connection to the grid of the first L.F. valve. There are no other points upon which we can dwell so far as the actual construction is concerned, and we may therefore pass to the actual testing.

### Testing

Plug the valves into the sockets, so that the two pentode valves are at the extreme left, and the L.2 valve next to them. The grid-bias positive lead should be inserted in the positive socket of the 16.5 volt battery, and G.B. 1 plugged into the 4.5 volt

socket. The remaining grid-bias plug is inserted in the 15-volt socket. H.T.3 is inserted in the 120-volt socket of the H.T. battery, and H.T.1 and H.T.2 should be inserted in sockets slightly lower than this. If you have a milliammeter you can experiment by trying different sockets for these two plugs. Without altering the value of grid-bias applied to the two output valves you will find that the variation of the high tension applied to the priming grids of the pentodes will vary the amount of current which is taken from the high tension battery, and as one of the chief features of the Q.P.P. system is economy, the anode current should naturally be kept as low as possible. The

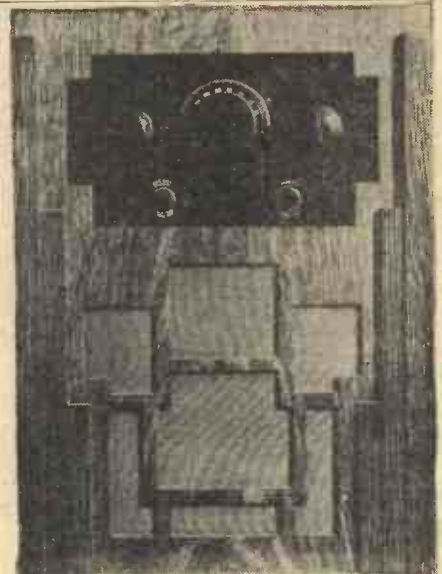

Front view of the Q.P.-P. Three-Four housed in its attractive Clarion cabinet.

THE WIRING DIAGRAM OF THE Q.P.-P. THREE-FOUR IS GIVEN OVERLEAF

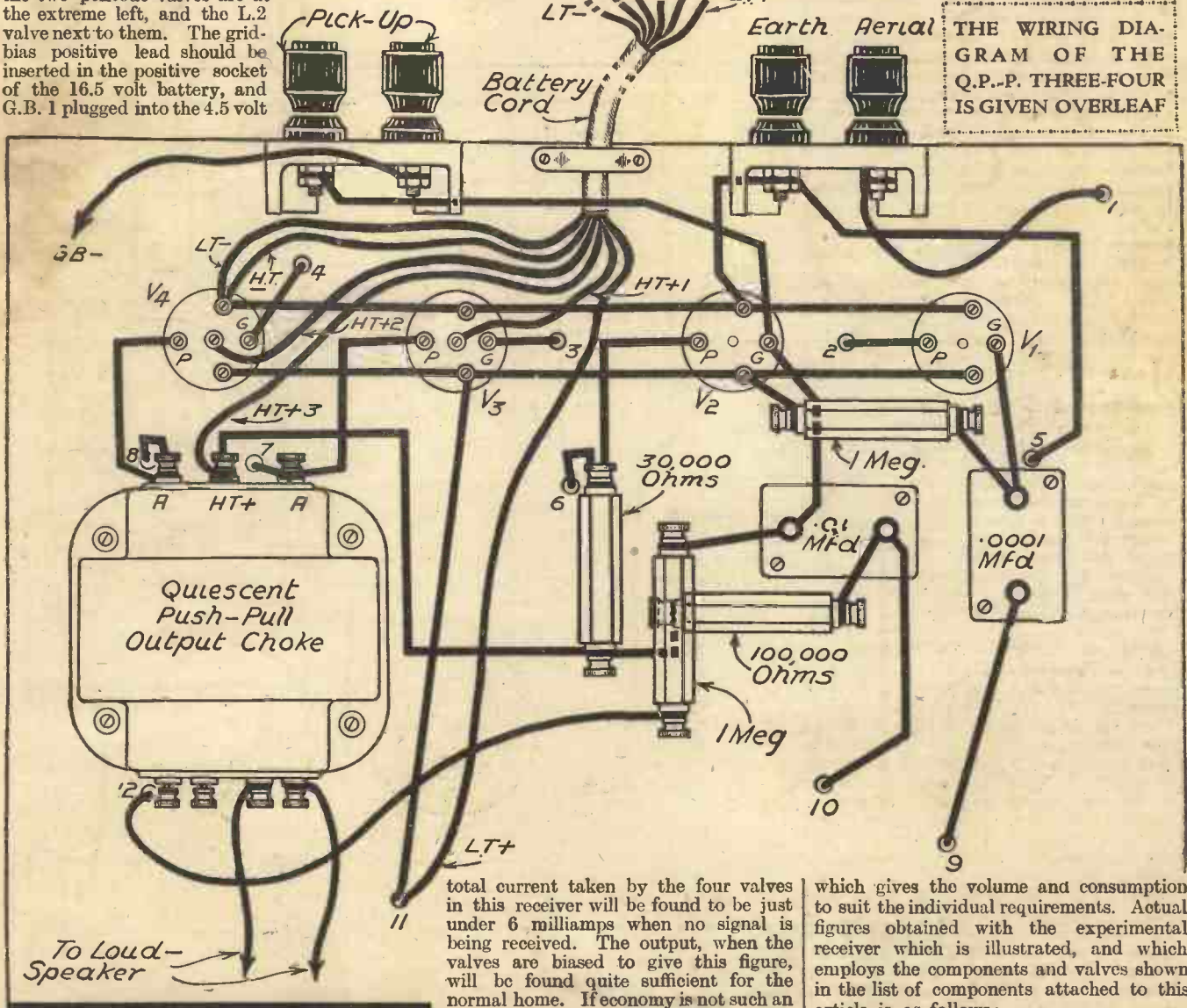

Fig. 3.—Sub-baseboard wiring diagram of the Q.P.-P. Three-Four.

total current taken by the four valves in this receiver will be found to be just under 6 milliamps when no signal is being received. The output, when the valves are biased to give this figure, will be found quite sufficient for the normal home. If economy is not such an important feature, the grid-bias value may be lowered, and in this way it is possible to experiment and obtain a value

which gives the volume and consumption to suit the individual requirements. Actual figures obtained with the experimental receiver which is illustrated, and which employs the components and valves shown in the list of components attached to this article is as follows:

Standing anode current of the complete  
(Continued on page 1152.)

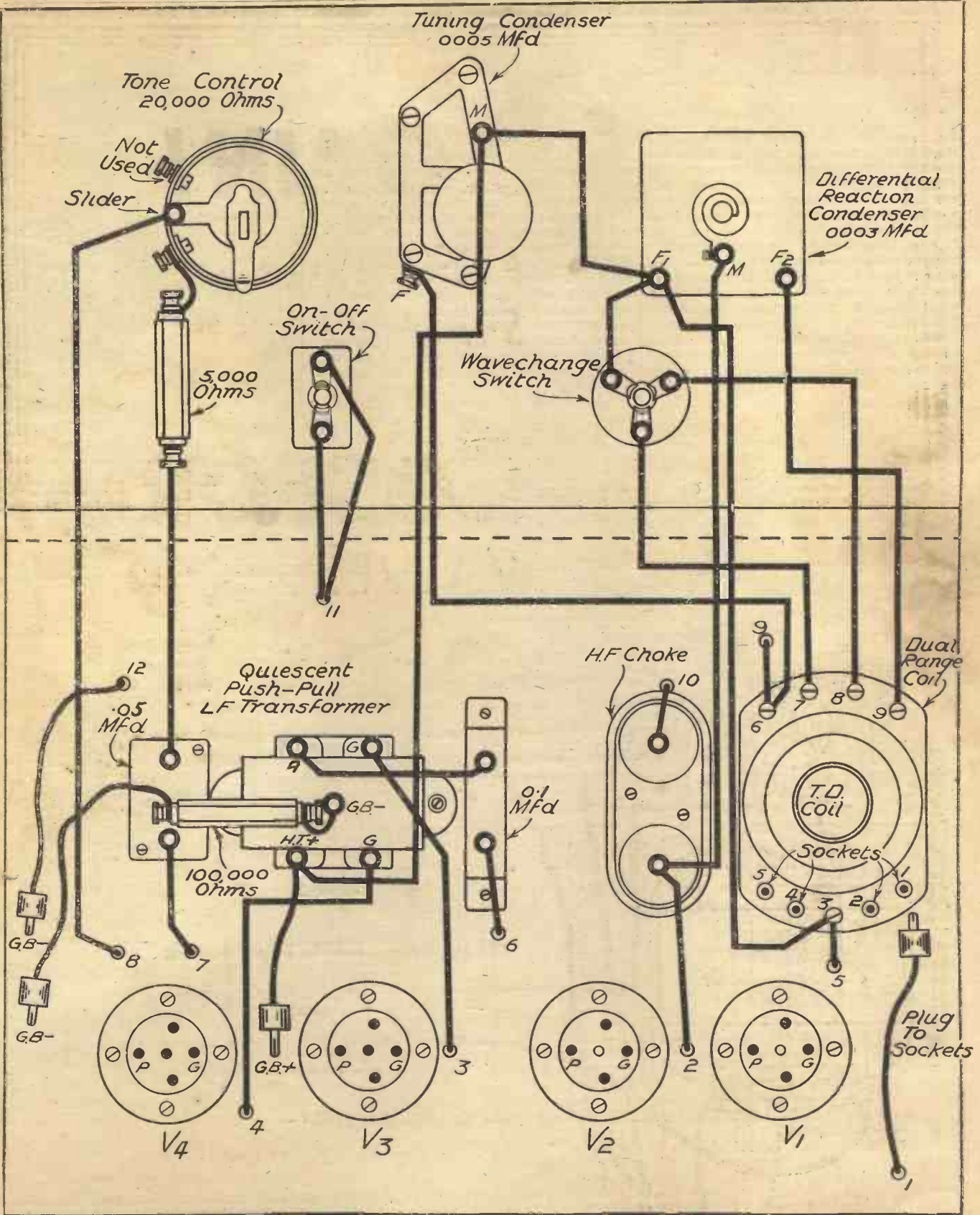

Fig. 4. Wiring diagram of the Q.P.-P. Three-Four.





KINGS  
OF THE  
AIR

# AGAIN!

## EXCLUSIVELY SPECIFIED

# COSSOR VALVES

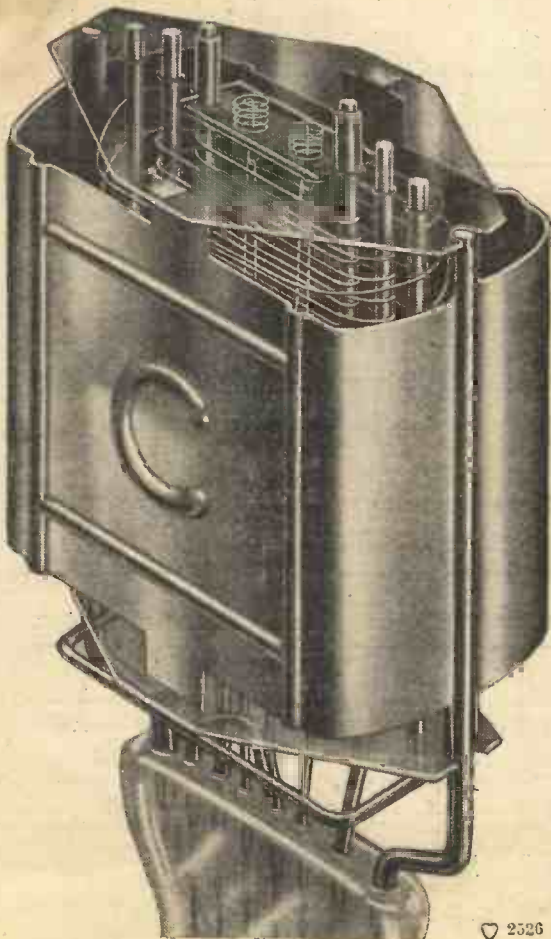

Following the famous "Fury Four" comes the "Push-Push Detector Three"—and again, "Practical Wireless" specifies Cossor Valves exclusively. Why?

Because the designers of these fine Receivers know that Cossor efficiency is largely responsible for their outstanding performance. In the "Q.P.P. Amplifier," too, Cossor Pentodes are exclusively specified.

Make certain of success—do as the designers did—use Cossor—Britain's most efficient valves.

for the

### "PUSH-PUSH DETECTOR THREE"

Detectors	Cossor 210 H.L. *	- 7/-
	Cossor 210 H.L. *	- 7/-
Output:	Cossor 220 P.A.	- 8/9

\* Metallised

### "Q.P.P. AMPLIFIER"

2, Cossor 220 H.P.T. 17/6 each

---

To A. C. COSSOR LTD., Name .....

Melody Department, Address .....

Highbury Grove, London, N.5. ....

Please send me, free of charge, .....  
a copy of the 40-page Cossor .....  
Valve and Wireless Book, B.17. PRAC. 4/3/33 .....

---

# BIG PRICE REDUCTIONS in T.C.C. CONDENSERS

## MICA CONDENSERS.

OPERATIVE from MARCH 1st.

Capacity Mfd.	Type M. Moulded-in with Soldering Tags.		Type 34. Upright with Terminals.		S.P. Type (Series-Parallel)	
	New	Old	New	Old	New	Old
.00005	s. d.	s. d.	s. d.	s. d.	s. d.	s. d.
.0001/3	0 8	1 0	1 3	1 6	—	—
.0004/5	0 8	1 0	1 3	1 6	2 0	2 4
.001/4	1 0	1 4	1 6	1 10	2 6	2 10
.005/6	1 6	1 9	2 0	2 6	3 0	3 6
.01	2 0	2 3	3 0	3 0	—	—

## PAPER CONDENSERS. TERMINAL TYPES

Capacity Mfd.	Type 50/51 200 V. D.C. Working		Type 80/81 400 V. D.C. Working		Type 101 800 V. D.C. Working		Type 121 1,500 V. D.C. Working	
	New	Old	New	Old	New	Old	New	Old
0.1	s. d.	s. d.	s. d.	s. d.	s. d.	s. d.	s. d.	s. d.
0.25	—	—	2 0	2 3	—	—	—	—
0.5	2 4	2 7	2 6	3 0	5 0	6 3	7 0	8 0
1	2 6	2 10	3 0	3 9	6 0	7 6	8 6	10 0
2	3 6	3 10	4 0	5 0	9 0	10 0	13 0	15 2
3	5 0	5 3	6 0	7 6	—	—	—	—
4	5 6	6 3	7 0	8 6	17 6	19 4	25 0	28 6
5	7 3	8 0	9 0	10 6	22 0	24 6	31 0	35 0
6	8 6	9 0	10 6	12 0	25 0	28 6	37 6	42 0
8	11 0	11 9	14 0	15 0	—	—	—	—
10	14 0	14 6	17 6	18 0	—	—	—	—

## PAPER CONDENSERS. SOLDERING TAG TYPES

Capacity Mfd.	Type 65 500 V. D.C. Test 250 V. D.C. Working		Type 84 750 V. D.C. Test 350 V. D.C. Working		Type 87 1,500 V. D.C. Test 450 V. D.C. Working	
	New	Old	New	Old	New	Old
0.1	s. d.	s. d.	s. d.	s. d.	s. d.	s. d.
0.25	1 8	1 9	2 0	2 0	2 2	2 3
0.5	1 10	1 11	2 2	2 4	2 4	2 6
1	1 11	2 0	2 4	2 8	2 6	2 10
2	2 0	2 3	2 9	3 3	3 0	3 8
3	—	3 0	3 9	4 6	4 0	4 9
4	—	—	—	—	—	—
5	5 0	5 0	6 9	7 6	7 3	8 0
6	—	—	—	—	—	—
7	7 0	7 9	10 0	10 9	—	—
8	9 0	9 6	13 0	14 0	—	—
10	11 6	12 6	16 0	16 6	—	—

## ELECTROLYTIC CONDENSERS

Capacity Mfd.	Type 802. Aqueous 440 V. D.C. Working		Type 801. Aqueous 460 V. D.C. Working		Type 902. Dry 500 V. D.C. Working	
	New	Old	New	Old	New	Old
6	6 0	9 0	—	—	6 6	9 0
4	5 0	8 0	—	—	—	—
7	—	—	6 0	9 0	—	—

THE PRICES OF ALL OTHER TYPES AND CAPACITIES NOT MENTIONED ABOVE REMAIN UNALTERED

HERE are the old and NEW Prices of T.C.C. Condensers. No longer is there an excuse to buy condensers of inferior quality—of doubtful characteristics. Every T.C.C. Condenser has behind it the experience of over a quarter of a century's specialised work. True to specification—unquestioned dependability are factors that have made T.C.C. the premier amongst condensers. And now you can get them cheaper.

# T.C.C.

ALL-BRITISH  
CONDENSERS

THE TELEGRAPH CONDENSER CO LTD., WALES FARM RD., N. ACTON, W. 3.



THE  
HALF-  
GUINEA  
PAGE

# Radio Wrinkles FROM READERS

### A Novel Switch

THIS simple switch can be made from an old catswhisker holder, a piece of spring brass, small piece of ebonite, a small bolt and nut, and a number of old type

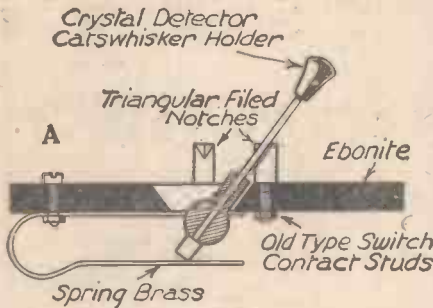

A three-point switch made from odds and ends.

switch contact studs, according to the duty of the switch. The brass should be about 1in. wide and bent as sketch, while the hole for the catswhisker holder should be drilled just a shade smaller than the ball on the holder, so as to allow greatest swing. The spring brass keeps the holder hard over into any notch in the stud contacts, at the same time forming the other contact. When the holder is upright, the flat face, where the catswhisker would go in, presses "end on" to the spring,

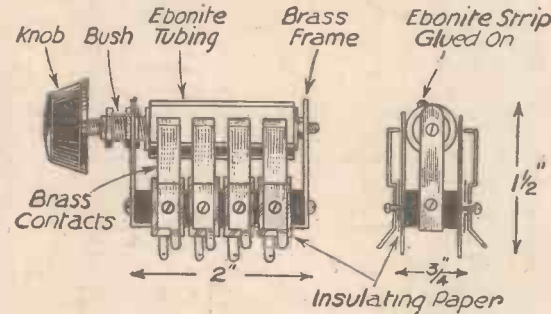

A neat rotary switch.

thus keeping contact broken. Using three studs, the switch can be used for changing tapping on an "X" coil, aerial connected to "A" and the three coil terminals to the three studs. As a radio-gram switch, with two studs, "A" to radio grid connection, one stud to grid of valve and the other to pick-up, other side of P.U. to G.B. battery. The sketch shows a three-stud switch.—P. D. P. (South Shields).

### A Neat Rotary Switch

THIS useful little switch can be made out of odds and ends in an hour or so. A length of ebonite tubing is clamped by means of nuts and washers on to a 6 B.A. rod. A small strip of ebonite is glued along the length of the barrel. The whole is then mounted in a frame of rigid brass, which also carries an ebonite or fibre "bed." The contacts are then cut from springy brass and mounted as shown, each strip being carefully insulated. I am using this switch for changing the accumulator from

### THAT DODGE OF YOURS!

Every reader of "PRACTICAL WIRELESS" must have originated some little dodge which would interest other readers. Why not pass it on to us? For every item published in this section we will pay half a guinea. The latest batch is published below. Turn that idea of yours to account by sending it in to us, addressed to the Editor, "PRACTICAL WIRELESS," George Newnes, Ltd., 8-11, Southampton Street, Strand, W.C.2. Put your name and address on every item. Please note that every notion sent in must be original. Mark envelopes "Radio Wrinkles."

"set" to "charge."—JAMES E. BARTHEL (Bradford).

### An Efficient Earth System

THE accompanying sketch shows an ingenious earth which is at present working in an efficient manner, and which has thoroughly repaid the time spent in construction. It consists of a main tube, surrounded by four outer rods. Leads are taken from the tubes and rod and are joined to the main earth lead from the set at the point A. The main tube follows the general lines of commercial earth

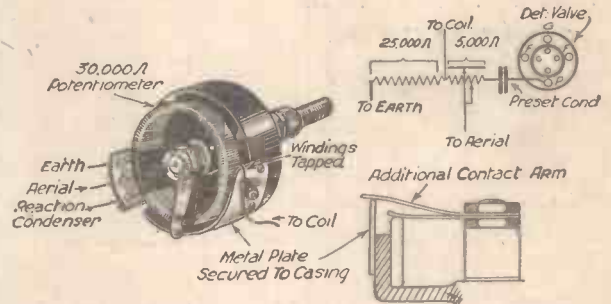

Adapting a potentiometer for use as a multi-control switch.

as my own band-pass tuning coil.—D. C. BROADBENT (Whetstone).

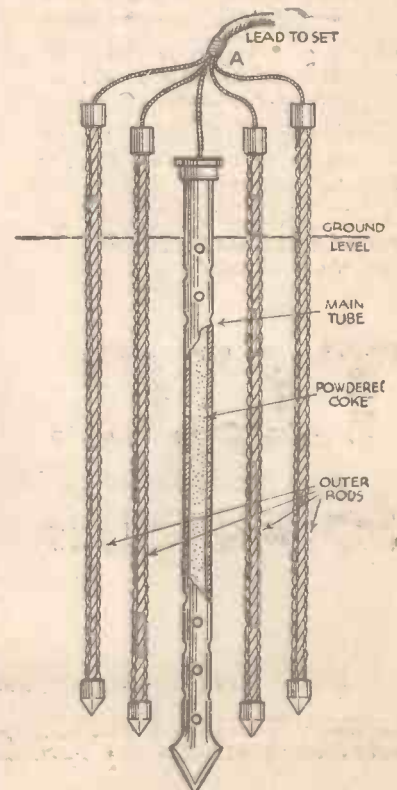

An efficient earth system.

£1 - 10s. - 0

for the Best Wrinkle!

WE PAY HALF-A-GUINEA FOR EVERY OTHER WRINKLE PUBLISHED.

Readers of "Practical Wireless" are invited to send in original radio ideas to us. We pay 10s. 6d. for every Wrinkle published in this section. This is in excess of ordinary space rates. Note that we make no distinction between Wrinkles sent in by readers. Where an idea is of especial merit and worthy of greater space than we can accord it in this feature, we shall be pleased to publish it as a short article and pay £1 10s. 0 for it.

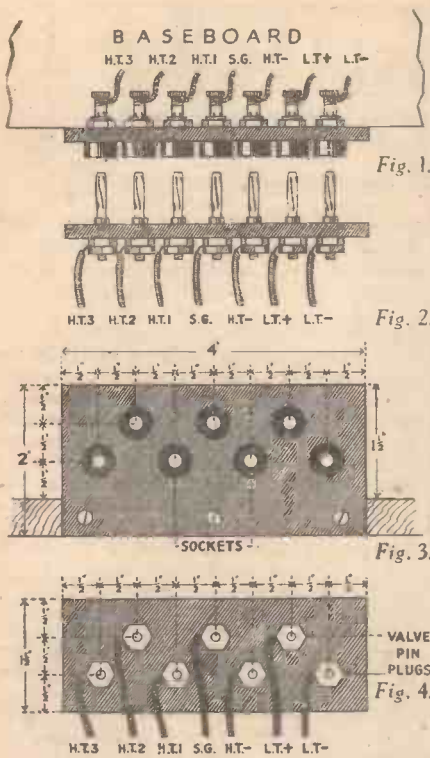

Terminal strips with plug and socket connectors.

Handy Plug and Socket-Battery Connectors

IN the early days of broadcasting, I happened to attach the H.T. to the L.T. terminals which cost me three new valves, and I made a vow that such a thing would not occur again. Accordingly, I fitted two terminal strips with lugs and sockets, as shown in the accompanying illustrations. I may say that I have had no more burnt-out valves through connecting the wrong wires, as, with this gadget, it is only possible to plug in the right way, and it is a simple matter to disconnect the L.T. and H.T., from one set, and transfer it to another, if desired. With most sets nowadays, if anything should go wrong, it takes quite a time to disconnect all the flex wires from the terminals, so that the set can be taken from the cabinet, and connected up again for testing purposes, but with this gadget it is a matter of seconds, and no danger of bare wires touching one another, nor is there any necessity of disconnecting the batteries. The material consists of one piece of ebonite 4in. by 2in., one piece 4in. by 1 1/2in., seven Clix sockets, and seven Clix valve pins. Fig. 1 shows the terminal strip with sockets, and Fig. 2

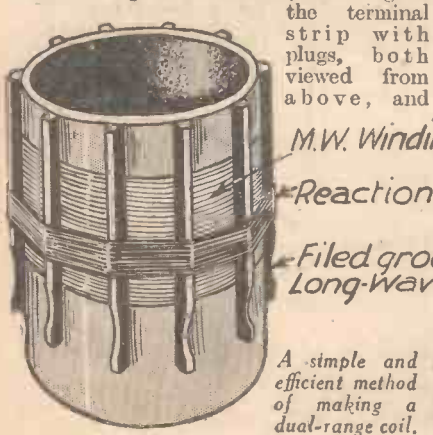

M.W. Winding  
 Reaction Winding  
 Filed grooves For Long-Wave Winding.

A simple and efficient method of making a dual-range coil.

Figs. 3 and 4 show them viewed from the back of the set.—JOHN H. WILSON (Glasgow).

A Simple Dual-range Coil

THE following description of an easily-made dual-range coil may be of some value to other readers. The sketch shows the main details. A 3-in. former is used and the medium-wave winding is wound upon this direct. Eight match-sticks, as shown in sketch, with heads removed, are now glued round the former at equally spaced intervals, and these form the base upon which are wound reaction and long-wave windings. The reaction winding is wound in single-layer form and is fixed in position at the lower end of the medium-wave winding. The ends are fastened in position by cutting a notch in an adjacent match-stick and passing the wire through, a drop of adhesive firmly holding a wire in position. The long-wave winding is "hank" wound and also uses the match-sticks as a base upon which it is wound. The lower end surfaces of the match-sticks are carefully filed down with a half-round file to accommodate the winding and keep it firmly in position. Ends of winding are secured as before. The sketch shows the former with medium-wave and reaction windings in place. The "grooves" which will hold the long-wave winding in position are clearly shown.—H. R. J. NEWTON (Streatham).

An Acoustic Baffle

A VERY effective baffle can be made up as shown in the accompanying diagram for little cost. A box is constructed as shown, the front being of thick plywood and the sides of deal; 6in. by 1/2in. thick being a convenient size. The outside dimensions are, of course, governed by individual requirements. A piece of linen with a hole cut in the centre to the size of the baffle opening is first secured by a circle of tacks, the inner diameter allowing room for the speaker to fit inside. The linen is then stretched over the edge of the box and secured about half-way round with tacks. This half is then packed with kapok or similar material. The linen should then be further secured round the box, more kapok being packed in, until the space under the linen is completely filled. The result is a baffle entirely free from audible resonance.—W. F. ADAMS (Plumstead).

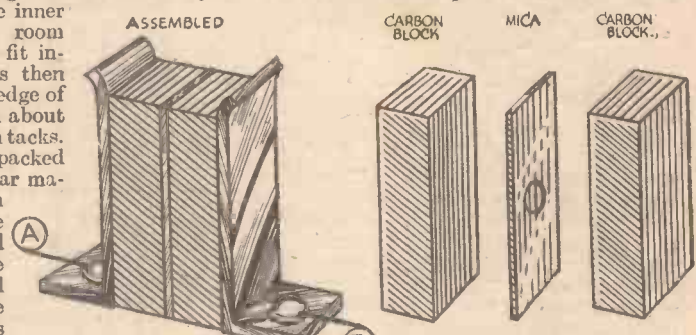

An effective method of preventing resonance in a loud-speaker cabinet.

blocks about 1in. by 1/2in. by 1/2in. separated by a piece of perforated mica about 6 mm. thick, fixed between brass springs, one of which is joined to the A. terminal and the other to the E. terminal of the set. Lightning discharges are generally considered to be oscillatory in character, so that the air gap in the mica, possessing neither induct-

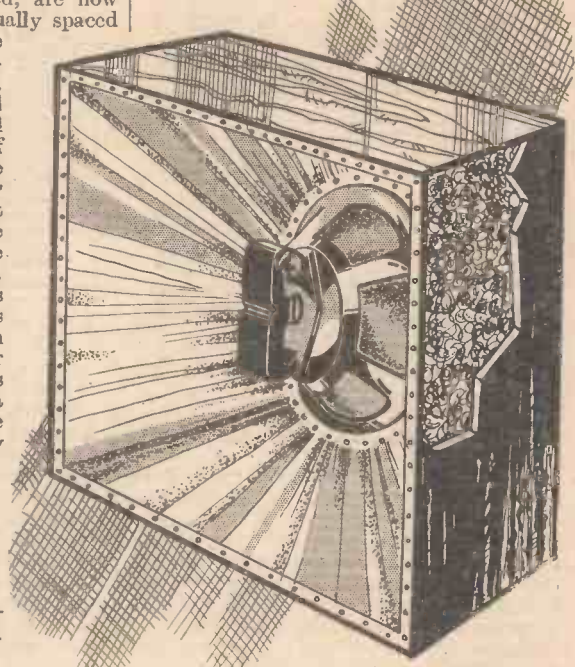

ance nor resistance, offers no impedance to a discharge of lightning. On the other hand, the coils in a set possess both inductance and resistance, and since a current will always take the easiest path, the discharge will jump the air gap in its effort to reach the ground in preference to going through the set. The simple construction of the

A novel form of lightning arrester. arrester may be seen from the illustration.—L. S. WILSDEN (Liverpool).

Sensitivity of Pick-ups

ALTHOUGH much has been said about the sensitivity of pick-ups, it is not always realized that a good deal of distortion is caused by the output from the pick-up being too great, and thereby overloading the grid of the first valve. One obvious way to overcome the trouble is to connect a potentiometer between the pick-up and the grid circuit of the first amplifying valve so as to act as a volume control on the pick-up.

Static Lightning Arrester  
 MANY wireless fans have, no doubt, at some time or other had to get out of bed to earth their aerials during a nocturnal thunderstorm. The static lightning arrester shown in the accompanying illustration, if joined between the A. and E. terminals of a set, would save this inconvenience. It consists of two carbon

# THE PROBLEMS OF FAITHFUL

Interesting Notes—

# REPRODUCTION

—By P. E. BARNES, B.Sc.

THE object of this article is to set out the important points on which faithful reproduction of broadcasting is dependent, and to indicate to the radio amateur general principles on which he may profitably work in an attempt to improve the standard of his set, and which

is only serious with the balanced armature or similar types of moving-iron speakers, where the moving parts have to travel across a very small air gap. Here it is necessary to allow the response to die away gradually in the extreme bass, beginning at, say, 150 or 200 cycles. Fortunately the human ear is a very adaptable organ, and if the reproduction is well maintained down to the point where the cut off really begins, it will reconstruct many of the lower frequencies from the harmonics which are not reduced in intensity, and there will be very little falling off in quality. Of course, we must make the best use of the reduced bass notes by the use of a large baffle, either of the box type, now the custom, or flat. In either case the

notes, which were never very loud anyway, while it will appreciate the increased output in the region of 80 cycles or so which is provided.

The mechanical resonance is usually obtained from the diaphragm surround, and is generally arranged by the makers to be quite unobjectionable. If it occurs at too high a frequency for the particular set, the surround must be slackened off to a suitable degree. The electrical resonance to be obtained by altering the value of the coupling condenser in a parallel-fed L.F. amplifier to such a value that it will produce a resonant circuit with the primary of the transformer is a very interesting field for experiment. The most suitable value can be calculated if the exact characteristics of the transformer are known, but if values around 0.05 mfd. are tried it will generally be quite easy to notice the effect on the output.

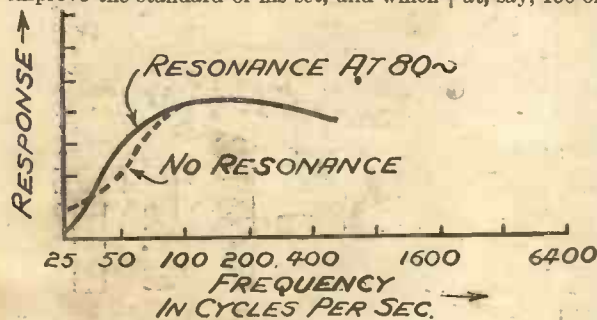

Fig. 1—A response curve showing resonance effects.

can be modified in accordance with his particular needs.

Given a reasonably good loud-speaker which is free from any objectionable resonances, there are really three problems which we must consider:—

- (1) to retain sufficient bass to give the body to the reproduction.
- (2) to retain sufficient of the upper frequencies to give to each orchestral instrument its own characteristic tone.
- (3) to eliminate, or at any rate to reduce as far as possible such undesired additions to the output as heterodyne whistles, needle scratch, and so on

Such questions as the elimination of "man-made static," mains hum and similar problems are really outside the province of this article, and in fact would need several articles each for their consideration.

### Bass Reproduction

Let us now consider these problems in order, and begin with the difficulties in the way of satisfactory bass reproduction. A transformer must be of larger size to deal adequately with lower frequencies, while the movement of the loud-speaker diaphragm, while being slower will be larger—these are the two fundamental difficulties with which we have to deal.

The inconvenience of large transformers has led recently to the introduction of special alloy steel cores, which will give the same properties as the larger soft iron cores only if they are so connected that none of the steady anode current is allowed to pass through the windings. If these are connected correctly, then results will be quite as good as, if not better than, with the old arrangement. Do not be led away, however, by the presence on the market of small transformers with the ordinary soft iron cores, usually of cheap foreign make. If the core is to have certain properties, then it must either be of large size or consist of special alloy.

The problem of the greater movement of the loud-speaker diaphragm for low notes

wood should not be less than half an inch thick if the full benefit is to be obtained.

### Inductor and Moving-coil Speakers

The inductor dynamic and moving-coil speakers have the moving portions travelling in a direction which is parallel to the face of the magnet, and consequently these

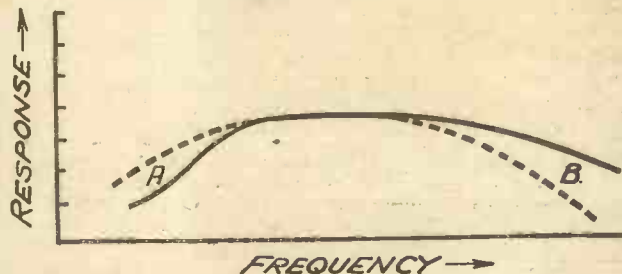

Fig. 2.—Lower frequencies reduced, and upper frequencies strengthened.

types can handle very large volumes with the bass at its correct value without difficulty. Hence with them it is usual to compensate for the usual loss of bottom notes in the amplifier by a resonance of some kind, either electrical or mechanical. Provided that this resonance is not too pronounced, it is almost indistinguishable from the "real thing," but it must be remembered that transient noises such as pistol shots will tend to set the speaker resonating always at this frequency, and so produce an objectionable booming.

The effect of such a resonance on the response curve can be seen in the diagram (Fig. 1). The bass output is maintained at its true value further down the scale, and a sharp cut off follows. Fortunately the ever-accommodating human ear comes to our assistance again, for it will scarcely miss the extremely low

### By-passing the Higher Frequencies

The common custom of shunting the primary of a transformer or the output terminals with a condenser to by-pass the higher frequencies is often abused in this connection, and the idea employed to give a "tone-lowering" effect under the impression that a lack of bass will be counteracted thereby. Fig. 2 shows the result, instead of providing the bass which is lacking at A, the upper frequencies and harmonics are reduced at B, with the result that violins sound like flutes and the other instruments similarly lose their character.

This is shirking the real issue, and it is the cause of the characterless reproduction so often described as "mellow." Henry Wood and Henry Hall, Berlin and Beethoven are the standards at which we should aim, and we shall not attain them by pretending to prefer something which we have to admit is far below. If we have succeeded in providing the bass response which we require, we find in general that the upper frequencies are lacking, rather than in excess.

A receiver which has two or more sharply tuned circuits will cut off a considerable amount of our high notes as compared with a band-pass filter, due to the cutting off of the outer sidebands of the transmission, while if we have a condenser of more than about .0005 mfd. as part of a H.F. filter in the detector valve anode circuit, we have another possible source of high-note loss. The effect is shown in Fig. 3.

(To be continued.)

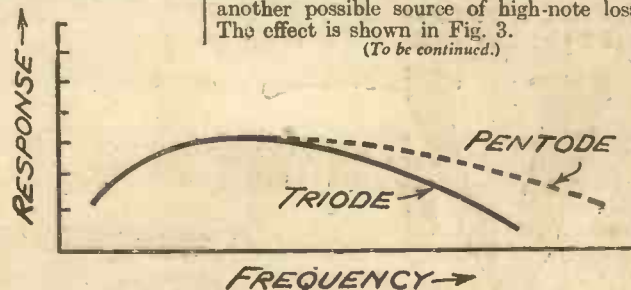
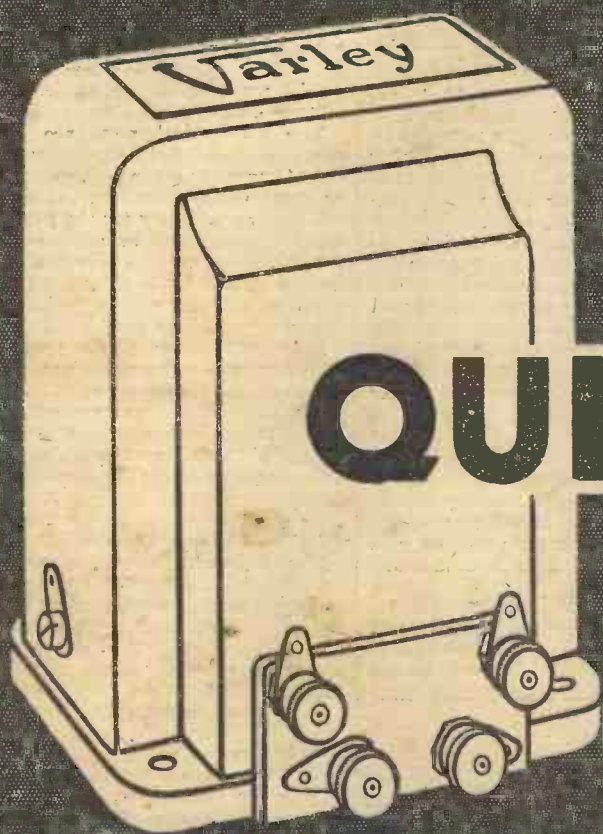

Fig. 3.—Response curves of pentode and triode valves.

Specified in the Q.P.P. 3-4



# QUIESCENT

## PUSH-PULL COMPONENTS

You are building the Practical Wireless "Q.P.P. 3-4"? Or adapting your existing battery set to Q.P.P.? *In either case can you do better than choose Varley?*

Varley Quiescent Push-Pull Components are made in a wide range to suit your every need... an Input Transformer, ratio 9-1, and three different Output Transchokes to give you accurate matching. Each Varley Output Transchoke is suitable for either high or low impedance speakers, thus avoiding the losses of an additional matching transformer and its expense—a double economy.

*For Q.P.P. everything depends upon the exact characteristics of the transformers. For your "Q.P.P.3-4" use the correct transformers—Varley DP 36 and DP 38—and you will get the results the designers got!*

# Varley

Proprs.: OLIVER PELL CONTROL LTD

Advertisement of Oliver Pell Control Ltd., Kingsway House, 103, Kingsway, London, W.C.2 Telephone: Holborn 5303.

● **DP36. QUIESCENT PUSH-PULL INPUT TRANSFORMER**  
 Ratio..... 9/1  
 Primary D.C. Resistance..... 825 ohms.  
 Total Sec. D.C. Resistance..... 9300 ohms.  
 Prim. Inductance..... 30 henries with no D.C.  
 ..... 27 " " 2 M.A.  
 ..... 22 " " 4 M.A.  
 PRICE, including Royalty.....17/6

● **DP38. QUIESCENT PUSH-PULL OUTPUT TRANSCHOKES**  
 Ratios..... 3/1 and 50/1  
 Primary D.C. Resistance..... 400 ohms.  
 Sec. D.C. Resistance (3/1)..... 130 ohms.  
 Sec. D.C. Resistance (50/1)..... 9 ohms.  
 Primary Inductance..... (each half)  
 8 henries with D.C. current of 26 M.A.  
 PRICE, including Royalty.....16/6

Write for Illustrated Literature describing the complete range.

# WHAT'S A WATT?

Some Illuminating Facts about the Unit of Electric Power

By

H. J. BARTON CHAPPLE,  
Wh.Sch., B.Sc. (Hons.), A.C.G.I.,  
D.I.C., A.M.I.E.E.

**A**N electric current is capable of doing work—either by producing heat or light, by driving a motor, or reproducing sound in a loud-speaker. It is a form of energy, and therefore there should be some method of measuring its power, as there is of measuring the power of, say, an engine. Mechanical power is measured in horse-power; electrical power is measured in watts. Practically, one watt is equal to one seven hundred and forty-sixth part of one horse power, electrically it is the amount of energy possessed by a current of one ampere when the electro motive force is one volt.

If the current in a circuit is two amperes and the applied voltage is one volt, the energy would be two watts. Similarly if the current was only one ampere and the pressure two volts, this would represent a power of two watts. It will be seen, therefore, that the power in a circuit can be calculated by multiplying together the number of amperes flowing in the circuit and the pressure in volts applied to the circuit, or, more simply:  
watts = amperes × volts.

### Useful and Wasteful Work

Although this fact is known to the majority of radio listeners, there are many who find some difficulty in differentiating between the amount of power absorbed in a circuit and the proportion of that power which represents useful work. In most electrical apparatus, and radio equipment is no exception, quite a large percentage of the total power or wattage supplied to the circuit is wasted in producing unwanted heat. In an electric lamp, for example, which operates as the result of the temperature of the filament being raised to an almost white heat, the proportion of the electrical energy used in the lamp which is actually converted into visible light is extremely small, most of the power being utilised in heating the filament.

A very similar state of affairs occurs in the output stage of a radio receiver. Let us consider, for example, a super power valve of the type which takes a high tension current of about 15 milliamperes at a pressure of 150 volts. The total power in the anode circuit of the valve is, therefore:

$$\begin{aligned} \text{Watts} &= 150 \text{ volts} \times .015 \\ &\text{ampere.} \\ &= 1.25 \text{ watt, or } 1\frac{1}{4} \text{ watt.} \end{aligned}$$

### Puzzled

Yet, if you asked a radio engineer what the *output* of such a valve is, he would tell you that you could not expect to obtain more than about  $\frac{1}{2}$  watt, or about one quarter of the total power. The novice would still be puzzled. He would say, "But my voltmeter and my milliammeter tell me that I have  $1\frac{1}{4}$  watts in the circuit.

That amount of power is being taken out of my high-tension battery. Why do you tell me that the output is only  $\frac{1}{2}$  watt?" The fact remains, however, that a power valve—or at any rate the majority of output valves, have an overall electrical efficiency of only about 25 per cent., and that approximately three quarters of the power they take from the high-tension supply is used to no practical advantage. Let me try to explain how this must be so.

If you examine the characteristic curve of any valve you will see that, with full

the actual voltage on the grid above and below the grid-bias value, much in the same way as a man's daily receipts and expenditures vary his bank balance above and below the average value. This variation of effective grid voltage causes similar variations in the anode current above and below the 15 milliamperes and it is only these variations, which are of service in operating the loud-speaker.

### Inefficient

This should be obvious from the fact that a speaker operates by virtue of the fact that a *varying* magnetic pull causes the armature of the moving-iron speaker or the coil of a moving-coil instrument to vibrate. A steady direct current, such as the 15 milliamperes taken by the valve when no signal is being received simply causes the moving element of the speaker to take up a certain position relative to the magnet, and it is the increases and decreases in the anode current which cause that position to change and thus produce a movement of the diaphragm.

Perhaps some reader will think that a device should be developed to increase the overall efficiency of the valves. It may appear to him that the output valve is a very inefficient piece of apparatus. He is, of course, perfectly correct. The inefficiency of an output stage is really appalling. Yet using a single valve, there is little that can be done to help matters. It is true that, by increasing the grid bias, the value of the mean anode current is reduced, but this cannot be carried too far because, by bringing the working point of the valve too far down the curve, distortion will occur, due to a partial rectification of the signal.

### Distortion

The special form of output circuit known as quiescent push-pull, which I described recently at length in PRACTICAL WIRELESS, does to a great extent reduce this inefficiency, but that is not within the scope of this article, which is intended to deal with the meaning of the terms "total power" of a circuit and "output." There is, of course, another way in which the useful output of a valve can be increased, namely, by increasing the signal voltage applied to the grid. The



An example of a transmitting amplifier dealing with many watts. Modulated power at a 5,000 watt level is accepted by this apparatus and is then amplified by six valves to a power level of 35,000 watts.

anode voltage and with the correct negative grid bias, the anode current will be a certain value—say 15 milliamperes in the case of a super power valve, and 6 or 8 milliamperes for a small power valve. This constant current will flow all the time the valve is in circuit, even when no signal is being received. And these 15 milliamperes at 150 volts represent the  $1\frac{1}{4}$  watts already referred to—the "dissipation" of the valve as it is termed.

The effect of an incoming signal is to vary

output quoted for the 15 milliamperes valve example was based on correct grid bias and the normal grid input. These figures are given by the valve maker, and for his own sake he rates the valve for the greatest practicable efficiency. That is to say, he specifies a grid-bias which reduces anode consumption to the lowest value consistent with good signal handling power and good reproduction. If the grid-bias is unduly increased, the normal signal will overload the valve

and cause distortion; and if the correct grid-bias is maintained and an excessive signal is applied, the output will be increased, but so will the distortion.

Although actual output figures are not, unfortunately, given by valve makers, the figures can be obtained, and it will generally be found that the output figure quoted is given with the reservation: "with 5 per cent. distortion." This means that when the valve is biased to the specified figure and fully loaded, a certain amount of distortion, to the extent of 5 per cent., occurs. As a matter of fact, 5 per cent. distortion is practically undetectable by the human ear, and users are quite safe in working to this limit.

#### Different Music Passages

Unfortunately however, in actual practice a large number of listeners overload their valves more seriously—chiefly by applying excessive signals. On the quieter passages of music, that is to say, signals which are not fully modulated, the reproduction is quite satisfactory, but on louder passages, or transients such as a sudden clang of cymbals or a trumpet blast, the overloading may be serious, and the effect known as "blasting" will be heard. I often say that the true test of good reproduction is the sound of the final cymbal crash at the end of a hot dance tune. If it sounds reasonably like cymbals the reproduction is satisfactory; if it sounds like a stifled sneeze the valve is being overworked. It is for this reason that, for really perfect reproduction, a valve having a very long grid base should be used with a very restricted input. Then there is plenty of reserve for dealing with sudden and violent increases.

Enough has been said to indicate that there is a very considerable difference between the total power consumed by an

output valve and the amount of energy actually available for working the loud-speaker. The tale of inefficiency does not, however, quite end here, for it cannot be claimed that the speaker itself is a 100 per cent. efficient mechanism. It is well understood that any current passing through a circuit possessing resistance will develop heat in the resistance, and this heat again represents so much waste energy. Now a loud-speaker has a certain amount of resistance, and heat is, therefore, developed in the speech coil—heat which adds nothing to the acoustic output. There are other causes of loss of energy in the loud-speaker, but they are somewhat com-

plicated, and they cannot, therefore, be gone into here, and it must suffice to say that, of the total energy drawn from the high-tension battery, only a very small fraction is finally converted into sound energy.

#### Output Values

Perhaps it will be of interest to see how output wattage compares with audible sound. Such information would assist in deciding what output is required for rooms of various sizes. In the first place, however, it must be remembered that different listeners have different ideas of what constitutes comfortable volume; some prefer their radio as a pleasant background to the ordinary conversation and noises of the home; others think that the loud-speaker should just overcome normal conversation, while yet others insist on the programme blotting out all other sound in the room. Comfortable head-phone strength represents an output of about 6 milliwatts (a milliwatt is one-thousandth part of a watt). The output required to make a loud-speaker just audible depends to a great extent on the sensitivity of the instrument, but approximately 10 milliwatts would generally be within the threshold of audibility.

For a small room, and moderate volume, an output of 150 to 200 milliwatts should give good results; from two to three times this amount should suffice to operate a small or medium-sized moving-coil loud-speaker, and from 600 to 1,000 milliwatts (one watt) output will work an average moving-coil speaker at good volume and excellent quality. For high-class performance, a valve giving from  $1\frac{1}{2}$  to 3 watts of undistorted output, but operated well within its rated capacity is ample for the largest domestic apartment.



When dealing with the question of watts, very careful measurements have to be made by meters on the amplifiers illustrated.

### The Design of Loud Speakers

(Continued from page 1127.)

this type of reproducer. If you imagine the reed in Fig. 3 to be  $\frac{1}{4}$  in. long, and supported a quarter of an inch from the magnet, it is obvious that for the first part of its travel towards the magnet there will not be much power to overcome. As, however, it gets nearer to the magnet, greater power will be required to overcome the tendency of the reed to spring back to its normal position. The electrical impulse operating on the magnet is, however, constant the whole time, and, therefore, the reed will not be able to perform correctly. In an attempt to overcome this point a movement was once introduced somewhat on the lines of Fig. 4. Here the reed is at an angle so that as it gets nearer to the magnet the angle varies.

The next type of reproducer is the class which is known as the "balanced" armature. In this, the reed is supported between two magnets (Fig. 5), and as these operate equally on each side the fixing of the reed may be very much lighter, and this enables it to answer more readily to the slow period which we have in mind. Again, unfortunately, the operating medium must be attached to the reed and this affects its movement. It may have been noticed that with each type of movement which we have so far examined, the reed has to be supported close to a magnet. It is obvious therefore, that the distance over which the reed can travel is limited in that direction, as it must not touch the magnet. A type known as the inductor dynamic has been

developed in an endeavour to overcome the various failings of the moving-iron reproducer, but sufficient has been said of this type of loud-speaker to show that it cannot answer faithfully to the low period which we are using as the basis of our discussion. We can see that to obtain an equal movement, backwards and forwards, as slow as 50 cycles, we must have no

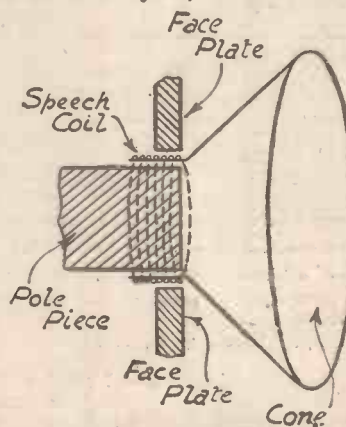

Fig. 6.—A diagrammatic illustration of the moving-coil loud-speaker.

restoring force, but must have as a reproducing medium something which may be drawn backwards and pushed forwards at the required rate. This brings us to the type of speaker which is now called the "moving-coil."

The principle upon which this type of

speaker works has already been discussed in these pages, but for the benefit of new readers, I will briefly repeat it. Fig. 6 shows, in more or less a diagrammatic form, a typical moving-coil type of loud-speaker. The essentials are a pole piece; a face plate having a hole slightly larger than the diameter of the pole piece; a cylinder having a diameter slightly smaller than the hole in the face plate, but at the same time slightly larger than the diameter of the pole piece, and to produce movement of the air and so reproduce the original sound, a cone of paper is attached to the cylinder. Round the cylinder a small coil of wire is wound, and this receives the signal impulses from the output valve of the receiver. The face plate and pole piece, shown in Fig. 6, are part of a powerful magnet system, which may be of the permanent magnet variety or energized by means of a winding joined to some electrical source. When the speech currents flow through the small winding of the speech coil the magnetic lines of force surrounding the gap between the pole piece and the face plate are affected, and the result of this is that the speech coil is moved inwards or outwards, according to the direction of the current. It is obvious, then, that here lies the ideal way of reproducing sound, as there is, at present, no restoring force, but the coil is moved in sympathy with the electrical impulses, and provided we could arrange the coil in the gap with no other attachment, we could reproduce exactly the original electrical impulse received by the microphone, especially when the method of attaching the moving coil to the speaker is considered.

# 5 New FERRANTI Transformers for QUIESCENT PUSH-PULL

- 1 **Type AF11c.** Ratio 1/10. Inductance 50/25 hys. 0/10 m/A. Good amplification curve, giving approximately double the amplification at 50 cycles hitherto obtainable. Price **34/-**
- 2 **Type AF12c.** Ratio 1/9. Inductance 30/15 hys. 0/6 m/A. A lower priced transformer which yet has a good performance and a higher step-up than others in this price class. Price **15/-**
- 3 **Type OPM11c.** P.P. Output Transformer. Ratio 35, 56 and 100/1. Specially suitable for use with AF12c, will carry a current, if necessary, up to a maximum of 100 m/A in Q.P.P. (200 m/A in ordinary P.P.). For operating low resistance M.C. Speakers. Primary **26/6** Res. approx. 230 ohms.
- 4 **Type OPM12c.** Ratios 1.7 and 40/1. To correspond in quality with the AF12c. Carries D.C. Primary Current up to 75 m/A in Q.P.P. (150 m/A in ordinary P.P.). For use with high resistance Speakers or low resistance M.C. types with or without built-in Transformers. Primary Res. approx. 210 ohms. Price **15/-**
- 5 **Type OPM13c.** Ratios 1.7, 2.7 and 4.5/1. Also specially suitable for use with the AF11c, but for operating high resistance Speakers of any kind, including M.C. Speakers with built-in Transformers. Max. D.C. Primary Current 100 m/A in Q.P.P. (200 m/A in ordinary P.P.). Primary Res. approx. 230 ohms. Price **26/6**

**ALL PRICES INCLUDE PUSH-PULL ROYALTY**  
 NOTE.—Either of these Quiescent Push-Pull A.F. Transformers may be used with any of the three Output Transformers mentioned above. Both the AF11c and AF12c types may be used in ordinary Push-Pull circuits, or as straight A.F. Transformers.

This system enables much greater power to be obtained from Battery Operated Receivers and Amplifiers for a given expenditure of High Tension Current than has hitherto been possible. In fact, by its use, Power Output and Volume comparable to that given by the average Mains set are obtainable, even when employing the small H.T. Batteries in common use.

Ferranti Ltd. have produced these five Transformers to enable the experimenter to obtain the best possible results from Quiescent Push-Pull at reasonable cost. It will be noted that the inductances and ratios of these new Ferranti Transformers are unusually high.



## FERRANTI TRANSFORMERS

FERRANTI Ltd., Hollinwood, Lancs. London: Bush House, Aldwych, W.C.2

# SPECIFIED in the Q.P.P. 3-4

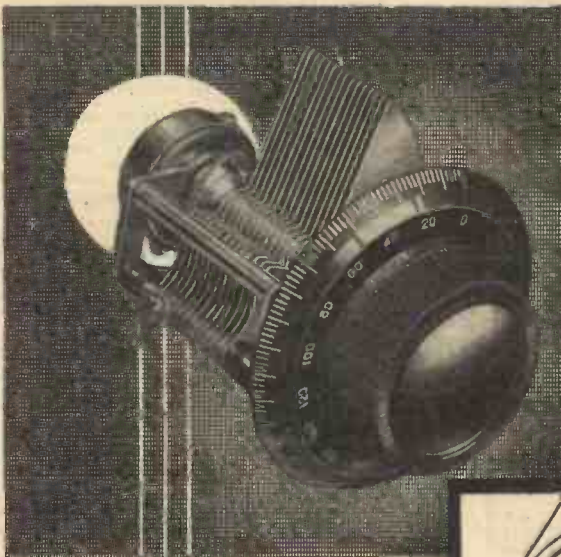

When you are buying the components for your "Q.P.P. 3-4" remember this:— the condensers used by "Practical Wireless" for the original model were the J.B. Popular Log (Slow motion type) and the J.B. Differential.

Build your "Q.P.P. 3-4" exactly as the original—then you are certain of fullest success. Follow the specification and use J.B.

### J.B. POPULAR LOG CONDENSER

(as illustrated)

Slow-motion type (35/1). Capacity .0005. Complete with 3 in. dial, 8/6. Extra heavy gauge brass vanes. Rigid nickel-plated frame. High-grade ebonite insulation.

### J.B. DIFFERENTIAL REACTION

.0003, 4/6. Insulated centre spindle. Bakelite dielectric between vanes. Also Specified.



In this illustration the end cap of the J.B. Popular Log has been cut away to show the Epicyclic Friction Drive, which is smooth and sure in action and absolutely silent.

**PRECISION**

**INSTRUMENTS**



# The BEST SET OF THE YEAR SPEAKS FOR ITSELF

The Fury Four carries a definite performance guarantee by the Editor, Mr. F. J. Camm, and Direct Radio, Ltd. And now you should add your own verdict. Come and operate the Fury Four yourself and test its performance against other sets at the "Practical Wireless" Official Demonstration Room at

159, Boro' High Street, London, S.E.1. But even if you cannot come along you can order with perfect confidence, as every Direct Radio Kit is guaranteed to give the same outstanding results as the officially demonstrated model openly offered to "Practical Wireless" readers for test and criticism.

*Official Demonstration of the FURY FOUR by special arrangement with Mr. CAMM, Editor of PRACTICAL WIRELESS at 159, Boro' High St.*



### ACCESSORIES FOR THE "FURY FOUR."

BATTERY MODEL	
SIEMENS 120-volt H.T. battery, standard capacity ..	13 6
OLDHAM type 0.50 L.T. accumulators ..	9 0
SIEMENS 9-volt G.B. battery ..	1 0
BLOCK L.T. accumulators, 50 ampere hours capacity ..	11 6
OLDHAM 120-volt wet H.T. accumulators (Or 12 monthly payments of 7/6) ..	4 1 0
ATLAS A.C.244 H.T. eliminators ..	2 19 6
ATLAS D.C. 15/25 H.T. eliminators for D.C. mains ..	1 19 0
ATLAS A.K. 960 H.T. eliminators, with trickle charger. (Or 12 monthly payments of 8/6) ..	4 10 0
CELESTION PPM Soundex permanent magnet moving-coil speaker, with input transformer ..	1 7 6
W.B. P.M.4 permanent magnet moving-coil speaker, with input transformer ..	2 2 0
COLLARO double spring grammo motor, automatic stop ..	1 13 0

## FURY FOUR BATTERY MODEL

### SPECIFICATION:

	£ s. d.	Brought Forward	£ s. d.
1 Lissen Three-gang Coil Unit type LN5162 ..	1 6 0	3 Dubilier 1-mfd. Condenser type B.S.	0 6 0
1 Erie 2-megohm Grid Leak with wire-ends ..	0 1 0	2 Dubilier .0003-mfd. Condensers type 065 ..	0 1 0
1 J.B. Unitune two-gang screened condenser .0005 mfd., with disc drive ..	0 18 6	1 Dubilier .0002-mfd. Condenser type 065 ..	0 0 6
1 J.B. Nugang Single screened condenser with disc drive ..	0 9 6	1 Leweos 50,000 ohm Potentiometer ..	0 3 0
1 Ready-Radio .0003-mfd. Differential Reaction Condenser ..	0 3 0	1 Sovereign .0003-mfd. Preset condenser ..	0 1 3
1 Varley Pentode Nichoke ..	0 12 6	1 Ready Radio 3-1 ratio L.F. Transformer ..	0 8 6
1 Erie 100,000 ohms resistance ..	0 1 0	2 Belling Lee Wander plugs G.B. +, G.B.- ..	0 0 4
2 Erie 30,000 ohm resistances ..	0 2 0	3 Clix sub-baseboard valve holders, 4-pin ..	0 2 0
1 Erie 5,000 ohms resistance ..	0 1 0	1 Clix sub-baseboard valve holder, 5-pin ..	0 0 9
4 Erie 1,000 ohms resistances ..	0 4 0	1 Belling Lee 4-way Battery Cord ..	0 1 9
1 Set of 8 Erie Resistor coupling links ..	0 1 0	3 Belling Lee terminal mounts ..	0 1 6
1 pair Panel Brackets ..	0 0 6	6 Belling Lee terminals A.E.P.U., L.S.+., L.S.- ..	0 1 3
1 Ready Radio fuse holder and fuse ..	0 1 0	1 Perincol Panel 10" x 8" drilled to specification ..	0 5 6
1 Wearite screened H.F. Choke Type H.F.P.A. ..	0 4 0	1 Drilled and foil covered baseboard 16" x 10" x 8", and 2 side strips 10" x 2" ..	0 4 0
1 Ready Radio 3-pt. switch ..	0 1 6	Connecting Wire, Screws, Flex, etc. ..	0 0 8
1 Ready Radio S.G. H.F. Choke ..	0 5 6		
1 Kinva standard screened H.F. Choke ..	0 2 9		
2 Dubilier .1-mfd. C.T. Condenser type B.E.31 ..	0 6 0		
		Carried Forward	25 0 9

### ACCESSORIES FOR THE "FURY FOUR"

A.C. MAIN VERSIONS	
COLLARO A.C. Induction & n.d. Grammo Motor ..	2 10 0
COLLARO Complete A.C. Grammo Motor Plain Unit, including Motor Pick-up and volume control. (Or 12 monthly payments of 7/6) ..	4 0 0
BOWYER LOWE A.E.D. Pick-Up with self-contained volume control ..	1 15 0
B.T. Minor Pick-up with self-contained volume control ..	1 5 0
W.B. P.M.2 Permanent magnet moving coil speaker. (Or 12 monthly payments of 8/6) ..	4 5 0
EPOCH A.2 permanent magnet moving coil speaker. (Or 10 monthly payments of 7/-) ..	3 3 0
IGRANIC D.9 permanent magnet moving coil speaker ..	1 12 6
Direct Radio "159" Type Fury Four Radiogram Cabinet ..	3 15 0

### "Q.P.P." AMPLIFIER SPECIFICATION.

	£ s. d.
1 R.I. "Q" Transformer ..	16 6
1 Ferranti Type O.P.M. 12C tapped output transformer ..	15 0
1 T.C.C. Type "S" .01 mfd. fixed condenser ..	2 6
1 T.C.C. Type 40 .05 mfd. fixed condenser ..	1 9
1 Ready Radio On/Off switch ..	10
1 Erie resistance 15,000 ohms ..	1 0
1 Erie resistance 10,000 ohms ..	1 0
1 Perincol Ebonite Panel drilled to specification 10 x 7 ..	4 0
1 baseboard 10 x 8 ..	1 6
1 Coil connecting wire ..	4
5 Belling Lee Wander plugs ..	10
6 Belling Lee Terminals ..	1 3
2 5-pin valveholders ..	1 0
Screws, Flex-wire, etc. ..	1 6
2 Pentode Valves, low consumption type ..	1 15 0
	£4 4 6

### THE "Q.P.P." THREE-FOUR

SPECIFICATION	
1 Colvern T.D. Coil ..	8 6
1 J.B. .0005 Slow Motion Variable Condenser, Type "D" ..	14 0
1 Ready Radio .0003 mfd. Differential condenser ..	3 0
1 T.C.C. fixed condenser type "S" .01 mfd. ..	1 2
1 T.C.C. fixed condenser type "S" .01 mfd. ..	2 0
1 T.C.C. fixed condenser type 40 .05 mfd. ..	1 9
1 T.C.C. fixed condenser type 60 .1 mfd. ..	1 10
2 Erie resistances 1 megohm ..	2 0
2 Erie resistances 100,000 ohms ..	2 0
1 Erie resistance 30,000 ohms ..	1 0
1 Erie resistance 5,000 ohms ..	1 0
1 Walnut 20,000 ohm wire wound Volume Control ..	5 6
1 R.I. type "Q" transformer ..	16 6
1 Varley Transchoke type D.F.39 ..	16 6
2 5-pin valveholders ..	1 0
2 5-pin valveholders ..	1 6
1 Perincol panel 12 x 7 drilled to specification ..	4 6
3 Belling Lee wander Plugs G.B.+., G.B.-., G.B.-2 ..	0
1 Belling Lee G-way battery cord ..	2 6
Screws, Flex-wire, connecting wire, etc. ..	1 2
4 Valves to specification ..	1 18 0
1 Direct Radio "159" Type Cabinet in Walnut ..	18 6
	£7 5 0

## FURY FOUR A.C. MAINS RADIOGRAM

Additional components required to those specified for battery kit.

SPECIFICATION:	
	£ s. d.
Brought Forward as above	
	6 19 3
1 Heayberd Fury Four Mains Transformer ..	1 4 0
(Please state voltage and frequency of Mains supply.)	
1 Westinghouse H.T.8 Metal Rectifier ..	0 18 6
1 Igranic type C.H.2 Smoothing Choke ..	0 9 6
2 T.C.C. 4-mfd. condensers 400-volt working ..	0 14 0
2 T.C.C. 2-mfd. condensers 400-volt working ..	0 8 0
	Carried Forward
	£10 13 3

### "FURY FOUR" BATTERY KITS

- KIT Model 1**  
As detailed specification, less Valves and Cabinet. **£6 : 19 : 3**  
or twelve monthly payments of 12/9.
- KIT Model 2**  
As detailed specification (with 4 Battery Valves less Cabinet) **£9 : 16 : 9**  
or twelve monthly payments of 18/7.

### KIT Model 3

As detailed specification (with Valves and Cabinet) **£10 : 17 : 9**  
or twelve monthly payments of 20/-.

### KIT Model 4

As detailed specification, with Valves and "159" Fury Four Walnut Console Cabinet and Celestion PPM Soundex Permanent Magnet Moving Coil Speaker **£13 : 0 : 0**  
or twelve monthly payments of 24/6.

### "FURY FOUR" A.C. MAINS KITS

- KIT Model A.C.1**  
As per detailed specifications **£11 : 4 : 3**  
or twelve monthly payments of 21/-.
- KIT Model A.C.2**  
As above, including 4 A.C. Mains Valves **£14 : 15 : 9**  
or twelve monthly payments of 27/8.
- KIT Model A.C.3**  
As above, including "159" type Console Cabinet and Celestion Soundex

### Permanent Magnet Moving Coil Speaker

**£18 : 0 : 0** or twelve monthly payments of 33/-.

### Three Valve PUSH-PULL DETECTOR

SPECIFICATION.

	£ s. d.
1 Panel drilled 8in. x 7in. ..	3 3
1 Strip drilled 8in. x 7in. ..	1 3
1 Baseboard 8in. x 7in. ..	9
2 Panel Brackets ..	6
1 Ready Radio Micaling Tuning Condenser .0005 mfd. ..	3 6
1 Ready Radio Moulded Slow Motion dial. ..	2 0
1 Set of Wire, Formers, Terminals, etc. for panel coil ..	5 6
1 R.I. Hypermute L.F. Transformer ..	12 6
3 4-pin valveholders ..	1 6
1 2 meg. Grid Leak wire ends ..	10
1 Ready Radio On/Off switch ..	10
3 Belling Lee terminals ..	1 8
Screws, flex, connecting wire ..	1 2
3 Valves to specification ..	1 2 9
1 Direct Radio "159" type Walnut Cabinet ..	15 6
	£3 14 0

Note. The Coil can be supplied ready wound and tested. Price 8/6.

- KIT Model 1**  
As per detailed specification without valves or cabinet .. **£1 : 16 : 3**
- KIT Model 2**  
As above but including valves **£2 : 19 : 0**
- KIT Model 3**  
As above and including valves and cabinet .. **£3 : 14 : 0**  
or ten monthly payments of 8/3.



CASH, C.O.D. and EASY PAYMENT ORDER FORM

To DIRECT RADIO, LTD., 159, Boro' High Street, London Bridge, S.E.1.  
Phone: Hop. 3000.

Please dispatch to me at once the following goods:

(a) I enclose { } (Cross out line)  
or which (b) I will pay on delivery { } (not applicable)  
(c) I enclose first payment of { }

NAME .....

ADDRESS .....

Practical Wireless, 4-3-33.



**T**H**E**R**E** are, no doubt, a number of readers who would like to try out this new method of L.F. coupling, but who do not wish to dismantle an existing receiver. This amplifier has therefore been designed for those readers who already own a receiver and who do not wish, for various reasons, to make up the Q.P.-P. Three-Four, for instance. As will be seen from the illustrations and list of components, very few components are required, and that the constructional work has been reduced to a very minimum. The panel only requires a 3/4 in. hole in the centre to accommodate the on-off switch, and this must, of course, be operated in addition to that incorporated in the receiver with which the amplifier is used.

**Mounting the Components**

The two transformers occupy positions at each end of the baseboard, and the valves are situated in between these. The small fixed condensers, the two resistances, and the terminal blocks are the only other components to be mounted, and these may be screwed anywhere approximating the positions shown in the illustrations. There is no need to get down to exact measurements in this amplifier. Provided the parts occupy the relative positions shown, the wiring will be easy to carry out. There is very little that can be said with regard to the actual wiring, as this is extremely simple and should not take more than an hour to carry out. Use the usual Glazite for this, and note that the Ohmite resistances are joined into circuit by means of Glazite attached to the terminal ends of these resistances. One point should perhaps be explained here. It will be noted that no H.T. negative terminal is provided on the amplifier. If the amplifier is connected up with an existing valve receiver, the terminals marked L.T.— and L.T.+ on the amplifier should be connected to the same terminals on the receiver, and not to the accumulator. In this way the H.T. negative return is automatically connected into circuit. Some receivers have H.T.— connected to L.T.—, whilst in others the H.T.— is joined to L.T.+ , and therefore the method of connection adopted in this amplifier is the most efficient, and prevents troubles.

The amplifier may be joined to any type of set, whether fitted with an output filter or not. The plugs attached to the high-tension side of this receiver are numbered 1, 2 and 3. H.T. 3 should be plugged into the highest voltage available, 120 volts being desirable to obtain the full benefit of this form of low-frequency output. H.T. 1 and H.T. 2 are attached to the priming grids of the pentodes, and these should be plugged into sockets slightly lower than 120 volts. The grid-bias negative

# A Q.P.-P. AMPLIFIER

A Simple Amplifier which will Enable Users of Existing Battery Sets to Obtain the Advantages of Q.P.-P.

which method of connection gives best results, unless the present receiver employs an output filter arrangement, in which case it will not make any difference to the primary of the input transformer.

**Balancing**

It will be seen that there are two variable H.T. tappings in addition to the grid-bias tapping, all of which affect the "balance" of the pentode valves; but, contrary to many expressions of opinion, there is not a great deal of necessity to "match" the valves when this method of output is employed. Of course, one of the claims of this type of circuit is the economy which is effected, but this is only one side of the question. The volume of the output interests most listeners more than the question of the cost of replacing the H.T. battery, and it must not be overlooked that if the valves are adjusted so that the consumption is at a very minimum, there is a risk of the listener being led to believe that the H.T. battery will last indefinitely, whereas the "shelf-life" of the battery must not be overlooked. Therefore, unless you intend to be extremely cautious, and fit a milliammeter in the anode lead

plug should be inserted into the 16-volt tapping on the grid battery, and two Cossor H.P.T. valves inserted in the valve-holders. Join the two terminals marked input to the loud-

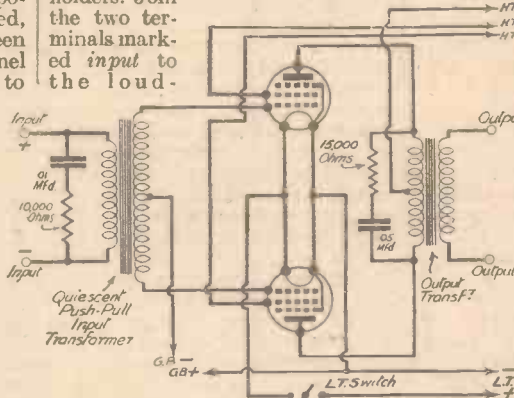

Circuit diagram of the Q.P.-P. Amplifier.

speaker terminals of your present receiver, and connect the loud-speaker to the terminals on the amplifier marked output. The leads joining the amplifier to the receiver may be changed round to see

of each valve and adjust the voltage of the primary grids to provide an equal current for each valve, all that is necessary is to adjust these two tappings to the most suitable for the volume and quality that you require. A further point which should not be overlooked is that the grid-bias battery is not discharged at the same rate as the high-tension battery, and therefore to preserve a true balance between the valves it is preferable to connect a resistance across the grid battery to discharge it at approximately the same rate as the H.T. battery, or adjust the tapping on the G.B. battery periodically. Beyond these small points, there is not much which can be said about an amplifier of this description. Of course, it is understood that if the receiver has many stages, care should be exercised not to overload either the amplifier valves or the output valve of the receiver; and, on the other hand, it is not much use adding the amplifier to a crystal receiver. Best results will be obtained when the amplifier is used in conjunction with a normal battery-operated two- or three-valve receiver.

It should hardly be necessary to point out that this type of amplifier should only be used with a high-class moving-coil loud-speaker, and if this is one of the ordinary types of speaker, having a matching transformer, probably best results will be obtained by disconnecting that transformer and joining the speech coil direct to the terminals on the Q.P.-P. transformer in the amplifier marked 40 to 1. The effect of joining the loud-speaker direct to the terminals marked 1.7 to 1 may also be tried.

(Continued on page 1158.)

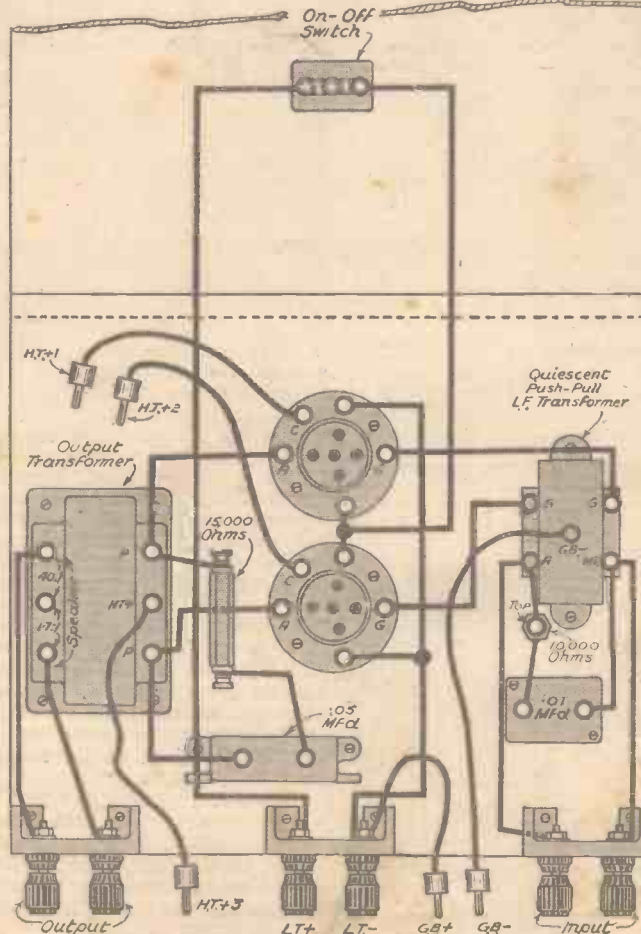

Wiring diagram for the Q.P.-P. Amplifier.

# COMPLETING THE

# The Fury

By F

## THE SET WHICH IS

L.S.

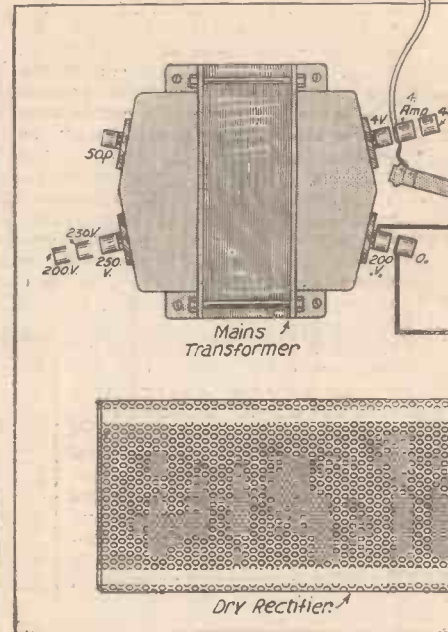

The mains portion wiring details

**T**HE illustrations this week will enable those readers who have anxiously awaited constructional details of the A.C. version of the "Fury Four" to complete what is a really powerful, reliable and prolific station getter. The Adaptagram cabinet will come to you with the front already fretted, and you will need, therefore, merely to make the set according to the instructions now given. First

side of the baseboard. Now locate all the components which are fixed to the top surface of the baseboard in their relative positions as shown by the wiring diagram on the next page. When satisfied that the positions are correct, mark the positions of the securing screws by stabbing through with a bradawl, and also drill holes through which the connecting leads pass from the top components to the sub-baseboard components. Small starting holes should be drilled for all wood-screws. The coils and all other components, excepting the variable condensers, should next be fastened down. The top surface components may now be wired and then wiring completed to the sub-baseboard components. Attach the fixed resistances in the positions shown, making sure that you use the correct values. Now, drill the panel (bear in mind that you can obtain a panel correctly cut from the British Ebonite Company, already drilled to receive the condensers, escutcheons, etc.), and mount the reaction condenser and potentiometer. Secure the panel to the front edge of the baseboard and complete the wiring. You should specially note that some wires

*The complete radio-gra*  
of all drill all the holes for the valve-holders in the baseboard and attach the side strips in exactly the same manner as for the battery version. These side strips or runners, of course, provide the necessary clearance for the valve-holders and the sub-baseboard components. Next, lay the metallized paper (very efficient, by the way) over the baseboard and rub it so that the positions of the valve holes are marked. Cut out the depressions in the paper caused by the valve holes, and paste the edges of the paper to the baseboard. Attach the paper with the screws at the side, placing large washers under the screw-heads to avoid cutting through the paper. Next attach the valve-holders and fix the condensers to the under-

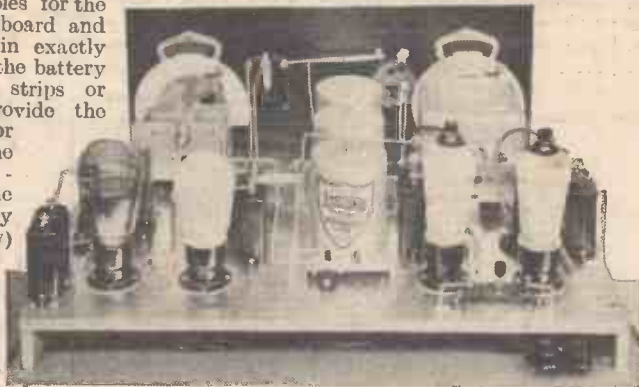

The receiver portion of the A.C. "Fury Four"

are passed under screw-heads or under the edge of some of the components in order to provide earth return through the metallized paper. It seems scarcely necessary to add that the wire must, of course, be bared at these points.

The earth return lead is made by attaching a soldering tag under a screw secured nearest to the earth terminal and solder a wire from this tag to the earth terminal itself. A careful inspection of the wiring diagrams overleaf will show the relative position of every component. Every wire as it is attached should be marked out on these diagrams. If you elect to cut the panel yourself, carefully mark it out according to the diagram given on the centre of these two pages.

And now regarding the mains unit; this, as will be seen from the top right-hand photograph, is placed on the floor of the Adaptagram cabinet and the various components may be mounted

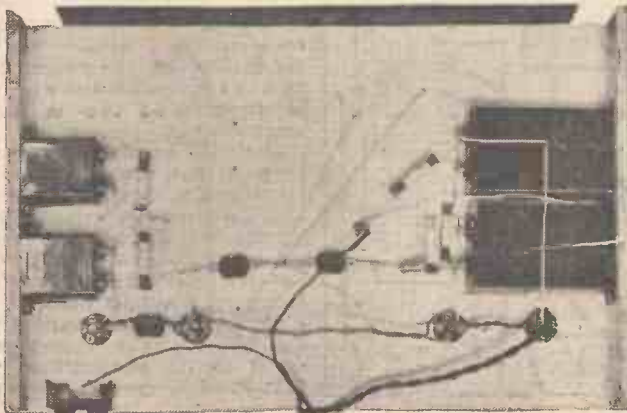

Sub-baseboard wiring of the receiver.

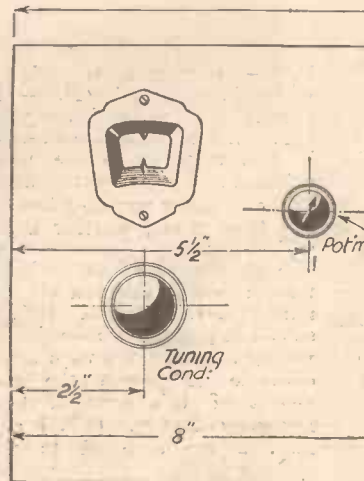

Panel

# THE A.C. VERSION OF—

# Fury Four

J. CAMM

REALLY GUARANTEED

on to a piece of plywood of convenient size. It will only take about half-an-hour to wire up

this, and the various connections should be made to the set. Note very carefully the arrangement of the flex for the heater leads of the mains valves. To join the unit to the set long leads are necessary, and in the illustration these are shown simply dropping down the back, but twisted to reduce the field. They may, if the reader so

### THE A.C. FURY FOUR RADIO-GRAM

- One Three-gang Coil Assembly. Lissen LN. 5162.
- One Lotus Two-gang Condenser Type P.C.2.
- One Lotus .0005 Condenser Type P.C.1.
- One Sovereign Compression Type Condenser, Type J.
- One Wearite S.G. Choke, Type H.F.P.A.
- One Bulgin S.G. Choke, Type H.F.4.
- One Peto-Scott Screened H.F. Choke.
- One L.F. Transformer, Ratio 3 to 1. Igranic Midget.
- One Telsen Pentode Output Choke, Type W.72.
- Six Dubilier 1 mfd. Fixed Condensers, Type BB.
- Two Dubilier .0003 mfd. Fixed Condensers, Type 665.
- One Dubilier .0002 mfd. Fixed Condenser, Type 665.
- Three 4 mfd. Dubilier Fixed Condensers, Type BS.
- Two 2 mfd. Dubilier Fixed Condensers, Type BS.
- Four Clix 5-pin Chassis mounting valve-holders.
- Four 1,000 ohm Erie Resistors, 1 watt type.
- Two 30,000 ohm Erie Resistors, 1 watt type.
- One 100,000 ohm Erie Resistor, 1 watt type.
- One 5,000 ohm Erie Resistor, 1 watt type.
- Two 350 ohm Erie Resistors, 1 watt type.
- One Lissen 2 meg. Grid Leak with wire ends.
- One Lewcos 50,000 ohm Potentiometer.
- One Telsen .0003 mfd. Differential Reaction Condenser.
- One Ebonite Panel 16ins. by 8ins. Becol.
- One Heayberd Fury Four Mains Transformer.
- One Westinghouse H.T.8 Metal Rectifier.
- One Igranic C.H.2 Smoothing Choke.
- One Becker Mains On-Off Switch.
- One Bulgin Radio-Gram switch, Type S.85.
- One Simpson's Electric Turntable.
- One Amplion Pick-up with Volume Control.
- One W.B. Loud-speaker, Type P.M.4.
- One Adaptagram Radio-Gram Cabinet.
- Two Cossor MSG-LA Valves (metallized).
- One Cossor MHL Valve (metallized).
- One Cossor PT.41 Valve.
- One yard Goltone Flexible Metallic Screening Tubing.
- Glazite, Flex, Screws, etc.
- One sheet Konductrite Metallic Paper for covering baseboard.
- One Baseboard, 19in. by 12in.
- One Belling-Lee Terminal Block.
- Two Belling-Lee Terminals, Type B, Aerial and Earth.

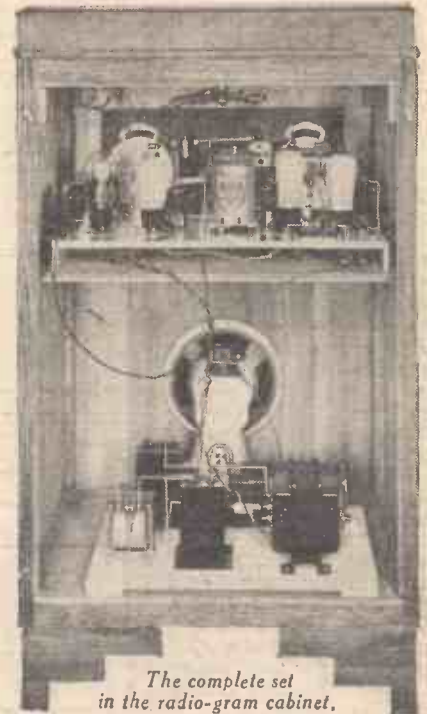

The complete set in the radio-gram cabinet.

point is not made clear by these notes, please address a letter to me personally, and helpful advice will be yours by return of post.

There is no need for me to repeat the operating instructions, as they are virtually the same as for the battery model. I would repeat that my guarantee of free personal advice also holds for the A.C. "Fury Four."

A small point concerning the Heayberd Mains Transformer. You will note that the tappings provided by the makers are for 200 volts, 230 volts and 250 volts. It is desirable in order to obtain best results to use a tapping higher than the voltage of which the set is to be operated should that voltage not coincide with one of the three tappings provided by the makers. For example, if your mains voltage is 220, use the 230 volt tapping, and if 240 volts, use the 250 volts tapping. A small point, and yet an important one is this; do not use a screw driver, pair of pliers or any tool whatsoever to make adjustments inside the set while it is on. Always switch off and thus avoid short circuits

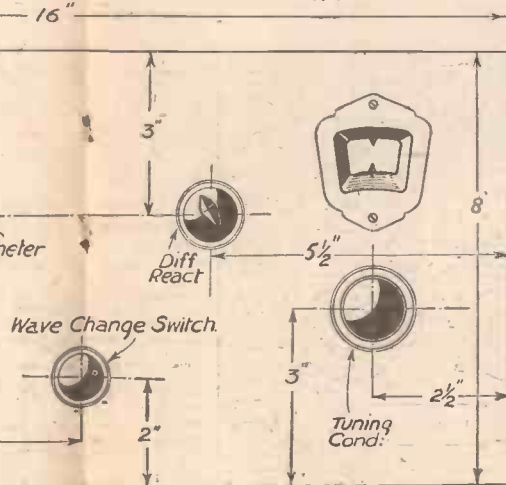
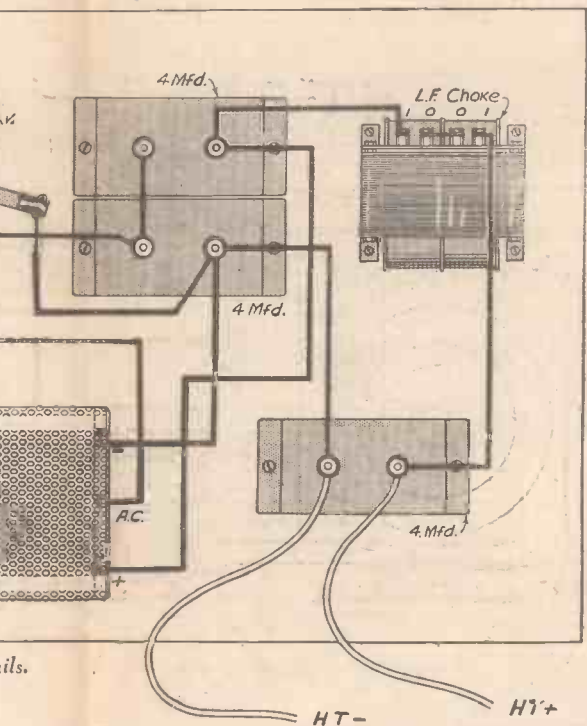

desires, be run along the baseboard and down the side of the cabinet for the sake of neatness. Also, if thought desirable, the reader may use valve-holders and valve bases, or some similar plug-in arrangement such as those sold by Bulgins for making the connections from the mains unit to the set. The actual connections are as follows: A lead is taken from the 2 mfd. fixed condenser to one of the loud-speaker terminals. Note that H.T. positive and H.T. negative leads are joined to the terminals on the 4 mfd. condenser on the mains unit; the loud-speaker lead remaining is connected to the centre terminal of the heater terminal on the mains transformer. I think you will agree that the A.C. "Fury Four" has particularly attractive lines, and by means of the complete diagrams given here no difficulty in construction should be experienced. If, however, any little

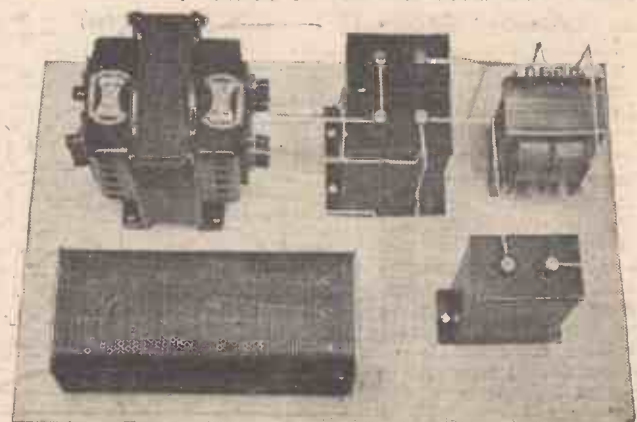

The mains unit for the A.C. "Fury Four."

and shocks. Unlike battery sets, which immediately jump to life when switched on, it will take a few moments for the filament of the "A.C. Fury Four" to reach emission temperature. This is, of course, common to all valves using indirectly heated filaments.

There is naturally much greater punch with the "A.C. Fury" than with the battery model, although the latter exceeds by many decibels that obtainable from the normal four valve wireless set.

And now concerning the many hundreds of letters I have received from readers who have already built the battery model of the "Fury Four." I have just space to deal with a few of the points raised by my correspondents. Firstly, my experiments with the D.C. version have now reached such a stage that I can say that I shall shortly deal with a D.C. version of it. That brief statement answers at one fell swoop some dozens of letters to which I have, of course, also-replied personally. Regarding adapting the "Fury Four" so that it will also receive the short waves, I am experimenting with that end in view, but I must say that, whilst such an adaptation is quite possible, I have been quite unsuccessful in getting more than three or four short wave stations, and then only at weak volume and even then not consistently. I have come to the conclusion that it can only be done satisfactorily by means of an adaptor, but I shall write more about this later; for whilst I realise that there is a great amount of interest in receiving short waves, I am yet to be convinced that the majority of listeners require to do so. The present state of short wave reception is not such that it is possible easily to tune in short wave stations with certainty and consistency. At present short wave reception is for the skilled experimenter only, but we are continuing our experiments and investigations and will pass on the results as soon as they have been collected into tangible form.

Some readers have written asking me to vary the design to suit local conditions. These I am bearing in mind and will give them considered treatment in greater issue. I have not been able to alter the design to suit individual readers' lists of components. I have struck a careful balance with the components I specify, and my guarantee relates specifically to "Fury Fours" built with those components.

### WIRING DIAGRAM OF THE A.C. "FURY FOUR"

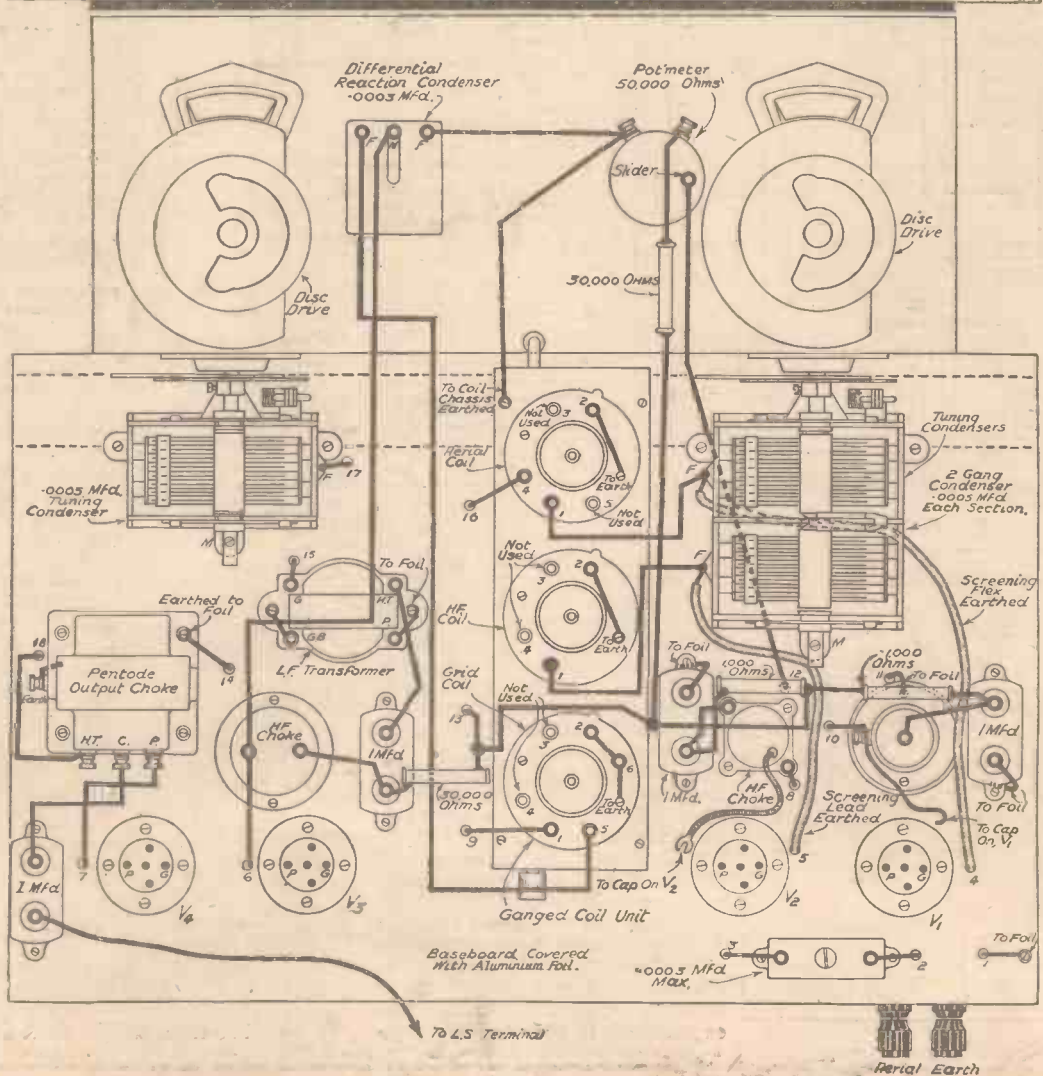
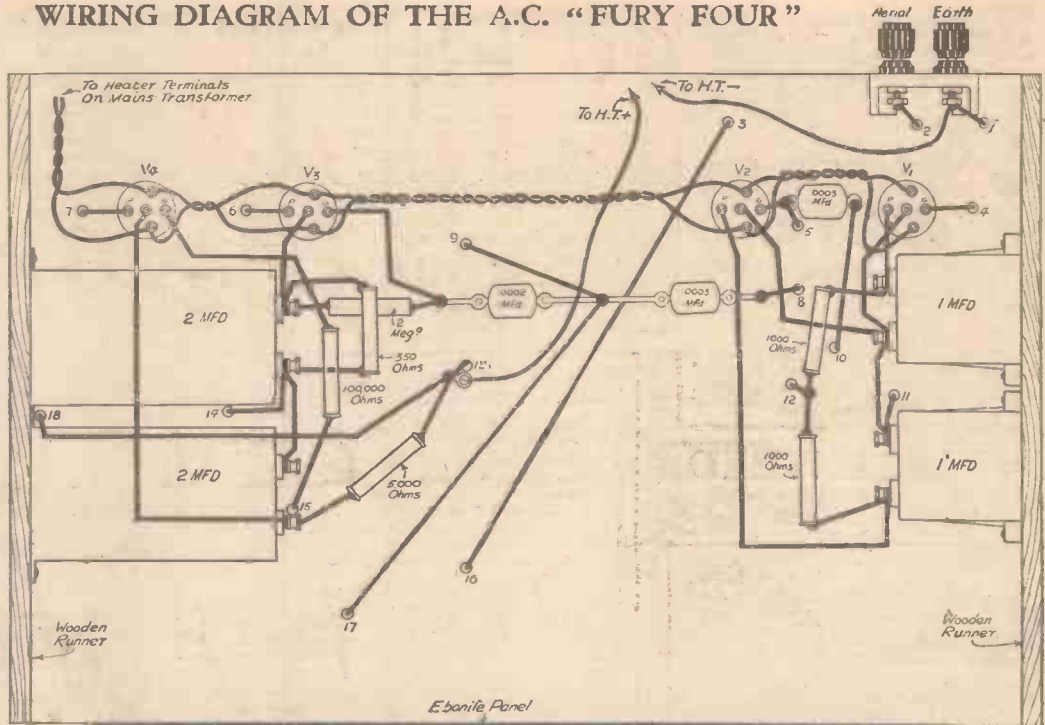

# PETO-SCOTT RADIO BY MAIL

## EXCLUSIVELY SPECIFIED For "A.C. Fury Four" Radiogram 1933 WALNUT ADAPTAGRAM

Constructed in Walnut with inlaid Walnut Veneers.

**MODEL A** converts your existing set to a Radiogram. Comes to you with vignitted front as illustrated and motor-board, ready to take your own Set, Gramophone, Motor and Pick-up. No skill or expensive tools are required to transform your Radio into a combination instrument, presenting the professionally finished appearance of the most luxurious Radio Gramophone money can buy. Carriage & Packing 2/6 extra, Eng. & Wales.

Or Deposit **63/-** 8/3 and 11 monthly payments of 5/9. Carr. paid.

**MODEL B** with Garrard Double Spring Motor, 12in. Turntable, Automatic Stop, B.T.H. Tone-Arm with Pick-up, and Volume Control Complete. Automatic Needle Cup. **6s.** Cash or C.O.D. or 12 monthly payments of 12/-.

**LISSEN "SKYS' RAPER 3."** Chassis Model with (Lissen) S.G. Detector and Pentode valves. Cash Price, £4/9/6. Carriage Paid. Balance in 11 monthly payments of 8/3.

**LISSEN "SKYSCRAPER 3."** Cabinet model. Complete with Lissen speaker and Lissen S.G., Detector and Pentode valves. Cash Price £5/6/0. Carriage Paid. Balance in 11 monthly payments of 11/6.

**BLUE SPOT UNIT AND CHASSIS**, Type 99 P.M. Including matched transformer. Cash Price, £2/18/6. Balance in 11 monthly payments of 5/6.



**MODEL C** with Collaco Induction Electric Motor with Tone-Arm, Pick-up and Volume Control in one Unit. 12in. Turntable. Automatic Stop. Automatic Needle Cup. **7s.** Cash or C.O.D. or 12 monthly payments of 13/9.

**ESSEN "SKYS' RAPER 3."** Chassis Model with (Lissen) S.G. Detector and Pentode valves. Cash Price, £4/9/6. Carriage Paid. Balance in 11 monthly payments of 8/3.

**LISSEN "SKYSCRAPER 3."** Cabinet model. Complete with Lissen speaker and Lissen S.G., Detector and Pentode valves. Cash Price £5/6/0. Carriage Paid. Balance in 11 monthly payments of 11/6.

**BLUE SPOT UNIT AND CHASSIS**, Type 99 P.M. Including matched transformer. Cash Price, £2/18/6. Balance in 11 monthly payments of 5/6.

## PUSH-PULL THREE-FOUR

Described this week.

### KIT "A"

Author's Kit of First Specified parts, including ready drilled panel, but less valves and cabinet. **CASH OR C.O.D. Carriage Paid.**

**£4-18-6**

or 12 monthly payments of 9/-

### KIT "B"

As Kit "A" but with valves, less cabinet, CASH or C.O.D. Carriage Paid.

**£7 7 0**

or 12 monthly payments of 13/6.

### KIT "C"

As Kit "A" but with valves and Peto-Scott American Type Cabinet with lift-up lid. CASH or C.O.D. Carriage Paid.

**£8 2 0**

or 12 monthly payments of 14/10.

### KIT-BITS

Selected C.O.D. Items. You pay the postman. We pay post charges over 10/-.

- 1 J.B. .0005 mfd. Slow Motion Condenser, Type D. . . . . 14/-
- 1 R.I. Q Type Transformer . . . . . 16/6
- 1 Varley Transchoke D.P.39 . . . . . 16/6
- 1 Set of 4 specified Valves . . . . . £2/19/0
- 1 Peto-Scott Cabinet . . . . . 15/-

## SNIPS

Special Bargain Offer to "Practical Wireless" Readers.

### BLUE SPOT 100U

Speaker and Chassis. For high or low-powered sets. Original Price £1 12s. 6d. Our Price (for a limited period only) **CASH or C.O.D.**

**19/6**

### AMPLION PICK-UP

with Arm, Base, and Volume Control. Original price £1 5s. 0d. Our Price (for a limited period only), **CASH or C.O.D.**

**19/6**

## Q.P.P. PILOT CONVERSION KIT

CONTAINS: 1 Q.P.P. Transformer. 1 Q.P.P. Output Choke. 4 Non-Inductive Resistances. 1 Potentiometer. 2 Mansbridge Condensers. 2 Valve Holders. 1 Tone - Compensating Condenser. 1H.F. Choke G.B. Plugs. Wires. Screws, Flex, etc.

**CASH or C.O.D. Carriage Paid**

**42/6**

or 8 monthly payments of 6/-

With FULL SIZE diagrams and constructional notes. SEE PAGE 1075 OF LAST WEEK'S ISSUE.

## QUIESCENT PUSH-PULL TRANSFORMERS and CHOKES

PETO-SCOTT (GUARANTEED) Cash or C.O.D. Carriage Paid.

Q.P.P. Intervalve Transformer 9:1 . . . . . 16/6

Q.P.P. Output Choke 1:1, 2:1, 3:1 . . . . . 10/6

R.I. "Q" Type Q.P.P. Multi-Radio Choke D.Y.35 . . . . . 12/6

"Q" Type Q.P.P. Transformer D.Y.34 8:1 . . . . . 16/6

VARLEY D.P. 36 Q.P.P. Input Transformer 9:1 . . . . . 17/6

D.P. 37 Q.P.P. Output Transchoke 3:1 and 42:1 . . . . . 18/6

D.P. 38 Q.P.P. Output Transchoke 3:1 and 50:1 . . . . . 16/6

D.P. 39 Q.P.P. Output Transchoke 3:1 and 75:1 . . . . . 16/6

Above Q.P.P. Transformer prices include Royalty 1/6

Q.P.P. Guardian Milliammeter . . . . . 10/-

**GUARDIAN MILLIAMMETER** Specially designed for Q.P.P. Panel or Pocket Type 10/- 2in Dismeter Dial



## GUARDIAN METER 10'

PETO-SCOTT CO., Ltd., 77, City Road, London, E.C.1 West End Showrooms: Telephone: Clerkenwell 9406-7 62 Htg. Holborn, London, W.C.2. Telephone: Holborn 3248.

Dear Sirs,—Please send me CASH/C.O.D./H.P. . . . .

for which I enclose £. . . . . CASH/H.P. Deposit.

NAME . . . . .

ADDRESS . . . . .

Pr.W. 4-3-33.

## QUIESCENT SPEAKERS PUSH-PULL CASH, C.O.D., H.P. Carriage Paid.

**CELESTION Q.P.P. 19a MOVING-COIL SPEAKER** with input transformer. Cash or C.O.D. Carriage paid, £2/10/0. Balance in 11 monthly payments of 4/7.

**W.B. PM4 Q.P.P. MOVING-COIL SPEAKER** with input transformer. Cash or C.O.D. Carriage Paid, £2/2/0. Balance in 7 monthly payments of 5/9.

**ROLA Q.P.P. MOVING-COIL SPEAKER** with input transformer. Cash or C.O.D. Carriage Paid, £2/9/6. Balance in 11 monthly payments of 4/6.

## R. AND A. CHALLENGER SPECIFIED FOR THE PUSH-PULL THREE-FOUR

**PERMANENT MAGNET MOVING-COIL SPEAKER.** With special Ferranti multi-ratio input transformer. Cash Price, Carriage Paid, £1/15/0. Balance in 5 monthly payments of 6/6.

**SONOCHORDE SN. Q.P.P. MOVING-COIL SPEAKER** with input transformer. Cash or C.O.D. Carriage Paid, £3/7/6. Balance in 11 monthly payments of 6/3.

**ATLAS ELIMINATOR.** Type A.C.244. Three Tappings, S.G., Detector and Power. Output: 120 volts at 20 m.A. Cash Price £2/19/6. Carriage Paid. Balance in 11 monthly payments of 5/6.

## FREE Peto-Scott — the first to commercialise Q.P.P.

SEND TO-DAY FOR CONSTRUCTIONAL CHART AND FULL-SIZE BLUEPRINT New and Revolutionary Q.P.P. 4 Valve Kit Set

## FURY FOUR Original Battery Model

**KIT "A"** Author's Kit of Specified parts, including ready drilled panel, but less valves and cabinet. **CASH OR C.O.D. Carriage Paid.**

**£6 10 0**

or 12 monthly payments of 12/-.

Specified Valves £2/17/6. Peto-Scott Oak Cabinet, 15/-

## A.C. FURY FOUR RADIO-GRAM.

**KIT "A"** CASH or C.O.D. Carriage Paid. Author's Kit of specified parts, including ready drilled panel but less valves, cabinet, Motor, Pick-up and Speaker. **£10 0 0** or 12 monthly payments of 18/4.

### ESSENTIAL ACCESSORIES:

- 1 PETO-SCOTT ADAPTAGRAM, as exclusively specified (Carriage paid) £3/5/6.
- 1 Simpson Electric Turntable, £1/19/6.
- 1 Amplion Pick-up with Volume Control, 19/6
- 1 W.B. Permanent Magnet Moving-Coil Speaker, £2/2/0.

FREE.—SEND 3d. POSTAGE FOR 3 PILOT ENVELOPES WITH FULL-SIZE BLUEPRINTS

SEND DIRECT to AVOID DELAY — CASH, C.O.D. or EASIWAY

**WE LEAD AGAIN!**

**A THREE-VALVE PUSH-PULL DETECTOR SET**

It is believed that "Practical Wireless" is the first Paper to deal with a Practical Push-Pull Detector Stage Receiver. This Arrangement gives a Powerful Output from a Weak Signal.

By S. J. GARRATT

**A** GLANCE at the circuit diagram (Fig. 1) will show that this set is very much out of the ordinary in the respect that it has twin detector valves but no grid condensers. The principle of push-pull detection has already been explained in PRACTICAL WIRELESS recently (see issue No. 20) in an article which pointed out that the radio frequency oscillations from each detector valve neutralise one another in the output, leaving only the audio-frequency component, thus avoiding de-coupling difficulties. Another advantage is that through the reduction of the damping effect of the ordinary grid condenser system the twin detector is more selective and more sensitive, providing a suitable tuning coil is used, while the output to

from a separate long wave coil but a really satisfactory dual-wave switch-over coil for this set remains to be produced.

It is essential to adhere to the components specified. The transformer for instance has a particularly high primary inductance, and gives definitely better results than a cheap transformer.

Also, if other valves are used, it may be found that it will be necessary to alter the number of turns on the reaction variometer. Reaction is frequently supposed to be unsatisfactory with push-pull detection, on account of distortion, but by applying the push-pull principle by means of a variometer in the manner described, very satisfactory results can be obtained.

**Making the Tuning Coil**

A special home-made coil is required, so it will perhaps be advisable to get this component made before commencing to assemble the receiver. Fig. 2 shows how this coil is to be made. The former consists of a piece of cardboard tube 2in. outside diameter and 2½ in. long. This is fixed to an ebonite base by means of a piece of wood about ¼ in. square, fixed across the bottom of the tube by a screw at each end, and two screws through the ebonite from underneath.

The tuned grid coil is wound direct on to the former commencing ¼ in. from the top. It consists of fifty-five turns of

small holes about ¼ in. apart. Run the ends down the inside of the tube and then out to the two terminals marked "G." Now, cut twelve pieces of wood ¼ in. square and 1in. long (good sound matches will do) and arrange these equidistantly round the former over



General view of the completed receiver.

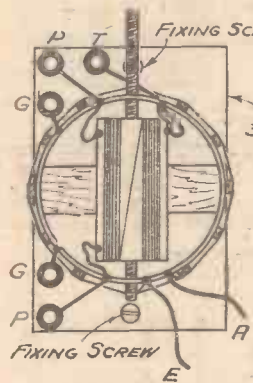
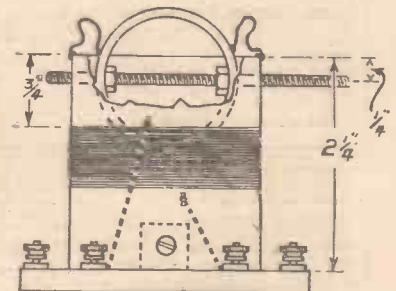

Fig. 2. (a)—Showing the construction of the special coil.

the next stage is double that of a single valve. The result is that the circuit is an extremely simple one requiring a minimum of components. With the single stage of amplification, as specified, good loud-speaker results have been obtained in the Wirral Peninsula from over thirty stations, the continentals coming in particularly well on the medium wave-band. Long waves have not given such good results. Moderate results can be obtained



Fig. 2. (b)—Further details of the coil.



the grid coil, and fix them to the former with a touch of Seccotine or other adhesive at each end. Wind the aerial coil on top of these pieces, as shown in Fig. 2. (b) Use 28 gauge enamelled wire for this, and put on twelve turns; fix the ends as you did for the grid coil, but do not attach the ends to terminals, leave about 3in. free and run these ends straight to the aerial and earth terminals of the set.

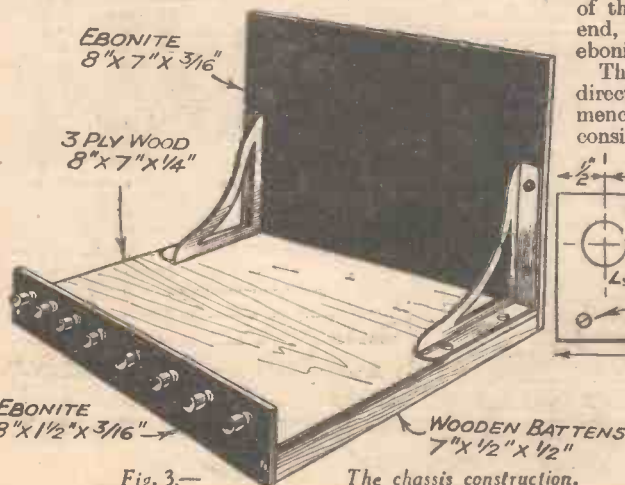

Fig. 3.—

The chassis construction.

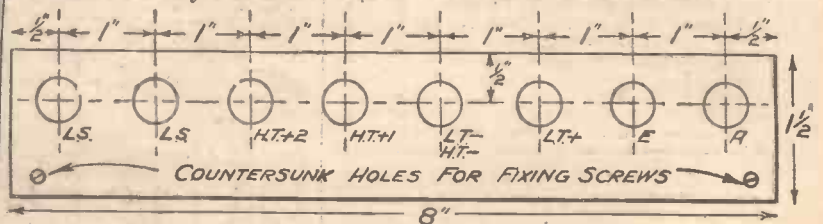

Fig. 5.—The terminal strip.

No. 36 double silk covered wire; fix the ends by threading the wire three or four times through two

**Reaction Variometer**

The reaction variometer is a piece of ebonite tube 1¼ in. diameter by ¼ in. long,

**A THREE-VALVE PUSH-PULL DETECTOR SET** (Continued from page 1148.)

and its spindle is a 6in. length of 6 B.A. screwed brass rod. Drill  $\frac{1}{8}$  in. holes in the ebonite for the spindle, which can then be screwed into place without tapping the holes; lock the ebonite tube to the spindle with two 6 B.A. brass nuts, as shown. Use similar wire to the grid coil for the winding; drill the ebonite with the  $\frac{1}{16}$  in. holes in three places, as shown, and fix the end of the wire (leaving about  $1\frac{1}{2}$  in. free) by threading it two or three times through the hole and over the edge of the ebonite. Wind on eight turns of wire on one side of the spindle then lead the wire across and put eight more turns on the other side; double the wire to form a loop about  $1\frac{1}{2}$  in. long and fix this loop by threading it through the  $\frac{1}{16}$  in. hole already provided. This forms the centre tapping. Now, continue winding in the same direction as before, and put on eight more turns over the second eight, lead the wire across to the other side of the spindle and put on another eight turns over the first eight, and finish off at the unoccupied  $\frac{1}{16}$  in. hole. This makes thirty-two turns altogether on the variometer. A few touches of Seccotine should be put on the coils to fix them.

Fix three pieces of 28 gauge wire at the top edge of the cardboard former, and run them down inside the former to the three terminals P, T and G. Fix the variometer to the former tube (it will, of course, be necessary to remove the spindle to do this); then solder the three connections on the variometer to the three wires leading to the terminals; be particularly careful to see that the double connection forming the centre tapping connects to terminal marked T, and loop up the wires as shown on the illustration to allow the variometer to move  $90^\circ$  each way from the position shown. The coil is then finished.

Build up the chassis as shown in Fig. 3. This is quite a straightforward job and needs no detailed description. The underside of the base will be a shallow box; this simplifies the wiring, because the low-tension circuit can be wired underneath the base all other wiring being on top. Figs. 4 and 5 show the drilling dimensions for the panel and for the terminal strip respectively.

**Fixing the Components**

The fixing of the components presents no difficulty, their positions being shown in Fig. 6, which also shows the wiring above the base. The wiring below the base is also shown above. When fixing the coil a little care is necessary to see that the variometer spindle lines up with the hole in the panel; the spindle should project through about  $\frac{1}{2}$  in. and a suitable knob with a grub screw fixing obtained from some old component. Two 6 B.A. lock-nuts and a spring washer behind the panel will serve to introduce a little friction so as to cause the variometer adjustment to "stay put."

The slow-motion dial goes entirely on the front side of the panel and is fixed by the two bolts provided with the dial. Fix the condenser first by means of the usual one-hole fixing so that its terminals are vertically above each other, then put on the slow-motion dial and hold it in position by hand while you mark the position of the two bolt-holes on the panel. Then remove the dial and drill the two holes  $5/32$  in. diameter; this is a good deal larger than necessary for the bolts, but will

(Continued on page 1150.)

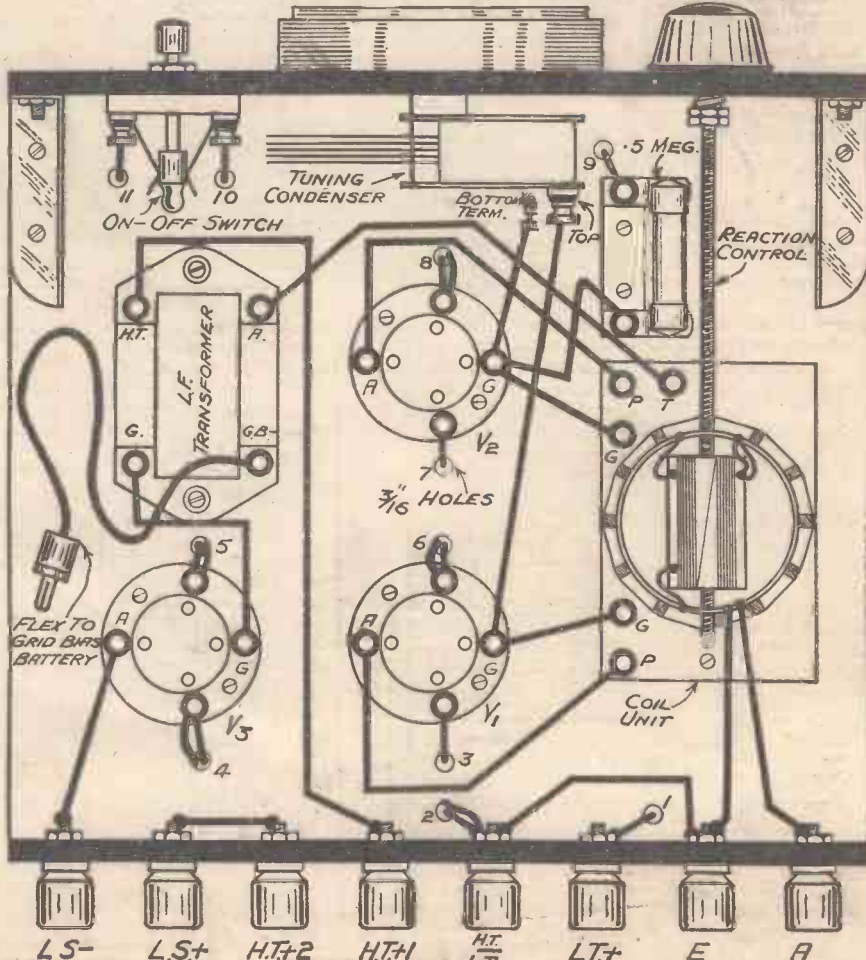
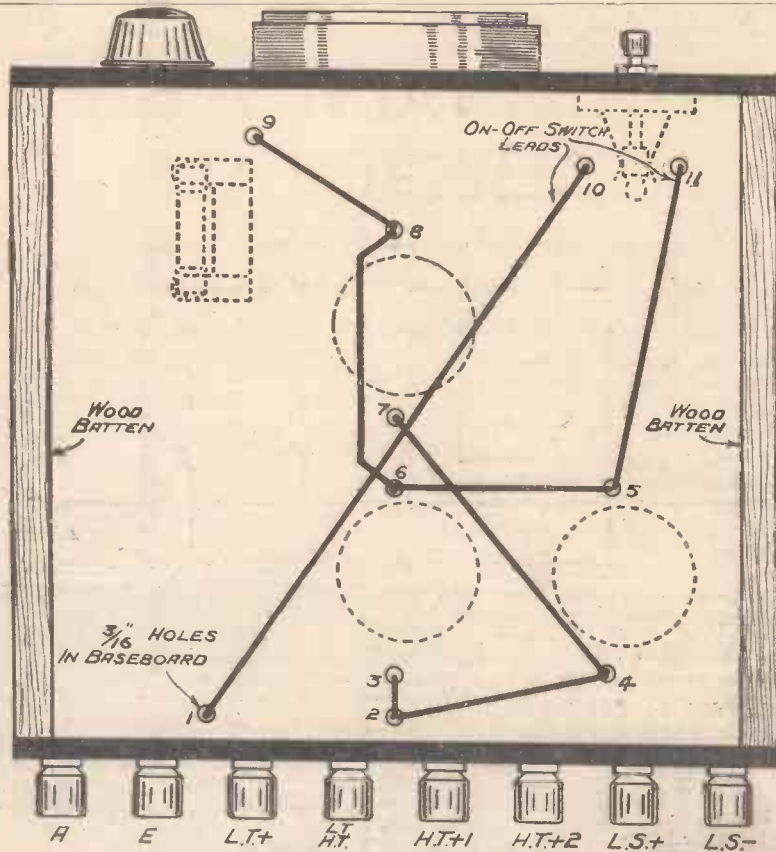

Fig 6.—Layout of components and (above) baseboard wiring diagram.

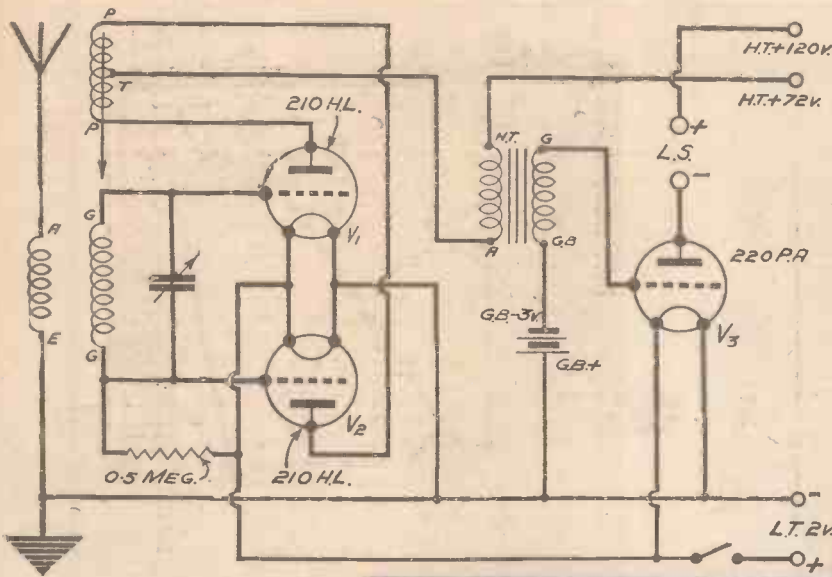
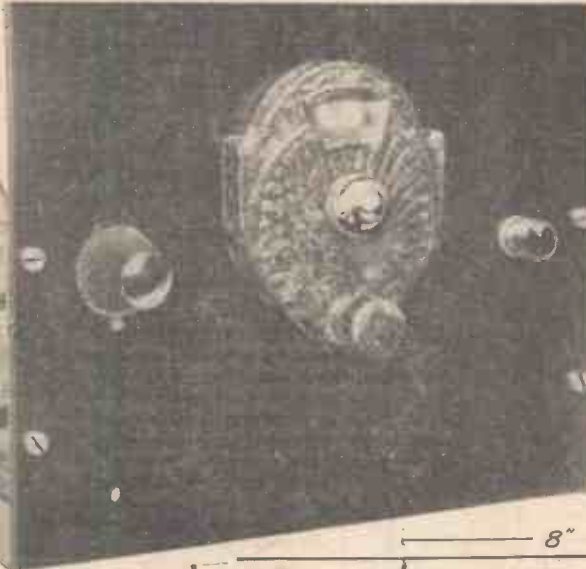

Fig. 1.—Circuit diagram.

**A THREE-VALVE PUSH-PULL DETECTOR SET**  
(Continued from page 1149.)

allow the dial to find its own position, otherwise it may not work freely. The resistance of the grid leak is rather lower than usual, but the value does not appear to be critical, the detector works just as well with 1 megohm or  $\frac{1}{2}$  megohm, but the lower resistance reduces hand capacity effects when tuning.

Use the 72-volt tapping for the detector high-tension, unless you want to experiment. With this voltage the anode current with Cossor 210 H.L. valves will be 2 milliamps for the two valves, which will not overload the trans-



former. If the 90-volt tapping is used the set will be a little more sensitive, but there may be some distortion due to transformer saturation, and the reaction will be found too fierce for convenience. The power valve (Cossor 220 P.A.) should have 120 volts on the anode and 3 volts grid bias.

**THREE-VALVE PUSH-PULL DETECTOR SET**  
**LIST OF COMPONENTS**

- 1 Ebonite panel 8in. by 7in. by 3-16in. (Becol).
  - 1 Ebonite terminal strip 8in. by  $\frac{1}{2}$ in. by 3-16in. (Becol).
  - 1 Three-ply baseboard 8in. by 7in. by  $\frac{1}{4}$ in.
  - 2 Wood battens 7in. by  $\frac{1}{2}$ in. by  $\frac{1}{2}$ in.
  - 2 Panel brackets. (Bulgin)
  - 1 Telsen bakelite tuning condenser .0005 (W. 193).
  - 1 Telsen slow motion dial (W. 141).
  - 1 Coil made as instructed.
  - 1 R. I. Hypermite transformer.
  - 1 Telsen grid-leak holder (W. 148).
  - 3 Valve-holders, Telsen (W. 224).
  - 1 Grid-leak  $\frac{1}{2}$  megohm (Telsen).
  - 1 On-off battery switch (2 point) (Bulgin).
  - 8 Belling-Lee junior terminals marked as shown.
  - 1 Short length of flex for grid bias connection.
  - 1 Coil Glazite connecting wire.
  - 1 Length screwed brass rod 6 B.A. and 2 nuts.
  - 2 Doz. brass screws  $\frac{1}{2}$ in. by No. 4, countersunk heads.
- Cost of above should not exceed 30s.

**ACCESSORIES**

- 2 Cossor 210 H.L. metallized valves.
- 1 Cossor 220 P.A. power valve.
- 1 6 Volt grid bias battery (Lissen).
- 1 120 Volt H.T. battery.
- 1 2 Volt accumulator (Block Battery).
- 4 Wander plugs (Clix G.B. +, H.T. +, H.T. +2, H.T. —).
- Celestion Soundex Speaker.
- 1 Filte earthing device.



The Celestion PPM Soundex cabinet speaker, specially recommended for the three-valve push-pull detector.

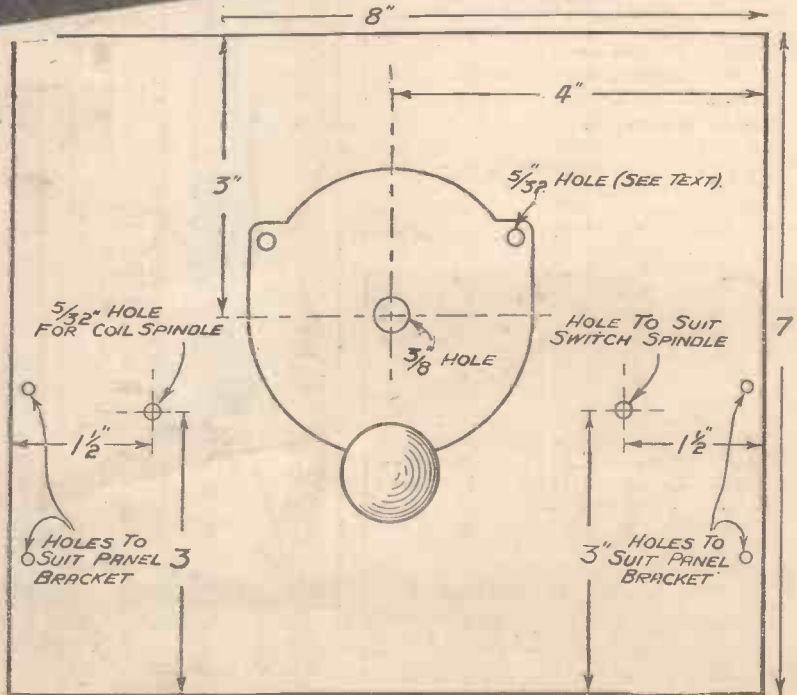
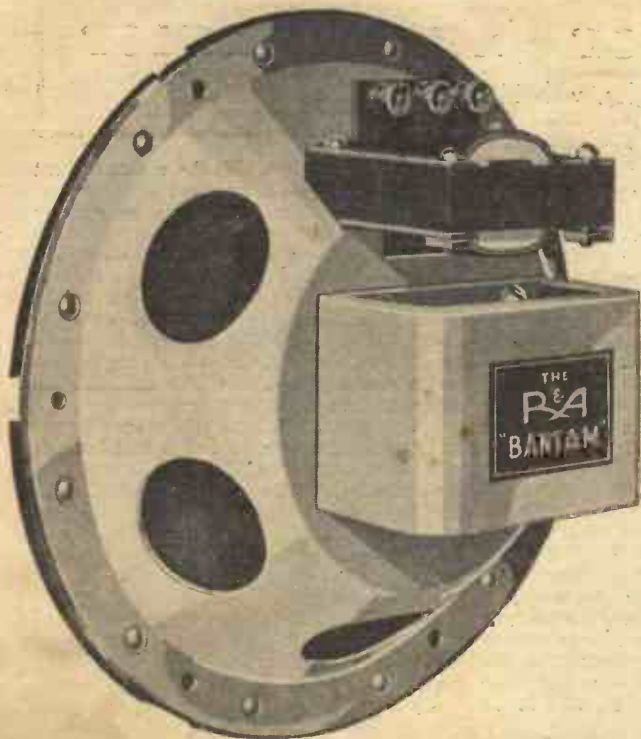

Fig. 4—How to drill the panel.





Exclusively specified for the 'Q.P.P. Three-Four' described in this issue

**27/6**

including 3-ratio Ferranti Transformer

The R. & A. "Bantam" has been specially chosen by the designer for use with the "Q.P.P. Three-Four" because it reproduces speech and music with such remarkable fidelity and purity, and handles a generous input without overload.

Indeed, the quality of reproduction is not equalled by many similar instruments of much higher price, and none is so well adapted to the requirements of the "Q.P.P. Three-Four," hence the designer's exclusive choice of the "Bantam." Your dealer can supply.

Purchase a 'BANTAM' the reproducer specified by the designer of the 'Q.P.P. THREE-FOUR'

The **R & A**  
**"BANTAM"**  
 PERMANENT MAGNET MOVING COIL  
 REPRODUCER

REPRODUCERS & AMPLIFIERS, LTD., WOLVERHAMPTON.



**"GOLTONE" SCREENED DUAL-RANGE COILS ON METAL CHASSIS**

For modern receiver designs, these "Goltone" matched Dual-Range units will meet all requirements.  
 Type GGR—Tuned grid with separate reaction and aerial tap.  
 Type GGO—Tuned grid with reaction and alternative aerial taps.  
 Type GGC—Special aerial coil with three tapings. No reaction.  
 Type GBA—Band-pass aerial coil with coupling winding.  
 Type GBS—Band-pass secondary coil with separate coupling winding.  
 Obtainable from all First-Class Radio Stores. Refuse Substitutes—if any difficulty, write direct.

Price for ALL TYPES **5/9** EACH.

**FREE**  
 Send for large Radio Catalogue page four with 1933 circuits and description of the various Goltone Coils.



**No!** Not a New Set-NEW VALVES-ETA VALVES

You may pay more but you won't get better. ETA valves are equal to the best—or even better. Why pay more?

**FREE** Ask for the ETA "Comparative Table" No. 13 showing which ETA valves to use in place of your old ones. Technical advice gladly given. Write to

THE ELECTRICAL TRADING ASSOCIATION, Aldwych House, Aldwych, W.C.2.  
 Scottish Agents: RADIOVISION LTD.  
 233, St. Vincent Street, Glasgow, C.2.

AMERICAN SETS. There are ETA valves for all types of American sets

PRICES FROM

**5/6**



THE INTERNATIONAL VALVE

As low in price as a really good valve can be

# The A.C. Eliminator Transformer

An Explanation of its Underlying Principles, with Notes on its Use

By G. H. WRAY, F.C.S.

It is beyond dispute that practice is generally found to be more interesting than theory, but however practical one desires to be, it is impossible to travel very far in any scientific pursuit without realizing that practice and theory go hand in hand, and that lack of some theoretical knowledge of the subject is a severe handicap.

The transformer is probably the most simple of all alternating current devices. It has no mechanically moving parts, its action depending upon what is known as electro-magnetic induction. Faraday discovered that by winding two insulated wires on an iron ring, and passing a current through one of the wires, a current was produced in the second wire every time he started or interrupted the current flowing in the first wire. This is the fundamental principle of the transformation of current, and although, of course, great strides have been made in the design of transformers since the time of Faraday's discovery, the actual principle remains unaltered.

power. The proportion in which power is increased at the expense of speed, or speed at the expense of power, depends upon the number of teeth in the different gear wheels. Exactly the same thing applies in the case of a transformer, which may be either a step up, an equal ratio, or a step down transformer, according to whether the voltage induced in the secondary winding is greater, equal to, or less than that which is flowing in the primary winding. This depends upon the ratio between the windings, or in other words, the number of turns of wire of which each winding consists.

## E.M.F. and Coil Windings

In all transformers, the electromotive force, or voltage, generated in the secondary winding, is compared to that applied to the primary winding, nearly in the same proportion as the relative number of turns on the two windings. That is to say, if the primary coil consists of 2,000 turns, and the secondary of 6,000 turns, the voltage generated in the secondary coil will be nearly three times as great as that used in the primary.

It is, of course, impossible to obtain from the secondary winding of a transformer more power than is supplied to the primary. The power put in and that taken out will be nearly equal. The output can never be quite equal to the input, because of certain inevitable losses of energy which occur in the transformer itself. These losses are due to the internal resistance of the windings, hysteresis and eddy currents in the iron core, and to the magnetizing current which flows continuously through the primary while the transformer is connected in circuit, whether current is being drawn from the secondary winding or not. The losses due to the resistance of the windings vary according to the load or output of the transformer, but the other losses remain practically constant irrespective of the load.

In a well-designed transformer, the losses are reduced to a minimum, otherwise the over-all efficiency of the transformer would be impaired.

If a transformer were connected to a D.C. mains supply, the result would be a dead short circuit of the mains and serious damage to the primary winding, and it is interesting to examine why this does not happen when the transformer is connected to A.C. mains. Suppose that our mains supply is 230 volts alternating at 50 cycles per second, and that the primary of a transformer is connected to this supply, the secondary being on open circuit, that is, no current is being taken from it.

## "No Load" Current

A small current known as the "no load," or magnetizing, current will flow through the primary circuit, the iron core of the transformer will be magnetized, the magnetic flux being alternating in character like the current which produces it and alternating at the same frequency as that current, in this case, 50 cycles per second. The transformer simply acts as a choke coil, a current being self induced in the primary circuit in a direction

opposite to that in which the mains current is flowing through the primary.

This induced back pressure or counter voltage in the primary is almost equal to the impressed voltage or mains current, and it therefore impedes the flow of mains current through the winding. The current in the primary, while the secondary is on open circuit, is consequently automatically controlled by the reactive current set up, and its magnitude is just sufficient to maintain the magnetization of the iron core.

If the secondary circuit of the transformer be now closed upon a load such as a lamp of suitable voltage, current will be drawn from the secondary, and although no direct connection exists between the secondary winding and the mains supply, an increased current will flow through the primary to compensate for the current drawn from the secondary.

The reason for this is that the ampere turns of the secondary winding will be approximately opposed to those of the primary and will tend to reduce the density of the magnetic field in the iron core. This in turn tends to reduce the back pressure or opposing voltage, self-induced in the primary winding, and therefore allows an increased current to pass from the supply mains through the primary, to balance the power drawn from the secondary. In this way, readjustment of the primary current automatically follows any variation in the current taken from the secondary, and the action of a transformer is therefore practically self-regulating.

Where more than one transformer is connected to the supply mains, the primary circuits are connected in parallel. It might appear that it would be more economical to connect them in series in order to utilize the same primary current in each primary winding, in the same manner as installing a number of water wheels in the same stream, but this is impracticable, owing to the fact that any change in the current taken from one transformer affects the electromotive force set up in the secondary circuits of the other transformers.

## Q.P.-P. THREE-FOUR

(Continued from page 1131.)

receiver: 6 mA.

Maximum current on full volume with dance band: 12 mA.

Mean current consumption at maximum volume over one hour's reception: 9 mA.

Maximum current on volume which would satisfy most listeners: 9 mA.

Mean current consumption under the above conditions: 7.5 mA.

## Range of Reception

Obviously, as this receiver only employs a detector stage followed by low frequency amplifiers, the range is not enormous. The use of reaction does, however, enable a number of stations to be tuned in, although the full advantage of the Q.P.-P. feature is not felt on all of these stations. A really good input to the detector is required, and therefore the receiver should be looked upon as a local station set designed to give a high quality, good volume output comparable with a mains-operated receiver, but at only a trifle of the cost, and with the very minimum of cost in upkeep.

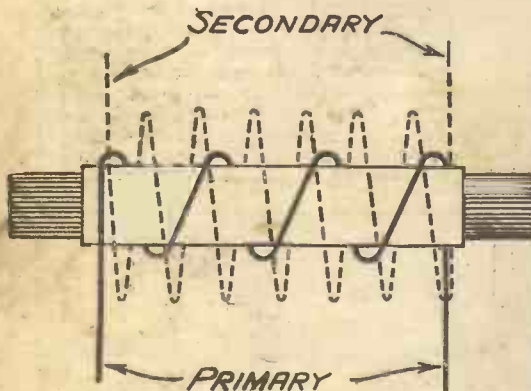

A diagram showing the construction of a transformer.

## Essential Parts

A transformer consists in its essential parts of two insulated coils of wire wound cylindrically outside one another on a straight iron core, as shown in the accompanying illustration. One winding, usually that nearest to the iron core, is termed the primary winding, and the other winding the secondary. In operation, an alternating current (that is, one changing in direction a number of times per second) in the primary winding, produces an alternating magnetic field in the iron core, and this produces an alternating current in the secondary winding.

A close analogy exists between a transformer and the gear box of, say, a motor-car, and a transformer may really be regarded as an electrical gear box. By the use of a transformer we can transform a strong alternating current to a weaker one, but of higher voltage, or vice versa, we can convert a weak current at high voltage into a strong current at lower voltage.

In the same way, a motor-car gear box is used either to transmit more power to the driving shaft, at a decreased number of revolutions per minute, or vice versa, an increased number of revolutions at a lower



Conducted by  
F. J. CAMM

**I**N Part 2 of this series we saw that the up and down movement or oscillations of the current in the aerial circuit of our three-valve set meant that the grid of the detector valve became alternately positive and negative. This had the effect of first attracting and then repelling the electrons which stream all the time from the filament to the plate.

**HOW YOUR SET WORKS**  
Part 3.—More about the  
Detector-Reaction.

The grid leak allows the surplus to leak slowly away.

**Like Two Men in a Boat**  
If you cannot quite follow this explanation of the action of the detector valve, and it is admittedly one



Fig. 1.—Diagram illustrating equal and opposing forces.

In other words it alternately increased and decreased their flow. I had yet to explain the "detector" action referred to—that is, how the valve cuts out the effect of the aerial current in one direction. If this were not done the rapid up and down movements would neutralise one another.

**How the Valve "Detects"**

Well, what happens is that every time the grid becomes positive it collects a few of the electrons on to itself as they rush from filament to plate. These remain on the grid and so assist in the repelling action that it has when it is negative. Thus the grid has more effect on the plate current when it is negative than when it is positive. This means that instead of the average effect on the plate current being nothing, as it would be if the attraction and repulsion were equal, the average effect is now a definite reduction of plate current below normal. Naturally, the amount of this reduction depends on the intensity of the rapid changes from negative to positive of the grid. This in turn depends on the strength of the current in the aerial circuit, which we have already seen varies with the fluctuations of the speech or music transmitted.

**The Grid Leak**

There is still one little point unexplained. I refer to the thing marked "grid leak" on the diagrams. This is connected to the grid to prevent too many electrons remaining on it. If it were not there the grid would get choked up with electrons because, as we have seen, each time it becomes positive it collects a few electrons from the filament.

of the most difficult things to grasp in the whole of the workings of your set, perhaps a simile will be helpful. Suppose there are two men sitting back to back in a canoe, as in Fig. 1. One is paddling vigorously in one direction while the other is paddling equally vigorously in the opposite direction. First one makes a stroke and then the other. Of course, the net result would be that the canoe would not move at all. As soon as it had begun to respond to one stroke it would be pulled back by one in the opposite direction. This is exactly like what goes on in your wireless set. The

loud-speaker is like the canoe, and the strokes of the two paddles are like the high-frequency currents going up and down in your aerial circuit. Naturally, if this quickly oscillating current were passed straight through the speaker it would have no effect, because it would be trying to pull the diaphragm or cone equally hard in opposite directions. Now suppose the boatmen vary their efforts. Say they both get tired and slack off a bit, and then the next moment both liven up and renew their efforts. If they both varied in the same degree the boat would still not move. This is similar to what happens when speech or music is being broadcast. The intensity of the current in your aerial circuit varies with each fluctuation of the waves emitted by the broadcasting station. But still it would be no use passing it through your speaker, since however weakly or strongly it pulled when flowing in one direction the next

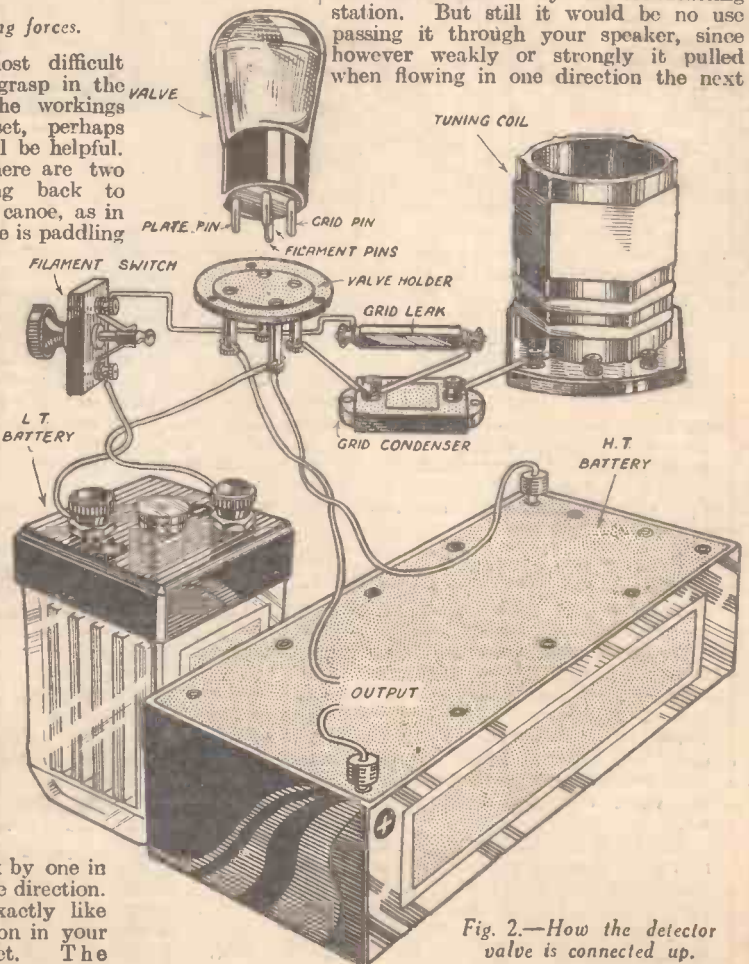

Fig. 2.—How the detector valve is connected up.

instant it would be flowing equally weakly or strongly in the opposite direction.

Now let us return to the boat again. Suppose the two men still vary their efforts together, one moment being energetic and the next moment being lazy, but—suppose one man breaks his paddle, and has only the handle to use! Why, naturally, the other paddle would have by far the greater effect, and the boat would move. And, moreover, it would vary its speed according to the varying efforts of the man using it. Thus, when he paddled energetically the boat would go fast, and when lazily it would move slowly. The efforts of his companion with the broken paddle would be negligible.

This is the sort of thing that occurs when we use a detector valve in our set. It cuts out the effect of the aerial current in one direction, so that instead of pulling first one way and then the other it pulls only one way. Then every fluctuation in current does have an effect, since it is not immediately neutralised by a current of equal strength in the opposite direction.

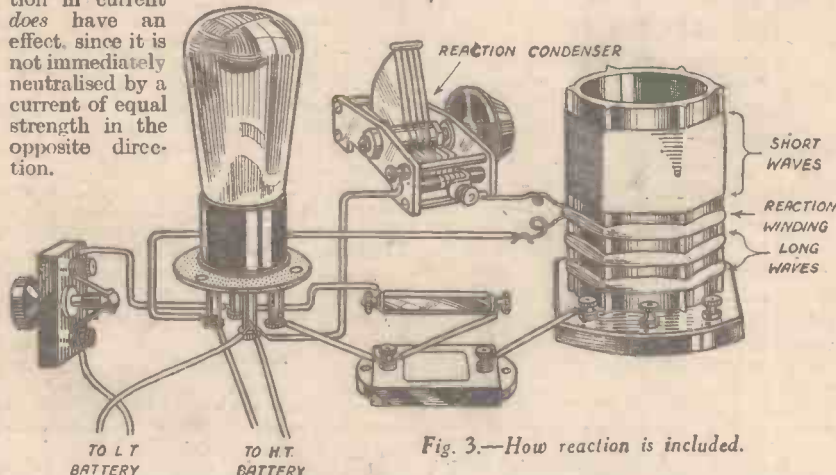

Fig. 3.—How reaction is included.

Actually, of course, we do not pass the current in the aerial circuit through our speaker. It is the plate current which we use. This, as I have shown, is controlled by the alternate swing from positive to negative of the grid, but as the effect of each negative swing, like that of the unbroken paddle compared with the broken one, is greater than the effect of each positive one, so it is virtually the variation in the intensity of each negative impulse on the grid which controls the current through the speaker.

#### Practical Points

Well, so much for the action of the detector valve! Now let us have a look at some of the practical details of how the valve is connected up. Like all valves it has a base fitted with several brass pins or "legs" so that it can be plugged into a holder or withdrawn at will. These pins are connected to the grid, plate and filament inside the valve and thus provide the means of connecting the valve with the other parts of the set.

In Fig. 2 all the framework and trimmings of the set are omitted, so as to show how the detector is connected to the batteries, etc. The wiring is shown in the very simplest form. Actually it would be a little more complicated than

this, as the other two valves would also be connected to the batteries. Again one or two refinements such as reaction (of which more later) would be included.

You will see that the pins of the valve are not spaced quite evenly, as the one joined to the plate is somewhat apart from the other three. This is so that the valve cannot be connected wrongly. If you attempt to insert it in its holder the wrong way round the pins will not register with the sockets.

#### The Batteries

Of the two batteries shown, the one on the left heats the filament of the valve and so makes it give off the stream of electrons on which its action depends. It is called the *low tension battery*, although the term "battery" is a misnomer. It is, strictly speaking, a *cell*. It requires two or more cells to make a battery. It is a "low tension" cell because it supplies current at a low pressure. It can be switched on and off by means of

the switch shown, thus saving current when the set is not working. The other battery is called the *high tension battery*. Unlike the first, this really is a "battery." It usually contains at least sixty cells which, being connected together inside the battery, will supply current at sixty times the pressure of one cell alone. Sixty cells would give about 90 volts. A volt, by the way, is the electrical unit of pressure or electromotive force.

You will notice that the positive (+) end of the high tension battery is connected to the plate of the valve. This, you will remember, is necessary in order to attract the electrons (negative particles) from the heated filament and so produce the plate current. Without this stimulus the electrons shooting off from the filament would tend to return to it again. Where the wire is broken and marked "output" indicates where in a one-valve set the loud-speaker would be connected. In our three-valver, however, this is where the coupling to the next valve comes, but before continuing with our investigations in that direction I want to say a few words about *reaction*.

#### How Weak Signals are Boosted

Reaction, or to give it its proper name, regenerative amplification, is the finest means of boosting up weak signals.

Well, let us see what it is and how

it is applied in our own set. We have already seen that the quickly oscillating currents in the aerial circuit acting on the grid cause corresponding oscillations in the plate current. Now, the plate current is much more powerful than the aerial current, since it is derived from the batteries of the set and is not dependent on the power of the incoming wireless waves, which may have travelled hundreds of miles and would therefore be very weak. So some of the comparatively strong plate current is led through a coil of wire similar to the aerial coil. This coil is either placed very near to the aerial or else wound on the same former. The effect of this *reaction coil* near the aerial coil is to induce a current in the latter which helps to increase the strength of the original oscillations. You see, there is always some loss in the strength of the aerial current due to the resistance of the wire of the aerial coil, etc., but the placing of the reaction coil near it virtually neutralises any resistance.

#### The Reaction Condenser

The effect of the reaction coil can be varied at will by means of the *reaction condenser*, which is an instrument similar to the tuning condenser. It thus acts as a volume control. When the plates or vanes are "right in" maximum reaction will be obtained and the signals will be loudest. Fig. 3 shows how the reaction arrangements are carried out. The reaction coil is here wound between two aerial coils on the one former. Although I have not mentioned it previously so as not to confuse you, it is usual to have two windings like this. They are not used together, but one is cut out of circuit by means of a switch, while the other is in use. The reason for both of them is that they each cover a different range of wavelengths. By the aid of the tuning condenser (shown in previous illustrations) one of the coils will usually cover a range of from 200 to 500 metres, while the other will tune in to any station using a wavelength between about 1,000 and 2,000 metres. The reaction coil is placed between them so that it will work equally well whichever one is in use. For the sake of clarity the connections to the reaction coil in Fig. 3 are shown taken direct from the winding itself. In practice the ends of the coil would be brought out to terminals on the base.

### DATA SHEETS already issued.

Data Sheet No. 1—	Accumulator Charging	Dec. 17th, 1932.
Data Sheet No. 2—	Coils and Coil Winding	Dec. 24th, 1932.
Data Sheet No. 3—	Resistances	Dec. 31st, 1932.
Data Sheet No. 4—	Mains Transformers	Jan. 7th, 1933.
Data Sheet No. 5—	Wire and Wire Gauges	Jan. 14th, 1933.
Data Sheet No. 6—	Chokes, H.F. and L.F.	Jan. 21st, 1933.
Data Sheet No. 7—	Condensers	Jan. 28th, 1933.
Data Sheet No. 8—	Battery Eliminators	Feb. 4th, 1933.
Data Sheet No. 9—	Screws and Screw Threads	Feb. 18th, 1933.
Data Sheet No. 10—	Battery Operated Valves	Feb. 25th, 1933.

Readers who wish to complete their files may obtain back copies of these Data Sheets, price 2d. each, from "Practical Wireless" Presentation Dept., 39, King Street, Covent Garden, W.C.2.

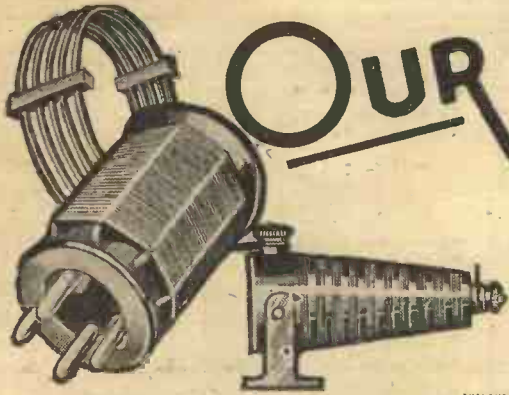

# OUR SHORT-WAVE SECTION



A SHORT-WAVE receiver is, basically, an extremely simple instrument having a minimum number of components arranged in a straightforward manner. Despite this, and although simplicity generally leads to high efficiency, there are a number of little refinements and modifications which often provide a surprising improvement in reception. Operating conditions are generally so critical that even the mere changing of the de-

## GETTING THE BEST FROM A SHORT-WAVER

By FRANK PRESTON, F.R.A.

In this article a few methods of improving the performance of short-wave receivers are explained.

therefore choose the station that is best received on your own particular set. To make the tests quite conclusive the tuning

250Ω POTENTIOMETER

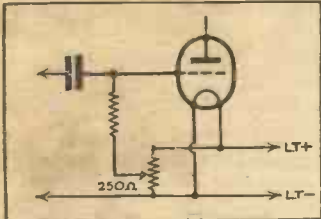
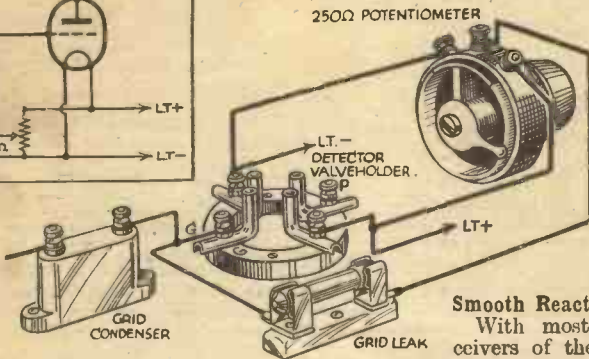

Fig. 1.—The connections for a grid leak potentiometer.



condenser should be adjusted between each alteration to grid condenser capacity in order to cover the possibility of tuning being affected by the other adjustments.

### Smooth Reaction Control

With most short-wave receivers of the Det.-L.F. type the greatest difficulty is that of obtaining a smooth control of reaction over the entire tuning range. It frequently happens that when the reaction condenser is being finally adjusted to bring a signal up to full strength the set suddenly bursts into oscillation with a "pop." This makes it necessary to slack off reaction and start all over again—a most annoying procedure. I believe that this kind of trouble is so frequent that many amateurs

of obtaining a smooth control of reaction over the entire tuning range. It frequently happens that when the reaction condenser is being finally adjusted to bring a signal up to full strength the set suddenly bursts into oscillation with a "pop." This makes it necessary to slack off reaction and start all over again—a most annoying procedure. I believe that this kind of trouble is so frequent that many amateurs

detector valve for another of similar type, but having very slightly different characteristics, might result in the set becoming much "livelier" and bringing in fifty per cent. more stations. Similarly, exchanging the grid leak for one of higher value often makes quite a surprising difference.

By way of making a start in "hotting-up" a short-waver it is therefore well worth while to try the effect of different detector valves and grid leaks which happen to be on hand. The next step should be to replace the fixed detector grid condenser by a pre-set one of about .0003 mfd. maximum capacity; there will probably be a particular setting of this at which the receiver's performance will be appreciably better than at all others. It is impossible to observe the effect of a gradual adjustment since the inevitable hand-capacity present during the operation will have more effect than the slight variation of condenser capacity, so the best method of procedure is as follows:—Connect up the pre-set condenser and adjust it to a capacity mid-way between maximum and minimum; tune in a "steady" and reliable station such as Zeesen, on 31.38 metres, or Vatican City, on 19.84 metres, and slack off reaction until signals are only just nicely audible; next slightly vary the grid condenser setting, first to a higher, and then to a lower, capacity and carefully note the effect on signal strength. It should be observed that these experiments will be of no value if the signal is subject to "slow-fading," and you should

valve, grid leak and condenser will go a long way towards simplifying reaction control, but further improvements can be made by varying the high tension voltage and experimenting with different values for the series aerial condenser. The latter should not generally have a greater capacity than .0001 mfd., whilst one-tenth of this (.00001 mfd.) might be noticeably better if the aerial is long or if it runs close to a roof. A good, low-resistance earth connection has a pronounced "stabilizing" effect on reaction control and can make a big difference. As with an ordinary broadcast receiver, the earth lead should be of well insulated (heavily rubber-covered) multi-strand wire.

Sometimes perfectly smooth reaction cannot be attained even by paying attention to the details referred to, and in that case still further modifications must be made. If the reaction condenser is of greater capacity than is necessary, that is if it never requires to be set to its "full in" position, it cannot be adjusted with sufficient delicacy, and thus a component of smaller capacity would be better. Instead of scrapping the condenser its capacity can be reduced by connecting a fixed one in series; the latter should be of such a size that oscillation can be obtained at any part of the tuning range by adjusting the variable reaction condenser to a point just short of maximum capacity. Incidentally it should be noted that the fitting of a good slow-motion dial to the reaction condenser is often well repaid by the better control thus made possible.

The use of a potentiometer to vary the detector grid potential is often advocated, but the value of this component is less frequently recognized by the constructor. A potentiometer can transform an unworkable set into one which it is a pleasure to handle—and at very small cost. Even though the information has been given scores of times before, I make no excuse for showing again the connections for a grid leak potentiometer in Fig. 1. The two "outside" terminals are connected to the

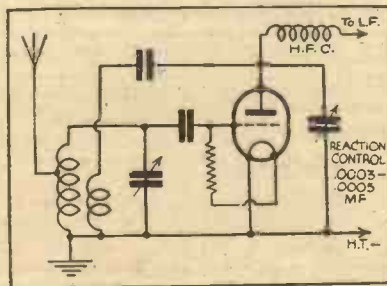

consider it to be insurmountable, but it can most emphatically be overcome by careful attention to details. Observation of those points referred to above, namely, proper choice of detector

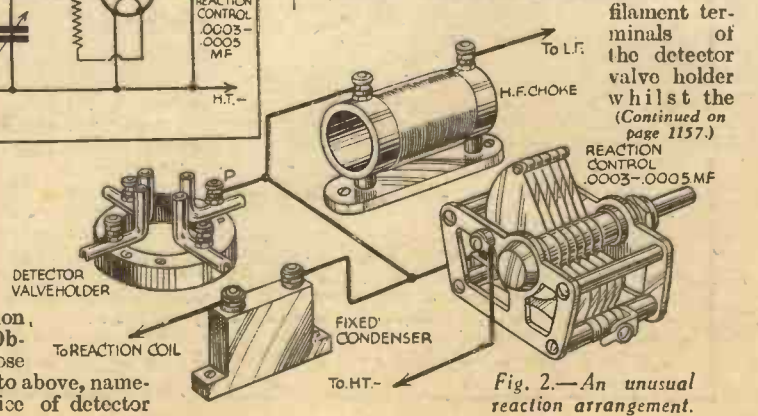
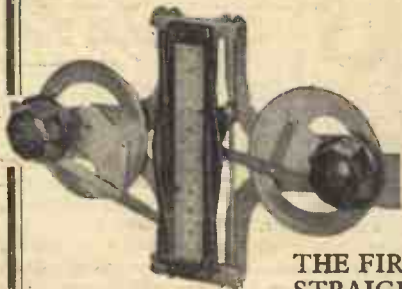

Fig. 2.—An unusual reaction arrangement.

filament terminals of the detector valve holder whilst the  
(Continued on page 1157.)

# THE LOGICAL CONTROL FOR THE 'FURY 4'



**SIMPLICON  
DOUBLE FV  
12'6**

THE FIRST FULL VISION STRAIGHT LINE CONTROL . . . . and proved the BEST!

**SINGLE TYPE FVH - - - 7/6**

Full details from all good dealers or direct from

Dept. F,  
**WILLIAMS & MOFFAT, LTD.**  
Ladypool Road, Sparkbrook, Birmingham.

# THIS IS THE CABINET Specified for the Q.P.P. THREE-FOUR



CABINET  
**19/9**  
CHASSIS  
**7/6**  
Carriage Paid.



## The CLARION "Q."

Here is a cabinet of distinctive modern design, soundly constructed and built to avoid all resonance effects. Solid Oak with hand-polished finish. For your own satisfaction, insist on the Genuine Clarion "Q."

There's a cabinet of equally fine design and finish for every radio need. Get the Clarion Illustrated Catalogue, FREE.

**CLARION** Radio Furniture (Dept. 'N'),  
28-38, Mansford St., London, E.2.  
(Telephone: Bishopsgate 6371.)

## "NEW RADIOS FOR OLD!"

### READ WHAT THIS DELIGHTED CLIENT SAYS

ANY MAKE OF SET, KIT OR RADIOGRAM SUPPLIED.

You will never realise the pleasure of radio until your set is right up to date.

Hundreds of testimonials from satisfied Clients!

VISIT OUR SHOWROOMS FOR WONDERFUL BARGAINS.

FREE WIRELESS SET TO INTRODUCE THE RADIALADDIN CLUB!

12.233

. . . your kind reply . . . for which I thank you. I quite appreciate the facts outlined . . . three other firms for quotations—not one can compare with your offer . . . Your terms are most fair and I will be sending my order . . . I am advertising your business amongst all I know and meet . . . perhaps you would let me have some pamphlets or literature to enable me to advertise your business more. Your kind, business-like and polite replies to enquiries are much appreciated by all . . . you can rely on my order coming along.

S.R.S.—Southall.

**RADIALADDIN, LIMITED** THE LARGEST RADIO EXCHANGE FIRM IN THE UNITED KINGDOM

DEPT. PR., 46, BREWER STREET, LONDON; W.1.

PHONE: GERRARD 4055.

IT WILL PAY YOU TO CHANGE YOUR SET EVERY FEW MONTHS BECAUSE WE CAN GIVE MORE WHEN YOU SELL AND CHARGE LESS, WHEN YOU BUY YOUR UP-TO-DATE MODEL—BALANCE PAYABLE BY CASH OR HIRE PURCHASE.

Write for particulars of our amazing exchange offer, enclosing 1½d. stamp, naming your old set and the new model you fancy.

A FREE QUOTATION WILL FOLLOW.



# QUALITY Produces EFFICIENCY

### TESTED BEFORE DESPATCH

The original BECOL ebonite low loss formers are thoroughly reliable. They are used in all parts of the world. Look for the BECOL trade mark. Ask your dealer. If unable to supply, write direct. Send now, enclosing 6d. (post free) for up-to-date handbook of tuning coils for DUAL RANGE, BAND-PASS, and SUPER-HET. circuits. Fully illustrated with data. A very interesting handbook.

RODS, SHEET, TUBES, PANELS  
**The BRITISH EBONITE Co., Ltd.,**  
Hanwell, London, W.7.

## The "LANGMORE" No. G10

The "Langmore" Radio-Gramophone Cabinet G10 is well and attractively constructed in all oak and will house most sets, giving ample accommodation for tone arm, turntable, pick-up, motor, etc., wireless set, speaker, and batteries.

Size Overall: 3 ft. 7 in. high, 21½ in. wide, 16 in. deep.  
Gramophone Compartment: 4½ in. high, 19 in. wide, 14 in. deep.

Set Compartment: 12 in. high, 18 in. wide, 14 in. deep.

Speaker Compartment: 18 in. high, 18 in. wide, 14 in. deep.

The back is enclosed by double doors, so that all parts are easily accessible, and all are fitted with hinged lid and stay, motor board, baseboard, etc. In oak, beautifully finished medium shade, with overlay finished slightly lighter shade.

Beautifully Finished Jacobean Oak.  
New Illustrated Catalogue Free.

**THE MISCELLANEOUS TRADING CO., LTD.,**  
13 and 17, NEW OXFORD ST., LONDON, W.C.1.

Phone: Holborn 4894. Trade Inquiries Invited.  
Carriage paid to any address in Great Britain.



No. G10  
**55/- Each**

(Continued from page 1155.)

centre terminal is connected to the grid leak. A .002 mfd. fixed condenser is shown as being joined between the grid leak and H.T. negative, for whilst this is not always essential it provides an easy by-pass for high frequency currents and so prevents any danger of instability. A value of some 400 ohms is generally recommended for the potentiometer but, personally, I find 250 ohms slightly better under some circumstances.

**Other Methods of Reaction Control**

Although it has become standard practice to obtain reaction control by connecting a variable condenser in series with the reaction winding, there are other systems which are worthy of consideration and trial. One of these is illustrated in Fig. 2, from which it will be seen that the usual variable reaction condenser is replaced by a fixed one of similar value, whilst a variable condenser is connected between the anode of the detector valve and H.T. negative. This variable condenser, which should have a maximum capacity between .0003 mfd. and .0005 mfd., serves as reaction control, but works in the opposite manner to the normal reaction condenser. In other words, its object is to check reaction, and in consequence, increasing its capacity reduces the degree of feed-back, by allowing more H.F. current to leak away to earth. The only difficulty with this form of control is that it is liable to introduce a certain amount of hand-capacity unless the condenser is operated through an extension spindle. Even then it is best to use an aluminium panel for screening purposes, or at least to employ a screened operating dial. In any event the moving vanes should be connected to H.T. negative and fixed vanes to the anode, or else hand-capacity will be incurable.

**Resistance-controlled Reaction**

Another form of reaction control, and one of which I am particularly fond, is that shown in Fig. 3, where adjustments are made by means of a 15,000 ohm variable resistance connected in series with the reaction winding; here again, the variable reaction condenser is replaced by a fixed one of equal capacity. If the terminal making contact with the resistance slider is earth connected, there is practically no hand-capacity and the system works with beautiful smoothness. It is imperative that the variable resistance should be dead silent in operation, for otherwise it will cause crackles loud enough completely to drown all reception. For this reason the method would have

ance of the "carbon-track" variety is generally to be preferred, but it is rather difficult to obtain a silent one of this type. I remember trying six only a short

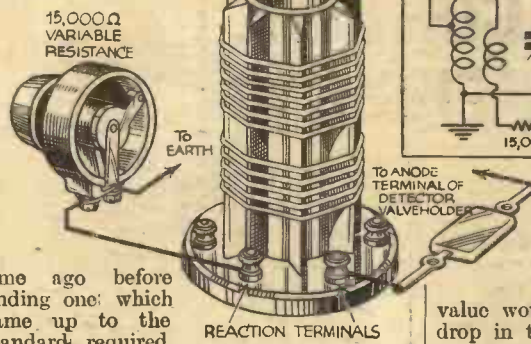

time ago before finding one which came up to the standard required. For use on wavelengths above about 20 metres I have found the new Lewcos wire-wound component extremely good, but even this gives rise to a little noise on the lowest wavelengths.

**Screened Grid Detector**

To anyone who is out for absolutely maximum efficiency from a short-waver, I can strongly recommend the use of a screened-grid valve for detector. It is a little more expensive, and requires a 50,000 ohm potentiometer, and .1 mfd. non-inductive condenser to provide its screening-grid potential, but is easily worth the extra cost. The connections for an S.G. detector are shown in Fig. 4, from which it will be seen that they are quite conventional except for the additional ones required for the potentiometer and condenser. In changing over from a three-electrode valve it is, of course, necessary to transfer the connections from the "anode" terminal of the valveholder to the terminal mounted on the glass bulb.

The potentiometer provides a very smooth control of reaction, and is used in addition to the existing variable condenser, etc., for making final adjustments. There is one important point to watch in connection with the use of an S.G. valve for detector, which is that the L.F. transformer following it must have a high primary inductance to match the high impedance of the valve. As an alternative, the transformer can be resistance-fed by using a 100,000 ohm coupling resistance, and the usual .01 mfd. to 1 mfd. coupling condenser. Even 100,000 ohms is insufficient to give accurate matching, but a higher

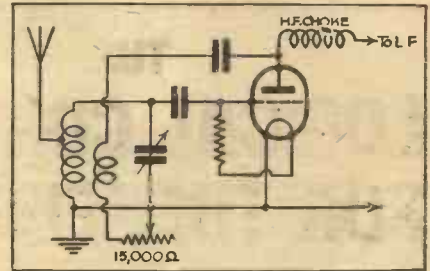

Fig. 3. — Showing how reaction may be controlled by a variable resistance.

value would cause too great a voltage drop in the high-tension supply.

**Preventing Hand-capacity**

Next to that of obtaining a smooth control of reaction, the difficulties of entirely obviating hand-capacity effects and minor forms of instability are of greatest importance in S.W. work. It is particularly trying to attempt long-distance reception on a set which goes out of tune immediately the hand is taken off the condenser dial, or which howls and shrieks when some other knob is touched, and yet I have seen a number of sets which do behave in this way. A golden rule to remember in wiring up is that all moving parts of condensers, variable resistances and so on which are mounted on the panel should be at earth potential, and if this is followed there are not likely to be many great difficulties in the way of hand-capacities. Screening is distinctly useful if arranged with care, but is best avoided by the less expert constructor, because it can be the cause of many unsuspected losses. There is certainly no harm in using an aluminium panel so long as tuning coils are not placed less than 3 ins. from it, and if this is effectively earth connected it will prove very useful as a screen. Do not, however, overlook the fact that it is earthed when mounting a reaction condenser connected on the "anode" side of the reaction coil, or the H.T. battery will be short-circuited; the condenser bush must be insulated by means of ebonite washers. The same thing applies in regard to potentiometers connected either in the high-tension or low-tension circuits, because if their bushes are not insulated a short-circuit is bound to occur.

**H.F. Leakage**

When hand-capacity is noticed, even though the latter precautions have been taken, it is fairly safe to assume that there is a leakage of high-frequency currents into the amplifier or 'phone leads if only a single valve is used. A cure can often be effected by the simple expedient of thoroughly de-coupling the detector anode by means of a 50,000 ohm resistance and 2 mfd. condenser. This should be done even in the case of a single-valve receiver, the resistance being connected between the high-frequency choke and the 'phone terminal as shown in Fig. 5. When L.F. amplification is employed, it is a good plan to insert a 100,000 ohm resistance between the secondary winding of the first L.F. transformer and the grid of the second valve; the resistance "stops" H.F. currents but offers no impedance to the L.F. ones. Another good way of preventing hand-

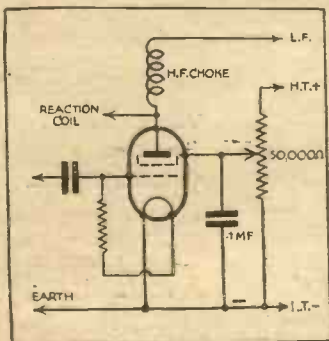
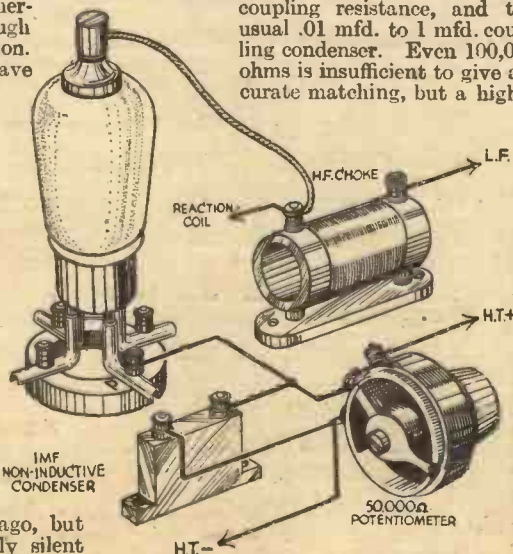

Fig. 4.—The additional connections required when using an S.G. valve as detector.



been impracticable a year or so ago, but there are now two or three really silent variable resistances on the market. A resist-

(Continued on page 1158.)



## CHOSEN for the A.C. 'FURY FOUR'

The mains transformer is the most important component in an A.C. mains receiver—it can make or mar the performance of the set. That is why the designer of the 'Fury Four' exclusively specified Heayberd Transformer for the A.C. version of this popular receiver. By incorporating a Heayberd Transformer, successful results are guaranteed. The best of materials and the finest craftsmanship go to the making of Heayberd apparatus. Excellent voltage regulation and negligible temperature rise is assured with the transformer described below.

**HEYBERD A.C. 'FURY FOUR' TRANSFORMER**  
Rectified Output:  
250v. 60 ma.  
L.T. 4v. 4 amps. A.C.  
**Price 24/-**  
GUARANTEED 12 MONTHS





### Post Coupon

for Heayberd handbook on Mains Working

I enclose 3d. stamps for New Handbook of Mains Equipment. Packed with Technical Tips, Service Hints and diagrams

Mr. \_\_\_\_\_  
Address \_\_\_\_\_

Prac.

**F.C. HEYBERD & Co.,**  
10 FINSBURY STREET, LONDON, E.C.2,  
One minute from Moorgate Stn



### FIT THIS ELECTRIC CLOCK TO YOUR SET!

NO MAINS NEEDED!  
KEEPS CORRECT TIME!  
NO WINDING!

Works off small battery lasting 12 months, or can be plugged into G.B. battery without affecting reception. Uses practically no current. Fits into hole 3/16 in. dia. in any panel up to 1/2 in. thick. Easy to fit—no screws required. Only 1/2 in. from front of panel to back of case. Swiss movement. Hands set from front. Nickel-plated bezel. Useful addition to any set.

**RIVERSIDE MFG. Co., Ltd.,**  
Dept. 21, Crisp Road,  
Hammersmith, W.6.  
Telephone: Riverside 6392

**COMPLETE WITH BATTERY**  
**POSTAGE 6D**

**LOUD SPEAKERS REPAIRED. 4/-**  
(Blue Spot a Speciality, 5/-).  
Transformers 4/-. all repairs magnetised free. Eliminator Repairs quoted for. 24 Hours Service. Discount for Trade. Clerkenwell 9069.  
E. C. WATSON, 44, EAST ROAD, LONDON, N.1.

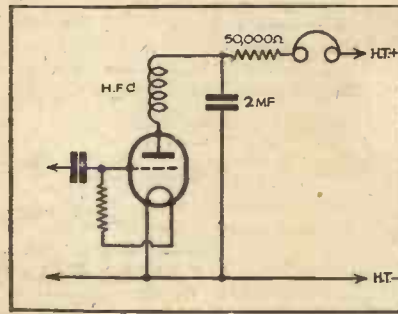
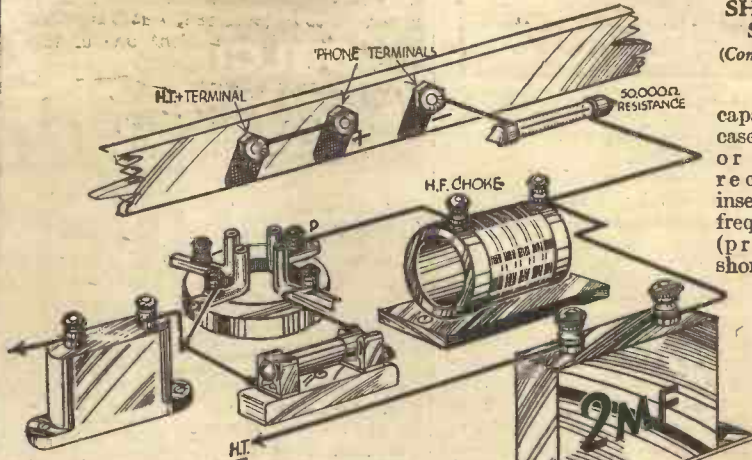

Fig. 5.—The method of decoupling a single valve short-wave receiver.

.002 mfd. fixed by-pass condenser between the anode terminal and earth; this is also shown in Fig. 6. Constructional details of a suitable short-wave choke appeared in PRACTICAL WIRELESS, dated December 17th, 1932.

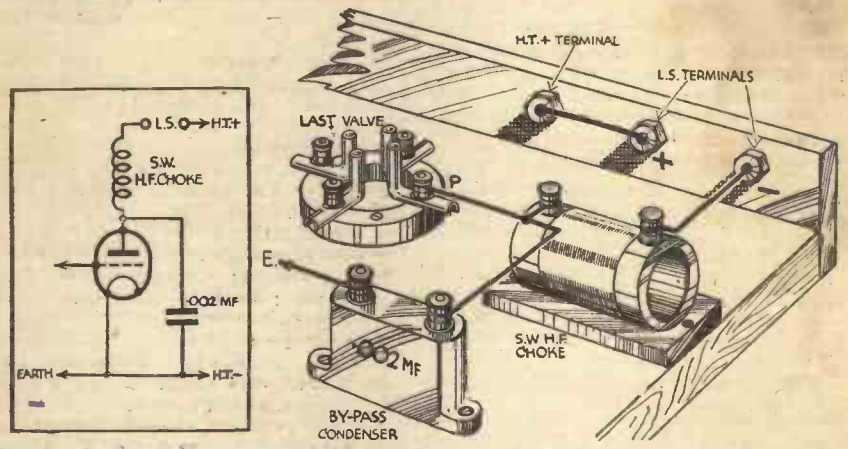

Fig. 6.—Preventing hand-capacity by connecting an H.F. choke in series with a loud-speaker lead.

## A Q.P.P. Amplifier

(Continued from page 1143).

### COMPONENTS FOR THE Q.P.P. AMPLIFIER.

- |  |   |
|--|---|
| 1 R.I. Q Type Transformer.                             | 2 H.P.T.—Q.P.P. Valves. Cossor.   |
| 1 Ferranti Type O.P.M. 12c. Output Transformer.        | 1 Becol Panel, 10ins. by 7ins.  |
| 1 T.C.C. Type S. .01 mfd. Fixed Condenser.             | 1 Plywood Baseboard 10ins. by 8ins.   |
| 1 T.C.C. Type 50, .05 mfd. Fixed Condenser.            | 1 Claron Cabinet.   |
| 1 Bulgin Type S.25 On-off Switch.                      | 1 Clion Glazite.  |
| 1 Graham Farish (Ohmite) Fixed Resistance 15,000 ohms. | 5 Wander Plugs, marked G.B.+, G.B.+, H.T.1, H.T.2, H.T.3, (Ealex.)              |
| 1 Graham Farish (Ohmite) Fixed Resistance 10,000 ohms. | 6 Belling-Lee Terminals marked Input—, Input+, L.T.—L.T.+, and 2 marked Output. |
|  | 2 Valve-holders, 5-pin Type (Benjamin).   |



**MOTORBOARD MUSINGS**

(Continued from page 1090, F.b. 25th issue.)

**Preventing Feed-Back**

Upon first connecting a pick-up to a receiver, it often happens that an unpleasant whistle sets up in the loud-speaker which can usually be traced to "feed-back" occurring in the amplifier, which in turn is frequently due to long pick-up leads. In some cases it is possible to overcome this trouble by using "screened" wire for the pick-up leads, taking care that both the screening element of the wire and the pick-up arm are efficiently earthed. Where these leads are exceptionally long and cannot be shortened, it may be found necessary to connect the pick-up to the set through a transformer, the pick-up being connected to the primary and the amplifier to the secondary. This isolating transformer must be positioned at the amplifier end of the circuit, i.e., the connections between the pick-up and the primary may be long, but the secondary connections to the amplifier must be as short as possible. Normally, the ratio of such a transformer should be 1 : 1, but it is possible to step-up the voltage from the pick-up if so desired by using a ratio of, say, 3 : 1, the larger number of turns being, of course, on the secondary winding connected to the amplifier. With such a transformer in circuit, the potentiometer control should be connected as shown last week.

Where a pick-up is connected to a receiver having a fully-ganged tuning arrangement, it is sometimes found that the slight additional capacity across the grid circuit caused by the pick-up switch, terminals and wiring is sufficient to upset the ganging to some extent causing a slight reduction in sensitivity and selectivity (it will, of course, be borne in mind that this additional capacity still exists even when no pick-up is connected to the pick-up terminals). Such an effect is not likely to be noticeable with an ordinary triode detector, but where a S.G. valve is used as detector, this additional stray capacity may have a very decided effect, as the "damping" imposed on the preceding circuit is much less in the case of a S.G. valve than in the ordinary triode valve. Consequently after adding a pick-up circuit to an existing (ganged) receiver it is always advisable to try a slight adjustment of the trimmer across the tuning coil.

**Eliminating Needle-Scratch**

Needle-scratch is another source of annoyance which frequently crops up, but this can be overcome to a considerable degree in quite a simple manner. The frequency of needle-scratch is always fairly high, somewhere above 4,000 cycles, and therefore if matters are so arranged that all response from the pick-up at this frequency is by-passed and not allowed to enter the grid circuit of the amplifier, these higher frequencies will be missing from the reproduction and with them the needle-scratch. We require, therefore, a variable impedance to the pick-up energy, and the simplest method of obtaining this is by connecting a variable resistance and a small condenser in series across the pick-up as shown in Fig. 6. In most cases, the resistance should have a maximum value of 50,000 ohms, but the capacity of the condenser is a matter to be determined by experiment. A good value to commence with is .01, which can be gradually increased until the most suitable value is found.

**BULGIN**  
*In a Class alone.* **THERMAL DELAYSWITCH**

A delayed-action arrangement is necessary in all mains-operated sets where, before the I.H. valves heat up, peak voltages could damage condensers, etc. The Bulgin "Thermo. Controls" give the necessary delay (approx. 30 seconds) and operate reliably and unfailingly, protecting the other components. Easily fitted to any set, a permanent safeguard.

List No.

S.100. Type "A" Heater rating, 4V., 0.9A. approx. Will switch 250 mA. Mottled green bakelite case.

PRICE

S.101. Type "B" Heater rating, 7.5V., 0.5A. approx. Will switch 250 mA. Black bakelite case.

7/6

S.111. Type "C" Heater rating, 16V., 0.25A. approx. Will switch 250 mA. Brown bakelite case.

EACH

Send for 80 pp. Catalogue "N" and Manual with full wiring diagrams and instructions. Free for 2d. postage.



Telephone : Grangewood 3266

Telephone : Grangewood 3267

A. F. BULGIN & CO. LTD., ABBEY ROAD, BARKING, ESSEX



Every listener needs . . .

**WATES UNIVERSAL METER**

The ONLY popular priced instrument testing resistances, as well as voltage of H.T. and L.T. batteries, valves, transformers, coils, condensers, short circuits, distortion, etc. NO SKILL REQUIRED to see what's wrong, yet nearly all the experts use it. FOUR readings on one dial, (1) 0-150 v. for H.T. (2) 0-6 v. for L.T. (3) 0-30 milliamps. (4) resistance test 0-2,000 ohms. Of all Wireless Dealers, Ironmongers, etc., including 4-page instruction leaflet. **12/6**

BRITISH MADE BY EMICOL LONDON Also the famous 3-IN-1 POCKET METER L.T. (0-6 v.), H.T. (0-150 v.), 0-30 milliamps **8/6**

Pocket case for same 1/3.

Explanatory Leaflets Post Free from

WATES RADIO LTD.

184-188, Shaftesbury Avenue, W.C.2

**CLIX** SPECIFIED for the Q.P.P.

**THREE-FOUR**

Again, CLIX are definitely specified in order to ensure perfect and reliable contact.

CLIX "MASTER" PLUG The Plug with positive METAL to METAL wiring. Firm grip and full contact with ANY battery socket. Curved ends for easy insertion .. **1 1/2d.**



You require G.B.1 ; G.B.2 ; G.B.+.

CLIX Chassis Mounting VALVEHOLDER

Sturdily built. Turned Resilient sockets guarantee full-surface contact without fear of collapse with any valve pin—solid or otherwise.

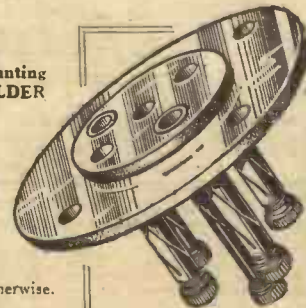

4-pin 8d. 5-pin 9d. Model Model

You require, 2, 4-pin, 2, 5-pin.

Folder N/4 gives details of the full CLIX range. FIT CLIX AND BE CERTAIN

LECTRO LINX Ltd., 79a, ROCHESTER ROW, S.W.1

# RADIO RAMBLINGS

## "Silent Backgrounds"

**A** PROPOS my remarks about short-wave working and silent backgrounds, I think this is the one way in which modern radio conditions have definitely deteriorated, for our silent backgrounds are no more. In the early days, with a straight two or three valver, an accumulator, filament current, and a really good H.T. battery, one could put on the headphones, and with luck hear absolutely nothing. Unless you put your tuning dials hopelessly out of step, or reduce your filament voltage until the set is to all purposes "dead," you will rarely attach headphones to a set and hear nothing nowadays. High power stations crowded together over the wave-bands have left hardly any part of the ether free from signals of some sort, to say nothing of the innumerable Morse and other stations using radio as a means of communication. In this way, radio more than any other invention, has made the world a very small place, and I don't suppose there is any spot on the globe, apart from those places where geological peculiarities make wireless reception impossible, where a good set would be unable to pick up signals of some sort. It is little wonder that advanced radio scientists are again toying with the idea of inter-planetary communications, for having sent wireless signals all over and around the earth it is but a step forward to send them to our nearest neighbours in space. The Heaviside layer is the only drawback, and for all intents and purposes the world might be encased in a steel sphere so far as the transmission of radio signals goes. Still, somebody somewhere may hit upon a solution of the difficulty and show that infinitely short or infinitely long wavelengths will penetrate this inconvenient layer. When this comes about what a fine excuse the radio "fan" will have for making another new set!

## Radio and Mount Everest Expedition

**T**HE vital link between the explorers of the Mount Everest expedition and their base camp will be a radio set designed by two London amateur transmitters. This radio link will be used to relay to the base by radio any message from the advance party. The organizers of the expedition applied to the Radio Society of Great Britain when they decided to use radio as a means of communication, and the Society found volunteers in two young amateurs known by the call signs of their respective stations as G6RU and G6US, who are partners in a radio concern in Earl's Court Road, W.8. The transmitter is a portable one which can easily be carried by one man and comprises a re-designed and rebuilt ex-War Department trench set operating on a wavelength of between 60 and 120 metres. High tension current is supplied by a rotary hand generator

## JOTTINGS FROM MY NOTEBOOK

By "DETECTOR"

giving 600 volts at 30 milliamps and low tension is supplied from inert cells. Two valves are used in the set and six spare valves are carried. The transmitter is fitted with folding legs and measures when closed only 9in. by 9in. by 11in., and the set is lined with felt to withstand shock and low temperatures.

## Shelf Life of Dry Batteries

**T**HE Institute of Patentees, as its name implies, does good work in assisting inventors and has just issued a booklet of 895 inventions needed called "What's Wanted." The number of inventions badly needed are surprising, while some of them are slightly fantastic. Some of them are for very lazy people indeed—the kind of people who use selenium-cell operated doors and automatic record-changing devices—and in this class is the electric toaster that switches itself off when the toast is made to the desired crisp brown. More serviceable inventions required are a dry cell that will not discharge itself on open circuit and will give a more "straight line" discharge, and a much lighter system of accumulator construction. Dry cell shelf life, as it is called, has been much improved upon in later years thanks to radio, and six months is a fair time to keep a battery in stock. After this the voltage of the very best batteries begins to drop and the internal resistance commences to rise, both undesirable in an H.T. battery designed for radio work. Of course, in a busy radio shop an H.T. battery may not be on the shelf six days, but in a village stores such a quick turn-over would be impossible and the need for a long shelf life is important for radio batteries. Batteries used for telephone work and for emergency alarm systems are often required to stand for years without attention and these, too, often fail through a battery running down which has not delivered a scrap of current in the circuit in which it is employed. Those of you who have carried accumulators for miles to be

charged will need no comment of mine as to the desirability of a light-weight system of "juice" storage!

## Wonders of the New Mond Laboratory

**I** WONDER if you have read about the wonders of the new Royal Society Mond Laboratory that has been erected at Cambridge in order that Prof. Kapitza might continue his research work in regard to electrical investigations. He will endeavour to discover the properties of matter when placed in intense magnetic fields and will also carry out investigations on the resistance of metals and conductors at the lowest attainable temperatures. You may remember my account of the lead ring immersed in liquid helium in which a current continued for days without a boost from a battery or any other source of electrical energy, showing that at very low temperatures the resistance of conductors to electrical energy is practically nil. Well, a special helium and hydrogen liquefying plant is installed at the Laboratory for studying this supra-conductivity of metals, as it is called, and temperatures as low as about 450 degrees Fahr. below zero will be obtained. At -450° F. anything might happen, and

## "PRACTICAL WIRELESS" LEADS DESIGN!

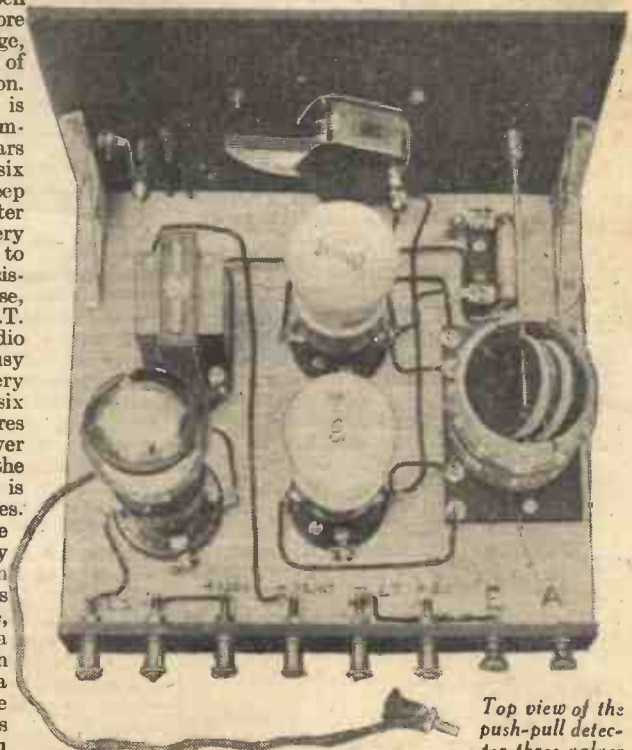

Top view of the push-pull detector three valver described on other pages. This is the first broadcast push-pull detector set ever described.

**Graham Farish**  
says:—

**I am to the fore with all my Components**

because I know what the constructor wants—reliability and efficiency. When I design a component I make up my mind to provide the best, no matter the cost. Then, and only then, can I be sure that the constructor is going to be satisfied. Whatever else may go wrong with his set, it will not be a Graham Farish Component. They're not built that way. They're built to last.

**LIT - LOS**

**VARIABLE CONDENSERS**

Compact and efficient. Accurately gauged bakelite dielectrics and solid brass pigtails connections to moving vanes. All capacities up to .0005 mfd. in tuning straight line capacity and differential types.

**2/-**  
EACH

**FIXED CONDENSERS**

In a complete range of capacities, upright or flat mounting. Registered design No. 723, 271. Every condenser is tested on 750 volts D.C. The capacities are accurate within fine limits. Every condenser can be thoroughly relied upon.

.00005 mfd. to .004 mfd. **1/-** .005 mfd. to .01 mfd. **1/6**

**L.M.S. H.F. CHOKE**

The L.M.S. is silk wound and has a consistent high inductance on all wavelengths, whilst its capacity is negligible. Particularly suitable for H.F. Circuit where high efficiency is the first consideration.

**4/6** EACH

**GRAHAM FARISH COMPONENTS**

**GRAHAM FARISH LTD.,**  
Masons Hill, Bromley, Kent.

Export Office: 11/12, Fenchurch St. E.C.3.

**RADIO RAMBLINGS**

(Continued from page 1160.)

metal without resistance has an attractive flavour of perpetual motion about it. In addition, different kinds of matter behave in a peculiar manner when placed in intense magnetic fields, and the field strengths used make those we employ in our moving coils look very puny indeed. Faraday's discovery of the electro magnet and its power was the foundation on which electricity and radio was built, but at the same time we know comparatively little of intense field strengths. One of the greatest problems, in fact, has been the production of these fields, and it is not possible to obtain an intense field of more than about 60,000 gauss without resorting to a magnet of impossible dimensions and cost. (Incidentally, a gauss is the unit given to the field strength of one line of force of a magnet per square centimetre.) A new method of obtaining intense fields had, therefore, to be evolved, and quite high field strengths have been reached by the use of a solenoid through which heavy currents are passed. The difficulty with this method, however, is the great heat that is generated in the coil and which is sufficient to destroy the material of the coil. This has been overcome by limiting the time of the experiments to fractions of a second, thus enabling the heat generated to dissipate before repeating the flow of current. Some years ago 125,000 gauss was produced in a solenoid for 1/100th of a second from accumulators, but in the new laboratory a special alternator is to be used capable of supplying 40,000 kW. to a coil for short periods. A special switch has been designed which allows the current to flow through the solenoid for the duration of one half period only, and field strengths of 320,000 gauss have been reached. With the use of powers of these magnitudes, mechanical stresses in the material of the coils are set up to the extent of from twenty to thirty tons per square inch so that it has been found to encircle the solenoids with bands of steel in the same way as the barrels of guns are reinforced against the internal pressure. It is expected that fields of a strength of half a million gauss will be attained when desired.

**Look to Your Aerial**

I WONDER how many readers have suffered the misfortune of having their aerials broken with the recent heavy falls of snow; I counted three broken wires on my way to the office the other morning. In most cases of damage of this kind the owner is to blame, either because the aerial was carelessly erected or had received no attention for several years. In these days far too little attention is paid to the aerial in many instances, and any kind of cheap wire is used. It is a sound investment to obtain really good aerial wire of the "7/22 hard drawn copper" variety, for it only costs a shilling or so more than the cheap stuff and lasts infinitely longer. Enamelled wire is much better than bare copper, especially for use in town areas, because it is better able to withstand the effect of smoke and chemical-laden fumes. Bare wire soon becomes corroded and gradually gets brittle, due to crystallization. If your aerial has been up for more than three years or so, I can strongly recommend you to examine it and, if there are any signs of brittleness or corrosion, to replace it by a new wire before the season of "March winds" comes along.

**The reason why!**

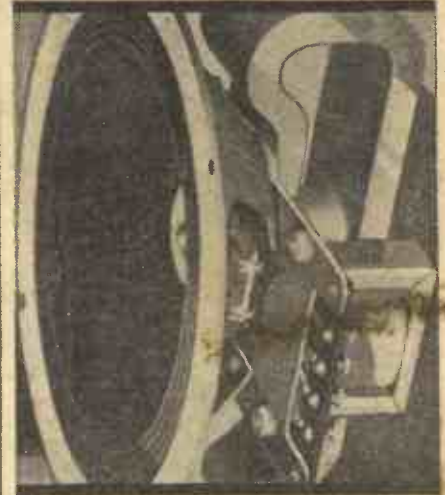

... Amplion have always concentrated on the production of a perfect reproducer of speech and music. The result is the M.C. 22 P.M. Moving Coil Speaker. You can rest assured that this concentration on the Quiescent Push Pull has produced for your use the very best possible speaker for Q.P.P. circuits.

You pay no more for the superiority in design of the Amplion Q.P.P.; in fact it is cheaper than many, costing only

**39/6**

**RECOMMENDED BY SET DESIGNERS**

**AMPLION**

AMPLION (1932) LTD.,  
82/84, ROSOMAN STREET, LONDON, E.C.1.  
CLERKENWELL 5440.



# Practical Letters

from

## Readers.

The Editor does not necessarily agree with opinions expressed by his correspondents

### Congratulations

SIR,—As a reader of PRACTICAL WIRELESS since No. 1, I did not expect to receive such a magnificent book as the Encyclopædia most certainly is, and I am agreeably surprised. As a wireless enthusiast I must say your paper has been a great help to me. I have been most interested in Mr. Barton Chapple's articles on "Television," also the short-wave section. I see that at the head of the first page are the words "The predominant wireless weekly," and I hope that you will always continue to be predominant.—F. W. ALLOTT (Rotherham).

### All Mains "Fury Four"

SIR,—Having bought your book every week since its inception, may I congratulate you on the wealth of information you are imparting each week for the benefit of your readers. I myself having gained considerably more knowledge as a result of its publication have naturally advertised it to others who have become regular readers. My object in writing chiefly is to ask if you will provide me with, either direct or through the medium of your paper, a circuit of the Fury Four for all mains purposes. I may say I am building my own power unit, thanks to information supplied in your journal, which will give a rectified voltage of 200, at 28 m/a. I can see your Fury Four is going to be a fine set, and I have no doubt that many enthusiasts, not only of the battery class, but all mains as well, will wish to build it.—S. TAYLOR (Bury).

### Standards of Quality

SIR,—You have asked for criticism and suggestion. In general composition I do not think PRACTICAL WIRELESS could be improved on. The admirable illustrations must help the veriest tyro in following the context. Now for my suggestion. I take a weekly interest in your "Receivers and their Records," and you generally say in plain unequivocal language what its selectivity is, also sensitivity, etc., but when it comes to what for many of your readers is an essential, viz., quality of output, we get vague terms, such as good "quality production," "up to standard of similar type sets," and so on. In order, sir, that your readers may know what you mean by these expressions, I suggest you should set a standard of your own, such as A, B and C. These standards would not introduce invidious distinctions between different makes of sets; but would indicate to the buyer which set would meet his requirement:

for instance, pleasing reproduction for an ordinary living-room might be better than a true or nearly true reproduction of the original. Hence, your A, B and C could represent something like the following:—

A. Straight line reproduction from say 30 to 8,000 cycles.

B. 50 to 5,000 (The cut off being for selectivity or to obviate needle scratch with records.)

C. Moving iron quality, i.e., nothing below, say, 150.

This or even an extended category would, I think, be helpful if you were to standardize it for use in your columns about either your own or other sets. Thanking you for an interesting paper.—J. C. BRENTON (Sutton).

### A Reader's Thanks

SIR,—I have to thank you for my copy of the "Wireless Constructor's Encyclopædia," received on Tuesday last. I have found it a most interesting and useful book, containing everything the amateur

is likely to want to know. Also, please allow me to congratulate you on the excellence of PRACTICAL WIRELESS, which I have taken from No. 1. I consider it to be the most practical radio journal to date.—READER (West Croydon).

### More Thanks

SIR,—Permit me to thank you for the splendid Encyclopædia, just received. It certainly is well worth the trouble of saving the coupons and small fee charged.

It is a worthy companion to PRACTICAL WIRELESS, which is practical, insomuch that it caters for every stage of constructor, whether professional or amateur.—E. W. ANDERSON (Norwich).

### A Splendid Book

SIR,—Kindly accept my best thanks for "The Wireless Encyclopædia," safely to hand. It is a splendid book and I must congratulate you on compiling such a valuable work which should be in the hands of every wireless fan. I conclude by wishing every success to the journal, which has long been needed by the wireless constructor.—A. H. KEYSE (Birmingham).

### Mains Valve Set Wanted

SIR,—I suppose I really owe you an apology for addressing you so often, but you have only yourself to blame. If PRACTICAL WIRELESS did not grip our interest any more than the radio journals of old did, we amateurs would not write you so often. I see that other correspondents are seconding my call for a really up-to-date, selective Det. 2 L.F. set to be published, and I presume when your Technical Department get breathing space they will tackle this problem, and give us an unganged, unscreened band-pass circuit to rebuild our old unselective Det. 2 L.F. sets to, using up old parts, apart perhaps from a new coil or two. However, the purpose of the present letter is to remind you that in the last paragraph but one on page 196 of No. 4 of your journal, "Pentamp" promised us a three-valve circuit utilizing the Ostar-Ganz all-mains valves. Now, these valves are to be had in Det. and L.F. only so far, so the promised circuit could not include an S.G. stage, and will need be a Det. 2 L.F. again, and this will suit thousands of old set owners, providing the circuit be right bang up to date in other respects, and will get 9 kc/s separation, etc. Never mind whether it will get dozens of foreigners or not, who cannot be held until we get a big set with automatic volume control. I run my sets with an eliminator off the A.C. mains and would like to go on all-mains—providing the set can be made selective at the same time. I also wish to acknowledge receipt of my volume of the "Wireless Constructor's Encyclopædia," which I find a mine

CUT THIS OUT EACH WEEK.

## DO YOU KNOW?

—THAT instability may be introduced in a receiver employing a multi-ganged condenser assembly, due to coupling between the various sections of the condenser.

—THAT a moving-coil loud-speaker with an energized field winding may be used in place of a resistance for biasing purposes.

—THAT when choosing a fuse for a mains eliminator, it is important to consider the surge voltage which may take place, and not consider only the normal current rating.

—THAT to maintain a balance, the grid-bias battery in a Q.P.P. amplifier should be periodically adjusted or discharged at the same rate as the H.T. battery.

—THAT all metal parts of a receiver (condenser cases, etc.), should be connected to earth in the interests of stability.

—THAT it makes no difference whether the grid leak is joined across the grid condenser, or to L.T. positive in a normal grid-detector circuit.

—THAT the weight of the gramophone pick-up has a great bearing on the quality of reproduction, as well as the life of the record.

### NOTICE.

The Editor will be pleased to consider articles of a practical nature suitable for publication in PRACTICAL WIRELESS. Such articles should be written on one side of the paper only, and should contain the name and address of the sender. Whilst the Editor does not hold himself responsible for manuscripts, every effort will be made to return them if a stamped addressed envelope is enclosed. All correspondence intended for the Editor should be addressed: The Editor, PRACTICAL WIRELESS, Geo. Neenes, Ltd., 8-11, Southampton Street, Strand, W.C.2.

Owing to the rapid progress in the design of wireless apparatus and to our efforts to keep our readers in touch with the latest developments, we give no warranty that apparatus described in our columns is not the subject of letters patent.

**EASY TERMS PROMPT DELIVERY**  
**WE RECOMMEND THE**

**CELESTION "REETONE" SPEAKERS**

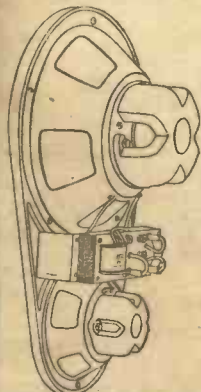

**MATCHED SPEAKERS**

Type 99. Two Permanent Magnets ... £4 5 0  
Type 88. Two Energised ... £4 5 0  
Type 98. One Permanent Magnet & one Energised ... £4 5 0  
Cash, carriage paid.  
Or 7/10 with order and eleven payments of 7/10.

**DUAL SPEAKERS**

Type S29. Two Permanent Magnets ... £6 0 0  
Cash, carriage paid.  
Or 12/6 with order and twelve payments of 10/.

**CELESTION SOUNDSEX on PAGE 1164.**  
Cash price 27/6 carriage paid, or 5/- down and 5 monthly payments of 5/- Q.F.P. 2/8 extra.  
**E. & A. BANTAM on PAGE 1151.**  
Cash price 27/6 carriage paid, or 5/- down and 5 monthly payments of 5/-.  
**AMPLION on PAGE 1181.**  
Cash price 39/6 carriage paid, or 4/- down and 10 payments of 4/-.  
Any Amplion, Blue Spot, Baker, Celestion, Epoch, Goodmans, Igranio, Lanchester, Ormond, E. & A., Eola, Sonochorde, or W.B. Moving Coil Speaker supplied promptly.

Send 5/- only and pay the balance by monthly instalments. No references. Entirely private and confidential. Write for Catalogue and details to:

**TURNADGE & PARTNERS, LTD.,**  
111, Fleet Street, London, E.C.4.  
Telephone: Central 1903.

**PRACTICAL LETTERS**

(Continued from page 1162.)

of information, and really a gift to the regular subscribers. Many thanks. The Data Sheets now appearing each week are also a wonderfully helpful idea. This week's, No. 5, is the very thing I have been hunting for. I am an engineer (but not of the electrical variety), and while my textbooks give all data of wire gauges, I had no access to any source of information on resistance and current-carrying capacity I require for an experiment. Trusting to see an up-to-date Det. 2 LF. circuit in PRACTICAL WIRELESS before long embodying the Ostar all-mains valves—F. M. BECK (London, W.C.).

**"Full of Good Things"**

SIR.—I beg to acknowledge receipt of your Presentation Volume—"Newnes' Wireless Constructor's Encyclopaedia"; thanks for same. I find it is like PRACTICAL WIRELESS, full of good things, plain and understandable to the lay mind and is invaluable to the beginner as well as the more advanced wireless fan. With best wishes for an ever increasing prosperity to PRACTICAL WIRELESS. It is a real titbit.  
—W. S. CROSBY (Horton).

**Plug-in Coils v. Dual Coils**

SIR.—To every advantage, there is the snag!—the disadvantage. Every debit must have a credit, so we are told. Here is an interesting topic for one of your experts to deal with in an article for PRACTICAL WIRELESS. The writer has reason to believe that in the Services, plug-in coils are preferred to any other. I can imagine the difficulty is in the matching of the coils, medium and long waves. To change a coil is no more than changing a gramophone record. Anyhow, may I suggest an article in the immediate future, giving the pros and cons.—A. J. (Cardiff).

**PUSH-PULL DETECTION**

(Continued from page 1129.)

Fig. 5. The amplitude, however, is not reduced, so that at the same time that the top half is pushed down the bottom half goes down also, or, in other words, the positive half is reduced considerably and the negative half increased.

It will be seen from Fig. 5 that the mean grid voltage is no longer steady at zero, but becomes negative in value and fluctuates at audible frequency. The fluctuations of each grid are reproduced in its own anode circuit and these two anode circuits being connected together as shown in Fig. 1, the two radio frequency components cancel themselves out as already explained, leaving a purely audio frequency current in the output. This output is double that which would be obtained from a single detector valve. The grid leak, of course, allows the negative charge on the isolated grid circuit to leak away gradually so that the grids have a definite tendency to return to zero potential when the grid current falls off. The location of the grid leak in Fig. 1 might seem open to criticism, the proper place to connect it being to a centre tapping on the grid coil. This point, however, is a "nicety"; in practice it makes no difference and it is much simpler to connect it as shown.

One advantage of this circuit has already been mentioned; another is that having eliminated the damping effect of the ordinary grid condenser and leak we should expect tuning to be sharper and the set therefore more selective and more sensitive. Experiments indicate that there is definite improvement in these points and distortion is more easily avoided.



*Graham Farish says:—*

**"Your Set is an Unknown Quantity without my NEW OHMITES"**

That's only one reason why PRACTICAL WIRELESS specifies them for their new set "Q.P.-P. Three-Four." The technicians know that my NEW OHMITES are dependable and carry for more than their stated electrical stresses. They are proof against mains "surge" and will not create hum.

**BETTER THAN WIRE WOUND**

The popular and efficient resistances for all general purposes. All values 50 ohms to 5 megohms. 1/6 each.

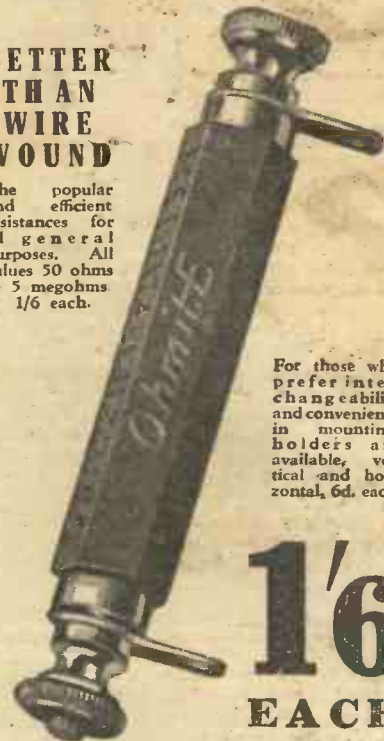

For those who prefer interchangeability and convenience in mounting, holders are available, vertical and horizontal, 6d. each.

**1'6 EACH**

**SAFE MAXIMUM CURRENT CARRYING CAPACITY OF "OHMITE"**

100° F. Temperature rise.

Ohms	Milliamps	Ohms	Milliamps
100,000	3.5	10,000	12.
80,000	4.24	5,000	20.25
60,000	5.	4,000	24.
50,000	5.5	3,000	29.
40,000	6.	2,000	35.
30,000	6.75	1,000	40.
20,000	8.	Other values pro rata.	

Heavy Duty type approximately double the above ratings. Price 2/3.

**GRAHAM FARISH COMPONENTS**

Graham Farish, Ltd., Masons' Hill, Bromley, Kent  
Export Dept.: 11-12, Fenchurch Street, London, E.C.3

**GRIP**

New Bowspring Wanderplug



1'2

Strong spring and wide self-adjustment. Side entry with Belling-Lee patent grip for flex. 12 indications and 6 plain colours. The "BOWSPRING" gives strong pressure over a far wider range of diameters than any plug we have so far tested.

Write for list of radio connections.

**BELLING-LEE FOR EVERY RADIO CONNECTION**

Cambridge Arterial Road, Enfield, Mdx.

**SERADEX COMPONENTS for Quiescent Push-Pull Circuits**

Milliameters type N.F.1 0-10Ma ... 5/11  
Ditto larger scale type N.F.2 ... 7/11  
Multi-ratio output chokes, as specified in "Wireless World" circuits ... 10/-  
Type M-150 resistors (1 1/2 watt), 20,000, 150,000, 50,000 ohms and most values from 100 ohms upwards ... 8d.  
Tubular condensers .005, .01, etc. ... 8d.  
List of above and other SeraDEX Lines for stamp from: **TREVOR PEPPER, WAKE GREEN ROAD, BIRMINGHAM,** or any good retailer.

# EXPRESS EASY PAYMENT SERVICE

Everything Wireless supplied on lowest terms  
Prompt Delivery Guaranteed.  
Price List Free on request.

## The Latest Kits.

**NEW LISSEN "SKYSCRAPER"** With  
KIT, including Valves. Cash Price, order  
£4/9/6. **5/-**  
And 11 monthly payments of 8/6.

**Q.P.P. AMPLIFIER  
Q.P.P. THREE - FOUR  
Three-Valve Push-Pull Detector**  
All components for the above supplied on low  
Easy Payment terms. Please write for quotation.

## Loudspeaker Units.

**NEW BLUE SPOT 99 P.M. MOVING-  
COIL UNIT** Cash Price, £2 19/6.  
And 11 monthly payments of 5/6. **5/-**

**NEW EPOCH Q.P.P. MOVING COIL UNIT.** With  
(Just released). Especially designed for the  
new Q.P.P. circuits. Cash price £1/19/6, or  
And 6 monthly payments of 5/2. **5/-**

## Accessories

**12 EKIDE W.H. HIGH-TENSION ACCUMU-  
LATORS** (120 volts, 5,000 m.a.). The cheapest  
and best High-Tension Supply where Mains  
are not available. Cash Price £3,15 0.  
And 11 monthly payments of 7/-. **7/-**

**ATLAS ELIMINATOR.** A.C. 244. 3 H.T.  
Tappings. 30 m.a. output.  
Cash Price £2/19/6. **5/-**  
And 11 monthly payments of 5/6.

## QUIESCENT PUSH-PULL

By converting your battery set to Q.P.P. it becomes  
equal to a first-class all-mains receiver at a lower  
cost of H.T. than before.

**R.I. PUSH INPUT TRANSFORMER** with  
and **R.I. P.P. OUTPUT CHOKE**, complete **5/10**  
with 3 Mazda pentode valves. List  
Price £3/4/-. And 11 monthly payments of 5/10.

Rolla Speakers Supplied on Similar Terms. All above  
Carriage Paid.

To avoid delay, will customers kindly  
send first payment with order.  
Goods ordered C.O.D. are dispatched by return of post.  
Post charges paid by us. **DEPT. P.**

The **LONDON RADIO SUPPLY COMPANY** ESTD 1925  
11, Oat Lane, Noble St., LONDON, E.C.2  
Phone NATIONAL 1977

# IGRANIC COMPONENTS

WILL TELL YOU HOW GOOD THEY ARE



**"REPAIRS? Send Them to Me."**  
When the repair has been O.K. by me, you can be sure your component is as good as new. All repairs are laboratory tested and guaranteed for 12 months. Any make of speaker unit, Transformer or Pick-up, 4/-; Blue Spots, 5/-; Moving Coils from 5/-. Address your repairs to: Repair Dept. B, Wedon Power Link Radio Co., 185, Earlham Grove, London, E.7 (Phone: Maryland 4344.)

# RADIO CLUBS & SOCIETIES

## NEW CLUB FOR CLACTON-ON-SEA

A number of local wireless enthusiasts have decided to establish a radio club for Clacton-on-Sea and District. A meeting was held recently at Dixon's Café, Station Road, Clacton-on-Sea, to which all interested in wireless matters were invited to attend. Particulars regarding future meetings can be obtained from Mr. Rodney Loader, "Aubretia," Southcliffe Park, Clacton-on-Sea.

## A SOUTH LONDON RADIO CLUB

A South London Branch of the Anglo-American Radio and Television Society is being organized by Mr. W. Cope, of 7, St. Alphonsus Road, Clapham, London, S.W.4. In the proposed programme of this branch are tours of radio factories in and around London and a tour of the Brookmans Park transmitters will, if permission can be obtained, be made. Meetings will be held as soon as sufficient members are obtained. Those interested should communicate with Mr. Cope at the above address. South London members of the A.-A.-R. and T.S. may obtain their copies of "Radio" from the South London Branch (members of other localities should apply direct to the headquarters of the society, 11, Hawthorn Drive, Willowbank, Uxbridge).

## THE SOUTHALL RADIO SOCIETY

On Tuesday, February 7th, the above society was visited by Mr. Carter, who gave a talk entitled "Jottings from My Technical Notebook," a well-chosen title, as it allowed him to cover a range of subjects from automatic volume control to the side-band theory in his inimitable way which is so popular with the members of the society. Full particulars of the society can be obtained from H. L. Hayner, 114, North Road, Southall, Middx.

## SLADE RADIO

A lantern lecture entitled "The Navy" was given by Lieut.-Commander Brewster at the meeting of the above society held last week. Commencing with the new recruits, it showed step by step the various items in the training which has to be undergone. A splendid series of slides was shown, and these included seamanship study, boating instruction, wireless, signalling, gun classes, manning the yard, boat sailing, stokers' class, cooks and bakery, electrical lectures, portable wireless, knotting and splicing, torpedo class, gun loading, and also the firing of large guns. The physical training was illustrated by slides of physical jerks, gymnasium, swimming, rowing, and sports side by photos of both soccer, rugged matches, hockey and hurdling. On the lighter side was shown the billiard rooms and also theatricals. The subject proved of great interest, as the slides were so capably explained by the lecturer, and it was keenly followed by all those present. Hon. Sec., 110, Hillaries Road, Gravely Hill, Birmingham.

## SIDCUP AND DISTRICT RADIO CLUB

A very successful inaugural meeting of the above club was held recently at the Regal Cinema, Sidcup. After the Club's officers had been elected, an interesting discussion on "man-made static" took place, and several technical members offered their services in a campaign against local interference. At another meeting a paper on cumulative grid rectification was read by T. W. E. Towers, and was followed by a lecture on "First Principles of Television" by E. G. H. Mobsby. Radio manufacturers who are willing to give lectures, demonstrations, etc., are invited to write to the Secretary. Meeting night, every Wednesday at 8 p.m. in the Regal Cinema, Sidcup. A hearty welcome will be extended to any prospective member who attends.—T. W. E. Towers, Hon. Sec., 22, Crombie Road, Sidcup, Kent.

## WOODFORD, WANSTEAD AND DISTRICT RADIO SOCIETY

On Thursday, February 16th, Mr. Nixon gave this society a demonstration and lecture on the Gas-filled Relay, G.T.I., and its parent the Hot Cathode Mercury Vapour Rectifying Valve G.U. It was explained by the lecturer that the former was a direct development of the latter. As scientific products, the photo electric cell and the relay prove of exceeding interest, seeing the many uses to which these can now be put for alarms and checking purposes. Mr. Headland, of this club, had also brought his receiver for demonstration. At the conclusion of the lecture this receiver, capable of giving a 10 Watt output, was worked on a moving-coil energised speaker. Mr. Nixon remarked that he, as an enthusiast, was probably as much interested to hear results as members. The quality was excellent, and the evening was considered the most successful of the season. Mr. H. O. Crisp, 2, Ramsay Road, Forest Gate, E.7, is the Hon. Secretary.

**PPM SOUNDEX**  
**27/6**

## INCLUDING TRANSFORMER

## CHOSEN FOR THE "PUSH-PULL DETECTOR"

Remarkable tonal response and sensitivity, coupled with finest quality workmanship and materials, has proved the supremacy of the Celestion P.P.M. Soundex Speaker, which is priced at only 27/6, including universal transformer. That is why the designers of the "Push-Pull Detector" chose this amazing speaker for their set, and why many hundreds of satisfied users are praising the merits of the Soundex.

Make certain of getting True-to-Life results when you build this set by fitting the speaker that has proved its worth, the speaker that is the choice of experts because of the outstanding results it gives.

**P.P.M. SOUNDEX, Price 27/6**

including universal transformer.

Ask your dealer to demonstrate this remarkable speaker; the fidelity of tone is truly amazing.

**CELESTION**  
The Very Soul of Music

CELESTION Ltd., London Road, Kingston-on-Thames. London Showrooms: 106, Victoria Street, S.W.1.

# Facts and Figures

Components Tested in our Laboratory

BY THE PRACTICAL WIRELESS TECHNICAL STAFF

### PLASTAPE AERIAL

THE problem of the indoor aerial is continually being attacked, and the latest entry into the field of easily-erected and more or less invisible aerials is the Plastape self-moulding wire manufactured by the Kenden Manufacturing Company. This consists of a plastic tape which is double, and in between the two surfaces is laid multi-strand wire. In the sample submitted ten strands were accommodated, and it is also available with eight strands or four strands. The latter two types are for loud-speaker extensions and earth connections respectively. The construction of the wire is very novel, five strands of bare copper wire (24 gauge) being stitched in a silk material, and the remaining five strands are laid on this, with the adhesive tape surrounding the complete assembly. The total width is half-an-inch, and the thickness under 1/32in. This form of wire may be affixed to the walls of a room, and passed round the jamb of a door, etc., without in any way affecting the closing of the door. As it is available in various colours, it may also be affixed to walls so as to be practically invisible. Joins are extremely easy to make and full instructions accompany the wire. A 30ft. coil of the 10-strand aerial costs 3s. 6d., whilst 20ft. costs 2s. 6d. The earth wire of four strands is sold at 3d. per yd., and the 8-strand costs 4d. per yd.

### WEEDON BOX BAFFLE

WE have already reported on the Weedon method of building a loud-speaker in the cabinet type which avoids box resonance and enables real bass to be obtained. The constructor will find the new Box Baffle Former a simpler method of carrying out the conversion. This incorporates the Weedon method in a ready built unit which simply needs to be inserted into the existing loud-speaker cabinet and avoids the building-up method previously necessary. It is obtainable in a standard size to fit the majority of speaker cabinets at 8s. 6d. A special type is also made for speakers which require a shelf for mounting.

### LEWGOS SCREENED COILS

A NEW form of screened coil manufactured by the London Electric Wire Company & Smith's is illustrated on this page. These consist of a deep-ribbed ebonite former having a cylindrical winding at the upper portion, and a sectional winding at the lower end. This is mounted on a moulded ebonite base, and a metal screen fits completely round the coil. The necessary switching gear is incorporated in the moulded base. This coil is made in four types — an Aerial and Tuned Grid coil, a Band Pass Link Filter coil, a Standard Oscillator and a Ganged Oscillator. These cost 8s. 6d. with the exception of the Band Pass coil, which costs 1s. more. All coils are accurately matched for ganging purposes, and each type has identical self-capacity and inductive values. The switching apparatus is designed for ganging, so that any number of these coils may be arranged to operate from one control knob. Very complete instructions for connection to receivers are supplied with the coils.



Ganged Lewgos potentiometers.

A further development by this company, which is also illustrated on this page, is the ganged potentiometer. In many receivers it is essential to have two such potentiometers for controlling different parts of the circuit, and in many cases the adjustment of these controls is more or less interdependent. By careful design, therefore, it is possible to arrange these two resistances (or potentiometers) so that only one control knob need appear on the panel. A common use of this form of control would be in an S.G. receiver where a potentiometer is arranged across the aerial coil to control the input signal strength, and a potentiometer is employed for adjusting the screening grid potential.

Lewgos screened coils.

### CLIX NON-CORROSIVE SPADE TERMINALS

MANY constructors experience difficulty in making a firm connection to the usual type of spade terminal. Messrs. Lectrolinx have introduced yet another form of spade terminal for the constructor, and in this two new features have been incorporated. Firstly, the spade end is lead-coated, which, of course, makes it ideal for connection to accumulators, etc. In addition, a special collar is provided, and this locks close up to the small ebonite end of the tag, and thus effectively prevents acid creeping to the copper wire. The second feature is the novel method of anchoring wires to these spades. As can be seen, a slot is cut in the flat end of the spade, and the threaded portion is a sliding collar running on this portion of the spade. The wire is passed through the slot, and then when the threaded collar is screwed into the ebonite it draws up and so clamps the wire rigidly. The illustrations should make this arrangement perfectly clear. Two sizes of the terminal are made, the large costing 2d. and the smaller 1d.

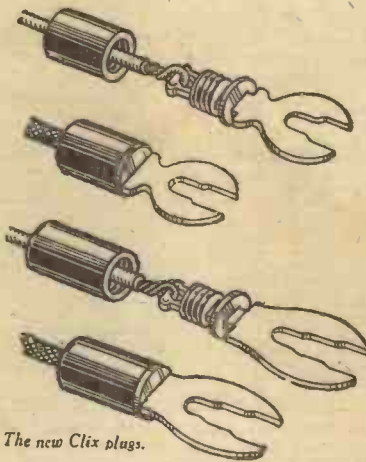

The new Clix plugs.

### BULGIN SENATOR TRANSFORMER

L. F. TRANSFORMERS seem to decrease in size every day, and the latest to be reviewed by us is the Senator manufactured by the well-known component manufacturers, Messrs. Bulgin. This is mounted in the now standard metal case, as used for this firm's H.F. chokes, etc. It is extremely small, measuring only two inches by two inches. It is of the nickel alloy core type, and gives remarkable results for such a small component. It may be mounted above, or beneath, a baseboard, fixing holes being provided at top and bottom. The primary inductance is quite high, and best results were obtained by using it on the parallel-fed method. At 6s. 9d. this is a splendid component for the low-frequency side of the receiver.

(Continued on page 1166.)

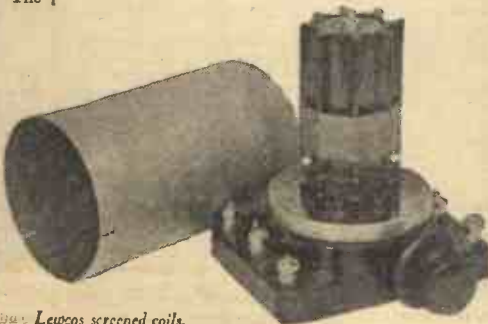

# Tune in on this New



# Wireless Instruction

The I.C.S. Wireless Courses cover every phase of wireless work, from the requirements of the youth who wishes to make wireless engineering his career to the man who wants to construct a broadcasting set for his home, and, at the same time, to know how and why it operates and how to locate any faults that may develop.

No branch of industry has ever progressed as rapidly as wireless and the rate of progress is increasing. Only by knowing thoroughly the basic principles can pace be kept with it. Our instruction includes American broadcasting as well as British wireless practice. It is a modern education, covering every department of the industry.

### OUR COURSES

Included in the I.C.S. range are Courses dealing with the Installing of radio sets and, in particular, with their Servicing, which to-day intimately concerns every wireless dealer and his employees. The Operating Course is vital to mastery of operating and transmitting.

There is also a Course for the Wireless Salesman. This, in addition to inculcating the art of salesmanship, provides that knowledge which enables the salesman to hold his own with the most technical of his clients.

We will be pleased to send you details of any or all of these subjects. Just fill in and post the coupon, or write in any other way, stating which branch of Wireless interests you—the information you require will be forwarded at once.

—YOU MAY USE THIS COUPON—

International Correspondence Schools, Ltd.,  
Dept. 94, International Buildings,  
Kingsway, London, W.C.2.

Without cost, or obligation, please send me full information about the Courses I have marked x

- THE I.C.S. WIRELESS COURSES
- THE I.C.S. RADIO COURSES

Name .....

Age .....

Address .....



Amplion Q.P.-P. Model.

SINCE the advent of the Quescent Push-pull arrangement, the component manufacturers have turned their attention to the production of components specially applicable for this form of coupling. It will be obvious from what has been already said in these pages that the intervalve transformer, as well as the output transformer requires certain characteristics if the full benefits of the Q.P.-P. method are to be obtained. In addition to these, however, the low resistance type of moving-coil loud-speaker requires an input transformer which has also been designed for the special purpose. On this page are illustrated a few of the many components which have been submitted to us for test and comment.

**INPUT TRANSFORMERS**

AMONGST the special L.F. transformers are the Varley, Sound Sales, Ferranti and Radio Instruments. Each of these firms has produced a high-class transformer for coupling the two push-pull valves to the preceding stage, and the ratio is in all cases quite high. The Varley Input Transformer (Type DP.36) has a step-up ratio of 9 to 1, and has a very efficient primary winding which is practically of the constant inductance type. With no D.C. flowing, the inductance is of the order of 30 henries, and with 4 mA this drops to only 22 henries. The D.C. resistance of this winding is 825 ohms. This is, therefore, a really first-class transformer and with its high ratio will ensure that Pen. 220A type valves will be fully loaded with the normal type of detector valve, without having to force the detector signal and so produce distortion. The price is 17s. 6d. Messrs. Ferranti have produced two types of input transformer, the AF. 11c. and the AF. 12c. The former is an expensive component designed especially for those who require only the very best, and although it costs 34s., it represents splendid value for money. The ratio is 10 to 1, and with no D.C. the primary is of the order



Varley Transchoke.

of 50 henries. The anode current may rise to as much as 10 mA with this particular transformer, and the inductance at this figure is reduced to approximately 25 henries—a very creditable figure. The other model is a cheaper component, costing only 15s. It possesses an inductance of 30 henries with no D.C., and the current which may be passed through the primary is approximately 6 mA. At this figure the inductance is 15 henries. The ratio of this transformer is 9 to 1, and both of these transformers give splendid quality, especially of the bass notes. The

Sound Sales component has a ratio of 9 to 1, and the inductance of the primary is 30 henries, at 2 mA. The performance of this transformer is also very good. The R.I. input transformer has a ratio of 8 to 1, with a primary winding having a D.C. resistance of 900 ohms. The windings are sectionalised giving a low self-capacity, and the inductance of the primary is 30 henries with no D.C., and this falls to 16 henries at a current of 2 mA. The windings are internally screened, and when attached to a metal or metallised baseboard, the screening is automatically earthed through the metal eyelet holes. This component costs 15s.

**OUTPUT TRANSFORMERS**

FOR combining the output of the two valves, there is a very large range of components available.

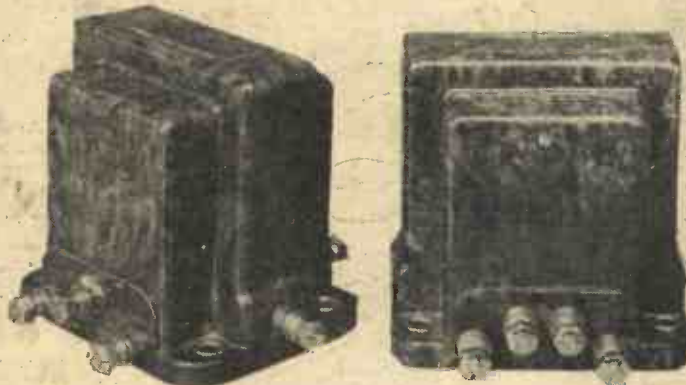

Sound Sales Q.P.-P. Transformer and Output Choke.

Messrs. Varley have produced three, Messrs. Ferranti also produce three, Radio Instruments and Sound Sales only manufacturing one. The Varley components bear the name "Transchoke," a combination of the words "transformer" and "choke." The DP.37 is a model having two output ratios, 3 to 1 and 42 to 1. The D.C. resistance of the primary is 460 ohms, and each half of the primary has an inductance of 13 henries with a D.C. current of 26 mA. The DP.38 has two ratios, 3 to 1 and 50 to 1. The resistance of the primary of this model is slightly lower, namely, 400 ohms, and consequently the inductance of the primary is not so high. The actual figures are 8 henries at 26 mA., which is, of course, quite a good rating. This model, with the DP.39 to be mentioned next, costs 18s. 6d., as compared with 18s. 6d. for the first-mentioned Transchoke. The DP.39 also has two ratios, the lower being 3 to 1 and the high 75 to 1. The D.C. resistance of the primary is the same as in the case of the DP.38, and the inductance value is the same. It will be seen from the above figures that any model of the Varley Transchoke may be obtained, and the speaker may be of high or low resistance. The performance of the whole range of the Varley transformers is of the high order which one usually expects from the products of this firm. The Radio Instruments Output Choke has four output terminals enabling ratios of 1 to 1, 1.4 to 1, 2 to 1, and 2.8 to 1 to be obtained. The total D.C. resistance of the primary in this model is 400 ohms, and the primary inductance of each half is 70 henries. This output choke costs 12s. 6d.

The Ferranti models range in price from 26s. 6d. to 15s., and are very substantial components. The largest model, the OPM 11c., is provided with three alternative ratios, 35 to 1, 56 to 1 and 100 to 1. It is designed to carry a current as high as 200 mA, and the primary resistance is only 230 ohms. This may, obviously, only be used with low resistance loud-speakers, but the most powerful output valve may be employed in view of the

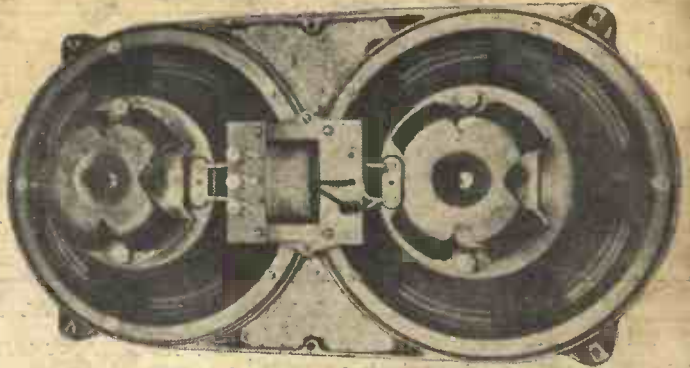

The Celestion Matched Speakers.

current rating of the primary. The OPM 13c. costs a similar amount, but is designed for low-resistance loud-speakers. The three ratios provided are 1.7 to 1, 2.7 to 1 and 4.5 to 1. The maximum D.C. current rating of the primary is similar to the OPM 11c., with a resistance of approximately 230 ohms. This type of transformer is, of course, suitable for use with loud-speakers which already have an input transformer built into them. The cheaper model, the OPM 12c. is provided with two ratios, for high or low resistance speakers. For high-resistance speakers the ratio is 1.7 to 1, and for low-resistance speakers it is 40 to 1. The current rating is lower than the other two models, being 150 mA, with a D.C. resistance of 210 ohms. The Sound Sales Output Choke has ratios of 2 to 1 and 3 to 1 and is a substantial component.

**LOUD-SPEAKERS**

WHERE a complete new receiver is being built to operate on this principle, it is necessary to obtain a loud-speaker, and the expense of one component may be saved by purchasing a loud-speaker which is fitted with a special Q.P.-P. transformer. Several firms are now producing this type of speaker, among which may be mentioned Amplion, Celestion and W.B. The Amplion model is practically the standard type, except for the matching transformer. This is designed for Pen.220A's, and gave a really splendid performance. The overall performance was, judged aurally, a practically straight line, the falling off at the bass and the upper register being very gradual indeed. The lowest notes seemed to be dealt with as well as the very highest flute notes, and at 39s. 6d. this is a splendid speaker. The Celestion people are making two types of Q.P.-P. Speaker, a single unit, and one of the Reetone type. This comprises two speakers of similar size and appearance, mounted on a metal plate. These two units are so designed that the bass resonances are "staggered," that is to say, they do not each resonate at the same particular frequency. The difference is, however, so arranged that the overall bass response is materially increased over that obtainable with one ordinary M.C. speaker, and the quality of reproduction with this type of speaker is of a very high order. The special matching transformer included on this unit enables any degree of matching to be carried out, and the tone may be varied between fairly wide limits by using a suitable tapping, for which a winder plug is fitted. Other Celestion speakers will be dealt with next week.



Celestion Q.P.-P. Speaker.



LET OUR TECHNICAL STAFF SOLVE  
YOUR PROBLEMS

REPLIES TO



**QUERIES and ENQUIRIES**  
by Our Technical Staff

If a postal reply is desired, a stamped addressed envelope must be enclosed. Every query and drawing which is sent must bear the name and address of the sender. Send your queries to The Editor, PRACTICAL WIRELESS, Geo. Newnes, Ltd., 8-11, Southampton St., Strand, London, W.C.2

The coupon on this page must be attached to every query.

**SPECIAL NOTE**

We wish to draw the reader's attention to the fact that the Queries Service is intended only for the solution of problems or difficulties arising from the construction of receivers described in our pages, from articles appearing in our pages, or on general wireless matters. We regret that we cannot, for obvious reasons—

- (1) Supply circuit diagrams of complete multi-valve receivers.
- (2) Suggest alterations or modifications of receivers described in our contemporaries.
- (3) Suggest alterations or modifications to commercial receivers.
- (4) Answer queries over the telephone.

Please note also, that all sketches and drawings which are sent to us should bear the name and address of the sender.

**S.G. ONE-VALVER**

"Will you please let me know if an S.G. valve can be used for a one-valve set? Would the amplification be greater than with a triode? Would the selectivity also be better?"—(N. W., Wooton, I.O.W.)

A screened-grid valve can with success be used in a one-valve receiver. The amplification and selectivity would be better than in the case of a triode valve. The S.G. valve is connected into circuit exactly as though it were an ordinary valve, and the screening grid is joined to a tapping on the H.T. battery in the neighbourhood of 60 to 100 volts. A little time should be spent in finding the best position for this tapping, as the smoothness of reaction and the amplification obtained will depend on the adjustment of this voltage. It would also be an advantage to try the effect of smaller values of Grid condenser and Leak, say .0001 mfd. for the condenser, and .25 to .5 megohms for the leak.

**LICENCE PROBLEM**

"I have a three-valve set, and have also a short-wave set. I have a licence for the three-valve, and wondered if it is necessary to have one for the short-wave set as they are both in the same house."—(J. T. W., Notts.)

You will see from the back of your licence, that any number of sets may be used by you on the same aerial, and, in addition, one portable receiver may be used at any place outside the house. If, however, the short-wave set (or any additional set) is employed in such a manner that it supplies other residents in the house or, in other words, not by the licensee, then an additional licence will be required. You will find that this is fully explained on the back of the licence.

**PARALLEL-FED TRANSFORMERS**

"I am only a beginner in wireless, but thanks to your journal, I am now beginning to understand the principles of radio. I must ask your indulgence, however, on one little point. It may seem that I am very ignorant, but when one is in doubt it is always advisable to ask, and the parallel-feed method of using a transformer has rather left me bewildered. I always understood that the transformer owes its action to the difference in potential that exists between each end of the primary winding, and this voltage difference sets up a voltage difference in the secondary. As, however, a condenser is interposed in the circuit of the primary, no current can flow through it. How, then, does it get any current to affect the secondary? I hope I am not betraying my ignorance too much, but it is a point which I should like explained."—(F. G., Yeominsten.)

The anode circuit of the valve in front of the transformer has a high resistance connected in it. This is joined from plate to H.T. positive, and therefore there is a drop in voltage across it. From the Plate a condenser is joined to a transformer primary, and the other end of this primary winding is joined to earth. Now the speech currents in the anode circuit are A.C.,

and consequently there is a constant variation across the condenser, and these variations are in turn passed to the primary of the transformer. The elimination of the direct current does not stop the transformer from functioning, but improves the performance inasmuch as it prevents the inductance from dropping if the anode current (D.C.) happens to be on the high side.

**VALVE SOFTENING**

"I have a powerful A.C. mains-operated three-valve set, employing in the output circuit two push-pull valves. The set has been working now for some months, and has given yeoman service. Last week I felt that the volume was not as it originally had been, and after a few nights I became certain that there was a falling-off in strength and quality. I turned the cabinet round to examine the leads, etc., and noticed that one of the push-pull valves was fairly illuminated with a bluish phosphorescent glow. Is this the sign where anything has gone wrong? I shall not look else- that for the trouble until you assure me on this point."—(R. H., Battersea.)

The blue glow in your power valve is a sign that the valve has been overrun and has become soft. You will need a new valve for that part of the circuit, but before fitting it examine the values of resistances, grid-bias, H.T., etc., which are used in this part of the receiver, and make quite certain that these are correct. We think you will find that you have been either under-biasing, or applying too much H.T. for the particular valve you are using. The fact that the valves are in push-pull also means that if the potentials applied are incorrect, the other valve will also have been damaged, and you may, therefore, need two new valves.

**DATA SHEET No. 24.**

**HANDY FORMULÆ.**

**REACTANCE.**

Cut this out each week and paste it in a Notebook.

$$\text{Reactance of a Condenser} = \frac{10^6}{2\pi f C}$$

$$\text{Reactance of a Coil} = 2\pi f L$$

Where C is the capacity in microfarads  
f is the frequency in cycles per second  
L is the inductance in henries.

**DIODE AND GRAMOPHONE PICK-UP**

"I have a home-made four-valve set employing two L.F. stages, an ordinary Screen-grid valve, and a detector working on the Diode principle. I have built a radio gramophone cabinet, and now wish to include this set as a gramophone reproducer as well as a normal broadcast set. I am not clear, however, how to join the pick-up into the Diode Grid circuit. I have tried one or two experiments, but so far have not met with much success, and I should like to know the correct way of using this."—(U. S., Manchester.)

The Pick-up cannot be joined up to the grid circuit as in a normal three electrode valve, and you must, therefore, connect it in a special manner, or join it alternatively, to the first L.F. valve. Preferably, we would use the latter method as it introduces no complications, and will give quite sufficient amplification, provided one of the standard types of pick-up is being employed.

**EARTHING COMPOUNDS**

"I note that you give space in your advertising pages to a device for 'improving earth connection.' This preparation, from what I can gather from reading the advertisement, is nothing more nor less than a chemical, and I fail to see how a chemical can have any effect upon wireless reproduction. All sorts of claims are

made for it, and I think you should investigate the problem before allowing your pages to be used for filching cash from your poorer readers who may be misled into believing that this sort of thing can work."—(D. F. C., Gloucester.)

You are quite wrong in assuming that the device can have no effect upon the results obtained by a wireless receiver. The first essential to good reception is, as everyone knows by now, a good aerial and earth system. The conductivity of the earth is governed by its condition. A dry, sandy soil, for instance, provides a very poor earth connection, and alternatively, a very damp clay soil provides a very good earth connection. Therefore, the first essential of a good earth is moisture. Many readers do go to the trouble of watering the earth two or three times a week, but even then, in some situations, the drainage is so good that the earth becomes very rapidly dry and a bad connection results. If you have a receiver employing an efficient S.G. stage, remove your earth connection, and we think you will find that the receiver will probably burst into oscillation, or at any rate, signals will be very much reduced in strength. The compound referred to in the advertisement has a very high hygroscopic value—in other words it attracts moisture, and maintains the soil in a very moist condition, even through the hottest days. It does definitely work as claimed.

**AUTOMATIC GRID-BIAS**

"The receiver which I am building is to employ an indirectly heated Pentode in the output stage. I wish to incorporate automatic bias, but should be glad of your advice as to where to insert the resistance. I appreciate the fact that, by including it as the cathode lead, it becomes part of the output circuit, and as I believe this is not desirable, I should like your advice."—(K. L., Wooton.)

The load in the Pentode anode circuit is bound to be high—if you correctly match the valve, and, therefore, there will be little loss in the method you at first suggest. If, however, you wish to use the H.T. method of biasing, where the cathode remains at a common negative potential, and a higher value of negative bias is applied to the grid, you must return the cathode lead direct to Earth, and join the G.B. terminal of the L.F. transformer to H.T. negative. The correct value of biasing resistance is then joined between H.T. negative and Earth.

**D.C. CHARGER**

"In January 14 issue a small Charging board was printed. Could you tell what voltage the bulb should be and how long I should leave an Exide 2-volt 45-Amp. on Charging Board. My meter current is 15 amp, 250 volts, from electric mains."—(J. Y., Bermondsey.)

The Charging board referred to can only be used if the mains are D.C. With a 250-volt D.C. supply, and a 250-volt-120-watt lamp, your 2-volt accumulator would be fully charged in approximately 80 hours. The lamp could, of course, be used for lighting purposes during the charging process. If your mains are A.C., a step down transformer and a rectifier will have to be used. We would refer you to "P.W., 9," page 435.

**VARIOMETER**

"When I turned out my Junk box recently I came across an old variometer. I should like to know whether it is worth while building up a set with this as the tuning element, or whether it has not become obsolete for any reason. It was a very good make and was quite expensive when purchased."—(Y. B., Wickford, Essex.)

Your variometer, like all old-fashioned wireless parts, is not of much use in these days. The principal defect with this form of tuning is, of course, bad selectivity and we think you will find that if you incorporate it in a set you will have great difficulty in separating various stations. Our advice, therefore, in the case of all possessing old parts is, scrap them.

**FREE ADVICE BUREAU  
COUPON**

This coupon is available until March 11th, 1933, and must be attached to all letters containing queries.

PRACTICAL WIRELESS 4/3/33

# CATALOGUES RECEIVED

To save readers trouble, we undertake to send on catalogues of any of our advertisers. Merely state on a postcard, the names of the firms from whom you require catalogues, and address it to "Catalogue," PRACTICAL WIRELESS, Geo. Newnes, Ltd., 8/11, Southampton St., Strand, London, W.C.2. Where advertisers make a charge, or require postage, this should be enclosed.

### FOTOS VALVES

AT the present time there is undoubtedly a demand for low-priced valves capable of standing up to the requirements of modern receivers, and in Fotos valves that demand has been well met. We have just received a leaflet from the Fotos people, giving full particulars of their battery-operated valves and also a useful range of indirectly and directly-heated A.C. mains valves. The prices range from 5s. to 14s. 6d. Also included in the leaflet are particulars of the Fotos transformer, a small but efficient component specially designed for use in portables and other small-spaced sets. The price is only 4s. 6d. Copies of the leaflet can be obtained from the Concerton Radio and Electrical Co., Ltd., 256-7, Bank Chambers, 320, High Holborn, W.C.1.

### BAKELITE ACCESSORIES

A USEFUL folder has just come to hand from Ward and Goldstone, Ltd., giving particulars of a large range of their well-known small components in moulded Bakelite. Plug attachments, lampholders, bell pushes, connectors and switch plates are amongst the fittings illustrated in the folder, a copy of which can be had on application to the firm at Pendleton, Manchester.

## ASTOUNDING! BARGAINS!

IN

**Mains Transformers  
Electrolytic and Block  
T.C.C. Condensers  
Mains Chokes  
Parafead Transformers  
Loudspeakers**

#### MAINS TRANSFORMERS.

No. 1. Primary, 0-240 volts. Secondary, 350-0-350 volts at 300 m/a. C.T. 4 volts, 2 amps, 4 volts, 1 amp. C.T. 25 volts bias. 4 volts, 2 amp. ....	6/6
No. 2. Primary 0-240 volts. Sec. 100 volts at 150 m/a. 15 volts bias. 4 volts, 2 amp. ....	6/6
No. 4 Primary 0-240 volts. Sec. 145 volts at 150 m/a. 15 volts bias. 4 volts, 2 amp. ....	8/6
No. 5. Primary 0-240 volts. Secondary 180 volts at 75 m/a. 4 volts, 1 amp. ....	8/6
MAINS CHOKES. 30 Henries 20 m/a. ....	8/6
30 Henries 20 m/a. ....	5/9
PARAFEED TRANSFORMERS	3/6
T.C.C. ELECTROLYTIC. 8 ml. 400 volts D.C. working. ....	3/6
T.C.C. BLOCK CONDENSERS. Type K.10 1+1+2+2+2 mfd. 300 volt test	2/6
T.C.C. BLOCK CONDENSERS. Type K.18. 1+1+1+2+2+2+2 mfd. 300 volt test	2/6
T.C.C. BLOCK CONDENSERS. Type K.11. 1+2+4+4 mfd. 300 volt test	2/6
T.C.C. BLOCK CONDENSERS. Type K.8. 2+2+2+1+1 mfd. 300 volt test	2/6
MOVING COIL SPEAKERS from	17/6

Send for Bargain List "P.K." ALL GOODS BRAND NEW AND GUARANTEED. Carriage Paid on all orders over 5/- Orders over 10/- sent C.O.D.

**CINE & ELECTRICAL SURPLUS CO.** Dept. "P.K.", 288, New North Road, London, N.1.

### Broadcast Query Corner

UNDER the above title, with the assistance of a recognized authority on foreign broadcasting matters and a regular contributor to wireless publications both at home and abroad, we have inaugurated a special Identification Service, which should prove of great assistance to our readers. When tuning in well-known stations it happens frequently that listeners pick up wireless transmissions of which they fail to recognize the origin. It is to solve these little problems that the Broadcast Query Service has been organized.

In order that a careful search may be made it is essential that certain data should be supplied to the best of the inquirer's ability and knowledge. When sending such queries to the Editor the following rules should be followed:—

1. Write legibly, in ink. Give your full name and address.
2. State type of receiver used, and whether transmission was heard on headphones or on loud-speaker.
3. State approximate wavelength or frequency to which receiver was tuned, or, alternatively, state between which two stations (of which you have the condenser readings) the transmission was picked up.
4. Give date and time when broadcast was heard. Do not forget to add whether a.m. or p.m.
5. Give details of programme received, and, if you can, some indication regarding the language, if heard.
6. State whether and what call was given and/or kind of interval signal (metronome, musical box, bells, etc.) between items.
7. To facilitate publication of replies, append a *nom-de-plume* to your inquiry.

### Replies to Broadcast Queries

SPOTO (Norwich): Barcelona (E.A.J.I), B.R.S.1038 (Herne Bay): YVIBC, Caracas (Ven.) on 49.1 m. NIM-ROD (Retford): WJSV, Alexandria (Va.); Columbia Broadcasting System (205.4 m., 1,460 kc/s). A. E. D. (Plymouth): WCAU, Philadelphia (Pa.) on 256.3 m. D. C. (Belfast): Wavelength wrong; Leningrad on 857.1 m. TOSH (Aicester): WCAU, Philadelphia (Pa.). PIP (Sussex): Trans-Pacific Communication Co., Ltd., Dixon (California, U.S.A.) on 19.53 m. (15,370 kc/s). TRED (Berkshire): (1) Call signs beginning with G emanate from British experimental amateur transmitters; write to the Radio Society of Great Britain, 53, Victoria Street, S.W.1; (2) Call signs beginning with W and a number emanate from American amateurs; (3) Radio Amateur Call Book (F. T. Carter, Flat A, Gleneagle Mansions, Streatham, London, S.W.7), 6s. 6d. post free; (4) PAOASD, WF. JACOT, 73, Euterpe Straat, Amsterdam (Holland); (5) Might tally with OH50B, Eero K. Neuvonen, Viipuri (Finland); (6) Poste Parisien on 328.2 m.; (7) Harmonic; (8) The call sign is apparently mutilated; probably a Dutch transmitter. ANTHONY (Manchester): WEEL, Boston (Mass.) on 508.2 m. BRS 1,038 (Herne Bay): (2) CTIAA, Lisbon (31.25 m.), the interval signal is a cuckoo call; (3) W8XK, Saxonburg, relaying KDKA on 48.86 m. MART (Lincoln): WCAU, Philadelphia (Pa.) on 256.3 m. (Direct). B. C. L. (East Finchley): The Broadcast was a Charity Ball from the Kaisersaal, Berlin; it was relayed to the U.S.A.; you may have picked it up through WQO, Rocky Point (N.Y.) on 44.61 m. (6,725 kc/s). R. S. W. (Wheatley): WCAU, Philadelphia (Pa.) Columbia Broadcasting Company on 256.3 m. direct. REO (Perthshire): WABC, New York (348.0 m.). YANKEE (Derby): (1) WCAU, Philadelphia (Pa.); (2) WTIC, Hartford (Conn.) on 282.8 m.; (3) LR3, Radio Nacional, Buenos Aires (316 m.); (4) WLW, Cincinnati (Ohio) on 428.3 m.; (5) WPG, Atlantic City (N.J.) on 272.6 m.; (6) (a) KDKA, East Pittsburgh, on 305.9 m.; (b) WABC, New York, on 348.0 m. DISTANCE (Hanwell): (1) WBVR, cannot be traced in list; apparently WBBR, Brooklyn, N.Y., on 230.6 m. (1,300 kc/s); (2) WX1AB cannot be traced in list; apparently WXYZ (z is pronounced zee), Detroit (Mich.) on 241.8 m. (1,240 kc/s); there is a WIXAV, Boston (Mass.) on 105 m. (2,850 kc/s); (3) WOR, Newark (N.J.) on 422.3 m. (710 kc/s); (4) WFW,

Tropical Radio Telegraph Co., Mobile (Ala.); (5) PNX, Diguel, N. Guinea, D.E.I.; (6) WPG, Atlantic City (N.J.) on 272.6 m.; we cannot quite understand your query as according to call signs, if correct, these are not all broadcasting stations; some indication of wavelength also should be given.

**EVEN IN AMERICA WITH ITS MULTI-VALVE SUPER SELECTIVE SETS A PIX IS NEEDED**

*Read this Letter—*

Hotel Grand, New York City.  
... Please send me another "PIX" as I find by test that they are all that you claim for them and then some more.  
I have tried it out on one of the new 8 tube D.C. sets... excellent clarity and volume. W. H. L.

This is only one of the many letters received from America. Thousands are being sold there weekly because they find a PIX improved the selectivity of even the finest sets.

**2/- PIX**

Clip 6d.

The selectivity of your set can be improved by fixing a PIX in the aerial lead-in. Even if a pre-set aerial condenser is fitted, inside your set, a PIX will give better and sharper tuning.

**NO MORE DUAL PROGRAMMES**  
Fix a PIX in your aerial and separate programmes. A PIX can be fitted to any set, crystal, battery or all mains, will cut out the local and bring in foreign stations clearly.

**THE LIT & PIX COMPANY, Ltd.**  
(Dept. 65), 118/28, Southwark St., LONDON, S.E.1.

**PIX**

Write for Illustrated Catalogue of **RADIO-GRAMOPHONE CABINETS**

of exclusive modern design, made by craftsmen, in highly figured Oak, Walnut or Mahogany, post free

**REMARKABLE VALUES.**  
Cabinets made to order in speciality.

Maker, under license, of the **HOWE BOX BAFFLE.**  
Recommended by the B.B.C. Full details on request.

**GILBERT,**  
Cabinet Maker, - SWINDON  
Estimates free. Est. 1886

## ADVERTISEMENT INDEX

	Page		Page		Page
Amplion (1932), Ltd.	1161	Gilbert	1168	Radialaddin, Ltd.	1156
Belling Lee, Ltd.	1163	Hayberd, F. C. & Co.	1158	Riverside Mfg., Co., Ltd.	1158
British Ebonite Co., Ltd.	1156	International Correspondence Schools	1165	Radio Instruments, Ltd.	Back Cover
British Pix, Ltd.	1168	Igranic Electric Co., Ltd.		Reproducers & Amplifiers, Ltd.	1151
Bulgin, A. F., & Co., Ltd.	1159		Inside Front Cover and	Seradex Products, Ltd. (Trevor Pepper)	1163
Celestion, Ltd.	1164	Jackson Bros., Ltd.	1141	Telegraph Condenser Co., Ltd.	1134
Cine & Electrical Surplus Co.	1168	Lissen, Ltd.	1122	Turnadge & Partners, Ltd.	1163
Clarion Radio Furniture, Ltd.	1156	Lectro Linx, Ltd.	1159	Varley, Ltd.	1138
Colvern, Ltd.	1121	London Radio Supply Co., Ltd.	1164	Ward & Goldstone, Ltd.	1151
Cossor, A. C., Ltd.	1133	Mason, E. C.	1158	Wates Radio, Ltd.	1159
Direct Radio, Ltd.	1142	Miscellaneous Trading Co., Ltd.	1156	Weedon Power Link Radio Co.	1164
Electrical Trading Association, Ltd.	1151	Newnes "Home Photographer"		Westinghouse Brake & Saxby Signal Co., Ltd.	1121
Ferranti, Ltd.	1141		Inside Back Cover	Williams & Moffat, Ltd.	1156
Graham Farish, Ltd.	1161, 1163	Peto-Scott, Ltd.	1147		

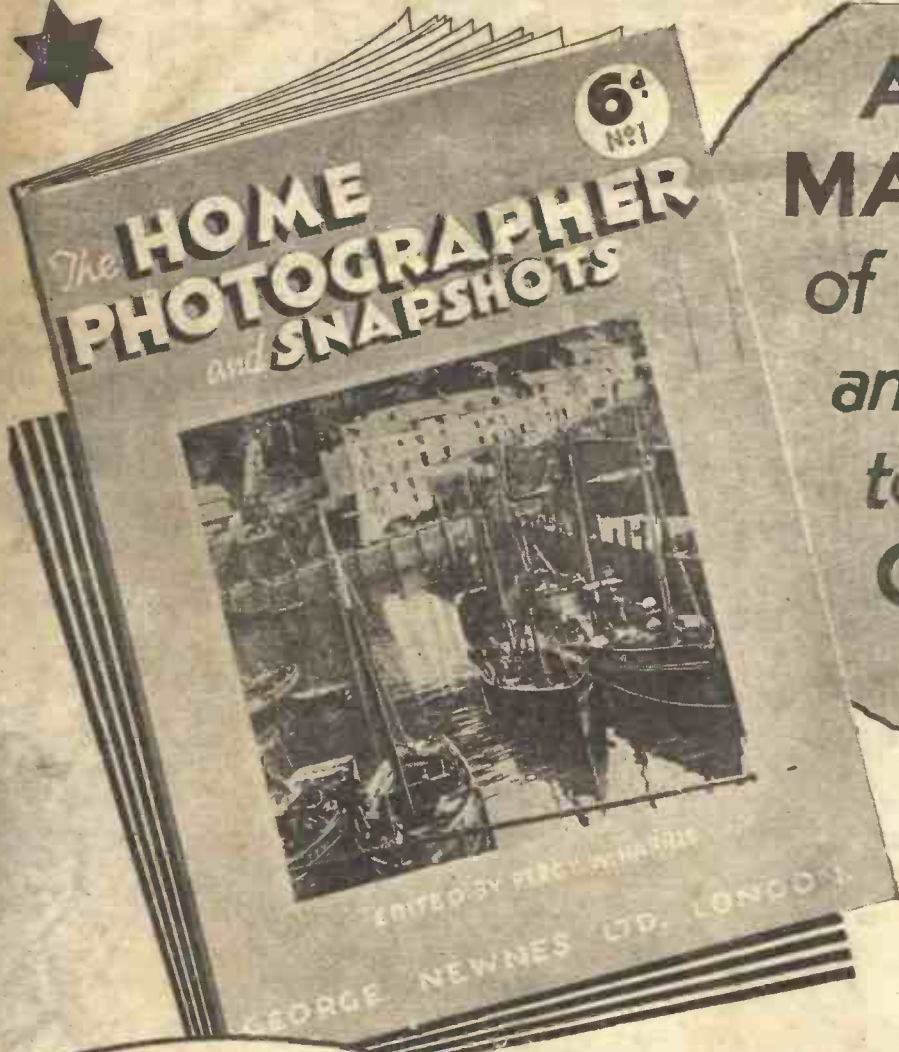

A NEW  
MAGAZINE  
of INTEREST  
and VALUE  
to EVERY  
CAMERA  
USER

No. 1 NOW  
ON SALE

### Contents

**SECRETS OF EXPOSURE**  
REMARKABLE new series of articles written by an expert in language all can understand. Your pictures will be better after reading this article.

**NEW-STYLE PICTURE CRITICISM**  
Five shillings is paid for every picture used in this section and the criticism—helpful, honest and friendly—is worth much more.

**THE YOUNG PHOTOGRAPHER**  
A special section devoted to the interests of the Young Photographer.

**THE ANIMAL LOVERS' PAGE**  
Like every other section of the magazine, this one is distinguished by a freshness of treatment and an intimacy which will assure its popularity.

**BEAUTIFUL PICTURES IN PHOTOGRAVURE**  
In the photogravure section you will see the finest pictures in sepia and green, just as if they were actual photographs toned to these tints.

**PICTURE LESSONS IN PHOTOGRAPHY**  
What better way of teaching than by photographs? See just how to develop your own films with the simplest apparatus—a jug, a bowl and a packet or two of chemicals! A remarkable new series of which this is the first.

**PRIZES! PRIZES!! PRIZES!!!**  
First Prize: Five Pounds  
Second Prize: Two Pounds  
Third Prize: One Pound

and eight prizes of five shillings each for the best pictures each month in THE HOME PHOTOGRAPHER and SNAPSHOTS Photographic Competitions. No irritating restrictions and no long waits. Full particulars are published in No. 1, Now on Sale.

HERE at last is a magnificent fully illustrated monthly magazine for every enthusiastic camera user. With new conditions, new material and new apparatus, photography has long ceased to be either the hobby of the few or one requiring technical knowledge. Everything of interest, of value and importance to photographers will be dealt with in this new illustrated magazine which will incorporate "Snapshots," that excellent pioneer magazine which has done so much to help the photographic industry.

# The HOME 6d PHOTOGRAPHER and SNAPSHOTS

Obtainable at all Newsagents, Bookstalls and Dealers, or post free 7½d. (Subscription rates: Inland and Abroad 7/6 per annum; Canada 7/- per annum), from Geo. Newnes, Ltd., 8-11, Southampton Street, Strand, London, W.C.2

Geo. Newnes, Ltd.

# R QUIESCENT COMPONENTS

*specified for the*

## 'Q.P.P. THREE-FOUR'

The enormous response to R.I. announcements concerning the "Quiescent" system and the amazing advantages to be gained by constructing or reconstructing battery sets with R.I. "Quiescent" components, proves the value and rightness of this revolutionary development. Public enthusiasm is shown by the hundreds of letters that continue to pour in from delighted constructors, who have applied the system, with R.I. components, to their sets—one correspondent writes:—

"I have been a keen radio enthusiast for the past 10 years, and have always made a special point of keeping my set up to date, and from previous experience of R.I. Components I had no hesitation in ordering the R.I. 'Quiescent' Input Transformer and Output Choke after reading your brochure on same. These components, working with 2 Pentode valves, Mazda Pen. 220A, do everything you claim for the system. The set gives

**FULL MAINS QUALITY AND VOLUME EQUAL TO ANY MAINS SET"**

The R.I. "Quiescent" brochure describes the "Quiescent" push-pull system in detail, and shows by diagrams how to apply "Quiescent" push-pull coupling to any battery set, and how to obtain new power, quality and economy in H.T. Triode output valves may be employed equally well with R.I. "Quiescent" components as pentode output valves.



**QUIESCENT TRANSFORMER**  
**15/-**

Royalty 1/6 extra.

List No. D.Y. 34. Primary inductance 30 henries without D.C., 20 henries with 1 m.a., 15 henries with 2 m.a.



**QUIESCENT CHOKE**

This choke acts as a highly efficient auto transformer coupling. It is more efficient in use than any ordinary push-pull output transformer

**12/6**

**R.I. QUIESCENT BROCHURE FREE**

Post this coupon in 3d. stamped unsealed envelope for a free copy of the R.I. "Quiescent" brochure. Your name and address will also be put on our mailing list for first news of the latest developments and components.

Name .....

Address .....

Pr. W.

Radio Instruments Ltd., Croydon, Surrey.

P. W. Gift Stamp No. 23

Printed by NEWNES & PEARSON PRINTING CO., LTD., Exmoor Street, Ladbroke Grove, W.10, and published by GEORGE NEWNES, LTD., 8-11, Southampton Street, Strand, W.C.2. Sole Agents for Australia and New Zealand: GORDON & GOTCH LTD. South Africa: CENTRAL NEWS AGENCY, LTD. Practical Wireless can be sent to any part of the world, post free, for 17/4 per annum: six months, 8/8. Registered at the General Post Office for Transmission by Canadian Magazine Post.

5-3 College

FREE INSIDE! DATA SHEET No. 12—HANDY FORMULÆ

# Practical Wireless

3<sup>D</sup>

Published every Wednesday by  
**GEORGE  
NEWNES  
LTD.**

Vol. 1. — No. 25.  
MARCH 11th, 1933.

Registered at the G.P.O. as a Newspaper.



## RADIO WORKSHOP

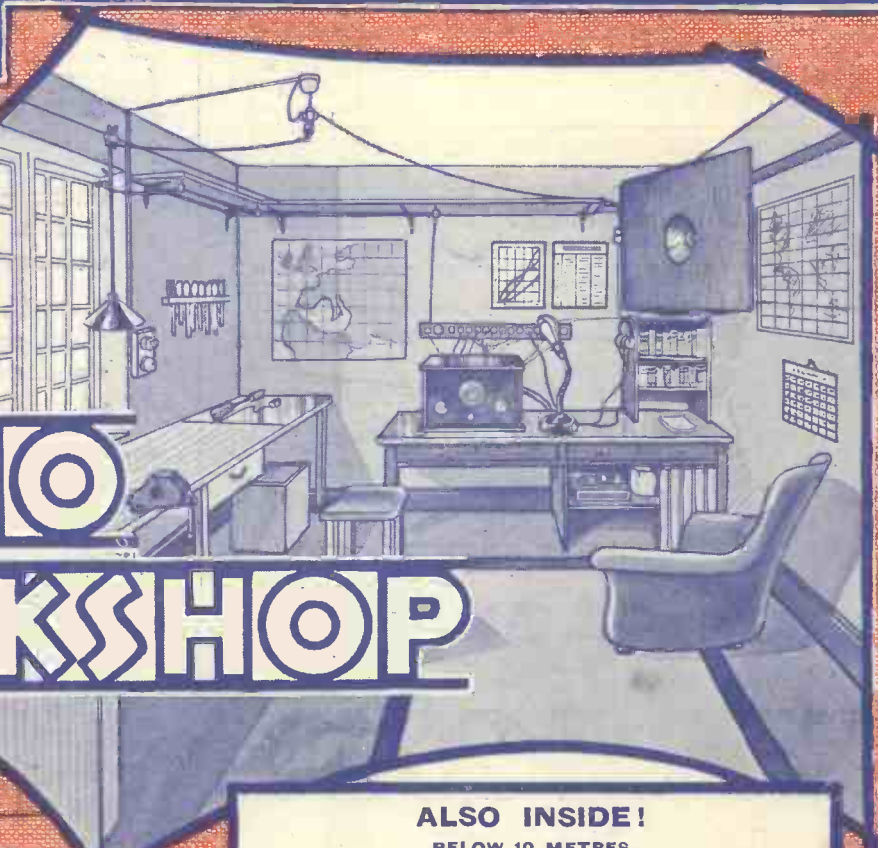

**ALSO INSIDE!**  
BELOW 10 METRES  
MORE ABOUT Q.P.-P.  
REDUCING THE NUMBER OF CONTROLS  
IMPORTANT ADD-ON COMPONENTS  
REAL TELEVISION IS HERE!  
SPECIAL BEGINNER'S SUPPLEMENT  
SHORT-WAVE SECTION, etc. etc.

Send for Free 11-Constructional Chart and Full Size Blueprint  
**NEW REVOLUTIONARY Q.P.P. KIT SET**

MAINS VOLUME AND QUALITY USING SMALL H.T. BATTERIES  
Write **PETO-SCOTT CO. LTD.**, 77 CITY ROAD, LONDON, E.C.1.

# AMAZING BARGAIN!

## Genuine B.T.H. Synchro Blue Elec. Gramo Motors

**12/-  
DOWN**



The B.T.H. Synchro-Blue Electric Gramophone motor is suitable for all A.C. 50 cycle mains.

The B.T.H. Synchro-Blue has been acknowledged by experts as one of the finest synchronous gramophone motors on the market. It is suitable for both portable and cabinet gramophones, and has a very low current consumption—playing 1,000 records per unit. There are no brushes to set up interference with radio sets. Due to a special purchase, we can offer these famous motors at a greatly reduced price. They are listed at 30/6—our price 25/-, carriage paid. Send your order immediately.

H.P. Terms, 12/- with order, and six monthly payments of 2/6. No references required. This famous motor will be despatched carriage paid on receipt of first payment of 12/-.

LIST PRICE 39/6

OUR PRICE  
**25/-**  
CASH

SEND YOUR ORDER NOW—STOCK LIMITED

## PEARL & PEARL

First in Radio

190, BISHOPSGATE, LONDON, E.C.2

# A NEW NIGHT-WATCHMAN STORY

# "The Stowaway"

BY

## W. W. JACOBS

The March

# STRAND

## MAGAZINE

**1/-**

NOW ON SALE

Geo. Newnes, Ltd.

# You must have a TD Coil for the "Q.P.P. Three-Four"

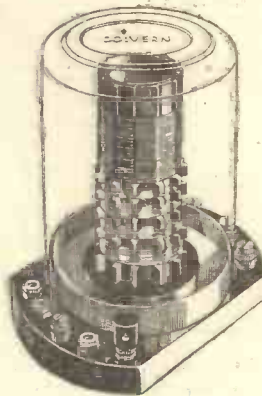

Selectivity and quality combined in this receiver.

Super Selectivity is vitally necessary under present-day broadcasting conditions. This is achieved with the Colvern TD Screened Coil.

Four Alternative Tappings are provided. They are arranged as sockets with a wander plug, giving varying degrees of selectivity. The first two tappings give aerial couplings similar to those normally employed but with greatly increased selectivity. Nos. 4 and 5 give a high degree of selectivity with weak aerial coupling, suitable for use in a swamp area.

There is no break through on the long wave band from B.B.C. stations.

PRICE  
**8/6**  
EACH

Send for the Colvern circuit booklet, RL 10.

# COLVERN LIMITED

MAWNEYS RD., ROMFORD, ESSEX.

LONDON WHOLESALE DEPOT:  
150, KINGS CROSS ROAD, W.C.1.

# Some Invaluable Practical Handbooks

This Series covers a wide field and will prove of the greatest value to everyone interested in models and how to make them; woodwork and other crafts. Each book is clearly written and fully illustrated.

### Accumulators

An up-to-date handbook dealing with every type of accumulator, methods of charging them at home, care and maintenance. This little handbook also explains how to erect a charging station.

### Motor Car Upkeep and Overhaul

In this handbook will be found information on the engine, decarbonising, valve grinding, the lighting system, the carburetter, cooling system, lubrication, springs and shock absorbers, steering gear, brakes, wheels, axles, tracing noises, etc., etc.

### Toy Making for Amateurs

Tells how to make clockwork toys, model aeroplanes, model locomotives, model boats, ingenious toys operated by sand, wooden models and toys, electrical toys, steam toys, guns, kaleidoscopes, acrobats, etc.

### Twenty-Five Tested Wireless Circuits

All the sets described have been designed to meet modern needs. They range from simple crystal receivers to a seven-valve super-heterodyne, and all the sets have been made and tested before inclusion.

### Simple Electrical Apparatus

An excellent little book for those who wish to make simple and useful electrical appliances, such as galvanometers, electric motors, dynamos and Leyden jars.

### Model Boat Building

In this book there are designs for a battleship, a speed boat, a paddle steamer and yachts, from which excellent models may be built with the help of the simple directions and diagrams that are given.

### The Home Woodworker

A fascinating book for the handyman. Clear instructions on how to make a large variety of articles in wood, together with many useful hints on wood-working.

### Model Aeroplanes and Airships

Contains full descriptions of easy-to-make models of every description that will fly.

### The Handyman's Enquire Within

Everyone should possess this book. Hundreds of practical ideas and hints of value to the man who is clever with his hands.

### 25 Simple Working Models

Ingenious and practical designs for electric, steam and clock-work models.

NEWNES'

# HOME MECHANIC BOOKS

One Shilling Each. Obtainable at all Newsagents and Bookstalls, or by post 1/2 each from George Newnes, Ltd., 8-11, Southampton St., Strand, W.C.2.

Geo. Newnes, Ltd.

STUDY  
AT  
HOME

IN YOUR  
SPARE  
TIME



CAN HAVE A  
COLLEGE TRAINING  
IN ALMOST ANY CAREER  
FOR A FEW SHILLINGS MONTHLY

## MATRICULATION

There are many ways of commencing a career, but Matriculation is the jumping-off board for all the best ones.

## CIVIL SERVICE

Suitable to both sexes. Ages 15½ to 24.

G.P.O. ENG. DEPT. CUSTOMS AND EXCISE;  
INSP. OF TAXES, Etc. NO EXPERIENCE  
REQUIRED. OPEN EXAMS.

We prepare candidates for all

## INSTITUTE EXAMS.

TECHNICAL, INSURANCE, COMMERCIAL,  
GENERAL, POLICE, Etc., Etc.

## ENGINEERS ALL BRANCHES

There are examinations which are open and suitable to you, others which are not. Get our advice before deciding.

Let me give you



DO NOT DE-

that fatherly advice

LAY - There may

which is FREE to

be chances for you

you, but which

to-day for which

may mean so

you may be too

much to you in the

late to-morrow.

future.

Every day counts

in a man's career

## LET ME BE YOUR FATHER

- Accountancy Examinations
- Advertising and Sales Management
- A.M.I. Fire E. Examination
- Applied Mechanics
- Army Certificates
- Auctioneers and Estate Agents
- Aviation Engineering
- Banking
- Boilers
- Bookkeeping, Accountancy and Modern Business Methods.
- B.Sc. (Eng.)
- B.Sc. (Estate Management)
- Building, Architecture and Clerk of Works
- Chemistry
- Civil Engineering
- Civil Service
- All Commercial Subjects
- Commercial Art
- Concrete and Structural Engineering
- Draughtsmanship, all branches
- Engineering, all branches, subjects and examinations
- General Education
- G.P.O. Eng. Dept.
- Heating and Ventilating
- Insurance

- Mathematics
- Matriculation
- Metallurgy
- Mining, all subjects
- Mining Electrical Engineering
- Motor Engineering
- Municipal and County Engineers
- Naval Architecture
- Pattern Making
- Police, Special course
- Preceptors, College of
- Pumps and Pumping Machinery
- Radio Reception
- Road Making and Maintenance
- Salesmanship
- Sanitation
- Secretarial Exams
- Ship-building
- Shorthand (Pitman's)
- Structural Engineering
- Surveying
- Teachers of Handicrafts
- Telephony and Telegraphy
- Transport Inst. Exams.
- Weights and Measures "Insp."
- Wireless Telegraphy and Telephony
- Works Managers

If you do not see your own requirements above, write to us on any subject.

IT COSTS NOTHING TO ENQUIRE

WE TEACH BY-POST IN ALL PARTS OF THE WORLD.

Also ask for Our New Book (FREE OF CHARGE)

## THE HUMAN MACHINE SECRETS OF SUCCESS.

Note Address carefully:

THE BENNETT  
COLLEGE, Ltd.  
(Dept. 192), SHEFFIELD.



Dept. 192.

**BUILD WITH YOUR OWN HANDS**

**THIS BETTER SET**

**SAVE POUNDS**

**SUCCESS A CERTAINTY**

YOU ARE TOLD EXACTLY WHAT TO DO WITH EVERY SINGLE NUT & SCREW



**89/6**  
INCLUDING VALVES

**GET YOUR FREE COPY OF MOST SUCCESSFUL CHART EVER PUBLISHED enabling you to build MOST SUCCESSFUL SET EVER BUILT!**

THE ONLY KIT YOU CAN BUILD YOURSELF EMPLOYING METALLISED S.G. HIGH-MU DETECTOR AND ECONOMY POWER PENTODE VALVES

NEVER before was there such a set within the reach of the home constructor. Never before such power from a battery set. Never before so many enthusiastic letters from constructors or so much talk about any radio set as this Lissen "Skyscraper" Kit has elicited. 50-60-70 loud-speaker stations—everybody who builds a "Skyscraper" gets results like that! Lissen have published a 1/- Constructional Chart, giving the most detailed instructions ever printed for the building of a wireless set. You can't go wrong—every part, every wire, every terminal is identified by photographs. Everybody, without any technical knowledge or skill, can safely and with COMPLETE CERTAINTY OF SUCCESS undertake to build this most modern of radio receivers from the instructions given and the parts Lissen have supplied. This new Lissen "SKYSCRAPER" Kit Set is the only one on the market that you can build yourself employing a Metallised Screened Grid Valve, High Mu Detector and Economy Power Pentode. Around these three valves Lissen have designed a home constructor's kit the equal of which there has never been before. Why be satisfied with whispering foreign stations when you can BUILD WITH YOUR OWN HANDS this Lissen "SKYSCRAPER" that will bring in loudly and clearly distant stations in a profusion that will add largely to your enjoyment of radio?



**YOURS FOR ONLY 8/6 DOWN**

**COMPLETE IN CABINET WITH LOUDSPEAKER £6/5** or 11/6 down & twelve monthly payments of 10/6

To-day you can buy the LISSEN "SKYSCRAPER" KIT on Gradual Payment Terms "Skyscraper" Chassis Kit, complete with Valves, CASH PRICE, 89/6. Or 8/6 down and twelve monthly payments of 7/6. "Skyscraper" Kit complete with Walnut Cabinet and in-built Loud-speaker, as illustrated: £6 5s. cash. Or 11/6 down and twelve monthly payments of 10/6. You can get the Lissen "Skyscraper" Chart FREE from any radio dealer, or by posting the COUPON below direct to factory.

**COUPON**  
To Lissen, Ltd., Publicity Dept. P.R.40, Worpole Road, Isleworth Middlesex.  
Please send me FREE copy of your 1/- Skyscraper Chart.  
Name .....  
Address .....

**LISSEN "SKYSCRAPER" KIT 3**





EDITOR:  
 Vol. 1. No. 25 || F. J. CAMM || March 11th, 1933  
 Technical Staff:  
 H. J. Barton Chapple, Wh. Sch., B.Sc. (Hons.), A.M.I.E.E.  
 Frank Preston, F.R.A.; W. J. Delaney, W. B. Richardson.

# ROUND *the* WORLD of WIRELESS

## New Aerial-System for Vienna Super-power Station

TO secure a more directional broadcast and thus ensure better reception in the eastern and south-western districts of Austria, a new aerial system has been devised for the 120 kilowatt station now nearing completion on Mount Bisamberg, overlooking the capital. Two masts, about 430 feet high, have been erected, one of which carries the aerial, and the other made to serve as a reflector tower, both being connected to the transmitter. The conventional metallic earth-ring has been dispensed with, and in its place a counterpoise earth has been adopted, consisting of a network of copper wire—there are roughly eight miles of this cable used—supported by thirty-six smaller masts. The transmitter will radiate an energy equal to that of the new Leipzig station, and has been equipped with two giant 300 kilowatt valves.

## Chicago Also Tries Out New Aerial System

ALTHOUGH good signals at present are being received from a number of U.S.A. transmitters, KYW, Chicago (Ill.), on 293.9 metres (1,020 kc/s), does not yet figure very prominently in our logs. Within the next week or so, however, according to an American report, broadcasts from that station may be better heard than hitherto on this side of the Atlantic, as the engineers have now erected what they term a "concentrator aerial." Not only are signals greatly increased in intensity by this means, but they have been found less liable to fade. The main aerial, or "exciter," is a vertical copper rod 204 feet high, fixed on a wooden mast, 200 feet in height. The "concentrator aerial" is also of copper, and of a similar structure. Situated at some distance from the exciter and adjusted to respond to the frequency used for the station's broadcasts, its object is to reflect the waves emitted from the former, and thus help to intensify them over the area required. Experiments have proved that with the new aerial installation a transmitter rated at 10 kilowatts, and working on a frequency between 550 and 750 kilocycles, will radiate a signal equal in power to the average 50-kilowatt station. In the course of the tests a series of experiments were made with various earthing circuits, but the engineers finally adopted, as the most

favourable system, a large copper sheet with a number of strips radiating in all directions.

## Dutch S O S Calls

SIMILAR to the S O S calls sent out by the B.C.C., the Dutch transmitters broadcast daily a number of police messages. According to recent statistics these transmissions, in the course of a few months, have led to the arrest of a number of criminals. In addition to this service, by arrangement with the Post Office authorities, the Hilversum and Huizen studios also broadcast the text of private telegrams in such cases where, through some cause, such

usually carried out at 10.30 p.m. G.M.T. and last until midnight. During March these relays will be given on the following dates: 4, 9, 11, 16, 18, 23, 25, and 30.

## How They Do Things in America!

THE installation of Franklin Roosevelt, as President of the United States, has induced the National Broadcasting Company to carry out a broadcast on a larger scale than has hitherto been attempted for any previous National demonstration. Fifteen different sites have been found for microphones, in addition to five mobile short-wave transmitters, for these both motor lorries and aeroplanes are to be used.

The relay necessitates the service of some thirty engineers and ten N.B.C. announcers, who are to be assisted by a dozen or more commentators to describe the historical event. Arrangements have been made to give a "bird's eye" view of street scenes from the airship *Akron*, and aeroplanes may be employed for the same purpose. In the procession, it is reported that the N.B.C. have been authorized to include a travelling short-wave transmitter equipped with parabolic microphones in order to secure a background of military music and the cheering of the crowds. The broadcast will be carried out through all U.S.A. transmitters, including a number of short-wave stations in the various networks. There appears to be little doubt that our American cousins intend that the entire world shall assist at these festivities. . . . Oh, Boy!

## Also in this Issue!

Real Television is Here!	... 1173
Adjusting & Operating The Q.P.-P. Three-Four...	... 1186
The Design of Loud-speakers	1183
Below Ten Metres	... 1179
Fitting up a Radio Workshop	1190
Beginner's Supplement	... 1195
Short-wave Section	... 1202
What is Wrong?	... 1177
Snags & Suggestions	... 1197

as an error in an address, they cannot be delivered in the usual manner. They need not necessarily be the conventional S O S calls launched by hospitals, etc., but may be purely communications of a private nature.

Regular Relay of Madrid Programmes  
 RADIO Ibero-Americana (EAQ), the Spanish short-wave transmitter on 30.3 metres, in addition to special broadcasts organised for the benefit of European listeners, frequently relays programmes from the Madrid EAJ7 studio. These are

**THE FIRST MILESTONE!**  
 NEXT WEEK'S ISSUE completes Vol. 1 of "Practical Wireless." An Announcement regarding Binding Case & Index will be made next week.

## Possible Broadcasting Developments in Spain

IN the course of eighteen months, much has been published regarding the re-organization of the Spanish broadcasting system, and many attempts have already been made to carry out a new scheme, but up to the present none has matured. It would appear, however, that with the backing of the new Republican Government a start will shortly be made to put Spanish broadcasting on a semi-official footing and the authorities have secured, as a consultant, Dr. Hans Bredow who was, until recently, the High Commissioner of the German Reichsfunk. In these circumstances it is expected that a complete re-organization of the Spanish network will be carried out in 1933-4.

# ROUND *the* WORLD of WIRELESS (Continued)

## Extension of Empire Broadcasts

FROM April 2nd, the hours of Empire broadcasting to the Indian, African and West African Zones are to be extended. Transmissions will begin at 1.30 p.m. and will last until 5.30 p.m. This increase in the programme time, whilst satisfying listeners within the Indian Zone, will also provide dwellers in Western Australia with an increased service, since the same two wavelengths, namely, GSC 31.30 metres and GSD, 25.53 metres, are used for both Zones.

## The B.B.C. S O S Transmissions

DURING 1932 a total of 1,007 S O S and similar messages was broadcast and, generally speaking, the results were slightly more successful than in the previous twelve months, the percentage working out at 40.91 as against 40.21 in 1931. The number of unsuccessful messages in which the results are unknown also continued to drop, and now stands at 3.28 per cent. It has been ascertained that an S O S put out through the National stations is more likely to reach the interested party than if sent through the Regional network.

## The Secrets of the Brussels Conference

NO official information has yet been obtained regarding the work carried out by the *Union Internationale de Radio-diffusion* at its last meeting at Brussels, but it is reported that a preliminary plan for the re-allocation of wavelengths has been prepared for submission to the meeting of delegates at Lucerne in June next. The difficulty of the problems to be solved may be judged by the fact that when the Prague plan was drawn up in 1929, Europe possessed 200 broadcasting stations with an aggregate of 420 kilowatts. To-day a totally different situation must be faced, as the number of transmitters is now 254, without taking into consideration some stations under construction and others of which the installation has been proposed and the power radiated has reached 4,600 kilowatts.

If an improvement is to be made in the general reception of broadcasts in individual countries, and heterodynes between transmitters working on neighbouring channels are to be avoided, an 11 kilocycle separation must be obtained. Moreover, a new re-allocation of wavelengths is necessary and a better geographical allotment of channels. By this is meant that stations working on neighbouring channels must be at the greatest distance possible from each other. Steps must also be taken to limit the output of the new transmitters. Finally, the question of the large number of relays taking the same programme in one country needs careful consideration; the transmitters must be synchronized by crystal control or other means, if interference is to be avoided. The number of common waves used by stations in different States may have to be reduced as, although in many instances,

## INTERESTING and TOPICAL PARAGRAPHS

they are widely separated, they cause trouble in the ether. To achieve a workable plan, some European States may be called upon to give up one or two wavelengths as an extension of the waveband does not appear probable; if no sacrifices are made it is difficult to realize that a mere shuffling of channels will achieve success.

## THE MOUNT EVEREST EXPEDITION SOME INTERESTING FACTS



The portable transmitter taken by the Mount Everest Expedition was designed and supplied by Loomes Radio, of Earls Court Road (G6RL and G6US).

The ex W.D. Mark III transmitter was chosen as a basis to work on, as this instrument was designed originally for very hard and rough usage, being built of half-inch hardwood and the whole being covered with canvas for weather protection.

The transmitter was redesigned to work on wavelengths of 60, 85, and 110 metres. The transmitter, with its associated components of six spare valves, hand generator and Siemens inert cells can be carried by one man, the weight being about 40 pounds. The high tension is supplied by a hand generator, and low tension by Siemens inert cells.

Batteries and valves are carried in specially made teak cases lined with felt to protect them from shock and the extreme cold. The transmitter will be used at camp No. 3, which is to be erected at an altitude of 21,000 feet; this will be linked in turn with the final camp by land lines.

The base camp transmitter is a high power commercial job which will keep the members of the Expedition in touch with the outside world.

## Carrier Pigeons and Wireless Waves

FROM experiments recently carried out in Italy, it has been observed that in racing competitions, in which a large number of carrier pigeons were released, those birds whose route took them in the neighbourhood of wireless stations, lost their sense of direction and, in most instances, flying blindly, failed to reach home. Tests made conclusively demonstrated that such was not the case when the stations were "off the air." In consequence, the Italian clubs are negotiating with the broadcasting authorities with a view to fixing the times at which these pigeon races can be run, namely, at periods when the local station is resting.

## Will India Build a High-power Station?

ACCORDING to a report from the Continent, there is a possibility that India may install a high-power broadcasting station with a view to the relay of the Empire programmes. Such a transmitter would make them available to a larger number of listeners, as the majority of them do not possess receivers capable of tuning in the short-wave channels on which the British wireless entertainments are sent.

## The New Moscow Super Transmitter

ALTHOUGH no definite news has yet been broadcast regarding the formal opening of the 500 kilowatt Noghinsk station it is unofficially stated that

it will be testing shortly on a wavelength between 900 and 1,000 metres. The actual frequency to be adopted will only be decided after experiments have been made.

## Danish Radio to Help Theatres

AS in Austria, Denmark proposes to assist the Copenhagen theatres by granting an annual subsidy taken from the income derived from wireless licences. The matter is to be thrashed out in Parliament as, in general, Danish listeners declare themselves against such a step taken, inasmuch as they consider that the Copenhagen National Theatre is enjoyed by the inhabitants of the capital only and, consequently a loss, if any, should not be borne by country subscribers.

## Chicago, Classical Music and Dyspepsia!

MANY curious tales emanate from the United States, and it is difficult to believe that they are published in all seriousness. A Chicago medical practitioner appears to have stated that following intensive study he has discovered that radio has valuable medicinal properties. He is a specialist in digestive disorders, and from experiments made affirms that a broadcast of classical music is an excellent remedy for indigestion! Jazz is likely to give the listener considerable pain. We can imagine the doctor's prescriptions in the near future: "A little light symphony taken after meals will keep you fit!"

(Continued on page 1176)

## SOLVE THIS!

### Problem No. 25.

Being attracted by the claims of the Fury Four (Battery Model), Simpson decided to make it up. He thought he would improve on the design by using a Screen-Grid valve in the Detector stage, and accordingly fitted an additional H.T. positive lead for the screening grid, using the correct value of resistance. No other alterations were made to the circuit, but on test, results were disappointing. He took the set round to a friend's house, and tried it against a Fury Four made to specification. The latter gave louder results. Why did Simpson's arrangement fail to give the results he expected from the S.G. valve? Three books will be awarded to the first three correct solutions opened. Address your solution to The Editor, PRACTICAL WIRELESS, Geo. Newnes, Ltd., 8-11, Southampton Street, Strand, London, W.C.2. Mark your envelope "Problem No. 25," and do not enclose any other correspondence with your solution.

### SOLUTION TO PROBLEM No. 24.

The metal coating of the mains valve was, of course, joined direct to the cathode. When Jackson connected this coating to earth by means of the wire, he was joining the cathode to earth, and as the biasing resistance was inserted in the cathode lead, he was short-circuiting the bias resistance. This naturally led to instability.

The following three readers received books in connection with Problem No. 23:—  
Wm. C. Hand, 58, Raymond Road, Redruth, Cornwall.  
J. H. Braddy, 4, Harbledown Road, Fulham, S.W.6.  
A. G. Stock, 7, Alfred Street, Bargoed, South Wales.

# REAL TELEVISION IS HERE!



1925

Mr. J. L. Baird demonstrating the first crude television images at Selfridge's in 1925.

WHEN so many mis-statements of fact are given for the public to read, I suppose it is only natural that the true explanation of what television implies and what it can now give should be misunderstood by so many. I therefore welcome the opportunity which has been afforded to me by PRACTICAL WIRELESS to voice a few personal comments on the matter.

The world's first demonstration of true television was given by me as far back as January, 1926, before Members of the Royal Institution. Steady and very material progress has been made since that date, and the present transmissions now sent out by the B.B.C., using the Baird System, give sufficient evidence that Television is worth while.

The general public are under the impression that television was first broadcast through the B.B.C. only a relatively short time ago, and it may therefore be a surprise to many to learn that this is not the case, for the first broadcast of television through the old 2LO Station took place as far back as 1926. It was in July of that year that an application was made to the B.B.C. for permission to send out television from Motograph House, then the headquarters of the Company, and the permission was granted with the proviso that use should

not be made of it for propaganda purposes. Several transmissions took place through 2LO, and were received by our engineers, but these were brought to an abrupt conclusion by the Post Office authorities, and it was then resolved that we would send out



Mr. J. L. Baird.

our own television programmes. A licence for the station 2TV was obtained whereby we were authorised to transmit television on a power of  $\frac{1}{2}$  kilowatt and a wavelength of 200 metres. The experiments through the B.B.C., however, short though they were of duration, had been sufficient to show definitely that the available sideband of 2LO was sufficient to send out television images. That was as far back as 1926, and, having witnessed a successful

transmission through that station (a fact which then could not be made public), I was, to say the least, "amused"

by the dogmatic assertions of "authorities" who, by making elaborate calculations based on the entirely erroneous assumption that television was transmitted by dots, "proved" to their own satisfaction that television on a side-band of 10 kilocycles was quite impossible.

To what extent television images may be improved within the present side-band limitation is a matter upon which it would be a mistake to dogmatize, but it must not be taken for granted that television is bound by the same laws which govern cinematography. In essence, there is really no need to send as many as 24 pictures per second. At the present moment only  $12\frac{1}{2}$  pictures per second are sent, but if, for example, we used a screen upon which was impressed a permanent or semi-permanent image, the recording point being preceded by an obliterating point, that is to say, that on each traversal of the screen, the previous image being obliterated by a point immediately preceding the recording point, then the limit of picture speed would be fixed by the rapidity of movement of the person or scene being televised, and not by any question of flicker. I reiterate, the speed of picture transmission in television is not bound by the laws of cinematography, and those who endeavour to fix limitations to the progress of television by basing their arguments upon established arts, may fall into as grave errors as those who based their calculations upon half-tone blocks, and assumed the television image to be made up of dots.

Real television is definitely and undeniably here, and I would urge everyone to take steps to see for themselves what can be offered by the service which is now being given by the B.B.C.



1933

The very latest televisor.

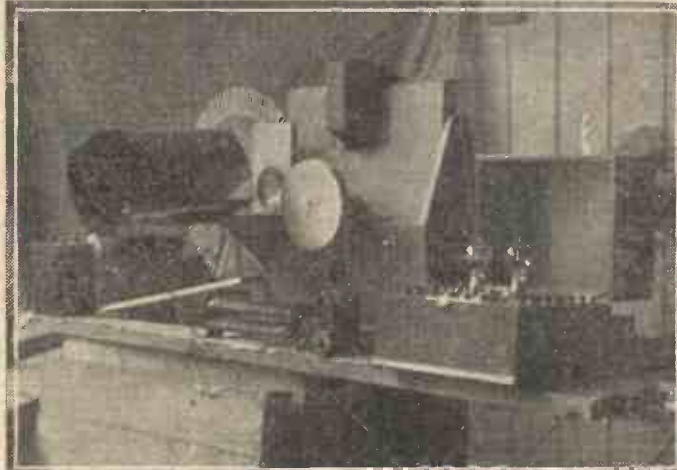

One of the first models of television receiving apparatus used by Mr. Baird. Its age can be calculated from the old type "R" valves used in the wireless amplifier.



Mr. H. J. Barton Chapple giving an address on television recently to the Rotary Club at Nottingham.

THE greater the progress made in every pioneering scientific work the greater seems to be the incentive for ill-advised and misinformed critics to burst forth into print and present the case in an entirely incorrect light. How easy it is for the critic to castigate! I suppose that is the function of a critic; but why, oh! why, does he not make sure of his facts before lauding an opinion?

I have been tempted to write in this strain after reading some of the remarks which appeared recently in a contemporary. First of all let us obtain an actual conception of what we imply by real or true television. It is the ability to see, with the aid of electrical methods of transmission, an image reproduction of moving or stationary objects situated at some distance from the observer. Don't confuse the issue by attempting to set up personal standards of the performance required before it will suit individual tastes. We are still doing that with wireless and it gets us nowhere. To-day the transmission of sight by radio is a matter of accomplishment, not speculation.

I do not propose to prognosticate indiscriminately—that does untold harm. So also does the cynical and biased criticism of those who rely on hearsay. Wireless and the telephone have satiated the desires of one of our senses—hearing—but complete intelligence will never be conveyed until both the senses of sight and hearing are harnessed and move together.

When one starts making comparisons with something of quite a different character in order to strengthen an argument the weakness of the argument is disclosed. Of course the cinema gives genuine pleasure to the people, but is the pleasure derived from the system used to make and project the "celluloid" events on to the screen or is it because of the nature of the subjects shown.

Reference was made in a contemporary to the Baird system of television and an effort was made to show what stopped this system from becoming real television. The ideas put forward, however, dodged the issue all along the line. For example, the system was blamed for the artificial limitations imposed by the vehicle used to transmit the signals, that is, radio. Would you condemn your loud-speaker, which you know, to be good, because the sound you

heard from it was of poor quality owing to using it in conjunction with a wireless set that was incapable of passing through its various stages an undistorted signal?

The system is not at fault, but the apparatus built has to conform to certain frequency standards which at once throttle it or

hold it back while all the time the system has equipment calmly waiting to show better results. Yet the writer in question says the system is doomed to failure because of a limitation imposed by an external body!

Again, it was said that mathematically it can be proved that television is impossible with present-day knowledge and technique. To this I would say that mathematically I can prove that one equals two, but I do not shout this fact from the housetops, for the simple and sufficient reason that the original premises were wrong. [Of course, one can prove without mathematics that a critic knows something less than nothing, but it still remains a matter of opinion.—ED.]

I can well remember the early mathematical theorists "proving" quite conclusively by using the ridiculous "dot" theory that a television transmission such as we now have presented to us by the B.B.C. service was absolutely impossible. No one can deny that television has a difficult furrow to plough, but why strew hypothetical obstacles in its path? It is beyond my comprehension why so many people have attempted to deal with the question by quoting a picture point analogy and referring to newspaper illustrations, when strip scanning is used almost universally for television purposes.

In detailing all the so-called drawbacks which are alleged to make the future of television gloomy, mention is made of distortion due to incorrect amplification, together with fading and heterodynes in the ether. Surely this is carrying things too far—cannot we say the same about ordinary reception of sound—they bear no relation to television as television? At the present moment television signals in this country are being broadcast by only one B.B.C. station, and if the same single service of short duration was offered to listeners for the use of their sound-receiving apparatus would you blame the system when you encountered fading outside the station's service area—of course not.

Allusion is also made to the inadequacy of brilliance in the source of illumination at the receiving end, and this is given as one of the reasons why more pictures per second are not presented by the television apparatus. This, again, is a travesty of truth. The Baird grid cell working in

conjunction with a projection lamp of high intensity gives brilliant images and increasing the speed or adding to the number of lines in a complete scan would still give sufficient brilliance in the final image. Then, again, there is the sodium lamp developed in Germany by Fernseh A.G. who sponsor the Baird interests in that country.

If we had adopted the same attitude of drawing up so-called standards of perfection for radio transmission and reception in those early days when we listened with rapture to what were travesties of sound by wireless, where would the industry be to-day?

## IGNORE CRITICS OF TELEVISION

By F. J. CAMM.

IT is unfortunately a fact that in all branches of science there are two classes, the pioneers and the plodders. Standing a comfortable distance away from these two classes you will find a smaller but unclassified group—the critics, and now and again the critics combine with the plodders and go out to attack the pioneers.

Television is no exception to this. One has only to do something in this life to arouse the critics, who batten themselves like barnacles on to anything which can be criticised and provide them with matter for a few lines at a penny a line. It is a very wise axiom that if you have no knowledge of a subject it is wise not to rush in and exhibit the fact. Critics of Television above all very much remind me of the old proverb about the blind trying to lead the blind. I have watched the growth of television from the time of Mr. Baird's first demonstration down to date, and PRACTICAL WIRELESS is in the fortunate position of being able to say that it will always be the first paper to publish details of television developments as they happen. I strongly advise all readers of this paper to ignore the criticisms, inspired and ill-informed, which have hampered its development in the past. Those who villify, condemn and disparage, are seldom more than arm-chair critics knowing little or nothing of the subject. You can find a parallel in the case of aviation. Wilbur Wright, having successfully demonstrated his aeroplane in America, arrived at Pau to fly it before some French experts, only to find himself surrounded there by the office-boy type of scribe anxious to prove to him that his machine could not possibly fly. His retort was: "Parrots talk; they cannot fly." We all know the story of the man who visited the Zoo and did not believe the giraffe! Uneducated, the inspired critics unfortunately are too easily endowed with critics' talons by lay editors who do not take sufficient trouble to investigate the qualifications of their contributors, and they permit untrained and uneducated people to join that reprehensible if select band of critics who, being unable to assimilate ordinary facts, bury their heads in the sand like the ostrich. Whilst one is always delighted to have criticisms from capable critics, I feel very strongly that television has not had a square deal, and for this reason I have opened the columns of this paper to Mr. Baird and to Mr. Barton Chapple, so that they can state their case. Television is inevitable; real television is here waiting on the doorstep, and none of the vapourings of youthful critics will stop it.

# IMPROVEMENTS AND REFINEMENTS

By GILBERT E. TWINING

This Article Describes the Benefit to be Obtained from Fitting Some Exterior Refinements to any Good Standard Receiver

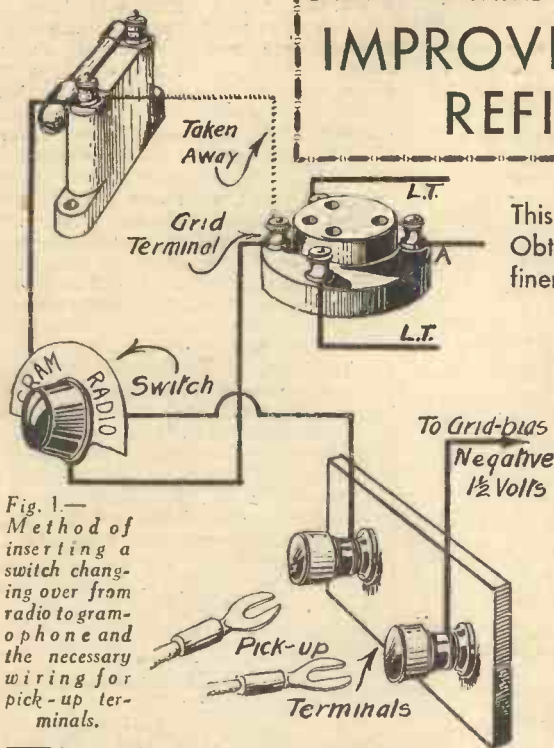

Fig. 1.— Method of inserting a switch changing over from radio to gramophone and the necessary wiring for pick-up terminals.

TO conscientious listeners who enjoy experimenting to improve their sets, also to those who have sets which are more than a year old and have not the latest gadgets incorporated in them, the following notes should be of interest. A good set will give excellent reproduction over a long period and the deterioration which takes place does so very slowly apart from actual breakdowns; from this it will be seen that a set which is slightly out of date in the way of refinements, but still giving good service, can very easily be brought up to modern requirements by the addition of inexpensive components. Naturally, all the refinements suggested here will not be applicable to all old sets, for some may already have them incorporated, but there must be some receivers, however, that will benefit from at least one of the following additions.

### Pick-ups

Perhaps one of the most outstanding refinements a set can have is the fitting of pick-up terminals, enabling by means of a switch, gramophone records or radio reception to be obtained at will. There are several different methods whereby a pick-up may be fitted, some being cheaper than others, however. It is possible to get results if one side of the pick-up is connected to one end of the grid-leak, which is joined to the detector valve,

the other lead of the pick-up being connected to low-tension negative; this is not generally considered good enough, and usually distortion is noticeable on account of lack of bias to the valve. A better way, in a set having a low-frequency stage where the power valve is fed by the detector, is to connect one of the leads from the pick-up to the grid terminal of the detector valve-holder; the other lead going to grid-bias negative,  $1\frac{1}{2}$  volts. In some cases the G.B. can quite well be altered to 3 volts provided it does not result in distortion. Bias is introduced to prevent the pick-up output from overloading the valve. In Fig. 1 is shown the

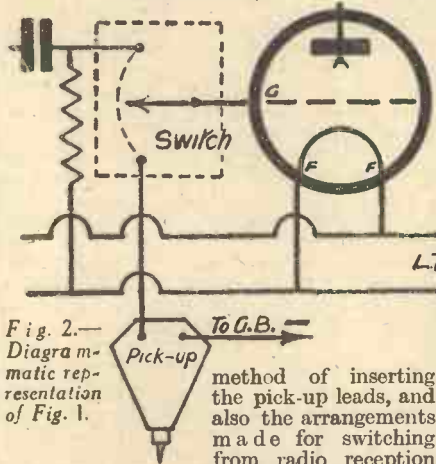

Fig. 2.— Diagrammatic representation of Fig. 1.

method of inserting the pick-up leads, and also the arrangements made for switching from radio reception to gramophone. Fig.

2 is the diagrammatic representation of Fig. 1. It is necessary to fit a volume control if one is not already built into the pick-up arm, and this should be a potentiometer of approximately 100,000 ohms. The best position is, naturally, on the motor board, where it can be easily operated. The slider of the potentiometer is connected to the grid of the detector valve through the change-over switch, the two other terminals on the volume control are joined to the two pick-up leads (see Figs. 3 and 4).

### A L.F. Volume Control

An excellent method of controlling volume is shown in Figs. 5 and 6. It has the advantage that even when the volume is cut right down to a whisper the quality does not suffer. It is a potentiometer

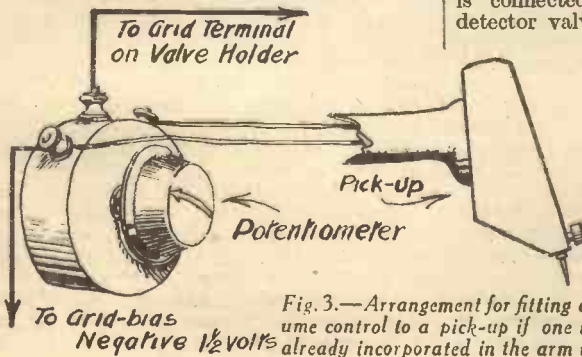

Fig. 3.— Arrangement for fitting a volume control to a pick-up if one is not already incorporated in the arm itself.

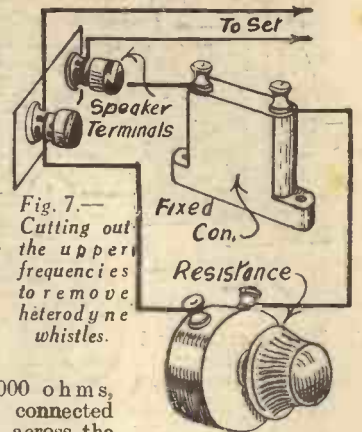

Fig. 7.— Cutting out the upper frequencies to remove heterodyne whistles.

of 250,000 ohms, and is connected directly across the secondary windings of the low-frequency transformer. The grid-bias wiring is left intact, but the grid of the power valve is connected to the slider or moving arm of the potentiometer. As the slider moves towards the end of the secondary windings of the transformer, remote from the grid-bias, the voltage applied to the valve is increased and likewise when moved in the opposite direction the voltage decreases.

### Heterodyne Filter

Most people are acquainted with the annoying interference of the high-pitched heterodyne whistle, especially noticeable in districts where jamming of stations tends to upset reception. Many of the foreign stations have increased their power to such an extent that this kind of interference presents a big problem. It must be understood that a carrier wave of any given frequency is always accompanied by side-band frequencies. Thus two powerful stations working with a separation of only 9 kilocycles are likely to cause interference by the heterodyning of the side-band frequencies of the unwanted station with the carrier frequency of the wanted station. The action of a whistle filter is to cut out all the very high frequencies of approximately 5,000 cycles and

(Continued overleaf.)

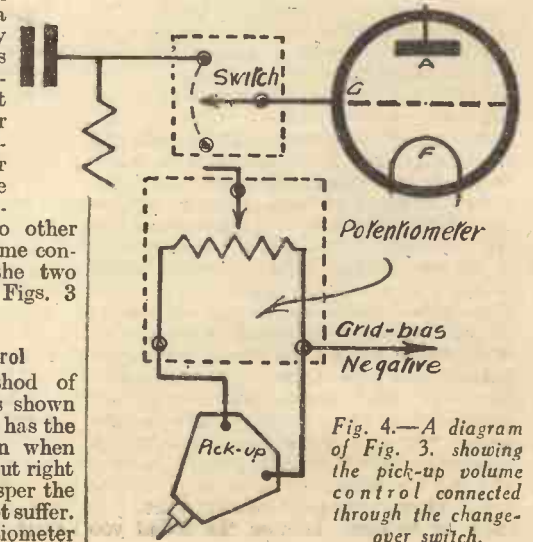

Fig. 4.— A diagram of Fig. 3, showing the pick-up volume control connected through the change-over switch.

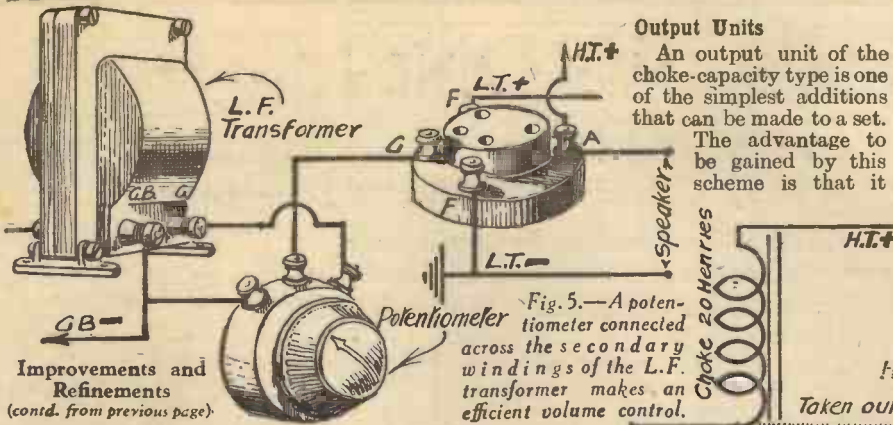

Fig. 5.—A potentiometer connected across the secondary windings of the L.F. transformer makes an efficient volume control.

Improvements and Refinements (contd. from previous page)

over, and as the frequency of the whistle is probably far greater than this, it obviously will be lost. When eliminating this type of interference it must be remembered that the set's frequency response must not be cut down too low otherwise a great sacrifice in quality will be the result. Where a choke output circuit is incorporated in the set, similar to the one about to be described, it is an easy matter to add a high note cut-out. One of the simplest forms of control is shown in Fig. 7—this will effectively remove the upper frequencies. It consists of a condenser of suitable value in series with a variable resistance shunted across the loud-speaker terminals. A variable resistance of approximately 10,000 ohms and a fixed condenser of 0.25 mfd. is used. The more resistance in circuit the less the upper note cut off and, therefore, as the value of the resistance is reduced so will the cut-off of the high notes be greater. The point to remember is, that for good reproduction, frequencies from approximately 50 cycles up to 3,400 cycles are sufficient for the loud-speaker to respond to, for anything much above these will also reproduce the high-pitched whistle formed by the adjacent carrier waves.

Fig. 8.—An output choke and condenser showing the alteration in the wiring.

enables mains operation with high voltages to be used without fear of damaging the loud-speaker caused by the mains current passing through the speaker windings, for unless a filter is used the windings have to carry the full anode current of

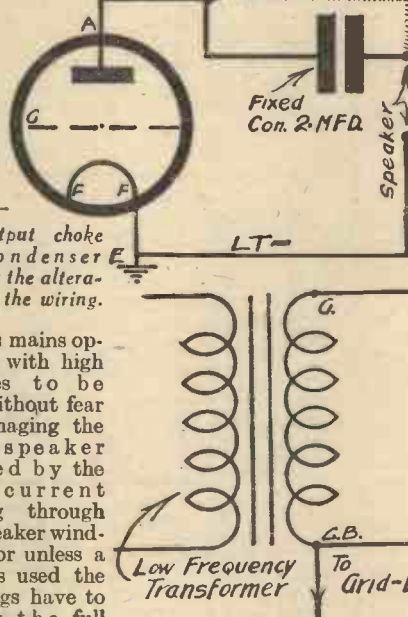

Fig. 6.—Diagrammatic form of Fig. 5.

the power valve. If this current is not flowing in the right direction through the coils, and it will not be if the positive lead of the loud-speaker is not connected to the positive terminal of the set and also the negative to negative, it will tend to weaken the magnets; as a matter of fact, if used in this manner for any length of time, it will actually demagnetise them considerably. But, with the output filter circuit, it does not matter which way round the loud-speaker leads are connected to the set. It is also possible to correct any fault in the tone of the speaker by altering the values of the two components, in any case the speaker is working under more satisfactory conditions if it is isolated from the set. Speaker extensions can be carried out with safety and no fear of receiving an electric shock if the two wires are inadvertently touched. The essential components are a high inductance choke and a low impedance by-pass condenser. The choke should not be less than 20 henries and the condenser of 2 microfarads at least. The connections can easily be followed from Fig. 8.

ROUND THE WORLD OF WIRELESS—Continued from page 1172

**Gramophone as Safety Device for Miners**  
 IT is believed that a novel idea of the manager of a large South Wales colliery will be responsible for minimizing the number of accidents in coal mines. When the miners at the Wyndham Colliery are about to descend the pits a stentorian voice warns them of the chief points of danger in underground working. A bell tolls and a voice then says: "Hullo! Manager Calling! Safety First. Search your pockets for matches, etc., before you go down the pit. Don't carry tools and blocks of timber in the cage with you. Take care of your Safety Lamps, hang them up in a safe position. Don't walk the engine plane when the ropes are in motion. Don't go in front of the trams where the gradient is over three inches per yard. You must not work under overhanging coal or ground unless securely spragged. Hauliers, take care of the horses under your charge, don't abuse them, treat them kindly, take your horses safely to the stables at the end of the shift. Cases of ill-treatment will be severely dealt with." Special gramophone records have been made by "His Master's Voice," which are played through loud-speakers situated at the pit-head whenever a party of men go on duty. Mr. D. Llewellyn Richards, the manager of the mine, conceived the idea of gramophone warnings

when he was listening to an SOS broadcast by the B.B.C. He had found that after the men had once read a printed warning they look little further notice of it. He realized in this case how much stronger an appeal through the ear would be than through the eye. He at once communicated with The Gramophone Company in London, who made two special records on which are warnings. In order that these should not become too familiar, different ones are played from day to day. It is reported that the number of small accidents has been reduced since the gramophone has been installed at the colliery, and Mr. Richards has demonstrated his innovation before a number of inspectors of the Ministry of Mines with a view to the adoption of this method of warnings in all collieries in the country.

**Wireless and Sound Beacon for Irish Waters**  
 A NEW Marconi automatic wireless beacon is to be installed in the Irish Lightship *Comet* to the order of the Commissioners of Irish Lights. The wireless beacon will have an energy of 100 watts in the aerial, and will be operated in conjunction with a submarine sound signalling device to enable navigators to ascertain not only their position in respect to the lightship, but also their distance from it.

During the transmission periods the wireless beacon will transmit a warning dash, followed by a series of dots at regular intervals. The submarine sound signalling device will transmit a signal, the beginning of which will be synchronized with the end of the five seconds warning dash of the wireless. Wireless waves travel with the speed of light and are therefore received practically without time lag by any receiving station within the service area of the beacon, while the sound waves emitted by the submarine signalling device travel through water at the rate of 4,800 feet per second. The signals will be arranged so that the number of dots received by wireless before the reception of the submarine signal will be equal to the number of miles the receiving ship is from the beacon. The navigator will thus be enabled to ascertain his distance from the beacon without computation. The lightship will have a distinctive signal, which will be emitted before each transmission.

The provision of lightships with wireless beacons working in conjunction with submarine sounding devices is a development of considerable interest to coastal authorities, and the practice has been adopted at home and abroad. A combined beacon of this type was recently fitted to a

(Continued on page 1178.)

# WHAT IS WRONG? — 4 —

This Week the Author Deals with a Further Series of Tests which should be Applied when Locating Faults in a Receiver. By FRANK PRESTON, F.R.A.

### Cutting Out L.F. and H.F. Valves

If the receiver passes all the tests so far referred to and yet fails to operate in the desired manner, a further series of experiments will become necessary. Those to be described are particularly useful as a means of finding the cause of crackling noises and distortion, but they will prove very effective in detecting the source of any other kind of trouble.

This time we start by cutting out the last valve, which involves the transference of the loud-speaker wires to the anode circuit of the previous valve. To do this the connections of the coupling component (transformer, L.F. choke, or resistance) in the anode circuit of the penultimate valve should be removed and joined to the loud-speaker leads, as shown in the sketch of Fig. 16. When the set embodies only a single L.F. stage, there will probably be insufficient power to drive a speaker, and therefore, it will be desirable to employ 'phones instead. If reception is normal and the distortion or crackling no longer exists, it will be obvious that the fault was in the output stage, and by applying the tests already mentioned, there should be no difficulty in tracking down the defective part. But if the fault still remains, we must eliminate the first L.F. stage (when two are used) and follow a similar system of deduction.

Having arrived at the detector we shall know with certainty that any remaining defects must be concerned with either this or preceding valves. Rather than test the detector at this stage, we will eliminate the preceding valves one at a time. To put the first valve out of action the aerial should be removed from its terminal and connected to the anode terminal of the first valve through a .0001 mfd. condenser (see Fig. 17). The set should function on the remaining valves, but it will not be so sensitive to weak signals. If the fault has been eliminated it must be associated with the first valve; if not it must be in the remaining H.F. stages or in the detector circuit. Other stages can be cut out by transferring the aerial to subsequent valves until it is connected to that immediately preceding the detector.

### Testing the Detector

Should the fault still persist it is obviously in respect to the detector, whose anode current should be measured, and all the components examined. When reaction is employed an attempt should first be made to induce oscillation by operating the

reaction condenser. If this proves impossible, even though the valve passes a normal amount of H.T. current, the grid leak should be removed and replaced by another. Still no improvement; try another grid condenser. We have now tested everything except the tuning and reaction circuits, so our attention must be directed toward these. All the wiring will be checked as a first measure, and then the tuning condenser disconnected to make certain it is not short-circuiting the tuning coil. Next we must see that the reaction condenser is functioning, and

tion of the set, a very high-pitched whistle (generally accompanied by weak reception, and lack of "range"), or a constant "groan" from the speaker. All these things, and many more, can be due to a poor earth lead, but as that should have been tested before we will not make further reference to it. Both of the first two faults might be due to the use of a high tension battery which is well past its prime of life, or to insufficient de-coupling. We cannot deal with the latter possibility in detail here for that is more the concern of the set designer. It can just be pointed out, however, that a higher value of de-coupling resistance might be tried in the anode circuit, or that the resistance might temporarily be replaced by a variable component so that the effect of alternative values can be tried. In some cases a cure can be effected by de-coupling the anode circuit of the first L.F. valve, or by using a choke-capacity output filter for the loud speaker.

Occasionally, a most annoying form of H.F. instability is noticed in sets having two or more S.G. stages, and is due to

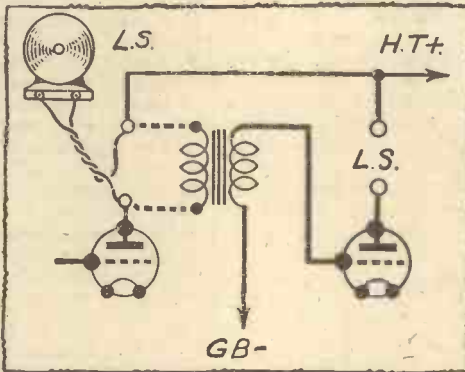

Fig. 16.—Cutting out an L.F. valve by connecting 'phones or loud-speaker in the anode circuit of the previous one.

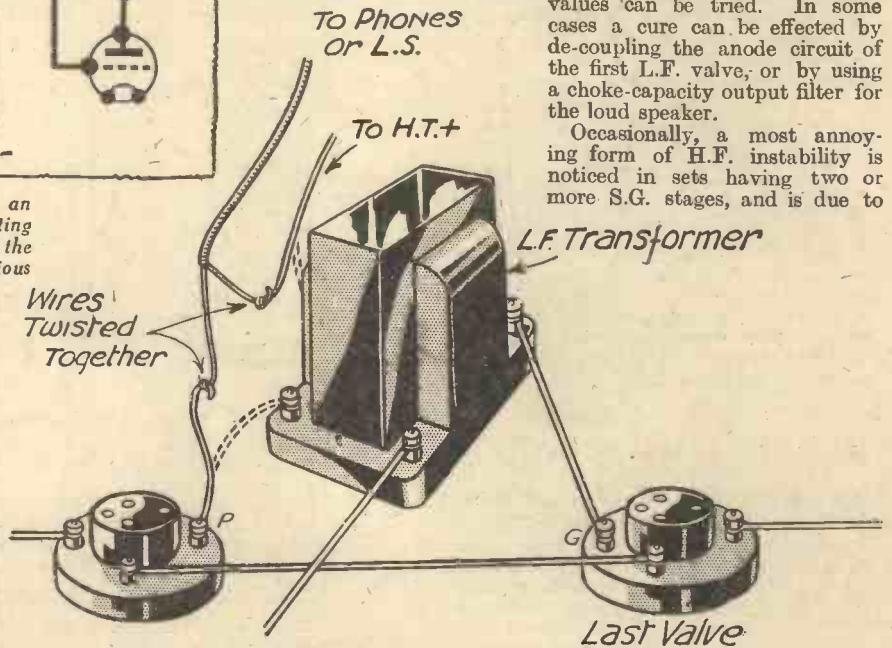

Fig. 17.—A pictorial diagram showing the scheme depicted in Fig. 16.

that the reaction winding is not disconnected from its terminals. By this time it is almost certain that the trouble will have been located, and if it has not we are left with the probability that the tuner is faulty and we must therefore remove it for further examination. The subject of testing this and other components will be dealt with in the next article.

### Other Forms of Trouble

At this juncture it will be interesting to deal with a few specific forms of trouble which are of common occurrence and which might not have been traced in previous tests. Let us treat these under separate headings.

### Instability

This heading covers a multitude of faults, such as sudden bursting into oscilla-

uncontrollable or parasitic oscillation. This is usually evidenced by the fact that the set is comparatively insensitive and the tuning not so sharp as it should be. The fault is often, but not always, indicated by a constant "whine" of extremely high pitch. Sometimes it is only present on one wavelength range, or even over only a portion of the tuning scale. It is almost invariably due to lack of screening or to the fact that screening is not effectively earthed; it might also result from poor contact between two portions of a shielding system, for example, between the base and cover of a coil can.

### Motor-boating

This is a term which has been badly misused during recent years, and, although it is intended to apply more particularly

(Continued on page 1178.)

(Continued from previous page.)

to the sound it resembles, it is now taken to mean any form of low frequency feedback, which might give rise to a noise resembling that made by a motor boat, or by a fog signal for that matter. But, whatever form the sound may take it is invariably due to back-coupling. The usually-prescribed remedy is to use more liberal de-coupling arrangements; in the case of an experimental receiver this might help, but we are more concerned with sets which have been properly designed, and which have previously behaved in an exemplary manner. With a set of the latter kind the trouble is more likely to be traced to the disconnection of a coupling, or by-pass condenser, or possibly to a fault in one of these components.

#### Microphonic Valve

When a continuous "ringing," or "booming" sound is heard which starts as a faint hum and gradually builds up to full intensity, it is a sign that a valve is "microphonic." The noise is due to sound

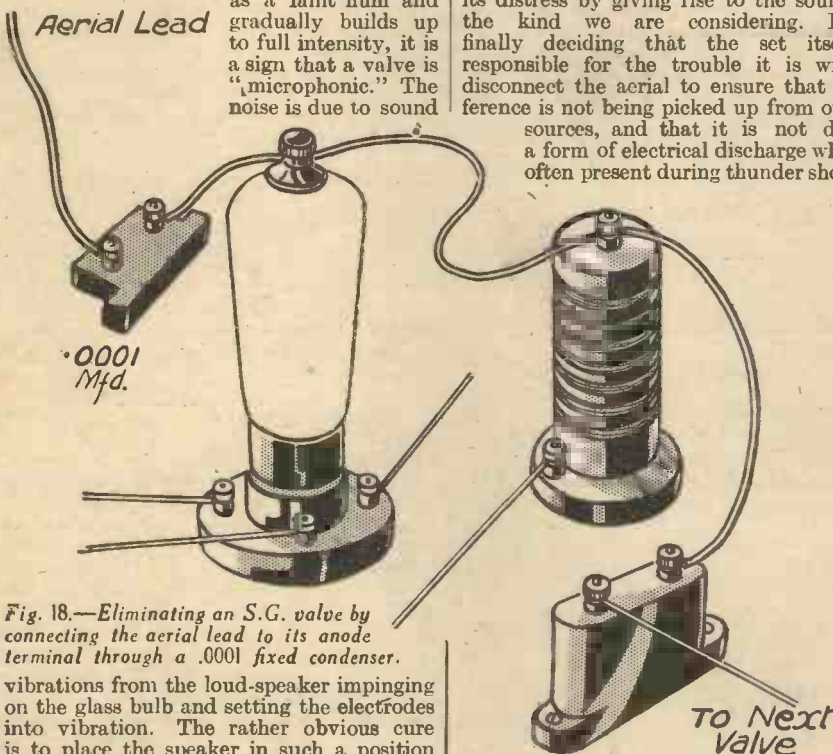

Fig. 18.—Eliminating an S.G. valve by connecting the aerial lead to its anode terminal through a .0001 fixed condenser.

vibrations from the loud-speaker impinging on the glass bulb and setting the electrodes into vibration. The rather obvious cure is to place the speaker in such a position that it cannot react on the valves, but this is seldom possible. It therefore becomes necessary either to replace the offending valve, or to insulate it from vibration by wrapping it in thick felt, or cotton wool. If the valve is mounted in a rigid holder, an improvement might be brought about by replacing the latter for one of the "anti-microphonic" type. It should be pointed out in passing that the fault under consideration is of rare occurrence with modern valves and most makers will willingly replace a new component which gives trouble in this respect.

There is no difficulty in finding which valve is wrong, for if each is tapped in turn with the finger nail, the defective one will cause a very audible "pong" in the speaker. The fault will generally be traceable to the detector, but this is not invariably the case since S.G. and L.F. valves occasionally become microphonic after long usage.

#### Continuous "Hissing" Sounds

These might be picked up by the aerial, but if so they will disappear when the aerial lead is disconnected. A faulty

high-tension battery or even a gassing accumulator can also give rise to this form of interference, but these two are not very likely sources. Screened-grid valves, especially earlier models of the A.C. type, are much more probable sources of "hiss," and in such cases it might be impossible to overcome the difficulty entirely, without changing the valves concerned. The trouble is generally much worse when a grid leak is included in the circuit of one or more S.G. stages; replacing the leak might occasionally effect an improvement, but it is generally necessary to re-design the circuit, so that a leak is unnecessary, before a complete cure can result. Some slight hiss often occurs due to the use of an unsatisfactory grid leak even in the detector or L.F. stages, and it might be worth while to try replacements. In a similar way an overloaded feed resistance of the composition variety (as opposed to wire-wound and metallized) often shows its distress by giving rise to the sounds of the kind we are considering. Before finally deciding that the set itself is responsible for the trouble it is wise to disconnect the aerial to ensure that interference is not being picked up from outside sources, and that it is not due to a form of electrical discharge which is often present during thunder showers.

#### Electrical Interference

It is almost astonishing to observe the multitudinous variations of sounds which can be produced by different kinds of electrical machinery. Practically every form of noise which a set makes when suffering its numerous disabilities can be imitated by electrical means, and so care must always be taken in diagnosing complaints that they are not due to electrical apparatus in the vicinity. Most small electric motors such as those used in vacuum cleaners, hairdressers' drying machines, coffee grinders, etc., cause a "whir-r-r-ing" sound, whilst larger motors produce a noise of a "grinding" character; the ignition systems of some cars and gas engines give a regular "click-click-click" in the speaker; flashing beacons and robots produce a chirp. And so we could go on—but these things are only mentioned to emphasize the fact that one should not always blame the set until other possibilities have been considered.

#### Tuning Circuits

We have now considered most of the troubles with which the amateur is likely to meet, but we have not given any attention to the question of defective tuning. When selectivity appears to be much worse than when the set was new it is very probable that an S.G. valve is passing grid current, either due to lack of grid bias or to deterioration of the valve itself. In either case an improvement can generally be effected by applying a slightly higher bias voltage or by reducing the voltage to the screening grid. When any doubt exists in regard to the proper ganging of coils and condensers some useful tests can be made by using the little instrument described in the first article of this series. Unfortunately the tests can only be applied to coils and condensers which are not fitted in screening boxes, but in any case they should not be necessary when using components of the latter type, which would probably have been accurately matched by the makers before despatch.

First of all tune in a station near the bottom of the condenser scale and then bring the wire loop towards the end of each coil in turn. This will slightly reduce the inductance of the coil under test and should therefore cause a reduction in signal strength; if signal strength becomes greater it will be seen that the circuit is tuned to too high a wavelength and, therefore, that the trimmer of the associated condenser section must be reduced in capacity. Should the capacity already be at its minimum value the same result can be obtained by increasing by an equal amount the capacity of all the other trimmers; this will make it necessary to re-tune to bring in the signal again. An "opposite" test can be made by touching the aluminium disc against the moving plates of one condenser section. The additional capacity formed between the disc and fixed vanes will increase the wavelength of the particular tuning section and should make the signal weaker; if it does not, the capacity of the condenser is too low and the trimmer should be increased.

In the next, and final, article of this series we shall deal with some of the faults peculiar to mains-operated receivers and I will show how tests of individual components can be made by using the simple instruments we have collected.

#### ROUND THE WORLD OF WIRELESS

(Continued from page 1176.)

light-vessel off the Uruguayan coast, in addition to two wireless beacons in light-houses.

#### First Micro-wave Radio Telephone Service

THE first regular micro-wave radio telephone service in the world, between the Vatican City and the Palace of the Pope at Castel Gandolfo, near Rome, was inaugurated by the Pope recently. "Micro-waves" is the name now generally given by technicians to radio wavelengths of less than one metre. The installation of the micro-wave stations in the Vatican City and at Castel Gandolfo, which will operate on a wavelength of 60 centimetres, has been personally supervised by Marchese Marconi, the Vatican authorities having been the first to decide upon the adoption of the micro-wave system for telephonic communication following a demonstration of two-way communication given by Marchese Marconi in Italy early last year.



It would be rather a difficult matter at the present time to give a satisfactory definition of the expression "short waves." Quite a few years ago all wavelengths under 1,000 metres were considered as short; later the term was applied only to waves of 200 metres or less, and then the limit fell to 100 metres, whilst to-day it seems that it can be fixed at any point from 1 metre to 80 metres, according to individual ideas. One thing is certain, however, and that is that shorter and shorter wavelengths are coming into use, and this is not surprising when one considers the facts that have become very obvious during recent times.

Up to some ten years ago it was generally thought that long-distance reception was impossible on wavelengths of less than 1,000 metres, but, principally due to the endeavours of amateur transmitters, the world can be spanned by signals on 50 metres and less with an infinitesimally small power, only a mere fraction of that employed by long-wave commercial stations. It has also been

# BELOW 10 METRES

In this Article FRANK PRESTON, F.R.A., gives you some Useful Information in regard to the Design of an Ultra Short-Wave Receiver

present congestion of the "broadcasting bands," and it seems feasible to imagine that in the not too-distant future the shorter waves will come into still more general use, especially by transmitters intended for broadcasting over long distances. As television transmissions become more general the advantages of shorter waves will be still more pronounced, because, as you know, each television transmitter requires not just one but two wavelengths—one for "vision" and one for "sound." Theoretically, wavelengths below about 10 metres should behave very much like light waves, and could thus be sent over "optical" distances only, but the results of numerous experiments point to the fact that much greater distances can actually be covered. It is therefore most probable that as soon as sufficient data has been collected and the transmitting range of these ultra short-waves—as they are frequently called—has been determined, several under-10 metres stations will be set into regular operation. Since there is already a good deal of fun to be had by experimenting on these very

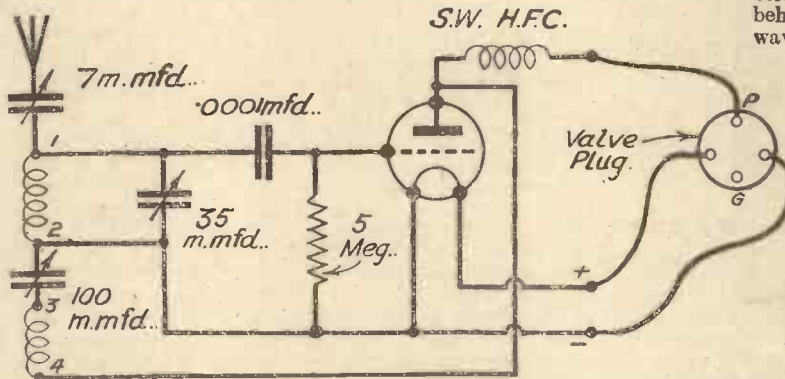

Fig. 1.—A simple and useful circuit for an ultra short-wave receiver or adaptor.

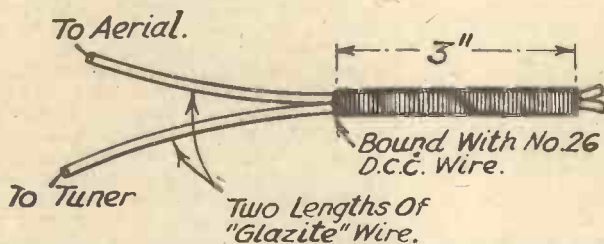

Fig. 3.—An easily made small-capacity series aerial condenser.

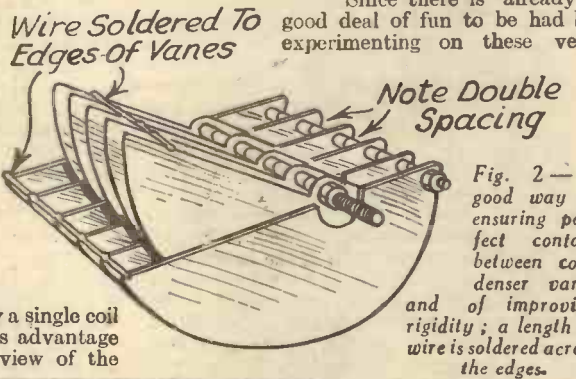

Fig. 2.—A good way of ensuring perfect contact between condenser vanes and of improving rigidity; a length of wire is soldered across the edges.

found that long-distance reception is possible, not only during hours of darkness as heretofore, but at any time of the day by choosing (short) wavelengths appropriate to the hour and the distance which it is required to cover.

Another very great advantage of the shorter wavelengths is that a much larger number of stations can be accommodated in any one particular waveband. This can more readily be appreciated when it is realized that the frequency range embraced by wavelengths between 7.5 and 10 metres is 10,000 kilocycles. Compare this with the paltry 1,000 kilocycles between 200 and 600 metres and you will see that ten times as many wavelengths are available within the former as in the latter band. (Incidentally, both of

these ranges can be covered by a single coil and variable condenser.) This advantage is particularly significant in view of the

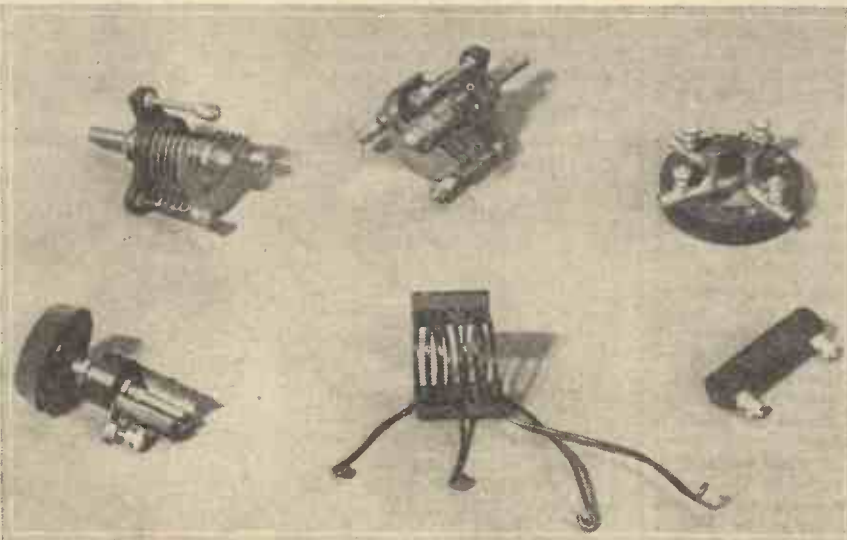

Fig. 4.—A group of special ultra short-wave components. They are:—top (reading from left to right), a 35m.-mfd. tuning condenser (note the double spacing of vanes); a 100m.-mfd. reaction condenser; low-loss valve holder. Bottom (reading from right to left), a 10 metre H.F. choke; 6-8 metre tuner; and a 7m.-mfd. variable series aerial condenser.

short waves, no doubt many readers will wish to participate, and so perhaps a few practical notes in regard to my own experiences will be of assistance.

### A Suitable Circuit

In my first 8-11 metre receiver I used a single valve adaptor having the circuit shown in Fig. 1, and after very little trouble succeeded in receiving a local amateur working on just over 10 metres. For the "aerial" I employed a 7ft. length of wire going from aerial terminal of the set to an insulated hook in the corner of the room, and I dispensed with an earth lead entirely because this was found

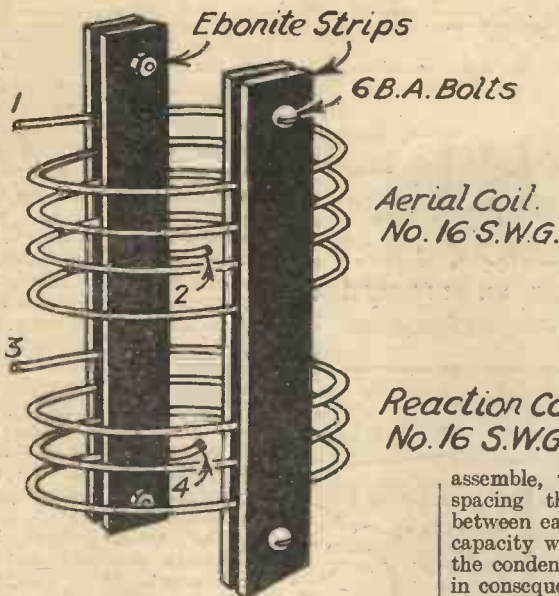

Fig. 5.—Constructional details for a 10 metre tuner.

to stop the valve from oscillating at certain settings of the tuning condenser. For some time no other stations were received, and so as to check up the set I made an oscillator (really a miniature transmitter), using the very same circuit as the receiver, except that it was connected directly to the H.T. and L.T. batteries and had no aerial connection. By setting this in operation a few yards away from the receiver I was able to pick up its heterodyne note and so make quite sure that the receiver was functioning correctly. As a matter of fact, the oscillator enabled me to do far more than this, because by making various adjustments and alterations I was able to improve the set fairly considerably; the improvement was evidenced, of course, by the increased strength of the heterodyne note. It appeared that the most important consideration was the correct choice of valve, and it was eventually found that a metallized one of the "L" type gave best results, principally because oscillation could more easily be maintained. Other modifications were of a minor character, and rather than explain them all it might be better to describe the whole receiver, and especially those components which were home-made or improvised.

The diagram of Fig. 1 shows that the circuit arrangement is quite conventional, being the same as that used for any short-wave receiver. One misses the usual earth connection, but otherwise there is nothing to distinguish the circuit from that of a normal broadcast set. On looking at the component values, however, vast differences are at once apparent. The series aerial condenser has a maximum capacity of 7 micro-microfarads instead of the more usual 100 micro-microfarads (or .0001 mfd.), whilst the tuning and reaction condensers are of but 35 and 100 micro-microfarads respectively. The capacity of the aerial series condenser is made so small to prevent undue damping by the aerial of the tuned circuit, which would prevent the valve from oscillating. The comparatively low capacities of the other condensers are chosen because capacity has a much greater effect on the shorter wavelengths and higher values introduce a detrimental amount of loss. Besides, the smaller condensers can

be adjusted much more accurately, since for any particular amount of spindle rotation the change in capacity is less.

#### Low-Loss Condensers

In my receiver I employed specially-made low-loss condensers of the type illustrated in the photograph, Fig. 4, but as many readers will not wish to go to the expense of new parts for their initial experiments it should be explained that excellent results can be obtained by using ordinary S.W. condensers after removing some of the vanes. The best method is to dismantle the condensers and then to re-assemble, using fewer vanes and double-spacing them by fitting two washers between each. By so doing the minimum capacity will be considerably reduced and the condensers will be much more efficient in consequence. It is very important that the contact between all fixed and moving vanes shall be absolutely perfect, and for this reason it is a good idea to solder a piece of wire across them as shown in Fig. 2. Whether the condensers are specially made or improvised ones, it is essential that a good slow-motion drive should be used for the tuning condenser at least, whilst this is also desirable in the case of that used for reaction control.

Those who have one or two neutralizing condensers on hand, of the type which were employed in neutrodyne receivers, will find that these make excellent substitutes for the special condensers referred to above. They generally have a maximum capacity of some 25 m.-mfd. and a particularly low minimum, so that a single one can be used for tuning and two may be wired in parallel for reaction. Having a "screw-thread" operation, they can be adjusted with extreme accuracy without the need for any additional vernier drive. The only difficulty is that they cannot very well be calibrated and, therefore, it is impossible to make a note of tuning positions. A good substitute for the series-aerial condenser can be made from two lengths of "Glazite" insulated wire bound together with a length of 26 gauge d.c.c. wire, as shown in Fig. 3; connections are made directly by means of the two wires themselves.

#### The Tuner

As might be expected, a tuner for wave-

lengths of the order of 10 metres must be very diminutive, and a good idea of the appearance of this component can be gained from Fig. 4. For a waveband of, approximately, 8 to 11 metres, the aerial coil should consist of four turns of 16 gauge enamelled wire, the turns being  $\frac{1}{4}$  in. in diameter. The reaction winding may then have three similar turns of the same material. In both cases the turns should be spaced by  $\frac{1}{4}$  in. and the two coils are mounted with their ends  $\frac{1}{4}$  in. apart. It must be understood that these particulars are only approximate and that they might have to be varied slightly according to the capacity of the valve in use and the lengths of the connecting wires. The simplest way to make the coils is to wind the wire round a  $\frac{1}{4}$  in. diameter wooden rod, putting on one more turn than is required. After winding, the turns will spring open and attain approximately the correct diameter. When they have been wound, the two coils can be clamped together by means of short strips of ebonite, as shown in Fig. 5. The best way to mount the tuner is to connect the ends of the winding directly to the other components in the manner illustrated in Fig. 6. (The numbered connections given in Fig. 5 correspond with those in the circuit diagram.)

#### The H.F. Choke

The grid condenser and leak have the fairly usual values of .0001 mfd. and 5 megohms, and any reliable components can be used. A special high-frequency choke is called for since even an ordinary S.W. choke has too high a capacity. A suitable component can be bought, or may be made at home very simply, by winding fifty turns of 24 gauge d.c.c. wire on a  $\frac{1}{4}$  in. diameter ebonite tube. The latter must be of the thinnest material obtainable, so that capacity may be kept down to the very lowest figure, and it is preferable slightly to space the turns with the same object in view. The valve-holder should be of the short-wave type, having a minimum of solid insulating material; the idea is, of course, to cut down capacity, and some experimenters prefer to dispense with a valve-holder entirely, soldering connections directly to the valve pins. Others even go so far as to remove the valve cap and make connections to the wires coming through the glass "pip." I do not consider this to be necessary, and my own experiments have failed to reveal any great advantage from such "ultra-low-loss" measures, so long as a suitable valve is chosen in the first place.

(Continued on page 1212.)

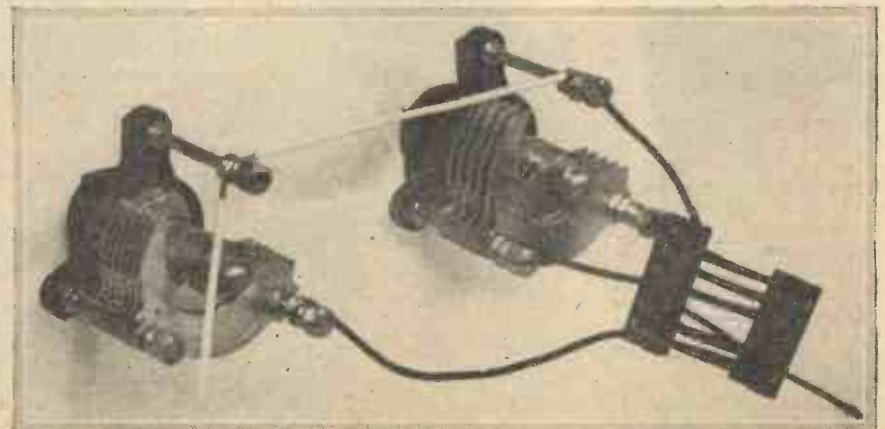

Fig. 6.—This photograph shows how the tuner should be connected directly to the other components; the actual tuner illustrated is for approximately 6 to 8 metres.

... the best Set I have heard for  
**SELECTIVITY** and **VOLUME** at  
 such a **REASONABLE PRICE**

Dear Sirs,  
 ..... I have one of your Melody Maker  
 Sets and can honestly say it is the best Set I  
 have heard for selectivity and volume at such  
 a reasonable price. I have logged 35 stations  
 including one American at full loudspeaker  
 strength. Yours faithfully,  
 Signed .....



Equipped with Cossor Variable-Mu S.G. Valve—  
 individually shielded coils—graded volume control  
 —every up-to-date feature of design the Cossor  
 Melody Maker is undoubtedly to-day's greatest  
 value for money in Screened Grid Radio. The  
 above letter is typical of the hundreds on our files,  
 from all over the country come similarly enthusiastic  
 reports. Send the coupon for full particulars of  
 this remarkable Receiver.

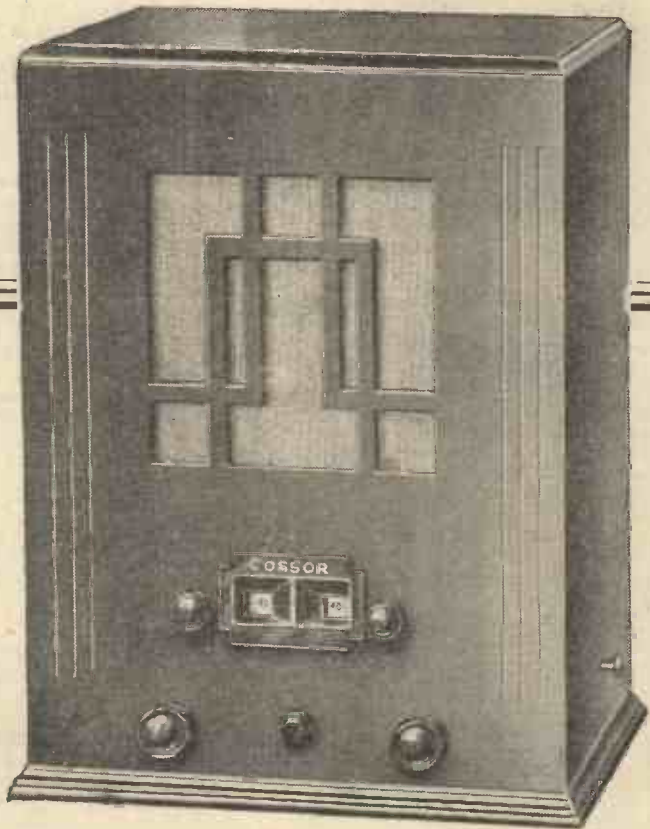

# COSSOR

## MELODY MAKER

### BATTERY MODEL 335

with Self-Contained Loud Speaker  
 Kit of Parts includes 3 Cossor Valves  
 (220 V.S.G. Variable-Mu Metallised  
 Screened Grid, 210 H.L. Metallised  
 Detector and 220 P. Output); Individually  
 Shielded Coils. All-metal Chassis and  
 all parts for assembling the Receiver as  
 illustrated; handsome cabinet 18½ in. x  
 13½ in. x 10½ in. and 10 in. Balanced-  
 Armature Loud Speaker. Provision is  
 made for fitting  
 Gramophone Pick-up  
 Socket and Plug.

**Price £6.17.6**

Hire Purchase Terms: 17/6 deposit  
 and 9 monthly payments of 15/-

### BATTERY MODEL 334

Kit of Parts, similar to Model 335  
 except that no loud speaker is supplied.  
 Handsome cabinet  
 9½ in. x 13½ in. x  
 10½ in.

**Price £5.15.0**

Hire Purchase Terms: 15/- deposit  
 and 9 monthly payments of 12/6

### BATTERY MODEL 333

Kit of Parts, complete with Valves for  
 building Cossor Melody Maker Chassis for  
 fitting to your own cabinet. Specification  
 as model 335 but  
 without loud speaker  
 or cabinet.

**Price £4.19.6**

Hire Purchase Terms: 15/- deposit  
 and 9 monthly payments of 10/6.

### ALL-ELECTRIC MODEL 337

With Self-Contained Loud Speaker  
 Kit of Parts for All-Electric Melody  
 Maker Model 337 similar to Model 335  
 (as illustrated) but for all-electric opera-  
 tion, including Cossor Valves, hand-  
 somely finished Cabinet, 18½ in. x 17½ in.  
 x 10½ in., Loud Speaker and all parts.  
 For A.C. Mains only 200-250 or 100-125  
 volts (adjustable).  
 40-100 cycles.

**Price £10.17.6**

Hire Purchase Terms: 25/- deposit  
 and 10 monthly payments of 21/6.

Prices do not  
 apply in I.F.S.

### ALL-ELECTRIC MODEL 336

Kit of Parts, similar to All-Electric Model  
 337 except that no loud speaker is sup-  
 plied. Handsome  
 cabinet 10½ in. x 17½  
 in. x 10½ in.

**Price £9.15.0**

Hire Purchase Terms: 19/6 deposit  
 and 10 monthly payments of 19/6

### ALL-ELECTRIC MODEL 338

Kit of Parts for All-Electric Melody  
 Maker Model 338 Chassis. Identical with  
 Model 336 except that no cabinet is  
 supplied. Escutcheon and template for  
 drilling your own  
 cabinet is included.

**Price £8.15.0**

Hire Purchase Terms: 32/6 deposit  
 and 8 monthly payments of 20/-

Models 336 and 338 are available for use on A.C. Mains  
 only, 200 to 250 volts (adjustable), 40-100 cycles.

To A. C. COSSOR LTD.,  
 Melody Dept., Highbury Grove,  
 London, N.5

Please send me free of charge a full  
 size Constructional Chart which  
 tells me how to build the Cossor

\* Battery Melody Makers.

\* All-Electric

(Strike out type not required).

Name .....

Address .....

PRAC. 11/3/33.

## COUPON BRINGS YOU FULL-SIZE CONSTRUCTIONAL CHART

A. C. Cossor Ltd., Highbury Grove, London, N.5. Depots at  
 Birmingham, Bristol, Glasgow, Leeds, Liverpool, Manches-  
 ter, Newcastle, Sheffield, Belfast, Cardiff and Dublin.





It will have been noted that the leads from the gramophone motor were not discussed last week, and the following point now arises. Obviously, it is necessary to connect these to the mains, and if they were joined direct to the input terminals on the mains transformer in the eliminator section of the "Fury" the motor would be switched on all the time. A switch must, therefore, be interposed so that the motor will only be switched on when required, and the small Bulgin Type S.80 will do admirably for this purpose. It should preferably be mounted on the motor board in close proximity to the radio-gram. switch or, if taste so demands, on the opposite side of the turntable. The connections will therefore be, one lead from the motor to one of the input terminals on the mains transformer, the other input terminal on the mains transformer to the gramophone motor switch, and the other side of the switch to the motor. It will be noted that the makers of the motor supply a very long length of flex, so that there is ample to enable you to run it round the side of the cabinet and so preserve a neat appearance.

#### The Pick-up

The pick-up is joined in series with the radio-gram. switch which is simply an on-off, or short-circuiting switch. One pick-up lead goes to one side of the switch, and the remaining pick-up lead is taken down to the nearest earth connection, which is the core-earthing terminal on the Telsen Pentode Output Choke. The remaining switch terminal is taken down to the junction of the grid condenser, leak and grid of the detector valve. It will be noticed, therefore, that the grid of the detector valve is connected always to the tuning circuit and, consequently, the preceding H.F. stages. There is nothing detrimental in this. A large number of readers have written me to asking whether this is not a misprint, but I can assure them that it is not, and furthermore, it is a simple way of introducing radio-gram.

## —MORE ABOUT— THE A.C. "FURY FOUR" RADIO-GRAM

The Amazingly Successful Receiver with the Editor's Personal Guarantee!

switching. The method usually adopted is to join the grid to the arm of a single-pole-change-over switch, but this always results in a terrific bang when the arm is moved, as the grid is temporarily disconnected, and in my opinion this is an objectionable effect, which is overcome by the method of switching here adopted. It is true that if the receiver is being used to receive a powerful station, and then the gramophone pick-up is simply switched into circuit and placed upon a record the radio signals will break through, but this is not the way to employ the arrangement.

#### Cutting Out Radio

When it is desired to use gramophone reproduction, the correct procedure is as follows. First of all turn the H.F. potentiometer to zero. This completely eliminates the wireless signals; then switch in the gramophone pick-up, and there will be no background whatsoever. The motor is switched on by means of the additional switch, and the turntable must be given a start. Just place the forefinger on the edge of it and give it a good spin in the correct direction, and it will be found to run into step very speedily and keep a nice constant speed. The best needles to use with the pick-up will depend to a certain extent upon individual taste. I prefer the needle known as the Columbia Talkie, as I have found these give longest life to the records, whilst preserving the musical characteristics very well. Some may prefer a softer tone needle, but a little experimenting in this direction will enable the best type of needle for individual taste to be easily found. The volume control on the rear of the pick-up arm will enable the degree of sound to be adjusted so that the output valve is not overloaded, and the results on the gramophone side will be found particularly pleasing, giving plenty of body, with a very good overall response.

#### An Independent Test Report

Readers may be interested in the following report, taken from the current issue of a certain publication.

#### THE "FURY FOUR" ON THE TEST BENCH

Best Radio Principles Incorporated  
By Norman Eceleston

The "Fury Four" marks a milestone in technical press history, as it constitutes a

properly designed receiver that both looks and behaves like a factory-built instrument in the top rank.

From the really thorough decoupling at the H.F. end to the tapped output choke, the "Fury Four" embodies all principles that are recognized as the best practice among Radio Engineers, and it is far removed from the tangled collection of ill-placed components and consequent untidy wiring so often presented to the public in the form of a blue print.

On the right is the circuit diagram; a glance will show that all chance of hit and miss is eliminated, all possible precautions being taken to ensure stability and consistency under varying conditions; the decoupling network is in itself noteworthy as being really thorough and complete.

A small point that means a lot is the use of a single high-tension tapping, the advantages of which our readers will appreciate too well to necessitate further mention here.

Mr. Camm, the designer, has realized the great difficulties that confront the constructor when faced with a triple-ganged condenser, and has used two-knob tuning (one controlling a twin condenser, the other a single condenser) which is an ideal compromise between maximum efficiency, simple manipulation and ease of initial construction.

On test the "Fury Four" proved itself to be all that the circuit diagram suggested, the range and volume were such that all the worth-while European stations and a good many others could be tuned-in on a Cossor Moving Coil Loud-speaker, type 495,

The selectivity was very good, and there is no question that the separation of the two dials gave a decided advantage assisted by the very delightful reaction control which was free from any undesirable backlash.

The quality of reproduction is well worth special mention as the most excellent

(Continued on page 1192.)

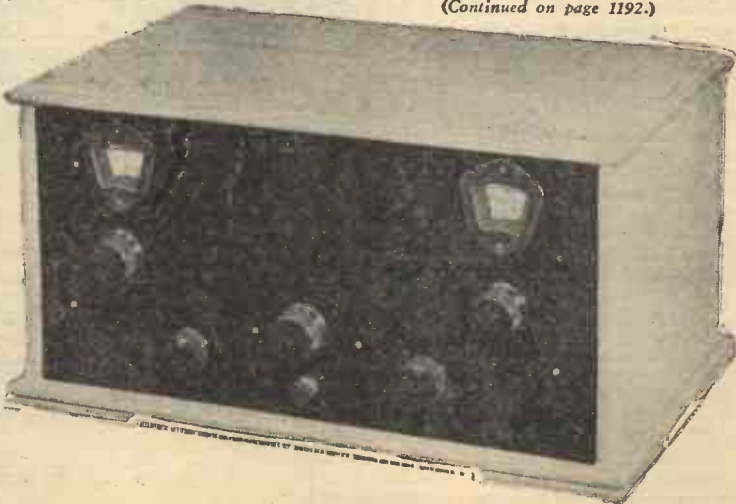

# The DESIGN of LOUD-SPEAKERS—2

A Continuation of the Article which Commenced Last Week. In this section the Fundamentals of the Moving-coil Speaker are Discussed

By W. J. DELANEY

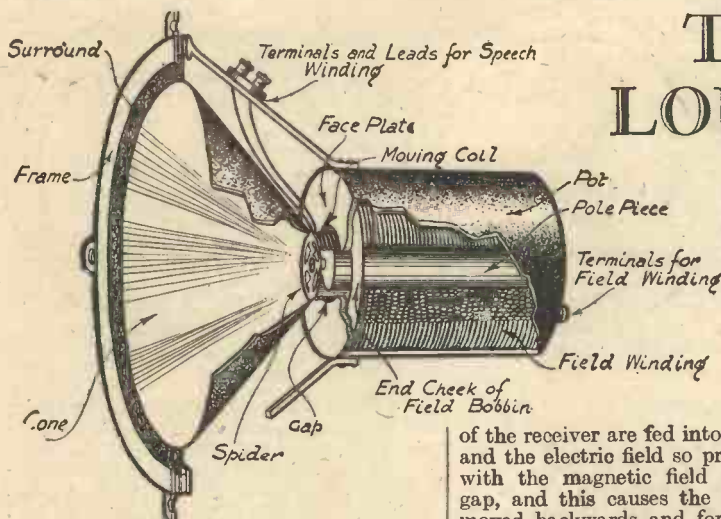

Fig. 1.—A complete diagram of a moving-coil loud-speaker.

I SHOWED last week how the ordinary, or moving-iron type of speaker, was not able correctly to deal with the 50 cycle note produced by the drum which was the basis of our discussion. The article closed by giving a rather sketchy description of the moving-coil (or electro-dynamic) loud-speaker, and before analysing the make-up of this type of speaker, with all its commercial refinements (and drawbacks), it would perhaps be as well to recapitulate the *modus operandi* of this type of sound reproducer. In Fig. 1 is a rather elaborate illustration of a commercial moving-coil loud-speaker which was on the market some time ago. This consisted of a cast pot in the form of a jar, or cylinder, about 6ins. in diameter, by about 8ins. long. Running down the centre of this pot was a solid rod of steel 2ins. in diameter. The lid of this pot fitted tightly round the end, and in the centre was a hole 2½ins. in diameter. The pole piece was of such a length that its upper surface was level with the lid, or as it is more correctly called—the face plate. A cone of stiff paper had the apex cut away, and cemented to this was a short cylinder of similar paper, 1in. deep by 2½ins. in diameter. Round this cylinder was wound a coil of very fine wire having a resistance of 2,000 ohms. The ends of the wire were stuck to the cone, and heavier gauge flex soldered to the end and taken to two terminals mounted on a small piece of ebonite attached to a heavy metal framework, which was bolted to the pot. The periphery of the cone was stuck to a thin rubber ring which was clamped between two rings of three-ply wood, which were bolted to the metal rim of the framework. The whole arrangement weighed 33lbs.

### The Parts of a M.-C. Speaker

To simplify the points which I am now going to deal with, this illustration has been fully referenced, and you will be able to see from this what every part of the moving-coil speaker is called. Although many changes have been made in the actual design of the loud-speaker, those terms are still used, and the illustration will therefore serve as a model. The essentials are a speech coil (more commonly known as the moving coil) attached to a cone, and a magnet with a small annular gap in which the speech coil is suspended. The signal impulses from the output valve

of the receiver are fed into this speech coil, and the electric field so produced interacts with the magnetic field surrounding the gap, and this causes the speech coil to be moved backwards and forwards according to the direction of the currents flowing through it. The first part to consider is the magnet. In the model illustrated the coil of wire known as the field winding

so produced may be measured, and the strength of this field is quoted in so many lines per sq. cm. In this particular model the strength was about 5,000 lines.

### The Permanent Magnet

The necessity for the energising battery prevented many listeners from using this type of speaker, and consequently there was not a great demand for what was, in fact, a great improvement on the speakers which were in existence at that time. The result of this lack of interest was an attempt on the part of the manufacturers to produce a speaker which required no exciting medium—in other words, an attempt was made to produce a "permanent magnet." To be effective, a magnet must be so designed that there is a minimum of leakage, and consequently it is not a simple matter to construct such a magnet. At Fig. 2 three representative types of permanent magnet are illustrated, and it will be seen that the principle is exactly the same in each case—namely, a pole piece surrounded by a magnet, and a face plate joining up the poles of the magnet. The face plate has a circle cut out, and the pole piece is fixed centrally, with relation to this cut-out, and so provides the air gap. The design of this type of magnet has now reached such a high degree that it is possible to obtain a magnet with a gap having a flux density of over 10,000 lines. You can see how this compares with the older form of energised magnet. The magnet, therefore, must have as high a value of flux density as possible, and in order to obtain this, the air gap must be as small as possible. Obviously, as the speech coil must be situated inside this gap, there is a limit to the size of the gap. The majority of speakers possess a gap of ¼in. or less.

### The Speech Winding

The speech winding, as has been already stated, has to be accommodated inside the air gap, and as this has to be as small as

(Continued on page 1184.)

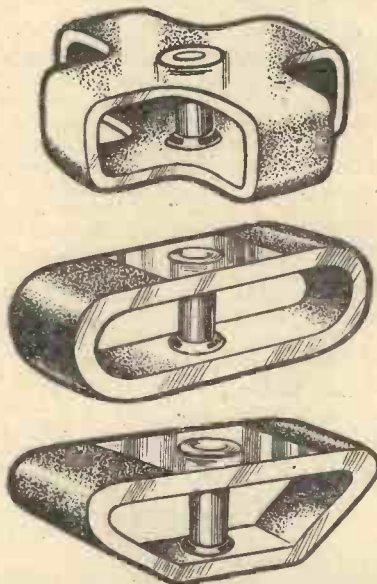

Fig. 2.—Three different types of permanent magnet used for loud-speakers.

was intended to be joined to a source of direct current having a voltage of 10, and it consumed a current of about 1 amp. The effect of this current flowing round the pole piece was to turn it into an electro-magnet, and so produce the magnetic field across the gap. These lines of force

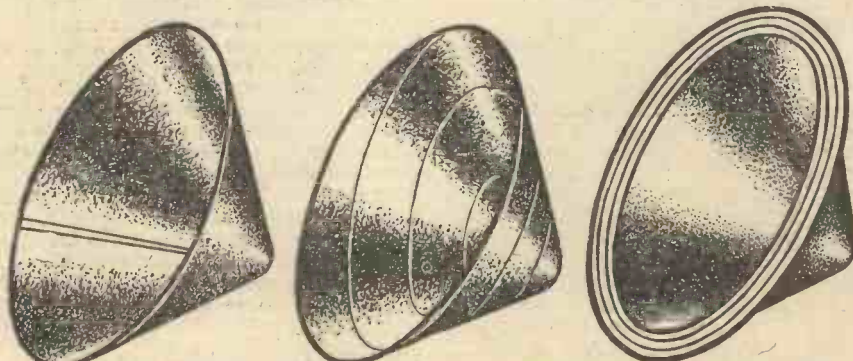

Fig. 3.—Two different methods of joining a cone diaphragm and (right) a moulded seamless diaphragm.

(Contd. from page 1183)

possible it naturally follows that the speech coil must also be as small as possible. In the early days the winding was intended for inclusion direct in the anode circuit of the output valve, and consequently a resistance of 2,000 to 4,000 ohms was necessary. To accommodate the necessary amount of wire it had to be extremely fine, and this made a naturally flimsy or fragile coil which was easily destroyed. To-day it is the custom to make this winding of only a few ohms resistance—actual figures taken from manufacturers' catalogues showing various values from 0.9 ohms to 7 ohms. Fairly thick wire is employed for this coil, but as it has to be moved in sympathy with the speech currents flowing through it, it must be extremely light. The actual former upon which the wire is wound has therefore to be made of the very minimum of material, and in one form of speaker no former at all is employed. Instead, the wire is wound round a jig at the works, and the entire winding doped with collodion. This causes it to set practically solid, and when the jig is removed, a self-supporting coil is the result.

**The Cone**

The speech winding will not, by itself, reproduce any sounds, as it is necessary (as explained in the first part of this article) to set the air into motion in order to reproduce the original musical sounds. To enable this to be done, the speech winding

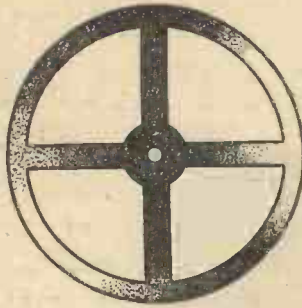

Fig. 4.—The crudest form of centralising spider.

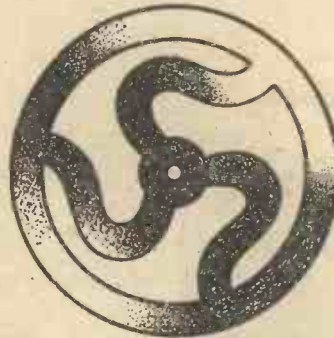

Fig. 5.—Two popular commercial forms of spider.



employs buckram, pressed out in one piece without a seam. Yet another utilizes the thinnest of paper, with thin card stiffenings glued to the cone in different positions, so as to break up the resonances set up in the thin paper. In some diaphragms the join runs straight from the periphery to the centre, whilst in others it winds in a spiral, beginning and ending on the same radial line. Some representative diaphragms are illustrated in Fig. 3.

**The Spider**

To ensure that the speech winding will remain central in the air gap some form of centralizing device is necessary, and this is called a "spider," and has probably received even more attention than the diaphragm. It was pointed out, when speaking about the moving-iron type of speaker, that the principal drawback was the fact that the armature had a natural restoring force, or, in other words, when drawn towards the magnet it tended all the time to spring back to its normal position of rest. The moving-coil speaker, therefore, as it is capable of a freer movement, must be made up so that there is no restoring force, and this is where the majority of moving-coil speakers fail. It is exceedingly difficult to arrange the speech winding so that it

In an attempt to do away with the spider cut from paper, many novelties have been produced, amongst which may be mentioned the patented arrangement used by the Film Industries Public Address loud-speaker. A thin disc of duralumin is provided with corrugations concentrically disposed, and a large hole in the centre permits of the cone being cemented direct to this disc. The edges of the disc are then attached to the edge of the magnet pot, so that the arrangement resembles very much an ordinary gramophone sound-box, with the cone attached to the centre of the diaphragm. The corrugations permit great flexibility in the direction of correct movement, but there is absolutely no possibility of side play. With any form of spider, however, there is always a tendency for the spider to return the diaphragm to a normal position, that is, the position of the cone when at rest. This will always be with the disc in a "flat" position. This is not, therefore, very much better than the ordinary moving-iron arrangement, except in so far as the spider or other centring device does not have the same tension as the moving-iron movement. Before ending this section dealing with the centring device, therefore, I must refer to the most ingenious of all movements, that of the Lanchester speakers. Here is a device which definitely has no restoring force, and yet maintains a perfectly centred speech coil, permits of perfect flexibility, and yet allows of no lateral movement. It is illustrated in Fig 6, and it will be seen that the pole piece has three equally disposed longitudinal grooves cut in it. Resting in these grooves are three small rubber balls with a diameter such that the former of the speech coil will just rest on these three balls, as shown at the right of Fig. 6. It is obvious that by this arrangement, the balls are free to travel up and down the slot, the speech coil former is free to travel along over the balls, and the combination of these two movements will permit of absolutely perfect flexibility and a true "piston-like" movement, with no side-play. This is, in my opinion, the most perfect solution yet offered to the question of accurate centring. But, as yet, we have only dealt with the centring of the apex of the cone, and there is still the edge of the cone to be dealt with. I must leave this till next week.

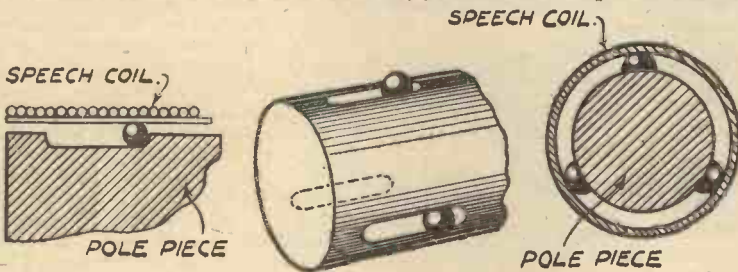

Fig. 6.—An ingenious centralising device which avoids the spider.

is attached to a cone, and as we have already seen that lightness is the first consideration, the actual material used for the cone has to be chosen with some care. If made of very thin paper, the vibrations which are produced by the movement of the speech coil will result in "dithering" or other obnoxious sounds. If made of a thick material the reproduction will be "woolly." The diaphragm (or cone) has therefore to be designed with the utmost care, and must, moreover, be designed in conjunction with the speech winding and flux density in the air gap. If the latter is small, then the cone and speech winding (or cone assembly, as the total is called) must be very light; if the flux density is very high, then we can afford to have a slightly more robust cone assembly. The method of making up the cone has received a great deal of attention from manufacturers, and various materials have been used in the course of experiments. One loud-speaker at present on the market

maintains its central position, and at the same time is not held by some means which will introduce this restoring force. So far, I have only discovered one loud-speaker on the market which answers to this requirement. However, more of that anon. At Fig. 4 is illustrated a very simple form of spider, and this consists simply of a disc of paper from which sections have been cut to leave four "spokes." This will be found to permit of the edge being drawn backwards and forwards whilst the centre remains at rest, but it will also permit of some lateral movement, and this must on no account take place. The spokes must therefore be shaped differently, and two of the most popular patterns are illustrated at Fig. 5. It is obvious that, with either of these patterns, the edge of the disc is perfectly free to move backwards and forwards, but no lateral movement is at all possible. The centre of the spider is bolted to the centre of the pole piece, and the edge is stuck to the cone.

**TWO USEFUL HANDBOOKS!**

96 pages—Fully Illustrated—1/- each.

**25 TESTED WIRELESS CIRCUITS**

**AND ACCUMULATORS : CHARGING, MAINTENANCE AND CARE**

Of all newsagents or 1/2 by post from Geo. Newnes, Ltd., 8/11, Southampton Street, Strand, W.C.2.

# Get Original Tone

Tone is radio's severest Test. When everything else about your set has lost its novelty, tone remains, day after day, year in, year out—doesn't it pay you over and over again to be right at the start? Get the fullest benefit of Columbia's latest radio development—ORIGINAL Tone—clear, brilliant, almost startling in its actuality.

Attractively presented in polished walnut, the four-valve mains model shown here has met with an amazing popularity. Test its superiority in the actual reception conditions of your own home. It will tell its own story! The coupon will bring you fullest particulars.

USE THE COLUMBIA DEALER SERVICE  
Expert advice on local radio conditions and service after sales

**ALL-ELECTRIC FOUR**

**16 gns. cash** (A.C. or D.C.)

or delivered on first payment of **£1 13s.**

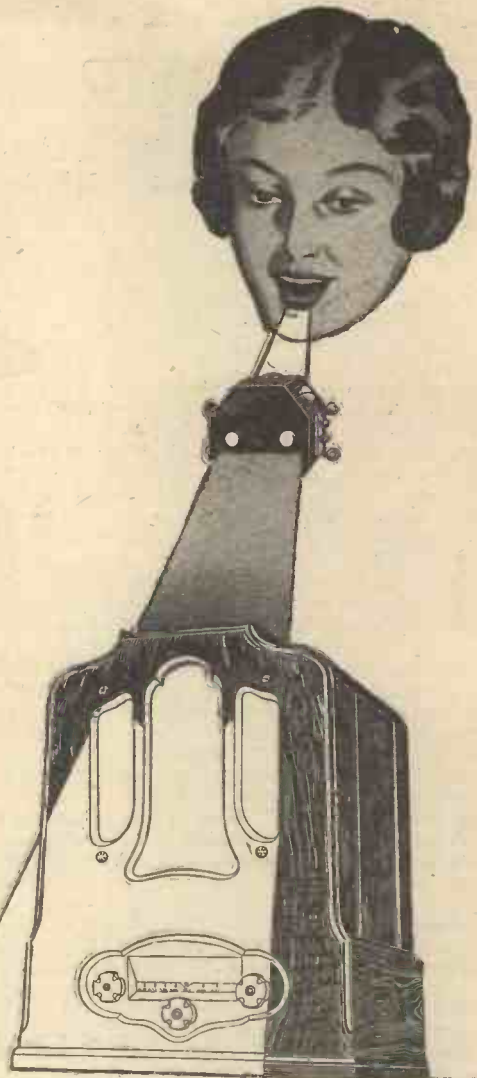

# Columbia

## ALL-ELECTRIC FOUR

**CUT OUT AND POST TO-DAY!**

Please send me fullest particulars of Columbia Model 355 and other Columbia instruments from £4.7.6 to 90 gns. (Write in block capitals.)



NAME .....

ADDRESS .....

Form. W. 11/9/33.

Cut this out and post in an unsealed envelope bearing 1d. stamp to:—Columbia 98, Clerkenwell Road, E.C.1.

## ADJUSTING AND OPERATING— THE Q.P.-P. THREE-FOUR

Some Notes on the Correct Operating Voltages of the Output Valves in the Interesting Receiver which was described last week

By W. J. DELANEY

THE article last week which described the Q.P.-P. Three-Four was completed in a rather hurried manner in order that those listeners who wished could use the receiver as soon as it was finished. There are, however, one or two points which should receive careful attention. The use of reaction and the adjustment of the tuning condenser are only normal in use, and therefore those instructions which have been given in these pages repeatedly concerning this part of a receiver apply. The tuning condenser should be adjusted until the station is received at its loudest, and then, if not sufficiently loud, the reaction dial should be turned to permit the signal to gradually build up. On no account adjust this condenser so that the receiver actually oscillates. That is, do not permit the speech or music to be gruff or accompanied by what may be called a "rattle." This introduces distortion and prevents full advantage being taken of the valuable feature of the Quiescent Push-Pull Stage. The coil used in the receiver is provided with four sockets on its base, and the aerial is joined to a small plug.

### Varying Selectivity

The socket at the extreme right—viewing the coil from the back of the cabinet, gives loudest signals, but poorest selectivity. In localities which are situated a long way from a powerful station this is the socket which should be employed. The other sockets increase the selectivity, and naturally result in a weaker signal, but as they will only be used when it is necessary to improve the selectivity, the loss of strength must be tolerated. No series aerial condenser is included in the receiver as the selectivity obtainable with this particular type of coil is sufficient for all normal requirements. As the receiver does not employ a S.G. stage there is no need for ultra-selectivity as the receiver will naturally not be used for logging every European broadcasting station.

### Tone Control

The knob on the extreme right of the panel is provided for the purpose of varying the tone produced by the output stage. It

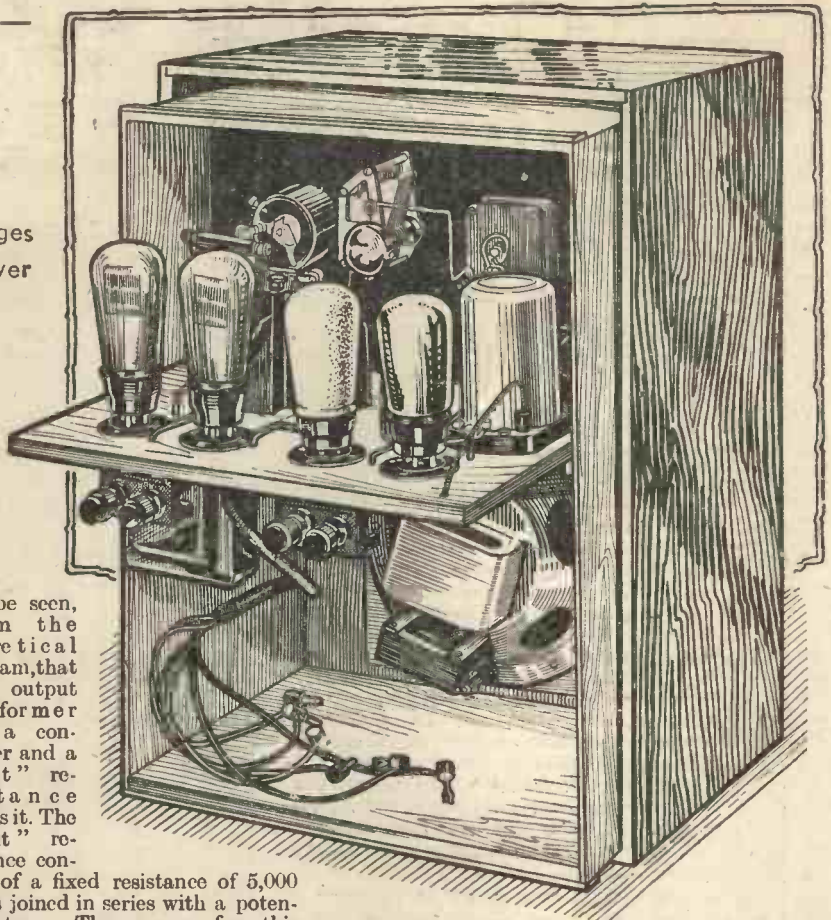

will be seen, from the theoretical diagram, that the output transformer has a condenser and a "split" resistance across it. The "split" resistance consists of a fixed resistance of 5,000 ohms joined in series with a potentiometer. The reason for this method of connection is that it is bad for the output transformer to completely remove the resistance. Therefore, by arranging the 5,000 ohms resistance in a fixed form it is impossible to reduce the value of the resistance below this. The remaining 50,000 ohms may be adjusted by the panel control and the brilliancy of the top notes reduced to that required by the individual requirements. The points which have been dealt with so far are only normal adjustments which may be required on practically any type of receiver, and we now come to the most important part of the setting up of this Q.P.-P. Three-Four. This adjustment may make or mar the receiver, and the following notes should therefore be studied in detail if it is desired to get the very last ounce out of the set.

### Balancing the Output

If the reader owns a milliammeter the adjustment of the output stage should be carried out in the following manner. The lead which joins the H.T. positive tapping to the centre terminal of the output transformer should be disconnected, and the negative terminal of the milliammeter should

be joined to the terminal on the transformer. The H.T. positive lead should then be joined to the positive terminal on the meter. (The meter should be one capable of reading up to, say, 10 milliamps). Now, remove one of the Pen. 220A valves (it does not matter which one), and insert the lead marked G.B.2 into the 15-volt socket on the battery. Insert the two H.T. positive leads (those marked H.T.1 and H.T.2) at some point slightly lower than 120 volts. Switch on the L.T. supply and note the reading shown by the milliammeter. It should be just over 2mA. Switch off, and insert the other pentode in the same socket in place of the valve which you have just tested. Upon switching on the L.T. supply again the same current reading should be obtained. If it is not, then your pentode valves are not matched, and you should proceed as follows. Adjust the grid bias to 15 volts permanently. Plug in one of the valves only, and adjust the H.T. lead joined to the priming grid of that valve until the current does read 2mA. or nearly so. It may be that the H.T. battery tappings do not permit of the valve receiving just the right voltage to produce the exact reading of 2mA. but the nearest reading to it should be easily found. When this has been done, remove that valve, and insert the other valve in the other socket, not in the socket you have just used.

Exactly the same procedure is carried out—that is, the H.T. applied to the priming grid is adjusted until the current is 2mA. or thereabouts. When this has been done, the remaining valve may be inserted in its socket, and the output stage is balanced.

**NEXT WEEK: Balancing the Q.P.-P. Three-Four Without Using a Meter.**

### COMPONENTS FOR THE Q.P.-P. THREE-FOUR.

- 1 Colvern T.D. Coil.
- 1 J.B. .0005 Slow Motion Condenser, Type D.
- 1 J.B. .0003 Differential Condenser.
- 4 T.C.C. Fixed Condensers. .0001 mfd. (Type S) .05 mfd. (Type 50). .01 mfd. (Type S), .1 mfd. (Type 50).
- 6 Graham Farish Ohmite Resistances. 2-1 megohm, 2-100,000 ohms. 1-5,000 ohms, 1-30,000 ohms.
- 2 Watmel 20,000 ohm Variable Resistance.
- 1 R.L. Q Type Transformer.
- 1 Varley Transchoke D.P. 39.

- 2 Clix 4-pin Valve-holders.
- 2 Clix 5-pin Valve-holders.
- 3 Clix Wander Plugs, G.B. +, G.B.1, G.B.2.
- 1 Belling-Lee 6-way Battery Cord.
- 1 Becol Panel, 12in. by 7in.
- Speaker.—R. & A. Bantam.
- Cabinet.—Clarion Q.P.-P.
- Valves.—Mazda, L.2, H.210 and 2 Pen. 220A.
- Batteries.—Drydex Special Q.P.-P. H.T. Battery. Drydex 16 volt G.B. Battery.
- Accumulator. 2 volt Block Battery.



**THE  
HALF-  
GUINEA  
PAGE**

# Radio Wrinkles FROM READERS

**An Improvised Grid-leak Holder**

WHEN experimenting it is often necessary to try different values of grid-leaks. A handy holder can be quickly improvised by the use of two crocodile clips and a few inches of stiff wire. They are arranged as shown in the accompanying

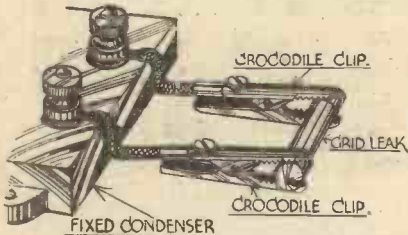

A useful dodge for holding grid-leaks.

diagram. The arrangement besides ensuring a good electrical connection possesses the additional feature of being easily adapted to different sized grid-leaks.—W. F. DAVEY (Selhurst).

**An Accumulator Charging Switch**

FOR obviating the nuisance of disconnecting the accumulator when it is desired to trickle charge it, the accompanying scheme will be found very useful to users of D.C. mains. It consists of a four-pole double throw (or two double-pole double-throw switches joined as in the sketch, a lampholder) and a two-pin socket. The switch is wired in such a way that when it is down, the accumulator is connected direct to the set, and the mains

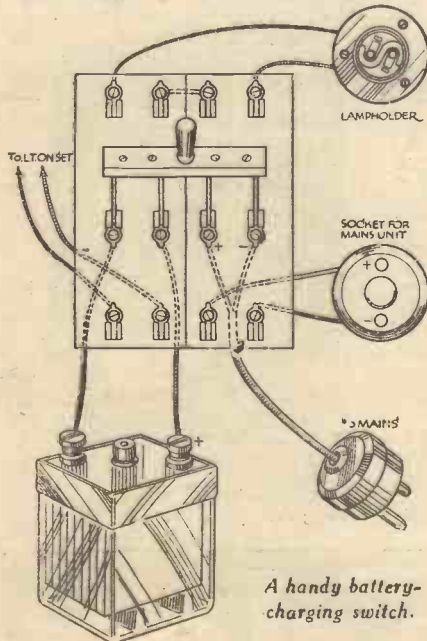

A handy battery-charging switch.

unit to the lighting mains. When the switch is up, the mains unit is entirely disconnected from the mains, and the accumulator from the set. This is also put on charge. The lamp for the lampholder depends upon the charging rate

**THAT DODGE OF YOURS!**

Every reader of "PRACTICAL WIRELESS" must have originated some little dodge which would interest other readers. Why not pass it on to us? For every item published in this section we will pay half a guinea. The latest batch is published below. Turn that idea of yours to account by sending it in to us, addressed to the Editor, "PRACTICAL WIRELESS," George Newnes, Ltd., 8-11, Southampton Street, Strand, W.C.2. Put your name and address on every item. Please note that every notion sent in must be original, and that we cannot return unaccepted contributions unless a stamped addressed envelope is enclosed. Mark envelopes "Radio Wrinkles."

of the accumulator, but generally for small accumulators a 60 watt lamp will be found quite satisfactory.—J. S. BROSTER (Liverpool).

**Remote Control Switching.**

IN the majority of remote control systems it is generally assumed that the set should be controlled from different rooms, but a simple form of "on and off" control from the easy chair by the fireside would meet the requirements of many listeners. Here is a simple method which anyone can rig up at a cost of about two shillings. The following description applies to an all-mains set, but this can easily be modified to suit a battery set. The parts required are: one B.J. lampholder, two B.J. adaptors, a pear-shaped switch and a suitable length of flex. The sketch illustrates the alterations to be made. It will be seen that the lampholder is inserted in the mains supply flex, thus forming a break in the circuit. A B.J. adaptor is short-circuited by means of a short piece of copper wire, and secured close to the lampholder with a suitable "whipping" of twine or silk, the other adaptor being connected to the pear switch through a sufficient length of flex to reach the position from which it is desired to control the set. If the short-circuited adaptor is inserted in the lampholder, the normal control is operative. To use the distant control, remove the short-circuited adaptor and insert the one connected to the switch. Close the switch on the set, and having adjusted the dials for the required station, the listener can then switch "on" or "off" at will without getting up from the chair.

—D. TANGUY (Portsmouth).

**The Tone Chamber Idea**

THIS tone chamber for a loud-speaker gives such excellent results, that I am passing it on to readers who are owners of home-made sets. My set is a straight two, fitted up with a switch for cutting out the power valve, and using phones without the speaker. This is a good idea, seeing that if only one member of the family wants to hear the programme, he can do so without bothering others. The speaker is a first-class balanced armature type, and was formerly housed in the cabinet. It is now connected to a tone chamber, which is a box 12in. square, made of 1/2in. wood, and this, in turn, is connected to a baffle of 2ft. square of six-ply wood. Instead of the usual practice of attaching the chassis direct to the baffle, a hole is cut in the box

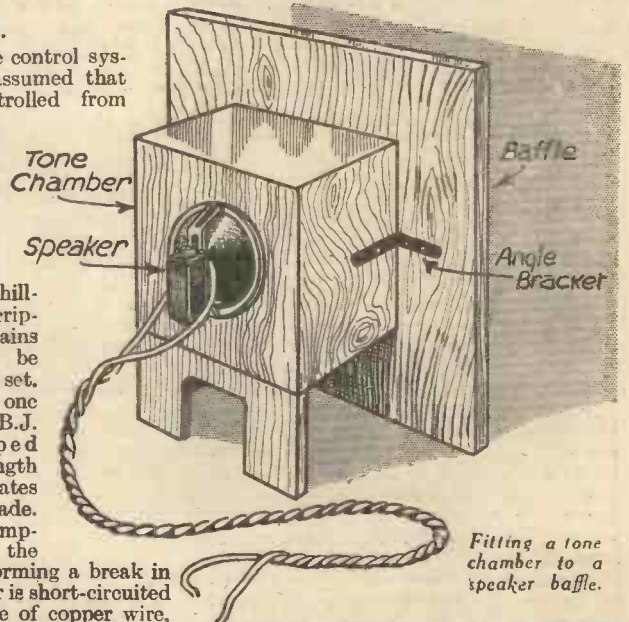

Fitting a tone chamber to a speaker baffle.

about 1in. less in diameter than the chassis. The tone is excellent, and the volume is such that it became necessary to fix a volume control. With an ordinary keyhole saw I cut an aperture in the baffle 12in. square.—G. DAVIS (Felling-on-Tyne).

(Continued on page 1189.)

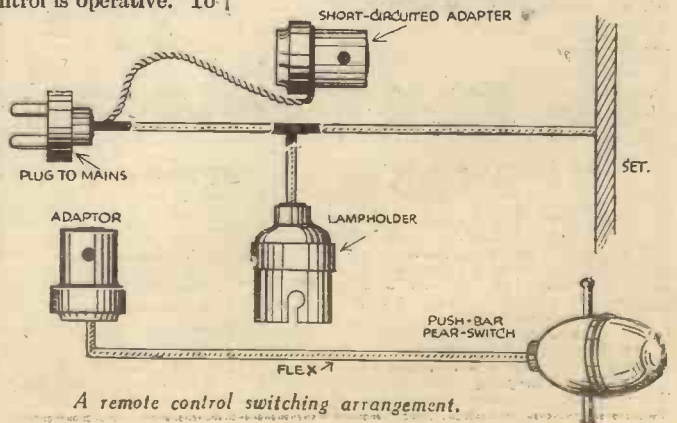

A remote control switching arrangement.



TO MAKE ASSURANCE DOUBLY SURE  
**THESE BATTERIES ARE GUARANTEED!**

**Guarantee**  
The Edison Swan Electric Co. Ltd. guarantees that Ediswan Batteries are of full voltage and capacity. Should any Ediswan Battery fail to give satisfactory service, we undertake to deal with customer's complaint within 24 hours of receipt of the defective battery.

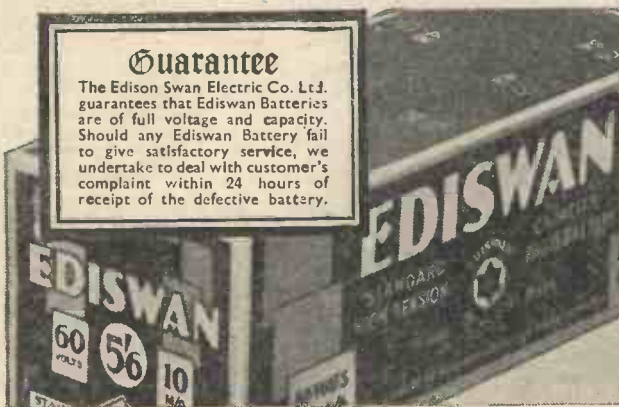

Owing to their guaranteed capacity of 10 milliamperes, Ediswan Standard Capacity Batteries definitely last longer when used with the new QUIESCENT PUSH-PULL circuits. Make certain then, that you get the greatest possible H.T. value for money by insisting on Ediswan Guaranteed H.T. Batteries.

60 volts  
Standard capacity

**5/6**

120 volts  
Standard capacity

**11/**

**EDISWAN**  
THE IDEAL BATTERY FOR QUIESCENT PUSH-PULL



THE EDISON SWAN ELECTRIC CO. LTD.  
PONDERS END, MIDDLESEX

EDISWAN - the Better Service Batteries

B 217

# SPECIFIED

in the "Q.P.P. Three-Four"

"What Q.P.P. components shall I use for my 'Q.P.P. Three-Four'?" . . . . . The designers of the original model were confronted with the same problem. Careful and deliberate tests convinced them that Varley DP 36 and DP 38 were exactly right.



DP 36

DP36 Q.P.P. INPUT TRANSFORMER . . . . . ratio 9/1. Primary inductance 30 henries with no D.C., 27 henries with 2 M.A. D.C. Price 17/6 (Including royalty)



DP 38

DP38 Q.P.P. OUTPUT TRANSCHOKES . . . . . ratios 3/1 and 50/1. Primary inductance (each half) 8 henries with 26 M.A. D.C. Price 16/6 (Including royalty)

Varley's FREE ILLUSTRATED BROCHURE "The Battery Set Comes Into Its Own," tells you all about installing Q.P.P. Write for your copy to-day.

# Varley

(Proprietors: Oliver Pell Control Ltd)

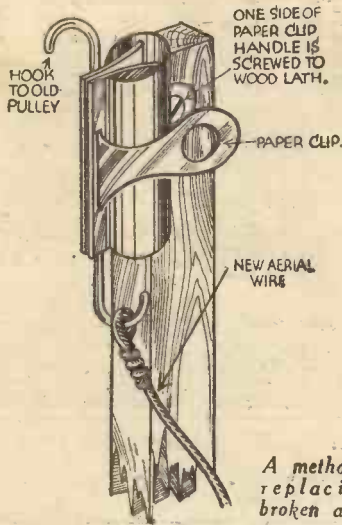

A method of replacing a broken aerial.

**RADIO WRINKLES**  
(Continued from page 1187)

**Replacing a Broken Aerial**

SOME time ago my aerial broke and it was not possible to take the mast down as this was an iron pipe set in concrete. To hook up another aerial pulley on the existing mast I procured a fair-sized paper clip and screwed one of the gripper handles to a length of wood lath as shown in the sketch. I then secured the new aerial system to an "S" hook (a 2d. meat hook), and placed same between the jaws of the paper clip. I was thus enabled to hook the new aerial to the old pulley as the strength of the spring of the paper clip was sufficient to hold the weight of wire and "S" hook. When I had got the hook in position, a sharp "snatch" released it from the paper clip and left it suspended in position. I have also replaced broken "guy wires" by the same method, as, provided that there is something to hook the "S" hook to, the job is quite simple.—W. G. ELVY (Crewe).

**A Pick-up Support**

A SUPPORT for a pick-up, which at the same time acts as an on-off switch for the valves, may be easily constructed from an old headphone "fork" and one or two odds and ends from the junk box.

As will be seen from the illustration, an old panel mounting bush from a scrapped

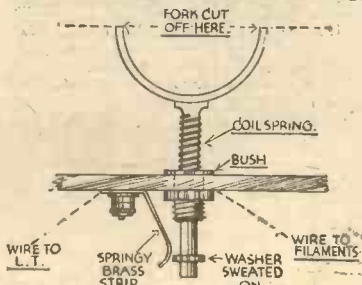

A novel pick-up support.

condenser, rheostat or similar component is fitted to the turn-table panel, and the stem of the headphone "fork" with a short spring on it is slipped down through this. It should be a nice smooth fit; if the hole is too large, a small piece of tubing should be fitted into the bush and reamed or drilled to take the stem.

Next, a washer is sweated on to the stem, and a piece of springy brass strip is bent as shown and screwed in such a position that when the spring lifts the fork up, the washer is in contact with it. When the pick-up arm rests in the fork, this is pushed down and breaks contact. A wire connects the bush with one side of the on-off switch, and another wire connects the brass strip with the other side of the switch.—E. H. OLIVER (Oxford).

**Self-contained Aerial for Portable Sets**

THIS is a device for making either one or two valve sets really self-contained with regard to the aerial, and with a little ingenuity the device could be used for the earth wire as well. As can be seen from the illustration below, the principal part of the gadget is a large pulley with deep groove made from three-ply wood discs, screwed together. The two side pieces shown are 8in. in diameter and 1/4in. thick, and the centre piece is 1 1/4in. diameter and 3-16in. thick. An ebonite rod, 1/4in. diameter, is used as a spindle, preferably with a hole down the centre,

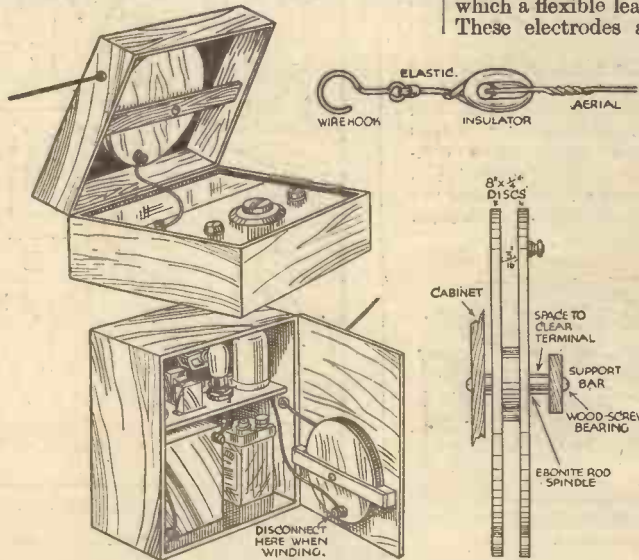

Housing an outside aerial in a portable set.

which enables two small screws to be used as bearings when mounting the pulley in any convenient place in the receiver. The aerial wire is pushed through a hole in the cabinet side, through a side hole in the pulley, and from thence to the aerial terminal on the set. When it is desired to pack the set up for transportation it is only necessary to turn the pulley and draw the aerial in like a awl, a suitable stop being fixed to the end to prevent it going through the hole in the cabinet. The insulated hook shown above can be carried in the pocket, and then, to run out the aerial, fix it to the insulator, and hook the latter on to a picture rail is but a moment's work.—D. W. GREY (Malton).

**A Band-pass Condenser**

ON a surprisingly large number of occasions the amateur finds that he has need of a variable condenser with an exceptionally small minimum capacity. The condenser illustrated here proved extremely satisfactory, and was made from an old fountain pen. The diagram is self-explanatory. The shortened barrel blocked with wood and screwed to a suitable base is shown at A. The electrode B is a small piece of copper foil attached with a dab of Chatterton's Compound and gripped under the

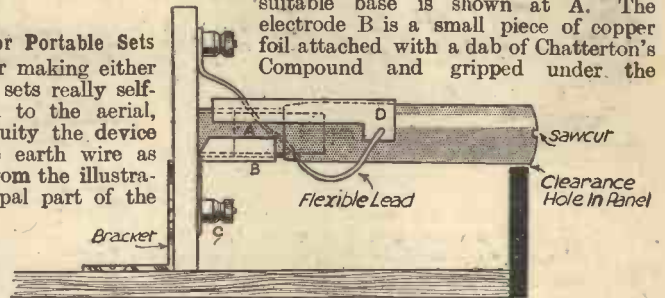

An improvised band-pass condenser.

terminal C. The other electrode D is similarly cut from a piece of specially-shaped foil attached to the fountain pen cap, also by means of compound, to which a flexible lead has first been soldered. These electrodes are kept apart by the thickness of the cap

and by a simple twisting motion the capacity can be varied between wide limits. I have found such a condenser to give perfect results in a top-capacity band-pass filter. This condenser can, if required, be controlled from the front of a panel by mounting it as illustrated.—STANLEY C. FISHER (Palmer's Green, London).

**Simple Remote Control**

FOR this simple remote control arrangement, all that is needed is a 3-contact plug and socket. One loud-speaker lead must be at earth (L.T.—) potential, so that choke and transformer output is essential. Two points on the socket are connected (through the extension wire) to the output of the set and the corresponding contacts on the plug to the loud-speaker, as is usual. Then the third contact on the socket is connected to the negative terminal of the low-tension battery, leaving the L.T.— terminal on the set free. Finally the contact on the plug,

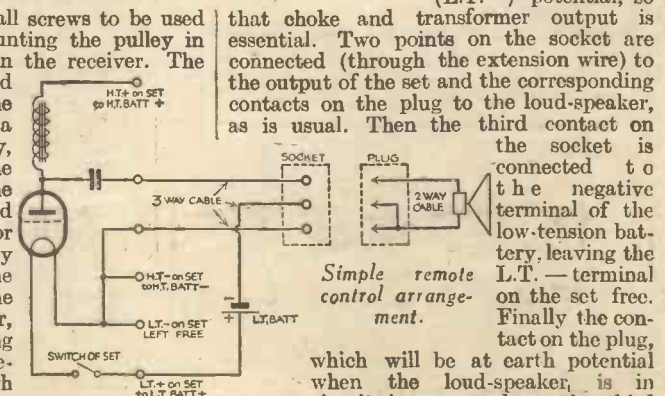

Simple remote control arrangement.

which will be at earth potential when the loud-speaker is in circuit, is connected to the third plug contact. It will be seen from the diagram that to switch on the set the loud-speaker plug is pushed in the socket, when the low tension circuit is completed, and to switch off the plug is simply pulled out.—E. J. STEADMAN (Eastcote).

OF INTEREST TO EVERY EXPERIMENTER

# FITTING UP A RA

**H**UNDREDS of thousands of home-constructed radio sets are built every year, and I suppose that a good ninety per cent. of them take shape in kitchens, in attics, in bedrooms, and in almost every conceivable place, with the exception of in a radio workshop.

It's really remarkable, isn't it? Surely there is no other hobby, which is taken quite so seriously, and yet to which so little official floor space is allotted. Take the average car owner! His garage at least boasts a workbench, and usually quite an efficient array of implements of repair, to say nothing of log-books, maps, and so on. The photographer has his dark-room; the philatelist, the gardener, the woodworker, they all have their hallowed domains, and yet the average wireless constructor persists in performing almost unbelievable contortions on the corner of the kitchen table.

It certainly does seem a mystery, and yet I don't suppose that the reason is far to seek.

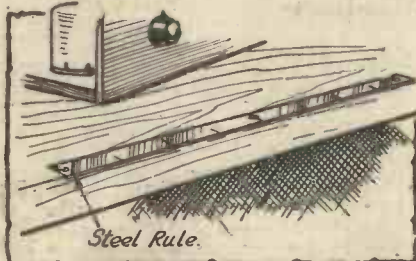

Steel Rule.

Fig. 2.—A steel rule screwed to the bench is handy for measuring wire, etc.

He probably starts off by building a simple two or three-valver in odd moments and in odd places. Later, a pick-up is added. Again, in spare moments and odd places; and so it goes on.

If you happen to be one of this band of enthusiasts, the following particulars of a

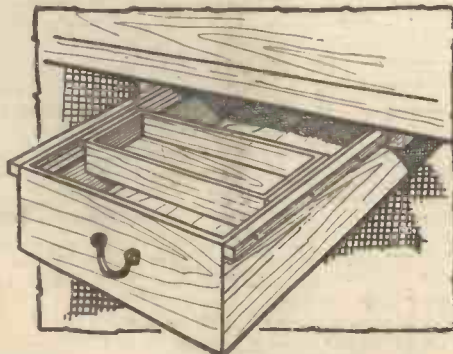

Fig. 3.—The more delicate tools should be kept together in the sliding tray of the tool drawer.

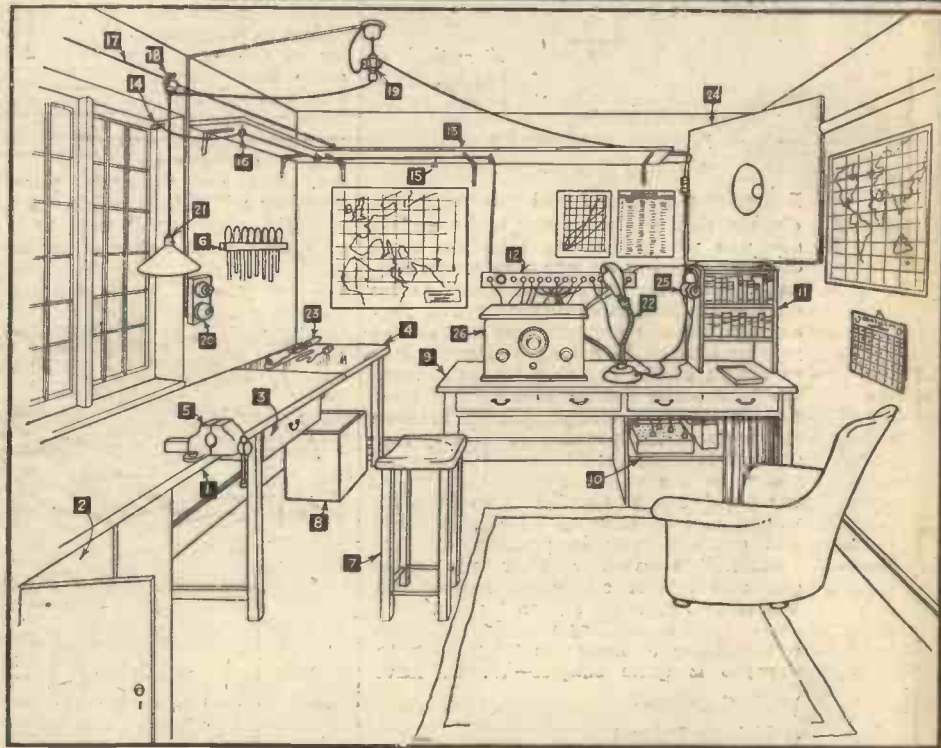

Fig. 1.—This Pictorial Chart shows the layout of the workshop.

- Item No. 1.—The work bench.
- .. .. 2.—A useful cupboard.
- .. .. 3.—The tool drawer.
- .. .. 4.—Sheet of zinc.
- .. .. 5.—The vice.
- .. .. 6.—The tool rack.
- .. .. 7.—The bench stool.
- .. .. 8.—The scrap box.
- .. .. 9.—The testing bench.
- .. .. 10.—The battery compartment.
- .. .. 11.—Bookshelf.
- .. .. 12.—Universal terminal strip.
- .. .. 13.—Shell.
- .. .. 14.—Lead-in tube.
- .. .. 15.—Aerial lead-in.
- .. .. 16.—Insulated hook.
- .. .. 17.—Stout galvanized wire.
- .. .. 18.—Sliding Clip.
- .. .. 19.—Three-way adaptor.
- .. .. 20.—Wall-plug and switch.
- .. .. 21.—Light plug and switch.
- .. .. 22.—Adjustable lamp.
- .. .. 23.—Electric soldering iron.
- .. .. 24.—Loud-speaker, mounted on baffle-board.
- .. .. 25.—Headphones.
- .. .. 26.—A set under test.

radio workshop will probably interest you. Surely you have that spare room, or a shed, or outhouse in the garden! Why not spring-clean the spare room, clean out the garden shed or the outhouse, and put a label on the door, "Radio Workshop, PRIVATE"! Having obtained a lease on suitable "premises," the rest is easy—if a little thought is given to the job in hand. We will assume that the room is small (as it will be in the majority of cases) and, therefore, every cubic inch is valuable.

**General Layout**

A glance at Fig. 1 will give an idea of the layout suitable for a small room. It is impossible, of course, to give a hard and fast layout (as the rooms will vary in almost

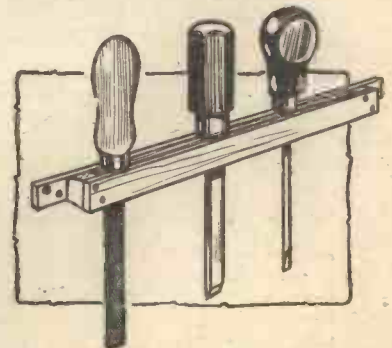

Fig. 4.—A handy rack for files, screwdrivers and chisels.

Supporting Bracket

# RADIO WORKSHOP

## A PRACTICAL ARTICLE BY A. ASHDOWN

### HOW TO RIG UP A HANDYMAN'S IN- EXPENSIVE RADIO DEN FROM ODDS AND ENDS

every case), but as we must start somewhere, we will assume that the room has four walls, a door and a window. In this pictorial chart it will be noticed that the various "furnishings" are numbered and indexed, so if we take them in numerical order we will have cleared up most of the points.

**Item 1.**—The bench, a most important fitting in any workshop. The construction of a bench of this description is very simple, as will be appreciated from the drawing. Whilst it is not necessary to have a very hefty affair for radio work it is as well not to go to the other extreme and have a flimsy one that bends at each sawcut. The supports should not be less than 2½ in. square and ordinary floor-boarding will be found very suitable for the top. It will be noticed that the bench takes up the whole length of the wall, in front of the window. Although this position is claimed at the expense of a short aerial-lead-in, it will be justified by better lighting on the job in the vice.

**Item 2.**—A cupboard, housed under the bench, will be found very useful for storing the enormous amount of oddsends, which only a wireless fan can hoard! If this cupboard is judiciously sub-divided a remarkable degree of orderliness may be maintained.

**Item 3.**—The tool-drawer, a "close-up" of which is shown in Fig. 3, is supported on wooden runners which are screwed to the underside of the bench. The sliding tray, shown here, will be found very handy for smaller tools, such as gauges, callipers.

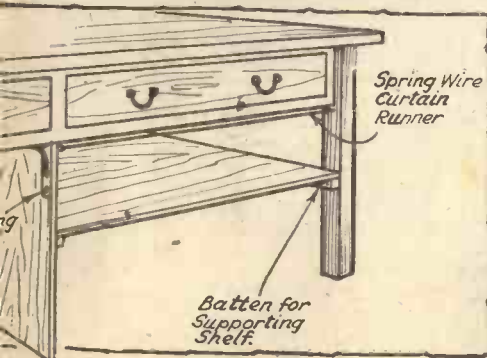

Fig. 5.—The "power-station" or battery compartment.

small screwdrivers, etc., which otherwise have a nasty habit of hiding themselves under the larger tools in the drawer.

**Item 4.**—A sheet of zinc covering one end of the bench will be found useful for the soldering department.

**Item 5.**—The vice. Although this need not be of cumbersome dimensions, for radio work, it is as well to have something fairly sturdy, as some of our jobs (such as metal chassis construction) may call for a solid foundation. Just a word about the mounting of the vice. Place it fairly

drawers will come in handy for storing our logbooks, slide rules, pencils, pens, and all the "clerical" records of our "works."

**Item 10.**—The generating station, otherwise known as the battery cupboard, is shown in detail in Fig. 5. The shelf should, for preference, be covered with a sheet of rubber (an old rubber mat will

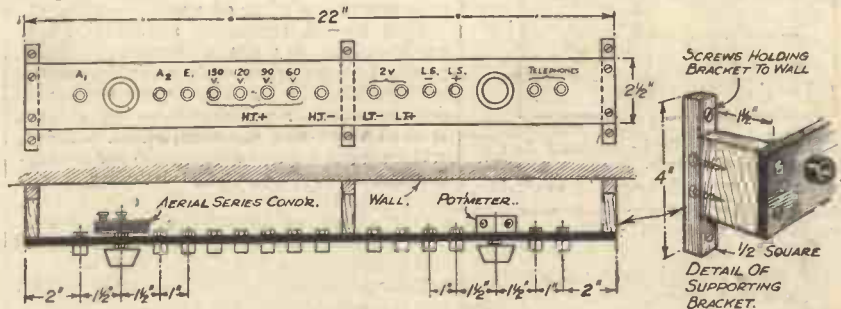

Fig. 6.—The lay-out of the universal terminal strip.

near a bench support for rigidity, but not directly over one, as some awkwardly shaped job, which we may have to tackle, may require space directly underneath the vice.

**Item 6.**—A rack for files, screw-drivers and chisels. The latter especially should be kept in this manner, as the cutting edges will soon become sadly out of condition if the chisels are kept in the tool drawer.

**Item 7.**—The bench stool may be frowned upon by the serious-minded mechanic as a luxury. Many back-aches, however, may be avoided by this means.

**Item 8.**—The scrap-box, if regularly and judiciously employed, will maintain the tidiness of our workshop.

#### The Electrical Side

Well, these items—1 to 8—give us the main essentials for our constructional department. Now let us step into our electrical and testing laboratory! It is here that the fruits of our constructional labours come up for judgment, so let's be fair and give them a good trial!

**Item 9.**—The testing bench. As may be readily seen from our chart, this is really a common or garden kitchen table. A couple of

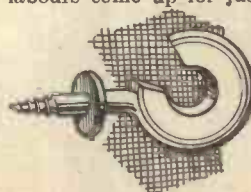

Fig. 10.—An insulated hook. A couple of

do nicely), so that any acid spilt, will do no damage.

**Item 11.**—The bookshelves, for our works of reference, can easily be put up, and this will complete all the constructional additions to our testing bench.

**Item 12.**—The power distribution department, or to be more homely, the universal terminal strip. This is simply an ebonite strip mounted on wooden brackets and fitted with sockets. Fig. 6 shows the

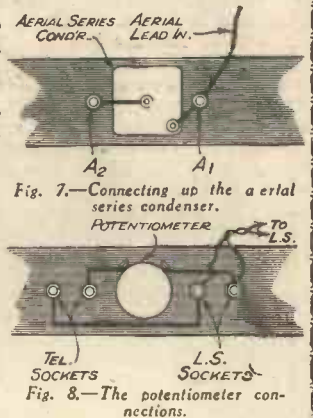

Fig. 8.—The potentiometer connections.



Fig. 9.—A flexible connection for use between the terminal strip and the set.

constructional details and layout. Two refinements will be noted; namely, the aerial series condenser and the potentiometer. The wiring up of the former is shown in Fig. 7, and by this arrangement we can either test a set directly from the aerial (by connecting to A) or through the aerial series condenser by plugging in to A2. The object of the potentiometer will be fairly obvious from Fig. 8. It is wired between the loud-speaker and the telephone terminals, in series and enables 'phones to be used in comfort, irrespective of the output of the set. A multi-flex battery cord connects the terminal strip to the power supply and thus a choice of voltages is available for use. The L.T. side may, of course, be elaborated with further plugs and a switch, so that

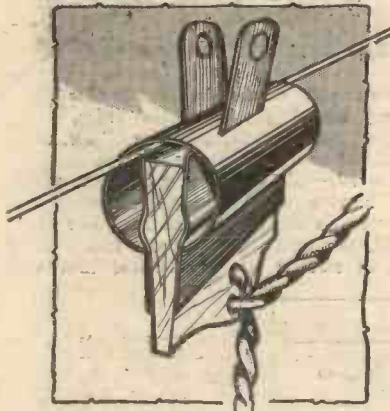

Fig. 11.—The sliding clip for supporting the bench light.

as a choice of 2, 4 or 6 volts is available. As most sets incorporate the grid-bias battery, it is not worth while, in view of the additional amount of wiring, etc., to include grid-bias tappings on the terminal strip. Fig. 9 shows a connecting lead suitable for use between the terminal strip and the set under test. If each of these leads is of a different colour it will obviate the risk of making incorrect connections.

Item 13.—As will be readily seen, this is a shelf and as such justifies itself. Its purpose, however, is twofold, as it also forms the support for the aerial lead-in.

Item 14.—The aerial lead-in tube.

Item 15.—The aerial lead-in is carried under the shelf (as suggested above) direct to the A plug on the terminal strip.

Item 16.—Insulated hooks, shown in Fig. 10, support the aerial under the shelf. Now we come to the lighting arrangements of our workshop.

Item 17.—This is a stout wire running parallel to and directly over the bench, and carries the bench light.

Item 18.—A sliding clip of this description enables the light to be moved to any position over the bench. This clip,

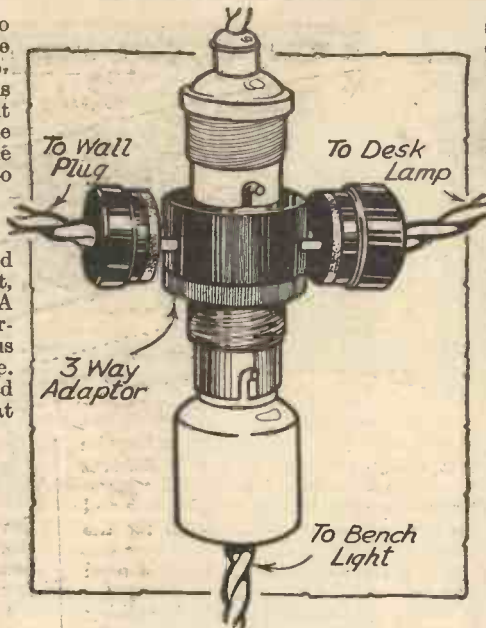

Fig. 12.—A three-way adaptor.

as will be seen by a glance at Fig. 11, is made from an ordinary spring paper-clip, gripping a piece of wood.

Item 19.—A three-way adaptor. There are innumerable ways of tapping a lighting point, but the three-way adaptor, shown in Fig. 12, will be found very useful for our purpose. An alternative suggestion is to fit a two-way adaptor (which, perhaps, will be more readily obtainable) for supplying the two lights. The wall-plug flex is then taken direct from the ceiling rose, either above or below the ceiling. This wiring should be encased in a lead covering if carried below the ceiling; it may be supported by staples driven into the rafters above the plaster. When the position of the first rafter has been found the subsequent



Fig. 14.—A useful lamp for the testing bench.

staples may be carefully driven in at distances equal to the pitch of the rafters. Fig. 13 illustrates this method.

Item 20.—This consists of a batten type lamp-holder and a switch mounted on a wooden base. This complete unit, when wired up, serves as a useful point of supply for the electric soldering-iron.

Item 21.—A lamp-holder incorporating a switch in its construction will be found most suitable for the bench light.

Item 22.—This table-lamp (shown also in Fig. 14) is very handy on our testing bench, for the flexible tubular standard enables the light to be directed in any required direction.

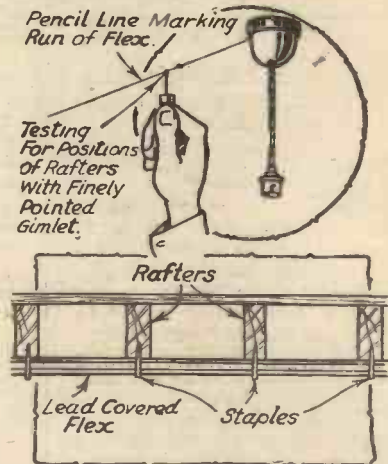

Fig. 13.—These pictures show how to support the lead-covered flex.

Item 23.—An electric soldering-iron will be found a great time, labour, and temper saver.

Item 24.—The loud-speaker (preferably of the moving-coil type) should be mounted on a baffle-board as large and as thick as possible. For space economy reasons the loud-speaker may be mounted in the corner of the room as shown and supported by brackets to the picture-rail. It is as well to remember to have a space of nine inches to one foot from the top of the board to the ceiling.

Item 25.—A pair of headphones will be found almost indispensable for short-wave work.

Item 26.—A set under test. This brings us to the end of our list and more or less completes the job.

These twenty-six items are, of course, just the "bare bones" of our workshop. Maps, charts, lists of stations, calendars pipe-racks, will all gradually find a place allotted to them and give a homely and individual atmosphere. Why not turn out that spare room now, for when you've a proper room for practising your hobby it will be twice as interesting.

**THE A.C. "FURY FOUR" RADIO-GRAM.**

(Continued from page 1182.)

quality was possible at really good volume, two features that all too seldom go hand-in-hand. This is largely attributable to the careful design of the detector circuit and adequate output arrangements.

The set is necessarily one using a large number of components and there has admittedly been a certain reluctance in the past for constructors to build elaborate receivers, but the method of presentation is

to some extent unique, and has introduced the would-be constructor to each step and part by slow degrees, which will in my opinion completely overcome any doubts. In addition, further encouragement is offered by the personal guarantee of satisfaction given by the author.

Cosor 220 S.G. metallized valves were used in the S.G. stages, 210 H.F. metallized in the detector stage and 220 P.T. in the output stage.

In conclusion, I would remark that the set used on an eliminator gave exactly the same performance as when used on batteries of similar voltage.

**The A.C. "Fury Four"**

In the article concerning the A.C. "Fury Four" it was stated that the Westinghouse Brake and Saxby Signal Company were supplying sets of parts for an eliminator for use with the battery version of the "Fury." We regret that this was incorrect, and that the reference should have been to the blue print only. The Westinghouse Company only supply the blue print, and the rectifier which is the type H.T.6. The parts required for the eliminator are obtainable from any good radio dealer, and we have pleasure in rectifying the former mis-statement.

# Here's more Power to your Set

THE extraordinary "life" and power of sets constructed with Lewcos Components is attributable to the precision and high quality materials with which these world-famous Units are made.

Before building your set write for a series of descriptive leaflets (Ref. W.) which are of vital importance to every constructor.

Follow the experts and insist on "LEWCOS."



RADIO COMPONENTS

**LEWCOS RADIO PRODUCTS FOR BETTER RECEPTION**

THE LONDON ELECTRIC WIRE COMPANY AND SMITHS LIMITED, CHURCH ROAD, LEYTON, LONDON, E.10

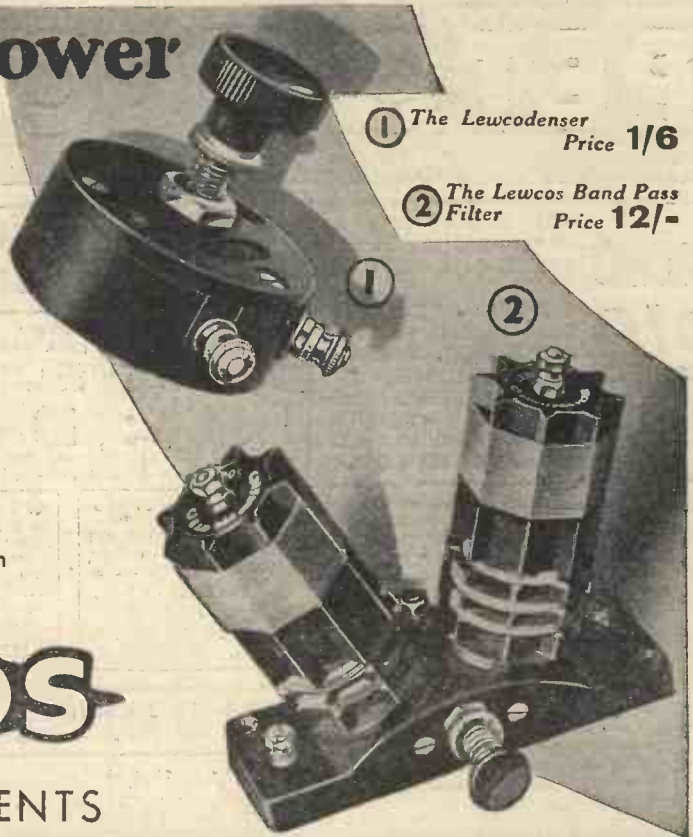

① The Lewcodenser Price 1/6

② The Lewcos Band Pass Filter Price 12/-

## WEARITE COMPONENTS

A Catalogue of Standard Wearite Components—range is ever expanding—sufficiently comprehensive to indicate the reason for Wearite's supremacy in the field of Radio Components

Follow the designer with YOUR "FURY FOUR" use WEARITE.....and GET THIS BOOK FIRST!

Here is an opportunity to build a really up-to-date receiver—a real "star" performer. But don't jeopardise its performance by using doubtful parts. The designer has specified the Wearite H.F.P.A. choke—a most important link in the chain that means efficiency. H.F. stability is assured if you follow the designer. He also specifies the Wearite G.W.C. Switch—follow him and be certain.

★ THE WEARITE H.F.P.A. CHOKE  
A Screened H.F. Choke with armoured pigtail connection. Covers 15-2,500 metres without resonances. Price 4/-

★ THE WEARITE G.W.C. SWITCH  
A soundly built job with definite "snap" action—self-cleaning contacts. Price 1/3

USE THE WEARITE POTMETER FOR SILENT ACTION AND EVEN VOLUME CONTROL.  
50,000ohms. Type 4/6

## WEARITE

DON'T FORGET—A GOOD EARTH.  
The Wearite Earth Tube. Price 3/6

WRIGHT & WEARE Ltd.,

740, HIGH ROAD, TOTTENHAM, N.17

Telephone: Tottenham 3847/9,9.



# PETO-SCOTT RADIO BY MAIL

**SEND 2/6 ONLY**

Just pay a further 2/6 on delivery and balance in 5 monthly payments of 5/6 for

**PETO - SCOTT GUARDIAN Q. P. P. MOVING-COIL SPEAKER** specially designed for Q.P.P. output. Extremely sensitive, and gives perfect quality. Cash or C.O.D., Carriage Paid, 29/6.

**LISSEN "SKYSCRAPER 3."** Chassis model with (Lissen) S.G., Detector and Pentode valves. Cash Price £4/9/6. Carriage Paid. Balance in 11 monthly payments of 8/3.

**LISSEN "SKYSCRAPER 3."** Cabinet model. Complete with Lissen speaker and Lissen S.G., Detector and Pentode valves. Cash Price £6/5/0. Carriage Paid. Balance in 11 monthly payments of 11/6.

**TELSEN "ASTRALA 3."** Chassis kit complete with full-size Blueprint, building and operating instructions. Detector, L.F. and Power. Cash or C.O.D., 39/6. Balance in 7 monthly payments of 5/6.

**ATLAS ELIMINATOR.** Type A.C.244. Three tappings: S.G., Detector and Power. Output: 120 volts at 20 m/A. Cash Price £2/19/6. Carriage Paid. Balance in 11 monthly payments of 5/6.

**W.B. PERMANENT MAGNET MOVING-COIL SPEAKER.** Type PM4. Complete with transformer. Cash Price £2/2/0. Carriage Paid. Balance in 7 monthly payments of 5/9.

**CELESTION P.P.M. PERMANENT MAGNET MOVING-COIL SPEAKER** with impregnated diaphragm and dual-impedance input transformer. Cash Price, Carriage Paid, £2/7/6. Balance in 11 monthly payments of 4/6.

**BLUE SPOT UNIT AND CHASSIS.** Type 99 P.M. Including matched transformer. Cash Price £2/19/6. Balance in 11 monthly payments of 5/6.

**R & A "VICTOR" PERMANENT-MAGNET MOVING-COIL SPEAKER DE LUXE.** With 0-ratio input transformer and protecting grille. Cash Price £3/10/0, Carriage Paid. Balance in 11 monthly payments of 6/5.

**EPOCH 20th-CENTURY PERMANENT-MAGNET MOVING-COIL SPEAKER.** (New Edn.) With 5-ratio input transformer. Cash Price, Carriage Paid, £1/15/0. Balance in 5 monthly payments of 6/6.

**EPOCH Q.P.P. PERMANENT MAGNET MOVING-COIL SPEAKER.** Type Q.M. With 0-ratio input transformer. Cash or C.O.D., Carriage Paid, £1/12/6. Balance in 5 monthly payments of 6/-.

## FURY FOUR BATTERY MODEL

**KIT "A"** Author's Kit of specified parts, including ready drilled panel, but less valves and cabinet. CASH OR C.O.D. Carriage Paid.

**£6 : 10 : 0**  
or 12 monthly payments of 12/-

Specified Valves, £2/17/6, Peto-Scott Oak Cabinet, 15/-.

**KIT "B"** As Kit "A" but with valves, less cabinet, CASH or C.O.D., Carriage Paid.

**£9 7 6**  
or 12 monthly payments of 17/3.

**KIT "C"** As Kit "A" but with valves and Peto-Scott American Type Cabinet with lift-up lid. CASH or C.O.D., Carriage Paid.

**£10 2 6**  
or 12 monthly payments of 18/6.

## A.C. FURY FOUR RADIO-GRAM

**KIT "A"** Author's Kit of specified parts, including ready drilled panel but less Valves, Cabinet, Motor, Pick-up and Speaker. CASH or C.O.D. Carriage Paid.

**£10 0 0**

or 12 monthly payments of 18/4

### ESSENTIAL ACCESSORIES

- 1 Simpson Electric Turntable, £1/19/6
- 1 Amplion Pick-up with Volume Control, 25/-
- 1 W.B. Permanent Magnet Moving-Coil Speaker, £2/2/0

### EXCLUSIVELY SPECIFIED FOR A.C. FURY RADIOGRAM

**PETO-SCOTT 1933 ADAPTARAM** CASH or C.O.D.

Real Inlaid Walnut. With Motor Board and ready for Set. Or send 8/3 deposit and 11 monthly payments of 5/9. **65/6** Carr. Paid

## PUSH-PULL THREE-FOUR

**KIT "A"** Author's Kit of First Specified parts, including ready drilled panel, but less valves and cabinet. CASH OR C.O.D. Carriage Paid.

**£4:18:6**

or 12 monthly payments of 9/-

**KIT "B"** As "Kit "A" but with valves, less cabinet, CASH or C.O.D., Carriage Paid.

**£7 7 0**  
or 12 monthly payments of 13/6.

**KIT "C"** As Kit "A" but with valves and Peto-Scott American Type Cabinet with lift-up lid. CASH or C.O.D., Carriage Paid.

**£8 2 0**  
or 12 monthly payments of 14/10.

## PILOT AUTHOR KITS - Exact to Specification

### Q.P.P. PILOT CONVERSION KIT FOR ANY BATTERY SET

**GIVES MAINS VOLUME & QUALITY**

Convert your set to Q.P.P. —it's easy with the

**PILOT CONVERSION KIT**, which comprises 1 Q.P.P. Transformer, 1 Q.P.P. Output Choke, 4 Non-inductive Resistances, 1 Potentiometer, 2 Mansbridge Condensers, 2 Valve Holders, 1 Tone-Compensating Condenser, 1 H.F. Choke, G.B. Plugs, Wires, Screws, Flex, etc., with **FULL SIZE** diagrams and constructional notes. Cash or C.O.D. 42/-

**KIT "B."** As above, with 2 Pentode 220A valves, Cash or C.O.D., £3/17/6 or 12 monthly payments of 7/-.

SEND ONLY

**6/-**

Balance in 7 monthly payments of 6/-.

### BLUE SPOT 100U

Speaker and Chassis. For high or low-powered sets. Original Price £1 12s. 6d. Our Price (for a limited period only) CASH or C.O.D.

**19/6**

### AMPLION PICK-UP

with Arm, Base, and Volume Control. Original price £1 5s. 0d. Our Price (for a limited period only), CASH or C.O.D.

**19/6**

## SNIPS

**SEND ONLY 2/6**



Just pay further 2/6 on delivery for

### PETO-SCOTT Oak Console CABINET

Balance in 4 monthly payments of 5/6. Cash or C.O.D., Carriage Paid, £1/5/0.

## CASH, C.O.D. or EASIWAY

**PETO-SCOTT CO. Ltd. 77, City Road, London, E.C.1.**

West End Showrooms: 62, High Holborn, London, W.C.2. Telephone: Clerkenwell 9406/7. Telephone: Holborn 3248.

Dear Sirs, Please send me CASH/C.O.D./H.P. for which I enclose £..... CASH/H.P. Deposit. Also FREE Guardian Q.P.P. 1/- Constructional Chart.

NAME .....

ADDRESS .....

Pr.W. 11-3-33

**FREE.—SEND 3d. POSTAGE FOR 3 PILOT ENVELOPES WITH FULL-SIZE BLUEPRINTS**

**ANY ITEM SUPPLIED SEPARATELY—ORDERS OVER 10/- SENT C.O.D. CARRIAGE AND POST CHARGES PAID**





Conducted by F. J. CAMM

I WANT this week to pass on to a consideration of the work of the second valve in our set. You will remember that in Parts 2 and 3 I showed that the currents flowing in the plate circuit of the first or detector valve fluctuated in accordance with the speech or music being transmitted from the broadcasting station.

### HOW YOUR SET WORKS

#### Part 4.—AMPLIFYING THE SIGNALS

illustrations here is because I want to refresh our memories as to the general

use. One is by means of a *resistance*, and the other by the use of a *transformer*. In the set under discussion the former method is used.

A *resistance*, as its name implies, is something which resists the passage of an electric current. Actually all conductors of electricity offer *some* resistance. Even a thick copper wire opposes the flow to a small extent. It is something like the flow of water through a pipe. However large the bore of the pipe it still offers *some* resistance to the passage of water through it.

However, the "resistance" used in this case is comparatively high. It might be likened to a constriction in a water pipe. If you look at Fig. 3 I think you will see what I mean.

At (a) is shown water flowing from a rubber pipe of generous dimensions. It offers very little resistance, therefore the flow is only impeded to a small extent. At (b) someone has gripped the pipe, so making it small in one place. It now offers a high resistance to the flow of water, and only a little dribbles out. If

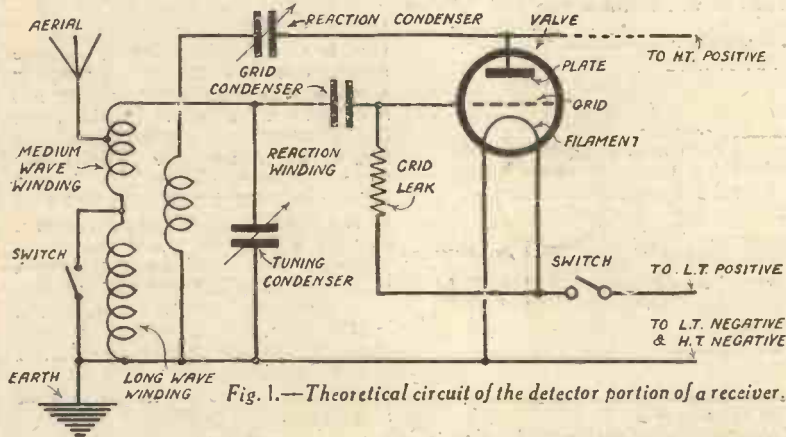

Fig. 1.—Theoretical circuit of the detector portion of a receiver.

This meant that if we were to connect a pair of headphones, or a loud-speaker in this circuit, we could hear the music. By doing this we should be using our receiver as a one-valve set.

However, with such an arrangement, signals would not be very strong, therefore we amplify the currents by passing them through the other two valves in the set. They are then many times stronger, and capable of producing correspondingly louder signals.

#### To Refresh Your Memory.

If you look at Figs. 1 and 2 you will see illustrated diagrammatically and pictorially respectively the parts of our set which we have already dealt with.

These diagrams may look a little more complicated than previous ones, but I don't want you to bother over that for the moment. The reason is that they show *all* the parts of the set we have so far studied, whereas most of the previous diagrams have been confined to the one particular section under examination at the time. Also, there are one or two little modifications shown here which would be found in the average receiver, but which, to avoid confusion, I have hitherto omitted. However, as I say, we will not bother over that for the moment—I shall explain all such little details later on. Why I refer to these

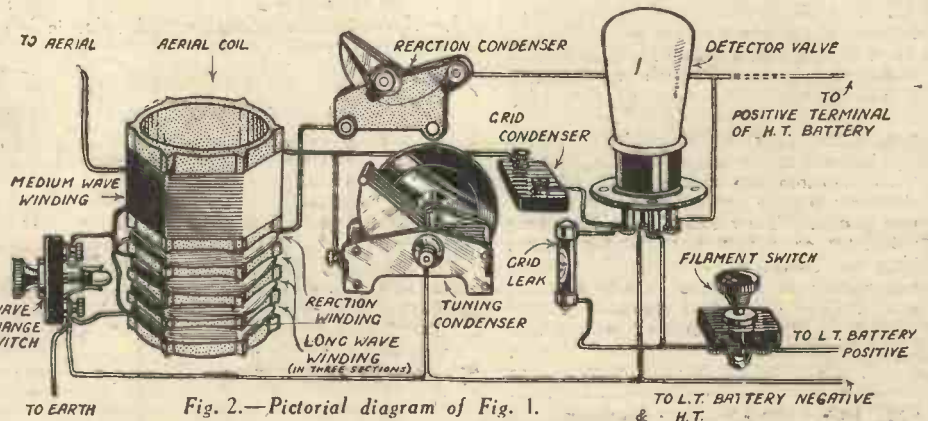

Fig. 2.—Pictorial diagram of Fig. 1.

scheme of things up to the present stage.

Starting from the left, we have first of all the aerial to receive the wireless waves, then the tuning arrangements, including the reaction coil. Next comes the detector valve with its grid leak and condenser, and, finally, we have the wires leading to the batteries. I have not actually shown the batteries here because this is not the end of the set. They will come after all the valves, at the extreme right.

#### The Use of a "Resistance"

Now let us see how the second valve is connected up, and how it increases the currents produced by the first one. There are two methods of connection in general

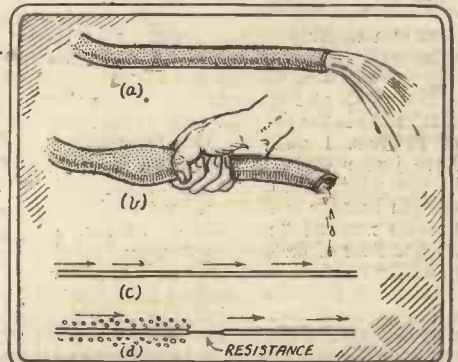

Fig. 3.—An analogy showing the effect of resistance.

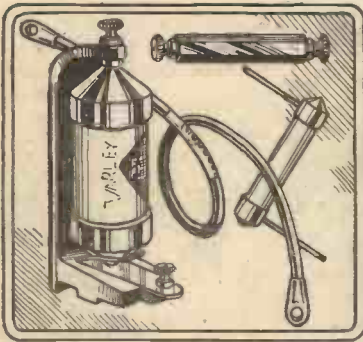

Fig. 4.—Typical resistances used in wireless receivers.

the pressure is sufficient there will be an accumulation of water behind the constricted part, causing the tube to swell as shown. Figs. 3 (c) and (d) show the electrical counterpart, (c) shows a wire with a current flowing through it as indicated by the arrows, and (d) represents the same wire with a "resistance" included. In this case the resistance is simply a very much thinner wire. What happens is that the flow of electric current is reduced in the same way as the flow of water is reduced in (b). The little dots represent the pressure of electrons due to the resistance corresponding to the pressure of water behind the constriction in the water pipe.

**A Difference in Pressure**

Now I will show you how a resistance is used to couple our two valves. You will remember that an electric current flows in the plate circuit of the detector valve. That is to say there is a current flowing along the wire connecting the plate of the valve to the high tension battery. What we do then is to include a resistance in this wire at the point shown by the dotted line in Fig. 1. This resistance may take various forms. Typical examples are shown in Fig. 4. Two of them are little stick-like things similar to the grid leak previously mentioned. They are about the same thickness as a pencil, about two inches long and composed of some composition, the nature of which is usually a trade secret. The other two are each wound with very fine "resistance" wire which is made of a special metal like German silver. The presence of the resistance causes a difference in pressure or "voltage" to use the proper term between the one side and the other just as a constriction in a water pipe would cause a difference in pressure between the water on the one side and that on the other.

Now look at Figs. 5 and 6. The valve on the left is the detector—the same valve as in Figs. 1 and 2. The resistance I have just mentioned as being connected in the wire from the plate to the high tension battery is denoted by the zig-zag portion marked "resistance" in Fig. 5. As a matter of fact, it is generally spoken of as the *anode resistance* since it is in the "anode" (another name for plate) circuit of the valve. There is also another wire coming from the plate which was not shown in Figs. 1 and 2. It leads first to a fixed condenser called the *coupling*

condenser, and thence to the grid of the next valve.

**A Water Pipe Analogy**

This wire might be compared with a branch pipe rising from the water pipe just before the constricted part. See Fig. 7 (a). The presence of the constriction causes water to rise in the branch pipe, whereas without it as at (b) no water would go into the branch pipe. If the upper end of the branch pipe were stopped up the pressure inside would be the same as in the main pipe. (I am neglecting the effects of gravity, of course.)

In the same way the pressure, or voltage, in the wire to the condenser is the same as in the main wire from the plate to the resistance.

Now we have already seen that the current flowing in the plate circuit of the detector valve fluctuates in strength and speed in accordance with the variation in power and tone of the music which is being received. Naturally this rise and fall in current will mean a rise and fall

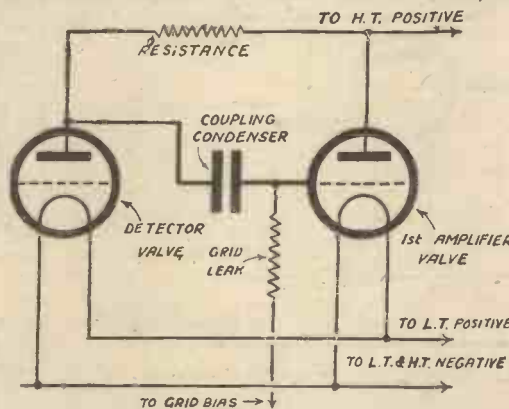

Fig. 5.—A resistance capacity coupled valve in theoretical form.

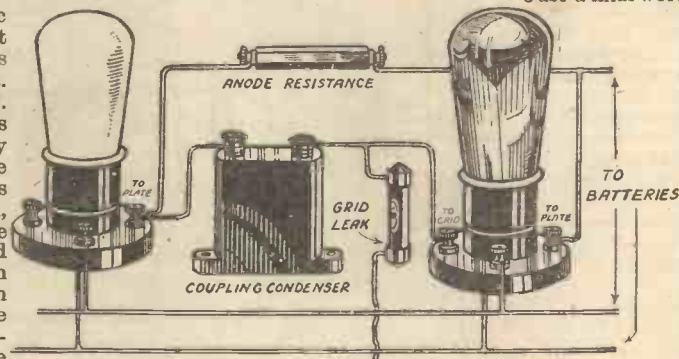

Fig. 6.—Pictorial illustration of Fig. 5.

in pressure, thus the pressure or voltage in the wire to the coupling condenser will rise and fall, too. We will not go into details regarding the action of the coupling condenser, suffice it to say that like the detector grid condenser it passes on these variations in pressure to the grid of the amplifier valve.

**How the Valve Amplifies**

You remember how when the grid of the detector valve became alternately positive and negative it accordingly attracted and repelled the electrons flowing from the filament to the plate and so increased or decreased their flow.

Well, the same kind of thing goes on in the amplifier valve. Actually, the grid does not vary from positive to negative. It is connected by means of a grid leak to a battery known as the *grid bias battery*, which keeps it negative all the time. This is done for certain reasons, which we need not go into here. However, the effect is the same, but instead of varying from positive to negative it varies in its degree of "negativeness." This variation in the state of the grid causes a variation in the number of electrons flowing from the filament to the plate, in other words a variation in the plate current. What causes the valve to amplify is that *small* variations in the voltage of the grid cause *large* variations in the plate current.

Perhaps this all sounds rather technical to you. That I cannot tell because I do not know just how much of the previous articles you have been able to follow. If I have not always made my explanations clear to you I must ask you to forgive me. As I said in the beginning some points are very difficult to explain in everyday language. Whenever possible I have tried to give simple analogies, but here again, one has to go very warily because a *simple* analogy may not always be a *true* one. For instance, I said that an electric current was like a flow of water in a pipe. This is easy to understand, although it is not strictly correct. However, I feel that it is better to give *some* idea even if it is not a complete one than to leave you with *none* at all, as might result if I persisted in laboured explanations at each awkward point we came across. If, therefore, you cannot quite grasp the idea of what goes on inside a valve I will simply remind you that the final effect is one of magnifying or amplifying.

**Grid Leak and Grid Bias**

Just a final word about the grid-bias battery referred to. You will notice in Figs. 5 and 6 that the amplifier valve has a grid leak, the same as the detector valve. The lower end marked "to grid bias" is joined to the negative terminal of this grid-bias battery. It is similar to an H.T. battery but smaller, and is included to ensure that the amplifier valve works correctly.

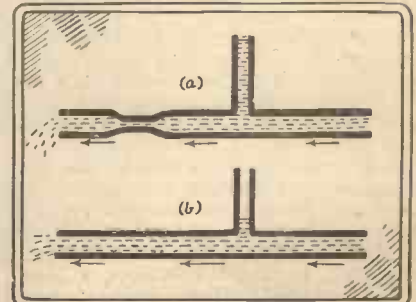

Fig. 7.—An analogy to demonstrate the action of the coupling condenser.

**N**O doubt there are many other readers who, like myself, keep at least two receivers in commission—one of a fairly simple nature for the use of those members of the family who wish to listen seriously, and the other a more elaborate set, incorporating the latest devices, for distant reception and for general experimental use. As a matter of fact, I often have a third set in being—or, rather, in process of construction, or destruction, to try out some of the latest developments. Perhaps it has happened to you as it did to me just before Christmas, that the

# SOME SNAGS AND SUGGESTIONS

By "CYNIC"

save cutting unnecessary and unsightly holes in the final chassis. (See Fig. 2.)

### Resistances

Another thought which occurred while I made soldered joints to nineteen fixed resistances of the metallized type. In only some of the cases were the wire ends of these resistances long enough to make the necessary connections, so that usually extra wires had to be soldered on. A

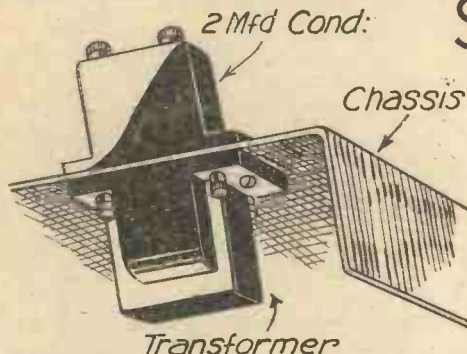

Fig. 1.—Simplification of mounting components by standardized spacing of fixing holes.

Family petitioned that the existing "house" set should be modernized, or at least made more presentable. In an expansive mood I succumbed, and promised them a really "posh" radiogram in time for Christmas. I kept my promise, and this is the chronicle of the snags I encountered.

In the first place, I decided upon an A.C. mains three-valver with a variable mu H.F. stage, power grid detector and pentode output valve. Band pass aerial tuning, tuned grid high frequency coupling, ganged condensers and automatic bias were also specified and, to crown all, this set was to be built upon an aluminium chassis. In the interests of economy as many components as possible were to be taken from the existing set and from my own stock of parts. It is in this connection that some of the worst snags were encountered.

### Standardization

I will make no attempt to recount these snags in any particular order, but just mention them haphazard in the hope that they may prevent others from falling into similar troubles. In the first place, the size of the chassis was chosen to give reasonable room for a kit of ganged coils, ganged condensers, valves and low frequency transformer on the top, while the sides of the chassis were made deep enough to permit all the other components to be accommodated underneath. Such small parts as fixed condensers (other than the big 2 mfd. chaps), resistances and grid leaks were included in the run of the wiring and were not screwed down. Heavier parts were secured by 4 B.A. screws and nuts to the chassis.

Now there was ample room for all the components, yet it was a difficult matter to fit them all in. You see, not only had they to be arranged in positions which suited the circuit and avoided any unwanted couplings, but they also had to be so located that there was a convenient fixing for each which did not foul components mounted on the other side of the base plate. As I arranged and re-arranged and played "chess" with the items I wondered why radio component manu-

facturers had not got together years ago and standardized the distances between the fixing holes of all components, or, failing that, at least similar ones. Then, don't you see, components on the underside of the chassis could be mounted on the same bolts that secure the components mounted on the top of the chassis, as depicted in Fig. 1. I understand that a committee of

### A Chronicle of Drawbacks for the After-Lunch Assimilation of the Component Manufacturer



Fig. 3.—Longer wire ends to resistances.

manufacturers has now been formed for the purpose of standardization—here's wishing strength to their arm and an early realization of their labours.

### Coloured Bands

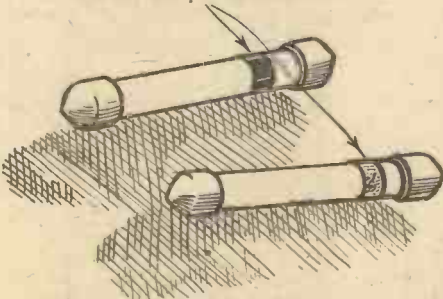

Fig. 5.—Colour coding of resistances.

Here is a tip if you think of building on a metal chassis. Make a temporary chassis of three-ply wood, or even tin, and do your preliminary arrangement on that. It will

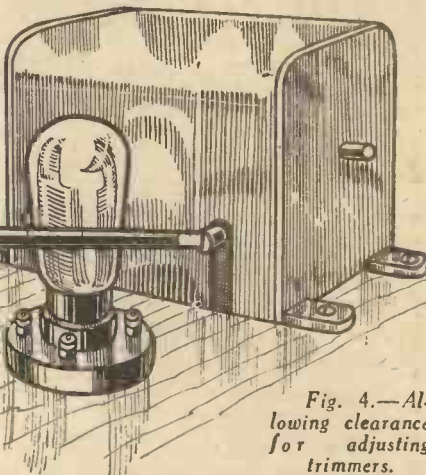

Fig. 4.—Allowing clearance for adjusting trimmers.

rather more generous length of wire ends, as shown in Fig. 3, would, I am sure, be appreciated. My pentode was a modern valve taking 30 milliamperes high tension, but I experienced a certain amount of difficulty in finding a semi variable resistance for automatic bias of the order of 1,000 ohms capable of carrying this current. Fixed resistances were available in shoals—but I have a weakness for adjustable bias on a big output valve.

The next snag concerns the variable resistances and potentiometers which were mounted on the front side of the chassis. They were of an excellent and well-known make and were taken from another set which was being dismantled at the time. It was not until just before the final test that I realized that the spindles of these components carry current and were earthed to the chassis, a fact which did not in the least suit this particular circuit. I had therefore to dismount them and re-drill the holes through which the spindles passed, inserting suitable insulating bushes. As a matter of fact, this discovery was made late on a Saturday night, and no suitable bushes were to hand, but a temporary bush was made by winding a narrow strip of the gummed paper tape used for doing up parcels round the spindle.

Remember then, if you are building on a metal chassis, or with a metal panel, to find out whether the spindles of any components should be insulated from the panel and see that you are provided with insulating bushes where necessary. Many modern components are sent out complete with such bushes, but if you are using up parts you have on hand, you may be caught napping.

### Trimmers and Coding

A very usual arrangement in a set of this character is to place the ganged condenser centrally on the base, the kit of coils at the left-hand edge, and the high-frequency valves, or valve, between the coils and the condenser. This layout is

(Continued on page 1198.)

**Some Snags and Suggestions**

(Continued from page 1197.)

very convenient for wiring and conserves space, but in my case it nearly ended in disaster, for when the set was completed it was almost impossible to reach the small trimmer condensers built into the ganged tuning unit. Actually, by removing the valves from their holders it was just possible to engage a small screw-driver with the trimmer screws, and fortunately this set required little or no adjustment for ganging up.

The moral is, therefore, when building a set with ganged condensers to see that a "right of way" for a long screw-driver to the trimming adjustment is left available, as in Fig. 4. Incidentally, condenser makers would do well to place the trimmers at the top of the condensers whenever possible, and not at one side and near the bottom as is done in some designs.

I mentioned just now that there were nineteen fixed resistances in the set. Each one was clearly marked by the maker with the rated resistance, but when the wiring was completed this marking could not be seen in most cases. I make a strong plea for the universal adoption of the international colour code for marking resistances. (See Fig. 5.) In a complicated circuit it is often impossible to check over the run of the wiring except by identifying the various components to which the different wires run, and with so many resistances in the circuit easy identification is greatly facilitated if the resistance values can be quickly checked. Many leading resistance makers have adopted the colour code. I wish they all would.

**Earthing**

My set was intended to fit into an existing radiogram cabinet which could accommodate the usual seven inches high panel. Unfortunately, with the tuning condenser mounted on a chassis the top of the tuning dial came just over the seven-inch limit. I got over the difficulty by scrapping the escutcheon supplied with the condenser and turning the slow-motion device round a quarter of a circle, using a separate window for the dial reading instead of the elaborate escutcheon. But there is a demand for a compact and efficient slow-motion drive and dial.

No other serious difficulty arose in construction, but in view of previous troubles I had had, I resolved not to rely upon the chassis alone for the common negative connection. All points which were supposed to be at earth potential were connected together by wires, and in addition there were several bonds to the chassis. It is not easy to make a good electrical connection to aluminium by bolts, as the aluminium is always covered by a thin film of oxide, and the conductivity of the junction is not to be relied upon. The same remarks apply to all screening cans and other metal covers. All were screwed to the chassis, but were also connected to the earth wire, which ran all round the set.

Most of the leads between the receiver proper and the power unit, which lives on a lower shelf in the radiogram cabinet,

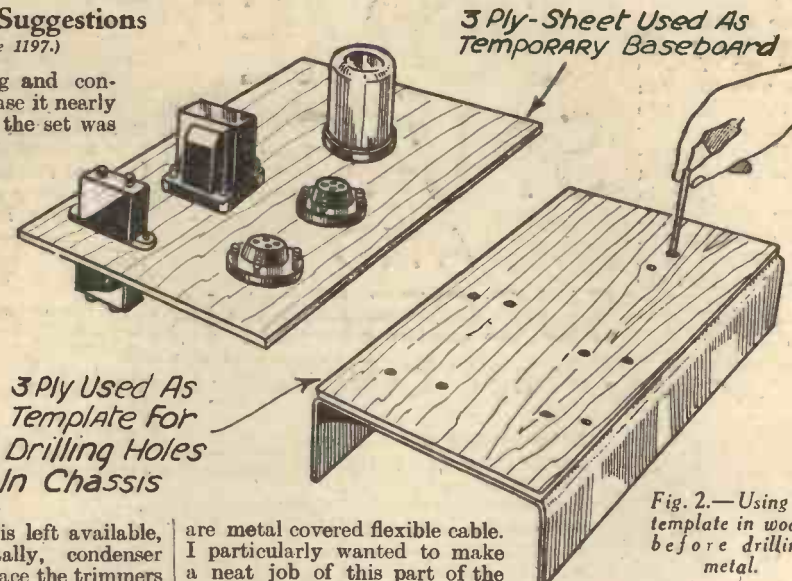

Fig. 2.—Using a template in wood before drilling metal.

are metal covered flexible cable. I particularly wanted to make a neat job of this part of the wiring, but was at a loss for some method of fixing the wires in position. As a temporary measure, I ran the wires down the corners of the cabinet, and kept them in position by loops of black insulating tape attached to the woodwork by drawing-pins. (Fig. 6.)

Oak Panel, Ply-Wood Mask.

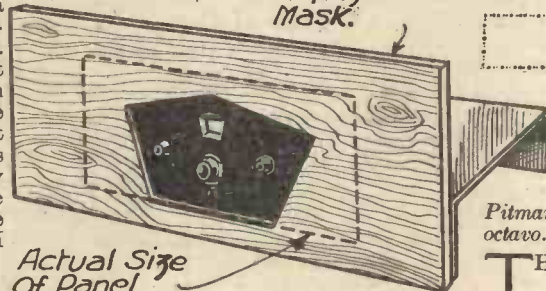

Fig. 7.—Using a mask of wood for the panel.

Eventually I made some brass bridge clips wide enough to accommodate all the cables lying side by side, and fixed them with small screws to the inside of the woodwork.

The panel space in my standard radio-

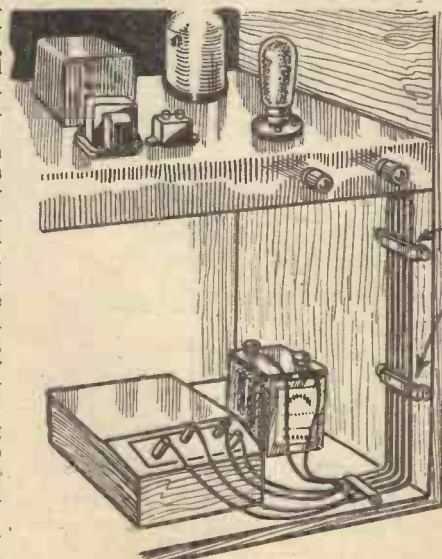

Fig. 6.—Holding wires in place with metal clips.

gram cabinet is 18ins. wide by 7½ins. high. My panel, for the sake of economy, was only 14ins. by 7ins., but I filled up the gap by making a mask of oak-faced plywood 18ins. by 7½ins. with a hole cut with a fretsaw in an artistic shape, and big enough to allow that part of the panel carrying control knobs to be seen, as in Fig. 7.

Finally, it should be mentioned that, in spite of the snags met with, the set was finished to time and functioned without a hitch. The decision to build it was taken exactly a week before Christmas; construction was carried out during the evenings only, and the set given its trial run about midnight on Christmas Eve. I am no D.X. fan—much less my family—but a very large number of stations are receivable at enjoyable volume, most of them quite consistently, and probably more could be picked up if it was thought worth while to search about critically, so what more could be asked of a straight three-valver?

**BOOKS RECEIVED**

"Television To-day and Tomorrow," by Sidney A. Moseley and H. J. Barton Chapple, with a foreword by John L. Baird, 3rd Edition, 7s. 6d. net. Sir Isaac Pitman and Sons, Ltd., 198 pages, demy-octavo.

THE third edition of this authoritative work is published at a time when television is on the threshold of great developments. Mr. H. J. Barton Chapple is, of course, a well-known authority on the subject, and it is easy to detect his extensive knowledge of the subject on almost every page. This volume is the only work of its type, for not only does it cover the entire history of the subject, but also it deals in a non-mathematical and practical way with this most modern of all sciences. Every reader of PRACTICAL WIRELESS should obtain a copy of this book, the chapter headings of which show the comprehensive nature of the work. They cover: History of Television, General Details; The Baird Disc Transmitter; The Baird Television Receiver; Synchronism, Photo Electric Cell and Neon Tubes; The Wireless Receiver for Television; The Tele-Cinema and Tele-Talkies; Noctovision and the Noctovisor Receiver; Daylight Television and Phonovision; Colour and Stereoscopic Television; Latest Developments, and Television in Other Countries. The volume is crammed with excellent illustrations, both in line and in half-tone, and it is printed on excellent paper. Interest in television continues to increase now that the B.B.C. is co-operating by putting out a regular programme. This volume will show the way in an easy and interesting manner, and we congratulate Mr. Chapple in the manner in which he has covered his subject.

A NEW FEATURE!

# IMPRESSIONS ON THE WAX

## A REVIEW OF THE LATEST DISCS

Standard

HERE are several good records of light music of the teatime wireless programme type, all of which one can hear again and again. First comes *Vienna Life*, Columbia DB1037 (2s. 6d.). This is a Strauss medley, very nicely played by the Bohemians, a little orchestra which knows everything about playing such music. A twin record is that by the famous Marek Weber's Orchestra on *H.M.V. B3898* (2s. 6d.). The titles are the well-known waltz *Du and Du (Fledermaus)* and *Morning Papers*. Again, the catchy, haunting airs of Vienna.

Now, two tunes often heard on the wireless—*Pavane* (backed by *Passepied*) from *Le Roi S'Amuse*, by *Delibes*. The first is a really charming thing, "old-world" throughout, and the London Symphony Orchestra play it delightfully. This record is *H.M.V. B4237*. Gounod is not so far removed from the last, so make a note of the *Mirella Overture* on Columbia DB1039 (2s. 6d.). Here the Wireless Military Band give a fine performance. We owe a lot of good music to this band, by the way; they tackle pieces which many similar bands avoid, and Columbia have built up a fine repertoire of their performances. I believe every healthy human gets a great thrill out of a military or brass band now and again. Here is one which is a thrill—*Under the Banner of Victory* and the dear old thing we footslogged to, *El Abanico*. On *Regal-Zono MR749* (1s. 6d.) they are played by *Massed Brass Bands*, and I will say just that this record is a real thrill. You will also like *Semper Fidelis* and *Steadfast and 'rue* by the same bands on *Regal MR813* (1s. 6d.).

A violin solo next, a real gem. On *Columbia DB1038* (2s. 6d.) Albert Sandler plays *Pale Moon* (an Indian Love Song) and *Allegro (Fiocco)*. These pieces are widely contrasted. The first is a melodious thing, and Sandler's playing is a feast of mellow harmony. The second is a brilliant show piece. A first-rate record, this. Now to the organ. Almost everybody knows the tune of *Sicilian Mariners*, even if they never knew the name. The late Arthur Meale played it with *The Magic Harp* on the organ of the Central Hall, Westminster. You will find these on *H.M.V. C2453* (4s.). Two very restful pieces which explain the popularity this organist always enjoyed.

Nothing adversely affects the popularity of the ballad. It is, indeed, a fact that it marches from strength to strength despite the "crooner" invasion. Four new records stand out as good examples of this school. First is Raymond Newell with his robust baritone singing *Devil May Care* and *The*

OF ESPECIAL INTEREST  
TO THE GRAMO-FAN  
By E. REID WARR

*Song of the Tramp* on *Columbia DB1040*. A well-worn theme, but they go with a splendid swing. Then a good tenor, Eric Bertner, sings *The World Laughs On* and *Red Lips Unkissed* on *H.M.V. B4335* (2s. 6d.). These songs are becoming almost famous and are really well sung here.

IMPRESSIONS ON THE WAX

Recorded music plays an enormous part in modern broadcasting. Apart from the great popularity of record programmes, listeners in increasing numbers appreciate the opportunity to recapture their favourite pieces—an advantage which only the record affords.

"Practical Wireless" will treat the latest record releases entirely from the listener's point of view. There will be news of unusual records—notes on the best recorded versions of current radio music—favourite artists and their best records—and hints on matters radio-gramophonic. Any reader is invited to write to our contributor for information or advice on any question concerned with gramophone records. This exclusive "Practical Wireless" service will prove a convenience to readers, and their queries and criticisms will be cordially welcomed.

No mention of ballads can omit Ireland, so we have Tom Burke singing *Macushla* (with *Love Everlasting*) on *Imperial Z137* (2s.). Apart from a few notes a trifle flat, this is a fine performance. And last, Titterton on *Decca F3379* (2s.) sings that lovely song, *The Snowy-Breasted Pearl*—and *Rose of Tralee*. The second is the better, but there is fine singing in both. Burns's songs everybody loves, of course. There are nine of them sung by the Light Opera Company on *H.M.V. C2511* (4s.). If only all the singers had been Scotch! Never mind: their performance is a real treat—they have captured the spirit of Burns's songs splendidly. This is a very enjoyable record indeed!

Variety

In this section we will start with a German record of a piece whose jolly melody is most infectious. This is *The Village Band* on *Parlophone R1425* (2s. 6d.). Somewhere in Germany the villagers have gathered and they and the band enjoy

themselves tremendously. So will you, if you listen to this (and *Mousey*) done by the Tanz. Orchester Dobbrindt. Whilst on the Continent we should hear Edith Lorand and her Viennese Orchestra. Her *Tango Medley*, entitled *Let's Have a Tango*, is splendid. On *Parlophone R1438* (2s. 6d.).

Now an American came—the tragic "Bread Line" in New York. *Brother Can You Spare a Dime?* on *Regal-Zono MR821* (1s. 6d.), as sung by "The Velvet Voice," is harrowing but well done. It is backed by *I Guess I'll Have to Change My Plan*—a more cheerful effort.

Hawaiian Guitars seem to follow. *Imperial 2808* (1s. 3d.) is an attractive rendering of *In a Shanty in Old Shanty Town* and *While We Danced at the Mardi Gras*. These are by Roy Smeck's Vita Trio. Similar is *Aloha, Sunset Land* and *Hawaiian Eyes* by José Norman's Novelty Band on *Regal-Zono MR783* (1s. 6d.).

There are lots of laughs in Wee Georgie Wood's *Black Hand Gang* on *Broadcast 925* (1s.). This little artist is always good.

Here is a record for the cinema fan of the "silent" days. Quentin Maclean brings back old times in *Cinema Memories* on *Columbia DX382* (4s.). He plays the organ of the Trocadero, Elephant and Castle, in fine style in all these old pieces.

Now for some Dance Records. There is one head and shoulders above the rest—*Every Woman Thinks She Wants to Wander* and *When Anybody Plays or Sings*—*Columbia CB550* (2s. 6d.). These are from "Mother of Pearl" (Oscar Straus). The band is a German one—Eddie Saxon's. Don't miss this: the contralto vocal is worth the money alone!

Having recovered from the shock of the titles, *Tantalizing Trovatore* and *Rigoletto Ramblings*, one can enjoy these one-steps by Debroy Somers' Band on *Columbia DX437* (4s.). First-class band, this.

I must mention another German dance record—one by Jack Bund's splendid Bravour Dance Band. This is *Parlophone R1440* (2s. 6d.), the titles being *Pipsy!*, *My Black Baby* and *The Mystery*. The pianist is especially brilliant in this—one of the very best recorded dance bands. Our own Ambrose has a fine pair on *Regal-Zono MR800* (2s. 6d.)—*Balloons* and *Fit as a Fiddle*. This is a real bargain. There are two very good foxtrots—*Strange Interlude* and *Always in My Heart* on *Brunswick 1414* (2s. 6d.). These are by Anson Weeks and his Orchestra. And, finally, the story of that unfortunate lady, *Wheezy Anna*, is told in a novelty foxtrot by Harry Roy and his Café Anglais Orchestra with *I Wish I Knew a Bigger Word than Love* backing it up on *Parlophone R1433* (2s. 6d.).

# RADIO RAMBLINGS

## Reducing Electrical Interference

I HAVE recently been carrying out a few experiments in an endeavour to find a means of reducing electrical interference. For some time I had been annoyed by regular "chirps" caused by a nearby electric flasher, and after trying the effect of removing the earth lead, connecting condensers of various capacities in series with the earth, and other similar well-known palliatives I was beginning to think my only hope was to approach the owner of the offending apparatus. However, as a last measure I decided to try a shielded lead-in cable in place of the ordinary bare wire one which had previously been in use. A length of this material (which has just recently been put on the market, by the way) was therefore obtained and fitted, and, to my astonishment I confess, the interference was almost entirely eliminated. In case you have not yet made the acquaintance of this new cable I might say that it is of rather



Our contributor, Mr. K. E. Brian Joy, who is also an expert transmitter.

ingenious construction, consisting of a single wire passing through the very centre of an insulated tube built up of a number of short lengths which are knuckle-jointed together. The outside is covered with woven metal braid similar to that used for ordinary shielded wire.

Due to the form of construction the cable is quite flexible, and yet there is an appreciable air space between the central wire and the outside metal shielding. In consequence the added capacity is not very great; actually it appeared to be about .0003 mfd. for the 20ft. length in use. When the capacity of the series aerial condenser was slightly reduced, signal strength was found to be practically as great as before. If you are troubled by electrical interference I can recommend you to try this new lead-in idea. By the way, it is no use employing ordinary screened wire because the capacity of this is much too great and it will probably prevent the aerial from functioning at all.

## Another Method Worth Trying

IN the course of my experiments I ran across another little method of reducing interference, and it seemed to work quite

## JOTTINGS FROM MY NOTEBOOK

well on the shorter wavelengths. The earth lead happened to be very long as the set was installed in an upstairs room, and on closing the aerial-earth switch before turning off the set I found that reception was still possible, although the electrical interference was barely noticeable. I should explain that the switch was of the single-pole type and although it connected the aerial to earth there was still a connection between the earth terminal and the earth lead. On transferring the latter wire to the aerial terminal results were better still, and in fact, signal strength was not very greatly below par. If you care to try the idea all you have to do is to connect both the earth and aerial leads to the aerial terminal. Of course it will not work unless the earth lead is long and of insulated wire. Even under these conditions I cannot give any guarantee, because the system does not follow any recognised principle and I might just have struck a "fluke." If you do get any results I should be pleased to hear of them. If you will write to me c/o the Editor.

## Remote Control of Volume

IT often happens that a loud-speaker is used in a different room to that in which the receiver is installed and it is rather awkward to have to go from one room to another each time you wish to alter the volume. And if you are anything like I am you will often wish to "tone-down" when a brass band or full symphony orchestra comes on, and to increase the volume for speech. Besides, you sometimes want to carry on a conversation whilst the set is in operation, and this is most trying when the speaker is going "full blast." There is a perfectly simple way of fitting a convenient volume control to the speaker itself. The only component required is a 50,000 ohm potentiometer so the modification is certainly not costly. All you have to do is to connect the outside terminals of the potentiometer to the leads from the set and to wire the speaker between the centre and one outside terminal. To make matters quite clear a sketch of the connections is given in Fig. 1. You might find that reproduction becomes rather shrill when volume is reduced to a fairly low level; if you do, connect a 1 mfd. condenser between the two potentiometer terminals indicated in the sketch.

## A Q.P.-P. Difficulty

YESTERDAY a friend asked me to have a look at his new Q.P.-P. amplifier which was distorting badly. He had used new components throughout, his batteries were all in perfect condition, and yet reproduction was distinctly poor. I first suspected that the valves might have been over-biased—you can overdo this sort of thing, you know, even with Q.P.-P.—but examination failed to reveal any fault in this direction. It eventually came to light that both priming grids were connected to the same positive terminal,

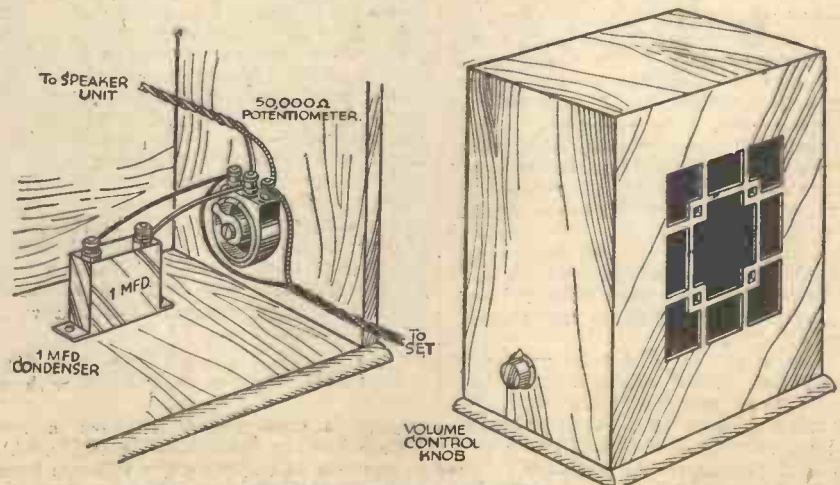

Fig. 1.—A potentiometer volume control fitted to the loud-speaker.

and on measuring the anode current to each valve a difference of nearly half a milliamp was noticed. By connecting the priming grids to separate wander plugs and putting these into different battery sockets we were soon able to equalise the anode current to each valve.

**Special H.T. Batteries**

If by chance you did not know, it is very important that both valves in push-pull, either quiescent or otherwise, should work under identical conditions. When using triodes the usual method of ensuring this is to employ a centre-tapped input transformer and apply separate grid-bias voltages, but with pentodes it is easier to accomplish the same result by independent regulation of priming grid voltages. The fact that the latter can be so critical has led to the introduction of a special high tension battery having a series of 1½ volt tapping points at its positive end. Naturally it would not be a very likeable proposition to buy a new battery if the one already in use was not run down, so the simplest thing is to connect a 9 or 16-volt G.B. battery in series with the H.T. Accurate adjustments of priming grid voltage can then be made quite easily.

**Athlone**

How is the new 80 kW. Athlone transmitter affecting your reception? Apparently this station is not yet working to a full time-table, but I have heard a few programmes from it on recent evenings. Despite several complaints that have reached me to the effect that Athlone drowns all the "smaller fry" between about 390 and 420 metres, and even interferes slightly with Midland and North Regionals, I must confess that I have found no difficulty whatever in cutting it out in favour of Berlin-Witzleben, working on 1.5 kW., and separated by only 10 kilocycles. Frankly, I have been rather disappointed at the poor strength of Athlone, which with me is no louder than Toulouse and nothing near so powerful as Rome, Trieste, or Fécamp. Perhaps it is not yet working on full power, and there is "worse to come."

**'Plane Transmissions**

I wonder if any readers were successful in picking up signals from the Air Ministry's 'plane, which recently made the record-breaking non-stop flight to the Cape. With the call-sign GEZAA, the machine was to have sent out a short transmission every two hours on 33.71 metres. I listened for it on two or three occasions, but without any success.

**D.C. to A.C. Conversion**

It was recently mentioned in these columns that the Fleetwood Rate-payers' Association were up in arms against the refusal of the local Council to contribute towards the cost of converting radio receivers consequent upon the change over from a D.C. to an A.C. supply. The Association are determined to thrash the matter out, and started a "shilling fund" to enable them to take the matter to the Courts if necessary. They have recently received a reply to their inquiry directed to the Electricity Commissioners, in which it is pointed out that, since the Council consented to the change in supply they cannot disclaim responsibility for the alteration of wireless apparatus. What will the next move be, and by whom?



The Dubilier Type BB Condenser is a high-efficiency condenser in moulded bakelite case. Working voltage 200 D.C. (peak) test voltage 500 D.C. Capacities from .09 mfd to 4.0 mfd. Prices from 1/9



**BUY THE  
CONDENSER  
WITH THE  
NAME  
YOU CAN  
TRUST  
DUBILIER  
CONDENSERS**

No matter whether a Dubilier Condenser is large or small, it is the most up-to-date in design and contains the finest materials it is possible to obtain. On every Dubilier Condenser rests the Dubilier reputation for Dependability. You may be sure that Dubilier will never let you down.

Dubilier Resistances are also equally reliable. Therefore, when buying your condensers and Resistances for the Fury Four specify Dubilier. They are stocked universally by all Dealers.

SEND FOR INTERESTING FREE BOOKLET ON CONDENSERS AND RESISTANCES.

P. 0.

**DUBILIER CONDENSER CO. (1925) LTD.  
Ducon Works, Victoria Road, North Acton, London, W.3**

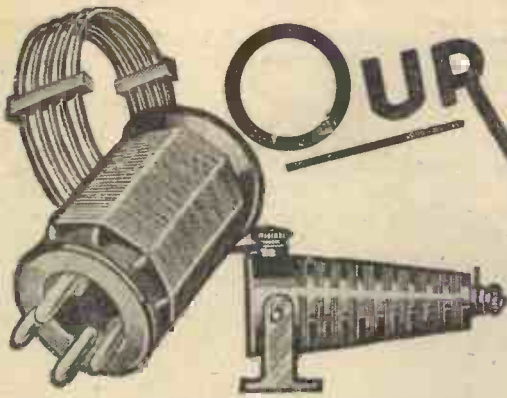

# OUR SHORT-WAVE SECTION



As already stated in a previous article, in order to avoid disappointment at the outset, it is wise to carry out your first search in a portion of the short-wave band which contains the more powerful transmitters. From my log I find that from 25 to 50 metres will prove the richest field for the beginner. This section, judged from the standpoint of the ordinary broadcast listener, would appear to be a small one; in effect, it is an enormous band when kilocycles as against metres are taken into consideration. Whereas the difference between 200 metres (1,500 kc/s) and 555 metres (545 kc/s) is only 955 kc/s, between 25 metres (12,000 kc/s) and 50 metres (6,000 kc/s) we find a separation of 6,000 kc/s. Taking, therefore, the conventional 9 kilocycle separation between transmissions, in the above-mentioned broadcast band, we could place, roughly, 106 transmitters; on the same basis the band from 25 to 50 metres could accommodate over 660 channels on which transmissions could be made without mutual interference. To make the illustration clear it is only necessary to add that this would represent considerably more than twice the number of broadcasting stations at present working in the United Kingdom and on the Continent of Europe!

Now it is for this reason that searching for signals on the short waves must be carried out much more carefully than when tuning the average set for the reception of signals on longer channels. The condenser dial must be turned very slowly, otherwise most of the transmissions will be missed. It is possible that some may be tuned in, but this will be due to mere luck if such an event takes place, and the chances of finding the station again at a future date are exceedingly remote. Most short-wave condenser dials are equipped with a slow-motion movement with a comparatively high ratio; in fact, the higher the better. Another important point to bear in mind is that whatever the circuit of the receiver may be, it is impossible to hear telephony if the set is in a state of oscillation; you will pick up the carrier waves, and also morse signals when valves are in that condition, but to hear speech or music it is necessary that reaction should be thrown back or reduced so that the receiver may be brought to just below oscillation point. Experience will soon teach you the procedure. In the case of strong signals you will find that to secure stability and steadiness of reception reaction must be reduced still further. Where separate coils are used to cover distinct bands of wavelengths, they invariably overlap to some extent; this, of course, is all to the good. If, say, three coils are required to cover from 15 to 18 metres, roughly, they would be wound to tune to (1) 13 to 28 metres, (2) 24 to 50 metres, (3) 40 to 80 metres. The overlap existing

## ON THE SHORT WAVES

(Continued from page 1120, Feb. 25th issue)

By J. GODCHAUX ABRAHAMS

would then permit you to tune in such a station as Rome 2RO, working on 25.4 metres, at either a high-condenser reading of coil No. 1, or at a low-dial reading of coil No. 2. This alternative is a useful one; it also avoids definite gaps in the sections covered. It is essential, if success is to be assured, that some kind of log should be kept; don't simply jot down the dial readings on odd slips of paper or on the backs of envelopes. A more exact method may be adopted in the shape of a graph, but a log and a list of wavelengths of the principal short-wave stations, as published in "The Constructor's Encyclopædia," will be sufficiently helpful at the start. The details to be entered are the call (if heard), the location of the station, accurate dial readings, time at which transmission took place, and interval signal, if any, as well as any other details which may facilitate the tuning in of that particular station at a future sitting. It will be realized that one factor, namely, wavelength, may be roughly estimated, as soon as a few transmissions on different channels have been accurately identified, if they are spaced over the band on which a search is being instituted. For instance, should a station at 10 degrees be found to correspond with, say, 25 metres, another at 60 degrees estimated at 32 metres, and a third on 175 degrees (all on 180 degree dial) to tally with 50 metres, it is not difficult to gauge approximately the position at which the condenser must be set to tune in, say, 40 metres. At least, these loggings will give you useful landmarks or jumping-off points, and will obviate a search over the entire dial, thus limiting the movement to some 10 degrees or so of the correct position either way. Gradually, as the gaps in the log are filled up, so the actual searches are narrowed down to closer limits.

Now let us take the 25 to 50-metre band and start on our tour of investigation. Probably one of the first transmissions picked up will be one from Pontoise, Paris, on 25.20 metres (11,900 kc/s). The call is *Allo! Allo! Ici Radio Coloniale, Paris*; the best time is between 16.30 and 19.30 G.M.T.; at 18.55 you may hear a news bulletin in English. The station relays concerts, operatic and dramatic performances, etc., for the benefit of French listeners overseas. Immediately above, a matter of a degree or so, you will find Rome (2RO), on 25.4 metres (11,810 kc/s). You cannot mistake this transmission, as announcements are made by a woman—it is the same voice you are familiar with on 441 metres. *Eh-yah-Radio-Roma*, coupled, perhaps, with Naples (*Napoli*). Rome opens its transmissions with a noisy gramophone record, of bells, organ, choir and orchestra. Try for it at 18.00 G.M.T.; the opening melody and call are followed by a time signal lasting until 18.15, it consists of a series of dots and dashes with verbal announcements by a man. Between Rome and Radio-Coloniale, on favourable nights, you may log W8XK, East Pittsburgh (Pa.), on 25.27 metres (11,870 kc/s). This short-waver works from 19.00 G.M.T. (2.0 p.m. New York time, E.S.T.). Here, a slight movement of the dial should bring you in the earlier hours of the evening, 25.51 metres (11,760 kc/s), DJD, Königswusterhausen, which is often used for the relay of the Berlin programme to America; after twilight the broadcast is carried on through DJC, on 49.83 metres (6,020 kc/s). A hair's-breadth away is GSD, Daventry, Empire

(Continued on page 1203.)

### A "PRACTICAL WIRELESS" READER'S WIRELESS DEN.



A reader whose modesty compels him to remain anonymous sends us this photograph of his den. Note the prominence of "Practical Wireless."



(Continued from page 1202.)

Broadcasting Station, on 25.532 metres (11,750 kc/s), which provides a programme to the Australasian Zone daily, between 09.30 to 11.30 G.M.T. Just 20 kilocycles lower, namely, on 25.57 metres, you will probably hear tests by the 40-kilowatt at Eindhoven (Holland), which, under the call sign PHOHI, puts out announcements in Dutch, German, French, English and Spanish. For the present, at least, its old wavelength of 16.88 metres (17,770 kc/s), now shared by GSG, Daventry, is also being used towards 8 a.m. on some mornings for experimental purposes. Barely a degree further on, we again find Radio-Coloniaie (Paris), on its 25.63 metre channel between 21.00 and midnight. As you may well judge from the foregoing, all these broadcasters are fairly close together, but their kilocycle separation is reasonable; in most instances careful tuning will permit you to log them, although, possibly, not at your first attempt. From this point we make a jump to the 30-metre region. At odd times within this gap you will hear calls from Transatlantic or other telephony services, such as GBX, Rugby, on 27.55 metres; SUV, Cairo (28.83 metres); LSM, Buenos Aires (29.15 metres); and so on. On exactly 30.43 metres (9,868 kc/s), if you listen at 18.00 G.M.T. (on Saturdays), or towards 23.30 daily, you should pick up the Madrid (EAQ) broadcasts to the South American States. (Call: *Aqui Madrid, radio Ibero-Americana*, and sometimes in English—*This is Radio Ibero-Americana, Madrid.*) The transmissions are not limited to news, but include some very good concerts. Here, again, we come to a portion of the band which will give a number of entries in our log. A cuckoo call (repeated *ad lib.*) on 31.19

metres (9,620 kc/s), between 21.00 and 23.00 G.M.T. (Wednesdays or Fridays), will tell you that you have tuned in Lisbon (CTIAA). The station styles itself *Radio-Colonial Lisbon*.

Then follow a number of important stations in quick succession, namely, VK2ME, Sydney (N.S.W.) on 31.28 metres (9,590 kc/s), best heard on Sunday mornings between 09.00–11.00, and again between 16.00–18.00 (Interval Signal—Song of the Lyre Bird—Kookaburra); GSC, Empire Broadcaster (Daventry) on 31.297 metres (9,585 kc/s); HBL, Prangins, Switzerland (31.31 metres) (9,580 kc/s) with its League of Nations transmission on Sundays (G.M.T. 22.00) and WIXAZ, on 31.35 metres (9,570 kc/s), relaying WBZ, Boston, in the National Broadcasting Corporation of America network. Only slightly above the "Yank" we tune in on most evenings DJA, Zeesen, on 31.38 metres (9,560 kc/s). Through this channel you may receive the Berlin programmes without interference, from G.M.T. 19.00; until that hour, the broadcasts are usually carried out on 19.737 metres. And then for another well-known American, W2XAF, relaying on 31.48 metres (9,530 kc/s), WGY Schenectady, and other stations in the N.B.C. network, from midnight until 3.0 or 4.0 a.m. G.M.T. The announcements are in English, and as a rule you are told that "you are listening to—"; approximately every fifteen minutes the interval signal is heard; it consists of three clear notes on an instrument akin to a xylophone. A degree or so further up the scale gives us a relay of the Copenhagen programme *via* Skamleback on 31.51 metres (9,520 kc/s), which, although only of a power of 500 watts, when conditions are favourable, will pro-

vide a loud-speaker reproduction. Broadcasts from Radio Maroc (Rabat) which are difficult to secure on the medium wave-band may be picked up fairly easily on Sundays (G.M.T. 19.00–22.00) on 32.26 metres (9,300 kc/s). They may be identified by the peculiar metallic sound of the metronome adopted as an interval signal.

By slow and sure stages—but interspersed with much morse—we have reached the 40 metres amateur band to which I referred in my previous article. Between 41.1 metres (7,300 kc/s) and 42.9 metres (7,000 kc/s), you will come across a welter of calls of almost every nationality, and an interesting hour or so may be spent in jotting down the call signs, which can be later traced to find the country of origin.

Do not be misled by the names of countries or towns used in such calls; the names are frequently adopted to avoid a misunderstanding. I have often heard a Frenchman state that he was, say, *Eff-whit-Canada, Yokohama*. This would show his call sign to be F8 (French: *huit*) CY, the country or city mentioned thus, clearly giving the letters. In the course of a two-way communication the amateurs will sometimes drop the first letters and retain the names. Thus *Canada, Yokohama* (F8CY), may call *Espagne Angleterre* (F8EA) and so forth. In the same way British amateurs adopt proper names: G6VH, for instance, might announce himself as *Six Victor Henry*, the G (Great Britain) being understood. This international amateur band includes Clubs, such as EAR58, Radio Station, Las Palmas, Grand Canary on 41.6 metres (7,212 kc/s), and which may be found working on Saturdays and Sundays between 20.00–22.00. G.M.T.

(To be continued.)

## HEADING A NEW MOVEMENT

By "PUSH-PUSH"

When I set out to write these notes I looked around for a "pen-name" to typify modern development. I chose "Push-Push"—which is another name for Quiescent Push-Pull. And didn't I pick a winner?

Quiescent Push-Pull is this season's outstanding development. It has been compared with the coming of the Screen Grid. Now, I'm not one of those enthusiastic chaps who hails every small development as the dawn of a new day, but I've got to hand it to Q.P.P. I've got to say that the battery set without it is only giving half the entertainment value that it could. And when one adds that Q.P.P. economises in

H.T., that is the final, unexpected bit of gilt on the gingerbread.

It's not a difficult matter to add this refinement (but it's more than a mere refinement!). There are Q.P.P. components, eliminators, batteries and speakers on the market by most of the leading makers. Or, if you want a commercially-built set, famous manufacturers have produced Q.P.P. receivers which will be a revelation to you of what a battery set can be.

And, as usual, Coradio, the part-exchange people, are ready to help you to better radio by the most economical path. All that is necessary is to send in particulars of the apparatus you want to get rid of

and they will tell you how much they can allow in part exchange for the new stuff you require.

It's an attractive idea from the point of view of economy. At the same time an enquiry doesn't commit you to anything, and they are helpful people who do make an individual effort to fix you up.

So whether it's for "Push-Push" or something else, here's the address you want.

# CORADIO

Dept. C.9, 78, Neal Street, Shaftesbury Avenue, W.C.2, D.P.T.

### JUST FIGURE IT OUT!

Without mathematics the Wireless Amateur—and especially the Home Constructor—wallows in a morass of doubt and uncertainty. This brilliant book will enable you quickly to grasp the essentials of Mathematics as applied to Radio. You'd hardly believe it, but it hasn't a dull page! The author knows his subject and how to make it interesting even to the absolute beginner. You need this book.

## THE MATHEMATICS OF WIRELESS

by RALPH STRANGER

5/-

Obtainable at all Booksellers, or by post 5/3 from Geo. Neumes, Ltd., 8-11 Southampton St., Strand, London, W.C.2.

Get a HET for Your Set!

**HET**  
AMALGAMATED METAL INDOOR AERIAL

Away with unsightly wires. Get greater selectivity, more stations and more volume with the neat and elegant "HET" Indoor Aerial. Just fix this adhesive aerial round the picture rail. It has the appearance of a frieze. It looks as good as it is—better than any other aerial.

16

In gold or silver finish from all radio dealers or direct from UNIVOLT ELECTRIC Ltd. Balfour House, Finsbury Pavement, London, E.C.2.

BRITISH MADE



## CHOSEN for the A.C. 'FURY FOUR'

The mains transformer is the most important component in an A.C. mains receiver—it can make or mar the performance of the set. That is why the designer of the 'Fury Four' exclusively specified Heayberd Transformer for the A.C. version of this popular receiver. By incorporating a Heayberd Transformer, successful results are guaranteed. The best of materials and the finest craftsmanship go to the making of Heayberd apparatus. Excellent voltage regulation and negligible temperature rise is assured with the transformer described below.

HEYBERD A.C.  
'FURY FOUR'  
TRANSFORMER  
Rectified Output:  
250v. 60 ma.  
L.T. 4v. 4 amps. A.C.  
Price 24/-  
GUARANTEED 12 MONTHS





Post Coupon

for Heayberd  
handbook on  
Mains Working

I enclose 3d stamps for  
New Handbook of Mains  
Equipment. Packed with  
Technical Tips, Service  
Hints and diagrams

Mr. \_\_\_\_\_

Address \_\_\_\_\_

Prac. \_\_\_\_\_

F.C. HEYBERD & Co.,

10 FINSBURY STREET, LONDON, E.C.2,  
One minute from Moorgate Stn

**R**YALS RADIO, 33, Chancery Lane, London, offer new guaranteed goods. Resistances, 1-watt wire ends, 100, 1,000, 2,000, 5,000, 6,000, 10,000, 20,000, 25,000, 30,000, 75,000, 150,000, 250,000 ohms, sixpence each. Mains transformers, 250v. 60ma. 4v.4v. 10/9, 350v. ditto 12/9, for HT7 rectifier, 10/9. Condensers, 4mf. 250v. working 3/6, 400v. working 4/-, 750v. working 5/6. Mains chokes, 25H at 60ma. 6/9, 20H at 100ma. 5/9, 40H at 100ma. 10/9. Meters, 0-6vAC 10/-, 0-3amp. AC 10/-, 0-50ma. DC 10/-, 0-250v. AC 12/-, 0-250VDC, 1,000, per volt 31/-. All meters flush mounting, bakelite case, 2 1/2 in. face. Note.—Condensers have terminals, chokes and transformers, long connecting wires. Polar Star 3-gang condensers 16/6.

# REACTION POINTERS

By H. J. BARTON CHAPPLE,  
Wh.Sch., B.Sc. (Hons.), A.C.G.I., D.I.C., A.M.I.E.E.

IN my previous general article on reaction I mentioned that some time ago I carried out a series of tests dealing with capacity controlled reaction, and it occurred to me that readers of PRACTICAL WIRELESS may be interested in the results obtained.

First of all we know that the capacity reaction circuit consists of a variable condenser and coil  $C_2$  and  $L_2$ , see Fig. 1, the last named being either a separate coil magnetically coupled but fixed relatively to a tuned grid coil  $L_1$ , or alternatively it

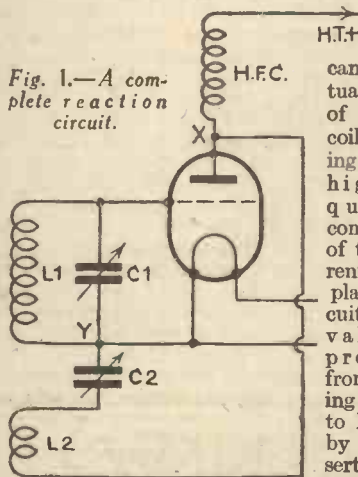

Fig. 1.—A complete reaction circuit.

can be actually part of the  $L_1$  coil winding. The high frequency component of the current in the plate circuit of the valve is prevented from flowing through to H.T. + by the insertion of a high frequency choke, and these checkmated currents find a low impedance path provided to the valve filament via  $L_2$  and  $C_2$ .

### Reaction Resonance

This reaction circuit between valve plate and filament, i.e., X to Y of Fig. 1, offers a certain impedance to the flow of the H.F. currents and by varying  $C_2$  this impedance will alter, being decreased when  $C_2$  is increased and vice versa.

If this impedance is expressed in mathematical terms the expression below is obtained:—

$$Z = \sqrt{R^2 + \left(\omega L - \frac{1}{\omega C}\right)^2}$$

$\omega$  = the frequency of the H.F. current multiplied by  $2\pi$  (6.2832).

$L$  = the inductance of the coil in Henries.

$C$  = the capacity of the condenser in Farads.

$R$  = the H.F. resistance of the coil in ohms together with the equivalent losses in the circuit which, of course, can be expressed in terms of ohms.

Examining this quantity, it is easy to see that up to a certain point any increase in the value of the condenser capacity will cause a decrease in the impedance and correspondingly there will be an increase in the amount of current flowing in the circuit. The point at which this ceases to be

a true statement is at resonance when  $\omega L = \frac{1}{\omega C}$ , for then the quantity inside the bracket becomes zero and the only impedance in the circuit is the high frequency resistance  $R$ . Any further increase in  $C$  will only serve to increase the impedance and consequently bring about a reduction in the flow of current. In actual practice the resonant condition for the reaction circuit mentioned above is seldom, if ever, reached. The primary object of the arrangement is to feed back sufficient energy into the tuned grid circuit so that the inherent losses are actually overcome and a state can then be reached where the valve will oscillate at the frequency to which the grid circuit is tuned.

### Varying Coil Size

If a large reaction coil is used and a small reaction condenser, then the size of this coil  $L_2$  when compared with the tuning coil  $L_1$ , in, say, a straightforward three valve set of the detector and two L.F. type, will depend on the degree of magnetic coupling between  $L_1$  and  $L_2$ , the looser the coupling the larger being the reaction coil. With a large reaction coil an uncontrollable oscillation may evidence itself if the magnitude of the self and stray capacities is sufficient to cause the coil to tune the same wavelength or frequency as the tuned grid circuit. Then, with this loose coupling, it is necessary to bear in mind considerations of space, the large coil size making a compact design somewhat difficult.

If in order to overcome these points the size of the coil is reduced, then the degree of coupling between  $L_1$  and  $L_2$  must be correspondingly increased to permit sufficient energy feed back. Another drawback arises here, however, owing to the damping on  $L_1$  introduced by the close proximity of  $L_2$ , this, of course, being additional to the existing valve and aerial damping already present in the coil.

(Continued on page 1205.)

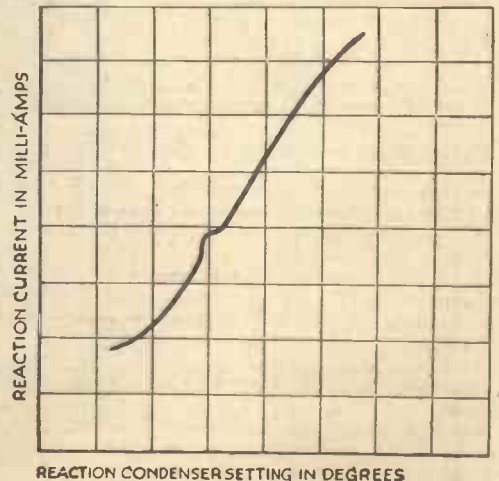

Fig. 2.—A graph showing the result obtained on actual test.

**REACTION POINTERS**

(Continued from page 1204.)

**Apparent Solution**

From this reasoning it would appear that the best solution lies in the adoption of a small reaction coil fairly tightly coupled to the tuned grid coil and a large reaction condenser (.0005 mfd). While smooth reaction control can undoubtedly be effected with a large reaction coil there is apt to be a lack of uniformity in the relationship between the settings of the tuning and reaction condensers, and a small coil tightly coupled would therefore appear to offer additional advantages.

Some of the tests I carried out were directed towards finding if there was any truth in this reasoning, but I will not bother the reader with all the experimental details. My tests were quantitative as well as comparative, but in passing it may be interesting to learn that I actually measured the magnitude of the reaction current in several cases by employing special high frequency meters. The value of this high frequency current was less than

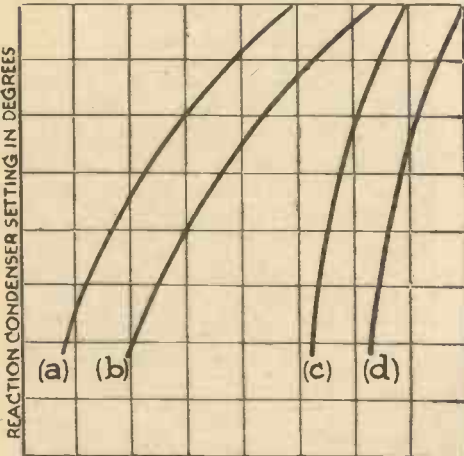

AERIAL CONDENSER SETTING IN DEGREES

Fig. 3.—Graph showing effect of reaction obtained on different sets.

a milliamp up to the condition of oscillation, and then rose to about 2 milliamps as the resonance condition was approached. The curve of Fig. 2 will show how the variations took place, the "hump" being where the set broke into oscillation. Near the top end of the scale the current increment per ten degree change of reaction setting starts to drop, indicating that the resonance condition is being approached. It will be noted, however, that the resonance condition is not reached in the reaction circuit. If it had, the current would have started to fall and, of course, this is not desired.

**Smoothness of Reaction**

The next point of interest deals with the smoothness of the reaction control. The procedure adopted here was to connect up the set and to note the readings of the tuning condenser and reaction condenser for the set just to oscillate first with no aerial and earth, and then with the aerial and earth leads joined to the appropriate terminals. Curves were then drawn to show whether the reaction control was reasonably smooth over the whole of the scale.

**Reaction Variations**

In Fig. 3, are shown the average types of curves I secured with three valve sets (detector and two L.F. stages), using a .0005 mfd. reaction condenser.

(To be concluded next week.—Ed.)

**BULGIN MEASURING METERS**  
*In a Class alone.*

Every Moving Coil Instrument complies with B.E.S.A. requirements for first grade accuracy to 1%, and is guaranteed for one year. Bakelite cases. The *Miniature Moving Iron* types are unique for the compactness and accuracy at such low cost.

**MOVING COIL MILLIAMMETERS**

M.C.1	0-1 M.Amps.	M.C.5	0-20 M.Amps.	Price <b>30/-</b> each
M.C.2	0-2 "	M.C.8	0-50 "	
M.C.3	0-5 "	M.C.10	0-100 "	
M.C.4	0-15 "	M.C.20	0-200 "	

**MINIATURE MOVING IRON METERS**

D.M.1	0-3 Volts.	Price	D.M.15	0-15 M.Amps.	Price
D.M.2	0-8 "	<b>7/6</b>	D.M.17	0-30 "	<b>8/6</b>
D.M.4	0-1 Amps.		D.M.19	0-50 "	
D.M.6	0-3 "	each	D.M.20	0-100 "	each

The D.M.15 model may be used in Quiescent Push-pull Units.

Send for 80 page catalogue "N." Enclose 2d. postage.



TELEPHONE:  
GRANGEWOOD 3266

TELEPHONE:  
GRANGEWOOD 3267

**A. F. BULGIN & CO., Ltd., Abbey Road, Barking, Essex**

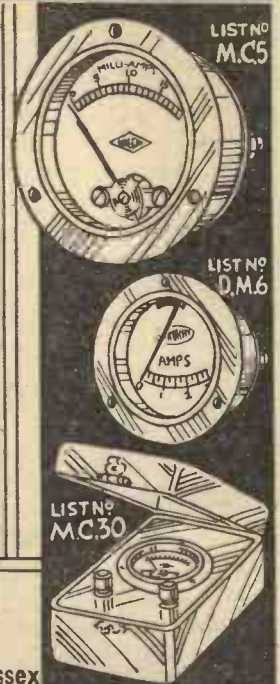

**GREATLY IMPROVED RECEPTION** The "FILTRON" EARTH



An inefficient connection to earth is often the unsuspected cause of crackling noises in your receiver, try earthing your set with "Filtron" and many of these disturbances will be eliminated.

The chemical properties of "Filtron" actually attract the moisture which is so necessary for a conductive earth, therefore it functions efficiently in the driest soil.

Get a "Filtron Earth" to-day—the price is only ... .. 2/-—and you will be amazed at the difference.

**Filtron**  
THE EARTH THAT GROWS A ROOT

MESSRS. AMPLION (1932) LTD., 82/84, ROSOMAN STREET, E.C.1.

# A BALANCE METER for PUSH-PULL CIRCUITS

## A Unique Visual Indicator for Adjusting Valves in Q.P.P. Circuits

By DEREK ARCHER

It is preferable in order that Quiescent Push-Pull arrangements function correctly and without distortion that the anode current of each valve used in the

### Details of Construction

The most important part is the magnetic needle and its pointer and the suspension pivot. If you already have an old compass, this can be dismantled and the needle used, but care should be taken to see that the needle is not too big, or variations in some of the dimensions will have to be made. The actual needle in the instrument is a piece of hack-saw blade. This should first of all be made soft by making it red-hot for a minute or two, and allowing it to cool off. Mark off with a steel scriber the needle shown in Fig. 2. Drill the

point. This is very important, and if this does not receive attention the needle will take up a new position on the pivot each time it moves, and extreme difficulty will be experienced in getting the needle to balance. Final drilling is best done by rotating the drill with the fingers.

### Fitting and Adjusting the Pointer

Next fit the pointer. This is a piece of fine enamelled copper wire about 5in. long. The enamel is scraped off about 2 1/2in. from one end, and the wire then carefully soldered in the small slot already made in the top of the bush. The longer end of the wire is then coiled up round a No. 26 drill, until its axis is 1/8 in. from the pivot hole. The other end of the wire is then formed up to the dimensions given in Fig. 4. The end of the wire will require nipping off so that it is 1 1/2 in. from the pivot hole. A temporary pivot is then made by pushing a soft tone gramophone needle through a piece of wood and the needle dropped on to it. The soft tone needle is not a catch, as apart from a wood or special needle, any needle may be used, but a soft tone needle is much longer than a loud tone needle. First balance the pointer. If the pointer goes up, nip a turn or two off the coiled up wire. If the needle goes down press a little piece of plasticine into the coil, adding or taking

away sufficient until a correct balance is obtained. Then balance the needle sideways. This can easily be done by setting the coiled balance weight to one side or the other. It is, of course, important, while the balancing is

being carried out, that the needle is kept away from magnets or iron, or a wrong setting will be obtained. Place the needle in a safe place until it is required, and commence the construction of the coils.

These are constructed from pieces of 1/16in. cardboard, four of the large pieces and four of the small pieces shown in Fig. 5 being required. Two of the small pieces are glued together to form the centre of the bobbins, and one large piece then glued to each side to form the flanges. Whilst the glue is drying the base can be prepared. Cut a piece of three-ply, 3/4in. thick, to the dimensions and shape shown in Fig. 6. With a marking gauge, score all

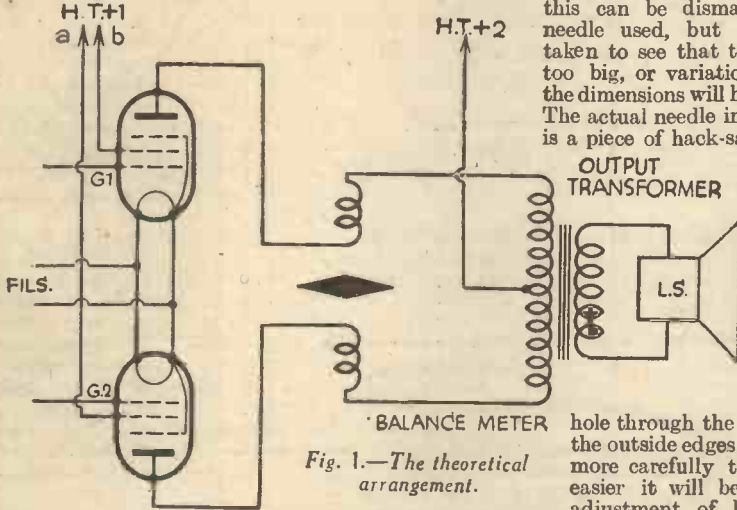

Fig. 1.—The theoretical arrangement.

output circuit should be matched. This matching of anode currents is usually performed with the aid of a milliammeter, which must be inserted into one circuit and a measurement taken, and then inserted into the other circuit and the voltage on the screen terminals of the valves adjusted individually until a balance of currents is obtained. The little instrument here is connected

into both anode circuits at the same time, and the high-tension voltages adjusted until the pointer comes to rest in a central position. It is possible with this little instrument to get an exact balance of both currents, which is not quite possible with a single instrument, because adjustments which are made on one circuit may affect the other and this is not noticed, for the milliammeter is then in the other circuit.

This balance meter is not difficult to make, and all the parts which went to make the original model were taken from the scrap box. No special tools are required, but care should be taken to get everything just right, especially the number of turns of wire on each coil, and the distance away from the needle. The two coils, one of each being connected in the anode circuit of each valve as shown in the diagram, Fig. 1, are connected

so that the field of each is in opposition to the other, and the magnetic needle in the centre takes up a position in a neutral position. If the needle goes over to one side it indicates that one of the anode currents is stronger than the other, and this can be corrected immediately by adjusting the voltage on one of the screens, H.T.+1, a or b, as the case may be.

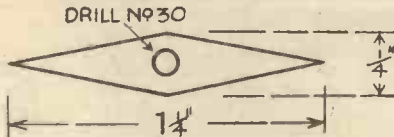

Fig. 2.—Needle dimensions.

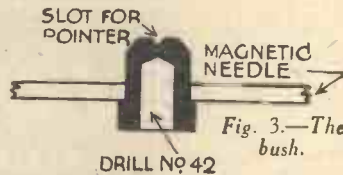

Fig. 3.—The bush.

screw, and drill a No. 42 hole down its centre. Then file the shoulder, using a hand brace for turning, so that it just fits into the hole drilled in the piece of hack-saw blade. Cut off any excess metal at the top. This can be gauged by a depth gauge, or by the more rough and ready method of trying the depth of the hole with a piece of wire. Make a very small slot across the top, and then make the needle red-hot and plunge it into water to harden it again. Press the brass bush into the hole, right up to the shoulder. The needle is now very hard and brittle, and care must be exercised when pushing the brass bush into the hole not to force it too hard, or the needle will snap and another will have to be made. Now the drill which you have used will have made the end of the hole flat and not sharp pointed as,

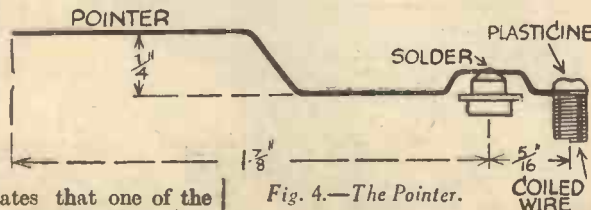

Fig. 4.—The Pointer.

so that the field of each is in opposition to the other, and the magnetic needle in the centre takes up a position in a neutral position. If the needle goes over to one side it indicates that one of the anode currents is stronger than the other, and this can be corrected immediately by adjusting the voltage on one of the screens, H.T.+1, a or b, as the case may be.

shown in Fig. 3. When the needle has been fixed re-drill the hole with a spear point drill which has been sharpened to a very fine

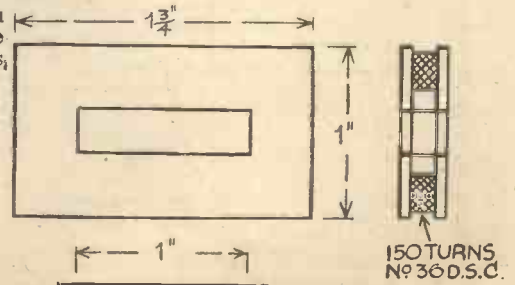

Fig. 5.—The coil former, with winding details.

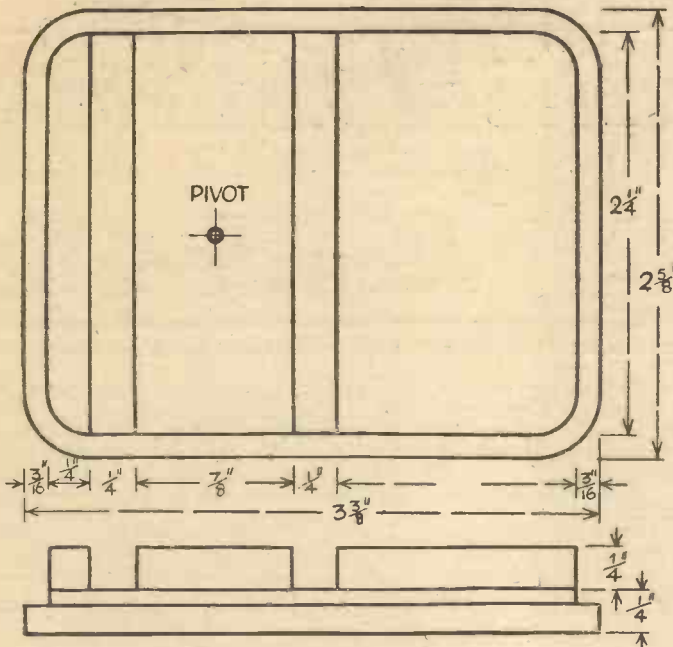

Fig. 6.—The containing case.

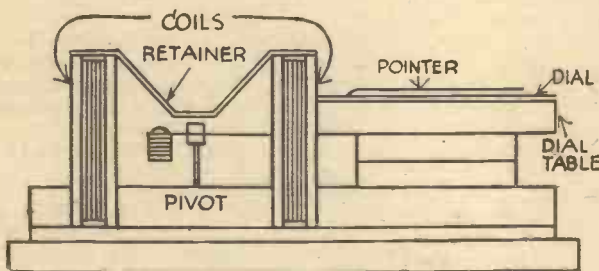

Fig. 7. The complete assembly.

round the edge for the depth of the top-piece of ply for 3/16in. and remove the strip of ply, which then forms a rabbet for the sides, which will be fixed later. The three smaller pieces of ply are then cut and glued or fixed with brass screws to the base. The two gaps between the three pieces of ply should be just a 1in. so that the coils when they are wound will fit snugly into these grooves.

the aperture through each coil and see that it is clear and free from ends of paper or drips of dope, as this might prevent the needle turning.

Mark off the position of the pivot, which is at the centre of the cross diagonals of the centre piece of ply fixed to the base, and pierce a small hole right through from the underside of the base. Push a soft tone gramophone needle into the hole,

leaving about a 1/16in. protruding on the underside. Then glue the two bobbins in position, so that their centres are dead in line with the pivot, the wire ends of one coil on the left-hand side and the wire ends of the other coil on the right-hand side. Figs. 7 and 8 show just where the coils have to be fixed.

Then magnetize the needle from another magnet. It does not affect the working of the

instrument if the needle is strongly magnetised or weakly, providing that it is magnetised. Pass the needle carefully through the core of the front coil and drop it carefully on to the pivot. See that it swings freely. Adjust the height of the needle, so that it swings freely through the apertures in the bobbins, by pushing the pivot through the base to the required distance. If the dimensions shown in the sketches have been followed the back end of the pivot will be just flush with the underside of the base. If the pivot projects, four small feet should be glued to the underside of the base to keep it clear of the table. If it does not, give more attention to the bottom of the hole in the bush. Then glue into position on the top of the coils the retainer strip. This is just a thin piece of cardboard about 3/16in. wide, to prevent the needle coming off when it is carried about. It must not, however, touch the needle or the pointer will not move.

Next paste a piece of thin white card to a piece of ply, and cut it to the shape shown in Fig. 8. No markings need appear on the scale except one straight line drawn dead down the centre, which is under the pointer in Fig. 8. Other markings can, of course, be made if desired, but these have no particular value and any effort to grade the readings in milliamps would be unnecessary and inaccurate. The dial is supported in position by two small pieces of three-ply glued to the base as shown in Fig. 7.

**Making the Casing**

The sides of the instrument can be made from cardboard or metal or any material which can be bent round the base, provided that iron is not used. The actual model used cardboard, which was given a coat of black cellulose paint after it had been glued up. The width of the material is 1 1/2in., and is glued down to the base on the rabbet made by cutting away one layer of ply. The four terminals are then fitted as shown in Fig. 8. Soldering tags should be used, and of course, if a metal case is made, these will have to be insulated. The two wires from each coil are soldered to the tags on the nearest side, and these can be connected to whichever terminals are most convenient, the correct direction of the current being made outside with the anode leads to the instrument.

The top cover should now be made.

(Continued in col. 1, page 1209.)

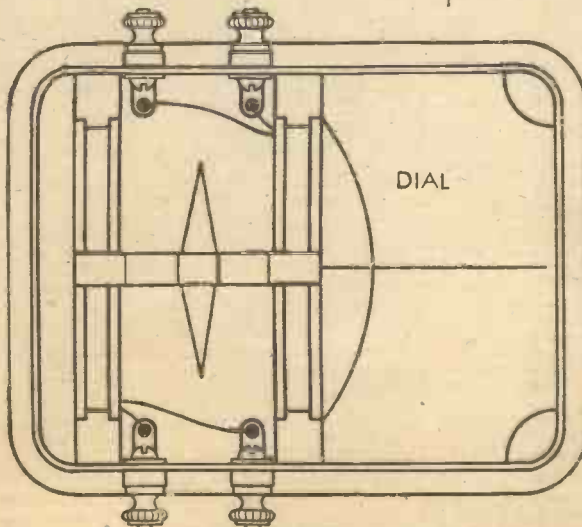

Fig. 8.—The connections and dial.

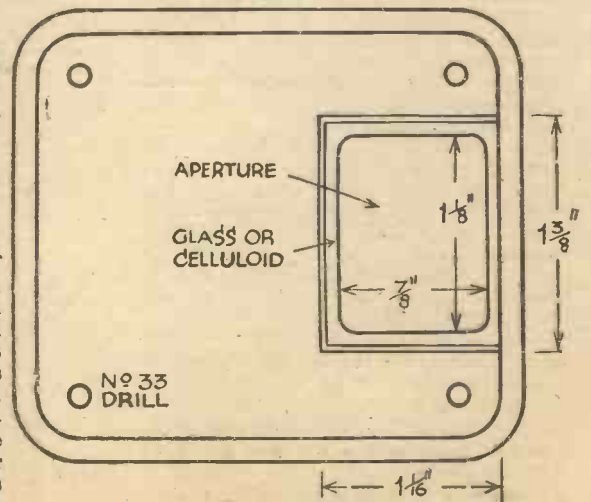

Fig. 9.—The lid of the case with window.



# Practical Letters

from

## Readers.

The Editor does not necessarily agree with opinions expressed by his correspondents

### Suggestions for Articles

SIR,—May I respectfully suggest articles in "Ours" on the following subjects, which I feel sure will interest many readers.

#### Advanced Wireless Mathematics

One full page weekly dealing with this and its practical application to set design, such as Resistance, Capacity, Impedance, Reactance, etc. Most people know where, say, a fixed condenser should be used. Let us know the reason why—the correct value, etc.

#### Fuses

Your correspondent (R. C., Liverpool) struck a good note here. As an enthusiast of many years standing I have yet to see a really comprehensive article on these. Let us have a detailed article on values, position, purpose, etc., in: (a) Battery sets; (b) Battery sets, H.T. eliminator fed; (c) All-electric sets.

#### Super-het Theory

As the super is attracting more and more attention, whilst most people are in a fog as yet as to its many modifications, etc., why not give us a series of articles somewhat on the lines below: (a) Frequency changing methods—their merits and demerits; (b) Pre-H.F. amplification. The pros and cons re number of stages, practical values, etc.; (c) Intermediate amplification. Maximum stages possible—effective value compared with pre-H.F. amplification, etc.; (d) First and second detector pros and cons. S.G., Pentode, Triode.

#### Super-het Practical Experimenting

Why not let us have some articles on the following lines: (a) Building a five or six valve super from odds and ends; (b) Gradual conversion of a S.G.-Det.-L.F. set into a eight-nine valve super; (c) Amateur construction of I.F. coils; (d) Amateur construction of oscillator coils.

#### Unusual Single-Dial Circuits

How many people can accurately gang two (or more) condensers? How many circuits have been published necessitating this, where an H.F. stage is required? Why not cater for the individual who really wants only one tuning condenser, together with a more or less helpful degree of H.F. amplification, even if not up to the full value possible when using a tuned H.F. stage. On the lines of: Kilodyne—Aperiodic Aerial—Tuned H.F. Transformer. Bijou 3—Tuned S.G. H.F.—Untuned Detector. Valves are so cheap nowadays that many people would not mind using two to get the same effects as with one, if the tuning can be simplified.

In conclusion, may I add my words of praise for "Ours." I do not like to draw invidious comparisons, but it simply puts all

competitors "in the shade," my wireless experience extends back to long before broadcasting commenced—my excuse for feeling competent to pass judgment on "Ours."—F. B. (Accrington).

#### "A Very Fine Volume"

SIR,—I have read PRACTICAL WIRELESS since it started and I find it most enjoyable. I was one of the lucky ones who were able to get your "P.W." Encyclopædia and I am glad to say I received my copy safely. After looking through it and reading various articles, I felt that I must write and congratulate you on a very fine volume, useful to any practical wireless enthusiast. Wishing your paper every success.—J. J. GASCOIGNE (Coventry).

#### "A Wealth of Knowledge"

SIR,—I have received the de luxe copy of the Wireless Encyclopædia and I am pleased to say that I was surprised at the finish and binding and the wealth of knowledge inside, far beyond my dreams of what I was expecting. I have nothing but praise for it, just the mine of information that every

wireless enthusiast could wish for, and in such a plain straightforward manner that anyone could understand. Please accept a reader's thanks for a very valuable book at such a small cost. Now about PRACTICAL WIRELESS. I have been a reader from the No. 1 and can say that it is just the book, at a small price, that everyone interested in the practical side of wireless construction should read. Every item is so plain and understandable that the merest novice can enjoy it. Please continue the future issues as you have begun, striving to please the ordinary man in the street. Wishing PRACTICAL WIRELESS every success in the future.—ENTHUSIAST (Eastwood).

#### "An Invaluable Reference Book"

SIR,—Many thanks for Encyclopædia just received. It is obviously an invaluable reference book and possesses a remarkably pleasing appearance. Heartiest congratulations.—D. C. GREEN (Clevedon).

#### "A Very Useful Book"

SIR,—My copy of Wireless Encyclopædia arrived safely, for which many thanks. It is a very useful book and I am delighted with it. That and PRACTICAL WIRELESS will supply me with all the knowledge for all constructional work.—A. S. RALPH (Catford).

#### "Inert" Dry Batteries

SIR,—Our attention has been invited to a paragraph appearing on page 1008 of the current issue of PRACTICAL WIRELESS in which it is stated that Inert Batteries are not available for the use of colonists situated in remote districts. As this article is liable to convey an impression that British manufacturers either do not realise or are displaying insufficient interest in the requirements in this direction of overseas customers, we venture to draw your attention to the fact that we have been manufacturing, *inter alia*, Dry and Inert cells and batteries for more than sixty years, and for many years past have manufactured batteries of the Inert type specially for H.T. purposes in connection with wireless apparatus. We may say that we have supplied and are still supplying many thousands of this type of battery annually to British and Colonial Government Departments for use overseas. In view of the above facts may we suggest that in a subsequent issue you dispel the apparent belief that no effort is being made to cater for the requirements of overseas customers.—M. A. STAPLEY, for Siemens Brothers and Co., Ltd.

#### A Norwegian Reader's Appreciation and Suggestions

SIR,—I have been reading PRACTICAL WIRELESS Nos. 1 to 19 inclusive, and hope I may live long enough to read many more of them, and I am also a satisfied possessor

CUT THIS OUT EACH WEEK.

## DO YOU KNOW?

—THAT if the cone of a M.C. speaker moves more easily in one direction than another, second harmonics will be produced.

—THAT for direction finding purposes, two frame aerials are used, one inside the other at right-angles.

—THAT cabinet resonance in a box-type loud-speaker may be avoided by filling the cabinet with non-resonant material.

—THAT new coils will shortly be available to the home-constructor which divide the present two-range wave-band into three sections for easier tuning.

—THAT amateur transmitters now use the term "megacycles" for the wavelengths employed by them.

—THAT television is now increasing daily in popularity, and the items broadcast by the B.B.C. cover a most interesting range of subjects.

—THAT it is preferable to use separate heater supplies for valves in push-pull operated from a mains unit.

—THAT a MHO is the unit of conductivity. It is the reciprocal of resistance.

### NOTICE.

The Editor will be pleased to consider articles of a practical nature suitable for publication in PRACTICAL WIRELESS. Such articles should be written on one side of the paper only, and should contain the name and address of the sender. Whilst the Editor does not hold himself responsible for manuscripts, every effort will be made to return them if a stamped and addressed envelope is enclosed. All correspondence intended for the Editor should be addressed: The Editor, PRACTICAL WIRELESS, Geo. Newnes, Ltd., 8-11, Southampton Street, Strand, W.C.2.

Owing to the rapid progress in the design of wireless apparatus and to our efforts to keep our readers in touch with the latest developments, we give no warranty that apparatus described in our columns, is not the subject of letters patent.

of the Wireless Constructor's Encyclopaedia. I am glad you intend to issue semi-annual indexes and binding cases. —A READER.

**BALANCE METER FOR Q.P.-P. CIRCUITS**

(Continued from page 1207).

This is another piece of three-ply, cut in similar manner to that of the base, but it has in addition an aperture through which the pointer is sighted. The dimensions are given in Fig. 9. The outside edge of the aperture should be rounded off. The dimensions 1 1/4 in. and 1 1/16 in. are for the layer of ply which is removed in the same manner as the rabbet round the edge.

The Balance Meter is now ready for use. Connect the terminals as shown in Fig. 1, one pair of terminals going to one side of the circuit and the other to the opposite side. Rotate the instrument so that the pointer is directly over the line drawn on the scale. This is the only drawback to the meter, that is, it is controlled by the earth's magnetism and must therefore be arranged correctly in the earth's field. This actually is a very small point but must, of course, be remembered or a wrong setting will be obtained. If the valves have not previously been matched the needle will in most cases swing hard over to one side. The anode which is passing most current can easily be found by short-circuiting with a piece of wire or a screwdriver each pair of terminals in turn. If on shorting one pair the needle swings hard over to the other side of the scale, then that pair of terminals is connected to the anode taking most current. If the needle swings to the same side whichever pair of terminals are shorted reverse one pair of leads. The terminals can then be marked for future reference. Adjust the screen voltage of the lower valve until the needle is over the line on the scale. It may not be possible to get an exact balance if the tappings of the H.T. battery are relied upon only, but the meter is sufficiently sensitive to show a discrepancy of less than 0.1 of a milliamp on either side.

**RADIO CLUBS & SOCIETIES**

**THE SOUTHALL RADIO SOCIETY**

That this Society considers that pentodes have better characteristics than triodes for modern circuit design was a motion which was lost in a debate held at a meeting of this society recently. The speakers for the motion were Mr. G. Lee and Mr. L. Swan; against, Mr. A. Stephens and Mr. H. Rayner. Points from the speakers in favour of the pentode were: (a) High amplification factor, (b) High frequency response was useful in Superhet and band pass designs to make up for attenuation, against: (a) Small grid swing; (b) Tone correction necessary with added expense.

**SMETHWICK WIRELESS SOCIETY**

At a recent meeting of this society, Mr. Valentine gave a most interesting lecture-demonstration of various L.F. circuits. By using a dual gramophone amplifier, the lecturer demonstrated the different effects produced by various couplings between valves

**SERADEX MAINS TRANSFORMERS**  
For Fury Four A.C. Model

Input 200 to 250 volts, Outputs 200V 200Ma. and 4 volts 4 amps C.T.

Price 18/6 post free from your dealer or from:

TREVOR PEPPER, WAKE GREEN RD., BIRMINGHAM.

and between output valve and speaker. He also showed the effect of using valves of different amplification factors and how reproduction was marred by incorrect bias and output couplings. He then went on to show how tone could be adjusted first by means of a tone compensating transformer, and then by means of introducing intentional resonances in the L.F. amplifier. Hon. Sec., Mr. E. Fisher, 33, Freeth Street, Oldbury, Nr. Birmingham.

**HACKNEY RADIO AND PHYSICAL SOCIETY**

At our meeting held on February 20th we had great pleasure in listening to a most interesting lecture on "Tone Control," given by Dr. L. E. C. Hughes. The talk covered the whole subject of sound reproduction, measurement and control and the lecturer's remarks were amplified by lantern slides. Two slides in particular were of great interest. The first of these showed a graph of amplification plotted against frequency, and the second slide dealt with the directive and sound-distributing qualities of various types of loud-speakers.—A. F. Rogerson, Hon. Secretary.

**CROYDON RADIO SOCIETY**

At a recent weekly meeting held at the Horse and Groom, Cherry Orchard Road, East Croydon, Mr. Parr demonstrated the Cathode Ray Oscillograph. Describing its construction, he said the cathode was an ordinary loop filament, in front of which was the positive anode having a hole in its centre, through which shoot the electrons. Means were taken that these should be conveyed to a beam which showed on the fluorescent screen on the other end of the bulb as a fine green point. Then by a positive plate placed above and a negative one below the beam, and just in front of the anode, the beam was deflected upwards. Thus, with a linear time scale and different frequencies applied to the deflecting plates, these frequencies could be seen as a green line in the mirror, vibrating up and down. Applications were numerous, such as the human voice via a microphone, though the society's technical adviser made the line zigzag until it shot off the screen! The output from a wireless receiver was connected, and it was seen what the weather forecast looked like against jazz. Actually, both were interesting pictorially, but not orally! The Society is anxious to send its full programmes to PRACTICAL WIRELESS readers interested in its activities. Hon. Sec., E. L. Cumbers, Maycourt, Campden Road, S. Croydon.

**GOLDERS GREEN AND HENDON RADIO AND SCIENTIFIC SOCIETY**

At a recent meeting of the Golders Green and Hendon Radio and Scientific Society, held at the Hampstead Art Gallery, an interesting lecture and demonstration of 16 mm. Home Talkies was given by Mr. Humphrey Andrews, B.Sc., A.C.G.I., A.M.I.E.E.

At another meeting of this society, held recently, a talk by Mr. Alexander Black on Tone Correction was eagerly followed.

A specially interesting meeting has been arranged for March 22nd, when Mr. G. G. Blake, M.I.E.E., F.Inst. P., will describe and demonstrate his new Radiometric Condenser, controlling an oscillating circuit by radiant heat, also a Crookes Radiometer and a Thermopile. A copper Oxide photo-electric cell will also be constructed and then tested, and if time permits, other scientific experiments will be shown. It is hoped that Sir Ambrose Fleming, M.A., D.Sc., F.R.S., will be able to take the chair. H. Ashley Scarlett, President.

**THE CREWE AND DISTRICT RADIO AND SCIENTIFIC SOCIETY**

An interesting evening was spent by members and associate members of this society recently, when Mr. Hornby lectured on the manufacture of the modern Superheterodyne. The lecturer dealt with the subject in a most interesting and clear manner, and by means of diagrams, explained the action of the Automatic Volume Control applied to mains sets, also the new "Push-Push" output stage incorporated in battery models. Anyone interested in Radio is invited to communicate with the Hon. Secretary, Mr. R. Peach, 84, West Street, Crewe.

**SLADE RADIO**

A lecture entitled "The Output Stage," was given by Mr. F. Youle, B.Sc., A.C.G.I., A.M.I.E.E., at the meeting of the above society held recently. After giving a brief outline of the various forms of L.F. amplification from the old Push-Pull of 1914-15, he went on to describe the present systems of Quiescent Push-Pull and Class B. Dealing with the subject in an unusual manner some extremely interesting points were raised and many of the side issues explored. Hon. Sec., 110, Hillaires Road, Gravely Hill, Birmingham.

Famous Maker's Offer: **PIANO-TONE! CABINETS**  
7 DAYS' FREE TRIAL (or 10/- Monthly)  
Piano built (Pat. 8123). The acoustic Tone brings a fine thrill. (Radio-Press, E.B.C., 3,000 clients)  
MAKER'S PRICES 35/- to £15 Photograph and List FREE  
PICKETTS Piano-Tone Cabinets, (P.R.), Aldon Road, Bexleyheath

For "FURY FOUR"  
**PICKETTS CABINETS**  
Recommended for Best Results!

**Oh! that aerial pole**



**NO MORE TROUBLE**

Now a new idea in aerials has been devised that eliminates that pole, loose wires, etc. Like wireless itself—an invisible aerial—that is in the form of a narrow self-adhesive metallized tape of remarkable efficiency as a pick-up, that is just pressed into position around the room, up the staircase—anywhere convenient. 30ft. of this Pix Invisible Aerial costs only 2/-. A longer length is supplied in 60ft. rolls which can be run from the room into the hall and up the staircase to the attic, costs only 3/6. This will be found to have a pick-up equal to an outside aerial of the same height. No tools are required and no holes have to be bored. It is the cheapest and most convenient aerial in the world.

**2/- 30 ft. Double Length 3/6.**

What an expense and trouble it has always been, and after the nervous tension during every high wind, adjustments and repairs. What are the total losses of high frequency current through the aerial corroding, touching window frame, wall, etc. And those cutting remarks of the ladies on loose, unsightly wires about the room. Poor man! You have to pay dearly for your wireless enjoyment!

**BRITISH PIX COMPANY, LTD.,**  
Dept. 459, 118/28, Southwark Street, London, S.E.1

**PIX INVISIBLE AERIAL**

**FIT THIS ELECTRIC CLOCK TO YOUR SET!**  
NO MAINS NEEDED! KEEPS CORRECT TIME! NO WINDING!  
Works off small battery lasting 12 months, or can be plugged into G.B. battery without affecting reception. Uses practically no current. Fits into hole 3/16 in. dia. in any panel up to 1/2 in thick. Easy to fit—no screws required. Only 1/6 in. from front of panel to back of case. Swiss movement. Hands set from front. Nickel-plated bezel. Useful addition to any set.  
**12/6**  
COMPLETE WITH BATTERY  
POSTAGE 6D  
**RIVERSIDE MFG. Co., Ltd.,**  
Dept. 21, Crisp Road, Hammersmith, W.6.  
Telephone: Riverside 6392

**LOUD SPEAKERS REPAIRED 4/-**  
(Blue Spot a Speciality, 5/-)  
Transformers 4/-. All repairs magnetised free. Eliminator Repairs quoted for. 24 Hours Service. Discount for Trade. Clerkwell 9069.  
**E. C. MASON 44 EAST ROAD, LONDON N.1.**

**EASY TERMS PROMPT DELIVERY**  
Any Amplion, Blue Spot, Baker, Celestion, Epoch, Goodmans, Igranic, Lanchester, Ormond, R. & A., Rola, Sonochorde, or W.B. Moving Coil Speaker supplied promptly.  
**SEND 5/- ONLY**  
and pay the balance by monthly instalments. No references. Entirely private and confidential. Write for Catalogue and details to:  
**TURNADGE & PARTNERS, LTD.,**  
Ludgate House, Fleet Street, London, E.C.4.  
Telephone: Central 1903.

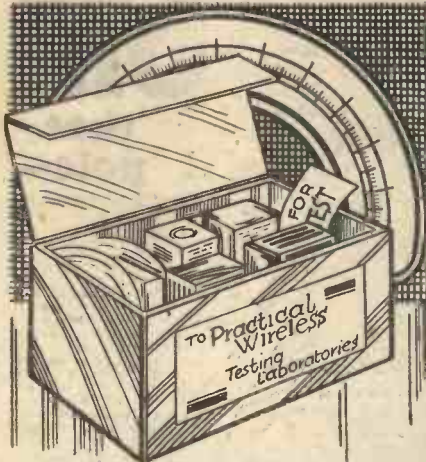

#### W/B THREE-WAY CHANGE-OVER SWITCH

A NOVEL development in switches of the rotary type is illustrated herewith. This is a production of the Whiteley Electrical Radio Co. (manufacturers of the famous W/B Speakers), and is a very substantial component. The operating mechanism is an ebonite triple-cam arrangement, shown in the centre of the illustration, and this operates against the spring contacts shown round the edge of the back plate. There are very many uses for a device of this type in a modern receiver, and it is also being developed in two-way and single-way models. The contacts are of nickel silver and have been found to clean very well in use. The single-way will cost 1s. 6d., the two-way 2s. 6d., and the model illustrated will cost 3s. The mechanism is the subject of Letters Patent.

#### TELSEN DRUM-DRIVE ASSEMBLY

THE ingenious assembly shown on the right is a complete two-circuit tuning arrangement possessing many novel features. Two .0005 logarithmic condensers (with right-hand and left-hand drive) are fitted on each side of a very rigid assembly containing a drum-type drive. This operates by means of a cord drive, which is held in tension by springs at each end. A very neat oxidized escutcheon is fitted, and the actual scale which is provided is marked in wavelengths in metres. The control knob is in two sections, one of which rotates the moving vanes of the two condensers, and the other portion of the knob acts in an ingenious manner for trimming purposes. The two condensers are attached to the drum drive by means of one-hole fixing nuts, and that portion which received the left-hand condenser is left free to move over a small area. The front knob is connected (by a cord drive) to this section of the drum, and therefore the whole of this section of the drum, and therefore the whole of the left-hand condenser may be moved through a few degrees. To enable the user to ascertain what movement has been made, a small pointer is attached to the moving part of the dial, and this is located immediately at the rear of the ivory scale. The latter is illuminated by means of a small pilot lamp, and the pointer casts a shadow on the dial. The accurate re-setting of the tuning condensers for any station is therefore an extremely simple matter. The complete assembly costs 17s. 6d.

#### Q.P.-P. AND P.A. TONE CONTROL

MESSRS. Ward and Goldstone are shortly producing two new tone controls. The Q.P.-P. control is a single bush panel fixing or two screw baseboard mounting. It includes a Q.M.B. Switch to allow for proper audio-frequency control on radio and gramophone. As an impedance linking device with push-pull pentodes, its effect is more severe on "pick-ups" than on radio. The values of .005 mfd. and 20,000 ohms total have been chosen for radio and .005 mfd., and 5,000 ohms for pick-up, or heterodyne whistle elimination. Another type of normal pentode output arrangement called "P.A." Tone Control includes a .01 mfd. condenser with the above values of resistances, 20,000 or 5,000 ohms. This unit is also suitable for quiescent push-pull where a more severe degree of radio control is considered desirable. On single pentodes the degree of audio high-frequency control on the "P.A." is similar to the Q.P.-P. type used with push-pull. The price is 5s. each, complete. Direct mounting on metal panels is possible, as the "live" parts of the Q.M.B. are insulated from the frame. The condensers in the units are tested to 1,500 volts D.C. No electrical breaks occur in the tone control circuit when switching with Q.M.B., and, consequently, large voltages cannot build up in the pentodes owing to accidental "open" loud-speaker circuits.

#### WARD & GOLDSTONE MAINS CHOKE

ALTHOUGH a D.C. Mains user considers himself lucky in not needing rectifying apparatus, it is still essential, in many cases, to smooth the supply, as there is very often a very distressing commutator ripple

# Facts and Figures

Components Tested in our Laboratory

BY THE PRACTICAL WIRELESS TECHNICAL STAFF

with this form of supply. This is especially the case for listeners who have D.C. operated valves of the indirectly-heated type. Messrs. Ward and Goldstone, makers of the well-known "Goltone" apparatus, have produced a most interesting form of H.F. choke for this purpose, and it will be found a very effective component. A paxolin former, 2in. in diameter, is wound with heavy gauge green-covered wire to an inductance of approximately 270  $\mu$ H, and the D.C. resistance is .75 ohm. The former is attached to a moulded bakelite base fitted with two substantial terminals. The makers state that the choke will carry current up to approximately .6 ampere without an appreciable increase in temperature. They also claim that an increase of efficiency in D.C. mains sets of 10 to 25 per cent. is assured by using two of these

types of chassis, complete with internal switching, thus completing their entire range of coils.

#### BULGIN "FUSEPLUG"

A VERY ingenious "Fuseplug" is being sold by Messrs. Bulgin and will be found invaluable to the listener who uses a mains-operated radiogram. In appearance it resembles the normal 5-amp. two-pin plug for insertion into a power point. It is in two parts, however, and contains two 1-amp. fuses in the leads between the pins and connecting screws. It therefore prevents the house fuses from blowing in the event of a short-circuit in the wireless apparatus. The standard 1in. type fuses are used, and these are obtainable at 6d. each. The "Fuseplug" costs 2s. complete with the two fuses.

#### LOTUS OUTPUT CHOKE

A CHEAP but efficient output choke is obtainable from Lotus Radio. This is intended for small battery-operated power valves, and is rated at 20 henries with a D.C. resistance of 720 ohms. The choke is very neat and will be found very useful for small receivers where the output valve does not pass more than about 10 mA. The price is 5s. 6d.

#### FILTRON

THE importance of a sound earth connection has continually been brought to the notice of our readers, and one of the latest methods of ensuring a continually damp earth has just been brought to our notice. This is known as "Filtron," and is a chemical contained in a small copper pot. A terminal is attached to the side of this pot, and to use it the earth wire is attached to this terminal. The contents of the pot are covered with a red wax-like material from the centre of which projects a small glass tube. When ready to use the device, this glass tube is removed, and this leaves a hole into which water may pass, and so reach the chemical under the red seal. If the condition of the soil in which it is to be buried is very dry, several more holes may be pierced in the red sealing compound with a nail. The copper pot should be buried about a foot below the surface, and a pint or two of water poured over it. The earth connection is then always in a very damp condition, and even the hottest summer day will not result in weak signals owing to dryness of the soil surrounding the earth connection. The device is marketed by Amplon (1932) Ltd., and costs 2s.

#### DIRECT RADIO BAFFLE-BOARD

TO enable really large volume to be handled without undue baffle resonances many interesting schemes have been proposed. A very interesting design is now being produced by Direct Radio, and is being marketed with one of the Celestion Matched Units attached. The baffle consists of two 30in. square boards, separated by a small air space. The Speaker Unit is attached to one of these boards, and the remaining board is veneered with a polished walnut front to present a neat appearance. The interior air space separating the two boards is then packed with Kapok, and this results in a perfectly non-resonant baffle, with a much better musical response. Booming, chattering, etc., are removed, and the design certainly represents an improvement over the normal type of baffle. The complete assembly, with the Matched Unit Celestion speaker, is £3 17s. 6d.

#### CELESTION Q.P.-P. SPEAKERS

A FURTHER interesting feature of the dual Celestion speakers which was not dealt with last week is that there are three different types available. In one, the two speakers are of the permanent field magnet type. In another, the two fields are of the energized type, and in the remaining model, one is of the permanent magnet type and the other has an energized field. The price in each case is £4 5s. The single model Celestion Speaker is of the Hy-flex type and is of similar characteristics to those employed in the dual unit. With all types of speaker used in the Q.P.-P. circuits it was found desirable to retain the tone compensating arrangement of resistance and condenser with values of .01 mfd. and 10,000 ohms, across the anodes of the two output valves.

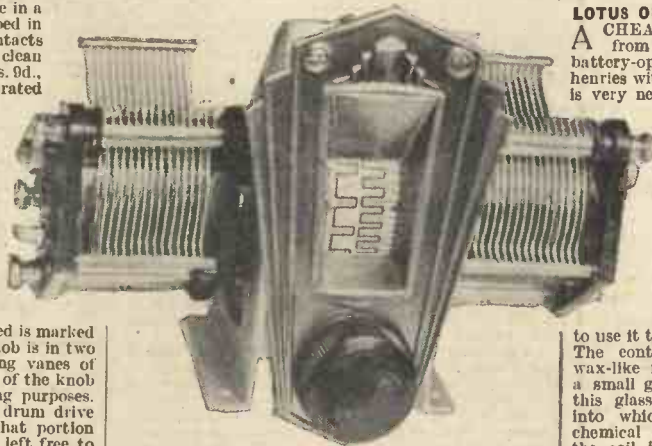

The Telsen drum drive assembly.

chokes, in addition to the elimination of the hum. The price is 3s. 6d. To enable the Goltone coils to be conveniently mounted and ganged, metal chassis are now available in 2, 3 and 4 coil mountings. The 2 coil costs 1s. 6d., the 3 coil 2s., and the 4 coil 2s. 6d. The holes are arranged so that vertical or horizontal mounting is possible, and by means of the slots and special extension terminals provided under-baseboard wiring is possible. Thus two coils, with chassis, and

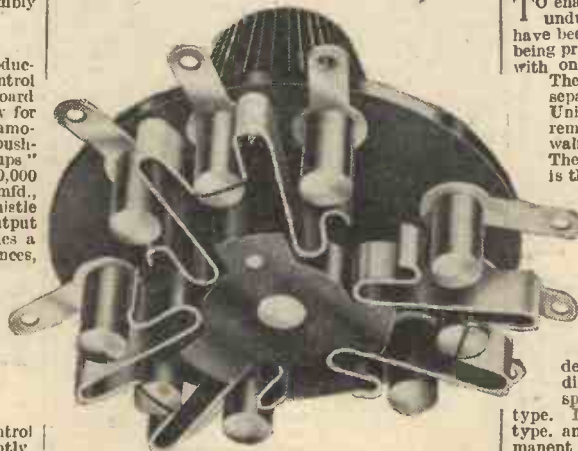

The new W/B rotary switch.

the special sub-baseboard terminals will cost 13s. 10d. complete. This represents a saving of twopence over the purchase of the coils, chassis and terminals separately. Messrs. Ward and Goldstone also inform us that later in the season they intend to produce new



LET OUR TECHNICAL STAFF SOLVE  
YOUR PROBLEMS

REPLIES TO



QUERIES and ENQUIRIES  
by Our Technical Staff

The coupon on this page must be attached to every query.

If postal reply is desired, a stamped envelope must be enclosed. Every query and drawing which is sent must bear the name and address of the sender. Send your queries to The Editor, PRACTICAL WIRELESS, Geo. Newnes, Ltd., 8-11, Southampton St., Strand, London. W.C.2.

SPECIAL NOTE

We wish to draw the reader's attention to the fact that the Queries Service is intended only for the solution of problems or difficulties arising from the construction of receivers described in our pages, from articles appearing in our pages, or on general wireless matters. We regret that we cannot, for obvious reasons—

- (1) Supply circuit diagrams of complete multi-valve receivers.
- (2) Suggest alterations or modifications of receivers described in our contemporaries.
- (3) Suggest alterations or modifications to commercial receivers.
- (4) Answer queries over the telephone.

Please note also, that all sketches and drawings which are sent to us should bear the name and address of the sender.

SPEAKER FIELD FOR BIASING

"I have a well-known make of moving-coil loud-speaker with a field resistance of 2,500 ohms. I do not want to use this for smoothing the H.T. supply, as this only delivers 200 volts, and I cannot afford to waste the voltage which would be dropped through the winding. On the other hand, I do not wish to buy or make up a separate eliminator for this winding. I understand that I can, however, use the winding for biasing the output-valve. Is this so? How do I adjust it to give me the correct voltage—it will give much too high a voltage as it stands, as the anode current is 50 mA, and only 33 volts grid-bias are required. I do not want to interfere with the actual winding of the field."—(R. T., Guildford.)

We presume that your output-valve employs a filter circuit for the loud-speaker, and, therefore, the following method should be adopted for using your field winding for bias purposes. The filter condenser should be joined to the anode of the output-valve, and the loud-speaker should have one lead joined to the other side of the filter condenser. The remaining speaker lead should then be joined to one side of the field winding, the other side of which is joined to H.T.—The centre tap of the heater winding should be joined to the junction of the loud-speaker and field winding, and from this point one end of a 13,000 ohm resistance should be connected. The other end of the resistance is joined to H.T.—It may be found necessary to decouple this circuit with the usual values of condenser and resistance (250,000 ohms and 2mfds.).

The "FURY FOUR"

"I intend, after arriving home on the 17th, to make up the 'Fury Four.' We use a D.C. eliminator with three positive tappings, No. 1: 40 to 100 variable suitable for screen voltage, also for anode voltage of detector valves taking not more than 2.5 mA.; No. 2: 80 to 130 variable suitable for valves up to 10 mA, and No. 3: 150 volts fixed total capacity 15 to 50 mA. As the 'Fury' is designed as a battery set, with resistors instead of H.T. intermediate tappings, I should be much obliged if you could give me instructions to suit the eliminator or other idea."—(J. P., Gibraltar.)

We would not advise you to remove any of the resistors in the "Fury," as these serve not only as voltage droppers, but as decouplers, and, therefore, if your eliminator tappings are provided by, for instance, a potential divider, you may find that the receiver will be unstable. Our advice is, therefore, to make up the receiver exactly as described, and to use only the third tapping on your eliminator, that is, the one delivering the maximum voltage. You will find, then, that the receiver will function exactly in the same manner as with a battery, providing perfect stability with maximum amplification in all stages.

DUAL-WAVE COIL

"I should be glad if you could instruct me in the making of a reaction coil for a four-pin coil with a reaction winding to suit the high-wave coil (900 to 2,000 metres). What gauge of wire would be required?"—(W. J. B., Swansea.)

The winding should consist of, approximately, sixty-five turns of No. 34 or 36 D.S.G. wire. This should be wound in a hank, and situated on the former about 1/2 in. from the commencement of the long-wave winding, and with a space of about 1/2 in. from the end of the medium-wave winding. The finish of the reaction-winding should be joined to the finish of the long-wave winding, and all windings should be in the same direction. The four pins will be (1) commencement of medium-wave winding; (2) commencement of reaction-winding; (3) junction of finish of medium-wave winding and commencement of long-wave winding, and (4) finish of long-wave winding and reaction-winding. The wave-change switch (of the ordinary on/off pattern) is joined from (3) and (4).

SHORT-WAVE ADAPTOR

"I have a 5-valve American set, differing from the ordinary set in that the coils are fixed. It is a neutrodyne circuit, having two stages of high frequency, detector, two stages of low frequency. The reception I have had since I bought it has been trouble-free, but could you please inform me why it is that the adaptors and converters usually made that will operate on my set? I have been informed will not work on my set? I notice in this week's 'Practical Wireless' a converter that seems to be just the thing I require to bring in the short waves. Will it combine with my set? If not, can you put up a circuit that will?"—(G. E. S., Towns River, Union of South Africa.)

The most suitable arrangement for use in conjunction with your set is the adaptor described on page 905 of PRACTICAL WIRELESS, No. 19. This is plugged into your detector-valve socket, and, therefore, your neutrodyne stages are isolated, and the fact that fixed coils are employed will not affect the functioning of the receiver. With this arrangement, you will be employing a detector valve followed by two L.F. stages, and you will find that this has a really excellent range, and is very simple to handle. We would not advise the use of a converter with the particular make of receiver which you have got.

DATA SHEET No. 25.

HANDY FORMULÆ.

Cut this out each week and paste it in a Notebook.

Resistances and capacities in series and parallel.

Resistance in series:  $R = R_1 + R_2$

Resistances in parallel:  $R = \frac{R_1 \times R_2}{R_1 + R_2}$

Capacities in series:  $C = \frac{C_1 \times C_2}{C_1 + C_2}$

Capacities in parallel:  $C = C_1 + C_2$

LONG-WAVE DIFFICULTY

"I have a small home-made two-valver employing detector and power valve, operated by an eliminator from the mains. I get remarkably good results on the short waves, but reception on the long waves is very poor indeed. Could you tell me the cause of this? I am using a commercial dual-range coil. Perhaps you could kindly suggest something to cure this."—(A. H. N., Taunton.)

The failure to get good reaction effects on the long waves may be due to an inferior H.F. choke, or a bad aerial and earth system. Overhaul the latter, and make quite certain that the earth connection is not broken, and then try the effect of a new or different H.F. choke. If this has no effect, then the dual-range coil itself, or the wave-change must be blamed for the fault.

LOW VOLTAGE MAINS

"Four months ago I bought an H.T. mains unit for use with 220-volt mains. I am now moving, and the house where I am going has a voltage supply of 110. Could you tell me the best course to take; I don't want to part with it, as it has never caused any trouble what-

ever and always gives good results."—(H. E., Wimbledon.)

The periodicity of 110 volt mains is usually lower than the higher voltage supply, and really the best course to adopt is to try to find someone locally who is situated in the reverse position to yourself. That is, someone who is moving to a district where the supply is higher, and try to get the two units exchanged. The unit as it is at present will not be suitable for the new supply, and the only method of using it is to get a transformer manufacturer to make you up a transformer with an input suitable for your present supply, and a secondary suitable for connection to the input of the unit. There is no other solution.

S.G. ANODE COMPONENT.

"I am making up a small receiver in which I wish to use a screened-grid valve as a detector. Is it advisable to use an ordinary L.F. transformer direct coupled with this valve? What I mean is, may I include the primary of the transformer in the anode circuit direct? I appreciate that the S.G. type of valve has a rather high impedance, but I do not know whether this precludes the use of a transformer in the manner I suggest. Your advice would be esteemed."—(R. X. S., Hanwell, W.)

The high impedance of the S.G. valve demands that the anode impedance shall also be high if full advantage is to be taken of the principal features of this type of valve. Therefore it is always preferable to use a resistance having a high value in the anode circuit, and so parallel feed the L.F. transformer. You will find that by this means you will obtain the maximum amplification, as well as a more even response over the entire musical scale.

NEW TYPES OF COILS

"I see from previous articles in your pages that in the near future some new types of coil will appear on the market. I should like to make up one of the receivers which are at present featuring, but I am rather anxious to know whether this will not be obsolete by the time I have finished it, owing to the introduction of these new coils. Shall I go ahead with the receiver, or would you advise me to wait for the new coils?"—(D. J., Windsor.)

The new coils will not be cheap. Furthermore, as with the majority of new ideas, some time must elapse before the arrangement becomes perfected. In addition there are other points which lend us to say, go ahead with the present set. If at some future date you wish to take advantage of the new coil development, you will not find it difficult to incorporate them in an existing set. If you want to see the new development, the same thing will be continually recurring in wireless, and as soon as one idea is brought forward some new scheme is proposed, and you would never get a receiver made up if you kept postponing the construction pending the arrival of a new idea.

SCREENING

"My receiver is a S.G., detector, and L.F. set, and I use a single coil of the dual-range type in a metal can. I have just bought this, as I am modernizing the set. The H.F. choke is a home-made one, wound on a 1 in. tube, and I wonder whether I ought to buy a screened choke to match the tuning coil, or whether the present choke will still do? It is a most efficient component, and works on the two wavebands in a perfectly satisfactory manner."—(W. L. K., Gleshorpes.)

There is no object in screening the choke. As you only employ one tuning coil, and this itself is screened, there is no risk of interaction between the choke and the tuning coil. Of course, we assume that there is no other component in your receiver with which it is possible for interaction to take place. If, however, you use two chokes, or have some other component which possesses inductance, then the two should be arranged at right angles. But provided the choke is working to your satisfaction, there is no need to buy a screened one.

FREE ADVICE BUREAU  
COUPON

This coupon is available until March 18th, 1933, and must be attached to all letters containing queries.

PRACTICAL WIRELESS 11/3/33.

# CATALOGUES RECEIVED

To save readers trouble, we undertake to send on catalogues of any of our advertisers. Merely state, on a postcard, the names of the firms from whom you require catalogues, and address it to "Catalogues," PRACTICAL WIRELESS, Geo. Neuenes, Ltd., 3/11, Southampton St., Strand, London, W.C.2. Where advertisers make a charge, or require postage, this should be enclosed.

## COLUMBIA RECEIVERS AND RADIOGRAMS

WE have received an attractive catalogue from the Columbia Graphophone Co., Ltd., dealing with a wide range of their receivers and radiograms. Amongst the various types included are two- and three-valve battery sets, four-valve all-electric and seven-valve superhet models. In the radiogram section there is the popular Radiogram Four, a highly efficient 4-valve instrument embodying all the latest improvements. The selling price is 32 guineas for the A.C. model and 34 guineas for the D.C. instrument. Also listed are Auto-Radiograph Superhet Seven, and the Auto-Radiograph "De Luxe Ten." Readers interested should obtain a copy of this catalogue by applying to the firm at 98-108, Clerkenwell Road, London, E.C.1.

## BELOW 10 METRES

(Continued from page 1180.)

Your first tests on ultra-short waves may not be very inspiring due to the absence of signals, but remember there are not many to be had as yet, although this state of affairs will undoubtedly be remedied in the very near future. If you try again later your persistence will probably be well rewarded, and you will have the great satisfaction of knowing that you are right up to date and ready to take full advantage of the very imminent future developments. But even if this knowledge fails to comfort you, make other coils having more turns, and use the adaptor temporarily as a normal short-waver. A tuner made in the manner previously described, and having seven turns for the aerial coil and five for reaction, will carry you over the 20-metre waveband, and by using still more turns other wavelengths can be reached. It is not worth while to make a large tuner and short-circuit tuners for wavelength adjustment.

Having made the receiver, the first difficulty will be to make it oscillate, but this may be overcome by experimenting with different aerials and by adjusting the capacity of the series-aerial condenser. In my experience the best aerial is a short one, consisting of not more than 15ft. of wire and erected vertically, but it might often prove beneficial to reduce the length to only 5 or 6ft.; you must experiment in this direction. Oscillation can be detected by a distinct "double-plop" heard when the aerial terminal is touched with a moistened finger. A better way, however, is to connect a milliammeter between the H.F. choke and the valve plug; the reading will suddenly drop as oscillation sets in and rise again as reaction is slackened off.

## Replies to Broadcast Queries

FRISKY (Southend-on-Sea): WCAU, Philadelphia (Pa) on 256.3 m.; Columbia Broadcasting System, NIBLICK (Ealing); Nyiregyhaza (Hungary), relays Budapest on 267.8 m. BR5 1038 (Hefne Bay): (1) Yes, WIXAZ, East Springfield on 31.35 m., relaying Boston (Mass.); (2) VK2ME, Sydney (N.S.W.) on 31.28 m.; (3) Rabat (Radio Maroc) on 32.26 m.; interval signal heard apparently CTIAA, Lisbon (31.25 m.); (4) HVJ, Vatican (Rome) on 50.26 m. SEARCHER (Cheshire): (1) Tropical Radio Telegraph Co. New Orleans (La.) U.S.A.; (2) American Tel. and Tel. Co., Lawrenceville (N.J.); (3) Possibly PAOARS, Amsterdam, 80 m. (3,750 kc/s); (4) Radio Coloniale, Pontoise, Nr. Paris, France. ONE VALVE (Faringdon): G6PS, A.F.M. Parsons, 358, Beverly Road, Hull (York); (G5SZ, J. W. Riddiough, Tranmere Park, Guiseley (York)); G2XP, J. P. Payne, 53, Otley Dr., Ilford, Essex, GFHK, regret, cannot trace; G6NF, A. D. Gay, 49, Thornlaw Road, West Norwood, S.E.27, London; G5ZI, regret cannot trace; G2EE, cannot trace; G5RO, cannot trace; G5WE, cannot trace; G5JB, J. S. Bamford, 14, Fountainhill Road, Edinburgh; G5RS, E. W. Rawlings, 20, Hedgeaway, Onslow Village, Guilford, Surrey; G0LI, A. E. Livesey, Stourton Hall, Horncastle, Lincolnshire; G5YK, G. W. Thomas, 169, Hills Road, Cambridge; G2YL, R. C. Horsnell, "St. Neots," Wick Drive, Weyford, Essex; G5PQ, W. F. Moore, 17, Lawn Road, Uxbridge, Middx. G2OB, cannot trace. For unidentified calls advise you to write to Radio Society of Great Britain, 53, Victoria Street, S.W.1. W2HY, Geo. Petersen, 820, 40th Street, Brooklyn, N.Y.; W2OCJ, cannot trace.

# PARTEX RADIO

Part Exchange Experts

WE GIVE YOU MORE

SEND US your requirements for SETS, KITS, COMPONENTS or ACCESSORIES together with list of goods for which you wish us to give our fullest allowance in PART EXCHANGE. Balance Payable by CASH or H.P.

NAME .....  
ADDRESS .....

Partex Radio, <sup>Vulcan House</sup> 56, Ludgate Hill, London, E.C.4  
Tel. W. 11/3/38.

## THE PROBLEMS OF FAITHFUL REPRODUCTION

(Continued from page 1137, March 4th issue.)

FORTUNATELY the use of a pentode valve in the output stage gives us a convenient and simple method of correction for such cases, for the pentode tends to give undue prominence to the high notes. Also, the use of a condenser across the output terminals in this case gives us an easy and correct means of varying this effect as we please. The need for any specified value can be avoided by using a value larger than necessary with a variable resistance in series, by which its effect can be varied. In the cases where a pentode valve has replaced a triode, the same method will often assist in removing the "screech" which is usually produced.

Many sets, well designed in the first place or carefully adjusted later, will give very faithful reproduction of what they receive in the form of signals. But stations will heterodyne, and needles will scratch, and so what we receive is not always what we want (or deserve), and so we must sacrifice to some extent our ideal of perfection, and try to achieve the nearest we can to it under difficulties.

In general the solution to both problems lies in providing some means of maintaining the high-frequency response at its correct value up to a certain point, and then providing a sharp cut-off.

# H.T.

## INVESTMENT or EXPENSE?

### Battery that Lasts Years

#### WRITE FOR FREE BOOKLET AND FIGURE OUT WHAT YOU CAN SAVE

"I have been using my Standard Battery three years. It is trouble free, always ready and speaks for itself. What more can one require?" (R. H., Stoke-on-Trent.)

Here's another testimonial giving facts beyond dispute. You WILL save money by installing STANDARD H.T. once for all. You WILL get better reception. The STANDARD battery recharges itself when the set is shut down, being a special adaptation of the famous Leclanche principle—and it is PERMANENT because the eventual replacement is merely a matter of changing cartridges (which you do yourself) at 3½d. each. We sell direct in order to Guarantee your satisfaction.

Send a postcard for our Free Booklet. It shows how to end battery expense and make it a permanent investment. Do it now, before you forget.

#### Model H.5

### 126 VOLT STANDARD BATTERY

No. 3 size. 84 cells, 12,500 milli amp capacity.

Cash Price **37/8** or delivered on 1st payment of **5/-**

STANDARD BATTERY Co., Dept. N.W.,  
184-188, Shaftesbury Avenue, London, W.C.2



"REPAIRS?"  
Send Them to Me."  
When the repair has been O.K.'d by me, you can be sure your component is as good as new. All repairs are laboratory tested and guaranteed for 12 months. Any make of speaker unit, Transformer or Pick-up, 4/-; Blue-Spots, 5/-; Moving Coils from 5/-. Address your repairs to: Repair Dept. B., Weedon Power Link Radio Co., 125, Earham Grove, London, E.7 (Phone: Maryland 4344.)

# ADVERTISEMENT INDEX

Amplion (1932), Ltd.	Page 1205
Bennett College, Ltd.	1169
British Pix Co., Ltd.	1209
Bulgin, A. F., & Co., Ltd.	1205
Columbia Graphophone Co., Ltd.	1185
Colvern, Ltd.	Inside Front Cover
Co-Radio, Ltd.	1203
Cossor, A. C., Ltd.	1181
Dubilier Condenser Co., Ltd.	1201
Edison Swan Electric Co., Ltd.	Back Cover and 1188

Heyberd, F. C. & Co.	Page 1204
Lissen, Ltd.	1170
London Electric Wire Co. & Smiths, Ltd.	1193
Mason, E. C.	1209
Newnes "Home Mechanics"	1169
;; "Home-Movies"	Inside Back Cover
;; Mathematics of Wireless	1203
Partex Radio	1212
Pearl & Pearl, Ltd.	Inside-Front Cover
Peto-Scott, Ltd.	1194

Picketts, Ltd.	Page 1209
Riverside Mfg. Co.	1209
Ryall's Radio	1204
Seradex Products	1209
Standard Battery Co.	1212
Turnadge & Partners, Ltd.	1209
Univolt Electric Ltd.	1203
Varley, Ltd.	1188
Weedon Power Link Co.	1212
Wright & Weaire, Ltd.	1193

# MOVIE MYSTERIES EXPLAINED

SOME remarkable "behind-the-scenes" photographs showing how parts of London were rebuilt in Hollywood for the film "Cavalcade" are a feature of the March issue of "Home Movies and Home Talkies". How to develop your own 9½ mm. films at low cost and numerous other hints for home cinematographers help to make it a "bumper" number. Scouts will be particularly interested in a description of how the famous scout film "The Trail of Youth" was made in Devonshire, and how many of the thrilling incidents were "faked."

**SEND POSTCARD FOR SPECIMEN COPY**

"HOME MOVIES" is obtainable at all Newsagents, Bookstalls and Dealers, or post free 7½d. (Subscription rates: Inland and Abroad, 7/6 per annum; Canada, 7/- per annum) from George Newnes, Ltd., 8-11, Southampton St., Strand, London, W.C.2.

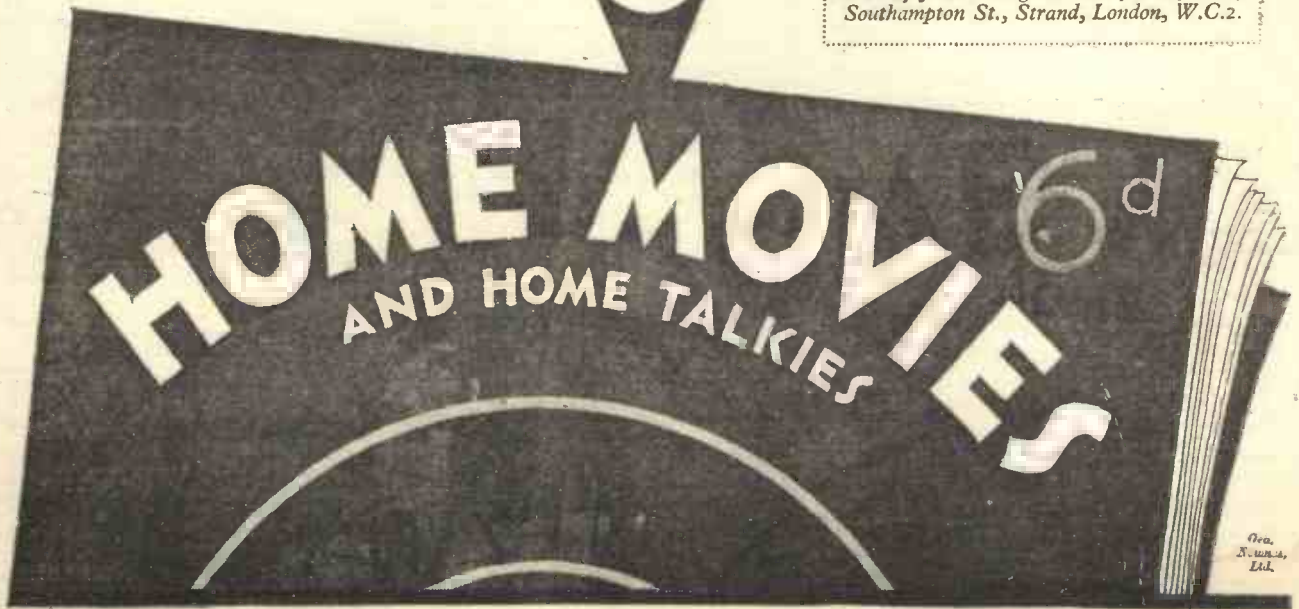



# EDISWAN

The name that means 'EXCELLENCE'

**SPECIFIED  
EXCLUSIVELY**  
for the  
"PRACTICAL WIRELESS"  
**Q.P.P.  
Three-Four**

The illustration shows the unitary construction of the Mazda Pen.220A, the highly efficient characteristics of which are advantageously used in the new "Practical Wireless" circuit.

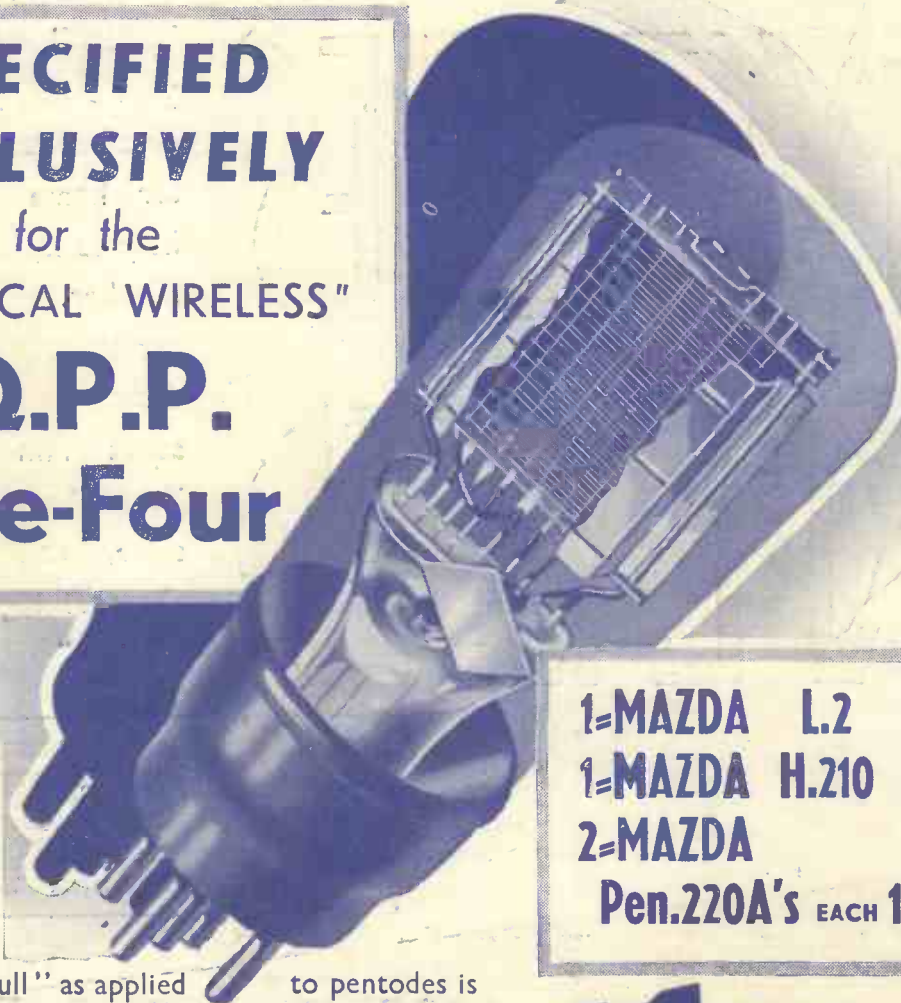

1=MAZDA L.2 7/=  
1=MAZDA H.210 7/=  
2=MAZDA  
Pen.220A's EACH 17/6

"Quiescent Push-Pull" as applied to pentodes is the latest achievement in battery receiver design, and was first developed in the Mazda Radio Valve Laboratories. It adds yet another item to the already long list of Mazda developments which have passed into standard practice. "Q.P.P." depends to a large extent for its successful operation on the use of highly sensitive pentodes; that is why the designer of the "Q.P.P. Three-Four" has specified Mazdas. The correct types can be obtained from all radio dealers.

**MAZDA**  
THE  
BRITISH  
VALVES

THE EDISON SWAN ELECTRIC CO. LTD.  155 CHARING CROSS RD., LONDON, W.C.2

**RECOMMENDED BY ALL GOOD RADIO DEALERS**

P. W. Gift Stamp No. 24

Printed by NEWNES & PEARSON PRINTING CO., LTD., Exmoor Street, Ladbroke Grove, W.10, and published by GEORGE NEWNES, LTD., 8-11, Southampton Street, Strand, W.C.2. Sole Agents for Australia and New Zealand: GORDON & GOTCH LTD. South Africa: CENTRAL NEWS AGENCY, LTD. *Practical Wireless* can be sent to any part of the world, post free, for 17/4 per annum; six months, 8/8. Registered at the General Post Office for Transmission by Canadian Magazine Post.

# "PRACTICAL WIRELESS" DATA SHEET No. 12

## HANDY FORMULÆ

### AMPLIFICATION.

Of a tuned circuit ..  $= \frac{\omega L}{r}$

Where r = equivalent series resistance.

### CAPACITY.

Capacity of a condenser :

(a) With parallel plates  $C = \frac{Ak}{11.31 \times 10^6 \times d}$  mfd.

(b) Spherical plates  $C = r/9 = 10^5$  mfd.

Capacity of a horizontal aerial :

$C = 1 \div \left( 4.144 \times 10^6 \log_{10} \frac{4h}{d} \right)$  mfd.

where l = length in cms.  
 d = diameter in cms.  
 h = height above earth in cms.  
 A = total area in cms. of one plate.  
 r = radius in cms.

Capacities in series  $C = \frac{C_1 \times C_2}{C_1 + C_2}$

Capacities in parallel  $C = C_1 + C_2$

### FREQUENCY.

$f = \frac{\sqrt{10^6 \times 10^6}}{2\pi\sqrt{LC}}$

### INDUCTANCE.

Inductance of a straight wire  $L = 2l \left( \log_e \left( \frac{2l}{r} \right) - 1 \right)$  cms.

Inductance of a solenoid  $L = 4\pi^2 a^2 N^2 b^2$ .

Inductance in series (with no mutual inductance)  
 $L = L_1 + L_2$ .

Inductances in parallel (with no mutual inductance)

$L = \frac{L_1 \times L_2}{L_1 + L_2}$

L = Inductance in cms.  
 N = Turns per cm.  
 b = Overall breadth of coil in cms.  
 r = radius of wire in cms

### AMPLIFICATION FACTOR.

$\mu = \frac{\text{Change in anode volts}}{\text{Change in grid volts}}$

MUTUAL CONDUCTANCE. =  $\frac{\text{Change in anode current}}{\text{Change in grid volts}}$

## TABLE OF SYMBOLS USED IN WIRELESS AND ELECTRICAL FORMULÆ

Amplification .. .. .	A
.. factor .. .. .	$\mu$ (Mu)
Ampere (unit of current) .. .. .	A
Current (R.M.S. value) .. .. .	I
.. (instantaneous) .. .. .	i
Capacity .. .. .	C
Energy .. .. .	W
E.M.F. (voltage—R.M.S. value) .. .. .	E
E.M.F. (instantaneous) .. .. .	e
Farad (unit of capacity) .. .. .	F

### IMPEDANCE.

In a circuit with Resistance, Inductance and Capacity in series.

$Z = \sqrt{R^2 + \left( \omega L - \frac{1}{\omega C} \right)^2} = \sqrt{R^2 + X^2}$

### OHM'S LAW.

$I = \frac{E}{R}$      $E = I \times R$      $R = \frac{E}{I}$

For A.C. circuits  $I = \frac{E}{2\pi fL}$

### REACTANCE.

Of a coil .. ..  $X = 2\pi fL$

Of a condenser .. ..  $X = \frac{1}{2\pi fC}$

Net reactance .. ..  $X = X_L - X_C$

At resonance .. ..  $f = \frac{1}{2\pi\sqrt{LC}}$

### RESISTANCE.

$R = \frac{E}{I}$

Of a tuned circuit .. ..  $R = \frac{L}{C \times r}$

Where r = equivalent series resistance.

Resistances in series  $R_1 + R_2$

Resistances in parallel  $\frac{R_1 \times R_2}{R_1 + R_2}$

### WATTAGE DISSIPATION.

$I^2 R = EI$

### WAVELENGTH.

Wavelength (in metres) =  $\frac{\text{Velocity}}{\text{Frequency}}$

Of a tuned circuit —  $\lambda = 1885\sqrt{LC}$

Where L = microhenrys.

C = microfarads.

$\lambda \times f = 300,000,000$

To convert Wavelengths (in metres) to Frequency (in kilocycles), divide 300,000 by the Wavelength.

To convert Frequency (in kilocycles) to Wavelength (in metres), divide 300,000 by the Frequency.

### IMPEDANCE. (This is actually A.C. resistance)

$R_o = \frac{\text{Change in anode volts}}{\text{Change in anode current}}$

Henry (unit of inductance) .. .. .	H
Impedance .. .. .	Z
Inductance .. .. .	L
Mutual inductance .. .. .	M
Ohm (unit of resistance) .. .. .	$\Omega$
Power .. .. .	P
Resistance .. .. .	R
Reactance .. .. .	X
Wavelength .. .. .	$\lambda$
2 $\pi$ f .. .. .	$\omega$



# Practical Wireless

**3<sup>D</sup>**

Published every Wednesday by  
**GEORGE NEWNES LTD.**  
Vol. 1. — No. 26.  
MARCH 18th, 1933.  
*Registered at the G.P.O. as a Newspaper.*

## Wireless in the Car

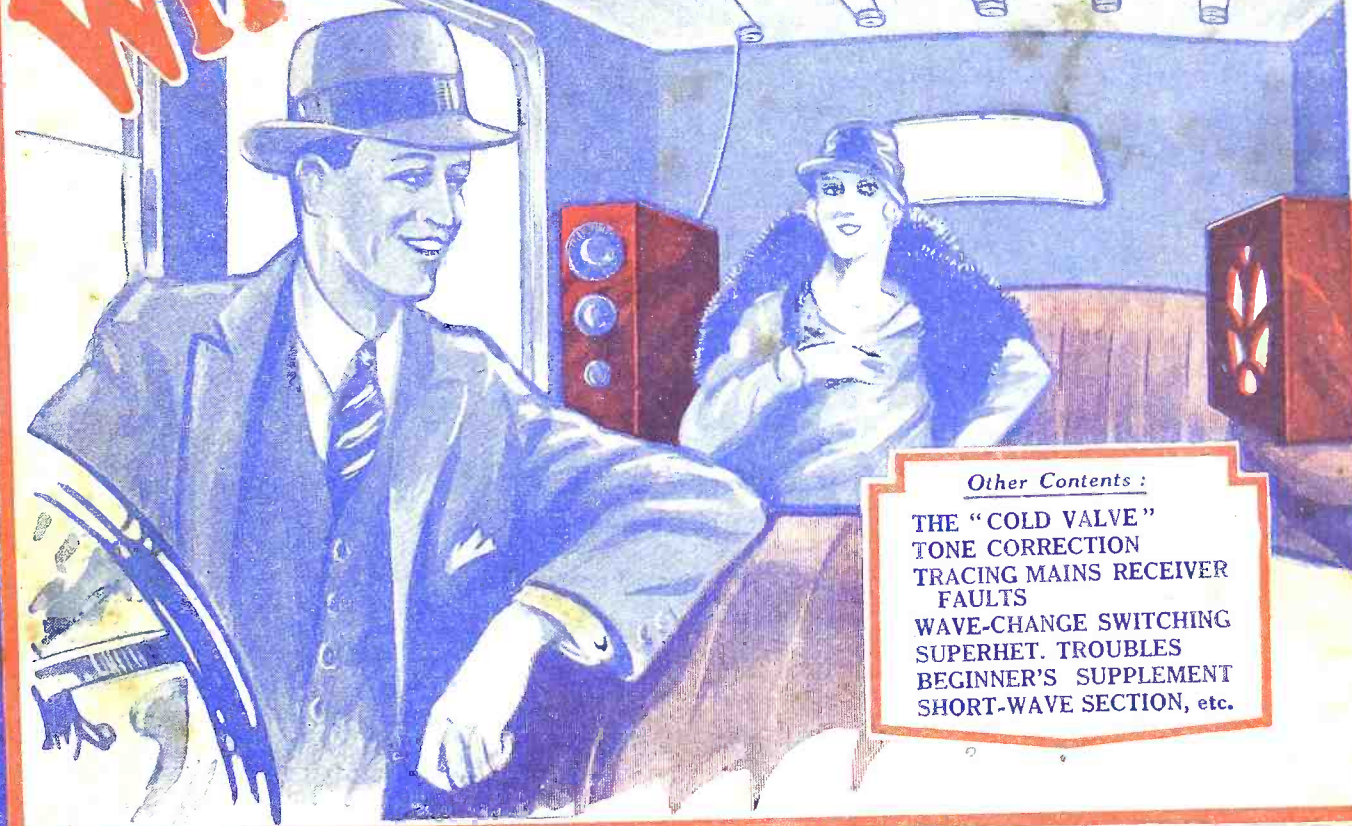

*Other Contents :*  
THE "COLD VALVE"  
TONE CORRECTION  
TRACING MAINS RECEIVER  
FAULTS  
WAVE-CHANGE SWITCHING  
SUPERHET. TROUBLES  
BEGINNER'S SUPPLEMENT  
SHORT-WAVE SECTION, etc.

**"FOR GOODNESS' SAKE" BUY YOUR KITS FROM DIRECT RADIO**

*With acknowledgments to Haver & Lee, the Fun Racketeers.*

**DIRECT RADIO, 159, Borough High Street, London Bridge, S.E.1.**

ADVT.

# Any Intelligent Man or Woman CAN Make These and Make Money!

Let us introduce you to genuine, honest spare-time work in the comfort of your home at which men and women to-day are making handsome profits regularly—week in and week out.

The wonderful part of it is that you need not have the slightest previous experience or technical knowledge.

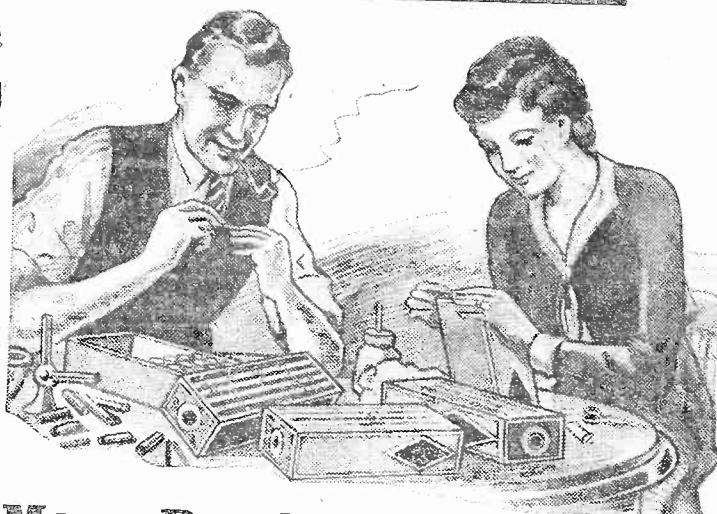

Many People LIKE YOU Have  
Doubled Their Incomes!

## RETIRED MINISTER'S TRIBUTE.

Dear Sir,— Marshfield, Wilts.  
I write as a retired Minister, and I can conscientiously say that in a fairly long life, during which I have come in contact with several hobbies and home-employment schemes, I have found nothing which offers so many advantages, both from an interesting and remunerative point of view, as your proposition does.

The fact that I have never had to ask you a single question in connection with the

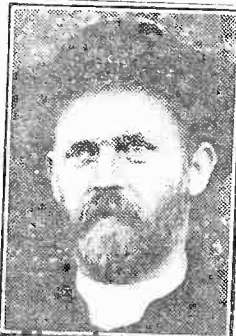

Rev. DAVID JARVIS.

work is sufficient proof of the ease with which I have learned to make your batteries. As for their efficiency I need only say that the very first battery I made I sold to a chemist in Bath, who wrote for another as soon as the first was run down, and is still a regular customer.

By judicious buying raw material the cost can be got down to 1d. per cell, for the standard size, when the wholesale market can be entered into without fear in spite of the fierce competition. I myself have made for a firm of wholesalers and have never had a single complaint.

Once introduced, the efficiency of your batteries results in repeat orders and recommendations. With every confidence I commend this enterprise to all who are seeking—  
INTEREST, ENTERTAINMENT,  
and INCOME.

Sincerely yours,  
DAVID JARVIS.

P. 463 9.

## One Man Earned £960 in Spare Time

You can commence on your Kitchen Table, in a spare room, or out-house. The work is clean, safe, pleasant, and quite simple. It is the making of our Patented Wireless Batteries. The demand for Wireless Batteries runs into MILLIONS.

You can make anything up to £300 a year this self-same way. Think what you could do with all those extra £s.

We GUARANTEE you profit and, if necessary, we will take sufficient of your output off your hands to ensure it, provided only that your work comes up to the easily attained standard of efficiency—we continue your training FREE as long as required.

The market is unlimited. It is a GOOD, HONEST BUSINESS which will help you to become your own "Master." Start now.

Send  
this  
Form  
for

There is no expensive "plant" to buy. Only a few small hand tools and presses, most of which you can make yourself at trifling cost. Your profits are only limited by the amount of time you choose to devote to the work.

## £5 per Week— 5 Hours a Day!

Dear Sirs,— Letchworth, Herts.  
I am writing to let you know how well I am progressing with the manufacturing of your Radiolene batteries.

I started 15 months ago with 30s. worth of chemicals. I made £3 11s. 11d. profit in the first five weeks, and now I have a stock of chemicals and plant valued at £40.

All my chemicals I buy in bulk, so that I can make as much as 200 percent. profit.

These last five weeks' business has brought me in £25 7s. 6d., working 5 hours a day.

I feel that these excellent results are due to the kind assistance you have shown me at all times. (Sgd.) E. W. EDWARDS.



E. W. EDWARDS.

# £'s COUPON

To Mr. V. ENGLAND-RICHARDS,  
THE ENGLAND-RICHARDS CO., LTD.,  
243, King's Lynn, Norfolk.

Sir,—Please send me at once, and FREE, full details as to how I can Make Money at Home in my spare time, and also Testimony from those already making money. I enclose 2d. in stamps for postage.

Print your name and address boldly in capital letters on a plain sheet of paper and pin this coupon to it.

"Practical Wireless" 18/33

FREE

Instructions How to Start



*You must have a*  
**TD Coil**  
*for the*  
**“Q.P.P.**  
**Three-Four”**

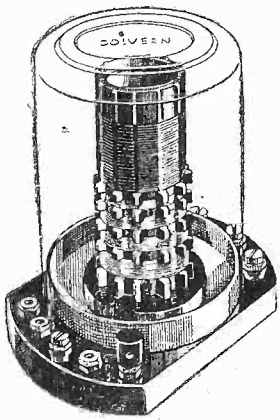

*Selectivity and quality combined in this receiver.*

Super Selectivity is vitally necessary under present-day broadcasting conditions. This is achieved with the Colvern TD Screened Coil.

Four Alternative Tappings are provided. They are arranged as sockets with a wander plug, giving varying degrees of selectivity. The first two tappings give aerial couplings similar to those normally employed but with greatly increased selectivity. Nos. 4 and 5 give a high degree of selectivity with weak aerial coupling, suitable for use in a swamp area.

There is no break through on the long wave band from B.B.C. stations.

PRICE
<b>8/6</b>
EACH

*Send for the Colvern circuit booklet, RL 10.*

**COLVERN LIMITED**

**MAWNEYS RD., ROMFORD, ESSEX.**

LONDON WHOLESALE DEPOT:  
 150, KINGS CROSS ROAD, W.C.1.

**NEW**  
*double capacity\**  
**ACCUMULATOR**



**IDEAL FOR Q.P.P.\***

A neat cylinder, taking less space than the average 40-amp. hour accumulator—yet giving you 80 amp. hours! You will find that capacity of this sort is essential for trouble-free Q.P.P.—that is why designers are specifying “Block.” The “Block” Accumulator is plate-less—it eliminates the lead grid, the great weakness of modern accumulators that wastes so much weight and space. The new accumulator is extraordinarily durable, too. Coloured bakelite case. Ask your dealer.

**80** AMP. 2. **11/6**  
 HRS. V.

**BLOCK**  
*Plate-less Accumulators*

BLOCK BATTERIES LTD., ABBEY ROAD, BARKING, TEL. GRA 3346

# "SKYSCRAPER" RADIO

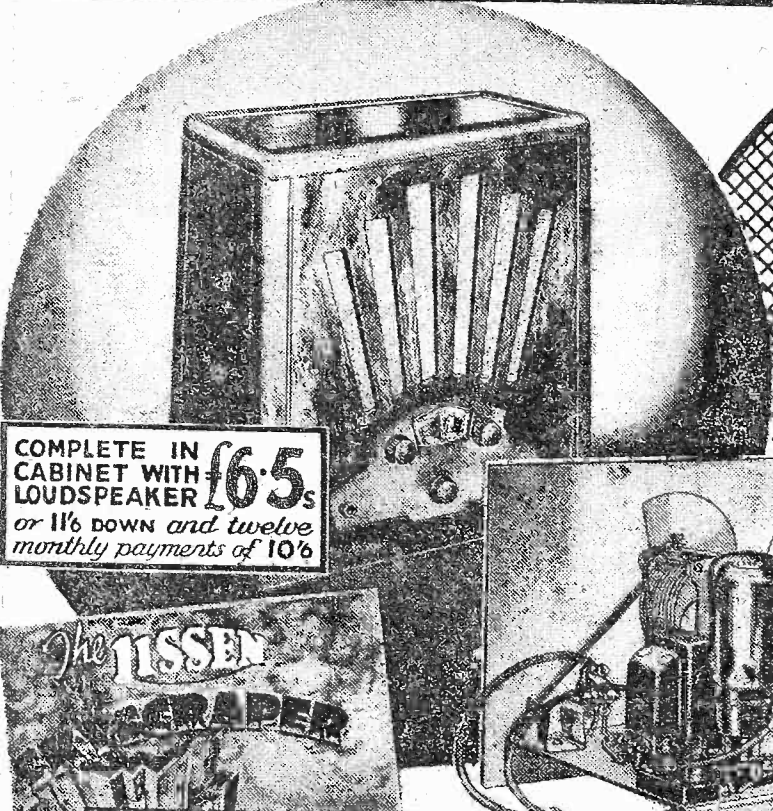
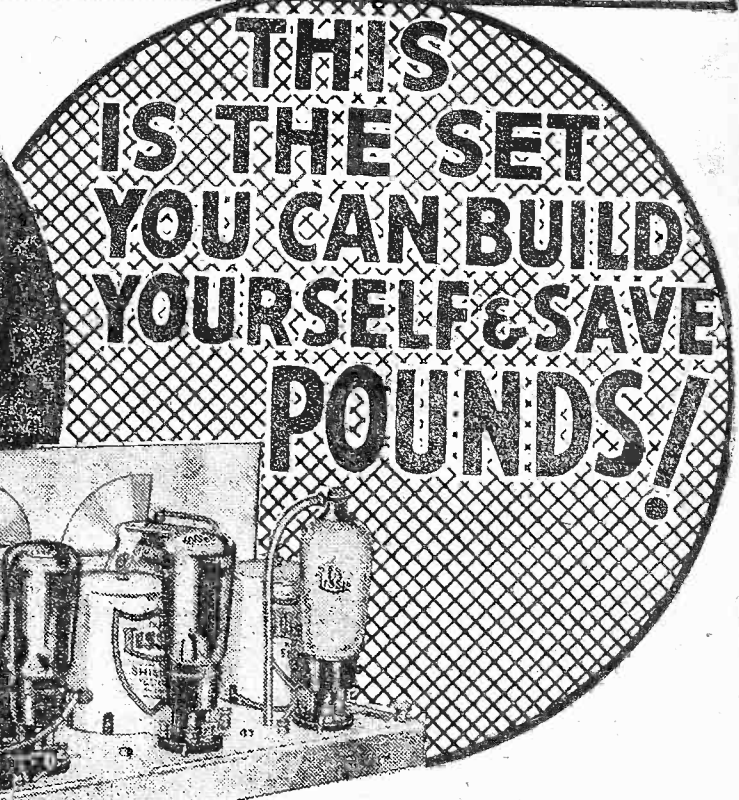

COMPLETE IN CABINET WITH LOUDSPEAKER **£6.5s**  
 or 11/6 down and twelve monthly payments of 10/6

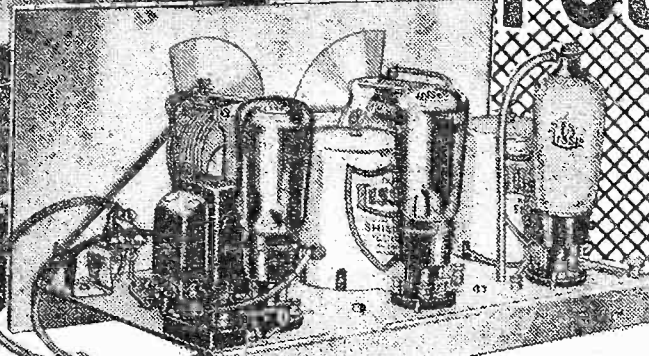

## SUCCESS A CERTAINTY

**GET YOUR FREE COPY OF GREAT CHART TELLS EXACTLY WHAT TO DO WITH EVERY SINGLE NUT AND SCREW**

**THE ONLY KIT YOU CAN BUILD YOURSELF EMPLOYING METALLISED S.G. HIGH-MU DETECTOR AND ECONOMY POWER PENTODE VALVES**

NEVER before was there such a set within the reach of the home constructor. Never before such power from a battery set. Never before so many enthusiastic letters from constructors or so much talk about any radio set as this Lissen "Skyscraper" Kit has elicited. 50-60-70 loud-speaker stations—everybody who builds a "Skyscraper" gets results like that! Lissen have published a 1/- Constructional Chart, giving the most detailed instructions ever printed for the building of a wireless set. You can't go wrong—every part, every wire, every terminal is identified by photographs. Everybody, without any technical knowledge or skill, can safely and with COMPLETE CERTAINTY OF SUCCESS undertake to build this most modern of radio receivers from the instructions given and the parts Lissen have supplied.

This new Lissen "SKYSCRAPER" Kit Set is the only one on the market that you can build yourself employing a Metallised Screened Grid Valve, High Mu Detector and Economy Power Pentode. Around these three valves Lissen have designed a home constructor's kit the equal of which there has never been before. Why be satisfied with whispering foreign stations when you can BUILD WITH YOUR OWN HANDS this Lissen "SKYSCRAPER" that will bring in loudly and clearly distant stations in a profusion that will add largely to your enjoyment of radio?

**yours for ONLY 8/6 down**

To-day you can buy the LISSEN "SKYSCRAPER" KIT on Gradual Payment Terms. "Skyscraper" Chassis Kit, complete with Valves, CASH PRICE, 89/6. Or 8/6 down and twelve monthly payments of 7/6.

"Skyscraper" Kit complete with Walnut Cabinet and in-built Loud-speaker as illustrated, £6 5s. cash. Or 11/6 down and twelve monthly payments of 10/6.

You can get the Lissen "Skyscraper" Chart FREE from any radio dealer, or by posting the COUPON on left direct to factory.

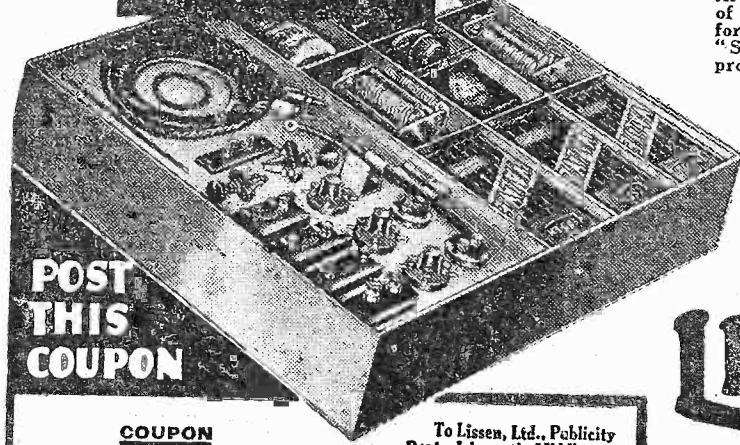

# LISSEN "SKYSCRAPER" KIT

**POST THIS COUPON**

**COUPON**

Please send me FREE copy of your 1/- Skyscraper Chart.

Name .....

Address .....

P.R.41. ....

To Lissen, Ltd., Publicity Dept., Isleworth, Middlesex.

SEND FOR YOUR COPY OF THE WIRELESS CONSTRUCTOR'S ENCYCLOPEDIA NOW! SEE BELOW!



**Practical Wireless**

EDITOR: F. J. CAMM  
 Vol. I. No. 26 March 18th, 1933  
 Technical Staff:  
 H. J. Barton Chapple, Wh. Sch., B.Sc. (Hons.), A.M.I.E.E.  
 Frank Preston, F.R.A., W. J. Delaney, W. B. Richardson.

# ROUND *the* WORLD of WIRELESS

### International Broadcasts

OF all the European countries Germany is probably the one which has shown most initiative in the development of inter-changed programmes with other continental and extra-European States. During 1932 the Reichsfunk broadcast 280 wireless entertainments for the benefit of foreign listeners, and in the same period, relayed 250 programmes from foreign transmitters. These figures include the regular weekly features exchanged with the United States of America.

### Two More Finnish High Power Stations

IT is reported that to ensure a better reception of the Helsinki programmes in Finland, the power of the Viipuri (Viborg) transmitter is to be increased from 10 to 40 kilowatts, and that a 10 kilowatt relay station is to be installed at Oulu (Uleaborg). Up to the present, the latter station situated on the borders of the Gulf of Bothnia has relayed the capital on 690 metres (434.7 kc/s) with a 1.5 kW transmitter. With the advent of larger stations, it is possible that some of the smaller relays such as Pietarsaari (Jakobstad), or Pori (Bjornborg) may be dismantled.

### Altered Wavelengths of Short-wave Stations

WITH the increase in number and power of transmitters in certain portions of the short-wave broadcasting band, some transmissions have been severely heterodyned. In order to alleviate this trouble Rome 2RO is now carrying out some of its broadcasts on 48.2 m. (6,220 kc/s) instead of the 25.4 m. channel. Skamleback (Denmark) during the past week or so has also temporarily moved from 31.5 m. to 49.4 m. (6,073 kc/s), and on this new wavelength provides very powerful signals. The station may be easily identified by its musical box interval signal; it is that of Copenhagen from which the programmes are relayed. As most readers are aware a simultaneous broadcast is carried out through the Kalundborg high-power station on 1,153.8 m.

### Sponsored Publicity Concerts

THE number of stations in Europe which have adopted this method for supplementing their income is daily growing larger. In addition to such stations as Radio Paris, Toulouse, Fécamp (Radio Normandie), Athlone (I.F.S.), and Ljubljana,

listeners may now hear an English musical transmission from San Sebastian (E.A.J.S) Spain on 456 metres, after midnight on the conclusion of the ordinary programmes. The call and details of the entertainment are given out in the English language by a woman announcer.

### Television In Italy

FOLLOWING a series of experiments, short-wave transmitters are to be erected shortly both at Rome and Turin in order to ascertain the useful area of telephony and television broadcasts on the higher frequencies. Several channels ranging from 3 to 7 metres are to be tried out.

### Proposed High Power Station on French Coast

ACCORDING to a Paris newspaper the popularity of Radio Normandie (Fécamp) has recently grown to such an extent that its owner seriously contemplates the purchase of a 60 kilowatt transmitter to be installed "somewhere on the coast of Normandy." All efforts, however, would be made to secure a more favourable wavelength, namely, one less liable to interference by the local coastal morse stations.

### State Ownership of Norway's Broadcasters

AS a result of a vote in the Oslo Storting (Chamber of Deputies) the Norwegian Government is taking over the existing broadcasting companies from July 1, and will carry out a new plan which calls for a network of some forty-three transmitters. The complete reorganisation will be carried out in three distinct periods, covering the next two years. The first step to be taken is the installation of a new 10 kW. transmitter at Bergen, and the transfer of the present plant to Stavanger or Haugesund. Trondheim may also be allotted a high-power station, and a general change-over will be carried out in respect to the smaller relays. In the second and third stages of the scheme small transmitters to take the Oslo programme will be opened at Arendal, Farsund, Kristiansand, Narvik, Egersund, Floro, Nordfjordid, Maaloy, Mo, Kragero, Steinkjer, Svolvaer, Vaagaa and Sogndal. Most of these will work on a common wavelength.

### When Vienna Closes Down

THE Austrian broadcasting authorities have decreed that at the end of the evening transmission the Vienna studio shall regularly close down with the playing of the National Anthem. In future you will hear the announcer's call: *Hallo! Hallo! Hier Radio Wien. Wir Schliessen mit der Oesterreichischen Bundeshymne* (We end our broadcast with the Austrian Anthem), and it will be followed by the melody of Haydn's *Hymn to the Emperor*.

**IMPORTANT!**

Readers please note that Gift Stamp No. 26, the last for their Presentation

**WIRELESS CONSTRUCTOR'S ENCYCLOPEDIA**

*will appear in next week's "PRACTICAL WIRELESS,"*

*on sale*

**Wednesday, March 22nd.**

Will readers who are qualifying for this Presentation Encyclopædia affix the last Gift Stamp to their Subscription Voucher, and forward the completed Voucher in accordance with the instructions thereon, at once?

**PLEASE DON'T DELAY**

There will be an enormous number of volumes to handle, and it will take some little time to get them all out. All applications will be treated in strict rotation. If you do not receive your volume within 14 days of posting your application—notify by post-card giving date sent.

NOTE: Carefully read instructions on your Subscription Voucher and make sure it is properly filled in before forwarding.

**YOUR LAST GIFT STAMP APPEARS NEXT WEEK**

Complete and send in your Subscription Voucher immediately you have the last Gift Stamp.

**"Practical Wireless"**

**Presentation Department,**  
**39, King Street, Covent Garden,**  
**London, W.C.2.**

# ROUND the WORLD of WIRELESS (Continued)

## More Relays for Hungary

THE small relay station installed at Pecs, formerly Funfkirchen, broadcasts the Budapest programme daily from 3.45 until 11 p.m. G.M.T., on 210 metres. The power is only 1½ kilowatts, but its signals have already been heard in many parts of Europe.

## France's Ambitious Broadcasting Scheme

IN view of the forthcoming Lucerne conference, at which wavelengths are to be re-allocated to European transmitters, most continental countries have already formulated their claims based either on existing systems or on plans to be carried out in the near future. If the Ferrié scheme matures in France that country, with an aggregate power of 828 kilowatts (aerial), will jump from a much lower position to the top of the list, now headed by Russia. The plan provides, in addition to the stations already in operation, for a further chain of nine stations with powers varying from 60 to 120 kilowatts. Paris PTT, as the "key" of the network, is to be endowed with a 120 kW. transmitter to be erected in the Chevreuse Valley, at some distance from the capital; Toulouse-Pyrenees (120 kW.); Rennes-Thouries (120 kW.); Lyon-la-Doua (90 kW.); Limoges and Bordeaux-Lafayette (60 kW.); Nice-La Brague (60 kW.); Marseilles-Reator (60 kW.), and Lille-Camphin (60 kW.). The cost of these installations is computed at roughly 100,000 francs, and the same amount would be earmarked in the Budget to run the system. It has not yet been definitely decided what is to become of such stations as Radio-Paris, Poste-Parisien and, in particular, the new Radio-Toulouse transmitter at St. Agnan, to which the State has not yet granted a licence to broadcast.

## France and British Made Sets

ACCORDING to a report in the *Journal Officiel*, the importation of British wireless sets into France is prohibited until further notice. It is pointed out that the quota for the period ended March 31 has already been reached so great has been the demand for wireless sets bearing the mark "Made in England."

## Wireless at the Wheel

AN entirely new built-in radio set which will enable motorists to enjoy programmes whilst actually driving was announced recently. These sets are a standard extra on many makes of American cars, and are widely used in an adapted form by the American police.

They are entirely unobtrusive and take up no room in the car. The aerial is hidden in the roof; a dry high-tension battery is fitted under the driver's seat, and both the receiver and the moving-coil loud-speaker are placed under the scuttle. All that can be seen of the set is a neat illuminated tuning plate fitted with a lock and key beneath the steering wheel.

Built-in radio sets of various types have been tried out before in this country; but, owing to the noises generated by the elec-

## INTERESTING and TOPICAL PARAGRAPHS

### BUSH FIRE WARNINGS FROM THE AIR



An aerial bush fire patrol has been formed in Victoria, Australia, to assist in combating the bush-fire menace. The scheme provides for forest officers in timbered country being equipped with wireless receivers. By the aid of the wireless the aerial patrol notifies the nearest forest officer immediately there is an outbreak of fire, and he is thus enabled to summon all available aid in a short time. Our photo shows: A forest officer in Victoria, complete with wireless equipment, receiving instructions from a plane overhead.

trical equipment and to constant variation in volume they have usually only been playable when the engine is shut off.

In the new Transitone, it is claimed, these difficulties are overcome. Special methods of insulation suppress electrical and engine noises, and volume is automatically controlled.

## Cinema Organist for Empire Broadcast

HAROLD RAMSAY, the "Flying Organist" who plays the wonderful organ at The Granada Cinema, Tooting, was recently honoured by being selected to do an Empire broadcast. This took place actually from the Granada, Tooting, at 1 a.m., on the morning of March 3rd, and was broadcast all over the Canadian zone. Mr. Ramsay was a very suitable selection, apart from his abilities as an organist. His youth was spent in Canada, where he received his musical education, taking his degree at the McGill University. He started his career in Canada, and was one of the first broadcasters there. Mr. Ramsay played a programme ranging from jazz to the classics, and also rendered a special item, "The Maple Leaf For Ever," variations on the Canadian anthem which he arranged himself. Amongst his listeners were his old father and mother, who still live in Canada.

## Gracie Fields Presses Her Own Record

ON Tuesday, February 14th, Gracie Fields, England's greatest comedienne, enjoyed one of the greatest days of her life. In the morning she visited the "His Master's Voice" factories at Hayes, Middlesex, to press her own four millionth record. After she had been received by the Manager of the Record Factory, she was conducted to the press on which her latest record to be released by H.M.V. in March—"Play, Fiddle, Play" and "So long, lads, we're off"—was being pressed by one of the workers. The pressman rolled up into a soft ball the warm record material for the four millionth disc. Gracie stepped forward, placed the labels on the top and bottom matrices (the metal dies on which her voice and music are engraved), put the ball of record material in the centre of the press and brought the two faces together. She turned a lever to the right, and after the steam had automatically circulated behind the faces of the matrices, followed by cold water, she lifted the top of the press and withdrew the black, shining disc, which was the four millionth impression of her voice. It is interesting to note that if the four million records were weighed together they would total 732 tons, and if they were piled face to face on top of one another they would reach a height of 6 miles 551 yards—higher than the highest mountain in the world.

## SOLVE THIS!

### Problem No. 26.

Abrahams made up a portable receiver, and used a small attache case for the containing box. The frame aerial was built in the lid, and this measured 15in. by 12in. A total of sixteen turns covered the normal wave-band, and gave very good results. Owing to the fact that the accumulator was rather small, he decided to build the receiver into a larger case so that larger batteries could be used. He accordingly chose a small suitcase roughly double the size of the former one. He cut a framework to fit snugly in the lid, wound on the sixteen turns, but when he tried it out he found that he could not receive the London National station on the tuning dial. Why? Three books will be awarded for the first three correct solutions opened. Address your envelopes Problem No. 26, The Editor, PRACTICAL WIRELESS, Geo. Newnes Ltd., 8-11, Southampton Street, Strand, and post to reach us not later than March 20th. Do not enclose any other correspondence with your solution.

### SOLUTION TO PROBLEM NO. 25

A screen grid valve is of very high impedance, and naturally required a high impedance anode coupling component. As the "Fury Four" only employs a 30,000-ohm anode resistance in the detector anode circuit, the valve did not function efficiently. Simpson should have used at least 100,000 ohms in place of the 30,000-ohm resistance which was originally specified.

The following three readers received books in connection with Problem No. 24.  
J. O'Neill, 36, Pearson Street, Lr. Broughton, Salford, E. Lancs. E. Berry, 43, Grafton Road, Keighley, Yorks. K. L. Davy, 94, Queens Gate, S.W.7.

## The New West Regional Station

WORK on this B.B.C. transmitter is well up to schedule time and it is hoped to carry out tests in the course of next month. If the engineers are satisfied with results experimental transmissions for listeners will be made in April.

# The "COLD VALVE"

## A Brief Discussion of the Principles Involved in the New Type of Rectifier

**F**REQUENTLY in wireless matters we can trace a very interesting cycle of events which brings us back to some of the early types of apparatus, or at least prototypes of these, although at first glance the components in question may be looked upon as obsolete. A typical example is found in the case of tuning coils which I dealt with quite recently in these columns. Originally we had the large single layer inductances, followed by rapid developments during which many ingenious arrangements were adopted to reduce self capacity and inherent losses, and yet make the inductance in a compact form. There is a tendency now to revert to the single layer type whenever possible.

### Valve and Metal Rectifiers

I am reminded of this and similar examples by garnering some details of what the lay Press have been pleased to dub the "cold" valve.

Is this another case of coherer, crystal, bright emitter valve, dull emitter valve and cold valve? It is my intention shortly to deal with this question of rectification in its many forms, but at the moment I want first of all to furnish readers with the only available details concerning this cold valve development. To the radio engineer the dream of a cold valve has had al-

By **BARTON CHAPPLE**,  
Wh.Sch., B.Sc.

most a parallel with that relating to the transmutation of metals by the alchemist whereby he hoped to change other metals into gold and also discover the elixir of life. We are all familiar with the use of the single or double anode valve as a rectifier when it is desired to work wireless apparatus from the alternating current

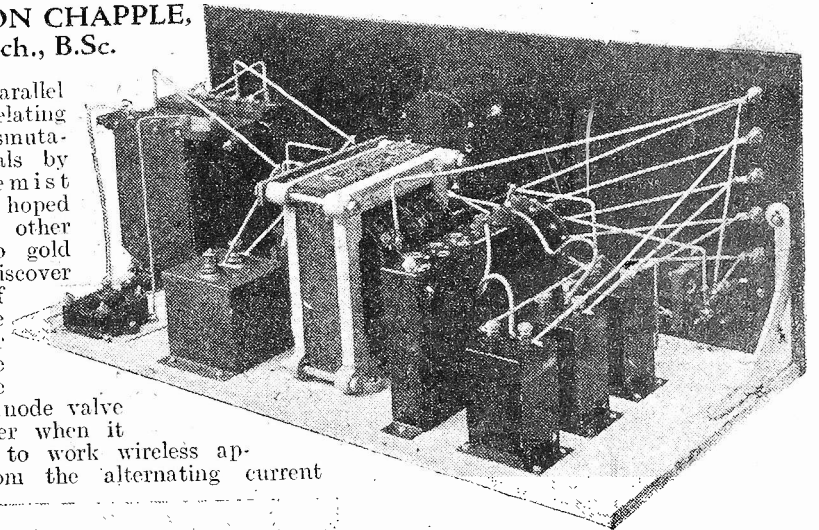

Fig. 1.—An example of a powerful mains eliminator which makes use of the valve for rectifying the applied A.C.

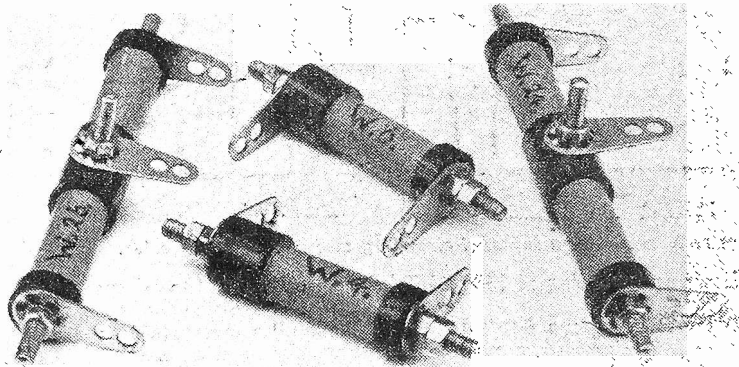

Fig. 4.—Samples of four types of the new cold valve or Westector units.

first valve rectifier another form of rectifier has come into popular use. I refer here to what is known as the Westinghouse Metal Rectifier. It has many advantages amongst which may be mentioned that there are no moving parts requiring maintenance and, in addition, the unit is reasonably compact. Essentially it is an electronic device depending for its operation on electronic action at a permanent junction between copper and copper oxide. No chemical action takes place during the process of rectification and, moreover, it has quite a high efficiency, something of the order of between 50 per cent. and 60 per cent.

The construction of the unit is shown diagrammatically in Fig. 2. every unit being assembled on steel bolts with the number of discs in series and parallel connections varied to suit the voltage and current output required. This rectifier is virtually a cold electronic valve and depends for its action as a rectifier on the

mains, and an example of an eliminator built up for this purpose and using a valve of this type is illustrated in Fig. 1.

### Rectifier Action

The valve action depends on the emission of electrons from a heated filament, but of more recent date than the

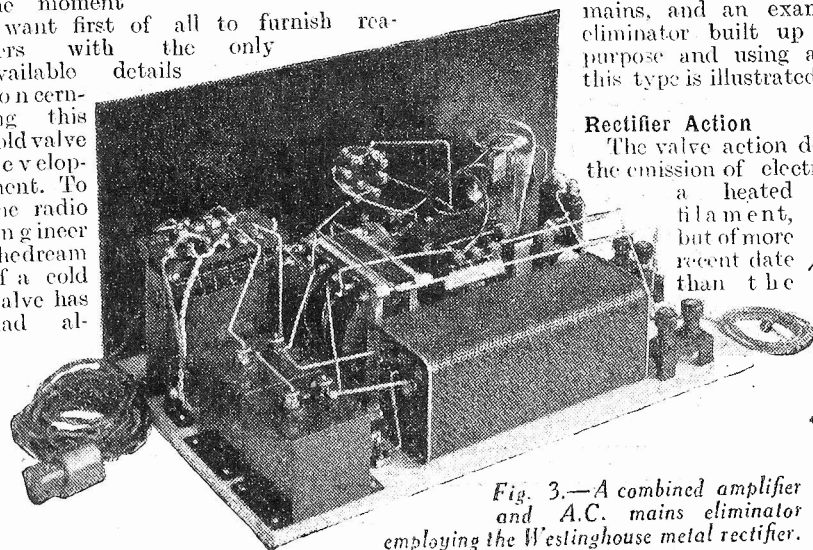

Fig. 3.—A combined amplifier and A.C. mains eliminator employing the Westinghouse metal rectifier.

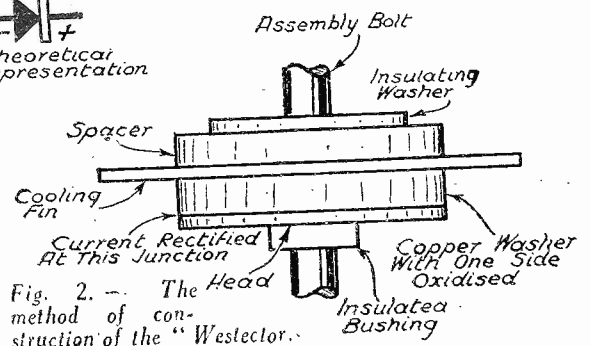

Fig. 2.—The Head method of construction of the "Westector."

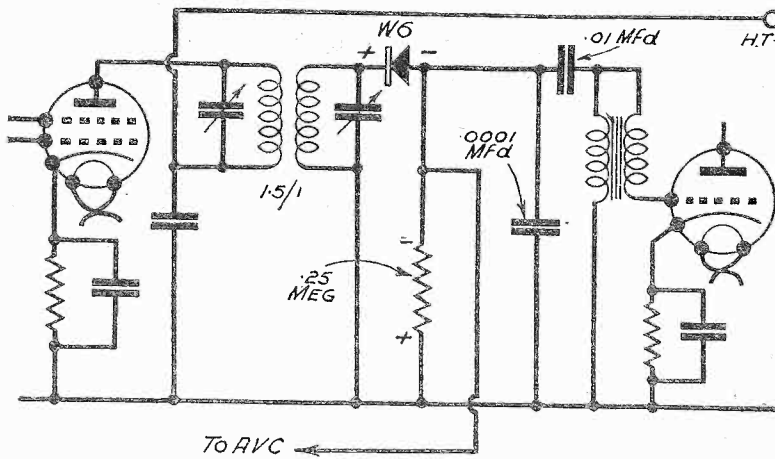

Fig. 5.—A simple method of using a Westector.

fact that the ratio of the resistance from copper to oxide coating is very high compared with the resistance from oxide coating to copper. The ratio between these two resistances is of the order of one thousand, and an example of a combined amplifier and A.C. mains eliminator employing this particular form of rectifier is shown in Fig. 3.

**A Natural Corollary**

For some time now it has seemed a natural corollary to expect this heavy duty rectifier to be the advance guard of a specially developed type which could find application in high frequency circuits quite apart from those used in measuring instruments. Certain advance information now to hand confirms this, for an announcement has been made that the Westinghouse Brake and Saxby Signal Co., Ltd., have produced what they have termed Westector units.

First of all, the makers state that the main use of these Westectors is as a second detector stage in a superheterodyne receiver, and as such will provide half or full wave rectification depending on the circuit used. A point of very special importance which needs to be stressed arises from the fact that no heater current is required with this component (hence the term cold valve) and, furthermore, no anode current is needed, and this in itself disposes of the usual necessity for the very adequate smoothing which has to be incorporated when consideration is given to the normal type of detector valve anode supply with mains driven sets.

**Samples and Circuits**

Samples of these new components are given in the photographic illustration, Fig. 4, four separate types being shown, namely W. 4, W. 6, W. 24, and W. 26. They are quite small and light, but look very robust and will certainly take up but little space in the normal wireless receiver. Arising from the fact that no heater circuit has to be supplied, and in consequence there is no self capacity between the negative end of the rectifier and earth, it is possible to employ the normal half wave circuit, such as that shown in Fig. 5, instead

ensure that the preceding transformer coupling has a ratio matching the impedance of the preceding valve to that of the Westector. In the cases of Figs. 5 and 6 the ratios should be 1.5 to 1 and 2 to 1 respectively when used in conjunction with low impedance type screen grid valves and the units

of the diode circuit in which the positions of the rectifier and reservoir condensers are interchanged.

Turning to Fig. 6 the reader can see the slight modifications introduced when full wave rectification is employed by using the centre tap. In these superheterodyne arrangements it is essential to

The makers suggest, however, that a more desirable form of automatic volume control is provided by the scheme shown in skeleton form in the diagram, Fig. 7.

**Types and Ratings**

According to data issued by the manufacturers the table included here gives the details concerning the types and ratings of the four models illustrated in Fig. 4.

Type.	Circuit.	Max. Input Volts.	Max. Current.
W.4	Half Wave	24 volts peak	0.25 mA.
W.6	Half Wave	36 volts peak	0.25 mA.
W.24	Full Wave	24 volts peak each side of centre tap.	0.5 mA.
W.26	Full Wave	36 volts peak each side of centre tap.	0.5 mA.

**No Reaction**

This is an interesting feature, but, on the other hand, the man who normally uses his reaction control almost to destruction instead of operating each valve stage efficiently and resorting to reaction on occasions, may look on the absence of amplification and reaction control with a cold valve as something of a mixed blessing. This point can, however, be offset by an appreciation of the truly

straight line detector characteristics offered by a Westector and a realization of its value in handling really large input signal volts (see table) coupled with the reminder that the reaction and amplification efficiency can very easily be made good by the addition of a second stage of high-frequency in lieu of the single stage which has had such a popular appeal for a long time.

In conclusion one other point must be mentioned in connection with these units as this has an important bearing on design. Due to the remaining self capa-

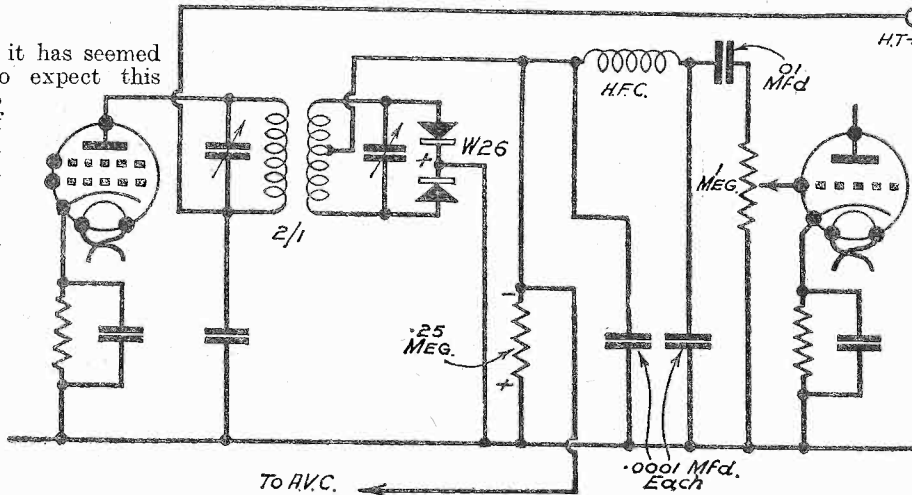

Fig. 6.—Full wave rectification in a superhet circuit by means of the Westector.

city the damping introduced at radio frequencies is high and is equivalent to an approximate load of 10,000 ohms. When used as a straightforward radio frequency detector, therefore, the Westector unit should be preceded by a high-frequency valve of very low impedance and preferably one of the triode class, as in this way the objections arising from the damping factor can be overcome in quite an effective manner.

**Automatic Volume Control**

With the intriguing possibilities afforded by the suggested applications of automatic volume control to variable mu valves it is necessary to see how the situation is affected by the substitution of a "cold" valve for one of its "warmer" brothers. It is merely a question of arranging suitably the polarity of the Westector so as to utilise the D.C. component of its output in the usual way to provide automatic volume control, using the variable grid bias method.

A circuit somewhat similar to that shown in Fig. 5 will form a basis for any readers who desire to experiment.

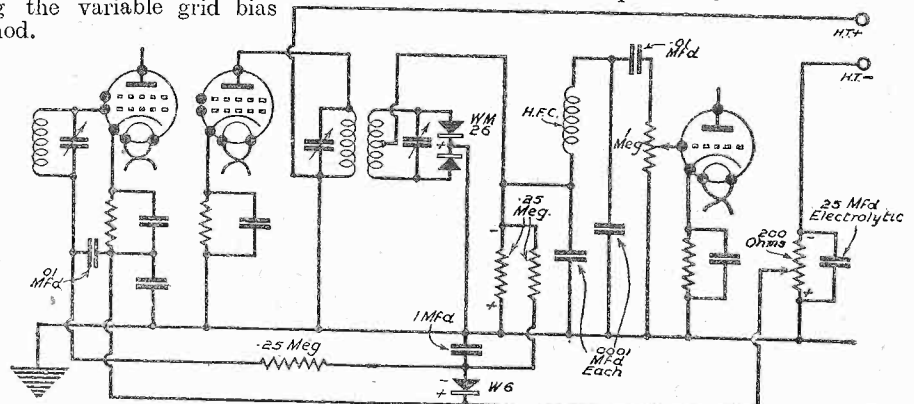

Fig. 7.—How automatic volume control may be effected by the Westector

# WHAT IS WRONG?—5

In this, the Concluding Article of the Series, Special Reference is Made to Mains Receiver Faults, and Some Methods of Testing Components are described. By FRANK PRESTON, F.R.A.

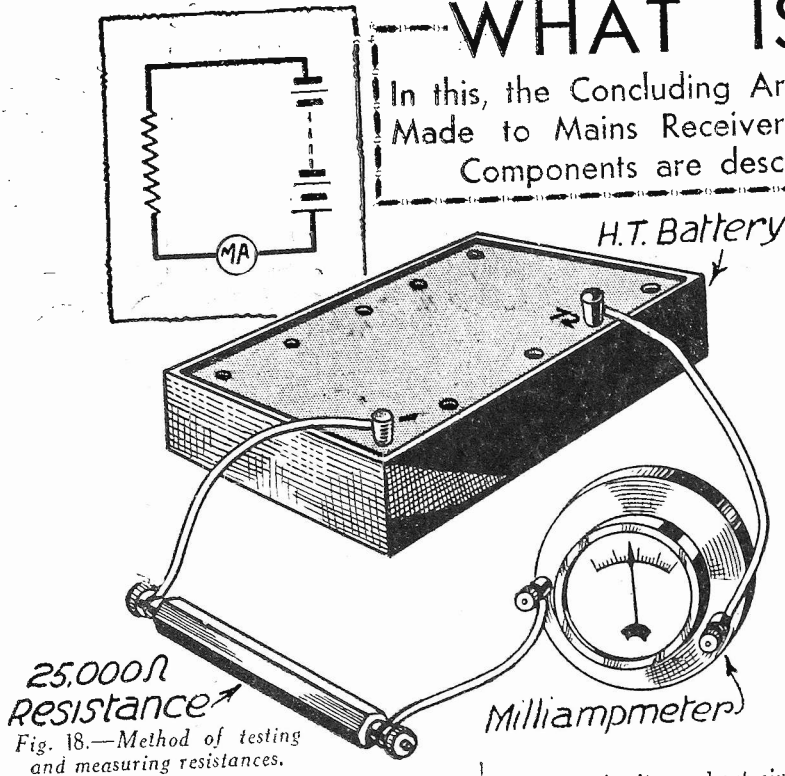

Fig. 18.—Method of testing and measuring resistances.

**M**OST of the tests I have previously discussed may be applied to any type of set, but before leaving the subject of fault finding it seems that I ought to make rather special reference to a few of the troubles peculiar to receivers which derive their power supply from the lighting mains.

When the mains receiver goes completely dead or begins to emit crackles and other noises, the best thing is to switch off the power supply and carefully examine the internal components. Such faults as burnt-out mains transformers, chokes, rectifiers, etc., are often obvious by the charring of portions of the parts concerned, and any which show signs of having been subject to great heat should immediately be suspected. In the same way, any component which feels excessively hot might be considered as a likely source of trouble, and should therefore be tested. Indirectly-heated valves always become fairly warm in use, but when one valve becomes very much hotter than the others it might be due to lack of grid bias, caused by the bias resistance having burnt out or become short-circuited in some way; this would be indicated by a high anode current. Just as excessive heat may point to a fault, so may the lack of warmth of some component like a receiver or rectifier valve, or even an H.T. feed resistance. Therefore, any of these components which feels cold to the touch should be tested. When smoothing condensers of too low a voltage rating have been employed they will almost certainly give rise to trouble sooner or later, due to the insulation breaking down and causing a short. If this does happen it is more than likely that the mains transformer and rectifier will also suffer, since they will be subject to a heavy load.

Should no fault reveal itself when the set is switched off, turn it on again and watch the inside of the receiver, but keep your fingers out of harm's way. Notice that all the valve heaters glow equally bright (the

received signals there is probably something amiss. It might be that the condenser in the earth lead has "gone," or that the rectifier valve is losing its emission. In tracing the source of hum it is often of assistance to cut out the various valve stages one at a time, as explained last week, but in doing this great care should be taken to switch off the mains every time any alteration is to be made.

### Mechanical Vibration

Hum is not always of an "electrical" nature, but is often caused by mechanical means; for instance, by vibration of the core stampings of a transformer or choke. This can be detected by short-circuiting the loud-speaker terminals; if the hum still remains it must be put down to mechanical vibration. Core stampings can generally be clamped up by means of their holding bolts, but if this is impossible an effective remedy is to pour a small amount of shellac varnish over the edge of the core. The varnish will sink in between the stampings and set hard, binding them together as a solid mass.

### D.C. Receivers

With receivers operating from D.C. mains extreme care must be taken in making necessary tests, since the whole of the electrical system is "live"; otherwise the procedure is similar to that followed in regard to A.C. sets. When working a receiver from some D.C. mains a peculiar hum is sometimes observed which cannot be traced to any of the sources mentioned above, and it is, in fact, caused entirely by the mains supply. It is not due to ordinary "roughness," but to a high-frequency voltage being superimposed on the D.C. current. The only cure is to fit an

(Continued overleaf)

for discontinuity or short-circuit. If no fault is revealed it might be helpful to remove the L.T. wires from the mains transformer and connect them to a 4-volt accumulator to find whether the transformer, wiring or valves are at fault. Similarly, when there is no sign of H.T. it is not a bad idea to connect the wires from the rectifier to a high-tension battery or separate eliminator to see if the H.T. supply system is defective. Where this is impossible the H.T. leads can be tested for voltage by means of a high resistance meter; as mentioned before, it is absolutely essential that the meter should be of at least 500 ohms per volt if anything approaching an accurate reading is to be obtained.

### Mains Hum

A certain amount of "hum" is almost invariably associated with mains receivers, but if it is so loud as to be audible through

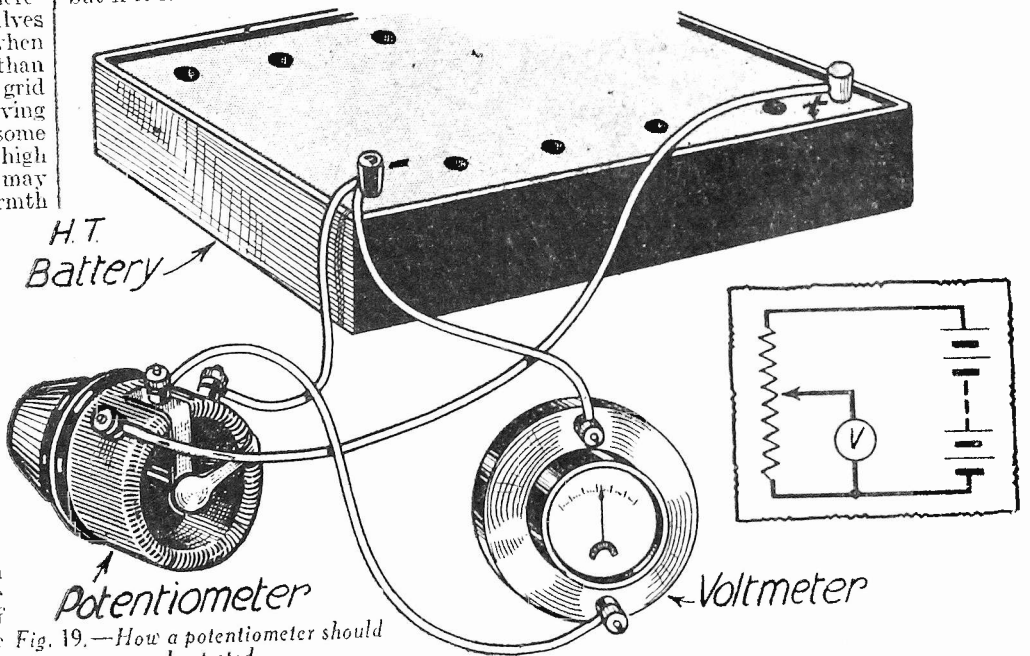

Fig. 19.—How a potentiometer should be tested.

(Continued from page 1219.)

H.F. choke in one, or both, of the supply leads. Naturally, the chokes must be able to carry the full current required by the set, and should therefore be of a special type; suitable components are made by a number of firms.

I think we have now dealt with the methods of detecting almost every fault likely to be found in any type of receiver, and I strongly commend my readers to read carefully through this and previous articles before setting to work, in order that they may have a thorough grasp of the principles involved, and appreciate the value of systematic and orderly investigation.

**Testing Components**

When any particular component appears to be faulty it is best to remove it from the set and give it a thorough examination. In almost every instance the object of the tests will be to ascertain that the part has not developed an "open" circuit (a broken interval contact) or a short circuit, and that its insulation is sound. It will not be necessary to mention every component separately, but it seems desirable to suggest specific tests which may be applied in a variety of cases.

**Resistances**

Either fixed or variable resistances can be tested, and their ohmic value measured, as shown in Fig. 18. It will be seen that the resistance is connected in series with a battery and milliammeter. If the component has become open-circuited there will be no current indication, whilst if it is short-circuited the needle of the meter will give a sudden "kick" to the top of the scale. So that there will be no danger of damaging the meter, it is advisable to start by using no more than  $1\frac{1}{2}$  volts of the battery.

The actual value of the resistance can be found with fair accuracy by adjusting the battery voltage until a reading of, say, 5 milliamps is given; the resistance can then be calculated by dividing the voltage by the current in amperes (1 milli-ampere equals one thousandth of an ampere). As an example, let us suppose that a voltage of 75 is found necessary

to drive a current of 5 milliamps through the resistance; the value will be 75 divided by 5 thousandths, or 75 by  $1,000/5$ , which equals 25,000 (ohms). If the needle flickers it will indicate a bad contact in the resistance, and since that would cause a

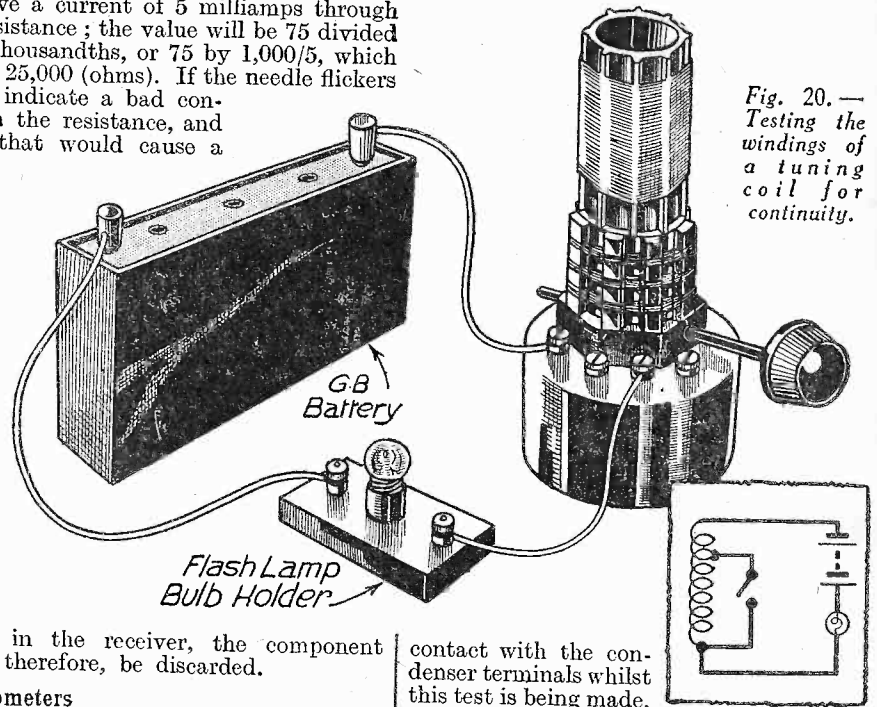

Fig. 20.— Testing the windings of a tuning coil for continuity.

crackle in the receiver, the component should, therefore, be discarded.

**Potentiometers**

Fig. 19 shows how a potentiometer may be tested. Its two outer terminals are connected across a high-tension battery, whilst a voltmeter is connected between the centre terminal and one of the others. If the component is in good condition a steadily varying voltage from 0 to that of the battery will be shown as the knob is rotated. A break in the winding will be indicated by a sudden change in voltage as the slider traverses a certain part of the track.

**Fixed Condensers**

There are several ways of testing fixed condensers, but the simplest and most satisfactory is to connect a battery to the terminals, allow the condenser to stand for some time, and then connect a pair of phone or loud-speaker leads; there should be a loud click as the latter connections are made. It should be borne in mind that the fingers must not come in

contact with the condenser terminals whilst this test is being made, or the charge will leak away through the body.

The battery voltage to be employed will depend upon the capacity of the condenser under test, and should be no more than about 10 volts for 4 mfd. condenser, to 100 volts for one of .0003 mfd. or smaller. If the voltage were too great there would be a possibility of damaging the phones by a heavy discharge.

**Tuning Coils**

These can be tested for continuity of the windings by connecting the latter in series with a G.B. battery and flash lamp bulb, as shown in Fig. 20. First set the wavechange switch to its "medium wave" position and adjust battery voltage until the bulb shows a bright light—probably about 6 volts will be required for a 4-volt bulb, due to the resistance of the windings. Next turn the switch to its "long wave" position; the light from the bulb should become fairly dim, or it might go out altogether, because of the added resistance of the long-wave winding. If the light does go out, try increasing the battery voltage. Should it be found that the light cannot be restored it will be obvious that the long-wave winding is broken or disconnected from its terminal. Were it noticed that the light remained equally bright, no matter which position the switch occupied, you would know that the switch was not functioning. Reaction windings can be tested in the same manner, but, of course, the wavechange switch will have no effect in this case.

The windings of any type of transformer can be tested by means of a battery and milliammeter, in just the same way as resistances. A further test is necessary, however, to discover whether or not there is a short-circuit between different windings or between any winding and the core; this can also be carried out by using the battery and milliammeter.

When previous tests have left some doubt as to whether or not a valve is faulty, the arrangement illustrated in Fig. 21 should be set up. By applying various voltages of H.T. and G.B. the anode current can be measured under different conditions and the readings obtained compared with those issued by the makers.

Fig. 21.—A simple "rig-up" for testing valves.

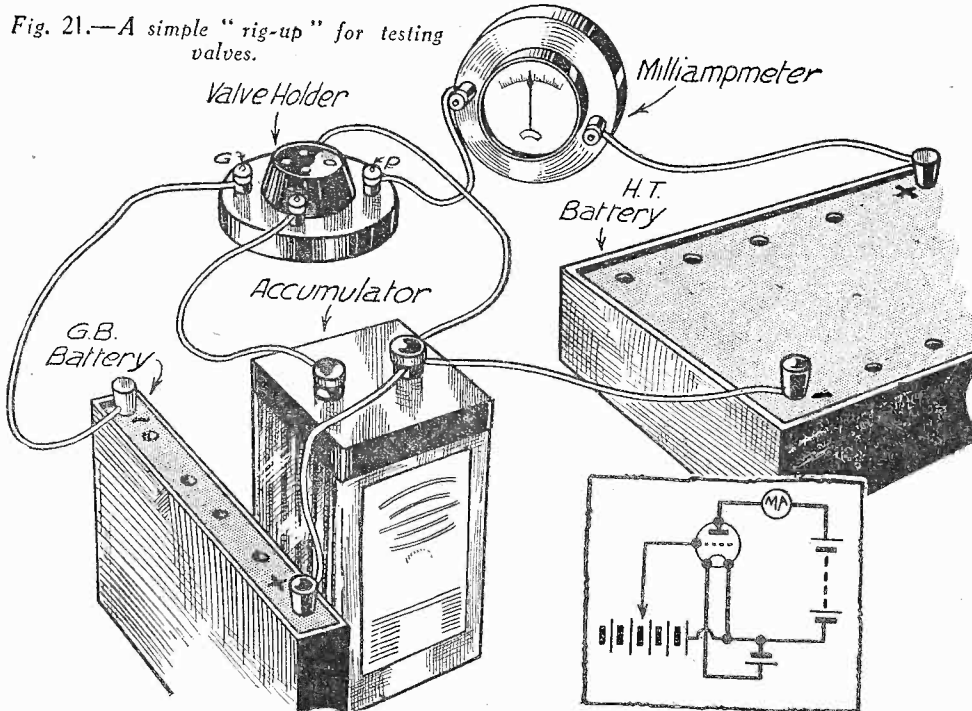



# Energising Electro-Magnetic Moving-Coil Speakers

Some Methods of Obtaining the Necessary Supply for the Field Coils of Loud Speakers

By J. H. WATTS

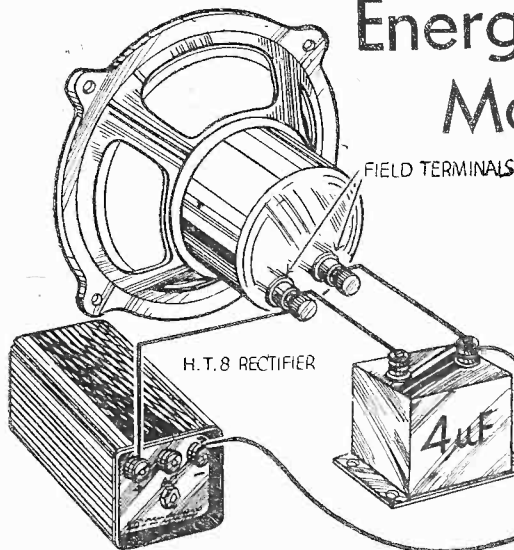

Fig. 1.—Energising a 2,500 ohm field-winding from 200-250 volt A.C. mains.

THE mains energised moving-coil speaker still remains the best type to use, owing to its much greater sensitivity and frequency response than other types, in spite of the great improvements made in modern permanent-magnet speakers. The fact that it has to be energised, however, seems to be regarded as a disadvantage by quite a number of constructors, and they fall back on the permanent-magnet type. In this article it is explained how to energise, without undue extra expense, the D.C. type of electro-magnetic speaker. Of course, if D.C. mains are available, the speaker can be energised independently direct from the mains. It is to those who rely on A.C. for their supply that the following methods will be found of value.

of 2,500 ohms. This type of speaker usually requires a voltage of 100-120 volts for field excitation. Therefore, if it is used on mains of the 200-250 volt class, an H.T.8 metal rectifier is used as a "half wave," while if the mains are of the 100-120 volts class the same type of rectifier is used, but it is connected for a "voltage doubler" circuit. There are on the market speakers having a field resistance of 5,000 to 7,500 ohms. These can be energised in the same manner as above, but the rectifier to use would be type H.T.7.

When using a

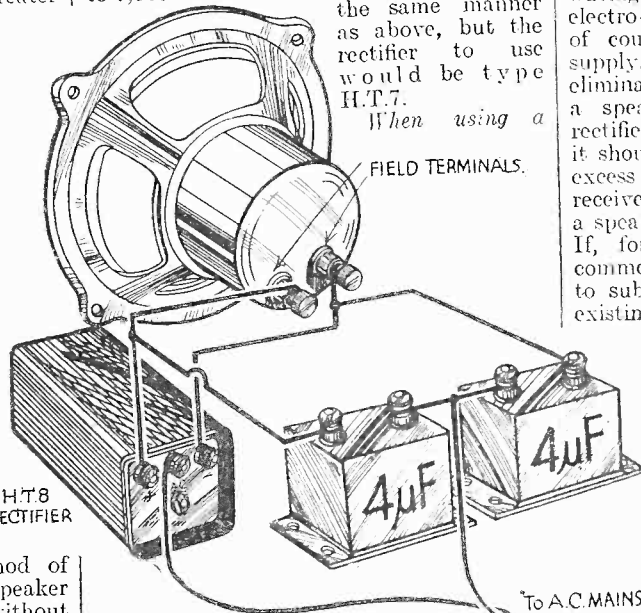

Fig. 2.—Energising a 2,500 ohm field-winding from 100-120 volt A.C. mains.

speaker in the way described, great care must be taken to see that no earth connection is made to the D.C. side of the rectifier.

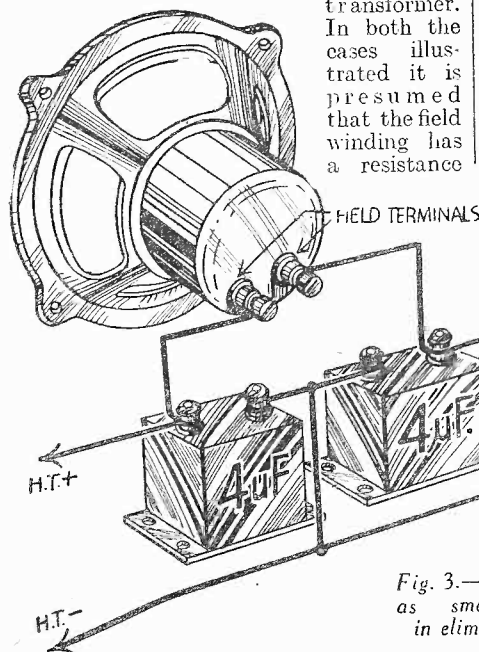

Fig. 3.—2,500 ohm field as smoothing choke in eliminator circuit.

Using the Field Winding as a Smoothing or Output Choke Where a mains receiver taking not less than 40 m.a. anode current is

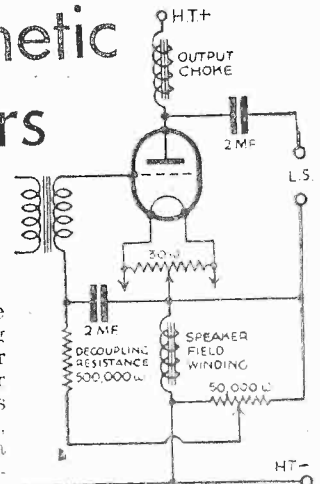

Fig. 5.—2,500 ohm field as automatic bias resistance.

in use, the field winding of a speaker designed for D.C. mains operation, and having a field resistance of 2,000-2,500 ohms, can be used as a smoothing choke in the eliminator which provides H.T. to the receiver. The current, in passing through the windings, causes a voltage drop across them (100 volts at 40 m.a.) which produces the necessary wattage dissipation for energising the electro-magnet. This voltage drop must, of course, be deducted from the H.T. supply. Therefore, when designing an eliminator to include the field winding of a speaker as a smoothing choke, the rectifier and transformer incorporated in it should be designed to give 100 volts in excess of the maximum required by the receiver. The connections for energising a speaker in this way are shown in Fig. 3. If, for some reason, such as with a commercial eliminator, it is inconvenient to substitute the speaker winding for an existing smoothing choke, it can be used as an output choke in the receiver. The output valve alone must take 40 m.a. or more if this method is to be used, and it must be borne in mind that a voltage drop will occur, which will be deducted from the H.T. supply to the last valve. In Fig. 4 the connections for this method are shown. It will be noticed that where an indirectly heated output valve is used (such as one of the large A.C. pentodes) as in the illustration, the low potential side of the speaker or output transformer is returned direct to the cathode, and not H.T. negative. The automatic bias resistance is then not included in the speaker circuit. In the same way, where automatic bias is used with a directly heated output valve, this connection must be taken to the filament side of the bias resistance.

Continued on page 1222.

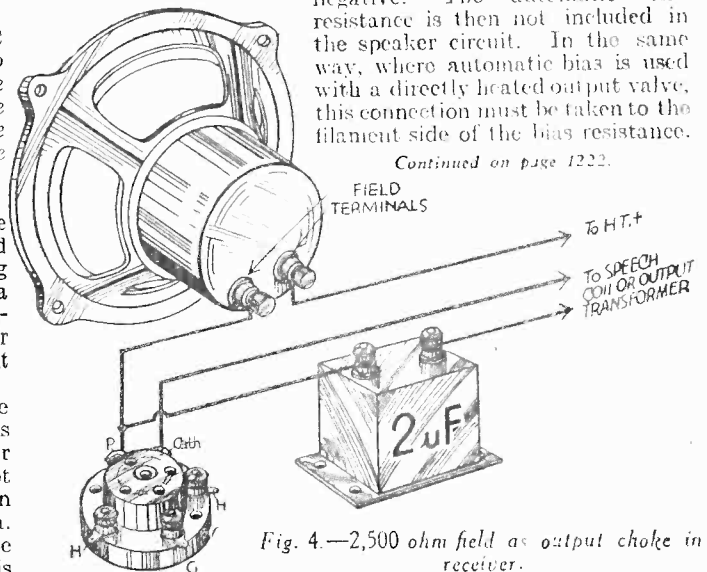

Fig. 4.—2,500 ohm field as output choke in receiver.

(Continued from page 1221).

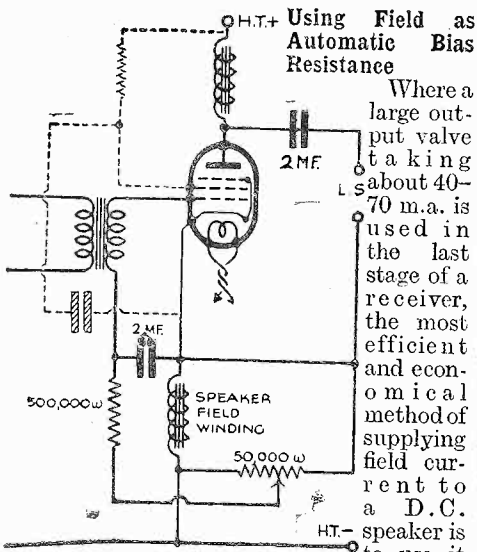

Fig. 6.—2,500 ohm field as bias resistance for indirectly heated output valve. Triode or pentode.

Where a large output valve taking about 40-70 m.a. is used in the last stage of a receiver, the most efficient and economical method of supplying field current to a D.C. speaker is to use it as the bias resistance for this valve.

It is well known that, if automatic bias is used in a receiver, the amount of bias voltage produced by the resistances has to be deducted from the H.T. supply. If, therefore, a speaker were included as a choke, this voltage drop would be a further reduction of H.T. voltage. If the speaker windings are used as a bias resistance, we, of course, have to deduct the full voltage drop across them from the H.T., but the bias voltage can be tapped from this voltage drop by means of a potentiometer without further voltage drop. The connections for this method are shown theoretic-

ally in Fig. 4 and pictorially in Fig. 5. When a valve taking 40 m.a. is used and a 2,500 ohm field, the bias voltage can be varied (by means of the 50,000 ohms potentiometer) from zero to 100 volts, while if the valve takes 60 m.a. it can be adjusted between zero and 150 volts, but this method is really meant where valves requiring above 30 volts bias or more are used.

When the circuit is first operated, the 50,000 ohms potentiometer should be turned to the end connected to H.T. negative. A milliammeter should be inserted in the plate circuit of the output valve, and the potentiometer carefully adjusted until the meter reads the correct anode current for the anode voltage in use. The slider of the 30 ohm potentiometer is turned to the centre of its resistance. The correct anode current for a given anode voltage can be found on reference to the pamphlet supplied by the valve.

In Fig. 5 the output from the amplifier is shown connected direct to the speech coil of the speaker, but, of course, an output transformer may

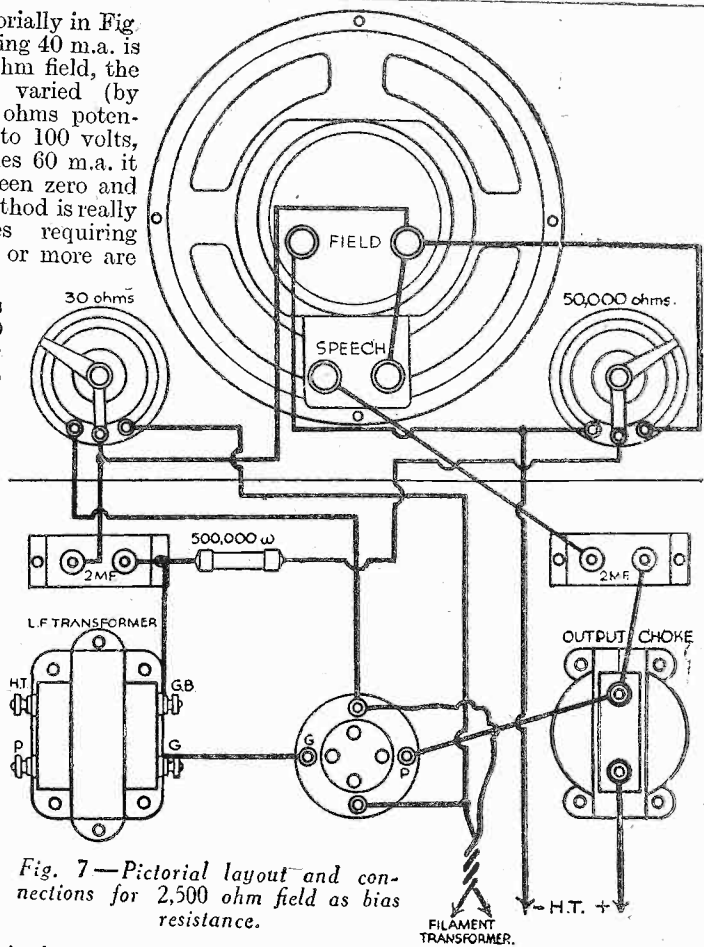

Fig. 7—Pictorial layout and connections for 2,500 ohm field as bias resistance.

be necessary, in which case the output of the amplifier would be connected to its primary.

**Aerial Damping**

Examining the curves it will be noted that the addition of the aerial system, while not materially altering the shape of the reaction curve, moves it bodily to the right. This means that a larger reaction capacity is required to make the set oscillate when aerial and earth are connected than is necessary when they are absent. Of course, this is to be expected, and is due to the extra damping introduced by the presence of the aerial system. The incorporation of a .0005 mfd. reaction condenser in sets with no H.F. stages is seen to give particularly good results, and from the previous theoretical reasoning—namely, a reduction in the damping introduced by the small reaction coil required—this was expected to be the case.

The use of a .0001 mfd. reaction condenser is more suited to those receivers where H.F. stages are included and reaction control is effected on the detector valve alone. Here the presence of a somewhat larger reaction winding is offset by the absence of the damping produced by the aerial connections, and as readers have no doubt found for themselves, the reaction control is quite smooth. This was tested out on different sets, but the curves are not shown. They were similar in character to those shown in Fig. 3, but the reaction settings for oscillation to take place occurred over a smaller number of degrees than was the case for the .0005 mfd reaction condenser just dealt with.

This indicates that, wherever possible, it is better to use a .0005 mfd. reaction condenser and a small reaction coil, but the gain is not so material as one would at

**REACTION POINTERS**

By H. J. BARTON CHAPPLE,  
Wh.Sch., B.Sc.

(Continued from page 1205, March 11th issue).

first imagine. Added to that, consideration of panel space and layout have to be borne in mind, and this often makes it necessary and preferable to use the .0001 mfd. condenser.

**Refusal to Oscillate**

There is one important point which must be stressed in conclusion, however, and that is the effect produced on the reaction condenser by the addition of the aerial system. Sets have been tested without any aerial connection, and the curve taken indicates that the reaction control involves a fairly uniform change over the scale, i.e., a progressive rise in reaction and aerial condenser readings for the oscillation condition. The addition of an aerial, however, often causes the set to refuse to oscillate at some particular part of the tuning condenser scale.

A little reasoning will show that this is the outcome of a serious load increase of the aerial at that position, and is due to the aerial resonating within the wavelength band over which oscillations refuse to occur. There are several ways of over-

coming this, but the most simple is the inclusion of a series condenser in the aerial lead. This will cause the resonant condition of the aerial to occur at a point below the wavelength range covered by the tuning circuit, and while a reduction in signal strength also takes place, this is generally small, and is to be preferred to an absence of reaction control.

In order to find the capacity best suited to one's own aerial a convenient type of series condenser for this work is a pre-set one. When connected in the aerial lead, it can then be adjusted until the reaction control over the whole of the tuning-condenser scale is reasonably uniform, and obviously with this condition the user of a set is in a far better position to search for stations than would be the case when there are prominent irregularities.

Curve (a) gives the variation on the normal broadcast band (250/550 metres) without aerial and earth, while curve (b) shows the alteration introduced when the aerial system is connected. It will be observed that in both cases the variation over the whole of the scale is reasonably smooth, there being a progressive increase of the reaction condenser reading as the aerial tuning condenser was increased.

The experiment was repeated for the long waves, and curves (c) and (d) are for similar conditions to (a) and (b) respectively. It is interesting to note that whereas on the medium waves the reaction condenser had a wide range for bringing the set into oscillation, on the long waves this oscillation effect generally was confined to a much smaller part of the reaction scale.

**BIND YOUR COPIES of "PRACTICAL WIRELESS."** Index and Binding Cases NOW READY!

# TOPE CORRECTION AND TONE CONTROL

An Article of Interest to All Those Who are in Search of "Quality" in Loud-Speaker Reproduction.

By FREDERICK BRIDGES

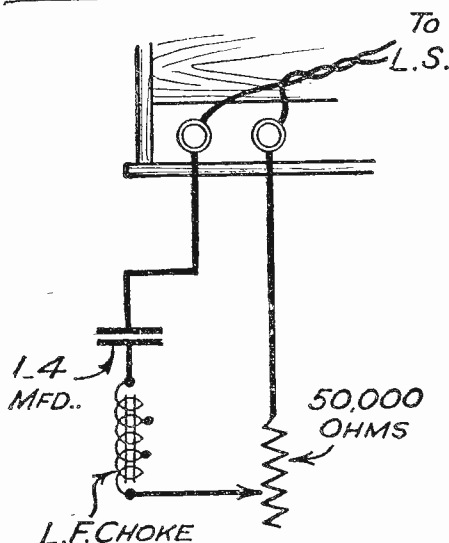

Fig. 1.—An effective method of reducing bass response by connecting a choke, condenser, and variable resistance in series across the loud-speaker terminals.

"TONE control" and "tone correction" are very popular expressions with the wireless amateur these days, but I am afraid they are not always understood quite so well as they might be. In the first place, tone correction is not a means of curing the evil commonly known as distortion, but is rather a system of compensating for high-note or low-note loss which occurs in the reproduction given by the loud-speaker. Tone control, on the other hand, enables the operator to adjust the degree of high- or low-note response of the set at will.

### Tone Correction

The need for tone correction is brought about by the uneven response of various components of the receiver to different parts of the musical scale. As an example, it is well known that a very selective tuner gives full response to the bass notes, whilst its response diminishes as the notes increase in frequency. In consequence, if the rest of the receiving circuit gave uniform amplification to the full range of audio frequencies (sound frequencies, if you like) the resultant output from the loud-speaker would be very low pitched or "boomy." But the average set does not give "straight-line" amplification—very far from it: the L.F. transformers usually emphasise higher frequencies, as does a pentode output valve; the loud-speaker, also, might give greater response to any part of the frequency range according to its particular design. It is clear, then, that a fair amount of tone correction is often obtained automatically in the set itself, so it remains to find what part of the musical scale is over-emphasised, and then

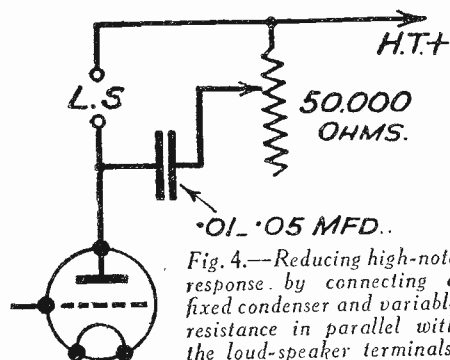

Fig. 4.—Reducing high-note response by connecting a fixed condenser and variable resistance in parallel with the loud-speaker terminals.

to devise a means of reducing amplification at that part.

### Bass Emphasis

In the case of the average present-day ultra-selective receiver it is usual to find

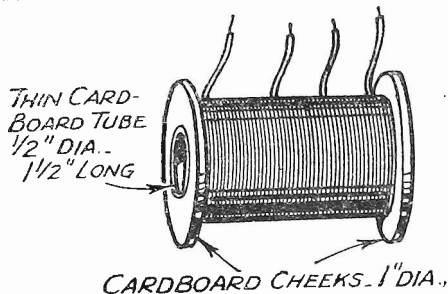

Fig. 2.—Showing constructional details of an easily-made tone corrector choke.

that low notes predominate, whilst the higher ones are somewhat neglected. This is indicated by the fact that a symphony

### TONE CORRECTOR CIRCUIT.

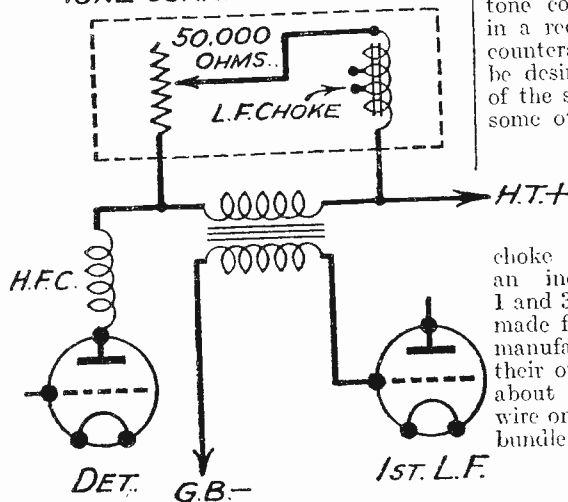

Fig. 3.—A tone corrector circuit connected across the primary winding of the first L.F. transformer.

orchestra sounds more like a quartet of double-bass and 'cello's, and the announcer seems to have a cold on his chest; organ music is very heavy and monotonous, and a dance band is reproduced principally as a series of "dull thuds." Having recognised the symptoms we must find a cure. If a three-electrode power valve is in use the necessary correction might be obtained by replacing it by a pentode. Alternatively, it might be possible to change the moving-coil loud-speaker for one of the balanced armature or electrostatic type, either of which is more sensitive to the upper register. Where neither of these "automatic" schemes

is practicable, some modifications must be made to the set itself. Perhaps the simplest is to connect a small L.F. choke, variable resistance and fixed condenser in series across the loud-speaker terminals, as shown in Fig. 1. Where an output transformer or choke-capacity filter is employed, the corrector circuit should be wired in parallel with the transformer primary, or with the choke, and not across the loud-speaker windings. The object of the choke is to provide an easy leakage path for the low frequencies, though being an effective barrier to the higher ones, and by varying the value of resistance in circuit the degree of low-note "cut-off" can be changed as desired. Since the fixed condenser is of high capacity (at least 1 mfd.) it offers no restriction to any audio frequencies, but merely serves to prevent the D.C. high-tension supply from passing through the choke. It will be seen that we do not actually increase the strength of the higher notes, but to achieve the same (apparent) effect the bass is curtailed. For this reason the fitting of any additional tone correction device necessarily results in a reduction in overall volume, and to counteract this it might in some instances be desirable to increase the amplification of the set by adding another valve, or by some other means.

### Making a T. C. Choke

Before proceeding further it might be as well to give some practical details of the L.F. choke shown in Fig. 1. It should have an inductance of something between 1 and 3 henries, and may be bought ready-made from one of the firms of transformer manufacturers. Those who prefer to make their own, however, can do so by winding about 2,000 turns of 36 s.w.g. enamelled wire on a core consisting of a tin diameter bundle of soft iron wires. The winding

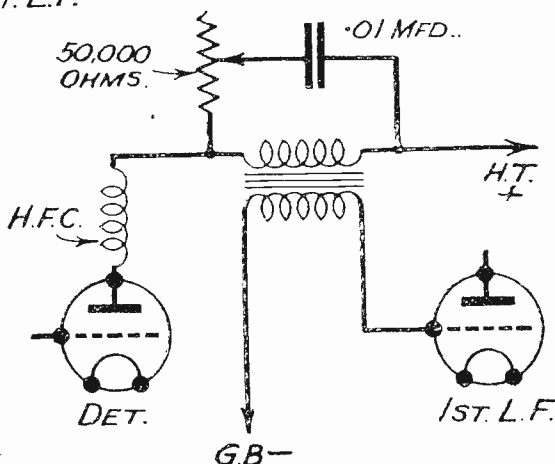

Fig. 5.—A greater degree of high-note attenuation is obtained by putting the condenser and resistance in parallel with the primary winding of the L.F. transformer.

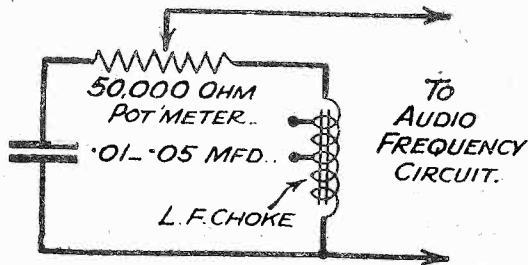

Fig. 6.—A simple tone control circuit which may be used for giving either high- or low-note attenuation.

may be placed on a small bobbin like that illustrated in Fig. 2 and, so as to enable the best value of inductance to be chosen experimentally,appings should be taken after putting on 1,000 and 1,500 turns.

**Increasing the Degree of Correction**

The latter method is only satisfactory when a comparatively small amount of correction is required, but a more pronounced effect can be obtained by connecting a similar choke-resistance combination in parallel with the primary winding of the first L.F. transformer, as shown in Fig. 3. The fixed condenser is not necessary in this case, since the choke will be quite able to carry the small amount of D.C. current which will be passed through it. Although this system gives a greater degree of correction, it also reduces amplification to a much greater extent and, to overcome this loss, it is best to use a transformer of higher step-up ratio than that originally employed.

**Band-pass Tuning**

When a band-pass tuner is employed, a fairly even response is given to the full harmonic range, although even then there is a distinct falling-off in strength beyond some 4,500 cycles. This is not so noticeable or objectionable because it does not affect the "fundamental" notes of any musical instruments, but it does reduce the intensity of overtones or harmonics, and as it is these which constitute the "individuality" of any particular instrument, they are very important to the trained musician and, in fact, to anyone with a critical, musical ear. In consequence, a certain amount of correction is sometimes deemed necessary even when a band-pass tuner is used. Either of the two methods described can be applied, but a little more care must be exercised in choosing the optimum value of inductance, and so it might be better to take moreappings from the choke.

**High-note "Cut-off"**

Where loud-speaker reproduction is "shrill"—that is when emphasis is given to higher notes, either due to the use of a pentode, an unsuitable L.F. transformer, or a speaker which favours the upper register—an entirely different method of correction must be applied. It was explained above that a low-frequency choke tends to "short-circuit" notes of low frequency, so it need only be pointed out that a condenser behaves in exactly the opposite manner. In other words, a condenser provides an easy leakage path for high frequencies, and a comparatively difficult one for low frequencies. In

consequence, we can get the very reverse effect to that referred to above if we replace the choke by a fixed condenser in the manner illustrated in Figs. 4 and 5. The most suitable capacity for the latter condenser will obviously depend upon the amount of correction required; the larger the condenser the greater the degree of high-note attenuation which will accrue. Generally speaking, a capacity of from .01 mfd. to .05 mfd. will prove suitable, and, in any case, a fair degree of latitude is permissible, since the variable resistance controls the condenser's effect upon the circuit.

Another very simple way of curtailing high-note response, is to join a condenser across the secondary winding of the L.F. transformer. It is usually found that sufficient correction can be obtained by the use of a fixed condenser of about .0003 mfd., but it is a good plan to employ a .0005 mfd. variable or pre-set one so that the optimum capacity can be found under normal conditions of operation. In a set with which shrillness is extremely pronounced the

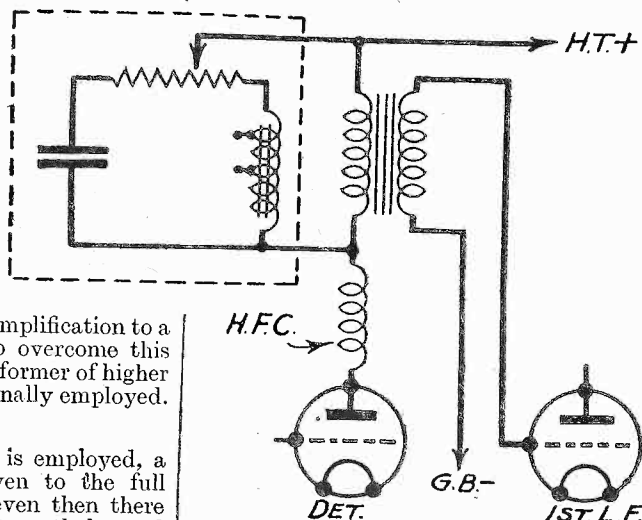

Fig. 7.—The tone control of Fig. 6 connected across the transformer primary winding.

.0005 mfd. condenser might not give sufficient correction, and in that case another fixed condenser may be connected in parallel with it until the desired effect is produced.

**Tone Control**

In general, tone control is much more satisfactory than tone correction, especially in a set which is used for the reception of a number of stations. As explained before, tone control makes it possible to reduce amplification at either end of the scale, as desired, and is thus very useful in enabling the operator to vary the tone of his loud-speaker to suit his own requirements, as well as to compensate for losses at various frequencies due to the peculiarities of individual components.

Those who make a practice of listening to distant stations know that the "tone balance" of different transmissions varies tremendously; some are "thin" and high-pitched, whilst others have a distinct tendency toward bass accentuation. It is more for this reason than any other that long-distance reception is considered by some to be not worth while, but by the use of a good system of tone control any station which is received at good strength and free from interference can be made to give the same quality as the local. Tone control has another very marked advantage from the point of view of long-distance reception,

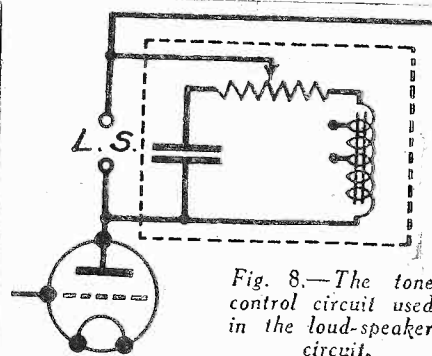

Fig. 8.—The tone control circuit used in the loud-speaker circuit.

in that it may be used to eliminate, or, at least, to minimize, heterodyne whistles and various forms of "mush." The whistles are, of course, high-pitched notes, and can, therefore, be considerably reduced in intensity by cutting down the treble response of the set. This necessarily reduces the strength of the higher frequencies in the transmission being received, but it is generally quite easy to strike a compromise so that the heterodynes are removed without making too great a sacrifice of quality.

**A Simple Tone Control Circuit**

It is quite clear that if we are to get a full control of tone from the bass right up to the treble we must combine the two systems dealt with above, and the simplest way of doing this is to connect the choke, condenser and a potentiometer in the manner indicated in Fig. 6. The combination may be connected across any audio-frequency circuit, and by moving the potentiometer slider from one end to the other of the resistance element, the opposite effects of the choke and condenser can be brought to bear in greater or lesser degree upon the circuit. As the slider is moved towards the "condenser" end there will be a gradual high-note attenuation, and when it is moved in the opposite direction the lower notes will be reduced in comparative intensity, whilst when the slider is at the centre of its track the circuit will give uniform response to all audio frequencies. Most of the tone control transformers on the market employ this system, and have a suitable choke and condenser built into the case; it is thus only necessary to connect an external potentiometer.

The tone control circuit of Fig. 6 may be connected across the primary winding of the first L.F. transformer, as shown in Fig. 7, but when used in the loud-speaker circuit it should be wired in series with a large-capacity fixed condenser, in the manner illustrated in Fig. 8, so that it will be isolated from the D.C. anode current.

**T.C. With a Pick-Up**

The advantages of a tone control circuit apply in equal force when a gramophone pick-up is being used. By suitable adjustment of the potentiometer it is possible to compensate to a certain extent for the lack of bass in the recording, and at the same time, to reduce needle scratch to a minimum. If scratch is entirely eliminated there will be a consequent "cutting" of high notes, but it is generally possible to find a setting at which scratch does not approach an objectionable intensity, and yet the loss in high-note response is not noticeable.

**Vol. II. Commences Next Week!**

**We continue to gain momentum, to get into our stride, to set the pace!**

THE HALF-GUINEA PAGE

# Radio Wrinkles FROM READERS

### Coil Matching Unit

FOR enthusiasts who, like myself, make their own coils, the following idea may be useful; although not original

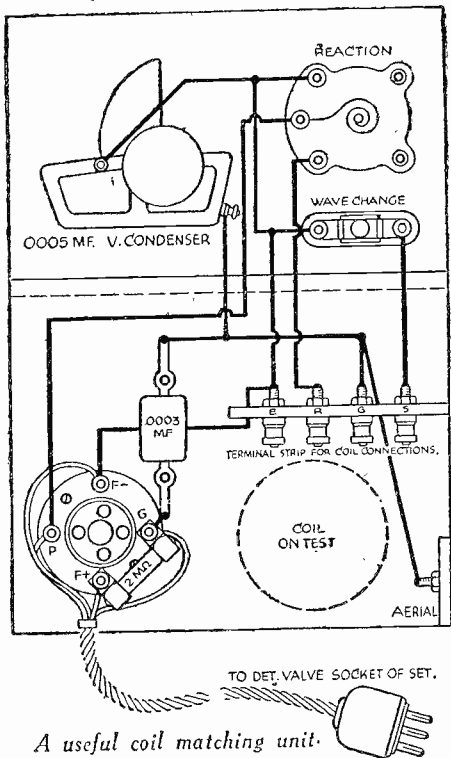

in its theory, maybe the idea of its use in this manner is. In construction the arrangement resembles a common tuning unit with an adaptor, the accompanying illustration showing the layout and wiring. The connections are as for the detector stage, the detector valve being placed in the socket and the plug into the set socket. Tuning is done by the unit and the coils can then be tuned and altered without much trouble.—V. M. RIX (Croydon).

### A Handy Testing Panel

HERE is a handy testing device which I have installed in my receiver (Det.—2 L.F.). It consists of a small panel upon

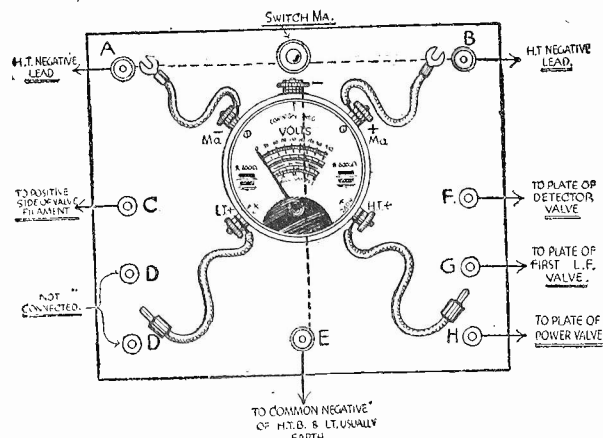

### THAT DODGE OF YOURS!

Every reader of "PRACTICAL WIRELESS" must have originated some little dodge which would interest other readers. Why not pass it on to us? For every item published on this page we will pay half a guinea. The latest batch is published below. Turn that idea of yours to account by sending it in to us, addressed to the Editor, "PRACTICAL WIRELESS," George Newnes, Ltd., 8-11, Southampton Street, Strand, W.C.2. Put your name and address on every item. Please note that every notion sent in must be original. Mark envelopes "Radio Wrinkles." Do NOT enclose Queries with your Wrinkle.

which is mounted a meter reading volts and milliamps. The remaining parts required are 6 plugs and sockets (4 red, 2 black), one 2-point switch and three terminals. The whole forms a useful instrument for taking instantaneous readings of batteries and also the total consumption of the receiver. The connections are as shown by the accompanying sketch. The negative lead from the H.T. battery to the set is broken and the two ends are connected to A and B. Terminal E goes to the common negative of L.T. and H.T., usually earth. Socket C is taken to the positive side of valve filaments. Sockets F G and H are taken to the plate terminals of the three valves. Sockets D and D are not connected, but are used for inserting the two plugs when not in use and so prevent them from dangling in set. When set is normally in use the switch MA is kept on, thus completing the H.T. negative lead. Breaking this switch will give an instantaneous reading of the total current being taken from the H.T. battery. When it is desired to ascertain the filament voltage the L.T. + plug is inserted into socket C. H.T. readings are obtained by inserting the other plug into either F, G, or H, and the reading shown will be the actual voltage on the plate of that particular valve. When voltage readings are taken the spade con-

### A Compact Circuit Tester

READERS of this page may be interested in this compact, but efficient, circuit tester. I have made it from odds and ends. From small pieces of scrap wood I constructed a box almost 3in. long by 1½in. wide and 1½in. deep. By cutting an old terminal strip I obtained an ebonite panel to fit, measuring 3in. by 1½in. On this, as shown in the sketch, I mounted two pairs of telephone terminals, a small toggle switch, and through the panel, a fuse holder. When wired as shown and connected to an ordinary flash-lamp battery one has a tester capable of showing a dead short or continuity in a circuit having a resistance of one megohm or more, simply by pushing over the switch. The toggle switch was used solely because it happened to be a spare one. Of course, a push-pull switch would do equally well. I

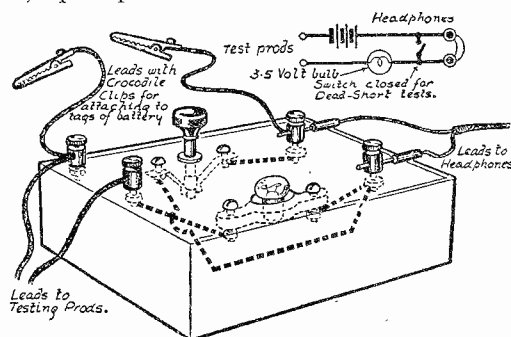

A circuit tester made from odds and ends.

find this little tester a great help when testing for continuity in the "inwards" of a radiogram, where space is very limited and where one appreciates being able to see the flash of the light for a short, or hear the double make-and-break "plop" in the 'phones.—G. COLEMAN (Finsbury Park).

### A Sectional Panel

FIRST obtain a length of quadrant moulding (Fig. 1), and some odd pieces of plywood of suitable size. Next

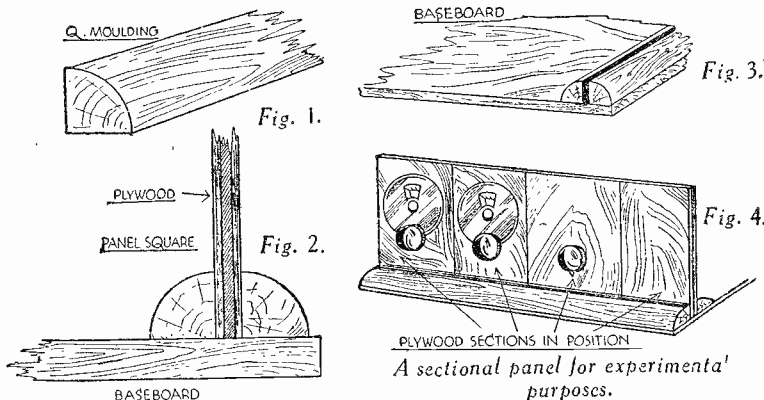

nection should be disconnected from A or B. This panel I have fitted to my baseboard with the idea of eliminating the trouble of getting at the batteries, which are usually stowed away in some other compartment.—A. W. MANN (Petworth).

cut two lengths of moulding the size of baseboard (Figs. 2 and 3), leaving a small gap for the thickness of your plywood panel sections to slide in. Cut the plywood into different size squares so as to make up the length of your panel, as indicated in Fig. 4. I have found this idea to be very successful.—H. WEBSTER Dulwich).

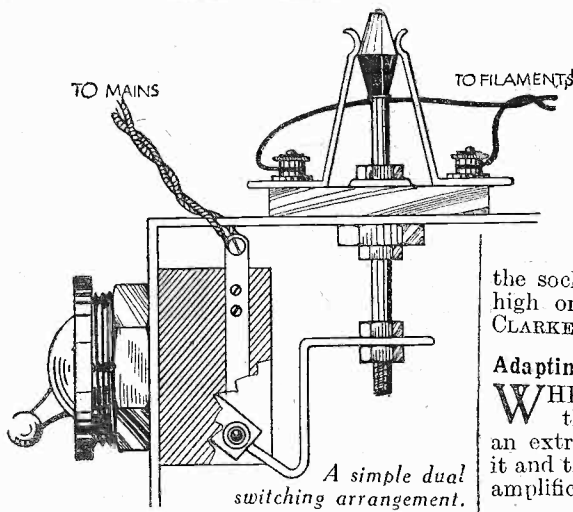

mfd.; three sockets for the panel and one plug. These are connected up as shown, and the plug attached to a short length of flex connected to the lead from the grid terminal of the valve-holder. These three condenser values should suit most speakers and by plugging into one or other of

the sockets a marked improvement in the high or low notes can be obtained.—G. CLARKE (Tulse Hill).

**Adapting a Radiogram Fader**

WHEN a radiogram fader is used in the usual way, following the detector, an extra L.F. valve is necessary between it and the output valve to provide sufficient amplification for the pick-up. My own

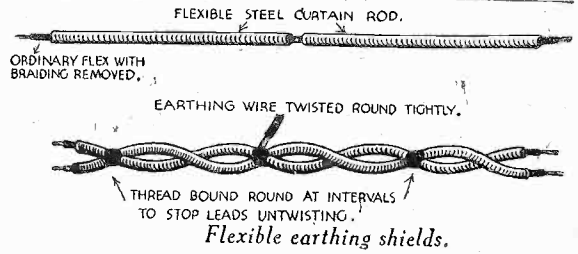

only have one control now instead of three (two volume controls and radiogram switch).—L. R. COWELL (Boscombe).

**Earthing Shields for Pick-up Leads**

THIS is a handy way of earthing pick-up leads. First obtain a quantity of flexible spring curtain rod, and some ordinary black and red flex. Cut the flex to length required, unwind and strip off the braiding. Cut off two lengths of curtain rod about two inches shorter than flex, and push flex through. Then twist the two leads together and bind at intervals with thread to stop untwisting. Then twist tightly round the two leads another piece of flex which is earthed. This effectively earths any interference which otherwise would be picked up by the leads.—E. BARNES (West Ealing).

**Dual Switching Device**

WHEN using a set employing battery-heated valves in conjunction with a high-tension eliminator, it is often found troublesome to have to switch the set off at two points. A switch to combine these two actions can easily be made. One of the small toggle mains switches is fitted with a strip of aluminium, bent at a right angle, a small "push-pull" switch being then mounted as shown in the sketch. To the spindle of this latter switch is clamped a short length of stiff wire, which is bent to engage with a hole drilled in the end of the switch arm, which point of course is usually insulated from the contact piece. Those "push-pull" switches having a definite "snap" action are difficult to adapt, but it will be found that those with a straight contact plunger work quite easily.—G. E. DRIFFIELD (York).

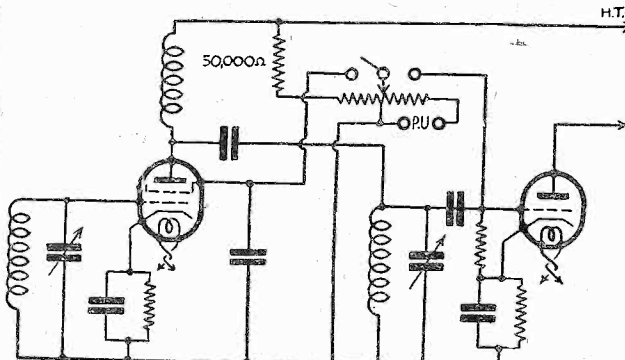

A novel method of incorporating a radiogram switch.

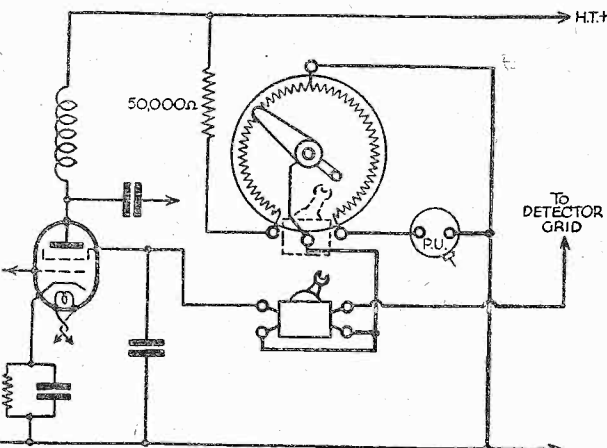

How the fader and switches are connected up.

set is a 3-valve H.F.-Det.-L.F., so I devised the following arrangement to work as a radiogram fader. A 100,000-ohm Bulgin volume control combined with single pole change-over switch is connected as shown in the diagram. It will be seen that an extra connection has been made to the centre of the resistance element, and that the switch control arm has been set to throw over the switch just as the potentiometer slider passes this connection. Turning the fader to control position either reduces the potential applied to the screen grid of the H.F. valve or the pick-up potential applied to the detector valve grid and the switch changes over the circuit at zero volume. Turned to the left maximum gives me maximum radio volume and turned to the right maximum gives me maximum gramophone volume, and I

of a small (brass) bracket. The selectivity could thus be controlled from the panel. A smaller degree of selectivity is normally required on the long waves, thus this device proved very convenient.—D. J. HOULDEN (Twickenham).

**Simple Tone Control**

TO make the simple tone control device shown in the accompanying sketch, the following components will be required:—Three fixed condensers .002, .001, and .01

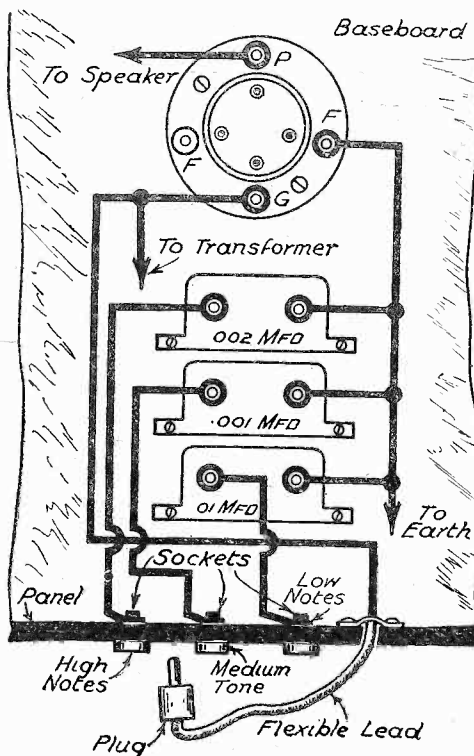

A method of adjusting tone control.

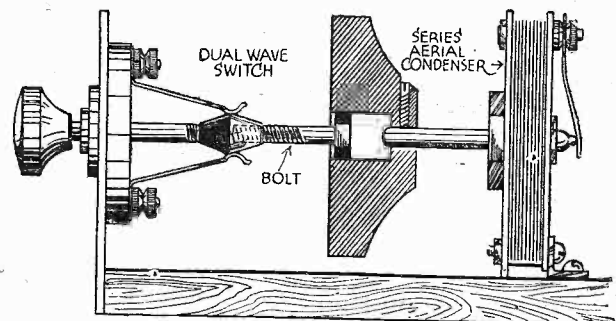

Operating two components with one knob.

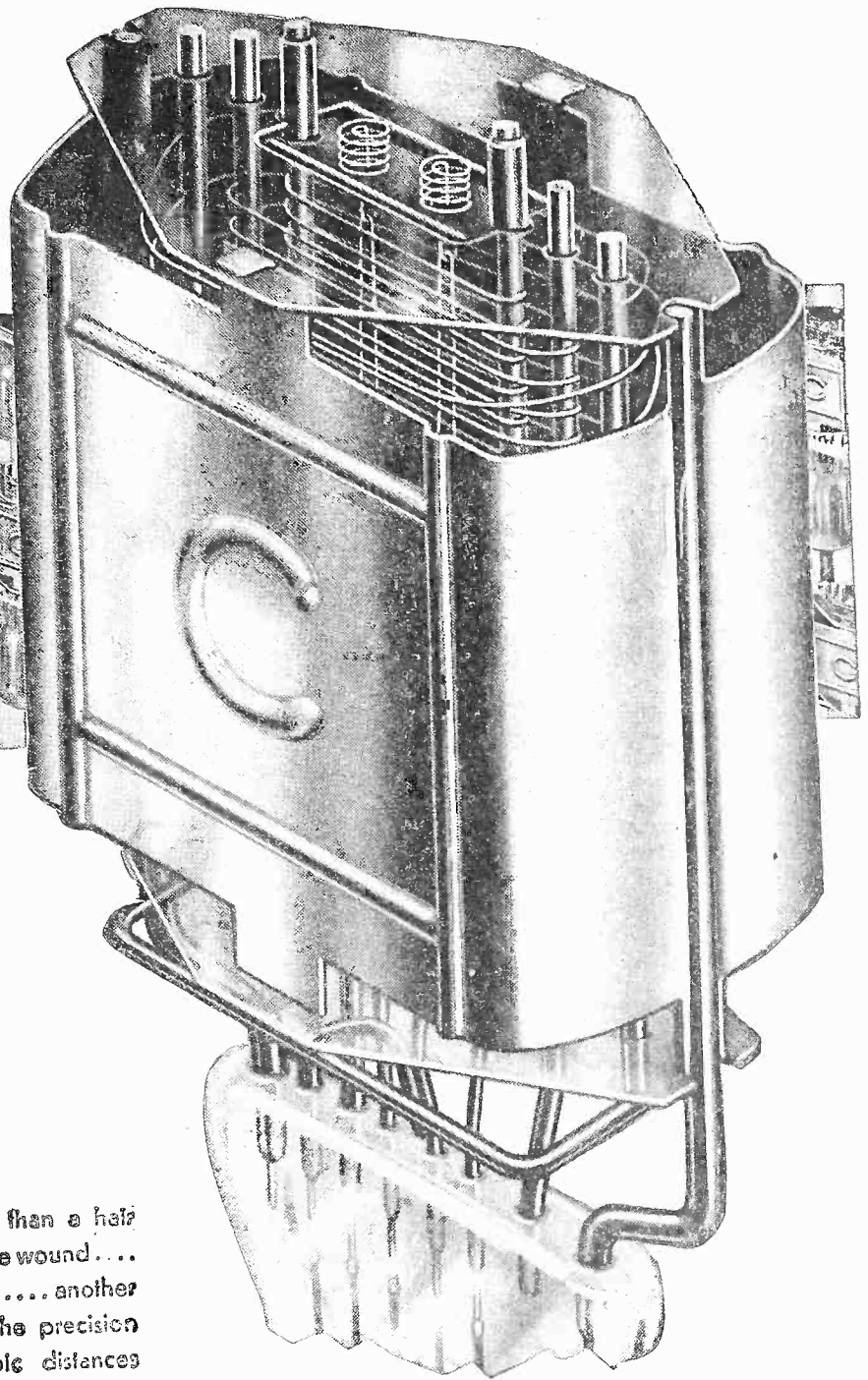
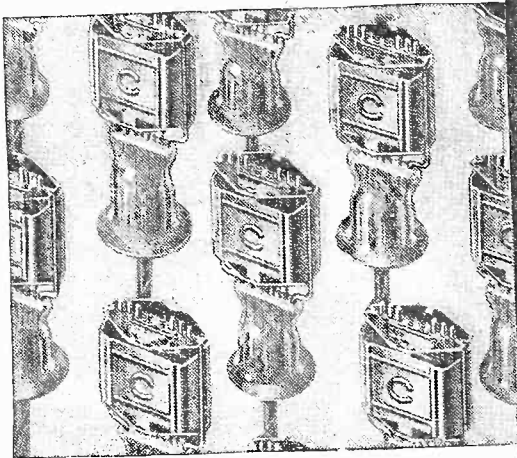

# ACCURACY

... meticulous ...  
microscopic .....

**M**ACHINES whier ... filaments finer than a hair ... nimble fingers work ... grids are wound ... anodes pressed ... a hundred operations ... another Cossor Valve is made ... made with the precision of a watch ... accurate ... microscopic distances exactly spaced ... meticulous accuracy ... accuracy that ensures that your Cossor Valve ... wherever you buy it ... whatever its type ... is the exact counterpart of the original laboratory-developed design.

# COSSOR VALVES

.....  
 To A. C. COSSOR LTD., Melody Dept., Highbury Grove, London, N.5.  
 Please send me, free of charge, a copy of the 40-page Cossor Valve and Wireless Book B.17.  
 Name.....  
 Address.....  
 P.P.A.C. 16/3182

Send for a free copy of the 40-page Cossor Valve and Wireless book which contains a wealth of interesting and useful information including Radio Definitions—Useful Circuits—List of Stations, etc., etc. Please use the Coupon.

A. C. Cossor Ltd., Highbury Grove, London, N.5. Depots at Birmingham, Bristol, Glasgow, Leeds, Liverpool, Manchester, Newcastle, Sheffield, Belfast and Dublin. Q2548

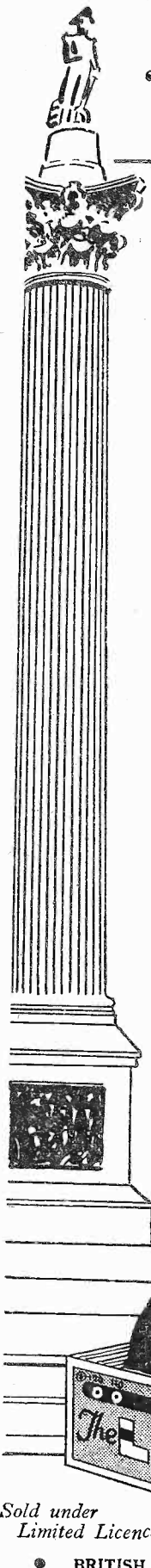

1805 A.D.

"England expects every man this day...!"

**1933**

You can expect  
The **LION**  
H.T. BATTERY  
to do its duty  
every day

... and besides giving you efficient service and giving your Set greater and more lasting power, the Lion H.T. Battery COSTS LESS! It is made in one of the largest factories in Great Britain devoted exclusively to battery manufacture. It is made by men who know what you want and who know how to produce it at the price you want to pay. It is the battery with the lowest internal resistance.

● LOOK AT THE PRICES!

- 60v. H.T. 4/6 ● 100v. H.T. 7/-
- 120v. H.T. 9/- ● 9v. G.B. 10d.
- 4½v. Pocket Lamp Battery 4½d.

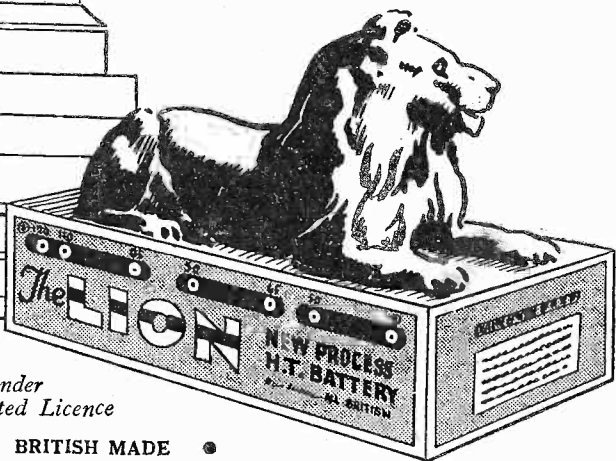

Sold under Limited Licence

● BRITISH MADE ●

**YOUR DEALER CAN SUPPLY**

Advt. of VINCES DRY BATTERIES LTD., LION WORKS, GARFORD STREET, LONDON, E.14. Telephone: EAST 1902.

**WHY PAY EXORBITANT PRICES FOR VALVES?**

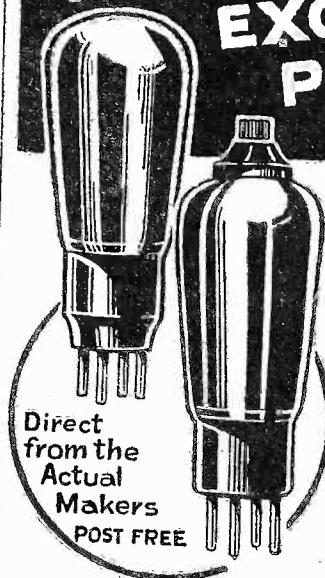

Direct from the Actual Makers POST FREE

For many years we have made Radio Valves, which we have supplied on contract to leading Set manufacturers. Now we are supplying these same tried and tested Valves direct to the public at "direct to the public" prices.

**BRITISH 362 VALVES**

Every 362 Valve is GUARANTEED to be the EQUAL of any other valve (British or foreign) of similar characteristics, and is NON-MICROPHONIC. Any 362 Valve failing to give entire satisfaction within a period of 6 months from date of sale, will be replaced FREE (provided it has not been mis-handled). R.C., H.F., L.F. POWER SUPER-POWER SCREENED-GRID

**3/6 4/6 4/6 7/6**  
all in 2v., 4v. or 6v. (Metallised 3d. extra)

If valves of a certain make have been specified for your Set, send the name and type with your order and we will send you 362 Valves of similar characteristics. Cash with order. Cheques and P.O.'s must be crossed and made payable to:— The 362 RADIO VALVE Co., Ltd., (Dept. W.1), 415, Mare Street, Hackney, London, E.8

FOR THE  
**"FURY FOUR"**  
USE

**PREH POTENTIOMETER**

50,000 ohms. Wirewound. Price 5/9

The new range of variable resistances have been designed to meet the demand for a component with a particularly silent and smooth movement. The curve of the potentiometer is arranged "straight line," which gives a straight line ratio between angular movement and resistance variation. The resistances can be supplied with "straight line" or logarithmic curves according to requirements. These components are also supplied with a combined switch, making an extremely neat and robust unit. The switch has a quick make and break movement and will handle 1.2 amperes at 250 volts without arcing.

Prices for your special requirements on application

*Preh*  
**POTENTIOMETERS AND RHEOSTATS**

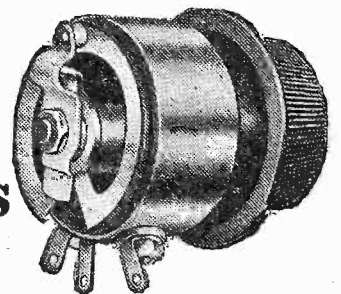

PREH MANUFACTURING CO., LTD., Broadwater Road, WELWYN GARDEN CITY.

Manufacturers and Wholesalers only supplied.

Sole Sales Organization: Clerkenwell Green, E.C.1.

Harwell Ltd., The Sessions House; Phone: Clerkenwell 6905-6.



# SUPERHETERODYNE FAULTS and THEIR CURE

Some Peculiarities of the Circuit Explained by W. WINDER

IN these days listening to foreigners can be a most annoying game. Aerial power has increased by leaps and bounds, and stations have crept closer and closer together in wavelengths, so that a receiver thought to be highly selective a year or two ago to-day finds itself quite incapable of dealing adequately with the interference problem. The straight three or four valve receiver, consisting of H.F. stages, detector and pentode, can give a very good account of itself, especially since the use of variable mu valves and band-pass filters have become standard practice, but for the very best interference-free foreign listening the claims of the superheterodyne cannot be ignored. Here is a type of receiver in which a very high standard of selectivity and sensitivity is fundamental to the design.

Unfortunately, most people are, without just cause, afraid of the design. The word "superheterodyne" has so many syllables and sounds so scientifically imposing that the uninitiated uncover their heads and bow down in awe whenever it is mentioned. In my meanderings round wireless emporiums I have even heard salesmen disparage superhets on the grounds that service problems would be more intricate. Now this is all wrong. The superhet certainly contains one process more than straight H.F. sets, but the idea behind it all is not really complicated. Some of the troubles are of the type liable to occur in any kind of set, whilst others are peculiar to the superheterodyne, and it is the purpose of this article to discuss a few of the latter, together with their causes and cure. Before dealing with these, however, a short description of a typical superheterodyne is given to make the following remarks quite clear.

The big difference from ordinary sets

is the "frequency changer." Signals picked up by the aerial vary, as you know, from 200 metres to 2,000 metres in wavelength. The frequency changer receives any signal between these limits and changes the wavelength to a fixed one in the neighbourhood of 3,000 metres. Whether the set is tuned to London National on 261 metres or Radio-Paris on 1,724 metres, by the time the signal has passed through the frequency changer it has a wavelength of 3,000 metres. A superhet is simply a wavelength changer (or frequency changer if you want to be more scientific), followed by an ordinary H.F. set, the H.F. set part being permanently tuned to 3,000 metres. If you have followed this simple explanation you will see that there are two kinds of "high frequency" in a superhet, one at the wavelength of the broadcasting station and the other at 3,000 metres. To avoid confusion we will call the first "high frequency" and the second "intermediate frequency."

After this brief explanation of the bare principle behind the design let us proceed to the special faults that may arise.

### Noisy Background

A hissing background to foreign programmes is not an essential fault of superhets, but it is a most common one. It occurs on sets working from an inefficient aerial, and generally only in sets not provided with H.F. amplification in front of the frequency changer. This hiss has its origin in the oscillating valve which forms part of the frequency changer, and when a station is tuned in, this unfortunate noise, known as the "Schrott effect," gets impressed on the radio signal, gets amplified in the intermediate frequency stage, and under certain circumstances can attain to an objectional roar. The obvious remedy, as we cannot design a hissless valve, is to limit the amount of amplification after the hiss occurs—in other words turn down the volume control. To allow this to be done and yet retain good volume on the weaker foreigners a good aerial is essential, and the provision of such an aerial is the cure for the trouble. Those readers having no facilities for fixing up a good aerial should be sure to buy or build a superhet containing a stage of H.F. amplification in front of the frequency changer. The common idea that superhets will work off any old aerial is an unfortunate legacy from the days when they could not be attached to an outside aerial for fear of interference with one's neighbours. Just one word of warning. If a preliminary H.F. stage is fitted it should use a variable mu valve—otherwise the benefits accruing from the selective design are largely thrown away through cross modulation troubles.

### Instability and Whistles

A misleading trouble to which superhets are prone is the appearance of whistles all round the dials. They are exactly like the whistles that are heard on a normal set when tuning through carrier waves with the reaction knob turned too far. The reader who has had previous experience of H.F. amplification will at once say "instability" and proceed to fix up more elaborate

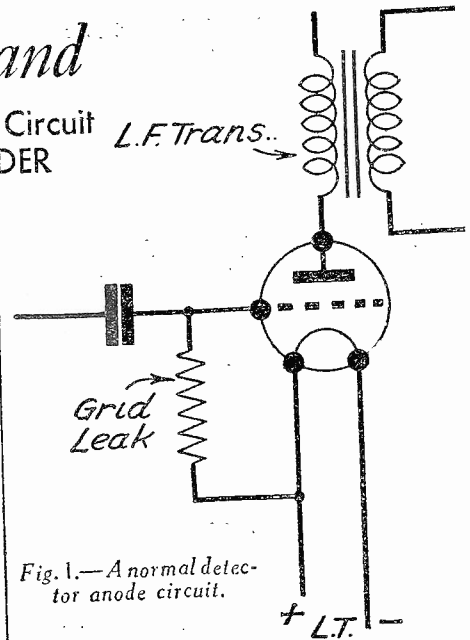

Fig. 1.—A normal detector anode circuit.

screening between the stages, but nine times out of ten he will be wrong, for the trouble is usually due to quite a different cause. If whistles occur on every station then the set definitely is unstable, in which case the cure does not generally lie in more elaborate screening, such as metallised valves, screened connecting wire, etc. These things are useful, but they do not touch the main cause of instability in superhets—the presence of intermediate frequency currents in the L.F. amplifier. The cure for this is to place in the second detector anode circuit (the detector proper) a good H.F. filter, consisting of a good H.F. choke connected to the anode of the valve, with a .0003 fixed condenser between each side of the choke and earth. (See Fig. 2.) All three components of this filter should be placed as close to the detector valve holder as is possible.

### Second Channel Interference

H.F. instability is not usually pronounced in superheterodynes. The whistles are nearly always due to what is called "second channel interference," and as an explanation would take up many pages we will proceed at once to the cure, which is to pay attention to the preliminary tuned circuits. Nearly all superhets contain three tuning condensers, one for the oscillator and the other two for the tuned circuits (at radio frequency) preceding the frequency changer. A set such as this, when used in the London area, would whistle about the Poste Parisien setting, and again in the neighbourhood of Prague, and perhaps there would be one or two other whistles, too faint to cause annoyance. Midlanders would be more lucky in that no strong whistle should appear, whilst listeners in the Huddersfield and Manchester area would find only one strong one—somewhere about Midland Regional.

A set using more tuning condensers would be less prone to second channel interference, but a set with only one tuned circuit, in addition to the oscillator, would get whistles all round the dial. This description of average results of the various designs has been given to enable the reader to see whether his own receiver is up to standard or not in this important respect. If there are more whistles than outlined

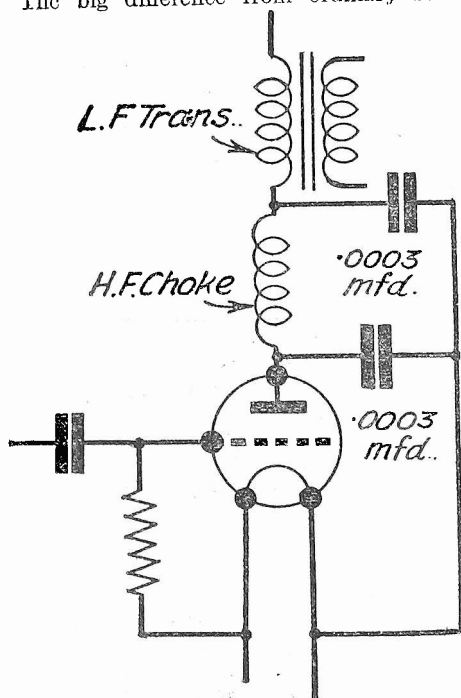

Fig. 2.—An H.F. filter circuit.

above, attention should be paid to the ganging of the tuning condenser.

**Ganging**

No manufacturer, and presumably, no reader building his own set, would be so foolish as to use a gang condenser unless the associated tuning coils were matched, so ganging merely resolves itself into adjusting stray capacities. Tune in as accurately as possible a station about 250 metres, and then adjust the trimmers for maximum volume. That is all that is necessary if the oscillator condenser is not ganged with the others, and any further misganging could only be due to poorly matched coils or condenser. Where the oscillator tuning is ganged with the others, *i.e.*, where there is only one tuning control on the set, adjusting trimmers can be tried without fear of upsetting things, as long as such adjustments are carried out on stations between 200 metres and 250 metres. If, however, such adjustments do not mend matters, further efforts are rather beyond the average amateur, being bound up with the question of intermediate frequency.

**Harmonics**

It is sometimes found that the local station comes in at several settings of the dial, thereby cutting out so many foreigners. This is due to the generation of harmonics by the oscillator valve, and is a question of design rather than something that can be tackled with a completed set. For the benefit of set builders, harmonics are not so troublesome if the anode circuit of the oscillator is tuned in preference to the grid circuit. This is, of course, just the opposite of our old friend the ordinary reacting detector, which has its untuned coil in the anode circuit and its tuned coil connected to its grid.

**Intermediate Frequency Interference**

This takes the form of interference, usually of morse, which is quite independent of the dial setting, and is due to telegraphy

**Full State Control of German Stations**

ACCORDING to a recent decision taken by the Berlin authorities, the control of the German Broadcasting System has been withdrawn from the Ministry of Posts and Telegraphs and has been handed over to the care of the German Chancellor (Adolf Hitler).

**The Flying Doctor**

AUSTRALIA has organised a flying Medical Service of which the base is situated at Clancurry (Queensland). It has been established to serve a large number of bush cattle stations. To secure medical assistance when required, the stations, which are provided with a small wireless transmitter, broadcast a special SOS call, on receipt of which a fully equipped aeroplane with staff consisting of mechanic, doctor and nurse is immediately sent to attend to the patient. The aircraft is so fitted that in case of necessity it can take an ambulance stretcher and thus rapidly convey the sick

stations working on a wavelength about 3,000 metres, that is, at a frequency about equal to the intermediate frequency. One cause of this trouble is the use of a capacity-coupled, band-pass filter as the preliminary tuning arrangement, the coupling condenser offering an impedance to these very long waves sufficient to set up an appreciable voltage on the grid of the frequency changer. Changing over to inductive coupling between the two units of the band-pass filter usually clears the trouble, but if it still creeps in on the long waves, a wave-trap, tuned to the intermediate frequency, should be inserted between the aerial and

and as you all know, absence of high notes leads to boominess and lack of clarity. In these days an intermediate transformer will nearly always consist of a pair of slab wound coils placed close to each other inside a metal container—something like an ordinary coil screen. The position of the coils relative to each other is usually adjustable, and if quality is thin they should be brought closer together. This will help put back the high notes at a slight expense of selectivity.

If the output valve is a pentode, it should be used without any corrective device such as a resistance and condenser across the output. A pentode's natural property of accentuating the high notes can compensate for those lost earlier in the receiver.

**Radiation**

In the old days superhets were always worked off frame aerials, because of the annoyance caused to neighbours when more ambitious collectors were used. A modern set should not offend in this way, but if it does, and if the reader does not feel sufficiently competent to undertake structural alterations, he can easily build a choke-coupled screen-grid unit to stop the nuisance.

Any H.F. unit will do, so long as the valve used is a variable-mu, but the circuit given in Fig. 3 is as good as any. The coil can be any dual-wave coil, or a pair of suitable "plug-in" ones mounted at right-angles to each other and wired in series. This unit, besides preventing radiation by isolating the oscillator from the aerial, will, incidentally, increase the range of the set, reduce oscillator hiss, reduce second channel interference and to a small extent increase selectivity. Its disadvantage is that there is another knob to turn.

It is to be hoped that the few possible troubles will not put intending builders off the idea of a superhet. A similar number of ills to which other types are heir would be quite as long, and the advantages of range and selectivity must be experienced to be believed.

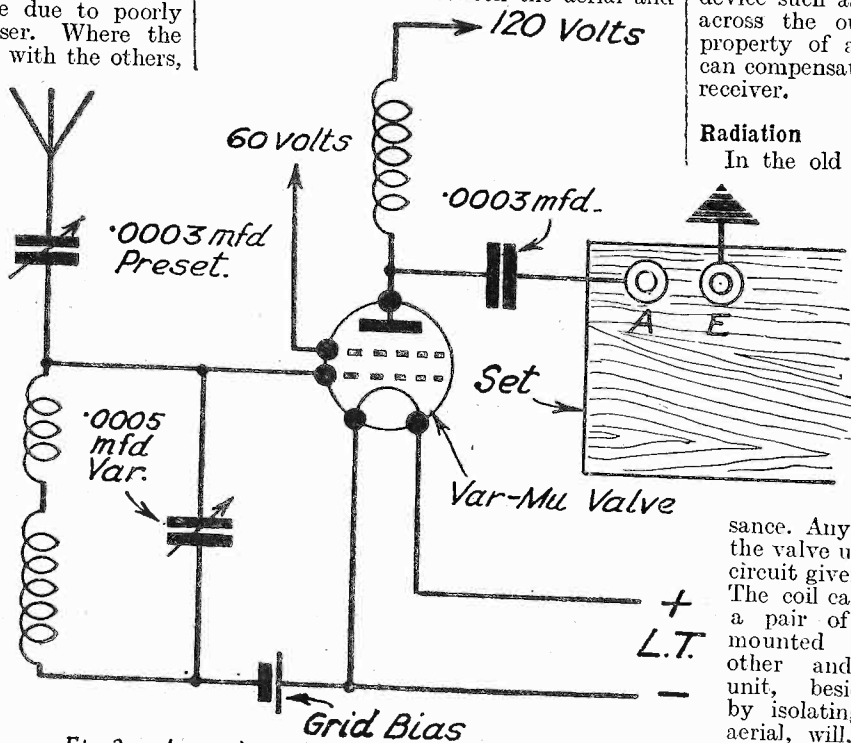

Fig. 3.—A superheterodyne convertor added to a receiver.

the set. The coil for such a wave-trap should have many turns—say, 500 in slots on a 2in. former—and the tuning capacity should be a pre-set condenser of .001 microfarads.

**Poor Quality**

A properly-designed superheterodyne can give as good reproduction as any other type of set. The design is, however, so selective, that most of the high notes will be lost unless suitable precautions are taken,

**ODDS and ENDS**

person to the nearest hospital. The service has proved very successful and larger planes are being built in order that a surgeon and anaesthetist may be added to this air ambulance.

**Make a Note Of It.**

LISTENERS would do well to tune in Prague (488.6 m.) on the evening of Monday, May 1st, when the station celebrates the tenth anniversary of the opening of the Czech broadcasting system. Special programmes in which all the stations in the network are taking part have been arranged for this occasion.

**Shanghai's 44 Radio Stations**

OF all Chinese cities Shanghai without doubt is the one which possesses the greatest number of broadcast listeners.

There are at present no less than forty-four transmitters in daily operation and radio programmes are given in seven different languages. Most of these stations are privately owned and many are used for publicity purposes.

**Dressmaking by Radio**

A FEATURE which has achieved considerable popularity amongst women listeners in Holland is one which is broadcast twice weekly through the Hilversum transmitter. It consists of lessons in dress-making. The paper patterns obtainable against payment of a small fee from the studio are made to one size, but bear a series of numbered perforations. From instructions received by microphone the listener need only connect up these perforations with a pencilled line to secure a pattern made to a special size. On a recent occasion when a child's frock was designed, the studio received applications for over twenty-thousand patterns!

# THE DETECTOR OF TO-MORROW— AVAILABLE TO-DAY!



Type W.4 half-wave Westector (actual size). Suitable for use as a radio-frequency or intermediate-frequency detector.

The use of the Westinghouse Metal Rectifier in modern A.C. Mains Receivers and Eliminators is quite familiar; and its long life and high efficiency has earned for it an outstanding position.

Now, however, after years of patient research and development, the Westinghouse Metal Rectifier is introduced to you in a new form—as a copper-oxide detector for the rectification of radio-frequency currents. No bigger than a grid-leak, the WESTECTOR is a great advance on previous pure detectors, and is undoubtedly the detector of the future. It requires no current or voltage supply, and retains the inherent qualities of long life and high efficiency associated with the Metal Rectifier.

The Westinghouse
  
WESTECTOR
  
high-frequency metal detector

Manufactured in England by —  
 THE WESTINGHOUSE BRAKE & SAXBY SIGNAL CO., LTD.,  
 82, York Road, King's Cross, London. N.1.

Types and Ratings.					
Model.	Type.	Length	Max. input volts.	Max. current output.	Price.
W.4	Half-wave	1 15/16in.	24v. peak	0.25mA.	7/6
W.6	Half-wave	1 15/16in.	36v. peak	0.25mA.	7/6
WM.24	Centre-tap. full wave	3in.	24v. on each side of centre tap	0.5mA.	10/-
WM.26	Centre-tap. full wave	3in.	36v. on each side of centre tap	0.5mA.	10/-

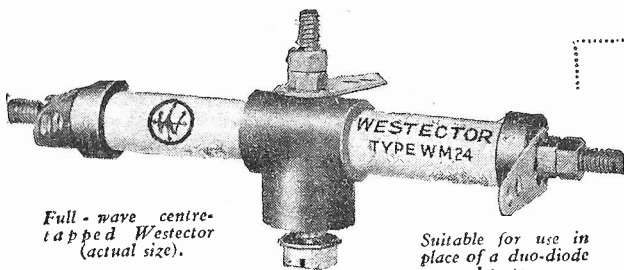

Full-wave centre-tapped Westector (actual size).

Suitable for use in place of a duo-diode detector.

**COUPON.**

Please send me full particulars of, and circuits for use with, the new Westector.

Name .....

Address .....

# Wave-Change Switching

Selected Methods of Changing from One Wave-Band to Another

By P. E. BARNES, B.Sc.

ONE of the features in which the modern radio receiver differs most noticeably from that of seven or eight years ago is the method of tuning. This is due in a large measure to the different conditions which existed then, for it was necessary for the amateur to have a means of tuning almost anywhere between 100 and 3,000 metres in order to obtain sufficient listening matter to justify the construction of a receiver. The earliest arrangements of huge coils, either tapped or arranged with a slider, had innumerable defects, for instance, considerable dead-end losses, copper dust collecting between the turns and shorting them, excessive size and so on.

The plug-in coil, which is still in use in many home-made receivers, provided a solution to many of these defects. They were simple, efficient, cheap to purchase or make and provided for tuning to any wavelength without the use of excessively large variable condensers. Even to-day, their only drawbacks are the difficulty of making tappings, the necessity for changing perhaps as many as three coils, and the large external fields. If suitable screening can be arranged, sets can be built incorporating such coils which will compare very well with present tuning systems, and at a considerably lower cost. If the need for occasional coil-changing is not objected to, these coils may well be adopted in a set intended mainly for short-wave reception.

The problem of continual coil-changing can be overcome by using loading coils, short-circuited on the medium wave-band; but if this is done, then why not construct a dual-range coil in the first place? Nowadays tuning systems are becoming more and more standardised: aperiodic aerial coupling is now almost

universal, for instance, while tuned grid coupling is now the usual method of handing on the signal to the detector valve.

### Simplifying Connections

There are one or two points in connection with the wave-change

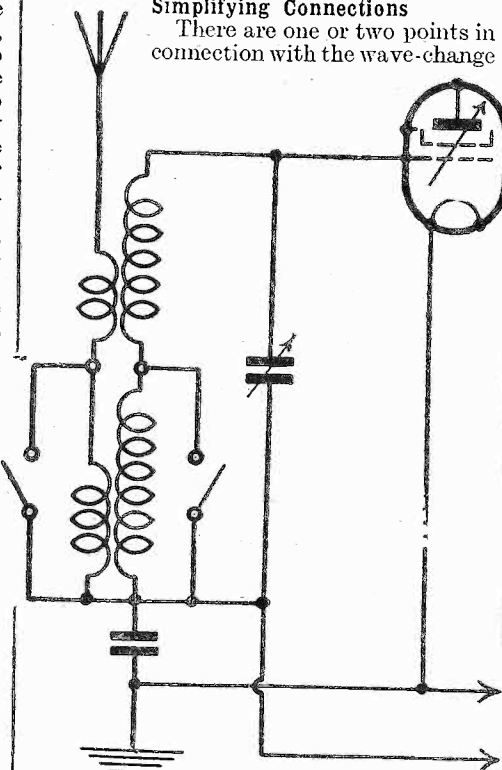

Fig. 1.—Wave-change switching in a variable-mu stage.

switching of receivers which are often neglected, sometimes with unfortunate results. In general the tuning coils have one end at earth potential—this is one of the advantages conferred by the tuned-grid system—and switching can be carried out with two or at the most three points of the switch at a high-frequency potential on long waves, and all points joined together and to earth on the medium waves. This avoids the need for insulating bushes, and simplifies the connections when a metal panel and baseboard are in use.

Very often, however, a variable-mu or ordinary S.G. valve is biased according to the system shown. This is often mentioned where a change from ordinary S.G.'s to variable-mu's is concerned, but this will require alteration, and sometimes complete scrapping of the wave-change gear. We can no longer use an earthed plunger through the panel nor can we join all the contacts for medium waves.

It is very easy to overlook this point in making any alterations to a receiver, and as a result the bias battery is shorted. With the small .9 volt bias cells used for S.G. valves, this is not a serious matter, but if

the main bias battery is shorted, then there is danger to the output valve, and also the H.T. battery. In most cases, however, it will be obvious that something is wrong before the damage is serious, but it is rather an elusive fault to track down if the real cause is not suspected.

Sometimes this alteration of switching is not a practical proposition, either because of the difficulty of obtaining a suitable switch (this applies particularly to cases of band-pass coils or H.F. transformers), or from practical objections, such as lack of space or inconvenient layout. The alternative method shown in Fig. 2 will enable the difficulty to be overcome.

### Preventing Break-through

Another point in dealing with wave-change switching is the provision of some means of preventing medium wave break-through on the long wave-band. The simplest solution is to use a choke (a 60-turn coil will often suffice) in the aerial circuit, shorting it for medium-wave reception. Often, however, it is possible to arrange that this choke is automatically shorted by the ordinary wave-change switch. The system shown in Fig. 3, for instance, does not require more switch contacts than if the choke were not used.

Remember that this choke must be so positioned that it has its axis at right-angles to that of the coil, in order to avoid undesired couplings.

In some dual range tuners, the reaction coil is included in the switching arrangements, with the intention of providing convenient control of reaction on both wave-bands. This is not always necessary, as the same effect can usually be obtained by re-positioning the reaction coil,

which will require to be nearer to the long-wave portion of the tuning coil than to the short-wave portion. It is often exceedingly useful to be able to save a switch contact in this manner, as it can often be put to a better use, e.g., to provide constant selectivity on both long and medium wave-bands, by transferring a tapping point on the aerial or H.F. transformer coil.

A further useful saving may be effected by "earthing" one end of the reaction coil on some types of dual range coil.

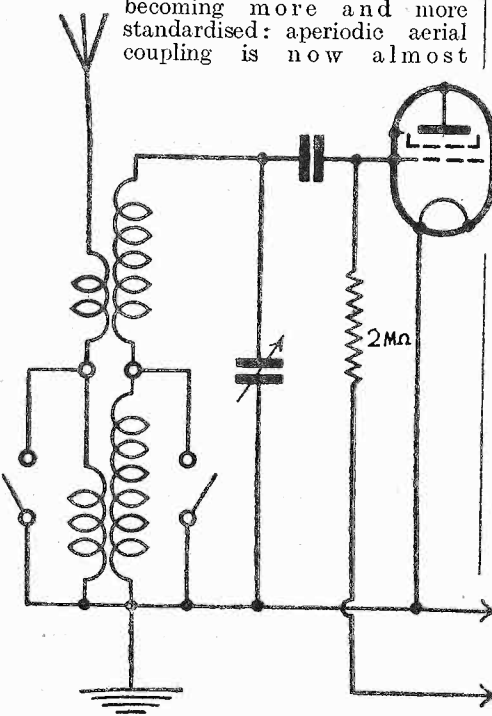

Fig. 2.—Wave-change switching in an ordinary H.F. stage.

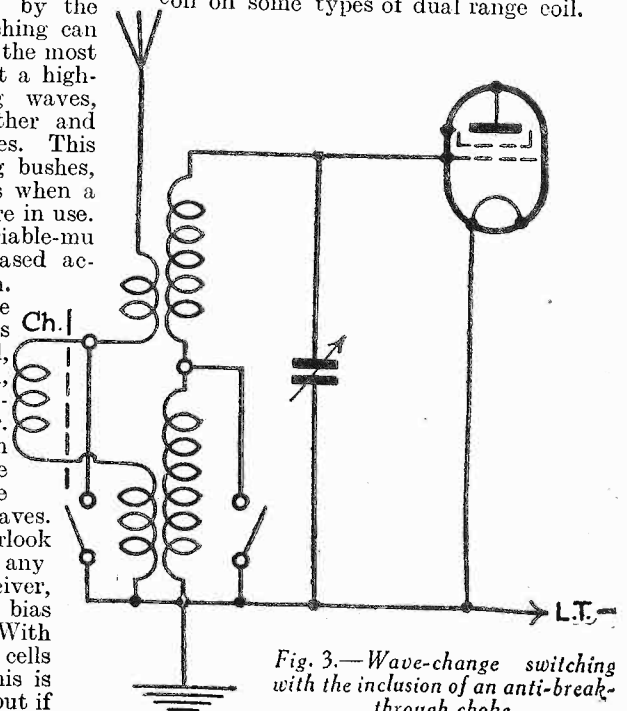

Fig. 3.—Wave-change switching with the inclusion of an anti-break-through choke.

# Receivers and their Records

We shall be pleased to advise readers regarding purchase of complete sets.

IN view of the peculiar conditions obtaining in the United States, where most cities possess a number of broadcasting stations on the medium waveband, selectivity and sensitivity are the main qualities required in a receiver by the listening public. It is for this reason that, in America, the superheterodyne circuit has achieved so much popularity. In their model 247, Philco have demonstrated that it is a practical proposition to pack eight valves, and all the necessary components, including a moving-coil loud-speaker, into a cabinet which in size does not exceed that of the majority of three-valve sets. In performance, the model under test was in every respect equal to that of its A.C. prototype, an achievement with which the makers may be well satisfied.

Both the radio frequency input, and the modulator oscillator circuits are identical with those of their other models, such as 56, 237, 248, etc. Briefly reviewed, we have a band-pass input circuit between the aerial and first valve of the screen-grid type delivering a substantially flat-topped wave-form to the grid. Incorporated in this valve anode circuit are four inductive circuits, the first of these being a series connected network of inductance and capacity, part of this tuning to the incoming frequency (at the grid of the valve) and this part, with, in addition, the first intermediate frequency transformer primary tuning to the intermediate frequency of 125 kilocycles, this forming the second inductive circuit.

The third and fourth circuits constitute the main part of the oscillator circuit, and are both inductively coupled to the above-mentioned. The local oscillations are generated by coupling the first of these two last circuits (tuned to a frequency of 125 kc/s higher than that of the incoming signal) to the second circuit, in this case aperiodic, and which is located in the cathode return of the valve. In its turn, it continues through a paralleled biasing resistance and by-pass capacity to a further aperiodic circuit inductively coupled to the aerial before passing to earth. The energy is fed to the control grid by varying the potential of the cathode at the oscillatory frequency in respect to the control grid. The oscillatory circuit is completed via a small, common, trimming condenser (which is the capacity already mentioned in reference to the first valve anode circuit); this condenser serves the triple purpose of tuning the anode circuit to the input frequency, and the primary of the intermediate frequency transformer to its operating frequency of 125 kilocycles, and oscillatory coupling condenser. If, therefore, we receive a signal on, say, 300 metres (1,000 kilocycles), it will be brought in amplified form to the anode of the first

PHILCO 8-VALVE SUPERHET  
(Model 247) for D.C. Mains.

valve. At this input frequency, the valve oscillatory circuit generates oscillations at 1,125 kilocycles, a frequency of 125 kilocycles higher than that of the incoming signal. As we have these two frequencies present in one common circuit (anode) it follows that a beat note will be generated of which the frequency will be, respectively, the sum and difference of 1,000 and 1,125, namely, at 2,125 and 125 kilocycles.

The beat note resulting from the sum of these two fundamentals is constantly changing as the input signal frequency is

## Bind Your Copies of "Practical Wireless"!

THE Binding Case for Volume 1, in Blue Cloth Boards, with Silver Lettering, and complete with title page and index, costs 2s. 6d. (by post, 2s. 9d.) from:

The Publisher,  
George Newnes, Ltd.,  
8-11, Southampton Street,  
Strand,  
London, W.C.2.

The index separately costs 4d. post free. All readers should have their copies of Volume 1 bound, and thus be able easily to refer to the contents, by means of the fully cross-referenced index.

Back issues to complete your volume may be obtained for 4d. each, post free, from The Back Number Department, Exeter Street, Strand, W.C.2.

altered when tuning in broadcasts on different frequencies, but their difference always remains constant, namely, 125 kilocycles. In consequence, as the primary of the intermediate frequency transformer is tuned to this frequency, it is passed on in this form to the next valve for amplification. The unwanted signal frequency, the oscillatory frequency, and the sum of these two are rejected. The 125 kilocycle signal is then passed through two pentodes, and again to a detector valve. Part of the rectified voltage is fed back through a resistance-capacity filter to the control grids of the two pentode intermediate frequency amplifier valves, of the variable- $\mu$  type, as grid bias, and thus controls the amplification of the signal passing through them. This, in effect, is the automatic volume

control. The rectified signal from the detector is then again amplified (resistance-capacity coupling), and finally passed through a centre-tapped secondary input transformer to the control grids of two pentode output valves, operating in push-pull. These valves deliver 6 watts undistorted output to the moving-coil speaker. The speaker field coil, in the D.C. mains receiver, is placed in the positive mains lead in order to effect the smoothing of any ripple in the valve-heater circuit supply. General high-tension smoothing is effected by iron-cored chokes in circuit with large-capacity condensers. The voltage-dropping resistance for the heater circuit of the valves is in the form of a regulator lamp; when in operation it plays an important part in determining the value of the grid bias applied to the output valves.

The station selector knob, immediately below the grid, operates the triple-ganged tuning-condenser; its working is remarkably smooth, and the slow movement such that it is possible to tune a station in and out within a fraction of a degree. The figures on the illuminated scale are always visible; they represent channel numbers which, with the addition of an "imaginary" zero, correspond with the kilocycle frequencies on which the transmitters operate, as shown in the wavelength lists of broadcasting stations. The high-frequency band

or lower wavelengths are indicated on the upper portion of the scale, and the low-frequency band or long wave stations, at the bottom of the scale. The actual range of the receiver is 200 to 545 metres (1,500 to 555.5 kc/s), and 1,000 to 2,000 metres (300-150 kc/s). For the use of the British listener, however, although kilocycles are, no doubt, more accurate, it would perhaps be more useful to calibrate the dial in wavelengths, or, better still, to give both readings. The wave-change is effected by a small knob on the right-hand side of the front panel. Its opposite number on the left is a combined "on" and "off" switch and volume control. Here, again, the pattern used is an efficient one. Actually, the automatic control incorporated in the receiver tends to equalise the reception strength of all signals tuned in at the sound level for which the manual control has been set. This prevents the blaring of the more powerful transmissions whilst tuning is taking place, and somewhat reduces the fading of more distant stations. With the volume-control knob in a given position the reproduction on all signals will not vary greatly in strength even when passing from a weak to a strong broadcast, or vice-versa.

This equalisation of volume is a principle which might well be adopted by more manufacturers of wireless receivers. In addition, immediately below the main tuning knob, you will find one which also fulfils a very useful duty. It is a special control which permits the user to adjust the tone quality of the broadcast according to his taste. It is possible to compensate for small differences by emphasising the high notes, or by accentuating the lower notes. In the former case, this enables one to make speech particularly crisp and clear and, alternately, giving more emphasis to the lower notes reduces, to a great extent, static and other electrical interferences.

The only three connections to be made to put the receiver into operation are the

(Continued on page 1256.)

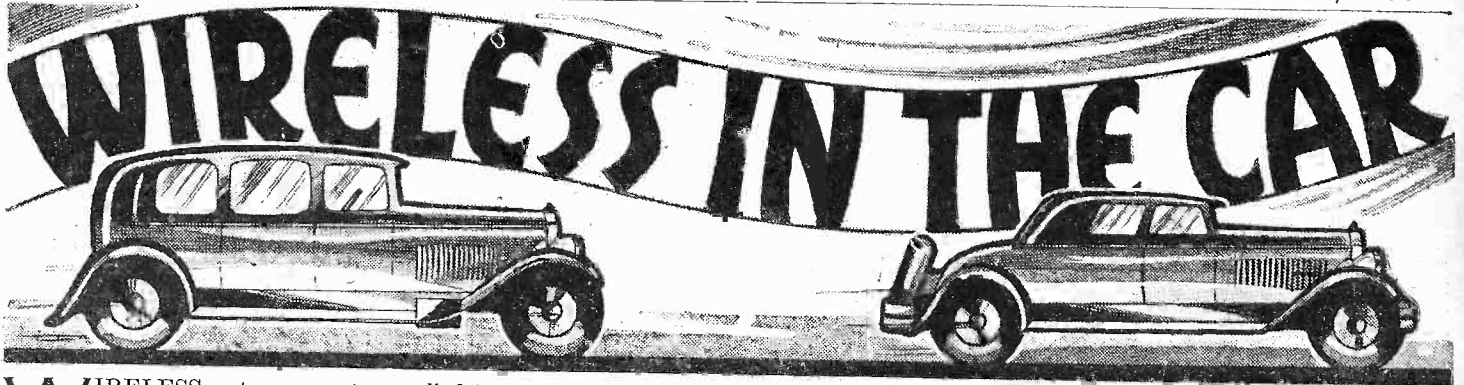

**W**IRELESS sets are not supplied as standard fittings on any British cars, but they do form part of the regular equipment of a few luxury "automobiles" made in America. Whether or not a receiver is desirable in the family car, I am not prepared to discuss, but it is both interesting and instructive to attempt to use one whilst the car is in motion. When a first attempt is made to use a receiver under such circumstances a number of difficulties immediately present themselves.

**SPECIAL RESISTANCE**

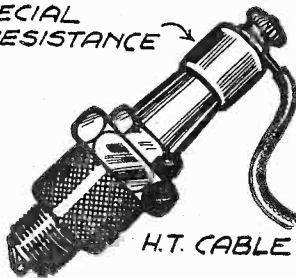

Fig. 1.—Method of fitting immediately special "anti-interference" present resistance to sparking plug.

If the set is of the ordinary type and the car has not been specially modified, the only "signals" that can be heard when the engine is running are those "transmitted" by the ignition equipment. And these are reproduced as a very loud and continuous crackle which completely drowns the reception of any legitimate broadcast. Thus, the first problem that arises is "How can the ignition interference be cured?" The simplest way is to insert a 100,000 ohm resistance in the lead to each sparking plug. If reliable metallized resistances are employed they will have no effect on the normal running of the engine, but will reduce interference very considerably. The easiest way to fit the resistances is to cut all the high-tension cables, solder each side of the cut to the resistance connecting wires and then cover the whole very thoroughly with insulation tape.

**SILK COVERED FLEX**

A neater job will result if use is made of the special resistances made by Messrs. Dubilier and also by the makers of Lodge sparking plugs. These latter take the form of a small cylinder fitted with a terminal. They screw on to the plug in place of the usual terminal nut and the high-tension wire is then attached to the terminal of the resistance as shown in Fig. 1.

**An Earth Lead**

Sparking plug resistances do not entirely eliminate ignition interference and the

Our contributor JACE here discusses the problems which arise when using a receiver in a motor-car.

next step is to fit an earth lead to the set.

It is obvious that an earth connection of the normal kind is entirely out of the question, but the chassis of the car provides almost as good an earth as does a water pipe or buried plate. All that is required, then, is a wire to a convenient chassis nut, or in the case of a car with a single wire lighting system, to the negative battery terminal. If the set is a portable, and not fitted with an earth terminal, connection should be made to the negative terminal of the low-tension accumulator.

**Screening**

After making the two alterations suggested above there should only remain a faint sign of interfering crackles which should certainly not be so loud as to drown reception. A further improvement can be effected by screening the set; this can be done by lining the containing case with tin foil and connecting the foil to the negative low-tension lead. Before going to the trouble of removing the "innards" for this purpose a trial can be made by covering the outside of the case with foil, or better still, with thin sheet copper.

Whatever form of screening is adopted, care should be taken that all the sheets of metal forming the screen are effectively connected together. If copper sheet is employed the joints should be soldered, but with foil the easiest way is to cover the joints with strips of metal screwed to the

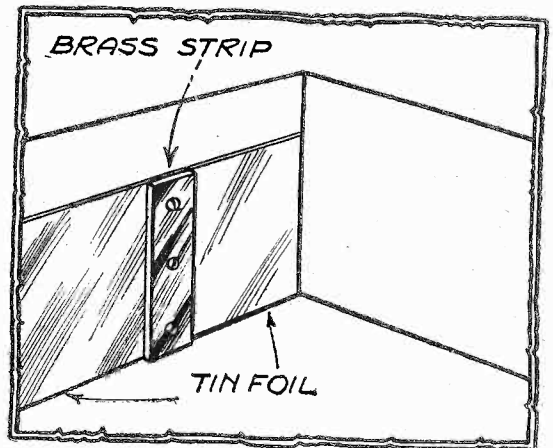

Fig. 2.—Joining together two pieces of tinfoil forming a screen.

case as shown in Fig. 2. When the set works from a frame aerial, this should certainly not be screened, for if it is, no signals will be received at all.

**The Aerial**

A frame aerial does not generally provide an efficient "collector" on account of the very great shielding effect of the metal bodywork panels, so it is better to employ a larger aerial exterior to the set. The best aerial would be one elevated slightly above the roof, but that would certainly affect the appearance of the car and would, in most cases, be undesirable.

A fairly good substitute can be provided by using a length of "Pix" aerial material. This consists of a 30ft. length of adhesive tape through which runs a strip of copper-foil. The tape can be attached round the edge of the fabric roof and a lead-in taken through a window, louvre or roof ventilator; since the material is very thin it will not interfere with the normal closing and opening of either the window or ventilator. The "Pix" aerial material is supplied in various colours

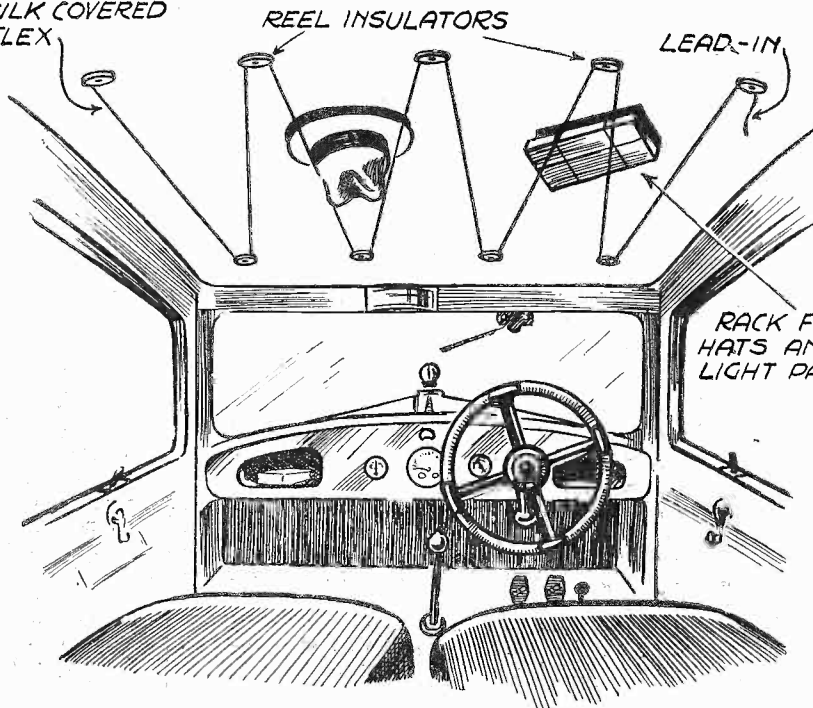

Fig. 3.—An inside aerial which also serves as a rack for hats and light parcels.

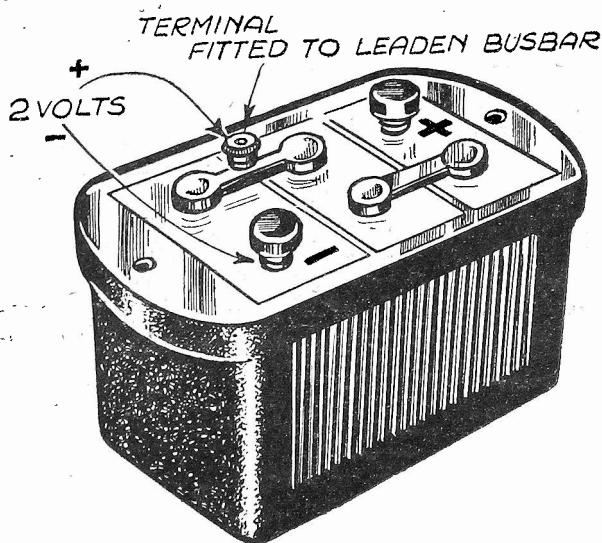

Fig. 4.—A terminal fitted to a lead busbar to provide a 2-volt tapping on the car battery.

and one can be chosen to match the colour scheme of the car. It is not really intended for outside use so it is best to apply a thin coat of varnish after sticking it down in order to protect it from the weather. In most cases the car will not be sufficiently large to take the whole 30ft., but even a much smaller length will give satisfactory results. When the car has fabric body-work, an inside aerial will be fairly efficient since the body will not exercise any great shielding effect. A suitable inside aerial can be made from one of the many kinds of silk-covered wires sold for use as ordinary domestic inside aerials. The wire is obtainable in several colours, and so it can be chosen to match the interior furnishings.

The aerial can simply be wound round the sides of the roof or it can be made in the form illustrated in the sketch of Fig. 3; it is taken from end to end of the roof in zig-zag fashion and is supported on small reel insulators, screwed to the top. As an alternative to reel insulators ordinary insulated hooks could be used. In addition to acting as an aerial the wire will prove useful as a rack for hats or light parcels.

**Power Supply**

Having decided on the type of aerial to be employed we might give some consideration to the matter of the power supply. Most portable sets have self-contained batteries, so these can be employed if desired, but putting extra batteries into a car does seem rather like "taking coals to Newcastle." The car battery can be employed for low tension supply, and the extra drain on it will be quite inappreciable. But since the set will only require 2 volts, whilst the battery gives either 6 or 12 volts, a regula-

ting resistance will be necessary. The correct value for this can be calculated by the use of our old friend, Ohm's Law; thus Resistance Required equals voltage to be dropped (4 or 10 according to voltage of battery) divided by the L.T. current consumption of the set. A suitable resistance can be made in the manner described in a recent article; it will be advisable to make it to have a resistance somewhat in excess of the calculated value, and to use a tapping clip so that the best position can be found by trial. From the point of view of valve life it will be best to use the highest value of resistance with which satisfactory reception is possible.

As an alternative to using a regulating resistance the L.T. supply can be taken from a single 2 volt cell of the accumulator by attaching a terminal to one of the lead busbar connectors (see Fig. 4), and taking wires from the extra terminal and the negative accumulator terminal.

**Connecting to the Car Battery**

Connection to the car battery can generally be made through sockets provided on the fascia board (for connecting an inspection lamp, etc.), but where these are not fitted, leads must be taken to the battery itself. In the former case it will be necessary to determine the polarity of the sockets, and this can be done by connecting a lamp bulb between the negative battery terminal and each socket in turn; the socket which causes the bulb to light will be positive. When the lighting is on the single wire system (only a single wire connection being made to each lamp) the voltage regulating resistance, if used, should be connected in the positive lead. The negative will already be connected to the chassis, and so no other earth connection will be required.

**Making a Special Set**

Our attention so far has been confined to the question of using an ordinary fixed or portable set in the car, but there might be a number of readers who would prefer to make a set specially for the job and to instal it as a permanent fitting.

**Circuit Details**

First we must decide on the most suitable type of circuit. As the principal requirement will be ample volume from the nearest Regional, a single S.G. valve followed by a detector and two L.F.'s will fill the bill. A small and comparatively inefficient aerial will be employed, and so our S.G. stage must be as good as possible. Tuning must be easy and "steady" so that it will not readily be upset by vibration or jolts. A very high degree of selectivity is not called for and therefore a band pass tuner is not in the least necessary.

**Solid Construction**

The next essentials are that the set should be very strongly constructed and housed in a substantial case. It should not fit rigidly into the containing case, but must be mounted on rubber buffers which will insulate it from road shocks. These latter can best take the form of sponge rubber pads fitting between the receiver chassis and the case. Compactness is a desirable feature which should be studied in conjunction with the question as to where the outfit is to be placed. To accommodate the components in a small compass it will be best to use a "box-form" chassis and to mount most of the low frequency-components on the under side of the base-board. As is always the case when components have to be crowded to a certain extent, all parts associated with the tuning circuits should be fitted with screening cans.

**The Position of the Set**

In a large car there is not likely to be much difficulty in finding a place for the set; it will generally fit either below the fascia board or behind the front seats. But in the case of a car coming within the "baby" class the question of accommodation is more difficult.

I recently solved the problem fairly satisfactory by making a set to fit into a container 12 inches square by 4 inches deep and fixing it to the side of the car above the rear wheel arch. A speaker of similar dimensions was mounted opposite the set over the other arch as shown in the sketch of Fig. 5. Of course, this limited the seating room of the back seat to a single person, but in any case it would have been a squash for two. Whenever a set is made specially for the car it should always be designed so that it can take the whole of its power from the accumulator so that battery replacements will never become necessary.

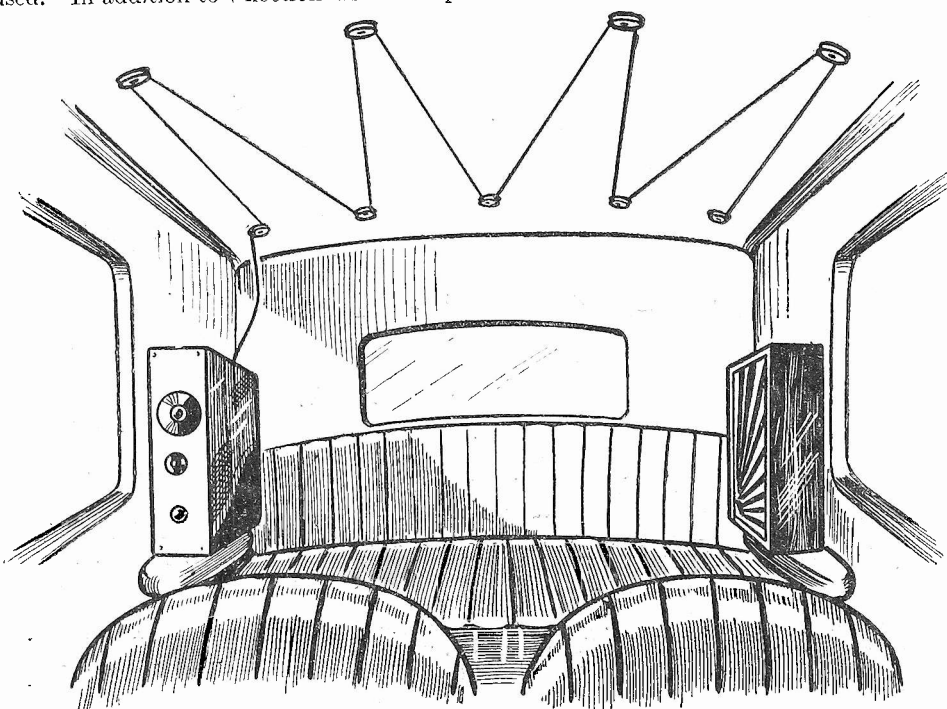

Fig. 5.—Receiver and speaker mounted over the opposite wheel arches in a small car.

# Reducing the Number of Controls

In this Short Article a Contributor Explains how many of the Panel Controls can be Ganged Together so as to Simplify the Operation of the Set

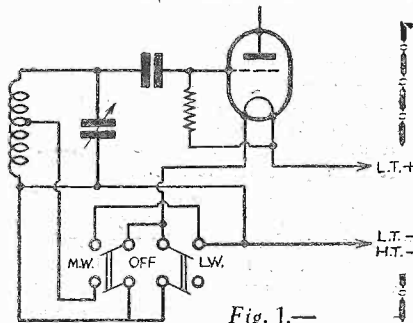

Fig. 1.—A rotary 2-way switch used as a combined battery and wavechange switch.

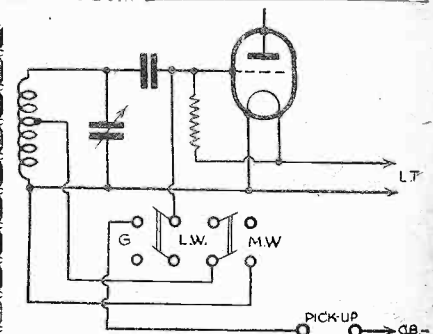
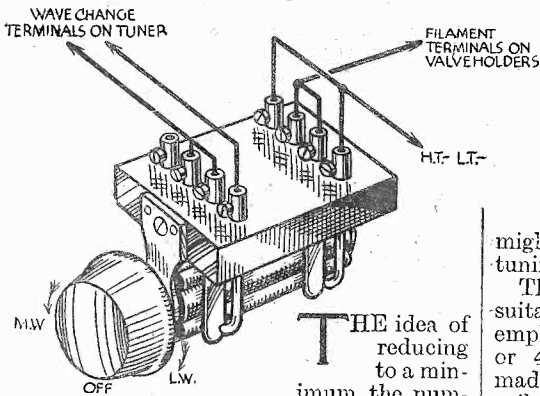

Fig. 2.—Showing how a single component can be used as combined wavechange and radio-gram switch.



THE idea of reducing to a minimum the number of receiver control knobs was started by the manufacturers of commercial broadcast sets some years ago, and it has proved very popular indeed. The great simplification effected in this way has considerably improved the appearance of contemporary receivers, and has made it much easier to build them into cabinets which are more in keeping with furnishing schemes. It has also simplified the operation tremendously, bringing easy tuning within the possibilities of the most inexpert and unmechanical listener.

I would not suggest that the experimenter should attempt to reduce the number of controls on his receiver to the bare minimum of a tuning knob and on-off switch, as some manufacturers have done, because he can get infinite delight from making delicate adjustments of all sorts, but I do think the time has come when he should give more attention to the matter of combining controls in such a way that one knob may be used for two or more purposes. Nearly every amateur now uses ganged condensers, but how many are there who "gang" the other controls such as on-off and radio-gram switches, pick-up potentiometer and reaction condenser, wave-change switch and radio-gram switch, to mention just a few examples? All these, and many more, operations can now be combined by the use of components already on the market. In many cases it is cheaper to use combined controls than separate ones, and there is no doubt that the appearance of the complete receiver is considerably enhanced by so doing. As there are probably a number of readers who do not realize the possibilities which lie in the direction I have indicated, perhaps a few practical examples will be of assistance.

### Combining On-off and Wavechange Switches

It is a very simple matter to combine the battery and wavechange switches in the manner indicated in the sketch of Fig. 1. A simple 2-way rotary switch takes the place of the more usual pair of push-pull switches, and the connections are just as simple as when separate components are used. When the knob points "straight

up" the set is switched off; turning the knob to the left switches on to "medium waves," and turning it to the right puts the set on to "long waves." The only point to watch when buying the switch is that it is of the low-capacity type, because otherwise it might have some effect on the correct tuning of the set.

The 2-way switch shown is only suitable where a single tuning coil is employed, but by using a 3-point or 4-point component it could be made to operate on two or three separate coils in precisely the same way.

### R.-G. and Wavechange Switching

A similar type of switch can be connected in the manner shown in Fig. 2 to serve the dual purpose of changing from radio to gramophone and from one waveband to another. When the knob is in its central position all the contacts are "open" and the set is on long waves, but by turning it to the left medium-wave tuning is obtained, whilst turning it to the right transfers the connection going to the grid terminal of the valve holder from the tuning coil to the pick-up terminal. This method is only applicable when the pick-up is connected in the grid circuit of the detector valve, or of an L.F. valve using resistance capacity coupling. If it were used with a transformer coupled valve the pick-up would be put in parallel with the transformer secondary winding, and that would have the effect of reducing volume and also of impairing the response of the pick-up to the high notes.

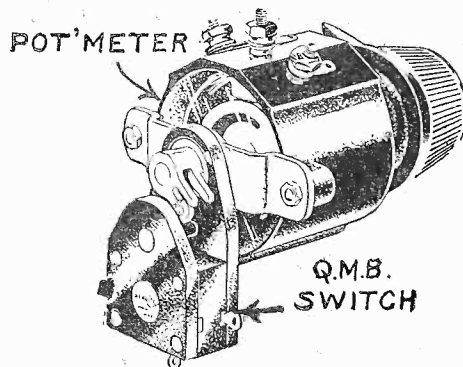
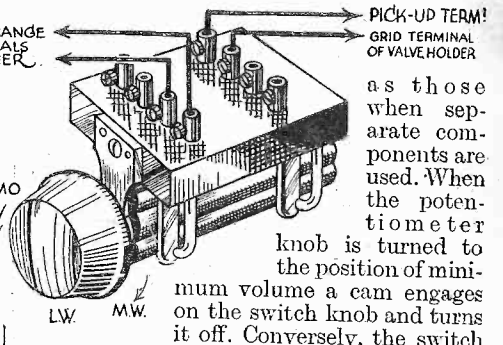

Fig. 3.—A combined potentiometer and battery switch.

### Volume Control and On-off Switch

Where a potentiometer is used as a volume control, either in the grid circuit of an L.F. valve or for varying the screening grid potential to an S.G. valve, a knob can be saved by employing a combined potentiometer and switch of the type shown in Fig. 3. All connections are just the same



as those when separate components are used. When the potentiometer knob is turned to the position of minimum volume a cam engages on the switch knob and turns it off. Conversely, the switch is turned on by moving the knob slightly in a clockwise direction, and then the potentiometer can be used in the normal way while the switch remains in the "on" position. This idea is very convenient with a mains set because after first switching on, the potentiometer can be left in the position of minimum volume until the cathodes heat up, thus reducing initial mains hum to the lowest possible limit. Incidentally, it might be added that all the switches used on combined components of the type suggested are of the quick-make-break variety, and are therefore equally suitable for use in either a mains or battery set.

### Potentiometer Reaction Control

By slightly modifying the receiver connections the potentiometer can be used as an excellent reaction control, for which purpose it is generally a good deal more efficient than the usual reaction condenser. It is only necessary to remove the variable reaction condenser, replace it by a fixed one of similar capacity, and connect two terminals (the centre and an outside one) of the potentiometer in series with it. The exact wiring is clearly shown in the sketch and diagram of Fig. 4, from which it will be seen that the potentiometer is used as a series variable resistance between the anode of the detector valve and the reaction winding; as the resistance value is increased the degree of reaction coupling is reduced, and vice versa. This is an excellent, though little known, method of reaction control, and I have just embodied it in a new receiver with great success. Besides acting as a reaction control the resistance also serves to decouple the reaction winding, and so entirely prevents the instability and hand-capacity effects so frequently met with in a sensitive receiver. The best value for the potentiometer is not by any means critical, but is generally about 15,000 ohms. Incidentally, a rather smoother reaction adjustment is possible if a "graded" type of potentiometer is used.

### Dual Volume Controls

It is very convenient to use a pair of ganged potentiometers for reaction and



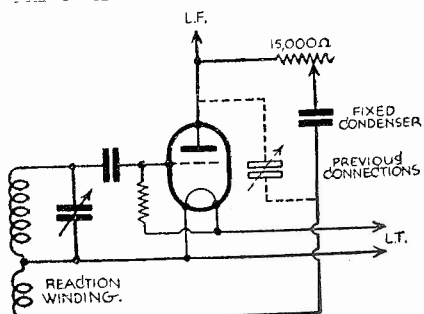

Fig. 4.—The method of using a potentiometer or variable resistance as reaction control; the potentiometer may be combined with an on-off switch if desired.

pick-up volume control in the manner suggested in Fig. 5. One unit is wired up exactly as described above, and the other is connected to the pick-up terminals and also to the radio-gram switch. This is a very logical system because it makes possible the regulation of volume on either radio or gramophone by the same knob.

**Other Arrangements**

A similar pair of potentiometers can be used for a set fitted with a variable-mu valve; one component is arranged to provide a variable grid bias voltage to the V.-M. valve and the other is used as pick-up volume control. If a little care is taken in choosing suitable resistance values, one potentiometer can be used to vary the screening grid voltage to an S.G. valve, whilst the other controls the degree of reaction. In this case the two components must be wired in "opposition," that is, in such a way that whilst one reduces the

S.G. voltage, the other simultaneously increases reaction by reducing the series resistance. This combination is a very good one and gives the very effect that is aimed at when using separate controls. As you know, the method of obtaining increased selectivity with an S.G. receiver is to reduce the sensi-

tivity of the first valve by lowering its screening grid voltage, and at the same time to increase the sensitivity of the detector by applying more reaction.

I have not by any means mentioned all the possibilities of dual controls, but I think that sufficient has been said to enable the reader to devise similar schemes which will be applicable to his own receiver. If a word of warning is necessary it is this: take great care that the wires to the dual-purpose components are not allowed to run parallel to each other because, since the terminals are of necessity fairly close together, unwanted capacity might be introduced which would affect the set's stability. This applies principally, of course, to wires in high-frequency circuits, like those going to radio-gram switches, S.G. volume controls and

wave-change switches, but it is well to play for safety by making the rule of general application.

If by chance there are any readers who are unfamiliar with the components referred to, it may be stated that all types of combined and ganged volume controls and switches are made by Messrs. Bulgin and Messrs. Wearite. Both makes are available in any required combination or resistance value. The multi-way anti-capacity switches are also made by the latter firm, and can be obtained with either lever or knob operation. Needless to say, any good radio dealer can supply the parts, so there is no need to order specially from the makers unless some difficulty is encountered in obtaining them through the usual channels.

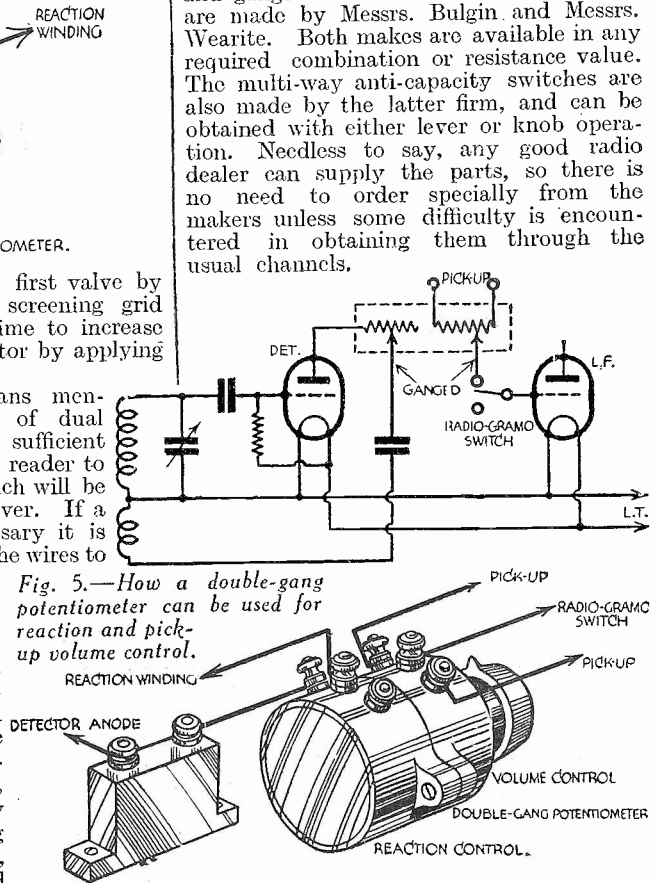

Fig. 5.—How a double-gang potentiometer can be used for reaction and pick-up volume control.

THE value of magnet steel to the user, whether it be the field magnet of a loud-speaker or for any other purpose, depends primarily upon the energy which, when correctly applied, a magnet will sustain in its external field. There are exceptions to this so far as the commercial value of a magnet steel is concerned, but for the time being these can be ignored.

To those not accustomed to this manner of expressing the value of a magnet the meaning may seem a little obscure. To make it clear let us suppose that a magnet be constructed, jointed in some way, so that its poles could come together, then in coming together they could be made to do work, such as lift a weight through a height, and this could be at once expressed in ft./lbs. energy. As a matter of fact, in this way a magnet could do more work than at the outset existed in the gap, because there is also energy in the magnet itself which partly comes out and becomes available when the gap is closed, but this need not trouble us, the idea of a definite quantity of energy in the gap has been made clear.

Now the unit of energy employed to match B (expressed as lines of force per cm.<sup>2</sup>) and H (in gauss) is the erg. We shall say nothing about this unit except that 10,000,000 ergs go to the joule, which is the electrical engineer's unit of energy, such that 1 joule per second=1 watt, or 746 joules per sec.=1 h.p., or 1 joule=.7373 ft./lbs. The ergs per cubic centi-



metre are given by the expression  $\frac{B \times H}{8\pi}$ , or conveniently,  $\frac{B \times H}{25}$ , or Joules =  $\frac{B \times H}{25 \times 10}$

The most favourable or optimum value of B x H for different grades of magnet steel is usually to be found in the manufacturer's catalogue or handbook, thus as average figures, we may take the following Col. 2 as representing "BH max." for cobalt steels of the percentages given:—

% Co.	BH max.	Joules per lb. of steel	Price per lb. pence.	Price per Joule s. d.
3%	350,000	.080	13	13 6
6%	420,000	.096	16	13 11
9%	480,000	.110	19	14 6
15%	600,000	.136	25	15 4
35%	900,000	.205	45	22 0

Col. 4 gives the cost per joule on the basis of prices given in Col. 3.

The makers of magnet steel find it impossible to ensure every casting, or length of bar, coming out exact to sample, and the question of rejection limits is thus a matter of difficulty. Also, when deliveries are below sample, but not down enough to reject, the same difficulty arises. The fair solution in the latter case is clearly to pay on *computed energy content*; when buying magnets it is *field energy* that is the commodity purchased. Thus in the case of a given magnet assembly the energy value is the measure of the B in the gap *squared*, the sample being taken as datum.

**Loss of Field Strength**

Another point of importance is the loss of field strength with time. In this different magnet samples differ greatly amongst themselves. It is commonly found that a sample which is exceptionally good, or above the average, holds its field better than one that is below standard in the first instance. Most of the loss takes place within the first month after being magnetized, after that the magnet has reached a stable condition, but there are exceptions even to this. The reduction in field strength is commonly about 5 per cent. and 10 per cent., but is sometimes as much as 15 per cent., or even more.

SEND FOR YOUR COPY OF THE WIRELESS CONSTRUCTOR'S ENCYCLOPÆDIA TO-DAY!

See page 1215.

# THE DESIGN OF LOUD-SPEAKERS—3

The Method of Suspending the Conical Diaphragm is Dealt With in this, the Third Article of the Series, by W. J. DELANEY

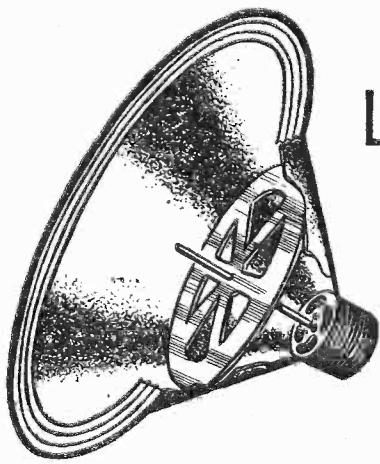

Fig. 1.—An ingenious double spider arrangement for ensuring centralisation of the speech coil.

LAST week we saw how the apex of the cone, or the point at which the speech coil is attached, is held so that the speech coil is accurately centred in the air gap surrounding the pole piece. It will be obvious to anyone that the weight of the cone, if the edge of it were not held in any way, would cause the cone to pivot about the axis formed by the centring spider, and consequently the speech coil would not remain truly centred. There must, therefore, be some arrangement to support the front of the cone, and it is here that the whole design of the majority of moving-coil speakers is spoilt. Last week we saw that the cone could be held, so far as the rear portion was concerned, so that, with a suitably designed spider, the speech coil was free to move in a true piston movement, over quite a considerable distance in the air gap surrounding the pole piece. Obviously this will enable more faithful reproduction to be obtained than with any of the other types of speaker previously mentioned. But this freedom of movement must not be destroyed in the remaining parts of the speaker make-up, and as the edge or front of the cone must be supported in some way, we seem that we have struck a snag. The commonest, and the oldest, form of holding the cone was to use a ring of rubber or leather stuck to the periphery of the cone, and clamped in a ring of plywood or similar arrangement, as shown in Fig. 1 last week. The method of attaching this was to turn over the edge of the cone for a distance of about a quarter of an inch and coat this with some sort of adhesive. It was then pressed against a square of rubber or leather, and when set the centre portion was cut away. The distance between the edge of the cone and the surrounding clamping ring was about half an inch, and to ensure that the cone would not twist, the material was stretched slightly when being clamped. What is the result of this arrangement? Obviously we have got back to the same fault that was found with the ordinary moving iron type of speaker—namely, a restoring force. If you can examine a speaker of this type you will find that the cone is held, almost rigidly, in a position where the surround, as we must call the leather, rubber, or other material, is perfectly flat. Now when the cone is drawn inwards it draws with it the surround, and as soon as the pulling motive is removed the surround pulls the cone back to a "normal" position. If the cone is driven forward, the same effect is present, and this naturally destroys quite

a lot of the advantage which has been obtained from the moving-coil principle.

## Round's Spider

One of the first developments which was introduced to overcome this defect was the idea known as the Round Spider, after the inventor, Capt. Round. This is illustrated in Fig. 1, and it will be seen that this is nothing more nor less than a second spider fixed towards the front of the cone. The pole piece was drilled centrally and tapped to accommodate a brass rod about 5-16ths of an inch thick. This projected almost to the front of the cone. About two-thirds of the distance along the cone a spider having only five thin radial arms was attached, and by suitable choice of the substance of this spider, and the length of the arms, great freedom of movement was obtainable, and the restoring force was almost entirely removed. There was still the tendency, however, to return to the position of rest, and although a great advance on previous arrangements it was still not perfect.

## Moulded Cones

The next step forward was the employment of vulcanized fabrics or other patented preparations which had the apex moulded to form a spider, and the speech coil was cemented to them. The periphery of the cone was moulded to form a number of circular corrugations (Fig. 2). This permits of the extreme edge being clamped, and the corrugations allow the cone to travel backwards and forwards fairly freely. This is a very good arrangement and is still adopted in a number of speakers at present on

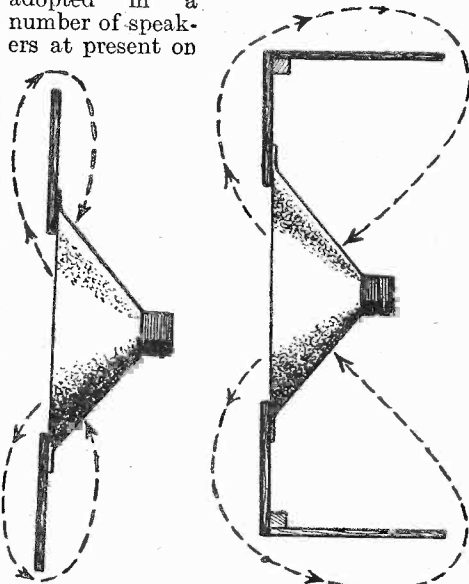

Fig. 3 and Fig. 4.—The manner in which a baffle prevents the sound waves from passing speedily from the front to the back of a cone.

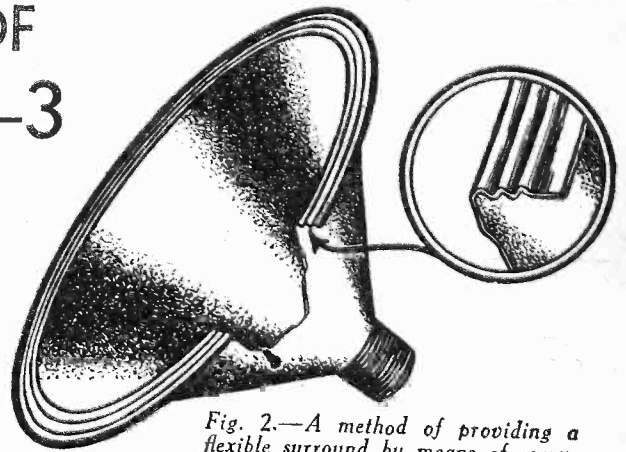

Fig. 2.—A method of providing a flexible surround by means of corrugations in the actual cone material.

the market. A further advantage of this method of building a cone is the avoidance of a seam which tends to break up the cone into sections and so produce unpleasant resonances. In Fig. 6 last week I illustrated a method of avoiding the centralizing spider, and mentioned that this was one of the most satisfactory solutions to the problem of centralization. This particular loud-speaker employs a material surrounding the edge of the cone, and this is secured to a wooden baffle. But to avoid the restoring force which is usually obtained by a surround, this firm employs a most interesting device. The cone is first of all cemented to the surrounding material, and when perfectly secured, this material is attached to the baffle by a slow-drying adhesive. The speaker is then placed on a raw A.C. supply of about 50 cycles, and this naturally causes the speaker diaphragm to vibrate backwards and forwards over a fairly large movement. It is left connected to this supply and allowed to vibrate until the adhesive has dried, after which it is, of course, still free to carry out movement at this low period. This device is, needless to say, patented and is, in my opinion, one of the most effective devices as yet developed.

## Angle of the Cone

There are many other features which enter into the quality of the reproduction, and the volume obtained from a moving-coil speaker, and it is possible to write a book upon the subject. Before closing this short series of articles, however, I must mention the fact that the actual shape of the cone has quite a large effect upon the output of the speaker. If the cone has steep sides, that is, if it resembles the cone in which ice cream is obtainable in the summer, it suffers from what is known as "focusing," that is, the sound is directed forward in a narrow beam, and the intensity of the sound when the listener stands a little to one side falls off tremendously. As the cone becomes more flat, so the radiation spreads out, and it would seem from this, that the ideal would be a flat diaphragm. So far, however, I have only seen one speaker which employed such a diaphragm, and this was at one time on the market in a commercial radiogram costing over one hundred pounds. A flat diaphragm requires very much more energy to set it in motion, and also presents a difficulty in attaching the speech coil, so that it may be positioned within the air gap of the magnet system. This particular model to which I have just referred employed a disc of wood,

(Continued on page 1240.)

FOR EVERY SET — there's a

# PILOT AUTHOR KIT

CASH — C.O.D. — or H.P.

**SEND  
2/6  
ONLY**

Just pay a further 2/6 on delivery and balance in 5 monthly payments of 5/6 for

**PETO - SCOTT GUARDIAN Q. P. P. MOVING-COIL SPEAKER** specially designed for Q.P.P. output. Extremely sensitive, and gives perfect quality. Cash or C.O.D., Carriage Paid, 29/6.

**LISSEN "SKYSCRAPER 3."** Chassis model with (Lissen) S.G., Detector and Pentode valves. Cash Price £4/9/6. Carriage Paid. Balance in 11 monthly payments of 8/3. Send **8/3** only

**LISSEN "SKYSCRAPER 3."** Cabinet model. Complete with Lissen speaker and Lissen S.G., Detector and Pentode valves. Cash Price £6/5/0. Carriage Paid. Balance in 11 monthly payments of 11/6. Send **11/6** only

**TELSEN "ASTRALA 3."** Chassis kit complete with full-size Blueprint, building and operating instructions. Detector, L.F. and Power. Cash or C.O.D., 39/6. Balance in 7 monthly payments of 5/6. Send **5/6** only

**ROLA PERMANENT MAGNET MOVING-COIL SPEAKER F.6.** With Universal tapped input transformer. Cash Price £2/9/6. Carriage Paid. Balance in 11 monthly payments of 4/6. Send **4/6** only

**W.B. PERMANENT MAGNET MOVING-COIL SPEAKER.** Type PM4. Complete with transformer. Cash Price £2/2/0. Carriage Paid. Balance in 7 monthly payments of 5/9. Send **5/9** only

**CELESTION P.P.M. PERMANENT MAGNET MOVING-COIL SPEAKER** with impregnated diaphragm and dual-impedance input transformer. Cash Price, Carriage Paid, £2/7/6. Balance in 11 monthly payments of 4/6. Send **4/6** only

**NEW BLUE SPOT 29 P. M. MOVING-COIL SPEAKER.** Cash or C.O.D. Carriage Paid, £1/12/6. Balance in 6 monthly payments of 5/2. Send **5/2** only

**NEW BLUE SPOT 45 P.M. MOVING-COIL SPEAKER.** Cash or C.O.D. Carriage Paid, £2/5/0. Balance in 11 monthly payments of 4/2. Send **4/2** only

**BLUE SPOT UNIT AND CHASSIS.** Type 99 P.M. Including matched transformer. Cash Price £2/19/6. Balance in 11 monthly payments of 5/6. Send **5/6** only

**EPOCH 20th CENTURY PERMANENT-MAGNET MOVING-COIL SPEAKER.** (New Edn.). With 5-ratio input transformer. Cash Price, Carriage Paid, £1/15/0. Balance in 5 monthly payments of 6/6. Send **6/6** only

**R & A "CHALLENGER" PERMANENT-MAGNET MOVING-COIL SPEAKER.** With special Ferranti multi-ratio input transformer. Cash Price, £1/15/- Carriage Paid. Balance in 5 monthly payments of 6/6. Send **6/6** only

**GARRARD INDUCTION GRAMOPHONE MOTOR.** For A.C. Mains. Model 202. Mounted on 12-inch nickel motor plate with fully automatic electric starting and stopping switch. Cash Price, £2/10/0. Carriage Paid. Balance in 11 monthly payments of 4/7. With **4/7** order

**ATLAS ELIMINATOR.** Type A.C.244. Three tappings: S.G., Detector and Power Output: 120 volts at 20 mA. Cash Price £2/19/6. Carriage Paid. Balance in 11 monthly payments of 5/6. Send **5/6** only

## FURY FOUR

BATTERY MODEL

**KIT "A"** Author's Kit of specified parts, including ready drilled panel, but less valves and cabinet. CASH OR C.O.D. Carriage Paid.

**£6 : 10 : 0**  
or 12 monthly payments of 12/-

**KIT "B"** As Kit "A" but with valves, less cabinet, CASH or C.O.D., Carriage Paid. **£9 7 6** or 12 monthly payments of 17/3.

**KIT "C"** As Kit "A" but with valves and Peto-Scott American Type Cabinet with lift-up lid. CASH or C.O.D., Carriage Paid. **£10 2 6** or 12 monthly payments of 18/6.

## PUSH-PULL THREE-FOUR

**KIT "A"** Author's Kit of First Specified parts, including ready drilled panel, but less valves and cabinet. CASH OR C.O.D. Carriage Paid. **£4 : 18 : 6**

or 12 monthly payments of 9/-

**KIT "B."** As Kit "A" but with valves, less cabinet. CASH or C.O.D., Carriage Paid. £7/7/-, or 12 monthly payments of 13/6.

**KIT "C."** As Kit "A" but with valves and Peto-Scott American Type Cabinet with lift-up lid. CASH or C.O.D., Carriage Paid. £9/2/-, or 12 monthly payments of 14/10.

## SNIP

Special Bargain Offer to "Practical Wireless" Readers.

## BLUE SPOT 100U

Speaker and Chassis. For high or low-powered sets. Original Price £1 12s. 6d. Our Price (for a limited period only) CASH or C.O.D.

**19/6**

### CONVERT YOUR SET TO Q.P.P.

#### PILOT Q.P.P. CONVERSION KIT FOR ANY BATTERY SET GIVES MAINS VOLUME AND MOVING-COIL QUALITY

Convert your set to Q.P.P. — it's easy with the **PILOT CONVERSION KIT**, which comprises 1 Q.P.P. Transformer, 1 Q.P.P. Output Choke, 4 Non-inductive Resistances, 1 Potentiometer, 2 Mansbridge Condensers, 2 Valve Holders, 1 Tone-Compensating Condenser, 1 H.F. Choke, G.B. Plugs, Wires, Screws, Flex, etc., with FULL SIZE diagrams and constructional notes. Cash or C.O.D. 42/6 Carriage Paid. **KIT "B."** As above, with 2 Pentode 220A valves. Cash or C.O.D., £3/17/6 or 12 monthly payments of 7/-.

SEND ONLY **6/-**

Balance in 7 monthly payments of 6/-.

#### FREE WE WILL CONVERT YOUR SET TO Q.P.P. FREE.

•FREE collection and delivery within 10 miles radius of Charing Cross. Country orders carriage paid one way, providing customers purchase from us necessary components including valves.

We also invite inquiries for the repair and modernising of all makes of receivers, including home-constructed sets. Customers sets of parts built up at low cost.

Write Technical Department, Pilot Repair Service, 77, City Road, London, E.C.1

## CASH, C.O.D. or EASIWAY

**FREE.** — Send 3d. postage for 3 Pilot envelopes with full-size blueprints

**PETO-SCOTT CO. Ltd. 77, City Road, London, E.C.1.** Telephone: Clerkenwell 9406/7 West End Showrooms: 62, High Holborn, London, W.C.2. Telephone: Holborn 3248

Dear Sirs, Please send me CASH/C.O.D./H.P. for which I enclose £..... CASH/H.P. Deposit. Also FREE Guardian Q.P.P. 1/- Constructional Chart.

NAME..... ADDRESS..... Pr W 18-3-33

## Send for Free 1/- Constructional Chart and Full Size Blueprint NEW REVOLUTIONARY Q.P.P. KIT SET

(Continued from page 1238.)

and to break it into sections and prevent resonances, small pieces of wood were glued to it at various positions. It certainly gave a wonderful response.

#### Dual Units

From what has already been said it is clear that there must always be present a fault of some kind, and this means that the speaker has resonances at one end or other of the frequency spectrum. For instance, if the speaker diaphragm is too firmly held, it will fail to do justice to the low vibration of our drum. On the other hand, if too freely suspended, the high notes, which require a very quick movement, will tend to be sluggish; or the particular material of which the diaphragm is made may result in a certain frequency receiving undue prominence. To attempt to overcome these faults it has now become popular to produce what is known as compensated, or dual units. This consists of two loud-speakers mounted on one large assembly. One unit is designed so that it does justice to one part of the musical range, and the other attends to the remainder of the range. In this way it is possible to get a better over-all response than

is possible from one unit which is designed to attempt to cover the entire range.

#### Baffles

It is now well known to all listeners that the moving-coil type of speaker requires a baffle. Why? In the first article of this series, I illustrated the principle of sound reproduction by showing the movement of the air caused by the vibration of a drum-head. If you refer back to this, you will see that the movement was slow—actually fifty vibrations a second. Now our loud-speaker possesses quite a small diaphragm, and it will be assumed that it is capable of travelling at this slow speed. If you remember, I said that the sound was caused by a rarefaction and compression of the air, and we must now see how this affects our cone diaphragm. When it is drawn inwards the air will follow the cone and become rarefied. Obviously, it is not possible to leave a "space" in the air, and naturally all the surrounding air will rush in to fill up the gap which is being created. Some of this air will naturally come from the front of the cone, but as the cone is pushing the air at the back into a state of compression, obviously this air will prefer to slip round to the rarefied part in the front, instead of being com-

pressed. The same thing will happen when the cone is driven forward on the other half of the note—the air in front, in preference to being compressed, will slip round the edge of the cone to the rarefied atmosphere which is being created at the back. We will not, therefore, get our piston movement of the air at a distance from the speaker. In other words, the sound vibration is cancelled out. To prevent this, we use what is known as a "baffle." This consists in the simplest form, of a flat wooden board, sufficiently thick to prevent it resonating at a frequency within the audible range, and having a hole cut in the centre, just a little bit smaller than the overall diameter of the mouth of the cone. When the cone is pushed forwards the air in front is compressed (as in our drum illustration), and it cannot get round to the rarefied area at the back without travelling along the front of the baffle and then along the back. The same thing occurs on the opposite movement, and so the air receives the full effect of the movement of the cone. Fig 3 shows the effective size of the baffle, which, it will be noticed, is from the front of the cone, back to the rear of the cone, and not simply from the cone to the edge of the baffle. Three feet is the smallest size which is advisable.

**A**T the present moment there are two new wireless features which are being introduced to the wireless amateur. The first is, of course, Quiescent Push-Pull, about which quite a lot has already been said in these pages. The other which has so far only been introduced to our readers, is the new type of coil known as Ferrocart.

This introduced, in the manner described in an earlier issue, a very high degree of selectivity into a receiver—much higher, in fact, than has hitherto been thought possible without introducing the super-heterodyne principle. We have given circuits and constructional data relative to the Q.P.P. principle, and all that remains is to introduce a receiver employing the Ferrocart coils. Unfortunately, these have not been obtainable until now, and therefore our readers have not been able to receive any constructional hints.

After tests, we have decided that the interests of the keen amateur would best be met by employing this type of coil in a receiver employing a variable mu valve for

### NEXT WEEK! THE FERROCART Q.P.P. HI-MAG. THREE

the H.F. stage, with a high efficiency detector valve. This would introduce a high-gain receiver with a high degree of selectivity, and would naturally enable a large number of stations to be tuned-in free of interference. The question then arises as to what form of L.F. amplification to adopt in order to ensure that these numerous stations shall be reproduced at a signal strength which is desirable, if the station is to offer real entertainment value. Obviously a pentode could be used but the anode current is high for this type of valve, and this would require a large capacity H.T. battery. Two L.F. stages would introduce difficulties in choosing the

transformers or other coupling units. It was decided, therefore, after a few experiments, to incorporate Quiescent Push-Pull, and so introduce into the one receiver the very latest in wireless practice, both for the H.F. side of the receiver and also the L.F. side.

As the coils are fairly expensive, and a three-gang condenser was chosen, it was decided to keep the total cost of the receiver within the limits of the purse of the majority of our readers, and therefore, in place of pentode valves in the output stage, high-efficiency power valves, of the low-consumption type, have been used. The result is a receiver of phenomenal merit, receiving dozens of stations at really good volume, on a moving-coil loud-speaker, without the slightest trace of interference. The selectivity is of such a high order that it must be heard to be appreciated. The volume also will satisfy the most critical, and the receiver is therefore one of the most advanced designs which has yet been produced in the wireless art. Constructional notes and further details will be given next week.

#### ATHLONE—IRELAND'S NEW BROADCASTING STATION

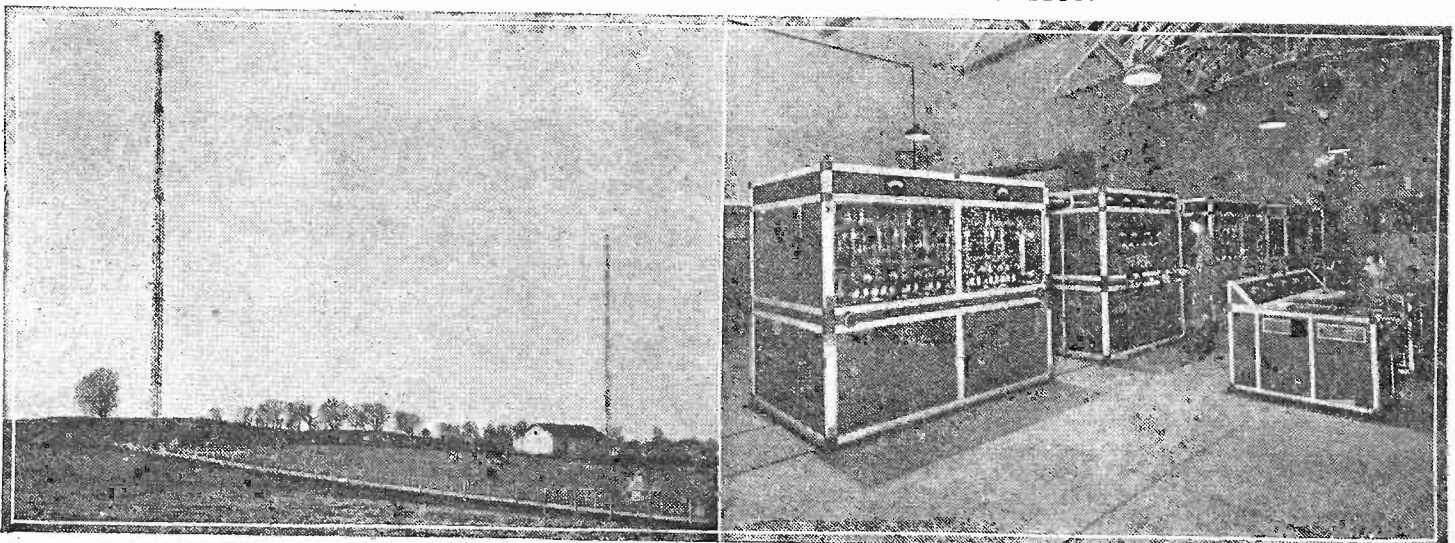

Left: the masts and aerials. Right: the transmitting room, showing the control desk.

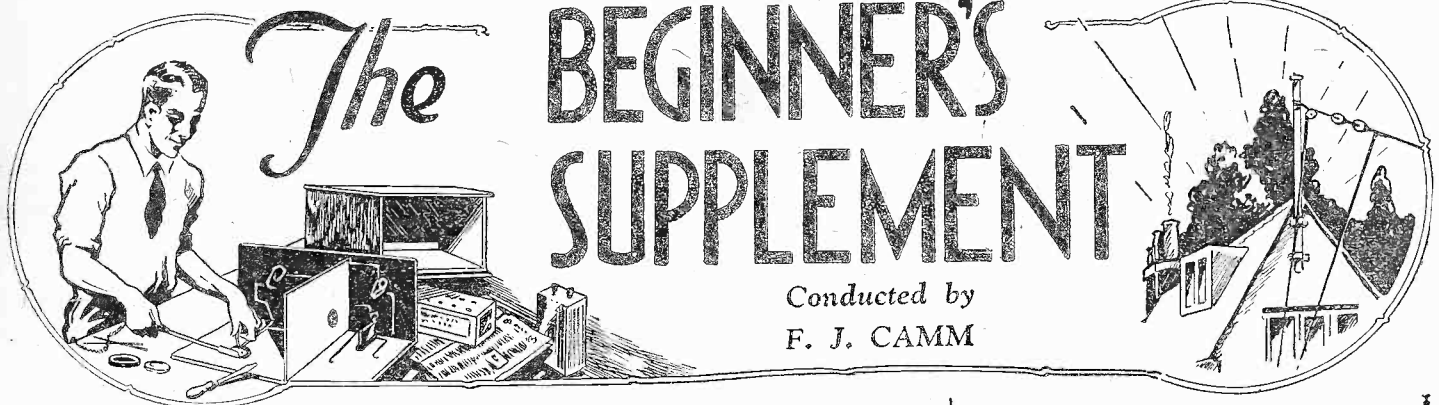

Conducted by  
F. J. CAMM

**T**HE second valve in our set, the one we dealt with last week, is generally known as the *first L.F. valve*, whereas the last one, which we are going to study now, is called the *second L.F.* or *power valve*. The term "L.F." stands for *low frequency*, and I will explain why it is used.

You will remember that the waves given out by the transmitting station follow one another at enormous speed and strike our aerial a million or more times a

**HOW YOUR SET WORKS**

**Part 5.—The Power Valve**

current than either of the other valves and produces more power.

**Using a Transformer**

Last week I said that there were two popular methods of adding amplifier valves—firstly by means of a *resistance* and secondly by means of a *transformer*. The last or "power" valve in our set is coupled by the transformer method. Of course, a resistance could be used just the same as for the second valve, but a transformer has certain advantages.

A glance at Fig. 1 will show just where we left off last week. If we were going to use resistance coupling again, we should connect a resistance from the plate to the H.T. battery, as shown by the dotted line. However, we do not do this. Instead, we use a coil of wire. This coil of wire is known as the *primary winding* of the transformer.

**How It Works.**

The action of the transformer is somewhat different from that of a resistance. To understand it we must first see what a transformer is.

A simple type consists of two coils of insulated wire wound round an iron rod. They may either be wound side by side,

as in Fig. 4(a), or one over the other, as at (b). When a fluctuating current is passed through one of the coils it acts something like the resistance we were studying last week. That is to say, a difference of pressure or *voltage* arises between one end and the other. Another thing that happens is that *the current passing through the one coil induces a current in the other coil*.

If each coil has the same number of turns, then the difference in *voltage* between the ends of the second coil will be the same as that between the ends of the first one. If, however, the second coil has *more turns* than the first, then the voltage produced will be *greater* than that across the first coil.

This is where the usefulness of the transformer comes in. It enables the voltage to be "stepped up" any desired amount. Thus, if we make the second coil twice the size of the first one, then the voltage across the second will be twice that across the first. If the second coil has three times as many turns as the first, the voltage produced will be three times as great, and so on.

**How It Is Made**

Incidentally, the type of transformer just described is rather primitive and would not be very efficient. The type used in a wireless set is much more carefully made. The chief difference is, however, in the iron "core." This is not a simple iron rod, but is made of a number of sheets of a special iron alloy, also it does not merely pass through the middle of the coils, but extends right round the outside of them. Fig. 4 (c) and (d) will show what I mean.

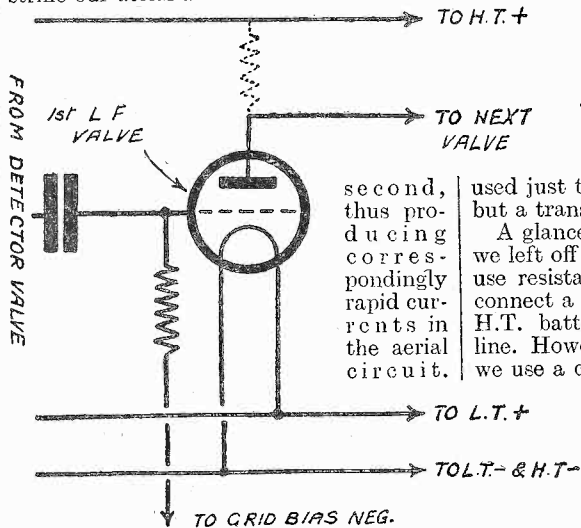

Fig. 1.—A resistance used to couple the valves together.

These currents, you will remember, are called *high-frequency currents*.

**The Meaning of "Low-frequency"**

I explained that the speech or music sent out was represented by a variation in the amplitude (height) of the waves. This meant a rise and fall in the strength of the high-frequency currents. This rise and fall occurs at a comparatively slow rate or *low frequency*. It is this low-frequency variation in the strength of the high-frequency current which corresponds with each vibration of the voice or of the musical instrument being broadcast. You will recollect that by means of the grid in the detector valve these variations in the strength of currents in the aerial circuit were able to make similar variations in the *plate current*.

There are thus *low-frequency variations* in the plate current of the detector valve, and it is because the work of the following two valves is to amplify these that they are called *low-frequency* or *L.F.* amplifiers. The one we are going to study this week is also called the *power valve*, because it has to handle larger fluctuations in

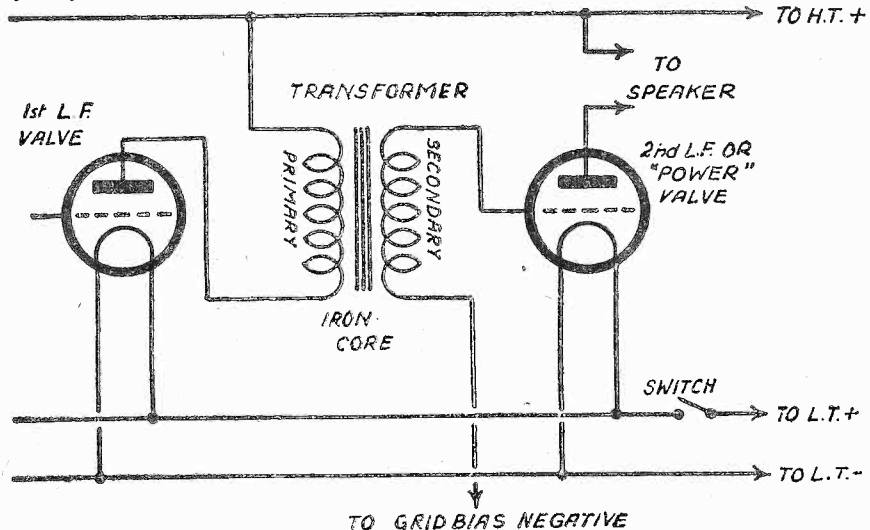

Fig. 2.—A transformer used for coupling purposes.

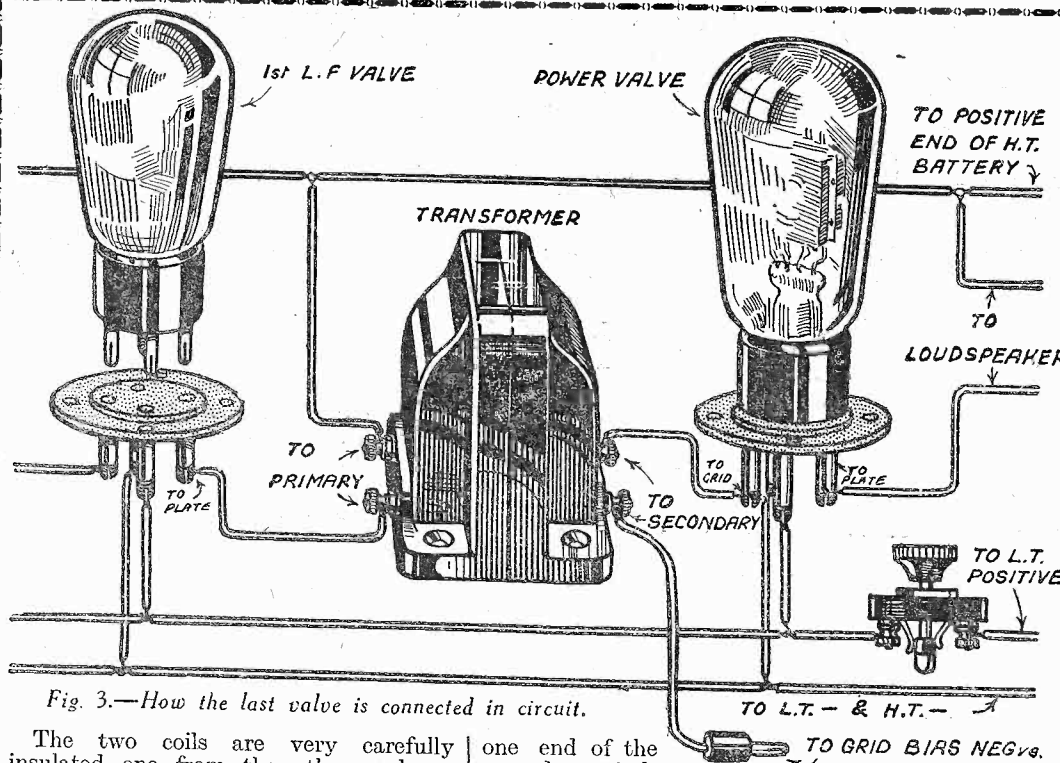

Fig. 3.—How the last valve is connected in circuit.

The two coils are very carefully insulated one from the other and are usually wound on the same bobbin. First the *primary* winding is wound on. Then a layer of waxed paper or similar insulating material is wrapped round it, and finally the *secondary* winding is put on. This latter usually has from three to five times as many turns as the primary, but it may have as many as eight times.

The core is made in two parts—one T-shaped and the other U-shaped—each part being composed of many sheets of the iron alloy. The two parts are fixed in position, as in Fig. 4 (c) and (d), after the bobbin is wound, and then the whole thing is sealed inside a bakelite case fitted with four terminals connecting to the windings inside. It then presents the appearance shown in Fig. 3.

**The Power Valve**

Of course, the object of the transformer, as you have probably guessed by now, is to increase the variations in voltage applied to the power valve. You will see how it is connected up from Figs. 2 and 3. Notice that

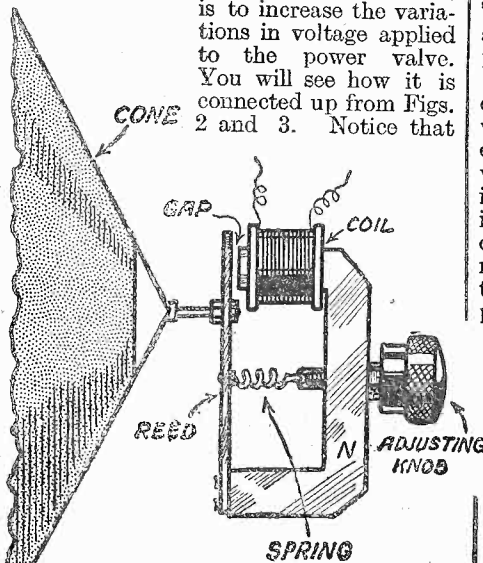

Fig. 5.—A simple reed type of loud-speaker.

one end of the secondary winding is joined to the grid of this valve.

The action of the power valve is exactly similar to that of the previous valve, small variations in the voltage of the grid giving large variations in the plate current. This amplifying property of the valve itself added to the step-up effect of the transformer causes the total amplification to be considerable, so it is now that we join up the loud-speaker. This is connected in the plate circuit of the power valve, that is to say, between the plate and the positive end of the high-tension battery, as shown in Figs. 2 and 3.

**The Loud-speaker**

To explain the working of the loud-speaker I am going to describe the simplest type. It consists of a magnet N (Fig. 5), a strip of iron known as the *reed*, a coil of fine insulated wire, and a paper cone attached to the reed by a small metal rod. There is also a knob and spring for adjustment purposes.

The coil is wound on to a small bobbin which fits over one end of the magnet while the reed, which is of a springy nature, is screwed to the other end of the magnet. The free end of the reed is just opposite the coil end of the magnet. Although the magnet attracts it, the springiness of the reed prevents it from actually touching. The distance it is away, however, can be adjusted by means of the adjusting knob shown. This knob, through the medium

of the little coil spring, pulls on the reed and so enables the gap between it and the magnet to be adjusted to within fine limits.

**Its Action**

The speaker works as follows:—The current from the plate of the power-valve passes through the coil. This tends to increase the power of the magnet.

It is quite a well-known fact that if you pass an electric current through a coil of wire wound round a piece of iron, the iron will become magnetised. In this case the iron is already magnetised, as it is a permanent magnet. The current through the coil therefore increases the magnetism. But we already know that when music is being received by our set this current fluctuates all the time in harmony with the sound vibrations of the instruments being played. This means that the increase in magnetism produced by the current will also fluctuate even as the current fluctuates.

Now, let us see what effect this has. Well, briefly, it varies the attraction of the magnet for the reed, so that the reed vibrates backwards and forwards all the time. Being attached to the paper cone, it pushes that backwards and forwards also. The vibrations of the cone cause ripples or waves in the air. These waves are waves of *sound*, that is to say, they are pulsations in the air which when they reach our ears produce the sensation of sound. That is, in fact, what all sound waves are—pulsations in the air. In fact, without air there could be no sounds at all. However, that is beside the point. The point is that the sounds of the studio miles away are reproduced with exactness in our own home.

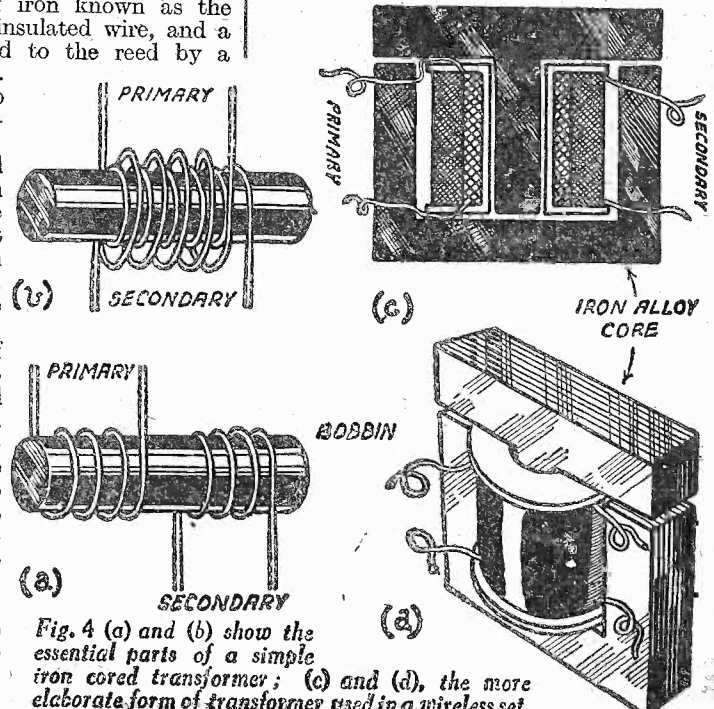

Fig. 4 (a) and (b) show the essential parts of a simple iron cored transformer; (c) and (d), the more elaborate form of transformer used in a wireless set.



# EDISWAN

The name that means 'EXCELLENCE'

YOU GET  
**BETTER SERVICE**  
FROM THESE  
**ACCUMULATORS**

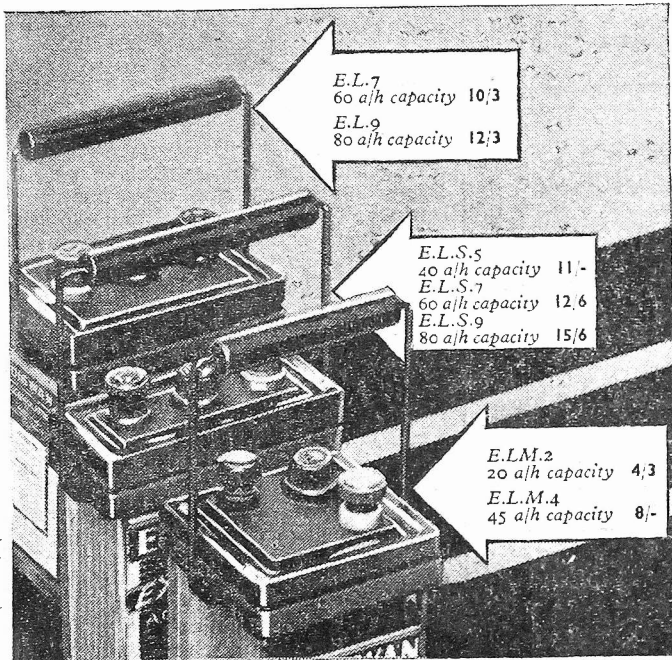

E.L.7  
60 a/h capacity 10/3  
E.L.9  
80 a/h capacity 12/3

E.L.S.5  
40 a/h capacity 11/-  
E.L.S.7  
60 a/h capacity 12.6  
E.L.S.9  
80 a/h capacity 15/6

E.L.M.2  
20 a/h capacity 4/3  
E.L.M.4  
45 a/h capacity 8/-

Balanced capacity—that is the secret of the extra and better service which Ediswan "Extralife" accumulators give you. It means that the positive and negative plates are designed to function in exact electrical balance. This makes quicker charging and slower discharging possible without damaging the plates. You get better service and longer life than with ordinary cells.

All good radio dealers sell them.

# EDISWAN EXTRA LIFE ACCUMULATORS



THE EDISON SWAN ELECTRIC CO. LTD.  
PONDERS END, MIDDLESEX

EDISWAN the Better Service Batteries

B.227

## PERFECT TRACKING WITH THE SIMPSON ARM & PICK-UP

**32/6**  
COMPLETE

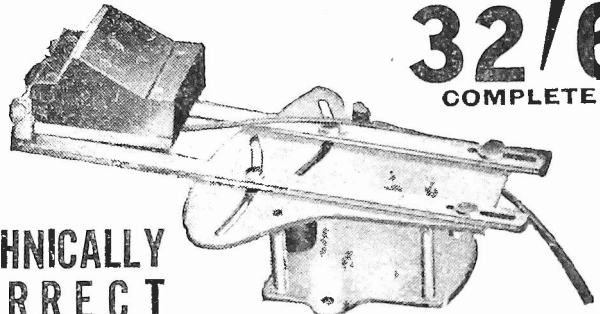

**TECHNICALLY  
CORRECT  
MECHANICALLY PERFECT!**

A Simpson Straight Track Arm and Pick-Up is the only instrument which will give you perfect gramophone reproduction through your radio set. Here are a few points which show that the Simpson has no equal in value at the price:—

1. Record wear minimised.
2. 100% Straight Track ensured
3. Needle scratch eliminated.
4. Life of records doubled!
5. Tone natural and pure!
6. Fits any gramophone!
7. A scientifically designed and produced instrument.
8. Incorporates *Automatic Stop*.

Consider these points in comparison with others and your choice of the Simpson will be fully justified. Ask your Dealer. Fill in coupon below for the Free booklet describing this Pick-Up and Arm.

**GUARANTEE**  
Unconditional guarantee to repair or replace, free of charge, within 12 months (misuse and abuse excepted.)

## SIMPSONS SYNCHRONOUS MOTOR & TURNTABLE!

CONSTANT SPEED  
NOTHING TO WIND  
2 1/2" DEEP

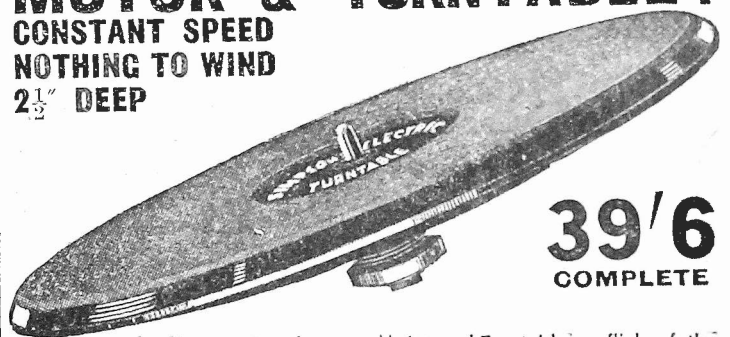

**39/6**  
COMPLETE

No winding the Simpson Synchronous Motor and Turntable, a flick of the finger starts or stops it, and with an almost negligible electricity consumption revolves at a constant speed of 78 (correct speed) with perfect silence! Consider the following points when purchasing an electric gramophone motor and see why the Simpson is supreme:—

1. Only 2 1/2" deep.
2. Nothing to go wrong!
3. Fits any gramophone.
4. Takes five minutes to fix.
5. Sizes 10" and 12"!
6. Costs less than 1d. per week to run!
7. Goes by itself.
8. Constant speed of 78 (correct speed)

Buy yours to-day! It is amazing value, and can be obtained from all good retailers for 39/6.

Fill in coupon below for your Free copy of booklet describing this motor.

**GUARANTEE**  
Unconditional guarantee to repair or replace, free of charge within 12 months (misuse and abuse excepted.)

**FREE** SIMPSONS ELECTRICALS LTD.  
Grange Road, Leyton, London, E.10.

To interested readers of "Practical Wireless" we shall be pleased to send our illustrated Folder (containing all technical details) on receipt of completed coupon.

NAME.....  
ADDRESS.....

**SUCCESSFUL  
EASY  
PAYMENT  
SERVICE**

**ALL GOODS CARRIAGE PAID TO YOUR DOOR  
NO TROUBLE  
NO DELAY**

During the last eight years, we have supplied many thousands of Listeners with their radio requirements. Our aim has always been to give our customers complete satisfaction, and our advice on all radio matters is at their disposal.

**THE BEST KITS**

**LISSEN "SKYSCRAPER" KIT**, With order including valves. Cash Price £4/9/6, And 11 monthly payments of 8/6 **5/-**

As above, but including high-class polished Cabinet and Loudspeaker. Cash Price £8/5/0, or 10/- with order and 11 monthly payments of 11/6.

**Q.P.P.**

Everything for the New Q.P.P. circuits supplied promptly, Cash, C.O.D. or Easy Terms. We shall be pleased to advise customers on all Q.P.P. matters.

**R.I. PUSH-PULL INPUT TRANSFORMER and R.I. P.P. OUTPUT CHOKE**, with two Mazda, Cossor or Mullard Pentode Valves. Cash Price £3/4/0, or 5/10 with order and 11 monthly payments of 5/10 **5/10**

**VARLEY or FERRANTI Q.P.P. components** also supplied on the lowest terms.

**Cash or C.O.D. Items**  
*We pay postal charges.*

R.I. Q.P.P. Input Transformer - 16/6  
R.I. Q.P.P. Output Choke - - 12/6

Varley Q.P.P. Input Transformer. 17/6  
Varley Q.P.P. Output Transformer 16/6

Ferranti A.F. 11/c Input Trans. 34/-  
Ferranti O.P.M.11/c Output Trans. 26/6

To avoid delay, will customers kindly send first payment with Order. Dept. P.

**LOUD SPEAKER UNITS**

**ROLA PERM. MAGNET M.C. UNIT F.6.** With Order Cash Price £2/9/6. And 10 monthly payments of 5/- **4/-**

**BLUE SPOT 99 P.M. MOVING COIL UNIT.** With Order Cash Price £2/19/6. And 11 monthly payments of 5/6. **5/-**

**NEW EPOCH Q.P.P. MOVING-COIL UNIT.** (Just released.) Especially designed for the new Q.P.P. circuits. With Order Cash Price £1/12/6. And 6 monthly payments of 5/2. **5/-**

**NEW EPOCH 20c PERMANENT MAGNET MOVING-COIL UNIT.** With Order Cash Price £1/15/0. And 6 monthly payments of 5/6. **5/6**

**ACCESSORIES**

**EXIDE W.H. HIGH-TENSION ACCUMULATORS (120 volts, 5,000 M/A).** The cheapest and best high-tension supply where mains are not available. With Order Cash Price £3/15/0. And 11 monthly payments of 7/- **7/-**

**SPECIAL ATLAS ELIMINATOR FOR Q.P.P.** (Just released). Output and H.T.appings arranged for Q.P.P. circuits. With Order Cash Price £3/12/6. And 11 monthly payments of 6/8 **6/-**

**ATLAS ELIMINATOR A.C.244.** Three H.T.appings, 20 m/a output. With Order Cash Price £2/19/6. And 11 monthly payments of 5/6 **5/-**

**SET OF THREE NEW VALVES.** Mazda, Cossor, or Mullard. r.S.G. r detector, and r power. With Order Cash Price £1/12/3. And 6 monthly payments of 5/2 **5/2**

*We shall be pleased to send you a quotation for any radio goods you may require. Price List free.*

**LOW-FREQUENCY INSTABILITY:  
Its Cause and Cure**

In addition to a high degree of freedom from distortion, the operation of a good wireless receiver should be characterized by perfect stability. It is appreciated by nearly all readers now, that by the use of screened grid valves and by careful screening, the risk of high-frequency instability due to unwanted capacitative and magnetic coupling between different radio frequency circuits and components can be avoided. Naturally, the careful operator will also take care to keep reaction under proper control. Some prefer to eliminate it altogether, and thus remove a possible cause of instability. There is, however, a further form of instability which may make itself manifest, namely, low-frequency oscillation.

The most usual cause of low-frequency instability is feed-back, due to the presence of a fairly high impedance component which is common to the anode circuits of several valves. It is clear that the variations in the anode current of one valve will produce a corresponding varying voltage drop across the common impedance, and that this will modulate the anode current of other valves. This modulation will then be amplified and re-amplified in the earlier stages, just as though it were a genuine signal and, the process being cumulative, a very strong spurious signal will be built up in the output circuit.

**Low-Frequency Variations**

To take a concrete example, the average high-tension supply unit, whether employing a valve or a metal rectifier, possesses a fairly high impedance, and this impedance is common to the anode circuits of every valve in the set. The anode current of the output valve contains very powerful low-frequency variations. A varying voltage drop will therefore exist across the impedance of the high-tension unit and low-frequency variations in sympathy therewith will be impressed upon the anode currents of the earlier stage valves, and will be amplified in the following stages. Further, if any part of the anode circuits should be modulated by mains ripple owing to bad smoothing, or to direct magnetic pick up from the mains leads or from the valve heater circuits, such ripple will be impressed on the anode currents of all the other valves, and considerable parasitic signals at mains frequency will be present in the output current of the set.

Fortunately, there is a simple and inexpensive cure for this trouble. It is termed decoupling, and consists in including in the anode circuit of each valve a resistance which is large compared with the common impedance. A large condenser is connected from the end of this resistance nearer the anode of the valve to earth, thus by-passing any parasitic modulation to earth. The minimum value of decoupling resistance to give any real protection is about 10,000 ohms, but the value should be as high as is consistent with maintaining the correct voltage on the anode of each valve. By-pass condensers should be of 2 mfd. capacity for low-frequency valves, and .1 mfd. in the high-frequency stages.

**The LONDON RADIO SUPPLY COMPANY**  
11, OAT LANE · LONDON · E.C.2  
Established 1925 Phone National 1977





# OUR SHORT-WAVE SECTION

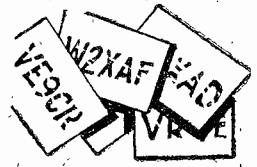

## ON THE SHORT WAVES

(Concluded from page 1203, March 11th issue)

By J. GODCHAUX ABRAHAMS

IF, as an interval signal, above the 40 metre point, you log the crowing of a cockerel, you should make an entry to the effect that the dial reading corresponds with a wavelength of 43.75 metres (6,865 kc/s) or that of F8LH, Radio Vitus, Paris (the programmes are simultaneously broadcast on 308.5 metres). A further slight shift to 45 metres (6,667 kc/s) may produce a Spanish call from San Sebastian (EARTBO), heard fairly well on Mondays, Wednesday, and Fridays between 19.30-21.00 G.M.T.; also there appears to be a new station in the Canary Isles (Las Palmas?) testing on that wavelength. On 45.11 metres (6,650 kc/s) I have often heard a powerful carrier wave which, when resolved, has been confirmed as IAC, Coltano (near Pisa, Italy). It appears in my log as a channel for a telephony service with the "crack" Italian trans-Atlantic liners. Some little way above this reading, on 45.38 metres (6,611 kc/s), there is a 10 kW. Moscow transmitter worked by the Central Club of the Red Army. In the early hours of the evening it broadcasts relays of concerts and operatic performances and is a different programme from that of Moscow (REN) on 50 metres (q.v.). On 46.6 metres (6,438 kc/s) you will discover another Russian relay; this time of Moscow (1,000 metres).

Passing over a number of commercial stations, we reach W8XK, a further relay of KDKA, East Pittsburgh (Pa.), on 48.86 metres (6,140 kc/s) and for which the best time to listen is from 21.30 G.M.T.; it is a very powerful signal from 23.00. In fairly close proximity, 49.1 metres (6,115 kc/s) you should hear YVIBC, Caracas (Ven.); its signals, although strong, may be somewhat distorted, but you will recognize the Spanish language. The interval signal is a distinctive one; four chimes on a clock gong. W3XAL, Boundbrook (N.J.), on 49.18 metres (6,100 kc/s) should prove one of your star stations at this period of the year. It acts as relay to WJZ, one of the N.B.C. group and can be tuned in on almost any evening from 22.00 G.M.T. UOR2, on 49.4 metres (6,072 kc/s) gives you the Vienna programmes on Tuesdays and Thursdays, between 13.30-21.00, G.M.T.; it is also a strong signal, of which quality is good and fading but little pronounced.

Finally, to finish up our little trip on this portion of the short-wave band, we may search for W4XB on 49.67 metres (6,040 kc/s); it relays WIOD, Miami Beach (Fla.) entertainments, or W9XF on 49.83 metres (6,020 kc/s), which is the short-wave transmitter of WENR, Chicago, and we end up on 50 metres (6,000 kc/s) with Moscow RW59, the powerful Trades Union station of the Soviet Republic. It is already on the air in the afternoon,

gives its main programme towards 18.00 G.M.T. and International talks in English, French, German, etc., at 20.00-21.00. At the latter hour, Moscow time being three hours ahead of G.M.T., you are taken over to the Red Square for chimes from the Kremlin, as a midnight time-signal. In another article I will deal with transmissions above 50 metres and below 25 metres.

Having dealt, in previous articles, with the favourite portion of the short-wave band, namely, 25 to 50 metres, by now we should have acquired sufficient experience to tackle channels of a higher frequency. Although, as a general rule, mention is less frequently made of wavelengths between 12 and 25 metres, this section is well worth exploring, as in this band there are powerful transmitters of which the reception, at this time of the year, during daylight and twilight hours, is particularly good.

Providing you possess an efficient receiver, you should find no difficulty in picking up W3XAL, Boundbrook (N.J.) on 16.878 m., almost on any day from 13.00 G.M.T., in fact, a careful search in most instances will reveal a powerful carrier wave at a few minutes before that hour. It is 08.00 Eastern Standard time as the station takes the air, and the first announcement made will be: *This is W3XAL, Boundbrook, New Jersey, a short-wave station of the National Broadcasting Company of America operating on 17,780 kc/s; Good morning, Ladies and Gentlemen.* The interval signal consists of three xylophone-like notes (the N.B.C. call) and it is given regularly every fifteen or thirty minutes. If atmospheric conditions are favourable, signals from this transmitter may be received at readable loud-speaker strength, and the programme, barring perhaps a few periods of high speed fading, may be held until 16.30 or 17.00 G.M.T. From that time it may prove fitful and it is then wise to search for W8XK, East Pittsburgh (Pa.), which also relays N.B.C. entertainments from New York and other North American cities. You will find it, at some distance above W3XAL, namely, on 19.72 m. (15,210 kc/s). There is no mistaking the transmitter as the announcer will tell you that *Your station is Westinghouse KDKA, or W8XK, East Pittsburgh.* Again providing conditions are good, you should be able to hold this transmission from roughly 17.30 to 19.30 or

20.00, when a change is usually made to 25.27 m. (If you refer to my previous articles you will observe that mention has already been made of the W8XK broadcasts on 48.86 m.; at present, this is one of the "star stations," of that band.)

Immediately below W8XK (19.72 m.) a search should be carried out for W2XAD (relaying WGY, Schenectady, N.Y.) on 19.56 m.; it is one of the General Electric Company's transmitters and this fact is usually made clear in the call. It only operates between 19.30 and 20.30 on Mondays, Wednesdays and Fridays and for an extra hour on Sundays, after which the broadcasts are carried out on 31.48 m. (q.v.).

Now, within a hairsbreadth of W8XK (19.72 m.), and only separated by 10 kc/s, on some afternoons you may pick up a Berlin programme through DJB, Zeesen (19.737 m., 15,300 kc/s). It is an experimental channel which may later be abandoned for a more favourable one, but is still used from time to time until 17.00, as an alternative to DJA, on 31.38 m., working during the rest of the evening.

As you will see, in view of the different times at which these stations work, it is essential that an accurate log with exact condenser dial readings should be kept; it is the only way in which you will successfully find broadcasts in relatively difficult portions of the short-wave band. Having established the exact position required for Zeesen, turn your condenser to this point on any weekday between 10.00 and 10.30; a slight movement with an increase in capacity will almost inevitably bring in HVJ, Vatican City (Rome) on 19.84 m. (15,120 kc/s). This station regularly opens up with the words *Laudatur Jesu Christu*, followed by *Radio Citta Vaticana*. The call is given in Italian, French, Spanish and German. You may always recognise this studio by the fact that a clock may be heard loudly ticking throughout the broadcast.

Between this station and 25 metres you will come across a number of commercial (morse) and public telephony service transmitters as well as ships (around 22.50 metres), and experimental amateurs of many countries working on channels between 20.9 m. and 21.3 m. One or two stations, however, are worthy of mention, in particular PDV, Kootwijk (Holland), on 24.9 m. (12,050 kc/s), which is habitually used for the rebroadcast of Dutch programmes to the Netherlands East Indies (Sumatra, Java, etc.). Whenever any event of importance takes place in Holland in almost every instance you may pick up a rebroadcast of it on this wavelength. In the same way, I have often found interest in conversations overheard between Rabat (Morocco) and Paris on 23.858 m. (12,605



**A new series of T.C.C. CONDENSERS built to withstand HIGH SURGE VOLTAGES**

The time-lag inherent with indirectly heated A.C. Valves induces high surge voltage in the set's anode circuits. The curve shown is an authentic example of what happens when switching on. Note how immediately 595 volts are built up—the 30 seconds taken before normality is reached. Consider the strain on the smoothing condensers! For safety's sake they *must* withstand these surges.

That is why T.C.C.—always to the fore introduced the type 87—a series built to stand up to surges of 650 volts. If you are building any mains equipment erect a sure barrier against condenser breakdown. Use the condenser specifically designed for these modern conditions—use the NEW T.C.C. Type 87—and be sure.

TESTED TO 1,500 v. D.C.

Capacity Mfd.	Dimensions			Price s. d.
	Height	Width	Thickness	
0.1	1 7/8"	1 1/2"	3/16"	2 2 4
0.25	2 1/8"	1 1/2"	3/16"	2 2 4
0.5	2 1/2"	1 1/2"	3/16"	2 2 6
1.0	2 3/4"	2"	3/16"	3 0 3
2.0	2 3/4"	2"	3/16"	4 0 3
4.0	2 3/4"	2"	2 1/4"	7 3

**T.C.C. TYPE 87 ALL-BRITISH CONDENSERS**  
*The Telegraph Condenser Co. Ltd., Wales Farm Rd., N. Acton, London W.3*

2553

# THE PERFECT PAIR

Now, with the perfect pair you get perfect tuning. Everyone knows Utility condensers, test them how you will there are no better condensers made. With the condenser comes a Utility Straight Line Dial, a device that gives you common-sense tuning. The essential feature is a *moving* pointer traversing a *stationary* and illuminated scale with the scale always in view; when you have once tried this method nothing else will satisfy you. And the price of the .0005 condenser with Straight Line Dial is within everyone's reach.

FROM YOUR DEALER OR POST FREE FROM THE MAKERS.

**PRICE 9'6**  
*complete as illustrated*

**WILKINS & WRIGHT LTD.**  
 UTILITY WORKS, HOLYHEAD RD., BIRMINGHAM

*London Agents:*  
 E. R. Morton Ltd., 22, Bartlett's Buildings, Holborn Circus, E.C.4.

**Utility**

Belmont

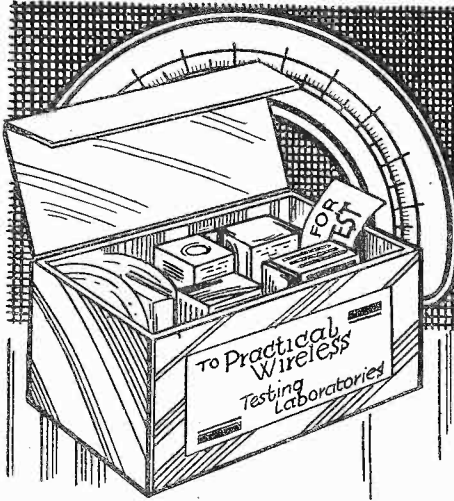

# Facts and Figures

Components Tested in our Laboratory

BY THE PRACTICAL WIRELESS TECHNICAL STAFF

### WEEDON EVER-DAMP EARTH

STILL another earthing device has been received for review. This time it emanates from the Power Link Company, and consists of a flat copper box roughly 4ins. by 3ins. To this is soldered a length of insulated wire, and the upper surface of the box is provided with a number of small holes. The box contains one of the now popular chemical earths, which is guaranteed non-corrosive. It is claimed that it is equal to a three-foot square copper earth plate, and it is used in the same manner as others which have been reviewed, namely, it is buried about a foot below the surface of the ground, and well-watered. The nature of the chemical ensures that the ground is always moist. The price is 2s. 6d.

### DRYDEX H.T. BATTERIES

THE Exide Company have now produced four special batteries for use with receivers employing the Quiescent Push-pull system. Type H.1060 has a total of 130 volts, and is tapped at 50, 60, 64½, 69, 75, 100, 120 and every 1½ volts up to 130. No grid-bias is included in this battery, which sells at 12s. 6d. Type H.1062 totals 139 volts, plus 9 volts grid-bias, and is tapped at every 3 volts from 120 to 150 volts. Type H.1063 totals 135 volts plus 18 volts grid-bias, and is tapped at every 1½ volts from 120 to 135. Type H.1064 totals 150 volts plus 24 volts G.B. and is tapped at every 3 volts from 125 to 135, and at every 1½ volts from 135 to 150 volts. Type H.1062 costs 17s. 6d., type H.1063 costs 18s. 6d., and the last mentioned costs 21s. These batteries will, of course, prove very useful to the listener who is experimenting with, or has a receiver adapted for, the Quiescent Push-pull principle.

### WEARITE MAINS TRANSFORMER

A MOST interesting mains transformer has recently been received from Messrs. Wright & Weaire, Ltd. and is illustrated below.

This is known as Model T.21A. and as will be seen it presents a handsome appearance. The finish of the complete casing is in gilt, and the disc which can be seen on one side is of bakelite. With the black terminals, this makes what is normally an uninteresting-looking component present quite a fresh appearance and should do much to attract the reader. The output of this particular model is 250 volts at 60 mA., 4 volts at 1 amp; and 4 volts at 4 amps. The input is designed for mains of 200 to 250 volts, and it is here that the component design displays real ingenuity. The centre terminal in the disc is intended for connection to one pole of the mains supply, whilst the terminal for the other pole is enclosed in a transparent envelope, together with holding-down screws, which is enclosed in the box containing the transformer. A small window is cut in the disc, and through this can be viewed a series of numbers, namely 200, 210, 220, 230, 240 and 250. The small hole above the window discloses a tapped hole when the window is directly over one of the above-mentioned numbers. To connect the instrument to the mains, therefore, the disc is rotated until the particular voltage of your mains is visible through the window, and then the loose terminal is screwed into the hole above it. The primary is thus adjusted for the mains with which it is employed. At 25s. this proves a most interesting component, and one which can thoroughly be recommended.

### SIFAM METERS

A MOST comprehensive range of meters is manufactured by the Sifam Electrical Co., Ltd., and we wish to take this opportunity of drawing particular

attention to one of these. In a recent article in these pages a handy multi-range meter was described. This was entitled "The Practical Wireless Multi-meter," and in it one of the Sifam range of meters was employed. This particular instrument is type E.70.M. and is of the moving coil type. It has a scale reading from 0 to 5 milliamps and has a D.C. resistance of approximately 50 ohms. No reference number was given in the article in question, and we should like readers to note also that the price of this particular instrument is 25s.

### ELEX TESTING PRODS

ON page 1029 of the issue dated February 18th, Mr. Preston showed an illustration of some testing prods in the course of his article on "What is Wrong?" The prods which were illustrated were old-type Elex products, and we have been informed by Messrs. J. J. Eastick & Sons, the manufacturers, that the particular type which was illustrated is now obsolete. The reason was that the grub screw, attached to the upper part of the handle, and which anchored the lead could come into contact

and makes the requisite contact. These prods cost 2s. each.

### BULGIN VOLUME-CONTROL WITH SWITCH

THERE are many parts of a receiver which often necessitate control of voltage and also connection or disconnection of the voltage. A typical instance is in the switching on of the S.G. potential applied to the H.F. side of a receiver. This is usually carried out by means of a potentiometer, and this must be disconnected from the H.T. supply when the receiver is not in use to prevent the constant drain on the supply. Extremely neat switches and controls are manufactured by Messrs. Bulgin, and these are totally enclosed. The appearance is much the same as an ordinary enclosed volume-control, with the addition of a small cam-shaped chamber at one end. Inside this a very efficient quick-make-and-break switch is incorporated, and this employs phosphor bronze and brass, so designed that the contact surfaces are self-cleaning. The spring loading ensures that the contact is made very rapidly and is also broken rapidly, which practically eliminates arcing. The switch is rated at 3 amps at 250 volts. The resistances are all rated at 3 watts and are obtainable in various values from 500 ohms to 100,000 ohms. The price varies from 5s. to 6s., which, of course, is extremely reasonable for a combined device of the high quality in which these are manufactured. The control is fitted with three terminals (potentiometer pattern) and two additional terminals are mounted on the base for the switch. A simple one-hole fixing device enables it to be readily mounted on the panel.

### SOVEREIGN VARI-CHOKE

THERE are many circuit arrangements where it is often preferable to be able to adjust the H.F. choking effect, and there are, of course, several ways in which this can be carried out. The Sovereign Vari-choke is an interesting component which is designed for this specific purpose. It consists of a neat bakelite case containing a terminal on the side and two terminals on the top. Between these two latter terminals is a small knob similar to that on a pre-set condenser. The side terminal and the one on top immediately above it are the two ends of a very efficient H.F. choke, and therefore it may be used simply as a choke if so desired. Where the variable factor is required, the other terminal is called into use, and the small knob adjusted to give the requisite degree of choking effect. The component costs 3s. 6d., and will be found very useful to the keen experimenter.

### BECKER "KIT-SWITCH"

WHEN building up a mains receiver on the chassis pattern for insertion into a radio-gram cabinet, the leads from the mains to the mains transformer are usually omitted until the receiver has been inserted into the cabinet. The necessary On-Off switch is then attached to the side of the cabinet in some handy position, and the mains leads are then attached. This usually proves a troublesome procedure owing to the difficulty of getting at the small terminals which

are usually attached to the normal mains On-Off switch. Furthermore, when the chassis has to be removed for alteration or some other purpose, the mains leads must first be disconnected, and the same trouble is required upon putting the chassis back. The Becker "Kit-Switch" overcomes this difficulty in a simple manner. In place of the normal small operating knob, the toggle is tapped. Into this screws an operating rod an inch long. The switch may therefore be mounted on a small metal bracket attached direct to the chassis, the wiring completed, and then when the chassis is slid into place, the operating knob may be screwed in from outside the cabinet. A neat bakelite escutcheon is provided for attachment to the cabinet side, and this is clearly engraved On and Off. This is a most useful accessory and will prove of inestimable benefit in the type of receiver above referred to. The price is 2s. 6d.

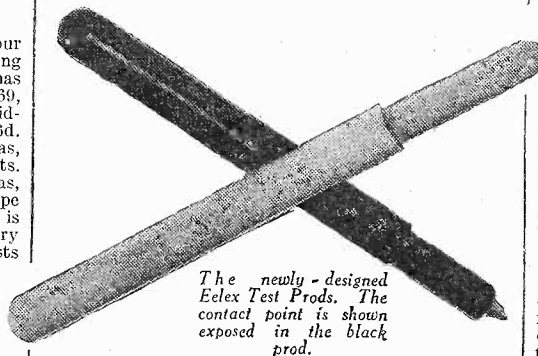

with the hand, and where very high voltages were being tested, this could result in a nasty shock, or perhaps some more serious result. Accordingly, this type of handle was scrapped, and the type illustrated on this page adopted in its stead. These new prods, or testing handles, have a completely detachable front portion, into which a thoroughly sound electrical connection can be made. The actual wire is led down through the end of the prod, and consequently the bare wire can nowhere come into contact with the hand of the user. Another interesting feature of these prods is that the contact point is covered until wanted, when the front portion is drawn back for about a quarter of an inch, given a partial turn to the right or left, and remains locked with the contact point exposed to view. This enables the point to be left exposed for lengthy tests, or, owing to the spring mechanism behind this portion of the prod they may be used in the ordinary way by pressing the end of the prod against a terminal, etc., when the point projects

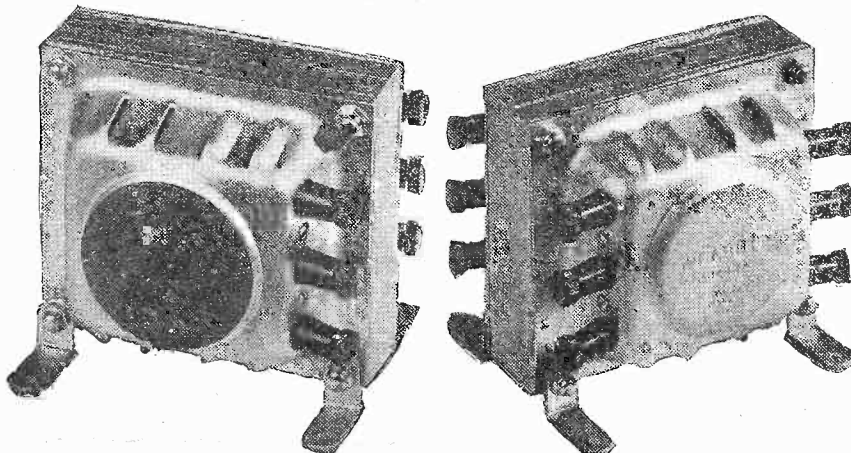

The Wearite T.21.A Mains Transformer. Note the selector disc in the left-hand illustration.

**WHY** Buy a new set?  
**ETA VALVES**  
 make your old set  
 like new!

These are not times to disregard economies. Other valves may cost more than ETA valves but they give you no more for your money. **FREE:** Ask for the ETA "Comparative Table" No. 13a, showing which ETA valves to use in place of your old ones. Technical advice gladly given. Write to:  
**THE ELECTRICAL TRADING ASSOCIATION, Aldwych House, Aldwych, W.C.2.**  
 Scottish Agents: **RADIOVISION LTD., 233, St. Vincent Street, Glasgow, C.2.**

PRICES FROM  
**5'6**  
 AMERICAN SETS  
 There are *ETA* valves for all types of American Sets.



**ETA**  
 THE INTERNATIONAL VALVE

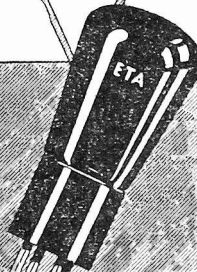

*As low in price as a really good valve can be*

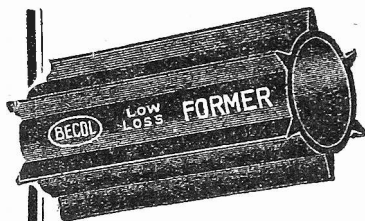

Read this  
**QUALITY**  
 Produces  
**EFFICIENCY**

**TESTED BEFORE DESPATCH**  
 The original BECOL ebonite low loss formers are thoroughly reliable. They are used in all parts of the world. Look for the BECOL trade mark. Ask your dealer. If unable to supply, write direct. **SEND NOW**, enclosing 6d. (post free) for up-to-date handbook of tuning coils for DUAL RANGE, BAND-PASS, and SUPER-HET. circuits. Fully illustrated with data. A very interesting handbook.  
**RODS, SHEET, TUBES, PANELS**  
**The BRITISH EBONITE Co., Ltd., Hanwell, London, W.7.**

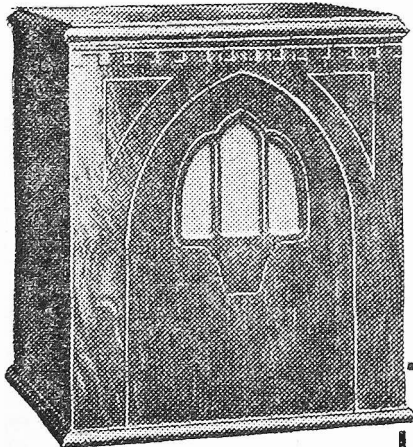

**PUT YOUR SET IN THE CAMCO "TABLEGRAM" CABINET**  
 This cabinet is specially suitable for converting your set into a modern radio-g am—takes up very little room. Am le space for Batteries, speaker, set, motor, pick-up, etc. Price 55/-, finished shaded walnut. See it at our showrooms and send coupon for: **FREE Camco Cabinet Catalogue.**  
**GARRINGTON MFG. CO., LTD.,**  
 Showrooms:  
 24, F.A. TON  
 GABLEY,  
 LONDON E.C.1  
 'Phone:  
 Eoll o n 8272.



Post in 1d. envelope.  
 Name .....  
 Address .....  
 SPBW .....

**SMITH BOASTS AN ALL-MAINS SET—**  
 (He has almost learnt to ignore the mains hum in the background)

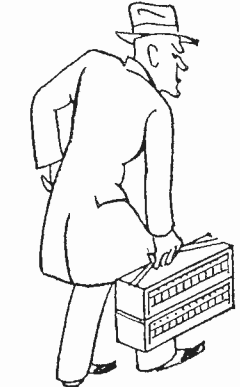
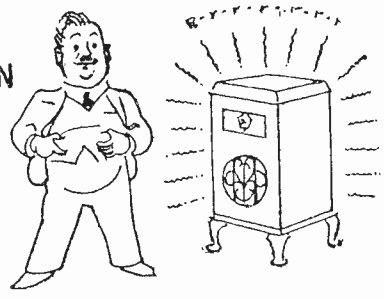

**JONES USED TO CARRY MASSIVE H.T. ACCUMULATORS TO CHARGE AND SPEND A RADIO-LESS WEEK AWAITING THEIR RETURN**

**BROWN ENJOYS DECENT REPRODUCTION FROM DRY BATTERIES BUT IS APPALLED BY THE EVER-RECURRING EXPENSE OF REPLACEMENT**

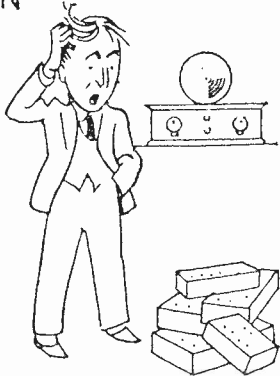

**ROBINSON HAS SOLVED THE PROBLEM IN THE RIGHT WAY— HE HAS INSTALLED A**

**MILNES H.T. SUPPLY UNIT**

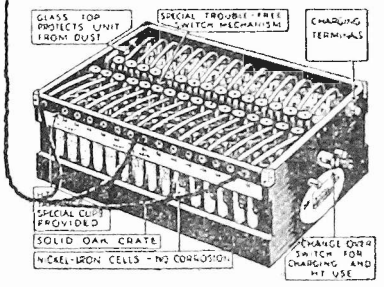

Robinson has H.T. current as smooth and silent as Brown's, as unfailing as Smith's and he has neither the bother nor the expense of recharging. His Milnes H.T. Unit recharges automatically from the L.T. accumulator. There are many more unique features about the Milnes H.T. Unit. Send the coupon to-day for descriptive folder.

PRICES IN U.K.

90 volt	£2 18 0
120 volt	£3 16 0
150 volt	£4 14 0

Electrolyte Extra.

**MILNES RADIO CO. VICTORIA WORKS BINGLEY YORKS**

Please send me full particulars of the Milnes H.T. Supply Unit.

Name .....  
 Address .....

KEIR DAWSON, BRADFORD.

# RADIO RAMBLINGS

## Improving S.G. Selectivity

I DO not think it is generally known that the selectivity of an S.G. receiver can often be improved fairly considerably by applying a small negative bias to the grid of the first valve. The object of the bias is to reduce the damping effect of the valve on the aerial tuning circuit. It is important that the voltage should be very low, because if it exceeds about .5 volt sensitivity is reduced and in consequence the volume on distant stations suffers.

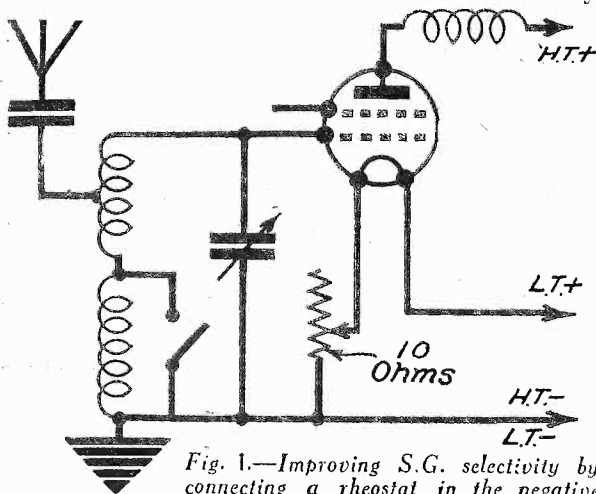

Fig. 1.—Improving S.G. selectivity by connecting a rheostat in the negative filament lead.

The lowest voltage that can be used in the normal way is .9 volt—that supplied by the smallest grid bias cells which are available—but a much lower voltage can be obtained “automatically” by connecting a rheostat in the negative filament lead, as shown in Fig. 1. The rheostat causes the filament to be made slightly positive in respect to the grid and this is, of course, equivalent to making the grid negative. As the resistance of the rheostat is increased the bias voltage rises, and *vice versa*. In addition to varying the grid bias the rheostat also reduces the filament current and so acts as a pre-detector volume control. By proper adjustment, however, it is usually an easy matter to find a setting at which selectivity is increased without any serious loss in volume. The idea is certainly worth a trial if you require to make tuning just a little sharper.

## Automatic Tuning

WITH a receiver intended for family use it is very convenient to make it so that any of the more popular stations can be received by the mere process of putting a plug into a particular socket. This can easily be arranged in the case of a Det.-L.F. set as shown in Fig. 2, without affecting the normal tuning control in any way. It is seen that two or three (according to the number of alternative programmes required) pre-set condensers

## JOTTINGS FROM MY NOTEBOOK

are connected by one of their terminals to one side of the variable condenser, whilst the other terminals are joined to sockets which may be mounted on the panel. A wander plug, connected to the earth terminal by means of a short length of flex, can be put into any of the sockets marked A, B, C and D; when it is in socket A the variable tuning condenser functions normally, but by transferring the plug to one of the other sockets a different pre-set condenser is brought into circuit. The method of “calibration” is to insert the plug into, say, socket B and tune in a station on the corresponding condenser; the process can then be repeated for the other condensers.

When an S.G. receiver is in use the same idea can be applied, but the modification is a little more involved. In this case two sets of pre-set condensers and a “double” plug are required. The latter can easily be made by attaching two wander plugs to a thin strip of fibre. All the necessary connections will be shown next week.

## Long-wave Instability

IF you have done much experimenting with portable receivers you will know the oft-encountered difficulty of obtaining complete stability on long waves. The trouble is most noticeable when using an S.G. circuit with tuned-grid H.F. coupling, and only this week I have been asked three times for advice on this matter. In each instance I have first of all suggested that the H.F. choke in the anode circuit of the S.G. valve was probably at fault and twice this has proved to be the case. It has been pointed out in these pages before that a choke for this position must have a really high inductance and in consequence a component specially designed for the purpose must be used. There are two distinct kinds of H.F. chokes, one of which is intended for reaction purposes and the other for use with S.G. valves. The latter type

will always work satisfactorily for reaction as well, but an ordinary reaction choke is almost invariably quite unsuitable for use with an S.G. valve; it has too small a number of turns and too high a self-capacity.

When a good and proper S.G. choke has been used, instability can often be cured by the simple expedient of de-coupling the screening grid of the S.G. valve by connecting a 1,000 ohm resistance in series with its high tension positive lead. If neither of the remedies suggested above proves effective it is a fairly clear sign that the set is badly designed or that insufficient screening has been used for the inter-valve tuning circuit.

## Anode Volts

I WAS approached the other day by an enthusiast who was greatly distressed because his new power valve distorted horribly when given the grid bias voltage recommended by the makers. He explained that reproduction was all that was desired when the G.B. was cut down from 9 to 6 volts, but this did not pacify him. On making full inquiries I found that my friend was using a new 120-volt high tension battery and a well-known make of balanced-armature loud-speaker. Now here is the snag, the battery certainly gave a full 120 volts and the Instruction Sheet issued with the valve said that the correct G.B. voltage for 120 volts on the anode was 7.5. But he had entirely overlooked the fact that the loud-speaker windings, of about 2,000 ohms resistance, were connected between H.T. positive and the anode terminal of the valve holder. They were “absorbing” something like 25 volts, and thus the actual anode voltage was about 95 instead of 120. In consequence it was quite correct to employ the lower grid bias voltage, and only by doing so could the valve be made to function properly.

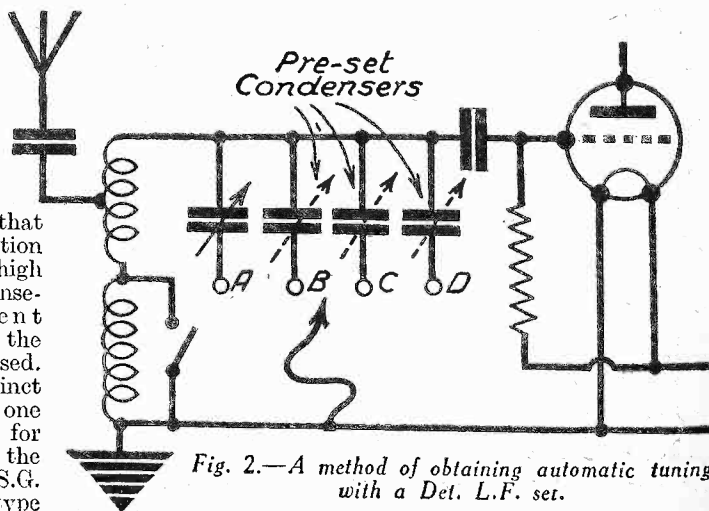

Fig. 2.—A method of obtaining automatic tuning with a Det. L.F. set.

**Condenser Voltages**

**Y**OU know that when making an eliminator or mains receiver the smoothing condensers should have a rated "working voltage" of at least twice that of the H.T. supply. The reason is, of course, that when the mains are first switched on the voltage rises to a "peak" value which is much greater than that normally maintained. This is because there is no "load" on the H.T. supply until the valve cathodes heat up.

Just recently I wished to carry out a few experiments with an all-mains set and found at the last moment that the only big condensers on hand were for 250 volts working, and the rectifier I was to use gave an output of 175 volts at 25 milliamps. Being pushed for time I used the condenser which I had, but so as to prevent a break-down, a 40,000 ohm resistance was connected between high tension positive and negative. The idea was that the resistance would impose a fair load on the circuit and thus keep the peak voltage down to reasonable limits; actually the latter was found to be just about 230 volts. There is one objection to it, namely, that the by-pass resistance absorbs a certain amount of current even when the set is working.

**500 Kilowatts !**

**A**S many readers can testify, the reception of American medium-wave stations is particularly easy this winter, and there is seldom any difficulty in bringing in one or two stations between 200 and 300 metres provided that one feels like sitting up until 1 or 2 a.m. If conditions are as good next year it looks as though we might even be subject to interference by American transmissions, for I hear that the 428.3 metre station, WLW, at Cincinnati, is shortly to increase its power to the phenomenal figure of 500 kilowatts. This should truly be the most powerful broadcasting station in the world.

**Dark-Emitters**

**I**N a recent note in these columns I referred to the possibilities of dark-emitter valves and now I hear that the Westinghouse Company has perfected a dry rectifier capable of working at radio frequencies. From this little piece of information it would certainly appear that we are getting a little nearer to the era of filament-less valves.

**WIRELESS TERMS TRAVESTIED**

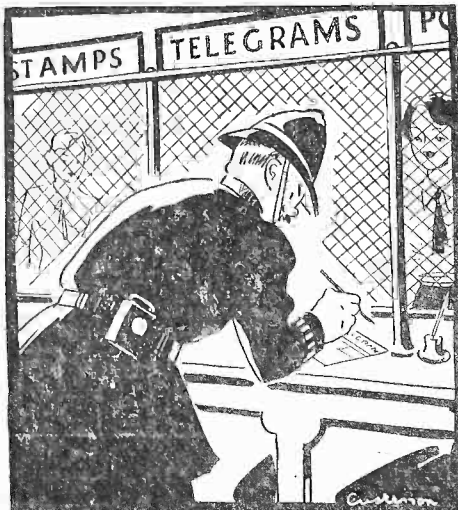

Copper Wires.

**SNAP OVER INSTANTLY FROM RADIO TO GRAMO.**

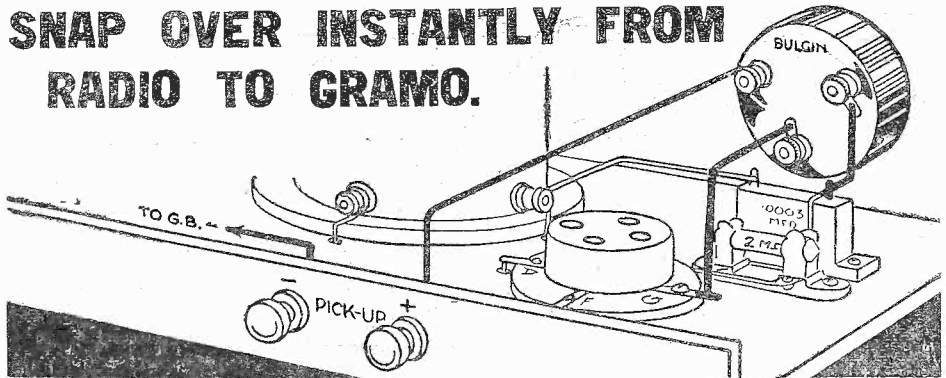

It is delightful to be able to change over instantly from your Radio to Gramophone reproduction, a facility made possible by Bulgin Radio-Gram Switch. The movement of the switch is positive, with its quick make and break action. Moreover, it can be fitted by the veriest novice in next to no time. Connections are clearly shown above, but further instructions are contained in our Manual.

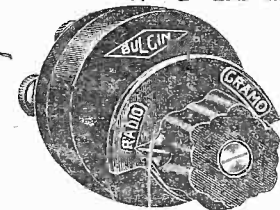

**ROTARY RADIO GRAM SWITCH**  
List No. S.26.  
In Black, Mahogany or Walnut, Bakelite Finish.

Price **1/9** Each.



Send for 80 p. Catalogue "N"  
Enclose 2d. Postage.

**A. F. BULGIN & CO., Ltd.,**  
Abbey Road, Barking, Essex.  
Telephone.....Grangewood 3206-7.



Send for 80 page Catalogue & Manual  
200 Illustrations. 60 Diagrams. Enclose 2d Postage

**RYALLS RADIO, 33, Chancery Lane, London, offer new guaranteed goods.**

Resistances, 1-watt wire ends, 100, 1,000, 2,000, 5,000, 6,000, 10,000, 20,000, 25,000, 30,000, 75,000, 150,000, 250,000 ohms, sixpence each. Mains transformers, 250v. 60ma. 4v.4v. 10/9, 350v. ditto 12/9, for HT7 rectifier, 10/9. Condensers, 4mf. 250v. working 3/6, 400v. working 4/-, 750v. working 5/6. Mains chokes, 25H at 60ma. 6/9, 20H at 100ma. 8/9, 40H at 100ma. 10/9. Meters, 0-6vAC 10/-, 0-3amp. AC 10/-, 0-50ma. DC 10/-, 0-250v. AC 12/-, 0-250VDC, 1,000, per volt 31/-. All meters flush mounting, bakelite case, 2 3/4 in. face. Note.—Condensers have terminals, chokes and transformers, long connecting wires. Polar Star 3-gang condensers 16/6.

**FOR UP-TO-DATE CONSTRUCTORS**

**GLIX CHASSIS MOUNTING STRIPS**

Besides providing an easier means of obtaining Perfect Contact, give your set a professional appearance. Strongly made of laminated paxolin. May be chassis mounted on metal, ebonite, or wood, or adapted to baseboard. Sockets of the Turned Resilient Type, take solid or resilient plugs with equal efficiency and with smooth insertion and withdrawal. Terminals allow secure and solderless connections

- Type 1.  
3 sockets for Aerial and Earth **7d.**
- Type 2.  
4 sockets: loud-speaker and pick-up. **8d.**

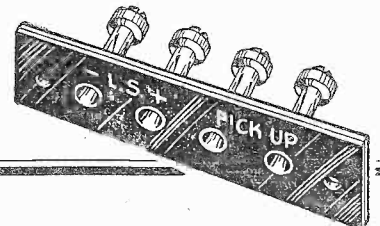

**No More Corroded Contacts GLIX NEW SPADE TERMINALS**

have a specially designed collar which fully protects from creeping acid a positive metal-to-metal contact. Corrosion is impossible and Perfect Contact is always assured.

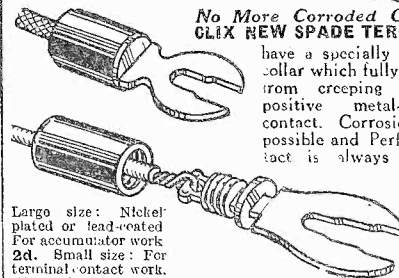

Large size: Nickel plated or lead-coated For accumulator work 2d. Small size: For terminal contact work. Nickel-plated 1d.

Write for Leaflet N.18.

**PARTEX RADIO**

Part Exchange Experts

**WE GIVE YOU MORE**

SEND US your requirements for SETS, KITS, COMPONENTS or ACCESSORIES together with list of goods for which you wish us to give our fullest allowance in PART EXCHANGE. Balance Payable by CASH or H.P.

NAME .....  
ADDRESS .....

Partex Radio, 56, Ludgate Hill, London, E.C.4  
House, 56, Ludgate Hill, London, E.C.4  
Fr. W. 18/3/33.

**GLIX CHEAPEST PERFECT CONTACT**

Lectro Linx, Ltd., 79a, Rochester Row, S.W.1.



# Practical Letters

from

## Readers.

The Editor does not necessarily agree with opinions expressed by his correspondents.

### Inert Cells

SIR,—In the current issue of your paper, PRACTICAL WIRELESS, under the heading of "Inert Dry Batteries," page 1008, there appears to be some doubt in the mind of your writer as to whether or not Inert Cells are still available. We have pleasure in advising you that we do, and have for a considerable number of years, manufactured inert cells. The size which would apparently appear to meet the suggestion made by your writer would be our No. 65,106, the dimensions of which are  $1\frac{1}{2}$ " by  $1\frac{1}{2}$ " by  $4\frac{1}{2}$ " high, the list price being 20s. per dozen.—THE EDISWAN ELECTRIC CO., LTD.

### A Satisfied Reader

SIR,—With reference to the "Long Range Express" and my previous correspondence, I am pleased to say the fault respecting the reaction has now been rectified. It was corrected by following your suggestion of reversing leads 5 and 6 on the grid coil.

I thank you very much for the assistance you have given me and I wish PRACTICAL WIRELESS every success.—H. K. (Leytonstone).

### Soldering Aluminium

SIR,—I noticed a query in your query section relating to Soldering Aluminium. Although the method suggested in the answer may work, it is a little difficult to get a clean result. I find the following answers, which I think could be used with success by most amateurs:

#### Flux:

80 per cent. stearic acid.

10 per cent. tin chloride.

10 per cent. zinc chloride (this could be made at a chemist's).

#### Solder:

80 per cent. tin.

20 per cent. zinc.

Bit nickel, if copper is used it will make the work dirty.—R. C. COLLINS (Sutton).

### Misnomers

SIR,—The recent articles by "Cynic" in PRACTICAL WIRELESS have prompted me to inquire whether or not it is a practical suggestion that your paper should attempt to eliminate all the unsuitable terms connected with radio. Of what use is it to point out the misnomers if we are to keep on using them. Radio to-day being one of the largest and most prosperous of our industries, surely proves that the time has come to scrap all the unsuitable

words which we apply to radio components, and also to describe correctly the use of the parts in the receiver. We still use "wavelengths in metres" and "frequency in kc/s." In my humble opinion it is quite possible to scrap "wavelengths in metres." Mild attempts to introduce the better system of "frequencies in kc/s" has been tried at intervals for many years, but, as you know, we are not at all nearer to the desired system. It would, I think, be very fitting for the newest, and also the leading, weekly radio paper to be the first in dropping the misnomers, and also a determined attack against the use of "wavelength in metres." I suggest that if lists of stations and their frequencies were printed, in all the wireless papers, B.B.C. included, leaving out the usual column of the stations wavelength, we could drop wavelengths in a very short time. The change over would have to be complete and quick,

whatever method to introduce "frequency in kc/s" is tried. We have tried to get used to kilocycles gradually and haven't got anywhere with it.—S. CARTER (Lepton).  
(What do our Readers think? We are in agreement.—Ed.)

### "Keep it Practical"

SIR,—I was only introduced to PRACTICAL WIRELESS a couple of weeks ago, but I'm a regular reader now. Please don't fill up space in your columns with bits of Broadcasting House gossip; keep them essentially practical and continue the articles you have hitherto provided; they seem to be good, to the point, and easily digested. With best wishes to you and your staff and hoping they will carry on the good work.—W. T. BARNESLEY (Morden).

### An Appreciation

SIR,—I wish to acknowledge receipt of my Encyclopædia, for which I thank you. I consider it to be very clear and concise and I should strongly advise all your new readers to take advantage of your renewed offer in PRACTICAL WIRELESS No. 21. I made up a dual range coil described in the Encyclopædia, and I admit I put it together hurriedly, but upon testing it in a det. 2 L.F. set I was amazed at the performance it gave, and I have since made another exactly similar. The Encyclopædia is an absolute mine of information. Thanking you again, and with best wishes for the future success of PRACTICAL WIRELESS.—ROBERT W. STEWART (West Hartlepool).

### That Handy Gauge

SIR,—Although I am rather late about it, I feel I simply must write and congratulate you on publishing such an excellent wireless journal. You have done a great service to wireless amateurs. Your strongest point lies, I think, in your clear, large, and fascinating diagrams, which can be understood equally well by beginner and advanced enthusiast alike. I am very pleased with my Home Constructor's Handy Gauge, and, as I am a keen wireless "fan," I can see that it will be of great use to me in the future. Wishing you the best of luck, and hoping for the prolonged continuance of such an AI weekly.—A. W. J. MASTERS (Midhurst).

### Another Reader's Gratitude

SIR,—I wish to take this opportunity of thanking you for the Data Sheet Self Binder, which I have just received, and also for the Wireless Constructor's Encyclopædia, of which I am very grateful. I have only one fault to find with it, the information in it is so valuable that I am afraid it will soon be worn out with being so much in use.—F. KIRBY (Leeds).

### CUT THIS OUT EACH WEEK.

## DO YOU KNOW?

—THAT the cold valve is now an accomplished fact, and it makes automatic volume control extremely simple and cheap.

—THAT television goes from success to success, and if you have not "looked-in" for some time you should take an early opportunity of doing so in order to see what strides have been made.

—THAT a tone-corrector should not be added to a commercial receiver unless you are certain one is not already included in the circuit.

—THAT H.F. decoupling condenser for use on the long waves should be larger than those needed for short waves, and, therefore, a large value should always be chosen for dual-range sets.

—THAT a receiver designed for use on 50-cycle mains should not be used on mains with lower frequencies owing to the risk of accentuated hum.

—THAT a mains receiver intended for use on 25-cycle mains may be used on 50-cycle mains without much risk of trouble.

—THAT over-charging is as injurious to an accumulator as under-charging if it is persistently carried out.

—THAT a receiver intended for short waves and normal broadcasting wavelengths should be fitted with both short-wave and standard H.F. chokes.

### NOTICE.

The Editor will be pleased to consider articles of a practical nature suitable for publication in PRACTICAL WIRELESS. Such articles should be written on one side of the paper only, and should contain the name and address of the sender. Whilst the Editor does not hold himself responsible for manuscripts, every effort will be made to return them if a stamped addressed envelope is enclosed. All correspondence intended for the Editor should be addressed: The Editor, PRACTICAL WIRELESS, Geo. Neuenes, Ltd., 8-11, Southampton Street, Strand, W.C.2.

Owing to the rapid progress in the design of wireless apparatus and to our efforts to keep our readers in touch with the latest developments, we give no warranty that apparatus described in our columns is not the subject of letters patent.



**EASY TERMS PROMPT DELIVERY**

Any Amplion, Blue Spot, Baker, Celestion, Epoch, Goodmans, Igranic, Lanchester, Ormond, R. & A., Rola, Sonochorde, or W.B. Moving Coil Speaker supplied promptly.

**SEND 5/- ONLY**

and pay the balance by monthly instalments. KITS, PARTS, SETS also supplied on EASY TERMS. No references. Entirely private and confidential. Write for Catalogue and details to:

**TURNADGE & PARTNERS, LTD.,**  
Ludgate House, Fleet Street, London, E.C.4.  
Telephone: Central 1903.

**PARTS AND MATERIALS FOR CONSTRUCTORS**

Stampings for transformers and chokes, clamping frames, L. Steel Clamps, Screws, all sizes. Copper and Alloy resistance wires, all coverings. Insulation materials, Rod, Sheet and Tube Bakelite, and Ebonite, Paxolin Tube for Coil Formers. Bakelite six-ribbed formers and Aluminium Covers. Eliminator parts. Rectifiers, Power Transformers, and chokes made to your requirements. All radio components supplied. Write me your requirements. Prompt service.—

J W BRIDGLAND, Electrical Instrument Maker,  
61, Dartmouth Rd., Forest Hill, S.E.23. Phone: SYD. 6741.

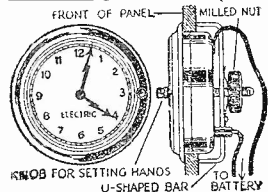

**FIT THIS ELECTRIC CLOCK TO YOUR SET!**  
NO MAINS NEEDED!  
KEEPS CORRECT TIME!  
NO WINDING!

Works off small battery lasting 12 months or can be plugged into G.B. battery without affecting reception. Uses practically no current. Fits into hole 3/16 in. dia in any panel up to 1/2 in. thick. Easy to fit—no screws required. Only 1/2 in. from front of panel to back of case. Swiss movement. Hand-set from front. Nickel-plated bezel. Useful addition to any set.

**RIVERSIDE MFG. Co., Ltd**  
Dept. 21, Crisp Road  
Hammersmith, W.6  
Telephone: Riverside 4392

**LOUD SPEAKERS REPAIRED 4/-**  
(Blue Spot Speciality, 5/-)  
Transformers 4/-, all repairs magnetised free. Eliminator Repairs quoted for 24 Hours Service. Discount for Trade. Clerkennell 9069  
E. C. WASON 44 EAST ROAD LONDON N1



**"REPAIRS? Send Them to Me."**  
When the repair has been O.K.'d by me, you can be sure your component is as good as new. All repairs are laboratory tested and guaranteed for 12 months. Any make of speaker unit, Transformer or Pick-up, 4/-; Blue-Spots, 5/-; Moving Coils from 5/-. Address your repairs to: Repair Dept. B., Weedon Power Link Radio Co., 185, Earham Grove, London, E.7 (Phone: Maryland 4344.)

**SERADEX MAINS TRANSFORMERS**

Primary tapped 200/230/250 volts 50 cycles. Output 135 volts tapped 80V and 110V, 90Ma. For Westinghouse rectifiers H T 5, 6 and 7. With 4 volts 4 amps C.T. winding.

**Price 12s. 0d.**  
Guaranteed one year by the makers.  
**TREVOR PEPPER, WAKE GREEN RD., BIRMINGHAM.**  
Lists of full range for stamp.

W.I.G. to. Illustrated Catalogue of  
**Radio-Gramophone Cabinets**  
of exclusive modern design, made by craftsmen in highly figured Oak, Walnut or Mahogany, post free.  
**REMARKABLE VALUES**  
Cabinets made to order a speciality.  
Maker, under license, of the **HOWE FOX BATTLE**.  
Recommended by the B.B.C. Full details on request.  
**GILBERT**  
Cabinet Maker  
**SWINDON**, Estimates 11ee., Est. 1866.

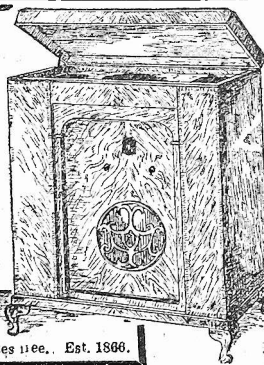

(Continued from page 1252).

**A Norwegian Reader's Appreciation and Suggestions**

I am not very much in love with the over-praised single-dial receiver practice, having come to the conclusion, confirmed by several years' experience, that it always pays to have at least the oscillator tuning condenser as a separate unit. But even in view of this fact, if an ingenious scheme were launched by you rendering it possible to have a single-dial receiver that would not incorporate too many sacrifices, I might be interested in trying once more. I am also taking an interest in S.W. reception, and a description of a really fine and outstanding S.W. superhet. would be a very welcome affair. But here, again, a S.W. superhet. is wanted as a separate, specially built receiver, not a more or less unsuccessful combination of short, medium and long-wave receiver. A really satisfactory solution of such a combination is in my opinion a feature that is not workable in practice, conditions being fundamentally widely different. Before closing, permit me to emphasize the point that not only do I appreciate the course taken by you in paying particular attention to the small and middle-size receivers, but it should also be clearly understood that there are so many home constructors throughout the world who have accumulated quite a decent stock of different expensive parts, so that only for that reason descriptions also of large receivers are wanted.—B. HJELMSTAD (Oslo, Norway).

**All-mains Receivers and Interference**

Sir,—I am taking this opportunity, through the columns of your excellent paper, to remark upon a subject which I am sure will be of interest to your readers who possess all-mains commercial receivers. No doubt the electrical interference which emanates through a loud-speaker when an ordinary house-lighting switch is turned on or off is only too well known. I understand that as this is external to the set, manufacturers thereby disclaim all responsibility. In my opinion, the manufacturers should incorporate in the set some sort of filter device, choke, etc., which would entirely eliminate this insignificant but very annoying type of interference. As an owner of a well-known make of all-electric receiver, I consider it rather unfair on the part of manufacturers to expect a purchaser who has paid a high price for a set to go to outside sources for a cure of this household type of interference.—N. D. SCOTT (West Wickham).

(Continued on page 1254.)

**An Invaluable Handbook**

**ACCUMULATORS**

An up-to-date practical handbook dealing with every type of accumulator, methods of charging them at home, care and maintenance. This little handbook also explains how to erect a charging station.

**This is one of NEWNES' HOME MECHANIC BOOKS - 1/- each**

Ask your Newsagent to show you other Titles in This Helpful Series.

Obtainable at all Booksellers, or by post 1/2 each from George Newnes, Ltd., 8-11, Southampton Street, Strand, London, W.C.2.

**BUY WATMEL SPECIALISTS IN POTENTIOMETERS & VOLUME CONTROLS**

**50,000 Ohms. 5/6**

Our policy this year is to specialise in Potentiometers and Volume Controls of all types. You can, therefore, be certain when purchasing a Watmel Potentiometer that you are obtaining the very best from a firm that is concentrating on this type of component.

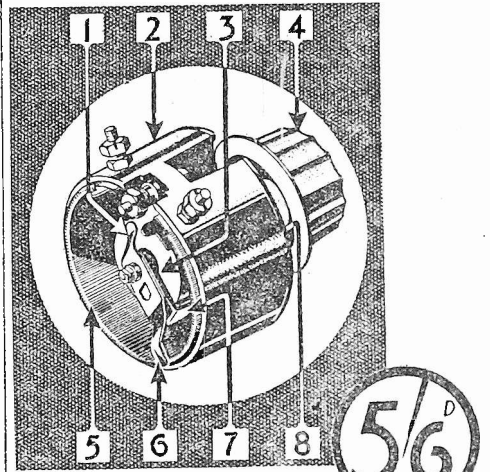

**THE WATMEL POTENTIOMETER**

(Type 1).

This resistance is wound on a special non-shrinkable former, which gives perfect contact. Note the points:—

1. Back self-cleaning contact.
2. Bakelite case, protects winding.
3. Large contact plate.
4. Polished easy-grip knob.
5. Wire wound former (not compound with wire contacts).
6. Contact finger, phosphor bronze.
7. Positive stop.
8. One hole fixing, brass bearing bush, resulting in perfect bearing.

Any resistance up to 50,000 ohms. **5/6**

If you cannot get this component from your local dealer, write to us and we will send what you require within 24 hours. Write for Catalogue.

**Watmel COMPONENTS**

**GET THE BEST OUT OF ANY SET**

**WATMEL WIRELESS CO., LTD.,**  
IMPERIAL WORKS, High Street, EDGWARE.  
Telephone: Edgware 0323. (M.C.86.)

# Tune in on this New Wireless Instruction



The I.C.S. Wireless Courses cover every phase of wireless work, from the requirements of the youth who wishes to make wireless engineering his career to the man who wants to construct a broadcasting set for his home, and, at the same time, to know how and why it operates and how to locate any faults that may develop.

No branch of industry has ever progressed as rapidly as wireless and the rate of progress is increasing. Only by knowing thoroughly the basic principles can pace be kept with it. Our instruction includes American broadcasting as well as British wireless practice. It is a modern education, covering every department of the industry.

### OUR COURSES

Included in the I.C.S. range are Courses dealing with the Installing of radio sets and, in particular, with their **Servicing**, which to-day intimately concerns every wireless dealer and his employees. **The Operating Course** is vital to mastery of operating and transmitting.

There is also a **Course for the Wireless Salesman**. This, in addition to inculcating the art of salesmanship, provides that knowledge which enables the salesman to hold his own with the most technical of his clients.

We will be pleased to send you details of any or all of these subjects. Just fill in and post the coupon, or write in any other way, stating which branch of Wireless interests you—the information you require will be forwarded at once.

### —YOU MAY USE THIS COUPON—

International Correspondence Schools, Ltd.,  
Dept. 94, International Buildings,  
Kingsway, London, W.C.2.

Without cost, or obligation, please send me full information about the Courses I have marked x

- THE I.C.S. WIRELESS COURSES
- THE I.C.S. RADIO COURSES

Name ..... Age .....

Address .....

(Continued from page 1253.)

### "An Excellent Stimulant"

SIR,—Being a keen amateur experimenter of some years' experience, I was certainly delighted when I recently purchased my first copy of your paper—you may rest assured that it will not be the last! Upon perusal I find your paper brimful of practical articles—an excellent stimulant indeed! The articles are soundly practical and suitable for the veriest novice, and not like some so-called "practical articles" that could only come within the compass of an experienced amateur. You are to be congratulated on the production of such an excellent paper—value for money, too!—L. N. RICHARD (Liverpool).

### Invaluable

SIR,—May I take this opportunity of thanking you for the safe receipt of the Encyclopaedia? I must say I am more than delighted with it as it exceeds by far my expectations and your earlier description of it. In fact, it is invaluable. I have been a regular reader of PRACTICAL WIRELESS since No. 1, and up to the present it is my ideal radio weekly. Now for a suggestion! Why not issue, say every six months, a self-binder and complete index, to enable one to keep a permanent record of your invaluable paper and at the same time do away with the bugbear of laboriously searching through each issue for a particular article or item.—H. L. ENNIS (Bromley).

[You will have already noted that we made an announcement regarding a binder and index in issues 18, 19 and 21.]

## RADIO CLUBS & SOCIETIES

### HACKNEY RADIO AND PHYSICAL SOCIETY

An exceptionally well-attended meeting was held on Monday, February 13, at which Mr. L. E. Cole gave the first of a series of talks on "Fault Finding in Receivers." Unfortunately, we were not able to have a faulty set for the purpose of this lecture, but Mr. Cole very ably demonstrated likely faults by means of diagrams which even the most inexperienced members were able to follow with ease. Commencing at the H.F. end, Mr. Cole described many simple faults which often occur, and in each case demonstrated easy and quick methods of determining the fault. This subject is to be followed up by further talks and demonstrations, and in the series we hope to cover every fault likely to occur in battery and mains-driven sets. We had pleasure in giving a welcome to four visitors who evinced great interest in our meeting.—A. F. Rogerson, Hon. Secretary, 19, Sewdley Street, Clapton, E.5.

### THE CATFORD AND DISTRICT RADIO AND TELEVISION SOCIETY

The members of the Catford and District Radio and Television Society were entertained recently by Mr. Hall. The lecturer first of all explained how short-wave reception had no appeal to the ordinary listening public in England, but in the Tropics it was in great demand. In fact, short-wave wireless was their only means of listening to the Mother Country. Next he explained the various short-wave adaptor systems, the Autodyne, Separate Oscillator, and the little-known American Intra Vario System. Mr. H. S. Ryland, the Chairman, opened the discussion by asking the speaker about the H.T. supply in the Tropics. The speaker admitted that this was a great difficulty, but even so, people out there are willing to go to any trouble to have their wireless. He quoted one instance of a man who hailed from the Congo who placed a standing order for a H.T. battery to be sent from England every fortnight at a cost of somewhere about 45s. per battery. Even where towns abroad had electric mains laid on their troubles were not ended, as the speaker mentioned one town he had heard of where the inhabitants were never sure whether they were on an A.C. or D.C. supply, as it was A.C. during

the day and D.C. at night. Various other questions were asked, all of which were promptly answered by Mr. Hall. After the discussion he demonstrated a short-wave adaptor and many short-wave stations were heard, including Moscow, which came through at great strength giving a programme in English. Full particulars can be obtained from the Hon. Secretary, Mr. H. W. Floyd, 38, Como Road, Forest Hill, S.E.23.

### A.-A. R. & T. S. CONCERTS FROM AMERICA

The Anglo-American Radio and Television Society and associated society, The International Radio Society, have pleasure in announcing that arrangements have been made with various American broadcasting (medium wave) stations for the broadcasting of special DX concerts dedicated to members of the A.-A. R. & T. S. and I.R.S. The societies would be extremely obliged if members, and others, hearing any of these broadcasts would communicate with Leslie W. Orton (Hon. President), at 11, Hawthorn Drive, Willowbank, Uxbridge, England, giving details of reception, fading, etc. Unfortunately, at the moment, the times at which these concerts will be broadcast are not at hand, but they will probably be "put over" between 3 and 6 a.m., G.M.T. May we remind readers that membership to the A.-A.R. and T.S. and I.R.S. is free? The aims of the societies are to promote goodwill and fellowship between nations and aid radio enthusiasts. A stamped-addressed envelope should be enclosed (except in forwarding reports of reception of special concerts, as above) when a reply is desired.

### WEST HARTLEPOOL S.W. CLUB

A start has been made to form a Radio S.W. Club in West Hartlepool. A meeting will be arranged as soon as a sufficient number of members can be got together, and any readers interested in the above club are invited to call or write to Mr. R. W. Stewart, 9, Kilwick St., West Hartlepool.

### THE SOUTHALL RADIO SOCIETY

The meeting of the above club held on Tuesday, February 28th, was addressed by Mr. A. Stephens, the subject being set design. He dealt with the theory underlying the design of sets, and pointed out the snags likely to be met with by any constructor who launched into making sets to his own design. Mr. Stephens dealt with the various forms of coupling on both the low and high frequency sides, output circuits and superhets.

### GOLDERS GREEN AND HENDON RADIO SOCIETY

At a recent meeting of the society Mr. F. E. Henderson, A.M.I.E.E., gave a very interesting talk on the variable mu valve, during which the many difficulties in its manufacture were described. The great advantage of the valve was its excellent possibilities for pre-detection volume control without upsetting ganging; rectification was not introduced with the consequent trouble of cross modulation and modulation hum. The use of graded potentiometers was most desirable. Some useful literature was distributed in which were to be found recommended circuits for reducing high voltages to the requisite potential.—H. A. Scarlett, President.

### KETTERING RADIO AND PHYSICAL SOCIETY

The above society, formed less than a year ago, now boasts a membership of over 150. Meetings are held each Monday in the Smoke Room, Victoria Picture House Café, Kettering. An excellent lecture is arranged for every week, usually with ambitious demonstrations.

A complete 5-metre transmitter, sufficiently small to be held in one hand, and a 5-metre receiver, complete with aerial and batteries, were exhibited. At a recent meeting of the society a lecture on Radio Communication on Ultra-Short Waves, was given by Mr. H. R. Bourne, B.Sc., of Rugby (G2KB). The various advantages of ultra-short waves were discussed, including their consistency, freedom from fading effects and insusceptibility to interference from electrical machines, motor-car ignition systems and atmospherics. The uses of these low wavelength transmissions were described and various types of receivers explained for the reception of signals of the order of five metres. Details of Mr. Bourne's experimental work with portable transmitters in and around Rugby terminated a highly instructive lecture.

Hon. Secs: Mr. R. J. Parkhurst (G5YF), 9, Shakespeare Road, Kettering, and Mr. Thomas H. Hall (BRS1018), 59, Tresham Street, Kettering.

### SLADE RADIO

The tenth of the society's "Junk Sales" was held at the meeting last week. A considerable amount of surplus apparatus was satisfactorily dealt with during the evening, and as usual the disposal of some of the lots provided considerable amusement. The opportunity was taken by Mr. Hornby to describe a new type of set on the market which has recently been installed in the cars of some very notable personages. Details were given of the special precautions which had been taken to eliminate possible pick-up from magneto, distributor, etc., also of the aerial and earth systems. Anyone interested in wireless is invited to write to the Hon. Sec., 110, Hillaries Road, Gravelly Hill, Birmingham, who will be pleased to forward particulars of the society, also copy of the advance programme.

LET OUR TECHNICAL STAFF SOLVE  
YOUR PROBLEMS

REPLIES TO

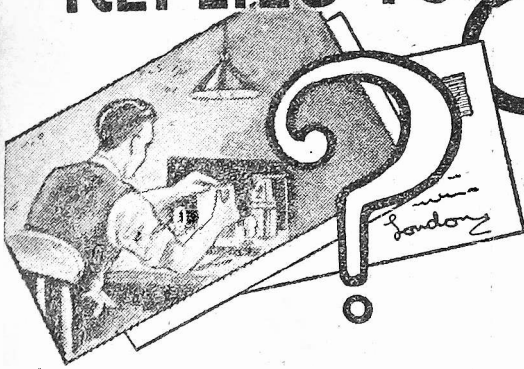

**QUERIES and ENQUIRIES**  
by Our Technical Staff

If a postal reply is desired, a stamped addressed envelope must be enclosed. Every query and drawing which is sent must bear the name and address of the sender. Send your queries to The Editor, PRACTICAL WIRELESS, Geo. Neuness, Ltd., 8-11, Southampton St., Strand, London, W.C.2.

The coupon on this page must be attached to every query.

**SPECIAL NOTE**

We wish to draw the reader's attention to the fact that the Queries Service is intended only for the solution of problems or difficulties arising from the construction of receivers described in our pages, from articles appearing in our pages, or on general wireless matters. We regret that we cannot, for obvious reasons—

- (1) Supply circuit diagrams of complete multi-valve receivers.
- (2) Suggest alterations or modifications of receivers described in our contemporaries.
- (3) Suggest alterations or modifications to commercial receivers.
- (4) Answer queries over the telephone.

Please note also that all sketches and drawings which are sent to us, should bear the name and address of the sender.

**ELECTROSTATIC LOUD-SPEAKER**

"I have read in your paper, and also from catalogues, etc., that the electrostatic type of loud-speaker has many interesting features. From what I can see of this it consists simply of a large condenser. I appreciate that it is two plates separated by a dielectric, and the two plates are joined to the output terminals of the wireless receiver. My query is this—can I make one of these speakers at home? I should be glad of your advice, and if it is possible, could you give me the requisite data, please?"—(Y. S. F., Bognor.)

We are afraid that the home-construction of this particular type of receiver is a little bit too difficult. There are certain other features which you do not mention which will make it extremely difficult to build up a worth-while electrostatic loud-speaker, and if you must have one of this type, then our advice is to buy it. You can, of course, build up at home a balanced armature, or even a moving-coil speaker, provided you can obtain a suitable unit to operate it.

**GANGED VOLUME CONTROLS**

"My receiver employs ordinary H.F. valves of the S.G. type. To reduce the volume of the signal which is received I have an ordinary potentiometer across the H.T. supply. For increasing the volume of distant stations and other purposes I use a small reaction condenser. It occurs to me that I could gang these two controls together so as to reduce the number of knobs which I have to twiddle, but there may be some reason against this. I should appreciate your assistance in solving my problem which amounts to this—how can I reduce the number of controls?"—(S. G., Edinburgh.)

The easiest solution is to remove the reaction condenser. In place of this use a small semi-fixed condenser, and adjust this so that the receiver just bursts into oscillation. Now in the H.T. lead to this valve (the detector) insert a high-resistance, the actual value of which must be determined by experiment. These two resistances, that is, the one which you insert in the detector anode lead, and the S.G. potentiometer should be of the same make, and you will find that the majority of such components are readily adaptable to ganging. The position of the moving elements must be chosen so that the reaction is increased as the H.T. on the screening grids is reduced. This provides a most efficient method of controlling volume and selectivity by means of one control.

**THE "FURY FOUR"**

"I am going to make up the 'Fury Four,' but I already possess a small mains unit which delivers H.T. at 150 volts 30 mA. and L.T. at 4 volts, 4 amps. I should like to use this with the 'Fury Four,' but should first like to know whether it is suitable?"—(W. C. F., Bath.)

There are two points to your query, W. C. F. If you intend to build the battery version of the 'Fury Four,' you cannot, of course, employ the L.T. section of your mains unit. On the other hand, if you intend to build the A.C. version of this receiver, then the H.T. supply is nowhere near large enough. You must

therefore either build the battery version and use accumulators for supplying the low-tension current, or build the Mains version, and obtain a fresh eliminator to supply the requisite 200 volts. The mains valves operated with 150 volts at 30 mA. will be very inefficient, and therefore the cheapest method is to build the battery receiver and use the H.T. side of the mains unit only.

**HOME-MADE CABINET**

"I have recently built up, at a fair amount of trouble, a small radio-gram, cabinet, and have fitted my old receiver inside this. The set, which previously gave splendid results, now seems to have gone all to pieces. First of all, the valves give off a terrible ringing noise. Secondly, the speaking sounds like a big drum, and you can hardly understand what is being said when the news is coming through. What have I done to cause all this? I am only a newcomer to wireless, and I am afraid I have upset things in some way, but I don't know how."—(J. G., Uppingham.)

Your trouble is no doubt due to the fact that you have built the cabinet too small, and probably have, in addition, used very thin wood. The result of this is that the volume of sound produced by your speaker causes a large amount of cabinet resonance, and the soundwaves echoing inside the cabinet are impinging on the valves, giving rise to the ringing. Your best remedy is, of course, to build another more substantial cabinet. As this will probably be a too expensive remedy, try the following dodges. Cover each valve bulb with lumps of putty, plasticine, etc., over which is wrapped a large duster or other rag. The idea is

**DATA SHEET No. 26.**

**HANDY FORMULÆ.**

Cut this out each week and paste it in a Notebook.

Frequency—  $10^6$  cycles.

$$2\pi \sqrt{LC}$$

Where L is inductance in microhenries.  
C is capacity in microfarads.

Wavelength— $\lambda$  1,885  $\sqrt{LC}$

Where  $\lambda$  is in metres,  
L is inductance in microhenries,  
C is capacity in microfarads.

to prevent the glass from vibrating. Secondly, screw large pieces of wood—any odd shapes and pieces will do—at different parts of the cabinet sides (inside, of course). This is to break up the wooden sides into irregular shaped pieces which will damp-out the vibrations. A final scheme would be to line the cabinet corners with kapok or similar material to stop echo.

**FITTING A FUSE**

"My receiver is rather old, and on no fewer than four occasions I have burnt out valves through the H.T. lead coming off the terminals at the back. I feel that I must fit some safeguard, but as I am only a beginner in wireless, I do not know what to fit. Could you enlighten me, please?"—(R. F., Cardiff.)

You will probably find that inside your receiver, behind the terminal strip, the two terminals marked H.T.— and L.T.— are joined together with a wire. This wire must be cut away. Now obtain a small base-board fuse-holder, and attach one terminal of this to H.T.— terminal, and the other terminal to the L.T.— terminal. The lead which goes on to the F terminals on the valve-holders should come from the L.T.— terminal, and not from the H.T.— terminal. If you do not have two terminals on your set, but the H.T.—

and L.T.— leads are both joined outside the set, you must do the same thing, namely, join the fuse between H.T.— and L.T.—, with the lead to the set coming from the L.T.— side.

**METAL RECTIFIER**

"I have just obtained from a friend a Metal Rectifier to make up a new H.T. eliminator. This has three terminals marked plus, minus and A.C. I am not sure how to connect this, but I am told it gives an output of 200 volts. What transformer must I get, and how is it joined to the three terminals. I believe a transformer only has two output terminals."—(R. H., Dulwich.)

The rectifier may be joined up in one of two ways. For half-wave rectification a transformer giving an output of 250 volts at 45 mA. will be required, and for full-wave rectification on what is known as a voltage doubler circuit, a transformer with a secondary of 135 volts at 90 mA. will be needed. For the latter case, one secondary transformer terminal is joined to the terminal marked A.C., and the remaining secondary terminal is joined to the junction of two 4 mfd. condensers. The free terminals of the two condensers are then joined to the plus and minus terminals of the rectifier. These two terminals also furnish the D.C. output of the eliminator. For half-wave rectification, one secondary terminal is joined to terminal A.C., and the remaining secondary terminal is taken to one side of a 4 mfd. condenser and becomes H.T.— (D.C.). The plus terminal on the rectifier is joined to the other side of this condenser and is H.T. plus (D.C.). In both cases a smoothing choke will, of course, be needed.

**RESISTANCE RATINGS**

"I notice that a good many of the solid type of resistances which are now on the market are called '1 watt type.' How does one ascertain what wattage is required of a resistance? And how is the wattage of the resistance obtained?"—(S. F., Peterborough.)

As has been explained many times in our pages, the passage of a current through a resistance results in a voltage drop. The value of this voltage is obtained by multiplying the resistance (in ohms) by the current (expressed as a decimal part of an amp.). Or, put in another way, the resistance in ohms is multiplied by the current in milliamperes, and the answer divided by 1,000. This will give the volts dropped through the resistance. If now this voltage is multiplied by the current in milliamperes, and the answer divided by 1,000, the answer will give you the watts dissipated by the resistance.

**ALTERING A BAND PASS TUNER**

"My set is a commercial make, and it is fitted with a band pass circuit. After reading several items in your paper I have come to the conclusion that the values of the couplings in this band pass arrangement could be modified to suit my particular district. I should be glad to know how to work out the best value, and the best make of parts to get for the purpose."—(K. A. R., Barmouth.)

We do not advise you under any circumstances to attempt to interfere with a commercially-made receiver. Whilst it is quite likely that only a simple band pass arrangement is employed, and that it is possible to improve upon it, there is always the risk that there is some peculiarity in the particular receiver which depends for its correct functioning upon the resistance, or condenser, or some other part in the tuner. The alteration of this may, therefore, completely ruin the performance of the receiver. It may even result in actual damage. An instance may be given of a band pass adapted circuit in which the resistance employed is one of a series which carries the total anode current of the set, and which serves as a biasing resistance for the S.G. valve. A change in the value would vary the bias on the valve which might result in instability, and might even result in preventing the valve from functioning.

**FREE ADVICE BUREAU  
COUPON**

This coupon is available until March 25th, 1933, and must be attached to all letters containing queries.

PRACTICAL WIRELESS 18/3/33.

# CATALOGUES RECEIVED

To save readers trouble, we undertake to send on catalogues of any of our advertisers. Merely state, on a postcard, the names of the firms from whom you require catalogues, and address it to "Catalogue," PRACTICAL WIRELESS, Geo. Neunnes, Ltd., 8/11, Southampton St., Strand, London, W.C.2. Where advertisers make a charge, or require postage, this should be enclosed.

## CELESTION SPEAKERS

WE have just received a handy loose-leaf folder from the Celestion people containing operating instructions and technical data concerning their various types of speakers. The instructions given should be particularly useful to possessors of these well-known instruments for enabling them to get the best results. Additional technical data concerning transformers and power handling capacity are also included for amateurs who wish to design their own amplifiers. A copy of any particular leaflet can be obtained from Celestion Ltd., London Road, Kingston-on-Thames.

## T.C.C. CONDENSERS.

FIXED condensers of various types and for all purposes are shown in the latest folder issued by Telegraph Condenser Co., Ltd., Wales Farm Road, North Acton, W.3. Small mica condensers with capacities of from .00005 to .25 mfd.; high voltage electrolytic and paper condensers; smoothing condensers; and a special line of sub-divided block condensers are included in the folder, together with useful tables giving the dimensions, capacities, and prices of each component.

## FORMO PRODUCTS

THE new range of components shown in the latest Formo list should appeal to all discerning constructors. Amongst the components listed are dual-range aerial and band-pass coils, L.F. transformers, multicouplers, and dual and triple gang condensers. The ganged condensers can also be obtained mounted on a common base plate with either two or three matched ganged coils with coupled switches. In the triple gang condenser each assembly is provided with an ordinary trimmer. The list also includes a range of Formo "Hymeg" fixed condensers of various capacities up to 14 mfd.

## "ATLAS" MAINS UNITS

IN the latest folder issued by H. Clarke and Co., of George Street, Patricroft, Manchester, a comprehensive range of "Atlas" mains units is listed. Some are combined H.T. units and L.T. chargers, while a new A.C. model is also provided with grid-bias tappings. Other models are designed for delivering H.T. only,

and one D.C. unit is provided with an ingenious switching arrangement which ensures the full voltage being delivered even when different amounts of current are being taken from the unit. It is for working on 200-250-volt mains, and the output is 15 to 25 milliamperes. Other "Atlas" components included in the folder are an L.F. transformer designed for parallel-feed circuits, a new permanent magnet loud-speaker, short-wave coils, and a pentode choke.

## THE HOUSE OF COSSOR

FROM the Cossor people comes a neat folder which tells briefly the history of the firm of A.C. Cossor, Ltd., from pre-war days to the present time. The folder, which is well printed in three languages, includes several half-tone illustrations of various processes in the manufacture of Cossor valves and components.

Another interesting leaflet we have just received from this firm is of special interest to overseas readers, and gives particulars of the new Cossor short-wave receivers for A. C. mains, and battery operation. Both models are based on a special development of the autodyne circuit giving one-knob control and enabling a low intermediate frequency to be used with consequent high amplification. The all-electric receiver is a six-valve super-het. housed in a handsome cabinet of modern design and embodies a mains-energised moving-coil speaker. The battery model is a 4-valver, and is fitted with a permanent magnet moving-coil speaker. The wavelength ranges of the receivers are 13.5 to 550 metres, and 13.5 to 500 metres respectively. These receivers are specially designed for overseas use and are not for sale in this country.

## Replies to Broadcast Queries.

SUPERHET (Bala) (a) San Sebastian (EAJS) on 456 m.; (b) Apparently a test by Radio Strasbourg (345.2 m.). BEGINNER (Sudbury): Heston Airport (833 m.); Air Ministry weather report broadcast by Automobile Association. 808 WH (Forest Gate): (1) WJSV Alexandria (Va.) on 205.4 m.; (2) Possibly WSAI, Cincinnati (Ohio) (225.4 m.); (3) WNAC, Boston (Mass.) on 243.8 m.; (4) WHAM, Rochester (N.Y.) 260.1 m.; (5) WOAI, San Antonio (Tex.) on 252 m.; (6) WTAM, Cleveland (Ohio) on 280.2 m.; (7) WTIC, Hartford (Conn.) 282.3 m.; (8) KDKA, East Pittsburgh (Pa.) on 305.9 m.; (9) WENR, Chicago (Ill.) (344.6 m.); (10) WGY, Schenectady (N.Y.) 379.5 m.; (11) Possibly WBBM, Chicago (Ill.) on 389.4 m.; (12) WJZ, Boundbrook N.Y. 394.5 m.; (13) KPO, San Francisco (Cal.) on 440.9 m.; (14) WPG, Atlantic City (N.J.) on 272.6 m. OPTIMIST (Sheffield): (1) R.A.F. Air Planes; ground station to aircraft; (2) Apparently U.S.A. experimental transmitter if call sign correct, WIID, H. Thomas, 69, Wellesley Avenue, North Providence, Rhode Island. W4IU, W. B. Taylor, AARS, 510, Brady Point Road,

Signal Mountain (Tenn); WIXU, cannot trace; WIABY, H. E. Powers, 151, Pond Street, Leominster (Mass.). WIXAL, 70, Brookline Avenue, Boston (Mass.). S. T. 400 (Bacup): Apparently aerodrome station, testing on 1,236 m. (242.9 kc/s). SEARCHER (Cheshire): (1) G6MM, for the name and address of this transmitter please write to Radio Society of Great Britain, 53, Victoria Street, London, S.W.1; G6MX, Manchester Wireless Society, 2, Parkside Road, Princess Road, Manchester; G5BK, W. Brown, 52, Winstontan Road, Cheltenham, Gloucestershire. S. W. F. (Cirencester): (1) WEA, Rocky Point (N.Y.) on 28.28 m.; (2) WTY, Rocky Point (N.Y.) on 21.65 m. NIP (Romsey): (1) WCAU, Philadelphia (Pa.) on 256.3 m.; (2) WABC, New York, (348.6m.) C.B.S.; KDKA, East Pittsburgh (305.9 m.). N.B.C.; WBZ, Boston (302.8 m.), N.B.C.; WTIC, Hartford (Conn.) on 282.8 m. (N.B.C.) —are all well heard. L. E. BARNES (Templecombe); Radio Toulouse, 60 kW. testing. PEN (Surrey): Regret, cannot trace.

## RECEIVERS AND THEIR RECORDS

(Continued from page 1233.)

plug to the mains system, and an outside aerial of not more than 40ft. in length to one of the appropriate Fahnestock terminal clips, the earth being taken to the remaining one.

The chief quality of a superheterodyne receiver is that of selectivity, and in this respect the "Philco 8-Valve Model 247E" was of outstanding merit. The scale is clearly marked, and tuning is greatly facilitated by the fact that as the condenser is revolved so a thin strip of light is thrown on to the dial, thus showing the exact fraction of a degree at which the station is heard at its best. Sensitivity, as might have been expected with this circuit, was excellent, and broadcasts were easily received throughout the wave-range, irrespective of their distance.

In view of its great selectivity, no difficulty was experienced in separating any two neighbouring stations working with a 9 kilocycle separation. On the longer wave-range, most of the broadcasting stations were tuned in at full loud-speaker strength.

## LEARN MORE ABOUT YOUR WIRELESS

Whether you are beginner or expert, study of this comprehensive and up-to-date work will result in both pleasure and profit. Its author is acknowledged to be one of the most brilliant exponents of Modern Radio both in theory and practice, and this "Outline" is filled with knowledge. It should be on every enthusiast's bookshelf.

## THE OUTLINE OF WIRELESS

By RALPH STRANGER

8/6

Obtainable at all Booksellers, or post free 9/- from George Neunnes, Ltd., 8-11, Southampton Street, Strand, London, W.C.2.

## ADVERTISEMENT INDEX

	Page		Page		Page
Belling & Lee, Ltd.	1246	Gilbert, J. C.	1253	Riverside Mfg. Co...	1253
Block Batteries	1213	International Corr. Schools	1254	Ryalls Radio	1251
Bridgland, J. W.	1253	Lectro Linx, Ltd.	1251	Seradex Products	1253
British Ebonite Co., Ltd.	1249	Lissen Ltd.	1214	Simpson's Electricals, Ltd.	1243
British Pix Co.	1246	London Radio Supply Co.	1244	Telegraph Condenser Co., Ltd.	1247
Bulgin, A. F. & Co., Ltd.	1251	Mason, E. C.	1253	The 362 Radio Valve Co.	1228
Carrington Mfg. Co., Ltd.	1249	Milnes Radio Co.	1249	Turnadge & Partners, Ltd.	1253
Colvern, Ltd.	1213	Newnes' Data Sheet Self-Binder	Inside B. Cover	Univolt Electric, Ltd.	1256
Cossor, A. C., Ltd.	1227	" Finding Foreign Stations "	1246	Vinces Dry Batteries Ltd.	1228
Direct Radio, Ltd.	Front Strip	" Home Mechanic "	1253	Watmel Wireless Co., Ltd.	1253
Edison Swan Electric Co., Ltd.	Back Cover & 1243	" Outline of Wireless "	1256	Weedon Power Link Co.	1253
Electrical Trading Assn.	1249	Partex Radio	1251	The Westinghouse Brake & Saxby Signal Co., Ltd.	1231
England-Richards, Ltd.	Inside Front Cover	Peto-Scott, Ltd.	1239	Wilkins & Wright, Ltd.	1247
		Preh Mfg. Co.; Ltd.	1228		

March 18th, 1933

PRACTICAL WIRELESS

# THE PRACTICAL WIRELESS SELF-BINDER

for our

## FREE GIFT DATA SHEETS

THIS OFFER IS SPECIALLY REPEATED FOR THE BENEFIT OF NEW READERS

### CLAIM YOURS TO-DAY!

The loose binders for preserving in permanently consultable form the Data Sheets which are being given every week in PRACTICAL WIRELESS are NOW READY.

The PRACTICAL WIRELESS DATA SHEETS LOOSE LEAF Binder as illustrated here has a stout linen-covered stiff-board cover specially made to stand hard wear, having a special flap with cloth hinges and enamelled press-button fitting for speedy insertion and removal of the Data Sheets which are specially "holed" to fit. There is an extremely useful manilla gusset pocket on the inside back cover for holding loose sheets, newspaper clippings, notes, and other odds and ends.

If you require one of these binders, you should fill in the label below, enclosing a postal order for 1s. 6d., to include cost of registration, postage, packing, insurance, etc., and send to PRACTICAL WIRELESS, Presentation Department, 39, King St., Covent Garden, London, W.C.2. Immediately on receipt of this your binder will be dispatched.

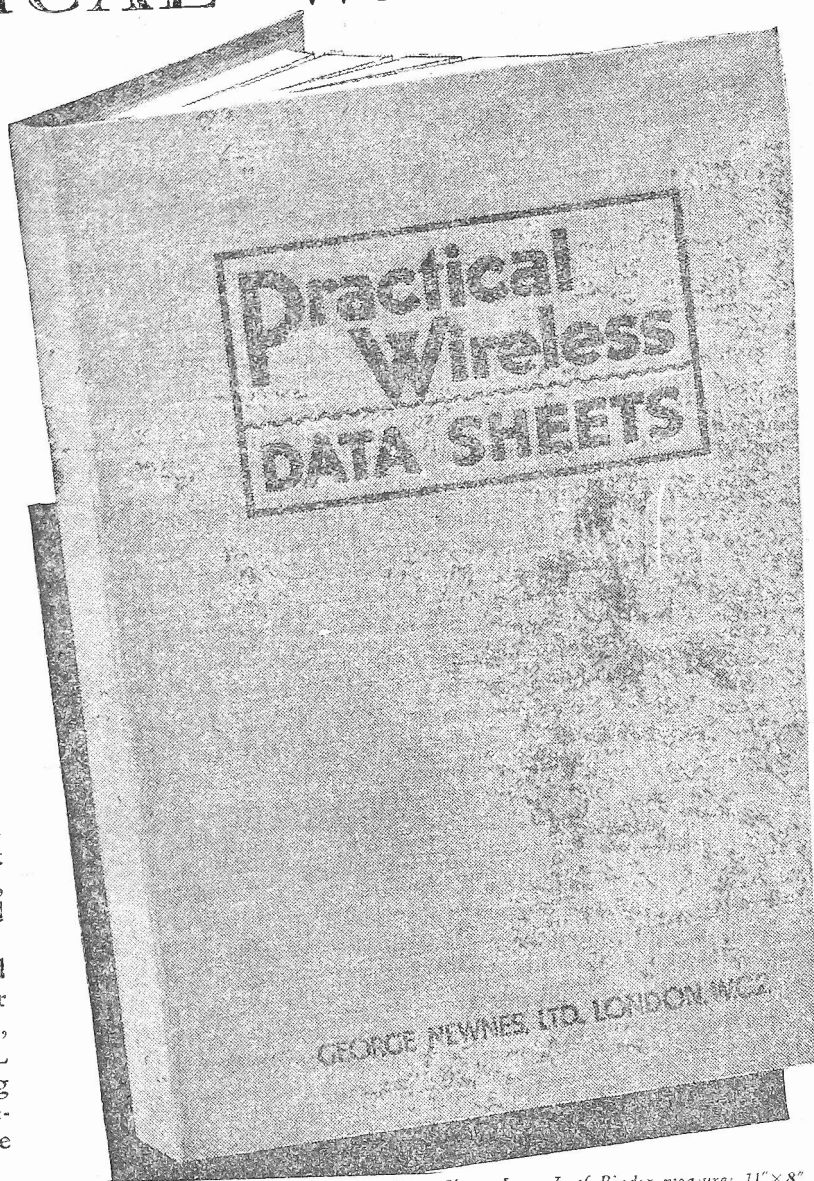

The PRACTICAL WIRELESS Data Sheet Loose-Leaf Binder measures 11" x 8"

FILL IN THIS LABEL AND POST TO-DAY

### BOOKS WITH CARE

Name.....

Full Address.....

If undelivered please return to

PRACTICAL WIRELESS Presentation Dept.,  
39, King Street, Covent Garden, London, W.C.2

### THE FOLLOWING DATA SHEETS HAVE ALREADY BEEN ISSUED:

- Data Sheet No. 1— Accumulator Charging - - Dec. 17th, 1932
- Data Sheet No. 2— Coils & Coil Winding - - Dec. 24th, 1932
- Data Sheet No. 3— Resistances - - Dec. 31st, 1932
- Data Sheet No. 4— Mains Transformers - - Jan. 7th, 1933
- Data Sheet No. 5— Wire and Wire Gauges - - Jan. 14th, 1933
- Data Sheet No. 6— Chokes, H.F. & L.F. - - Jan. 21st, 1933
- Data Sheet No. 7— Condensers - - Jan. 28th, 1933
- Data Sheet No. 8— Battery Eliminators - - Feb. 4th, 1933
- Data Sheet No. 9— Screws & Screw Threads - - Feb. 18th, 1933
- Data Sheet No. 10— Battery-Operated Valves - - Feb. 25th, 1933
- Data Sheet No. 11— Mains Valves - - Mar. 4th, 1933
- Data Sheet No. 12— Handy Formulae - - Mar. 11th, 1933

Those new readers who are desirous of completing their files of these Data Sheets may have those already issued for 2d. each from the address given above.

Fill in this label in block letters, and send with postal order for 1/6, to: "PRACTICAL WIRELESS" Presentation Dept., 39, King Street, Covent Garden, London, W.C.2.



# EDISWAN

The name that means 'EXCELLENCE'

## DO YOU KNOW

### how to get the best out of a Pentode?

In most cases poor reception is caused by bad valves or wrongly used valves. Here's the way to make sure of good reception. Always rely on "The Book of the Mazda Valve." If you are using, or are going to use, a pentode for instance, get this book first. You will find that there are six pentodes in the Mazda range. You will also find complete information about using each one. No trouble, no unnecessary expense. You get the results you want—first time, and all the time.

## THIS BOOK TELLS YOU HOW

"The Book of the Mazda Valve" is a mine of useful information about valves in general and Mazda Valves in particular. It contains facts and figures, circuit diagrams, component values, characteristic curves—in fact, all the valve user wants to know about valves. Send for your FREE copy to-day—or ask your dealer for one.

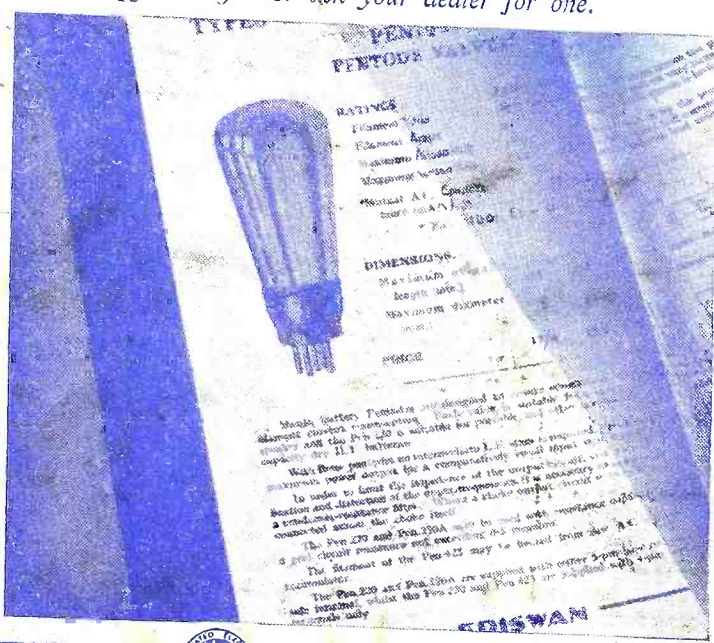
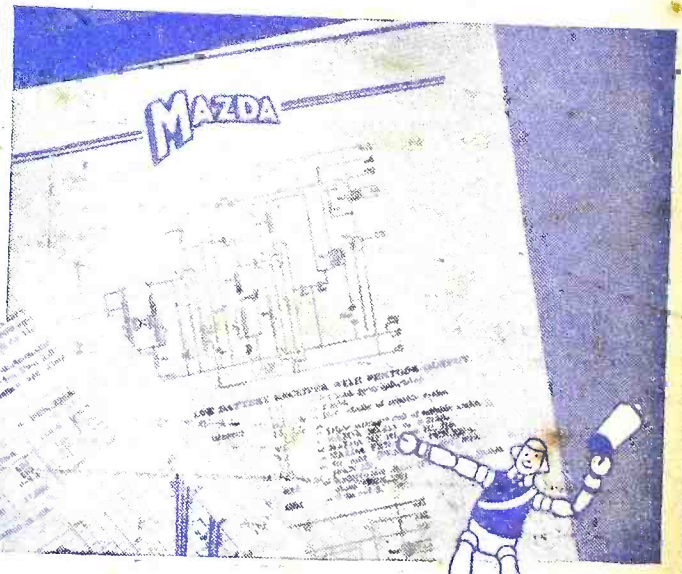

# MAZDA THE BRITISH VALVES



THE EDISON SWAN ELECTRIC CO. LTD., 155 CHARING CROSS ROAD, W.C.2

*Mazda Radio Valves are manufactured in Great Britain for The British Thomson-Houston Co. Ltd., London and Rugby.*

### RECOMMENDED BY ALL GOOD RADIO DEALERS

P. W. Gift Stamp No. 25  
See page 1215.

Printed by NEWNES & PEARSON PRINTING CO., LTD., Exmoor Street, Ladbroke Grove, W.10, and published by GEORGE NEWNES, LTD., 8-11, Southampton Street, Strand, W.C.2. Sole Agents for Australia and New Zealand: GORDON & GORON LTD., South Africa: CENTRAL NEWS AGENCY, LTD. *Practical Wireless* can be sent to any part of the world, post free, for 17/4 per annum; six months, 8/8. Registered at the General Post Office for Transmission by Canadian Magazine Post.

# "PRACTICAL WIRELESS" DATA SHEET No. 13

## TERMINALS, FUSES, ETC.

### TERMINAL SIZES

Terminal shanks are practically all 4 B.A. The older form of slotted shank supplied by Belling-Lee is 2 B.A. These sizes are clearance dimensions.

### TERMINAL TYPES

Terminals are obtainable in many sizes and patterns, but the markings set out below are those which are standardised by the majority of terminal manufacturers. The Belling-Lee terminals are manufactured in four sizes, Types B, M, R and Q. Types B, R and Q have ebonite heads, whilst Type R is of metal. Types B and M also have non-rotatable heads so that the name is always easily read.

Eelex terminals are manufactured with non-rotatable indicating heads, and with socket centres so that plugs may be inserted. In addition, the Treble Duty terminal has removable indicating plates which are held in place on the head. The shank is slotted to accommodate connecting wires.

### TERMINAL BLOCKS

Terminals are usually attached to a strip of ebonite fixed to the rear of a baseboard, but to simplify this method of construction, special terminal mounting blocks are manufactured by Belling-Lee, Ward & Goldstone, Telsen, etc. The Belling-Lee accommodates two terminals of any type, whilst the Ward & Goldstone accommodates only one terminal. The Telsen is complete with two terminals, one red and one black.

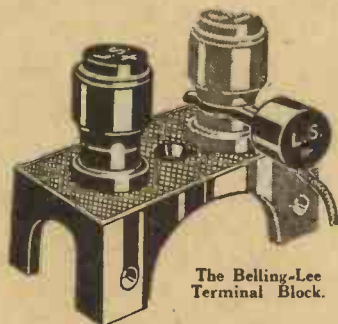

The Belling-Lee Terminal Block.



The Eelex Treble Duty Plug.

### STANDARD TERMINAL INDICATIONS

Aerial	Aerial 1	Aerial 2
Aerial 3	Earth	Pick-up
L.S.+	L.S. -	Phones+
Phones -	L.T.+	L.T. -
H.T.+	H.T.+1	H.T.+2
H.T.+3	H.T.+4	H.T. -
Grid+	Grid -	Grid -1
Grid -2	Grid -3	Screen
Input+	Input -	Output+
Output -	+	-
Mains+	Mains -	A.C. Mains
L.T.A.C.		

And in addition, plain red or black.

### FUSES

H.T. - is invariably joined to L.T. -, and it is advisable always to make this connection by means of a fuse. The leads to the valveholders are then taken from the L.T. - side of the fuse-holder. Fuse-holders are manufactured by Telsen and Bulgin and accommodate small lamp fuses of the flashlamp bulb type. They are obtainable in various ratings

and the choice should be made in the following manner. Add together the total filament current consumption of each individual valve, and choose a fuse which will blow at a value slightly lower than this total. Microfuses are also obtainable, and these consist of a thin gold film and not a lamp type. They are also obtainable in various ratings. (Note: .2 amp. is 200 milli-amps.)

### BATTERY CORDS

To obviate the necessity of joining battery leads to terminals, special multi-way battery cords are obtainable.

Those manufactured by Messrs. Belling-Lee are fitted with two spades for connecting to the accumulator, whilst the remaining cords are provided with wander plugs. These may be obtained in lengths of 30 in. or 54 in. and are made up in 5-way, 6-way, 7-way, 8-way, 9-way and 10-way cables. The leads are intended for C.B. and H.T. tapplings, but obviously the plugs may be altered to suit individual requirements. Messrs. Bulgin, Ward & Goldstone and Harbro also manufacture multi-way battery cords similar in type to those above mentioned. Messrs. Bulgin do not supply spades or plugs with their cords so that these may be made up to suit particular demands.

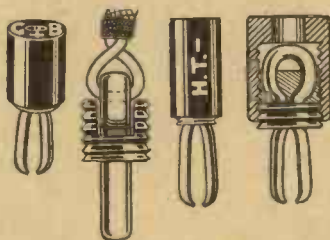

Various Types of Wander Plugs.

### TERMINAL MOUNTING STRIPS

In place of the customary terminal block or strip, special paxolin strips are obtainable from Clix, in which resilient sockets are fixed. These are appropriately engraved and accommodate the solid type of plug. This is an improvement on the terminal with screw top, as it enables rapid connection to be made. Messrs. Bulgin also manufacture a small ebonite terminal block with two terminals fitted.

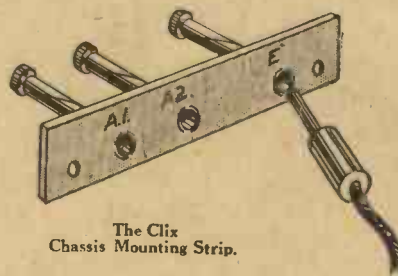

The Clix Chassis Mounting Strip.

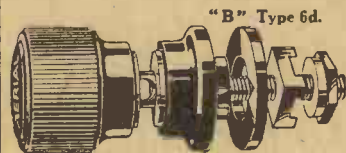

"B" Type 6d.

**BELLING-LEE**  
FOR EVERY RADIO CONNECTION

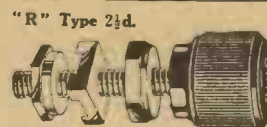

"R" Type 2jd.





FREE INSIDE! DATA SHEET No. 14—"LOUD-SPEAKERS"

# Practical Wireless

3<sup>D</sup>

Published every Wednesday by  
**GEORGE  
NEWNES  
LTD.**

Vol. 2. — No. 27.

MARCH 25th, 1933.

Registered at the G.P.O. as a Newspaper.

## The ALPHA Q.P.P. THREE

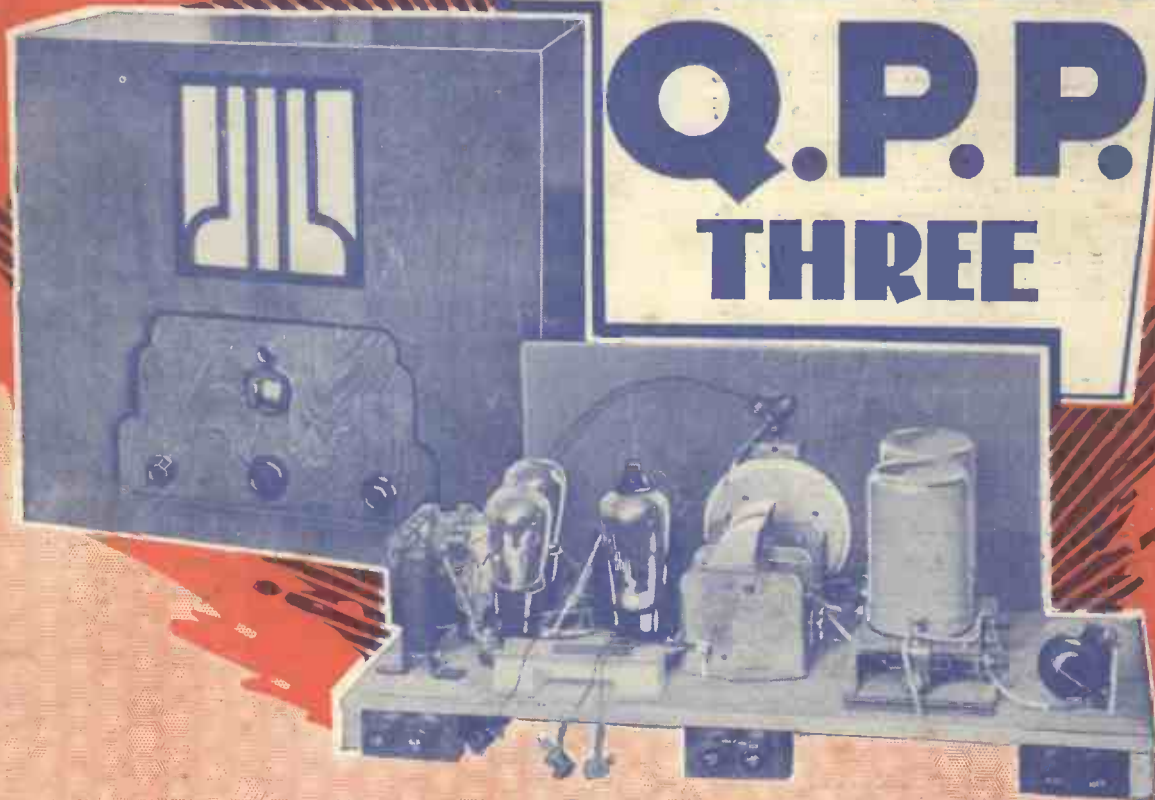

"OHMITE" RESISTANCE



Better than Wirewound  
All values from 50 ohms to  
5 megohms. Accurate and  
Constant.

1/6 each. Holder 6d.

Made by  
**GRAHAM  
FARISH**  
Bromley  
Kent,

**PROGRESS!**  
**COLVERN FERROCART COILS**  
 OPEN A NEW ERA IN RADIO RECEPTION

It has long been recognised that tuning coils of maximum efficiency are of paramount importance in the attainment of selectivity and sensitivity in a receiver. The design of tuning coils has made large strides in the past few years, but space considerations and the realisation of effective screening for band-pass filters and between the various stages of a receiver has involved the use of relatively small winding diameters for the coils. Thus, although actual progress has been made, this self-same progress has involved a reduction in the efficiency of the coils themselves.

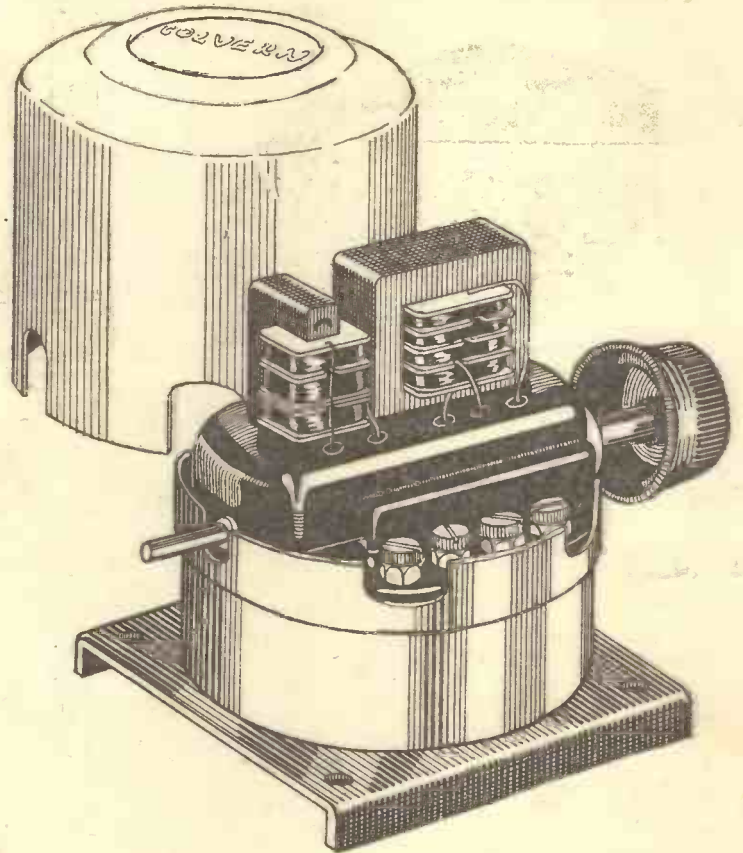

Colvern Ferrocart coils have, however, changed all this at one fell swoop. These coils, though of considerably smaller dimensions than the relatively inefficient screened air-cored coils to which we have become accustomed, are actually more efficient than the unscreened Litz wound large diameter coils which have always been regarded as the last word in efficiency but which could never be put to practical use in a receiver, owing to their bulk and the impossibility of screening without very serious loss of efficiency.

The first types to be available are —

TYPE F1—F2.

Input band-pass filter.  
 Constant selectivity,  
 ganging unaffected by  
 variations in aerial  
 reactance, symmetrical  
 resonance curve.

TYPE F3.

Autotransformer intervalve  
 coupling with reaction, gang-  
 ing perfectly maintained on  
 both wave ranges by transfer  
 of tapping point in correct  
 turns ratio, practically con-  
 stant reaction.

**SPECIFIED FOR THE**  
**FERROCART-Q.P.-P. HIGH MAG THREE**

One set F1, F2, F3 Coils ganged on sub base plate with wave change switch .. .. . Set	<b>50/-</b>
---	-------------

MADE UNDER LICENCE FROM THE PATENTEE, HANS VOGT.

**COLVERN LTD., MAWNEYS RD., ROMFORD, ESSEX**

(London Wholesale Depot, 150, King's Cross Road, W.C.1.)



# FIRST AGAIN



with  
**SPECIAL NEW UNITS** for  
 the **"Q.P.-P. Three Four"**  
 & ALL OTHER **"Q.P.-P." SETS**

"ATLAS" are first again with their new "Q.P." Units specially designed for "Quiescent Push-Pull" Amplification. In these circuits the anode current varies widely according to the signal strength. But the voltage must remain quite steady, regardless of the current passed in order to prevent distortion. The ordinary unit is quite unsuited because its voltage varies with every fluctuation of output current. "ATLAS" "Q.P." Units have specially designed smoothing, voltage regulation and provision for pentode matching and are the only units specified by the author of the "Q.P.P. Three-Four." They give an average output of 12 m/A at 150 v., but peak loads of up to 20 m/A are passed without appreciable voltage drop.

**MODEL D.P.Q.** for D.C. Mains. H.T. only. 45/- or 10/- down.

**MODEL Q.P. 24** for A.C. Mains. H.T. only. 72/6 or 10/- down.

**MODEL Q.P. 26** for A.C. Mains. H.T. and L.T. Trickle Charger. 25 or 10/- down.

Post coupon to-day for full details and, if your dealer cannot demonstrate, write direct to

**H. CLARKE & CO. (M/CR) LTD.,**  
**PATRICROFT, MANCHESTER.**

London: Bush House, W.C.2.  
 Glasgow: G. E. S. Co. Ltd., 38, Oswald St.

# SPECIFIED EXCLUSIVELY

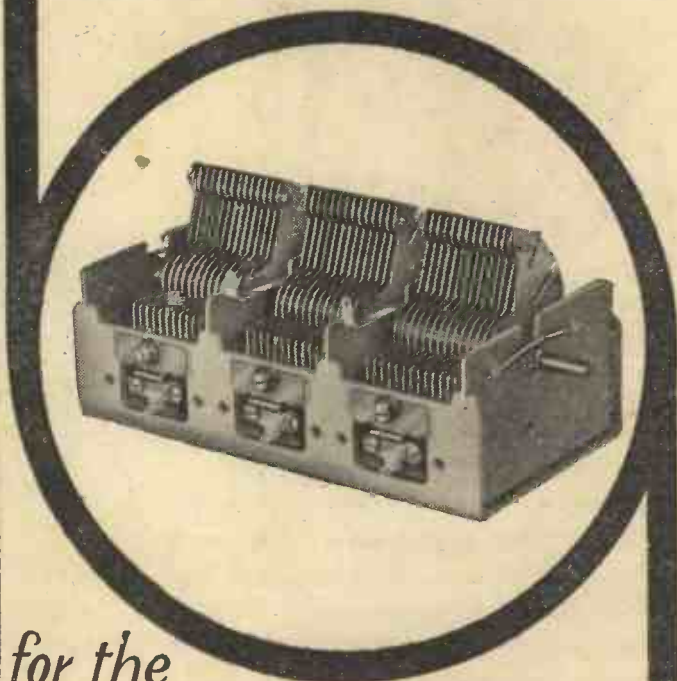

for the  
**FERROCART**  
**Q.P.P. HI-MAG. THREE**

On account of their great efficiency only ganged Condensers matched with the highest possible degree of accuracy can be successfully used with Ferrocart Coils.

That is why British Radiophone Ganged Condensers have been chosen WITHOUT ALTERNATIVE for the above receiver, which is one of the first to be designed.

British Radiophone Ganged Condensers are built with such precision that accuracy is guaranteed between any two sections to within 1 m.mfd. or 1/2 per cent. whichever is the greater. Furthermore, this accuracy is rendered lasting by virtue of sound mechanical construction which maintains the electrical characteristics at a fixed value under the most exacting conditions.

**FOR THE FERROCART**  
**Q.P.P. HI-MAG. THREE**

Type 344J 3-gang condenser complete with cover	PRICE	<b>28/-</b>
Disc Drive Assembly with Pilot Lamp attachment		<b>5/-</b>

Messrs. H. Clarke & Co. (M/CR) Ltd.,  
 George Street, Patricroft, Manchester.

Please send me full details of the new "ATLAS" "Q.P." Units.

Name .....

Address .....

61/25/3 .....

# RADIOPHONE GANGED CONDENSERS

BRITISH RADIOPHONE LTD., Aldwych House, London, W.C.2.

# "SKYSCRAPER" RADIO

## THIS IS THE SET YOU CAN BUILD YOURSELF & SAVE POUNDS!

COMPLETE IN CABINET WITH LOUDSPEAKER **£6.5s** or 11/6 down and twelve monthly payments of 10/6

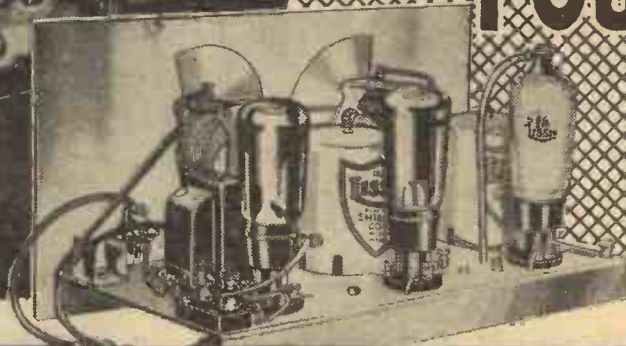

## SUCCESS A CERTAINTY

**GET YOUR FREE COPY OF GREAT CHART TELLS EXACTLY WHAT TO DO WITH EVERY SINGLE NUT AND SCREW**

**THE ONLY KIT YOU CAN BUILD YOURSELF EMPLOYING METALLISED S.G. HIGH-MU DETECTOR AND ECONOMY POWER PENTODE VALVES**

NEVER before was there such a set within the reach of the home constructor. Never before such power from a battery set. Never before so many enthusiastic letters from constructors or so much talk about any radio set as this Lissen "Skyscraper" Kit has elicited 50-60-70 loud-speaker stations—everybody who builds a "Skyscraper" gets results like that! Lissen have published a 1/- Constructional Chart, giving the most detailed instructions ever printed for the building of a wireless set. You can't go wrong—every part, every wire, every terminal is identified by photographs. Everybody, without any technical knowledge or skill, can safely and with COMPLETE CERTAINTY OF SUCCESS undertake to build this most modern of radio receivers from the instructions given and the parts Lissen have supplied.

This new Lissen "SKYSCRAPER" Kit Set is the only one on the market that you can build yourself employing a Metallised Screened Grid Valve, High Mu Detector and Economy Power Pentode. Around these three valves Lissen have designed a home constructor's kit the equal of which there has never been before. Why be satisfied with whispering foreign stations when you can BUILD WITH YOUR OWN HANDS this Lissen "SKYSCRAPER" that will bring in loudly and clearly distant stations in a profusion that will add largely to your enjoyment of radio?

### yours for ONLY 8'6 down

To-day you can buy the LISSEN "SKYSCRAPER" KIT on Gradual Payment Terms. "Skyscraper" Chassis Kit, complete with Valves, CASH PRICE, 89/6. Or 8/6 down and twelve monthly payments of 7/6. "Skyscraper" Kit complete with Walnut Cabinet and in-built Loud-speaker, as illustrated, £6 5s. cash. Or 11/6 down and twelve monthly payments of 10/6.

You can get the Lissen "Skyscraper" Chart FREE from any radio dealer, or by posting the COUPON on left direct to factory.



**POST THIS COUPON**

**COUPON**

To Lissen, Ltd., Publicity Dept., Isleworth, Middlesex.

Please send me FREE copy of your 1/- Skyscraper Chart.  
Name.....  
Address.....  
P.R. 42. ....

# LISSEN "SKYSCRAPER" KIT 3

THIS ISSUE COMMENCES A NEW VOLUME!



**EDITOR:**  
 Vol. II. No. 27 || **F. J. CAMM** || March 25th, 1933  
**Technical Staff:**  
 H. J. Barton Chapple, Wh. Sch., B.Sc. (Hons.), A.M.I.E.E.  
 Frank Preston, F.R.A., W. J. Delaney, W. B. Richardson.

# ROUND *the* WORLD of WIRELESS

## Publicity Broadcasts in U.S.A.

IF at any time you have heard broadcasts from America you must have picked up some transmission or other in which the goods of well-known concerns have been given a microphone "boost." From statistics recently published the largest amount paid by one manufacturer in 1932 for time on the air is 3,639,782 dollars. This sum represents the fee actually paid to the stations and does not include the salaries of artists taking part in the sponsored programmes, put out by the advertisers. Over the N.B.C. and C.B.S. networks one firm alone with a view to pushing the sales of a popular brand of cigarettes spent 1,851,000 dollars in the course of a few months. The salaries paid to artists specially engaged for these publicity entertainments is also worthy of consideration, some receiving as much as 7,500 dollars per week for their daily broadcast.

## Radio Tessino

IT is hoped that the new Monte Ceneri high power transmitter, which is destined to give a service to the Italian speaking population of Switzerland, will be ready to work on April 1st. In the meantime programmes from its Lugano studio are being broadcast through Beromünster. The announcements are given out in the Italian language, the call being: Radio Svizzera Italiana (Radio Tessino).

## The French Riviera Station

THE powerful broadcaster which the French Posts and Telegraphs propose to install at La Brague between Nice and Cannes on the French Riviera will be known as "Nice-Monaco-Corse," as its transmissions are also destined to Monte Carlo and to the Island of Corsica. In addition to studios at Nice, Cannes, Juan-les-Pins and Mentone, the station will also be connected to Paris in order to permit a relay of the *École Supérieure* or of any others in the French State network.

## Vatican-Castel Gandolfo Micro-wave Stations

DAILY broadcasts from the Papal See are being carried out simultaneously on 19.84 or 50.26 metres and on the 50 centimetre wavelength of the new Marconi transmitter. Transmissions on the micro-waves have proved remarkably successful, as the energy required is only 50 watts as against 10-12 kilowatts for the longer channels.

## Radio to the Rescue

DURING the recent blizzard in Wales and consequent breakdown of overhead telephone cables, many districts were temporarily completely isolated from the rest of the country. Two-way wireless communication was rapidly established between

Swansea and Fishguard, and in a similar manner with the help of the army authorities Tenby and Carmarthen were promptly reached by wireless.

## Higher Aerials for Wychbold

THE 100 kilowatt transmitter which the B.B.C. is erecting at Wychbold, near Droitwich, will possess two giant aerial towers; they are to be 700ft. in height or only roughly 100ft. shorter than the masts used by Hillmorton (Rugby) for its long distance transmissions. Up to the present the highest masts built for the new B.B.C. National and Regional stations have not exceeded 500ft.

## Drastic Wavelength Alterations

ALTHOUGH no decision can be taken before the meeting of the European Broadcasting Conference at Lucerne in June, it is already reported that some drastic alterations in wavelengths may be expected. According to a Swiss paper there is a likelihood that a long wave channel may be found for Beromünster and that Sottens may be displaced and moved higher up in the waveband. If such a step can be accomplished the 459 metre channel might be allotted to the new Tessin station. In the meantime listeners who twirl the dials after midnight may hear from time to time tests carried out by a number of European transmitters, as was the case before the last plan was brought into operation.

## "Cut-Price" Components

A RATHER prevalent "penny-wise" procedure is that of buying components from the many cut-price wireless stores which have sprung up so rapidly during recent years. Obsolete components, like obsolete sets, can be particularly troublesome, unless the purchaser realizes that they are out of date and uses them accordingly. Definitely faulty parts can be even worse, and besides causing the constructor no end of difficulty, might be the means of ruining a set of perfectly good valves. It is better in every way to deal with a legitimate trader, and to pay the current list price; you then have the assurance that in the very event of a component being in the least defective, it will be replaced without demur. Remember that all manufacturers positively refuse to hold themselves responsible for any article bought for a penny under list price.

**IMPORTANT!**

Readers please note that the Gift Stamp No. 26, the last for their Presentation

**WIRELESS**

**CONSTRUCTOR'S**

**ENCYCLOPÆDIA**

*appears on the back cover of this week's*

**"PRACTICAL WIRELESS,"**

Will readers who are qualifying for this Presentation Encyclopædia affix the last Gift Stamp to their Subscription Voucher, and forward the completed Voucher in accordance with the instructions thereon TO-DAY?

**PLEASE DON'T DELAY**

As announced last week there will be an enormous number of volumes to despatch, and it will necessarily take some little time to get them all out. All applications will be treated in strict rotation. If you do not receive your volume within 14 days of the despatch of your application—notify by post card giving date application was made.

NOTE: Carefully read instructions on your Subscription Voucher and make sure it is properly filled in, in every detail, before forwarding.

**YOUR LAST GIFT STAMP APPEARS THIS WEEK!**

Don't forget to complete and send in your Subscription Voucher immediately.

**"Practical Wireless"**

Presentation Department,  
 39, King Street, Covent Garden,  
 London, W.C.2.

# ROUND the WORLD of WIRELESS (Continued)

## Women Again Leading!

ACCORDING to a recent report published by the American Radio Relay League, of the 232 licensed feminine amateur wireless experimenters, 190 dwell in the United States. The total number of amateur stations in the world has now exceeded the 50,000 mark.

## A Gigantic S.B.

FOR the broadcast of Mr. Franklin Roosevelt's speech, on the occasion of his installation as President of the United States, all stations were linked up with Washington, eighty-seven being controlled by the National Broadcasting Company and eighty-eight in the Columbia System. In addition to re-lays carried out by the B.B.C. for the benefit of British listeners, the ceremony was also transmitted throughout Germany, Austria, Switzerland, and other European countries.

## For Early-morning Listeners

THE *Poste Parisien* (Paris) is now on the air daily at 7.0 a.m. G.M.T. The broadcast opens with a fanfare of trumpets, a few pleasant greetings by the announcer, and is followed by a short recital of records. A programme consisting of a weather report, news bulletin, and hints to the housewife completes this early transmission.

## Our Far-flung Line!

FROM time to time we receive letters from readers in various parts of the Empire, showing that PRACTICAL WIRELESS reaches many odd corners of the world. The postcard reproduced on this page, which we have just received from a reader in Soviet Russia, indicates that our journal is active, even in that country.

## Great Britain Still Forges Ahead

IN a recent statement made in Parliament, the Postmaster-General said that the number of listening licences issued during 1932 totalled approximately 5,263,000. During that year 2,825 convictions were obtained against persons using wireless receivers without permits, and the fines imposed amounted to £2,833. By the end of February, 1933, the number of licences increased to 5,425,700, showing 61,200 more registered listeners than in the previous month.

## Canine SOS

THE Budapest studio broadcasts almost nightly, at the end of the news bulletin, a number of SOS messages in respect to stolen or lost dogs. This regular feature was instituted as a result of a test, and has proved so successful that by the help of these broadcasts 95 per cent. of the dogs are now returned to their owners.

## Radio Wien

IN order to hurry forward the tests of the new high power Bisamberg transmitter with a view to a formal opening

## INTERESTING and TOPICAL PARAGRAPHS

of the station in April, the first broadcasts will be carried out by means of the single aerial tower; the second or reflector mast will be built later.

## Protecting the President

AS a sequel to the attempt on the life of President Roosevelt, the Columbia Broadcasting Company proposes to use a special bullet-proof shield which, equipped

with microphones, can be erected whenever occasion arises for a presidential or other address on the occasion of open-air broadcasts. The steel shield is shoulder-high, thus completely protecting the speaker, can be quickly dismantled and re-erected, and will form part of the equipment of Mr. Roosevelt's private railway carriage when he travels through the States.

## Census of German Wireless Receivers

ACCORDING to a recent report issued by the German Reichspost, following a general investigation in regard to the class of wireless receivers used by licence holders in that country, the census shows that only 7 per cent. of the listeners possess crystal sets. The figures also demonstrate the popularity of one- and three-valve receivers (74.8 per cent.), and the number of instruments using more than three valves reached 18.2 per cent. of the total. These statistics are based on replies received from 97 per cent. of Germany's listeners and, consequently, will prove very useful in planning out further improvements of the broadcasting system. It would be interesting to know what the position is in Great Britain, and to what extent the old crystal set is still used in these islands.

## OUR FAR-FLUNG DISTRIBUTION



Here is further evidence of the world-wide popularity of "Practical Wireless," and incidentally a tribute to the remarkable organisation of Geo. Newnes, Ltd., who publish it.

## SOLVE THIS!

### PROBLEM No. 27

Brown's receiver consisted of S. G. Detector and Output stage, operated from a small mains unit giving H.T. and Grid Bias. The filaments were operated from a separate accumulator. Reading about Quiescent Push Pull he decided that it would be interesting to try out, and accordingly purchased another valve similar to that in the Output stage, together with the necessary input and output Q.P.P. transformers. The wiring was altered (correctly) to suit the new scheme, but when tried out the results were definitely bad. Distortion, poor volume, and instability were the result. The Grid Bias output terminals on the mains unit gave sufficient bias to enable the Q.P.P. scheme to be adopted, but for some reason or other it did not work. What do you think was the reason? Three books will be awarded for the first three correct solutions opened. Address your envelopes, marked Problem No. 27, to the Editor, PRACTICAL WIRELESS, Geo. Newnes, Ltd., 8-11, Southampton Street, Strand, London, W.C.2, and post to reach us not later than March, 27th, 1933.

### SOLUTION TO PROBLEM No. 26

The amount of wire required for the larger size of frame should, of course, have been the same, and this would have resulted in a decrease in the number of turns. By winding on the same number of turns, therefore, Abrahams had a frame which was much too large.

The following readers received books in connection with Problem No. 25:—  
H. T. Lunson, 65, Brockhurst Road, Gosport;  
W. Smith, 4, Detmold Road, Clapton, London, E.5;  
E. Williams, Gwental, North Road, Aberystwyth.

experiments have been carried out privately for some time, the Columbia Broadcasting Company was the only concern which actually devoted a special short-wave transmitter (W2XAB) to daily television broadcasts over a period of eighteen months. The sound part of the programme was regularly transmitted by W2XE, Richmond Hill, New York, on 49.02 metres (6,120 kc/s), and vision through W2XAB on 2,800 kc/s. In view of this suspension, W2XE has now reverted to its former duties, namely, the relay of the WABC, New York, wireless entertainments, and is now well received in the British Isles from midnight onwards.

## New Canadian State Owned Transmitters

THE Canadian Radio Broadcasting Commission has taken over from the Canadian National Railways, the latter's stations at Monckton, Ottawa, and Vancouver. They will be operated independently until arrangements have been made to include them in the existing network.

## Country With Greatest Percentage of Listeners

DENMARK still holds the record for possessing the greatest percentage of registered listeners in respect to general population. Recent statistics show that there are fourteen licence-holders for every one hundred inhabitants, or an increase of one per cent. over the previous year.

# THE ABC OF SELECTIVITY

An Interesting Article on What It Is and How It Is Obtained.

By W. B. RICHARDSON

LEAKAGE IS LIKELY TO OCCUR ACROSS HERE

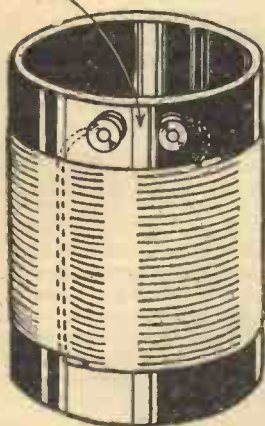

Fig. 2.—In designing efficient coils, terminals connecting the extreme ends of the windings should not be mounted close together.

THERE is no more vexing problem in modern radio than that of selectivity. That it arises from the increase in power and number of the broadcasting stations of the world is obvious, but how to tackle it is not always so clear. That a solution can be found is evidenced by the performance of carefully designed receivers such as the Fury Four, and also many of the more expensive commercial receivers. However, what the home constructor wants to know is the "how" and the "why."

Why is one circuit more selective than another? Why does H.F. amplification give more selectivity than L.F.? Why is one tuning arrangement better than another?—and so on. Such questions are always being asked, and it seems that all too often they are left unanswered, or else are answered in such a delightfully indefinite manner as to leave the inquirer with just as hazy a conception as before.

Perhaps it is this inquisitiveness in my own nature which leads me to expect it in others and to sympathize with the home constructor of an inquiring turn of mind. It seems to me that all too often he is put off with the kind of statement that such and such a new set is very selective because "it has two H.F. stages," or that twiddling this knob or that "increases the selectivity." But no suggestion is ever made as to why it does it.

This sort of thing is annoying, as it presupposes that the reader either knows all about the theory of the thing, or else that he is not interested. I grant that it is possible to overdo the explaining business, and that, for example, a long-winded dissertation on elementary principles is out of place in describing a receiver; but I should like to see occasionally a reason given when claims are made regarding the selectivity of some particular coil or receiver. How often, for instance, does one come across any explanation of why a band-pass coil gives a "square" peak? Very, very rarely indeed. No, we are just told that it does, and with that we have to be content.

Well, what I am going to attempt here is to answer some of the "hows" and "whys."

### The Effect of Resistance

The selectivity, or if you prefer it, the sharpness of tuning of a receiving circuit, is dependent on the ratio of the resistance to the inductance. The reduction of resistance, therefore, is all important.

This resistance, which might be termed the "wasteful" resistance, is due to various losses which occur in the circuit. They may be classified as follows:—

- (1) Conductor losses (copper losses, etc., in the wire itself).
- (2) Dielectric losses.
- (3) Losses in surrounding conductors.
- (4) Losses at terminals or contacts.
- (5) "Dead-end" losses.

Fig. 1 illustrates this point. Here is a group of resonance curves. They represent the signal strength obtained with various circuits over a band of frequencies. Curve (a) shows a very efficient circuit. It will be noticed that a large response (loud signals)

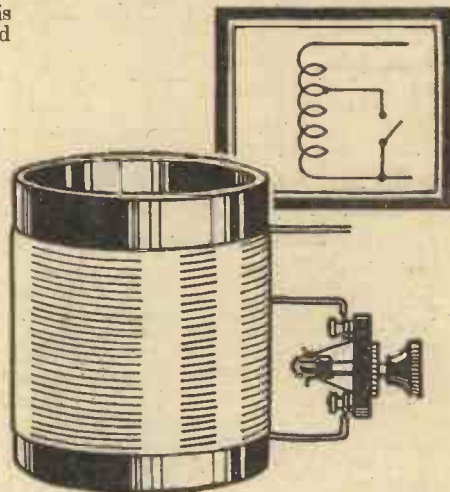

Fig. 3.—Simple, but not the most efficient arrangement for a dual-wave coil

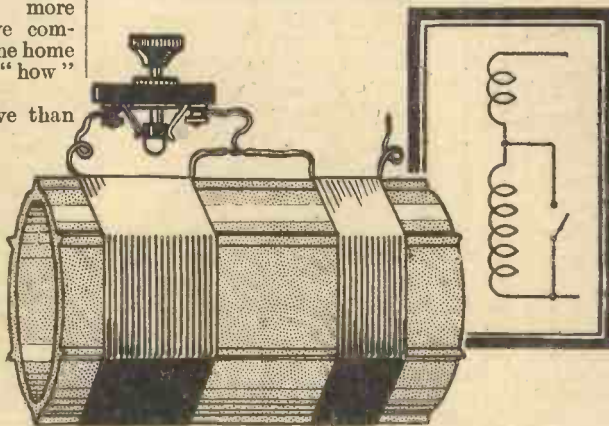

Fig. 4.—A better arrangement in which the two windings are separated.

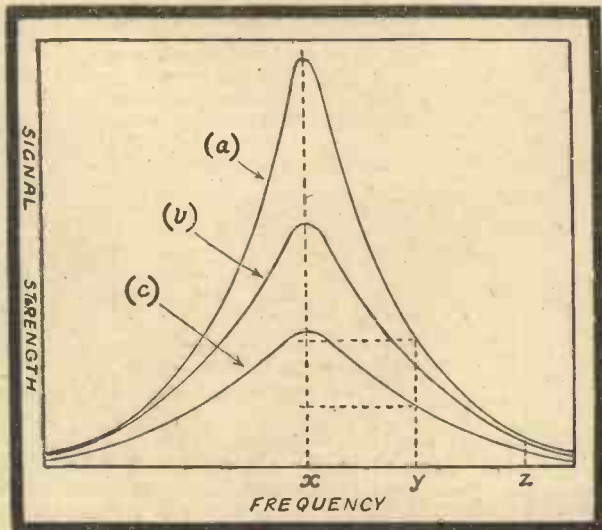

Fig. 1.—Group of resonance curves for circuits of varying efficiency.

is obtained at what is called the Resonant Frequency, that is, the point at which the circuit is exactly in tune with the broadcasting station. This is shown by the height of the curve at the point  $x$  on the graph. On either side of the resonant frequency, however, there is a quick falling off in response. This means that another station of equal power broadcasting on a nearby frequency, say at  $y$ , would give in this case less than one-third of the response (compare height of curve at  $y$  with that at  $x$ ). Again at  $z$ , still further from resonance, there is practically no response. Contrast this with curve (c), that of the most inefficient of the three circuits, and see how it differs. In this case the maximum response, even when the wanted station is dead on tune, is not as good as with the first circuit. The most important point, however, is the shape of the curve. Instead of being pointed it is comparatively flat. The result of this is that the broadcasting station at  $y$  would come through comparatively loudly, actually at about half of the strength of the wanted station. This you can see by comparing the height of the curve (c) at  $x$  with its height at  $y$ .

### How to Improve Selectivity in a Simple Circuit

Now suppose you have a set with a simple tuned circuit, such as is found in most sets of the "det. and 2 L.F." type. How can the resonance curve be made to approach that of (a)? Well, first of all there should be a good tuning coil. Screened coils are quite unnecessary with this type of circuit, as the screening is not necessary, and only introduces losses of

(Continued on page 6.)

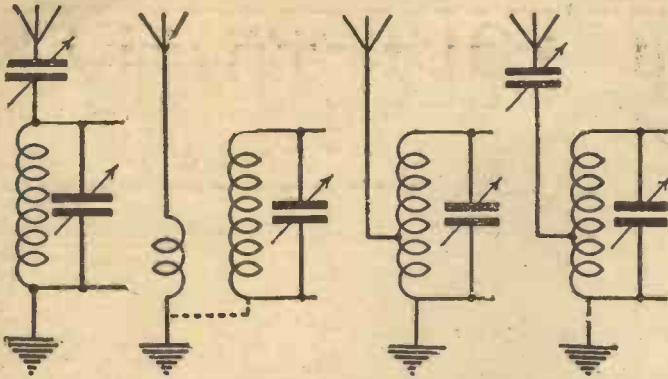

Fig. 5.—Various methods of obtaining selectivity in a single tuned circuit. They all suffer from certain drawbacks. (See text.)

(Continued from page 5.)

the third class previously mentioned, namely, losses in surrounding conductors, the screen or "can" being the surrounding conductor.

The former of the coil should not be too small (two to three inches is suitable), and the insulation between the turns should be of a high order. In this connection silk is better than cotton as a covering for the wire, and the windings should not be coated with shellac varnish or wax. A ribbed former is better than a plain one, as there is less risk with the ribbed type of leakage from one turn to another through the material of the former. Again, avoid bringing out the ends of the coil to terminals placed very close together, as in Fig. 2, as the full voltage across the coil will then be applied across the narrow strip of material between them, and unless the insulating properties of this is of the very highest order there will be leakage between the terminals. Even if the former is of the finest ebonite, it is better to have the terminals well spaced because of the possibility of surface leakage due to the accumulation of dust or moisture.

Attention to these points will all help to reduce losses (2), (3) and (4). We have yet to consider losses (1) and (5), namely, conductor losses and dead-end losses. Not much need be said regarding the former beyond reminding you to use wire of a reasonable thickness, by which I mean not thinner than about 28 gauge. On the other hand, no useful purpose is served by having it of a larger section than 22 gauge, as it only makes the coil bulky.

I will not over-stress the question of dead-end losses as the tapped tuning inductance is very rarely used nowadays, and it is only in this type that true dead-end losses occur. However, in dual-range coils where part of the windings are short circuited, as in Fig. 3, some slight loss of efficiency will occur on the medium waves if the shorted portion is not a separate winding some distance from the medium wave section. This is not, of course, a true dead-end loss as the turns are shorted, but may be looked upon more as losses in surrounding conductors. Fig. 4 will show what I mean by a separate winding.

**Self Capacity**

There is one point in connection with tuning coils which I have not mentioned. I refer to *self capacity*, that is the capacity between the turns of wire. This should be kept as low as possible by avoiding pile winding (winding one turn over the other to save space), and in the case of short-wave coils by spacing the turns. Wave-change switches associated with the coil

should also have low self capacity, that is why only switches intended for use in H.F. circuits should be used, ordinary plugs and jacks and many types of mains switches being quite unsuitable.

The tuning condenser is another component in the tuned circuit which should be above reproach. Most modern types are very good and losses here are al-

most certain to be confined to the dielectric. For this reason the minimum solid dielectric is advisable, therefore an air dielectric instrument is preferable to one with bakelite between the vanes.

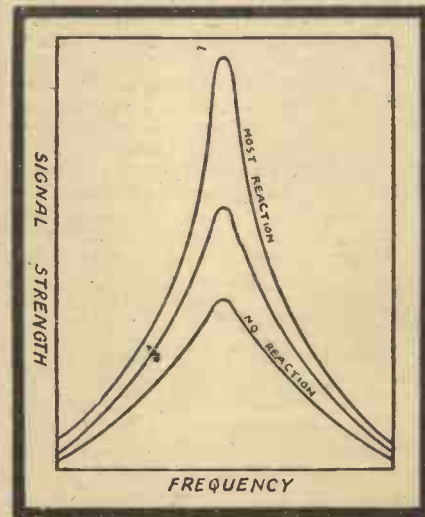

Fig. 6.—Graph showing how sensitivity and selectivity increase with the addition of reaction.

**Selectivity and Signal Strength**

A low-loss coil and condenser alone will not give sufficient selectivity for modern needs, so recourse has to be made to one or more of the dodges shown in Fig. 5. Unfortunately, all these arrangements cause some loss in signal strength for the gain in selectivity. Fitting a series aerial condenser, using a loose-coupled semi-aperiodic aerial coil, or tapping the aerial on to the coil near the earthed end, all have much the same effect in that sensi-

tivity drops rapidly with the increase in selectivity. This means that where interference from the local station is very bad the series condenser has to be reduced to such a small figure or the tapping has to be taken to such a low point that

sensitivity is sadly reduced, with the result that the wanted station then disappears with the unwanted one.

**The Effects of Reaction**

The fact is that the single tuned circuit has its limitations, therefore if the best is to be got out of it it should be carefully designed. There is, however, one easy means of overcoming the losses already mentioned, that is by using *Reaction*. The effect of reaction is virtually to negative the resistance of the circuit. "Well, then," you may ask, "why bother about having the circuit efficient if all the losses can be overcome by a twist of the reaction knob?" The answer is that the difference lies in the ease of operation. The inefficient circuit has to be made to work at the bayonet-point of reaction in order to maintain the maximum response, which response will drop to a low figure if the reaction is reduced slightly. The low-loss circuit, on the other hand, will give quite a good response even with minimum reaction.

That reaction is able to increase selectivity is shown by Fig. 6, which gives the different resonance curves obtained with varying degrees of reaction. If you study these curves carefully, you will see that an increase of reaction means a great increase in sensitivity at the resonant frequency, but only a very slight increase off-resonance. This means that if you had tuned in to a station and were experiencing interference from another station, on increasing reaction you would get a large increase in the strength of the wanted station, but only a small increase in that of the unwanted. It does not mean that interference from the unwanted station would disappear on bringing up the reaction as many people seem to expect. These argue that if there is no reduction in the strength of the unwanted station there cannot be an increase in selectivity. This is wrong. True selectivity is determined by the ratio of the two signal strengths. We must not forget that although the strength of the unwanted station is slightly greater when reaction is applied, yet the strength of the wanted station becomes many times greater than it was before.

Now suppose we reduce the strength of the wanted station by means of a variable condenser in series with the aerial or some similar device until it is back at its original level. What will happen to the unwanted signals? Well, naturally they will be reduced also. In fact they will either become very weak indeed or else disappear.

This clearly shows there is an increase in selectivity since whereas without reaction

(Continued on page 30.)

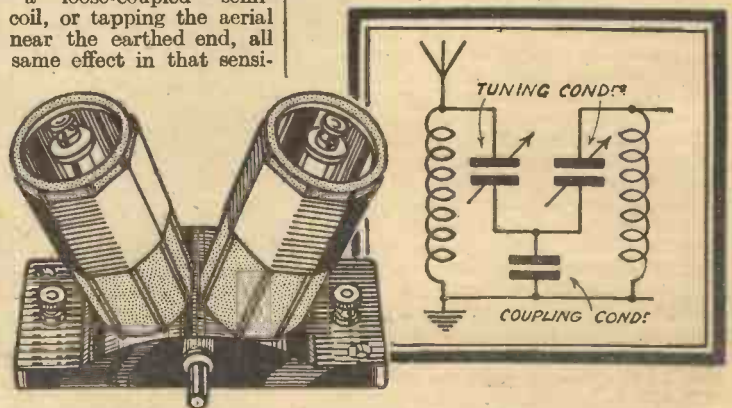

Fig. 7.—For selectivity two tuned circuits are better than one. The example here is of a typical band-pass filter.



# MATCHING YOUR SPEAKER

An Article of Special Interest to the Amateur Experimenter

By S. J. GARRATT

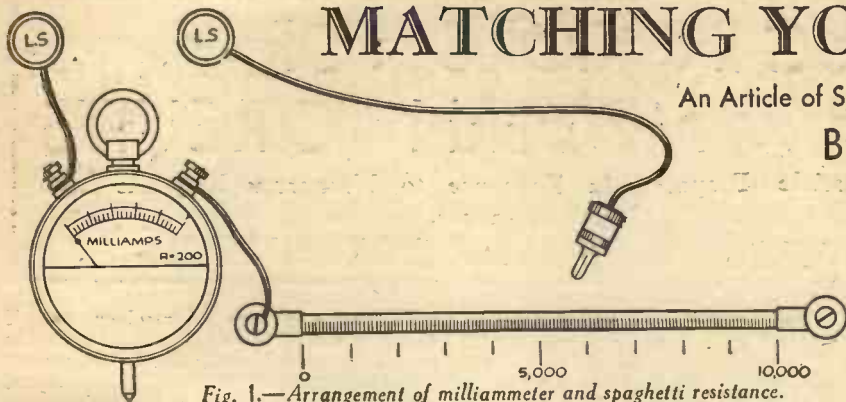

Fig. 1.—Arrangement of milliammeter and spaghetti resistance.

**W**IRELESS experimenters and constructors are frequently advised to see that their loud-speaker is matched to the output valve. Excellent advice as far as it goes, but not of much use to an amateur unless accompanied by instructions as to how the matching business is to be done; this article explains how to conduct a series of tests, and how to apply the results. PRACTICAL WIRELESS, of course, specializes in practical articles, but our present subject is an example of how practice and calculation help each other; practical experiments give the results, but simple calculation and a graph are required to apply them.

### A Question of Wattage

First, let us clearly understand what results we want to obtain. We have a certain strength of current passing through the speaker and a certain voltage across its terminals. Now current multiplied by volts gives watts, and watts are a measurement of power, and we want to get as much power—or, in other words, as many watts—as possible into the speaker. Let us consider two extremes. If the speaker had a negligible resistance we should get a big current but no voltage across the terminals, therefore multiplying the current by the voltage the result is 0 watts. At the other extreme, if the resistance of the speaker was infinitely high, we should get a high voltage but no current, the watts, as before, would therefore be nil. But somewhere between a very low resistance and a very high one there is a value which will give maximum watts and we want to find that value; it will depend upon the characteristics of the output valve and is termed the optimum load for that valve.

Now to proceed with the testing. The only instruments required are a milliammeter and a spaghetti resistance of, say, 10,000 ohms. An ordinary small watch pattern meter reading to 30 milliamps or less will do fairly well for our present requirements, but a larger instrument with a more open scale would be better; it should be as low in resistance as conveniently possible because we shall ignore the resistance of the instrument in arriving at results. The resistance is usually marked somewhere on the instrument; it will probably be about 200 ohms, but it is advisable that it should not exceed this. The covering of the spaghetti should be stripped off very carefully and inside will be found a strip of insulating material closely wound round with very fine wire; great care should be taken not to break this wire.

### Using the Milliammeter

Disconnect the speaker, and connect up the milliammeter and the bare spaghetti

to the output terminals of the receiving set, as shown in Fig. 1. (See remarks at the end of this article if the set has choke or transformer output.) The resistance should be screwed down on to a flat piece of wood covered with white paper; mark out a scale on the paper, dividing up the length of the resistance into ten equal parts so that each division represents a resistance of 1,000 ohms. This gives us an inexpensive variable resistance. See that the high-tension and grid-bias batteries are adjusted at their usual tapings and then switch on the low-tension.

Now take the wander plug shown in Fig. 1, and press it on to the resistance at the first mark (nearest the meter terminal) which represents a resistance of 1,000 ohms, and make a note of the meter reading. Take similar readings at all the other markings on the resistance scale, and write them out as shown in the accompanying table. This will fill up the first two columns, and we now have to work out the figures for the third column from the other two.

The watts absorbed by the resistance equals resistance multiplied by the square of the current. We therefore multiply the current by itself, then multiply again by the resistance. For example, the first reading is 8, the square is  $8 \times 8$ , which equals 64; multiplying this by 1,000 ohms = 64,000, but this must be divided again by 1,000 to bring it to milliwatts (1,000 milliwatts equals 1 watt), so the answer is 64 milliwatts, which is put down in the third column. The second line will be  $\frac{7^2 \times 2,000}{1,000} = \frac{49 \times 2,000}{1,000} = 98$  milliwatts, and so on for all the other readings. If you can use a slide rule you can read off all the answers direct, otherwise you must work them all out.

### Plotting a Graph

The next step is to draw a graph representing milliwatts for any value of resistance; you will require some squared paper for this. Mark the milliwatts scale on the left and the resistance scale at the foot, as shown in Fig. 2. Using the figures of the table (yours will, of course, be a different

set of figures) run your pencil up the vertical line representing a resistance of 1,000 ohms, and when you reach a point level with 64 milliwatts make a firm dot. Do the same for all the other values shown in the table (ignoring column 2) then draw a free hand curve to pass evenly among the dots. Almost certainly, you will find that you will not be able to draw a smooth curve to touch all the dots, but there will be a certain amount of unavoidable error in your readings, and a smooth curve will give the approximate mean of all your results. If the dots are too scattered, repeat the series of tests, and if the curve does not have a definite downward trend at the maximum resistance, use a higher value of spaghetti.

You will find, if you made your tests very carefully, that you will get a curve something like Fig. 2 in shape, though the actual figures will be different. The highest point on this curve represents the highest, or optimum output of the valve under the conditions of the test. In Fig. 2 the optimum is at about 7,000 ohms, and this should be the impedance (impedance is the resistance plus the inductance) of the speaker in such a case.

You may ask how to find the impedance of the speaker. Well, there is no need to find it. You now know the optimum load for the valve, and on referring to your table you will find that at this load (i.e., resistance, column 1) the current is, say, 4.5 milliamps. So connect up the milliammeter in series with the speaker while it is working, and if the meter reads in this case 4.5 milliamps the speaker is right. Of

(Continued on page 30.)

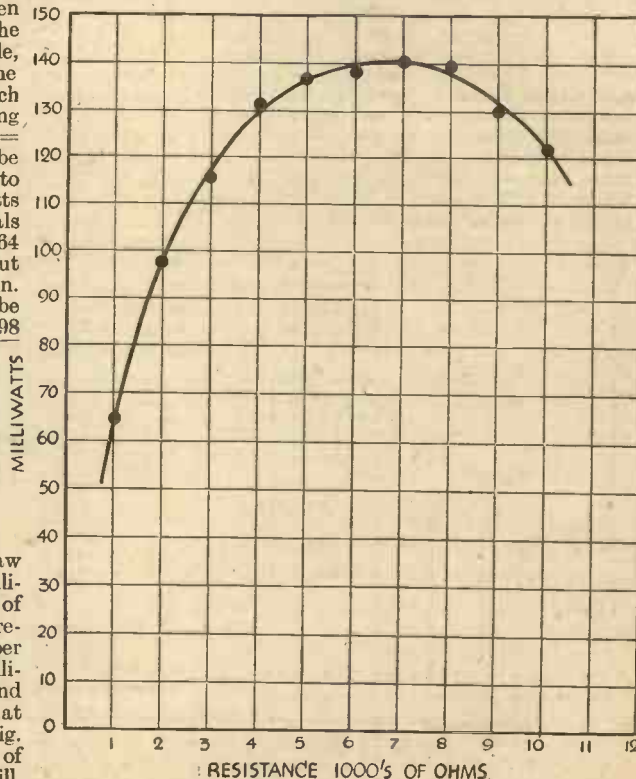

Fig. 2.—Plotting the graph.

# PLUG-IN COILS FOR MODERN CIRCUITS

An Article Prepared in Response to Numerous Requests from Readers.

By FRANK PRESTON, F.R.A.

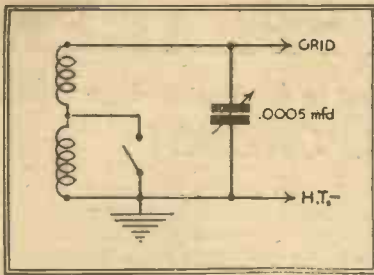
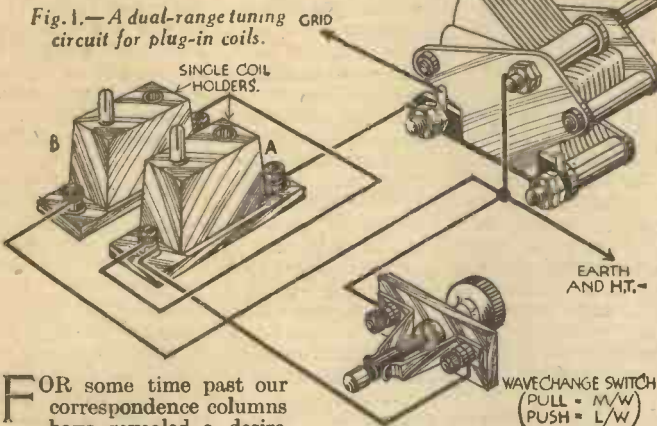

Fig. 1.—A dual-range tuning circuit for plug-in coils.



bands there is absolutely no reason why two coils should not be wired in series to cover the long waves, and a switch arranged to short-circuit one of them when medium-wave reception is required, thus entirely overcoming the old bogey of coil-changing. This is, of course, precisely the same principle as is used for nearly all dual-range tuners at present in use.

To make use of this scheme you will

need two single baseboard mounting coil-holders and a push-pull wave-change switch, the connections being as shown in Fig. 1. Notice especially that the holders are "cross-connected," so that the turns of both

coils go in the same relative direction. If adjacent terminals were joined together the two coils would act in opposition, and the wavelength covered by both coils together would be something less than that of the larger one used by itself. Also notice that the moving vanes of the variable condenser are connected to earth; if the condenser connections were reversed, trouble due to hand-capacity effects would most probably be experienced. The arrangement can be used for tuning either the aerial or grid

circuit of any type of receiver, and if coil A is a size 50 and B, size 150, tuning ranges of approximately 300 to 600 metres and 1,000 to 2,000 metres will be covered by using a good .0005 mfd. tuning condenser. Other ranges can be covered by using alternative coil sizes, and under

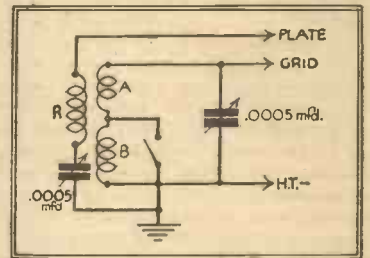
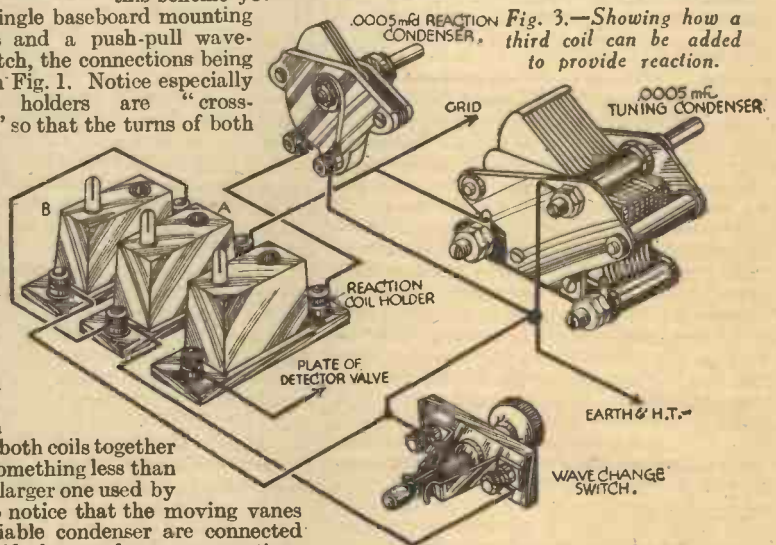

Fig. 3.—Showing how a third coil can be added to provide reaction.



different circumstances it will be necessary to use a 25 or 35 coil for the medium waveband. By "different circumstances" I refer principally to the length of the aerial in use and the minimum wavelength required. For example, if the aerial were particularly long a 35 coil would cover the same range as a 50 coil used with a short aerial. On the other hand, when reception of such stations as Fécamp, London National, or Newcastle was desired, a 25 or 35 coil would be necessary.

When the coils are used for aerial tuning a .0001 mfd. pre-set condenser must be inserted in series with the lead-in or else selectivity will be very poor and the wavelength range will seriously be restricted. In Fig. 2 a skeleton circuit diagram is given, showing how two dual-range tuners of the type illustrated in Fig. 1 can successfully be employed in the aerial and tuned-grid circuits of a typical screened-grid receiver. It will be seen that the connections are very straightforward and easy

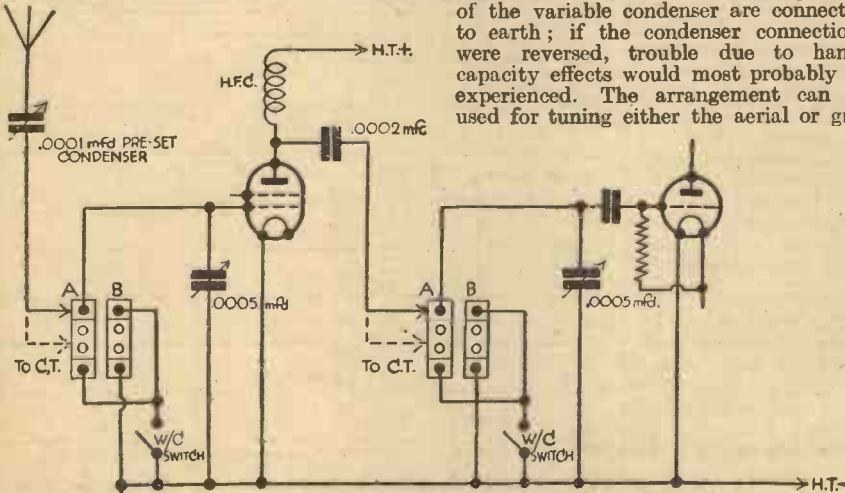

Fig. 2.—This circuit shows how plug-in coils can be used to provide two dual-range tuners, one of which is connected in the aerial, and the other in the tuned-grid circuit of an S.G. receiver.

FOR some time past our correspondence columns have revealed a desire on the part of numerous readers to make use of plug-in coils which happen to be on hand. Whilst I would not advise anyone to buy a new set of coils of this type, I do not hesitate to say that, for a simple set, plug-in coils can be quite as efficient and satisfactory as their more modern dual-range counterparts, if they are properly employed. I would go further by expressing the opinion that the older types of coil are often more efficient than many of the cheaper tuning units now on the market, and that if their limitations are realized they can be built into distinctly modern circuits of the less pretentious patterns, with every success.

### Dual-Range Tuning

Probably the principal reason why honeycomb and basket coils fell into disfavour was that they had to be changed every time a different wavelength range was to be covered, but as nearly all broadcasting is now confined to two wavelength

to follow. When centre-tapped coils are available, additional selectivity can be obtained by transferring one connection from the "grid" end of the tuner to the centre tapping of the medium-wave coil, and this modification is shown on the diagram by two broken lines. Generally speaking, long-wave selectivity will be sufficiently good when using the connections shown, but here again still greater selectivity can be obtained where necessary by taking the aerial and anode leads to the centre-tap terminals of the long-wave coils (B). Provided that both pairs of coils had identical characteristics, a two-gang tuning condenser could be employed, but as in practice the coils will rarely be sufficiently well matched, even if they are of the same make and type, it is always advisable to tune each circuit by a separate condenser.

In a receiver having a circuit similar to that of Fig. 2, there will be a good deal of feed-back between the two tuners unless certain precautions are taken. It would obviously be best to erect an aluminium screen between them, but in addition to this the two sets of coils should be mounted with their axes at right-angles to each other to avoid respective interaction. Very often the screen can be dispensed with if this

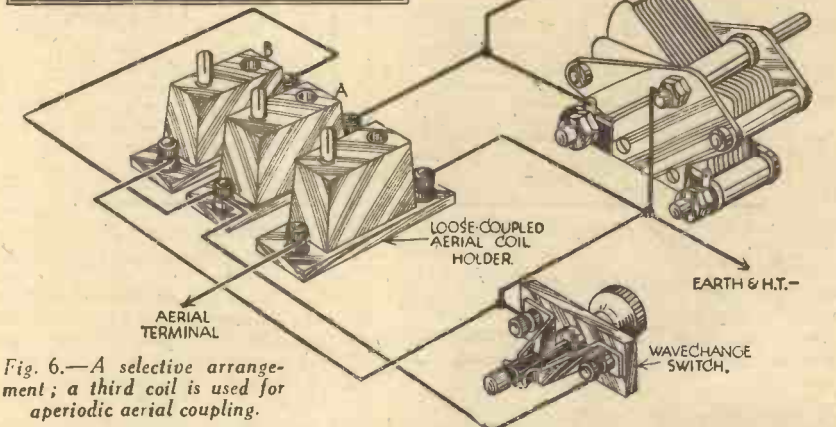
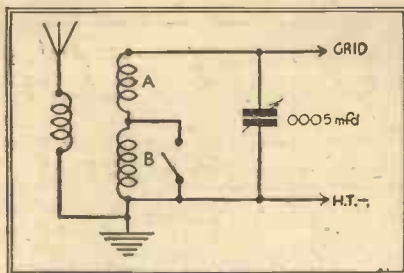

Fig. 6.—A selective arrangement; a third coil is used for aperiodic aerial coupling.

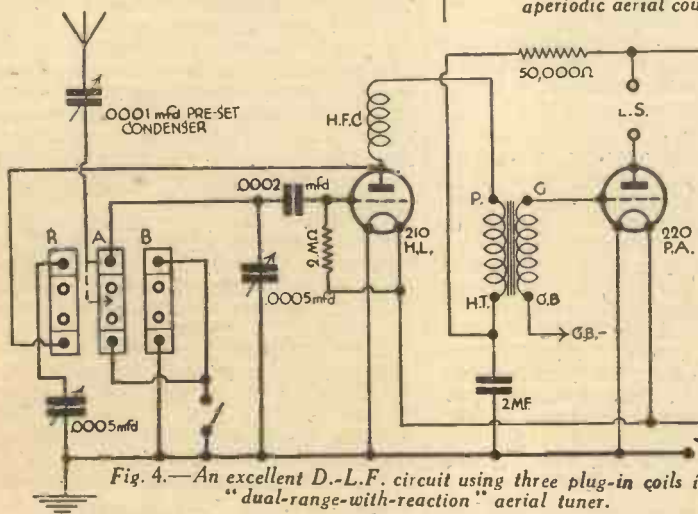

Fig. 4.—An excellent D.-L.F. circuit using three plug-in coils in a "dual-range-with-reaction" aerial tuner.

is done and if the tuners are fairly well spaced.

**Reaction**

We have not yet considered the question of applying reaction to our tuner, so let us see what can be done in this respect. We could, of course, use a three-coil holder and "swinging-coil" reaction, but this is certainly not advised, since the moving-coil introduces many variable factors due to unwanted coupling with other components. Besides, it is generally far more difficult to obtain a smooth control by this method than by the use of Reinartz or capacity reaction. In consequence, it will be better if we concentrate our attention on the latter system. The reaction coil will be mounted in a separate holder placed next to that taking the medium-wave coil, in the position shown in Fig. 3—all three coil-holders are so placed that the coils, when inserted, will just touch each other. A reaction condenser of

potential, and therefore its operation will not introduce the difficulty associated with

hand-capacity. Connections to the reaction coil must be right way round, for otherwise signal strength will be reduced, instead of being increased, as the reaction condenser setting is advanced; the connections shown in Fig. 3 must therefore be duplicated exactly.

The size of the reaction coil will obviously be of importance, since it must so be chosen that it will function equally

well on both wavebands—it would be futile to use a dual-range tuner if the reaction coil had to be changed for different wavelengths, and it would introduce undesirable complications if an attempt were made to switch over from one coil to another. As a matter of fact I always find that a 75 coil gives practically uniform degree of reaction over both ranges, once the H.T. voltage has been adjusted to a nicety, but if any difficulty is experienced a few different sizes should be tried.

**A Good Two-valve Circuit**

A good circuit for a two-valve D.-L.F. circuit using three plug-in coils as a dual-range tuner with reaction is given in Fig. 4, and I can strongly recommend this from a long and successful experience with it. The two-valver represented is as good as any similar type of set which can be made at the present time. It has a distinctly long range combined with a degree of selectivity ample for most requirements. Values of the principal components as

(Continued on page 10.)

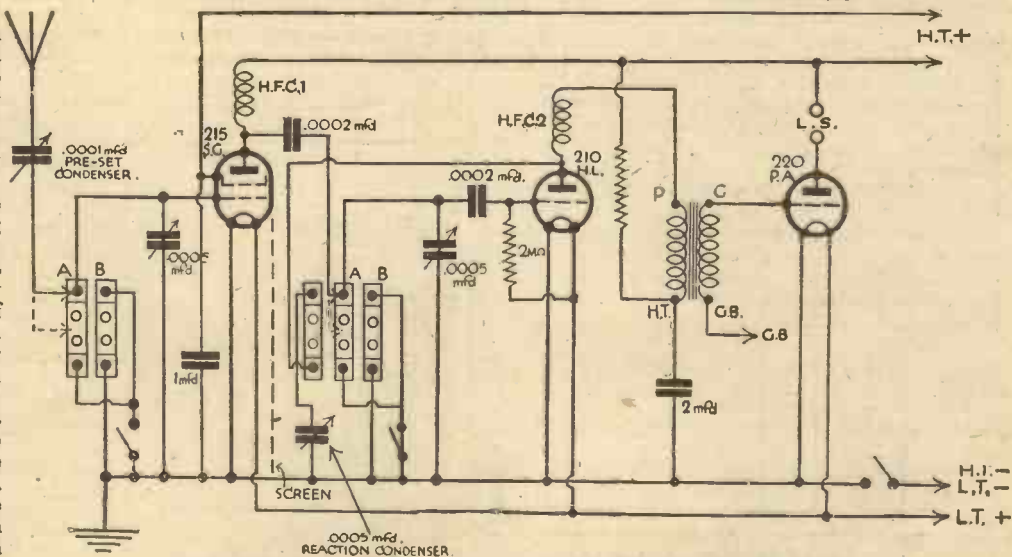

Fig. 5.—The circuit of an S.G. receiver of modern design using plug-in coils.

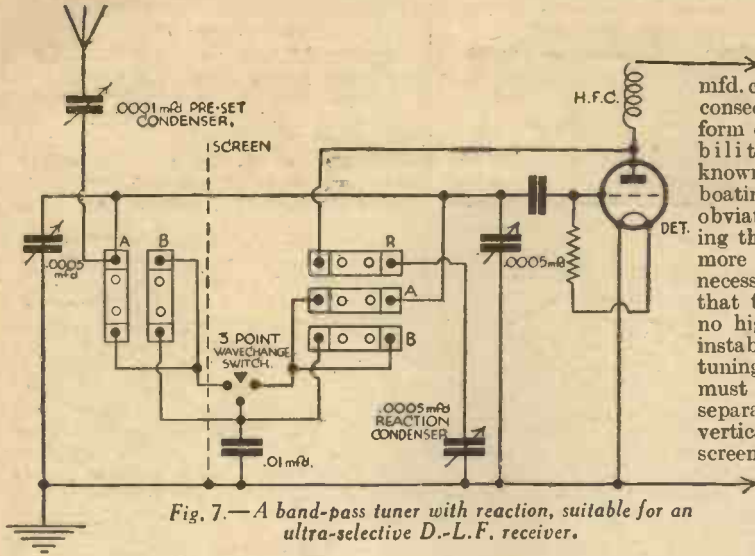

Fig. 7.—A band-pass tuner with reaction, suitable for an ultra-selective D.-L.F. receiver.

(Continued from page 9.)

well as the most suitable types of valves are indicated, so I do not think you should have much difficulty in building the receiver.

A Three-valve S.G. Circuit

If you want a rather bigger set with a greater margin of power and easily capable of bringing in as many as thirty or more stations at full loud-speaker strength the circuit of Fig. 5 will appeal to you. This represents a three-valve S.G. receiver of perfectly modern design and using plug-in coils throughout. The aerial circuit is tuned by a pair of coils connected as shown in Fig. 1, whilst the tuned grid circuit employs the coil arrangement depicted in Fig. 3. Reaction is applied to the latter circuit, but in this case a .0003 mfd. condenser is specified for reaction control, the lower capacity being quite sufficient to produce oscillation over the entire tuning range, due to the fact that the tuning circuit is not now "damped" by the aerial. As in the two-valve circuit previously mentioned, the detector valve is decoupled by means of a 50,000 ohm

fixed resistance L.F. and 2 mfd. condenser, and consequently the form of L.F. instability commonly known as motor-boating is entirely obviated. In building this set a little more care will be necessary to ensure that there shall be no high frequency instability. The tuning circuits must therefore be separated by a vertical aluminium screen and the two sets of coils should for preference be mounted at right-angles to each other. Metallised valves should be used in the S.G. and detector stages and the choke marked H.F.C.1 must be of a high inductance type designed for use in S.G. circuits. The second choke (H.F.C.2) can be of any good pattern, but should for preference differ from H.F.C.1; if both chokes were alike there would be a danger of uncontrollable oscillation setting in at certain wavelengths.

Increasing Selectivity Although the two circuits dealt with are thoroughly good and reliable they cannot be considered as being ultra-selective. Do not misunderstand me—they are quite as selective as the average present-day receiver, but could not be expected to separate, say, London Regional and Mühlacker at a distance of less than twenty miles of Brookmans Park. To attain a sufficiently high degree of selectivity for that purpose it is essential to use either a loose-coupled aerial coil or a band-pass filter. Both of these arrangements can be provided quite easily with plug-in coils if a little extra complication is not objected

to. Fig. 6 shows how a loose-coupled aerial coil can be used in conjunction with the dual-range tuner of Fig. 1. The additional coil might conveniently be a size 25 or so for medium-wave reception, but the optimum size must be found by trial, since it will vary considerably with the type of aerial in use and the degree of selectivity required. It is sometimes possible to find a particular coil with which the set's sensitivity is just as good as with the less selective arrangement, but in general a little loss in volume must be expected when selectivity is increased. The larger the aerial coil employed the greater will be the sensitivity and the smaller the degree of selectivity, whilst the reverse is also true.

Unless there is a good margin of volume it will be necessary to use a larger aerial coil for long-wave reception or otherwise to revert to the original arrangement. Of course two coils could be wired in series and one of them short-circuited by means of a switch just the same as with the tuning coils, but this method would introduce too much complication to make it generally acceptable.

Band-Pass with Plug-In Coils

The arrangement of Fig. 6 is only suitable for the aerial circuit of an S.G. receiver, because it could not conveniently be modified for use with reaction. When reaction is to be applied to the aerial, as in a Det.-L.F. set, the only really efficient way to obtain ultra-selectivity is by the use of a band-pass tuner. The connections for a band-pass circuit with reaction are shown in Fig. 7. It will be seen that five coils are used in all, two of them forming the dual-range circuit of Fig. 1 and the other three making the arrangement of Fig. 3. The two circuits are tuned by separate condensers, but a single three-point wave-change switch acts on both. Coupling between the two circuits is on the "capacity" system, a .01 mfd. non-inductive condenser being used for coupling purposes. It is essential that a screen should be placed between the two tuned circuits and it is also advisable to place the two sets of coils with their axes at right angles, as shown in Fig. 7.

FOR all uses, where insulation is required—as in panels for fitting in mahogany or other radio cabinets—the construction of formers for coils—aerial windings—chokes—condensers of various types—and multifarious other uses, this apparently useless material which possesses insulative qualities of the highest order combined with a hard surface should prove a boon to constructors. In working thin plates, place them between thin ply boards.

If made hot, it bends well, and may be worked round an iron "core," which should also be made hot—but not a burning heat, as this would damage the composition. It will easily mould into casings or sheaths for various components, the seams or joints being closed with a hot knife-shaped blade of metal, or a thick spirit-shellac mixed with vegetable black to match the record.

The accompanying illustrations show a readily made former with octagonal base and top plates.

First of all describe the circumference of desired diameter of former, and draw line through centre A to B. Set compasses to points A and O, place leg in point A and mark off point K and L,

A USE FOR OLD RECORDS

Draw Line K L, and mark line C D through O, parallel to K L. Draw line from point

A to point C, and from point O draw line through F to I. The dotted lines at the 8 points of octagonal plate, Fig. 2, indicate the slots for side pieces. As a wiring guide, 3 times the diameter A to B plus once I to F gives the measure of the circumference. —J. A. C. PETTIT (Leigh-on-Sea).

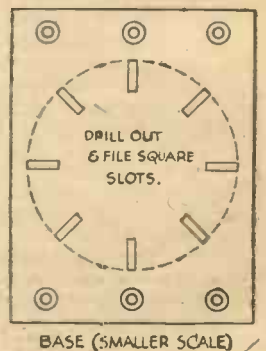
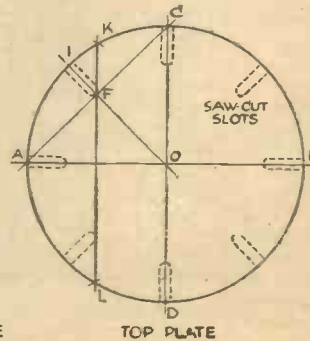
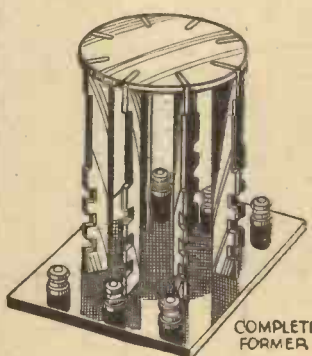

THE HALF-GUINEA PAGE

# Radio Wrinkles FROM READERS

### Novel Indoor Aerial Insulators

THE accompanying sketch shows a neat and cheap method of making indoor aerial insulators. It consists of small curtain rod brackets and pieces of lead-in tube fitted to the ferrule made to take the

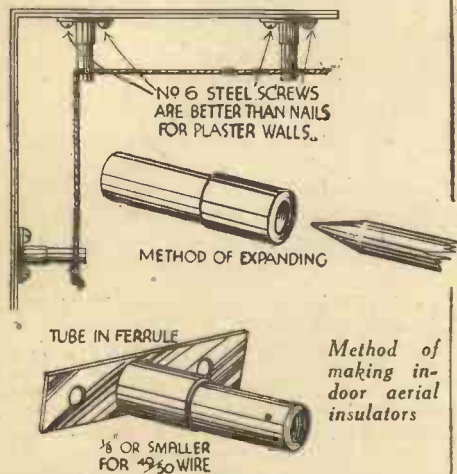

curtain rod. If the ebonite tube is too large it can be held in the steam from a kettle until soft, then pushed in and dipped in cold water to set it. Should the tube be small, this is just as easily overcome. Unscrew the ferrule from the back plate and place it over the tube.—L. A. VINTON (Hackney).

### Working Sheet Metal

MANY amateurs hesitate to build their own chassis owing to the difficulty in bending the metal. Here is a method by which an almost professional result may be obtained by simple means. Secure three boards, the length of the metal to be bent—1in. flooring board will do—and plane one edge of two of the boards true. Very lightly score the metal where it is desired to bend, and clamp between two of the boards, as shown, in the sketch, with the scored side of the metal away from you. Place the third board as shown and press over until the metal is bent at the desired angle. If the corner is not as sharp as you may wish, gently hammer the top board adjacent the

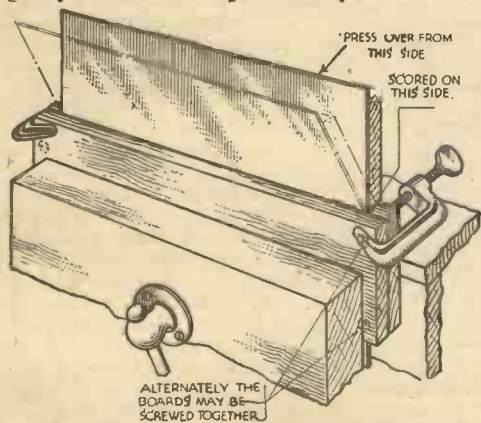

A clamping arrangement for bending sheet-metal.

### THAT DODGE OF YOURS!

Every reader of "PRACTICAL WIRELESS" must have originated some little dodge which would interest other readers. Why not pass it on to us? We pay £1-10-0 for the best wrinkle submitted, and for every other item published on this page we will pay half a guinea. Turn that idea of yours to account by sending it in to us, addressed to the Editor, "PRACTICAL WIRELESS," George Newnes, Ltd., 8-11, Southampton Street, Strand, W.C.2. Put your name and address on every item. Please note that every notion sent in must be original. Mark envelopes "Radio Wrinkles." Do NOT enclose Queries with your Wrinkle.

angle. This method may be employed for cutting sheet metal. Score deeply on both sides and clamp between the boards as before, and bend the metal backwards and forwards by pressing on the board until the metal is severed. The edges may afterwards be trimmed up by means of a file. Flanges for securing the sides of a chassis may be bent by inserting the metal in a saw cut in a piece of hard wood held in a vice and the metal manipulated as before.—E. A. DINMORE (Forest Gate, E.7).

### Making Pliers Self-opening

BY fitting a spring between the handles of a pair of pliers, as shown in the accompanying sketch, they can be made

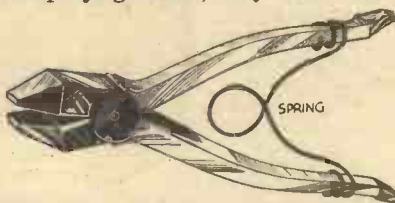

Fitting pliers with a spring for self-opening.

self-opening. The ends of the spring should be slightly softened so that they can be coiled round the pliers in the manner shown.—H. J. NICHOLSON (Liverpool).

### An Inexpensive Baseboard Potentiometer

A VERY efficient yet cheap potentiometer or variable resistance may be made of the following materials, which in most cases can be obtained from the "junk box":—

- 1 Spaghetti Resistance (of any desired value).
- 1 strip of ebonite of any thickness, about 1in. wide, and 1in. longer than the Spaghetti.
- 3 small terminals.
- 1 wire connector, and a length of flex, about the same length as the resistance.

Remove the connecting tab from one end of the spaghetti

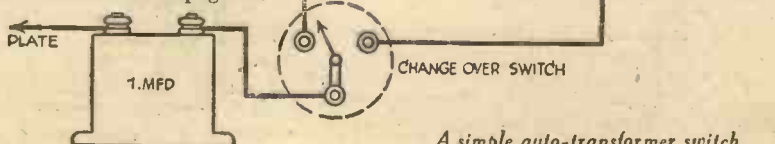

A simple auto-transformer switch.

resistance, and then slide off the sleeving, exposing the resistance wire, which is wound round a stringy material. Slip the brass connector over the resistance, and refix the connecting tab. Next drill a small hole suitable for mounting one of the small terminals at a distance of about 1/4in. from the one end of the ebonite, and drill a small hole of the same size at a distance equal to the length of the resistance away from this hole, near the other end. Then mount the resistance on the terminals which are screwed to the ebonite as shown in sketch, and mount the remain-

Fixing Screw

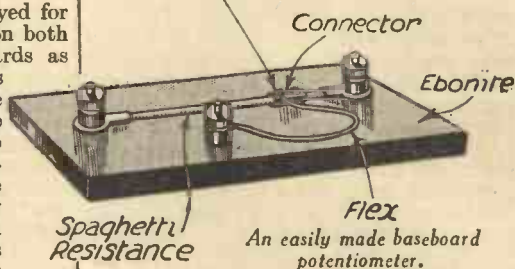

ing terminal near the centre of the ebonite strip, but not allowing it to catch the resistance. This last terminal may be connected to the connector with the flex, and this completes the potentiometer. This gadget may be mounted on the baseboard of the set, and will prove invaluable for biasing, or voltage dropping in an "All mains set." This idea may also be used to save the cost of buying another resistance, which you may need, though you have a resistance of greater value.—A. J. PERRY (Wellington).

### Auto-transformer Switch

WHEN a transformer is parallel fed, different step-up ratios may be obtained by altering the connections. By means of the arrangement shown in the illustration, it is possible to quickly and simply change the ratio when desired. When the switch is over to the right, the ratio is 1-1 which, when local or powerful stations are being received, prevents overloading, and gives improved quality. For weak signals the switch is put over to the left, resulting in a step up ratio more than the normal stated ratio, i.e., 4-1 in the case of a 3-1 transformer. Thus greater amplification is obtained.—R. G. MITCHELL (Edinburgh).

(Continued on page 12.)

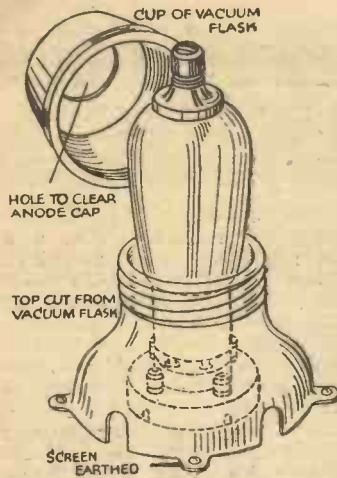

A novel screening device.

An Improved Screening Device

AN efficient screen for valves or any small component can be made from a disused Thermos flask, as shown in the accompanying sketch. Remove the top part of the flask and turn up the bottom edge to form lugs for fixing to the base-board. Cut out the slots for the connecting wires, and if the screen is to be used for a screen-grid valve, cut a hole in the top of the cap as well. The bottom part of the screen can be fitted over the valve-holder and the cup screwed on after the valve is inserted.—W. E. HASKELL (Newport).

A Handy Battery-charging Switch

THE battery-charging arrangement shown in the sketches has been in use for over eighteen months, and has proved satisfactory in every respect. It is very cheap to make up, and providing a little care is used in making the slot for the switch arm there is nothing to give any trouble. In the event of the accumulator running down whilst the owner of the set is absent, any member of the family can move the switch arm to the opposite position and do so without any risk. In my case the box is mounted on the wall of an outhouse and is kept away from the wall by half-inch battens. The lid of the box is used as a cover and is screwed on to prevent any inquisitive member of the family from interfering with the interior, and also to keep the vital parts clean. The switch arm, of course, carries the direct leads from the

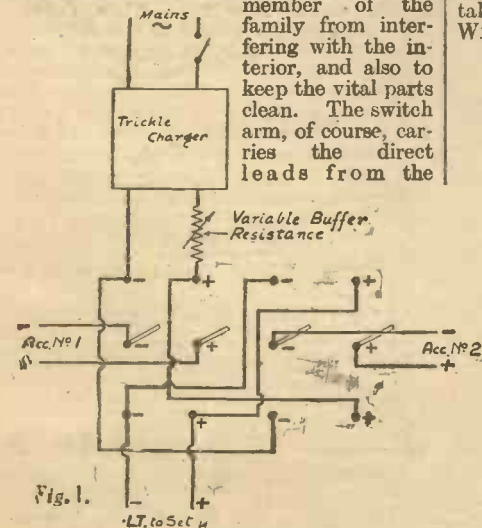

Circuit diagram and general arrangement of a handy battery charging switch.

accumulators, and they are held down by small staples, leaving the switch arm as near to the pivoted end as possible to prevent them from being broken by the movement of the switch. The wiring on the pictorial diagram, Fig. 2, is omitted, as this can be easily followed on the circuit diagram, Fig. 1. All contacts made with the copper foil are, of course, soldered. The platform on the bottom of the box should be fixed securely, as this has to carry the weight of the two accumulators.—G. W. READ (Bow).

Mounting a Volume Control

WHEN potentiometers are used as volume controls across the transformer secondaries, they are in some cases used with a semi-permanent adjustment, especially when tuned to the local station. To those readers who have sets with easy access to the interior, the following method of mounting the component will be found quite satisfactory, and will mean the saving in many cases of long lengths of wire which would normally go to the panel. Two small strips of stout brass are the only requirements, and these should be cut to the desired lengths and bent to shape, according to the transformer in use—a hole being drilled in the end of each. The potentiometer can then be mounted above the transformer as shown in the accompanying sketch. If the core is joined to earth, care should be taken to prevent a short-circuit.—H. WEARING (Devonport).

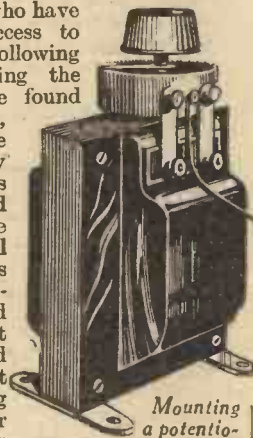

Mounting a potentiometer on a transformer.

Novel Coil-formers

HERE is a novel way of making low-loss coil-formers, which will appeal to the amateurs who enjoy constructing their own apparatus. First the required number of discs are cut from three-plywood; the total number of these will depend upon how many slots the long-wave coil will occupy. One slot must be provided for

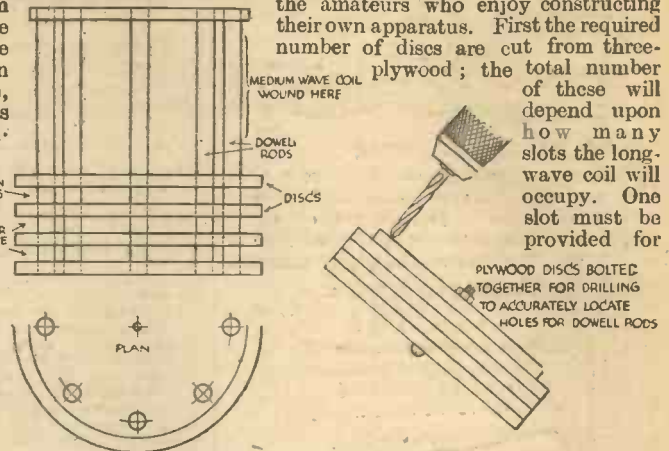

Making coil-formers with plywood.

the reaction coil. All the necessary data can be obtained for this by consulting PRACTICAL WIRELESS Data Sheet No. 2. Upon one of the discs a circle is scribed and divided into eight equal parts, as in the lower sketch in Fig. 1. All the discs are now clamped together as shown in Fig. 2 and drilled right through with a 3/16in. drill at each of the eight points, to take a like number of 3/16in. dowel rods. Before removing the clamping bolt, mark all the discs so that all the holes can be brought into line when assembling. The whole when put together will appear as in Fig. 1.—A. S. RICHARDS (Bargoed).

Eliminating Hum

HUM from mains sets may be due to a number of causes, and it is often difficult to effect a complete cure. The trouble, however, can sometimes be minimised by using a potentiometer having an adjustable tap instead of a fixed tap in the heater circuits. If a centre-tapped transformer is used the potentiometer is connected in the circuit by taking the wire from the centre tap to the sliding contact of the potentiometer.

The ends of the potentiometer are joined one to each side of the heater transformer. A total resistance of about 90 is usual.

Reducing Mains Hum

By the way, 50 cycle mains hum can generally be reduced fairly considerably by inserting a fixed condenser somewhere in the loud-speaker circuit. When using an output transformer the condenser can be connected between one secondary terminal and the loud-speaker; a capacity of .5 mfd. or so will generally prove just about right. If the speaker is fed through a choke-capacity filter it is only necessary to reduce the capacity of the filter condenser to a value similar to that referred to above. The idea in both instances is to provide a comparatively difficult path to the very low frequencies without restricting the passage of any others. This can be done quite easily by the methods suggested, and if care is taken in choosing the optimum condenser capacity, the quality of reproduction will scarcely suffer at all.

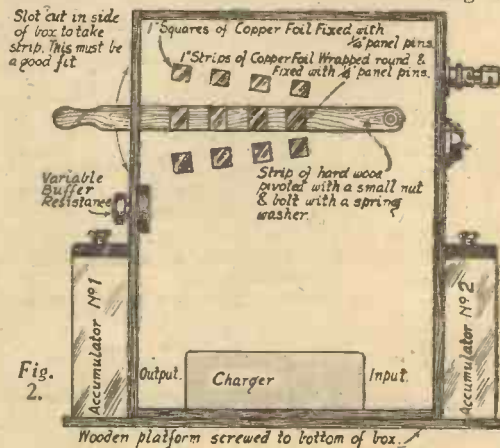

Fig. 2.



# BIG PRICE REDUCTIONS IN COSSOR RADIO

## COSSOR MELODY MAKER KITS

### Cossor Melody Maker ALL-ELECTRIC Model 337 with self-contained Loud Speaker

Complete Kit of Parts for building Cossor All-Electric Melody Maker Receiver Model 337 as illustrated above includes Cossor M.V.S.G. Variable-Mu Metallised Screened Grid, Cossor 41 M.H. Metallised Detector, Cossor 41 M.P. Output and Cossor 442 B.U. Rectifier Valves; Individually Shielded Coils; All-metal Chassis; Cossor Mains Transformer and all components for home assembly. Handsomely finished cabinet (18½ in. by 17½ in. by 10½ in.); Balanced Armature Loud-Speaker. Provision is made for fitting Gramophone Pick-up Plug and Jack. For A.C. Mains only, 200-250 or 100-125 volts (adjustable), 40-100 cycles. **PRICE £8.10.0**

Hire Purchase Terms: 20% deposit and 9 monthly payments of 18/6.



### Cossor Melody Maker BATTERY Model 335 with self-contained Loud Speaker

Complete Kit of Parts for building the Cossor Melody Maker Receiver Model 335, as illustrated above including Cossor 220 V.S.G. Variable-Mu Metallised Screened Grid, Cossor 210 H.L. Metallised Detector and Cossor 220 P. Output Valves; Individually-Shielded Coils, Cossor L.F. Transformer; all-metal panel and base and all the components, bolts, nuts and screws necessary for the rapid assembly of the Receiver; handsomely finished Cabinet, 18½ in. by 13½ in. by 10½ in., and 10-in. Balanced-Armature Loud Speaker. Provision is made for fitting gramophone pick-up socket and plug if required. **PRICE £6.17.6**

Hire Purchase Terms: 17s. 6d. deposit and 9 monthly payments of 15s.

Outstanding performance — simplicity of operation — value for money — the keynotes of Cossor Radio. To-day, at the new prices, Cossor Kits and Receivers represent even greater value than ever. Never before has it been possible to obtain such high-grade Radio for so small an outlay. Before you decide on your new Set—ask your Dealer to let you hear Cossor.

## COSSOR Radio de Luxe



### Cossor ALL-ELECTRIC Receiver Model 532A 5 valves including Rectifier)

Complete Receiver as illustrated, with 5 Cossor A.C. Mains Valves, viz.: Two Cossor M.V.S.G. (Metallised Variable-Mu Screened Grid), Cossor 41 M.H. Metallised Detector, Cossor 41 M.X.P. (Super-power Output) and Cossor 442 B.U. (Rectifier). Completely shielded coils, triple-gang condenser giving one-knob tuning. Illuminated dial, calibrated in wavelengths. Graded volume control and alternative tone selector. Mains-energised Moving Coil Loud-Speaker, gramophone pick-up plug and jack, magnificent cabinet with conveniently-placed controls. Wavelength range 200-580 and 1,000-2,100 metres. For A.C. Mains only 200-250 or 100-125 volts (adjustable), 40-100 cycles. **PRICE £13.15.0**

Hire Purchase Terms: 27/6 deposit and 11 monthly payments of 25/-.  
2586

To Messrs. A. C. Cossor Ltd., Melody Dept.,  
Highbury Grove, London, N.5

Please send me, free of charge, full particulars of

- Cossor Melody Maker BATTERY Models
  - Cossor Melody Maker ALL-ELECTRIC Model
  - Cossor ALL-ELECTRIC Receiver Model 532A
- Strike out whichever not required

Name .....

Address .....

# TIT-BITS

2<sup>D</sup>

ONE MILLION

FREE

COLOURED

ROAD MAPS

OF ENGLAND

SCOTLAND

& WALES

*A Map in Every Copy*

*Make Sure of yours  
To-day*

NOW ON SALE AT ALL NEWSAGENTS & BOOKSTALLS



# THE ALPHA Q.P.-P. THREE

A simple-to-construct, highly-efficient three-valve Receiver employing a Screened-Grid Detector and two Pentode valves

Designed by T. D. BAKER

THE receiver described in this article is a splendid self-contained, battery-operated receiver which will give a really high standard performance. The circuit diagram shows that the aerial tuning arrangement is designed to provide the necessary degree of high selectivity which must be employed in order to ensure that there shall be no difficulty in separating stations working on adjacent wavelengths. This is carried out by means of band-pass tuning, and the coils used are a little different from those normally employed. Instead of a two-band tuner, the usual wavelengths have been divided up into three bands, the first covering a range of from 150 metres to 230 metres, the second covering the range from 200 to 500 metres, and the third tuning to the long-wave stations working on wavelengths from 1,000 metres to 2,000 metres. A small adjustable series aerial condenser is fitted to the rear of the baseboard, and this enables the set to be adjusted to the particular aerial with which it is employed. The remainder of the circuit is quite orthodox, the special input and output quiescent push-pull transformers being provided with the necessary tone-control and safety resistances. The detector-valve is of the normal H.F. screen-grid type, and this provides a high degree of amplification and selectivity in this stage, and ensures that the two output pentodes will be fully loaded so as to enable the moving-coil loud-speaker fitted in the upper part of the cabinet to give of its best. The photograph of the rear of the receiver will show that a shelf is provided for the accommodation of the H.T. and L.T. batteries. The grid-bias battery is held in a clip at the rear of the lower baseboard. Provision for gramophone reproduction is made by the usual pick-up terminals connected between the grid circuit of the detector and earth.

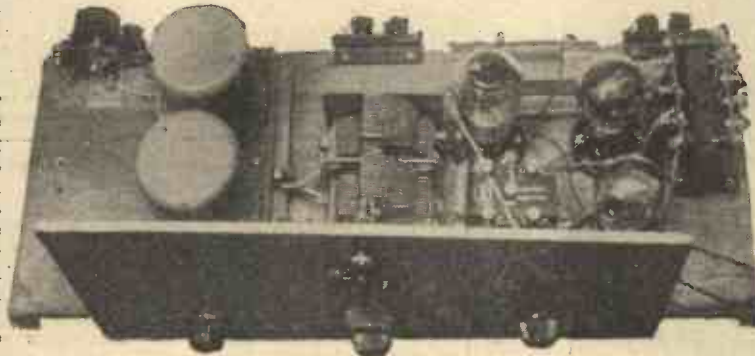

The above-board view of the Alpha Q.P.-P. Three.

For Wiring Diagram, see page 18.

For List of Components, see page 16.

preferable to first of all fix the parts on the underside of the baseboard, as shown in Fig. 2. Attach the terminal blocks in the required positions, after fitting the terminals to them.

Turn over the baseboard and mount the remaining components, taking their position from Fig. 4. Notice particularly the actual way round for the two transformers, so as not to be met with difficulty when wiring is commenced. It should also be pointed out that care should be taken in handling the variable condenser, so as not to damage or bend any of the vanes. Mount the reaction condenser on the panel, and fit the escutcheon window.

The on-off switch is easily fitted above this window, and the panel may then be attached to the baseboard by means of appropriate wood-screws. The dial should be just clear of the back of the window, and if there is any bad alignment here, such as the dial touching the window, or being too far to the back, the panel should be removed and the variable condenser fitted in a more suitable position. The small hole through which projects the control rod of the tuning-coils should be just large enough to prevent rubbing.

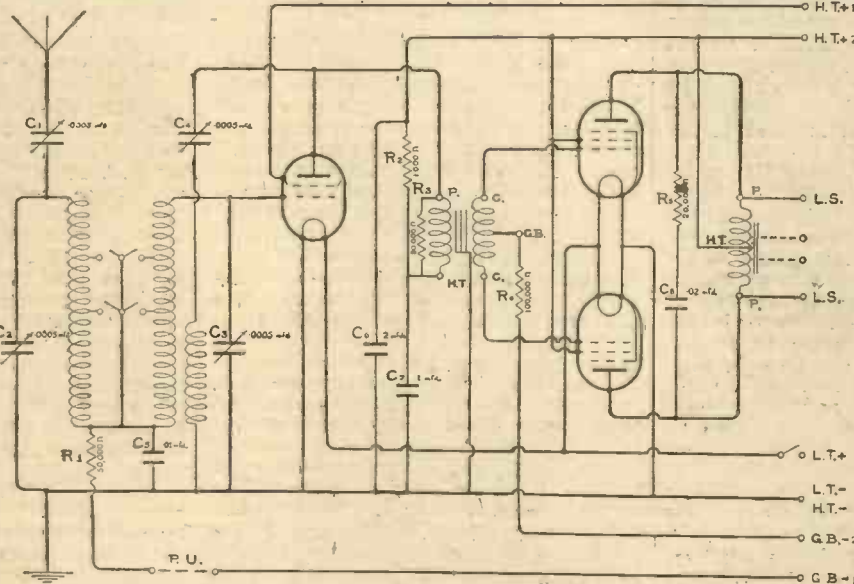

Fig. 1.—The theoretical circuit of this receiver.

drill the panel from the details given in Fig. 3. The actual fitting of the various parts may now be commenced, and it is

### Construction

Remove the baseboard from the cabinet and mark out the positions for the Cliv valve-holders, as shown on page 18. Whilst cutting work is in progress, mark out and



The neat panel layout of the finished receiver.

means of a loop) under the holding-down screw of one of the feet of the variable condenser assembly. This prevents a long lead being run round to the terminal on the opposite end of the condenser. The 100,000 ohms resistor is attached to the GB terminal of the input transformer by means of a short length of Glazite, and the flexible grid-bias lead is attached to its opposite end. The thick Glazite wire keeps it in position. The remaining resistors are also held in position by means of the connecting wires, no special holders being provided for them. It will be noticed in Fig. 2 that the pick-up terminals are short-circuited with a small piece of wire. This procedure is necessary only

LIST OF COMPONENTS FOR THE "ALPHA" Q.P.-P. THREE

- |   |  |   |
|---|--|---|
| 1 2-gang .005 mfd. Variable Condenser with escutcheon. (Polar). | 1 1,000 ohms 1 watt resistance. (Erie.)                                    | 1 7-way Battery Cord. (Bulgin.)                       |
| 2 .0003 mfd. Precision Condensers. Lissen.                      | 1 2,000 ohms 1 watt resistance. (Erie.)                                    | 2 L.T. Spade Terminals. (Clix.)                       |
| 1 .01 mfd. Fixed Condenser. (T.C.C. Type S.)                    | 1 8,000 ohms 1 watt resistance. (Erie.)                                    | 1 Grid Bias Clip. (Bulgin.)                           |
| 1 1 mfd. Condenser. (T.C.C. Type 50.)                           | 1 50,000 ohms 1 watt resistance. (Erie.)                                   | 2 Coils Glazite.                                      |
| 1 2 mfd. Condenser. (T.C.C. Type 50.)                           | 1 100,000 ohms 1 watt resistance. (Erie.)                                  | 2 Valves Pen 220A. (Mazda.)                           |
| 1 .02 mfd. Condenser. (T.C.C. Type M.)                          | 1 Q.P.P. Transformer. (R.I.)   | 1 Valve 215 S.G. (Mazda.)                             |
|   | 1 Q.P.P. Output choke. (R.I.)  | 1 P.M. Moving Coil Speaker.                           |
|   | 2 5-pin valve holders. (Clix.)   | 1 Alpha Cabinet. (Hambling.)                          |
|   | 1 4-pin valve holder. (Clix.)  | 1 Panel 14in. x 8in. (Becol.)                         |
|   | 1 Coil Unit. (Hambling.)   | 1 Plywood Baseboard 19in. x 7in.                      |
|   | 1 On-off Switch. (Busco.)  | 1 120 volt H.T. Battery. (Lissen.)                    |
|   | 6 Terminals, marked E, A, L.S., L.S. Pick-up, Pick-up. (Belling Lee.)      | 1 16 volt G.B. Battery. (Lissen.)                     |
|   | 6 Wander Plugs, marked G.B.+, G.B.1., G.B.2, H.T., H.T.+1, H.T.+2. (Clix.) | 1 L.T. 2 volt Accumulator. (Lissen.)                  |
|   |  | 1 Q.P.P. Moving Coil Speaker. (Ormond No. R/494 C.T.) |



The finished Alpha Q.P.-P. Three.

when the receiver is used for radio reception, and a convenient switch could, of course, be mounted on the motor-board of the gramophone portion of the equipment. There are no other points which require attention, and the receiver may be completed by reference to Fig. 4 and the photographs of the receiver which are included in this article.

Operating Notes

The screen-grid valve is inserted in the socket nearest the variable condenser, and the flexible lead, which is joined to the A terminal on the input transformer, should be attached to the cap of the valve. A point which should be mentioned here is that this lead should never be disconnected whilst the H.T. plugs are in their sockets. The reason is this. H.T. negative is joined to earth, and the primary winding of the transformer is joined to the other side of the H.T. battery. Therefore, if this lead is allowed to drop on to the variable condenser, or the metallized

coating of the valve (if such a valve is used), the high-tension battery is short-circuited, with, of course, disastrous results. Therefore, use a soldering ring on this lead, and you will remember, when going to remove it, first of all to take out the H.T. plugs. The two pentode valves are inserted in the remaining holders, and they may, of course, be used indiscriminately in any holder. A 16 volt grid bias battery must be inserted in the clip, and the three plugs inserted in the appropriate sockets. G.B.+ is inserted in the end socket marked with a plus sign; G.B. P.U. is inserted in the 3-volt tapping, whilst G.B.— is inserted in the opposite end socket on the battery. The position of the socket marked P.U. should be varied to see if, with your particular valve, there is any better position for it. The H.T.1 plug should be inserted in the high-tension battery at some point between 60 volts and 80 volts. The

best position will be found by experiment. The best voltage will be that which gives smoothest reaction control, and this will no doubt be nearer to 60 than 80 volts. The battery, as already mentioned, should be stood on the upper shelf, together with the L.T. accumulator. If now the set is switched on, it will be found that maximum signal strength will be obtained when the series aerial condenser is turned with the vanes "all in." This should be adjusted to give the best compromise between selectivity and signal strength, and when tuning to a station, the small knob which is concentric with the main tuning knob should also be adjusted to give the accurate tuning spot. The selectivity will be found ample for normal requirements, and it may be augmented, where required, by suitable adjustment of the reaction condenser.

(Continued on page 18.)

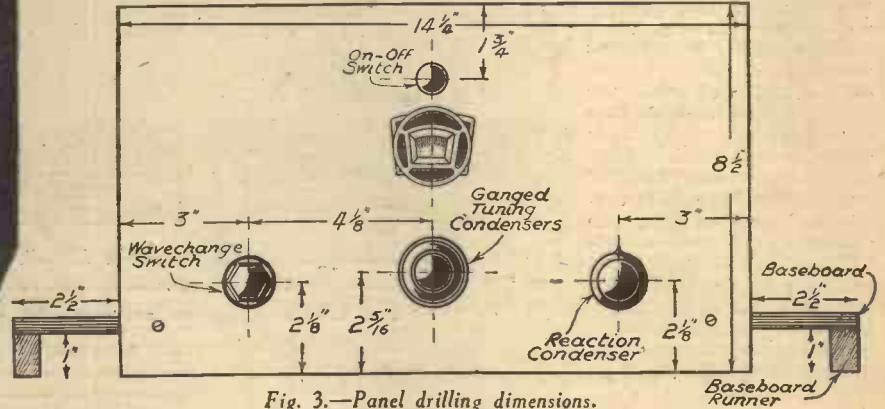

Fig. 3.—Panel drilling dimensions.

Points About Selectivity

USUALLY, if a set is made too selective, tuning will be more difficult. It is not an easy matter to obtain a good tone when tuning is of the knife-edge variety. If a station can be received anywhere within three degrees on the dial, the correct point at which it is properly tuned in can easily be found.

By increasing the potential of the detector valve selectivity is automatically increased. In circuits employing magnetic reaction the use of a larger capacity condenser across the primary of the first transformer will increase sensitivity, and, to a certain extent, selectivity as well. Many tuning units work in a very unselective condition. When they do, connect a small capacity in series with the aerial and the aerial terminal of the unit. If your earth lead is long your set may tune broadly. Here, again, sharper working can be obtained by connecting a variable condenser in series—this time with the earth.

Long aerials tune broadly and it is a good plan to limit the length to about 70 feet, including the down lead. A set

may be unselective through being earthed to a water main to which other sets, generally tuned to a local station, are earthed. If possible, use an independent earth.

Bind Your Copies of "Practical Wireless"!

THE Binding Case for Volume 1, in Blue Cloth Boards, with Silver Lettering, and complete with title page and index, costs 2s. 6d. (by post, 2s. 9d.) from:

The Publisher,  
George Newnes, Ltd.,  
8-11, Southampton Street,  
Strand, London, W.C.2.

The index separately costs 4d. post free. All readers should have their copies of Volume 1 bound, and thus be able easily to refer to the contents, by means of the fully cross-referenced index.

Back issues to complete your volume may be obtained for 4d. each, post free, from The Back Number Department, Exeter Street, Strand, W.C.2.

A Fuse Hint

IN sets where a flashlamp bulb is fitted to act as a fuse, constructors are often puzzled by the bulb glowing at the moment of switching on, and sometimes fusing. It may be thought that a fault exists, but this may not be the case.

If a set contains various fixed condensers of fairly large capacity, these take a relatively heavy current when switching on, and it may therefore be necessary to use a fuse bulb of larger capacity. If the valves take a total filament current of .5 ampere, which is usual for a three-valve set, a bulb that will blow .4 ampere will afford protection and leave a sufficient factor of safety.



# EDISWAN

The name that means 'EXCELLENCE'

*"Quiescent Push-Pull" was successfully launched by the Mazda engineers*

**NOW—here is a specially designed Permanent Magnet**

B.T.H.



**MOVING COIL REPRODUCER**

for use with Q.P.P. output



*R.K. "Minor" Permanent Magnet Loudspeakers fitted with Q.P.P. output transformer and high efficiency permanent magnet. Price 57/6. Also available complete with cabinet.*

Here is a new model B.T.H. R.K. Reproducer specially designed for operation by a "Quiescent Push-Pull" output stage. It incorporates a special accurately matched transformer to suit Mazda PEN.220A valves. The speaker itself is of the well-known "Minor" R.K. type with powerful permanent magnet. The combination produces the best possible results from Q.P.P. receivers.



The Edison Swan Electric Co. Ltd.,  
155 Charing Cross Road, London, W.C.2

GOOD RADIO DEALERS RECOMMEND EDISWAN

W.208

## Exclusively Specified

by 'Practical Wireless' for the 'Ferrocart Q.P.-P. Hi. Mag. Three'

described in this issue.

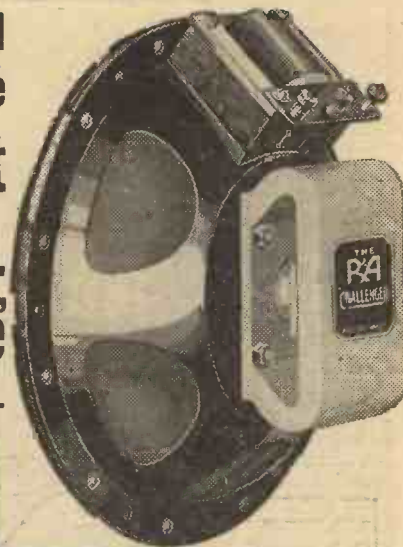

The R & A  
**"CHALLENGER"**  
PERMANENT MAGNET M.C. REPRODUCER

The R. & A. "Challenger" Reproducer is constantly specified by Set designers, and now by the designer of the 'Ferrocart Q.P.-P. Hi. Mag. Three,' because of the amazing quality of reproduction, the tonal beauty, the crispness and brilliance of musical passages and the life-like rendering of speech.

Fidelity, Sensitivity, Permanence. All these are demanded by the modern Set designer, and are found combined in their ultimate choice—the R. & A. "Challenger."

**Your dealer can supply. Insist on the R. & A. "Challenger" and refuse any so-called substitute. Had there been a substitute, the designer of the 'Ferrocart Q.P.-P. Hi. Mag. Three' would have specified it.**

**35/-**

including 3-ratio Ferranti Transformer

**—the finest**

**value ever**

**offered!**

REPRODUCERS & AMPLIFIERS LTD., WOLVERHAMPTON

# Top- and Sub-Baseboard Wiring Diagram of the Alpha Q.P.-P. Three

(Continued from page 16.)

OPERATING INSTRUCTIONS OF THE ALPHA Q.P.-P. THREE WILL BE GIVEN NEXT WEEK!

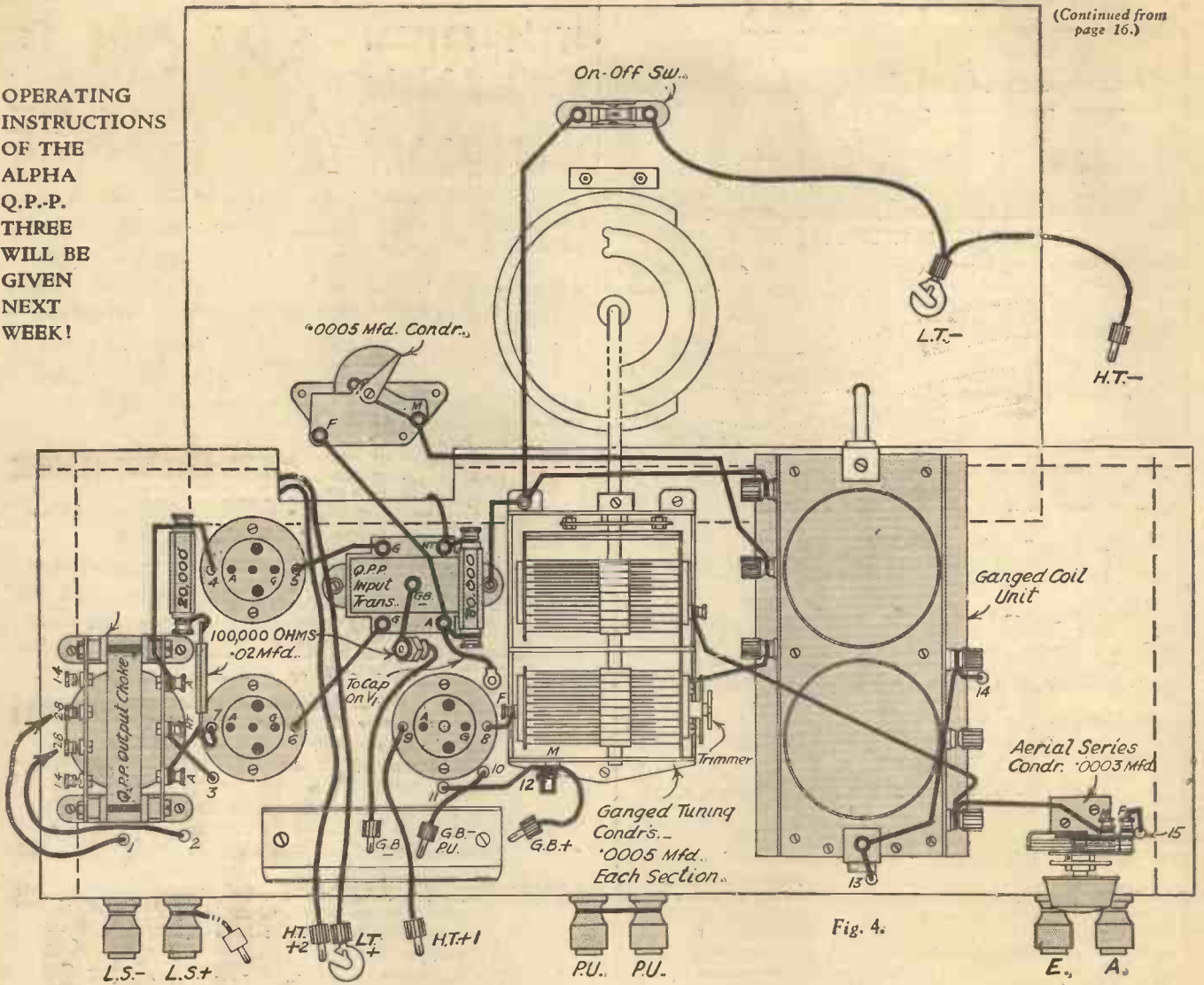

Fig. 4.

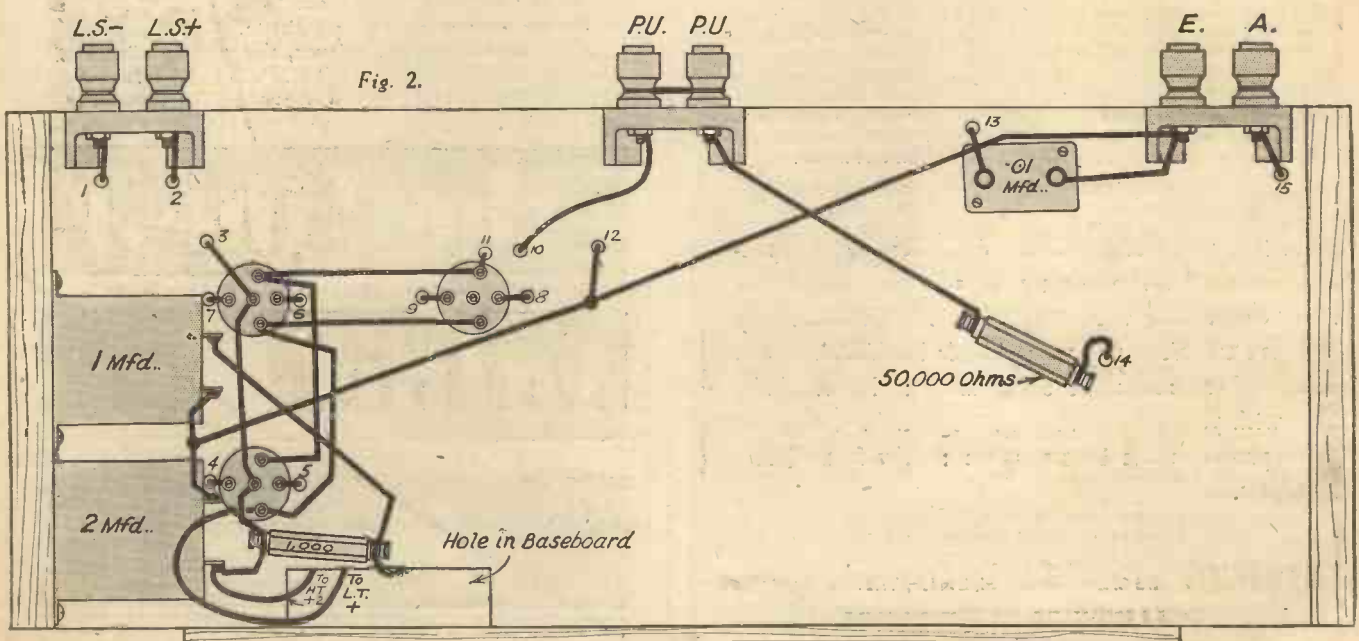

Fig. 2.

# The FERRANTI SUPERMIN

**3**

You will find a keen exhilarating enjoyment in building the "Supermin 3." First you have the pleasure of actual assembly and of seeing high-grade components take up their appointed duties according to a pre-determined plan. Then there is a unique sense of pride in having built a receiver which is not only a beautiful engineering job and a splendid piece of technical apparatus, but which is one capable of giving really satisfying reproduction.

The Supermin is a screened-grid 3 receiver with two tuned circuits giving unusual selectivity and quality. The kit comprises all you need (except valves, cabinet, and batteries).

The price of the kit, including all components, fixing screws and wire, complete with metallised panel and baseboard, in sealed carton, represents radio's best value at £4 12s. 6d.

**92/6**

# FERRANTI SUPERMIN 3

Ask your dealer for a FREE Construction Chart, or in case of difficulty, write to:

**FERRANTI LTD., "S" Constructor's Section,  
HOLLINWOOD, LANCASHIRE.**

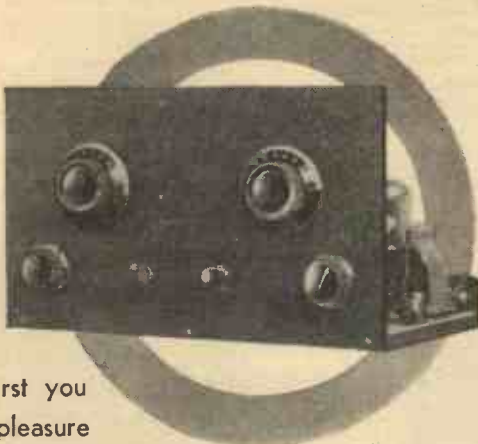

# Specified exclusively for the FERROCART Q.P.P. HI-MAG THREE

..... a receiver that combines the two most revolutionary improvements in radio reception. The designer naturally turned to the pioneers in L.F. Transformer design for his Q.P.P. Components. He knew that Varley would do credit to the capabilities of this outstanding circuit—that there were no better input or output Q.P.P. components than Varley DP 36 and DP 38.



DP36 Q.P.P. INPUT TRANSFORMER ..... ratio 9/1. Primary inductance 30 henries with no D.C., 27 henries with 2 M.A. D.C. Price 17/6 (Including royalty)

# Q.P.P.

DP38 Q.P.P. OUTPUT TRANSCHOKE ..... ratios 3/1 and 50/1. Primary inductance (each half) 8 henries with 26 M.A. D.C. Price 16/6 (Including royalty)



# Varley

(Proprietors: Oliver Paul Condon Ltd)

POST THIS  
COUPON  
TO-DAY

To Messrs. VARLEY, Kingsway House, 103, Kingsway, W.C.2.

Please send me, post free, your new brochure on Q.P.P. (with diagrams for converting existing sets), "THE BATTERY SET COMES INTO ITS OWN."

NAME .....  
ADDRESS .....

PWR1.

# TELE-TALKIE TOPICS



THE unmistakable interest which is now being manifest in television and all its allied problems (letters from readers form one definite criterion in this matter) prompted me to suggest to the Editor of PRACTICAL WIRELESS that it would be advisable to furnish readers with items of topical and technical interest in the subject. His ready acquiescence finds material realisation in this new feature called Tele-Talkie Topics. Through the medium of these columns I hope to give readers details which will enable them to keep abreast with the times as far as television is concerned and in addition, where such a course is possible, I shall be pleased to make use of the space available to settle any reader's problems in this most fascinating science.

## A Tele-Talkie Cine Transmitter

The Fernseh A.G. recently built and delivered to the Reichsrundfunk Gesellschaft is a new tele-talkie cine transmitter capable of giving twenty-five pictures per second. The film is horizontally scanned with ninety lines and the resultant image has a ratio of 4 horizontal to 3 vertical. This transmitter, shown in Fig. 1, has been fitted up in the Haus des Rundfunks Masurenallee and, as its name implies, is intended for the transmission of sound films. The television signal is made to modulate the powerful ultra short-wave transmitter (7-metre wavelength) of the Central State Post Office. The aerial and wireless transmitter is accommodated on the Witzleben wireless tower, being connected with the television transmitter in the Wireless House by a cable 750 yards long.

The tele-cine transmitter is a most ingenious piece of apparatus, and consists of a cinema projector together with a disc analysing device complete with a single photo-electric

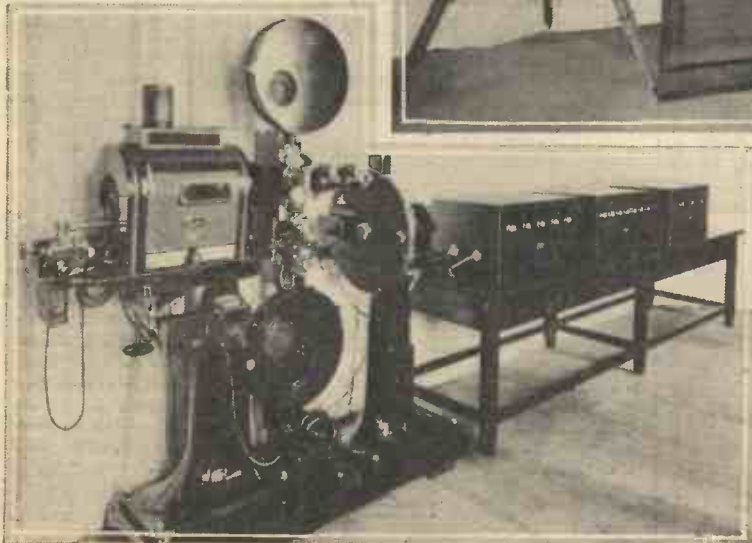

Fig. 1.—This new tele-cine transmitter consists of a cinema projector together with disc analysing device and photo-electric cell built with it.

By H. J. BARTON CHAPPLE,  
Wh.Sch., B.Sc. (Hons.), A.C.G.I.,  
D.I.C., A.M.I.E.E.

cell built into it. In addition, there is a device for the production of the synchronising frequencies specially required by cathode ray tube apparatus together with a first stage amplifier, power amplifier and a mains drive for feeding the last named, and these are seen in the illustration.

The power amplifier has two separate outputs, one being intended for the modulation of the wireless transmitter and the second for driving a

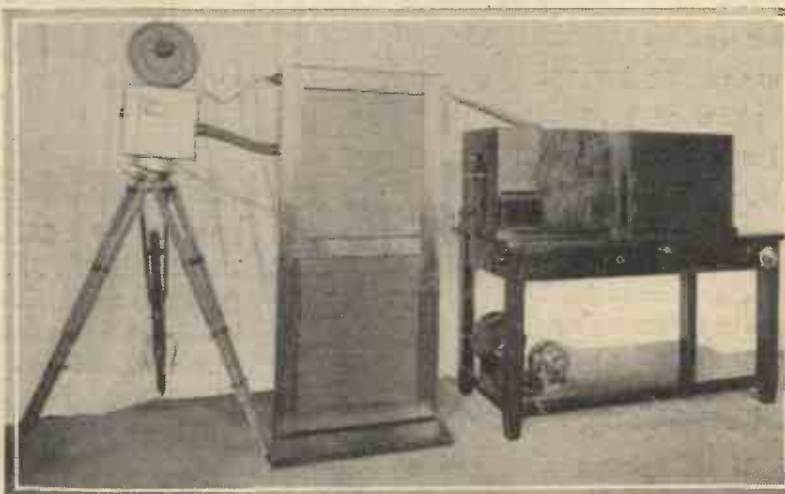

Fig. 2.—Showing the relative simplicity of the new film apparatus developed for television transmissions.

control or pilot receiver. The cinema projector and picture analysing device form a completely enclosed unit situated next to the photo-electric cell housing. The scanning disc

as well as the driving motor is completely enclosed in a dust proof casing and mounted on a strong pedestal.

## Daylight or Floodlight Television by Films

Another most important piece of apparatus which is clearly to be of far-reaching importance in the future has been developed by the same firm. This is a television inter-film transmitter and is illustrated in Figs. 2 and 3. It permits television transmission to be made of any event which may be filmed at all within the very short period of from 10 to 20 seconds, the number

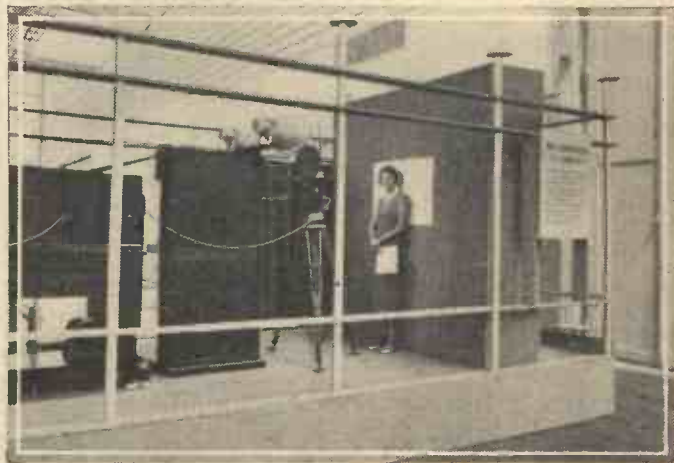

Fig. 3.—A transmission of a daylight television taking place with the new inter-film transmitter.

of pictures per second being 25. In operation a film is first taken of the actual event to be transmitted, and immediately following the filming of the subject the film is rapidly developed and fixed. The negative so obtained passes to the next section of the apparatus which is a special and extremely simple cinema transmitter, specially built for the purpose.

Between the taking of the film and the appearance of the image in the television receiver there is a lapse of time of about 15 seconds. It will be obvious, therefore, that this apparatus can be made adaptable for the televising of events at choice even with a very high number of scanning lines. The small delay of 10 to 15 seconds can be ignored in many cases and does not in any way give rise to difficulties as far as the delay of the sound which has to be transmitted with the television image. With this particular apparatus either scenes by daylight or those lit by artificial lamps can be transmitted, and the transmission will depend solely on the sensitiveness of the films used and the quality of the photographing optical system.

# REVIEWS of LATEST KITS

## THE FERRANTI SUPERMIN 1933 THREE

By F. J. CAMM

**I**n all industries there are certain firms whose ideals are not alone the acquisition of large profits, but the establishment of a reputation for quality which imparts a hall-mark or *cachet* to goods bearing their name. A name revered in the electrical industry since 1882, and since the earliest days of radio telegraphy and telephony because of quality, and whose name sets a standard not easily emulated because it stands first for superlative quality—is that of Ferranti, Ltd., of Hollinwood, Manchester. Even their rivals will admit that components of

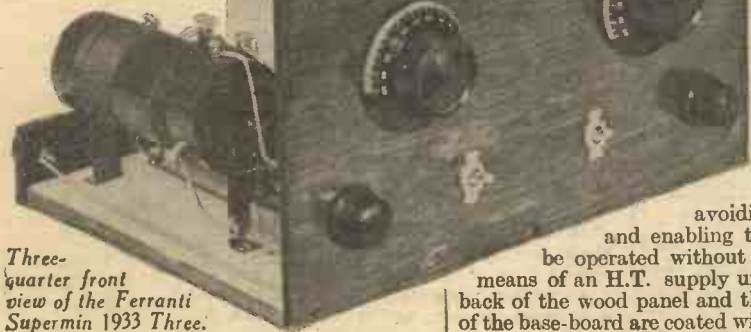

Three-quarter front view of the Ferranti Supermin 1933 Three.

Ferranti manufacture are of impeccable quality, original design, and really superb workmanship. They set standards by which others may be judged. Everyone knows the name; and therefore when they entered the kit market with their "Supermin" Three it was a natural corollary that it would be good. Only recently have I been able to test one, and in according praise to a worthy article,

I would firstly draw attention to the circuit itself. An examination of this discloses that it is of the screen-grid three type, making use of special Ferranti coils, tuned anode connection forming the coupling between the screen-grid valve and the detector. Risk of overloading the high-frequency valve is eliminated by the use of an aerial series volume control condenser. The detector valve is transformer-coupled by

means of the Ferranti A.F.10 transformer to an output power valve, and the anode feed system is used for decoupling. This effectively prevents back coupling and interaction between the stages, thus avoiding distortion and enabling the receiver to be operated without alteration by means of an H.T. supply unit. Both the back of the wood panel and the upper side of the base-board are coated with aluminium for screening purposes, and this metal coating is imparted by a special Ferranti process, and is thoroughly effective.

Separate tuning controls are used so as to ensure selectivity. The "Supermin" may be erected in eight simple operations within a couple of hours, the valves used in my set being a Cossor 220S.G., the Cossor 210H.L., and the Cossor 215P. The aerial series volume control is, of course, judiciously used to cut down the signal strength where necessary.

If the station heard is too loud the volume control condenser which is located at the bottom left hand corner of the panel should be set back in an anti-clockwise direction until the station is heard at the desired strength. This control has a marked effect on the selectivity of the set, and where interference is experienced it may, in many cases, be entirely removed by rotating the volume control in an anti-clockwise direction, at the same time increasing the signal strength by rotating the re-

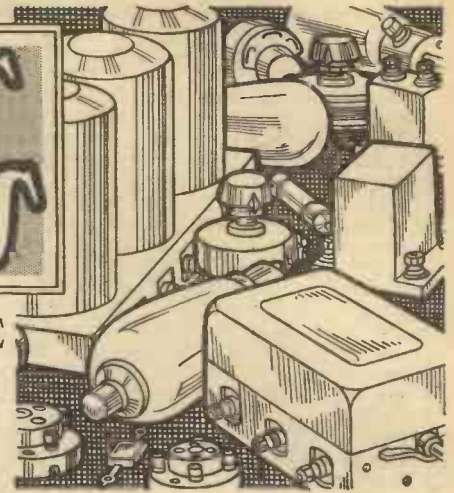

action control clockwise to the required amount. The running costs of the "Supermin" are quite low, for with a 40 ampere hour accumulator fully charged the set should operate for seventy-five hours before the accumulator will need re-charging. In one evening I logged twenty-three stations on the medium wave, and six stations on the long wave, all of the programmes received being of a strength and quality to provide entertainment value. Only here and there (such, for example, as with Mühlacker) was interference experienced, and even then by use of the volume control it was reduced to tolerable minimum.

I have no adverse comments to make on this receiver, every part of which bears the impress of high-class workmanship. It is cheap and good; you can roam over the Continent with it (at least over the ether Continent), and it is delightfully simple to operate, the reproduction of excellent quality.

The Supermin 1933 Three readily lends itself to fitting into any of the ready-made cabinets now sold by most wireless dealers. I find that it fits quite well into a Clarion self-contained cabinet, which has a loose inside frame to accommodate the loud-speaker and all of the batteries. Although the Cossor 215P valve is recommended, the Cossor 220P will give even greater volume and even better reproduction, although, of course, it will consume more H.T. current and require an increased amount of grid bias.

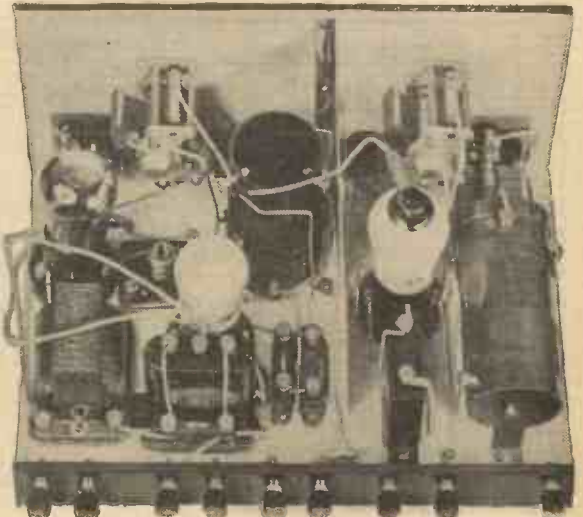

Top view of the Ferranti Supermin 1933 Three. Note the special coils and the compact lay-out.

### SPECIFICATION AND BRIEF DETAILS

- Kit:** The Ferranti Supermin 1933 Three.
- Makers:** Ferranti, Ltd., Hollinwood, Lancs.
- Price:** £4-12-6 (excluding H.T., L.T., G.B. batteries, cabinet and valves).
- Circuit:** Screened Grid, Detector and Power.
- Stations Received:** Medium waves: 23 stations; long waves: 6 stations (all at loud-speaker strength).
- Quality:** Excellent.
- Selectivity:** Good.

AS was announced last week, the receiver bearing this name has been designed round the two most popular and up-to-date methods of employing tuning circuits and low-frequency output circuits. In other words, Ferrocart coils are employed for the tuning circuits, whilst valves working on the quiescent push-pull principle are employed to feed the loud-speaker. For the benefit of those who may be new readers, or who have not read the previous announcements, it would perhaps be as well to briefly point out what Ferrocart coils are. As has been stated in many articles in these pages, the tuning circuit is a most vital affair. The high-frequency resistance has to be kept low; the self-capacity has to be kept low; all-round efficiency has to be kept high; and many other factors have to be correctly dealt with. Selectivity is, of course, the principal consideration in these days of high-power stations working on the minimum separation. Where it is necessary to employ more than one coil in a receiver (and this must be done to provide selectivity, as then there is more than one tuned circuit which assists in the separation of closely-situated stations) the over-all size of the coil must be kept small in order to prevent the baseboard assuming dimensions which would prevent the installation of the receiver in the ordinary living room. As soon as the dimensions of the coil are reduced, down goes the efficiency factor, and so the coil designers have tried again and again to bring about some sort of compromise, but, until the arrival of Ferrocart, without success. The new coils owe their design to the fact that an iron core in a coil of wire increases the value of the inductance, but for high-frequency circuits, the losses introduced by the core offset the gain so obtained. The Ferrocart coil, however, employs the iron in the form of a finely divided dust held in suspension in a material which is easily worked. The finished coil is shown in the "close-up" on this page,

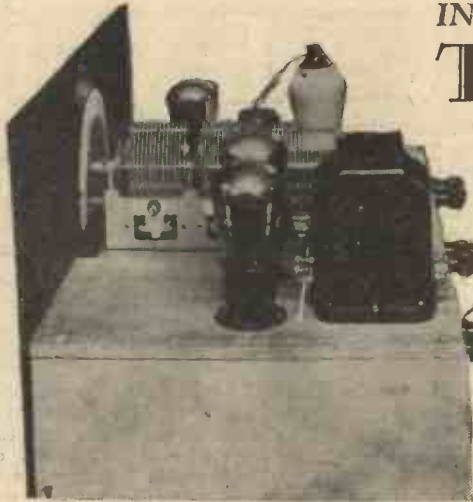

Side view of the new receiver.

from which it will be seen that the finished tuning coil bears a striking resemblance to an ordinary L.F. transformer. The larger coil is the medium-wave coil, and is wound on a core built up of "I" and "E" stampings of the new material, and the long-wave coil (on the right of the medium-wave coil) is built up on "L" stampings. The actual windings are of Litz wire, and thus the H.F. resistance is low, whilst the inductance is high.

The two coils are mounted at right-angles to each other on the substantial bakelite base, inside which the necessary switching is incorporated. This is much more complex than that adopted for the ordinary types of coil, and as will be seen from the theoretical circuit of this receiver, there are several changes carried out in the coil, in the process of switching from normal to long waves. The actual containing case for the coils is no smaller than those adopted for the normal coil, except that the over-all height has been reduced somewhat. Eight terminals are provided on the base of each coil, but in this particular receiver, they are not all employed. The design of the coil is such that the remaining parts of the receiver must also be carefully chosen, and in particular the three-gang condenser is essentially critical.

The Circuit

As will be seen from the circuit diagram, the



Rear view of the new "Practical Wireless" receiver, employing Ferrocart coils.

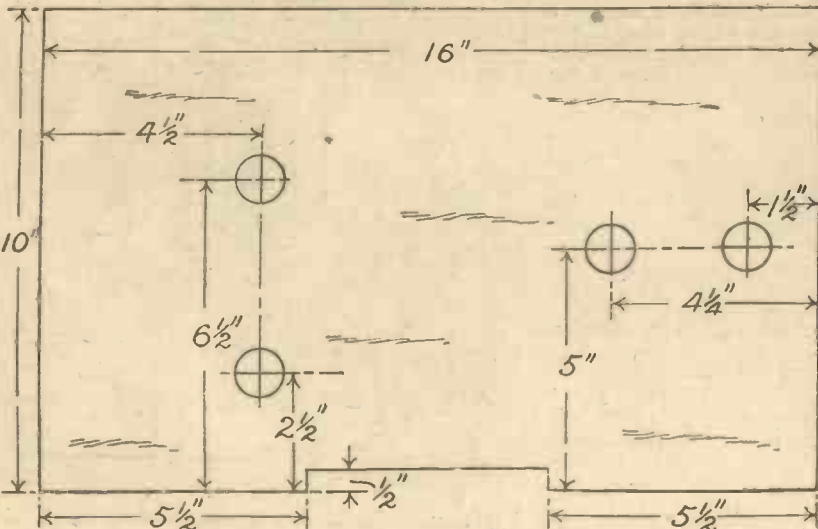

INTRODUCING—  
**THE FERRO**  
**Q.P.-P.**  
**THE**  
**SUPERHET**  
**WITHOUT SUPE**

By the "Practical W"



The complete set of Ferrocart coils.



Close-up of one of the coils.

LIST OF COMPONENTS  
**THE FERRO-CART Q.P.-P.**

- |  |   |
|--|---|
| 1 Set Ferrocart Coils. Colvern.                    | 1 2 mfd. fixed condenser, Type B.D. Dubilier. |
| Three-Gang Condenser Assembly. Brit. Radiophone.   | 1 20,000 ohms resistance, Graham Farish.      |
| 1 5-Pin Valveholder. Clix.                         | 1 50,000 ohms resistance, Graham Farish.      |
| 3 4-Pin Valveholders. Clix.                        | 1 5,000 ohms resistance, Graham Farish.       |
| 2 L.M.S. screened H.F. Chokes. Graham Farish.      | 1 10,000 ohm Potentiometer, Luxus. Preh.      |
| 1 Q.P.-P. Input Transformer, Type D.P. 36, Varley. | 1 One Megohm Grid Leak, Farish.               |
| 1 Q.P.-P. Transchoke, Type D.P. 38, Varley.        | 1 .0003 Reaction Condenser, Dubilier.         |
| 1 .0002 fixed condenser, Type 670, Dubilier.       | 1 On-Off Switch, Type S.                      |
| 1 .1 mfd. fixed condenser, Type B.D. Dubilier.     | 3 Terminal Mounts, Bell.                      |
| 1 .001 mfd. fixed condenser, Type 670, Dubilier.   | 6 Terminals, Aerial, Ear.                     |



# FERROCART HI-MAG THREE

SELECTIVITY  
WITHOUT EXPENSE

"Wireless" Technical Staff

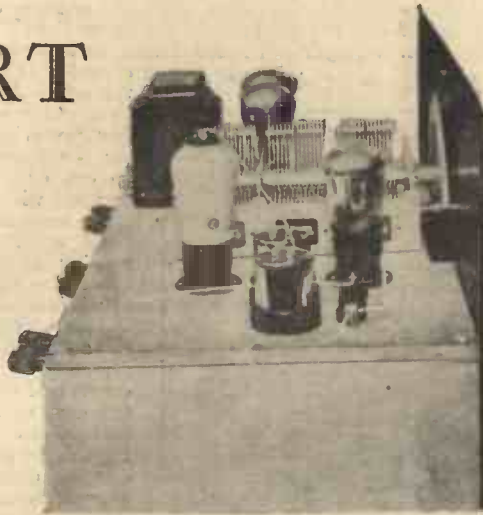

A further view of this new receiver.

input arrangement consists of a more-or-less normal band-pass filter, with the third coil acting as the detector grid coil. Reaction is employed in a normal manner in this coil, and the same winding here serves for both wave-bands.

The H.F. valve is of the variable- $\mu$  type, this being chosen to assist in the removal of a high-powered station working within a few miles of the receiver. The detector valve is a normal valve working with a rather lower value of grid-leak than is usually employed in a battery receiver. The output valves are arranged to work with an increased grid bias voltage, and with the use of an input transformer and output transchoke of the quiescent push-pull type, the anode current is kept at a minimum, whilst the undistorted output is somewhat higher than would be obtained with one valve alone. In view of the expense of the remaining part of the circuit it was thought undesirable to include pentode valves in this stage, although if expense does not matter,

there is no objection to employing two valves of the pentode type in these two sockets. A three-gang condenser is employed for tuning purposes, and this requires a little care in trimming, a point about which more will be said later on.

### The Constructional Work

The layout of the receiver is on somewhat unorthodox lines, and therefore the method of construction should be rigidly adhered to. First of all the baseboard must be drilled to accommodate the special Clix valve-holders. The positions of these are shown on the baseboard diagram below. Before the coils can be attached, they must each be reversed on the base. This must be carefully done to avoid damage, or wrong connections. First of all withdraw the switch rod. Next remove the can of the coil at one end of the base and unscrew the two holding-down bolts. Turn the coil base round one-half of a revolution—that is, so that the numbers are reversed. Screw the coil down and replace the cover. Carry out this process with each coil, so that the terminal numbered 1 will be nearest the ganged condenser when the coil unit is mounted underneath the baseboard. Next position the coils, ganged condenser, and output choke. Screw these in place, but remember most particularly, do not remove the covers of the coils. You will, no doubt, have examined the coils before affixing them, and the reason for the above admonition will have been apparent to you. The formers of the coils are extremely delicate, and any mishandling will undoubtedly result in damage. The baseboard will now stand upon either side, and the side supports may, therefore, be left



Ferrocart coils.



Ferrocart coils.

WIRING  
DIAGRAMS  
WILL  
BE GIVEN  
NEXT WEEK!

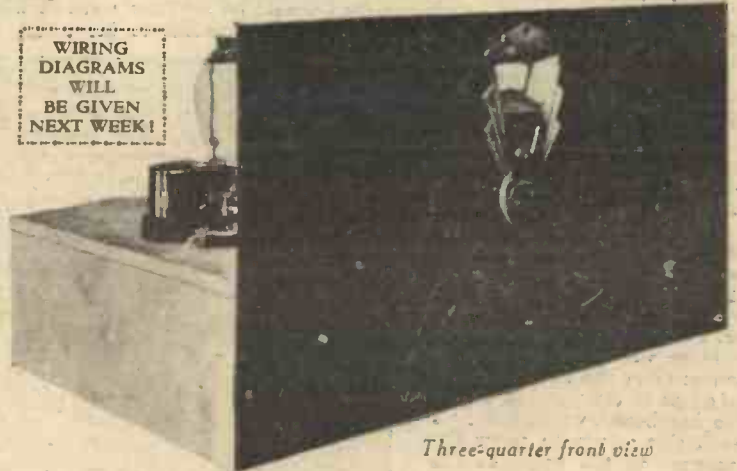

Three-quarter front view

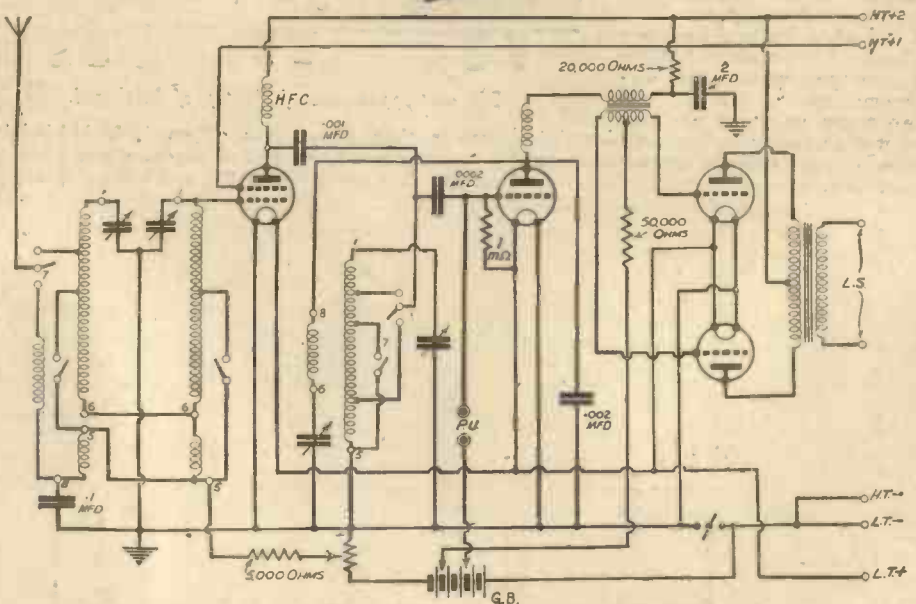

Fig. 1.—Circuit diagram of the Ferrocart Q.P.-P. Hi-Mag Three. Baseboard layout is opposite.

### COMPONENTS.

#### HI-MAG. THREE.

- Type B.B. L.S.—, and L.S.+ (Type H). Belling Lee.
- (Ohmite). 3 Wander Plugs (G.B.+ , G.B.1, G.B.2). Clix.
- (Ohmite). 1 5-Way Battery Cord (H.T.1, H.T.2, H.T.—, L.T.—, and L.T.+). Belling Lee.
- (Ohmite). 2 Coils "Quickwyre." Bulgin.
- er, Type B. 1 220 V.S.G. Valve } Cossor.
- 1 210 H.F. " }
- 1 220 P.A. " }
- t. Graham 1 Plywood Baseboard 12in. by 9in.
- er, Lissen. 1 New Hertford Cabinet. Smiths.
- 35. Bulgin. 1 120-volt H.T. Battery. Lissen.
- ng Lee. 1 15-volt G.B. Battery. Lissen.
- h. Pick-up, 1 2-volt L.S. Accumulator. Lissen.
- 1 R. and A. "Challenger" Speaker.

until the last, so that wiring is facilitated. Next screw down the valve-holders, and the other baseboard mounted components, making quite certain that the

valveholders are put on the right way round. For this purpose pay particular attention to the direction of the anode pin of each valve. In order that all the constructional work may be finished before undertaking the wiring, it would perhaps be as well at this point to drill the panel. This is a fairly simple piece of work, and the only difficulty is likely to arise over the hole for the escutcheon. There is a drilling template supplied with the Radiophone condenser, and this should be cut so that the centre line comes to one edge of the paper, and the centre line should be marked down the back of the panel. Lay the template over this line, so that it coincides at both top and bottom. The edge of the baseboard comes  $3\frac{1}{2}$ in. from the lower edge of

the panel, provided the baseboard is  $\frac{3}{8}$ in. thick. If any deviation is made in this respect it will have to be allowed for when marking out the hole for the escutcheon. The line upon which the remaining panel controls are positioned is 2in. from the bottom edge of the panel, and the two outside controls are situated  $2\frac{1}{2}$ in. from the right and left-hand edges of the panel, whilst the two remaining controls are situated  $3\frac{1}{2}$ in. from these towards the centre. The necessary holes for attaching the panel to the baseboard and the side runners may be drilled to suit individual ideas, but in the original design two holes were drilled at equal distances from the right and left-hand edges of the panel to attach to the baseboard, whilst one hole at each side serves to screw the lower part of the panel to the runners. These latter are  $3\frac{1}{2}$ in. deep and 10in. long. As already mentioned, they should not be fixed into position until the wiring is completed, as there are one or two wires going to the coils which will be rather difficult to place into position if the runners are attached at this juncture.

#### Wiring

The wiring is carried out with the usual Glazite, the required lengths being cut off and the insulation stripped for a length of

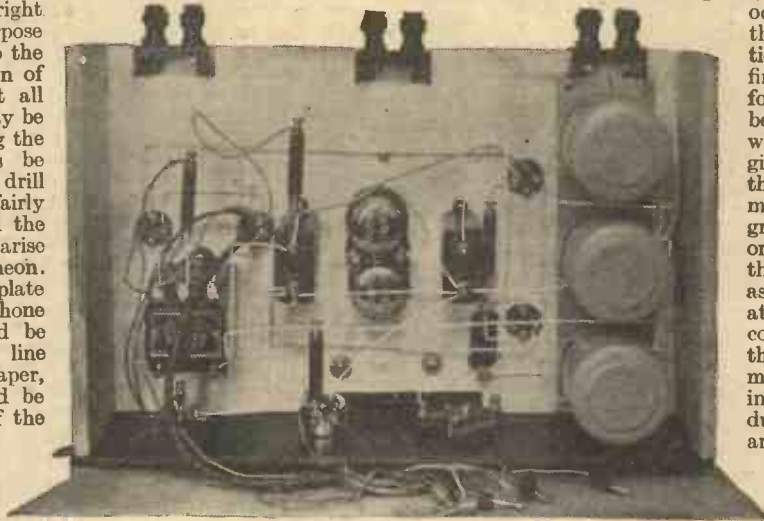

Under view of baseboard.

five-eighths of an inch at the end for the formation of a loop. This is a point which should be carefully watched when making the connections to the coils. If a space

and this will result in a short-circuit. The loop for attachment to the terminals should be formed with a pair of round-nosed pliers, and made so that it fully occupies the bared portion of the wire. The actual connections to the coils should be made first, removing the covering cans for the purpose. It will not be out of place to repeat the warning which has already been given regarding the handling of these coils. Therefore, when making the connections, take great care that the screwdriver or pliers do not slip and damage the coils. Furthermore, as soon as all the leads have been attached to a coil, replace the cover, and remove the cover of the next coil, and so on. This method of carrying out the wiring will prevent disappointment due to damage which might arise through carelessness. It

will be noticed that in the case of two of the coils more than two wires are taken to one terminal. This may, of course, be avoided by baring one of the wires and soldering the remaining leads to the bared portion, but this is a matter which must be left to the constructor. Notice that the Ohmite resistances are not fixed into any form of holder, but are simply held in situ by the stiff wire used for wiring-up.

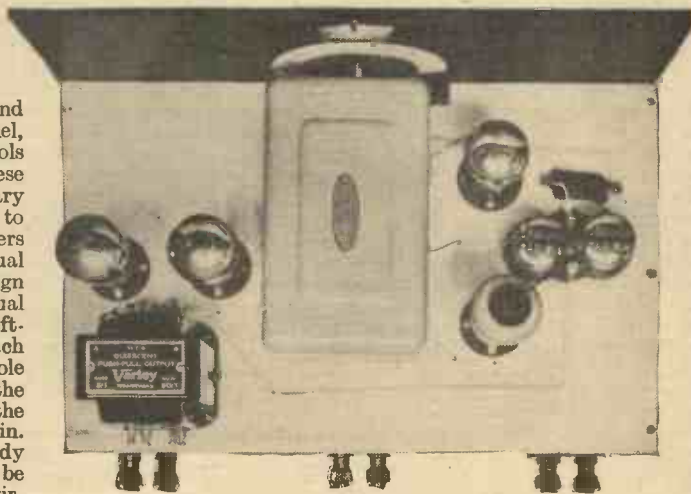

The neat appearance of the top of baseboard.

greater than five-eighths of an inch is bared, there will be a risk of the bare wire coming into contact with the coil screens,

#### Speaker Connections

In the photographs no connections are made to the loud-speaker terminals, and this is left so that the appropriate pair of terminals may be used. Similarly, the connections for the pick-up should be made according to the method which is to be adopted for gramophone reproduction. That is to say, if a self-contained radiogramophone is employed, the lead from the detector grid to the pick-up terminal may be wired in permanently, whilst the remaining pick-up terminal should be taken up to the motor-board and joined to one side of the pick-up. The remaining lead from the pick-up should then be taken to one side of an ordinary on-off switch, which is joined on its other side to earth via a grid bias battery. Further notes and operating details, will be given next week.

WE HERE draw the reader's attention to the latest development in L.F. amplification, explaining the advantages of "Class B" working, and give advance details of the new types of valve which has been developed for the purpose. After the calm comes the storm, and fast in the wake of Q.P.-P. comes "Class B." Storm is not a far-fetched metaphor to describe "Class B" amplification, because it bids fair to take its place in upwards of seventy-five per cent. of the battery sets now in general use, and further, this ultra-economical "Class B" twin-valve speaks with a voice suggestive of thunder.

Q.P.-P. may have filled a certain need, or perhaps gap would be a better word, but it has certain disadvantages in its generally accepted form. Firstly, Q.P.-P. calls for two pentodes costing 35s.; secondly, with all but the larger pentodes, a high ratio

### THE LATEST DEVELOPMENT IN L.F. AMPLIFICATION.

output transformer is required; with low resistance speech coils the ratio is so high that it becomes impracticable, with the result that a makeshift ratio is used. Thirdly, the correct matching of anode currents in a pair of Q.P.-P. valves is a simple matter to the fortunate owner of a suitable milliammeter, but there are thousands of constructors not so equipped. |

#### The New Valve

The "Class B" valve which we have received is the Cossor 240B\*, which is the result of many months of extensive and continuous research, aimed to place in the

\* To be released shortly.

hands of the battery user a make capable of giving all-mains volume for a few milliamperes. So successful have the designers been that the valve, with suitable values, will give double the volume obtainable from the average mains set for a total anode current no greater than that taken by a small standard power valve.

Additional advantages of "Class B" include: simple speaker matching, low initial expenditure and upkeep costs, with volume far greater than that required for normal purposes, with irreproachable quality and simplicity.

Following the usual custom of PRACTICAL WIRELESS to be first with all important information, we shall very shortly publish an exclusive article, placing before our readers for the first time complete theoretical and practical details of this revolutionary valve.

# The BEGINNER'S SUPPLEMENT

Conducted by F.J. CAMM



**Coil**  
THIS term is applied in a general sense to any length of wire wound round and round. In fact, it is capable of a very wide interpretation, and is not by any means confined to wireless. Almost any piece of electrical apparatus has some form of "windings" or "coils" of wire through which the current passes. Usually these coils are of copper wire with some form of

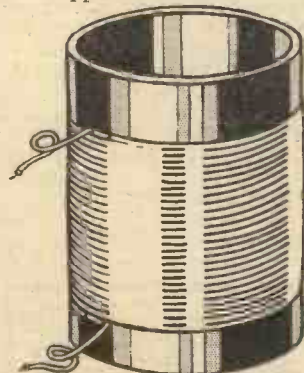

Fig. 1.—Simple tuning coil wound on an ebonite tube.

covering such as rubber, cotton, or silk. Good examples are to be found in the field and armature coils of the dynamo and electric starter on a motor car, or the motor of an electric fan, or vacuum cleaner. Coils

much finer wire of many thousands of turns are used in medical coils; the "coil" of the motor coil ignition system, magnetos, etc.

In radio the term is most often used to mean "tuning coils." Of course, other components embody coils as part of their construction, but they are not usually spoken of as such apart from the component itself. For instance, transformers contain primary and secondary coils, loud-speakers have moving coils, so also have many measuring instruments such as milliammeters, voltmeters, etc.

Tuning coils form a necessary part of every wireless receiver. There must

be at least one tuning coil in a set (although there are sometimes more), and it is connected directly, or indirectly, to your aerial. Wireless waves striking the aerial cause an electric current to flow through the coil. It is the fluctuations in this current which control the sounds emitted by your loud-speaker.

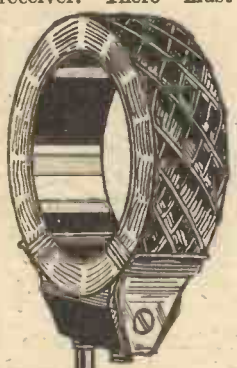

Fig. 2.—A typical plug-in coil.

## THE BEGINNER'S A B C OF WIRELESS TERMS (continued)

The coil has to be "in tune" with the incoming waves, otherwise no current will be generated. To ensure this it has to have the right number of turns of wire—a few turns to receive short-waves, and a large number of turns for long-waves. Coils are usually wound with sufficient turns to receive the shortest waves required, and then, instead of adding more turns to get longer waves, a tuning condenser is joined to the coil. By rotating the knob of the condenser the coil can be made to tune to a range of different wavelengths. Any stations broadcasting on wavelengths within that range will then be heard as soon as the condenser adjustment is in the right position. The capacity of the condenser is unfortunately limited, so in order to extend the range still further, two and sometimes three, coils are wound on one

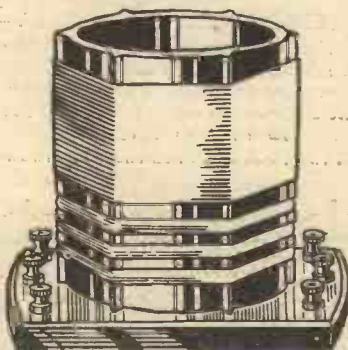

Fig. 3.—A commercial dual-range coil.

tube. Each winding in turn may be connected to the condenser by using a switch.

A few examples from the countless varieties of coils in existence are illustrated on this page. Fig. 1 shows one of the simplest coils possible. It is wound with cotton covered wire on a cardboard, or ebonite tube. Fig. 2 is a "plug-in" coil with the wire wound in lattice fashion. Fig. 3 is a typical dual-range coil. Fig. 4 is a similar, but more compact coil with a metal cover or shield. This last is the most modern type, and is used where compactness is desirable.

### Coil Former

The support on which the wire of a tuning coil is wound. It may consist simply of a cylindrical cardboard, or ebonite tube, as in Fig. 1, or it may have "ribs" as in Fig. 3, which keep the wire

from touching the rest of the tube. This latter pattern is usually more efficient as it tends to reduce any possible leakage of current from one turn of wire to the next should the insulating properties of the tube not be very good, or should the wire become damp. It also reduces what is known as the "self-capacity" of the coil. Low self-capacity is a very desirable feature in a coil. Self-capacity is at a minimum where there is the least possible solid matter near the turns of wire, so you can see that by supporting the wire well away from the body of the tube or former, the self-capacity is reduced. (See also, "Self-Capacity").

The coil former need not necessarily remain always in position. Some coils are wound so as to be self-supporting, and when the winding is completed the former is removed. One method greatly used by amateurs some years ago consisted of driving an odd number of nails into the circumference of a disc of wood. The nails were usually in two rows radiating from the disc like the spokes of a wheel. The wire was wound in lattice fashion in and out between the spokes. When complete it was soaked in wax, drained, and the "spokes" pulled out. It could then be slipped off of the

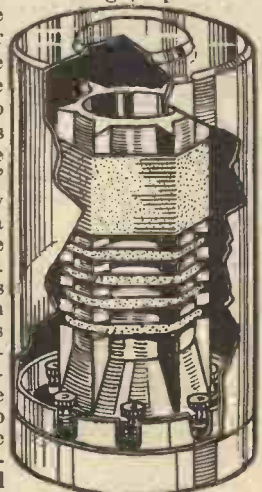

Fig. 4.—A screened coil with cover cut away to show coil.

Fig. 5.—A low-loss coil former.

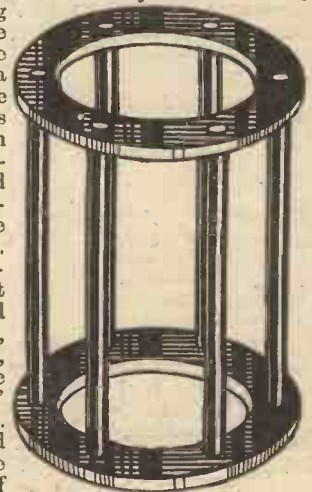

Fig. 5.—A low-loss coil former.

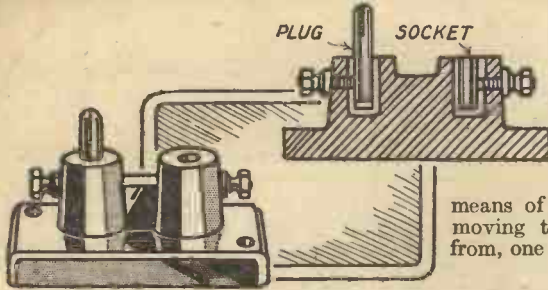

Fig. 6.—A coil holder for baseboard mounting also sectional drawing of the holder.

wooden disc and was ready for use. The honeycomb arrangement of the wire together with the wax prevented it from collapsing or unravelling. One of the most efficient types of coil former is that shown in Fig. 5. It is used for ultra short-wave coils, and is wound with bare copper wire. It is usually made of ebonite.

**Coil Holder**

A device for supporting plug-in coils. There are several types, the most common being baseboard mounting holders, as in Fig. 6. These consist of a small bakelite stand with a plug and socket to receive the coil and two terminals for making the necessary connections. Other types of coil holder are made to take two or three coils and allow of movement of the coils in relation to one another. A typical example is shown in Fig. 7. These holders are not often used nowadays as the plug-in type of coil has been largely

displaced by the types shown in Figs. 3 and 4. Where plug-in coils are still used they are usually mounted on the baseboard in the type of holders shown in Fig. 6, and any variation in the coupling between them is arranged by means of variable condensers, and not by moving the coils nearer to, or farther from, one another.

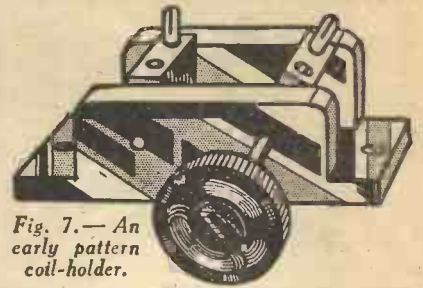

Fig. 7.—An early pattern coil-holder.

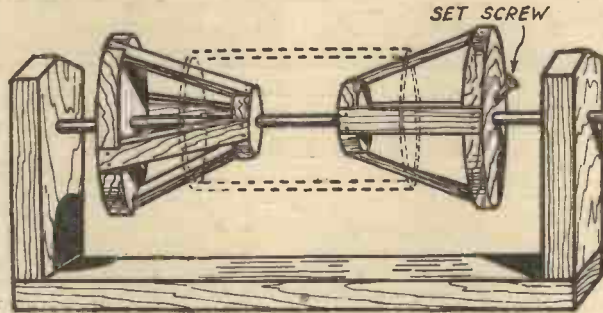

Fig. 8.—An easily-made coil winder. Dotted line shows position of coil former when being wound.

pays in the long run to buy a simple coil-winding machine, or else to rig one up from odds and ends. The one shown in Fig. 9 is, as you will see, very simple to make. The object of the tapered wooden chucks is to accommodate any size of former. They slide along the spindle, but can be secured in any position by means of set screws. Ordinary wood screws with the points filed off will do. They should be screwed into the

**Coil Winder**

A machine for winding the wire on the former when making tuning coils. Manufactured coils are often wound on very elaborate automatic machines, but the home constructor, when he undertakes the making of his own coils, usually winds them by hand. This is quite simple, and if only an occasional coil is needed is quite satisfactory. If, however, a large number are likely to be wanted it

wooden discs forming the end of the chucks at an angle so as to pass through and drive into the spindle. To wind a coil the chucks should be placed one in each end of the coil former which should then be placed in position between the two uprights of the machine. Then thread the steel spindle through the whole lot and tighten up the set screws. The wire is fed to the revolving former by hand.

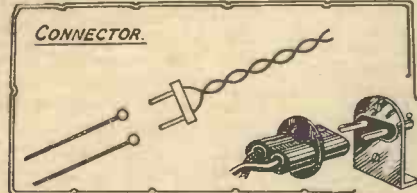

**THE SHORTHAND OF WIRELESS.—4**

At the special request of many beginners, we reproduce below a complete series of theoretical signs used in wireless circuits. The diagrams to the left and right show two actual interpretations.

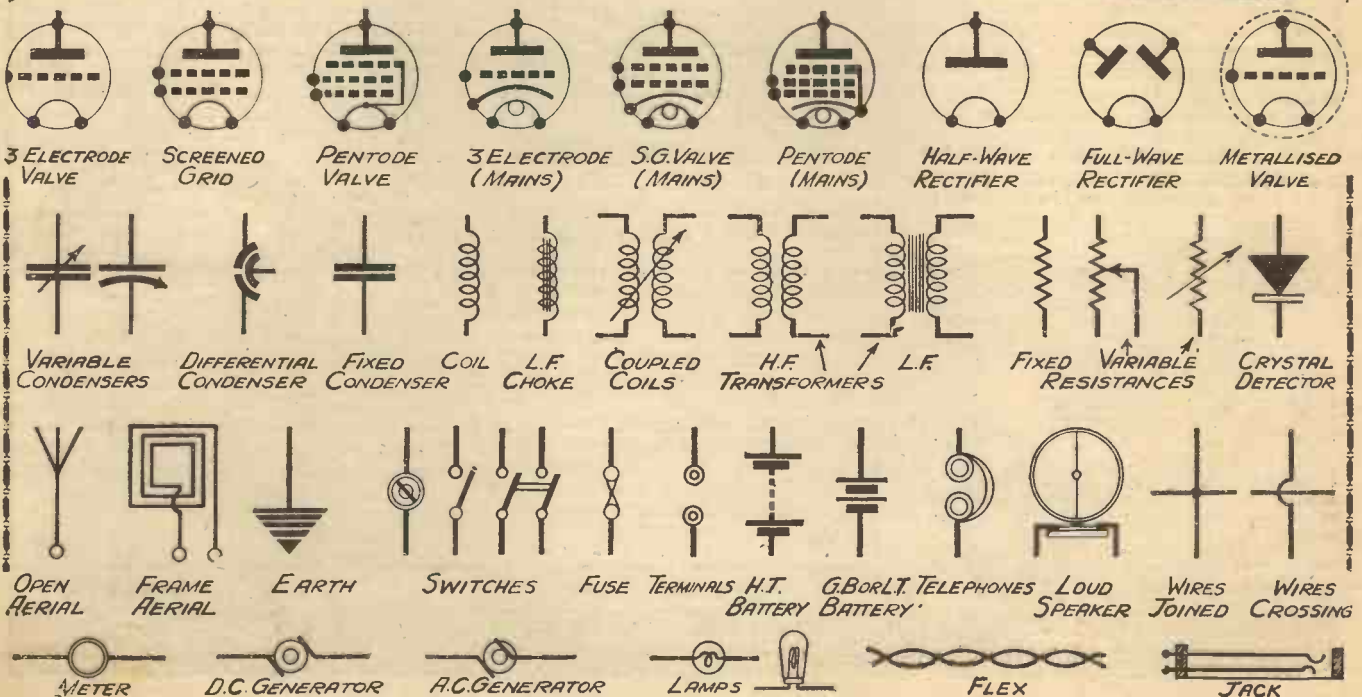
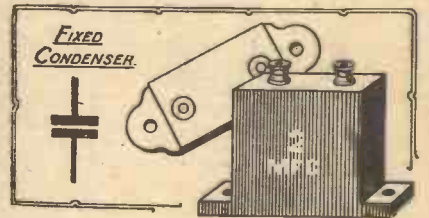

# PETO-SCOTT RADIO BY MAIL

## SNIP FOR "PRACTICAL WIRELESS" READERS

**BLUE SPOT 100U Speaker and Chassis.** For high or low powered Sets. Original Price £1/12/6. Our Price (for a limited period only), **CASH or C.O.D. Carriage Paid. 19/6**

**S.G. BROWN ELECTRIC PICK-UP.** Famous for sensitivity. List Price £2/15/0. Our Price (while stocks last), **CASH or C.O.D. Carriage Paid. 17/6**

**LISSEN "SKYSCRAPER 3."** Chassis model Send with (Lissen) S.G., Detector and Pentode valves. Cash Price £4/9/6. Carriage Paid. **8/3** only  
Balance in 11 monthly payments of 8/3.  
**LISSEN "SKYSCRAPER 3."** Cabinet model. Send Complete with Lissen Speaker and Lissen S.G., Detector and Pentode valves. Cash Price £6/5/0. Carriage Paid. **11/6** only  
Balance in 11 monthly payments of 11/6.

## Q.P.P. PILOT CONVERSION KIT

Mains Results on any Battery Set.  
CONTAINS 1 Q.P.P. Transformer, 1 Q.P.P. Output Choke, 4 Non-Inductive Resistances, 1 Potentiometer, 2 Mansbridge Condensers, 2 Valve Holders, 1 Tone-Compensating Condenser, 1 H.F. Choke, G.B. Plugs, Wires, Screws, Flex, etc.  
**CASH or C.O.D. Carriage Paid. 42/6**  
or 8 monthly payments of **6/-**

With FULL SIZE diagrams and constructional notes. SEE PAGE 1075, PRACTICAL WIRELESS, FEB. 25th ISSUE

**NEW BLUE SPOT PERMANENT MAGNET MOVING-COIL SPEAKER 29 P.M.** With input transformer. Cash or C.O.D. Carriage Paid, £1/12/6. **5/2** only  
Balance in 6 monthly payments of 5/2.

**NEW BLUE SPOT PERMANENT MAGNET MOVING-COIL SPEAKER 45 P.M.** With input transformer. Cash or C.O.D. Carriage Paid, £2/5/0. **4/2** only  
Balance in 11 monthly payments of 4/2.

**BLUE SPOT UNIT AND CHASSIS.** Type Send 99 P.M. Including matched transformer. Cash Price, £2/19/6. **5/6** only  
Balance in 11 monthly payments of 5/6.

**R & A "CHALLENGER" PERMANENT MAGNET MOVING-COIL SPEAKER.** With special Ferranti multi-ratio input transformer. Cash Price, Carriage Paid, £1/15/0. **6/6** only  
Balance in 5 monthly payments of 6/6.

**SEND 2/6 ONLY** Just pay a further 2/6 on delivery and balance in 5 monthly payments of 5/6 for **PETO-SCOTT MOVING COIL SPEAKER** Extremely sensitive, and gives perfect quality. Cash or C.O.D., Carriage Paid, 29/6.

**ROLA PERMANENT MAGNET MOVING-COIL SPEAKER F.8.** With Universal tapped input transformer. Cash Price, £2/9/6. Carriage Paid. **4/6** only  
Balance in 11 monthly payments of 4/6.

**ATLAS ELIMINATOR.** Type A.C.244. Three Send tappings, S.G., Detector and Power. Output: 120 volts at 20 m.A. Cash Price, £2/19/6. Carriage Paid. **5/6** only  
Balance in 11 monthly payments of 5/6.

**GARRARD INDUCTION GRAMOPHONE MOTOR.** For A.C. Mains. Model 202. Mounted on 12-inch nickel motor plate with fully automatic electric starting and stopping switch. Cash Price, £2/10/0. Carriage Paid. **4/7** only  
Balance in 11 monthly payments of 4/7.

## FERROCART Q.P.P. HI-MAG KIT "A"

Author's Kit of First Specified Components including ready drilled panel and assembled and drilled plywood chassis, less valves and Cabinet.

**CASH or C.O.D. Carriage Paid. £8:7:6**

or 12 monthly payments of 15/4. Set of Specified Valves, £2/1/0.

### KIT "B."

as "Kit "A," but with valves. Cash or C.O.D. Carriage Paid, **£10:8:6**

or 12 monthly payments of 19/-.

### KIT "C."

As Kit "A." Complete with valves and cabinet. Cash or C.O.D. Carriage Paid **£11:8:0**

or 12 monthly payments of 21/-.

## EXCLUSIVELY SPECIFIED

**PETO-SCOTT OAK CONSOLETTA CABINET** (Type F.J.C.), 19/6. Battery Shelf and Baffle, 3/6 extra.  
**R. AND A. CHALLENGER P.M. MOVING COIL SPEAKER,** £1/15/0  
(or add 3/3 to each monthly payment).

## These are the Parts the Author Used

1 COLVERN Set Ferrocart Coils	£2 10 0
1 BRITISH RADIOPHONE Three-Gang Condenser Assembly, type 314, with Dust Cover & Disc Drive	1 13 0
1 CLIX 5-pin Valveholder	9
3 CLIX 4-pin Valveholders	2 0
2 GRAHAM FARISH L.M.S. Single screened H.F. Chokes	9 0
1 VARLEY Q.P.P. Input Transformer, type D.P. 36	17 6
1 VARLEY Q.P.P. Transchoke, type D.P. 38	10 6
1 DUBILIER .002 mfd. fixed condenser, type 670	1 0
1 DUBILIER 1 mfd. fixed condenser, type B.B.	1 10
1 DUBILIER .001 mfd. fixed condenser, type 670	1 3
1 DUBILIER 2 mfd. fixed condenser, type BB	3 6
1 GRAHAM FARISH 20,000 ohm resistance (Ohmite)	1 6
1 GRAHAM FARISH 50,000 ohm resistance (Ohmite)	1 6
1 PREH 10,000 ohm Potentiometer Type B. Luxus	4 6
1 GRAHAM FARISH One Megohm Grid Leak	1 6
1 LISSEN .0003 mfd. Reaction Condenser	2 6
1 BULGIN On/Off Switch, type S.38	10 1
3 BELLING LEE Terminal Mounts	1 6
1 BELLING Lee Terminals, Aerial, Earth, Pick-up	1 3
1 BELLING L.S. & L.S.-4 Type B.	1 3
3 CLIX Wander Plugs (G.B.-, G.B.1., G.B.2.)	4 1
1 BELLING LEE 5-way 30" Battery Cord (H.T.); H.T., H.T.-, L.T.-, & L.T.+)	2 0
Connecting Wire, Screws, flex, etc.	2 8
1 Plywood Chassis 16 x 10 x 3/16" assembled and ready drilled for valve holders	3 6
1 PETO SCOTT Red Triangle Panel 16 x 9" ready drilled	6 0

Any of the above items sent C.O.D. You pay the postman. W pay post charges on orders over 10s.

## PILOT AUTHOR KITS - Exact to Specification

## FURY FOUR NEW TELSEN 1933 KIT SETS

Battery Model.

**KIT "A"** Author's Kit of specified parts, including ready drilled panel, but less valves and cabinet. **CASH OR C.O.D. Carriage Paid. £6:10:0**

or 12 monthly payments of 12/-

**KIT "B"** As Kit "A" but with valves, less cabinet, CASH or C.O.D., Carriage Paid. **£9 7 6**  
or 12 monthly payments of 17/3.

**KIT "C"** As Kit "A" but with valves and Peto-Scott American Type Cabinet with lift-up lid. CASH or C.O.D., Carriage Paid. **£10 2 6**  
or 12 monthly payments of 18/6.

**TELSEN "ASTRALA" 3.** Complete Kit of Send Parts in sealed Carton less valves. Cash or C.O.D. Carriage Paid £1/19/6. **5/6** only  
Balance in 7 monthly payments of 5/6.

(Set of valves add 3/6 to each of 8 payments.)  
**TELSEN SUPER "SELECTIVE" 4.** Complete Send Kit of Telsen Parts in Sealed Carton. Cash or C.O.D. Carriage Paid £4/18/6. **9/-** only  
Balance in 11 monthly payments of 9/-.

(Set of valves add 5/3 to each of 12 payments.)  
**TELSEN "SUPER" 6.** Complete Kit of Send Telsen Parts in Sealed Carton. Cash or C.O.D. Carriage Paid, £5/18/6. **10/10** only  
Balance in 11 monthly payments of 10/10.

(Set of valves add 7/5 to each of 12 payments.)  
**TELSEN "ALL-MAINS" 3.** Complete Kit of Telsen Parts in Sealed Carton. For A.C. Send Mains only. Cash or C.O.D. Carriage Paid **12/8** £6/18/6. **12/8** only  
Balance in 11 monthly payments of 12/8.

(Set of valves add 5/7 to each of 12 payments.)

## CASH, C.O.D. or EASIWAY

SEND 1/- FOR SPLENDID SHORT-WAVE BOOK written and edited by Mr. G. T. Kelsey, the world-famous Short-Wave Expert. Describes 4 efficient receivers with full building and operating instructions. 48 pages, 4 colour cover. Amply illustrated. FREE FULL-SIZE BLUE PRINT WITH EVERY COPY. Obtainable from all Shops and Branches Messrs. W. H. Smith & Sons.

**PETO-SCOTT CO., Ltd. 77, City Road, London, E.C.1.**

Telephone: Clerkenwell 0406/7.

West End Showrooms: 62, High Holborn, London. W.C.2 Telephone: Holborn 3248.

Dear Sirs, Please send me CASH/C.O.D./H.P. for which I enclose £.....s.....d. CASH/H.P. Deposit.

NAME  
ADDRESS

Pr. W. 25/3/33

FREE. -Send 3d. Postage for 3 PILOT ENVELOPES with FULL-SIZE BLUE PRINTS.

ANY ITEM SUPPLIED SEPARATELY—ORDERS OVER 10/- SENT C.O.D. CARRIAGE AND POST CHARGES PAID

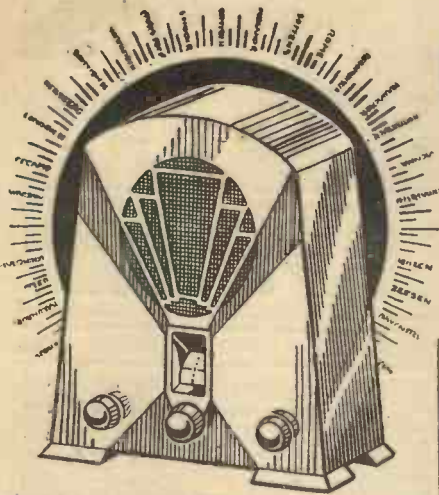

**T**HE name of McMichael has been known in connection with wireless since before the days of broadcasting, and their new products year by year have invariably proved excellent examples of skill in workmanship and maintain the highest standards of performance. The Duplex Mains Four (Transportable) model illustrated on this page is no exception. Externally, it is most prepossessing, the chassis being housed in a figured walnut cabinet with an operating panel of polished grained ebonite suitably engraved. The control knobs are of polished ebonite, while a dustproof glass covered Duplex scale facilitates station logging. A pilot light shows whether the set is "alive" and a ball bearing turntable enables the whole set to be rotated and point in the direction of the station it is desired to receive.

#### Circuit Details.

So much for external qualities and before giving details of performance attention will be turned to the circuit used in this set. It is a four-valve receiver using indirectly-heated A.C. mains valves. A dual range frame aerial (which incidentally has provision made for connection to an external aerial and earth system) tuned by a .0005 mfd. condenser is coupled to a MS4B metallized screened grid valve *via* a .01 mfd. condenser. The volume control is effected by adjusting the bias to the grid of this valve from a 2,000 ohm potentiometer, a grid leak of 0.5 megohm resistance being included in the circuit together with proper decoupling. In the anode circuit of this valve there is a dual range coil functioning as a tuned anode circuit (gang tuned with the aerial circuit) with the usual grid leak and condenser coupling to a second high-frequency valve, an AC-HL metallized. A high-frequency choke in the anode circuit of this second valve serves to checkmate the high-frequency currents and the reaction control—a .0001 mfd. differential condenser—is included here, the feed-back taking place by means of a reaction coil coupled to the tuned anode coil of the first valve. This second high-frequency valve is coupled to the detector valve, an AC-HL metallized, by the conventional resistance capacity method, the detector valve functioning in the normal leaky grid fashion.

Provision is made here for a pick-up jack. In the anode circuit of the detector valve we have a second high-frequency choke by

# OUR VIEWS ON RECEIVERS

## McMICHAEL DUPLEX MAINS FOUR (Transportable)

passed at each end with two condensers of different capacity, namely, .001 mfd. and .0003 mfd, the first named being connected at the anode end of the choke and the second at the H.T. end. In the output stage there is a pentode valve, AC-Pen, this being coupled to the preceding detector stage by a transfeeder unit (resistance capacity fed transformer method). The signals are fed by a transformer to a moving-coil loud-speaker (provision being made for

servicing becomes necessary. Very complete and explicit instructions are furnished for installation and operation, and in addition there is a service manual available at no charge for those who should desire same, this latter giving full details for testing and servicing when such is necessary. Having seen that the valves are firmly in their sockets by removing the back, the mains plug is simply inserted in place and the set switched on *via* the combined switch and volume control, the reaction control being left at minimum. Both the pilot light and Duplex scale light up and after a wait of approximately twenty seconds the set is ready for use.

The normal working position of the volume control is with the index pointer opposite the letter "L" in the word "volume" but in places remote from broadcasting stations greater range is obtained by turning the control round to maximum. On the left-hand side of the control panel is a lever marked "range" and when moved up and down the wavelength pointer is correspondingly moved up and down so that it can sweep over the medium or long-wave markings on the scale. In use the pointer is set to the actual wavelength of the station desired and within reasonable distance of that station it will be heard, the final and critical tuning being obtained by the trimming device, that is the right-hand lever marked "adjust."

The reaction control on the left of the control panel intensifies the reception in the usual manner and causes the set to oscillate, a necessary feature when searching for distant transmissions. The selectivity of the instrument, while already remarkably high, may be further increased by reducing the volume on the right-hand control and turning the reaction control in a clockwise direction when it will be observed that the tuning becomes sharper on the knurled control.



The McMichael Duplex Mains Four (Transportable).

the use of an external speaker when such a course is desired) whose energized field acts as the smoothing choke in the main H.T. feed. Dry metal rectifiers connected up as voltage doublers supply the main H.T. current and throughout the circuit it is noticed that adequate decoupling provision is made and this very effectively removes the slightest trace of L.F. instability. In a compact transportable mains set of this character this feature is essential if consistently good performance is to be maintained.

#### Controls.

The complete metal chassis accommodating all the set's components is a remarkably fine piece of workmanship, being neat and compact but with each part readily accessible on those remote occasions when

#### Performance

Using the frame aerial alone it was possible to tune in at full loud-speaker strength over thirty stations with ease. This number was doubled when a small external picture rail aerial and good earth was added.

Background noises, often very troublesome in a set of this nature, were absent, while the quality of reproduction from the moving-coil loud-speaker was markedly natural. Speech was crisp and clear without any slurring of sibilants, while musical selections and songs came through in a manner which was a delight to listen to. The price of the set is 21 guineas, complete, this being for either 100-115 or 200-250 volt models.

# TEMPORARY EXPEDIENTS

By H. J. BARTON CHAPPLE, Wh.Sch., B.Sc.

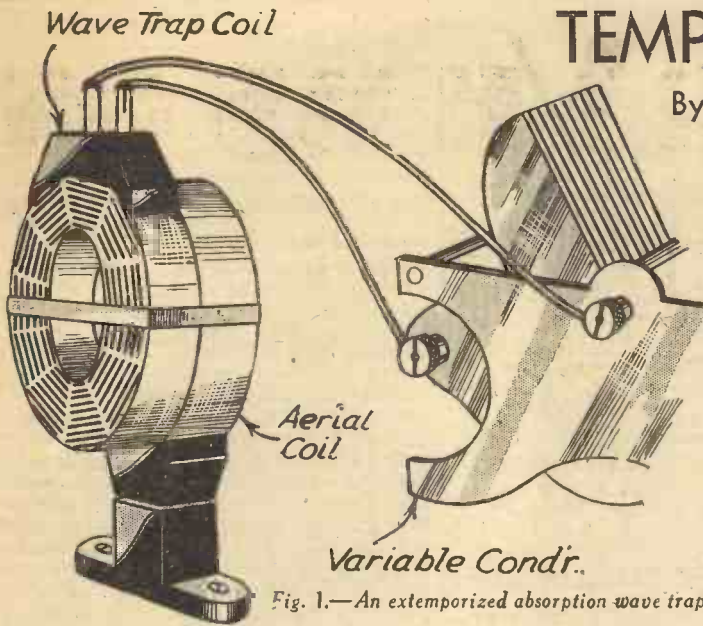

Fig. 1.—An extemporized absorption wave trap.

THE sage who declared that you cannot make a silk purse out of a sow's ear never spoke a truer word, and the adage applies with its full force to radio. Good reception and consistent results cannot be obtained without good design and good components. In an emergency, however, passable results are obtainable by the use of temporary expedients and there are hundreds of little wrinkles whereby substitutes may be made to serve a turn. Many of these have been published in PRACTICAL WIRELESS from time to time, and here is another selection which readers should bear in mind for necessitous occasions.

Everyone knows the vexation which is caused when a major component such as a condenser or a transformer breaks down—usually just when a most interesting or important transmission is about to commence. The knowledgeable constructor, however, frequently can provide a jury rig which will tide matters over until a new part can be obtained.

### Transformer to R.C.

For example, suppose the primary winding of your low frequency transformer burns out suddenly. You can speedily convert the stage for resistance capacity coupling in this way. Disconnect the burnt out primary winding and in its place fit a spaghetti or metallised resistance, then connect a small fixed condenser between the anode of the detector valve and the grid terminal of the transformer secondary, leaving the secondary winding with its normal connections to serve in place of the more conventional grid leak. Fig. 3 shows exactly how this is done.

The value of the anode resistance should be from twice to five times the impedance of the detector valve, but for temporary use the actual value is not critical and even an old grid leak will do at a pinch. The same remarks apply to the value of the coupling condenser for any capacity between .005 mfd. and .05 mfd. will serve. It is true that in all probability the detector valve is not a true R.C. valve, that is, one of the fairly high impedance, high amplification factor type, so that for this reason and also because of the loss of the transformer step up the overall magnification of the stage, and therefore the volume of

leak of approximately correct values to hand. Failing this, it is useful to remember that any old transformer, however ancient, can be made to serve, and will give quite reasonable quality, too, by adopting the well-known parallel feed system. It means, of course, a resistance of about 50,000 ohms and a condenser having a capacity of 1 mfd. or thereabouts, but values departing greatly from these figures will give results of a sort.

Another method of using a transformer with a broken secondary winding is to convert to choke capacity coupling. To do this leave the primary winding connected to act as a low frequency choke, disconnect the faulty secondary, connect a small condenser from the detector anode to the grid of the next valve and a grid leak from the grid to G.B.—. This arrangement is indicated in Fig. 2.

A broken down resistance in a complete R.C.C. unit can be repaired by connecting a spaghetti resistance of suitable value between the anode and H.T.+ terminals of the unit. It is not a bad plan to keep on hand a small assortment of spaghetti, grid leaks and fixed condensers for emergency use, and remember that instead of a fixed resistance a potentiometer or volume control can always be used at a pinch, and there is no reason why a variable condenser should not be requisitioned as a coupling condenser if no fixed capacity unit is available.

### Another Vulnerable Point

Another rather vulnerable point in radio sets is the high frequency choke so often included in the detector anode circuit to sidetrack the high-frequency currents to the reaction circuit. Should this break down it is useful to know that the average long-wave tuning coil can be used as a temporary substitute. A plug-in coil of size No. 200 or thereabouts will probably be quite satisfactory. It should be borne in mind, however, that coils of this type have a fairly large magnetic field and may

cause a considerable amount of magnetic coupling, often sufficient to produce a condition of instability. It may be necessary, therefore, to move the coil about until a position is found where no harmful effects are noticed. Alternatively, the coil can be screened, and for this purpose any tin box such as those used for packing cocoa or other products can be used. Even a wrapping of "silver" paper can be used for a temporary screen. Many modern low-frequency transformers of good quality have a primary winding of sufficient inductance to render the use of a high-frequency choke, if not quite unnecessary, at least unessential in an emergency, so if your H.F. choke does go down, try shorting it out by connecting a wire across its terminals.

If it is the secondary winding of the transformer which has broken down it is not so simple to apply a temporary remedy. Of course a hasty resistance capacity coupling can be hooked up if you happen to have a resistance, condenser and grid leak from the grid to G.B.—.

### Temporary Measures for Mains Sets

It is not wise to play too many tricks with an all-mains set, but there are some directions in which temporary expedients may be used. For example, if the rectifier valve should fail, some sort of results can be obtained by using in its place any four-volt valve of fairly large emission which is handy. There have been many recorded cases of old "bright emitter" general purpose valves spending their last days as "temporary" rectifiers, while four-volt output valves will also serve. Of course under this treatment the life of the valve will not be very long, and it is not likely to be of much use for its legitimate purpose afterwards, but there are occasions when it may be considered worth while to take these somewhat heroic measures.

If the filament winding of your power transformer breaks down, it is as well to know that indirectly-heated valves can be operated quite satisfactorily from a four-volt accumulator. Of course the consumption is high—that is one ampere per valve—but if you are a car-owner your car battery will stand the strain quite well. Do not forget, however, that if you adopt this

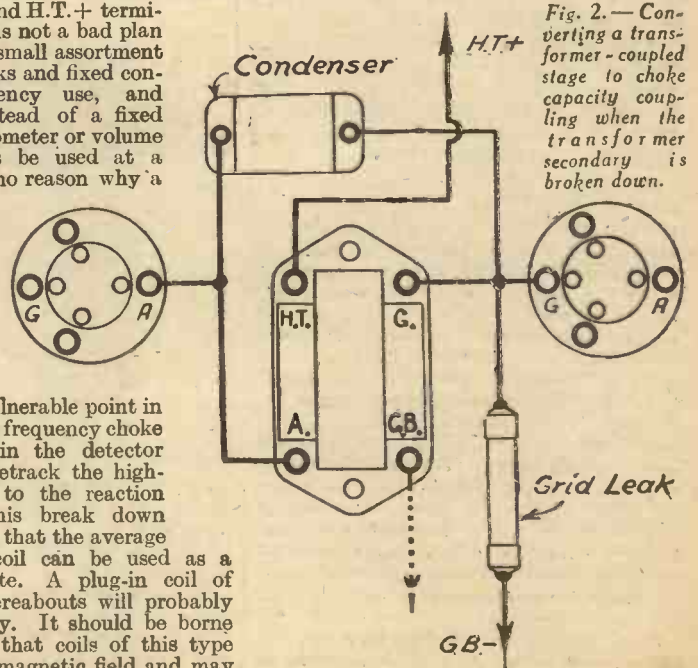

Fig. 2.—Converting a transformer-coupled stage to choke capacity coupling when the transformer secondary is broken down.

expedient it will be necessary to connect the centre point of the battery; that is to say, the two-volt tapping of the battery, to the cathode wire of your set—i.e. to the point usually connected to the centre tap of the filament winding. This is necessary to complete the anode circuit of the output valve, should this be of the directly-heated type.

While on the subject of filament transformers, it sometimes happens that the centre tap is not at the true electrical centre, with the result that bad hum is experienced. The usual cure is to disconnect the lead from the centre tap and join it to the slider of a potentiometer connected across the filament winding. Quite a low value of resistance, say 100 ohms, is suitable, but if no potentiometer is available a satisfactory "hum dinger," as it is sometimes called, can be improvised from two old filament resistances connected in series across the filament winding and with their point of junction joined to the set's cathode wire.

**Variable Mu's**

It is not often that indirectly-heated mains valves fail, but if you are using a variable mu valve and it does happen to go on strike, you can often replace it temporarily with an ordinary screened-grid

valve. It will be necessary, of course, to cut out the variable biasing resistance, and you will not be able to obtain the

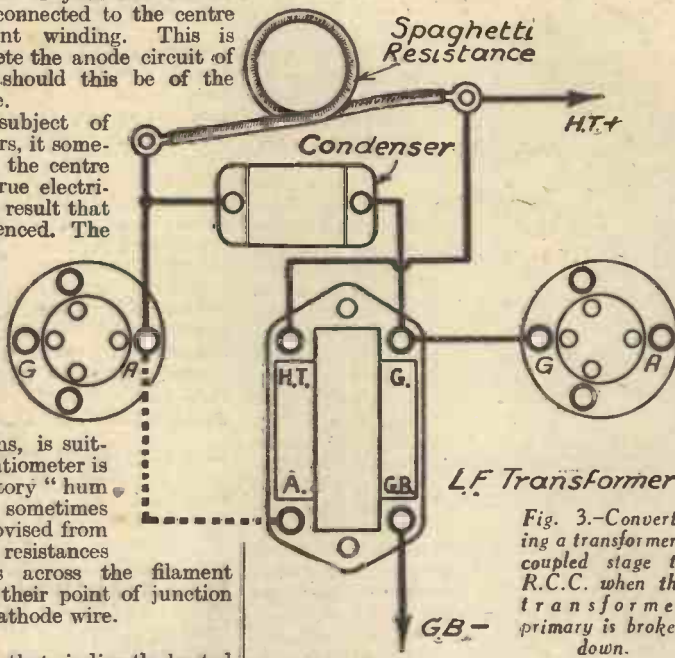

Fig. 3.—Converting a transformer-coupled stage to R.C.C. when the transformer primary is broken down.

volume-control effect which you enjoyed with the variable mu.

It is not generally realized that it is not essential for the biasing resistance of

variable mu valves to be incorporated in the set itself. As the resistance is in the cathode lead and not in the grid circuit, it may be removed quite a considerable distance from the set without harmful results. Fitted at the end of a pair of flexible wires, which can be taken to any part of the room, distant volume control may be arranged. It is very convenient to be able to control the volume on occasions from your chair instead of having to tinker with the set.

Most listeners to-day are installing modern and highly-selective sets, and it is rather old-fashioned to talk about wave-traps. It may happen, however, that you are troubled with a little interference which you cannot cut out with your existing tuning, especially if your set is of the detector and L.F. type. An "absorption" wave-trap is easily rigged up at short notice. Should your set have plug-in coils, look out a coil of approximately the same size as your aerial coil and place it as close to the aerial coil as you can, keeping it in close coupling with a couple of elastic bands. From the ends of this coil run wires to a variable condenser of .0005 mfd. capacity. This can be accommodated anywhere. Now tune in with the aerial tuner to the interfering station, and then adjust the condenser of the wave-trap until the interference disappears, after which you can proceed to tune in the wanted station. Note that the wave-trap is not electrically connected to the receiver circuit in any way—it is just a tuned circuit closely coupled to the aerial coil as shown roughly in Fig. 1, and its function is to absorb any signal of the wavelength to which it is tuned.

**ABC OF SELECTIVITY**

Continued from page 6.

the desired station is of a certain strength, but accompanied by interference, yet with reaction it is still the same strength, but without interference. Of course, some method of reducing the input is necessary in order to achieve this result.

**A Useful Expedient**

The method just described of reducing the input from the aerial and compensating for the resultant loss of signal strength by increasing the reaction is quite commonly used, and is a very useful way of reducing interference from other stations.

**Band-pass Filters**

As I have already said, the single tuned circuit has its limitations, and if it is found that such a circuit when efficiently designed and used with a judicious amount of reaction is still inadequate then the only thing to do is to use more than one tuned circuit. Perhaps the simplest arrangement is the addition of another tuned circuit before the detector. The two circuits are loosely coupled, the degree of coupling determining the shape of the resultant response curve. The advantage of this scheme is that it gives increased selectivity without a very great loss in signal strength. Such an arrangement is shown in Fig. 7, which is an illustration of one of the popular *Band-Pass Filters*. Here the coupling, which is partly capacitive, and partly inductive, is of such a value as to give a flat topped response curve.

**THE ATLAS Q.P.-P. MAINS UNIT MODEL "Q.P.24"**

The Mains Unit illustrated below has been developed by Messrs. H. Clarke & Co. (M/C), Ltd., especially for use with receivers employing the Quiescent Push-Pull principle. There are four tapplings, one negative and three positive. Tapping 1 gives 60/80 volts for Detector or H.F.



The new Atlas Q.P.-P. Mains Unit.

valves; Tapping 2 gives 130/140 volts and enables accurate adjustment of Pentode valves to be made. The third tapping is 150 volts fixed. The average output is 150 volts at 12m/A which enables it to operate satisfactorily on multi-valve sets employing this particular type of output stage. The price is £3 12s. 6d.

**MATCHING YOUR SPEAKER**

Continued from page 7.

**VALVE 215P.**

Anode Volts = 100. Grid Bias = 1.6.

Resistance Ohms	Current Milliamps	Valve Output Milliwatts
1,000	8.0	64
2,000	7.0	98
3,000	6.2	115
4,000	5.8	134
5,000	5.2	136
6,000	4.8	138
7,000	4.5	141
8,000	4.2	140
9,000	3.8	130
10,000	3.5	123

course, the figure 4.5 will probably be different in your case and is only given here as an illustration.

**Variable Ratio Transformers**

If the current is appreciably more or less you will probably obtain better results with a different speaker or by using a step-down transformer. If your speaker has a variable ratio transformer it will only be necessary to find the terminal that gives a milli-amp reading in the anode circuit equal to or the nearest below the figure required. It will not do to reduce the anode current by altering the grid bias or by putting a resistance in series with the speaker, but you can put two speakers in series when you may get greater volume with less anode current.



**AMAZING OFFER! ROLA P.M. M.C. SPEAKER**

**ONLY 26 DOWN**

The large majority of British radio manufacturers and designers of the finest "home constructor" sets use and specify British ROLA Speakers. We offer Model FG-P.M. on extremely easy terms. This Permanent Magnet Moving-Coil Speaker employs a high-grade Cobalt steel magnet of special design, and incorporates a universal tapped transformer for either pentode or power valves. The brilliance of tone and unrivalled fidelity of reproduction it gives will amaze and delight you. SEND ONLY 2/6 FOR SEVEN DAYS' TRIAL; if satisfied pay further 2/6 at once, then 10 monthly payments of 5/- (Cash in 7 days, 49/6). Diameter 7 1/4". All other Rola Speakers on similar easy terms, leaflet post free.

The British Made WATES UNIVERSAL METER is the only popular priced instrument testing resistances as well as batteries, valves, circuit, and all components; 4 readings on one dial. SEND ONLY 1/6 for 7 days' trial, if satisfied complete purchase by 5 monthly payments of 2/6 (Cash 12/6).

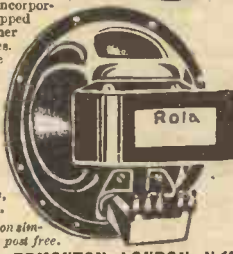

**E. J. HERAUD, Ltd., Dept. P.18, Number One, EDMONTON, LONDON, N.19**  
 Branches: 78/82, Fore St., Edmonton; 77, West Green Rd., Tottenham; 84, St. James St., Walthamstow; and 139, Hertford Road, Enfield Wash.

**The Magazine of Electrical Progress**

Makes an instant appeal to the engineer, whatever his status in the industry. Read the outline of contents and judge for yourself.

**Principal Contents of April Number**  
 The Mercury Arc Rectifier, by SIR AMBROSE FLEMING, F.R.S.  
 — Spot Lighting in the Theatre. — Useful Circuit Diagram.  
 Fifty Amperes from two Thermo-Couples. — Another Transformer Design. — Demagnetizing a Watch.

**THE PRACTICAL ELECTRICAL ENGINEER**

Obtainable at all Newsagents and Bookstalls, or by post 1/3 from George Newnes Ltd., 8-11, Southampton St., Strand, London, W.C.2.

1/-

**PREH POTENTIOMETER**

10,000 ohms Type B Luxus Price 4/6

Specified for the "FERROCART Q.P.P. HI-MAG. 3"

The new range of variable resistances have been designed to meet the demand for a component with a particularly silent and smooth movement. The curve of the potentiometer is arranged "straight line," which gives a straight line ratio between angular movement and resistance variation. The resistances can be supplied with "straight line" or logarithmic curves according to requirements. These components are also supplied with a combined switch, making an extremely neat and robust unit. The switch has a quick make and break movement and will handle 1.2 amperes at 250 volts without arcing.

Prices for your special requirements on application

*Preh*  
**POTENTIOMETERS AND RHEOSTATS**



**PREH MANUFACTURING CO., LTD.,**  
 Broadwater Road, WELWYN GARDEN CITY.

Manufacturers and Wholesalers only supplied.

Sole Sales Organization: Harwell Ltd., The Sessions House, Clerkenwell Green, E.C.1. Phone: Clerkenwell 6905-6.

Purchase your **KIT** for The "ALPHA" Q.P.P. Three from the Officially Approved Suppliers:

**A. W. HAMBLING LTD.**  
 15, ALFRED PLACE, LONDON, W.C.1.

- Complete Kit of Parts - £5. 6.0
- Complete Kit of Parts (including valves) - £7.17.6
- Complete Kit=Valves, Batteries, Speaker and Cabinet - £11.17.3

(Any component supplied separately if desired.)

A. W. HAMBLING LTD., 15, ALFRED PLACE, LONDON, W.C.1

**FREE!**

A beautiful Walnut Cabinet given FREE to "Practical Wireless" readers.

WRITE FOR DETAILS

Enclose stamped, addressed envelope.

# RADIO RAMBLINGS

By JACE

*Gettings from my Notebook*

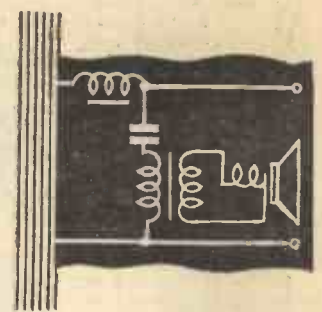
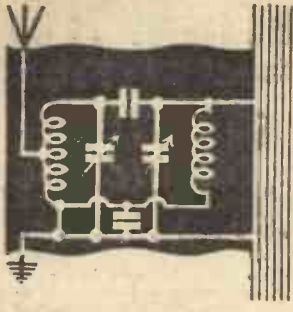

### Broadcast Music

I SEE it has been suggested by a well-known musical composer that special music will have to be written for broadcasting purposes. His theory is that under present conditions it is quite impossible for either transmitter or receiver to do justice to the range of frequencies encompassed by existing musical scores. Of course, there is much truth in this, especially since the frequency separation of the main European transmitters is only 9 kilocycles. (This makes it impossible to take full use of musical frequencies exceeding  $4\frac{1}{2}$  kilocycles for any other than "local" reception.) Nevertheless, I think that we shall find it a more acceptable

very high anode voltage. I refer to the use of what is commonly known as a thermal delay switch; the principle of this is that the H.T. supply circuit is automatically broken until the valve cathodes attain a normal working temperature. The switch consists essentially of the parts shown in the sketch of Fig. 1; two contact points are connected respectively to the H.T. positive lead from the rectifier smoothing system and to the H.T. circuits of the set; the two ends of the coil are connected to the 4-volt heater terminals of the mains transformer. When the mains supply is switched off the H.T. contacts are open, but after switching on, current flows through the coil and heats it up. The heat is transferred to the two metal strips forming the contact maker and they tend to expand. But since the strips are of different kinds of metal the

### The Super-Regenerative Receiver

THE super-regenerative receiver looks like returning to popularity for long distance short-wave reception. This type of set was popular with amateurs about 1923, but its principal disadvantage was that reception was always accompanied by a high-pitched whistle or hiss. On the shorter waves, however, this form of interference is much less pronounced and can, in fact, be almost completely eliminated. The idea of the circuit is that the detector valve is more or less continually maintained in a state of oscillation. But to prevent the carrier wave being heard as a whistle the oscillations are "quenched" at super-sonic frequency, or in other words, some 20,000 times a second. As a result, although the detector is oscillating the usual heterodyne note is not heard. Sometimes

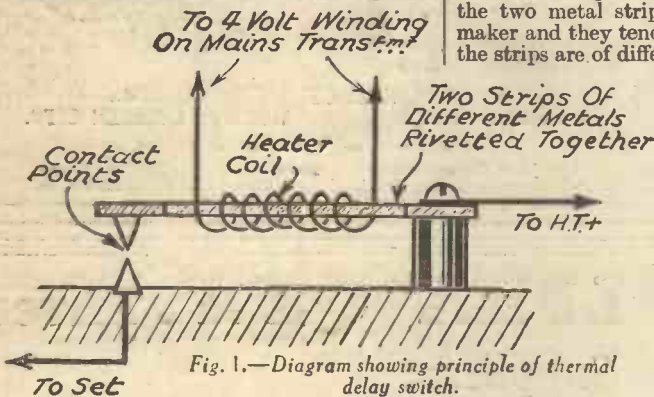

Fig. 1.—Diagram showing principle of thermal delay switch.

problem to devise means of allowing a wider station separation rather than to narrow down our harmonic range.

### Selectivity or Quality?

HISTORY repeats itself in wireless matters just as with everything else, and the old controversy as to whether or not broadcast sets should be designed for purely local reception or whether they should be capable of receiving over long distances has cropped up again. On the one hand it is said that the foreign programmes are scarcely ever used for real entertainment purposes, whilst on the other we have the folk who swear they scarcely ever listen to the home stations. My personal opinion is that all better-class receivers should be designed to bring in a number of foreigners—with the proviso that they should give really good quality from the British stations. You might argue that the two conditions cannot be fulfilled in any one instrument, because a selective set, which is necessary for distant reception, cannot possibly give perfect quality. But why not make the set so that the degree of selectivity can be varied as easily as can the volume?

### Thermal Delay Switch

THIS reminds me of another scheme for preventing the application of excessive H.T. voltages to the receiver components, and which is employed principally with more powerful sets and amplifiers taking a

expansion is uneven and, being rivetted together, they bend and so close the H.T. contacts. The switch is generally designed so that the coil heats up sufficiently to close the contacts in the same space of time as the valve cathodes take to reach the correct working temperature.

a single valve is made to perform the combined function of oscillating detector and quenching valve.

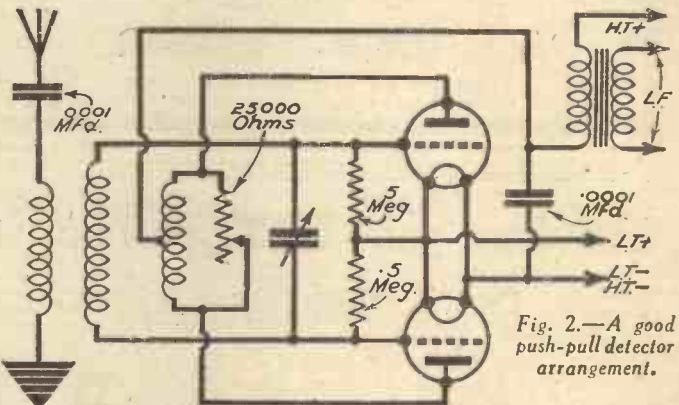

Fig. 2.—A good push-pull detector arrangement.

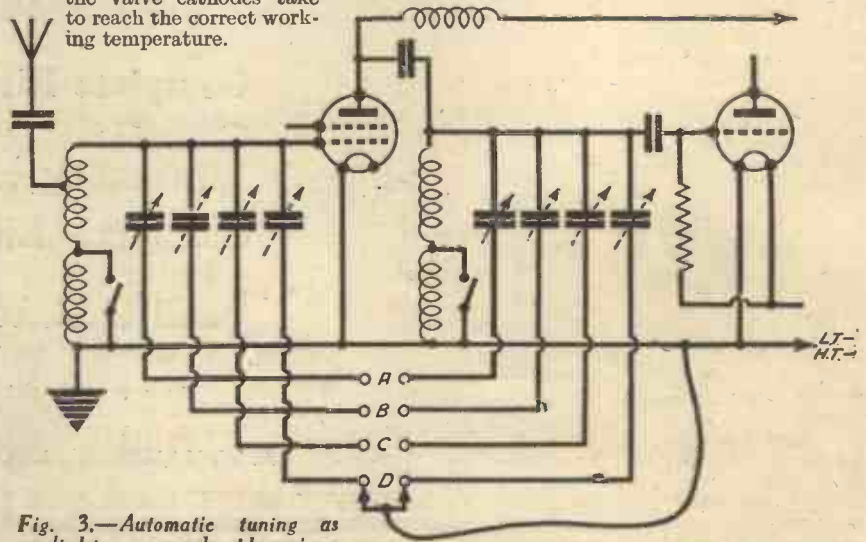

Fig. 3.—Automatic tuning as applied to a screened-grid receiver. Details concerning this arrangement were given in last week's Radio Ramblings.

**The Only Way**

WHILE things remain as they are, we listeners will have to fight our own battles. If we know the cause of the interference, we must approach the owner of the apparatus concerned and reason with him to apply a cure. Should he refuse it is not a bad idea to invite him round to hear the disturbance he is causing, but beyond that we can do nothing. At least, we can do nothing to cure the existing interference, but we might minimize future trouble by insisting that any electrical device we might buy, such as a vacuum-cleaner, hair-drier, etc., shall be effectively silenced. By so doing we shall strike at the root of the trouble and possibly, in time, make the manufacturers realize that we will not buy any apparatus which is a potential source of interference with our musical entertainment.

**Ask the Post Office**

ANYONE suffering from electrical interference of which the source is unknown would be well advised to call in the assistance of the Post Office, by making application either at the local branch or by writing to The Secretary, General Post Office, London, E.C.1. The P.O. engineers have already done some excellent work in this direction, and are apparently only too pleased to do more. No charge is made, unless some silencing device, generally only a combination of fixed condensers, is necessary to effect a cure, and in that case the owner of the apparatus is called upon to carry the bare cost of the components. This is, in effect, a reply to numerous querists who have recently written to our Advice Bureau, and it might be helpful to many who have not yet written. It must be borne in mind that no person or firm is compelled to silence any apparatus, so it is useless to adopt a "high-handed" attitude; a little gentle persuasion will prove far more effective in the long run.

**A Station Log-Dial**

I HAVE previously suggested in these notes that some kind of calibrated tuning-dial would be very much appreciated by the amateur constructor. In view of this, I am very pleased to note the introduction of a new drum dial of excellent design. The drum is some 3ins. wide, and has the ordinary 0-180 degree scale running round its middle. In addition to the usual window, however, there are two others, one on each side of that through which the scale divisions can be seen. The plain white, matt-finished, celluloid drum is visible behind the side windows, and it can easily be marked with a pencil to show the names of stations corresponding with various scale readings; medium-wave stations can be marked in one window and long-wave ones in the other. Unlike most station-calibrated dials it is adaptable to any wavelength changes, since the pencil marks can easily be erased with an india-rubber.

**Reception Conditions**

SINCE I last referred in these notes to the reception of American medium-wave stations, there has been a most decided tendency for conditions to become worse. Whereas towards the end of last year, and especially just after Christmas, I found no difficulty in bringing in at least four "Yanks" at good strength on any evening with my "Selectone," I now have some difficulty in receiving even an odd one until well into the "wee small hours."



*Tested 500 volts A.C. Suitable for 250 volts D.C. working*

The "Ferrocart Q.P.-P. Hi-mag Three" described in this issue employs four Dubilier condensers. You must use them to get first-class results. Dubilier condensers are world-famous for their efficiency and dependability. That is why the following Dubilier condensers are exclusively specified:—

- One Type 670 .0002 1/- each
- One Type 670 .001 1/3 each
- One Type B.B. .1mfd. 1/10 each
- One Type B.B. 2 mfd. 3/6 each

*That's why*

Every  
**DUBILIER**  
Condenser  
before  
being  
offered  
for sale is  
**3 times**  
treble  
tested

**manufacturers  
& constructors**

FIND  
**DUBILIER**  
CONDENSERS

so exceptionally  
reliable



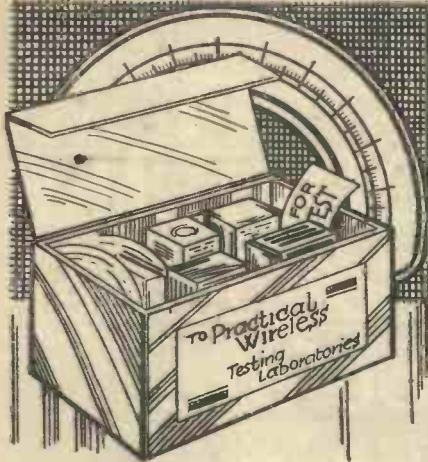

# Facts and Figures

Components Tested in our Laboratory

BY THE PRACTICAL WIRELESS TECHNICAL STAFF

### LISSEN UNSHIELDED COIL

A NEW coil has now been produced by Messrs. Lissen, Ltd., and is illustrated below. This is of the Dual Broadcast Band type, tuning from 190 to 560 metres on the one band, and 800 to 2,100 on the other. It will be noticed first of all that the minimum wavelength has been reduced so as to enable the now popular E-tramp station to be well received. With many of the older coils, of course, the minimum wavelength was about 220 metres, and this prevented the correct tuning of this station. The appearance of the coil is very neat, being finished in mottled bakelite and provided at the top with a small knob. This is the adjusting screw of a small pre-set condenser, and with this at its maximum setting the minimum wavelength is raised a few metres. The inductances of the coil for both bands are 0.18 mhy. for the medium, and 2.3 mhy. for the long, and



New Lissen unshielded coil.

these inductances are guaranteed to within 10 per cent (plus or minus). The disposition of the terminals on the base of the coil will enable it to be mounted direct on to the Lissen Triple switch, and in this condition it forms a most easily-mounted, and highly efficient component. The use of this type of coil, is, of course, owing to the fact that it is not screened, restricted to one or two simpler types of receiver, but as the cost has been reduced to the low figure of 5s. 6d., it is rendered admirably suited for the listener who wishes to make up a simple, cheap, yet at the same time, efficient little receiver for general all-round purposes. It may thoroughly be recommended.

### BRITISH GENERAL GANGLING DEVICE

MANY keen experimenters often find a necessity for using a ganged condenser, when such condenser is not readily handy. The cost of purchasing such a condenser is one of the principal drawbacks, and many a time has no doubt prevented a keen reader

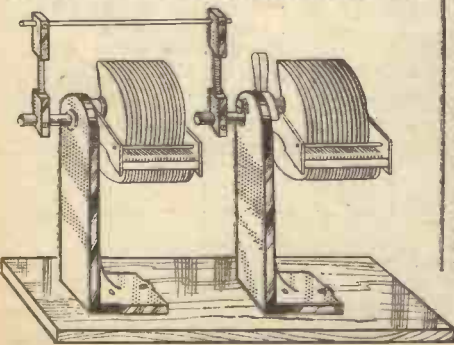

British General ganging device.

from trying out some little idea where such a condenser was a necessity. In addition to those readers just mentioned, there are no doubt many who possess two separate condensers, and who wish to make up a set employing a ganged condenser, but who do not feel disposed to scrap the two existing condensers and buy a ganged unit. The little device shown below has been produced especially for the benefit of this class of listener, and it is a most efficient device. As can be seen, two brackets are supplied, into which ordinary condensers may be mounted by means of the normal one-hole fixing screw. To the spindle of each is screwed one of the special bars which are, in turn, locked together by means of the rod. A small device (seen on the rear condenser) enables trimming to be carried out where necessary. This is an extremely useful accessory and can be recommended. The price is 2s. 6d.

### HOWE BOX BAFFLE

THE principle of filling the corners of a cabinet with non-resonant material for the avoidance of resonance has already been mentioned in these columns, and the Howe Box Baffle was referred to. This is the patented device which is used by the B.B.C., and it is claimed that all resonance is removed and that the reproduction from a moving-coil speaker fitted in such a cabinet gives the very best reproduction. Readers who are interested in this device should write to the manufacturers, Messrs. F. McNeill and Co., Ltd., 52, Russell Square, W.C.1, for a copy of the booklet issued by them describing the invention, and showing the various types of cabinet manufactured and incorporating the device. Where a good cabinet is already being used we understand a special simple box baffle may be purchased for insertion in the existing cabinet. In the smallest size, 15in. by 15in. by 10in, made of thick plywood and complete with the absorbent material, the price is 30s. In polished oak, walnut or mahogany, the price is 37s. 6d.

### LOTUS BAND-PASS UNIT

WE have already mentioned that the Lotus Company were producing a new type of triple band-pass unit, and the unit is now ready for the market. Slight improvements have been made in the experimental model which was submitted to us originally, and the unit is shown in its completed form in the lower right-hand corner of this page. The unit is one of the neatest and most comprehensive we have yet had the pleasure of examining. As can be seen, the base is very deep, and is made up of stout aluminium, with a substantial front plate bolted into position. The whole assembly is, therefore, extremely rigid. As was mentioned in the previous report, the assembly consists not only of the three band-pass and secondary coils, but also the band-pass coupling units and an on/off switch. On the complete unit a bakelized card is attached to the under-side of the base, and upon this is printed the complete contents and wiring. A copy of this is reproduced at the top of this page. The heavy lines denote the portions of the circuits which are included in the Unit, and the broken lines show the wires and components which are required to be added to complete the receiver. As can be seen from this diagram, there is very little left. In the event of the small coupling

condenser not being required, or some different value being wanted, terminal 1 is joined to the earth terminal. The total inductance of the combined coils as used for long waves is 2,160 microhenries, and the medium-wave inductance is 155 microhenries. The inductance

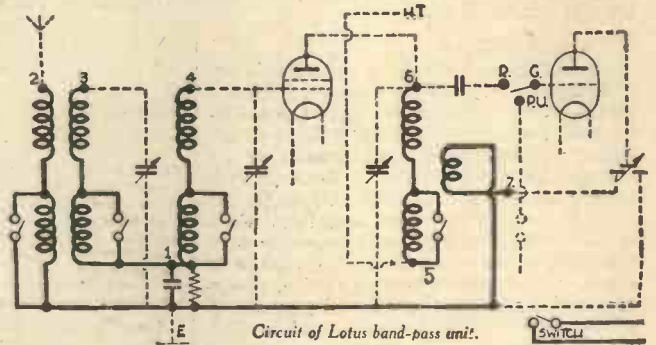

Circuit of Lotus band-pass unit.

of the three coils in respect to each other is guaranteed accurate to within 1 per cent., whilst the tuning range is 200 to 550, and 900 to 2,000 metres. A very important feature of this Unit is the provision of a Radio-Gram. switch, so that the control knob which projects from the front serves as a wave-change switch, on/off switch, and Radio-Gram. switch, and this greatly reduces the number of controls which are normally required on the panel. The on/off switch is of the Q.M.B. type rated at 5 amps. The Unit is sold complete with metal (escutcheon engraved off-short-gram-long.) The price has now been fixed at 27s. 6d.

### LISSEN I.F. BAND-PASS TRANSFORMERS

WE have received from Messrs. Lissen samples of their new Band-pass Intermediate Transformers for use in superheterodyne receivers. These are, in appearance, very similar to the standard Lissen screened coil, and to ensure accuracy the necessary padding condensers is included in each coil, is adjusted by the makers at the works, and is then sealed. The most interesting feature of these coils is their size, for they are by far the smallest we have yet seen of this type. The transformer is tuned to 126 kc., and it is claimed that a stage gain of the order of 100 can be obtained with an appropriate valve. No trimming is required, and these coils would appear to meet a great demand. We shall have more to say about these in a later issue.

(Continued on page 39.)



The Lotus band-pass unit.

# Simple Home-Made Tuning Coils

An Explanation of the Principles Governing the Design of Efficient Tuning Coils, with Constructional Data to enable readers to make up various types of Tuning Inductance.

By  
W. J. DELANEY

Fig. 1.—Three simple broadcast coils, made up according to the details in this article.



**T**HERE is a certain fascination in making up your own wireless parts, and probably one of the simplest parts of the normal receiver which can be made by the average listener is the tuning coil. Fixed condensers, low-frequency chokes, high-frequency chokes, and one or two other parts of a receiver certainly may be made at home, but these are now obtainable so cheaply from the manufacturer and are so standardised, that there is not much fun in making these. The tuning coil, however, comes into a different category. It is true that there are many different makes of tuning coil on the market, and that these are certainly not expensive. It is also true that the different types of coil which are manufactured should enable everyone to choose a coil to suit a particular need. The coil is so simple to make, however, that many listeners prefer to carry out this part of the construction of a receiver—not on the grounds of saving expense, but purely out of interest in the art of radio. This article is, therefore, not written to tell you how to save money, but how to make up different types of coil for experimental use, and it should be borne in mind that the commercial coil, made by a reputable manufacturer, will be of a higher degree of efficiency (although more expensive), and will be most certainly standardised, so that where a second coil is required to match one already in use, it may safely be taken that a second coil of the same make as the first will be identical in all respects. However, the following notes will no doubt prove of interest to many readers.

### What Governs the Efficiency

A tuning coil, as every reader now knows, consists of a coil of wire, either wound on a former of some type, or self-supporting. The electrical features possessed by the coil include high-frequency resistance; self-capacity; inductance. The H.F. resistance is determined by the thickness of the wire; the self-capacity is governed by the spacing of the adjacent turns; and the inductance is governed by the number of turns (principally). In addition to these features, there is what is known as "dielectric losses." This means that the high-frequency currents are able to leak away through the material from which the coil former is made, and obviously these losses must be kept at a

minimum. A reduction in the high-frequency resistance may be obtained by using very thick wire. This leads to a rather clumsy coil, and when a coil is large, the surrounding electrical field is also large (I am speaking, of course, of the plain solenoid, or cylindrical coil). The H.F. resistance may be lowered by using stranded wire, but this is expensive, and owing to the size of the electrical field, leakage losses occur, and there is also the risk of stray couplings with other components in the receiver. The spacing of the turns will reduce the self-capacity, but here again the size of the coil will be increased, with the same troubles as previously mentioned. Dielectric losses may be reduced (or even completely eliminated) by making the coil self supporting.

### Is It Necessary?

From the foregoing remarks it will be obvious that the design of a *highly efficient* coil is no simple matter, and the question therefore arises, "Is all this necessary?" For the average home-receiver, where it is not desired to get 100 per cent. efficiency from one or perhaps two valves, it is certainly not. For an experimental receiver, built with the idea of achieving results from a one-valve set which are comparable with a five-valve, by all means study the points above set out—but remember, if the coil is to be 100 per cent. efficient, every other part of the receiver must also be of the same order, or you will be wasting the efforts spent on the coil construction.

### Easily Made Coils

The use of an ebonite former upon which to wind a tuning coil will enable dielectric losses to be reduced to a very low order. The type of ebonite former having a series of ribs along the surface will enable the coil to be practically air-spaced and will increase the efficiency. The difficulty arises, however, in the homes of many readers, of making the necessary slots to accommodate a pile winding, or of even making the anchoring holes or securing holes for terminals. Where this is the case, or for those readers who are desirous of making up a series of coils for experimental purposes, with the advantage of stripping down one coil and building

(Continued on page 36.)

# Tune in on this New Wireless Instruction



The I.C.S. Wireless Courses cover every phase of wireless work, from the requirements of the youth who wishes to make wireless engineering his career to the man who wants to construct a broadcasting set for his home, and, at the same time, to know how and why it operates and how to locate any faults that may develop.

No branch of industry has ever progressed as rapidly as wireless and the rate of progress is increasing. Only by knowing thoroughly the basic principles can pace be kept with it. Our instruction includes American broadcasting as well as British wireless practice. It is a modern education, covering every department of the industry.

### OUR COURSES

Included in the I.C.S. range are Courses dealing with the installing of radio sets and, in particular, with their servicing, which to-day intimately concerns every wireless dealer and his employees. The **Operating Course** is vital to mastery of operating and transmitting.

There is also a **Course for the Wireless Salesman**. This, in addition to inculcating the art of salesmanship, provides that knowledge which enables the salesman to hold his own with the most technical of his clients.

We will be pleased to send you details of any or all of these subjects. Just fill in and post the coupon, or write in any other way, stating which branch of Wireless interests you—the information you require will be forwarded at once.

—YOU MAY USE THIS COUPON—

International Correspondence Schools, Ltd.,  
Dept. 94, International Buildings,  
Kingsway, London, W.C.2.

Without cost, or obligation, please send me full information about the Courses I have marked x

- THE I.C.S. WIRELESS COURSES
- THE I.C.S. RADIO COURSES

Name .....

Address .....

# EVERY SET A SUPER HET!

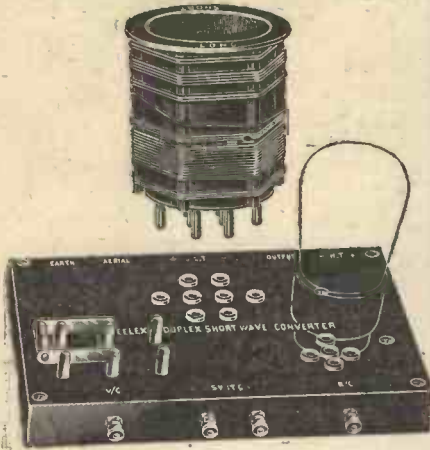

Eelex Short-Wave Converter Chassis, which enables you to receive stations on the short-wave bands now supplied for building into most screened grid receivers. You should certainly incorporate one in the next circuit you build and make it an all-wave receiver. Instructions for wiring supplied with each model. For particulars, write for Eelex Short-Wave Converter Booklet. The model illustrated is the Duplex type—Price £1 15. 0. complete with coil.

## TEST WITH SAFETY

You should use Eelex Testing Prods when testing your set, cheaper than burnt out valves. Red and Black insulated handles—Price 3/6 per pair. Write for list EE4.

J. J. EASTICK & SONS,  
Eelex House, 118, Bunhill Row, LONDON, E.C.1.  
Phone: Metropolitan 0314 (6 lines).

Indispensable for Your  
Bookshelf

# WIRELESS STEP BY STEP

By "Dictron"  
(9th Edition)

This book shows the wireless enthusiast how to obtain the maximum enjoyment from his wireless set.

## 2/6

Obtainable at all Booksellers, or post free 2/9 from George Newnes, Ltd., 8-11, Southampton Street, Strand, London, W.C.2.

## SIMPLE HOME-MADE TUNING COILS

(Continued from page 35.)



Fig. 2.—A simple wave trap.

another of a different type, the coil former illustrated in this article will be found extremely useful. This is the article known as a "Ewebec" former, and, as can be seen, it consists of two hexagonal discs of bakelised material, with six strips of similar material having one edge smooth and being cut on the opposite edge into a number of slots—very similar to the ordinary comb. The two discs are provided with slots, and slots in the strips enable the whole assembly to be put together to form an air-spaced, six-sided coil former, having either smooth sides, or sides divided into a number of sections. The six points on the hexagonal ends are provided with holes, against which is printed a number, and terminals may be inserted into these holes for connections to the ends of a coil winding, or to tapping points. The photographs show six different types of coil built up on these formers, and the following data will enable readers to make up some of these coils, and variations may, of course, be carried out to suit any particular ideas or requirements. These coil formers are very cheap.

### Simple Coils

The simplest coil is shown in the centre of the group in Fig. 1, and this consists of a solenoid, or single-layer coil, having a total of fifty turns of No. 24 D.C.C., which just fills the straight side of the former. The H.F. resistance of a coil of this description would be roughly 5 ohms, and the inductance approximately 150 microhenries. This will tune, with a .0005 mfd. condenser in parallel, to just about 500 metres. Obviously, such a type of coil would not be of very much use on the average valve receiver owing to lack of selectivity, but it is a suitable illustration of how the coil is made up. A coil suitable for covering both the normal and the long-wave bands, and which is efficient enough to be included in a modern receiver, is shown on the right, in Fig. 3. This is a dual-range coil wound with 28 gauge double-silk-covered wire. Six terminals are fitted into the top of the coil, and two or more small feet, constructed from aluminium or brass, should be attached to the lower end to enable the coil to be

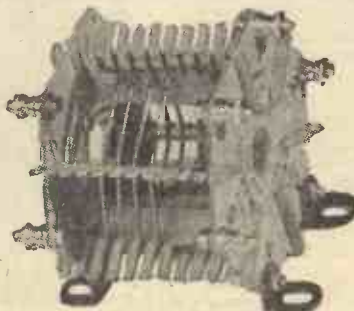

Fig. 4.—A short-wave coil.

mounted in the receiver. It should be particularly noted that iron brackets must not be used for this purpose. The beginning of the wire is attached to terminal No. 1, and fourteen turns are wound into the first slot, after which the wire passes into the second slot, in which a further fourteen turns are wound. The wire then passes into the third slot, in which a further fourteen turns are wound, and the wire is then taken up to terminal No. 2, a space of about half an inch scraped clear of the silk covering and the bare wire attached to that terminal. The wire is then taken back to slot No. 4, into which ten further turns are wound. The wire is then carried up to terminal No. 3 and a connection made as for No. 2, after which the wire is led back into slot No. 4, into which four more turns are wound. The wire is then taken up to terminal No. 4, connection made, and the wire led down to the third slot from the opposite end. Into this, and the remaining two slots at the lower end, fifty-five turns are wound (in each slot),

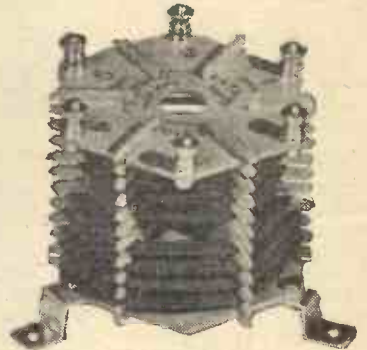

Fig. 3.—A dual-range coil.

and the end of the wire taken up to terminal No. 5. A length of wire is then cut off and joined to this terminal and taken down to the fourth slot from the lower end, into which thirty-five turns are wound. The end of this small winding is joined to the remaining terminal, No. 6. All the turns are, of course, wound in exactly the same direction. The connections for this coil are 5 and 6 to earth, 1 to the tuning condenser, and 6 to the reaction condenser. An on-off switch is joined between terminals 4 and 5, whilst the aerial is fed through a small pre-set condenser (.0003 mfd.) to either terminal 2 or 3, according to the degree of selectivity required.

### Short-Wave Coils

This type of former is ideal for the construction of short-wave coils, a specimen of which is shown on the left in Fig. 4. For this particular coil three turns of No. 28 D.S.C. wire are wound in the first slot, the commencement being joined to terminal 1 and the finish to terminal 2. Two slots away, the grid coil is commenced, and this consists of 18 gauge enamelled wire, wound one turn per slot, for five slots. The commencement of this winding is joined to terminal 5 and the end to terminal 6. Into the next, and final slot, is wound five turns of the 28 gauge D.S.C. wire, joined to terminals 3 and 4. This latter winding is for reaction purposes, whilst the first fine wire winding is used as an aperiodic aerial coil. The remaining coil in Fig. 2 is a simple type of wave-trap for use on the 200 to 500 metre wave-band, and a series aerial condenser is mounted upon one end, by using two of the holes as fixing holes. The spacing will be found just right for this purpose.

# SHORT WAVE SECTION

ONE of the most prevalent faults in home-constructed short-wave receivers is all too often noisy reception. Until this is cured it is useless to consider the addition of any further amplification, as it must be quite obvious that, however great the extra magnification may be, the actual ratio of signal to noise remains the same; were it not for this fact, setting aside questions of stability, there is really no reason why L.F. stages should not be added *ad infinitum* until the required amplification be obtained. Many listeners must have noticed that reception of short-wave stations is often much better on their own modest set than when received as a relay, the reason being that the B.B.C. is compelled to amplify to an inordinate extent to ensure a successful re-broadcast. It must be pointed out, of course, that the accompanying noise in this case is almost entirely external, and quite outside human control. Atmospheric disturbances are rarely severe enough on the high frequencies to seriously mar reception on the small set of comparatively low amplification. In this article, however, we are more concerned with preventable noise which actually originates inside the receiver itself.

No apology is made for the oft reiterated advice concerning the importance of good sound connections, and the avoidance of anything with a tendency to wobble. Soldered joints are naturally the best, but if there is any doubt about skill in this connection, a well-screwed-down connection will be infinitely better. A soldered joint may pass muster for mechanical strength, but it is not nearly so uncommon as one would imagine to find that from an electrical point of view it leaves much to be desired; the average amateur often makes a semi-conducting join consisting more of flux than anything else. In short, if you really can solder, do so, but if in any doubt, leave it alone.

### Look to Your Components

Having disposed of the wiring part of the receiver, we turn now to the components. From a noise point of view the *bête noire* of short-wave sets is the tuning condenser. Economy in this connection should not be attempted; a few extra shillings spent on this vital component is a very sound investment. A large number of condensers on the market rely for the connection from the moving-vanes on a rubbing contact. This is a highly unsatisfactory arrangement, and usually a prolific source of noise. The only reliable method of connection is by means of a "pig-tail," a small piece of springy metal akin to a hair-spring, one end attached to the central spindle and the other to the terminal shaft. This, in effect, shorts the doubtful rubbing contact. Although the reaction condenser is not so prone to develop noise, it is wise to use a pigtail connection also. In both cases it is essential

## NOISE SUPPRESSION ON THE SHORT WAVES.

By TOGNI.

to see that the moving-vanes are properly aligned, as any shorting between fixed and moving plates will result in terrible cracklings, and in the case of the reaction condenser a damaged H.T. battery or worse. In this last connection it is always wise to insert a fixed condenser of comparatively large capacity in series with the reaction condenser; this forms a very effectual guard against shorting the H.T., whilst in no way impairing the working of reaction. Yet another source of trouble with variable condensers is the tendency to collect particles of dust between the vanes; if the latter are at all closely spaced a leakage path is easily formed, giving rise to fryings and cracklings every time any adjustment is made. The remedy, of course, is obvious.

### Faulty Resistances

With regard to other components, the only ones likely to give much trouble are variable resistances, particularly the potentiometer commonly used in connection with the detector valve for improving reaction control. It often happens that the resistance wire possesses actual inductance of an order comparable with that of the tuning coil, especially if one is working below 20 metres. Consequently, if we are in the habit of giving the finishing touch to reaction by adjustment of this, loud crackling is the result, because of partial absorption of the H.F. oscillations by the entirely unintentional tuned circuit. The writer has often experienced this trouble using potentiometers of good make, which are quite above reproach and absolutely noiseless on the broadcast band. For-

tunately, it is an easy matter to cure this fault by connecting a fixed condenser of not less than .0002 mfd. across from the slider to earth. Whilst on the subject of absorption noises, it is well to remark that practically any coil or length of wire near the set which is likely to move in any way is liable to cause crackling. In windy weather persistent crackling may often be traced to the intermittent earthing of outside guy-wires, more particularly if, as often happens, the natural wavelength of the wire (or harmonic thereof) happen to fall within the tuning range of the set. A cure may generally be effected by breaking up the guy-wire into odd lengths with insulators, thus removing the natural period of the wire from the danger zone.

Apart from the above likely sources of noise in short-wave sets, it must not be forgotten that any common faults which develop in ordinary broadcast sets are just as liable to happen on the higher frequencies. Nowadays it is rare to hear of a transformer breakdown, but the possibility must not be overlooked when searching for those elusive frying noises. In nearly every case of transformer failure it is the primary winding which is to blame. A continuity test is not always conclusive, and the best test is by replacement. Such elementary precautions as the cleaning of plug contacts must also not be overlooked. In all cases of doubtful contact, plugs, whether of the old-fashioned split-pin variety or the modern "banana" type, should be opened with a penknife.

### Exterior Noises

A large amount of noise originates outside the set, and little can be done in this connection. In passing, it should be noted that the removal of the aerial wire will definitely establish whether the noise is external or not; a cessation or reduction thereof with the aerial disconnected conclusively proves that the set is not to blame. Trams, of course, are responsible for a lot of trouble, as are all electrical appliances which cause sparking to any degree. A diplomatic approach to the people concerned will often result in their endeavours to find a palliative for the nuisance. It is surprising how effective a few large fixed condensers can be when employed usefully. Noise emanating from brush sparking on electric motors can often be entirely stopped by fixing a condenser across. Motor vehicles are also troublesome by reason of their ignition; it is seldom, however, that the noise from this source is annoying unless the set is used under 20 metres. It is amusing to note that one car of very well-known make, and widely used commercially, can be identified by the abominable crackling it causes on or about 10 metres. As this latter is a frequency allotted to amateur transmitters, their exasperation may be well imagined, especially those who are unfortunate enough to live on a main road.

### Indispensable for Your Bookshelf

## WIRELESS STEP BY STEP

By "Dictron"

(9th Edition)

This book shows the enthusiast how to obtain the maximum enjoyment from his wireless set.

2/6

Obtainable at all Booksellers, or post free 2/5 from George Newnes, Ltd., 8-11, Southampton Street, Strand, London, W.C.2.



50, 25 or 15 ma.

at 150 volts from D.C.

Several unique features prove that the Heayberd D.C. Mains Unit is a wise investment for the man on D.C. mains. Scrap your expensive H.T. batteries now and improve the tone and range of your receiver. Four chief advantages are:

- TRIPLE ADJUSTABLE OUTPUTS:** Simply by plugging in to base of unit, a tapping of 50, 25, or 15 m/a. at 150v. can be obtained.
- CONVERTIBILITY.** Unit is constructed on a special chassis, with ample room in metal case, so that it can be converted to A.C. mains in a very short time.
- EXTRA SPECIAL SMOOTHING.** Heayberd balanced circuit comprising two constant inductance Chokes and 16 mf. Block Condenser ensures freedom from hum and noise.
- GUARANTEED 3 YEARS.** Heayberd display confidence in their units by issuing a Three Years' Guarantee against breakdown.

**HEAYBERD HDC. 150 MAINS UNIT.**  
Supplied complete in neat metal case. Fuses in both mains leads. Complete with flex and adapter—ready to switch-on.  
**OUTPUTS:** 50, 25 or 15 ma. at 150v.  
**TAPPINGS:** 40/100v. Var., 80/130v. Var. and 150v. fixed. **PRICE 55/-**



**Post Coupon**  
for Heayberd handbook on Mains Working  
I enclose 3d stamps for New Handbook of Mains Equipment. Packed with Technical Tips, Service Hints and diagrams

Mr. \_\_\_\_\_  
Address \_\_\_\_\_  
Prac. \_\_\_\_\_

**F.C. HEAYBERD & Co.,**  
10 FINSBURY STREET, LONDON, E.C.2.,  
One minute from Moorgate Stn

## AN ALL-TEST METER

THE handy instrument shown in the accompanying illustration can be made for a few shillings. The components required are as follows:—

A volt-amp. meter; 10,000 ohm resistance; a valve holder (chassis type); a 3 v. dry cell; 8 sockets (3 black, 5 red); 4 plugs (2 black, 2 red); and 18in. red and black flex. First of all construct a box about 6in. by 5in. by 1in. deep, with a lid if desired, and obtain a piece of 3-ply or ebonite to fit as a panel. Cut a large hole in the panel into which the meter should fit flush with the face of the panel. Make this a fairly tight fit, so as to avoid

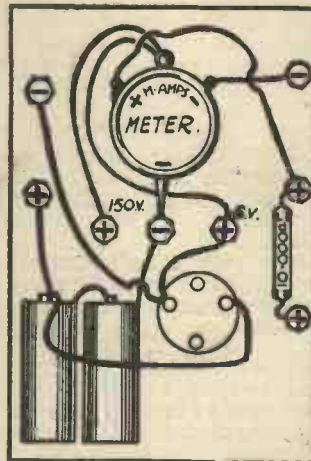

Fig. 1.—The wiring of the complete test-meter.

testing prods should be fixed at one end. Now for its uses: To test valve filaments, plug the valve into the holder and if needle

the meter dropping out. Next drill a hole for the valve holder and eight 1/8 in. holes for the sockets.

Now fix all components and sockets in place and wire up as shown in Fig. 1. Fix a red and black plug to each end of the flex, or if preferred a pair of

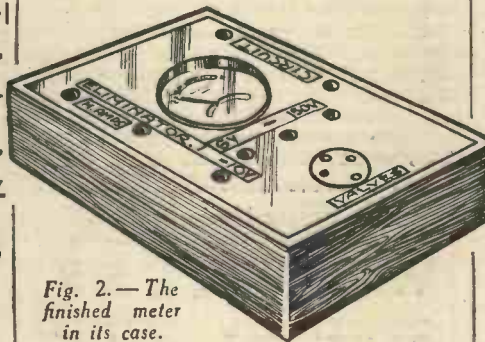

Fig. 2.—The finished meter in its case.

deflects the valve is O.K. To test continuity of coils, chokes, transformers, etc., plug into circuit plugs and the other end on to the ends of the winding under test. A needle deflection again indicates that the winding is O.K. Now to test batteries, use the sockets marked 6 v. or 150 v. But for H.T. eliminators I have included a 10,000 ohm resistance for this purpose, and the milliamp. scale should be taken here so that 1 milliamp.=10 volts. A truer reading would be obtained by using the same plugs for H.T. batteries instead of the 150 v. socket.—J. WILLIAMS (Abertridwr).

**FIT THIS ELECTRIC CLOCK TO YOUR SET!**  
NO MAINS NEEDED!  
KEEPS CORRECT TIME!  
NO WINDING!

Works off small battery lasting 12 months, or can be plugged into G.B. battery without affecting reception. Uses practically no current. Fits into hole 3 1/2 in. dia. in any panel up to 1/2 in. thick. Easy to fit—no screws required. Can be removed from front of panel to back of case. Swiss movement. Hands set from front. Nickel-plated bezel. Useful addition to any set.

**RIVERSIDE MFG. Co., Ltd.,**  
Dept. 21, Crisp Road,  
Hammersmith, W.6.  
Telephone: Riverside 6392.

**12/6**  
COMPLETE WITH BATTERY  
POSTAGE 6D

**BLOCK ACCUMULATORS, 7/6.**  
(The best 2v. 80 amp.; usual price 11/6), and EVERYTHING else CHEAP at THE GREAT INTERNATIONAL EXCHANGE STORES, 87, Chiswick High Road, London, W. Wireless, Electrical, Mechanical, Models, Sports, Games—in fact, ANYTHING bought, sold, and exchanged. (Est. Thirty Years.)

**EVEN IN AMERICA**  
WITH ITS MULTI-VALVE SUPER SELECTIVE SETS A PIX IS NEEDED

Read this Letter—

Hotel Grand, New York City.  
Please send me another "PIX" as I find by test that they are all that you claim for them and then some more.  
I have tried it out on one of the new 8 tube D.C. sets... excellent clarity and volume.  
W. H. L.

This is only one of the many letters received from America. Thousands are being sold there weekly because they find a PIX improved the selectivity of even the finest sets

**2/- PIX**

Clip 6d.

The selectivity of your set can be improved by fixing a PIX in the aerial lead-in. Even if a pre-set aerial condenser is fitted inside your set, a PIX will give better and sharper tuning.

**PIX**

**NO MORE DUAL PROGRAMMES**  
Fix a PIX in your aerial and separate programmes. A PIX can be fitted to any set, crystal, battery or all mains, will cut out the local and bring in foreign stations clearly.  
**THE BRITISH PIX COMPANY, Ltd.**  
(Dept. 478) 113/38, Southwark St., LONDON, S.E.1.

**WRITE FOR OUR ALLOWANCE**  
for your surplus apparatus when ordering a new set. Our long experience in Part Exchange and Mail Order and our steady connection with satisfied customers is your guarantee. A perfected system and highly trained staff mean rapid attention, prompt deliveries and courteous dealings.

**CORADIO**  
Dept. C.11, 54, MALDEN ROAD, LONDON, N.W.5

**LOUD SPEAKERS REPAIRED 4/-**  
(Blue Spot a Speciality, 5/-)  
Transformers 4/-. all repairs magnetised free. Eliminator Repairs quoted for 24 Hours Service. Discount for Trade. Clerkenwell 9069.  
**E. C. MASON, 44, EAST ROAD, LONDON, N.1.**

**Increased VOLUME!**  
*Banish Earth trouble for good!*

The latest scientific wireless wonder! Revolutionises Radio reception! Results guaranteed! Powerful permanent action. 6ft. of earth-wire soldered to container for direct connection to set. Raises your Radio to Super-het standard. If unobtainable locally, direct from makers, 2/6 post free.

**2/6**  
POST FREE

**The WEEDON Ever-Damp EARTH**  
Weedon Power Link Radio Co. (Desk B), 135, Earham Grove, London, E.7 (Phone: Maryland 4344.)

**MPR**

**RUN YOUR RADIO FROM THE MAINS AT 1/- PER YEAR**

D.C. MODEL 21/- or 3/- Monthly.  
A.C. MODEL 39/6 or 5/7 Monthly.  
FITTED WESTINGHOUSE RECTIFIERS.

**MAINS POWER RADIO ROMFORD ESSEX**



(Continued from page 34.)

**SILTIT**  
**M**ANY readers already have purchased a good metal earthing tube, and have buried this in an appropriate position. We have previously pointed out the need of a moist earth for good results, and various types of chemical earthing devices have also been reviewed. With all of those so far examined, the chemical was enclosed in a metal container, to which the earth lead had to be attached. The Birka Laboratories, of Birkenhead, have now produced an earthing device which is intended for use with an existing earth tube which is already efficient in an electrical manner. This earthing material is enclosed in a cardboard carton, and appears to consist of the normal hygroscopic material to which has been added a substantial quantity of metallic dust. The carton contains, of course, very much more chemical than the other devices. To use it, we recommend you to remove the earth rod, and dig out a fair quantity of the earth into which the rod is to be driven. When the required hole has been dug, the earth which has been removed should be spread out as evenly and thinly as possible, and then the contents of the carton sprinkled over the earth. When all has been emptied, the earth and Siltit are mixed together, and the hole filled with the mixture. The result is, of course, that the earth contains a large quantity of metal in powder form, together with a well-distributed quantity of the chemical. When the earth rod is then driven into this mixture, the result is a really high-class earth, having a very low-resistance, and remaining quite moist over a very long period. The price is only 1s. 6d.

**FERRANTI MAINS UNITS**  
**W**e understand that following certain new production arrangements the prices of the well-known Ferranti A.C. Mains Power Units are being reduced in price, as follows:—

Type	£ s. d.
Type E.1 Mains Unit .. ..	10 0 0
" E.2 " " " " " " " " " "	3 17 6
" E.3 " " " " " " " " " "	4 7 6
" E.4 " " " " " " " " " "	7 10 0

The latest details of these units, together with details of trickle chargers, etc., are included in the new list published by Messrs. Ferranti. Those readers who are interested should write to Messrs. Ferranti, Hollinwood, Lancs., for a copy of list No. Wb523. There is no charge.

**BLUE SPOT LOUD-SPEAKERS**  
**T**HE British Blue Spot Company inform us that their loud-speakers are being re-designed and reduced in price. The Type 99 P.M., recently reported upon in these pages, will, in future, be fitted with a de-luxe transformer, a moisture-proof cone, and, in common with all Blue Spot Speakers, will have plugs and sockets provided with the transformers in place of the usual soldering tags. This will prove of great value to the listener. Models of this re-designed speaker will be ready by the beginning of April.

**LISSEN PT. 2A VALVE**  
**T**HE Lissen laboratories have now produced a new pentode, designed to give a very large output from a moderate grid input voltage. It is of the 2-volt, 2 amp. type, with a slope of 2.5 mA/V. The maximum power output is rated at 1,100 milliwatts, and is designed for 150 volts H.T. The optimum load impedance is 8,500 ohms. For Quiescent Push-pull two of these pentodes may be used and biased down to provide about 2 mA. per valve. The normal Push-pull arrangements should be used.

**THE "WESTECTOR"**  
**F**OUR types of the new high frequency metal rectifiers are now available, and the type numbers and prices are as follows:—W.4, W.6, Half-wave. Retail list price 7s. 6d. WM.24, WM.26, Full-wave centre tap. Retail list price 10s. Further particulars of these "Westectors," and the circuits suggested for use with them, are given in an instruction sheet, I.P.11.W, which can be obtained from The Westinghouse Brake and Saxby Signal Co. Ltd., 82, York Road, King's Cross, London, N.1.

**RADIO CLUBS AND SOCIETIES**  
 (Continued from page 42.)

**BATTERSEA AND DISTRICT RADIO SOCIETY**  
 On Tuesday, 28th February, the Battersea and District Radio Society greatly enjoyed a lecture by Mr. Parr on the manufacture of valves. The lecturer carefully explained, with the aid of a well-chosen set of lantern slides, each process from the beginning until the valves had been tested and passed out to the public. At the conclusion a large number of questions were asked and ably answered by the lecturer.—S. F. Harris (G5SH), Hon. Sec., 93, Salcott Road, Battersea, S.W.11.

**SMETHWICK WIRELESS SOCIETY**  
 At a recent meeting of this society, Mr. G. Parr gave an interesting lecture on "The Output Stage of a Wireless Receiver." He discussed the differences between triodes and pentodes and referred to 2nd and 3rd harmonic distortion. Push-pull (including Q.P.P.) and Class B amplification were explained in full. Finally the lecturer summed up his discourse by giving a table wherein the peak acceptances of the grid, the power outputs and the optimum loads of triodes and pentodes were compared in straight output, in parallel output and in push-pull.—Hon. Sec., Mr. E. Fisher, M.A., 33, Freeth Street, Oldbury, Nr. Birmingham.

**GREATER VOLUME & PURITY**

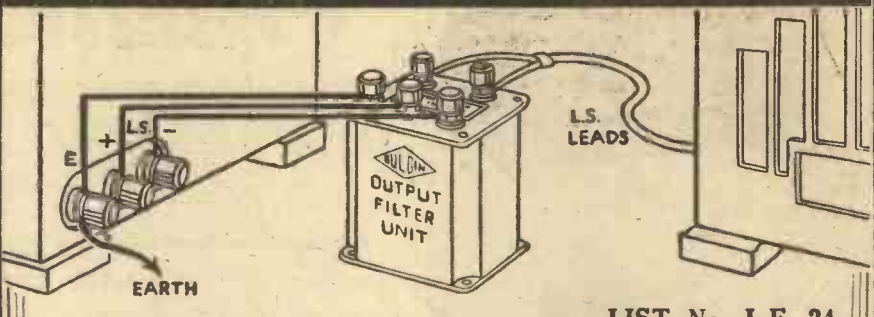

Follow the sketch closely and fit this fine Output Filter Choke in the anode circuit of your output valve. It diverts the steady anode current (D.C.) from the windings of the loud-speaker, passing only the signal currents. The loud-speaker is thereby safeguarded from over-loading and consequential breakdown, and ensures that a moving-iron speaker cannot become demagnetised. It is essential with most moving-coil speakers. These units incorporate a 20H. L.F. Choke and 250-volt 2-mfd. Condenser. Fitted in the new Bulgin Universal mounting case with clearly indicated insulated terminals, and ready for use with any set.

- LIST No. L.F. 24.**  
 20 HENRY AT 20 M.A.  
 COMPLETE WITH  
 2 M.F.D. CONDENSER  
 PRICE 12/6 EACH.
- LIST No. L.F. 25.**  
 20 HENRY AT 50 M.A.  
 COMPLETE WITH  
 2 M.F.D. CONDENSER  
 PRICE 15/6 EACH.

**A. F. BULGIN & CO., LTD.**  
 Abbey Road, Barking, Essex

Telephone: Grangewood 3266-7



Send for 80 page Catalogue & Manual  
 200 Illustrations. 60 Diagrams. Enclose 2d Postage.

**SPECIFIED - because they must be used**

**ERIE RESISTORS**  
 for the  
**"ALPHA PUSH-PULL 3"**



Erie Resistors are essential for safety. They are positively **GUARANTEED** against breakdown. That's why everyone recommends them—and why five of them are specified for the "Alpha Push-Pull 3." They save money, too!

**1/- PER WATT**

In all values, 60 ohms to 5 meg-ohms, 1 to 5 watts. Tag identified and colour coded.

At all dealers. Ask firmly for Erie Resistors, also write for leaflet and colour code chart.

**THE RADIO RESISTOR CO.**  
 1, Golden Sq., Piccadilly Circus, London, W.1

**SPECIFIED for the**

**ALPHA PUSH PULL 3**

and also for the **FERROCART Q.P.P. HI-MAG. 3**  
 Experience has proved to the designer the wisdom of specifying only **CLIX** where perfect contact is essential.



**CLIX "MASTER" PLUG**  
 Firm grip and full contact with ANY battery socket. Curved **1 1/2d.** Ends for easy insertion

**CLIX NEW SPADE TERMINALS**  
 Specially designed collar definitely prevents corrosion. Positive metal-to-metal wiring. Large type as specified **2d.** Small type (Nickel-Plated only) **1 1/2d.**

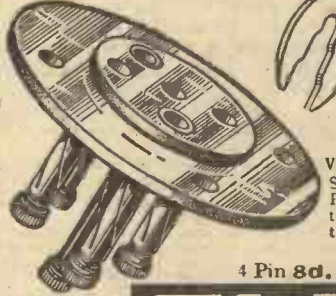
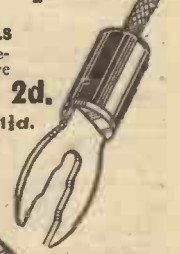

**CHASSIS MOUNTING VALVEHOLDER.**  
 Sturdily built. Perfect contact with any type of valve pin

4 Pin 8d., 5 Pin 9d.

**CLIX**  
 Leaflet N125 free on request.  
**CLIX**  
 CHEAPEST PERFECT CONTACT  
**LECTRO LINX LTD., 79a, ROCHESTER ROW, S.W.1**



# Practical Letters

from

# Readers.

The Editor does not necessarily agree with opinions expressed by his correspondents.

### A Boon to the Beginner

SIR,—I have just received my presentation volume in good condition, and am greatly pleased with it. I should like to express my extreme satisfaction, for it has surpassed my greatest expectations. I have found PRACTICAL WIRELESS invaluable to me as I am only a raw amateur, but since taking your paper I have learned a great deal about wireless. Although my set is an old-fashioned one, I especially appreciate your articles on selectivity with plug-in coils, but as I shortly intend to build a modern set, the whole of the paper is greatly appreciated. I look forward every Wednesday, which to me means some more highly interesting and valuable reading matter. Here is one suggestion.

Could you not add some small cartoon or joke in a corner each week so as to give us a laugh? Thanking you for your speedy despatch of my volume.—B. T. H. DALE (Charing, Kent).

[We have some excellent cartoons in hand which will be published shortly.—ED.]

### Carry On the Good Work

SIR,—Please accept my thanks for the cover for Data Sheets; this is really excellent and is as pleasing a possession as was the Encyclopaedia. Carry on the good work! PRACTICAL WIRELESS is a boon to all amateurs.—F. G. CHRISTALL (Coulston).

### Full of Sound Information

SIR,—Allow me to express my thanks and entire satisfaction for a volume so comprehensive and full of sound information that I would have thought it impossible to present on such generous terms.

Also my best wishes for the success of PRACTICAL WIRELESS, which fills a long felt want.—HUGH V. DAVIES (Liverpool).

### "Handiest Book in My Collection"

SIR,—I would like to express my appreciation of your wonderful weekly. I have taken wireless weekly papers for a number of years, but give me PRACTICAL WIRELESS every time. Having shown this to several of my wireless friends, it is now enough to say they have placed orders with their newsagents for a copy every week. I need not add that I have already got your Encyclopaedia, which is the handiest book I have in my collection.

Wishing your paper the success it deserves.—S. ROBSON (Felling-on-Tyne).

### "A Splendid Book"

SIR,—Allow me, as a regular reader of PRACTICAL WIRELESS, to thank you for your "Wireless Constructor's Encyclopaedia," which I received under your gift scheme. I am delighted to possess such a splendid book, which contains such valuable information for anyone interested in wireless. A more concise and useful collection of radio information will be hard to find, being so well illustrated, and the circuit diagrams are a good addition to the book. I have taken PRACTICAL WIRELESS since its first number, and I sincerely hope that your journal will continue to supply the long felt want to those interested in wireless. Again thanking you, and wishing PRACTICAL WIRELESS the success it so richly deserves.—JOHN ALFRED WHITLEY (Lytham).

### CUT THIS OUT EACH WEEK

## DO YOU KNOW?

—THAT in a receiver employing two H.F. stages, both a pre-detector as well as a post-detector volume control should be incorporated.

—THAT a Pick-up must not be left connected to the grid of a detector valve when using the receiver for radio—in view of the biasing of the grid.

—THAT the choice of the wrong value of the coupling condenser in an R.C.C. stage will affect the response curve by cutting off top notes.

—THAT a variable series aerial condenser used as a volume control should be provided with a short-circuiting switch in the minimum position.

—THAT dial illuminating lamps may be operated from the normal heater windings of mains operated receivers.

—THAT the metal braiding surrounding shielded wires must be connected to earth to be effective as a screen.

—THAT for the above-mentioned reason, all metal screens should be joined to earth.

—THAT a vertical wire running to one of the upper windows of the house may prove more effective than an indoor aerial.

### NOTICE.

The Editor will be pleased to consider articles of a practical nature suitable for publication in PRACTICAL WIRELESS. Such articles should be written on one side of the paper only, and should contain the name and address of the sender. Whilst the Editor does not hold himself responsible for manuscripts, every effort will be made to return them if a stamped and addressed envelope is enclosed. All correspondence intended for the Editor should be addressed: The Editor, PRACTICAL WIRELESS, Geo. Neumes, Ltd., 8-11, Southampton Street, Strand, W.C.2.

Owing to the rapid progress in the design of wireless apparatus and to our efforts to keep our readers in touch with the latest developments, we give no warranty that apparatus described in our columns is not the subject of letters patent.

### A South African Reader's Appreciation.

SIR,—You will no doubt be surprised to receive a letter from a schoolboy reader in South Africa. I have been getting PRACTICAL WIRELESS since the first number. Although I have not got a set of my own yet, I hope to have one later on. I did not understand much about wireless till I read the Beginners' Supplement, and now I am able to follow circuits and articles quite well. I will certainly take great care of your Data Sheets till I need them one day! It is a great pity that overseas readers have not been given time to send in their forms for the Wireless Constructors' Encyclopaedia, or the special binder for the Data Sheets. Will we be able to obtain one of these binders without sending in the Reservation Form, if so, let us know. Please give us more sets like the Midget Two, as these types of sets are of more interest to the beginner than sets like the Argus Three. Thanking you for your very fine paper, that caters so well for the beginner and the advanced wireless fan. Wishing it every success.—C. THORNLEY (Bloemfontein, S. Africa).

### From An Outpost of Empire

SIR,—As a "Radio Teacher" and Lecturer at various Boys' and Men's Clubs, also Scout Halls of Western Australia, I extend to you and your staff my heartiest congratulations on the two new publications, namely, "Newnes' Complete Wireless" and PRACTICAL WIRELESS. They are just the very thing that we have been wanting so that we could instruct young and old alike, along the simple and easy road to a better understanding of Radio. I do not hesitate to state that I have noticed a greater display of interest on all subjects since using your two excellent magazines. I intend using them throughout my classes, and have asked all my pupils to subscribe to them. Whilst on the subject, I wish also to congratulate you for being the first to publish the useful and up-to-date Data Sheets.

I trust that you will maintain the standard of your publications in the future as you have to date.—C. S. SOUTH-COTT (West Subraco, Western Australia).

### Metal Chassis Construction

SIR,—Please accept my thanks for PRACTICAL WIRELESS; it lives up to its name and contains much instructive and useful information in an "easy to take" form. No complaints, and as for suggestions, I would like to see published articles on "Meters (including A.C. and frequency), their construction and how they operate," and "How to make a metal chassis." Best wishes for future success.—S. H. GREGORY (Birmingham).

[An article on Making a Metal Chassis appeared in PRACTICAL WIRELESS, dated October 22nd, 1932.—ED.]

# How to save H.T. Battery Expenses

A Standard in use 8 years

FREE BOOKLET TELLS HOW EASY IT IS TO INSTALL

"I have been using your Standard battery 8 years with every satisfaction. The extra trouble of putting together to begin with, repays by the service you get from it."  
C. H.—Bedford.

ANY man or woman can fix up a Standard battery, simply and easily—and get PERMANENT service, BETTER reception and TRUE economy. A little more trouble, perhaps, than buying a dry battery over the counter, but think of the money you save! The Standard RECHARGES ITSELF when the set is shut down, being a special adaptation of the Leclanché principle, and the eventual replacement is just changing the cartridges at 3½d. each. We sell direct to GUARANTEE your satisfaction, so take the first step to end battery expense by writing for the STANDARD FREE BOOKLET Now.

### Model H5

126 VOLT STANDARD BATTERY

No. 3 size. 84 cells, 12,500 milliamp capacity.

Cash **37/8** Easy deferred terms available in England, Scotland and Wales

STANDARD BATTERY Co. (Department N.W.)  
184-188, Shaftesbury Avenue, London, W.C.2

## SET CRACKLING IS ANNOYING!



**IF IT'S YOUR SWITCH**

**FIT THE "BUSCO" SWITCH**

each 1/3 Post Free. Patents Pending

and ensure perfect switch contact! There is no contact point to turn round, and when you "switch on" you have contact like a power switch. They are as cheap as the inferior type but far superior in operation.

From your local dealer or

**BUSBY & CO., LTD. (Patentees)**  
Dept. P.W., PRICE ST., BIRMINGHAM

## PRACTICAL LETTERS

(Continued from page 40.)

**A Plea for Quality**  
SIR,—Ignoring the "practical" contents of PRACTICAL WIRELESS (which is its chief attraction) you, in common with others, proclaim (modestly, I admit) the wonderful "reaching" and "volume" capabilities of your circuits. We hear nothing about a set, the prominent feature of which is "quality" of reproduction.

Without casting any reflections, I will suggest that any old S.G.3. circuit will produce a crop of stations satisfying to most people. Whether a super-circuit adds another half-dozen or so stations to the crop doesn't make a deal of difference, actually. I say "actually," because when we have a crowd of friends around we naturally feel proud to pull in plenty of stations and "show 'em" what we can do. We never "listen" to a third of the stations we can obtain, and when the home circle, as it were, is gathered around, "quality" is what, in our hearts, we need. To be as unbiased (?) as possible, I will say that the quality of my set is such that speech can be heard clearly in any part of the house and every note of music is clear and faithful to the instrument producing it. I do not proclaim my reproduction to be perfect, but I will most definitely state that few super-sets can touch it for clarity. You will note I make no mention of "tone," as this is an elusive and individual affair. The more far "reaching" a set is the more it has to be "compensated," "balanced," "tone controlled," etc., etc. Certain natural (if I may use the word) quality in the super-super-sets is lost and has to be restored, and, to condense my argument, I will merely mention the words "selectivity," "side-bands." To further omit details, I suggest the older S.G.3, with flat tuning (as far as circumstances permit), and limited range, gives purer quality than the super "put and take" circuits. It is said that one watt output is necessary for perfect reproduction and that it is the despair of designers to be able to produce a battery set capable of delivering this output. All I can say is that a pleasant Sunday evening by the fireside with one watt blaring out for hours is not my idea of "quality." Instead of the customary headlines, why not "the star set of the year. Quality like the like of which you've never heard before"?

Believe me, it would be phenomenally popular.—H. S. BASSETT (Llansamlet).

## WIRELESS TERMS TRAVESTIED—2



Gramophone Pick-up

# EXPRESS EASY PAYMENT SERVICE

We specialise in the supply of all radio goods on convenient easy payment terms. We have supplied many thousands of listeners in the past years and every effort is made to give customers complete satisfaction.

Prompt Delivery Guaranteed.

**NEW LISSEN "SKYSCRAPER" With order**  
KIT, including Valves.  
Cash Price £4/9/6. **5 -**  
And 11 monthly payments of 8/6.

## Q.P.P.

Everything for the new Q.P.P. circuits supplied promptly. Cash, G.O.D. or Easy Terms. We shall be pleased to advise customers on all Q.P.P. matters.

**R.I. PUSH-PULL INPUT TRANS. With order**  
**FORMER AND R.I. P.P. OUTPUT CHOKE.** With two Mazda, Cossor or Mullard Pentode Valves.  
Cash Price £3/4/- **5/10**  
And 11 monthly payments of 5/10.

Same as above, but with two Super Power Valves instead of Pentodes.  
Cash Price £2/13/- **5/4**  
And 10 monthly payments of 5/4.

**VARLEY P.P. INPUT TRANSFORMER AND VARLEY P.P. OUTPUT CHOKE.** Complete with two Mazda, Cossor or Mullard Pentode Valves.  
Cash Price £3/9/- **6/4**  
And 11 monthly payments of 6/4.

Same as above, but with two Super Power Valves instead of Pentodes.  
Cash Price £2/18/- **5/4**  
And 11 monthly payments of 5/4.

## ACCESSORIES

**BLUE SPOT 99 P.M. MOVING-COIL UNIT.** Cash Price £2/19/6. **With order 5/-**  
And 11 monthly payments of 5/8.

**R. & A. "VICTOR" PERMANENT MAGNET MOVING-COIL REPRODUCER DE LUXE.** With 6-ratio transformer and cadmium-plated grille.  
Cash Price £3/10/- **With order 6/5**  
And 11 monthly payments of 6/5.

**EXIDE W.H. HIGH-TENSION ACCUMULATORS** (120 volts, 5,000 M/A). The cheapest and best high-tension supply where mains are not available. Cash Price £3/15/- **With order 7/-**  
And 11 monthly payments of 7/-.

**ATLAS ELIMINATOR A.G.244.** Three H.T. tappings. 20 M/A output. Cash Price £2/19/6. **With order 5/-**  
And 11 monthly payments of 5/6.

**SET OF THREE NEW VALVES.** With Mazda, Cossor, or Mullard. 1 S.G., 1 detector, and 1 power. Cash Price £1/12/3. **With order 5/2**  
And 6 monthly payments of 5/2.

We shall be pleased to send you a quotation for any radio goods you may require. Price List free.

All above Carriage Paid.  
To avoid delay, will customers kindly send first payment with order. (Dept. P)

The **LONDON RADIO SUPPLY COMPANY** ESTD 1925  
11, Oat Lane, Noble St., LONDON E.C.2  
Phone NATIONAL 1977

## ENGINEERS

SIT DOWN AND THINK THIS OVER

THIS 200 PAGE BOOK ON SUCCESSFUL ENGINEERING CAREERS FREE

Can you allow any opportunity for a first-class job to pass by unheeded? "ENGINEERING OPPORTUNITIES" points the sure way to many such opportunities. You cannot afford to miss this book. It gives details of all recognised Examinations (A.M.Inst. C.E., A.M.I.Mech.E., I.E.E., G.P.O., etc.), outlines Modern Home-study Courses in all branches of Civil, Mech., Elec., Motor, Radio, Aero and "Talkie" Engineering, and explains the unique advantages of our Employment Dept. The book is FREE. Send a postcard for your copy NOW.

**BRITISH INSTITUTE OF ENGINEERING TECHNOLOGY,**  
390, Shakespeare House, 29/31, Oxford Street, London, W.1.

Genuine AMPLION Units, Limited number. Over 75 per cent. reduction. Guaranteed. To clear, 2/3 each, carr. paid.—G.B. Pioneer Radio, Coptic St., W.C.1.

**THE WORLD'S BEST**  
**20 AC** MA AT 20v **45!**  
MAINS 200-250

**50% CHEAPER**  
**25% BETTER**  
 than any other make

**ONE VARIABLE AND 3 FIXED WIRE WOUND RESISTANCES ONLY**



**ALL BAKELITE CASES**

**RUNNING COST 1d. PER MONTH**

**OTHER MODELS**

- A.C.2** Same as A.C.1, but with Trickle Charger **60/-**
- A.C.3** 150 v. 30 mA. 4 v. Raw A.C. **60/-**
- A.C.4** Same as A.C.3, but with Trickle Charger **75/-**
- A.C.5** 200 v. 50 mA. 4 v. Raw A.C. **70/-**
- D.C.2** 140v. 35 mA. One Variable, three fixed **35/-**

**WESTINGHOUSE METAL RECTIFIERS**

**D.C.1** 25 mA. OUT-PUT. For 150v. or 230v. Mains **22/6**

**10/-** Deposit and balance monthly, will secure any Bullphone Eliminator. Ask your local dealer for particulars or write direct to address below.

**UNSOLICITED TESTIMONY**

Dear Sir,  
 14, Stamford Close, Southall, Middlesex.  
 I have received the A.C.2 Eliminator quite safely. It is very satisfactory and the Trickle Charger works excellently. It has made a big difference to my Set, and is good value for my money.  
 I thank you for the attention you gave my order and will recommend my friends to use Bullphone Products in the future. I might add that there is no trace of Hum in the Unit.  
 Thanking you, I remain, Yours sincerely,  
 Mr. W. Lounton.

Dear Sirs,  
 43, Portland Street, Norwich, Norfolk.  
 I purchased one of your Eliminators, model A.O.1, to run my S.T.400 Set, and I have yet to hear a smoother, and better Eliminator even at double the price. Four tappings and enough power to work a large power valve is a splendid example of real value for money.  
 Thanking you, I remain,  
 Mr. E. J. Parkinson.

Dear Sirs,  
 11, Aldborough St., Blyth, Northumberland.  
 The A.C. H.T. Eliminator arrived intact, and having fixed up on my 3 Valve Set, and it in good order. It has done all that you claim for it, being very smooth and silent, with ample reserve power. Thank you for an excellent unit.  
 Yours faithfully, R. Budd.

The Technical staff of "Practical Wireless" highly recommend Bullphone Eliminators and components for all their circuits. Don't be put off with any other make. There is no other as good, not at double the price. If your dealer cannot supply send direct.

**BULLPHONE RADIO**  
 NEW NORTH RD. BARKINGSIDE, ESSEX  
 PHONE CHIGWELL 102

**RADIO CLUBS & SOCIETIES**

**SLADE RADIO**

A lecture was given by Mr. E. F. Handley to the members of the above society at a recent meeting. After referring to modern receivers and volume control he went on to describe overloading and also correct working of rectifiers. The formula for grid to anode gain was given and mutual conductance described, this being followed by the formula for H.F. stage gain and characteristics of variable mu valves. Diode rectifiers came next and a circuit of a 3-stage H.F. amplifier and diode described. Control of sensitivity was referred to, after which full details were given of the double diode triodes and it was shown how these function and also how they can be controlled. Automatic volume control, new variable mu valves and resistance coupled push-pull were all dealt with during the evening. The lecture proved exceptionally interesting and was enjoyed by all those present. Details of the society, which still has room for anyone interested, may be obtained from the hon. sec., 110, Hillaries Road, Gravelly Hill, Birmingham.

**THE CROYDON RADIO SOCIETY**

Mr. E. G. Power, of a well-known wireless firm, lectured upon and demonstrated one of the latest types of mains-driven superheterodyne receivers at a recent meeting at "The Horse and Groom," Cherry Orchard Road, E. Croydon. A lantern slide of millivolts per metre of wanted signals against voltage amplification of the unwanted, enabled the lecturer to explain the problems involved in foreign station reception. For instance at a certain place, London Regional gave 300 m.v. per metre, and Stuttgart 3 m.v. per metre, so Mr. Power made it clear why, to receive Stuttgart, the British station must be received at a thousandth of its original value, or a tenth of that of the German. A unique feature of this set was its automatic volume control, which could deal with a 20:1 fade. Its theory was discussed, it being shown how a greater signal caused more bias to be applied to the H.F. valves with consequent cut down of gain. Mr. Power mentioned that he had designed the set to give 1 watt output for full room strength, the signal input being .01 m.v. per metre. As regards its response, it cut off at 5,000 cycles, which he considered was correct for avoiding heterodyne whistles and sideband "splash." Finally members explored Europe with the set, noting how easy it was to operate with its automatic volume control. Hon. Sec., E. L. Cumbers, 14, Campden Road, South Croydon.

**THE CATFORD AND DISTRICT RADIO AND TELEVISION SOCIETY**

Members of this society listened with great interest to a lecture on "Valve Characteristics" given by Mr. Deal at a meeting held on March 2nd. The speaker dealt with this subject very lucidly and explained many points which have always puzzled the novice. Valve Curves, Optimum Load, and measuring undistorted output were all thoroughly dealt with. The Chairman, Dr. Bannounah, opened the discussion that followed, and members were soon busy telling Mr. Deal all their valve troubles, all of whom received a ready answer. In conclusion the speaker forecast some very radical changes in valve design in the coming year. A hearty vote of thanks was accorded to Mr. Deal and all present agreed that it had been a very enjoyable and instructive evening.

Full particulars can be had from the hon. secretary, Mr. H. W. Floyd, 38, Conno Road, Forest Hill, S.E.23.

**CLACTON AND DISTRICT RADIO CLUB**

The inaugural meeting of the Clacton and District Radio Club was held at Dixon's Café, Station Road, Clacton-on-Sea, on Thursday, March 2nd. Mr. J. A. Dixon presided, and the club was formed on the proposition of Mr. Frank Baynton, seconded by Mr. Arthur Byrnes. The officers were elected as follows: Chairman, Mr. A. J. Dixon; vice-chairman, Mr. Lewis; hon. secretary, Mr. Loader; hon. treasurer, Mr. Woods; committee, the above four officials and in addition, Messrs. D. Heightman, A. Brynes, and H. Greenfield. Mr. F. L. Stollery, district representative of the R.S.G.B. (Radio Society of Great Britain) was also present and promised the club his support.

The club has been formed to encourage interest in radio in Clacton and District, and the activities of the club will be many and varied. The programme will be designed to interest everybody, however small their knowledge of the science of radio. Meetings will be held each Monday at 8.0 p.m. at Dixon's Café, Station Road. Further particulars may be obtained from the hon. secretary, Mr. Rodney Loader, 49, Southcliff Park, Clacton-on-Sea.

The annual subscription to the club will be 5s. and 2s. 6d. for members under seventeen years.



Graham Farish says:— "My COMPONENTS are built on the right principles."

If you are making up the Ferrocart Q.P.P.3 you cannot do better than include my components wherever possible. You will then be sure of reliability where it is most needed. Otherwise, the peculiar virtues of this extraordinary new circuit may be entirely nullified. Fit my components and be certain.

**"OHMITE" Resistance**

The most popular and efficient type of fixed resistance for all general purposes. "Better than wire-wound." All values 50 ohms to 5 megohms. Also in Heavy Duty for use where the load is high. All values 50 ohms to 100,000 ohms. Ohmites required for Ferrocart Q.P.P.3.:  
 1-20,000 ohms, 1-50,000 ohms. **1/6**  
 1-5,000 ohms, 1-10,000 ohms. each

**L.M.S. H.F. Chokes**

The L.M.S. is silk wound and has a consistent high inductance on all wavelengths, whilst its capacity is negligible. Particularly suitable for H.F. Circuit where high efficiency is the first consideration. **4/6**

**"LITLOS" VARIABLE CONDENSERS**

Compact and efficient. Accurately gauged bakelite dielectrics and solid brass pigtail connections to moving vanes. All capacities up to .0005 MFD. in tuning straight line capacity and differential types. **2/-**

**GRAHAM FARISH COMPONENTS**

Write for free copy of Catalogue and Station Tuning Chart to:

**GRAHAM FARISH, LTD.,**  
 Masons Hill, BROMLEY, KENT.

Export Office,  
 11-12, Fenchurch Street, E.C.3.

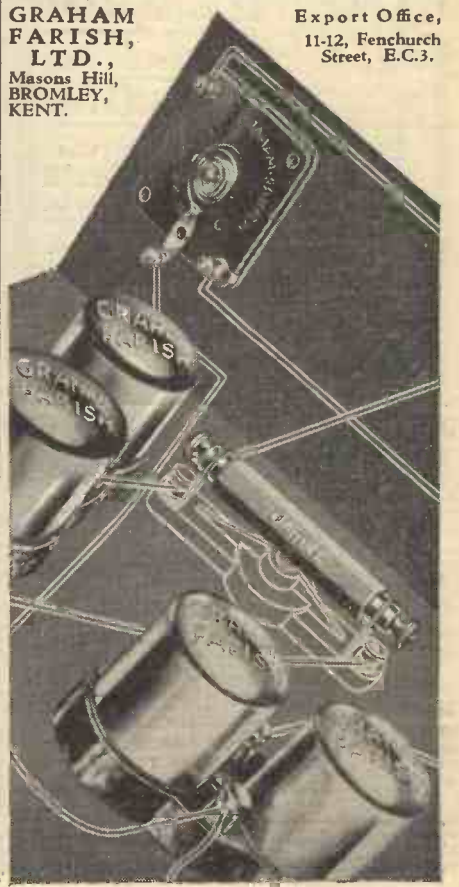

LET OUR TECHNICAL STAFF SOLVE YOUR PROBLEMS

REPLIES TO



QUERIES and ENQUIRIES by Our Technical Staff

The coupon on this page must be attached to every query.

If a postal reply is desired, a stamped envelope must be enclosed. Every query and drawing which is sent must bear the name and address of the sender. Send your queries to The Editor, PRACTICAL WIRELESS, Geo. Neumes, Ltd., 8-11, Southampton St., Strand, London, W.C.2.

SPECIAL NOTE

We wish to draw the reader's attention to the fact that the Queries Service is intended only for the solution of problems or difficulties arising from the construction of receivers described in our pages, from articles appearing in our pages, or on general wireless matters. We regret that we cannot, for obvious reasons—

- (1) Supply circuit diagrams of complete multi-valve receivers.
(2) Suggest alterations or modifications of receivers described in our contemporaries.
(3) Suggest alterations or modifications to commercial receivers.
(4) Answer queries over the telephone.

Please note also, that all sketches and drawings which are sent to us, should bear the name and address of the sender.

METAL RECTIFIER

I am building the A.C. 'Fury Four,' and have come across a point which I have not yet seen in print, but which is one which I think ought to be raised. The mains unit employs a metal rectifier, and obviously, when the mains voltage is switched on the rectifier will at once deliver its full voltage. However, the valves in the set are indirectly heated, and consequently, will not need full voltage on the anode. This must, in my mind, result in a heavy strain on the fixed condensers. Could not some device be fitted to prevent this sudden surge with its consequent danger of breakdown?—(P. R. V., Bournemouth.)

The risk you refer to is, of course, present in every type of mains receiver, and the choice of condensers has been made with the surge values in mind. However, if you are anxious to instal a safety device, the thermal delay switch will meet your requirements. This should be wired in the H.T. negative lead, and the supply to it taken from the heater winding terminals. The switch is obtainable from several advertisers in this paper, and as you probably know, it works on the principle that the circuit is not completed until the element in it has attained a certain temperature. This is arranged so that it takes practically as long as the normal indirectly heated filament takes to gain normal emission temperature.

SUPERHET. AND OUTSIDE AERIAL

I have an American superheterodyne receiver employing six valves, and where I live it does not give too good results. I am anxious to know whether I can use it with an outdoor aerial, as I have heard it said that this type of receiver will not work on this type of aerial. Will any alteration be necessary to the set?—(R. S., Gt. Yarmouth.)

Some types of superhet. receiver employ a circuit which necessitates the use of a centre-tapped frame aerial. If your receiver is of this type, then we would not advise you to attempt to use it with an outside aerial. Without knowing, therefore, what type of circuit is employed, we regret that we cannot be of any assistance to you in this connection.

CRACKLING NOISES

I had a small two-valve set, operating from the mains by an eliminator. One afternoon it started crackling. I put this down to atmospherics at the time, but when it continued and sometimes eliminated the programme altogether, I thought something was wrong. Thinking it might have been the eliminator, I connected up batteries in its place, but the same result. I went over all connections, but all were in order. Having previously decided to make it into a three-valve set, I did so, but the crackling was there as bad as ever. Would this be the Washford transmitting station? I shall be grateful if you can conquer this trouble.—(A. H. N., Taunton.)

There are many points in your receiver which could give rise to the trouble, but we do not think you can blame the nearby transmitter. First of all, disconnect both your aerial and earth. If the crackling ceases upon doing this, then the noises are being received

on your aerial, and there is nothing wrong with your set. If however, the noises persist when no aerial and earth is attached, the crackling is caused by a faulty component, and you should examine all resistances, and the transformer primary winding. Naturally, the simplest way of finding the culprit is to substitute the components one by one, but if you can obtain a good meter, this will enable you to test the various parts of the circuit for partial disconnection, high resistance, leaks, etc. Test the transformer primary first. After that has been passed O.K., look to the resistances, and we think you will not be long in finding the faulty component.

RAIN AND NOISE

Whilst it was pouring with rain the other day I noticed a most peculiar noise in my set. There was a sort of loud plop, plop, plop at almost regular intervals, and I did not take a great deal of notice of it until it stopped. Just after this I noticed that it had stopped raining. I only noticed the matter as a slight peculiarity, and would have forgotten all about it, except that last night, when it started raining again, on came the plopping. I watched carefully, and just after the rain stopped, so did the noise. What do you think this can be?—(R. S., Hornsey.)

We should imagine that you have fitted, outside the house, an aerial-earth switch. The rain running down the lead-in wire is dripping across the contacts of this, and owing to the conducting properties of water, the contacts are temporarily short-circuited with each large drop of rain-water, and this gives the

DATA SHEET No. 27

Cut this out each week and paste it in a Notebook.

CONVERSION TABLE

English Measures to Metric System.

Table with 2 columns: English units and Metric units. Includes conversions for inches to centimeters, feet to meters, yards to meters, square inches to square centimeters, square yards to square meters, cubic inches to cubic centimeters, etc.

plop you can hear. You should be able to verify this when next it rains, and if this is found to be the cause, the switch should obviously be covered, or some device attached to the wire above the switch to prevent the rain water running across the contacts of the switch. A good scheme is to pierce a hole in a tin lid and thread this on the wire just above the switch. The rain will accumulate in this and then run over the edge, clear of the switch. This arrangement will also not prevent the switch being operated, as would be the case with a box or other device enclosing the switch.

SOLDERED CONNECTIONS

I notice that you do not include any soldered joints in the sets which you describe in your interesting book, and I am anxious to know whether there is now no necessity to make this method of connection. Not so long ago it was thought very inefficient to run wires to a terminal and not make a soldered joint, and I should therefore be glad to know why you do not adopt this scheme.—(T. R., Watford.)

There is no necessity to solder a joint, although, without doubt, a soldered joint is the most secure. The majority of parts now made for wireless receivers

are fitted with terminals, and if the wire is clean, and the terminal contacts are clean, and the wire is clamped tightly under the terminal a sound electrical joint is the result. No oxidation will take place owing to the exclusion of air at the point of contact. There is no need to use a soldered joint with the terminal arrangement, but where no terminals are provided, a soldered joint must be made, and you will note that there are still one or two component parts used in our receivers which call for this method of connection.

THREE-BAND COIL

I wish to make up a coil for myself to cover the long, medium, and short waves. I have worked out the required number of turns on the particular size of former I wish to employ, and the only point I am in doubt about is the method of arranging these coils. I could build it up on the lines of the normal dual range coil, with appropriate short-circuiting switches. Do you recommend this arrangement? The alternative which I have thought of is to include the normal and long wave sections on the one former, and to place the short-wave winding on a separate former arranged at right-angles to the remaining coil. This would necessitate a separate switch. I should be glad to have your remarks upon the above suggestions, and which you think is most desirable.—(J. B., Pinner.)

The inclusion of three separate coils on one former as at first outlined by you would probably lead to losses owing to the presence of the earthed medium and long wave coils when using the short-wave coils. We assume, of course, that you are simply going to short-circuit the unused winding. Therefore, the better arrangement is to fix the normal broadcast coils on one former, with the short-wave coil at right-angles, and, if possible, at some distance from the remaining coils. You do not mention what type of tuning you propose to adopt, but we would inform you that the normal .0005 mfd. condenser used for broadcast purposes would be very unsuitable for the short-wave work. The most efficient arrangement is, of course, to use separate receivers for the two purposes, or where this is not suitable for some reason or other, build up a separate detector circuit.

HOME-MADE COIL

I am going to build a simple tuning coil, but I am not sure as to the gauge of wire to employ. I have read that the wire should be thick to reduce the resistance, but I do not want a clumsy coil. The set is not for foreigners, but I want to get the loudest possible results on the local station. What shall I use? The circuit is a simple detector, followed by a L.F. stage.—(N. H., Hatfield.)

As you are employing a detector valve there will be a certain amount of damping due to the grid leak. Furthermore, you are situated very close to Brookmans Park, and, therefore, practically anything will do for tuning purposes. However, to ensure the very utmost we would suggest a 4in. diameter paxolin tube, upon which is wound 60 turns of 22 D.C.C. wire. This should be tapped at the 10th turn from one end, and at the 10th, 20th, and 30th turns from the opposite end. This latter end should be joined to earth and the moving vanes of the tuning condenser, whilst the opposite end of the coil should be joined to the fixed vanes of the tuning condenser. The aerial should be joined to the 10th, 20th, or 30th turn from the earth end—according to the particular result which works best with your aerial, whilst the grid condenser should be tapped on to the 10th turn from the other end of the coil. This will give you the best on the local, with the advantage of probably being selective enough (with signal strength of a sufficiently high order) to enable you also to receive the Northern Regional station in your district. Naturally, the spread will prevent your hearing the Midland without interference, but the two London stations should be easily separated.

FREE ADVICE BUREAU COUPON

This coupon is available until April 1st, 1933, and must be attached to all letters containing queries.

PRACTICAL WIRELESS 25/33.

# CATALOGUES RECEIVED

To save readers trouble, we undertake to send on catalogues of any of our advertisers. Merely state, on a postcard, the names of the firms from whom you require catalogues, and address it to "Catalogue," PRACTICAL WIRELESS, Geo. Newnes, Ltd., 8/11, Southamton St., Strand, London, W.C.2. Where advertisers make a charge, or require postage, this should be enclosed.

## IGRANIC COMPONENTS

IN an attractive booklet issued by Igran Electric Co., Ltd., a full range of their well known components is listed. Amongst the various items shown are plug-in short wave coils, H.F. chokes, fixed and variable condensers, slow motion dials, L.F. transformers, mains transformers, potentiometers and a series of push-pull and other switches. For radiogram work there is also the "Igranovox" pick-up and a response corrector, which is designed to afford the requisite compensation for the deficiencies of the record at the lower frequencies. Constructors who look for high-class workmanship in their components would do well to obtain a copy of this booklet. The address is 149, Queen Victoria Street, London, E.C.

## HOWE BOX BAFFLE

IT has long been recognised that one of the chief causes of unbalanced quality of reproduction is resonance in speaker cabinets, and the Howe Box Baffle affords a scientific solution of the problem. Briefly, the Howe Box Baffle consists of an inverted cone, shaped like a short, wide, exponential horn comprising a special type of sound absorbing material known as Slagbestos made from silicate of cotton. The baffle, which can be fitted in any box cabinet and is suitable for all moving coil and cone loudspeakers, can be supplied either in kit form, for the home constructor, or assembled and ready for immediate use. In a booklet we have received from the sole licencees, F. McNeill and Coy., Ltd., 52, Russell Square, London, W.C.1, particulars and prices are given of assembled units, and also various types of cabinets complete with baffles.

## THE MILNES H.T. SUPPLY UNIT

IN a new booklet we have just received from The Milnes Radio Company, full particulars are given of this unit which consists of indestructible nickel iron cells which are kept automatically fed from the L.T. accumulator, when the set is not being used, and is always ready to supply a steady H.T. current when required. The only attention required is to top up

the cells with distilled water about twice a year, and an occasional refill of electrolyte about once in every two or three years. There is no possibility of sulphation, and the cells may be overcharged or discharged without damage to the unit. Readers interested in trouble free H.T. should make a point of getting a copy of this booklet, together with the technical data sheet, which will be sent post free on request. The address is Cottingley Bridge, Bingley, Yorks.

## Replies to Broadcast Queries.

BRS 1038 (Herne Bay): VQ7LO, Nairobi (Kenya Colony) on 49.5 m. HAMPER (Bradford): Hilversum. TRIPLE THREE (Wednesbury): These amateur experimental stations were probably working on 40 m. band, but in view of proximity of G6PC, you could hear signals on higher wavelength; G6PC, C. D. Price, "Ardath," Park Lane, Wednesbury (Staffs); G2AK, D. H. Young, Jr., 52, Maidstone Road, Handsworth, Birmingham. Regret, cannot trace G6UI(?); G2NB, advise you to write to Radio Society of Great Britain, 53, Victoria St., S.W.1. For list of Amateur transmitters see the Radio Amateur Call Book Magazine, obtainable from F. T. Carter, Flat A, Gleneagle Mansions, Streatham, London. NEWCOMER (Radstock): (1) cannot say, but apparently more than the limit stated; (2) Yes, W3XL relaying Boundbrook (N.J.) on 46.69 m.; (3) DJH, Zeesen (25.25 m.); (4) G6CW, J. J. Curnow, "Tregenna," Garrard Rd., Banstead, Surrey; If G5LX, P. H. Dutton, 8, Somers Grove, Skegness, Lincolnshire; If G5YB, R. C. Ashton, 41, Sithney St., St. Budeaux, Plymouth, Devonshire; If G5UL, J. W. Coveney, 15, Rochester Gardens, Ilford, Essex; all on the 40 metre Amateur Band, i.e., about 41 metres odd; you would do well to write to Radio Society of Great Britain, 53, Victoria St., S.W.1, for wavelengths. A. J. (Glasgow): Willie Lewis's Band from the Penguin Club. GO GETTER (Kensington): YVIB, Caracas (Ven) on 49.1 m. CANNY (Aberdeen): Cannot understand your wavelength as the programme would tally with that of Athlone. PUZZLED (Bratton): Breslau; German election results; Hitler demonstrations. LUMMY (Gosport): (1) W8XK, Saxenburg (25.27 m.) relays KDKA programme; (2) PAOIM, M. B. Gorter, 30 Pieter de Hoogh Straat, Amsterdam Z, Holland; PAOMC, H. V. Swanenburg, 52B Groote Visscherz Straat, Rotterdam; for English call signs write to Radio Society of Great Britain, 53, Victoria St., S.W.1. IBERICA (Wimbledon): (1) Moscow Popoff (BW50) on 25.16 m.; probably Radio Bulletin; slow dictation for reception by Clubs, etc.; (2) Belgian Amateur experimental probably ON4WM (Waterloo Maroc) Antwerp; (3) W2XE, Richmond Hill (N.Y.) relays WABC (Columbia Broadcasting System) on 49.02 m.; (4) W8XAL, Cincinnati (Ohio) on 49.5 m.; (5) Taschent working with Moscow; (6) Must be EAQ, Madrid according to call, Radio Ibero-Americana.

## EASY TERMS PROMPT DELIVERY

Any Amplion, Blue Spot, Baker, Celestion, Epoch, R. & A. Rola, Sonochorde, or W.B. Moving Coil Speaker supplied.

Send 5/- only

and pay the balance by monthly instalments. No references. Entirely private and confidential.

KITS, PARTS, SETS, ELECTRIC CLOCKS ON EASY TERMS.

GET YOUR R. & A. "CHALLENGER" FOR THE FEROCART Q.P.P. HIGH MAG. THREE FOR 5/- DOWN IMMEDIATE DELIVERY.

Write for Catalogue and details to: **TURNADGE & PARTNERS, LTD.** 107, Fleet Street, London, E.C.4.

Telephone: Central 1903.

Famous Maker's Offer! **PIANO-TONE! CABINETS** 7 DAYS' FREE TRIAL (or 10/- Monthly) Piano built (Pat. 8123). The acoustic Tone brings a fine thrill! (Radio-Press, B.B.C., 3,000 *Amteley* MAKER'S PRICES 25/- to £15. Photographs and List FREE. Piano-Tone Cabinets, (P.R.), Albion Road, Bexleyheath.



LIST FREE

## For "FURY FOUR" PICKETTS CABINETS

Recommended for Best Results!

**MAINS TRANSFORMERS** For Full Wave Valve Rectification Type B.R.1.—H.T. 250v. 60m.a. L.T. 4v. 1a. 4v. 3a. Type B.R.2.—H.T. 350v. 90m.a. L.T. 4v. 2-5a. 4v. 4a. FILAMENT TRANS. 4v. 1 to 6a. ALL PRIMARIES 200-240v. 50-100 cycles. ALL SECONDARIES CENTRE TAPPED PRICES—B.R.1 £1 B.R.2 £1 10s. Fil. only 9/- to 12/6 PACK & POST 9d. EXTRA **BRIONE TRANSFORMERS** 34, Marylebone Lane, Oxford St., London, W.

**500 RADIO VALVES GIVEN AWAY** Absolutely free, while stocks last. A matched set of 1933 Barum guaranteed valves to every purchaser of one of our new bargain super kit receivers: Screen-grid III, 27/6; Straight III, 18/6; Straight II, 14/6. Post free. Cash or C.O.D. Full instructions with each kit. Screened Dual-range Coils employed. Absolutely unprecedented value. Also hundreds of Radio components at the lowest liquidation prices ever. 3d. stamp enclosed brings complete lists of these.—**LONDON EAST CENTRAL TRADING CO.** Dept. E.5 (Phone: NATIONAL 8523, 23, Bartholomew Close, London, E.C.1.

Any make of Loudspeaker L.F. Transformer, or Pick-up. **REPAIRS** IN 24 HOURS 1 YEAR'S WRITTEN GUARANTEE one fixed price 3/- Terms to trade. Post extra. Quotations for Inductors, Moving Coils and Mains Transformers. **TRANSFORMER REPAIR CO.** 208 High St., Tooting, London, S.W.17

## DATA SHEET No. 4—Correction.

In the PRACTICAL WIRELESS Data Sheet No. 4, as well as on Page 535 of PRACTICAL WIRELESS dated 3rd December, 1932, a table of Stalloy Core Proportions was given. Owing to errors in the information supplied to us by manufacturers, one or two slips occurred in some of the dimensions. The table has therefore been corrected, and is given here in its correct form. This table is printed in the same size as that on the Data

Sheet referred to, and it should, therefore, be cut out and pasted over the Data Sheet in order to prevent any mistakes arising.

### CORE PROPORTIONS

Size of Stalloy Stampings.	Dimensions (Ins.)				Number of Stampings.	Watts (approx.)	Turns per volt.
	A	B	C	D			
5	3 1/4	1 1/2	1 1/2	1 1/2	6 doz.	25	15
4	3 3/16	1 1/8	1 1/8	2 1/8	6 doz.	50	8
4A	3 3/16	1 1/8	1 1/8	2 1/8	6 doz.	50	8
30	3 3/16	1 1/8	1 1/8	1 1/8	6 doz.	40	8
30A	3 3/16	1 1/8	1 1/8	1 1/8	6 doz.	40	8
28	5	1.22	1.765	3	6 doz.	100	6
29	6 1/2	2	1 1/2	4 1/2	6 doz.	250	4

## ADVERTISEMENT INDEX

"Amateur Gardening" ..	Inside Back Cover	Edison Swan Electric Co., Ltd. ..	Page 17	Newnes' "Practical Wireless Engineer" ..	Page 31
Brione Transformers ..	.. 44	Eric Resistor, Ltd. ..	.. 39	Newnes' "Tit-Bits" ..	.. 14
Brit. Inst. of Engineering Technology ..	.. 41	Ferranti Ltd. ..	.. 19	Peto-Scott, Ltd. ..	.. 27
British Pix Co. ..	Page 38	G.B. Pioneer Radio Co. ..	.. 41	Picketts, Ltd. ..	.. 44
British Radiophone, Ltd. ..	.. 1	Graham Farish, Ltd. ..	Front Strip and 42	Preh Mfg. Co., Ltd. ..	.. 31
Bulgin, A. F., & Co., Ltd. ..	.. 39	Hambling, A. W. ..	.. 31	Reproducers & Amplifiers, Ltd. ..	.. 17
Bullphone Radio ..	.. 42	Hayberd, F. C., & Co. ..	.. 38	Riverside Mfg. Co. ..	.. 38
Busby & Co. ..	.. 41	Heraud, E. J., Ltd. ..	.. 31	Smith, V. (Gt. International Exchange) ..	.. 38
Clarke, H., & Co (M/cr), Ltd. ..	.. 1	International Correspondence Schools ..	.. 35	Standard Battery Co., ..	.. 41
Columbia Graphophone Co., Ltd. ..	Back Cover	Lectro Linx, Ltd. ..	.. 39	Transformer Repair Co. ..	.. 44
Colvern Ltd. ..	Inside Front Cover	Lissen, Ltd. ..	.. 2	Turnadge & Partners, Ltd. ..	.. 44
Coradio ..	.. 38	London Radio Supply Co. ..	.. 2	Varley, Ltd. ..	.. 19
Cossor, A. C., Ltd. ..	.. 13	Mains Power Radio ..	.. 38	Weedon Power Link Radio Co. ..	.. 38
Dubilier Condenser Co., Ltd. ..	.. 33	Mason, E. C. ..	.. 38	"Wireless Step by Step" ..	.. 37
Eastick, J. J., & Sons. ..	.. 36				

# Stupendous Gift Offer

inside this week's

## AMATEUR GARDENING

DOUBLE EASTER GIFT NUMBER  
Now on Sale

2<sup>d</sup>.

*Closing date April 10<sup>th</sup>*

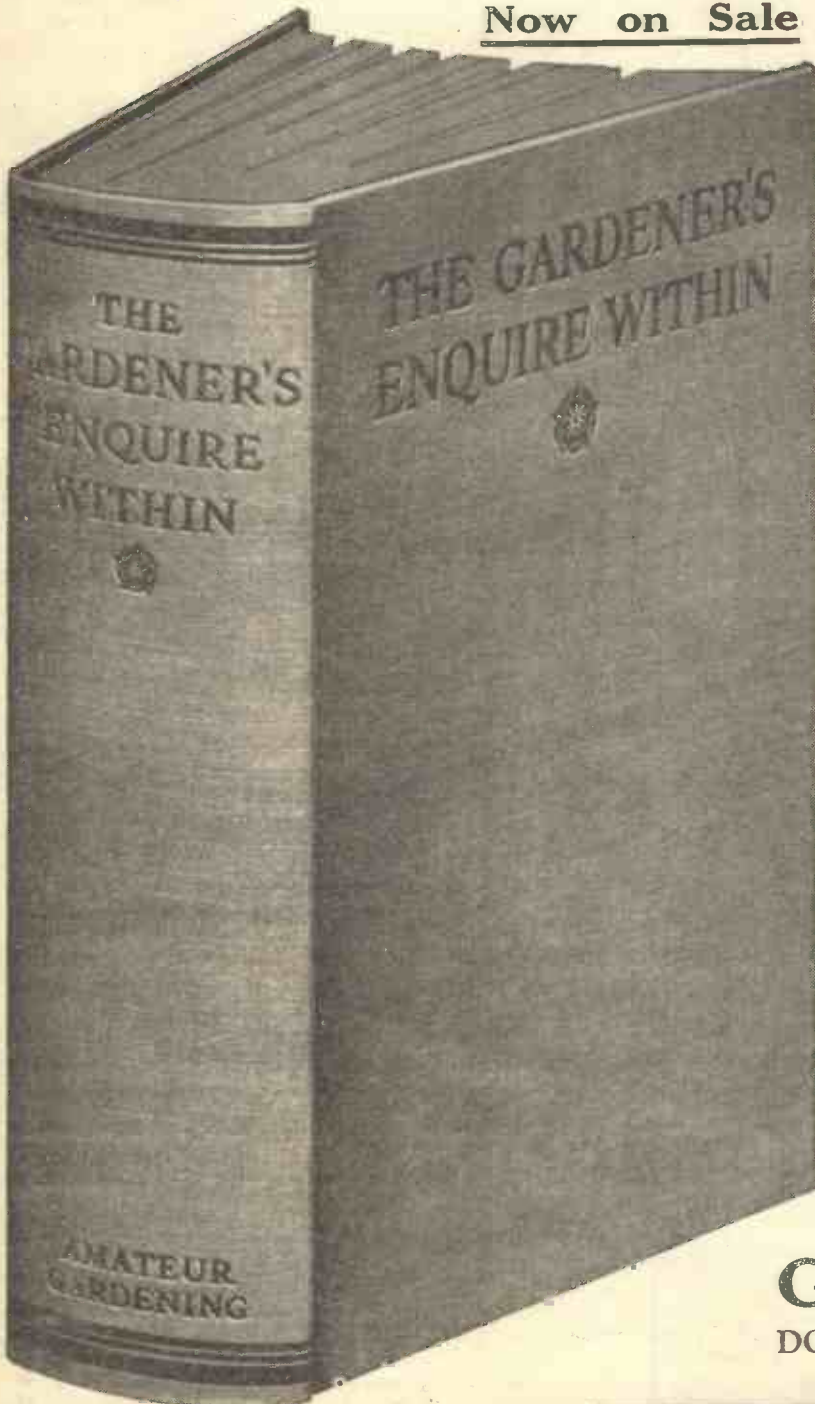

**YOU** are invited to accept this entirely new and Superb Book!

### THE GARDENER'S ENQUIRE WITHIN

"Amateur Gardening"—the world's most popular gardening weekly—celebrates 50 years of triumphant progress by offering you a copy of its Jubilee Souvenir, "THE GARDENER'S ENQUIRE WITHIN."

This wonderful book has been specially prepared, and is the latest, greatest, and most comprehensive guide to the fascinating hobby of gardening. From cover to cover it has been produced by British craftsmen with British materials, and as an outstanding example of modern book production the volume is unequalled.

Don't miss this remarkable offer but purchase a copy of the Double Easter Gift Number of "Amateur Gardening" on sale this week, containing full particulars, and a large size colour gravure, all for the small sum of 2d. If you are not a gardener yourself, will you please make this record offer known to your gardening friends.

640 PAGES, 500,000 WORDS, HUNDREDS OF ILLUSTRATIONS

Broadcast this Great Offer to all your Garden Friends

*and buy this week's*

## AMATEUR GARDENING

DOUBLE EASTER GIFT NUMBER  
from any Newsagent

**NOTE.**—It is not possible to buy this fine work easily worth 12/6. It has been specially produced as a JUBILEE SOUVENIR for regular readers of Amateur Gardening.

**DO NOT DELAY. BUY A COPY TO-DAY**



# Get Original Tone

Tone is the one certain quality in radio about which you can safely form your own opinion. It tells its own story. Sound experts believe that after thirty years of intensive research, Columbia's latest development — ORIGINAL Tone — completes the final step towards perfect reproduction. But we invite YOU to judge its superiority by actual comparison.

Test this wonderful new radiogram with any other; preferably at home. After you have tried its radio performance thoroughly, hear how vastly different your records sound. And note how attractive a modern floor cabinet can be in rich polished walnut. Let us send you complete particulars.

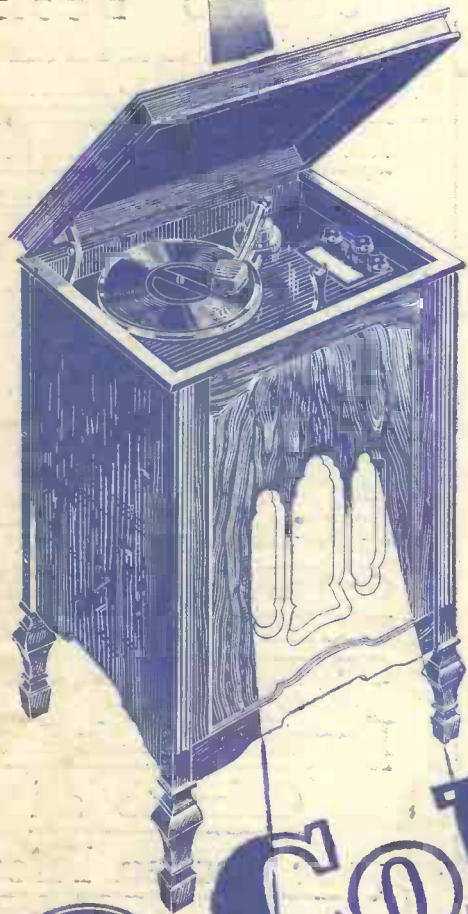

**USE THE COLUMBIA DEALER SERVICE**  
Expert advice on local radio conditions and service after sales.

Columbia Radiogram Four

**32 gns. (A.C. or D.C.)**

or delivered on first payment of **£3. 7s.**

# Columbia RADIO-GRAPHOPHONES



Prac. W. 25/3/33

**CUT OUT AND POST TO-DAY!**  
Please send me fullest particulars of Columbia Model £20 and other Columbia instruments from £4. 7. 6 to 90 gns. (write in block capitals).

NAME ..... ADDRESS .....

Columbia Graphophone Co., Ltd.,  
98, Clerkenwell Road,  
London, E.C.1



# "PRACTICAL WIRELESS" DATA SHEET No. 14

## LOUD SPEAKERS

Loud speakers are divided into two classes: Moving-iron and Moving-coil. But no matter what type of loud speaker is employed it is essential that it should match the valve if the maximum undistorted power output is required. With normal three-electrode valves, the loud-speaker load, or as it is more correctly called, the "optimum valve load," should be roughly twice the normal impedance of the valve. A moving-coil loud speaker (and some types of electrostatic loud speaker) remains constant in impedance throughout the normal frequency range, but moving-iron speakers vary in impedance with the frequency. It is, therefore, usual to take the impedance of this type of speaker at 256 cycles. To enable the matching to be carried out it is necessary to use a transformer, and the ratio of this may be obtained from the adjoined formula. Where two or more valves are connected in parallel in the output stage, the load is proportionately less. For instance, two valves in parallel would require a load half that of either valve used separately. Where two valves are connected in push-pull in the output stage, the load required is just double that of either valve.

$$\text{Transformer Ratio} = \sqrt{\frac{\text{Optimum Valve Load}}{\text{Loud Speaker Impedance}}}$$

### MOVING-IRON LOUD SPEAKERS.

Moving-iron loud speakers may consist of a simple reed movement, a balanced armature, or an inductor-dynamic arrangement. The former is the simplest, but owing to its inertia fails to deal with the lower frequencies in the musical range. The balanced armature possesses slightly more freedom and, therefore, gives better response at the lower frequencies, whilst the inductor-dynamic is especially designed to respond well down in the musical scale. It is not, however, very good at the higher musical frequencies. Owing to the fact that the impedance of moving-iron loud speakers varies with the frequency, it is inadvisable to employ this type of speaker with a pentode valve. Great care should be taken with these speakers to see that the reed does not get bent out of alignment, and the cone washer employed for attaching the diaphragm should be kept well tightened. The material of which the diaphragm is made will affect the response, and, generally speaking, this should be of thin material with felt rings between the cone washers and the diaphragm at both back and front.

### DIAPHRAGMS.

With all types of loud speaker, the material from which the diaphragm is made will affect its response. The effects are especially noticeable with the moving-coil type of loud speaker. A very good all-round material is No. 2 sheet Bristol Board. This should be formed into a cone with right-angled sides, and the edge turned back at an angle for a distance of not more than a quarter of an inch. This turned-back edge should be cemented to thin leather, and this should not be stretched when attaching it to the clamping ring or other device to which it may require to be affixed. The speech coil should be of the minimum weight, and it should, therefore, be wound on a very thin paper cylinder, and doped with collodion. A very good material to use for this purpose is Durofix. The resistance of the speech coil should be from 5 to 50 ohms, and the matching carried out by means of a transformer as pointed out in the first section above. The angle of the cone will affect its response, and for general results in the home, a right-angled cone will be found best. It should not be made less than a right-angle owing to the risk of focussing. Generally speaking, a light, thin diaphragm will give brilliancy, whilst a heavy dead material will result in a deep tone.

### MOVING-COIL LOUD SPEAKERS

Moving-coil loud speakers are divided into two classes, those having a permanent magnet and those possessing an energised field. In the former the magnet may take on any shape, but it requires no method of energising, and owing to modern methods of manufacture it is sufficiently permanent in its magnetism to outlast the design of the speaker. The other type has a large winding round the pole-piece, and this requires the application of a direct current in order to produce the magnetic field. The required voltage may vary from 10 volts in some designs to 200 volts in others. The type of speaker which requires a high voltage usually has a field winding with a resistance of from 2,000 ohms to 10,000 ohms, and, therefore, in the lower values it may be employed as a smoothing choke in a mains eliminator. For this purpose the eliminator should be designed to give an output of 350 volts at 100 mA or so, and the drop through the field will give a dissipation of from 3 to 10 watts, according to the resistance of the field. The voltage drop will permit of the full 200 or 250 volts being applied to the receiver. Care must be taken in handling this type of speaker so as not to introduce hum by induction, and with all types of moving-coil speaker the diaphragm should be handled carefully so as not to upset the centralising device.

### BAFFLES.

Practically all types of loud speaker necessitate a baffle, which prevents the sound waves from one side from passing round to the other side and so neutralising the effect of very low notes. The baffle should be as thick as conveniently possible—not less than three-eighths of an inch. The hole in it should be of the same size as the mouth of the diaphragm—not smaller. The speaker should be securely fixed to the baffle to prevent rattle, and it is also a good plan to glue large odd-shaped pieces of wood to the inside of the baffle at various positions to break up unwanted resonances. In cases where the baffle is built in the form of a cabinet, resonance may be removed by packing the corners with non-resonant material such as wool, kapok, etc. The size of the baffle will govern the reproduction of the bass notes, and the following details will assist in the choice of the correct size for particular individual requirements. For the reproduction of a 200-cycle note, the baffle should be 18 inches wide. For 100 cycles, 2 ft. 9 ins.; for 60 cycles 4 ft. 6 ins., and for 30 cycles at least 9 ft. must be provided. Where undue emphasis is given to the bass notes, a reduction in strength may be obtained by removing the loud speaker to a distance of about one inch behind the baffle. In other words, a slight air space between the front of the diaphragm and the rear surface of the baffle will assist in reducing the low note response.

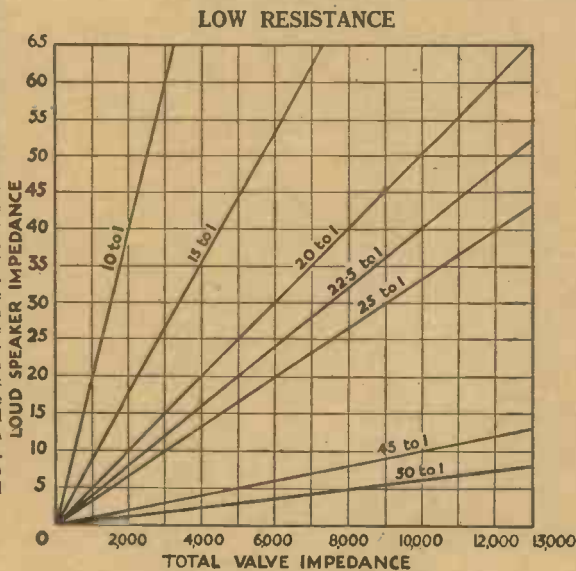
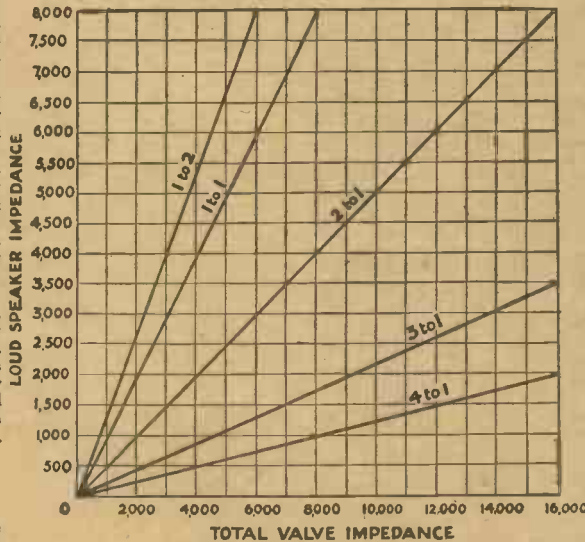

### TRANSFORMER RATIOS AND FIELD BIASING.

The two graphs above have been designed on the assumption that the optimum load required for the valve is double the A.C. impedance of the valve. As pointed out above, however, this does not hold good for Pentodes, Valves in Parallel and Valves in Push-Pull. To ascertain the ratio of transformer, find the point of intersection of the lines, corresponding to the valve resistance and speaker impedance. The nearest line running from the lower left-hand corner will then give the transformer ratio required. Where the field of the speaker is of the energised type having a D.C. resistance of 2,000 to 5,000 ohms, it may be employed for biasing the output valve. The illustration on the left shows the method of connection. The total anode current of the output valve passes through the field, and therefore the bias obtained may be worked out by multiplying the resistance of the field (in ohms) by the anode current (expressed as a decimal fraction of an amp.). If this results in an excessive voltage, a reduction may be obtained by joining a high-resistance potentiometer (of the order of 50,000 ohms) across the field, and connecting the arm, as well as one end, to H.T.—as shown on the right. The slider should be adjusted until the anode current, as shown by a milliammeter, is of the correct value. The manufacturer's instructions should, of course, be carried out in all cases.

