

THE TELEVISION CAMERA EXPLAINED

Practical Television '13

SEPTEMBER, 1956

AND TELEVISION TIMES

EDITOR: F.J. CAMM



Special Show Report



**COMPLETELY BUILT
SIGNAL GENERATOR**

Complete with built-in power supply, 230-250 v. A.C. mains. Crackle finish case 5 1/2 in. long, 3 1/2 in. wide, 4 1/2 in. high. Incorporating gain control and band switch.
Less power supply **£2.19.6** P. & P. 26

**COMMERCIAL
TELEVISION
CONVERTER**



Illustrated with cover removed
SUITABLE ANY T.V.
No Alterations To Set
Plus Post
£3.19.6
& Pkg. 2/6

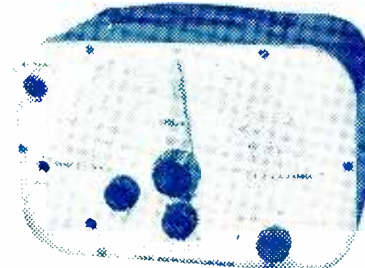

**SIGNAL & PATTERN
GENERATOR**

Coverage 7.6 Mc/s-210 Mc/s in five bands, all on fundamentals. Slow-motion tuning, audio output, 8 vertical and horizontal bars, logging scale. In grey hammer finished case with carrying handle. P. & P. 5 6

Completely built Signal Generator, coverage 120 Kc/s-320 Kc/s, 300 Kc/s-900 Kc/s, 900 Kc/s-2.75 Mc/s, 2.75 Mc/s-8.5 Mc/s, 8 Mc/s-28 Mc/s, 16 Mc/s-56 Mc/s, 24 Mc/s-84 Mc/s. Metal case 10 x 6 1/2 x 4 1/2 in. Size of scale 6 1/2 x 3 1/4 in. 2 valves and rectifier. A.C. mains 230-250 v. Internal modulation of 400 c.p.s. to a depth of 30 per cent., modulated or unmodulated R.F. output continuously variable 100 milli-volts. C.W. and mod. switch, variable A.F. output and moving coil output meter. Black crackle-finish case and white panel. Accuracy plus or minus 2%. **£4.19.6** or 34/- deposit and 3 monthly payments 25/-. P. & P. 4 6 extra.

Accuracy 1%. A.C. mains 200-250 v. Or £3 deposit, P. & P. 5 6 and 3 payments of 30/-. **£6.19.6** P. & P. 5 6

Line or Frame oscillator Blocking Transformers, 4 3 each. Smoothing Choke, 250 mA. 5 henry. 8 6; 250 mA. 10 henry, 10 6.

**3-speed
TRANSCRIPTION MOTOR
BY FAMOUS MANUFACTURER**

Complete Kit of parts comprising accurately balanced precision made, heavy turntable with rubber mat, large constant speed condenser start motor, base plate. Can be assembled in half an hour.
A.C. Mains 200 250 v. Fully guaranteed. **£6. 19. 6**
Parts sold separately. Post Paid.

BAND III CONVERTER KIT

comprising 5 channel tuner, mains transformer, metal rectifier, electrolytic, 2 valves, 12AT7 and EF90, and all necessary components for A.C. mains operation. Complete with conversion data.
£2. 5. 0 P. & P. 26.

Three-speed automatic changer by B.S.R. MONARCH, current model. Will take 7in., 10in. or 12in. records mixed. Turnover crystal head. Cream finish. BRAND NEW.
VERY LIMITED QUANTITY.
A.C. Mains 200 250. **£7.15.0**. P. & P. 3 6.

Line and E.H.T. Transformer, 9kV. Ferrocort core, EY51 heater winding, complete with scan coils and frame output transformer and line and width control. 35/-. P. & P. 3/-

As above but complete with line and frame blocking transformers, 4 henry 250 mA. choke, 100 mfd. and 150 mfd. 350 wkg., 380 mA. A.C. ripple. **£2.9.6**. P. & P. 3/-

Standard wave-change Switches, 4-pole 3-way: 1-pole 3-way: 3-pole 3-way, 1 9 each; 9-pole 3-way, 3 6; Miniature type, long spindle, 4-pole 3-way and 4-pole 2-way, 2 6 each. 2-pole 11-way twin wafer, 5/-; 1-pole 12-way, 5/-. P. & P. 3d.

USED metal rectifier, 250 v. 150 mA., 6 6.

Combined 12in. Mask and Escutcheon perspex. New aspect, edged in brown. Fits on front of cabinet. 12 6. As above for 15in. tubes, 17 6.

Polishing Attachment for electric drills, 1in. spindle, chromium plated 5in. brush, 3 polishing cloths and one sheepskin mop mounted on a 3in. rubber cup. P. & P. 1 6. 12 6. Spare sheepskin mops, 2 6 each.

R. & T.V. COMPONENTS (ACTON) LTD.
23 HIGH STREET, ACTON, LONDON, W.3

**16in. TUBE
BY FAMOUS MANUFACTURER**

Brand new E.H.T. 14 Kv. Heater, 6.3 volts, 0.6 amp., guaranteed 3 months. **£9.19.6**, post, packing and insurance 22 6. H.P. terms available. E.H.T. and scanning components available.

Wide Angle P.M. Focus Unit, Vernier adj., state tube, 15/-.
P.M. Focus Unit for Mullard tubes with vernier adjustment, 15/-.

Ion Traps for Mullard or English Electric tubes, 5/-. Post paid.
T.V. Coils, moulded former, iron cored, wound for rewinding purposes only. All-can 1 1/2in. x 1 1/2in., 1 - each; 2 iron-cores All-Prac. T.V. Converter.

Dubilier .001 10kV. working, 3 6.

Primary, 200-250 v., P. & P. 2/-.
330-0-300, 100 mA. 6 v. 3 amp., 5 v. 2 amp., 22 6.

Drop thro' 350-0-350 v. 70 mA. 6 v. 2.5 amp., 5 v. 2 amp., 14 6.

Drop thro' 250-0-250 v. 80 mA. 6 v. 3 amp., 5 v. 2 amp., 14 6.
280-0-280, drop through, 80 mA. 6 v. 3 amp., 5 v. 2 amp., 14 6.

**GARRARD RC/110
3-SPEED AUTOMATIC CHANGER**

10 Records, turnover crystal head.
BRAND NEW. A.C. Mains. 100 250 v. **£3.19.6** P. & P. 5/-
LIST PRICE £14.10.0.

Drop thro' 270-0-270 60 mA. 6 v. 3 amp., 11 6.
250 v. 350 mA. 6.4 v. 4 a., twice 2 v. 2 a. 19 6.

Semi-shrouded drop-through 380-0-380 120 mA. 6.3 v. 3 amp., 5 v. 2 amp., 25/-.

Auto Trans. Input 200 250 H.T. 500 v., 250 mA., 6 v. 4 a., twice 2 v. 2 a. 19 6.

Auto Trans. Input 200 250. H.T. 350 v. 350 mA. Separate L.T. 6.3 v. 7 a., 6.3 v. 11 amp., 5 v. 3 amp., 25/-, P. & P. 3/-.

Heater Transformer, Pri 230 250 v. 6 v. 14 amp., 6/-.
350-0-350 75 mA. 6.3 v. 3 a. tap. 4 v. 6.3 v. 1 a., 13 6.
500-0-500 125 mA. 4 v. C.T. 4 a., 4 v. C.T. 4 a., 4 v. C.T. 2.5 a., 27 6.
500-0-500 250 mA. 4 v. C.T. 5 a., 4 v. C.T. 5 a., 4 v. C.T. 4 a., 39 6.
Chassis mounting or drop thro'. Pri 110 250 v. Sec. 350-0-350 250 mA. 6.3 v. 7 amp., 6.3 v. 0.5 amp., 5 v. C.T. 0.5 amp., 4 v. 4 amp., 32 6. P. & P. 3 6.

P.M. Speakers, closed field 3 ohm speech coil 12in., 25/-; 10in. 25/-; 8in. 20 6; 6in., 18 6; 5in., 18 6. P. & P. 2/- each extra.
1,200 ft. High Impedance recording tape on aluminium spool, 12 6 post paid.

Valve Holders, moulded octal Mazda and loctal, 7d. each. Paxolin, octal Mazda and loctal, 4d. each. Moulded BTG, BRA and B9A, 7d. each.

Where cost and packing charge is not stated, please add 1 6 up to 10/-, 2/- up to £1 and 2 6 up to £2. All enquiries S.A.E. Lists 5d. each.

NEW Signal Generator

FOR BANDS I, II & III

... ON FUNDAMENTALS

Regd. Trade Mark

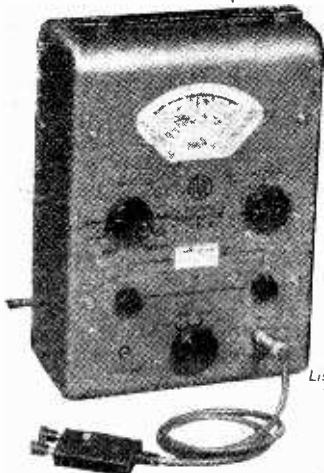

The "AVO" Signal Generator Type III

An inexpensive A.M. Signal Generator of entirely new design, for the Service Engineer. Provides six frequency bands covering 150kc/s—220Mc/s. Accuracy 1%.

- 150 kc/s — 500 kc/s
- 500 kc/s — 1.6 Mc/s
- 1.6 Mc/s — 5.5 Mc/s
- 5.5 Mc/s — 18 Mc/s
- 18 Mc/s — 70 Mc/s
- 70 Mc/s — 220 Mc/s

Continuous wave or modulated at 1,000c/s. L.F. signal available for test purposes.

A new type of attenuator, ensures close adherence of the output to the attenuator calibration. The instrument provides a force output of 250mV, whilst the following outputs are available via the attenuator:—

Minimum to 100 μ V, x 1, x 10, x 100, x 1000. Output Impedances—80 Ω , 200 Ω and 400 Ω .

List Price £29

This instrument operates on 100–120, 200–260V, 50–60 c/s A.C. mains. It is light and compact and employs double screening to ensure minimum radiation.

Full details available on request.



Sole Proprietors and Manufacturers:—

THE AUTOMATIC COIL WINDER & ELECTRICAL EQUIPMENT CO. LTD.

AVOCET HOUSE · 92-96 VAUXHALL BRIDGE ROAD · LONDON · S.W.1 Telephone: VICTORIA 3404 (9 lines)

SG.5

HOME RADIO OF MITCHAM

187, LONDON ROAD, MITCHAM, SURREY

MIT. 3282

The full range of

EDDYSTONE

short wave components in stock. Eddystone catalogue price 1/-.

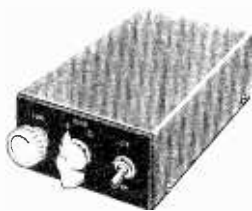

The STIRLING band 3 converter.

Completely self-contained and ready to plug in.

PRICE £6-6-0.

Full leaflet on request

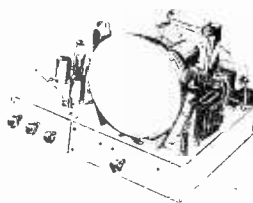

Commercial TV for your VIEW-MASTER

All parts in stock. This is THE conversion for View-master, no patterning, no breakthrough, full definition

BAND III AERIALS

- Single dipole loft or room use... 7/6
- 3 element yagi loft aerial ... 30/-
- 5 element yagi loft aerial ... 42/6
- 8 element array (state channel) 72/6
- Belling Lee Diplexer tuned filters 12/6
- Airspaced low loss coaxial cable 9d.yd.
- TV aerial manual ... 4/6
- How to Make TV Aerials ... 2/6

E.H.T. TESTER



Don't guess E.H.T. —test it. 3-16 kV. A.C. and D.C. for line fly-back or transformer E.H.T. Boxed with full instructions. 52/6 post paid.

DENCO 3 station tuner coils and screens. Price 30/-.

DENCO ready wound modification coil set. Price 20/-.

DENCO Switch kit, fine tuner, and coil mounting plates, 27/-.

T.C.C. Complete kit of condensers, printed circuits and special valve-holders. £23.0. (or available

separately).

LAB. Complete set of resistors as specified. 5/-.

Coaxial plugs, 1/3. Sockets, 1/3.

VALVES. PCC84 and PCF80 10/6 ea.

TRANSFORMER. Special 16 volt, 10/6.

Goods despatched promptly. C.W.O. or C.O.D. Open until 6.30 p.m. including Sats. (Weds. 1 p.m.)



FOR VALVES—GUARANTEED NEW AND BOXED

021	5/6	6F13	14-	5006	5/6	6F80	14/0	6Y80	10/
1A3	7/3	6F17	12/6	954	2/-	6F82	15/	6Y81	10/-
1A3PT	6/	6F15	14-	955	4/9	6H35	11/6	6Y82	8/-
1A7	11/6	6G00	4/6	956	3/8	6H42	10/6	6Y8	13/8
1C2	7/6	6H6	2/6	1081	1/10	6H81	11/-	8P220	6/9
1C54T	9/6	6J34	5/	1082	10/6	6E80	10/-	1F10	9/-
1C64T	10/6	6J35T	5/6	1083	11/-	6E82	8/6	1C22	8/-
1L4	8/6	6J3M	6/6	1084	11/-	6E40	10/6	1C25	13/6
1L5	10/0	6J6	6/	1085	11/6	6F41	11/-	1F40	10/-
1L5	8/6	6K74	6/	1086	11/6	6F86	12/6	1F44	11/6
1L5	7/6	6K7M	5/9	1087	8/6	6F89	12/6	1F4P42	11/6
1L4	7/6	6K84	8/9	12A7	9/-	6I2	12/6	1F41	9/-
1U5	7/6	6K8G	9/6	12A7	9/-	6I22	6/6	1F43	11/6
2X2	4/6	6L93	9/	12A17	9/6	6I41	10/6	1F44	11/6
3A3	7/	6L94	7/8	12A27	10/	6L42	11/6	1F41	11/6
3M6	5/	6N7	7/8	12B56	10/	6L43	11/	1Y41	10/-
3Q4	9/6	6Q74T	8/	12B8	7/	6M31	10/	1Y21	3/
3Q5	9/6	6R47G	8/	12D6	3/	6M40	11/	1Y3	3/
384	7/6	6H47	7/6	12D5	4/6	6Y51	11/6	1Y9	6/6
3V4	8/6	6H47	7/6	12J7	9/6	6Y86	12/	1V54	2/-
4B1	3/	6K7	8/	12K7	9/	6Z90	10/-	1V55	2/-
4B4	8/	6M7	8/	12K8	11/	6Z91	10/-	1G6B	3/7/6
4B44V	9/6	6M7	8/	12Q7	9/6	6Z90	10/-	1V56	3/7/6
5U46	8/	6N7	8/	12Q7	9/6	6Z91	10/-	1P260	6/
5Y361	8/	6Q7	9/3	12R7	9/6	6E148	2/-	1V57	8/
5Y36T	8/	6R7	8/	12R7	9/6	6W4	30/-	1R65	8/
5Z45	8/9	6L44T	15/-	12R5	5/6	6E22	12/6	1R65	3/
6A7	11/0	6L54	8/6	12Q2	12/6	6E39	5/	1R66	3/9
6A8G	10/6	6L7G	8/6	12Q7	8/6	6E40	11/6	1R67	3/9
6A8G	6/6	6L81	7/	12Q7	7/6	6E41	10/6	1R68	4/6
6A85	6/6	6L82	7/	12Q11	10/8	6E42	11/6	1R69	4/6
6A85	6/6	6K4	7/6	12P11	10/8	6E43	11/6	1R70	4/6
6A15	6/6	6M6	7/6	12P11	6/9	6E44	11/6	1R71	4/6
6AM5	5/	6N34T	7/6	12K2	5/	6E45	11/6	1R72	4/6
6AM6	7/6	6N3	8/6	12K3	5/	6E46	11/6	1R73	4/6
6AQ5	7/6	6T6	8/6	12K4	5/	6E47	11/6	1R74	4/6
6AT6	8/6	7L3	8/	12K5	5/	6E48	11/6	1R75	4/6
6B8	4/	7L6	8/	12K6	5/	6E49	11/6	1R76	4/6
6BA6	7/6	7H7	9/-	12K7	5/	6E50	11/6	1R77	4/6
6B86	8/	7K7	9/-	12K8	5/	6E51	11/6	1R78	4/6
6BW6	8/6	7S7	9/6	12K9	5/	6E52	11/6	1R79	4/6
6B87	10/	7Y4	8/6	12L7M	10/-	6E53	11/6	1R80	4/6
6E4	7/	75	10/6	6AB80	10/	6E54	11/6	1R81	4/6
6E50T	6/6	77	8/	6AF32	12/6	6E55	11/6	1R82	4/6
6E6	6/6	80	8/6	6B41	9/	6E56	11/6	1R83	4/6
6E9	10/6	807	6/6	6B41	10/	6E57	11/6	1R84	4/6
6E46	7/6	8D2	2/0	6B41	10/	6E58	11/6	1R85	4/6
6E6	6/6	9D2	3/9	6B42	11/	6E59	11/6	1R86	4/6
6E91	12/6	901	5/6	6B43	9/6	6E60	11/6	1R87	4/6
6E61	7/6	9003	5/6	6B44	12/6	6E61	11/6	1R88	4/6
6E6M	7/6	9004	5/6	6B85	10/	6E62	11/6	1R89	4/6

A NEW ALPHA KIT FOR YOU TO BUILD

Main Portable. A.C./D.C. Modern Battery Receiver. Four valves (latest types), 2 Wave-band Superhet. In an attractive Lizard Grey Case, size 8 3/4 in. x 8 3/4 in. x 4 1/2 in. Full Kit of Parts down to last nut and bolt.



£9.9.0

Or if you prefer you can build the battery version first for £7.17.6 and add the mains components later.

Post extra on Kit, 2/6.
Full Circuit Diagram, Shopping List, and Point-to-Point Wiring Diagram, 3/-.

Aerialite Band III Aerials, 5-element, 702XV. An array with Universal 1 1/2-in. masthead bracket, suitable channels 8, 9, and 10. Price 43/- carriage 4/6.
Aerialite Universal Outer Boxes at 4/6 each.
Aerialite Coaxial Plugs and Sockets at 1/4 each.

TRANSFORMER MT6
Small mains transformer suitable for T.V. converters, etc. Primary 230 v., secondary 250 v., 40 M/A and 6.3 v. 1.5 amp. Price 15/6 each, postage 1/6.

TRANSMITTERS
T1154N, 25/- each; T11541, 37/- each; T1154, in rough condition 15/- each. Carriage and postage on these three is 12/6.
Meters 6-100 M.A., panel mounting, 7/6 each; 100 amp. R.P. panel mounting, 7/6 each.

MAINS TRANSFORMERS

2-way mounting type	
MT1	Primary: 200-220-240 v.
	Secondary: 250-0-250 v., 50 M.A. 0-6.3 v. 4 amp., 0.5 v. 2 amp. Both tapped at 4 v. each ... 18/6
MT2	Primary: 200-220-240 v.
	Secondary: 250-0-250 v., 80 M.A. 0-6.3 v. 4 amp., 0.5 v. 2 amp. Both tapped at 4 v. each ... 18/6
MT3	Primary: 200-220-240 v.
	Secondary: 30 v. 2 amp., 3 v. 10 v., 15 v., 18 v., 20 v., 24 v. each ... 18/6

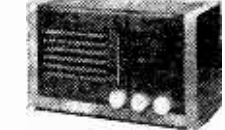

- Easy to Build.
- Valves 6T7, 6K7, 6V6GT plus metal rectifier.
- Walnut cabinet.

Full instructions, point to point wiring diagram, Circuit diagram, and full shopping list 1/-. All components may be purchased separately.

£5.10.0

Post and Packing 3/-.

WHEN ORDERING PLEASE QUOTE "DEPT. P.T."

LOUDSPEAKER UNITS, ETC.

Each	
3in. Types	17/6
5in. Types by Clar, Lothorn, Colebrook, etc.	17/6
9in. Types by Goodmans, Bala, R. & A.	18/6
5in. Types by Goodmans, Plessey, R. & A.	19/6
6in. Types by R. & A., Colebrook, etc.	25/6
6in. Water Speaker by Triton, suitable for Car Radio, etc.	20/-
12in. Plessey Lightweight	35/-
Edipical Speakers, Goodmans	19/6
4in. x 7in.	
All above are P.M. Speakers. Standard 24 ohms. Speech Coil.	
HEATER TRANSFORMERS	
230v. Input 2 volt 2 amp., each h	5/-
230v. Input 2 volt 5 amp., each h	6/3
230v. Input 4 volt 1.5 amp., each	5/6
230v. Input 4 volt 3 amp., each	10/6
230v. Input 5 volt 2 amp., each	10/6
230v. Input 6.3 volt 1 amp., each	5/6
230v. Input 6.3 volt 1.5 amp., each	6/6
230v. Input 6.3 volt 2 amp., each	9/6
230v. Input 12 volt 75 amp., ea	5/6

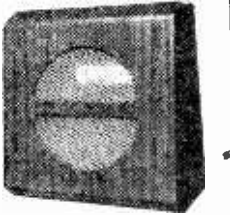

LOUDSPEAKER CABINETS

This attractive walnut finished cabinet is available for 8 1/2 in. or 8 in. speaker units. Metal speaker feet, complete with back and rubber feet.

5 1/2 in. type: Measures 8 1/2 in. x 8 1/2 in. x 4 1/2 in. at base. Price 16/6 each.

8 in. type: Measures 10 1/2 in. x 10 1/2 in. x 5 in. at base. Price 20/6 each.

5 1/2 in. type: Measures 6 1/2 in. x 4 1/2 in. x 7 1/2 in., 16/6.



5/6 VINCES CHAMBERS
VICTORIA SQUARE
LEEDS I.

TERMS: Cash with order or C.O.D. Postage and Packing charges extra, as follows: Orders value 10/- add 9d.; 20/- add 1/6; 40/- add 2/-; £5 add 3/- unless otherwise stated. Minimum C.O.D. fee and postage 2/3.

MAIL ORDER ONLY

BAND III CONVERTER.

Coil kit by TELETRON, with circuit and wiring details, etc. For use with TRF or Superhet TV Receivers. **ONLY 15/-**. Cascode coil kit **17.6**. Drilled chassis **3.9**, or slightly larger to hold power pack components, **6-** (postage on either 6d.). Instruction leaflet only, 6d.

INDICATOR UNIT TYPE 6.—Contains VCR 97 tube with mu-metal screen, 4 valves EF50 and 2 of EB34, valveholders, CRT holder, condensers, resistors, etc. **NEW CONDITION. ONLY 39.6** (carriage, etc., 7.6).

AMPLIFIER TYPE 223A or 208A.—As described in July, 1955, issue of *Practical Television*, for making a TV CONVERTER. Complete with 2 valves—EF50. **ONLY 10-** (post, etc., 2-).

PYE 45 MC S.F. STRIPS.—Ready-made for London Vision Channel. Complete with 6 valves EF50 and 1 of EA50, and details of very slight mods. required. **BRAND NEW. ONLY 49.6** (post, etc., 2.6).

I.F. STRIP 194.—Another easily modified strip for TV. Complete with 6 valves—SP61, 1 of EA50, and 1 of EF50; also mod. data. **ONLY 29.6** (post, etc., 2-).

RECEIVER UNIT 159.—Contains 4 valves, 1 each EF50, EA 30, SP61, RL37 and 21 v. selector switch. **ONLY 7.6** (post, etc., 2-).

R.F. UNITS TYPE 26.—Complete with 2 valves EF54 and 1 of EC52, (lit. 1) the valuable tuning unit covering 67-50 mc/s (34 metres). **BRAND NEW IN MAKEUP'S CARTONS. ONLY 27.6.**

POCKET VOLTMETERS.—Head 0-15 and 0-300 v. A.C. or D.C. **BRAND NEW. ONLY 18.6.**

COMMAND RECEIVERS.—Huge purchase from the Air Ministry. These famous compact American receivers which can be used for a variety of purposes are offered at ridiculously low prices while stocks last. Complete with 3, 5, 6 metal type valves, one each of 12B8, 12SK7, 12AG and 3 of 12SQ7, in aluminium case, size 11in. x 5 1/2in. x 5in. Used, but in good condition. Choice of models, BC 455 (6-9 Mc.), 25-, BC 454 (3-6 Mc.), 27.6. BC 453 (100-350 kc/s), 59.6, and a few of the 1.5-3 Mc.s model, 65-. (Postage on all models 3-). Circuits supplied.

COLLINS TRANSMITTERS.—The renowned American TCS models covering 1.5-12 Mc.s in 3 bands. Complete with 7 valves, employing 2 of 1625 in P.A. stage, one of 1625 in each of buffer and modulator stages, and 3 of 12AG in oscillator stage. Provision for V.F.O., or crystal control for 4 Xtal positions. Incorporates plate and aerial current meters. In Brand New Condition. **ONLY £12.10.0** (Carriage, etc., 15-).

COLLINS RECEIVERS.—Matches the above transmitter and is exactly the same size, 11in. x 13 1/2in. x 11in. Has same coverage, and is complete with 7 valves, 1 each of 12SA7, and 12SQ7, 2 of 12AG, and 3 of 12SK7. Also has provision for Xtal control. A really terrific receiver for the amateur operator. In Brand New Condition. **ONLY £8.10.0.** (Carriage, etc., 15-). **OR THE TRANSMITTER AND THE RECEIVER TOGETHER. £20.0.0.** (Plus Carriage, as above).

I.T. HEAVY DUTY TRANSFORMER.—Ex Admiralty. Has 3 separate windings of 5v., 0-5v. at 5 amps, and by using combinations will give various voltages at high current. **BRAND NEW. ONLY 29.6** (post, etc., 2.8).

MODEL MAKERS MOTOR.—Reversible pole. Only 2in. long and 1 1/2in. diameter, with 1/4in. long spindle. Will operate on 4.6, 12 or 24 volts D.C. **ONLY 10.6** (post, etc., 1-).

TRANSFORMERS.—Manufactured to our specifications and fully guaranteed. Normal Primaries. 425-0-425 v. 200 ma. 6.3 v. 1 a., 6.3 v. 4 a., 5 v. 3 a., **ONLY 65-**; 350 v. 0-350 v. 100 ma., 6.3 v. 5 a., 6.3 v. 3 a., 5 v. 3 a., **ONLY 47.6**; 250 v. 0-250 v. 100 ma., 6.3 v. 6 a., 5 v. 3 a., **ONLY 37.6**; 350 v. 0-350 v. 150 ma., 6.3 v. 5 a., 5 v. 3 a., **ONLY 27.6**; 250-0-250 v. 60 ma., 6.3 v. 3 a., 5 v. 2 a., **ONLY 21-**. The above are all shrouded, upright mounting, 5.5 kv. E.H.T. with 2 windings of 2 v. 1 a. **ONLY 79.6**; 7 kv. E.H.T. with 4 v. 1 a. **ONLY 89.6.** PLEASE ADD 2- POSTAGE FOR EACH TRANSFORMER.

E.H.T. TRANSFORMER FOR VCR97 TUBE.—2,500 v. 5 ma., 2-0-2 v. 1.1 a., 2-0-2 v. 2 a., 42.6 (postage 2-).

SPEAKERS.—P.M. 6in. less trans., 19.6; 8in. less trans., 16.6; 10in. with trans., 27.8 (post 2-).

CHOKES.—10H 60 mA., 4-; 5H 200 mA., 7.6 (post 1-).

Open until 1 p.m. Saturdays, we are 2 mins. from High Holborn (Chancery Lane Station) 5 mins. by bus from King's Cross. Cash with order, please, and print name and address clearly. Include postage and carriage on all items.

U.E.I. CORPN. THE RADIO CORNER, 138, GRAY'S INN ROAD, LONDON, W.C.1
(Phone **TE**minus 7937.)

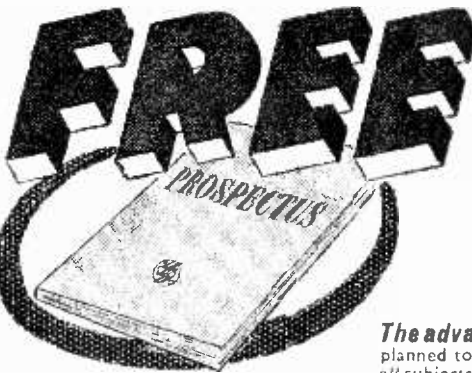

POST THE COUPON TODAY FOR OUR BROCHURE ON THE LATEST METHODS OF HOME TRAINING FOR OVER 150 CAREERS & HOBBIES

PRIVATE AND INDIVIDUAL TUITION IN YOUR OWN HOME

City and Guilds Grouped Certificates in Telecommunications; A.M. Brit. I.R.E. Examination, Radio Amateur's Licence, Radio and Television Servicing Certificates, General Radio and Television Courses, Radar, Sound Recording, etc. Also Courses in all other branches of Engineering and Commerce.

The advantages of E.M.I. training. ★ The teaching methods are planned to meet modern industrial requirements. ★ We offer training in all subjects which provide lucrative jobs or interesting hobbies. ★ A tutor is personally allotted by name to ensure private and individual tuition. ★ Free advice covering all aspects of training is given to students before and after enrolling with us.

Equipment supplied upon enrolment and remains your property.

Courses from 15/- per month

POST THIS COUPON TODAY

Send without obligation your FREE book, E.M.I. INSTITUTES, Dept. 138K, 43 Grove Park Road, London, W.4.

NAME _____

ADDRESS _____

SUBJECT(S) OF INTEREST _____

NEW LEARN THE PRACTICAL WAY. COURSES WITH EQUIPMENT
With many of our courses we supply actual equipment thus combining theory and practice in the correct educational sequence. Courses include: Radio, Television, Electronics, Draughtsmanship, Carpentry, Photography, and Commercial Art, etc.

EMI INSTITUTES
The only Postal College which is part of a world-wide Industrial Organisation.

CERAMICS

for all electronic applications

Silvered Ceramic Condensers cover a variety of useful shapes, including Pearls, Discs, Beads and Tubes, and have many applications in R.F. circuits — particularly where ultra-high frequencies are present, when their low inductance and excellent power factor are of special advantage. A wide choice of negative and positive temperature co-efficients permits the temperature compensation of other components, and frequency stabilisation of tuned circuits.

HI-K CERAMIC DISCS

for decoupling purposes in T.V. and spark suppression in small electrical apparatus—extremely low inductances. Up to 10,000 pF at 500 v. D.C. working. Finished in a moisture-resisting compound that does not soften or crack up to 100°C.

LOW-K TUBULARS

with the choice of four temperature co-efficients and a wide range of capacity values, serve many purposes in general circuitry.

HI-K TUBULARS

combine high capacity with small physical size: used widely as by-pass condensers in T.V. and other H.F. receivers where low inductance is of special value.

LOW-K PEARLS

of up to 10 pF capacity and

LOW-K DISCS of up to 50 pF. with high negative temperature co-efficient permitting compensation of other components and frequency stabilisation in tuned circuits.

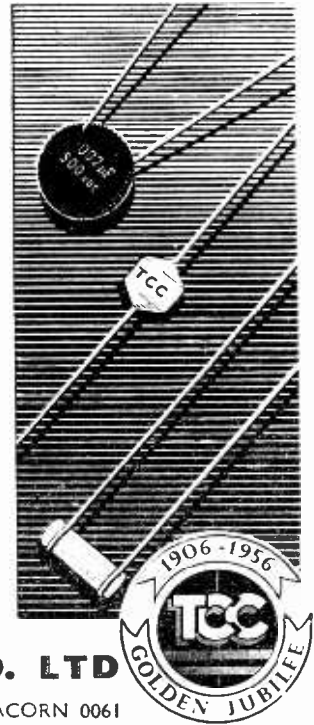

THE TELEGRAPH CONDENSER CO. LTD

RADIO DIVISION: NORTH ACTON · LONDON · V.3 · Telephone: ACORN 0061

PREMIER RADIO COMPANY

OPEN TILL
6 P.M. SATURDAYS

(Regd.) B. H. MORRIS & CO. (RADIO) LTD.

Telephone:
AMBASSADOR 4333
PADDDINGTON 3271

(Dept. P.T.) 207, EDGWARE ROAD, LONDON, W.2

★ **Band Three (Commercial)**
For the Home Constructor

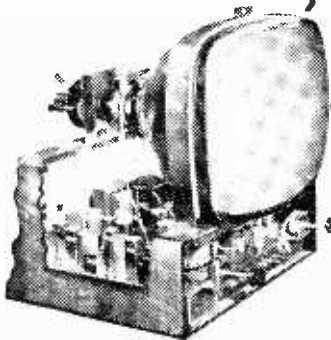

Instruction Book 3/6. Post
Free. Includes details of
both designs.



THE NEW PREMIER TELEVISOR

13 CHANNEL DESIGN

SUITABLE FOR USE WITH ANY POPULAR WIDE ANGLE TUBE

DESIGN 1. Includes a Multi-Channel Tuner (Channels 1-13) continuously variable 40-100 Mc/s and 170-225 Mc/s. The Tuner is supplied wired and tested and is complete with Valves, all connecting leads and fixing brackets.

THIS DESIGN MAY
BE BUILT FOR **£32. 7. 11** (plus cost of
C.R.T.)

DESIGN 2. Channels 1-5, tunable from 40-69 Mc/s.

THIS DESIGN MAY
BE BUILT FOR **£27. 9. 4** (plus cost of
C.R.T.)

- ★ Constructors who have built Design 2 (5 Channels) may convert their Receivers to Design 1 for £6: this price includes Multi-Channel Tuner, New Vision Input Coil and full instructions.
- ★ All Coils supplied for these two Superhet Receivers are PRE-TUNED, ASSURING ACCURATE ALIGNMENT AND EXCELLENT BANDWIDTH.
- ★ Duomag permanent magnet focusing with simple picture centring adjustment.
- ★ Exceptionally good picture "hold" and interlace. ★ Noise suppression on both Sound and Vision.

The Televisor may be constructed in 5 easy stages: (1) Vision, (2) Time Base, (3) Sound, (4) Power Pack, (5) Final Assembly. Each stage is fully covered in the Instruction Book, which includes layout, circuit diagrams and point-to-point wiring instructions. The Instruction Book also includes full details for converting existing Premier Magnetic Televisors for use with modern wide angle tubes. All components are individually priced.



Practical Television

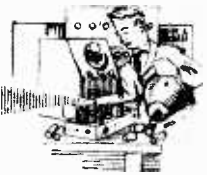

& TELEVISION TIMES

Editor : F. J. CAMM

Editorial and Advertisement Offices : "Practical Television," George Newnes, Ltd., Tower House, Southampton Street, Strand, W.C.2. Phone : Temple Bar 4363. Telegrams : Newnes, Rand, London.
Registered at the G.P.O. for transmission by Canadian Maritime Post.

Vol. 7 No. 74

EVERY MONTH

SEPTEMBER, 1956

TelevIEWS

COMMERCIAL TV IN THE RED

THE accounts recently published by the Associated British Picture Corporation very clearly indicate that the programmes at present are not profitable for the contractors, in spite of the much larger sums of money which manufacturers are spending on commercial television and apart from the fact that the number of TV licences continues to increase notwithstanding the hire purchase restrictions and the credit squeeze.

According to official figures, there are 16,000,000 homes in Great Britain and television is installed in 5,925,000 of them. This is 37 per cent. of the total, and of this 37 per cent. 1,600,000 have receivers converted for or capable of receiving I.T.A. programmes. We understand that some advertisers who have taken programme time have not found it so profitable as older established advertising media.

The three areas covered by I.T.A. are London, Birmingham and Manchester, and 45 per cent. of the homes in those areas have TV sets and 20 per cent. of these can receive the commercial programmes. The conclusion, therefore, is reached that the programmes are not reaching or not looked into by the potential viewing public or that the fleeting publicity allowed in return for the high price charged per minute is too ephemeral to provide worth-while returns to manufacturers. Before another year has passed, at least 7,000,000 homes will be equipped with television and 2,500,000 of these will be able to receive I.T.A. It is undeniable, however, that more and more people are watching I.T.A. programmes, and this is admitted by the BBC.

Up to March 31st, £3,918,000 has been spent on programme time, in addition to the cost of producing the programmes. Up to that date, however, London only was operating for the major part of the time, and Birmingham had only been running for about six weeks. As an encouragement, since the end of March, the price of programme time has been lowered and

free bonus time has been accorded to some advertisers. Manchester has been on the air since May 3rd, and the programme time has been increased from 43 hours to 48 hours per week per station. Commercial TV will start its second year at the end of September, and the financial prospects from then on are brighter. It has been suggested in some quarters that the I.T.A. revenue should be augmented by a proportion of the licence money collected by the Post Office for the BBC., the supporting argument being that the number of sets and licences has increased during the past year because of the introduction of commercial TV.

HOME-BUILT TV

THE number of home-built receivers continues to increase and according to our records something like half a million home-built receivers are now in operation. This includes those built round the VCR97 and similar units. Very large numbers of those described in this journal or in our Handbook, "Practical Television Circuits" (15s. 6d., by post), have been built and are still being built.

BAND III CONVERTERS

THOSE readers who were unable to obtain copies of our series of articles on the Band III converter for the Viewmaster will be interested to know that they are now reprinted in the form of a booklet and copies may be obtained from the offices of this journal, address as above, for 2s. 9d., by post.

QUIZ PROGRAMMES

THE American-inspired quiz programmes in which a selected viewer is invited to answer a series of questions on a double or quits basis does not strike us as having a particular entertainment value for anyone, except the persons concerned. It is always possible to frame a series of questions, some of which could not be answered by anybody without reference.—F.J.C.

TELEVISION AT THE RADIO SHOW

A REVIEW OF MANY OF THE SETS TO
BE SEEN AT THIS YEAR'S SHOW

OWING to the fact that this issue goes to press before the opening of the Radio Show, we are only able to reveal those details of the exhibits which have been released by the manufacturers. As in previous years no doubt one or two surprises will be kept until the opening day, but developments during the past twelve months are such that it would not appear that there will be anything startling. The most interesting surprise last year was the portable TV produced by Ekco, and this year other portables will be on view. There is a tendency in the U.S.A. for all homes to have two receivers—one a permanent installation and the other a portable which is intended to be carried from room to room. A similar trend is gaining ground here,

and of the portables to be shown one is illustrated above. This is the Murphy V230, which is an A.C., D.C. superhet with a 12in. tube. A turret tuner is fitted giving reception on Bands I and III, and the cabinet is in a resin-bonded fibre. The total weight of the receiver is 28 lb. and it measures 14½in. high by 14in. wide and 17½in. deep. The price is £54.

The only other possible development will be the extended use of the printed circuit technique. Although one or two firms had introduced this in certain places last year, the practice has steadily grown during the past year, and although we have no details of an "all-printed circuit" for the complete receiver it will be found in several vision strips and tuners and no doubt also in other parts. Accompanying this development there is, of course, the extended miniaturisation of components, many being designed specifically for use in printed circuits and having special contact surfaces for this purpose.

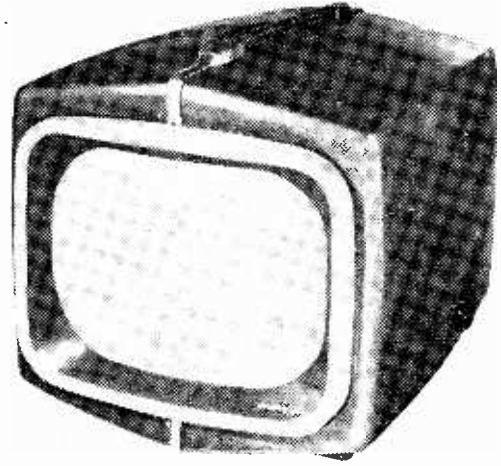

The Murphy 12in. portable 4-channel receiver.

Amongst the test equipment further items designed especially for television purposes will be found, both of the ordinary testmeter type and of the specialised form, such as pattern generators, wobblers, etc.

So much for the general overall picture, and now to deal with the individual exhibitors on the television side.

THE RADIO SHOW
August 22 to Sept. 1
OUR STAND No. 111

AIRMEC, LTD.
(Stand No. 212). The well-known Televet, shown on page 57, will be featured on this stand and, as has already been mentioned in these pages, this is a complete television servicing unit. It incorporates a wobbler,

pattern generator, A.M. signal generator, L.F. oscillator, oscilloscope, E.H.T. voltmeter and an A.C. and D.C. valve voltmeter, all in a case measuring only 15½in. by 9½in. by 8½in. The weight is 25 lb.

ALBA (A. J. Balcombe, Ltd.) (Stand No. 61). Under the trade mark Alba several receivers will be seen here, and the main feature will be the low price at which they sell. For instance, the Model T644 (seen on page 56), with a 17in. tube costs only 68 guineas. Amongst the features in the models are separate sensitivity controls for Band I and Band III, and electrostatically focused tube. A new 21in. model will also be seen but no details of this are available as we go to press.

AMBASSADOR RADIO & TELEVISION, LTD. (Stand No. 43). A feature of the Ambassador receivers is the corner-type cabinets in which the overall space which the receiver takes up is considerably reduced, and at the same time the use of large tubes is permitted. A receiver with a 17in. tube will, therefore, take up less room than an orthodox

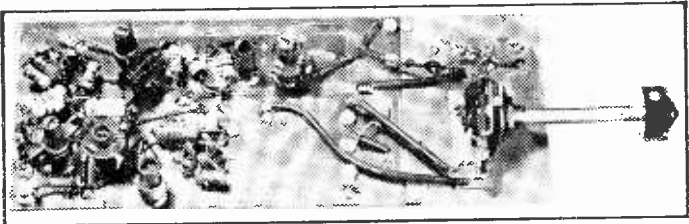

A printed circuit panel as used in the Spencer-West converter.

style cabinet with a much smaller tube. Twenty-one-inch models are to be seen, and these are available with or without protecting doors. All other standard features, such as turret tuning will also be seen.

ANTIFERENCE, LTD. (Stand No. 69). Here the emphasis is on aerials, and in addition to the various forms of Band III models some interesting combined types will also be seen. These are sold under the reference HIL-O, an exclusive feature making use of what the makers term "electronic coupling," which ensures good matching without some of the intricate aerial coupling bars and other devices usually employed.

BELLING & LEE, LTD. (Stand No. 49). The well-known Belling-Lee products will be seen here and also include many types of combined aerial. Band I aerials for horizontal or vertical mounting and some indoor Band III models will also be shown, and will include a "bat's ear" type Band III model shown for the first time. Diplexers and various coupling units, etc., will also be featured.

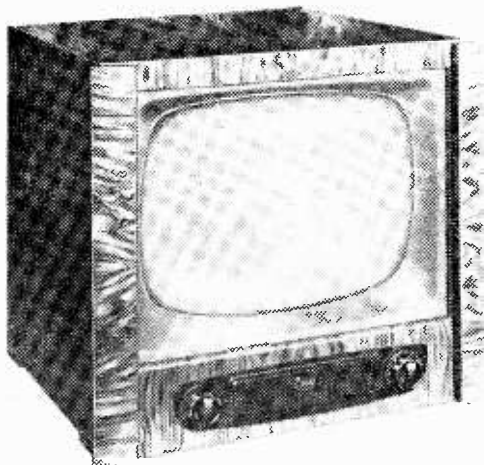

R.G.D. Model 1756T.

BRIMAR (Standard Telephones & Cables, Ltd.) (Stand No. 39). The special teletubes shown here are all of the aluminised variety, are flat faced and rectangular, and of the tetrode type. A new model will be the C21KM, a 21in. model with 90 deg. deflection angle. The overall length of this tube is the same as the 70 deg. model in 17in., thus permitting the designer to build a model with a larger picture but with no overall increase in cabinet size. All types of valve will also be shown including many specially designed for television reception.

BULGIN, A. F. & CO., LTD. (Stand No. 26). The multitude of Bulgin accessories are already well known and the exhibit forms one of the most attractive in the show. The various coloured signal lamps, control knobs and similar items will form a mass of colour, and every constructor will no doubt be able to find something here which he can use, either in experimental apparatus or in existing equipment.

BUSH RADIO, LTD. (Stands No. 17 and 29). The latter stand is devoted solely to television, whilst

the former has a complete range of all their models—including radio. On the television stand all models are equipped to receive either BBC or I.T.A., and converters are available for use with any Bush receiver made since June, 1950. One of the models which will no doubt prove most popular on this stand is TV62, which has a 14in. tube and costs 59 guineas.

CHANNEL ELECTRONIC INDUSTRIES, LTD. (Stand No. 108). In addition to various Band III converters and other types of test apparatus, a TV waveform generator will be shown. This has direct video and audio outputs and provides an unmodulated video carrier, a synchronised blank raster, adjustable patterns, graduated bars and a separate modulated sound carrier.

COSSOR, A. C., LTD. (Stand No. 57). All of the Cossor models are designed for both Band I and Band III and all are of the A.C./D.C. type. Here, also, will be seen a 21in. model, in this case a table version with a completely new chassis layout and cabinet design. Fitted with a touch-tuning turret, this set incorporates an aluminised tube, self-centring flywheel sync. and A.P.C. The new cabinet design is particularly noteworthy as it permits the tube face to be easily cleaned.

DECCA RECORD CO. LTD. (Stands No. 35 and 37). Under the Decca trade mark will be found nine television receivers, at prices from 69 and 159 guineas. Some novel features in cabinet design are promised, and one model will include, in addition to the television receiver, V.H.F. and an automatic record changer. No actual details have been received as we go to press.

DEFIANT (Co-operative Wholesale Society Ltd.) (Stand No. 60). The eight models shown here include such features as aluminised tubes, flywheel sync, turret tuning and, of course, facility for receiving either BBC or I.T.A. transmissions. The models range from a 14in. table model to a 21in. 15 valve console, incorporating a 10in. loudspeaker, and a permeability tuned 13-channel tuner. A Band III converter for use with either Defiant or other receivers will also be seen.

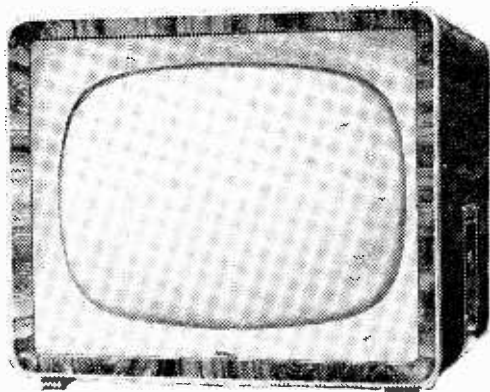

In this model by Sobell the entire front is devoted to picture area.

DYNATRON RADIO LTD. (Stand No. 4). In the two basic models to be shown by Dynatron one of the features is that of high-definition. Incorporating in one case a 17in. and in the other a 21in. tube, these models are supplied in different types of cabinet under various references, basically TV31 for the 21in. models and TV30 for the 17in. models. The TV.31C, for instance, in addition to the television circuits incorporates F.M.

EDISWAN (Edison Swan Electric Co. Ltd.). (Stand No. 19). As manufacturers of valves and tubes under the Mazda trade mark, a 14ft. high cathode-ray tube will be used to identify this stand. Various valves and tubes specially for television use will be featured.

EKCO (E. K. Cole Ltd.). (Stand No. 30). Again the range is from 14in. to 21in., and amongst the many features included, will be turret tuning, aluminised tubes and flywheel sync. A remote control device enables a viewer to adjust brightness and volume from the viewing position, and is known as the Ekco "Armchair" control.

ENGLISH ELECTRIC CO. LTD. (Stand No. 40). In addition to valves and tubes for television, ten receivers with screens from 17in. to 21in., and also in table, console and console versions, will be shown. No further details are available.

FERGUSON (Thorn Electrical Industries Ltd.) (Stand No. 12). Amongst the Ferguson models will be three new ones, incorporating 17in. and 21in. tubes. One of these, the 306T, employs a new vertical

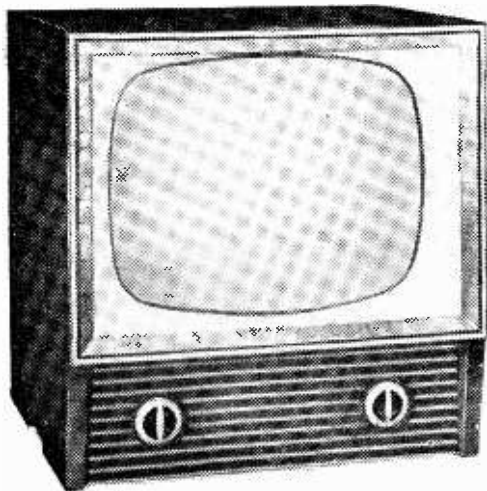

The Ferranti Model 17T6, a 17in. table model.

chassis, whilst two of them have a moulded control escutcheon with finger-tip on/off switch. In addition, they include the Channel-lite programme selector which indicates to what programme the receiver is tuned and serves also as a pilot light.

FERRANTI LTD. (Stand No. 31). The Ferranti ranges run from a 14in. model at 67 guineas to a 24in. projection model. Shown above is a table model 17in. set, Model 17T6, which costs

78 guineas including P.T. A table projection model giving a 20in. picture is the latest model, and this includes a multi-channel turret tuner. Some converters for older Ferranti models will also be seen.

G.E.C. (General Electric Co. Ltd.) (Stand No. 53). The new models here, all of which have aluminised tubes, include 17in. and 21in. tubes. Further, all new models include a 12-position turret tuner and neutral filters to provide good definition. A novel feature is the 21in. table model which has detachable legs. Other models will include flywheel sync. and

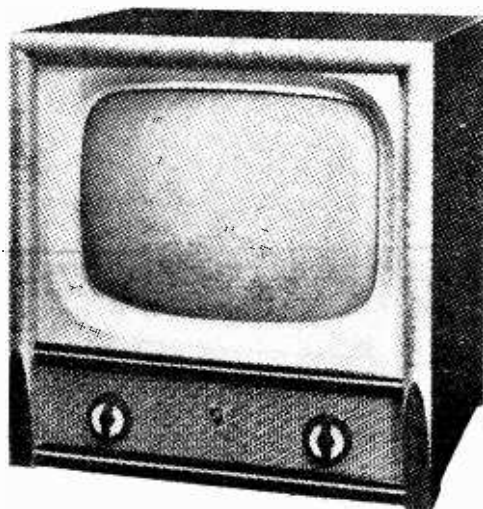

This is the Alba Model T644.

there will also be a range of Band III adaptors for use with earlier models.

H.M.V. (Gramophone Co. Ltd.) (Stand No. 28). Two new 21in. models will be shown and these include twin loudspeakers for high-quality sound reproduction. Model 1847 has removable metal legs, and other 14in. and 17in. models include the electrostatically focused tube.

INVICTA RADIO LTD. (Stand No. 65). Here again the models range from 14in. to 21in., the latter being in the form of a console with full-length doors and costing 140 guineas. No technical details are available.

J-BEAM AERIALS LTD. (Stand No. 1). Among the many different patterns of aerial to be seen here, one of the interesting features is the utilisation of the "slot," well depicted in the Hornbeam 13-channel model. These also have telescopic Band I elements so that they may be accurately adjusted for any BBC channel, whilst the "slot," or "Skeleton Horn" as the makers have named it, covers the whole of Band III.

KOLSTER-BRANDES LTD. (Stand No. 20). All the K-B models have turret tuners and aluminised tubes. They range from 14in. to 21in. and are available in table or console versions. Turret-tuned 12-position adaptors for older models will also be seen.

LABGEAR (Cambridge) LTD. (Stand No. 203). Among the various specialised items to be seen here, the most interesting will be the new composite Band I/Band III aerial. It is believed that this is the first combined aerial for direct plugging into an aerial socket without a feeder. It is patented and consists of a Band III dipole round which the Band I aerial is wrapped in the form of a spiral so that it only takes up the same amount of length as the Band III dipole. The overall diameter is only 1in., with the length 30in.

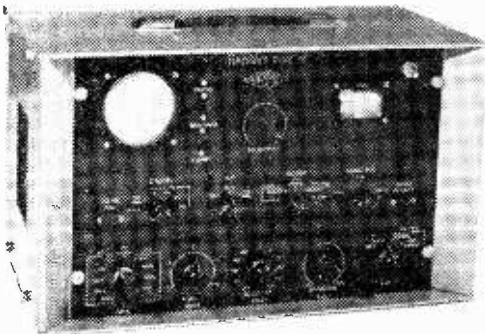

The Televet, a complete television servicing set with oscilloscope readings instead of a meter.

MARCONIPHONE CO., LTD. (Stand No. 23). Two 14in., two 17in. and a 21in. model will be shown here, featuring the electrostatically focused tube. Various other features will be included, but details are not to hand.

MASTERADIO, LTD. (Stand No. 15). Amongst the main features incorporated in the Masteradio models will be found that of the easily removable mask to facilitate cleaning the face of the tube. A.V.C. fly-back suppression and multi-channel tuning are other features to be found in the 14in., 17in. and 21in. models.

McMICHAEL RADIO, LTD. (Stand No. 59). 14in., 17in. and 21in. receivers will be shown here, in cabinets with and without doors, and one of them, a 17in. model, incorporates an A.M./F.M. radio receiver. No other details are available.

MULLARD, LTD. (Stand No. 32). Although no details have been received at the time of going to press, we understand that the main feature of this exhibit will be the tubes and valves produced by Mullard specifically for television.

MURPHY RADIO, LTD. (Stand No. 42). As mentioned in the opening remarks, a portable is one of the main features of the Murphy stand. In another model, shown on the right, the circuit includes turret-tuning, aluminised tube, gated automatic picture control, flywheel sync. line suppressor and black spotter. This model costs £159.

PAM (Radio and Television), LTD. (Stand No. 55). Again 17in. and 21in. receivers form the main feature on the Pam stand. The table 17in. set costs 78 gns. and the 21in. console, with full-length doors, costs 133 gns. No technical details are available.

PETO SCOTT ELECTRICAL INSTRUMENTS, LTD. (Stand No. 14). One of the models to be shown here, No. 1419, is a 14in. electrostatically focused table model, so designed that servicing of most of the circuits may be carried out without removing the chassis from the cabinet. The conventional mask has been dispensed with, providing the largest possible picture on a 14in. tube.

PHILCO (GT. BRITAIN), LTD. (Stand No. 22). No details have been received so far, other than that the models will range from 14in. to 21in.

PHILIPS ELECTRICAL, LTD. (Stands Nos. 44 and 45). In addition to a 14in., three 17in. and a 21in. direct viewing models, Philips will also be showing a 23in. projection model with turret tuner. This tuner is used in all the models, which range in price from 66 gns. to 112 gns. No other technical details are available.

PILOT RADIO, LTD. (Stand No. 27). Five models are to be shown here, one with a 14in. tube, three with 17in. tubes, and the fourth with a 21in. tube. This is a luxury console model with fold-back double doors, 13-channel tuning and costing 130 gns. The 14in. model—an A.C. table set—costs 65 gns.

PYE, LTD. (Stand No. 13). All the Pye receivers are fitted with A.P.C., 13-channel tuning and tinted screens for daylight viewing. No further details are available concerning sizes and circuitry.

R.G.D. (Radio Gramophone Development Co. Ltd.) (Stand No. 52). On page 55 may be seen one of the new R.G.D. Models - the 1756T. This is a 17in. model with 17 valves and 13-channel tuning.

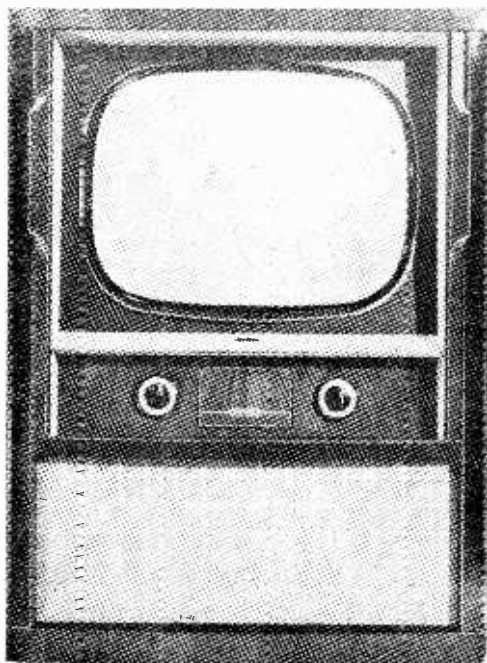

The Murphy 21in. set with all modern circuitry. It costs £159.

and costs 69 guineas. "Synchrolock" control is provided for fringe area reception, together with a control for picture tone—giving "hard" or "soft" pictures at a touch. The same model is available in console form with full-length doors for 109 gns.

REGENTONE RADIO & TELEVISION, LTD. (Stand No. 60). Big pictures on standard tubes form a feature of the Regentone receivers, due to the use of a special mask. Included in the various models is the 173, which combines with a 17in. picture a V.H.F./F.M. and normal broadcast receiver, as well as a record-changer. This model costs 183 gns. This television receiver, as well as its table counterpart, incorporates an "anti-flutter" device.

SOBELL (Radio & Allied Industries, Ltd.) (Stand No. 33). The most interesting exhibit here will be the model shown on page 55. Known as the 21in. All-picture receiver, this includes a 21in. tube in a cabinet measuring only 20in. by 23in. by 20in. As will be seen from the illustration, the entire front of the cabinet is occupied by the tube face and no controls or loudspeaker fret appear on it. These are all on the sides and thus the cabinet dimensions have been kept very small and the general appearance improved. The price of this model is 86 gns.

SPENCER-WEST, LTD. (Stand No. 211). Among the many interesting items to be seen here, one of the most interesting is the Band Converter shown on the right. This incorporates a printed circuit as shown in the panel view on page 54 and has many interesting details. Other products include aerial coupling units, matching units, distribution accessories, and a pattern removing unit for use in conjunction with Band III converters.

STELLA RADIO & TELEVISION CO., LTD. (Stand No. 56). Again here 14in., 17in. and 21in. receivers will be shown, but no details of circuitry, etc., have been received.

T.C.C. (Telegraph Condenser Co., Ltd.) (Stand No. 64). In addition to the wide range of condensers and similar items for which T.C.C. are famous some printed circuit equipment will also be seen. Aerial filters, cross-over networks, I.F. transformers, and TV tuners will also be shown, especially the printed circuit panel which was specified in these pages for the conversion of the View Master for Band III.

TAYLOR ELECTRICAL INSTRUMENTS (Stand No. 106). The most important item on the Taylor stand will undoubtedly be the Model 94A Waveform generator, which incorporates in one case four separate instruments—a pattern generator, an A.M. signal generator, an F.M. signal generator and a sweep oscillator—covering the range from 7 to 240 Mc/s. Other items include a TV and F.M. sweep oscillator, an oscilloscope and a valve tester which has provision for the testing of TV tubes.

TELEQUIPMENT, LTD. (Stand No. 63). Various items for servicing and testing television equipments will be seen here, but no details of them have been received.

TELERECTION, LTD. (Stand No. 18). The accent on this exhibit will be on low-priced aerials designed to facilitate easy erection. The range extends from simple indoor Band I model to large 6-element

stacked arrays for Band III. The latter is in a new series of Double Delta designs which the makers have produced for easy assembly and for reception in difficult close-in areas and at the other extreme—"fringe" areas.

ULTRA ELECTRIC, LTD. (Stand No. 41). Again 21in. models will be featured but no details have been received of the various models.

VALRADIO, LTD. (Stand No. 213). In addition to specialised converters and power units for television receivers, the Valradio exhibit will feature the well-known projection system and screens, as well as

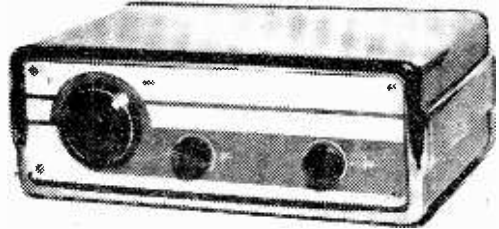

The Spencer-West Type 50 Band III converter.

multi-channel tuners in 10, 11, 12, and 13 station models.

VIDOR, LTD. (Stand No. 11). Two Vidor models will be featured, both with channel tuning, automatic picture control and a feature which the makers term "edge-to-edge" pictures. No other details are available.

WAVEFORMS, LTD. (Stand No. 205). Here will be featured a new portable oscilloscope of new design, specially for the television engineer. This will include a new Miller timebase and a signal amplifier bandwidth of 6 Mc/s.

WOLSEY TELEVISION, LTD. (Stand No. 2). Various single and multi-element arrays are to be shown by Wolsey, and a special feature is to be made of loft and indoor models. Amongst the latter will be a table top Band III aerial claimed to be the first to be shown. It includes a cross-over network and arrangements for the connection of a Band I aerial.

**PRACTICAL WIRELESS SEPTEMBER ISSUE
NOW ON SALE PRICE 1/3**

The current issue of our companion paper "Practical Wireless" describes the construction of a battery-operated Tape Recorder as its main feature. This utilises a clockwork gramophone motor as the driving mechanism, and it will prove an ideal unit for those wishing to make outdoor recordings.

Other articles describe the construction of an Experimental Power Pack—a most useful piece of equipment for the experimenter or serviceman's workbench, and a Transistor Two, an ideal basis for a pocket portable or other miniature receiver. A comprehensive article on push-pull amplification is to be followed by a constructional feature on a practical design incorporating this circuit. Users of ex-service equipment will be interested in the article on the R.1155 communications receiver which explains how to modify this popular set for domestic use. A regular contributor tells how to add another Transistor Stage to various transistor circuits, whilst this month's Servicing article deals with the Bush DAC10.

The regular features such as the Short Wave Section, Transmitting Topics, Letters from Readers, On Your Wavelength, etc., will also be found in this issue.

A Beginner's Guide to Television

A NEW SERIES

6.—THE TELEVISION CAMERA EXPLAINED

By F. J. Camm

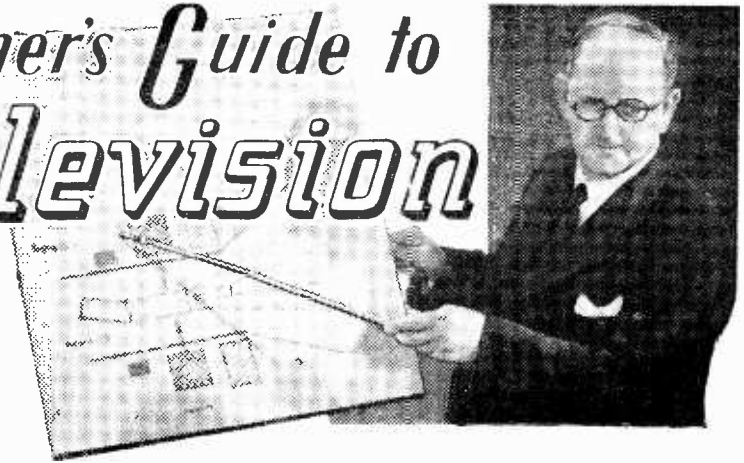

THE television camera is the basis of television transmission. It is the device which, so to speak, surveys the scene in the studio and feeds the scanning system which breaks the picture up into a number of pieces, to be reassembled through the timebase system of the television receiver. In this country the Emitron, the super Emitron and other cameras are in use, and in America there is the Iconoscope, the Orthiconscope, or Orthicon, the Image Orthicon and several others. I will deal with the Iconoscope since its principles apply to all television cameras. The Iconoscope is really a development of the cathode ray tube. It was invented by Dr. V. K. Zworykin, and it is actually a cathode ray tube with a memory. In order to understand the functioning of the Iconoscope it is necessary to remember what we have learned about the functioning of the cathode ray tube. We have seen that an electron stream is liberated from the filament or cathode and "fired" on to the phosphorescent screen on the end of the tube by means of an electron gun and various deflecting plates and coils. By applying various potentials to the deflecting plate, the electron stream can be made to move backwards and forwards in a horizontal and in a vertical direction so as to traverse a complete rectangle on the screen, known as the raster. If the beam is modulated by the received television signals, it will produce a series of spots of light of different intensities on the phosphorescent screen, resulting in the formation of a complete picture.

In the case of the Iconoscope, however, the phosphorescent screen is replaced by millions of minute photo-electric cells, each of which consists of a tiny globule of metallic silver covered with caesium. This mosaic of cells is deposited as a thin film and each individual cell is insulated from its neighbour. The

picture which is to be transmitted is focused by means of a lens on to the mosaic bank of photo-electric cells inside the tube; and the varying light intensities applied to this mosaic of cells produce an electrical change which can be compared with the chemical change taking place on an ordinary photographic plate, when a camera lens is opened and focused. Each individual cell of the mosaic liberates a certain number of electrons, proportional to the intensity of the light directed upon it. This results in the cells (which act as minute condensers) becoming charged. As light falls upon the sensitised surface of each cell, some free electrons are liberated with the result that there is a surplus charge of positive electricity on one plate of the condenser and a corresponding negative charge on the other. The next step is to convert the electrical charges built up on the condensers into corresponding signal currents which can be used after suitable amplification to modulate the carrier wave of the transmitter, so as to radiate the electrical equivalent of the complete picture.

The electrode assembly is set in the path of the electron stream produced by the gun which acts as a scanning beam as it passes to and fro over the cells. The beam discharges each cell in turn and causes a series of

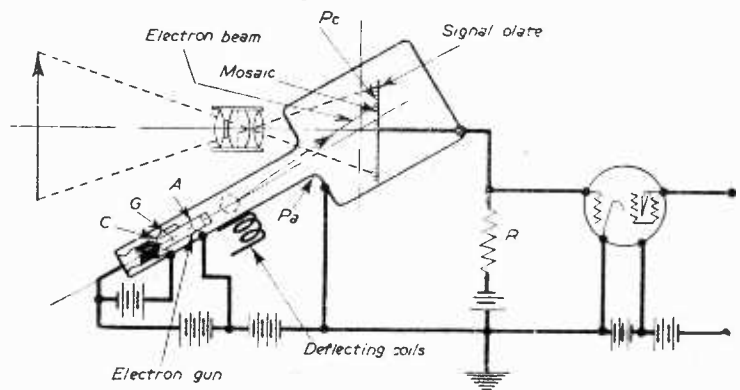

Fig. 21.—Theoretical circuit of the Iconoscope and part of the associated equipment.

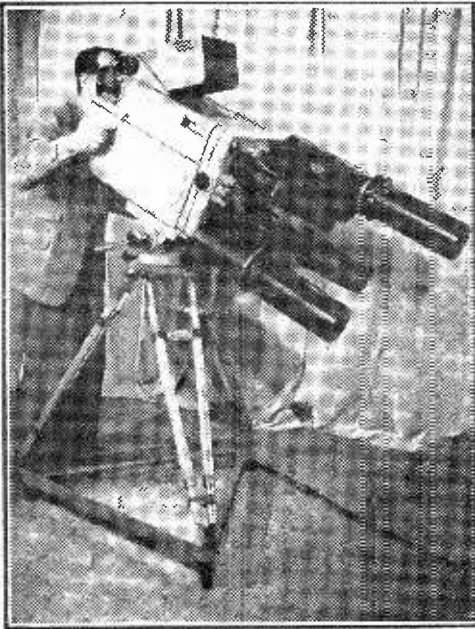

Fig. 22.—A Marconi Type BD.687 camera in operation. Note the assembly of telephoto lenses and the viewfinder.

current surges to pass through a resistance which is connected in the input circuit of the amplifier. Each pulse of current is the electrical equivalent of the light intensity of a particular portion of the original picture. It will thus be seen that the whole of the original picture is converted into its electrical counterpart by the charging action of the mosaic of cells.

These charges are afterwards scanned in correct sequence by the electron beam and thereby applied to the amplifier and thence to the transmitting apparatus proper. At the receiving end the signals are applied to an ordinary type of cathode ray tube, and the electrical pulses are thereby reconverted into points of light which are of varying intensity.

The result is that the picture seen on the fluorescent screen of the cathode ray tube is identical with that focused on to the bank of photo-cells of the transmitter.

Outdoor Scenes

A particular advantage of the Iconoscope is for the transmission of outdoor scenes. This is because the picture to be transmitted is constantly focused upon the mosaic cells, so that they are constantly building up a charge during the complete length of time between one scanning period and the next. This permits of the formation of a much stronger

electrical image than can be obtained by normal methods of scanning, where the spot of light rapidly passes over the picture, and is only applied to the photo-electric cell for a very short time. As a matter of fact, the response of the cell to a ray of light which rests on it for one-twenty-fifth of a second is 40,000 times stronger than it is to an impulse which lasts barely the one-millionth of a second. It is clear, therefore, that the Iconoscope has this much more energy in hand, for which reason it will operate efficiently in outdoor conditions and even in dull weather—when televising by ordinary methods is not practicable.

Thus, we see that it is the purpose of the television camera to scan the picture and at any and every instant to produce an output current which is proportional to the intensity of the light falling upon the camera at that instant. The picture being televised is scanned in zigzag lines from left to right, the start of each line being below that of its predecessor by a distance equal to twice its own thickness or depth, as we have already seen. Fundamentally, the camera consists of a conventional optical system, in which the lenses focus the scene upon a flat screen about 4in. square, which occupies a position in the camera where one would normally expect to find the photographic plate. This screen is made up of several millions of photo cells distributed uniformly over the entire surface of the plate. The construction and the external appearance of the Emitron camera are illustrated. All power supplies, together with the timebase signals which operate the scanning gun, are generated in a central control room, since it is essential that all cameras should be synchronised with one another and with the transmitted waveform. These timebase signals are saw-tooth in shape. That which controls frame movement is of 50 cycles and the line frequency is 10,125, that is, 50 multiplied by $202\frac{1}{2}$ since half the total number of lines are traversed during each frame transmission.

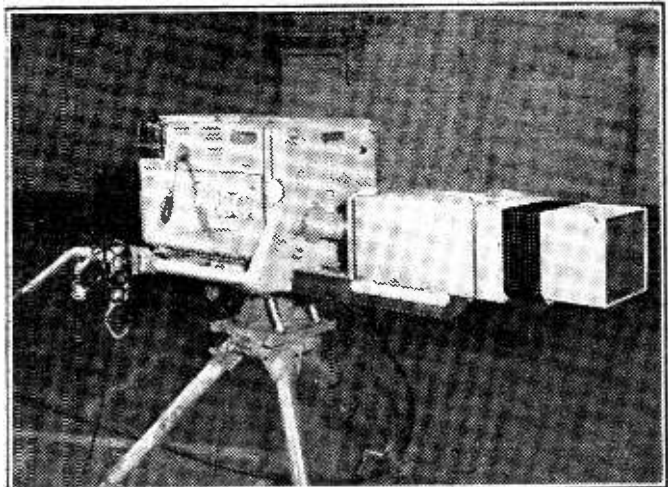

Fig. 23.—A camera fitted with a zoom lens. This is a British invention which enables the operator to run from long distance to close-up shots, keeping the picture constantly in focus. It is now also used in cinema work and is often seen in cricket and tennis relays.

The signal output is taken from the metal backing plate which forms one electrode common to all the individual load condensers. It is taken direct to a cathode follower which acts rather like a step-down transformer but without any large reduction in voltage.

The output from this is amplified several hundred times by an internal valve unit, in order to raise the signal well above any normal interference level, and then fed via a second cathode follower to the cable which connects the camera to the control room and ultimately to the modulation circuits of the transmitter.

The super Emitron separates the functions of photo-electric cell and storage condenser. The light is focused on to a continuous transparent sheet which emits electrons from its reverse side in proportion to the light falling upon each particular area. These electrons are drawn away in strictly parallel lines to a second sheet, which is a mosaic but without any

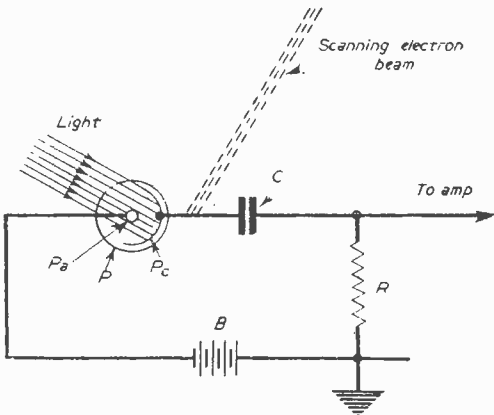

Fig. 24.—Showing the condenser action of each cell of the mosaic.

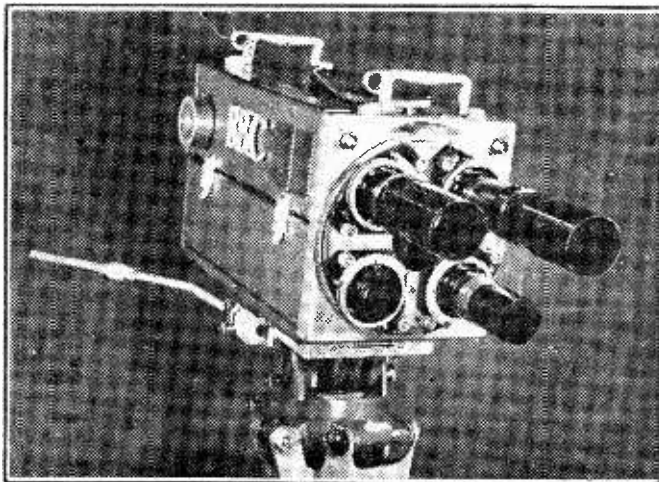

Fig. 25.—The lens turret system of a Pye camera which is of the Orthicon type. This turret is motor-operated enabling either the camera operator or the producer at a distant position to change lenses. The focus as well as the iris diaphragm of the lens may also be controlled from either position.

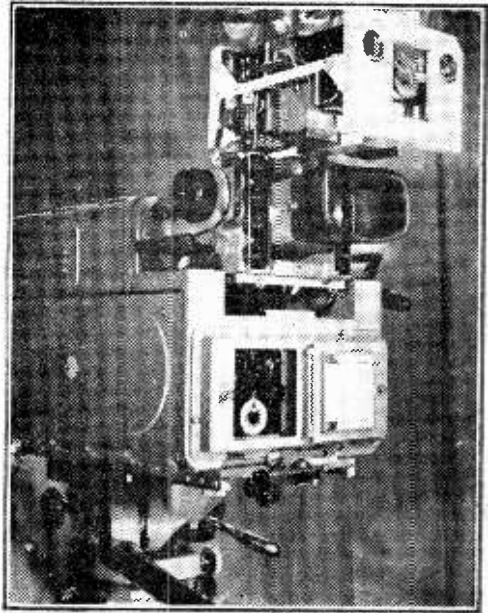

Fig. 26.—The view-finder on a camera turned up for easy servicing. This type of view-finder is, in effect a miniature television receiver, providing the camera operator with a small picture on the end of a C.R. tube.

photo-electric properties. The action of the primary electrons in striking this second screen disturbs many other electrons—it is the possibility of a multiplicative effect due to secondary emission which forms the main advantage of the super Emitron—and each individual unit of the mosaic is sequentially scanned by a cathode ray beam exactly as in the original instrument. The additional sensitivity which is available from this improved camera makes it very suitable for use on outside broadcasts, where the intensity of illumination may be several hundred times less than that met with in the studio.

Photographs and Television

We may thus see that a television picture differs from a photograph. When a photograph is taken the camera is uncovered to permit the whole of the view to be impressed upon the photographic plate at one instant and the varying degrees of light and shade are recorded on the photographic emulsion. If movement is to be recorded, a cinematograph camera is employed in which this process is carried out a number of times each second, each section of the film being exposed to the view instantaneously. It is not possible to transmit television pictures by similar means. At the back of the human eye is a focusing screen known as the retina, which consists of millions of minute cells from each of

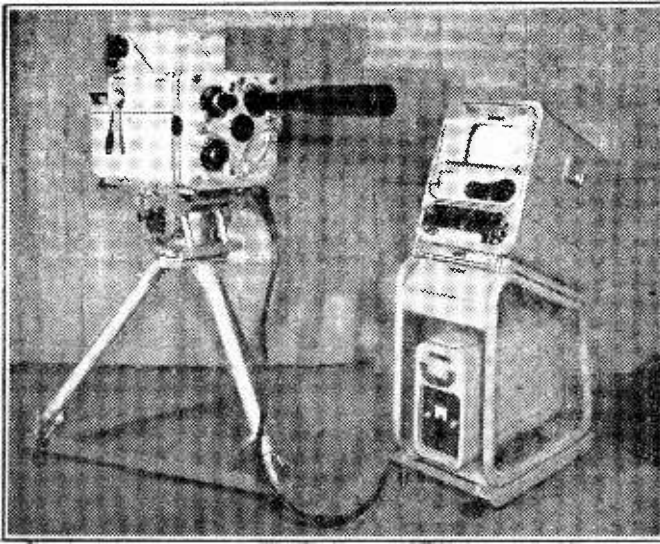

Fig. 27.—A complete Marconi channel system. The Mark 111 camera seen in Fig. 22, a picture and waveform monitor, a camera control unit, and a regulated power supply.

which a nerve cell connects to a similar cell in the brain. These retina cells contain a purple substance and when light falls upon it a message is sent to the brain. The eye, therefore, sees things as millions of tiny bits which the brain reassembles in their correct sequence and value of light, shade and colour.

In the transmitting system a somewhat similar process occurs. The scene in the studio is merely broken up into tiny pieces and translated into an electrical waveform which is radiated through the ether and reassembled in the correct order and translated back into light and shade on the television tube.

With sequential scanning, one difficulty which immediately arises is that of getting adequate sensitivity, bearing in mind that each individual section is viewed for roughly one two-hundred-thousandth part of the duration of each picture, which in any case only lasts for one twenty-fifth of a second itself. Camera minded readers will appreciate the problem of exposure times in the order of 0.0000002 seconds! It is this problem of combining a sensitivity high enough to overcome the inevitable background noises with the demand for a high rate of scanning and therefore a short duration of coverage on each individual section that has determined the characteristics of the television camera as we know it today. It is interesting to recall that in the early days, Baird produced an interesting example of what may be called solution by evasion. The scene to be televised was photographed by a fairly conventional film camera on to a continuous band of film. In a matter of seconds this continuously moving

band was processed and developed, and passed through a scanning raster which directly televised it. The great practical advantage is, of course, that practically unlimited light can then be made available to illuminate it under these conditions. The film was then "washed" clean and returned via the camera head to complete a continuous moving loop; needless to say, it was necessary to delay the sound by a corresponding interval, using a magnetic tape or wire recording system also based upon a closed loop.

Ingenious as such a system was, it had many disadvantages; the outstanding one was the fact that such apparatus was too bulky and complicated to be suitable for outside broadcasts. It was also found that the loss of complete topicality, short as the actual interval was, proved an important psychological deterrent.

The first successful direct-action cameras were the Emitron, produced by McGee and others for Electric and Musical Industries Ltd. (hence its name), and the Iconoscope, developed at about the same time by Vladimir Zworykin for R.C.A. in

America. They were not unnaturally very similar in general design.

Other systems have, of course, been employed but are now entirely obsolete. For example there was the Fultograph, a system invented by Captain Otto Fulton. The Fultograph system was employed by the BBC as long ago as October 1928. In the Fultograph receiver the transmitted picture was traced out by an electrical stylus moving over iodised paper.

There have also been other scanning systems such as the mirror screw and mirror drum, which comprised a number of mirrors arranged in the form of a screw spiral. When rotated it broke up the picture into a number of small pieces; and of course there was the scanning disc which consisted of a circular sheet of metal with a spiral of equally-spaced holes which, when rotated, scanned each piece of the picture. This was the low definition system of 30 lines.

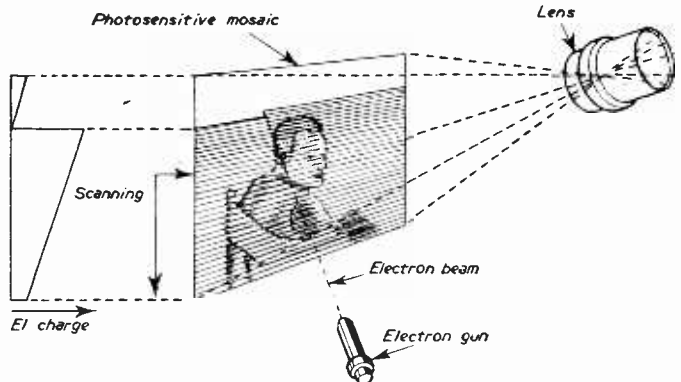
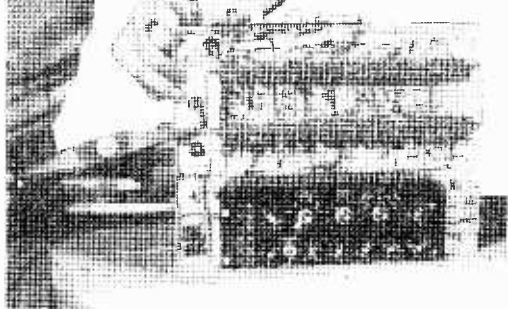

Fig. 28.—Showing how the screen projected on to the mosaic are scanned.

Serviceing TELEVISION RECEIVERS

No. 22.—THE COSSOR 927

By L. Lawry-Johns



THIS is a table receiver employing a 12in. tube and 17 valves. It is a superhet capable of being tuned to any of the five channels in Band 1. It is intended for 200-250 volts A.C. or D.C. mains supply, and two plugs are provided for voltage setting.

The aerial input is designed for 80 ohm coaxial cable and there are two inputs, one direct to the aerial coils and the other attenuated.

The tube is a Cossor 121K which is a tetrode with a bent gun (ion trap) assembly.

Seven 6BX6 valves are employed, these being the equivalent of the EF80 type.

Two double diodes of the 6AL5 type are used (EB91) and three 6AB8 (ECL80).

One each of the following valves are used: 21A6, SU61, 17Z3, 16A5 and 19Y3.

The chassis is very accessible, the lower R.F. chassis being detachable. Removal of this is effected by releasing the side screws, removing the right side wander plug and the octal plug from the right side of the main chassis.

Viewing the R.F. unit from the rear, the left side two valves are the R.F. amplifier and frequency changer which are common to both sound and vision. The rear row after this is concerned with vision only, whilst the nearer row are the sound valves up to the double diode V9, the sound output valve being located on the left far corner of the main chassis (V16, 16A5).

On the lower left side of the R.F. chassis are three core adjustments. The left-hand one is the aerial coil core (L1), the centre is the R.F. coil core (L2) and the right-hand one provided with a marker plate is the oscillator coil core (L3).

Sound on vision, which is indicated

by interference upon the picture in sympathy with sound modulation, and vision on sound, which is indicated by a buzz on the sound which varies with the white content of the picture, may be removed by adjustment to L3. The actual movement required is only slight and is best done upon the BBC tuning note which causes regular ripples of the picture when sound on vision is likely to be troublesome.

The picture and sound interference limiters are mounted on the right side of the rear chassis. The rotary (top) control is the vision limiter, and the plug and socket adjustment is the audio limiter.

Rotation of the vision limiter control anywhere near one end of its travel will cause the peak white content of the picture to be attenuated and the picture will appear flat and lifeless.

Unless severe sound interference is experienced, the plug should be left in the minimum position so as not to impair the sound quality.

Before leaving the R.F. chassis, it may be mentioned that the vision I.F. is 13.6 Mc/s and the sound 10.1 Mc s.

Main Chassis

Viewing the main chassis from the rear and

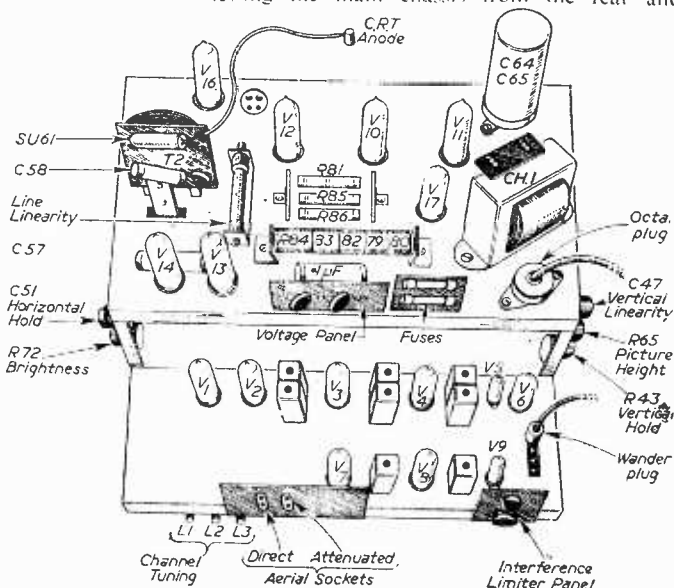

Fig. 1. This diagram shows the R.F. chassis removed for clarity.

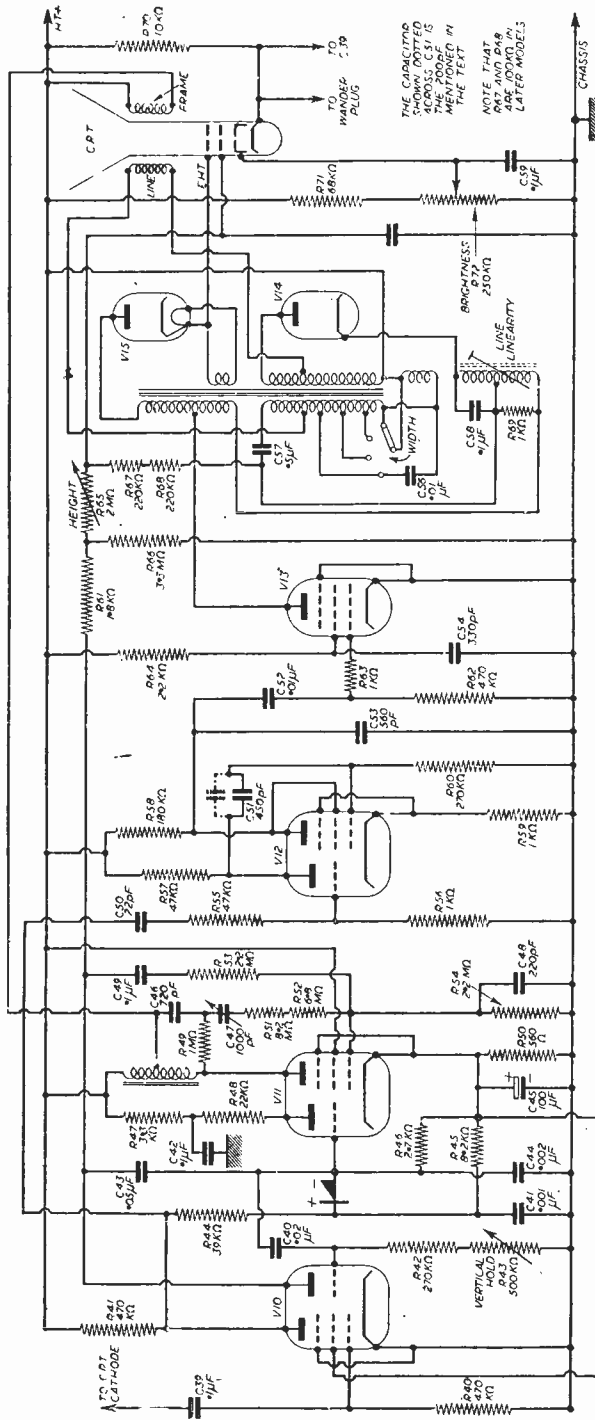

Fig. 2.—Theoretical circuit of the timebases. Note: that C40 should be joined to R48 and the anode V11, not to C43.

referring to Fig. 1, V14 is the 17Z3 efficiency diode, V13 is the 21A6 line output valve.

Behind these is the line output transformer which carries the width control tapping and the SU61 (EY51) EHT rectifier. To the right of this is L14, which has an adjustable core, this operating as the line linearity control. Adjustment widens or narrows one side of the picture more than the other, thus enabling an even horizontal scan to be obtained.

Behind the line output transformer is mounted the (V16) 16A5 sound output valve, and to the right of this is the scan coils socket to which the deflection coils on the tube neck are connected by the four-pin plug.

In the centre of the chassis is a row of three 6AB8 valves. V12 is the line timebase oscillator, V10 is the sync separator and (triode section) part frame oscillator. V11 is the frame timebase output valve (pentode) and part oscillator (triode).

In the rear right corner is the main smoothing capacitor C64 C65. In the centre are two tag boards with three resistors suspended between them.

The separate resistor is the R81, 40Ω, 19Y3, (PY82) anode surge limiting resistor. In the centre is the Thermistor heater circuit surge limiter, whilst its 500Ω shunt resistor is toward the rear of the chassis. The large tapped resistor is, of course, the mains dropper. To the right is the 19Y3 H.T. rectifier and to the right of this again is the smoothing choke. The fuses at the rear are in series with the mains supply and should be rated at 1 ampere.

The vision and sound circuit is conventional and need not be described at length, but there is one point of interest and that is the use of the V5 6AL5. One section of this is used as the vision detector, but the other section is concerned with the sound A.G.C. system and not with vision interference suppression as might be thought. The actual vision limited diode is of the crystal type and is located against the V5 valve base.

The sound 6AL5 (V9) is used as the sound detector and noise limiter. An A.G.C. voltage is derived from the detector diode and applied to the sound I.F. stage (V7), but the actual A.G.C. potential is held at chassis potential until the received signal exceeds a certain level.

Thus, although V5 is "in the vision strip," part of it is concerned with the sound A.G.C. circuit.

Pin numbers 2 and 5 are the anode and cathode of the A.G.C. delay diode.

Timebases

The frame timebase consists of two 6A8 triode sections (V10 and V11) working as a multivibrator, driving the pentode section of V11 which as previously stated is the frame output.

A very common fault is for V10 or V11 to become defective, resulting in a complete loss of vertical control, loss of height sometimes resulting in a thin horizontal line across the screen only, and severe cramping at the bottom of the picture. V11 should be changed first, and then V10.

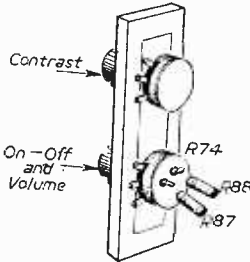

Fig. 3.—Position of R87 and R88.

If loss of frame hold is caused by weak sync pulses, i.e., the picture can be made to roll up or down slowly but will not lock, check V10 and then the crystal diode interlace filter. If the picture roll is only occasional try a slight modification to the value of the resistors R41 and R44. Normally R41 is 470 K Ω , reducing this to approximately 220 K Ω and R44, which is normally 39 K Ω , to some 20 K Ω , will improve the frame hold. Poor frame linearity, that is, when the picture is expanded or contracted excessively at the top or bottom, should direct attention to V11, R49, R51, R52 and C46. If R49 is found to be a single 1 M Ω resistor shunt this with a 10 M Ω to reduce its value slightly. Readjust vertical linearity. If the frame hold is at one end of its travel and the picture still tends to roll check R42, R47 and R48. Sometimes interchanging V10 and V11 will effect an improvement.

Lack of height should direct attention to R61 (1.8 M Ω) if changing V10 or V11 does not improve matters, this resistor being the anode load of the V10 triode section and is in series with the height control. The line timebase is fairly straightforward, V12 has both sections operating as a multivibrator feeding V13 line output pentode.

In the event of insufficient width check V12 and V13 and also the capacitor C56 (.01 μ F) by substitution. If the loss is greater on one side, and is accompanied by cramping, check C57 (.5 μ F) and V14, 17Z3 (PY81). A poor defocused raster should direct attention to C52 (.01 μ F) if the 21A6 (PL81) is in order. The horizontal hold control is a 450 pF variable capacitor; sometimes a 200 pF will be found shunted across this. If the control is fully screwed in without obtaining reliable line lock examine the circuit to see if the 200 pF is fitted before changing V12. If the shunt capacitor is not fitted this small addition should be made so as to allow line lock to be achieved at the approximate centre of the travel of the control.

Loss of line hold should not be confused with intermittent line triggering which may occur, even although the line hold is at its optimum setting. Where triggering does occur, i.e., parts of the verticals are displaced irregularly, check C39 and C50 for leakage. C39 is the .1 μ F sync feed capacitor connecting to the control grid (pentode section) of V10. C50 is the 22 pF sync feed from the anode (pentode section) of V10 to the V12 line multivibrator.

Ragged verticals may be caused by a defective V13, a fault in the line output transformer and, in at

least two cases known to the writer, a loose R.F. unit! The two screws securing the lower chassis were found to be loose and upon tightening these the picture cleared completely. A very common fault on these and other receivers is the presence of left side vertical light bands or striations. This effect can be misleading since although it usually indicates a line timebase defect, such things as the aerial feeder cable, proximity of the receiver to the aerial, defective chassis to earth capacitor and a focus assembly which is not bonded to the chassis can equally be responsible. If the focus unit is not bonded to the chassis this should be done with copper braided cable such as the outer screening of coaxial cable.

If these points are checked and the striations remain operation of the contrast control is a good check since if the mentioned items are responsible the effect will fade when the contrast is reduced to minimum and advancing the brilliance will show a clean raster; check the 21A6 line output valve and then inspect R58 (180 K Ω), increasing this to 270 K Ω if necessary to minimise the bars. To be quite clear about this, if the vertical bars are present with the contrast at minimum R58 or V13 may be fairly suspected.

If line timebase radiation is causing interference with local radio receivers ensure that the cabinet lining foil is in proper contact with the chassis and that the outer conductive coating of the C.R.T. is in proper contact with the chassis spring.

A further point to check is the .1 μ F capacitor which is connected across the fuses. If this is open circuit some radiation will take place.

(Concluded on page 86)

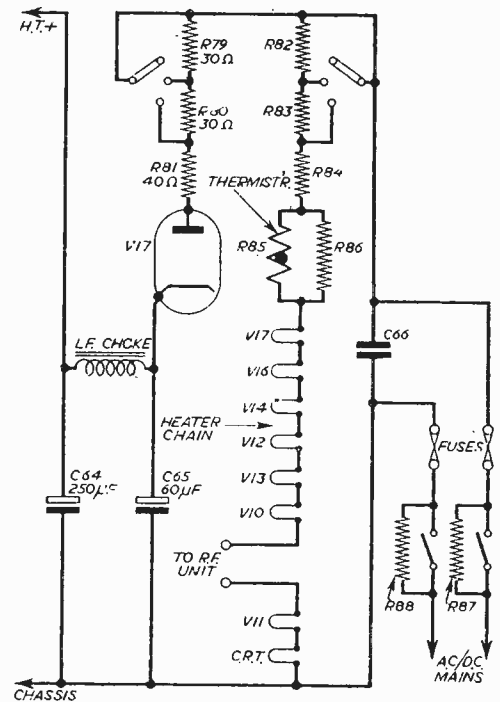

Fig. 4.—Circuit of the power supply section of the Cossor 927.

Facts About TV in Sweden

SOME DETAILS CONCERNING THE ORGANISATION, LICENCES AND RECEIVERS

ON January 25th, 1956, delegates from 10 industrial and commercial organisations, representing the major part of Sweden's economic life—retailers, wholesalers, industry, large and small, exporters, bankers and advertisers—handed over to the Minister of Communications a project aimed at making television accessible within two years to four million Swedes, or about a half of the population of Sweden.

The project, which marks an interesting departure from conventional schemes so far adopted, is intended to try to put an end to the Swedish television stalemate which has so far prevented one of Europe's most technically developed countries from taking full advantage of its possibilities in the television field.

The story of television in Sweden began in 1947, when, as a result of an exchange of views between some private firms on one side and some State controlled organisations on the other, a joint committee was set up to study television research. The committee decided to build an experimental TV transmitter in Stockholm.

In 1950 the Swedish Board of Telegraphs and the Swedish State Broadcasting Company asked the Government for a grant of 2.2 million crowns (then about \$440,000) for the purchase of experimental equipment. The Government refused the grant. Instead, a State commission was created the following year to inquire into television.

In 1952 the commission asked the Government for funds to start some television activities in 1954. The Government said "No."

The following year a group consisting of four large firms manufacturing radio and TV equipment, the co-operatives, the Association of Retailers and the Agricultural Federation asked the Government for permission to start an independent commercial TV organisation with ample room for cultural programmes. The Government turned down the request.

In 1954 a Swedish film producer was granted permission to stage a purely commercial "television week." For once, the Government said "Yes." The idea was to show that commercial TV could have educational and cultural value. But when the film producer asked to go on with commercial TV experiments from September 1st, 1954, to May 30th, 1955, the Government again said "No."

A short time later, in June, 1954, the Government withdrew the right it had granted the Board of Telecommunications to permit TV broadcasts, while the State Radio Company was allowed to take 450,000 crowns out of licence funds to conduct TV research in 1954-1955. Thereupon, the State Broadcasting Company increased its capital from 360,000 to 540,000 crowns to finance its technical equipment.

Regular experimental programmes of one or two hours a week were started by the State Radio on October 29th, 1954—a few days before the publication (on November 8th) of a 213-page report by the Government commission created in 1951.

Since the publication of this report things have remained practically at a standstill in Swedish TV. Parliament was to discuss the findings of the commission in the spring of 1955, but it did not. The State Radio has since increased the length and frequency of its experimental programmes, but there has been no new move on the part of the authorities.

Private interests, however, have not remained inactive. The result of their efforts is shown in the project which has just been handed over to the Government.

The purpose of this project is essentially to provide the public with a TV organisation on a sound economic basis by a compromise between State-controlled TV.

The Project

The main features of the new project are as follows:

1.—The cost of setting up television would be shared equally by the State and private commercial and industrial interests, each contributing one half of a five million crowns initial capital, a further seven million being furnished by credits obtained jointly from the State and the private interests concerned.

2.—The first step of this proposed TV organisation would be to make television accessible within one year to the three largest centres of population in Sweden, Stockholm, Göteborg and Malmö, with a public of over 2.1 million viewers. Within one more year another two million viewers would be provided for. Later, less populated areas and regions in distant parts of the country would be served.

3.—The financing of the scheme would be based on two chief sources of income, one being the licence fees collected by the Board of Telecommunications, the other being the funds derived from advertising time bought by special programme companies.

4.—Strict rules would apply to the commercial programmes; close supervision would ensure high standard and quality. In no case shall the actual advertising in these programmes exceed one tenth of the time; advertising would have to come at the beginning or at the end of the programme and would never be "mixed" with it.

5.—The relatively important place made for the State Radio in the organisation is an interesting feature of the project: the State Radio would benefit from the increased number of licences for the financing of its growing share in the programmes and its technical development. The State Radio would also be responsible for handling the essential links of Swedish TV on the international level.

6.—The TV corporation is asking for a 15 years' concession.

The final decision was reached in Parliament on May 22nd, when the Government Bill was passed in both chambers. This means that Sweden for the moment has decided to have a non-commercial monopolised State television.

AERIALS IN FLATS

SOME INDOOR AERIAL SYSTEMS FOR TELEVISION RECEPTION

By B. L. Morley

EVERY day the number of flat-dwellers is increasing and many town and city councils are overcoming problems of lack of building space by the erection of new multi-storey flats.

The flat-dweller has particular problems with regard to his television aerial: it is obvious that each individual cannot have an aerial on the roof of the building, nor would an aerial mounted on the wall outside each living-room window meet with approval. Such methods would entirely spoil the appearance of the building.

The solution to the problem can be found either in the provision of an indoor aerial for oneself, or in the provision of a communal aerial system by the builder or landlord.

In the case of flats owned by the corporation, or council, then internal aerial installations seem to be becoming the usual practice. Quite often a central aerial is installed which feeds into a pre-amplifier which has multiple outlets (see Fig. 1).

An amplifier giving an overall gain of about 10db is commonly employed.

In very large flats the system is often duplicated and a good high gain aerial used to feed each system.

From many points of view it is desirable to have a single aerial system and where this can be done it provides a good solution to the problem.

Common Aerials

In areas where the signal strength is good, then a single good aerial can provide

up to four outlets. A simple method of connecting the outlets is given in Fig. 2. Pads are inserted so as to prevent or minimise interaction and mismatch.

Of course, losses are incurred in the pads and the system is therefore suitable only for those areas which have plenty of signal to spare.

Such a system is very useful where a large house has been split into two flats. A common aerial can be erected on the chimney and fed into two outlets, as shown. Where it is possible in the ordinary way to make do with a dipole aerial, then if a common aerial system is employed an aerial of the "X" or "double X" can be used, for the extra gain which it gives will counter the losses in the pads.

The system can be extended further by the use of a pre-amplifier having split outputs, the gain of the amplifier being such that the losses caused by splitting the output is more than overcome.

With the inception of Band III the position is further complicated but by the use of "Diplexer" or crossover units and separate wideband amplifiers the problem can be overcome.

The outline of such a scheme is shown in Fig. 3. Much will, of course, depend upon local circumstances, not the least of which is the respective signal strengths in the area.

Individual Aerials

In spite of the now common provision of communal aerial systems there are many cases where this scheme does not fulfil the need. We have cases where the system does not cater for Band III reception: where no communal system exists;

Channel	Length		
1	5ft. 5in.	Dipole Lengths	
2	4ft. 10in.		
3	4ft. 3in.		
4	3ft. 7½in.		
5	3ft. 4in.		
8	1ft. 3in.		
9	1ft. 2½in.		
10	1ft. 2in.		
TABLE II.			
1	11ft. 2in.		Reflector Lengths
2	9 ft. 8½in.		
3	8 ft. 10in.		
4	8ft. 0½in.		
5	7ft. 5½in.		
8	2ft. 5in.		
9	2ft. 4in.		
10	2ft. 3½in.		
TABLE III.			
1	5ft. 7in.	Spacings	
2	4ft. 10in.		
3	4ft. 5in.		
4	4ft. 0in.		
5	3ft. 8in.		
8	1ft. 2½in.		
9	1ft. 2in.		
10	1ft. 1½in.		

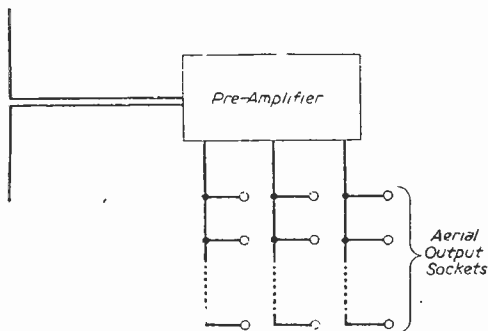

Fig. 1.—Multiple outlets to a single amplifier.

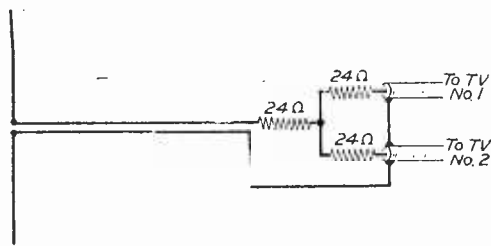

Fig. 2.—How to take two or more feeds from a single aerial.

where the communal system does not fulfil the needs of the viewers.

There are a surprisingly large number of cases where a simple indoor aerial will give sufficient signal strength and there is no need to "hire" an outlet socket from the communal system.

In localities where the signal strength is high, then a simple test can be made to verify if an indoor aerial will suffice. The test need cost nothing.

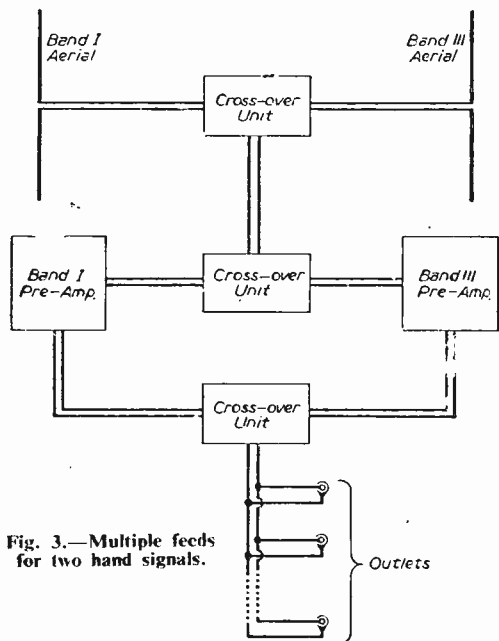

Fig. 3.—Multiple feeds for two hand signals.

Obtain a length of ordinary lighting flex, say about 4yds. long. The flex must be of the twisted wire type, where the two individual wires are insulated from each other and then twisted together.

Now unravel one end for a distance, depending upon the channel of the local station which is given on Table 1. Tack one end of the unravelled portion to the picture rail and let the other end hang downwards. Connect the two free ends of the wire to the aerial input socket. (Fig. 4.)

With this array it may be possible to get a picture and sound on the television. If the picture is good but grainy, then a proper indoor system will do the trick. If the picture is very poor, a more elaborate system can be tried, but results are not guaranteed.

Incidentally, this improvised aerial can save the situation if anything happens to an outdoor one, by providing a signal which is often of usable proportions.

In places where a rough aerial of this type works, then a proper indoor aerial will give a suitable signal. Flat-dwellers who live at the top of the building stand the best chance because not only have they the benefit of greater height, but also they are further from interfering sources.

Indoor Aerials

One of the most versatile aerials for indoors is undoubtedly the ordinary dipole. It is not often realised that this aerial can be bent into a variety of shapes which seem to affect but little its pick-up

properties. What the alterations do in the main is to modify the polar diagram. For this reason some variation in shape may be needed if there is unwanted pick up of interference signals.

In Fig. 5 we show a variety of shapes to which the dipole may be bent in order to accommodate it within a confined space.

The length of each arm is given in Table 1. Note that Fig. 5A and 5B are to a certain extent directional. Where horizontal polarisation is required then the aerial is mounted horizontally. In certain cases this could be along a skirting board or picture rail. Vertical arrangements can be made by fitting along a doorpost or between picture rail and skirting board.

Wire used for the aerial can be the same as that used for an indoor aerial on broadcast wavelengths where conditions will allow. There may be some loss in quality but normally it will not be noticed. Thicker stranded copper wire can be used provided it is not too unsightly.

A point of some importance is the position of the aerial in the room. The best method is to try moving the aerial about to different parts until a really satisfactory position can be found. In steel-framed buildings it may be that the frame will carry interference to the aerial and it should therefore be sited as far away from the steel as possible.

Ghosting

With indoor aerials, trouble may be experienced from reflections which give rise to "ghosts." By this we mean a second image on the screen displaced a little to the right of the main image. The reason for this is the reception of a second signal which is reflected from some nearby object. This second signal arrives at the aerial a little later than the main signal and the result is the production of the second fainter image on the screen.

In some cases it is possible to have a third, or even more "ghost" images.

The cure is first to try to find a position for the aerial where the ghost signal is not picked up, and if this fails, then it would be possible to add a reflector or director to the aerial system.

As an example, a dipole could be fitted between the skirting board and the picture rail on a wall which points in the direction of the transmitter. At a quarter wavelength behind it could be fitted a reflector (Fig. 6).

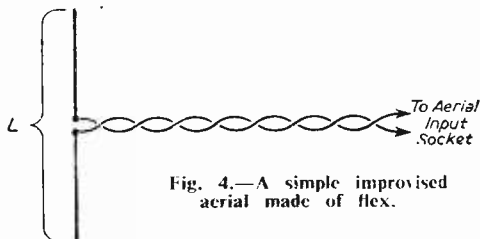
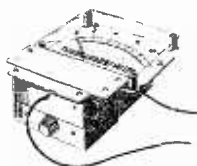

Fig. 4.—A simple improvised aerial made of flex.

First the dipole proper is suspended vertically between picture rail and skirting board so that the centre fed portion comes half-way between the two points. At the high Band III frequencies there will be no difficulty with this but at the lower end of Band I, the dipole ends will have to be bent to accommodate the length.

(Continued on page 71.)

HIGH VOLTAGE TESTER



An instrument that will measure voltages up to 10,000 but which draws no current from the source. Will probably be a valuable addition to your workshop equipment. It can be made entirely from odds and ends. Booklet giving full instructions, plans, etc., 25¢ post free.

14" T.V. CABINET

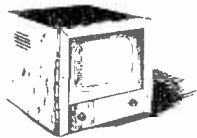

14in. T.V. cabinet of the latest styling made for one of our most famous firms—beautifully veneered and polished—limited quantity—19 6 each. Carriage and packing 3/6 extra.

BAND III PRE-AMP



In difficult areas it will be necessary to increase the signal level and this is the ideal unit for this purpose. It is A.C. mains operated and is fitted with input and output coax. plugs. Price £4. post and packing 3/6.

MULTI-METER KIT

Parts suitable for making a multi-meter to measure volts, milliamps and ohms. Kit containing all the essential items including moving-coil meter, resistors, range selector, calibrated scale, etc., etc., is only 15/- plus 1/- post and packing.



THE CASCODER



Of the several circuits used for Band III conversion at aerial frequencies, undoubtedly the most popular is the Cascoder circuit. We can offer a very good converter suitable for any Band I to any Band III station, in a very neat, polished cabinet with fine tuning, on/off mains. Band I-III contrast switches. Price £7 10/0. post and packing 2/6.

PRODUCTION INCREASED—CIRCUIT IMPROVED—PRICE REDUCED

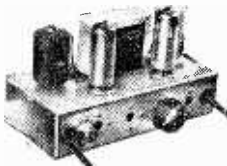

To-day's best value in Band III converters suitable for your T.V. or money refunded. Complete ready to operate. 49 6 non mains, or 69 6 mains, post and insurance. 3/6.

ANNOUNCING THREE NEW SPECIALS THE SKYSEARCHER

An all mains set for 19 6. This is a 2-valve plus-metal rectifier set useful as an educational set for beginners, also makes a fine second set for the bedroom, workshop, etc. All parts, less cabinet, chassis and speaker, 19 6. Data free with parts or available separately. 1/8.

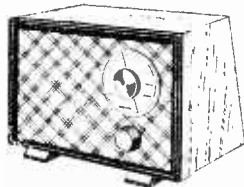

THE REALITE

This is a complete metal fitting, stove enamelled all ready to install. Price 25/- plus 4/6 carriage and packing. 40-watt tube. 10/- extra for packing. £ ordered with fitting.



BABY ALARM

Unlike most baby alarms this not only enables you to hear baby but also to talk to him. Price complete with one microphone and 30 ft. twin flex. £6 19 6. carriage 3/6. additional microphone 19 6.

BAND III AERIALS

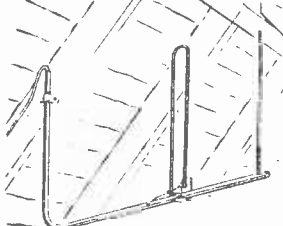

THE INDOOR

This is a 1 wave, 3 element array. Of all alloy construction, the aerial is completely assembled and ready for instant mounting in loft, bedroom cupboard, window frame, etc. Price 12 8. plus 2/6.

- 3 element array with swan-neck mast with U-bolt clamp for fitting to existing masts from 2in. to 2 1/2in. dia. ... 41 6
- 3 element array with cranked mast and wall mounting bracket ... 42 6
- 3 element array with cranked mast and chimney lashing equipment ... 65 -
- 5 element array with swan-neck mast and U-bolt clamp for fitting existing mast from 1 1/2in. to 2 1/2in. dia. ... 52 6
- 5 element array with cranked mast and chimney lashing equipment ... 67 -
- 8 element array with swan-neck mast and U-bolt clamp for fitting to 1 1/2in. to 2 1/2in. dia. mast ... 69 -

BARGAINS TO CLEAR

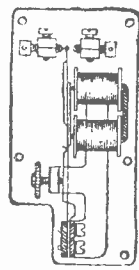

HIGH-SPEED RELAY

This is a miniature type relay with change-over platinum contacts. Bobbins are 250 ohms each. Brand new—limited quantity, 7/6 each, post 1/6.

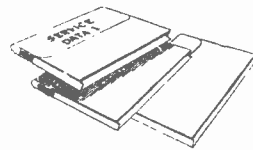

SERVICE DATA

129 service sheets, covering British receivers which have been sold in big quantities and which every service engineer is ultimately bound to meet. The following makers are included: Aerodyne, Alba, Bush, Cossor, Eico, Ever-Ready, Ferguson, Ferranti, G.F.C., H.M.V., Kolster, Brander, Lissen, McMichael, Marconi, Mullard, Murphy, Philco, Philips, Pye, Ultra. Undoubtedly a mine of information, invaluable to all who earn their living from radio servicing. Price: £1 for the complete folder.

Our folder No. 2 consists of 100 data sheets covering most of the popular American T.R.F. and superhet receivers "all dry," etc., which have been imported into this country. Names include Sparton, Emerson, Admiral, Crosley, R.C.A., Victor, etc. Each sheet gives circuit diagrams and component values, alignment procedure, etc., etc. Price for the folder of 100 sheets is £1. post free.

VERY HIGH-POWERED VALVES

Triode Type CV 1038 this is a high-power air-cooled triode. Specification of which is as follows: Filament voltage 8.2 v., filament current 35 amps., anode dissipation 750 watts, anode volts 25 kv.

This valve is very suitable for R.F. heating at high frequencies and two of these in push-pull under Class C conditions would have an output of approximately 2 kilowatts. Brand new, still in original shock-proof packing, price £5 each. Carriage and insurance 10/-.

ELECTRONIC PRECISION EQUIPMENT, LTD.

Post orders should be addressed to E.P.E., LTD., Dept. 5, Sutton Road, Eastbourne.

Personal shoppers to one of these addresses please:

- 42-46, Windmill Hill, 152-3, Fleet Street, 29, Strand Green Rd., 249, Kilburn High Road, Kilburn.
- Ruislip, Middx., E.C.4, Finsbury Park, N.4.
- Phone: RUISLIP 6780 Phone: FLEET 2833 Phone: ARCHWAY 1049
- Halt day, Wednesday. Halt day, Saturday. Halt day, Thursday. MAIDA VALE 4921.

GREAT NEW DO-IT-YOURSELF

FREE
for 7 Days

**NEWNES
PRACTICAL
HANDYMAN**

**THE MOST ALL-EMBRACING WORK
OF ITS KIND EVER PUBLISHED**

This fascinating new work is guaranteed to save you money! With labour costs so high, it will pay you—and pay you handsomely—to do your own repairs and renovations. All you need is the professional knowledge—the know-how of the experts in Newnes PRACTICAL HANDYMAN. The information is given step by step, fully, in SIMPLE language, and deals with a THOUSAND AND ONE JOBS around the home. It costs you nothing to examine, and there is no obligation to purchase. **POST COUPON TO-DAY.**

**REPAIRS - REDECORATION
HOW-TO-MAKE**

- 127 Sections including:—
- Wall coverings. Painting, inside and out. Ceilings.
- Water systems. Frost protection. Sheds. Fences.
- Damp walls. Concrete work. Dry rot and wood-worm. French polishing.
- Graining. Veneering. Built-in furniture. Shelves. Re-upholstering. How to make kitchen cabinets. Electric repairs. Car Troubles . . . And much more besides!



It's easy and saves MONEY!

2 VOLUMES
Art Vellum binding
864 PAGES
with 1,500 illustrations
And in addition
18 HOW-TO-DO-IT CHARTS
in Special Data Case
How to make—
Table, Bookshelf, Garden furniture, Stool, Model Yacht, Writing Desk, Doll's house & furniture, Aquarium, etc.
Don't miss seeing these helpful Charts.
Hurry—Apply now for Free Examination. You'll learn so much at no cost to yourself!

★ Do-it-yourself and you pay for materials only—it's the labour cost which makes bills so high!

SEND FOR FREE EXAMINATION NOW

George Newnes, Ltd., 66-69 Great Queen St., London, W.C.2
Send me Newnes PRACTICAL HANDYMAN. I will either return it in 8 days or send only 5s. deposit 8 days after delivery, then 10s. monthly, paying 45 5s. in all. Cash price in 8 days 45s.

Name

Address

Occupation

Signature (Or Parent's Signature if under 21)

Place X where it applies

<input type="checkbox"/>	HouseOWNER
<input type="checkbox"/>	Householder
<input type="checkbox"/>	Living with Parents
<input type="checkbox"/>	Lodging Address

Apply on own stationery if you do not wish to cut your Practical Television.

ADCOLA
PRODUCTS LIMITED
(Regd. Trade Mark)

SOLDERING EQUIPMENT

ILLUSTRATED

3" Detachable bit type (List No. 64)

Protective Shield (List No. 68)

Catalogues sent FREE

Telephones:

MACaulay 4272 & 3101

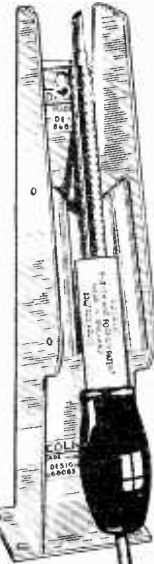

British and Foreign Pats.

Reg. Designs, etc.

Head Office, 8 & 9:

ADCOLA PRODUCTS LTD.

Gauden Road, Clapham High St., London, S.W.4

HANNEY of BATH offers:—

ERIE RESISTORS. All values from 10Ω to 10MΩ. Type 9 (1 watt), 6d.; Type 8 (1 watt), 8d.; 10 watt Silertex wire-wound resistors, all values 10Ω to 10 KΩ, 2/- each.

SILVER MICA CONDENSERS. top quality, close tolerance (up to 33 pF 1 pF, from 33 pF up to 100 pF), 1.5 pF to 300 pF, 1/- each; 316 pF to 815 pF, 1/3 each; 1,000, 1,500, 1,800 and 5,000 pF, 2/- each.

SILVER CERAMIC CONDENSERS. .3 pF to 500 pF, 1/- each. Hi-K Midget ceramics, 500, 820, 1,000, 1,500, 2,200, 3,000, 5,000 and 10,000 pF., 1/- each.

COILS, Osamor "Q" full range, 4/- each; Weymouth "H" type, full range, 3/9 each; Weymouth CT2W2 coils, TRF, 10/3 pr.; Denco Type "C" TRF, 9/- pr.; REP Crystal set coils, 2 6; Single TRF, 4/-; Matched pr. TRF, 6/-; Denco 465 Kcms midget I.F.S., 12/- pr.; Weymouth, ditto, 15/- pr.

COILPACKS. Osamor Type HO, 50/5; H.F. stage for HO, 21/-; Osamor TRF (L. and M.W. only), 42/-; Denco CP.3/370 and CP.3/50, 44/5 each; CP.4L and CP.4M, 35/- each; CP.4L.G and CP.4M.G, 43/5 each.

FERRITE ROD AERIALS. M. and L.W., 12/6 each by Denco, REP and Teletron.

TRANSISTORS. MULLARD OC.50, OC.51, OC.72, 30/- each; OC.70, 21/-; OC.71, 24/-; BRIMAR, 3X100N, 3X101N and 3X300.4, 40/- each; 3X301N, 45/-; 3X302N, 50/-.

GERMANIUM DIODES. BRIMAR GD3, GD4 and GD5, 7 6 each. MULLARD OA70, 5/-, OA71, 6/-; G.E.C. GEX34 and GEX35, 4/- each.

METAL RECTIFIERS. Full range of the popular types of Westinghouse and Brimar available.

ALL COMPONENTS AND PRICED PARTS LIST ARE AVAILABLE for:

Osram 912 AMPLIFIER, Passive Unit and Pre-Amplifier, MULLARD 510, 20 watt, 3 watt Amplifiers and Pre-Amplifiers, MULLARD, OSRAM, WIRELESS WORLD, DENCO and TSL F.M. UNITS, HIWAYMAN, VIEWMASTER, V-MASTER, 3 STATION TUNER CONVERTER, TELEKING, MAGNAVUEW, etc., etc. Send 2d. stamp for lists required. Please add sufficient postage to orders under £3.

L. F. HANNEY

77, LOWER BRISTOL ROAD, BATH

Tel.: 3811

Behind the dipole is mounted the reflector and the length of it should be as in Table II. The distance "x" between dipole and reflector should be as given in Table III (page 67).

Where a horizontal installation is needed, then the problem is a little more difficult. In some cases it may be possible to fit the wires under the floorboards.

Note that there is *no* electrical connection between dipole and reflector. The reflector is a parasitic element which is self energised and in turn energises the dipole (to put the matter simply).

Where conditions allow it may be more practical to fit an "X" type of aerial. This may be possible in a top flat where there is access to the roof.

Mains Aerials

In localities of high signal strength it may be possible to use a mains aerial as shown in Fig. 7. The mains lead is fed to the primary coil of the first R.F. coil via two fuses and 100 pF mica condensers. Best results are obtained if the mains feed is of balanced twin; the mica condensers should, of course, be of the highest quality.

If the input coil of the television is strapped to chassis as for coaxial feed, then this connection should be broken. If in any doubt, a separate winding of P.V.C. covered wire can be used as the primary coil.

The mains aerial is not always successful and it has one serious drawback; this is that it is poor from the interference angle, as mains borne interference can come direct into the receiver.

However, it often overcomes a difficult problem in a neat way and may be well worth trying. It has been used in commercial receivers.

The Square Aerial

The square aerial may be new to some; it is quite compact and can often be used indoors as it does not take up a great deal of room.

The aerial is in the form of a square with each side one quarter of a wavelength long. One of the sides is split at the centre so as to make connection to the cable. The scheme is shown in Fig. 8.

The aerial is somewhat directional and should be pointed in the direction of the transmitter.

Some difficulty may be encountered in the impedance as this is 300 ohms (approx.) and therefore a quarter wavelength matching section is suggested

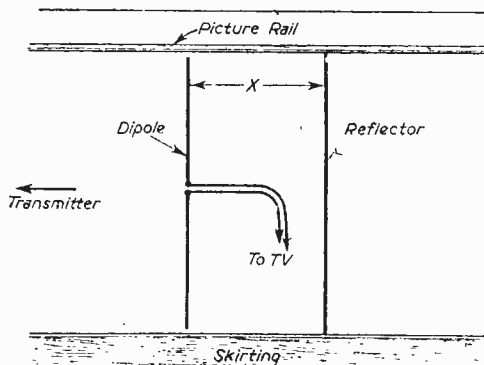

Fig. 6.—Diagram of an indoor "H" type aerial.

if the television input is 80 ohms. The matching section should be inserted between aerial and feeder cable. Balanced twin cable of about 150 ohms would effect a fair match if cut to quarter wavelength.

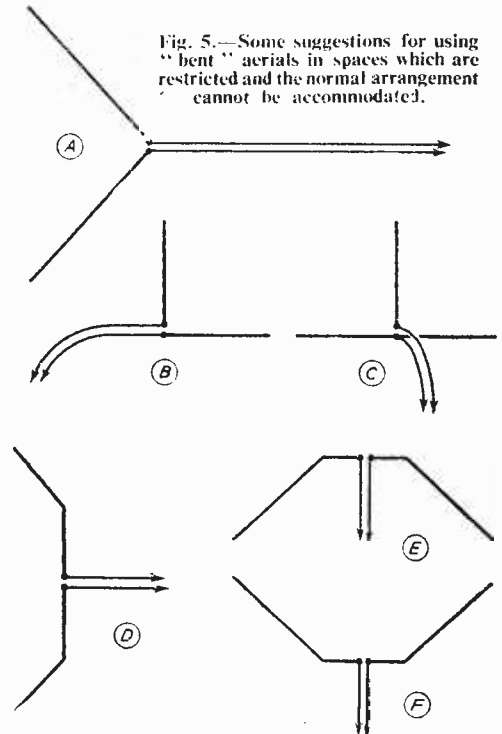

Fig. 5.—Some suggestions for using "bent" aerials in spaces which are restricted and the normal arrangement cannot be accommodated.

A quarter wavelength can be taken as about 0.66 of the figures given in Table III. (0.66 is given as an average V_0 or velocity factor of balanced twin cable.)

The aerial can be used for both vertical and horizontal polarisation.

Band III Aerials

Band III aerials have much smaller overall dimensions than Band I types and therefore lend themselves more readily to indoor work.

There is no difficulty in making dipoles with reflectors and directors suitable for indoor work, and there is also the added advantage of making aerials which may be classified as being semi-ornamental.

Aerials in this class are the circular aerial and the Rabbit Ears. The latter is a very popular type of aerial used in America and is quite suitable where signal strength is adequate.

One disadvantage of these aerials is that the presence of nearby objects affects them, and even a person walking near the aerial can cause picture fluctuations.

The practically universal use of A.G.C. in modern receivers helps to overcome this problem.

In all cases it is wise to test the aerial in different parts of the room. Even a movement of a foot can alter considerably the value of the signal picked up.

Interference

One problem which arises with indoor aerials is

that of interference. Those who live towards the upper parts of the building are in a better position than those low down, yet even here interference can be a real problem as the steel framing of the building carries and retransmits the interfering signals.

The interference is radiated in a number of ways but those in which we are immediately interested are

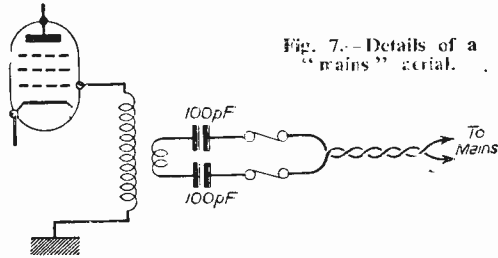

Fig. 7.—Details of a "mains" aerial.

by direct mains radiation and from the steel structure, and also the interference received by direct radiation.

The main thing to worry about with interference is that a big signal-to-interference ratio must be obtained. This means increasing the pick-up of the aerial system so that the desired transmitter comes in much stronger than the interference.

Where the interference is brought in by the house wiring then suppressors can be fitted at the mains input to prevent it getting through to the rest of the wiring. The Post Office will advise on this. The method generally employed is to use filter circuits comprising chokes and condensers.

If it is not practicable to apply suppression to the whole of the house wiring, then some suppression fitted on the mains lead to the television may help if fitted at the outlet socket.

When troubled by interference the aerial should be moved to different positions: it should be tried in different rooms and even in different positions in the same room.

Screens are of little value but to offset this it is

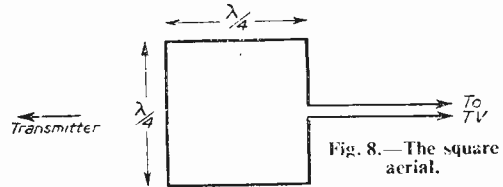

Fig. 8.—The square aerial.

often possible to provide additional elements such as a director and reflector. To do this standard methods can be employed and the same matching devices used as employed on an outside aerial.

A shorted stub is often of great value. This can be a length of feeder cable connected across the aerial input socket. It should be about half a wavelength long at the desired frequency. (In case of difficulty here, start with a cable 10ft. long for Band I and 3ft. long for Band III).

To effect the suppression try cutting the cable an inch at a time, short-circuiting the end each time it is cut. Quite often a position will be found where the interference is cut out or at least, reduced considerably in value.

Making a Simple Aerial Attenuator

By A. W. Duncton

NOW that the BBC are transmitting from Crystal Palace, many people are experiencing difficulty in reducing the strength of the received signal.

The general effect of this "overloading" is excessive brilliance of picture and/or distortion of sound.

It is a comparatively simple matter for the handyman to make and fit an attenuator, and brief instructions follow:

Basic requirements are:—

- 3 off—130 ohm resistances $\frac{1}{2}$ or $\frac{1}{4}$ watt, carbon type.
- 2 off—2-way porcelain connectors, obtainable from any electrical shop or multiple store's.
- 1 off—box (the author has used various metal boxes, and a typewriter-ribbon box serves very well).

Method

1. Mount the porcelain connectors inside the box as shown.
2. Scrape the wire ends of the resistances clean, twist ends together as shown, and assemble to the connectors.
3. Use a piece of copper wire to join together the "shield" side of connectors, and the metal box body. The attenuator is now finished.

Connection to Aerial

Cut the lead-in from aerial about 12in. from connecting plug, and attach to the attenuator as shown.

The attenuator described above will introduce a loss of approximately 12 db, which means that the power will be reduced to a quarter of the original strength. If the signal is still too strong (in positions close to Crystal Palace), the value of the resistances can be altered to R1 and R3 100 ohms, R2 400 ohms.

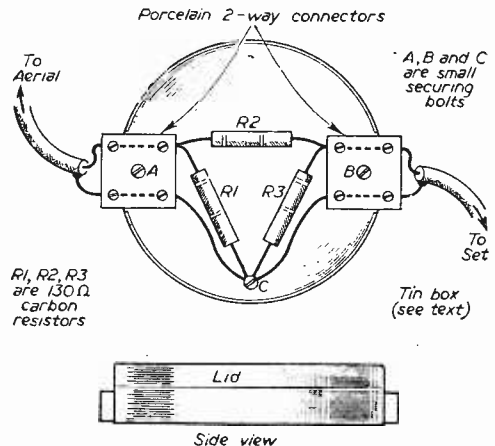

Details of the aerial attenuator described here.

ATV

ALTHOUGH of a very simple design, this wobulator will give a good trace of the bandwidth of TV sets and has been designed to work with the oscilloscope described in the May issue of this journal. It uses the power supply socket of the oscilloscope, but there is no reason why it should not be used with other oscilloscopes, and a modification of the circuit is given later for this purpose. It can also be used as a pattern generator in conjunction with the oscilloscope, and will give horizontal and vertical lines to check frame and line linearity.

Construction

First, mark out and cut panel in 20 s.w.g. aluminum as in Fig. 4. The holes marked A are $\frac{3}{16}$ in. in diameter and all other holes are $\frac{1}{16}$ in. (B).

Next, make the valve bracket as in Fig. 2, and cut off corners as indicated. Bend a $\frac{1}{2}$ in. section at right-angles and drill two $\frac{1}{16}$ in. holes (B) and fit to front panel with two nuts and bolts.

When fitting the valveholder place it so that pins 1 and 7 come nearest to the coil before drilling holes to fix the valveholder.

Now cut out two pieces of hardboard as in Fig. 3 and bolt to the front panel so that the slot comes over the hole in which the variable condenser is fixed.

Now mount the rest of the components and wire up as in Fig. 8. The coil is wound as in Fig. 5 and L1 is made so that it can slide on the former until the final position is fixed.

The R.F. chokes are wound on a high-resistance 1-watt resistor as in Fig. 6. The layout of the components is shown in Fig. 8, and if this layout is followed no difficulty will be experienced in obtaining short wiring.

C1 is made from a 50 pF variable condenser, and in this particular one one vane only was used, and the rest of the moving vanes were removed by bending back and forth with a pair of pliers until the solder gave way, and they came away quite easily. Using this condenser the coverage of the grid dip meter is 41.5 Mc/s to 45 Mc/s on Band 1, but if greater coverage is required, then two or more vanes may be left on the rotor. The pointer is made up as in Fig. 7 from a strip of celluloid or Perspex to suit the knob used. Use a knob with a

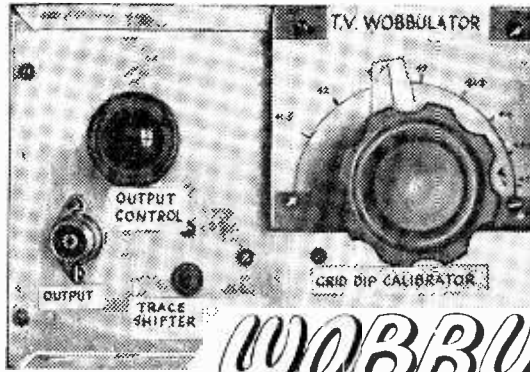

A WOBBULATOR AND PATTERN GENERATOR FOR USE IN CONJUNCTION WITH AN OSCILLOSCOPE

By J. Hillman

WOBBULATOR

wide base so that the two holes can be drilled and tapped and still leave room for the spindle. The hair line is made by placing a rule from the centre of the spindle to midway between the end of the celluloid, and with a compass-point scribe a line and then rub Indian ink in the depression formed and wipe off, and a black line will be left.

The calibration and setting up is done next, and then the cover is made. First, make two ends as in Fig. 10 and bend up all four sides for $\frac{1}{2}$ in. Drill two holes in the 4 in. sides, and bolt up to the front panel as in Fig. 9. Next, cut two pieces as in Fig. 11 and bend $\frac{1}{2}$ in. and $\frac{1}{4}$ in. sides at right-angles and drill one hole in each end as indicated, and bolt up to the sides already in position. The appearance of the cover should now be as in Fig. 13. The back plate is now made, as in Fig. 12, and a $\frac{1}{2}$ in. diameter hole is drilled and a slot cut as indicated to accommodate the power supply cable. The plate is now drilled with six holes, $\frac{1}{16}$ in. in diameter, and placing the plate on the box mark out one hole only; drill $\frac{3}{32}$ in. and insert a self-tapping screw; move plate so that it fits square on the back and mark off and drill another hole, and

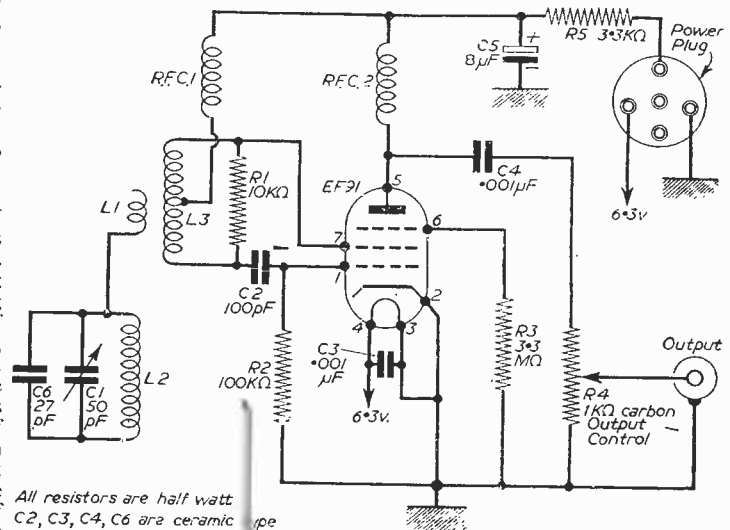

All resistors are half watt
C2, C3, C4, C6 are ceramic type

Fig. 1. -- Theoretical circuit.

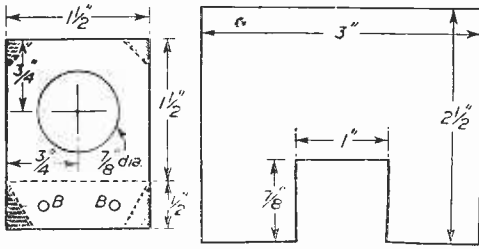

Figs. 2 and 3.—The valve mount and the hardboard.

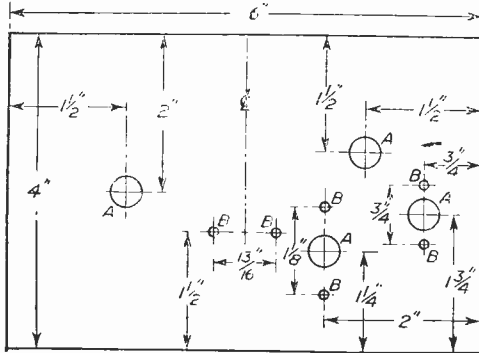

Fig. 4.—Details of the front panel.

then fit self-tapping screw. Proceed to drill the other holes and fit screws.

Calibration

First, plug in to oscilloscope and set controls as follows :

Sync switch to external ; Y amp to low ; coarse frequency to 2 ; fine frequency to 4 ; Y amp to 5 ; Y output lead connected to cathode of C.R.T. in TV set, and wobulator output coupled to the aerial socket of the TV set with coaxial lead. First, adjust core of L3 until a pattern appears on the TV screen.

If no pattern can be obtained, try another EF91 or equivalent valve, as some valves oscillate better than others. When a pattern appears on the TV set screen a trace similar to Fig. 14 should appear on the oscilloscope and by adjusting the output control R4 the trace can be expanded vertically until it will flatten off at the top of the trace. Do not use too much output as this distorts the trace and gives a false

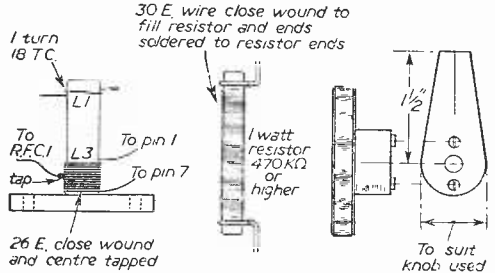

Fig. 5.—The coil.

Fig. 6.—The R.F. chokes.

Fig. 7.—The pointer.

idea of the bandwidth of the set. By moving the core L3 the trace can be drawn out in three stages to cover the 3 Mc/s bandwidth. When the trace is satisfactory proceed to adjust the grid dip meter. By moving C1 a pip should appear on the trace as in Fig. 15, and by adjusting the position of L1 this pip can be adjusted properly to appear as in Fig. 15. When the pip is satisfactory, cement L1 on the coil former.

Next, by adjusting the spacing of the turns of L2, C1 can be made to give the required coverage in conjunction with C6.

Before calibrating the grid dip meter see that cover and back are securely in place. Use

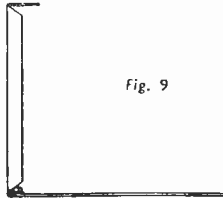
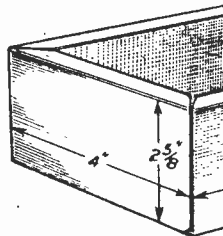

Fig. 9



Figs. 9 and 13.---

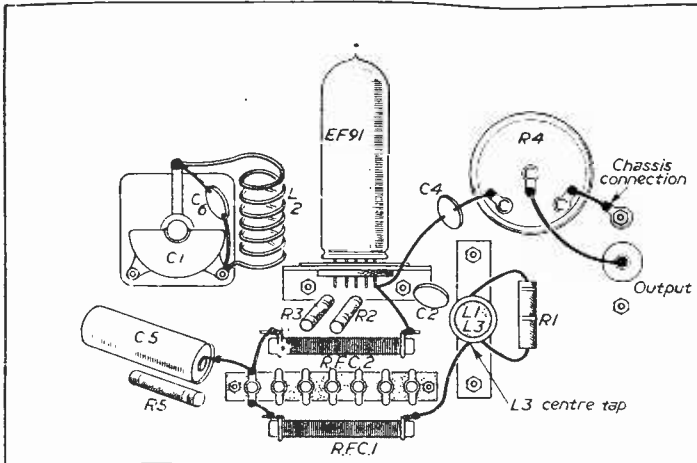

Fig. 8.— Practical wiring details.

a signal generator to inject a signal into the aerial socket of the TV set, and this should appear as a modulated envelope as in Fig. 16 on the trace or the oscilloscope. In the centre of the envelope a thin vertical line will appear, and this is the calibration point.

The best way is to inject, say, 42 Mc/s and then move the trace by means of the X shift until the calibration point comes opposite a mark on the oscilloscope transparency, then switch off the signal generator and move C1 until the pip point comes on to the mark on the oscilloscope transparency, and then put a pencil mark on the C1 scale

and mark it 42 Mc/s. Similarly, for 42.5 Mc/s and in 0.5 Mc/s steps until the whole scale is calibrated and the marks can then be inked in.

To use the wobulator as a pattern generator, disconnect the Y output connection and keep the output coaxial cable connected between wobulator output and aerial socket of TV set. Then by adjusting the timebase of the oscilloscope, any required number of lines can be put on the screen of the TV. Horizontal lines will appear at first, but as the timebase frequency is increased vertical lines will appear. The horizontal lines will be perfectly straight, but the vertical lines will be rather wavy, but are quite all right for checking linearity. For other ranges of coverage see table, Fig. 17.

If the wobulator is used with

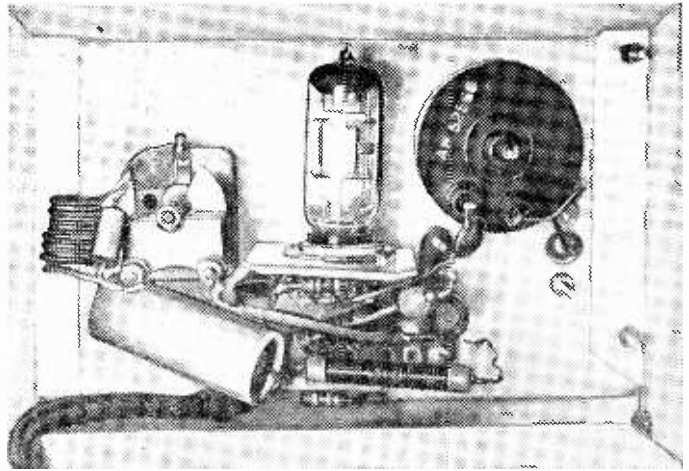

Rear view of the completed instrument.

Band	L2	L3
1	8 T 18 Tc	8 T 26 E C/T close wound
2	8 T ..	8 T
3	6 T ..	6 T
4	5 T ..	5 T
5	5 T ..	5 T

Fig. 17.—Table for other ranges.

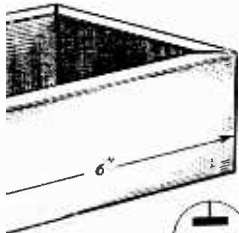
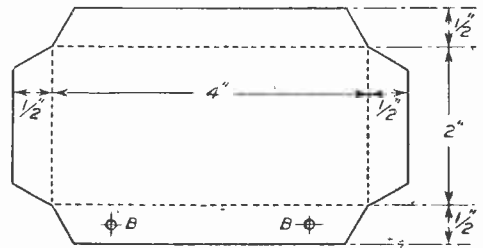

any other oscilloscope, a power pack would be necessary, and also the circuit from pin 6 of the valve would need to be modified as in Fig. 18.

sides of the case.

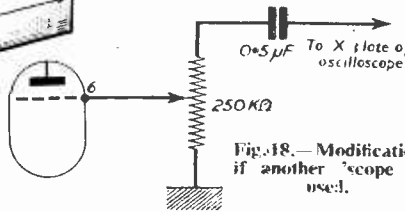
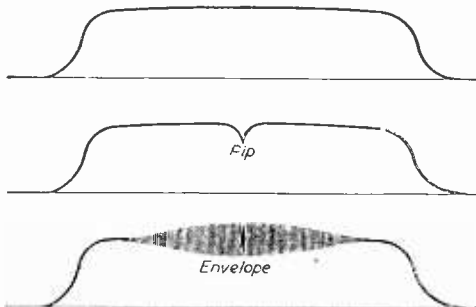
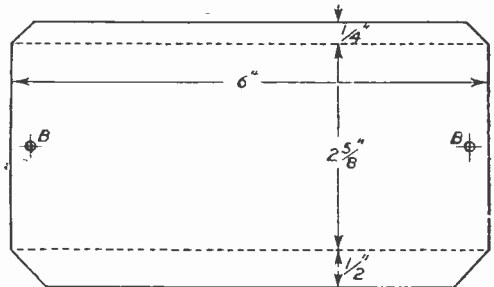
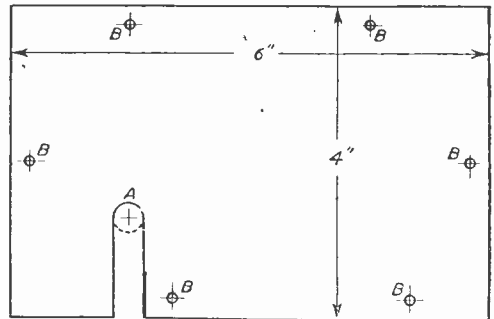

Fig. 18.—Modification if another scope is used.



Figs. 14, 15 and 16.—Check traces.



Figs. 10, 11 and 12.—Details of the sides of the case and the rear.

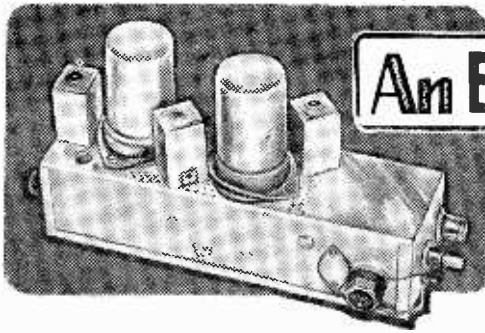

An EF50 Converter

A COMPACT BAND III UNIT EMPLOYING
"SURPLUS" VALVES

By R. Shatwell

At the time the Winter Hill programmes started, the author's plans for a dual-band receiver were not complete, and as a stop-gap measure a "spares box" converter was assembled. No special valves or components were used and the old faithful EF50 was pressed into service. Postage stamp type mica condensers, some ex-View Master formers, and canned formers from a dismantled chassis were used. Sockets can be Pye, but the modern push-on types have advantages in the bandswitch compartment.

Performance

No doubt the first query will be re the performance to be expected from the unit. Used in a built-up town area 20 miles from Winter Hill, with an indoor loft "H" aerial, the signal output is ample, used with a set of the R.F. F.C. two-vision I.F., one sound I.F. type; 230 volt H.T. is used, but at 300 volts H.T. gain is considerably increased without ill-effects. H.T. consumption is 20 mA at 230 volts. Picture quality is good and, viewed on a 16in. tube, the grain is visible only if uncomfortably situated for viewing. The 3 Mc/s bars can be seen clearly without grain being visible. Stability is quite adequate after a few minutes' initial warming up, and drift is apparently due to valve changes, as the unit itself appears to run with no noticeable increase in temperature. If the

oscillator is adjusted after 15 minutes no improvement can be made in its setting after a full night's viewing, this being the correct setting.

Circuit

This is quite conventional for these frequencies, and although the writer's first opportunity to venture in practical form into Band III, the unit worked at once (Fig. 1). No wire as such was used in the "wiring" other than heater wiring, the components being directly soldered in their circuit point and a very clean result is obtained. L3 and C2 are rather unconventional, but served to remove the last vestige of breakthrough. In areas remote from the Band I transmitter these could possibly be omitted. Fig. 2 gives the chassis size and layout, which should be adhered to, as the correct coil turns then coincide with direct and short connection to valve-pins, etc. Earthing is by a wire from each valveholder fixing bolt to the centre spigot. R3 is omitted from Fig. 2, as is the heater line, for reasons of clarity. Coil taps are made by cleaning, timing and soldering a wire at right-angles to the coil. The heavy-gauge coils are best made up and sprung on to the formers, which should be ready fixed to the chassis. Although it is often stated that little is gained by input transformers at Band III frequencies, in experiments on the unit

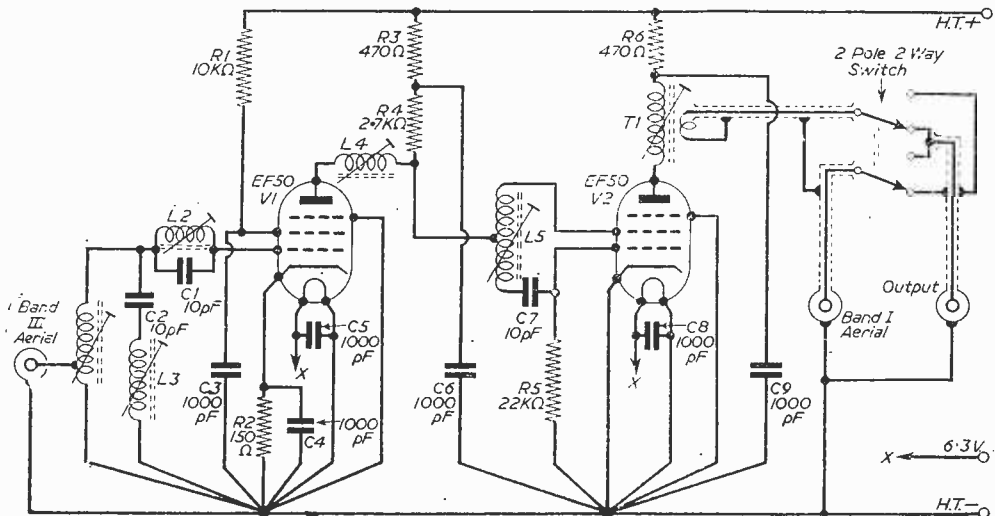

Fig. 1.--Theoretical circuit of the converter.

considerable advantages over aperiodic coupling were evidenced.

No shunts to preserve bandwidth are necessary at signal frequency and none were necessary across T1. As a means of disposing of excess gain, a shunt across T1 can be fitted if necessary, but picture quality does not demand it. For this reason no gain control has been fitted, as it is easy to throw away the converter gain by this method or by staggering the tuning, as was done in the author's case, the use of the "H" aerial as opposed to the dipole being unnecessary from the point of view of signal strength in the locality.

Bandswitch

This was designed by the author. The leads to it are all short and the switch is positioned between the Band I aerial socket and the output socket. Even so, complete elimination of pick-up in this section could not be achieved with Pye sockets, as the bulky nature of the inner connection caused trouble. With the modern type only a thin spigot protrudes into the chassis, and a wire was soldered to this and a sleeve pushed over wire and spigot, followed by a piece of coaxial outer braiding right up to the chassis and the switch connection, this being earthed at the switch.

Alignment

This is simple, but some slight variation in spacing of L1, L4 and L5 may be necessary. Initially, the can of L5 is best left free to lift away for such adjustment. With a lead from the Band I aerial connected to the F.C. grid, adjust T1 for maximum output on vision. Remove this lead and connect Band III aerial to input socket. Adjust L5 until the Band III signal appears. If necessary, open or close the spacing of this coil to peak on sound output. Treat L1 and L4 similarly; L4 and L5 are slightly interdependent. Adjust L3 for maximum rejection of Band I and L2 similarly. Staggering of these should completely cut out any breakthrough on both sound and vision. L1 may then need slight readjustment. T1 should be set to give a balanced output between vision and sound.

Patterning

The above should be carried out with the Band I aerial disconnected. The addition of this aerial may introduce patterning, but this is not necessarily introduced by the switch, but can be caused by the positioning of the leads and especially by the connecting lead between the converter and the set. The writer's tests were with a 8ft. to 9ft. connection, the converter being on a table some distance from the set, and breakthrough was very light. On insertion in position in the set results were quite unacceptable. Progressive repositioning and shortening of the link had left a 9in. length of coaxial in this position with slight

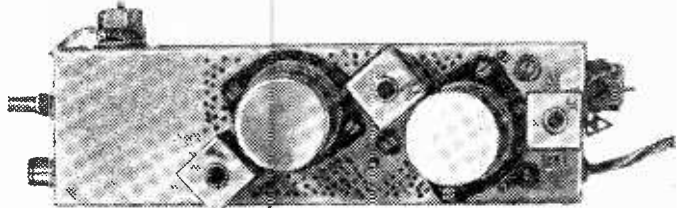

Top view of the converter.

patterning at times. Taping together the two aerial leads removed this, but the position of these leads is still of significance. Peculiarly enough, even the

CHANNEL 8 OR 9 TO CHANNEL 2

Coil	Turns	S.W.G.	Spacing	Former
L1	2 1/2	20 Enam.	1/2 in.	Aladdin 1/2 in.
L4	2 1/2	20 "	1/2 in.	" 1/2 in.
L2	10	26 "	Closewound	Canned .3
L3	10	26 "	" "	Aladdin 1/2 in.
L5	5	20 "	1/2 in.	Canned .3
T1	10	26 "	Closewound	" .3
Sec.	2	26 "	Closewound	—
			1/16 in. from H.T. end of Pri.	

Dust iron cores throughout. L1 tapped at half-turn from earth. L5 is centre-tapped.

position of a table-lamp lead on the set can cause slight patterning. Ideally, if the link between converter output and set input coil can be reduced to

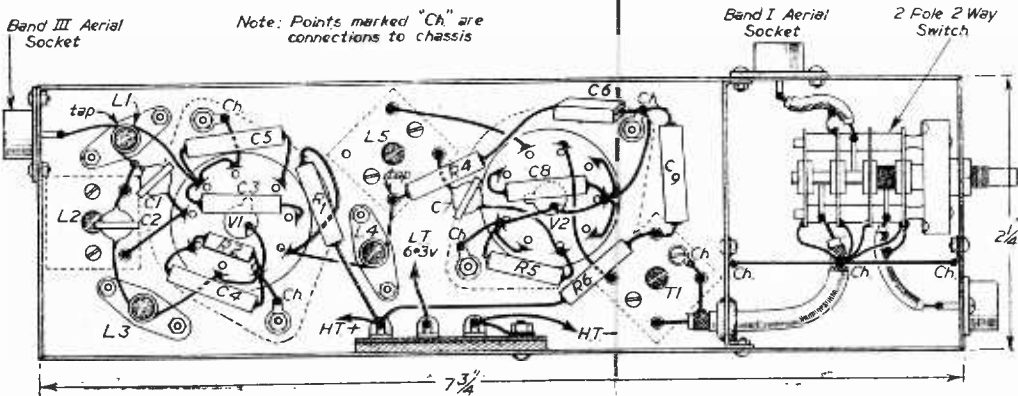
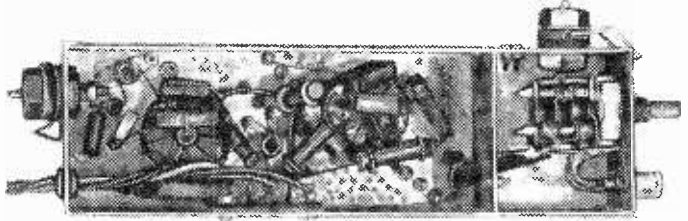

Fig. 2.—Wiring details.

Coax. earthed to 20swg. wire Output Socket

3in. to 4in., this should be done. The bottom of the converter chassis, which is 2in. deep, should be completely enclosed by a tightly fitting lid, liberally perforated, beneath the valves. Similarly, perforation of available space on the chassis top will assist ventilation and stability.

A second unit was made up, and in this Pye inputs were used with only the output socket of the modern type. As will be seen from the photos, slight repositioning of the Band I input cut the lead to the switch to about $\frac{1}{4}$ in. and the socket is suitable in this position. In this unit 500 pF condensers



A view of the underside.

were used for all decoupling, in place of the 1,000 pF and were quite satisfactory. Made up to the specification otherwise, the unit operated perfectly without the need to touch any of the coils

Use of Industrial Television

THIS is the story of how a serious emergency in the biggest steel works in South Wales was minimised by the use of industrial television.

The Steel Company of Wales has long been alert to the potentialities of closed circuit TV, and some while ago experimental demonstrations by various manufacturers of such equipments were carried out at Abbey Works, Port Talbot. As a result of these stringent tests an order was placed with Marconi's Wireless Telegraph Co., Ltd.

But before the equipment could be delivered a crisis arose. A telephone call from South Wales revealed that the operation of the 45in. slabbing mill was being very seriously affected by the failure of a slab manipulator, which would take at least a fortnight to repair. Previously a similar breakdown (but on the front side of the mill and within the direct vision of the operator) had been overcome by the use of a special hook, manipulated by an overhead crane. This time, however, it was necessary to use the same method on the outgoing side of the mill and this prevented clear sighting by the operators. It was therefore decided to provide an "eye" behind the mill by the use of industrial TV.

At 10 o'clock that night two engineers were dumping the equipment on the works floor at Port Talbot. By 2 o'clock in the morning the gear was in position, successfully tested, and the mill again rolling.

The effect of the breakdown has, by this means, been limited to such an extent that an average of 1,600 tons per shift is still being produced. To date the camera equipment has been working continuously day and night and will continue to do so until repairs to the manipulator are completed.

Background Information

The function of a rolling mill of this type is to reduce ingots weighing

up to 20 tons to a slab section suitable for passing on to strip rolling mills, where the thickness is further reduced to plates and sheet steel.

The mill itself is massive in construction and its bulk prevents an operator positioned on one side from seeing the ingot once it has passed through the main rollers to the other side.

Under normal circumstances progress is controlled by two operators, one of whom is in charge of an equipment known as the manipulator. Once through the rollers, the ingot is stopped and is turned over by special mechanisms before being reversed through the rollers for further passes.

The industrial TV camera was set up to view the far side of the mill, with a monitor screen at the manipulator operator's position. The operator was then able to see the ingot's position exactly and affixing the crane-hook became a matter of routine.

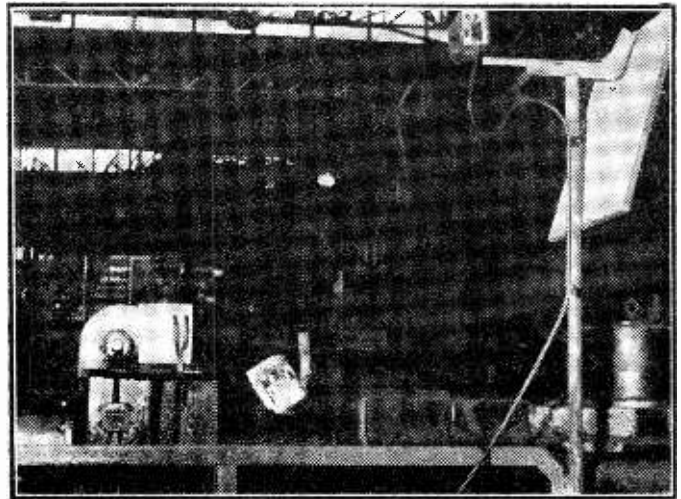

Picture shows the far side of the slabbing mill, with a glowing ingot being turned by an overhead crane before being reversed through the main rollers. The Marconi industrial TV camera is seen top right.

CRYSTAL MICROPHONE INSERTS

5/- POST FREE



POST FREE

Ideal for Tape Recording, Gramophone Amplifier, etc. Very sensitive. Guaranteed and Tested, 5- (ex-units), or 8/6 Brand new and boxed.

INDICATOR UNIT TYPE 182A

Unit contains VCR57 Cathode Ray 6in. tube, complete with Mu-Metal screen, 3 EF50, 5SP6 and 1 5U6 valves, 9 wire-wound volume controls and quantity of resistors and condensers. Offered BRAND NEW (less relay) at 67/6. Plus 7/6 carr. "Radio-Constructor" scope circuit included.

TR 1196 RECEIVER

Complete with 6 valves: 2 EF36, 2 EF39, 1 EK32, 1 EB23, 463 L.F.T. ideal for conversion. In absolute new condition. 27.6 p.p. 2/6, with circuit. TR 1196 TRANS-MITTER Transmitter section comprising EL32, EF50, VT501, Relay, etc., 12.6 p.p. 2/6. COMPLETE TRANS-MITTER RECEIVER with 24 v. power-pack in original transit case. 57.6 p.p. 5/-.

CATHODE RAY TUBES

VCR138A WITH SCREEN £11/5-
VCR139A, 2 1/2in. CR Tube. Brand new in original cartons (carr. free) £11/5-
VCR97, Guaranteed full TV picture (carr. 2/-) £2/-
VCR137, Guaranteed full TV picture £11/5-
MU-METAL SCREENS for VCR97 or 517. P.P. 16/6 or 10/-
6in. ENLARGER for VCR97 or 517. P.P. 16/-
VCR97, Slight cut-off. Carr. 2/-
3BP1, Brand New £11/0-

BAND III CONVERTER UNIT

Complete Kit of Parts. Including 2-EF80 and Chassis and Wiring Diagram. Voltage required 200 v. at 30 mA. 6.3 v. 6 amps. 48.6 plus 2- P.P. Or assembled and tested. 67/6, plus 2- P.P. Power Supply Components, 92/-
The Unit Complete with Power Supply. Tested and ready to plug in. 97.6.

GARRARD 3-SPEED MINER AUTO-CHANGER Model RC110

A.C. 200/250. List price £14/13/- Brand New. £8/18/6 P.&P. 5/-

TRANSISTORS

(OFFERED AT LESS THAN HALF-PRICE) JUNCTION TYPE P.N.P. (RED-SPOT)

These Junction Type Transistors are designed for audio-frequency application up to 800 Kcs, and are suitable for use in most transistor circuits including the following: Radio Control, Local Station Receivers, Signal Tracers, Oscillators, Transistor Voltmeters, Audio-Amplifiers, Microphone Pre-Amplifiers.

10/- EACH

Tested and Complete with Technical Data and Circuits.

N.B.—The above transistors may be used in place of Mullard N.C., OCT1 or similar types.

R.F. TRANSISTORS (BLUE-SPOT) 1.6 mcs. ... 15/- each

BUILD THE "TELEVISION" TRANSISTOR SUPERHET Kit of Parts complete with 4 transistors, I.F.T.s, 2-gang miniature condenser, ferrite rod, 3in. P.M. speaker, V.C. res. and cond. ... £6 10/-
Or as above with push-pull output 6 transistors and 6 x 1/2 elliptical speaker ... £9 -/-

CALL AND HEAR DEMONSTRATION MODELS WORKING

MINIATURE COMPONENTS FOR TRANSISTOR CIRCUITS

Teleton Miniature Oscillator Coils	...	6/6
Teleton Miniature I.F.T.'s	...	6/6
Perrite Rod Double Wound	...	10/-
J.B. 2-Gang 375 P.F. Miniature Condenser	...	11/-
Fortiphone Sub-Miniature Intervalve Trans.	...	10/-
Fortiphone Sub-Miniature Intervalve Push-pull Trans.	...	12/6
Fortiphone Miniature Push-pull Intervalve Trans.	...	15/-
Fortiphone Miniature Push-pull Output Trans.	...	15/-
Miniature W.W. 1000V V Control	...	2/6
Miniature On-off Slide Switch	...	1/6

Resistors and Condensers at usual low prices.

WE HAVE OVER 50,000 BRITISH AND AMERICAN VALVES AVAILABLE AT VERY LOW PRICES—SEND FOR LISTS.

LATEST TYPES NOW IN STOCK

EB41	10/-	DK40	10/-	PY82	10/-	35W1	8/6	12AX7	10/7
EY51	12/-	EF80	10/-	PCC84	12/6	PCF80	15/-	DK86	9/7
EF41	11/-	EABCB80	10/-	PCF82	12/6	EBF80	11/6	DL96	9/7
EL41	11/-	EC685	10/-	12AU7	9/-	EF85	10/6	DAF93	9/7
EZ40	10/-	EF89	10/-	12AT7	8/-	EF89	10/6	DP96	9/7
EM34	10/-	ECL80	12/6	12A7T	9/-	ECF82	15/-	EC84	12/6
UL41	11/-	PL81	12/6	12A7T	9/-	ECF85	15/-	EC84	12/6
UY41	11/-	PL82	10/-	12A7S	8/-	EP85	12/6	PAQ5	10/-
UF41	11/-	PY81	10/-	12BA8	9/-	FABCB90	15/-	EC42	12/6
UC42	12/6	EM80	10/-	12BE3	10/-	6AU6	9/6	EC42	12/6
UB41	10/-	6X4	8/-	12AH8	12/6	117Z3	8/6	9A5	12/6

SPECIAL REDUCTION FOR SETS OF VALVES

1A7GT, 1N5GT, 1H5GT, 1A5GT (or 1Q5GT or 3Q5GT)	37/6 Set
10 EF50 (Box-Brand New Units) 5/- each	45/-
10 EF50 (Red-Sylvania (x-new units) 6/- each	55/-
6K8C, 6K7G, 6Q7G, 5Z5G, 6V6G	35/-
1R5, 1S5, 1T4, 1S4 (or 3S4 or 3V4)	27/6
DK96, DF96, DAF96, DL96	32/6
TP25, VP23, HL23DD, P (n25 or QP25)	25/-
6K8C, 6K7G, 6Q7G, 2A8G, 25Z5 (or 25Z8G)	37/6
12SRGT, 12K7GT, 12Q7GT, 35Z4GT, 35L6GT (or 50L6GT)	37/6
12S47GT, 12K7GT, 12S4GT, 12S4GT, 35Z4GT, 35L6GT or 50L6GT	35/-

QUARTZ CRYSTALS

Type FT243 fundamental Frequencies. 2 pin 1/4in. spacing. 120 Types, 5675 Kcs to 8650 (in steps of 25 Kcs).
80 Types, 5706 Kcs to 6340 Kcs (in steps of 31.333 Kcs).
ALL BRAND NEW 10/- Each.
Special price for complete sets of 80 or 120
Above are suitable for re-girding.

Type FT241A 54th harmonic Crystals. 2 pin 1/4in. spacing. 80 Types Available 20 Mcs—27.9 Mc/Mcs (in Steps of 100 Kcs). Complete sets available. ALL BRAND NEW 7/6 each.
FT241A 200 Kcs 10/- each. Crystal Holders for both Types 1.3 each

SEND 2/- for 25-PAGE ILLUSTRATED CATALOGUE

HENRY'S (RADIO LTD.)

"RF 26" F.M. CONVERTER UNIT 88 100 Mc
This well-known RF26 Unit is now adaptable for F.M. reception using 2 I.F. stages and separate local Oscillator and tuned by a Muirhead graduated Vernier drive. Can be converted at low cost of 92/6. Send 1/6 for 8-page Descriptive booklet containing full wiring instructions, circuits and layout diagrams.

B.S.R. RECORD CHANGERS
Very latest type "Mon-arch" 3-speed with HGP37 crystal turnover pick-up. Plays mixed records Brand new and guaranteed. Listed at £15 10.
£7 19/6, carr. paid.

MINIATURE "TRANS-MITTER" STRIP TYPE S1
Size 7 1/2in. x 6in. x 3in. Complete with Valves Type CV415, CV309, 2-6AM6, 2-7B9 and Quartz Crystal, 4.800 Kcs. Fully wired with circuit.
£4 10/- complete.

MINIATURE I.F. STRIP TYPE 373 9-72 MEG. Brand new miniature I.F. Strip size 10 1/2in. x 2 1/2in. x 3in. high. Valve line-up 2-EF92, 3-EF91 and EF91. With circuit.
Price (less valves) 7/6. P. & P. 1/6
This I.F. Strip is part of above equipment.

U.S.A. INDICATOR UNIT 10929A
Complete with 3BP1 CR tube and screen. 7 valves—2-8N1GT, 2-6HG2T, 4G6 2X2, 6X6G, volume controls, condensers, etc. Ideal for portable "scope" in black crackle case size 15 1/2in. x 9in. x 9in. BRAND NEW. 65/- carr. FREE.

TRANSMITTER RECEIVER "38" WALKIE-TALKIE SETS
Special offer of above set, complete with 6 valves, 4-AR12 and ATP, with circuit. Range 7.4 to 9 Mc/s. These sets are not guaranteed but are serviceable.
25/-
Junction box 2, 6 extra.

62A INDICATOR UNIT
Containing VCR97 with Mu-Metal Screen. 21 Valves 12-EF50, 4-SP61, 3-EA50, 2-BB34, 2-PUS, Switches, H.V. Cond., Resistors, Muirhead S M Dial, Double Deck Chassis and Crystal. BRAND NEW ORIGINAL CASES, 67/6. Carr. 7/6.

PYE 45 Mc/s STRIP TYPE 3583 UNITS
Size 15in. x 8in. x 2in. Complete with 45 Mc/s. Pye Strip, 12 valves, 10-EF50, BB34 and EA50, volume controls, and hosts of Resistors and Condensers. New condition. Modification data supplied.
Price 89/6. Carr. paid.

OSMOR VARIABLE Band I ATTENUATOR

Balances reception of ITA and BBC in all areas and avoids constant adjustment of controls. The Osmor is the only variable attenuator that will reduce the signal exactly to the required level. Easily Fitted—just plug in. Reduction ratios variable 2-1 to 10-1. An Essential with all types of Band III Converters. 10/-, plus 9d. p. & p. From your Dealer—or direct.



BAND I FILTER

Rejects BBC from ITA aerial and improves picture. Suitable for all makes. Fitted in 2 minutes. 10/-, plus 6d. p. & p. including instructions.

ITA CONVERTERS LONDON · LICHFIELD · MANCHESTER

A very efficient Band III Converter for all TV sets of any age (including TRF). Approximately one hour to build! Guaranteed no breakthrough of Band I. Will convert any Band III Channel to any Band I Channel. Station switching. A.C. or A.C./D.C. Size 4½ in. x 2½ in. x 3 in. Circuits, Wiring Diagrams and full constructional information, ready to fit inside your TV cabinet.

Complete Kit **65/-** Completely wired **80/-**
Both plus 2/- post and packing.

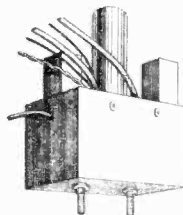

FREE We keep right up to date in building the latest circuits published in "Practical Wireless," "Wireless World" and "Radio Constructor" and we stock the components specified. Send 7½d. in stamps for circuits, fully descriptive literature together with coil and coilpack leaflets, component lists, chassis drawings and templates.

ITA Band III CONVERTER KIT

Complete with all components, including power unit, for construction of an efficient Band III converter. Nothing else to buy. Circuit, wiring diagram, chassis templates and complete instructions, **£6.19.0.**

plus 2/6 p. & p.

OSMOR RADIO PRODUCTS LTD. 418 Brighton Road, South Croydon, Surrey, Croydon 5148-9

Dept. PT.2.

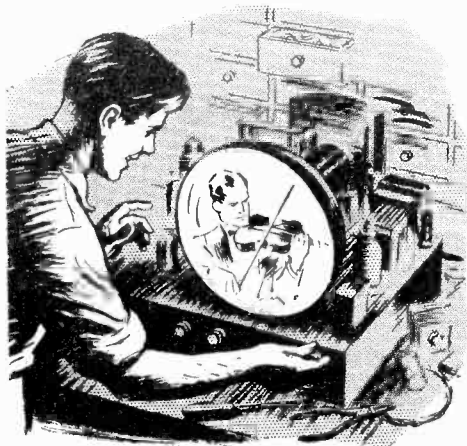

The Bennett College can make you an expert TV technician

—IN YOUR OWN HOME!

Here's your big chance! The Bennett College, famous the world over for its first-class postal tuition, now offers you a course in Television Servicing. Right away you can start adding to your knowledge of television repairs and maintenance, increasing your technical ability—and making a sound investment for your future.

Studying with The Bennett College is a pleasure. You work in your own home, as quickly—or as slowly—as you like. Your personal tutor at the College sends you your lessons—and gives you his friendly help based on years of teaching experience. The College guarantees to continue teaching you until you reach the standard you wish—and all your text-books are provided free of charge.



Send for a free prospectus today! Just fill in the coupon opposite and post it off—The Bennett College will send you a prospectus free of charge and without obligation.

EXCELLENT COURSES in the following subjects are also offered by The Bennett College. Write on your coupon the course that interests you.

ELECTRICAL ENGINEERING

ELECTRICAL WIRING

POWER STATION ENGINEERING

RADIO ENGINEERING

TELECOMMUNICATIONS

To: THE BENNETT COLLEGE (Dept. 155), SHEFFIELD.

Please send me free of charge and without obligation, a copy of your prospectus on _____ (subject s)

NAME _____

ADDRESS _____

Age (if under 21) _____ Please write in block letters.

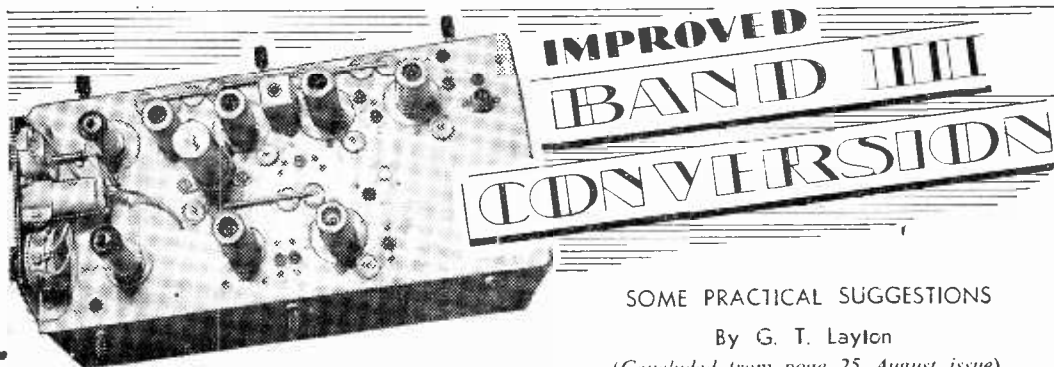

SOME PRACTICAL SUGGESTIONS

By G. T. Layton

(Concluded from page 25 August issue)

At this stage both units can be connected together as shown below and the output passed into the I.F. unit with the appropriate aerial connections to each of the inputs. Then by arranging a simple two-way switch in the heater circuit the heater of either unit is switched on in turn and thus only one unit will function at a given time. Now the normal aligning on both test cards can take place and, by setting the contrast controls on each of the converters, it is possible to obtain a perfectly aligned signal of equal strength on both transmissions

and from a domestic point of view is effected by the operating of a simple switch. The only disadvantage is the slight time lag on changeover. The switch can easily be put into the H.T. circuit instead, and thus the time lag is obviated but there will be a waste of heater current on the unused section. With the complete arrangement there is a very adequate signal strength because one has a complete Viewmaster with more modern valves, working on a lower frequency, and thus more gain than the original. In addition, the converter units have a gain of at least 5 and thus stagger tuning for bandwidth leaves more gain than normally required.

It may be that the foregoing method would not be very readily adopted by commercial manufacturers because they would either have to send out different units for different localities or have to arrange for the dealers to adjust them locally to suit the transmissions, but from the point of view of an amateur this method will undoubtedly give better and more reliable results than the commercial method, with the advantage of complete simplicity.

As the two output coils are connected in parallel there is, of course, some loss in efficiency, although this is unimportant. Also, adjustment of one coil slightly affects the other. This could be improved by arranging one output coil only common to both anodes, but this would complicate the switching and is therefore undesirable.

On lining up the converters it may be helpful to check first that the output coils are on the desired band by injecting a 35 Mc/s signal via a small condenser to the grid of V2 on each converter.

It will be noticed from the illustrations that the receiver in question is all built on a unit construction method, with plug and socket

Channel		A	B	C	D	S
2	H.M.	48.75	51.25	51.75	52.25	48.25
8	L.	186.75	189.25	189.75	190.25	186.25
9	W.H.	191.75	194.25	194.75	195.25	191.25
I.F.	—	37.65	35.15	34.65	34.15	38.15

Table of frequencies.

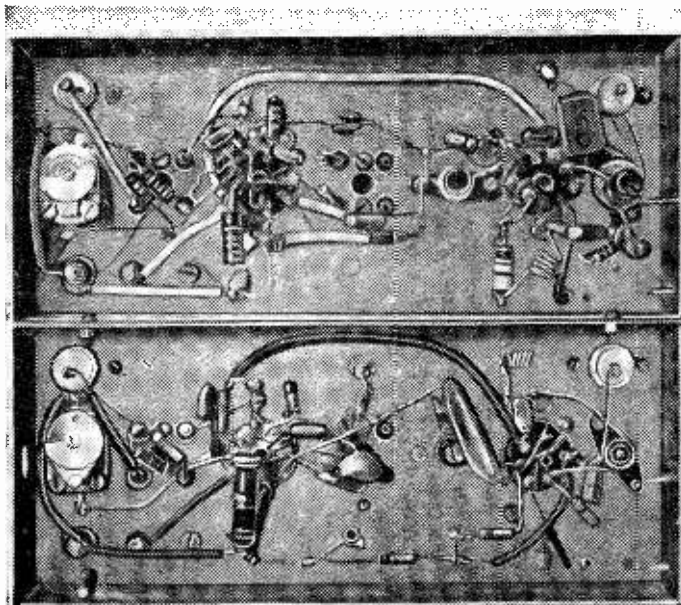

Fig. 7.—Underside view of the two converters.

arrangements for inter-connection. This is a very convenient method but is not, of course, salient to the design.

Picture Quality

With reference to recent correspondence in this journal concerning picture and sound quality and sound volume on various BBC and I.T.A. programmes, with these units we have an opportunity to make instantaneous checks. These were originally carefully lined up to give the same response curve on card C for sound and vision, and it has become obvious

since that the proportion of sound to vision is variable as transmitted even for what should be similar cases. A typical test is at news time when it is sometimes obvious that with equal pictures contrast and brilliance the I.T.A. is relatively shouting and this also occurs on some commercials, but variations are outside the control of the viewer. At least the instantaneous switching will give reassurance that the set is in order. Similarly the bad quality of sound on some of the commercials can be checked and an armchair control on/off switch on the sound volume can stop this annoyance. One other point that has emerged from subsequent tests is that the arranging of the output side of the converters in series instead of in parallel gives a slightly better gain and makes the adjustments of one less affected by the other. This is an optional variation worth trying.

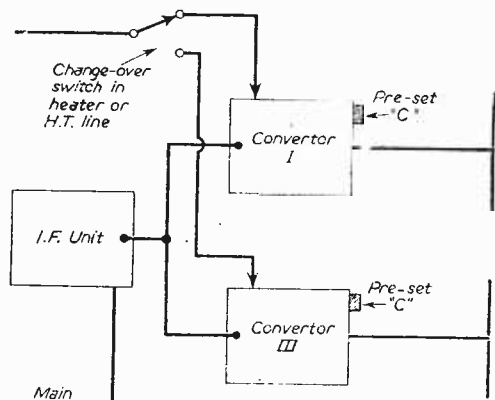

Fig. 8.—Connection details.

Channel		R.F.	I.F.	Osc.
9	S.	191.25	38.15	229.40
	V.C.	194.75	34.65	229.40
2	S.	48.25	38.15	86.40
	V.C.	51.75	34.65	86.40
9	S.	191.25	48.25	143.00
Converted to 2 (not used)	V.C.	194.75	51.75	143.00

Fig. 9.—Response curve and frequency table.

Colour Television

THE recent series of articles on colour television aroused considerable interest, and a number of enquiries have been received on the picture detail and make-up. As already pointed out, the system is a modification of the American N.T.S.C. arrangement and therefore the following data is given for those who are interested.

Specification of the Modified N.T.S.C. Signal

It is assumed that the reader is familiar with the N.T.S.C. specification about which a great deal has been written in the last year or so. Here we give the major parameters of the signals as modified to suit the British 405-line standard.

Colour sub-carrier frequency.—2,657,812.5 Mc/s ± 8 c/s with a maximum rate of change of 0.1 c/s/s.

Q Channel bandwidth.—At 300 kc/s less than 2 dB down; at 340 kc/s less than 6 dB down; at 450 kc/s less than 6 dB down.

I Channel bandwidth.—At 1.0 Mc/s less than 2 dB down; at 2.5 Mc/s less than 20 dB down.

Time delay between luminance and chrominance.— E_y^* , E_Q^* , E_I^* and the components of these signals match one another in time within 0.07 μ seconds. (* Gamma corrected signals.)

Picture carrier/sound carrier frequency relation.—The difference in frequency between the picture signal carrier and the sound signal carrier is a multiple of the line frequency. The exact relation is:

$$f_c \text{ vision} - f_c \text{ sound} = 350 f \text{ line.}$$

Delay specification.—The overall delay characteristics of the transmitted signal conform to the shape set out in the following table to within ± 0.07 μ seconds.

<i>f</i> Mc/s	<i>Envelope Delay</i> μ secs.
0.1	-0.22
1.0	+0.22
1.5	-0.22
1.8	-0.19
2.0	+0.17
2.2	+0.133
2.4	-0.085
2.6	+0.015
2.8	-0.12
3.0	-0.35

All but the last of these items are direct modifications of the American specification to suit British standards. The last is an additional feature of the British signal. Its purpose is to make the beat frequency between the sound carrier and colour sub-carrier an odd multiple of half-line frequency, so that the pattern produced on the screen is both stationary and frequency interleaved, thus giving minimum visibility. Only receivers which have an appreciable amount of the sound carrier present in the input to the vision detector will produce this beat frequency, but since its frequency is low (approximately 880 kc/s), every precaution to minimise its effects is worthwhile. In the U.S.A. frequency modulation, as opposed to the British amplitude modulation, is employed for the sound signal. This obviously makes rigid frequency locking an impossibility.

C.R.T. ISOLATION TRANSFORMER
For Low Leakage winding. Ratio 1:1.25 giving a 25% boost on secondary.
2 v., 10/6; 1 v., 10/6; 0.3 v., 10/6; 10.8 v., 10/6; 15.3 v., 10/6.
Info with mains primaries, 12.6 each.
Type B. Mains input 220-240 volts. Multi Output 2, 4, 6.5, 7.5, 10 and 15 volts. Input has two taps which increase output volts by 25% and 50% respectively. Low capacity, suitable for most Cathode Ray Tubes. With "Tag Panel," 21" wide.
Type C. Low capacity wound transformer for use with 2 volt Tubes with falling emission. Input 220-240 volts. Output 2-21-22-23 volts at 2 amps. With "Tag Panel," 17" wide.
NOTE.—It is essential to use mains primary types with T.V. receivers having series-connected heaters.

TRIMMERS, Ceramic. .50, .50, .70 p.f., 9d., 100 p.f., 150 p.f., 250 p.f., 1 s; 200 p.f., 750 p.f., 1 p.

RESISTORS. All values. 10 ohms to 10 meg. 1 w., 4d.; 1/2 w., 6d.; 1 w., 8d.; 2 w., 1 s.

HIGH STABILITY. 1 w., 1 1/2 s.; 2 w., 1 1/2 s. Preferred values 100 ohms to 10 meg.

WIRE-WOUND RESISTORS 1/3 10 watt 25 ohms 10,000 ohms 1/4 15 watt 12 15,000 ohms 50,000 ohms 5 w., 1 p.; 10 w., 2 s.

F.N.B.S. GOLD ENGRAVED Walnut or Ivory. 12in. diam., 1 1/8 in h. Not engraving, 1 1/8 each.

1 1/2" PURETONE RECORDING TAPE
1,200 ft. on standard fitting "P" Plastic reels. Brand new, boxed, 12 6.
Spoon 5" metal, 1 1/4" plastic, 4 3.

TOP TRANSFORMERS, Heavy Duty 30 mA., 4 o. Multi-tap, push-pull, 6. 7 tap per small pentode, 3 9.
L.F. CHOKES 15/10 H. 60 15 mA., 5 s.; 10 11 120 mA., 10/8; 15 H. 150 mA., 12 3.

MAJNS TRANS. 350-0-350, 30 mA., 6 3 v. tapped 1 1/4 s.; 5 v. tapped 1 1/2 s.; 5 1/2 v. tapped 2 1/2 s.

BEATER TRANS. Tapped primary, 200-250 v., 6 3 v. 1 1/2 amp.; 7 6; tapped sec. 2, 1.6 v., 1.2 amp., 1/3.

VCR97 TESTED FULL PICTURE, 82.

COPPER PLATED AERIAL ROD, 1/2 x 12in. push button, 3 4oz. 1 1/2.

ALADDIN FORMERS and comp. 1/8in., 8d., 10 1/2in., 10d. 1/4in. FORMERS with Caps and Cond. 1/8in. sp. x 1 1/4in. and 1/16in. sp. x 2 1/4in., 2 s each.

PYANA. Widget Soldering Iron, 200-250 v. or 200-250 v., 16 s. Salon Drying Box, 21 s.

MIKE TRANS. Rect. 100 x 1 1/2, 9 8 o.

MAJNS DROPPERS. 3 x 1 1/4in. Adj. Sliders, 2 amp. 750 ohms, 4 3. 2 x 2 amp., 1,000 ohms, 4 3.

LINE CORD, 3 amp., 60 ohms per foot, 2 2 amp., 100 ohms per foot, 2 6d. 2 x 2 amp., 175 w., 7d. per foot.

LOUDSPEAKERS P.M. 3 OHM.

5in. Goodman, 17 3. 7in. x 1in. Goodman, 21 s. 3 1/2in. square, Elac, 21 s. 8 in. Elac, 22 6. 6in. Goodman, 18 6. 10in. K. & A., 30 s. 6in. Elac, 21 s. 8 in. Elac, 22 6. 8in. M.E. 2 s. 2k. or 2k 1/2 field, tapped 1/2 p. 24 6.

CRYSTAL DIODE, G.E.C. 2 s. Crystal Box, 1 s.

GEX34, 4 s. 10 Circuits for Germanium Diodes, 3 3.

HIGH RESISTANCE PHONES, 4,000 ohms, 17 6 p.

CRYSTAL MIKE INSERT by Acos, precision engineered. Size only 1 1/2 x 3 1/16in. Britain Price 6. No transformer required.

SWITCH CLEANER Fluid, solvent spirit, 4 3 tin.

TWIN GANG TUNING CONDENSERS, .0005 and .001 with trimmers, 8 6; .375 p.f. meter less trimmers, 6 6; .0005 Standard size with trimmers and rect, 8 s; less trimmers, 8 s; ditto, sealed, 2 6.

SPEAKER FRET. Aco Plastic T.V. CAN, Walnut tone. 1 1/2in. wide, 2 s per foot.

Expanded metal, Silver, 1 1/2in. x 1/4in., 2 s each

A SMALL SELECTION FROM OUR STOCKS		New & Guaranteed	
All Boxed		1 6	1 6
1 6	5 6	EA50	6/6
8/6	4/6	642	6/15
EP4	6/12	2 6	6/15
1 8 5	EP50	2 2 9	6/6
3 8 1	Eppm	E1148	6/6
3 8 1	SD1	EB31	EB91
3 8 1	SD4	3 6	HYR2
6 3 6 5	EP92	2 1 6	new
6 3 6 5		6 6 6 6	7 6
6 3 6 5		6 6 6 6	7 6
6 3 6 5		6 6 6 6	7 6
6 3 6 5		6 6 6 6	7 6
6 3 6 5		6 6 6 6	7 6
6 3 6 5		6 6 6 6	7 6
6 3 6 5		6 6 6 6	7 6
6 3 6 5		6 6 6 6	7 6
6 3 6 5		6 6 6 6	7 6
6 3 6 5		6 6 6 6	7 6
6 3 6 5		6 6 6 6	7 6

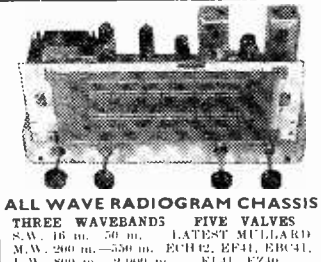

ALL WAVE RADIOS FIVE VALVES
LATEST MILLARD
M.W. 200 m. 550 m. EHT4, EF4, EB41, E.W. 800 m. 2,200 m. EL41, EZ40.
12 month Guarantee.
A.C. 200-250 v. 4-way Switch; Short-Medium-Long-Gram. A.V.C. and Negative feedback; 4.2 watts, Chassis 12 1/2" x 5 1/2" x 2 1/2" in. Glass Dial 10 x 4 1/2 in. horizontal or vertical adjustable; 2 Pilot Lamps, Four Knobs, Walnut or Ivory. Aligned and calibrated. C.R.T. section isolated from mains. T.S.L. Tweeter Supplied Free!
10 gns. Car. & Ins. 4 s.
TERMS: Deposit £5.50 and six monthly payments of £1.
MATCHED SPEAKERS FOR ABOVE CHASSIS
5in. 10/6. 1 1/2in. 25s; 1 1/2in. 30s.

R.C.S. SCOOP
Collaro Aut-changer RC531 for 78 rpm, 10in. and 12in. records. Brand new in maker's boxes. High impedance light-weight Pick-up with sapphire needle, will match any Amplifier or Radio. Less than half price.
£5.19.6. Car. and Ins. 5 6.

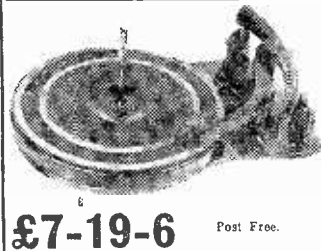

£7-19-6 Post Free.

TERMS: Deposit £4 and six monthly payments of 15 s.
Brand new Plessey 3-speed Autochanger Mixer Unit for 7, 10 and 12in. Records. Twin Hi-Fi Xial Head with Dupont sapphire stylus. Plays 4,000 records. Spring mounting. Baseboard required 15 s 1 1/2in. Height 5 1/2 in. Depth 2in. Super Quality. 200-250 v. A.C.

Walnut Veneered Playing Desk cut out ready for Plessey, only sold complete with Changer 10 6 extra.

ALLRY UNIT POWER PACK. Replaces Battery Bin, etc. 6V, plus 1 1/2 v. Size (Diam. x H) 4 1/4 x 1 1/4in. 4-pin socket. Same as battery. ONLY 1 s a year to run on A.C. 200-250 v.

FAMOUS MAKE. LIST PRICE, 95 s. OUR PRICE, 39 6. Ready for use.

B.S.R. MONARCH 3-speed Motor and Tunable with selecting switch for 20, 45 and 78 rpm. records. 100-100 v. and 200-250 v. A.C. 250 ohms. Also B.S.R. MONARCH Light-weight Pick-up with Aco Stylus (turnover head, separate Sapphire stylus for L.P. and Standard records).
SPECIAL OFFER. THE TWO: £4.15.6. post 2 6.

T.V. PRE-AMP (McMICHAEL) Tunable Channels 1 to 5. (W/3 Amplify Output of your Band 3 Converter.) Midgit Size. High Quality. Complete with A.C. and Full Instructions. Ready for use. (H.T. 250 v., 1.7, 6.3 v., 2 amp. required.) **BRAND NEW. 25s each. SPECIAL MAINS POWER PACK** for above, 25s+ extra.

SUPERB COIL PACK. 278. Minimum size 2 1/2in. x 2 1/2in. High Q. Built Copper Coils. Short, Medium, Long. Gram Switching. Single hole tuning. Complete with connection diagram, and circuit.

TELETRON BAND III CONVERTER
For London, Midland and Northern Transmitters.

Suitable all T.V. makes. P.F.F. or Superbet. Ready-wound coils, two EF80 valves, all components, punched chassis, cut out diagram, wiring plans. **COMPLETE KIT** for mains operation 200-250 v. A.C. £3.10.0.

- As ABOVE less POWER PACK. Requires 200 v. 20 mA. H.T. 6.3 v., 30 mA. L.T. £2.5.0
- Mains Transformers to above Spec. ... 10 6
- M.C. Westinghouse Rect. Diode ... 8 6
- B.R.C. L.T.A. Aerial crossover unit ... 7 6
- Punched and drilled chassis ... 3 9
- Larger chassis for Mains Model ... 15 0
- Teletron Cabinet with plans ... 15 0
- Full plans and cut-out details ... 6d.

Volume Controls 80 ohm COAX
Long spindles. (control Semi-adjustable. Poly-Vinyl 1 volt. Midgit. 100 ohms insulated. 1in. dia., 10,000 ohms to 2 Meg. Stranded core. 9d. yd. No S.A. D.P.S.W. D.P.S.W. Losses cut 50%.

3- 4- 4-8 STANDARDO 8d. yd.
Larger Log Tracks. 1/2in. COAX. 1/2in. COAX.

COAX PLUG: 1/- **DOUBLE SOCKET** ... 1 3
SOCKETS 1/4" OUTLET BOXES ... 4 8
BALANCED TWIN FEEDER, yd. 6d. 100 ohms only.
WIRE-WOUND POTS, 3 WATT. 1/2-set Minut. T.V. Type. All values 25 ohms to 30 K., 3 - ca. 50 K., 4 - 500 ohm, 30 K. to 2 m., 3 s.

WIRE-WOUND 4 WATT. Pots, 2 1/2in. Spindle. Value 100 ohms to 30 K., 5 8; 100 K., 6 6.
CONDENSERS. New stock, 400 pfd. 7 K.V. T.C.S. 5 6. Ditto, 20 K.V., 6 6; 100 pfd. 500 pfd. M.C. 6; Tubular 500 v. 001 to 100 nfd., 9d.; .05, 1 p. 25, 1 6; .5, 1 9; 1, 2 5 1/2; 9d.; 1, 4 0 0 v. 3 1/2 in. and 2,000 v. 4 s. 5 6; 100 K. 6 6.

CONDENSERS. New stock, 400 pfd. 7 K.V. T.C.S. 5 6. Ditto, 20 K.V., 6 6; 100 pfd. 500 pfd. M.C. 6; Tubular 500 v. 001 to 100 nfd., 9d.; .05, 1 p. 25, 1 6; .5, 1 9; 1, 2 5 1/2; 9d.; 1, 4 0 0 v. 3 1/2 in. and 2,000 v. 4 s. 5 6; 100 K. 6 6.

SILVER MICA CONDENSERS. 100v., 5 p. to 500 pfd. 1 s; 100 pfd. to 5,000 pfd. 1 3. **DITTO** 1 1/2. 1 1/2 p. to 500 pfd. 1 9; 514 pfd. to 1,000 pfd. 2 s.

I.F. TRANSFORMERS 7/6 pair
465 Kcs. Slur tuning Miniature Can., 2 1/2 in. x 1 1/2 in. x 1/4 in. High Q and good bandwidth. By Pye Radio. Data sheet supplied.

TUBULAR	TUBULAR	CAN TYPES
1 2 7 5 v. 2 - 100 25 v. 2 - 8	16 300 v. 5 6	
2 4 2 0 v. 2 3	150 v. 4 6	11 16 300 v. 5 6
1 4 2 0 v. 2 - 16 1/2	100 200 v. 5 6	25 20 4 50 v. 5 6
8 4 2 0 v. 2 3	6 - 32	32 2 5 0 v. 4 6
16 4 2 0 v. 2 6	CAN TYPES	32 2 5 0 v. 6 6
16 4 2 0 v. 3 6	40 sps.	34 50 350 v. 7 6
16 4 2 0 v. 4	10 400 v. 5 6	64 4 120 v. 4 11 6
24 2 5 0 v. 5 6	4 2 500 v. 5 6	64 2 5 0 v. 5 6
25 2 5 0 v. 1 6	4 4 500 v. 5 6	64 2 5 0 v. 5 6
30 2 5 0 v. 1 4	5 12 12 v. 2 - 3	1,000 v. 1,000 6 v. 12 6
30 2 5 0 v. 2 - 8	1 4 5 0 v. 5 - 6	14 500 v. 4 8
30 2 5 0 v. 2 3	1 2 3 2 v. 3 2	14 500 v. 4 8
30 2 5 0 v. 2 3	1 2 3 2 v. 3 2	14 500 v. 4 8

RYBAC VOLTAGES. K 25 v. 2 1/2 in. 4 3; K 30 4 3 1/2 K.V., 6 s; K 45 3 1/2 K.V., 6 6; K 50 4 K.V., 7 6; K 3 100 s.K., 12 6; MAINS TYPE, RM 1, 125 v., 6 6; RM 2, 100 v., 4 9; RM 3, 120 v., 5 6

G.E.C. Neon 0.2in. M.B.C. 180 v. 5 mA., 2 6.

COLLS Winding. T.V. type, 3 each. Osmor Midgit Q type all dust core, 4 each. All ranges.

TELETRON, 1 s. A 30d. with resaction, 5 6.

H.F. CHOKES. Iron core, 14 M.H. 3 s each.

ALUMINIUM CHASSIS. 1 1/2 s. w. insulated. With 4 sides, raised corners and built in Fly-tie holes. 2 1/2 in. sides. 7 3/4 in. 4 8; 9 3/4 in. 5 9; 11 7/8 in. 6 9; 13 3/4 in. 8 6; 14 1/2 in. 10 6; 15 1/4 in. 12 6; 18 x 16 3/4 in. 16 6.

FULL WAVE BRIDGE SELENIUM RECTIFIERS. 50 or 12 v. 1 1/2 amp., 6 s; 2 s., 11 s; 4 s., 17 6.

CHARGER TRANSFORMERS. Tapped input 200-250 v. for charging at 2, 5 or 12 v. 1 1/2 amp., 13 6; 3 amp., 21 6.

AL ALBARNIS books in stock. List 3d.
VALVE MANUALS I & II 5 s. each. Part
VALVE and TV TUBE equivalents book, 5 s.
ACID HYDROMETER. New E.A. type. Unbreakable. Pack in metal case 7 x 1 1/2 in. dia., 4 6.

WAVECHANGING SWITCHES
5 p. 4-way 2 water, long spindle ... 6 6
2 p. 2-way, 3 p. 2-way, short spindle ... 2 6
2 p. 6-way, 4 p. 2-way, 4 p. 3-way, long spindle 3 6
3 p. 4-way, 1 p. 12-way, long spindle. 3 6

VALVE HOLDERS, Pax. Int. Oct. 4d., EF50, EA50, 6 s; B7A, CWP, 1 3; Eng. and Amer. 4 s, 5 6, 7 s; 9 p. 10 s.

Moulded Mazda and Int. Oct. 6d.

B7G, B8A, B8G, B8A, 9d., B7G with can 18.

VCR97 2 6, B9A with can 2 6.

CERAMIC, EF50, B7G, B9A. Int. Oct. 1 s., B7G with can 1 9.

BLACK CRACKLE PAINT, air drying, 2/- tin.

We have no connection with any other firm. Please address all Mail Orders correctly as below.
RADIO COMPONENT SPECIALISTS 307 WHITEHORSE RD., WEST CROYDON
OPEN ALL DAY - (Wed. 1 p.m.) 10 page list 3d.
Tel. THO 1665, Buses 133 or 68 pass door. 48-hour postal Service. P. & P., 1/-, £2 orders post free. (Export Extra.) C.O.D. Service 1/6

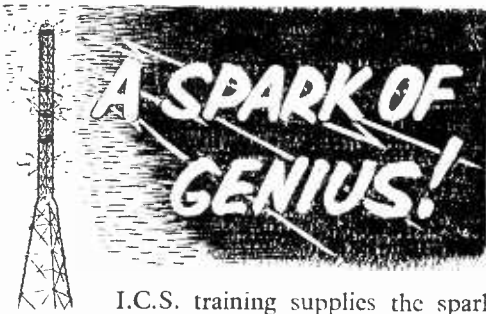

I.C.S. training supplies the spark you need to further your career. The Courses I.C.S. offer are practical and up to date, they recognise the present emphasis on Frequency Modulation, and can help you attain one of the many well-paid posts that exist today in the radio world. Prepare yourself now, at home and in your own time, with the expert help of I.C.S. tutors. The cost of an I.C.S. Course is moderate and includes all books.

Among the I.C.S. Courses available are:

- FREQUENCY MODULATION ENGINEERING
- T/V ENGINEERING
- RADIO SERVICING
- RADIO ENGINEERING
- RADAR ENGINEERING
- BASIC ELECTRONICS
- INDUSTRIAL ELECTRONICS
- ELECTRONIC ENGINEERING

Complete the coupon below and post it to us today for further details of the Course which interests you. Write to: Dept. 172B, I.C.S., Kingsway, W.C.2.

INTERNATIONAL CORRESPONDENCE SCHOOLS
DEPT. 172B, INTERNATIONAL BUILDINGS KINGSWAY,
LONDON, W.C.2.

Please send FREE book on.....AGE.....

NAME.....
(Block letters please)

ADDRESS

OCCUPATION

**INTERNATIONAL
CORRESPONDENCE SCHOOLS**

VIEW MASTER CONVERTER

All items for the View Master Converter as described in "Practical Television" can be supplied from stock. Full details are given in our special list which is available free upon request.

COIL SET AND METAL PARTS. Denco. Includes a ready wound set of coils, switch screens and metal cover. 30/-.

SWITCH ASSEMBLY. Denco. Complete switch with fine tuner and coil platforms. 27/-.

CONDENSER AND PRINTED CIRCUIT KIT. TCC. Contains all the condensers, printed circuit and valve holders. 43/-.

RESISTOR KIT. We make up this kit with the specified LAB resistors. All labelled with value and position. 8/-.

GAIN CONTROLS. Colvern CLR901 5,000 ohms. Three required. 3/3 each. Panel for mounting three controls. 1/-.

VALVE SCREENS. Carr Fastner. Skirt and screen. Two required. 1/3 each.

CO-AXIAL PLUG AND SOCKET. Beiling Lec. L604S Socket. 1/3. L734P Plug. 1/3.

SOLDER. Ersin Multicore. Special for printed circuits. 2/6.

VALVES. Mullard PCC84 24/4. Surplus 13/6.

Mullard PCF80 25/9. Surplus 13/6

KNOB. Pointed knob for switch. 1/-.

SUNDRIES KIT. Contains all nuts and bolts, flex wire co-axial cable, copper foil and spring wire. 8/-.

COMPLETE KITS. All above items supplied at one time.

KIT A. With new Mullard valves. £9.4.0. Credit Terms: Deposit £1.6.9 and seven monthly payments of £1.6.9.

KIT B. With surplus valves. £8.2.0. Credit Terms: Deposit £1.4.0 and seven monthly payments of £1.4.0.

PLEASE NOTE. These kits do not include the items needed for conversion of the View Master Sound/Vision Chassis. We can supply the chassis conversion kit for £2.0.0. Full details in our list.

SET OF TWIST DRILLS. Complete set of the correct size twist drill for drilling the Printed Circuit Panel. 10/-.

WATTS RADIO

8 Apple Market, Kingston-on-Thames, Surrey.
Telephone: KINGston 4099.

VIDEO ELECTRONICS

(LONDON) LTD. (Dept. P.T.)

Head Office: 27, Bacon Street, London, E.1.

Works: 16/22, Bacon Street, E.1.

Telephones: Bishopsgate 0419/0410.

T.V. Tubes (17in. £8, 14in. £6, 12in. £5, etc.)

Cheap, reliable high grade seconds and reconditioned C.R.T.s, as supplied to the trade and leading Television Insurance Companies, prices from £3.

Valves

Send at once for our useful list of cheap valves which will save money, we are the cheapest in the trade.

Condensers

Electrolytics, bias, coupling, etc., etc., at giveaway prices. All types stocked.

Resistors

A fine stock of these at very low prices.

T.V. & Radio Cabinets

A few 17in. Table cabinets, new, ex famous manufacturer, and about 500 very handsome radio cabinets.

Send for stock list of speakers, valves, components and T.V. and Radio Spares.

All our goods are guaranteed.

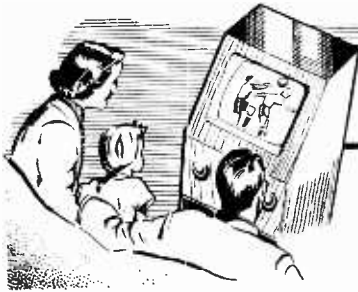

UNDERNEATH THE DIPOLE

TELEVISION PICK-UPS AND REFLECTIONS

By Iconos

AUDIENCE MEASUREMENTS
THE measurement of TV audience response has become quite a business and small organisations are now undertaking this type of "industrial research." The questioning of several hundred viewers by the organisations' representatives is still the main source of information, but other methods include diary notes from selected viewers, time clock measurement meters of various types fitted to TV receivers and measurements of sales response at shops, are used for the information of the Commercial TV contractors. The Manchester area has revealed surprising figures on two of these research systems, both of which register up to a percentage of 75 in favour of commercial TV. Birmingham district also appears to be extremely I.T.V. conscious. Of course, these figures only apply to those receivers which are capable of receiving both the BBC and the commercial channels. The overall number of BBC viewers will greatly exceed the I.T.V. viewers for some time to come, even when the Welsh and Scottish areas are covered by the I.T.A. There is no doubt that the I.T.A. engineers under Mr. Pat Bevan, responsible for the actual transmitting stations, have done a wonderful job.

CUE DOTS

QUESTIONNAIRES. Gallup polls, public opinion registers, and plebiscites have been carried a stage further in the U.S.A., by dealing with the state of technical progress in the hundreds of independent and networked TV stations now operating there. The use of cue dots has thus come under scrutiny by the American National Association of TV Film Directors. A month or so ago I grumbled in this column about the cue-dots used to mark the picture in inter-polated film sequences. A few seconds before the film is due to be

cut off, and a reversion to be made to live TV, a dot appears in the top right-hand corner as a reminder to the engineer to make this change-over. This "telegraphs" what is about to happen and spoils the artistes' effect. This opinion has long been held in the U.S.A. and the result of the questionnaire revealed that 91 per cent. of the directors and engineers who replied had abandoned this method and were using other methods. The question was a simple one: "Have you abolished hand-type punch cues yet?" It is about time that the BBC and the I.T.A. contractors followed the example of the American stations in this matter.

PICTURE GRADING

HAND-PUNCHED cue-dots can be replaced by various methods which operate buzzers or bells, or automatically make the change-overs. Similarly, picture grading of film could be improved by automatic methods. In the case of the films transmitted of the Stockholm Olympic horse jumping events, the pictures varied a great deal from shot to shot. Sometimes, the picture went completely dark, taking a few seconds to recover its brilliance while the engineers made adjustments. Such adjustments could be anticipated by invisible pre-warnings, by means of staples or adhesive magnetic tape, which would cue the engineer to be ready with the next adjustment of picture grading. Incidentally, international horse jumping events contrive to be top-line attractions on TV. The horse looks marvellous on TV and in Technicolor. Someday, maybe, we'll see both.

ERTHA KITT

I MUST say that until a few months ago the name Ertha Kitt indicated to me a sultry voice heard on the BBC radio programmes of American gramophone records. The off-beat cabaret

numbers sent the jazz fiends into ecstasies. Since then she has appeared in a rather specialised type of film, "New Faces," and in West End cabaret, in which she has achieved a terrific success. Her name is now in neons! But it was not until I saw her in the BBC-TV production "Mrs. Patterson" that I realised the potentialities of this coloured girl as a dramatic actress. Here was a pay which gave her opportunities for which every actress longs: a part which enables her to display the whole gamut of the emotions. In this day and age such a chance has to be handled very carefully to avoid the criticism of "hamming"—the theatrical jargon for over-playing and exaggeration. She grasped the opportunity and avoided all the pitfalls, thanks partly to the sensitive direction of Anthony Pelissier. The play gave her opportunities to sing a couple of haunting songs. What more could a young actress want?

TELERECORDINGS

AR-TV brought out telerecordings of "Before Your Very Eyes," the Arthur Askey show which was transmitted a few months ago. Arthur usually gives me a good laugh, but on two of the telerecordings I have seen I spent a great deal of time fiddling with the contrast and brilliance knobs of my set, trying to obtain a picture of reasonable quality. Ultimately, I came to the conclusion that the contrast on the filmed record must have been too great; at any rate, it was impossible for me to resolve a tolerable picture. And yet I have no doubt that on the closed circuit monitor screens at AR-TV's headquarters the picture was acceptable. I noticed this very wide difference of quality between the closed-circuit picture and the same picture on a good commercial receiver on a recent visit to the I.T. News Studio. On this occasion,

Muriel Young, an attractive announcer, was putting over a weather forecast. Her glamorous personality and soothing voice seemed to make even the prospect of heavy thunderstorms pleasurable!

BRITISH POPULAR SONGS

PLUMBING the depihs for new theme tunes is the constant occupation of dozens of composers of "pop" songs, who make a reasonably good living supplying the music publishers of London's Tin Pan Alley with jingles. The quest for newer and brighter tunes has been taken up in the Festival of British Popular Songs, in which the BBC-TV have put over unpublished songs with slick production numbers and first-class artistes. Panels in different parts of Britain registered their votes for the ones they considered the best. The result was interesting so far as the presentation was concerned. But the musical compositions betrayed an extraordinary lack of original ideas, and followed closely the well-worn paths of Charing Cross Road clichés. Their second best. There was no sparkle about them, no new twist, no gimmick and nothing much that one could remember. It is the "memorability" of song tunes

which really matters, and though this programme was beautifully produced, it is the picture only, the faces of Carole Carr and other artistes, together with the visual production numbers which I, for one, remember. The tunes themselves escaped my memory almost instantly. It makes one realise the brilliance of those masters of popular music, Leslie Stuart, Noel Gay, Cole Porter, Ivor Novello and, in a more sophisticated vein, George Gershwin and Noel Coward.

Tin Pan Alley at its best was featured in Billy Cotton's show of that name, in which this great showman restored our faith in the musical products of that thoroughfare. Billy Cotton was ably assisted by Leslie Hutchinson ("Hutch"), who was at his best and in great form at the piano, and also Bert Weedon, Harold Smart and the Coronets. Interpolated

were some exciting dance production numbers in which Gillian Lynne and Terence Theobald were seen in settings which were attractive and not overburdened with too much busy detail. Incidentally,



The mobile test transmitter recently purchased by the I.F.A. from Belling and Lee is seen here leaving the Belling factory at Enfield. This transmitter started life as G9AED at Croydon and has been used for field tests on all I.F.A. stations so far.

I think that this series has done a lot to clear up certain misconceptions which had existed concerning British songs and music.

SERVICING TELEVISION RECEIVERS

(Continued from page 65)

Horizontal pulling on the white parts of the picture can be due to incorrect positioning of the cathode (C.R.T.) lead, that is, the lead to tag 11 of the tube base, incorrect positioning of the lead to the lower wander plug, which is the other end of the same lead, incorrect L3 oscillator adjustment or a capacitor failure either in the video amplifier stage or in the heater circuit.

EHT Circuit

The EHT of approximately 8 kV. is derived from the line output transformer overwind rectified by the SU61.

Absence of EHT should direct attention to the line timebase if the whistle is absent, check V12, V13 and V14.

If the timebase is operating check SU61 heater and remove lead from the tube anode cap in case the tube itself is responsible; see June article on EHT failure, etc.

The line output transformer is often the cause of "no EHT, no line output" fault. A word about replacing the line output transformer is required, since replacement types require a slight alteration to the tag panel.

Connect the centre tap of the width control to the left-hand tag of the two situated at the bottom of the tag panel located on the right of the mounting

bracket. The original lead joining this tag is now taken to the additional anchor point that forms the junction of R69, C58 and C57, this latter capacitor being mounted on the chassis. See layout diagram. The transformer has been modified to take care of the electrical centring of the picture and the revised type can be identified by an additional anchor tag fixed to the bolt clamping the transformer together. A small degree of electrical shift was introduced on later models to allow for tolerances of cathode-ray tubes and focus magnet variation.

Two 100Ω ½-watt resistor (120Ω in some models) are connected between the width control centre tag and the H.T. rail, with a 25 μF 25 V.D.C. capacitor across them. 20 μF may be found in some models. Tag 7 on the multi-way plug and screen feed of V13 are both fed from the centre tap of these two resistors.

When the C.R.T. is replaced and the picture is not central with the magnet in line one or both of the 100Ω resistors should be shorted out.

Power Supplies

The rectifier is a single valve with conventional smoothing, single choke and large capacity electrolytics. The heaters are, of course, all in series, the chain being broken at the multi-plug and socket to supply the R.F. unit. The rectifier may be damaged if the receiver is switched on within two minutes of being switched off, and this, of course, applies to all receivers employing valve rectifiers.

LASKY'S PAGE OF MONEY-SAVING OFFERS

12-CHANNEL TV TUNER

Famous make. Covers Bands I and III. Complete with valves EF80 and ECC81. Ceramic valve holders, finest quality components. Switch and fine tuning. I.F. output 20-25 Mc/s. Freq. coverage 30-87 Mc/s. and 175-215 Mc/s. Full details and circuit diagram supplied. **79/6**
Reduced to **Post 5/6. KNOBS 2/9 extra.**

MIN. CRYSTAL DIODES

Glass type, wire ends, each **44FN.45** and equivalent types, various makes. **3/6**

GERMANIUM CRYSTAL DIODES

GEX.00... 1/6 WG1A..... 3/6
CLX.34... 3/6 VGH4..... 4/-
CBX.54... 5/- WGS4 & B 5/-
CA.71... 5/- VGG6A..... 5/-

METER BARGAINS

2 1/2 in. moving coil Brand new micro-ammeters F.S.D. 0-750 microamps, 15 ohms resist. **15/-**
0-15 amps., 12/6. 0-200 v. A.C. rect. incorporated. 12/6.
Dozens of other types.

TRANSISTORS

Lowest prices. Fully guaranteed. By Mullard, S.T.C., etc. SUB-MINIATURE TRANSISTOR TRANSFORMERS. **4/6**
4 to 1 ratio. Each

MAKERS' SURPLUS COMPONENT BARGAINS

- WIDE ANGLE 38 mm. Line E.H.T. trans., ferrox-cube core, 9-16 kv..... 25/-**
Scanning Coils, low imp. line and frame..... 25/-
Ferrox-cube cored Scanning Coils and Line Output Trans., 10-15 kv. EY51, winding Line Trans. incorporates width and linearity control. Complete with circuit diagram, the pair..... 50/-
Frame Output Transformer Scanning Coils low imp. line and frame..... 6/6
Frame or line block osc. transformer..... 4/6
Focus Magnets Ferroxdure P.M. Focus Magnets, Iron Cored..... 19/6
Duomag Focussers..... 22/6
300 ma. Smoothing chokes Electromagnetic focus coil, with combined scan coils STANDARD 35 mm. Line Output Transformers. No E.H.T..... 12/6
Line Output Transformers 6.9 kv. E.H.T. and 6.3 v. winding. Ferrox-cube..... 19/6
Scanning coils. Low imp. line and frame..... 12/6
Bitto by Igranic..... 14/6
Frame or line blocking oscillator transformer..... 4/6
Frame output transformer Focus Magnets :
Without Vernier..... 12/6
With Vernier..... 17/6
Focus coils, Electromagnetic 200 ma. Smoothing Chokes 10/6

TURRET "TELETUNER" COMPLETE WITH 12 COIL SETS

Covers all Channels Bands I and III. Valves used : PCC84, R.F. double triode, cascade R.F. amplifier, PCH30, triode pentode i.e. and mixer, I.F. output 33-38 Mc/s. Easily modified to other I.F. outputs. Full instructions and circuit diagram supplied.

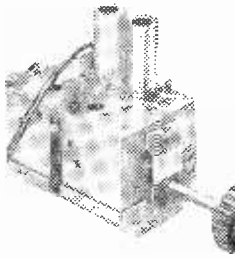

LASKY'S PRICE **99/6**
Post 2/6. Knobs, 3/6.

BIGGEST BARGAINS EVER OFFERED IN TV CATHODE RAY TUBES!

A BIG NEW PURCHASE OF THESE TUBES ENABLES US TO STILL FURTHER REDUCE OUR PRICE FROM **£9.18.6** to **£8.9.6**



BRAND NEW, PERFECT 16" METAL CONE C. R. T.

6.3 v. heater. Ion trap, 14 kv. E.H.T., wide angle 70°, standard 38 mm. neck, duodecal base, magnetic focus and deflection.

Length 17 1/2 in. Gives large black and white picture 11 in. x 14 in.

Used in original cartons. GUARANTEED BY US FOR 3 MONTHS. Full data, connections and suggested time base supplied with every Tube.

LISTED AT **£23.9.10**

LASKY'S PRICE **£8.9.6.**

Carr. & Insur. 22/6 extra.

Masks, Anti-Corona Rings, Bases and Ion Traps available.

Note to Previous Customers : As a gesture of goodwill to customers who paid our former price of **£9.18.6**, we will make a rebate of **£1.10.0** in the form of a merchandise credit note. Proof of purchase must be furnished and claims made by September 14th, 1956.

GARRARD RC.110 3-SPEED AUTO-CHANGERS STILL FURTHER REDUCED!

Brand new in maker's cartons. Complete with turnover crystal pick-up. Incorporates automatic record size selection (mixer). Cabinet space required: 14 in. x 12 1/2 in. x 4 9/16 in. above and 2 1/2 in. below motor board. Cream and Brown enamel finish. Limited quantity only.

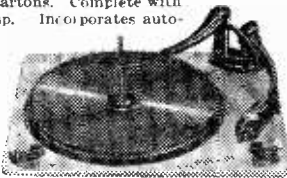

List **£14.13.0.** LASKY'S PRICE **£7.19.6**
Carr. 5/-. Cabinets available.

SEND FOR OUR NEW LIST covering radio and television, enclosing 3d. in stamps.

LASKY'S (HARROW ROAD) LTD.

42, TOTENHAM COURT ROAD, W.1.
Telephone : MUScum 2805.
370, HARROW ROAD, PADDINGTON, W.3.
LADBROKE 4075 and CUNNINGHAM 1979.
Open all day Saturday, early closing Thursday.

BUILD A FIRST CLASS TAPE RECORDER AT POUNDS SAVING

Send for details of Lasky's New Portable Tape Recorder Kit comprising fully fitted Case, Truvox Deck, Amplifier, Elliptical Speaker, 1,200ft. EMI Tape, Plastic Spool and full instructions. Price of the

COMPLETE KIT, **£35**
Carr. & pkr. 25/- extra.

6-VALVE RADIOGRAM CHASSIS COMPLETE WITH VALVES

Famous Manufacturer's Superplus, 6 valve 3-wave Superhet, 18-50 m. short, 300-550 m. medium, 1,600-2,000 m. long. Brand new Mullard valves : ECH42, EF41, L63, EB41, 6V6 e.t.c. E240 and finest quality components. Gram. switch, 465 kc/s I.F., tone control three-colour dial. Overall size 13 1/2 x 5 1/2 in., height 12 1/2 in. Aperture required for dial and controls 11 x 3 1/2 in. Complete with valves, output trans., knobs, etc.

LASKY'S PRICE **£10.19.6**
Carriage and packing 7/6 extra.

SPECIAL OFFERS OF CABINETS

Call and inspect our splendid bargains in TV, Radiogram and Radio cabinets, also Tape Recorder Cases.

PROJECTION TV UNITS

(Mullard.) Consisting of optical unit and E.H.T. unit, complete with valves and C.R. tube. Limited quantity. Full details on request.

LASKY'S PRICE **£21**
Carr. 21/-.

FEW ONLY!

14-in. C. R. TUBES

14 in. rectangular aluminised C.R. Tubes, famous make, 6.3 heater, 10-14 kv. E.H.T., **£12.19.6**
LASKY'S PRICE
Carr. and Ins. 22/6.

C.R.T. MASKS

12 in. rubber, complete with armour plate glass. Dustproof. Black, 7/6. White, 10/-. Plastic Masks, 14 in., 6/6; 17 in., 7/6; De Luxe, 17 in., 15/-; E.E. 16 in. polystyrene. List 42/-
LASKY'S PRICE **29/6**
Post extra.

COMPLETE 5-VALVE RADIO CHASSIS

Brand new and unused. A.C. D.C. 200-250 v. I.F. 465 kc/s. A.V.C. 4 watts output, 3-station pre-set, frame aerial, fully aligned, chassis 10 x 5 1/2 in., max. height 5 1/2 in. Completely wired and ready for use with the addition of a speaker and output transformer. Two controls, volume and station switch. Valves used : 10C1, 10F9 or UF41, 10L D11, 10P4, U404 or UY41. Ideally suitable as radio receiver for inclusion in a TV set.
NOW REDUCED TO 52/6
less valves. Post 3/6.



ALL MAIL ORDERS TO HARROW ROAD PLEASE

RADIO SUPPLY CO. (LEEDS) LTD.

Dept., N.

32, THE CALLS, LEEDS 2.

Post Terms C.W.O. or C.O.D. NO C.O.D. under £1. Postage 1/- extra under 10/-; 1/6 extra under £1; 2/- under £3. Open to callers 9 a.m. to 5.30 p.m. Sats. until 1 p.m. S.A.E. with enquiries, please. Full list 6d.; Trade list 5d.

R.S.C. TRANSFORMERS

Fully Guaranteed.
Interleaved and Impregnated.

Primaries 200-230-250 v. 50 c/s screened TOP SHROUDED DROP THROUGH

260-0-250 v 70 ma, 6.3 v 2a, 5 v 2a	16 9
350-0-350 v 80 ma, 6.3 v 2a, 5 v 2a	19 9
250-0-250 v 100 ma, 6.3 v 4a, 5 v 3a	23 9
350-0-350 v 100 ma, 6.3 v 4a, 5 v 3a	23 9
350-0-350 v 150 ma, 6.3 v 4a, 5 v 3a	29 9

FULLY SHROUDED UPRIGHT

250-0-250 v 60 ma, 6.3 v 2 a, 5 v 2 a	17 6
Midget type, 2 1/2-3 in.	17 6
250-0-250 v 100 ma, 6.3 v 4a, 5 v 3a	28 9
250-0-250 v 100 ma, 6.3 v 6 a, 5 v 3 a	28 9
for R1335 Conversion	31-
300-0-300 v 100 ma, 6.3 v 4a, 5 v 3a	28 9
350-0-350 v 100 ma, 6.3 v 4a, 5 v 3a	23 9
350-0-350 v 150 ma, 6.3 v 4a, 0-4-5 v 3a	31 6
425-0-425 v 200 ma, 6.3 v 4a, C.T. 6.3 v 4a, C.T. 5 v 3a	49 9

FLAMENT TRANSFORMERS

All with 200-250 v 50 c/s Primaries: 6.3 v 1.5 a, 5.9 v 1.5 a, 7.6 v 1.5 a, 0-4-6 v 3 a, 7.9 v 1.2 v 1 a, 7.11 v 1.5 v 3 a, 8.11 v 1.5 v 3 a, 17.9 v 1.5 v 3 a

CHARGER TRANSFORMERS

200-250 v 0.9-15 v 1 a, 11.9 v 0.9-15 v 3 a, 16.9 v 0.9-15 v 5 a, 19.9 v 0.9-15 v 6 a, 22 9.

OUTPUT TRANSFORMERS

Standard Pentode 5,000 to 30 ohms ... 4 9
Small Pentode 5,000 to 30 ohms... 3 9

E.H.T. TRANSFORMERS 200-230-250 v.

2,500 v 5 ma, 2-0-2 v 1.1 a, 2-0-2 v 1.1 a for VCR57, VCR517 ... 36 6

SMOOTHING CHOKES

250 ma 5 h 50 ohms ... 11 9
100 ma 10 h 250 ohms ... 8 9
80 ma 10 h 350 ohms ... 5 6
60 ma 10 h 400 ohms ... 4 1

SELENIUM METAL RECTIFIERS

G.E.C. 300 v 250 ma, 12 9; 120 v 40 ma, 3 9; 6 12 v 1 a F.W., 8 9; 6 12 v 50 ma, 5 9; 6 12 v 1 a F.W., 8 9; 6 12 v 4 a, 16 9; 250 v 80 ma, 7 9; 6 12 v 6 a F.W., 19 9; 6 12 v 10 a, 28 9.

BATTERY SET CONVERTER KIT

All parts for converting any normal type of Battery Receiver to A.C. mains 200-250 v 50 c.s. Supplies 120 v 90 v or 60 v at 40 ma. Fully smoothed and fully smoothed I.T. of 2 v at 0.4 a to 1 a. Price including circuit 49 9. Or ready for use 9 9 extra.

ALL DRY RECEIVER BATTERY ELIMINATOR KIT

All parts for the construction of a unit (metal-case 5 1/4-2 in.) to supply Battery Portable receivers requiring 90 v and 1.5 v. Fully smoothed. From 200-250 v 50 c.s. mains. Price, inc. point-to-point wiring diagrams, 39 9. Or assembled and tested at 46 9.

R.S.C. TAI HIGH QUALITY TAPE DECK AMPLIFIER

For A.L.T. Tape Decks with High Impedance, Playback and Erase Heads, such as Lane, Truvox. Adjustment to type of deck Ready for made by alteration of a Use ONLY resistor. For A.C. Mains

200-250 v, 50 c.s. Positive compensated identification of recording level given by Magic Eye. Recording facilities for 15, 7 1/2 or 3 1/2 in. per sec. Automatic equalisation at the turn of a knob. Linear frequency response of 3db, 50-11,000 c.p.s. Negative feed-back equalisation. Minimum microphony and hum. High output with completely effective erasure and distortionless reproduction. Sensitivity is 15 millivolts so that any kind of crystal microphone is suitable. Provision is made for feeding a P.A. amplifier. Unit can also be used as a gram-amplifier requiring input of 0.75 v R.M.S. Carriage 7 6. Illustrated leaflet 6d.

EX-GOVT. UNIT RDF1

Brand new, cartoned. Complete with 14 valves, including 5Z4G. Also mains trans. L.F. choke rectifier, etc., etc. Only 28 9. Carr. 7 9.

11 GNS

SMALL POTTED MAINS TRANSFORMERS

Removed from New Ex-Govt. units Primary 0-200-230-250 v Secs 250-0-250 v 80 ma, 6.3 v 2 a, 5 v 2 a. 11 9

CO-AXIAL CABLE

Size 3 1/4 x 3 in. 75 ohms 14 36 ... 8d. 3d.

Twin-screened Feeder ... 110d. 3d.

EX-GOVT. SMOOTHING CHOKES

100 ma 10 h 250 ohms Tropicalised ... 3 11 9

150 ma 6-10 h 150 ohms ... 6 9

150 ma 10 h 150 ohms ... 11 9

250 ma 10 h 50 ohms ... 14 9

E.H.T. SMOOTHERS

5 mfd 2,500 v Blocks (ex-Govt.), 2 11.

BATTERY CHARGER KITS—Consisting of attractive Green Crackle Case, Transformer, F.W. Rectifier, Fuse, Fuseholder, Tag strip, Grommets and Circuits. For mains input 200-230-250 v 50 c.s. 6 v 2 a, 25 9; 6 v or 12 v, 2 a, 31 6; 6 v or 12 v, 4 a, 49 9. Any type assembled and tested for 6 9 extra.

R.S.C. 6 v or 12 v BATTERY CHARGER

For normal A.C. mains Input 200-230-250 v 50 c.s. Selector panel for 6 v or 12 v charging. Variable charge rate of up to 4 AMPN. Fused, and with meter. Well ventilated case with attractive hammer finish. Guaranteed for 12 months. 99 6. Carr. 2 6.

V.C. CABINETS

Handsome well-constructed with walnut veneer finish. Size 18 in. high, 20 in. wide, 13 in. deep. Size of aperture 17 in. 13 1/2 in. Fitted Doors. For 15 in. or 17 in. Tube. Limited number at only 79 6

BATTERY CHARGERS

For mains 200-250 v 50 c.s. Output for charging 6 v or 12 v at 1 amp. In strong metal case. Only 25 9. Above can also be used for electric train power supply.



BAND III AERIALS OR FITTINGS

Whether you are contemplating the construction of a Band III aerial or purchasing one complete it will be well worth your while to write to us who, as manufacturers, can offer you real

VALUE FOR MONEY

THE FOLLOWING IS A CROSS SECTION OF ITEMS TAKEN FROM OUR NEW COMPREHENSIVE CATALOGUE.

- * 10 Element Band III Aerial, 77/6.
- * 8 Element Band III Aerial, 62/6.
- * 6 Element Band III Aerial, 47/6.

FITTINGS

- * Universal Band III Clamp-on Fitting.
- * Band III Insulator, complete with folded dipole.
- * Director and Reflector Rod Holders for Bands I, II, and III.
- * Straight and Cranked Masts (all sizes).
- * Chimney and Wall Brackets. Alloy Tubing, etc. etc.

Send 1/- P.O. for the NEW MULTI-PAGE illustrated Catalogue (together with element and boom measurements (all Bands) to help the constructor) to:

FRINGEVISION LTD. MARLBOROUGH WILTS.
Phone 657/8



QUALITY TELEVISION COMPONENTS

SCANNING COILS, 6'10 kv. R.F., E.H.T. UNITS, E.H.T. and OUTPUT TRANSFORMERS, LINE FLY-BACK E.H.T. UNITS.

COIL KITS FOR "P.T." BAND III CONVERTERS

Write for illustrated list (Publication 75)

HAYNES RADIO Ltd., Queensway, Enfield, Middlesex.

NEW-MAX ELECTRONICS LTD.

220, Edgware Rd., London, W.2 Tel. PAD. 5607

Come and visit us. The largest Electronic Bargains Store in London. We have 500 Repressed T.V.s, all sizes always in stock, also Radio Sets, Radiograms, Reclaimed and guaranteed C.R. Tubes, 12in. £5. 14in. £6 10/-, 15in. £7 10/-, 17in. £8/-, p. and p. 10 -; Tubes with Heater Cathode Short, 14in. £3 10/-, 15in. £4 10/-, 17in. £5 -/-, p. and p. 10 -; Surplus Valves, Components and Test Equipment, etc., etc. Also available all types and makes of new C.R. Tubes at list prices. Part exchanges welcomed!

SPECIAL OFFER

Projection T.V. Unit. Complete optical projection box with focus and frame coil, usual cost £30 our price £6 -/- incl. p. and p. Any set can be converted to large screen T.V. with this unit by increasing E.H.T. (to approx. 15-20 kv).

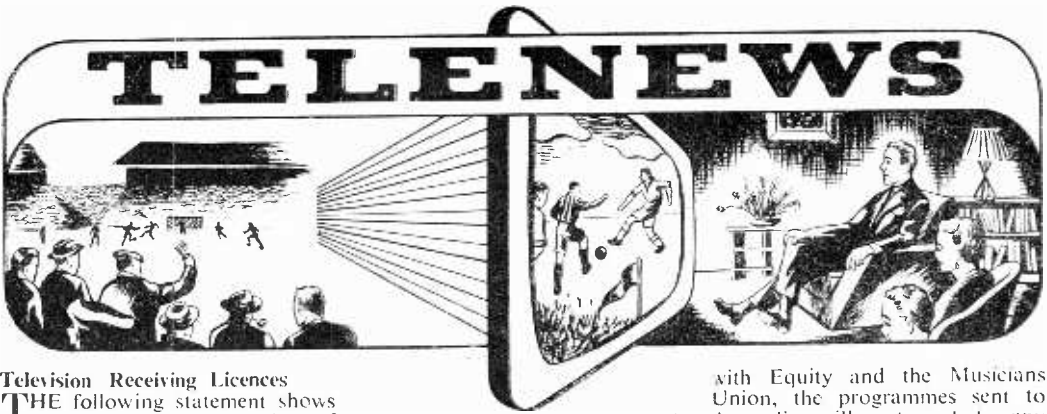

Television Receiving Licences

THE following statement shows the approximate number of Television Receiving Licences in force at the end of June, 1956, in respect of receiving stations situated within the various Postal Regions of England, Wales, Scotland and Northern Ireland.

Throughout the whole country during June the number of television licences increased by 58,547.

14,332,856 broadcast receiving licences, including 5,922,020 for television and 302,042 for sets fitted in cars, were current in great Britain and Northern Ireland at the end of June, 1956.

Region	Total
London Postal...	1,326,068
Home Counties ...	680,096
Midland...	1,021,171
North Eastern...	902,242
North Western...	851,889
South Western...	399,100
Wales and Border Counties...	330,291
Total England and Wales ...	5,510,857
Scotland ...	365,646
Northern Ireland ...	45,517
Grand Total ...	5,922,020

In the Midlands

THE Midland Region of the Post Office joins the London Postal Region in having more licences for television than for sound. At the end of June there were 1,021,171 licences current for television and 1,011,463 for sound in the Midland Region.

BBC Rugby Union Agreement

THE four Home Rugby Unions and the BBC Television Service announce that they have reached agreement whereby the BBC has been given exclusive television rights for international and certain representative Rugby Union football matches in the next two seasons, with an option for renewal for a third season.

Australia Buys BBC Films

THE Australian Broadcasting Commission, which is begin-

ning its television transmissions in Melbourne in November, has already placed orders for 101 BBC films and 61 telerecordings of BBC television programmes. They cover the "War In The Air" series, the "Watch With Mother" series about Andy Pandy and the Flowerpot Men, films portraying the artists Graham Sutherland, John Piper and Walter Sickert, the Peter Scott "Look" series on animal and bird life, the archaeological programme "Buried Treasure," "Speaking Personally" (with Peter Ustinov and Emyln Williams), "At Home" at Admiralty House, the one-hour version of the Coronation, and a number of important outside broadcast occasions such as the eightieth birthday presentation to Sir Winston Churchill.

Pending further arrangements

with Equity and the Musicians Union, the programmes sent to Australia will not include any drama or musical performances.

American Underwater TV Show

FORTY-TWO million American viewers, with the help of a Pye underwater television camera, recently explored 50ft. under the surface into the mouth of a subterranean river—Silver Springs in Florida.

In these freshwater springs—said to be the largest in the world—the bones of mastodons and other prehistoric creatures have recently been found, and during an N.B.C. "Wide Wide World" TV programme, a team of archaeologists explored 60ft. into the back of the cavern through which the river appears. From an underwater camera viewers could see the team, using aqualung breathing appara-

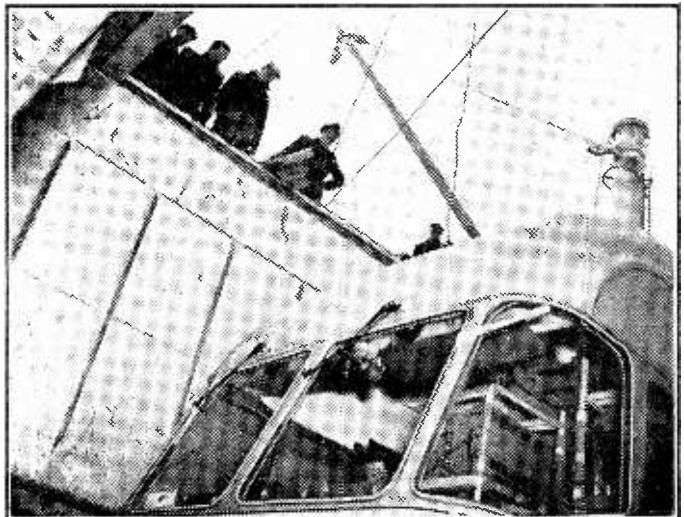

One of the mobile O.B. television units bought from Marconis by Australia, being shipped at the Royal Albert Dock.

tus, dive deep into the heart of the great natural springs.

Their leader carried a smaller Pye underwater TV camera, so that in addition to watching the archaeologists at work, viewers saw, as if through the eyes of the explorers, all the ancient relics as they were discovered and brought to the surface. Throughout the programme, probably the most ambitious live underwater TV broadcast yet made,

their sets immediately before the start of the programme. It is not to be confused with Test Card "C" which is radiated at regular times for the benefit of the radio industry and trade.

New Colour System

A NEW television system, in which a revolutionary method of producing the picture on the face of the tube is employed, has been

from the "flat" TV tube recently demonstrated in the U.S., the electron beam which forms the picture hits the face of the screen, or viewing end of the tube, at right angles. Unlike the U.S. system, this new U.K. system does not require the use of any large amount of additional electronic equipment.

Further work on this project is now being supported by a grant from the National Research Development Corporation.

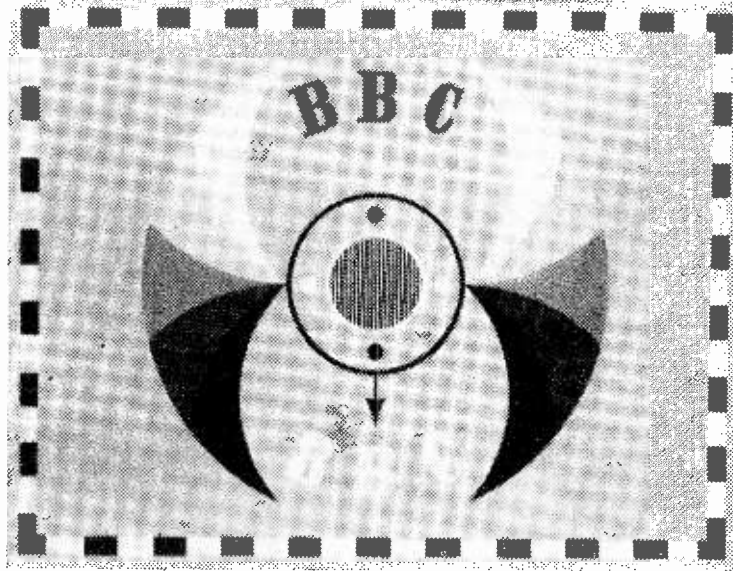

The new BBC tuning signal, introduced in June.

high-powered lights illuminated the scene, and fish and turtles could be seen swimming amongst the divers in the clear water.

New BBC Tuning Signal

THE BBC introduced a new television tuning signal on Saturday, June 16th. The new tuning signal retains all the essential features of the old one but the presentation and general appearance have been improved, as a reproduction of it is given above.

The purpose of the tuning signal is to assist viewers in making any necessary minor adjustments to

designed by Dr. D. Gabor of the Imperial College of Science and Technology, London University.

This is among many new U.K. inventions of potential industrial importance described in the annual report of the National Research Development Corporation.

One of the outstanding features of the new TV system is that it enables a virtually flat cathode ray tube to be used, in which the customary "stalk" is eliminated. This will enable less bulky TV receivers to be built.

In the Gabor system, which differs radically in many ways

TV for Damascus Fair

FOR the Damascus Fair, which is to be opened on September 1st by the President of Syria, Pye, Ltd., are to take an outside broadcast vehicle and a complete television studio, similar in many respects to the station which they took to the Baghdad Trades Fair in 1954 and sold to the Iraq Government.

The studio, which will be in the British Pavilion at the Fair, will be 40ft. by 60ft. and will contain three camera chains and a telecine unit. A transmitter is to be installed, and this will give coverage not only to the receivers at the Fair, but also to receivers in the city.

In conformity with CCIR standards, the television equipment will operate on 625 lines on channel 8. As with the Baghdad station, glass windows will be set into the wall of the studio to enable visitors to follow everything that happens inside.

Manchester ITV Audience Increase

THE latest survey conducted by the A. C. Nielson Co. in the Manchester I.T.V. area estimates that 337,000 homes are now able to receive Granada and A.B.C.-TV programmes, and the number of such homes is increasing at the rate of 6,000 per week.

This is an increase of 94,000 homes, almost 40 per cent. more than when the Manchester I.T.V. transmitter opened in May.

The Editor will be pleased to consider articles of a practical nature suitable for publication in "Practical Television." Such articles should be written on one side of the paper only, and should contain the name and address of the sender. Whilst the Editor does not hold himself responsible for manuscripts, every effort will be made to return them if a stamped and addressed envelope is enclosed. All correspondence intended for the Editor should be addressed to: The Editor, "Practical Television," George Newnes, Ltd., Tower House, Southampton Street, Strand, W.C.2.

Owing to the rapid progress in the design of radio apparatus and to our efforts to keep our readers in touch with the latest developments, we give no warranty that apparatus described in our columns is not the subject of letters patent.

Copyright in all drawings, photographs and articles published in "Practical Television" is specifically reserved throughout the countries signatory to the Berne Convention and the U.S.A. Reproductions or imitations of any of these are therefore expressly forbidden.

NEW!

EXPERIMENTAL KITS in Radio, T.V. etc.

LEARN THE PRACTICAL WAY

Specially prepared sets of radio parts from which we teach you, in your own home, the working of fundamental electronic circuits and bring you easily to the point when you can construct and service radio sets. Whether you are a student for an examination; starting a new hobby; intent upon a career in industry; or running your own business — these Practical Courses are intended for YOU — and may be yours at a Very Moderate Cost.

EASY TERMS FROM 15/- A MONTH

With these outfits, which you receive upon enrolment, you are instructed how to build basic Electronic Circuits (Amplifiers, Oscillators, Power Units, etc.) leading to complete Radio and Television Receiver Testing and Servicing.

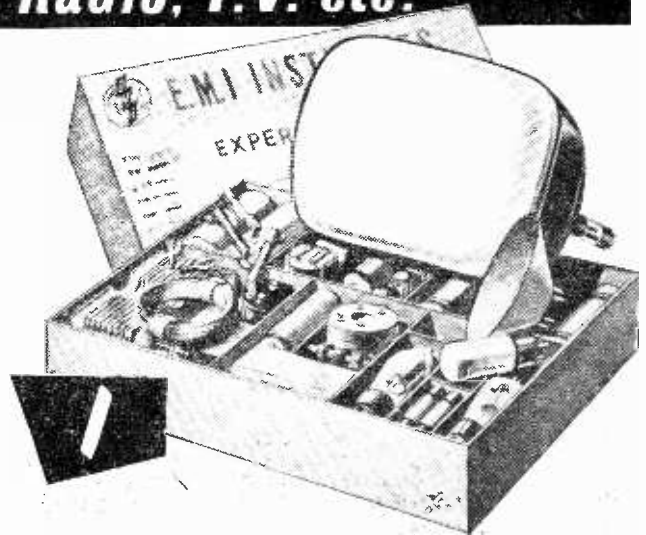

TELEVISION—With this equipment you are instructed in the design, construction, servicing and testing of a modern high quality Television Receiver.

ALL EQUIPMENT SUPPLIED IMMEDIATELY AND REMAINS YOUR PROPERTY

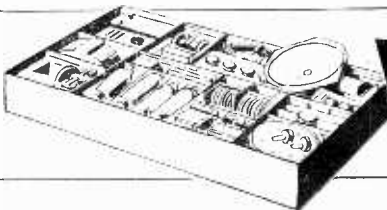

BEGINNER'S RADIO OUTFITS

—For carrying out basic practical work in Radio and Electronics, from first principles and leading to the design and building of simple Receivers.

ADVANCED RADIO OUTFITS

—With this equipment, you are instructed in the design, construction, testing and servicing of a complete modern T.R.F. and Superhet Radio Receiver.

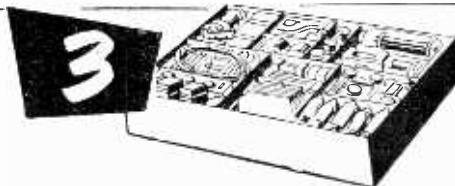

OTHER COURSES WITH OUTFITS INCLUDE:

**MECHANICS • ELECTRICITY
CHEMISTRY • PHOTOGRAPHY
CARPENTRY**

**ALSO DRAUGHTSMANSHIP • COMMERCIAL ART
AMATEUR S.W. RADIO • LANGUAGES • ETC.**

POST THIS COUPON TODAY

Please send me your FREE book on Practical Courses: I am interested in Television , Radio: Beginners , Advanced , Other subjects

(Please indicate Item(s) required)

To: E.M.I. INSTITUTES, Dept. 1384, Grove Park Road, London, W.4.

NAME

ADDRESS



SEPT.

E.M.I. INSTITUTES

The only Postal College which is part of a world-wide Industrial Organisation



Whilst we are always pleased to assist readers with their technical difficulties, we regret that we are unable to supply diagrams or provide instructions for modifying surplus equipment. We cannot supply alternative details for constructional articles which appear in these pages. WE CANNOT UNDERTAKE TO ANSWER QUERIES OVER THE TELEPHONE. The coupon from p. 97 must be attached to all Queries, and if a postal reply is required a stamped and addressed envelope must be enclosed.

G.E.C. BT7092

I have a television and radio set which I purchased in about 1948 and which was manufactured by G.E.C. On the back cover there appears the number :— B.T. 7092. Instructions No. L.U.1955.

I should be pleased if you could let me know whether it is possible to convert this set to receive the I.T.A. programmes.—H. Marsden (W.7).

It is quite possible to convert this receiver using the normal type of converter as advertised or as supplied by dealers. We would suggest one with its own power supply be used so as to render the converter independent of the receiver. Should Band 1 patterning be experienced, a "Spencer-West Type 54" patterning removal unit may be used.

BEETHOVEN B94

I would be pleased if you could diagnose the present faults.

Lack of height (about 1in.) is the first, and valves ECC82 and ECL80 have been checked and found O.K.

Secondly, after about half an hour the picture will go, and leave a more pronounced and darker than usual raster with a white vertical line through centre. The line whistle changes pitch at this point. This condition can also come about by the throwing of a light switch or at the end of programme, or even when there is a change of camera.

The picture can sometimes immediately be regained by manipulation of line hold control, but will gradually slip sideways into former condition or range diagonally over screen and rotate horizontally from left to right quite quickly. I have the service sheets for this model.

I should also like to mention that the 150 mA. fuse on the line output circuit has blown for the second time.—L. W. Welljane (Southampton).

You should check the resistor values in the anode circuits of the ECC82 and ECL80 valves. This is of course the frame time-base section, and lack of height, assuming the H.T. line is in order, can usually be traced to a resistor "gone high" if the valves are known to be good. The dimming of the raster and the

appearance of the white line is usually an indication of a PY81 fault or a defective connection to the valve, to the scan coils, or an intermittent capacitor fault, still associated with the PY81 or line scan coils.

HMV 1807A

I wonder if you could diagnose the following fault which has developed on my TV ?

The model has given good service, but the vision has ceased to function. I am unable to get a spark from the anode of tube. I disconnected this connection and held near chassis, but still no line whistle, which seems to prove tube O.K., but line time-base not working. H.T. is O.K. and I have examined associated parts and wiring and found them to be O.K. Shortly after the breakdown the B36 flashed over internally and has been replaced without any difference. Sound is all right, but there is a pronounced motor-boating hum which advances and retards in speed on adjustment of vertical hold control.—D. E. Gibson (Richmond).

P.S.—I have also replaced the efficiency diode U35 without any change in the situation.

Ensure that the top slider of the rear panel (horizontal hold) is functioning correctly. This is a 25K^Ω wire-wound element of either Colvern or E.M.I. make (different lengths). If this is in order, have the KT 36 and U31 valves tested. The U31 is the efficiency diode. The U35 is the EHT rectifier. If the hum level is excessive, check the capacity of the main smoothing (double can) capacitor.

EKCO T141

Owing to a burn-out of my Ekco T141 I have rebuilt it, and have the following trouble that I am unable to rectify.

Interference from traffic, showing as white blobs across the screen and loud popping on sound; also, flutter of picture similar to the start of aircraft, only persistent.

The reception of the new BBC station here at Horsham is far worse than expected, and I have not re-positioned aerial until full power is put out.—Gerald F. Mitchell (Horsham).

It appears that the receiver is out of alignment. On the right side of the second valve from the far end (right side R.F. strip) is the oscillator trimmer capacitor, located in the large round can. This should be tuned initially to maximum sound. Then retune the aerial and R.F. cores (either side of the first valve) for optimum results. Slightly alter oscillator trimmer if any sound or vision effects are noted.

EKCO T161

I fitted a new tube and had the set working on the correct voltage tapping perfectly. Recently, when switching on the set the tube failed, sparks were seen discharging from the electrodes in neck of tube. As the tube was still under guarantee I sent it back to the firm and had a letter from them to say that a replacement would be sent as soon as possible. In the meantime I fitted the old tube back in the set but other faults have developed. I had all valves tested and found the two 20D1s were faulty. I have had them replaced. The trouble is the sound. The only way I can hear is by turning the volume control full on, and then it is poor; also a sizzling noise is present, but this almost goes when turning the volume control down. I notice also that the set picks up a lot of interference (car ignitions, etc.) which we used not to get. Before I

had the two 20D1s replaced there was a distinct hum, but now this seems normal. Will you please advise me of what may be the trouble? Could this have been caused when the tube went faulty?—J. Murphy (Birkenhead).

Your remarks indicate that possibly the sound channel alignment has been disturbed. This may have happened due to valve replacement, or it may in itself signify a defective and noisy valve, thereby giving rise to the "frying" noise and low sound sensitivity. We would, therefore, suggest that you first check the condition of the valves associated with the sound channel and then go on to check the alignment of the receiver generally.

PHILIPS 1800A

I wonder if you can advise me on where to look for a defect which takes the form of a gradual stretching from the right to the left. There is no correcting adjustment on this set, yet I think the fault is more than would be tolerated originally.

I have had the L.O. valve tested and am told this is O.K.—F. Northover (N.W.6.)

The efficiency diode V22 provides a correcting factor on the linearity of the line scan. Ensure that this valve is in good order and also that the associated components are of correct values. Low H.T. voltage aggravates the effect by making it necessary to employ an advanced setting on the width control (inductor). Check the condition of the H.T. rectifier valves and their limiting resistors, which sometimes tend to go open-circuit and thus cut down H.T.

McMICHAEL 483

I would be grateful if you could suggest the cause of the trouble to a portable McMichael 483.

It seems that the tuning trimmers T1, T2, T3 and T4 have been interfered with, and in trying to retune, the set seems fairly good at nearly half volume, but if extra volume is turned on the set becomes very distorted.

New batteries have been fitted and the valve DAF91, which seemed a bit microphonic, has been tested and found O.K.—R. J. Morgan (Cardiff).

Misalignment would not cause distortion at full volume. The most likely cause is a leak in the A.F. coupling capacitor—between the DAF91 and output valve control grid.

STELLA U105

Could you inform me of the value of the mains dropper as used in the Stella U105 wireless set, as it has burnt out completely, leaving no indication of its resistance in ohms.—F. A. Hunt (Southend-on-Sea).

The mains dropper is tapped at 240 ohms, 250 ohms and 538 ohms, the lowest value being in series with the H.T. rectifier valve anode and acting as surge limiting resistor. The correct replacement part should be obtained from a Stella agent.

VIEW MASTER

Could you please assist me in eliminating the following faults in a View Master timebase recently constructed? Horizontal scan: a broad white band right down the tube face which, when the width control is operated, resolves itself into three very white, bright lines at equal distance up and down the tube face. Frame scan 2½ pictures divided by black horizontal lines although the frame locks correctly; also, upon turning up the brilliance control a definite fold can be

seen in line scan. All valves and components are new and I can trace no faults of this description in the View Master booklet.—W. R. (Crewe).

From your description it is quite certain that your time base is not locking to the sync. pulses, but to a ripple voltage. It may be that R21 or C18 is faulty or even V4 or R20. It is also possible that C48, R58, C38 and R44 may be faulty or of wrong value, and we suggest that all these be carefully examined.

EKCO T164

My Ekco T164 suffers from pairing of the lines, despite all adjustments of the line hold control. In your experience, is there a component which is likely to be the cause of this, please?—C. F. W. Mangold (Liphook).

The crystal diode associated with the frame oscillator and sync. separator valves is at fault. These valves are the 20F2 and the 20L1. The small diode is wired from the anode circuit of the 20F2 to the grid circuit of the 20L1.

PHILIPS 600

I shall be pleased if you could give advice with the following Model 600 Philips projection television.

The picture is full width, but cannot fill screen within 1½ in. at the top and 1½ in. at the bottom. Objects and people are shown large at the top and short at bottom.—W. H. Forder (Lightwater).

You should have the UL42 frame output valve tested. This is mounted on the right side of the chassis, just to the left of the raised EB91. If the valve is in order, examine the associated capacitors for leakage, etc., and ensure that the linearity feedback resistors are of the correct value.

TELEMAX 2352

I have a Telemax type 2352 projection receiver which has developed a fault that I am unable to solve.

The trouble arose about a fortnight ago. Switching the receiver on everything seemed to warm up normally (sound on, EHT oscillating).

Advancing the brilliance brought up a very dim picture, absolutely out of focus and covering the whole of the C.R.T. face instead of being within a rectangle on the tube face as is normal.

The above fault continued for the whole of one evening. The following day I switched on the picture was perfect, no trouble at all.

This continued for about a week, then the fault reappeared exactly as before.

I have the manufacturer's servicing data to hand. I have had the set switched on while I have been writing this letter and the fault has again corrected itself.

A pinging sound came from the EHT section and the brightness came up like the heater of a valve warming up.

I notice that the servicing data calls for an EL38 as V.19 EHT output and V.20 an EBC33. These have been replaced by a 21A6 and ECL80 respectively, the set being secondhand when purchased.

I might add that there has been occasional sparking in the 21A6 (EHT rectifier) since I have had the set.—F. C. Lockett (Bristol).

The symptoms definitely indicate that the EHT oscillator transformer, associated with the ECL80, has a defective primary winding. This is quite a simple job to replace and the standard Philips Mullard transformer is suitable.

VIBRAPACKS, Mallory, 12v. D.C., to 250v. 80mA, synch., reversible, new. 18/6; Jefferson Travers, synch., 12v. D.C. to 150v. 40mA, smoothed. 16/- (post each 2/9); I.F. Amplifier (postage 2/9 each); Condensers, Bak. Inbulvar, 0.1/1.2 kV, 5 800v., 25/80V. 93 each; 0.02/2.5kV, 0.05/3.5kV, 25 1.5 kV, 1/- each; 1/2 kV Block, 2/6. Relays, 6v. 2 break, 1/6. R1355 I.F. Strips only, complete, new, with valves. 25/-, less valves. 12/6 (post 2/6). Brand new R.F. Units, Types 26 or 27, 27/6 (postage 2/9); R.F.24, R.F.25, soiled, 10/6. I.F.T.s 10/13 mc/s, canned, new, 1/3. Speakers, n.w., 8in., in round metal case, on/off switch, 27/6 (post 2/6); G.P.O. type, new, handset (mic./carpiece), 10/-; Command Receivers, brand new, 1.5-3 mc/s, 6 valves, 55/- (post 3/-). List and enquiries, S.A.E. please! Terms: C.W.O., postage extra. Immediate despatch. W. A. BENSON (P.T.), 308, Rathbone Rd., Liverpool, 13.

SERVICE SHEETS, T.V. and Radio, over 2,000 models. Sale or hire. Valves and Components. S.A.E. with enquiries. W. J. GILBERT, 24, Frithville Gardens, London, W.12.

B.S.R. MONARCH 3-speed auto-change units; new in maker's sealed carton; guarantee, complete with instructions, template, suspension springs. £9/15/4, carriage paid; immediate delivery. TOMLINS, 127, Brockley Rise, Forest Hill, S.E.23.

TELEVISION, 9in. models, £6/10/-; 12in. models, £15; all makes; working; carriage paid. TOMLINS, 127, Brockley Rise, Forest Hill, S.E.23.

16IN. TELEKING, new, complete; constructor cannot clear; gift at half component cost; any offer. Box No. 187, c/o PRACTICAL TELEVISION.

DIRECT TV REPLACEMENTS offer the most complete Handbook of TV Components and R-winds, price 1/-, TV Components for all kit sets in stock. "Nurav" heater booster isolator for 2-volt C.R.T.s. just plus rs. 27/6, plus 2/- packing and postage. 124-136, Lewisham Way, S.E.14. (11Deway 3698-2330.)

TELEVISION INTERFERENCE. Receiver Filters, High-Pass E.5037, 30/-; Low-Pass E.5031, 30/-; Composite Band 1/III, 49/6; Transmitter Filter E.5043-5043B, 1kV, £6. LABGEAR (CAMBRIDGE) LTD., Willow Place, Cambridge.

SUPER-TONIC SUN-RAY LAMPS. Ultra-violet Infra-red combined. Superb therapeutic quality, controlled output, automatic exposure. All mains. Listed £7/10/-, our price 80/-, S.A.E. illustrated brochure. Dept. 16, SCIENTIFIC PRODUCTS, Cleveleys, Lancs.

RATES: 4/- per line or part thereof, average five words to line, minimum 2 lines. Box No. 1 - extra. Advertisements must be prepaid and addressed to Advertisement Manager, "Practical Television", Tower House, Southampton St., Strand, London, W.C.2.

MAKING YOUR OWN? Telescopes, Enlargers, Binoculars, Microscopes, Projectors, or, in fact, anything that needs lenses. Then get our booklets, "How to Use 'Ex-Gov. Books & Prisms," Nos. 1 & 2, price 2/6 ea. Also our stereo book, "3-D Without Viewers," price 7/6. Comprehensive list of lenses, optical, radio and scientific gear free for s.a.e. H. W. ENGLISH, Rayleigh Road, Hutton, Brentwood, Essex.

TELEVISION, 12in., 5 channel, tunable anywhere models, £28 each, carriage paid; guaranteed perfect. RYAN, 4, Evelme Road, Forest Hill, London, S.E.23.

LOUDSPEAKERS repaired promptly. MODEL LOUDSPEAKER SERVICE, Bullington Rd., Oxford.

SEVERAL EARLY MODELS 9in. Television, complete and mostly working, £5/5/- each; carriage paid. TOMLINS, 127, Brockley Rise, Forest Hill, S.E.23. (FOR 5497.)

TELEVISION AND RADIO BAR-GAINS. - 12in. 5 Channel, £18/10/-; 12in. London Station, £12/10/-; 9in. London Station, £7/10/-. All guaranteed. Phone AD 1734, call 1070. Harrow Rd., N.W.10.

GUARANTEED TELEVISION, 12in. models, first-class picture, 5-channel, £30 each carriage paid. THE GRAMOPHONE SHOP, 19-21, Brockley Rise, Forest Hill, S.E.23.

THE NEW AUTOMATIC twin track 3-speed Collaro Tape Deck (no amplifier) is available at PHOTO-OPTIX (LONDON) LTD., The Tape Recorder Socialists, at 19 gns., 7375, Praed St., London, W.2. (PID 2391.)

ENGRAVING. - Amateurs and trade surplus can be undertaken by getting in touch with A. G. ENGRAVING, now at 292, Earlsfield Road, London, S.W.18. (Tel.: BAT 9897.) (Engravers to well-known makers of Electronic Equipment used by the Aircraft Industry. A.W.R.E., etc.)

CHANNEL 9. - Aerial, 4 Element; I.T.V. Converter with power supply; V.C.R. 97; C.R.T.; 16in. Enlarger Lens; 9in. Enlarger Lens; Electric Gram. Motor (78); Transformer. H.T. L.T., E.H.T., for V.C.R. 97 T.V. S.A.E. details, Box No. 188, c/o PRACTICAL TELEVISION.

TELEVISION BAND III CONVERTERS, complete with 2 valves; the tuning can be set to any frequency between 166-196 mc/s; I.F. output can be varied between 42-68 mc/s; EP80 as R.F. amplifier. ECC61 as local oscillator; will work into any I.F.R. or superheterodyne receiver; £27/6, p. and p. 2/6. Complete with circuit diagram. WALTON & LUNN, 243A, Manchester Road, Swinton, nr. M/c.

SERVICE SHEETS, Radio, TV, 4,000 models. Lists 1/-, Enquiries s.a.e. TELRAY, 11, Maudland Bk., Preston.

F.M. RECEIVERS and Complete Kits from £5. BEL, Marlborough Yard, Arghway, N.19. (ARC 5078.)

BRAND NEW Electrolytic Condens. rs. 24/-, 600 volts, wkg. 2/6 each, p. and p. 9d. TELEMT, 596, College Rd., Erdington, Birmingham, 23.

WANTED

WANTED, Valves 6F13, 6F15, 6U4, EY31, 5Z4, ECL80, KT61, 25A6, etc.; prompt cash. WM. CARVIS LTD., 103, North Street, Leeds, 7.

ALL TYPES OF VALVES REQUIRED for cash. State quantity and condition. RADIO FACILITIES LTD., 38, Chalcot Road, N.W.1. (PRImrose 996c.)

EDUCATIONAL

BUILD YOUR OWN TV and learn about its operation, maintenance and servicing. Qualified engineer-tutor available while you are learning and building. Free brochure from E.M.I. INSTITUTES, Dept. P.T.58, London, W.4. (Associated with H.M.V.)

I.P.R.E. Data for constructing TV Aerial-strength Meter, 7/6; 5,500 Alignment Peaks for superhets, 5/9; sample copy "Practical Radio Engineer" 2/-. Membership-examination particulars, 1/-. Syllabus of seven postal courses free and post free. SECRETARY, I.P.R.E., 20, Fairfield Road, London, N.8.

FREE! Brochure giving details of Home Study Training in Radio, Television, and all branches of Electronics. Courses for the Hobby Enthusiast or for those aiming at the A.M.Brit.I.R.E., City and Guilds, R.T.E.B., and other professional examinations. Train with the college operated by Britain's largest Electronics organisation. Moderate fees. Write to E.M.I. INSTITUTES, Dept. P.T.28, London, W.4.

POSTAL COURSES in Radio and Mathematics. Up-to-date and easy-to-understand private tuition, backed by 23 years' continuous success. Write: T/C RADIO COLLEGE, Duart House (CT), Ashley Road, New Milton, Hants.

RADIO AND TELEVISION COMPONENTS

All parts in stock for: Viewmaster, Soundmaster, Te'king, etc. Easy Terms Available. 2/d. stamp (only) for Catalogue. **JAMES H. MARTIN & CO.** FINSTHWAYTE, NEWBY BRIDGE, ULVERSTON, LANCs.

OSMOR CONVERTERS

LONDON, BIRMINGHAM, MIDLANDS. Simple, efficient for all TV (including TRF). Guaranteed no break-through of Band I or re-radiation. Approx. 1 hr. to build. Will convert any Band III channel to any Band I channel. AC or AC DC. Kit, £3.5.0. Ready wired, £4.0.0. Post free. Terms: C.W.O. Post orders only. **THE ELECTRONIC SUPPLY CO.** 29, Leigh Rd., Highbury, London, N.5

RADIO & TELEVISION SERVICE ENGINEERS

QUALIFIED MEN FOR HAMMERSMITH AND PLAISTOW E. DEPOTS.

5s. 0/d. per hour. Time and a half over 44. T.U. Conditions. Pension Scheme. Holiday and Sickness Benefits. Staff Canteen. Superannuation Scheme.

Apply to: Staff Office, **LONDON CO-OPERATIVE SOCIETY, LTD.** 54, MARYLAND STREET, STRATFORD E.15.

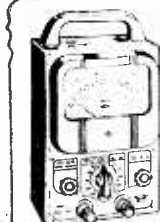

PULLIN
SERIES 100
TEST METER
AC/DC 10,000 μ V
21 RANGES
100 μ A to 1000 V
CIRCUITS IN ONE CASE
CASE WITH TEST LEADS
CALIB. AND PRODS.
FULLY GUARANTEED

SENT POST FREE FOR £2.10s. DEPOSIT AND NINE FURTHER MONTHLY PAYMENTS OF £1.5s. CASH PRICE £12.7.6.

FRITH RADIOCRAFT LTD
69 21 CHURCHGATE LEICESTER PHONE 58927
28 HIGH STREET NEWPORT PAGNELL, BUCKS PHONE 237

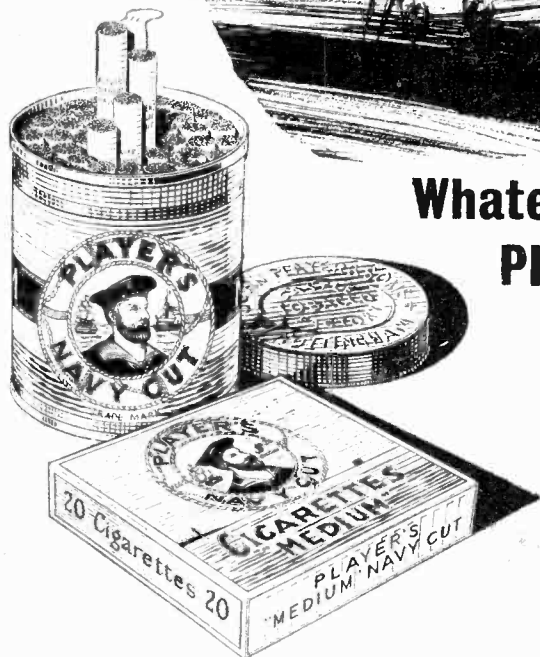

Whatever the pleasure Player's complete it

The greater pleasure one gets from Player's comes from the consistently high quality of their tobacco—so perfectly packed.

*Player's
Please*

[SCC 49K]

CORRESPONDENCE

The Editor does not necessarily agree with the opinions expressed by his correspondents. All letters must be accompanied by the name and address of the sender (not necessarily for publication).

TV BREAKTHROUGH

SIR.—I have just been reading my PRACTICAL TELEVISION and have noticed Mr. Stewart's letter concerning television breakthrough on short-wave radio. I have heard this unusual effect several times when television and radio have been working fairly closely together. On one occasion I was tuned to approximately 30 metres when the BBC test transmission music came through perfectly; I tried to receive it on the rest of the band, with no result. I then switched off the television, whereupon the sound on the radio faded also.

The only suggestion that I can make is that there must be a form of radiation from the television—possibly in the I.F. that the radio was receiving.—**D. MERRY** (Bournemouth).

STRAIGHT SETS AND INTERFERENCE

SIR.—This problem is experienced by everyone who uses a converter on a T.R.F. TV. Sooner or later they find out that they are causing interference to BBC viewers through re-radiation. May I suggest that if a complete article were published by PRACTICAL TELEVISION about effective cures, or at least ways to minimise the effect, it would be greatly appreciated by your readers?

I have tried 5,000 pF in the heater chain and lined the inside of the cabinet with tinfoil and one or two other things, but without success. The only way I could reduce it was by earthing the set. This, I should think, cut it down about 25 per cent. I have spoken of this matter to several professional mechanics and they say it's a matter of trial and error and by putting rejector coils into the set. Apart from this there is not much that one can do. But surely there must be a way? Would it not be possible to put a filter to block all frequencies around 45-47 Mc/s between aerials and converter that can, of course, be switched off to enable BBC to be used when required?—**W. E. WALKER** (Ruislip).

[This is a most difficult question and we have published several ideas from time to time, including the use of odd lengths of aerial lead attached to the converter connecting lead. A rough filter may be made by winding the coaxial which connects converter to receiver round a pencil so that about 10 turns are made. Stick this with Sellotape to hold it in place and remove the pencil. This has proved very effective on some cases in which it has been tried. The only really satisfactory solution, of course, is to convert the straight receiver into an I.F. strip and use a new two or more position tuner on the lines of the View Master conversion recently published in these pages.—Ed.]

COLOUR TELEVISION

SIR.—The news that colour is being experimented with by the BBC raises the old question—are we to be the odd man out again? When we started TV in this country we had the 30-line system—alone in the world. The U.S.A. started up, but used high definition and we had to follow. Now we are again

on our own in the 400-odd line system. America uses one, France two others, and most continental stations yet another. Surely, as a committee examined this question some time ago and recommended 625 lines, we should now see that experiment is directed to converting existing sets to this definition rather than trying to make a colour system compatible on 405 lines? What will manufacturers do if we adopt it? Just as with our receivers there is no overseas market and separate production lines are necessary for home and export. If people expect sooner or later to have to get a new set to receive colour they could also be trained to expect to have to change for a better picture before colour, and one would have thought that this change should have come first—and before there are too many sets in existence. Otherwise we shall reach the point where it will be uneconomic to ask people to get new receivers on such a large scale, and we shall then be left alone with no export market. What is the official view on this point—that is, the manufacturers and the BBC? Could we not have some information or considered report from them on the subject?—**G. PRESSLOW** (Edgware).

POOR FACTORY WORK

SIR.—From time to time my firm have serviced many well-known makes of television receivers, and have found some points of interest, which it is felt should be raised.

Metal rectifiers—one lead was simply passed through the hole, and bent to prevent it coming out, not a trace of solder had been applied to the join.

Likewise, reservoir condensers, found in the same manner, to say nothing of dry soldered joints!

Valves, which play a vital part in the vision circuit, and which are often suspect, placed in such positions that it very often necessitates taking the entire chassis out to remove them for testing.

The chassis itself could do with more sturdy construction, since in one instance an intermittent fault was traced to the weight of the cathode tube, which was mounted on to the chassis, and was bending the side of the chassis, thus resulting in a coil near to the side becoming short-circuited.

Time plays an important part in radio and television servicing, and if dealers are to assist manufacturers in giving good service, and to protect them from trivial claims, then surely dealers can expect manufacturers not to put vital valves in awkward positions, thus resulting in reduced labour charges.

To take two different makes of television receivers, and carry out the same task on each of them, can vary from 10 minutes in one case to over half an hour in the other.—**F. C. PALMER**, A.M.I.E.T. (Truro).

QUERIES COUPON

This coupon is available until SEPTEMBER 21st, 1956, and must accompany all Queries.
PRACTICAL TELEVISION, SEPTEMBER, 1956.

SPENCER-WEST TYPE 50 BAND III CONVERTER



Ask for Leaflet Ref. 2356 which gives full technical details of this wonderful new unit.

Perfect results with any receiver. From your dealer or on 7 days' approval from :

SPENCER-WEST, LTD.

Quay Works, Great Yarmouth

Phones : 4794 & 3009

THE VALVE SPECIALISTS Bentley Acoustic Corp. Ltd.

38, CHALGOT ROAD N.W.1
PRImrose 9090

1st grade goods only. No seconds or rejects.

02A	6/	6SK7	5/6	812	70/	6X22	12/6	
1A3	0/	6BL7	8/	806A	12/	6H30	5/	
1A5	6/	6BR7	8/	885	10/6	H83	12/6	
1D6	8/6	6C87	7/6	906	3/	HK90	10/	
1D5	11/	6L1	14/6	1263	7/	HL2	3/	
1E4	7/6	617	8/6	1535	12/6	HL3C	7/6	
1E45	9/6	6V91	7/	7133	2/6	HL23	7/6	
1E2	5/	6V6GT	7/6	7473	2/6	HL4	10/6	
1E7	11/	6X4	7/	7062	5/6	HL41D	7/6	
1E5	8/	6X5	7/6	8006	5/6		12/6	
1E55	7/6	6Z4	5/	12/6	9006	6/	HV2A	7/6
1F1	7/6	6Z5	12/6	AC/HP	K832	8/6		
1F5	7/	7A7	12/6	DD1	15/	KF5	9/	
2AB	12/6	7B7	8/6	AC/6P	6/6	KL3	8/6	
2026	4/	7C5	8/	AC/4	8/	KT2	5/	
2D1A	7/6	7F6	8/	AP4	7/6	KT23	10/	
2D1B	4/	7H7	7/6	AP1	3/6	KTAG1	7/	
2A4	7/	7Q7	8/	AZ61	12/6	KT22	6/	
2A9	7/	7S7	9/	BS19	12/6	KT24	6/	
2B7	8/6	7V7	8/6	BL33	2/6	KT23	6/	
2D9	2/6	7Y4	8/6	K523	6/6	LN30	12/6	
305	9/6	8A8	12/6	K523	6/6	LN30	12/6	
8E4	7/6	812	2/6	CL85	12/6	M1	5/6	
8Y1	8/6	812	3/	DL	3/6	M14	4/	
8Y1	8/	10C2	10/	DL3	5/	M813	15/	
8Y4	10/	10D1	7/6	DAP26	9/6	M11	8/6	
8Y8	10/	10F1	10/	DL36	7/	DL37	9/	
8Y8	7/6	12A6	6/6	DL96	6/6	DL96	6/6	
8Y1	10/	12A5	15/	DK92	8/6	PABCS0	5/6	
2E3	8/6	12AH7	12/6	DK36	9/6		15/	
2Z1	9/6	12AH8	12/6	DL2	15/	PC24	9/	
10/	12AT7	8/6	DL35	11/	PC45	12/6		
6A17	8/	12AT8	8/	DL41	9/6	PC48	8/6	
6A85	10/	12AX7	10/6	DL510	10/6	PCF82	10/6	
6A7	6/6	12BA6	9/	E1148	2/	POL83	12/6	
6A15	6/6	12BE6	10/	EA50	2/	Pen25	6/6	
6A67	12/6	12C1	30/	EAC/30	8/6	Pen46	10/6	
6A68	10/	12D16	5/	EAF42	12/6	PL51	10/6	
6AK5	5/	12E5GT	6/	ED24	2/	PL82	9/6	
6AK8	10/	12J7	9/6	EB41	8/	PL83	12/6	
6AL5	6/6	12K7	9/6	EB91	6/6	PM12	4/	
6AM5	5/	12Q7	9/	EB32	12/6	PM2M	6/6	
6A47	7/6	12Q8A7	8/6	EC73	7/6	PM35	12/6	
6A45	12/6	12R7	7/6	EBG41	10/	PY80	10/	
6AT6	8/6	12R67	7/6	RP90	10/	PV8	10/	
6B1	8/	12RH7	5/6	EG2	5/6	PV82	9/6	
6B7	10/6	12RH7	5/6	EG4	6/	PV83	10/	
6R46	7/6	12R87	6/6	EG10	8/6	QF21	10/6	
6R93	4/	12R97	8/6	EG23	8/6	QF23	12/6	
6DSM	4/6	12R17	7/6	EG35	8/6	QF25	6/6	
6H16	7/6	12U51	7/6	EG40	12/	QS10	15/	
6H16	12/6	12V1	10/6	EG81	9/6		10/6	
6H45	8/	12P4A	10/6	EG82	10/6	4M6	7/6	
6RW6	7/6	12V1A	10/6	EG82	10/6	SP27	7/6	
6RW7	10/	14R7	10/6	EGC84	12/6	SP47	12/6	
6R82	10/	16A5	10/	EGC85	10/	SP61	3/6	
6Y7	10/	19H1	10/	EG94	6/	TD02A	8/6	
6Y4	7/	20L1	10/6	EG98	12/6	TE53	12/6	
6Y6	6/	20P3	12/6	EGC87	12/6	TE54	10/6	
6C8	8/	25Z1	9/	EGH5	10/6	TF6	12/	
6WH3	9/	25Z5	8/6	EGH12	10/6	U7	12/6	
616	6/6	27	7/6	EGH81	9/	U22	7/6	
6P1	12/6	28D7	7/	EGJ80	10/	U25	13/	
6F7	7/6	29	7/6	EGH9	10/6	U50	7/6	
6E8	10/6	36C1	12/6	EG19	12/6	U29	12/6	
6E13	12/6	31	7/6	EG26	4/6	U4F42	11/	
6F15	12/6	35E9	9/	EG29	6/	U4F42	10/6	
6F17	12/6	37A	8/6	EG50	15/	U4F43	9/6	
6F22	10/6	35Z3	8/6	EG41	9/6	U4F43	10/6	
6F23	12/6	35Z51	12/6	EG42	12/6	U41	10/6	
6C6	8/6	41M1	12/6	EG50A	7/	U46	12/6	
6H93	2/6	41M2	7/6	EG50L	8/	U41	10/6	
6HM1	8/6	45Z5	12/6	EG51	5/	U57	5/	
6536	5/	53A5	10/	EG80	9/	VL8P2A	2/6	
653GT	5/6	50L6	8/6	EG85	9/		23	
6H6	6/	57	8/6	EG86	12/6	VM46	15/	
6G76	6/	58	8/6	EG89	10/	VP27	8/6	
6H23	7/6	61HT	12/6	EG91	8/	VK47	12/6	
6K76	6/	61MP	10/6	EG92	8/6	VP26	10/6	
6K81	8/	61PT	15/	EL32	6/	VP4	7/6	
6K84	8/6	72	8/6	EL41	10/6	VP35	10/6	
6L93	9/	75	7/	EL42	12/	VT501	6/	
6L97	7/6	77	8/6	EL49	15/	X08	10/6	
6N7	7/	78	8/6	EL84	11/	XPW10	8/6	
6Q7	8/6	80	8/6	EM84	10/	XF12	6/6	
6Q7GT	9/	83	8/6	EV71	11/	XRHL2	4/	
6K7	8/6	150B2	12/6	EX86	12/	XRGL3	4/	
6M7	8/	150L8	8/	EY40	8/	Y68	7/6	
6M7	6/6	24QP	10/6	EZ41	11/	Y65	10/6	
6M17	6/	307	6/6	EZ60	8/6	Z7	6/6	
6M17	8/	303	25/	FE18	12/6	Z719	10/6	

All boxed. Full maker's guarantee. Post 6d. each. Insurance (optional) 6d. per order. Shop hours 8.30 to 5.30, Sat. 1 p.m. Why not phone or wire that urgent order for immediate despatch C.O.D.?? F.R.L. List and conditions of sale S.A.L.

● COLOUR TELEVISION RECEIVER PRACTICES

by HAZELTINE 36/-
Laboratories Staff
EDITED BY C. E. DEAN Postage 1/-

TELEVISION TIMEBASE CIRCUITS PRINCIPLES AND PRACTICE. By C. H. Banthorpe. 5s. 0d. Postage 4d.

SWEEP AND MARKER GENERATORS FOR TELEVISION AND RADIO. By R. G. Middleton. 20s. 0d. Postage 9d.

INTERNATIONAL TUBE HANDBOOK (M. K. Buzen). 15s. 0d. Postage 9d.

THE RADIO AMATEURS HANDBOOK. By A. R. R. L. 30s. 0d. Postage 1s. 6d.

T.V. FAULT FINDING. Data Book Series No. 5 5s. 0d. Postage 4d.

THE OSCILLOSCOPE AT WORK. By A. Haas and R. W. Hallows. Published for "Wireless World." 15s. 0d. Postage 6d.

The MODERN BOOK CO.

BRITAIN'S LARGEST STOCKISTS of British and American Technical Books
Please write or call for our new 1956 catalogue.
19-23, PRAED ST., LONDON, W.2
Phone : PADdington 4185.
Open 6 days 9-6 p.m.

WHY WASTE TIME

Give that set its best chance

FIT QUALITY COMPONENTS

Catalogue 1/-.

Parts for the choice :—
Manual

Osram "912" plus Amplifier 4/-
Mullard 10-watt Amplifier 3/6
The Coventry
2-watt Amplifier ... 1/-
4-watt Amplifier ... 1/-
6-watt Quality Amplifier ... 1/-

The Coventry A.M. Tuner Unit ... 1/-
Denco F.M. Tuner Unit ... 1/6

Complete Component Price Lists will be supplied with each Manual.

COVENTRY RADIO

EST. 1925

189, DUNSTABLE ROAD,
LUTON, BEDS.

Phone : Luton 2677

FIRST-CLASS TELEVISION and RADIO COURSES . . .

GET A CERTIFICATE!

After brief, intensely interesting study—undertaken at home in your spare time—YOU can secure your professional qualification or learn Servicing and Theory. Let us show you how!

FREE GUIDE . . .

The New Free Guide contains 132 pages of information of the greatest importance to those seeking such success compelling qualifications as
A.M.B.I.R.I.E., City and Guilds
Final Radio, P.M.G. Radio
Amateurs' Exams., Gen. Cert. of Educ., London B.Sc. (Eng.), A.M.I.P.E., A.M.I.Mech.E., Draughtmanship (all branches), etc., together with particulars of our remarkable Guarantee of
SUCCESS OR NO FEE
Write now for your copy of this invaluable publication. It may well prove to be the turning point in your career.

**FOUNDED 1885—OVER
. . . 150,000 SUCCESSES . . .**

**NATIONAL INSTITUTE OF
ENGINEERING**
(Dept. 462), 148, HOLBORN,
LONDON, E.C.1.

BAND III T.V. CONVERTER

12 months' guarantee all items.

FOR I.T.A. LONDON, BIRMINGHAM, MANCHESTER, YORKS, GLASGOW. For superhet or T.R.F. State B.B.C. station. Fully wired with power pack, aerial switching, tested and ready for use.

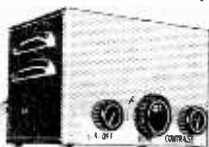

£4-10-0

Post Free
C.O.D. fee 1/6 extra

Ditto in walnut cabinet, £5.

High gain : satisfaction or money back.

OR Complete kit of parts including two valves, wound coils, punched chassis 6 1/2 in. x 4 1/2 in. x 2 in., metal rectifier, and all screws, solder, etc. As illus., but 1 knob. Price 62/6, less metal box.

Without power pack, 42/6. Power required 200 v. 17 m.a. and 6.3 v. 1 A.,

Print showing details exc. valves, 1/6.

Wooden cabinet Converter for D.C. mains 200-250 v. complete with switching, etc., as for A.C. model, £5.7.6, carr. pd.

Cross-over units, 8/-.

B.B.C. Filter to eliminate interference patterns, 8/-.

GLADSTONE RADIO

P.O. BOX 8, CAMBERLEY, SURREY

SURPLUS TELEVISION STOCK AVAILABLE

IDEAL FOR THE HOME CONSTRUCTOR

Limited number of 14in. table model cabinets, modern design, including back and base boards, mask, glass and control escutcheon. £4.5.0 each, packing and postage 8/- extra.

Complete set of time base transformers and deflector coils; line output transformer, 10-15 Kv. £2.10.0, postage and packing 1/- extra.

Boxes of 100 assorted resistances, 1 and 1/2 watt, 33 ohms to 2.2m., 3 of each type, 12/6, postage and packing 6d.

Assorted wax mica condensers, 5pf-1,500pf., 6d. each.

Electrolytic condensers 100, 200mf., 275v., 5/1 each.

16 + 16mf., 350v. 1/8 each. 250mf., 25v., 1/1 each.

Pots., pre-set, 5k, 25k, 100k, 500k, 1M, 1/9 each.

Pots., long-spindled, 25k, 100k, 500k, 1M., 3/- each.

Pots., long-spindled, 1M, with double pole switch, 4/- each.

Focus units for 14in. and 17in. tubes, 9/9 each.

Ion traps for 14in. and 17in. tubes 1/2 each.

Many other components available. Write for catalogue to :—

LIGHT DIFFUSION LTD.,

FRANKLIN ROAD, PORTSLADE, SUSSEX

OPPORTUNITIES IN TELEVISION

144 pages

Free!

Television offers unlimited scope to the technically qualified. Details of the easiest way to study for A.M.Brit.I.R.E., R.T.E.B. Cert., City and Guilds, Television, Television Servicing, Sound Film Projection, Radio Diploma Courses, etc. are given in our 144-page Handbook "ENGINEERING OPPORTUNITIES" which also explains the benefits of our Appointments Dept.

We Guarantee "NO PASS—NO FEE"

If you are earning less than £15 a week you must read this enlightening book.

Send for your copy NOW—FREE and without obligation.

WRITE TODAY!

British Institute of Engineering Technology
237, College House,
29-31, Wright's Lane,
Kensington, W.8.

BIET

LINE E.H.T.

TRANSFORMERS

REWOUND

PROMPTLY

Our 30 years' experience of winding and wave-winding enables us to provide the finest service in the Country for all types of

TELEVISION COMPONENTS.

We repair or manufacture all types of transformers singly or in quantity and welcome your enquiries.

Catalogue on request.

H. W. FORREST (TRANSFORMERS) LTD.,

349, HASLUCKS GREEN ROAD,
SHIRLEY, SOLIHULL, WARWICKS.

Telephone : SH 2483

TELEVISION COMPONENTS

in stock for the

P.T. SUPER-VISOR, TELE-KING, VIEWMASTER,

E.E. TELEVISOR and BAND III

and wide angle modifications

Price lists available on request to :

J. T. FILMER, Maypole Estate, Bexley, Kent.

Tel. : Bexleyheath 7267

VALVES • SAME DAY SERVICE

All Guaranteed New and Boxed

1A7	midget	IR5	185	1U5	1T4	381	DAF91	DF91	DK91	DL92	DL94	any 4 for 27 6.					
1A7GT	9 6	6Q7GT	9 6	DF33	11 6	EM34	10 6	1CSGT	11 -	8SNTGT	DF96	8 6	EY91	10 6			
1D5	11 -	8 6	DHT	8 6	EZ40	8 6	1H5GT	11 6	6U4GT	15 -	DK92	12 6	EZ41	9 -			
1N3GT	11 6	6V6G	7 6	DK92	7 6	EZ80	9 -	11 6	6V6GT	7 6	DK96	9 6	GZ32	15 -			
1R5	11 6	6X4	7 6	DL33	11 6	KT33C	10 6	185	7 3	7B7	8 6	DL96	9 6	KT63	7 6		
1T1	10 5	2 3	7C5	8 6	EAF	4211 6	MU14	9 -	1U5	5 7	37C6	8 6	E891	6 9	PCC84	9 6	
3A5	7 6	2H7	7 6	EBC33	7 6	PCF80	9/-	3Q5GT	11 6	7Y1	8 6	E8F80	10 6	11 6	11 6		
384	7 6	10C1	13 6	ECC40	13 6	PEN34C	13 6	3V4	8 6	10C2	10 -	12 6	13 6	13 6	13 6		
534G	8 6	10F1	10 -	ECC81	10 -	PEN 41 6	PEN 41 6	533GT	9 0	10L	D11	10 -	ECC81	10 6	PEN 41 6	7 -	
5Z4G	9 -	12A7	10 6	ECC81	10 6	PL81	11 3	6AK5	5 -	12AT7	8 9	ECF80	6 -	11 3	11 3		
6A15	6 9	12AU7	8 6	13 6	PL83	12 6	6AN15	5 -	12J7GT	9 6	ECH35	11 -	PY80	9 -	10 -	10 -	
6AM6	7 6	6 -	3Z4GT	8 6	10 6	PY82	7 9	6AQ5	7 6	12K7GT	8 9	10 6	PY81	10 -	10 -	10 -	
6AT6	8 6	12K8GT	8 6	ECH41	9 6	PZ30	15 -	8BA6	7 9	12 6	ECL80	10 -	U25	12 6	12 6	12 6	
8B95	7 6	12Q7GT	7 6	EF37A	U50	7 9	8B95	7 9	9 9	10 6	U7B	7 6	6C9	10 -	14S7	15 6	
6P1	13 -	201	10 6	EF40	14 6	CAF12	11 6	6P13	7 6	25L6GT	8 6	EF41	10 -	UBC41	9 -	9 -	
6P15	13 -	25Z4G	9 6	EF42	12 6	UCH12	12 6	6P16	11 6	35L6GT	8 6	EF50	7 6	8 6	UF4	10 9	
6P18	6 -	3Z4GT	8 6	EF50	7 6	8 6	UF4	10 9	6P19	6 -	3Z4GT	8 6	EF50	7 6	8 6	UF4	10 9
K76G	6 -	AZ1	11 6	EF86	12 6	UY47	11 6	8K7GT	6 -	CH35	16 -	EF91	7 6	UY41	8 6	8 6	
6K3C	8 6	D15	7 -	EF92	6 6	W7	6 6	6K3C	8 6	D15	7 -	EF92	6 6	W7	6 6	6 6	
6K8GT	9 6	DAC	3211 6	EL32	6 6	X79	12 6	6L18	10 6	DAF96	9 6	EL41	10 6	X83	7 6	7 6	
6LD20	9 6	DCC90	7 6	EL84	10 6	Z77	7 6	6LD20	9 6	DCC90	7 6	EL84	10 6	Z77	7 6	7 6	

Postage 5d. per valve extra.

READERS RADIO

24, COLBERG PLACE, STAMFORD HILL, LONDON, N.16. STA. 4537

TELEVISION TUBES

MULLARD ...	12in. £6.10.0	14in. £7.0.0	7in. £8.10.0	} Ex Stock
COSSOR ...	12in. £6.10.0	14in. £7.0.0	7in. £8.10.0	
EMITRON ...	12in. £6.10.0	14in. £7.0.0	7in. £8.10.0	

MAZDA. 12in. only £6.10.0. 4 Weeks Delivery.

All Tubes plus 12/6 carriage and insurance.

SIX MONTHS' GUARANTEE

- Converter M.1. Midlands area high gain, own power supply, built in crossover unit £9.9.0
- Converter M.2. Midland fringe area, own power supply £9.18.0
- Crossover Box. Low loss 12.6

Finished in Stove Enamelled Steel Case.

Terms to the Trade.

RE-VIEW (LONDON) LTD.

81, HIGH STREET : MERTON, S.W.19

Telephone : CHERRYWOOD 3255

MAKE SOUND JOINTS SIMPLY BY USING Multicore

ERSIN MULTICORE

Contains 5 cores of extra-active, non-corrosive Ersin Flux. Prevents oxidation and cleans surface oxides.

SIZE 1 CARTON

5/-

HANDYMAN'S CARTON

Suitable for 200 average joints. 6d.



Wherever precision soldering is essential, manufacturers, engineers and handymen rely on MULTICORE. There's a MULTICORE SOLDER just made for the job you have in hand. Here are some of them.

ARAX MULTICORE

FOR METAL FABRICATION

(Not wire-to-tag joints)

Contains 2 cores of Arax flux. Flux residue is easily removed with water.

SIZE 8 CARTON

5/-

Handymans Carton 6d.



HOME CONSTRUCTORS 2/6 PACK

In addition to the well-known Home Constructors Pack (containing 19ft. of 18 s.w.g. 60/40 alloy) a similar pack is now available containing 40ft. of 22 s.w.g. 60/40 alloy especially suitable for printed circuits.



BIB WIRE STRIPPER AND CUTTER

Strips insulation without nicking wire. cuts wire cleanly. splits extruded flex 3/16 each



MULTICORE SOLDERS LTD.,

MULTICORE WORKS, HEMEL HEMPSTEAD, HERTS. (BOXMOOR 3636)

ARTHURS HAVE IT!

LARGE STOCKS OF VALVES AND C.R.T.S.

AVO METERS IN STOCK

Avo Model 7	—	—	—	—	£19 10 0
Avo Model 8	—	—	—	—	23 10 0
Electronic Test Unit	—	—	—	—	27 10 0
Electronic Test Meter	—	—	—	—	40 0 0
AC/DC Minor	—	—	—	—	12 0 0
* Cossor Oscilloscopes Model 1052	—	—	—	—	104 0 0
" " " " " " " " " "	—	—	—	—	120 0 0

Full range Taylors Meters.. List on request.

LEAK Pick-up Arm	—	—	—	2 15 0
" Long Play or Standard Heads With Diamond Stylus	—	—	P.T.	1 3 1
" Matching Transformer	—	—	P.T.	2 8 4
	—	—	—	1 15 0

Leaflets on Request

JASON AF/FM Tuner, complete with valves and automatic frequency control, also cascade input — — — — £28 13 0

LATEST VALVE MANUALS

MULLARD, 10/6, OSRAM & BRIMAR No. 6, 5/- each, OSRAM Part 2, 10/- Post 9d. each extra. TRANSFORMER for 200/230 v., 37/6.

Terms C.O.D. OR CASH with order and subject to price alterations and being unsold.

Est. 1919

Arthurs

PROPS: ARTHUR GRAY, LTD.

OUR ONLY ADDRESS : Gray House 150-152 Charing Cross Road, London, W.C.2

TELEGRAMS—" TELEGRAY, WESTCENT, LONDON." CABLES—" TELEGRAY, LONDON."

2 'musts'

for the home constructor



THE G.E.C. 'nine-one-two PLUS'

The publication contains step by step wiring instructions for this high quality Amplifier together with many additional features of exceptional interest to the Home Constructor.

PRICE **4/-** from your dealer or by post—5d. extra—from the G.E.C. Valve and Electronics Dept.

THE "FM PLUS" TUNER

The "FM PLUS" Tuner is ideal for use with the 'nine-one-two PLUS' Amplifier and the publication gives constructional details and suggests circuits for inter-station noise suppression and a 'magic eye' tuning indicator.

PRICE **2/6** from your dealer or by post—5d. extra—from the G.E.C. Valve and Electronics Dept.

G.E.C.

Valves

Both these publications are obtainable from the G.E.C. Stand at the Radio Show.

THE GENERAL ELECTRIC CO. LTD · MAGNET HOUSE · KINGSWAY · LONDON WC2