

PRACTICAL TELEVISION

AND TELEVISION TIMES

A NEWNES PUBLICATION

Vol. 2 No. 17

OCTOBER 1951

1½

EDITOR
F. J. CAMM

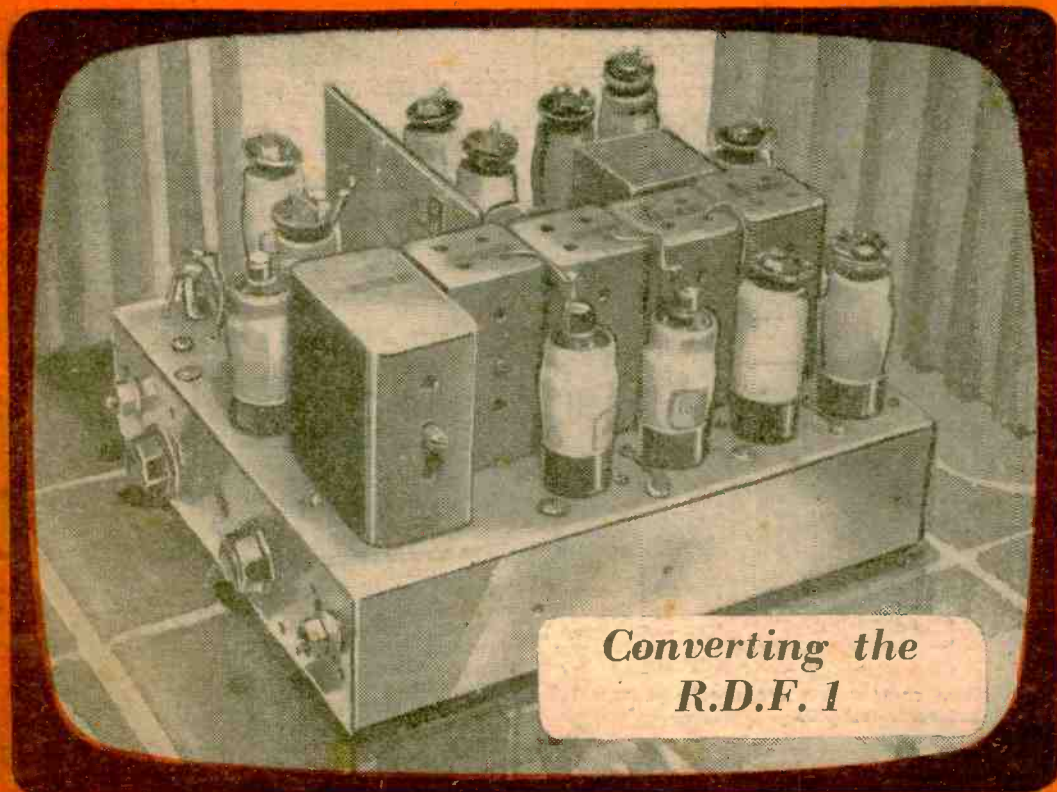

*Converting the
R.D.F. 1*

FEATURED IN THIS ISSUE

The National Radio Show
Coil Winding
The Design of the Video Stage

Using the 194 Strip
The Blocking Oscillator
Converting "H" Aerials

D. COHEN

Radio and Television Components

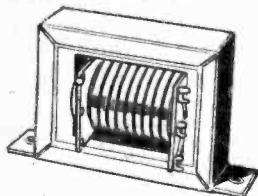

Line and E.H.T. Transformer 5-7 Kv., removed from chassis, guaranteed **9/6**

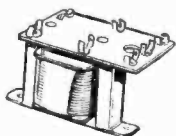

Smoothing choke 150 mA 2 Henry **3/6**



Line and frame scan coils, removed from chassis, guaranteed **6/6**



Frame oscillator blocking transformer **4/6**

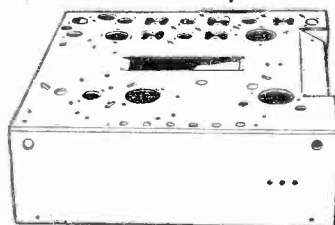

T.V. Chassis, could be adapted for use with the above components. Size 9 1/2 x 9 1/2 x 3 1/2 **3/-**

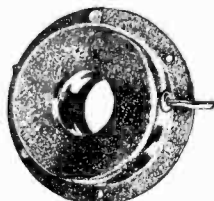

Focus ring **9/6**

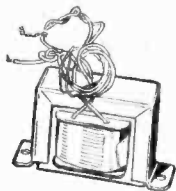

Heater transformer Pri. 230-250 volt, Sec. 2 volt 2 1/2 amp. **5/-**

The above components are a very famous T.V. manufacturer's surplus.

- 9in. White rubber mask with armour-plate glass **10/-**
- 12in. Rubber mask with armour-plate glass ... **15/-**
- 15in. Rubber mask **15/-**
- 12in. Armour-plate glass **4/-**
- 9in. Armour-plate glass **3/-**

Terms of business Cash with Order.

Orders under £2 add 1/6. Under £1 add 1/- post and packing.

All inquiries and lists, stamped addressed envelope.

23, HIGH ST., ACTON, W.3.
(OPPOSITE GRANADA CINEMA) Acorn 5901

G2ACC OFFERS YOU—

A NEW 8th EDITION OF OUR ILLUSTRATED CATALOGUE

9th POST FREE

Approximately 50 pages, illustrated on fine art paper containing over 2,000 items with technical information. Listed are all the best branded names from the foremost radio manufacturers including :—

- BELLING & LEE — BRIMAR — BULGIN — COSSOR
- DENCO — EDDYSTONE — EDISWAN — E.M.I.
- ERIE — G.E.C. — HAMRAD — J.B. — LABGEAR
- MARCONI — MAZDA — MULLARD — MORGANITE
- PLESSEY — Q.C.C. — Q-MAX — RAYMART
- ROTHERMEL — TELCON — T.C.C. — WEARITE
- WEYMOUTH — WESTINGHOUSE — WODEN ETC.

Backed by

SPEEDY, RELIABLE & EFFICIENT SERVICE

Southern Radio & Electrical Supplies

85 FISHERTON STREET, SALISBURY, WILTS

Telephone : Salisbury 2108

The solder for all HOME TELEVISION CONSTRUCTOR SETS

Designers of television constructor sets know that the efficiency of their equipment depends on the solder used by the constructor—that's why they recommend Ersin Multicore for trouble-free, waste-free soldering. Ersin Multicore, the only solder containing three cores of extra-active, non-corrosive Ersin Flux, is obtainable from all leading radio shops. Ask for Cat. Ref. C.16018, 18 S.W.G. 60/40 High Tin Television and Radio Alloy. The size 1 Carton contains 37 feet of solder, costs 5/-.



Ersin Multicore Solder

In case of difficulty in obtaining supplies, please write to :

MULTICORE SOLDOERS LTD.,

MELLIER HOUSE, ALBEMARLE STREET. LONDON. W.1 • REGent 1411

THE *New* WINDSOR Television **WOBBULATOR**

MODEL 260A

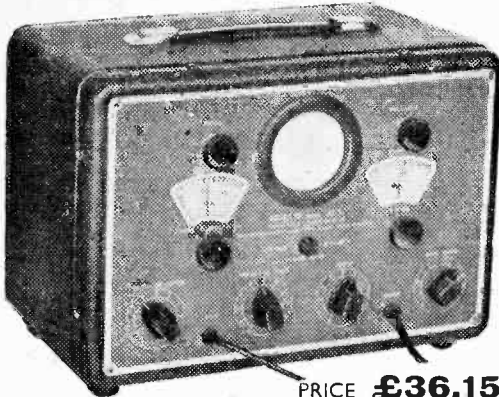

PRICE **£36.15.0** LIST

EARLY DELIVERY. Please write for further details and information on other WINDSOR and TAYLOR products.

TAYLOR ELECTRICAL INSTRUMENTS LTD.
419/424 MONTROSE AVENUE, SLOUGH, BUCKS
Telephone: SLOUGH 21381 (4 lines). 'Grams & Cables: Taylins, Slough

The first self-contained electronic instrument providing visual alignment facilities for television receivers. Simple, compact and efficient—its use will save many hours of valuable time in the service department.

FEATURES

- CARRIER FREQUENCY. 5-70 Mc/s. 10-140 Mc/s (on 2nd harmonic).
- BANDWIDTH. 0-5 Mc/s total. 0-10 Mc/s (on 2nd harmonic).
- SWEEP FREQUENCY. 50 c.p.s. sinusoidal, return trace blacked out automatically.
- OUTPUT. Adjustable from 0-10 mV. approx. Fixed and variable attenuators are fitted. Output impedance 75 ohms.



MODEL 260 A TELEVISION WOBBULATOR - MODEL 260 A TELEVISION WOBBULATOR

ARTHURS HAVE IT!

LONDON'S OLDEST RADIO DEALERS
LARGE VALVE STOCKS

AVOMETERS IN STOCK

Avo Model 7	£19 10 0
Avo Model 8	19 10 0
Avo Model 40	19 10 0
Universal Bridge	26 0 0
Test Bridge	11 0 0
Avo Minor Universal	10 10 0
Electronic Test Meter	40 0 0
Signal Generator (Mains and Battery)	30 0 0
Valve Characteristic Meter	50 0 0
TAYLORS METERS, Special Lists on	...	Request.	
COSSOR DOUBLE BEAM OSCIL-	
LOSCOPE	85 0 0
PHILIPS PHILISHAVE (Complete)	6 6 0
in pouch	
Wire-wound volume controls	7 0

LATEST VALVE MANUALS

JUST PUBLISHED "Osram," 5/-.
MULLARD 5/- each. BRIMAR TELETUBE & Radio, 4/- each.
MAZDA 2/- each. POST 6d. EACH EXTRA.

TELEVISION SETS, WIRE AND TAPE RECORDERS
AT PRE-BUDGET PRICES

Arthur's Est. 1919 **first**

PROPS: ARTHUR GRAY, LTD.
OUR ONLY ADDRESS: Gray House,
150-152 Charing Cross Road, London, W.C.2

TELEGRAMS—"TELEGRAY, WESTCENT, LONDON"
CABLES—"TELEGRAY, LONDON"

TELEVISION AERIAL DIPOLE and REFLECTOR MOULDINGS TYPE MKII

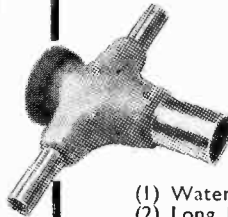

- (1) Watertight assembly.
- (2) Long leakage path.
- (3) Element rods reinforced by the inserted metal tubes, at a point where fracture is liable to occur.
- (4) Mycalex has high surface resistivity to moisture under damp conditions.
- (5) Great physical strength due to nature of Mycalex which is a bond of Mica and Glass.
- (6) Electrical connections easily accessible by means of removing the tough rubber end cap illustrated.

**MYCALEX
COMPANY LIMITED**
ASHCROFT ROAD
CIRENCESTER, GLOS.

TELEPHONE: 400



CONDENSERS

The abbreviated ranges of two popular types given here are representative of the wide variety of T.C.C. Condensers available.

Hi-K 'PEARL' CERAMICS

Capacity pF.*	Wkg. Voltage		Dimensions		Type No.
	D.C.	A.C.	Length	Dia.	
1-0	500	250	3.5 mm. to 7 mm.	5 mm. to 7 mm.	SPG 1
10-0	500	250			SPG 1
33-0	500	250			SPG 1
150	500	250			SPG 1
330	500	250			SPG 1
470	500	250			SPG 1

Hi-K MULTIPLE TUBULAR CERAMICS

Capacity pF.*	Wkg. Voltage		Dimensions		Type No.
	D.C.	A.C.	Length	Dia.	
2 x 500	500	250	10 mm.	4.5 mm.	2CTH 310/W
2 x 1000	500	250	10 mm.	4.5 mm.	2CTH 310/W
2 x 1500	500	250	15 mm.	4.5 mm.	2CTH 315/W
2 x 2200	500	250	22 mm.	6 mm.	2CTH 422/W
3 x 500	500	250	15 mm.	4.5 mm.	3CTH 315/W
3 x 1000	500	250	15 mm.	4.5 mm.	3CTH 315/W
3 x 2200	500	250	22 mm.	6 mm.	3CTH 422/W

* Guaranteed not less than stated values at 25°C.

THE TELEGRAPH CONDENSER CO. LTD.

Radio Division: North Acton, London, W.3. Tel: Acorn 0061

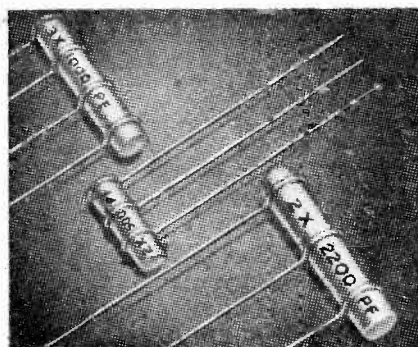
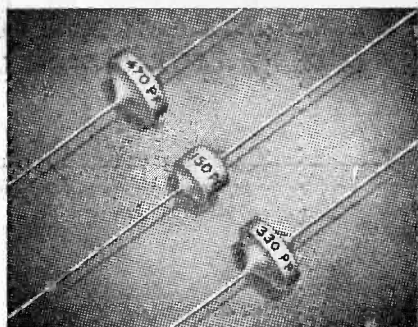

FOR AMATEUR CONSTRUCTORS

Comprehensive valve and tube data

Designers and Constructors who require full technical details, including characteristic curves on any Mullard valve or tube are invited to apply to our Technical Service Department.

Data sheets on individual types will be supplied free of charge.

Those who require comprehensive data on complete ranges of Mullard valves and tubes are invited to subscribe to the Mullard Technical Handbook Service, details of which will be supplied on request.



MULLARD LTD., Century House, Shaftesbury Avenue, W.C.2

PRACTICAL TELEVISION

& "TELEVISION TIMES"

Editor: F. J. CAMM

Editorial and Advertisement Offices: "Practical Television," George Newnes, Ltd., Tower House, Southampton Street, Strand, W.C.2. Phone: Temple Bar 4363.
Telegrams: Newnes, Rand, London.

Registered at the G.P.O. for transmission by Canadian Magazine Post.

Vol. 2. No. 17

EVERY MONTH

OCTOBER, 1951

Televiews

Compulsory Interference Suppression?

AN advisory committee set up by the Postmaster-General to investigate the matter has recommended that interference suppressors should be compulsorily fitted to motor-cars to prevent interference with television reception. The committee has, however, recommended that at least six months should elapse between the making of any regulation and the enforcement of it.

The committee also makes the statement that in 60 per cent. of existing cars satisfactory suppression can be achieved by fitting a single resistor costing 2s. 6d. Some motor-car manufacturers have anticipated such a regulation by turning out all new cars satisfactorily suppressed. We do not think, however, that the recommendations go far enough. It is true that motor-car ignition systems are responsible for a high proportion of interference, which takes the form of snowstorms on the screen.

There is other apparatus, however, which causes considerable interference, such as carpet sweepers, hair driers, and electro-medical apparatus. Whilst this is in use it is continuous for a fairly long period and can almost blot out the picture, whereas interference from motor-cars is spasmodic. Would it not have been wise to have included in the recommendation a clause that within a certain period electrical apparatus which can cause interference must be supplied when sold with suppressors fitted?

HOLME MOSS—

THE Postmaster-General is to open the new high-powered television station at Holme Moss on October 12th, as announced in a previous issue, and this will open out the television service area to a possible viewing public of 32,000,000 people, out of a total population of about 50,000,000. Readers in the Holme Moss area have been busy during the past months preparing for the opening, either by making television receivers, or by ordering them. A large number of PRACTICAL TELEVISION receivers are being built and many thousands of viewers will obtain their first experience of television by viewing the end of the tube of a "P.T." receiver. The Holme Moss transmitter will cover most of Lancashire, the East and West Ridings of Yorkshire.

parts of the North Riding, Lincolnshire, Nottinghamshire, and Derbyshire, as well as the whole of Cheshire and Flintshire.

—AND KIRK O'SHOTT'S

THE Kirk o'Shotts station will open in January, and this will further widen the viewing public and satisfy those tens of thousands of people in the north who are anxious to sample the new electronic entertainment. We shall issue instructions for the mild modifications to the "P.T." receiver necessary to adapt it to the transmissions of both Holme Moss and Kirk o'Shotts.

Readers in those two areas who are in need of advice on the selection of a television receiver, on the construction of one or on the selection of aerials, should get into touch with us without delay.

TELEVISION PLAYS

ONCE again it is our duty to criticise those responsible for the selection of television plays. With all the wealth of material available why within a very short space of time select two of Shaw's boring plays, the first far too long for television, even if it were worth viewing, and the second, "Androcles and the Lion," which is more reminiscent of a child's first effort at play writing than the work of one who claims to be slightly greater than Shakespeare and has therefore had a bust of himself carved slightly larger than Shakespeare's bust to be placed by the side of latter when the National Theatre is opened.

Apart from its lack of originality, the plot, such as it is, and the dialogue, such as it was, did not amuse many listeners. The B.B.C. should realise that Shaw is not so popular as he said he was!

INDEXES TO VOLUME 1

OUR first volume comprised issues No. 1, dated April, 1950, to No. 12, dated May, 1951 (12 issues). Indexes for this first volume are now available for 1s. 1d. each, by post from the publisher, George Newnes, Ltd., Tower House, Southampton Street, Strand, W.C.2. Readers are strongly advised to have this first volume bound.—F. J. C.

Converting the R.D.F.1

DETAILS OF A COMPACT CHASSIS CONTAINING VISION, SOUND RECEIVERS AND TIME BASE

By B. L. Morley

THE R.D.F.1 unit, which can still be bought for just over £1, is quite suitable for conversion into an inexpensive unit containing vision and sound receivers, together with a time base suitable for operating an electrostatic tube.

With the aid of this unit plus a few parts from the spares box it should be possible to construct a complete television for about £12.

The converted unit is shown on the cover. Looking at the chassis from the front (i.e., the "Pye" socket end), the vision receiver is on the right. This is a 4RF-stage unit with diode detector and video output valve. The first RF valve is mounted in the first can; the last valve in the line is the video valve and the diode detector is mounted just behind it. In the original chassis this portion was an IF unit and it is converted to TV with very few modifications.

On the left of the chassis in front of the screen is the sound receiver. This comprises two RF stages, the first of which is fed from the first video RF valve; these are followed by a diode detector, AF amplifier and audio output valve which uses a 6V6 tetrode. This last valve is just out of sight behind the first two cans.

Behind the screen and occupying the rest of the chassis is the time base comprising phase inverter (VR137), sync separator, line oscillator with parphase

amplifier and a similar frame oscillator. A D.C. restoring diode is mounted underneath the chassis.

The Pye socket on the extreme right is for aerial input and that on the left for the video output feeding the tube. Next to the aerial socket is the contrast control and, next to that, the volume control. Actually these controls may be regarded as pre-set controls as the unit is designed to work in the normal service area, although the prototype has actually given pictures of quite good quality 80 miles from Sutton Coldfield when a 2-valve pre-amplifier was used; the adjustments, however, were rather tricky at this long distance.

The outfit can be used on any BBC station by increasing or reducing the turns on the tuning coils.

Preliminary Work

When the chassis is received it will have a total of 11 valves: 5 of VR65, 2 of VR92, one of VR137, one of VR54, one of VR66, one of CV63. The last three are not required.

The first step is to remove all the valves to avoid damaging them, then take off the front panel and angle brackets which hold it; take off the two sockets on the left- and right-hand sides of the chassis, and replace them with Pye sockets. Recover all the components

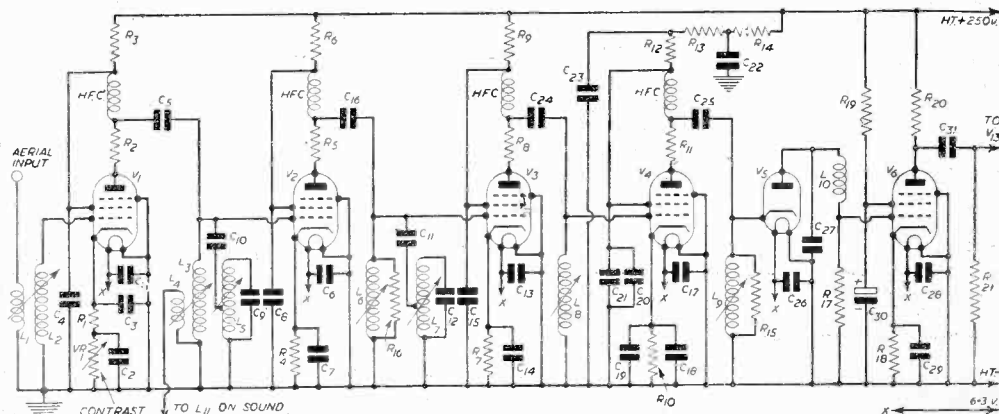

Fig. 1.—The vision receiver.

LIST OF COMPONENTS

C1, 6, 13, 17, 26, 28 = 50 pF.
 C2, 3, 4, 7, 8, 14, 15, 18, 21, 29 =
 0.01 μ F.
 C5, 16, 24, 25 = 200 pF.
 C9, 12 = 10 pF.
 C10, 11 = 5 pF.
 C19, 20, 22 = 500 pF.
 C23 = 0.002 μ F.

C27 = 15 pF.
 C30 = 8 μ F.
 C31 = 0.1 μ F.
 R1, 4, 7, 10, 18 = 100 Ω .
 R2, 5, 11 = 27 Ω .
 R3, 6, 9, 12, 13 = 1 K Ω .
 R8 = 30 Ω .

R14 = 2 K Ω .
 R15, 16, 19 = 10 K Ω .
 R21 = 1 M Ω .
 R17, 20 = 4.7 K.

V1, 2, 3, 4, 6 = VR65.
 V5 = VR92.
 VR1 = 3 K Ω .

which are in the compartment reserved for the sound receiver, on the top of the chassis.

Underneath the chassis will be found two resistor panels, which should be removed, together with their associated wiring. Work can now proceed on the vision receiver.

The Vision Receiver

The circuit is shown in Fig. 1. L1 is the aerial coupling coil feeding into L2 and the first RF valve V1, which is a VR65 (SP61). This stage is common to sound and vision. The output from V1 feeds into V2 via L3. L4 is a small coupling coil wound round L3 former to tap off the sound signal. The circuit comprising L5 and C9 is the sound rejector and is coupled directly to the grid of V2 via the small capacitor C10. The output from V2 is passed to V3 via L6 and here is another sound rejector L7 and C12 similar to that in the previous stage. V3's output is fed similarly to V4 but no sound rejector is used. V4 feeds the diode detector V5, which is coupled to the grid of V6 via the correction choke L10. The diode is connected in such a direction as to provide a correctly phased signal for tube operation and the time bases. The output of the video valve V6 is passed to the time base via C31. It will be noted that chokes are used for the anode loads of the valves; this helps to reduce the voltage loss caused by the more commonly used resistors. The chokes are already in situ in the unit.

The modifications required now follow.

Remove the existing wiring from the coil in the first can; wind on L2, which is three turns of 22 S.W.G. wire. (All the tuning coils use this gauge of wire.) The respective ends are soldered on to the tags to which the original coil was connected; the existing short section of coaxial cable is recovered. L1 is now wound and this is one turn of wire (Sistoflex covered) which is wound on top of the previous winding. The earthy end goes to the same tag as the earthy end of L2 and the other end is connected to the centre conductor of a short coaxial section running from inside the can to the input Pye socket. The outer sheath of the coaxial is connected to the earthy end of the coils in the can, and at the other end is connected to the earthy side of the Pye socket.

Now turn the chassis upside down and remove the first

condenser mounted in the LH side of the chassis (50 μ F). It is no longer required. Also disconnect the brown wire going from VR1 to V2, 3, 4 and 5. Remove or short circuit the resistor on the top cap of V1.

L3 can now be modified by removing the existing

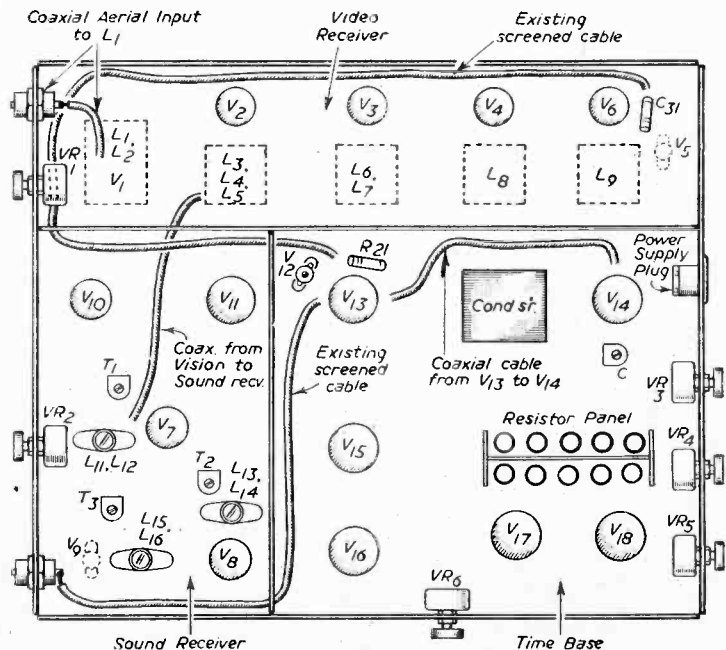
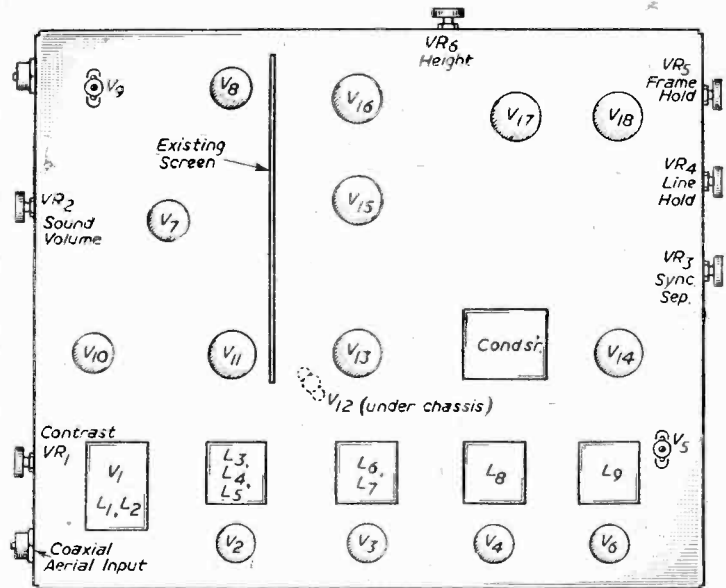

Fig. 2 (above).—Top of chassis layout, and Fig. 4 (below)—Underneath view of the chassis.

winding and rewinding it with $2\frac{1}{2}$ turns. The $6.8\text{K}\Omega$ resistor connected across the coil can be removed. Wind on L₄, which is similar to L₁ and is of one turn. The "earthy" end is connected to the "earthy" end of L₃ and the other end to a short length of coaxial. The other end of the coaxial is connected to the sound receiver input (L11). Earthing of the outer sheath should be dealt with in a similar manner to L₁.

L₅ (the rejector coil) consists of 9 turns of wire on a miniature former which is mounted on the bakelite panel which contains the resistors and H.F.C.; the ironwork holding this panel is drilled so that the core of the coil can be adjusted when the can is replaced, through the spare bottom hole in the can. The 10 pF and 5 pF condensers are mounted on the panel. C10 is tapped on to the coil $2\frac{1}{2}$ turns from the "earthy" end. Remove the 50 pF condenser connected to terminal 7 of V₂ and earth this terminal; disconnect the wire from this terminal to terminal 7 on V₃. (The valve numbers mentioned here are those in the diagram and not those marked on the chassis.)

L₆ is now modified similarly to L₃, using $2\frac{1}{2}$ turns, and L₇ is dealt with in the same manner as L₅. Remove the 0.1 μF condenser from terminal 7, V₃, and earth this terminal.

L₈ is now modified and is wound with 2 turns. The $6.8\text{K}\Omega$ resistor connected across the coil is removed.

The final tuning coil L₉ is then modified, $3\frac{1}{2}$ turns being used in a similar manner to the previous coils.

The diode circuit is next and here the 15 pF condenser will be found in situ; the resistor existing on the same mounting as the condenser is replaced with a $4.7\text{K}\Omega$. L10 is wound with 30 turns of fine enamelled S.C.C.

wire on a $\frac{1}{4}$ in. mandrel. This coil is mounted with the 15 pF condenser.

V₆ is the last valve to be modified. A $10\text{K}\Omega$ resistor is connected from H.T. common to the screened grid and is decoupled by the existing 8 μF condenser. A spare 100 pF condenser is connected across the 8 μF . Connect a $4.7\text{K}\Omega$ resistor in the anode circuit of the video valve.

From the anode of V₆ is connected an 0.1 μF condenser, the other side of the condenser going to the centre core of an existing screened cable, which runs round the chassis. The far end of the cable is diverted as shown in Fig. 4 to the valve base of V₁₃. The resistor R₂₁ is connected at that end.

Resistors existing on the grid caps of the valves are not required and may be removed and/or short-circuited. This completes the modifications of the vision receiver. If the detailed directions given are followed carefully it will save a lot of time. All the resistors and condensers not mentioned specifically are already in situ.

The Sound Receiver

A glance at Fig. 2 will show the disposition of the valves for the sound receiver and time base. The actual positions are not precisely symmetrical, because it was desired to use the existing holes in the chassis and reduce drilling to a minimum. V10, 17, 18 and V11 will require holes to be cut for them.

The circuit is shown in Fig. 3. It comprises two R.F. stages, which are transformer coupled; these are followed by a simple diode detector which feeds the first A.F. valve via the filter L17 and C36.

(To be continued)

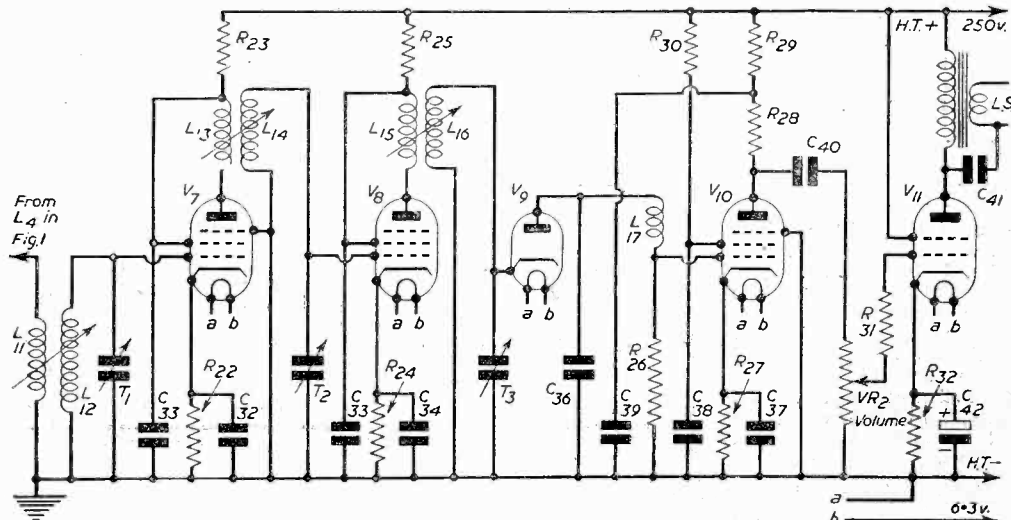

Fig. 3.—Sound receiver.

LIST OF COMPONENTS

C32, 33, 34, 35 = 500 pF.
C36 = 15 pF.
C37, 38, 39, 40 = 0.01 μF .
C41 = 0.002 μF .
C42 = 50 μF .
VR2 = 250 K Ω .

R22, 24 = 180 Ω .
R23, 25, 26 = 4.7 K Ω .
R27 = 220 Ω .
R28 = 10 K Ω .
R29 = 2.2 K Ω .
R30 = 22 K Ω .

R31 = 50 K Ω .
R32 = 250 Ω .
V7, 8, 10 = VR6S.
V9 = VR92.
V11 = 6V6.
T1, 2, 3 = 0.30 pF.

The National Radio Show

THE TRENDS OF DESIGN ARE REVIEWED IN THIS "AFTER-THE-SHOW" DISCUSSION

THE multiplicity of cabinets and designs which are seen at a Radio Show usually leave one a little breathless and in doubt as to just what it all means. Every manufacturer has his own claims as to his circuits and design, and it is difficult for the layman to make up his mind concerning quite a number of points. Looking back in a general way over all the exhibits and claims it is now obvious that the main trend of design has been towards bigger pictures. This may justly be stated to have been the keynote of the television exhibits. Not only were there more projection receivers than have ever been seen before, but even small table cabinets were seen with 16in. tubes. Gone are the old arguments that a large tube is useless because "you can see the lines." As we have stated before in these pages, a receiver in which proper interlacing is taking place and in which correct voltages are being used on the tubes does not have the lines unduly prominent. They are, of course, visible if one sits close enough, but the old arguments arose from the fact that pairing of the lines was taking place on most sets, or tetrode tubes were used with a voltage on the first

anode which was too high, thus producing a very fine line.

Spot Wobbling

However, what is left of the line structure even in a properly designed and operated receiver can be removed by a properly operated "spot wobbler." As most readers know, this consists of an oscillator attached to a small coil fitted round the tube so that the line as it crosses the screen is made to travel slightly up and down—forming a small sine wave as it goes. This breaks up the structure and enables closer viewing—although again, experts are divided on the argument as to whether it does, in fact, spoil detail. The user can now see this for himself, as Ekco are incorporating the feature in one of their new models and it should be noted that a switch has been fitted so that the "wobbler" may be made inoperative whilst focus, etc., are adjusted. It is then possible to switch it in or out as desired and see the effect.

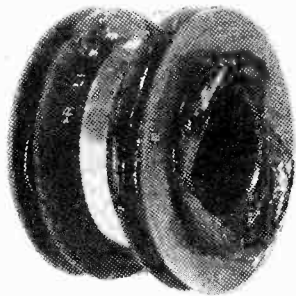

Designed for the new 16in. tubes, this is the new Haynes scanning coil unit. Line inductance is 9 mH and frame 10 mH.

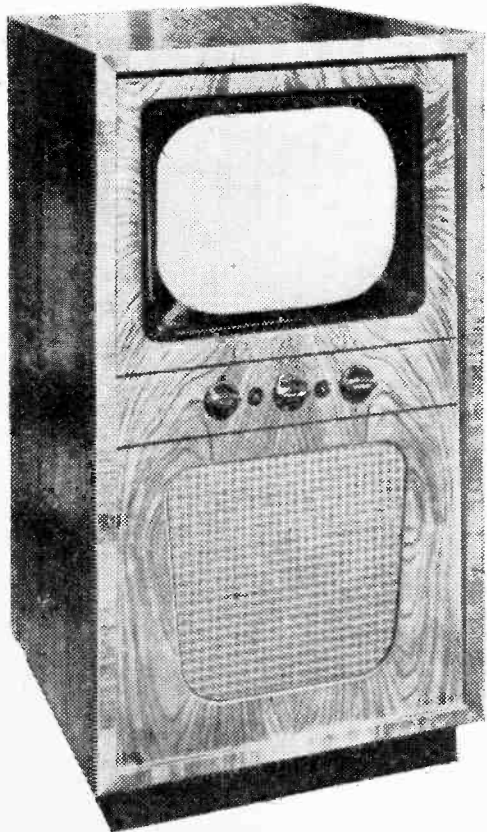

The new Ekco receiver with "spot wobbler."

Larger Tubes

A larger picture naturally calls for improved definition and some of the new makes were definitely as good—in some cases better—than the home cinema. The demand for the larger picture has again brought into prominence, however, the question of economics. Projection receivers give a large picture not quite so bright as a direct-view large screen, but replacement tubes, when required, are only about £2 or so—plus a charge for installation which must be carried out by a reputable dealer. On the other hand, the direct-view large screen calls for a tube 15in. or more in diameter and, at approximately £1 per inch diameter plus 66 $\frac{2}{3}$ per cent. Purchase Tax, this is an expensive replacement item. The new 16in. tubes which were announced by both Mullard and the English Electric cost £24 6s. 5d. The details of the Mullard tube will be found on page 210. The English Electric tube gives a picture 14 $\frac{1}{2}$ in. by 11in., using the full screen diameter, or, for a rectangle with rounded corners, a picture 13 $\frac{1}{2}$ by 10in. Both of these tubes are short in relation to their diameter, using a wider angle deflection system, and thus may usually be accommodated in a cabinet which normally accommodates the standard 12in. tube. The wider angle, plus the fact that the neck is of a different size from standard all-glass tubes (38 mm. instead of 35 mm.) means that a special deflection or scanning coil assembly must be used, and these were shown by Haynes Radio. These are available in round or square-fronted units with ferro-ceramic ring core.

Constructor Components

This firm were also showing many new units for home-constructors' or manufacturers' use for standard tubes as well as the new ones, and these included line output transformers, E.H.T. units, etc. A very useful item which appeared on the market for the first time is a complete power unit for a television receiver. This consists of a step-up auto transformer, selenium rectifier, smoothing condensers and choke, giving 335 v. at 280 mA and 6.3 v. at 8 A for the receiver, plus 2, 6.3 v. at 2 A for a C.R. tube heater. The well-known coils and

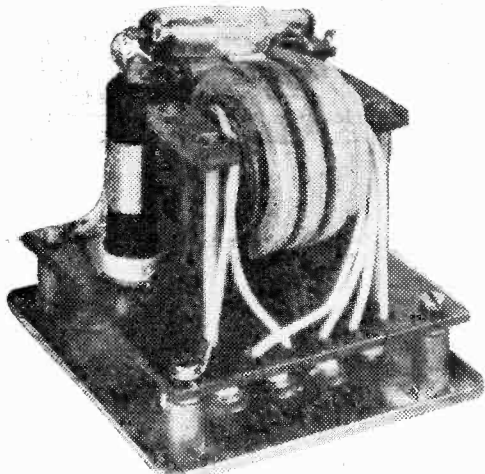

A fly-back EHT line transformer for 12 kV and wide-angle scan, with case removed. Normally this is supplied totally sealed and impregnated.

screens which were used in some recent designs in these pages were also featured.

Another very interesting item on this stand was the Television Monitor. This was fitted with a wide-angle tube and utilised a five-stage single sideband receiver with provision for interchanging tuner units for the required frequencies. The sound section has a push-pull output stage. There is a vision level indicator, and separate cable-connected power unit. It is of all-metal construction for portable or laboratory use.

Novelties

In addition to the practical side there were a number of interesting novelties of which the H.M.V. exhibit was quite outstanding. At the extremes of size they showed a miniature receiver fitted with a 1in. screen, and a large cabinet incorporating a 21in. screen. In both of these, cathode ray tubes were used and they both worked. The miniature receiver was merely shown as a novelty to show just what could be done in the way of miniaturisation and is not intended to be a commercial product. We understand that it is to be presented

for inclusion in the Queen's Doll's House. The large screen also incorporated what is claimed to be the largest cathode-ray tube ever built. This was well over 21in. in diameter and of all-metal construction, but again it is doubtful whether such a size would be a commercial proposition. At the time of going to press no technical details could be obtained.

Picture Size

Apart from the competition in tube and projection receivers there is still the problem of the actual size of the picture and one or two firms were claiming larger pictures on a given size of tube. In some cases this has been done by using a tube of a certain make which has a flatter surface than another tube and then adopting an outside mask, specially made for the set. In this way a slightly larger area is obtained and the drawback of the curved tube surface is avoided. In the case of the English Electric and Baird, the mask took the form of an opening with a very curved side, almost as though the circular tube front had simply been ruled across above and below centre. In this way increased width is obtained but there is more "corner cutting." The effect is to give a larger picture area, but after the standard rectangular area with straight sides it looks a little strange. No manufacturers appear to have carried on with the American idea, which was so popular at one time, of using the complete screen by adopting a round picture area, and this English Electric shape is a compromise between the two ideas.

Neither could any details be obtained from the stands of any firm adopting the American idea of switching the picture so that a "blown up" version of close-ups could be obtained. As older readers will remember, this arrangement enables the full tube face to be used, or a rectangle to be obtained as desired.

It is, of course, possible to obtain a larger area by using a rectangle without rounded corners. In this way a strip is gained on all sides and the home constructor may adopt this idea provided the tube has a fairly flat front. Masking may be carried out by using black card, as rubber masks are not available for the purpose.

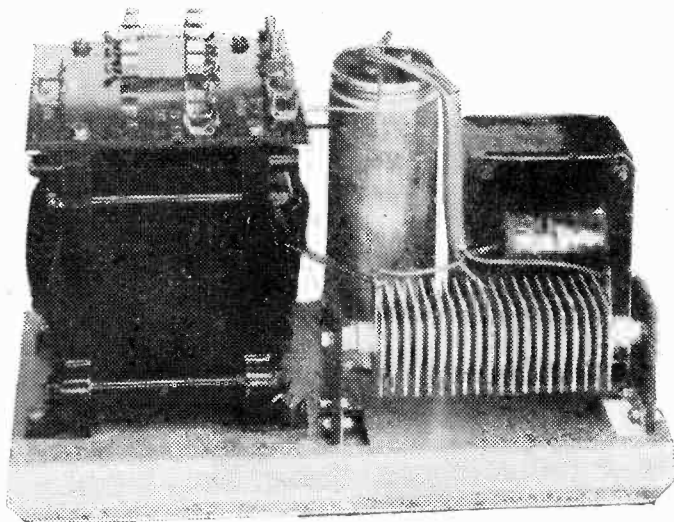

A complete television power pack available for the first time to the home-constructor.

Converting "H" Aerials

HOW TO ADAPT EXISTING AERIALS FOR OTHER TRANSMISSIONS

By "Erg"

As new stations come into operation many constructors will be changing their aerials to work to the nearest transmitter. Modifying an aerial to work on a higher frequency can be carried out quite easily by cutting the elements to the new length required, but when the frequency is lower it generally means that a new outfit has to be bought.

It is possible to adapt an aerial to work from a high to a lower frequency without much difficulty. A problem of this nature arose when a friend of the writer converted his "H" aerial from London to Birmingham; unfortunately he made an error in his calculations and cut the elements too short, with the result that it would have worked very well on 68 Mc/s but not on Sutton Cold-

Now we want our aerial to cover the sound and vision channels; this means that a Sutton Coldfield aerial (for example) should cover from 58.25 Mc/s to 61.75 Mc/s. With single side-band reception we are concerned mainly with this range as, although the carrier is set at 61.75 Mc/s, it tails off rapidly above this figure. The aerial should therefore be adjusted to tune to a mean frequency and in this case 60 Mc/s will be found to be a good figure. In Table I will be found approximate mean figures for the four new channels to be worked by the B.B.C., together with the lengths of the various elements and the 0.25λ spacing between dipole and reflector.

TABLE I

Station	Mean f Mc/s	Dipole	Reflector	Spacing (0.25λ)
		ft. in.	ft. in.	ft. in.
Holme Moss	50	9 4½	9 11½	4 8
Kirk o' Shotts ..	55	8 6	9 0½	4 3
Sutton Coldfield ..	60	7 9½	8 3½	3 10½
Wenvoe ..	65	7 2½	7 8	3 7½

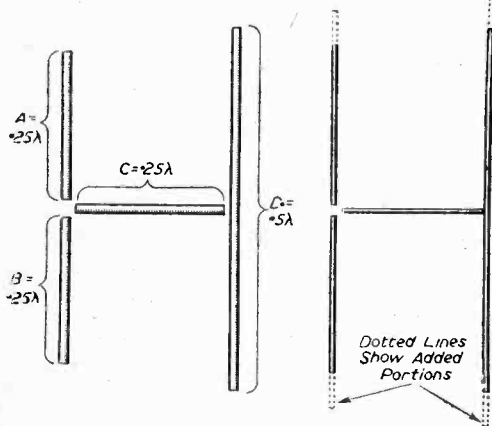

Fig. 1.—The standard "H" aerial.

Fig. 2.—The added positions are shown dotted.

field at 61.75 Mc/s. The element rods were lengthened by the process outlined here and when the modified array was tested against a similar commercial type, no difference in signal strength could be detected.

Composition of the "H" Aerial

Before going any further it should be explained that the ensuing calculations are worked out to the nearest approximation, so as to keep the subject plain; please don't write to say that we have given 9ft. 2in. when it should have been 9ft. 2.1964in.; the odd fractions will not make any practical difference.

Now let us have a look at a standard "H" aerial. It consists essentially of four pieces (see Fig. 1). A and B form the dipole, C is the cross-bar, and D is the reflector. A and B are 0.25 wavelength (λ) each and the actual physical length determines the frequency to which it will tune. If you want more technical details see "Aerials Principles and Practice" in the August issue.

The combined length of A and B is 0.5λ and a simple formula for calculating the actual length was given in the article mentioned above; it was,

$$\text{Length in feet} = \frac{468}{f \text{ (Mc/s)}}$$

Converting an Aerial: Figures

As an example, supposing it is desired to convert an aerial from Sutton Coldfield to Holme Moss, from Table I we have:

	Dipole	Reflector
	ft. in.	ft. in.
Holme Moss	9 4½	9 11½
Sutton Coldfield	7 9½	8 3½
Difference	1 6½	1 7½

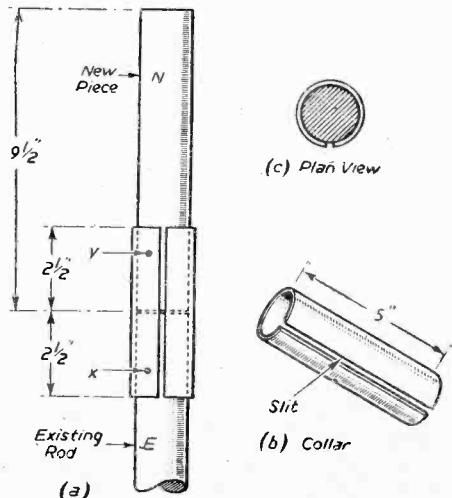

Fig. 3.—Details of the fixing of extension pieces.

This means that we must add 1ft. 7 $\frac{1}{2}$ in. to the dipole and 1ft. 7 $\frac{1}{2}$ in. to the reflector to make it work on Holme Moss. Now it is no good just sticking a bit on one end, as the aerial would then be lopsided physically and electrically: we must divide the extra piece into two, and stick a bit on each end of the existing elements. Fig. 2 shows the scheme.

In this case we must take our extra 1ft. 6 $\frac{3}{4}$ in. for the dipole and divide it into two, making two pieces of 9 $\frac{3}{4}$ in., the reflector pieces will be 10in. each.

Converting an Aerial: Practice

Obtain some lengths of duralumin tubing of the same diameter as the existing elements; cut the lengths required and then cut an additional piece about 5in. long; this piece should then have a longitudinal slit cut in it with a hacksaw, as shown in Fig. 3 (b).

The two ends "x" and "y" should be polished with fine emery until a smooth, clean surface is obtained; the split length of dural is then forced over the end of the existing element "E" for a distance of 2 $\frac{1}{2}$ in. The extension piece "N" is then forced into the remaining 2 $\frac{1}{2}$ in. of the collar; the two ends "N" and "E" should come into close contact with each other. A few

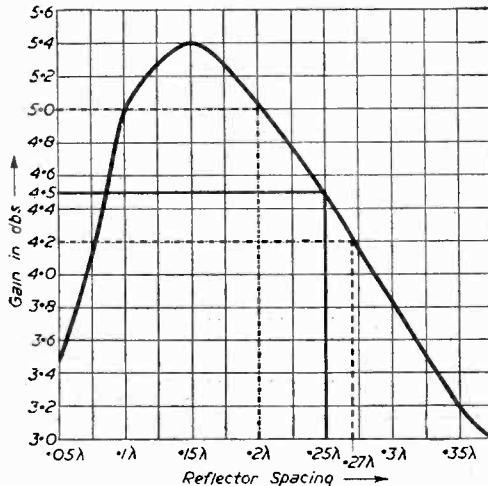

Fig. 4.—Graph giving spacings.

Flows with a hammer (interposing a block of wood) on the end of "N" will assist the process.

If you don't mind the ends of the aerial looking like bandaged fingers, the joint can be covered with insulating tape. The joint should finally receive two coats of paint to keep it watertight. A small wooden plug should be used to block up the open end of "N," and that, too, given two coats of paint. It is good practice to make the whole of the elements smooth and bright and to give them two or more coats of paint to prevent corrosion. Battleship grey is a good colour to use.

Treat each element in a similar manner, and if you feel nervous about the gales loosening the joint, the collar may be bolted on.

Reflector Spacing

So much for the elements, and now for the spacing between them. The graph in Fig. 4 gives the theoretical gains of "H" aeriels with various reflector spacings. It will be seen that when the aerial was 0.25 λ the gain

was 4.5db. The 0.25 represents the 3ft. 10 $\frac{1}{2}$ in. spacing when the aerial was working on Sutton Coldfield. This distance has not been altered, but as the wavelength of the elements have been changed the 3ft. 10 $\frac{1}{2}$ in. will represent a different proportion of the new wavelength. In actual fact it will be 0.2 λ, approximately. Referring to Fig. 4, again we see that the gain has been increased from 4.5db to 5.0db!

It is a pity, but the fact is, this small amount of gain will not be noticed on the picture; but the main point to note is, that for all practical purposes the spacing between the dipole and reflector can remain the same as it was before, without any harmful effect.

This point holds good when converting an aerial to work on a higher frequency than it did before.

Changing an Aerial to a Higher Frequency

Supposing it is desired to convert an aerial from Sutton Coldfield to the Wenvoe frequency; from Table I we have:

	Dipole ft. in.	Reflector ft. in.
Sutton Coldfield	7 9 $\frac{1}{2}$	8 3 $\frac{1}{2}$
Wenvoe	7 2 $\frac{1}{2}$	7 8
Difference	7	7 $\frac{1}{2}$

Therefore, we must cut off each free end of the dipole 7 ÷ 2 = 3 $\frac{1}{2}$ in. and from the reflector 7 $\frac{1}{2}$ ÷ 2 = 3 $\frac{3}{4}$ in. each end. The open ends of the elements should be stopped up as explained previously.

The reflector spacing was 3ft. 10 $\frac{1}{2}$ in., representing 0.25 λ. It remains at 3ft. 10 $\frac{1}{2}$ in., but now represents 0.27 λ. Referring to Fig. 4 we see that the gain has been reduced from 4.5db to 4.25db—a negligible amount, so that once again the cross-boom need not be touched.

Although we have dealt only with a standard "H" aerial the same principles apply to more complicated arrays, though where multi-directors are used it will probably be better to cut out the directors altogether if you come well within the service area of the new station. If this is done, any device for matching the aerial to the feeder will have to be cut out, or a mis-match will result when the directors are taken away.

Where a folded dipole is in use the problem becomes more complicated, though if the "fold" is of the same diameter as the dipole it could be cut out entirely, together with the directors, and used to lengthen the existing elements if required.

Club Report

NORTHAMPTON AREA TELEVIEWERS' SOCIETY

General Secretary: G. T. Wilson, 95, Enderdale Road, Northampton.

MR. M. J. W. BELL, of Pye Radio, Ltd., was principal guest speaker at the Society's August meeting when he addressed some 100 members. Mr. Bell spoke on sponsored television. Whatever their individual views on the prospect of sponsored television or radio programmes, the members of the Society certainly found Mr. Bell's talk on this subject a provoking one. Mr. Bell said that colour television is unlikely to reach Britain in force for at least another six years.

The Society are holding a Television Exhibition in Northampton at the beginning of October, when viewers and members of the public will be able to see lanes of television working under normal conditions. Ten local firms have promised to exhibit, and aerial installations will be carried out by a local firm who manufacture a well-known T/V aerial.

Mr. A. N. Wright (Chairman), Mr. G. T. Wilson (Hon. Secretary), Mr. P. Webster, and Mr. F. Astle met the trade at the Grand Hotel, Northampton, to discuss how they could work together to help viewers, the means of social intercourse and to promote mutual assistance in the betterment of television reception in all aspects.

Tube Screen Coatings

THE POWDERS AND TECHNIQUE USED IN THE COATING OF TELEVISION
CATHODE-RAY TUBE SCREENS

By S. R. Neuburger, M.A.(Cantab.) and J. H. Jupe, A.M.I.E.E.

THE great majority of domestic viewers might describe the screen of the cathode-ray tube as being merely a piece of glass coated with a powder on the inside. This, however, is a misleadingly simple description. Behind the development of this particular part of the modern television cathode-ray tube lies a story of continuous research carried out over a number of years.

The fact that many substances fluoresce when subjected to irradiation by cathode rays was first established by Sir William Crookes as long ago as 1870. Crookes was not only the first to discover the actual nature of the cathode rays, but he also examined systematically the effect of this new form of excitation on a wide variety of common substances. He found that most compounds showed "cathodo-luminescence," as he called it, to a greater or lesser degree.

At about the same time, attempts were being made to prepare synthetic luminescent materials, or phosphors as they are now termed, that would have specific required properties with regard to brightness and colour. Not until about a quarter of a century later, however, could consistent results in the preparation of phosphors be obtained. The earliest luminescent materials prepared were mainly confined to the sulphides of certain elements, including zinc sulphide which can be regarded as the parent substance of modern cathode-ray tube phosphors.

Impurities

As the basic principles governing the preparation of phosphors began to be understood, it was realised that the presence of small amounts of accidentally-introduced impurities had often been responsible for the fluorescence of the early samples. When these impurities had been identified and classified into those promoting and those suppressing luminescence (known as "activators" and "inhibitors" respectively), it became possible to make consistently phosphors having the desired properties. It is even possible for the same substance to be an activator in one instance, and yet an inhibitor in another. One of the first steps in the preparation of a particular phosphor is therefore the rigid purification of all reagents, while contamination must also be scrupulously avoided. Only then are activator impurities incorporated in the main material in carefully controlled amounts. As shown in Table I, different activators may cause substantial changes to take place in the character of the fluorescence of a basic material.

Uniformity

It has been found that the favourable subjective effect of a television picture is very largely dependent, among other factors, on obtaining a screen that is extremely uniform over its whole area, both in colour and intensity.

The results of a large number of subjective tests have shown further that the colour generally preferred for television screens is a "cold" white having a bluish tinge. Phosphors giving fluorescence of this colour are therefore chosen for television cathode-ray tubes. In order to obtain the required subjective white colour,

TABLE I.

Fluorescence of Zinc Sulphide with Different Activators

Activator.	Colour of Fluorescence.
Zinc	Pale Blue.
Silver	Deep Blue.
Copper	Green.
Manganese	Orange.
Lead	Green or Orange.
Phosphorus	White or Yellow.
Tin	Orange-red.

two or more phosphors may be mixed together, or special single compounds with the desired properties may be prepared.

The important zinc-cadmium sulphide class of phosphors may be used to illustrate the former technique. Zinc sulphide activated by copper shows green fluorescence, but if the zinc is replaced by more and more

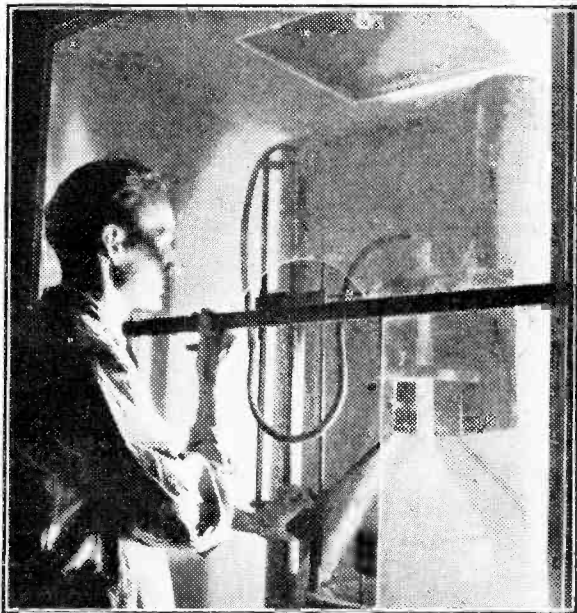

Blowing the screen material on to the prepared surface with a special air-gun.

cadmium, the resultant colour of the fluorescence moves progressively towards the red. The colour of silver-activated zinc sulphide can be controlled in a similar manner and, as the cadmium content increases at the expense of the zinc content, an even wider range of colours, from blue through green and yellow to deep red, can be produced. The variety of colours made available by this means has enabled sulphide mixtures to be produced giving substantially white light under cathode-ray excitation. For example, two sulphides, one showing blue and the other yellow fluorescence, can be blended to produce a subjectively attractive white colour. While these mixed sulphide phosphors have a number of advantages, including a comparatively high efficiency, there may be a very slight tendency for the components to separate out again on application to the screen.

Recent attempts have therefore been made in the Research Laboratories of The General Electric Co., Ltd., to produce single component white sulphides and these have been entirely successful. Zinc sulphide powders activated by phosphorus can be prepared by a special technique and the colour of their fluorescence can be changed by various means from bluish-white through other shades of white to a deep yellow. These new phosphors, which enable white fluorescing sulphides to be prepared as a single component powder, are more stable to the processing conditions used in cathode-ray tube manufacture than mixtures of zinc-cadmium sulphides.

The sulphides are by no means the only class of compound that can be used for coating television screens. One compound which may become important is zinc phosphate, activated by manganese, which gives a deep red luminescence and may be needed for colour television purposes. Activated zinc oxide is another interesting material in that it has an extremely short

afterglow, a property which is of value for film scanning purposes.

A suitable fluorescent material having been chosen, further problems arise in connection with its manufacture and also the application of the powder to the screen itself. The brightness of a phosphor coating, excited by cathode-ray bombardment, depends not only on the phosphor used, but also on the beam current, the effective bombarding voltage and the thickness and structure of the coating. The latter two factors are of considerable importance. The grain size of the coating powder must be critically adjusted, for if the particles are too large, the structure will become visible in the luminescent spot and the television picture will appear coarse and granular. Since, however, smaller grains have a less perfect crystal structure, screens made up of very small particles will not be particularly efficient in converting into light the energy falling on them. If the density of the phosphor layer is too low, the thickness of the coating may be insufficient to absorb the full power of the electron beam, and, in extreme cases, the screen may not even be well covered by the phosphor. On the other hand, too high a density causes the deeper layers, into which the electrons cannot penetrate, to absorb or scatter the light emitted by the material nearer the surface that is bombarded.

Practical Methods

The methods which are used for coating the glass cathode-ray tube screen with phosphor powders can be classified into the dry processes and the wet processes. Most dry coating techniques depend on first preparing a tacky layer of a binder over the glass face and then applying the powder. As an example, the glass surface may be soaked in a solution of ortho-phosphoric acid in acetone which is then drained out of the bulb leaving a sticky layer behind. Excess powder is then scattered fairly uniformly over the screen and the bulb is rolled until a uniform coating has been achieved.

There are several wet processes. The phosphor may be mixed with a lacquer to make a paint and this is made to flow over the screen so as to produce a uniform coating. After drying in air, the screen is baked at a temperature of about 350-450 deg. C. until the medium or lacquer is destroyed. Alternatively, the phosphor may be dispersed in a suitable liquid to form a dilute suspension which is poured into the bulb and allowed to stand until the powder has settled out to form a sediment coating the screen. The liquid is then removed and the sediment allowed to dry. Both wet and dry processes are equally capable of producing satisfactory coatings and the various refinements in technique that are introduced contribute considerably towards ensuring the high quality of the final television picture.

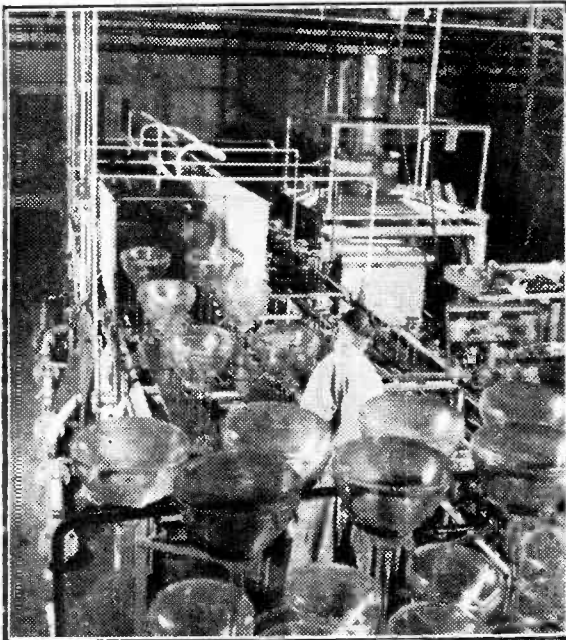

Semi-automatic plant for washing the bulbs prior to coating.

JOIN THE PRACTICAL GROUP

Edited by F. J. Camm

PRACTICAL WIRELESS, 4/-
Every Month.

PRACTICAL MECHANICS, 1/-
Every Month.

Devoted to Mechanics, Science and Invention

PRACTICAL ENGINEERING, 6d.
Every Friday.

For Engineers, Mechanics, Designers and Works Managers.

COIL WINDING

USING MODERN COIL FORMERS AND WINDING FRACTIONAL TURNS WITHOUT
A COIL-WINDING MACHINE

By W. J. Delaney (G2FMY)

FOR the Compact Televisor and the Combined Televisor and Broadcast Receiver, recently described in these pages, a type of coil former was specified which is used to a very large extent in commercial receivers. It is an extremely useful former and is available in two sizes, and screening cans are normally available for both sizes. The large size is the most useful as this permits of the inclusion of an H.F. choke on the same former (in addition to a grid winding) or a transformer, and at the same time the general design permits of the inclusion of a coupling condenser and a damping resistor if required. In this way all essential interval couplings may be contained in a single screened unit and thus reduce the danger of interaction between stages. The coils and cans are normally available from Haynes Radio and Bel Sound Products, but at the moment cans are in short supply, due to rearmament

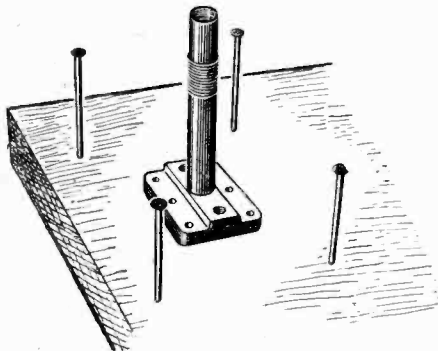

Fig. 1.—General idea of the arrangement for winding the coil as described in this article. A number of these arrays may be arranged on a single board if desired.

requirements. Stability is, of course, of prime importance in a vision receiver and a coil made up in this fashion may be rigidly attached to a chassis in such a manner that the only external connections will be less than one inch in length. The usual arrangement is to place the coil in between the two valveholders, with the connections (three-eighths of an inch long) projecting through the chassis and the winding disposed on the former in such a manner that the grid and anode connections come right close to the appropriate valve pins. This removes the need for interval screens, etc., and provides a very stable circuit arrangement. Unfortunately, however, these coils are small in diameter and when using a fairly thick wire it is very inconvenient to try to wind them by hand. Even when a fine gauge of wire (36 or so) is used, it is difficult to hold the wire in position and successfully terminate the ends. Added to this is the problem of inserting the side wires afterwards and making the necessary connections.

Winding Jig

Whilst it is possible to turn the required amount of wire round the former and fix it in place with hot wax or some similar material, there is still the problem of

mounting the side wires and the coupling condenser, etc. It will therefore be found that a mounting jig is desirable, and for some types of coil it is a necessity. The arrangement which has been found simplest and most convenient is illustrated in Fig. 1. It consists merely of a piece of wood upon which the coil is mounted, and into which a number of nails are also driven. You can make up a separate board for each coil, or wind them singly, completing each coil before making the next, or can use a long piece of wood and wind three or more at the same time. Where a number of coils have to be made this is obviously the most satisfactory. The side wires are required to project below the chassis, and if thin wire is used for the particular coil there is a risk of breaking the wire inside the can if the side wires are bent or twisted after assembly. Therefore, I have found that the best scheme is to make the projection exactly the correct length in the first place and the procedure I have adopted is as follows. Firstly, the wood is three-eighths of an inch thick. Alternatively, if you cannot obtain a suitable piece of this thickness a thinner piece may be used and the overall depth made up to the required three-eighths by side strips (Fig. 2). At the

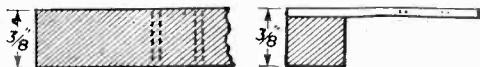

Fig. 2.—The baseboard may be a single thickness or made up by side runners so that the overall height is $\frac{3}{8}$ in.

required positions on the board (dependent upon whether a single coil or several are to be wound at once) a set of holes is drilled as shown in Fig. 3. The four corner holes and the two central ones which take the side wires are drilled with a No. 21 drill. Incidentally, these positions are marked on the base of the coil former with the numbers 1 to 6. The remaining two holes which accommodate the fixing screws are drilled with a No. 39 drill. Next, the numbers on the base are written on the wood just outside the position of the base making certain that they coincide with the coil base when it is mounted. Now, just about $1\frac{1}{2}$ in. away at the four corners an ordinary $\frac{1}{2}$ in. wire nail is driven into the wood.

Winding the Coil

The procedure for winding the coil is now as follows: The coil former is attached to the board by the normal threaded holes and suitable bolts. A length of wire is cut off and twisted round one of the corner nails, preferably one back (in an anti-clockwise direction) from the point at which the coil starts. That is, taking for instance Fig. 4, where a coil consisting of $6\frac{1}{2}$ turns is required, between pins 1 and 3. We will suppose pin 1 is the commencement. The wire is anchored round nail A and taken across as shown and twisted round the former six times and finally anchored round pin B and any excess cut off. The wire may be pulled tight and the piece of wood is easily handled and held whilst the wire may be put on under considerable tension. When anchored any further windings may be put on in a similar manner. When all winding are in position the coils are painted with Belsol or some similar poly-

styrene cement, and then left to dry. When thoroughly dry the wire is cut close to the nails, and the ends, from the coil former outward, cleaned by gently scraping or drawing emery cloth across them. The cleaning should be carried right to the coil former. Next holding the wire close against the former with a pair of thin-nosed pliers the ends are tinned right up as close to the nose of the pliers as possible. The coil should now be still quite firm and ready for the side wires. The required number are now dropped through the eyeleted base with the coil-winding board standing on the bench. The wires will go through to bench level and thus will all be even and of the required length below the chassis. The top paxolin spacer is now pushed down over the wires and the top of the coil former until it rests against the shoulder on the coil former. The projecting tops of the wire may now be clipped off level with the surface of the paxolin spacer. Now the ends of the coil are bent out to the required pin and it will be found that a small part may have to be unstuck, but with the cement mentioned and the wires taken in at the angles as suggested, it will be possible to have exactly one-eighths of a turn if called for, and there is no waste, whilst the space is left between the wires to accommodate small waxed or ceramic condensers for coupling purposes, or $\frac{1}{4}$ -watt damping resistors. When all the ends have been twisted once round the required side wire and the surplus cut off, soldering can be carried out. The wires are soldered to the eyelets and all the soldered points up each wire made at one time. When all the soldering is complete the screws are removed and the

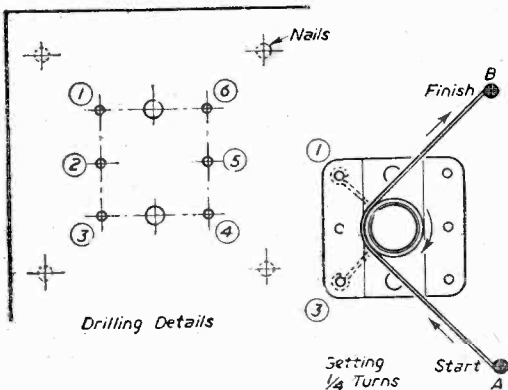

Fig. 3 (left).—The board is drilled as shown and side-wire identification numbers written on the board.

Fig. 4 (right).—Method of winding so as to provide fractional turns.

coil lifted off the wood and it is then all ready for the screening can to be placed over it and the lugs turned in ready for mounting on the chassis.

Correction Choke

Another component which is often used in a video circuit and which is not too easy to make neatly is the correction choke which one is told to wind on a standard ceramic-type resistor. These are approximately $\frac{1}{4}$ in. in diameter, and the neatest arrangement is to cut out two circles of ordinary card (an old postcard is ideal) 1 in. in diameter. At the centre, punch a $\frac{1}{4}$ in. hole, using any piece of $\frac{1}{4}$ in. diameter tube. The metal ferrule of an ordinary pen will be found just right and sharp enough

to cut through with a single hammer blow. One disc should then have a short slot cut out from the hole upwards and the other from the outside downwards. A sharp penknife or razor blade will do this, making two cuts a short distance apart and bending out the intervening piece. Next, a strip of the same card, 2 in. long and the required width is cut out. This is usually $\frac{1}{4}$ in. or $\frac{3}{8}$ in. This is coated with cellulose cement and

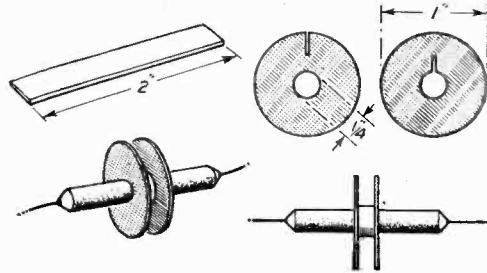

Fig. 5.—Details of former construction for winding correction chokes on a resistor.

wrapped round the centre of the resistor (Fig. 5). When dry, the sides are coated round the holes with the cement, and the two end cheeks pushed up close against the wrapped strip and held in position by wrapping string round the sides. When dry, you will have a perfectly rigid bobbin on which any amount of wire may be wound without the risk of the side cheeks coming adrift or bending out and making an untidy and inefficient job. The beginning of the wire is easily threaded through the central slot and the termination taken out through the outer slot, a dab of the cement holding the latter in place. This type of choke is usually wound on a 1-megohm resistor and the two ends of the winding joined to the wire ends of the resistor, but the method of making the former is the main point here.

More TV Applications

EVERY day comes news of some new development of television equipment to an industrial or scientific application, and the latest from America is that a remote-controlled camera has been perfected. General Precision Laboratories have developed this camera which may be controlled from a panel miles away, and the control is complete, permitting the camera to be turned about in any direction, to track (that is, move in or away from the object being televised) and even to adjust telephoto lenses. A camera of this type is, of course, ideal for relaying for inspection operations which might be dangerous to human beings such, for instance, as the effect of an atomic explosion or some forms of fire. Whilst the camera might be damaged or even destroyed, the effects could be watched safely right up to the last minute and much valuable data collected which would justify the expense.

Another use now proposed for television is in high-speed jet aircraft. In an endeavour to gain even more speed, the windscreens is being found a hindrance and it is proposed to remove this, have a very small periscope, and allow the pilot to see only through the medium of a screen. On a test a pilot flew a plane quite satisfactorily using an 8 in. screen.

More About the C.R. Tube

FURTHER DETAILS CONCERNING THE ELECTRON BEAM, ION TRAPS, ETC.

By Gordon J. King, A.M.I.P.R.E.

THE beam of electrons accelerated by the electron gun in a cathode-ray tube tend to diverge owing to their mutual repulsion, which takes place between electrons as they make their way towards the fluorescent screen. As is well known, the diverging beam of electrons will need to be "focused" to the finest point if maximum picture detail is to be obtained. As a lens causes rays of light to be refracted to form a "principal" focus, so it is possible by electrostatic and electromagnetic means to refract or bend a beam of electrons to converge to a point of focus at the fluorescent screen of a cathode-ray tube, thereby rendering the spot small and sharply defined. The focusing system employed in conjunction with a cathode-ray tube is, therefore, the electronic counterpart of a lens used for optical purposes. It is proposed to explain in the following notes the more practical aspect of such systems, together with the phenomena of electrons in relation to the cathode-ray tube.

The Electron Gun

With a few modifications the electron gun of a cathode-ray tube corresponds to the electrode system of an

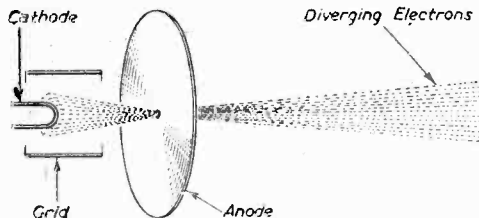

Fig. 1.—Diagram showing the "spread" of the beam after passing through the hole in the anode.

ordinary triode valve. The electron source is, in most tubes, an indirectly-heated cathode. Surrounding the cathode is a cylindrical electrode closed at the far end by a disc in the centre of which a hole is pierced. This electrode is normally furnished with a standing negative bias, which is rendered variable by the inclusion of a potentiometer and is termed the "brightness" control. The signal voltage is also applied to this electrode and modulates the intensity of the spot on the screen; since its function is similar to the control grid of a thermionic valve it is commonly termed the "grid." A short distance above the grid an electrode known as the "accelerator" or "anode" is mounted, and it generally takes the form of a disc pierced in the centre with a small hole. By reason of the velocity of the electrons as they are attracted to the positively-charged anode, and the space charge produced by the grid in compressing the electron stream as it leaves the cathode, a large proportion of the electrons will pass through the hole in the anode and impinge on the fluorescent screen at the end of the tube, see Fig. 1. It is for this reason that the anode current of a cathode-ray tube is very small; since it is composed only of stray electrons which have not passed through the hole in the anode.

The "efficiency" of the electron beam may be expressed thus:

$$\frac{\text{Electrons from the gun}}{\text{Electrons attracted to anode}}$$

Some tubes of the magnetic type employ an extra anode which is charged with a reduced positive potential, and mounted between the grid and the accelerator anode.

The Characteristics of Electrons

It should be noted that a passage of electrons represents the movement of electric charge, and if their movement is continuous they must be evidenced in an electric circuit somewhere in the form of an electric current. If an anode current flows due to the emission of electrons, then the product of the anode potential and the anode current gives the power dissipated measured in watts or:

$$\text{Watts} = \text{Anode voltage} \times \text{Anode current,}$$

in the same way as the product of the voltage and the current through a resistor is computed. It will thus be seen that the power dissipated is proportional to the number of electrons travelling from the cathode to the anode, and also the voltage difference between the cathode and the anode. This means that if provision is made to keep the flow of electrons constant, the power dissipated by a given number of electrons travelling from the cathode to the anode, can be varied by changing the anode potential. The electrons are, therefore, accelerated to a higher velocity by the time they reach the anode when the potential is raised, thereby explaining the increased energy dissipation with increased anode voltage. This indicates that the electrons store kinetic energy due to their movement, which must be transformed to some other form when they strike the anode or impinge on the fluorescent screen.

Kinetic Energy

A practical illustration to help understand the principle of kinetic energy can be the opening of a road by means of a pick-axe. As the pick-axe head is brought down on to the road a force is exerted upon it which moves the pick-axe head at an ever increasing rate until it makes contact with the road. It is then suddenly brought to a standstill, but at the expense of penetrating into the road, which takes considerably greater effort than could be applied in the form of a direct push. Owing to the mass of the axe head it stores the energy which was exerted in the downward stroke in the form of its velocity, and on making contact with the road all of the energy

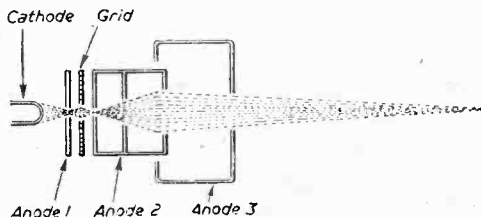

Fig. 2.—A modern "gun" showing beam control.

which was put into bringing the axe down is exerted at once. A greater force is, therefore, applied to the road during this short instant than was applied in swinging the axe.

Even though the mass of an electron is very diminutive indeed, it stores energy in much the same way as the pick-axe head, but the energy it stores as it is accelerated from the cathode to the anode is due to the velocity v by which it builds up owing to the potential E applied to the anode. By the ordinary mechanics of a moving particle, kinetic energy of a body is the energy it possesses in virtue of its mass (m) and velocity (v) or :

$$\text{Kinetic energy acquired} = \frac{1}{2} m v^2.$$

Now the charge of an electron is usually denoted by

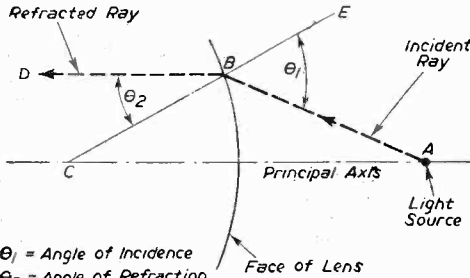

$\theta_1 = \text{Angle of Incidence}$
 $\theta_2 = \text{Angle of Refraction}$
 $\frac{\sin \theta_1}{\sin \theta_2} = \text{Index of Refraction or } \mu$

Fig. 3.—Effect on a beam after passing through a spherical surface.

(c), thus if an electron is subjected to an accelerating field due to the anode potential of the tube, its potential energy is : Ee

$$\text{Hence } Ee = \frac{1}{2} m v^2$$

$$\text{Therefore the velocity } (v) = \sqrt{2E \frac{e}{m}} \text{ cms./sec.} \dots \dots (1)$$

Since $\frac{e}{m}$ is a constant it is shown, therefore, that the velocity of the beam is proportional to the square root of the anode potential. The energy stored by the electrons due to their accelerating potential must be given up when they finish their journey. In the thermionic valve the electrons bombard the anode, thereby producing heat. It is for this reason that if the dissipation of any thermionic valve is allowed to exceed the maximum rated value the anode may become red hot, since the whole of the energy dissipated in the valve as represented by the product of the anode potential and the anode current is being dissipated at the surface of the anode where the electrons strike it. In a cathode-ray tube the electrons impinge on the fluorescent screen, which has the property of converting the energy of the electrons

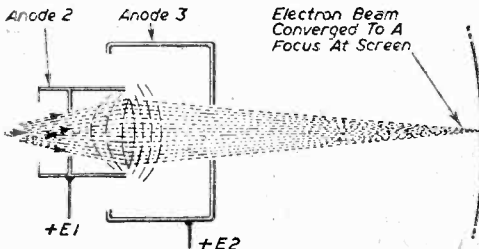

Fig. 5.—This diagram shows how focusing is effected.

striking it into light radiation. A graphitic deposit is in connection with the anode and extends nearly to the edge of the fluorescent compound providing a return path for the slower moving secondary electrons.

Gas Focusing

By the introduction of a small quantity of inert gas such as argon, or helium, into the tube a means of focusing is obtained. Gases at low pressure such as the above are very easily "ionised." This means that the electrons in the atoms can be displaced from their normal position so that the atom splits up into a positively charged "ion" and free electrons. On their way up the tube the electrons in the beam collide with the gas molecules and ionise them. The electrons which are moved from the atoms add themselves to the beam, the positive ions are relatively heavy and slow moving compared with the high velocity electrons. They will tend to remain in the path of the beam, with the result that the beam acquires a core of positive ions. Owing to the attraction exerted by the ions for the electrons, the latter cluster round the centre core to form a very thin beam. Very small spot diameters are attained with this method of focusing, but owing to a loss of focus which accompanies the modulation of the beam the gas-focused tube is unsuitable for television reproduction.

Electrostatic Focusing

Tubes employing the principal of electrostatic focusing are of the "hard" or high vacuum type. With the removal of the gas from the tube, there is less risk of damaging the cathode by ionic bombardment which is

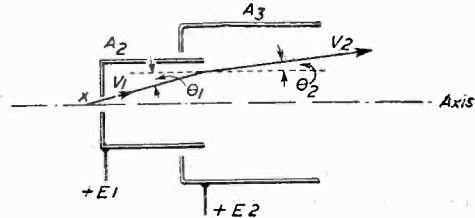

Fig. 4.—The second two anodes of a tube showing essential beam factors.

inevitable in the gas focus tube ; it, therefore, has a longer life. Further, the focus of the tube is not affected by beam modulation, thus rendering them suitable for television work. The electrode assembly differs slightly from the magnetic type. In modern tubes three anodes are usually employed, and in some tubes the control grid follows the first anode. The first anode is of a similar construction to the anode in a magnetic type tube. The second and third anodes are of a cylindrical construction and assume the shapes shown in Fig. 2. The anodes are charged positively at increasing voltages to accelerate and focus the electron beam. It has already been shown that an electrostatic field tends to accelerate an electron towards the positive. If an electron already travelling in some direction is subjected to an electrostatic field created by the anodes A2 and A3, Fig. 2, it will tend to continue travelling in the same direction due to its momentum, but the effect of the field will be to turn it so as to move along the direction of the field. It is this principle which is employed in electrostatic focusing. We shall now have to digress a little to the subject of optics in order to see how closely related are the law of refraction of light and the law of refraction of an electron beam.

Fig. 3 depicts a spherical refracting surface and could be the face of a lens. Consider a ray of light AB emitted from a light source on the principal axis, on entering the sphere it will be refracted along BD. The angle of the emitted ray of light or the "incident ray" to the normal EC is θ_1 , while the angle of the refracted ray is θ_2 . Now the law of refraction states that the

Magnetic Focusing

Magnetic focusing was the original method employed with the earlier cathode-ray tube and its use is becoming universally adopted for the focusing of the modern picture tube for television reproduction. Its function is explained by considering the behaviour of an electron in a magnetic field. As have already been shown, a path of moving electrons can be represented as a flow of electricity and, therefore, have associated with them a magnetic field. If a beam of electrons are subjected to a magnetic field the electrons will experience a force which will cause them to be deflected away from their normal path and the direction of their deflection will be determined by the direction of the field, as explained by the elementary theory of magnetism and electricity.

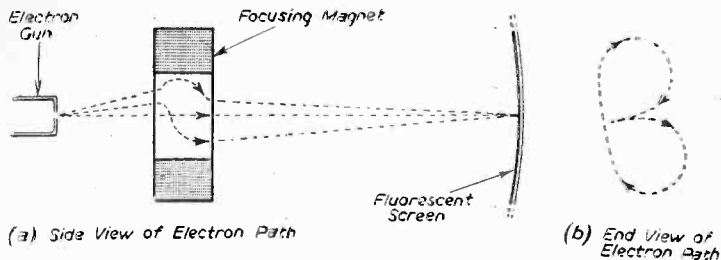

Fig. 6.—The beam actually travels in a spiral path as shown here.

"sin" of the angle of incidence to the "sin" of the angle of refraction is a constant quantity for any two given media and is termed the "index of refraction" and notated by μ

$$\text{or } \sin \theta_1 / \sin \theta_2 = \mu.$$

Referring now to Fig. 4, A2 and A3 represent the second two anodes of an electrostatic tube. Consider an electron to enter A2 at x and that it comes from a place of lower potential. If A2 is given a potential of E1 the velocity of the electron on entering the field will be :

$$V_1 = \sqrt{2eE_1 \frac{e}{m}} \quad (\text{as shown by equation 1}).$$

The electron now passes into anode A3 and the field created by E2 the velocity of the electron becomes now :

$$V_2 = \sqrt{2eE_2 \frac{e}{m}}$$

The component of the velocity normal to the surface of the anodes is in the first place, $V_1 \sin \theta_1$, and in the second place $V_2 \sin \theta_2$. Since there is no force at right angles to the axis these two components must be equal, thus :

$$V_1 \sin \theta_1 = V_2 \sin \theta_2$$

$$\text{or } \sqrt{\frac{2e}{m} E_1} \sin \theta_1 = \sqrt{\frac{2e}{m} E_2} \sin \theta_2$$

$$\text{therefore } \frac{\sin \theta_1}{\sin \theta_2} = \sqrt{\frac{E_2}{E_1}} = \mu.$$

Thus, there is a law of refraction for the path of electrons similar to the law of refraction of light. If E2 is greater than E1 μ will be greater than 1 and the potential field will be such as to refract the beam towards the axis as in optics. The focusing properties of the field depend, therefore, on the ratio of the potentials applied to the anodes. Fig. 5 shows how the diverging beam of electrons are refracted and brought to a focus by the electrostatic field existing between anode 2 and anode 3. As an optical system suffers from the effects of spherical aberration, an electron lens suffers in general form from the same effects. In some instances where the spot is circular at the centre of the screen it appears elongated when deflected off centre. This is one reason why the electrostatic tube is being superseded by the magnetic type for the reproduction of television pictures.

Focusing is carried out by means of a focusing coil or magnet mounted concentrically on the neck of the tube; the field at the centre of the coil will thus be parallel with the axis of the tube and the direction of travel of the beam. Paraxial electrons, i.e., electrons moving axially along the tube, will experience no deflecting force. An electron straying from this direction will experience a force since it will cut the focusing field and can be regarded as having two components to its velocity, one along the axis of the tube and another moving initially outwards away from the central axis. The latter component of the electron velocity will tend to cause it to travel in a circular path as illustrated by Fig. 6(b); since it is also travelling towards the screen at a much faster rate, the combined velocities will result in the electron following a spiral path, Fig. 6(a). To enable all the electrons to arrive at the same spot on the screen the strength of the focusing field must be such that while an electron is travelling through it, it is given sufficient twist as it leaves the field to bring it to the same point on the screen as the one which travels straight along the axis, i.e., the beam is brought to a focus. Thus, by a variation of the focusing field the spot can be brought to a very fine focus at the screen; this may be achieved by altering the current through the focusing coil, or by mechanical means in the case of a permanent focusing magnet. It should be noted that the dimensions of the spiral are a function of both the transverse velocity of the electrons and the focusing field; it follows, therefore, that alteration of the anode voltage of the tube will tend to cause a defocusing effect. At least one manufacturer has taken advantage of this by fitting a permanent magnet on the tube and rendering the focus variable by slight alterations to the anode potential of the tube, which can be comparatively simple where the E.H.T. source is derived from an R.F. oscillator or similar device. Again, for the same reason the regulation of the E.H.T. supply should be such that there is negligible voltage variation between minimum and maximum beam current, ensuring that the beam remains in focus for all levels of picture illumination. The same reasoning applies to line and frame deflection, i.e., more deflection field, whether derived from electrostatic or electromagnetic means, will be necessary for increases of E.H.T., or conversely a reduction of E.H.T. will result in the picture increasing in size. The position of the focusing coil or magnet is normally just a little way past the tube anode.

If it is mounted immediately in front of the anode the focus at the centre of the screen will be very sharp, but it will fall off as the spot is deflected to the edges of the screen; as the focusing field is moved towards the screen the spot size will become a little larger, but the focus will be more uniform over the whole of the screen. The position of the focusing field is, therefore, a compromise but in practice the optimum position can readily be found. This point is well worth remembering if the picture appears to be defocused at the edges.

Negative Ion Burn

Since it is impossible to obtain a perfect vacuum inside a cathode-ray tube there will always be present inside the tube a minute trace of gas, and, as explained in gas focusing, the electrons moving at high velocity will cause the gas to be ionised. Also present due to ionisation are negatively charged ions which accompany the electron beam; these are thousands of times heavier than the electron and contribute very little to the brilliance of the spot, but they can damage the fluorescent screen. A characteristic of these negative ions is that in electrostatic tubes they are focused and deflected in exactly the same way as the electrons, while due to

their greater mass which tends to make them continue moving in their original direction, are hardly deflected at all in magnetic tubes. Thus, in electrostatic tubes the ions will have the effect of deteriorating the brilliance of the whole of the screen with age. In a tube of the magnetic type the negative ions are not brought to a focus on the screen at all, but converge outwards and strike a large area in the centre of the screen, having the effect of destroying the fluorescent compound with time; and producing a large patch in the centre of the screen which in time will cease to give light.

Ion Traps

Ion traps are now extensively being developed for use with certain cathode-ray tubes; these tubes employ a twisted electrode assembly and the ions are arranged to bombard a special anode. The electrons are lifted out of the path of the ions by the field of a small magnet mounted on the neck of the tube and take their usual course to the screen. In this way the negative ions are trapped and never reach the screen. The position of the small magnet is adjusted for maximum screen brilliance which indicates its correct position for maximum suppression of negative ions.

Mullard 16in. Picture Tube

THE new Mullard 16in. television picture tube type MW41-1 was shown for the first time on the Setmaker's Section of the Mullard Stand at the National Radio Exhibition.

The new tube, which incorporates a magnetic ion-trap, has a useful screen diameter of approximately 14½ in. (365 mm.). This enables a picture with rounded corners of approximately 130 sq. in. (825 sq. cm.) or 13in. by 10in. (33 cm. by 25 cm.) to be obtained.

Short Neck

A feature of the tube which should prove of particular interest to set designers is its short neck measurement, which is, in fact, no greater than that of the standard 12in. type of tube. This means that it is possible to design larger-screen television receivers without any appreciable increase in the size of the cabinet.

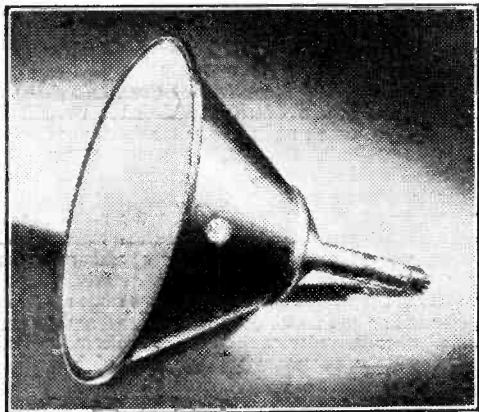

The new Mullard all-metal 16in. tube.

The tube consists of an almost flat, glass viewing screen, a metal cone envelope and a glass neck containing the electron gun. It can be operated from power supplies normally used in television receivers and sufficient light is produced for the picture to be viewed under average conditions of ambient light in the home.

Characteristics

The principal features of the MW41-1 tube are as follows:

Heater.—Suitable for series of parallel operation, A.C. or D.C. Voltage, 6.3 volts. Current, 0.3 ampere (series operation).

Screen.—The fluorescent screen material is an efficient emitter of white light providing high-definition pictures of good contrast.

Deflection Angle (approximate).—70 degrees.

Anode Voltage.—Recommended 9 to 12 kV. Maximum value, 12 kV.

Anode Connector.—Metal-cone lip.

Base.—B12A (Duodecal).

Dimensions.—Overall diameter, 15.9in. (403 mm.). Maximum overall length, 18.1in. (459 mm.).

Weight.—Approximately 11½ lb.

Price.—£16, plus Purchase Tax £8 6s. 5d.

Radio Engineer's Vest Pocket Book

5/-, or 5/6 by post

from GEORGE NEWNES, LTD., Tower House,
Southampton Street, Strand, London, W.C.2.

test and adjust TELEVISION independent of B.B.C. transmissions



On ALL Frequencies with the new Radar '5 Channel' Video and Sync Generator.

For television engineers whose services cover more than one transmission area, Waveforms Ltd. now introduce an instrument which provides a fully synchronised test pattern together with simultaneous sound on all B.B.C. Frequencies. A three-position attenuator is incorporated giving outputs of 10 mv, 1 mv and 100 Microvolts, equivalent to local, average and distant signal conditions. The inclusion of this inexpensive instrument in the servicing equipment of retailers' service departments ensures a full 8-hour working day for all engineers now handicapped by the inadequacy of the present B.B.C. Test Transmission periods. Send to-day for full technical details to:



PRICE: £55 Net. Single Channel model (London, Midland or Northern Frequency), £48 Net.



WAVEFORMS LIMITED, 26, Oakleigh Road, New Southgate, N.11. Telephone: ENT 5967.

LASKY'S RADIO

TELEVISION LARGER PICTURES FOR ALL

WESTINGHOUSE BOOST E.H.T. KIT. Contains 1 30EHT140 1.2 meg. resistance, and 2 T.C.C. .001 mfd. 6 Kv. condensers. **LASKY'S PRICE 30/-**, plus 1/- post.

REPLACEMENT LINE TRANSFORMERS. For use with our £25 T.V. receivers. Now available from stock, 29/6, plus 1/6 postage.

T.C.C. CATHODE RAY VISCONOL HIGH VOLTAGE CONDENSERS.
 .1 mfd. 7,000 v.w. 15/-
 .001 mfd. 6,000 v.w. 4/6
 .001 mfd. 12,000 v.w. 7/6
 .1 x .1 mfd. 3,500 v.w. 8/6

CATHODE RAY TUBE MASKS.
 12in. White Soiled. **LASKY'S PRICE 19/-**.
 12in. White with fitted safety glass. **LASKY'S PRICE 21/-**.
 12in. White, flat face. **LASKY'S PRICE 22/-**. Postage 1/6 each extra.
 12in. Armour plate glass, 4/11 per piece. Postage 1/- extra.

CATHODE RAY TUBES. BRAND NEW AND FULLY GUARANTEED.
 12in. Mullard £18 4 10
 12in. Mazda £18 4 10
 12in. Mazda Aluminiumed £20 10 4
 12in. Brimar £18 4 10
 12in. Brimar Aluminiumed... .. £19 7 8
 10in. English Electric £24 6 5
 Carriage and packing extra.

FOR CALLERS ONLY. STILL AVAILABLE AT PRE-BUDGET PRICE. New Cossor C.R. tubes, type 10SK, 10in., black and white picture. **£12 12 0.**

FOCUS MAGNETS. P.M. FOR TELEVISION. Suitable for any type of cathode ray tube. **LASKY'S PRICE 16/11.** Post 1/- extra.

T.V. SCAN COILS. FOR LINE AND FRAME. Brand new manufacturer's surplus. For 9in. or 12in. C.R. Tubes. **LASKY'S PRICE 14/6.** Post 1/-.

E.H.T. RECTIFIERS.
 Type 36 RHT100 (Selenium) 26/3
 Post 4d.
 Type 1Y51 (Valve) 24/4
 Post 4d.

MINIATURE SELENIUM RECTIFIERS. 800 volts at 5 m/a or 1,200 volts on pulse circuits. Size: 2 1/2in. long. 3/4in. diam. Wire ends. **LASKY'S PRICE 9/6.** Post 6d. extra.

FAMOUS MANUFACTURER'S TELEVISION COMPONENTS.
 Line E.H.T. Trans. 5 kV. **LASKY'S PRICE 9/6**, post 9d. extra.
 Frame Block Oscillator Transformer. **LASKY'S PRICE 4/3**, post 4d. extra.
 Choke. 150 m/a, 2 Henries. **LASKY'S PRICE 3/3**, post 6d. extra.
 Heater Transformer. 2v. 2 amp. **LASKY'S PRICE 4/11**, post 6d. extra.
 Frame Transformer. **LASKY'S PRICE 13/6**, post 9d. extra.

DE LUXE TELEVISION CONSOLE CABINETS. Beautiful walnut veneer. For 9in., 10in. or 12in. cathode ray tubes. Figured medium walnut finish, with high polish. Fitted with shelf for receiver, glass, speaker baffle and fret, also castors for easy movement. Undrilled.

LASKY'S PRICE £8 10. Carriage and packing 12/6 extra.
 Outside dimensions 17 1/2in. x 16 1/2in. x 32in. high. Send S.A.D. for illustration.

THE VIEWMASTER. Every component stocked and sold separately. For London, Birmingham and Holme Moss. **CO-AXIAL CABLE.**
 Single screened 1/- per yard.
 Twin screened 1/6 per yard.
 Twin balanced feeder 7/4 per yard.
 Post extra. Any length cut to your requirement.

LASKY'S RADIO, 370, HARROW ROAD, PADDINGTON, LONDON, W.9. (Opposite Paddington Hospital.)

Phone: Cunningham 1970 and 7214. Hours: Mon. to Sat. 9.30 a.m. to 6 p.m. Thurs. half-day. Send a 2d. stamp with your name and address for a copy of our current Bulletin. We have large stocks of new surplus radio components, valves, transformers, etc., details of which are given in our Bulletin.

T/V TECHNOLOGY



Home Study will give you a fuller understanding of Television problems

To the enthusiast for whom television is an absorbing interest and who wishes to understand more about it, or to those who are constructing their own sets and want complete knowledge of the theory underlying the constructional details, ICS offer a sound, practical and comprehensive course of instruction. It has given a high level of efficiency to many, who studied in their own time. What about you?

FOR THE ENTHUSIAST OR INTENDING T/V ENGINEER

Course 'A' provides a sound introduction to radio and television principles, deals with the principles of reception and transmission, and includes the preliminary study of Mathematics, Electrotechnics and Radio and Television.

Course 'B' offers a more comprehensive treatment of receiving equipment, deals in detail with modern principles of transmission and reception, and contains the necessary introductory instruction in mathematics, electrotechnology and radio.

The ICS also offer the following Courses in Radio :

- Complete Radio Engineering
- Radio Service Engineers
- Radio Service and Sales
- Advanced Short-Wave Radio
- Elementary Electronics, Radar and Radio

And the following Radio Examinations :

- British Institution of Radio Engineers
- P.M.G. Certificates for Wireless Operators
- City and Guilds Telecommunications
- Wireless Operators and Wireless Mechanics, R.A.F.

For FREE BOOKLET and full details of these highly successful courses, fill in and post the coupon below.

Generous Discount granted to Members of H.M. Forces.

CUT HERE

INTERNATIONAL CORRESPONDENCE SCHOOLS LTD.
(Dept. P.T.14)

International Buildings Kingsway, London, W.C.2.

Please send booklet on subject.....

Name..... Age.....
(BLOCK LETTERS PLEASE)

Address.....

START TO BUILD THE 'VIEWMASTER' FOR \$5 DOWN Exclusive H.P. Offer

Ref.	Components	Deposit	12 monthly payments of
A	W. B. Sound and Vision Chassis. Time base chassis, side supports, frame transformer, Stentorian speaker, tube supports	£2	10/10
B	Sound and Vision Chassis. Time base chassis, side support, tube supports	£1	4/1
C	TCC Condensers. London	£2	9/3
D	TCC Condensers. Midland	£2	10/-
E	Westinghouse Rectifiers	£1	3/11
F	Plessey Scanning Coil. Focus ring, width control, line transformer, boost choke	£2	3/8
G	London. Morganite resistors. Q pots (100k. and 250 k.), set of six Colvern pots. Wearite RF choke L9, Belling connector, neon "G" Bulgin, panels and switch. Bulgin plug and socket, feeder	£2	5/8
H	Midland. As for G but including four Wearite filter coils	£2	6/5
I	London. Pre-amplifier chassis. Five condensers, five resistors, two coils, one valve and base. Instructions	£1	2/2
J	Midland. Preamplifier. As for I	£1	2/2
K	Conversion Kit. Table to console plus components as A	£2	12/9
L	Set of 12 valves: 5 off EF50, 1 off EB91, 1 off EL 33, 2 off GK25, 1 off GP28, 1 off GP25, 1 off EBC33. Owing to the variation in supply we reserve the right to substitute recommended equivalents for the above	£2	11/5
M	9in. Cathode Ray Tube, Mullard MW22.17	£5	15/10
N	12in. Cathode Ray Tube, Mullard, MW31/17 or Mazda CRM121A	£5	£1 4/7

C.R.T.'s to callers only or at customers risk by passenger train.

Please note that no more Viewmaster components will be available after present stocks are exhausted, as manufacture has ceased.

MOS MAIL ORDER SUPPLY COMPANY
The Radio Centre
(Dept. PT10)
33, Tottenham Court Road, London, W.1.

For T.V. Constructors

I.F. STRIP TYPE 194.—An easily modified I.F. Strip which gives first class results. Readily adaptable into any layout, measuring only 18in. x 5in. x 5in. Complete with 8 valves VR65, 1 VR92, and 1 VR53 or VR56, and mod. data. BRAND NEW. ONLY 45/- (postage etc., 2/6).

IDENTIFICATION UNIT ZC 13312.—A very powerful 14 valve receiver with 4 I.P. stages of 12 mc/s with 4 mc/s bandwidth. Will convert into a first class TV receiver. Valve line up: 5 of 6P6, 2 of P61, 3 of EA50, and 1 each CV63, EB34, EC52, 5Z4. ONLY 49/6 (carriage, etc., 5/-).

RECEIVER R1355.—The very popular unit recommended for "Inexpensive TV". Complete with 8 valves VR65, and 1 each 5U4G, VU120, and VR92. ONLY 55/- (carriage, etc., 7/6).

EHT TRANSFORMER FOR VCR97 TUBE. with 4v. for tube heaters and 4v. tapped, 2v. for EHT rectifier. ONLY 32/6 (postage 1/6).

EF50 (VR91) VALVES.—British 6.6, American Red Sylvania's 8/6, Ceramic valve holders for these 10d.

6in. MAGNIFYING LENS FOR VCR97 TUBE.—First grade oil filled. ONLY 25/- (postage 1/6).

PLESSEY P.M. SPEAKERS.—6in. with transformer 14/6, 6in. less transformer 14/6 (postage 1/6).

CHOKES.—20H 80/120 ma. 6.6. 5H 200 ma. 6.- (postage 1/-).

Cash with order, please, and print name and address clearly.

U.E.I. CORPN., The Radio Corner, 138, Grey's Inn Road, London, W.C.1. (Phone TERminus 7937).

Open until 1 p.m. Saturdays, we are 2 mins. from High Holborn (Chancery Lane Stn) or 5 mins. by bus from King's Cross.

The Design of Video Frequency Output Stages

THE FIRST OF A SHORT SERIES EXPLAINING THE PRINCIPLES OF MODERN CIRCUITS

By K. D. J. Grosvenor

THE video frequency amplifier is the output stage of the vision receiver. Unlike the output stage of an audio system, it is required to deliver a voltage output instead of a power output, thus it is a voltage-amplifying stage.

The voltage-amplifying stages used in an audio amplifier are, unfortunately, incapable of dealing with the higher video frequencies (as will be seen later), and therefore special circuits have to be used.

The object of the following notes is to show why these special circuits are necessary, and explain how they function and how the respective values for the components are determined.

In suitable cases formulae are given for the benefit

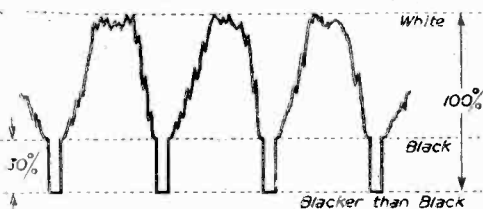

Fig. 1.—The waveform of a television signal.

of the enthusiasts who wish to design their own V.F. output stage. The author regrets that it is outside the scope of this article to give design formulae for all the circuits considered.

Desired Performance

It must be capable of giving at least the minimum required voltage output.

The output of the V.F.A. will go either directly or via a cathode follower to the C.R.T. In neither case is there any further amplification, and therefore the output voltage at the anode of the V.F. amplifier must be sufficient fully to modulate the C.R.T.

This means that if the C.R.T. requires, say, 20 volts to change the picture from black to white, then the video stage must be capable of giving an output of about 30 volts to allow for the "blacker than black" sync pulses (Fig. 1).

If the C.R.T. is to be grid modulated the output will have to be positive going, thus the absolute maximum output voltage (base to peak) will be the mean anode current times the anode load impedance, this corresponding to a signal driving the grid to cut-off. It is, however, not desirable to drive the valve to cut-off and therefore the practical maximum output is only about four-fifths of the absolute maximum (Fig. 2).

Thus, in order to obtain a large, positive-going output it is necessary to have a low value of bias on the valve and as large a value of anode load as is permissible, the former being limited by the maximum permissible anode or screen dissipation (current times voltage) and the latter by the frequency response requirements.

If the C.R.T. is to be cathode modulated the output

will have to be negative going, and in this case the maximum output voltage will be

$$(I_{max} - I_{mean}) \times Z_L$$

where Z_L = Anode load impedance.

I_{mean} = Anode current with no signal.

I_{max} = Anode current for zero bias, this corresponding to the maximum permissible input signal.

Thus, in order to obtain a large negative-going output, it is necessary to have a high value of bias on the valve (so that I_{MEAN} is small) and as before a large anode load.

Cathode modulation has the advantage that by connecting the V.F. output direct to C.R.T. a valve is saved and associated components, also the mean current taken by the V.F.A. valve is very small (Fig. 3) and gives a consequent increase in valve life. The output signal current is larger than with a positive-going output, but any advantage due to this tends to be lost, as the anode load resistor has generally to be made smaller owing to the higher output capacity. It is also necessary to ensure that the frequency response is flat right down to zero frequency.

With grid modulation the mean current taken by the valve is relatively very high (Fig. 2), due to the necessarily low grid-bias, and the output current swing is smaller than with a negative-going output. This is, however, compensated for by using a higher value of anode load and a cathode follower to keep the output capacitance smaller.

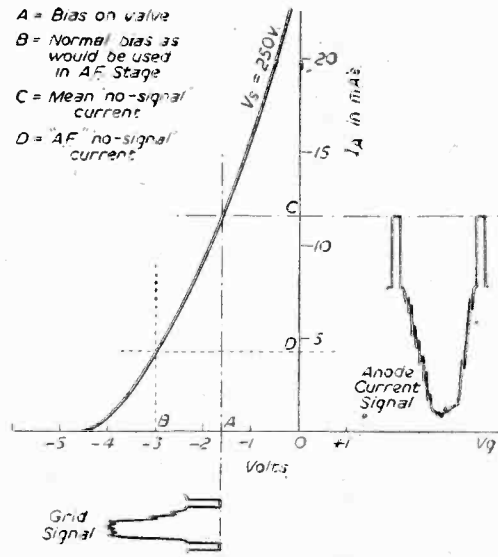

Fig. 2.—Typical characteristics of a video output valve showing biasing, etc., for a positive-going output.

While grid modulation is widely used by constructors, cathode modulation is generally to be preferred, especially on grounds of economy. The main reason for the pre-eminence of grid-modulated circuits is, no doubt, due to the fact that a VCR97 is usually employed and the cathode-to-heater insulation in these tubes is not rated to stand more than 10 volts, consequently making it generally unsuitable for use with cathode modulation.

The amplitude-frequency response should be flat over the V.F. range.

Methods of obtaining a flat response are dealt with later, the practical requirements are, for a high-quality system, as follows:

If there is no D.C. restorer after the video amplifier, the response at low video frequencies must be flat right down to zero frequency. When a D.C. restorer is employed it tends to re-insert the low video frequencies. This action will be considered in detail later.

Over the mid-video frequency range the response should be flat.

At highest video frequencies the gain should not have fallen to less than 90 per cent. of the mid-frequency gain.

The time delay distortion should be zero.

The time delay distortion is zero when the time delay is constant over the whole frequency range. Fig. 4 shows diagrammatically why this is so. The primary cause of lack of high V.F. definition is time delay distortion, as it becomes serious before the loss of amplitude could have any noticeable effect. At low video frequencies it is permissible to have a limited amount of time delay distortion, and even at high frequencies it is, of course, not possible to make the distortion absolutely zero. This is, however, essentially a practical article and therefore there is no point in pursuing the problem of time delay distortion here.

It is, however, important to realise that in television

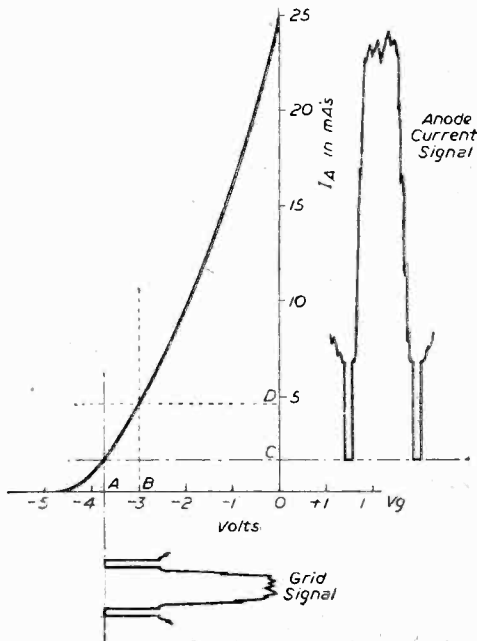

Fig. 3.—Typical characteristic of a V.F. output valve showing biasing, etc., for a negative-going output.

time-delay distortion is a very real concern, whereas in radio it is of almost negligible importance. This will become apparent during later sections of this article.

The Basic Amplifier

The circuit (Fig. 5) will be recognised as the standard type of voltage amplifier as used at audio frequencies, and provides a convenient starting point to the design of a V.F. output stage.

High V.F. amplitude response

At low frequencies the reactance of C_s will be very large, so large in fact that it can be assumed that there just is no stray capacity and (providing there is no feedback due to the cathode bias circuit) the gain of the stage will be the same as the mid-V.F. gain.

However, at the very high frequencies such as a V.F.A. will encounter, the reactance of C_s becomes small and this has the effect of shorting some of the output to earth and consequently the output will be relatively smaller.

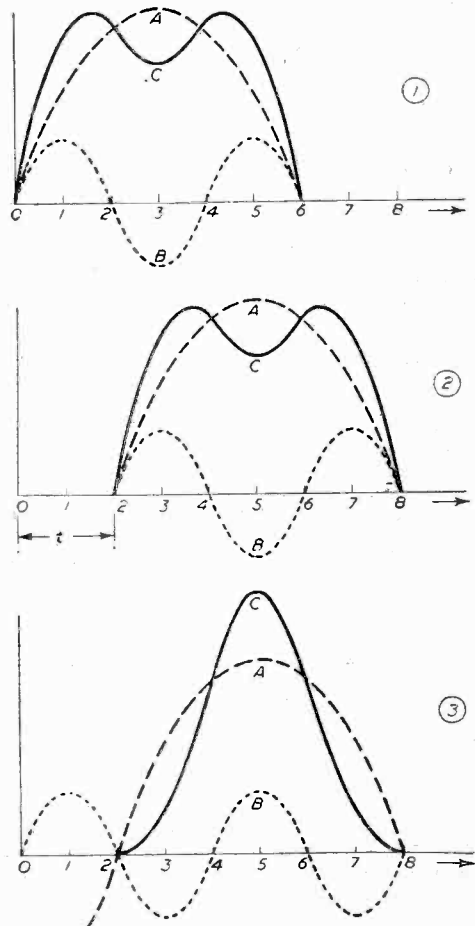

Fig. 4.—Effect of time-delay distortion. 1 shows component waves; A plus B produces C; 2 shows the effect after delay time t ; 3 shows distorted waveform C due to A being delayed and B not delayed.

The output drops to 90 per cent. of its normal value when the frequency is

$$f = \frac{80}{R_1 \times C_0} \text{ Mc/s.} \quad \begin{array}{l} R_1 \text{ in K}\Omega. \\ C_0 \text{ in pF.} \end{array}$$

The value of C_0 is always kept as low as possible and is thus equal to the minimum obtainable value of anode plus associated wiring to earth capacitance that can be obtained practically. This stray capacitance is made up of the internal anode to electrodes and screening can capacitance (5 to 10 pF.) plus the stray capacity to earth of the wiring to the anode (about 5 pF.) and in addition:

- When output is fed to a cathode follower with appropriate D.C. restorer an additional 3 to 8 pF.
- When output is fed direct to the C.R.T. an additional 4 to 10 pF. of co-axial (used to connect the video

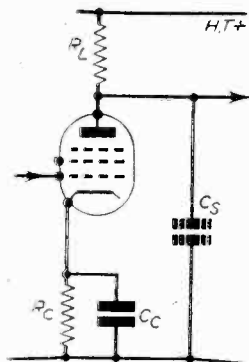

Fig. 5.—This is the basic video amplifier circuit with stray capacities indicated as C_0 .

anode to the C.R.T.), and in addition, in this case, the input capacity to the C.R.T. which will be about 25 pF. for VCR 97 grid modulated, and about 10 pF. for a normal picture tube (grid modulated) and when normal tube is cathode modulated about 5 pF. The actual values can be obtained from the relevant makers' published data. Plus also the input capacity of the sync. separator, about 5 pF.

The important point to be gathered from these figures is that the anode plus strays-to-earth capacity is considerably greater than the so-called output capacity of the valve alone (i.e., the internal capacity). Recently the author measured the output capacitance of a video stage in a home-built receiver and informed the owner that it was about 22 pF. His reply, and he should have known better, was "it can't be that high, the valve makers give it as 6 pF. and surely they are not wrong?" The makers' figure does not, of course, allow for the external stray capacities.

In order to see why the normal value of R_1 as used for an A.F. stage cannot be used at video frequencies

$$\text{Let } R_1 = 200 \text{ K}\Omega.$$

$$C_0 = 20 \text{ pF. (Average value for V.F.A. with cathode follower.)}$$

$$\text{Then: } f = \frac{80}{R_1 \times C_0} = 20 \text{ Kc/s for 90\% response.}$$

This is obviously nowhere near the required value of some 3 Mc/s and therefore a much smaller value of anode load has to be used for a video amplifier, the value in this example being 1.3 K Ω . This is unfortunately very small and means that only a small output voltage will be obtainable and this may not be sufficient fully to modulate the C.R.T. If it is sufficient, then this simple circuit could be used; however, it is usually necessary to have a larger voltage output and therefore a larger anode load must be used. It is in order to compensate for the otherwise poor high V.F. response that

peaking chokes, etc., have to be used when a larger value of anode load is employed. The time delay distortion of the simple basic circuit is within the required limits up to the frequency at which the response has fallen to 90 per cent. of its original amplitude. When a larger value of anode load is used the time delay distortion increases very rapidly and makes it absolutely essential to use a compensating circuit if high definition is to be maintained. These compensating circuits are described in the next section.

(To be continued)

Picture Transmitter

KNOWN was the Electronic Telescribe, a novelty was introduced at Earls Court. It consists of two units linked by a single electric cable. As marks are made on the glass plate of the first unit, a small cathode ray tube and photocell transfers the marks into electric currents. These are instantaneously conveyed to the second unit (a very slightly modified commercial television receiver), where they are changed back into a visible reproduction of the original writing.

This simple equipment is fully capable of reproducing photographs, drawings and printed matter laid face down upon the glass plate, and in this way it offers an excellent and greatly simplified medium for picture transmissions. Whilst the model shown is limited to 200-line definition, Mullard engineers state that, with only a few minor modifications, this could be extended to a full 1,000-line system. Under these conditions, picture reproductions of near-photographic quality could be readily obtained.

Although not originally intended as a commercial instrument, the principle of the Telescribe could certainly be adapted to a number of important practical applications.

The Electronic Telescribe utilises, in a special manner, the flying-spot scanning technique. The time bases of two cathode-ray tubes—one a "transmitting" and the other a "receiving" tube—are synchronised. In the transmitting unit, a raster is produced on the screen of a special Mullard projection tube. By means of an optical system, the light from this raster is projected on to the glass writing plate at the top of the unit. In this way the glass plate is continuously scanned by a pencil of light.

In the absence of any picture or writing, the light beam passes through the glass plate. If a mark is made on the plate, however, some of the light is reflected and dispersed, and is picked up by a photocell. Electric currents, corresponding to the light variations, are in this way produced. These currents are amplified and are then used to modulate the beam on the "receiving" cathode-ray tube, which, being synchronised with the "transmitting" tube, will trace "bright" or "dark" in sympathy. In this way a visible reproduction of the original work is immediately produced.

NEWNES' RADIO ENGINEER'S POCKET BOOK

By F. J. CAMM

5/-, or by post 5/6

Obtainable from booksellers, or by post from
George Newnes, Ltd. (Book Dept.), Tower House,
Southampton Street, Strand, W.C.2.

USING THE

A COMBINED SOUND

By W. N. Ste

THIS I.F. Strip, which is easily obtainable from advertisers of this journal, at an extremely low cost, consists of six I.F. amplifiers, a diode demodulator and an output stage. As such, the unit can be converted to a highly sensitive broad-band video receiver.

In the majority of sites, however, the gain obtained from six R.F. amplifiers (assuming conversion to a T.R.F. arrangement), is greatly in excess of requirements. A more useful arrangement is to convert the unit into a combined sound and vision receiver; the conversion about to be described uses one stage of R.F. amplification common to both sections, three video R.F. amplifiers and two sound R.F. amplifiers. The sound demodulator and audio stages are built in separately and, of course, a separate power pack will be required to power the unit.

The circuit of the modified I.F. strip is shown in Fig. 1(a) and (b). The valves are numbered as they appear in the unit—commencing at the aerial input terminals—with V9 (6Q7) and V10 (6V6) as the extra sound section valves. Much of the original wiring and components can be left untouched and components which need not be altered are shown with their appropriate values to aid in identification. Components which have reference numbers are either new components or those moved into a new position—this will all be dealt with in the following description.

At the side of the unit will be seen seven screening cans; these are removed, as required, by loosening the two fixing bolts. The cans house the coils, grid resistors and anode decoupling components but the large can contains the diode and its associated circuits. All the coils, which were originally R.F. transformers, must be stripped and rewound; data for all new coils is given in the table on page 218. A certain amount of work is necessary below chassis but first of all the modifications necessary in the can compartments will be dealt with.

Compartment One

This is the compartment nearest the two aerial input Pye sockets. Apart from the transformer will be found three resistors; remove the 56 ohm and 12,000 ohm resistors. Rewind the coils L1/L2 as table (remember when stripping existing coils that there are two layers—separated by paper insulation). The original input circuit

provided straight or attenuated input couplings—hence the two Pye plugs. The two large tags in compartment one are those from the insulated terminals of the Pye sockets.

The coils L1/L2 can now be wound, noting that a damping resistor is placed across L2. There will be a spare resistor of the right value (3,000 ohms) taken from the anode circuit of V1 and this can be used after it has been removed from its original position. This completes all modifications in this compartment.

Compartment Two

This contains V1/V2 anode-grid components. All

LIST OF CO

RESISTORS

These resistors are removed in modification, but can be used in new positions.

- R1—6.8 KΩ, originally in V3 anode circuit.
- R2—3 KΩ, taken from V1 anode circuit.
- R3—5.6 KΩ, originally V5 grid resistor.
- R4—180 ohm existing, but originally returned to chassis.
- R5—6.2 KΩ, originally across diode coil.
- R6—36 KΩ, originally V8 screen-grid resistor.
- R7—15 KΩ, originally in V4 anode circuit.
- R10—5.6 KΩ, originally V3 grid resistor.
- R11—1 KΩ, originally V3 anode decoupling.
- R12—15 KΩ, originally in V2 anode circuit.
- R13—2.2 KΩ, originally V3 screen-grid decoupling.
- R16—100 KΩ, taken from V8 input circuit.
- R17—27 KΩ, taken from V7 output circuit.

These resistors are additional new components required.

- R8—2.2 KΩ, 1 watt.
- R9—1.5 KΩ, ½ watt.
- R14—47 KΩ, ¼ watt.
- R15—47 KΩ, ¼ watt.
- R18—270Ω, ¼ watt.

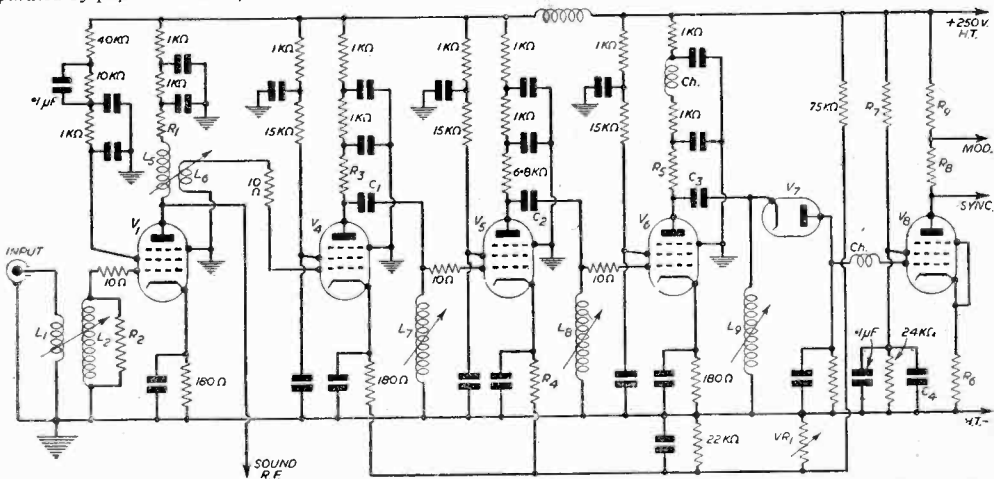

Fig. 1 (a).—The modified I.F. strip as a vision receiver. Note: the diode load is 6.2 KΩ.

194 STRIP

SOUND VISION RECEIVER

type (G3AKA)

are removed, except the 10 ohm grid stopper. The transformer is stripped and rewound as L3—forming the input to V2 the first sound R.F. amplifier. Two leads with white rubber covering enter the compartment from the sub-chassis; the one coming from the anode (pin 3) of V1 is retained and the other one snipped off. The other end of this lead can be snipped off where it meets the 1,000 ohm resistor and 0.0023 μ F capacitor on the mounting strip. The coupling capacitor C5 (a new component) is then fitted.

Compartment Three

This contains the V2/V3 coupling circuits. Remove

COMPONENTS

- VR1—2 K Ω , wirewound (contrast control).
- VR2—250 K Ω (sound volume control).

CAPACITORS

These are new capacitors required.

- C1, C2, C3, C7, C8, C9—100 pF.
- C4—8.0 μ F., 350 v. D.C. wkg.
- C5—5 pF.
- C6—20 pF.
- C10—1.0 μ F.
- C11—0.01 μ F.
- C12—25.0 μ F.; 25 v. D.C. wkg.
- C13—0.001 μ F.

VALVES

New valves required are :

- V8—SP61 (VR65)—to replace the existing VR53 (EF39).
- V9—6Q7 (as sound demodulator and 1st audio amplifier).
- V10—6V6 (as sound output valve).

the grid resistor (5.6 K Ω). Remove the 15,000 ohm resistor and replace with the 5.6 K Ω component—this is the new anode load resistor. All other components are left untouched in this compartment except the transformer, which is stripped down and rewound as a single coil (L4). The coupling capacitor C7 is then fitted. (N.B. a white lead between the junction of the 15,000 ohm, 1,000 ohm resistors and the 0.0023 μ F capacitor and one of the coil former tags should be snipped off; a similar lead is found in all other compartments and should be removed likewise.)

Compartment Four

All components in this compartment are retained, except the 3.6 K Ω grid resistor. The white lead which is taken through to the anode (pin 3) of V3 is removed—at the compartment tag and at the valveholder; the white lead which is taken to the H.T. line is not touched. As this compartment is now to be used to house the V1 anode and V4 grid components a connection must be made to the V1 anode; this will be dealt with when the under-chassis modifications are given.

Compartment Five

Housing the V4/V5 coupling circuits, there is little to do here. The 5.6 K Ω grid resistor is removed and used to replace the 15,000 ohm resistor (thus forming the new anode load). The coil (L7) is wound and the coupling capacitor C1 fitted—this completes all alterations.

Compartment Six

The V5/V6 coupling arrangements need little attention. All that has to be done is to remove the 3.6 K Ω grid resistor and rewind the coil as for L8; the 6.8 K Ω resistor can be retained as the new anode load resistor. The coupling capacitor C2 is the only other addition.

Compartment Seven

This is the large compartment and it is subdivided into upper and lower sections by a metal bracket. The upper half contains the diode V7, and its output components,

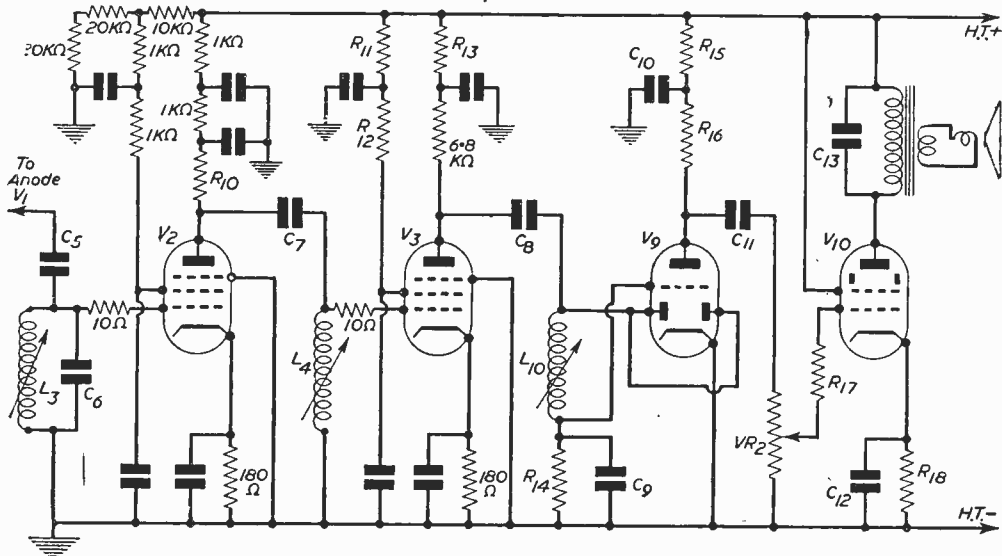

Fig. 1 (b).—The sound section of the modified unit.

and the lower half houses the V6/V7 coupling and H.T. feed circuits.

In the lower section these modifications are necessary: remove the 6.2 K Ω resistor, replace the 2 K Ω resistor with the 6.2 K Ω component, rewind the transformer as L9 and add the coupling capacitor C3. Other components in this half are V6 anode decoupling components and can be left alone. Regarding the coil, it will be found easier if the former is removed in order to put on the new winding. This can be done quite easily by removing the fixing bolt (near the base of the V8 valve). It will not be necessary to remove the other coil formers to rewind as they can be modified without undue trouble *in situ*.

The top section is easier. All that need be done is to remove the two 27 K Ω resistors and their associated decoupling capacitor (0.0023 μ F).

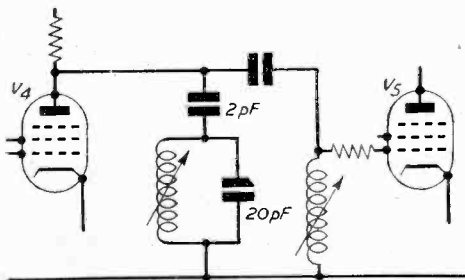

Fig. 2.—Details of a suitable rejector.

The Valveholders and Under Chassis Modifications

V1 holder: Nothing need be touched on this holder except that a lead must be run from the anode (pin 3) to the coil L3 (via C5) in compartment 4.

V2 holder: Owing to the different sequence of valves in the modified circuit, the variable bias system, which will form the vision contrast control circuit, has to be altered slightly. The 180 ohm cathode resistor lies across two tags on the strip; the "earthy" end is taken via a brown-covered lead to its V4 counterpart. This brown lead is snipped off between the two 180 ohm resistors and the V2 component is taken to chassis (to the tag alongside).

V3 holder: The anode (pin 3) should now be "in the air" since the white lead previously going through to compartment four has been removed. Wire in a 6.8 K Ω resistor from pin 3 to the junction of the 2.2 K Ω resistor and 0.0023 μ F capacitor on the tag strip adjacent. Snip off the lead going from the 2.2 K Ω resistor back to the V1 screen-grid circuit and take it to the H.T. positive line (this is wired throughout in red-covered wire). Then replace the 10 K Ω screen-grid resistor of V3 with a 15 K Ω resistor; this is taken to the spare tag alongside the 2.2 K Ω resistor. From this tap a 1 K Ω resistor is taken to the H.T. line and a 0.0023 μ F capacitor to chassis; the capacitor can be one of those removed earlier.

V4 holder: No alterations of any kind are needed here.

V5 holder: The only modification is to disconnect the 180 ohm cathode resistor from chassis and take it to the bias resistor of V4; that is to the end joining the "free" brown wire line.

V6 holder: No modifications are necessary.

V7 holder: This will depend on the arrangements to be used in individual cases following the video amplifier. As the circuit of Fig. 1(a) indicates, the output from the V.F. amplifier will have positive-going signal modulation and negative-going sync pulses. This is usually satis-

factory where surplus electrostatic tubes are used. However, if a magnetic tube is used and, as is normal, cathode modulation employed, the polarity will need to be reversed to give a negative picture modulation. All that need be done in this case is to reverse the anode and cathode connections of V7.

V8 holder: Unfortunately, the existing valve in this position is a variable-mu pentode not suitable as a V.F. amplifier. It should be replaced with another VR65 (SP61) which means that the valveholder will have to be changed.

The wiring is then carried out according to the circuit diagram. The small anode choke is removed and the heaters re-wired. Break the connection between the 36 K Ω and 24 K Ω resistors and take the erstwhile H.T. end of the 36 K Ω resistor to chassis. The free end is taken to the cathode and suppressor grid. The 24 K Ω resistor and the 0.1 μ F capacitor remain connected between the screen-grid and chassis, and an 8 μ F new capacitor shunted across them. A 15 K Ω resistor is then wired from the screen-grid to the H.T. line; this can be the component already removed from compartment five. The anode resistors (one 2.2 K Ω and one 1.5 K Ω) are then wired in; the 2.2 K Ω to the tag marked "8" (which is spare) and from this the 1.5 K Ω to tag 4.

The Numbered Tags

The nine lettered tags should not present any difficulty. They are used as follows: (1) the bias network line; (2) and (3) chassis; (4) H.T. positive; (5) originally used in connection with the V7/V8 coupling circuit but now not required—the wiring may be left in circuit since the removal of the components in the upper section of compartment seven leave it "in the air"; (6) blank; (7) original H.T. feed for anode of V8, now not used; (8) original screen-grid H.T. feed for V8, now not used; (9) L.T.

Other Modifications to the Video Circuits

Two further modifications are needed to complete the video circuits. Firstly, the fitting of a contrast control. This is quite a simple matter, for the existing network is quite satisfactory and all that remains is to provide a manual control. This takes the form of a 2,000 ohm potentiometer wired in between tag 1 and chassis (shown

COIL DATA

Coil	Alexandra Palace	Sutton Coldfield	Holme Moss
L1	1½ turns	1 turn	1½ turns
L2, L4	7 turns	5 turns	6 turns
L3	6 turns+	4 turns+	5 turns+
	20 pF.	20 pF.	20 pF.
L5, L6	6 turns	4½ turns	5 turns
L7, L8	6 turns	4 turns	5 turns
L9	7 turns	6 turns	6½ turns
L10	8 turns**	6½ turns*	7 turns*

All coils wound on existing formers with 22 s.w.g. tinned copper wire and space wound, except those marked * (these are wound on Alladin 11 num. formers). All coils tuned by iron-dust cores.

Transformer couplings L1/L2 and L5/L6 should have primary and secondary windings running in opposite directions.

N.B.—Owing to wiring and circuit capacities which may vary with individual conversions it may be necessary to increase or decrease the spacing of windings in some cases to enable coils to peak correctly when using the Sutton Coldfield channel.

as VR1 on circuit diagram). The potentiometer may be wired in at any convenient point which will enable easy adjustment when the complete unit is housed.

The other modifications are also simple; the whole network of components from the output choke of V7 to the grid of V8 are removed. They comprise various resistors and capacitors which are mounted between V6 and V8; don't forget to remove the 10 K Ω grid stopper fitted to the V8 top cap clip.

The Audio Section

The sound receiver demodulator and audio stages must now be provided. It was found the most convenient position was in the space between the large (compartment 7) screening can and the back of the chassis.

As will be seen from the circuit, there are two valves. V9 is a 6Q7 as a demodulator and first audio amplifier; the 6V6 is a standard output stage. All components associated with these circuits (from C8 to the output) can be accommodated in the space available. In the author's conversion the audio section was mounted on a stand-off type of bracket-chassis; it is not possible to mount the valve holders direct to the 194 chassis as this would disturb the components mounted on the mounting strip below chassis.

The volume control VR2 can be mounted at the end of the case and, incidentally, the contrast control could be fitted in a similar position by V8. The wiring of these stages is so straightforward that no further comment is called for.

Coils and Alignment

Data for all coils is given separately. L3/L4 and L10 are, of course, peaked at the sound channel frequency; L1/L2 is best tuned midway between the vision and sound channels. For maximum bandwidth, the vision section is best tuned: L9 and L7 to the lower end of the vision side and L5/L6 and L8 to the higher end of the sideband.

If any trouble with sound breakthrough is experienced, retractor circuits can be easily added. Using miniature formers (tuned with dust cores) the retractors can be fitted either in compartment four or near the V4 grid top cap. Fig. 2 shows how they can be fitted and data on coil winding is given on page 218. The settings of the trap circuits are critical and should be adjusted for minimum sound breakthrough by tuning to the exact sound-channel frequency. There should be no trouble with sound breakthrough on Alexandra Palace transmissions (providing that the vision circuits are tuned to the upper sideband) but retractors may be required in many cases where Sutton Coldfield or Holme Moss transmissions are concerned.

Power Supplies

An H.T. supply of 250 volts will be perfectly adequate to run the modified unit. The total current consumption of the 10-valve receiver is just under 100mA., and it should be seen that the transformer is capable of delivering this current. The L.T. is, of course, 6.3 volts but the total current consumption is rather high—actually it is 6.1 amps; make sure that the supply is able to provide this current.

Dutch Progress

BUSSUM is the site which has been chosen for the Dutch television studios. Television transmissions by means of the station at Lopik-IJsselstein will start this month or early in October. The programmes will be produced by the four Dutch broadcasting organisations. Eight delegates of the Dutch broadcasting societies have attended during three weeks a special television programme-production course, organised by the B.B.C. The price of a Philips 625-television receiver with a 12in. screen is £93 (table model). A console projection television receiver with 17in. screen is also available, price £165.

American Dealers Fly to Paris

A PARTY of 70 American television dealers and their wives left New York by B.O.A.C. Strato-cruiser recently for a 10-day holiday in Paris as guests of the General Electric Supply Corporation, of Newark, New Jersey. They were the winners of a four-week sales competition of television sets.

Travelling with the group as host was Mr. David N. Klein, manager of the Electronics Sales division of G.E.S.C. Before leaving New York he said that the dealers had the

Here and There

distinction of being the first group in the history of the electronics industry to enjoy such a vacation abroad.

Two for the Price of One

A LARGE store in New York has been advertising two receivers for the price of one, while a taxi company of the same city has been experimenting with 6in.-screen sets for proposed use in its taxis.

Wired Television Tie-up

BBROADCAST RELAY SERVICE, LTD., and Electric and Musical Industries, Ltd., have agreed to a long-term basis of co-operation in the field of wired television. The two groups will pool their wired television research and techniques, and the unique E.M.I. development and manufacturing resources will thus be allied to the world-wide operating experience of the Broadcast Relay Rediffusion Group in distributing broadcast programmes by wire. The arrangement envisages the participation of radio retailers.

The introduction of the retail trade by E.M.I. in their arrangements with B.R.S. will, of course, be of particular interest to television dealers

throughout the country. This arrangement will give retailers the opportunity of participating in existing or new television relay services operated by B.R.S.

Brit.I.R.E. Premiums and Examination Awards for 1950

The senior award of the Brit.I.R.E., the Clerk-Maxwell Premium, has been awarded to D. W. Heightman (now with the English Electric Co., Ltd.) for his paper on "The Propagation of Metric Waves beyond Optical Range." This Premium is for the most outstanding paper published in the Institution's Journal during the year 1950.

Other 1950 awards which have been announced by the General Council of the Institution are as follows:—

Rudolf Kompfner, Dipl.Ing. (The Clarendon Laboratory, Oxford), received the Heinrich Hertz Premium for his paper "On the Operation of the Travelling Wave Tube at Low Level," which appeared in the August/September, 1950, issue of the Journal.

The Louis Sterling Premium was presented to J. E. B. Jacob, B.Sc. (Cinema Television, Ltd.), for his paper on "High Performance Television Monitors" which was published in the April, 1950, issue of the Journal.

HOW IT WORKS

The Blocking Oscillator

AN EXPLANATION OF THE MOST IMPORTANT PART OF THE MODERN TIME BASE

By A. Dunn

THE television signal, as received, is of quite a different form from that encountered in ordinary broadcasting. The vision carrier is modulated by signals which correspond to the mean level of illumination, the variations in brilliance which make up the light and shade and picture detail, and the line and frame synchronising pulses.

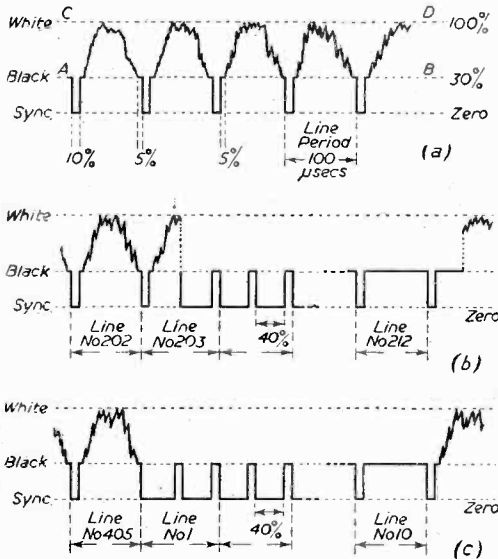

Fig. 1.—(a) Typical line signals. (b) Signals at end of odd frames. (c) Signals at end of even frames.

The waveform as it appears after detection is shown in Fig. 1(a). The picture signal occupies only 84.5 per cent. of each line, and the modulation for this period lies between the line AB (black level equal to 30 per cent. of maximum) and the line CD at full modulation level (white). At the end of each line the modulation falls to black, then to zero for the sync pulse and finally rises again to black. The time interval in each case being .5 per cent., 10 per cent., and 5 per cent. respectively of the line period of 100 microseconds.

The waveform at the conclusion of the first and each alternate frame thereafter, referred to as the "odd" frames, appears at Fig. 1(b). In the middle of line 203 the modulation falls through black to zero, remains at this level for 40 microseconds, rises to black for 10 microseconds, and returns to zero. This cycle of events is repeated several times after which the signal rises to the 30 per cent. level for at least 10 lines interrupted only by the line sync pulses. The breaking up of the frame sync signal is necessary to maintain line synchronism as explained in article two of this series.

The signal content at the end of even frames (2nd, 4th, 6th, etc.) takes the form shown at (c) in Fig. 1 where

it can be seen that the initial pulse occurs at the end of line 405 and recurs at 10 microsec. intervals.

To make these signals intelligible the electron beam of the cathode ray tube is required to explore, or trace out, a series of lines to cover the tube screen and the means of accomplishing this must be provided within the receiver. It is further necessary, for the formation of a picture, that the beam be made to move at the correct frequency both in a horizontal and vertical direction, and also that means be provided whereby the incoming sync signals can control the movement to ensure that the spot is at each moment in the correct position relative to the picture signal.

Interlacing

The particular manner in which this process of exploration is carried out in present-day receivers is known as interlaced scanning. It may be as well to elaborate somewhat on this point.

Assume that each line in Fig. 2(a) is formed in one hundredth of a second. If the spot requires one-tenth of a second to move downwards over the distance X then 10 lines will be traced in this period. On arrival at the point R the simultaneous vertical and horizontal return movement will bring the beam back to point O and the second series of lines will be superimposed on the first. Now consider the effect if the horizontal movement is speeded up as at (b) to 105 lines per sec. so that during each downward stroke 10.5 lines are formed. The spot reaches the point S halfway along line 11 as the first tenth of a second expires and flies upward over the distance X to point T. Having now but half a line to traverse, the downward movement of the beam will be proportionately less and the line will end at point A, midway between P and Q. The ensuing lines will now occur between those of the previous series as shown.

In practice the scanning spot moves in a horizontal direction backwards and forwards across the screen 10,125 times in each second. The vertical traverse of the beam up and down the face of the tube occurs 50 times during the same period. Since the former figure is not a multiple of 50, interlacing of the lines occurs, as explained above, and the screen presents a series of frames, each

(Continued on page 223).

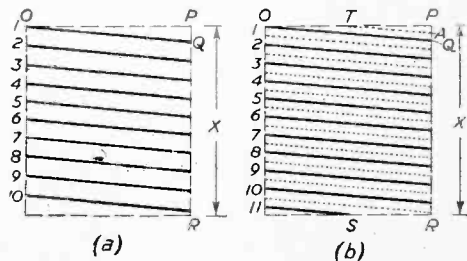
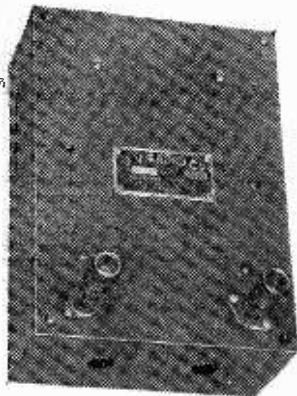

Fig. 2.—Sequential and interlaced scanning.

Television at 200 miles

NEW MODEL SC23 TV PRE-AMPS. ALL CHANNELS



- High gain and low noise.
- Customs built to the highest standards.
- Ample bandwidth for good definition.
- Ideal for the "difficult" fringe and ultra fringe areas.
- Each pre-amp. supplied guaranteed to have been "air tested" and to have received both vision and sound at 200 miles using a standard commercial superhet. receiver.
- Models SC22 and SC23 have self-contained metal rectifier power supply, 200/250v. A.C.
- 12 months' guarantee.
- Immediate delivery.

RETAIL PRICE LIST

(Trade enquiries invited)

SC23, new model, £5. 5. 0. SC22, two-stage, £8. 10. 0.
 SC21, two-stage, £6. 6. 0., requires power supply.
 SG12, TV Sig. Gen., £6. 19. 6. PG11, Patt. Gen., £14. 0. 0.

TELEVISION SIGNAL GENERATOR

- Frequency range 40/70 Mcs.
- Calibration chart for all Television Channels.
- Modulation on sound and vision optional.
- Sensitive meter fitted for use as grid dip oscillator.
- Ideal for service engineer and experimenter.
- Measures coil, aerial frequencies, etc.
- The only one of its kind on the market.
- Self-contained power supply, 200/250v. A.C.
- 12 months' guarantee.
- Immediate delivery.

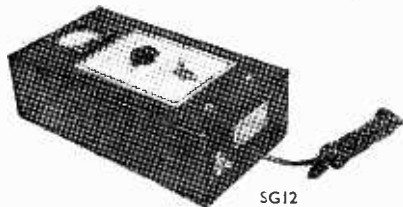

SG12

J. V. RADIO CO. 84, EMBANKMENT ROAD, PLYMOUTH.
 Manufacturers of Television Equipment. Tel. 4737.

**BUILD YOUR OWN
 MODERN RECEIVER**
 for
HALF the normal cost



**SOME POPULAR
 CIRCUITS for the
 HOME CONSTRUCTOR**

- ★ **A MIDGET 4 STATION "PRE-SET" SUPERHET. RECEIVER** for A.C. mains. Designed to receive any three stations on Medium Waveband and one on Long Wave by the turn of a Rotary Switch, no Tuning being necessary. The set can be supplied either as a complete Kit of Parts, or by purchase of the Components separately. The Complete Assembly Instructions, showing the Wiring Diagram and Component Layout and Point-to-Point connections, together with a Component Price List, available for 1/9.
- ★ **A 4-VALVE T.R.F. BATTERY PORTABLE "PERSONAL" SET**, available as a Complete Kit of Parts or by purchase of the Components separately. The complete price details, including an individual Component Price List, are included in our set of Assembly Instructions, which is obtainable for 9d. In addition, these detailed Assembly Instructions also show the complete circuit, with a Practical Component Layout, which in themselves make the assembly of the set quite simple.
- ★ **A MIDGET 4-VALVE SUPERHET, PERSONAL SET**, covering Long and Medium Wavebands and designed for Mains or Battery operation. This receiver is designed to operate on A.C. mains or by an "All-dry" Battery; either method is selected by means of a Rotary Switch. It is so designed that the Mains Section is supplied as a separate section which may be incorporated at any time. The set, therefore, can be made either as an "All-dry" Battery Personal set or as a Midget Receiver for Combined Mains/Battery operation. The set can be supplied either as a complete Kit of Parts or by purchase of the Components separately. The Assembly Instructions, which include Wiring Diagram and Practical Component Layouts, are available for 1/8. This also includes a separate Component Price List.

- ★ **THE MIDGET A.C. MAINS 3-VALVE RECEIVER**, as designed and published by "Wireless World," covering Long and Medium Wavebands. Cost of all Components to build this set is £3/17/9. A reprint of the complete Assembly Instructions, including Practical Layouts, is available for 9d.
- ★ **THE "WIRELESS WORLD" MIDGET A.C. MAINS 2-VALVE RECEIVER**. We can supply all the components, including Valves and M/Coll Speaker, to build this set for £3/10/0. Reprint of the original Assembly Instructions and Circuit may be obtained for 9d.
- ★ **THE "SUMMER ALLDRY" BATTERY PORTABLE**, as published in the June issue of "Practical Wireless." We can supply from stock all of the Components to build this Midget 3-Valve Receiver. A reprint of the complete article and circuits, including Practical Layout and Component Price List is available for 1/6.
- ★ **A COMPLETE KIT OF PARTS** to build a MIDGET "All-dry" BATTERY ELIMINATOR, giving approx. 69 volts and 1.4 volts. This eliminator is suitable for use with 4-valve Superhet Personal Sets. It is easily and quickly assembled and is housed in a case size 4 1/2 in. by 1 1/2 in. x 3 1/2 in. Price of Complete Kit, 42/6. A similar complete Kit (size of Unit 7" x 2 1/2" x 1 1/2") to provide approx. 90 and 1.4 volts is also available. Price 47/6.
- ★ For £8/5/0. A Complete Kit of Parts, including Drilled Chassis and Valves, to build a 6 to 8 watt PUSH-PULL AMPLIFIER for operation on A.C. Mains. Incorporates Tone Control and is suitable for use with any type of pick-up. The complete set of Assembly Circuits, including Practical Layouts, is available for 9d.

★ Send 9d. P.O. for our NEW STOCK LIST, showing many KITS OF PARTS for Sets and Battery Chargers and "hundreds" of Wireless Components. When ordering please cover cost of postage and packing.

STERN RADIO LTD., 109 & 115, FLEET STREET, E.C.4.

Telephone :
 Central 5814 & 2280

" YOU CAN RELY ON US "
FOR CLEAN COMPONENTS
AT COMPETITIVE PRICES

IMMEDIATE DISPATCH

VALVES

C1C	10/-	W61	7/6	6K7 meta	8/-
CV1141	5/-	1Q4	8/6	6K7G	8/-
DH63	12/-	1Q5	8/6	6L7 metal	8/6
EASO	3/6	1S4	10/6	6SA7gt	8/-
EB41 Gov.	8/6	1T4	9/6	6S7	8/6
EB91	7/6	3A4	7/6	6SK7 metal	8/-
EB39	10/6	3Q4	7/6	6SH7 metal	7/6
EF39 Gov.	7/6	3Q5gt	8/-	6Z5V	6/-
EF50	7/6	3S4	10/6	12SF7	7/6
EF54	7/6	5Z3	9/-	12A6	7/-
EF55	8/6	5Z4 metal	9/6	12SC7	7/-
EF91	10/6	6AG5	8/6	12SG7	6/-
EF92	12/6	6AK6	8/6	12SK7	8/-
EL32	8/-	6B9m	7/6	12SR7	6/6
EL33	10/6	6C4	7/6	75	6/-
EL35	8/6	6C5m	7/6	77	7/6
EL42	8/6	6C9gt	8/-	80	10/-
KTW61	8/6	6D6	10/-	954	5/-
KT30C	16/-	6F6G	4/6	855	5/-
MS Pen	6/6	6H6m	6/6	903	5/-
N37	10/6	6J4	6/6	VU111	7/6
Pen46	8/-	6J5gt	8/-	3Z5	12/6
PT26H	5/-	6J7 metal	8/-	3Z5gt	12/6
U73	10/-	6J7G	8/6	2Z5	12/6
VU12A	4/6	6K6	8/6		12/6

Postage 6d. any quantity.

Thousands of valves in stock including many BVA types at List Price. Let us know your requirements and we will quote the price.

SWITCHES.—Rotary : 1 pole, 18 way 2/6. 4 pole, 3 way, 4/-, 3 pole, 4 way, 4/-. 2 pole, 6 way, 4/-.

SELENIUM RECTIFIERS.—24v. 11a., 7/6. 350v. max. 75 m.a. 7/6. 230v. 60 m.a., 5/6. Type 14D36, 10/6. Type 14A86, 18/6. Type 36EHT100, 26/6. W33, 3/5. W26, 3/5. Meter rectifiers, midget, 5 m.a., 1/-.

EASYBUILT CIRCUITS.—Two chassis for the Easybuilt Television, heavy gauge tinplate soldered four sides, 8/6 each. EF50 3in. x 3in. screens, 6d. Ask for complete list of parts.

SPEAKERS.—2in. WB, 17/3. 6in. R.A., 12/6. 6in. Truvox with Trans., 16/-. 8in. Plessey Lightweight, 16/-. 5in. Mains energised 750 ohm, 12/6.

TELEVISION TRANSFORMERS.—RS/GB 200-250v. tapped 350-350v. 250 m.a., 6/3v. 8 a., 6/3v. and 2v. at 1a., 5/- at 2.5a., 6/7/6.

FILAMENT TRANSFORMERS.—Midget dimensions, finished in green crackle. Primary 210/240v. to 6.3v. 1.5a., 8/6; to 6.3v. 3a., 12/6; to 4v. 3a., 12/6. Multi purpose type for instruments, models, etc., tappings 3v. to 30v. at 2 amp., 21/-.

SPEAKER TRANSFORMERS.—Super Midget for personals. DL32, 3S4, 1S4, 5/-; Standard Pentode, 4/6; 10 and 30 : 1 4/6; 30 : 1, 4/-; Mains Pentode Midget, 4/-.

COILS.—Wearite "P" Coils, 3/-. Wearite Viewmaster coils, per set, London, 20/-; Midland, 28/-; MWLW TRF Matched pair with circuit, 7/6; Weymouth CT3W3, 9/6 pair. CS2W2, 11/6 pair. K.O. Coils, 4/9. "H" Coils, 3/3.

I.F. TRANSFORMERS.—RS/GB Semi-Midget 465 kc/s, 12/6 pair. Wearite M400B, M 401, 21/- pair. Weymouth P4, 15/- pair.

FORMERS.—Aladdin with cores, 1in. 7d., 1in., 10d., 1in., 9d. Cores 1in. 3d., 1in. 4d.

BOOKS.—Viewmaster Book and Circuits, 5/-. London or Midland, Easybuilt Television, 2/6; Portable Television, 3/-; Personal Portables, 2/6.

MISCELLANEOUS.—Bulgin Octal plug 2/-. Belling Lee Co-axial plug 1/8, Socket 1/3, Connector 1/3, Bulgin rotary DP Switch 4/3. Bulgin feeder plug 1/3, Socket 1/3.

ELECTROLYTIKs.—2 mfd. 350v. 1/3. 4 mfd. 350v. 1/6. 4 mfd. 500v. 2/-. 8 mfd. 350v. 2/6. 8 mfd. 500v. 3/6. 16 mfd. 450v. 4/6. 16 mfd. 350v. 3/-. 32 mfd. 450v. 4/9. 60-100 mfd. 350v. 9/-. 8 mfd.-16 mfd. 450 v. 5/6. Offer 30-30 mfd. 350v. 6/-.
CHOKES.—First quality Audio Chokes, high impedance. 10/6. 40 m.a. Midget 5/-, 60 m.a. 6/6, 150 m.a. 14/6, 250 m.a. 21/- shrouded. Smoothing chokes.

TCC PICOPACKS, ETC.—Picopacks 2/6, Metalmites 1/8, .001 mfd. 6 Kv. 4/8, .001 mfd. 12 Kv. 7/8, Hunts W99 .001 mfd. 1/3.

We regret unavoidable price increases on most surplus valves and a few standard components, but our aim is still Quality First.

Our No. 10 Catalogue, price 6d., Post Free.

Postage : Over £2 free, below 10/- 6d., £1 9d., £2 1/-.

RADIO SERVICING CO.

444, WANDSWORTH ROAD, CLAPHAM, LONDON, S.W.8.

Telephone MACaulay 4155.

77, 77A, 168, 169 Bus, S.R. Station, Wandsworth Road. Open till 6.30 p.m. 1 o'clock Wednesday.

An indispensable reference work for all who are concerned with Radio, Radar and Television

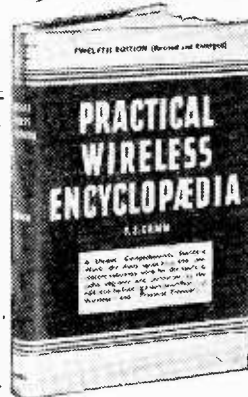

Twelfth Revised and Enlarged Edition just published 21/- net from all booksellers

The Most famous Radio Book in the World —over 300,000 already sold

1440 Cross Indexed References Fully Illustrated throughout.

By F. J. Camm

New Sections deal with Radar, Television, Remote Control, Oscillators, Kirchoff's Laws, Photo-electric Cells, an entirely new series of modern circuits for receivers and amplifiers, Automatic Station Selection, Car Radio, Electron Multipliers, Quartz Crystals, Amateur Transmission, Fault Finding, Building a Television Receiver, the New Colour Codes, Aerials, Meters, Table of Short Wave Stations, New Valves and all of the officially approved Service Terms, etc.. etc.

In case of difficulty a copy will be sent you C.O.D. on receipt of a postcard (send no money with order).

GEORGE NEWNES LIMITED

Tower House, Southampton Street, Strand, London, W.C.2

(Continued from page 220.)

containing 202.5 lines (10,125/50). Development of the picture is not complete until two consecutive frames have appeared with their lines interlaced. There are, therefore, 25 complete pictures per second, each containing 405 lines. It may be worthy of emphasis that the fly back trace is invisible since immediately before, during and after the sync pulses, the carrier modulation is at or below black level.

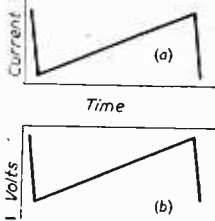

Fig. 3.—Ideal waveforms.

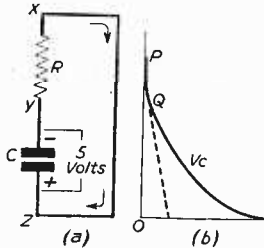

Fig. 4.—Discharge of a capacitor.

Exploration of the screen in magnetically operated tubes is effected by feeding to the deflector coils current having a sawtooth waveform similar to Fig. 3(a). To obtain the necessary current variations the voltage applied to the line and frame scanning amplifiers must also vary in a sawtooth manner and should be of the shape shown in Fig. 3(b).

In the time bases of most television receivers exist circuits for generating sawtooth waveforms. Of the many interesting and ingenious circuits devised for this purpose the blocking oscillator, on account of its reliability and simplicity, is rapidly taking pride of place. This generator, in common with many others, depends for its operation on the alternate charge and discharge of a capacitor.

It has been shown in a previous article of this series that when a capacitor is discharged through a resistor as in Fig. 4(a) the variations in voltage with time follows an exponential law and that the curve showing the collapse of the capacitor E.M.F. takes the form shown at (b) in this figure.

If it were necessary to obtain from a circuit of this type a voltage which varied in a linear manner the output would be restricted to that portion of the curve between P and Q which is comparatively straight, and the variation would be confined to a small fraction of the total.

The reason for this non-linearity is, of course, the falling off in the rate of discharge. If the current could be maintained at a more or less constant value the E.M.F. across C would depreciate at an even rate.

Fig. 5 shows a capacitor C connected in series

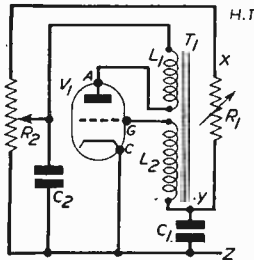

Fig. 7.—The blocking oscillator.

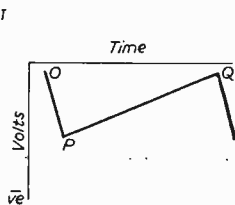

Fig. 8.—Voltage waveform across C1 of Fig. 7.

with a 1 megohm resistor to a battery B supplying an E.M.F. of 195 volts. Assume that the capacitor is charged by some external means and that its E.M.F. of 5 volts is acting in the same direction as that of the battery. When the key K is closed electron movement will take place in clockwise direction, and the total E.M.F. will be dropped across R. In consequence the current will equal 200 microamps (200 volts/1 megohm). From this moment the conditions in the circuit will alter. In Table I below appear the various voltages and currents as C gradually discharges.

TABLE I

Battery E.M.F.	195	195	195	195	195	195
Capacitor E.M.F. (Vc)	5	4	3	2	1	0
Effective E.M.F.	200	199	198	197	196	195
Current in microamps	200	199	198	197	196	195

Progressing from col. 1 to col. 6 the capacitor E.M.F. drops from 5 volts to zero—the required 100 per cent. decrement. The current, however, during this period shows only a variation of 2.5 per cent. (from 200 to 195 volts). In col. 2 the rate of discharge has altered by merely 1 part in 200. In col. 3 the electron flow is still 99 per cent. of the original. It would appear then that the greater the total E.M.F. acting in the circuit the more constant the current over the discharge period and the

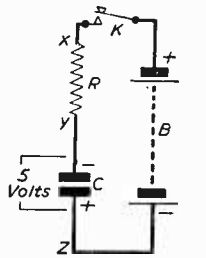

Fig. 5.—This circuit improves the shape of Vc curve.

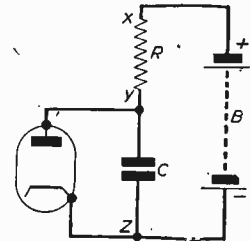

Fig. 6.—The diode prevents C from developing a charge.

closer will the Vc curve approximate to that of a straight line as shown dotted at Fig. 4 (b). It is also to be observed that by adjusting the value of the applied E.M.F. the time taken to discharge C can be varied. An increase in the H.T. voltage by increasing the rate of discharge would shorten the process while a slowing up of the discharge rate as a result of a decrease in the H.T. would lengthen it.

In Fig. 6 a capacitor C and a 1 megohm resistor are connected in series to an H.T. supply source B. The capacitor in a discharged condition offers no opposition to the applied H.T., the full E.M.F. of which appears across R. Point Y initially at the same potential as Z can only acquire a positive value by C gradually charging through R. If, however, a diode is connected between the points Y and Z as shown, it will react immediately to the slightest tendency of the point Y to move in a positive direction. The resultant clockwise electron flow discharges C. The diode acts in effect as a short circuit across C which cannot under the condition shown develop a positive charge. Incidentally, the fact that the diode anode requires to be somewhat negative before emission ceases has been ignored in the above explanation.

It is now opportune to consider the arrangement sketched in Fig. 7. Note that the grid of V1 in conjunc-

tion with the cathode acts as a diode across C1. In order to simplify the following explanation certain effects will, at first, be ignored.

Operation

Application of the necessary supply voltages will result in an electron movement through valve V1 and coil L1 of the transformer T. The onset of this current will induce an E.M.F. in L2, the winding of which is in a direction to make G positive. The anode current response to a positively rising grid is instantaneous—a soaring electron flow, which, passing through L1 accelerates

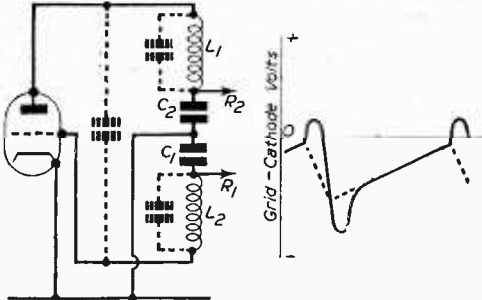

Fig. 9.—Blocking circuit with winding capacitances added.

Fig. 10.—Oscillatory voltages due to strap capacitances.

the growth of the E.M.F. in L2. This cumulative process is very rapid and the grid is carried well positive relative to cathode.

Observe at this point the effect in circuit GYZC. Heavy grid current, a result of the positive trend at G, moves in a clockwise direction to charge C1 and makes point Y negative. The developing E.M.F. across C1 acting in opposition to that induced in L2 retards the rate of growth of the grid potential. Again the reaction is immediate and cumulative. The rate of change of anode current decreases. The resultant braking effect on the rising E.M.F. induced in L2 is such that the voltage across C1 ascending to its maximum takes charge and biases the valve to cut off. The anode current collapses, the coil E.M.F.s disappear and the circuit becomes quiescent.

The discharge of C1 in a clockwise direction round the path Y, X, HT, Z, is a comparatively lengthy affair compared to what has gone before, owing to the high value of R1. Vc gradually decreases until the potential at G is within the grid base of the valve when the cycle of events is again initiated.

The output waveform obtained at Y takes the shape of the Vc curve of Fig. 8 which closely approaches the required form of Fig. 3 (b). The portion OP depicting the charging period is almost vertical, illustrating the speed of this process. The linear shape of the curve between P and Q indicates that the current flow while C discharges is fairly constant. This was to be anticipated, from what has previously been said, in view of the high voltage acting in the circuit which equals Vc plus that of the H.T. supply.

Consider again the moment when current first flows in L1. A self-induced E.M.F. will appear in this winding in a direction to oppose the change being made in it.

This E.M.F. acting in opposition to the H.T. will reduce the voltage at the anode and consequently the electron flow through the valve. Suppose the ratio of the transformer to be 1 : 1. The potential rise at G will

approximate to the decline at A. It is clear that the valve response to the former voltage movement will greatly predominate over that caused by the latter.

In view of the various stray capacitances inherent in any practical circuit the coils L1 and L2, instead of forming the windings of an ideal transformer, really form the inductance of a series-fed Hartley oscillator. The circuit takes the form of Fig. 9 where the winding and inter-winding capacitances are shown dotted.

The appearance of sustained oscillatory voltages in the coils causes a marked increase in the time required to charge C1 since the valve will only be conductive during part of the positive half cycles of the oscillations. As it is necessary to restrict this time interval to an absolute minimum the effect is avoided by arranging that the inductance resonates with the circuit capacitance at a frequency such that one half cycle is equal in duration to the charging period. In short, the valve is allowed to oscillate for only one half cycle. The voltage resulting at the grid can be seen in Fig. 10 together with the Vc curve shown dotted. Oscillatory voltages which persist after the valve has cut off are effectively damped by using a transformer with heavy core losses or the employment of damping resistors.

In spite of the defects inherent in a circuit of this type the observed voltage wave obtained across the capacitor from a practical oscillator very closely approaches that of Fig. 8. The rapid charge of C1 while

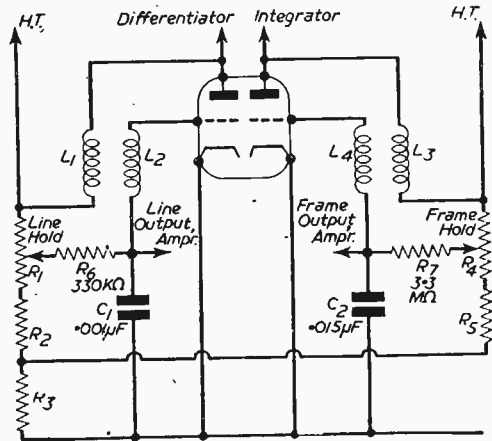

Fig. 11.—Sawtooth voltages at line and frame frequencies are obtained from the above generator circuit.

the valve is conducting represents the fly back and the slow discharge through R1 constitutes the scan stroke. Synchronisation is effected by applying sync pulses to the grid which precipitates the charging cycle.

An extremely effective arrangement appears in Fig. 11 which illustrates the use of a double triode as generator of sawtooth voltages at line and frame frequency. The grid resistors R6 and R7 are returned to the H.T. potential dividers formed by R1, R2, R3 and R4, R5, R3. Line and frame repetition frequency is controlled by R1 and R4 respectively. The sync pulses fed to each anode must, of course, be negative-going. Should any difficulty be experienced in appreciating this, note that the resulting electron movement in L1 will be in the direction anode to H.T. This coincides with the direction of flow when the valve is conducting and the induced E.M.F. in L2 will, therefore, be such as to trigger the valve by making the grid positive.



**T.V.
FREQUENCY CONVERTER**

Model HM2. 2 valve model, self-contained power unit, enables immediate change over SUTON COLDFIELD tuned receivers to HOLME MOSS reception, without ANY alteration to chassis, etc. Price £8-0-0.

**T.V.
PRE-AMPLIFIERS**

One-valve model, self-contained power unit, retails £5-17-6.

TWO-valve model, self-contained power unit, for EXTREME fringe areas, retails £7-10-0. Many thousands in use.

Your dealer will be pleased to demonstrate.

**RAINBOW RADIO MFG. CO.
LTD.**

Mincing Lane, Blackburn, Lancashire



Best in Design

**Best in
Performance**

CLEAR PICTURES
in "poor reception" areas

**RADIO & TELEVISION MODEL 100 G.R.T.
SIGNAL GENERATOR**

(A Trevill Product)

12 Months
Guarantee

£14-10-0

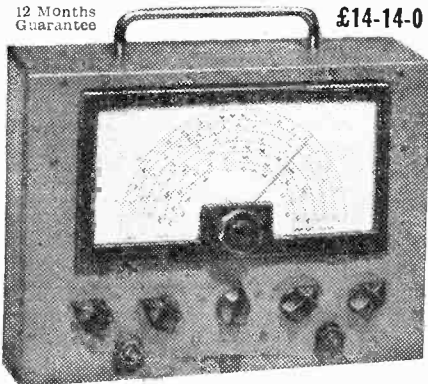

- 100 Kcs.—100 Mcs. Plus or Minus 1 per cent.
- Frame-Line-Pattern & Sound Modulation-C.W.
- A.F. Output 0-10 Volts.
- Coarse & Fine Attenuators—75 Ohms.
- Complete 10 Ohm Unit—Dummy Aerial.
- A.C. Mains Operation, 100/250 Volts.

Sole Distributor :—

MERVYN LEA

5, HYDE ROAD, MAIDSTONE, KENT.

The models 63 and 63A have been designed for maximum performance in fringe and difficult reception areas. Since the reception of your TV receiver is wholly dependent on the efficiency of the aerial system, the Aerialite features of greater gain, broader bandwidth and sharper directivity are very worthwhile. There is every reason why you should specify Aerialite for your TV aerial if you wish to ensure strong, clear and interference-free pictures. The models 63 and 63A. are priced at **£11.15.0** and **£12.5.0** respectively, complete with 10ft. masts, lashings, etc. Models with 14ft. masts are available at 17/- extra. Aerialite are manufacturers of a comprehensive range of TV and radio aerials as well as coaxial and R.F. cables.



Aerialite LTD
CASTLE WORKS STALYBRIDGE CHESHIRE

A.C. MAINS MIDGET RADIO RECEIVER

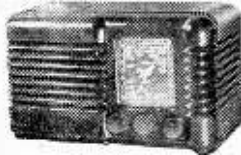

Why not build a few all mains receivers this Autumn, and you will find them ready sellers among your friends and relations, or maybe they will solve your Christmas Present problem. We can offer all the parts and cabinets complete with all the mechanical and decorative details, chassis, tuning scale, knobs, back, etc. The one illustrated is the "ELPREQ OCCASIONAL 4." This costs less than £6 to make and it really is a nice looking job that plays well. Constructional data and detailed price list 1/6. Cabinet in walnut, green or ivory with knobs. Printed dial and backplate, pointer, metal chassis completely drilled, fibre back, and constructional data 31/6 (plus 2/6 post).

MAINS CHASSIS

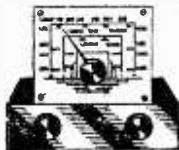

Equivalent to 4-valve receiver, uses 3 valves and rectifier. Not a kit, ready to work. Large clear dial, tunes long and medium waves and operates off A.C. mains. Can be fitted into cupboard, cabinet, or made into really compact portable. Complete with valves but less

speaker. Price 69/6, plus 2/6 post and insurance. Moving coil speaker, with tax, 16/6 extra.



E.F. 50 GUARANTEED AND IN 10/6 ORIGINAL CARTONS EACH

As a result of a large purchase of EF50 (VR91) valves, which were meant for abroad for the service of British equipment, but were never needed, we are able to offer these absolutely new still in the original cartons as shipped. Each one is guaranteed for six months from the date of purchase.

The EF50 as you know is still one of the best valves for TV work, it will outlast most of the newer types, and is recommended by the designers of the "Viewmaster." Limited stocks—so order as soon as possible.

We carry very large stocks of all types of radio and TV valves by all the leading makers, and because we purchased in such large quantities before the Budget, we can offer most valves at single purchase tax, i.e. pre-Budget prices. Our stocks are too varied to list here, we suggest you call on us, or alternatively, post your order to Ruislip and we shall be pleased to send by insured registered post.

Government surplus valves are very rapidly coming to an end, we have had our share, but unfortunately most of the good types have now gone. On request, we will send you a list of the types still available, there are still plenty of bargains if you can adapt the types.

The "Viewmaster" is a television set which any average man can construct, mainly because the data has been so carefully worked out, and even possible faults have been anticipated and fully dealt with. Why not see this data and judge it for yourself we are quite willing to supply it on approval. Simply send 5/-, which amount less postage will be returned to you if you don't think you can make the set and return the data within 7 days. Please state whether London, Birmingham or Holme Moss. All parts, even cabinets, available. H.P. terms if required.

Orders under £2 add 1/6, under £1 add 1/-. Postable items can be sent C.O.D., additional charge approx. 1/-. ALL POST ORDERS TO RUISLIP, callers at either address. Note early closing Wed. Ruislip and Sat. City.



PRECISION EQUIPMENT

152-153, Fleet Street, E.C.4.

42-46 Windmill Hill, Ruislip Manor, Middx. (5)

RECEIVER TYPE 25. The receiver portion of the T/R 1196. Covers 4.3-6.7 Mc/s and makes an ideal basis for an all-wave receiver, as per *Practical Wireless*, August, 1949, issue. Complete with valves type EF36 (2), EF39 (2), EK32 and EBC33. Supplied complete with necessary conversion data for home use. 35/- new condition. Chassis only 8/6.

PLESSEY. 3in. P.M. Speaker with miniature O/Trans. 17/6. W.B. 21in. P.M. 3 ohms. 1/trans. 15/-.

R.3515 I.F. STRIP. A complete I.F. Unit comprising 6 SP61 I.F. Stages, tuned to 13.5 Mc/s. 1 EA50 diode detector and 1 EF36 or EF39 output or video stage. A few modifications only are required to adapt this unit, which will give pictures of extremely good quality. Price, complete with valves and fool-proof modification instructions, is 45/- plus 5/- carriage and packing. Limited quantity only.

5CP1 C.R. TUBES. Brand New and Boxed, 25/- carriage paid.

3 BP1 C.R. TUBE complete with base and shield in holder with leads. 30/- Brand new.

3547 RECEIVERS. Absolutely brand new, in sealed manufacturers' packing cases. Incorporating 15 valves type EF50, 2 of SP61, EF36, EBC33, 3 of EB34. Complete 145 Mc/s I.F. Strip, motor dial and drive, pots, etc., etc. 26 only, plus 10/- packing and carriage. Whilst they last!

MIDGET .0005 mfd. TWO-GANG TUNING CONDENSER. Size only 2 1/4 in. x 1 1/4 in. x 1 1/4 in. Capacity guaranteed, standard length 1/4 in. spindle, complete with mounting bracket, less trimmers, 6/6, or complete with "built-in" trimmers, 7/6. Each plus 6d. post.

NO. 38 "WALKIE-TALKIE" TRANS/RECEIVER. Complete with throat mike, phones, junction box and aerial rods in canvas bag. Fred. range 7.4 to 9 Mc/s. All units are new and tested before despatch. As supplied to Overseas Police Forces. 24/19/6. Carriage 2/6.



5 HARROW ROAD, LONDON, W.2
PADdington 1008/9
0401

GERMANIUM CRYSTALS complete with circuit diagram, 4/6.

MIDGET TWO-GANG .0005 WITH 4W. PUSH BUTTON, 8/6.

RECEIVER R.1355 as specified for "Inexpensive Television." Complete with 8 valves VR85, and 1 ea. 5U4G, VU120, VR92, and a copy of "Inexpensive TV." ONLY 55/- (carriage, etc., 7/6).

RECEIVER TYPE 21. The receiver portion of the W/S 21 operating from 4.2-7.5 Mc/s. Double superhet from 18-30 Mc/s. Incorporating B.F.O. and crash limiter. Valve line-up 7-ARP12 (VP23) and 2-AR8 (HL23DD). Absolutely brand new, complete with circuit. Only 45/- complete. Vibrator power unit for above, brand new, 17/6 only.

Send stamp for current Component List. Probably the most comprehensive in the trade.

EF50 (VR91) BRAND NEW RED SYLVANIAN. 10/- Original boxes. British Types boxed, 8/6. Unboxed British Types, 6/-.

I.F. TRANSFORMERS. Manufacturers' surplus, iron-cored, 465 kc/s. Size 4in. x 1 1/4 in. x 1 1/4 in. Per pair, 8/6, whilst they last.

VIBRATOR POWER UNITS, 2 volt. As for Canadian 58 set. Completely smoothed, output 1.5v. L.T. and 90v. and 180v. H.T. at 35 m.a. Complete in grey metal box. Size 6 x 3 x 4 1/2. 50/- only.

METAL RECTIFIERS. S.T.C. 303 volts 75 m.a., 6/-; G.E.C. 6 volts 1 amp., 4/-; Westinghouse, 12 volts 2 amp., 12/6; Pencil Type E.H.T., 600 v. 1 m.a. 4/7; 1,000 v. 1 m.a., 6/-; 2,400 v. 3 m.a., 15/-.

MOVING COIL METERS. 2in. scale. 0-50 micro/amp. round projecting type. 10/-; 0-1 m.a., panel mounting, 10/-; 0-50 m.a., panel mounting, 7/6; 0-40 volts, panel mounting, 7/6; 0-20 amps. round projecting type, 7/6; 0-40/120 m.a., double reading, round projecting type, 12/6.

A SIGNAL TRACER at minimum cost. An easy-to-build unit that can be used for R.F., I.F. and Audio signal tracing, without any switching or tuning. Highly sensitive, easy-to-build, responds to signals picked up from an ordinary receiving aerial. The circuit is that of a high-gain, 3-stage resistance-coupled audio frequency amplifier, with a 5-inch speaker in the Output of the Power Amplifier stage.

We shall be pleased to supply a complete kit for the construction of the above, right down to the last nut and bolt, for the low price of £3/18/6. Concise instructions and circuits are supplied. If preferred, circuit and instructions only can be supplied for 1/6 post free. All items may be purchased separately. This is a highly efficient instrument, and a MUST for every radio man. Completely assembled and tested, ready for use, 25/5/-.

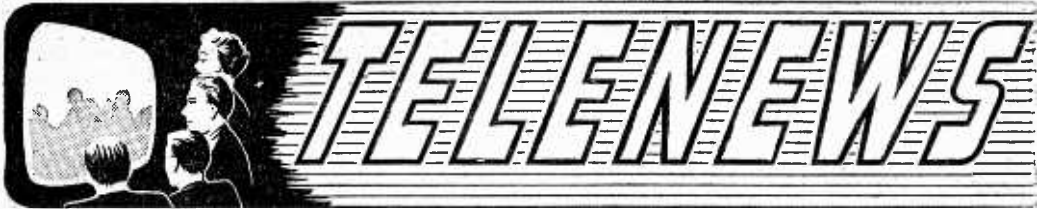

Compulsory Suppression?

UNDER the Wireless Telegraph Act, 1949, motorists may be forced legally to fit suppressors to their cars, thus eliminating much of the interference experienced by most viewers in the form of white spots moving over the screen.

At least 60 per cent. of cars on the road could be satisfactorily suppressed by the fitting of an ordinary resistor, costing about two shillings, but in any case, at least six months would have to elapse between the making and the enforcement of any such regulation.

Reception in Dublin

PROGRAMMES transmitted from Alexandra Palace and from Sutton Coldfield have been received on sets, imported some time ago, at high points surrounding Dublin.

At times the picture appears crystal clear for a whole evening and then perhaps not even a faint signal may be received for days. The actual city of Dublin, however, has been unlucky as the Welsh mountains obstruct the path of the waves from the transmitters.

Protest from the North-east

AS the result of a ballot conducted by a Newcastle newspaper, to find how many people were in favour of television for the north-east and how many against, a parcel was recently handed to Mr. Richard Ewart, M.P., secretary of the Northern Group of Socialist M.P.s, containing 2,477 ballot papers showing that the "anti's" had been outnumbered by 166 to one.

These papers took the form of an official protest against the lack of consideration given to the north-east in respect of the expansion of television.

Eventual Priority for North-east

IN a recent personal letter to Mr. C. F. Grey, Durham's Socialist M.P., the Postmaster-General, Mr. Ness Edwards, disclosed that when restrictions owing to the rearmament programme are lifted, first priority for completion will be given to the transmitter at Pontop Pike.

The Editor will be pleased to consider articles of a practical nature suitable for publication in "Practical Television." Such articles should be written on one side of the paper only, and should contain the name and address of the sender. Whilst the Editor does not hold himself responsible for manuscripts, every effort will be made to return them if a stamped and addressed envelope is enclosed. All correspondence intended for the Editor should be addressed to: The Editor, "Practical Television," George Newnes, Ltd., Tower House, Southampton Street, Strand, W.C.2.

Owing to the rapid progress in the design of wireless apparatus and to our efforts to keep our readers in touch with the latest developments, we give no warranty that apparatus described in our columns is not the subject of letters patent.

Copyright in all drawings, photographs and articles published in "Practical Television" is specifically reserved throughout the countries signatory to the Berne Convention and the U.S.A. Reproductions or imitations of any of these are therefore expressly forbidden.

The cost of installation of these sets is 35 shillings, and the hire charge 3s. 4d. per day.

Association Warned

THE Televiewers' Association has been requested by the G.P.O. to refrain from conducting its own investigations into sources of interference with reception.

The detection is carried out in three cars which track down the trouble in any district from whence a complaint is received.

As the Post Office has protested that these "sleuths" may be taken for "official G.P.O. snoopers," however, detection efforts have ceased for a trial period of three months.

Report on Holme Moss

OVER 500 dealers in the north-west have been asked by the Radio and Television Retailers' Association to send in a detailed report on the picture received from the Holme Moss transmitter.

Results will be purely for the guidance of the trade.

Weather Effects

FOLLOWING years of study on the subject, the Department of

Service for Ships

SHIPS visiting the River Thames now have at their disposal a service which equips them with 9in. screen console receivers, hired to them for the duration of their stay.

The service is operated by Pye, Ltd., through their subsidiary company, Rees Mace (Marine), Ltd.

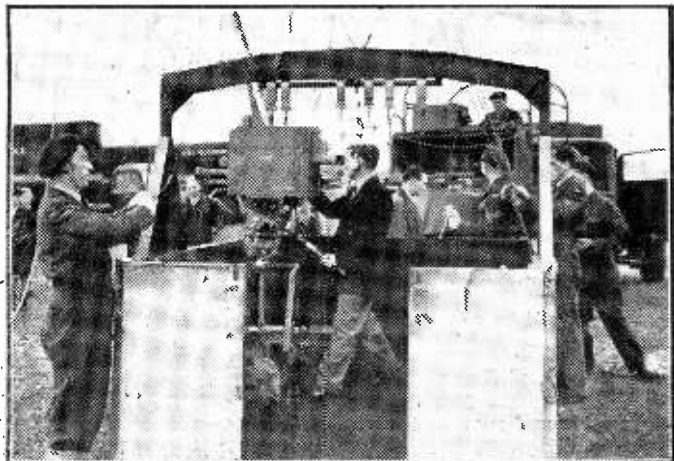

The camera being fitted into the "cradle" shown overleaf.

Scientific and Industrial Research demonstrated at the National Radio Show at Earls Court their findings on the effects of the weather on reception.

Viewers within normal range are not unduly affected, but those in fringe areas and others with excellent receivers and aerials living out of normal range who often obtain a reasonable picture, may wonder what causes a clear picture one evening and a mass of flashes another.

It can all be blamed, says the Department, on the British weather: "The best results usually occur in the summer when a clear, warm day is followed by a clear night—typical summer anticyclonic weather."

Broadcast Receiving Licences

STATEMENT showing the approximate numbers issued during the year ended 31st July, 1951.

Region	Number
London Postal	.. 2,360,000
Home Counties	.. 1,655,000
Midland	.. 1,760,000
North Eastern	.. 1,914,000
North Western	.. 1,617,000
South Western	.. 1,072,000
Welsh and Border Counties	.. 732,000
Total England and Wales	.. 11,110,000
Scotland	.. 1,116,000
Northern Ireland	.. 209,000
Grand Total	.. 12,435,000

The above total includes 915,200 television licences.

The monthly increase in television licences (18,200) was the lowest in any month since July last year when the increase was nearly 17,000. The sales of licences usually decline in the mid-summer months; this year there has been the additional effect of the increased purchase tax on receivers.

Football in Colour

WHEREAS the sound broadcasting of soccer matches in this country still hangs in the balance, it is reported from the United States that baseball matches were televised in colour last month and it is hoped that football will be covered in the same way this month.

Menace Considered Beaten

SPEAKING to the 20th Century Fox Pictures' sales conference, Mr. Spyros P. Skouras, the president, stated that he considered the menace of television beaten.

Mr. Darryl F. Zanuck, production vice-president, agreed with him and added that box-office takings over the past five years indicated that films in which the accent was on action had proved the most successful. He considered that the industry should stop trying to imitate the theatre and concentrate more on the motion side of pictures.

Watch Trouble

AS a result of experiments, the 'National Jewellers', 'Silversmiths' and Allied Trades Association believe that the increasing number of watches being sent in for repair is a result of their being introduced to the magnetic field surrounding television receivers. The magnetism is strong enough, they say, to deflect a small compass.

As no trouble of this nature has ever been experienced at Alexandra Palace, the B.B.C. do not appear to agree with the Association's views.

British Television for South America

AN important contract for the supply of television equipment has been awarded to two British firms by the Municipality of Bogota, Columbia. The Marconi Co. will be supplying the transmitter and the complete studio centre similar to those being supplied to the United Nations Organisation in New York and Montreal, Toronto, Madrid and Barcelona. The equipment will be manufactured to the American standard of 525 lines.

E. K. Cole (Ekco) will be supplying the television receivers.

An interesting feature of this announcement is that television in Bogota will be a municipal effort. The Municipality—in co-operation with the Municipal Bank of Bogota—will supply all the programmes and will provide television receivers under a hire-purchase scheme.

Studying British Television

SENATOR J. ZAVALA MUNIZ, who led the Uruguayan delegation to the recent UNESCO Conference in Paris, spent a fortnight in Britain under the auspices of the British Council. A second purpose of his visit to Europe was to study the organisation of television services, as it is proposed to establish a television service in Uruguay.

He is president of the Municipal Theatre Commission and was until recently chairman of the board of the SODRE, which has entrusted him

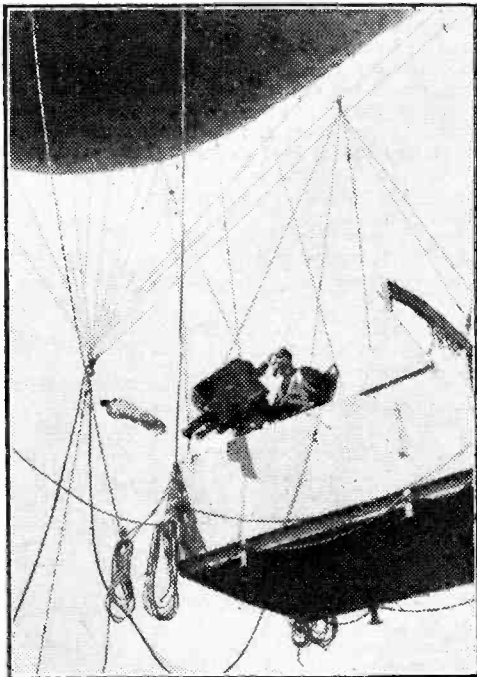

A B.C.C. television programme on the training of parachute jumping, recently, was notable for some remarkable air-to-air "shots" made by a B.B.C. cameraman with a Marconi television camera in a cradle, slung beneath a barrage balloon at a height of 700 feet.

with an official Government grant to assist his studies in Europe. The National Broadcasting Commission of Uruguay controls the National Symphony Orchestra, the National Ballet Company and the Cine Arte Service as well as the official radio station.

Having spent his first week-end at Stratford-on-Avon, Senor Zavala visited B.B.C. studios; attended a promenade concert; visited E.M.I., Ltd., Hayes, Middlesex; Marconi, Ltd., Chelmsford, Essex; and a concert at the Royal Festival Hall. He also visited the Edinburgh Festival.

RADIO MAIL

74 MANSFIELD ROAD, NOTTINGHAM

For Bargains in Good, Clean Ex-Govt. Gear.

EX-GOVT. VALVES, NEW, BONED, EF50 (British). 6/6.
EF50 (Red Sylvania). 8/6. SP61, 3/6. EA50, 3/-. EB34, 2/6.
EF36, 5/-. EBC33, 5/-. VP23, 5/6. HL23DD, 5/6. ATP4, 2/9.
I.F. TRANSFORMERS. Iron-cored 465 Kc/s. 1 1/2 in. square by
3 1/2 in. high, 6/9 per pair.

INDICATOR UNITS. Complete with VCR97 in mu-metal shield. This two-deck, 21-valve unit is offered less valves, at the value of the VCR97 short-persistence T.V. Tube, shield, holder and mask, the unit itself, with its host of useful components, being included in the price. This unit, in exceptionally clean condition, is supplied in its original transit case at the low price of 47/6, plus 6/- carriage.

MUIRHEAD SLOW-MOTION DRIVES. Ratio 50-1, 8/-.

COLVERN WIRE-WOUND POT'RS. 25,000 ohms, 1/9.

"PYE" 45 MC/S STRIPS. The complete T.V. vision receiver, employing 6 of EF50's and one of EA50. Brand new, less valves, these are unrepeatable at only 38/6, plus 1/6 post.

MOVING-COIL TEST METER, 0-1 m.a. 3in. instrument by Ferranti, Weston, etc. Mounted in sloping front bakelite case with insulated terminals. Supplied in felt-lined case with chrome carrying handle. A bargain at 25/-, plus 1/6 post.

RECEIVERS TYPE 3584. Brand new, less valves and "Pye" strip. Component stripping value of at least £10. Good length of wire ends on the hundreds of resistors, etc. Also included are multi-contact relays, tropicalised pot'rs, gear box, motor, drive and dial. Supplied in metal case 20 x 13 x 7in. Only 28/6, plus 5/- carriage.

CONDENSERS. Micamold metal cased .1 mfd. 350 v., 10d. Erie 20 pf Ceramicon. 3d. Bakelite cased .1 mfd. 2,500 v., 3/6. Cornell-Dubilier .5 mfd. 3,000 v., 2/6.

WAFER SWITCHES. 3 pole, 6 way. Unrepeatable at 8d.

S.A.E. WITH ALL ENQUIRIES, PLEASE.



THE CORRESPONDENCE COLLEGE THAT PUTS YOU IN A CLASS AHEAD.

POSTAL TUITION

paves the way to success
in the whole field of



RADIO & TELEVISION TECHNOLOGY

Subjects taught are:—

- | | |
|-------------------|---------------------|
| AVIATION WIRELESS | RADIO SERVICE ENG. |
| ELECTRICAL | RADIO SHORT WAVE |
| ENGINEERING | TELEVISION |
| ELECTRICAL | WIRELESS TELEGRAPHY |
| DRAUGHTSMANSHIP | TELECOMMUNICATIONS |

Special Courses for: P.M.G. CERTIFICATE. AIR MIN. EXAM. CITY & GUILDS. RADIO TRADES EXAM. BOARD

★ Each student of the College is provided with tuition until he has passed the examination for which he has enrolled.

To Dept. 55.

THE BENNETT COLLEGE Ltd., SHEFFIELD

HOLME MOSS CONVERSION

Type AC14 Converter unit for use with Sutton-Goldfield receivers. Optimum picture detail and Sound reception without retuning or alterations. Incorporates power supply unit, R.F. stage and the highly successful double mixer stage ensuring freedom from noise and correct reception of the new single side band transmitters.

Delivery at present ex-stock. Price complete with 5 valves, etc., 15 gns. On approval 7 days C.O.D. if desired or by arrangement through your own Dealer. Holme Moss models of the type AC13 neutralized triode Pre-Amplifier are also available ex-stock. A well designed and proved unit giving the best possible results for 'Fringe' viewers. Our confidence in the unit is revealed by our 7 days approval offer. C.O.D. if desired or by arrangement through your Dealer. Illustrated leaflets and details, etc., available on request.

SPENCER WEST
Quay Works, Gt. Yarmouth

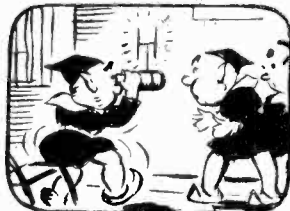

The "Fluxite Quins" at Work

"The light in our TV's gone out.
It needs overhauling, no doubt,
'Til we get some FLUXITE;
And just for to-night
I've borrowed your headlight, old scout."

See that **FLUXITE** is always by you—in the house—garage—workshop—wherever speedy soldering is needed. Used for over 40 years in Government works and by leading engineers and manufacturers. Of all ironmongers—in tins, from 1/- upwards.

The **FLUXITE GUN** puts **FLUXITE** where you want it by a simple pressure. Price 2/6, or filled 3/6.

FLUXITE

SIMPLIFIES ALL SOLDERING

Write for Book on the Art of "SOFT" Soldering and for Leaflets on CASE-HARDENING STEEL and TEMPERING TOOLS with **FLUXITE**. Price 1sd. each.

FLUXITE Ltd., Dept. P.T.
Bermundsey Street, London, S.E.1

LONDON CENTRAL RADIO STORES

PHILCO RADIOS RECONDITIONED

LARGE TABLE MODEL in light walnut. Large circular dial, very selective. 125/-.

DE LUXE MODEL with bronze speaker grill. 147/-.

ALL-WAVE DE LUXE TABLE MODEL. Large circular dial. 2-speed tuning. Takes normal or di-pole aerial. 189/-.

CATHEDRAL MODEL, in light or dark oak, receives all British and European stations with great clarity. 120/-.

A STANDARD TABLE MODEL. Square cabinet in light or medium oak. An absolute gift. Very few of these are available. 95/-.

ALL TYPES have pick-up sockets. Supplied in A.C. or A.C./D.C., cover all voltages 200-260 volts. Take extension speakers and are tested before dispatch. Have 5 valves.

WALKIE-TALKIE TRANSCIEVERS. A compact superhet receiver with an R.F. stage covering 7-9 mcs, wonderful for field work. The speech modulated transmitter has remarkable power and aerial sockets are provided for portable whip or long aerial. Supplied complete with mike and 'phones, circuit and full-instructions. These are Air Tested prior to dispatch. Post paid. 75/-.

23, Lisle Street, Leicester Sq., W.C.2

Telephone: GERrard 2969.

FIRST-CLASS TELEVISION and RADIO COURSES . . .

GET A CERTIFICATE!

After brief, intensely interesting study—undertaken at home in your spare time—**YOU** can secure your professional qualification or learn Servicing and Theory. Let us show you how!

FREE GUIDE

The New Free Guide contains 132 pages of information of the greatest importance to those seeking such success compelling qualifications as **A.M.Brit.I.R.E., City and Guilds Final Radio, P.M.G. Radio Amateurs' Exams., Gen. Cert. of Educ., London B.Sc. (Eng.), A. M. I. P. E., A. M. I. Mech. E., Draughtsmanship (all branches), etc.,** together with particulars of our remarkable Guarantee of

SUCCESS OR NO FEE

Write now for your copy of this invaluable publication. It may well prove to be the turning point in your career.

FOUNDED 1885—OVER

150,000 SUCCESSES

NATIONAL INSTITUTE OF ENGINEERING
(Dept. 462), 148, HOLBORN,
LONDON, E.C.1.

—THE MODERN BOOK CO.—

Television Explained, by W. E. Miller. 3rd revised edition. 5s. Postage 3d.

Questions and Answers on Radio and Television, by E. Molloy. 4th edition. 5s. Postage 3d.

Theory and Design of Television Receivers, by S. Deutsch. 55s. 6d. Postage 9d.

Television Servicing, by S. Heller and I. Shulman. 51s. Postage 9d.

Television Interference, by "Amateur Radio." 2s. Postage 2d.

Practical Wireless Encyclopedia, by F. J. Camm. 12th revised edition. 21s. Postage 6d.

Radio Circuits, by W. E. Miller. 3rd edition. 5s. Postage 4d.

Television Receiving Equipment, by W. T. Cocking. 3rd edition. 18s. Postage 6d.

Receivers, by "Amateur Radio." 8s. 6d. Postage 3d.

6 Call Book: Radio Amateur Stations of the United Kingdom. 4s. 3d. Postage 3d.

Radio Amateur Stations of the World (Exclusive of U.S.A.). 8s. 6d. Postage 6d.

A Portable Televisor, by E. N. Bradley. 3s. Postage 3d.

Valve and Service Reference Manual, by "Mullard." 2nd edition. 5s. Postage 3d.

Radio Valve Data, by "Wireless World." 2nd edition. 3s. 6d. Postage 3d.

Comprehensive Radio Valve Guide, by W. J. May. 5s. Postage 3d.

We have the finest selection of British and American Radio books in the Country. Complete list on application.

19-23, PRAED STREET
(Dept. T.10),
LONDON, W.2.

Paddington 4185

VALVES TELEVISION CONSTRUCTORS

6V6G, 6V6GT, 5Z4M, 1T4, 1R5, 1S5, 78, FW9, 500, 5U4G, 6F6, 6X5, VU39, 6C6, 6D6, VR150/9, 42, 99, 1C5, OZ4, PEN40, 25A6G, 25L6GT.

ALL AT 9/- each.
KT68, 907, 6L6, KT33C, 6SN7. ALL AT 11/6 each.

6E8, MS/PEN, EK32, 6G6C, 6N7GT, 6B9, 6C5. ALL AT 7/6 each.

KT241, MH41, BR33. ALL AT 7/- each.
VUI11, GJ5GT. ALL AT 5/- each.

VUI20, 215SC, 2X3, PEN20A, CV9, SP41, SP61, 6H6, VS68, VR116, EB34. ALL AT 4/- each.

7193, CV6, E1148. ALL AT 2/- each.

WIRE WOUND VOLUME CONTROLS. 50 ohms, 200 ohms, 1K ohms, 10K ohms, 20K ohms, 50K ohms. ALL AT 2/9 each.

CONDENSERS. Standard Can Fixing. 32 x 32 mfd. 450 v. 7/- each.
32 x 16 mfd. 350 v. 5/6 each.
16 x 16 mfd. 450 v. 4/9 each.
16 mfd. 450 v. 3/6 each.

MOULDED MIC. .001, .0001, .0002, .0005. ALL AT 5/6 dozen.

VALVE HOLDERS. International octal amphenol. 7d. each.
Mazda octal amphenol. 4d. each.
BTG amphenol. 9d. each.

SPEAKERS. Rola 10in. 2.3 ohms. 34/6 each.

Plessey. 8in. 2.3 ohms. 13/6 each.
Truvox. 6in. 2.3 ohms. 13/9 each.

Elac 3in. 2.3 ohms. 13/6 each.
Aladdin coils and slugs. 7d. each.
Throat microphones. 2/6 pair.

Low resistance M.C. Headphones Pieces. 1/6 each.

6in. Tube Lens improves your picture. 19/6 each.

Good stocks of Resistors, Volume Controls, Condensers, etc. Order with confidence, delivery by return of post.

MAIL ORDERS ONLY. C.W.O. or C.O.D. 21d. stamp for full list. Carriage Paid on orders over £2.

ALPHA RADIO SUPPLY CO.

5/6 Vinces' Chambers, Victoria Square,
LEEDS 1

"Television Aerials"

"H" type Television Aerials, complete with mast and chimney brackets, any channel. 49/6.

3 Element long-range aerial, complete as above. £415/0.

3 Reflector type, complete as above. £4/15/0.

Wrotham V.H.F. Aerials, complete as above. 49/6.

We can supply any type of Television Aerial to your specification at the same competitive prices, quotations by return. Chimney brackets supplied separately and to special order.

Co-axial cable, stranded core thin. 70-90 ohm. 1/5 per yard, special low loss (usually 2/6 per yard).

SOUND TELEVISION CO.

42, Elms Road, Aldershot

"ADCOLA" SOLDERING INSTRUMENTS

Reg. Trade Mark



Read Design No. 860302

(British, U.S. and Foreign Patents.)

For Wireless and Television Assembly

The advanced design of the Adcola Instruments meets the modern requirements of Television, Telecommunication and Radar Engineers.

SUPPLIES FOR ALL VOLT RANGES FROM 6/7v. to 230/250v.

3/16in. dia. Bit. Standard Model 22/6

1/2in. dia. Bit. Standard Model 25/-

3/16in. dia. Detachable Bit. Model 30/-

Sole Manufacturers

ADCOLA PRODUCTS LIMITED

GENERAL OFFICES AND WORKS

Cranmer Court, Clapham High Street, London, S.W.4.

(MACaulay 4272)

THE NEW 1355 CONVERSION The now famous self-contained TV receiver. Data for all Five TV channels, 3/- per copy.

RECEIVER TYPE 1225 A UHF receiver, containing five EF30's, two EF39's, and one EB34. Chock-full of useful components, these are pre-tuned to four predetermined frequencies, and may easily be slightly modified for normal UHF working. Only 39/6 (1/6 post).

POWER UNIT 532 Containing 5Z4 rectifier, VU120 EHT rectifier (5,000 v., with 2 v. indirectly heated heater), two 80 v. transformers, one smoothing choke, high resistance relay, .1, 2 1/2 kV. condenser, two other condensers, etc., etc., complete with our 50 cps conversion data for EHT or HT. 17/6 (2/3 carriage).

RADIO EXCHANGE CO.,

9, CAUDWELL STREET, BEDFORD.

Phone: 5568



QUALITY TELEVISION COMPONENTS
SCANNING COILS P.M. FOCUS UNITS
6/10 kV. R.F., E.H.T. UNITS
E.H.T. and OUTPUT TRANSFORMERS
LINE FLY-BACK E.H.T. UNITS

"TELEVISION CIRCUITS"

Third Edition, 64 pages, 2/6 post free

HAYNES RADIO Ltd., Queensway, Enfield,
Middlesex.

TELEVISION PICK-UPS AND REFLECTIONS

UNDERNEATH THE DIPOLE



By Iconos

THE BBC's new Charter is due for ratification by Parliament at the end of this year. It is to be expected that the Charter will implement the findings of the Beveridge Committee. From time to time various points concerned with the Beveridge Report have been raised in the House by members, but have attracted little attention—rarely greater notice from the Press than a mere “Mr. So-and-so also spoke.” One of the national daily newspapers recently headlined a story that delegates from several trade unions would shortly have seats on the BBC's Council. This seems reasonable enough but, nevertheless, it is a disturbing thought, since in the case of at least two of the unions concerned with television the delegates would almost certainly be Communists. This would constitute a major victory for the Kremlin, as members of that party are always expected to put their political views well ahead of their duties as trade union representatives.

A BEVERIDGE AMENDMENT?

IT could hardly be expected that the Government would give much of its time to the discussion of BBC and television matters. The Beveridge Committee met, made its report, and that was that. The Government's White Paper on the subject indicates general approval of most of the recommendations. And yet, there are members of all Parties who are not very happy about it. Mr. C. I. Orr Ewing, M.P. for Hendon North, for instance, recently raised the question of sponsored programmes and the establishment of a competitive television network. This M.P. was once on the BBC staff at the Alexandra Palace and has also seen for himself the American television services. He is not wholly a devotee of the American alternative television programmes, but he is convinced that there is a real need for a competitive service here. Furthermore, he has a practical plan for the establishment of such a competitive television service, which, he says, would prove a real incentive both to the BBC and to the alternative system (or systems!). Readers of this journal should watch Mr. Orr Ewing, of Hendon (not to be

confused with the Mr. Orr Ewing representing Weston-super-Mare). If there is a General Election before the Beveridge proposals are formally ratified, then there is an even chance that some of his ideas may result in important amendments to the new BBC Charter.

HIGH DEFINITION CAMERAS

TELEFILM recordings of topical events are reasonably good, but I don't think that anyone would claim that telefilm recording has reached a state good enough for recording plays and other studio performances. I have often wondered whether the studio cameras could be operated at a much higher definition—say, 1,000 lines—notwithstanding the fact that the image would actually be radiated from the aerials at 405 lines. A very high definition on closed circuit would permit really good quality telefilm recording to be carried out, providing a useful stand-by for repeat performances, apart from its immense value as an export to the Commonwealth, the Continent—or even the U.S.A. Just how high in lines, so to speak, has television to go before it equals the definition of the cinema film? I have been informed that if it was simply a case of very high definition cameras on closed circuit, then the sequential scanning of a 600-line picture would do the trick better than a higher number of lines, interlaced. Indeed, I have heard that a TV camera designed for sequential scanning at 675 lines has already been planned by one of the British manufacturers. This camera is not specifically intended for TV use. It will be a true electronic camera, which can be used in place of a still or movie camera for any purpose. Furthermore, by the elaboration of its optical and electrical circuits, the electronic camera can be made to give three outputs, separately filtered through yellow, cyan and magenta filters, respectively. These

three outputs can be recombined to form a colour picture, the three separate circuits being connected with projection tubes fitted with the appropriate filters. Alternatively, motion-picture negatives can be made of the three separate outputs, and from these three “colour separation” negatives can be made a single positive colour film by any of the subtractive three-colour systems, such as Technicolor or Dufay-chrome. At first thought, it all seems a little fantastic. And yet, the development of a general-purpose electronic camera was absolutely inevitable. This is a field in which the British manufacturers are well ahead of the Americans.

TELEVISION CAMERA CHARACTERISTICS

SINCE writing the above, I have referred to a paper read before the Royal Photographic Society a few months ago by Mr. W. D. Kemp, of the BBC Research Department. Dealing with the special problem of telefilm recording, he referred to the six types of TV cameras now being used by the BBC, each of which has a different characteristic for tone rendering, requiring variations in correction circuits when the output is recorded on telefilm. Distortion is likely to be introduced by the non-linear contrast characteristic of the photographic emulsion—a snag which can also be compensated for in the electrical circuits. Thus, we have the interesting possibility of an overall television-recording characteristic which would provide a linear density/log subject brightness law, which is at present unattainable by photographic processes alone. This would seem to confirm the possibility of an electronic camera eventually superseding the normal optical camera for precision photography. Well, well—I don't suppose that that will be perfected in our time, so we should not be tempted to throw away our box cameras as being obsolescent just yet! Nevertheless, it is reassuring to realise that the BBC Research Department has all these possibilities well in mind, as well as well in hand.

THE STANDARD TV CAMERA

WHAT will be the eventual standard television camera of the BBC? Which types seem to be

fitting in best with the requirements of producers, apart from the engineers? Mr. Kemp, in his paper, listed the following cameras at present in use at the Alexandra Palace, Shepherd's Bush, or on Outside Broadcasts:

1. The Standards Emitron (Iconoscope type).
2. The Midget Super Emitron (super Iconoscope type).
3. The Photicon (super Iconoscope type).
4. The P.E.S. Photicon (super Iconoscope type (experimental)).
5. The C.P.S. Emitron (Orthicon type).
6. The Image Orthicon.

The first four types employ high-velocity scanning and are, therefore, subject to that defect known as "shading," which requires correction during the actual transmission. It must not be assumed that these types are out-dated by the last two, since every single type seems to have some kind of "gremlin" from time to time. The snag is that when the trouble occurs we, at the receiving end, rush forward to our receivers and start fiddling with various control knobs, much to the annoyance of the family.

THE PLAY REVIVAL

I HAVE felt that the standard of plays, on the whole, has been less good than a year ago. However, there are occasional outstanding performances by either producers or actors which restore one's faith in the dramatic possibilities of television. Mary Jerrold's performance in "Her Best Foot Forward" was memorable, and it is pleasant to be able to record this fine actress's mastery of the television medium. The somewhat restricted canvas to which the producers of TV plays are confined will shortly be broadened somewhat when the "back projection" system comes into regular operation at Lime Grove. Already, great success has been achieved by the projection of lantern slides of exterior scenes upon a cellulose acetate screen (similar to ground glass) behind the actors. Special provision has to be made to keep the slides cool, otherwise they crack. The fact that the newer type of television camera permit a much lower lighting intensity on the TV stage enables the slide or stereopticon projector also to be run with less light. But when a glass slide is illuminated with a high-intensity arc burning at about 200 amperes, very special precautions have to be taken. Cool air is carefully blown over the slide, and sometimes this air is additionally cooled by passing it

through a copper tube spiral immersed in liquid air or through dry ice. Great care has to be taken to cool the slide very evenly, of course. Another method is to use a colourless oil in place of the air; this slowly circulates around the slide and works very well, providing the oil is quite clear of minute air bubbles. These give a very peculiar effect upon the screen: greatly enlarged and superimposed upon the photographic background, they look exactly like slowly descending footballs!

LIME GROVE LIGHTING

LIME Grove Studios were first established as film studios in 1914. Additions and alterations have taken place from time to time since then, and when the BBC took it over last year it was rather a patched-up rabbit warren compared with the Denham, Pinewood or Ealing Studios. The BBC have made a great many improvements which have been noted in this column, such as the improved flooring, the excellently arranged control rooms and the general cleanliness. Lighting of sets has continued on the old method of slinging banks of lamps from the roof trusses or supporting them on tubular scaffolding floor rostrums. Now, the BBC are experimenting with the slinging of cradles from the roof, the method used in the most modern film studios. The cradles carry various arrangements of spotlights and a man to operate them, and the electric feeder cables come down from the roof. Thus, there is little or no need for the cluttering up of the stage space with lengths of heavy

lamp cable, which is an even bigger disadvantage to television producers than film directors. Another facility essential for television is the remote control of lighting circuits from the stage by means of contactors. The normal method of controlling light intensity (or colour temperature) of individual tungsten lamps in a studio is by means of local rheostats. These are satisfactory for pre-setting purposes but if, for some special effect, the lamp has to be varied during a scene, the rheostat is liable to make noises.

SOUTH AMERICAN TELEVISION

WHEN the Alcalde Mayor announced in a special broadcast a few days ago that Bogota was to have a television system he was also announcing yet another export order for a complete television system won by Marconi's Wireless Telegraph Co., Ltd.

This new order follows swiftly on the heels of similar contracts awarded the Marconi Company by Canada, the United Nations Organisation (for installation at their New York Headquarters) and Spain.

The installation will consist of a 5 kW. vision transmitter, 3 kW. sound transmitter, a television studio including telecine apparatus, and a specially constructed vehicle which will contain all the equipment necessary for televising special functions, such as public ceremonies, theatre plays or sporting events. Thus Bogota will be assured of a television service which will combine outstanding entertainment and cultural value with the highest technical quality.

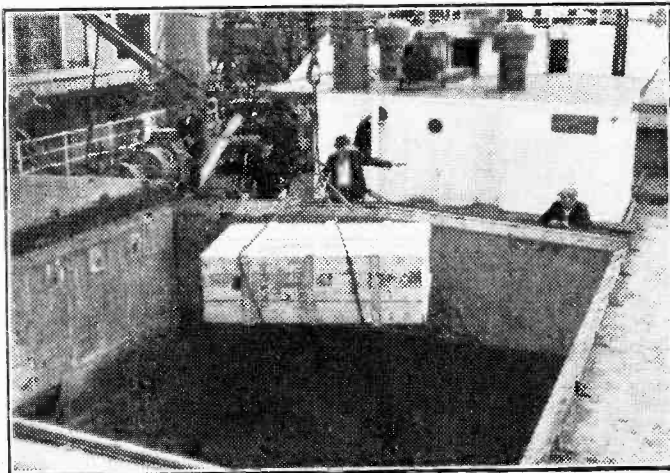

The first consignment of Marconi dollar-earning television equipment left London Docks for Canada recently.

**G.E.C.
GERMANIUM
CRYSTAL DIODES**

**LATEST, SMALLEST
SUPREME CRYSTAL DETECTOR**

Midget Size, 5/16in. x 3/16in.
Wire Ends for Easy Fixing.
4/6 each, postage 2d.
Technical Details and Selected Types available.

SILICON CRYSTAL VALVE
3/6 each, postage 2d.
Fixing Brackets 3d. Extra.

COPPER INSTRUMENT WIRE

ENAMELLED, TINNED, LITZ.
COTTON AND SILK COVERED.
Most gauges available.
B.A. SCREWS, NUTS, WASHERS,
soldering tags, cyelets and rivets.
EBONITE AND BAKELITE PANELS
TUFNOL ROD, PAXOLIN TYPE
COIL FORMERS AND TUBES.
ALL DIAMETERS.
Latest Radio Publications.
SEND STAMP FOR LISTS.
TRADE SUPPLIED.

POST RADIO SUPPLIES
33, Bourne Gardens,
London, E.4.

Pre-Amplifier Transformer. Prim. 200/250 v. Sec. 230 v. at 30 mA. 6.3 v. at 1.5/2 amps. 23/-.
HS150. 350-0-350 at 150 mA. 6.3 v. 3 amps. C.T. 5 v. 3 amps. Half shrouded, 30/9.
FS43. 425-0-425 at 200 mA., 6.3 v. 4 amps. C.T., 6.3 v. 4 amps. C.T., 5 v. 3 amps. Fully shrouded, 51/-.
F35X. 350-0-350 v. at 250 mA., 6.3 v. 6 amps., 4 v. 8 amps., 4 v. 3 amps. 0-2-6.3 v. 2 amps. Fully shrouded, 71/6.
FS160X. 350-0-350 v. 160 mA. 6.3 v. 6 amps., 6.3 v. 3 amps., 5 v. 3 amps. Fully shrouded, 45/-.
FS43X. 425-0-425 v. 250 mA. 6.3 v. 6 amps. 6.3 v. 6 amps. 5 v. 3 amps. Fully shrouded, 69/-.
FS50. 450-0-450 v. 250 mA. 6.3 v. 4 amps. C.T. 6.3 v. 2 amps. C.T. 5 v. 3 amps. Fully shrouded, 75/-.
F36. 250-0-250 v. 100 mA. 6.3 v. C.T. 6 amps. 5 v. 3 amps. Half shrouded, 30/9.
FS150. 350-0-350 v. 150 mA. 6.3 v. 2 amps. C.T. 6.3 v. 2 amps. C.T. 5 v. 3 amps. Fully shrouded, 34/9.
F30X. 300-0-300 v. 80 mA. 6.3 v. 7 amps., 5 v. 2 amps. Framed. 31/9.
E.H.T. TRANSFORMERS. Prices on application.
The above have inputs of 200/250 v. C.W.O. (ADD 1/3 in £ for carriage.)

H. ASHWORTH
676, Great Horton Road, Bradford,
Yorks. Tel. : Bradford 71916.

**THE
BRITISH NATIONAL
RADIO SCHOOL**
ESTD. 1940

Now in our eleventh year and Still—

**NO B.N.R.S. STUDENT
HAS EVER FAILED**

To pass his examination(s) after completing our appropriate study course! All courses are by post and our syllabus includes C. & G., Brit.I.R.E. & P.M.G. examinations, Radio, Radar, Television, Maths. and Physics.

Six months' trial period without obligation to continue.

Please mention this advt. and send for free booklet to—

**STUDIES DIRECTOR
BRITISH NATIONAL RADIO SCHOOL
86, ADDISCOMBE ROAD, CROYDON**
Phone : Addiscombe 3341

NOW READY
For the
VIEWMASTER
(HOLME MOSS)
SETS OF COILS
WIDTH CONTROLS
BOOST CHOKES
RF CHOKES
OLYMPIC RADIO COMPONENTS,
COIL WINDING SPECIALISTS,
224, HORNSEY ROAD, HOLLOWAY, N.7
Phone : NORTH 2914.

C. & W. ELECTRONICS

TEST INSTRUMENTS
20 Range Multimeter M.M.2.
A.C. D.C. Volts from .25v. to 2,500v. at 4,500 Ω/v.
Basic Movement 200 μA.
Scale Length, 3in.
D.C. current from 10μA to 1 amp.
Resistance from .1 ohm to 5 megohms.
Power and D.B.s.
1st Grade Accuracy on all ranges.
Complete with Test-prods and instructions.
Early Delivery. £8 0/0.
Signal Generator S.2.
Range 100 kc.s. to 70 mc/s.
400 c.p.s. Audio. Int. & Ext. Mod.
Ladder, and fine Attenuator.
Direct Reading Frequency Dial.
Grey Crackle finish.
Complete with R.F. & A.F. leads.
Immediate Delivery. £8/8/0.
12 months' guarantee on all instruments.
Send S.A.E. for leaflets.

C. & W. ELECTRONICS, 61, CHURCH STREET
OSWESTRY, SALOP

VIEW MASTER
SPECIAL OFFER
Complete set of resistors for the View Master.
Every resistor packeted and labelled with the value and number.
London, 26/-. Midland and Northern, 24/9.
All View Master components are available separately and a fully detailed list will be sent upon request.
M. WATTS & CO.,
8, BAKER STREET, WEYBRIDGE, SURREY

GRAM MOTORS & PICK-UPS for MICRO-GROOVE RECORDS

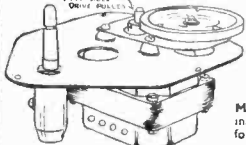

B.S.R. MU-10 motors for 35 & 78 r.p.m. Speed change by reversing drive pulley. 10in. turntable. 100-750v. **£3.15s.**

MU-14 de luxe model with ROTACAM instant speed change for 33 45 & 78 r.p.m. **£7. 3. 4.**

ACOS GP-20 pickups, standard **£3.11.5**
GP-19 LP microgroove head only **£3.4**

Fifth RADIOCRAFT Ltd. PHONE 58927
69-71 CHURCH GATE-LEICESTER

Enjoy

ANOTHER FAMOUS " PRACTICAL "

Readers of "Practical Television" will also find a great deal to interest them in PRACTICAL MECHANICS, edited by the celebrated technical authority, F. J. Camm, and devoted to all branches of Science, Mechanics and Industry. Among the subjects covered by experts are atomic energy, rocket propulsion, radio, television, engineering, electricity, chemistry, physics, photography and cinematography. There are also regular features on model-making and a special section on the Home Workshop. Make sure of PRACTICAL MECHANICS every month by placing a regular order with your newsagent.

Here are some of the interesting features in the October number of PRACTICAL MECHANICS

- Making an Electric Heater.
- The Beginning of Flying.
- A Passenger-hauling Model Locomotive.
- Submarine Escape Apparatus.
- Facts About Columbian Metal.
- A Simple Hygrometer.
- British Railways' New Tank Locomotive.
- Hardening Plaster Castings.

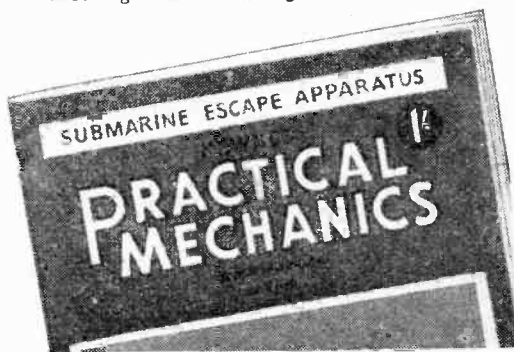

MONTHLY, 1/-

October Number on sale
Friday, September 28th.

FOR GREATEST EFFICIENCY
AT
THE HIGHER FREQUENCIES

SILVERED



CERAMIC

PRECISION CAPACITORS

FOR TELEVISION, F.M., AND
ALL U.H.F. APPLICATIONS

Constructors', service replacement, and
all kit types.

High precision and laboratory types.

Lists from:

SPHERE RADIO LIMITED,
HEATH LANE, WEST BROMWICH.

Walton's of Wolverhampton

Astounding offer in Ex-Service Valves, some slightly soiled, but many brand new in boxes. All one price. Your selection.

4 for 20/-. Carriage Paid.

(Single valves *not* supplied)

EF36 (VR36), EF39 (VR53), EK32 (VR57), EB34 (VR54), SP61 (VR65), SP41 (VR61A), VU133A (CV54), VU120A, KT44 (VT75A), 215SG (VR18), 210LF (VR21), 955, 7193, 12SH7, 12SJ7, 6AC7, ATP4, EA50, DI, 2X2.

Where can you buy valves to-day at these prices?
They cannot last long!

WALTON'S WIRELESS STORES,
48, STAFFORD ST., WOLVERHAMPTON

VIEWMASTER

LINE TRANSFORMERS

24/6 post 6d.

SCANNING COILS

29/6 post 6d.

Trade supplied. Quotations on application.

AUDIO LTD.,
37, HILLSIDE, STONEBRIDGE,
LONDON, N.W.10.

CORRESPONDENCE

re DIODE RECTIFIER AND D.C. RESTORATION

SIR.—Here is my contribution to the points raised by Mr. Watson in your July issue.

The answer depends upon *whether conditions are considered at one particular instant or over a period of several cycles.*

At any given instant the current paths through the diode and the resistor are certainly in parallel, and currents flow in the same direction in each branch, as Mr. Watson says. But we must now consider the characteristics of the diode rectifier and the action of the coupling condenser.

The fundamental point about the rectifier is that its resistance varies according to the polarity and amplitude of the applied voltage. Thus it passes a relatively large current when a positive voltage is applied to the anode, and practically no current when the applied voltage changes to negative. In other words, the diode has a *low* resistance when its anode is made positive and a *high* resistance when the anode becomes negative at a different point in the A.C. input cycle, and this fact, combined with the action of the coupling condenser, will, I think, give the required answer.

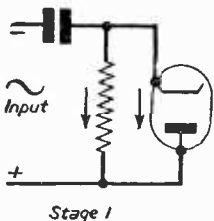

Diode conducting, resistance in parallel.

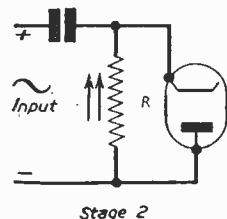

Input polarity now reversed, so diode is not conducting. Current now flows through resistance in the opposite direction, and this current through R is greater than in Stage 1.

Thus current flows through the resistance in *both* directions over a period, but it is greater when the diode is non-conducting. The net *balance* of flow is therefore as indicated in Fig. 4 of the February issue, so there *does* exist a net circulating current in the closed circuit, and this current can be measured with a sensitive meter. In brief, currents flow through R in both directions at different times during a cycle, but there is a greater current in one direction than in the other, giving a resultant D.C. potential across R.—C. A. EDGINTON (Godalming).

P.S.—All my references to “current flow” are intended to mean “electron flow.” Surely it is time the “conventional current” idea was dropped.

STEREOSCOPY

SIR.—Although the practical possibility of large-scale projection television was certainly demonstrated at the South Bank Exhibition Telekinema, the principal

feature was really the three-dimensional film, which clearly proved that the light-polarising method of picture separation stands head and shoulders over the anaglyph method. The discomfort of seeing a blue-green picture with one eye and a red impression of the same scene with the other, was entirely dispensed with and, consequently, stereoscopic films in true black and white and full technicolor were shown with a fidelity comparable to that of ordinary cinematography.

From my position towards the rear of the auditorium, however, a “scale model” effect was noticeable, particularly in the Thames-side scene. The Round Tower of Windsor Castle is a rather impressive structure, and would hardly have appeared to the cameraman as a tower about 8ft. high suspended in mid-air nearly 20 yards in front of him! This, perhaps, shows that the projectionists had to effect a compromise in the register of the two pictures on the screen which would appeal favourably to patrons both in the front seats and at the rear of the cinema, and towards the front a very large optical angle is subtended by the screen upon the eye of the observer.

In the anaglyph system right- and left-eye impressions were through sheer necessity superimposed, but this meant that the extreme background of the scene appeared no farther away than the screen. If this happens, all other relative fore-to-back distances are reduced, and the linear dimensions of all objects portrayed are reduced in the same proportion.

Where separate projection systems are used for the two pictures, making a stereoscopic pair, it is highly possible that true-to-life perspective can only be obtained under the following conditions.

The screen should be viewed squarely and from such a distance that the optical angle subtended by any detail on the eyes of the observer is the same as the angle subtended by the original detail on the lenses of the camera.

The right-eye picture should be projected $2\frac{1}{2}$ in. to the right of the left-eye picture.

In all probability these conditions would hold good whether the size of the viewing screen is 15in. by 20in. or 18ft. by 24ft., and would apply equally to cinematography or television, where it is possible to project the two pictures of the stereoscopic pair by independent optical units.—G. E. LAND (Coventry).

THE NOISE FACTOR

SIR.—In his article, “The Noise Factor,” Mr. Thomasson obtains some surprising results, so surprising indeed that “technical purists” may not be the only ones to object to their accuracy. When he obtains a noise factor of 10 for an EC52 grounded-grid first-stage correctly matched to the aerial feeder and a noise factor of 3 for a similar stage without the impedance converter circuit, some further investigation appears to be necessary.

Without being able to consult the reference quoted by Mr. Thomasson, it is not possible to say whether the statement, “the noise factor for a single stage of any type which is matched to its input feeder is approximately $2 + \frac{4 R_{eq}}{R}$ ” is a misquotation, but it is easily shown that this equation is only true when the input resistance of the valve is much greater than the dynamic resistance of the tuned input circuit.

The noise factor of a single stage is given, approximately, by $F = 1 + \frac{R_T}{R_D} + \frac{(R_T + R_D)^2}{R_T R_D^2} R_{eq}$ where R_T = transferred aerial resistance.

R_D = dynamic resistance of aerial coupling circuit at resonance.

R_{eq} = valve equivalent noise resistance.

When matched to the aerial impedance this becomes

$$F \text{ matched} = 1 + \frac{R_i}{R_i + R_D} + \frac{(2R_i + R_D)^2}{(R_i + R_D) R_i R_D} R_{eq}$$

where R_i = valve input resistance.

Now, when R_i is much greater than R_D this reduces to $F \approx 2 + 4 \frac{R_{eq}}{R_D}$, but this approximation is not applicable to a grounded-grid stage where R_i is much less than R_D . In this case, the noise factor equation reduces to $F \approx 1 + \frac{R_{eq}}{R_i}$ which is thus the formula to use for the matched grounded-grid stage.

Using the figures quoted in the article, the noise factor for a matched EC52 stage is given by the approximate formula as 3.06, whilst using the more exact formula and assuming $R_D = 5,000$ ohms it becomes 3.28. Consequently, the degradation in noise factor due to using an impedance converter circuit is about 1.07, a not very serious factor.

It should be noted that these figures do not give the minimum noise factor obtainable with a grounded-grid stage. The noise factor can be improved at the expense of signal amplification by increasing the transferred aerial resistance, when it will be found that a minimum noise factor of 1.64 is obtained. However, the signal amplification is then 13 db less than for matched impedance operation, and due to the limited value of anode load allowable this noise factor could not be attained in practice. The optimum figure would lie somewhere between 1.64 and 3.28, depending on the stage gain required, bandwidth and noise generated in the following stages.—L. E. LAND, Lieutenant (L) R.N. (Lossiemouth).

In reply the Author states:—

"The difference between Mr. Land's figures and mine arises entirely from a differing interpretation of the symbol R_D in his generalised equation. I think the best way of dealing with the matter is to show the origin of a part of the equation. In order to simplify the working, I will take the case of an ideally noise-free valve by putting $R_{eq} = 0$. I think Mr. Land will find that the same result is obtained with the full equation.

"The essentials of the circuit are a generator of voltage E_s and internal impedance R_s , loaded by an impedance which I will denote by R_L . It must be made clear that R_L represents the whole loading applied to the generator.

"If the load is removed, the signal power is E_s^2/R_s , and the noise power is, as always, $4 KTB$. The reference signal/noise ratio is thus:

$$\left(\frac{S}{N}\right)_0 = \frac{E_s^2}{4 KTB R_s}$$

"When the load is connected, the voltage drop in the source impedance reduces the voltage output to $E_s R_L / (R_L + R_s)$, and the impedance of the circuit falls to $R_s R_L / (R_L + R_s)$ owing to the parallel connection of R_L and R_s . The signal power is $E_s^2 R_L / R_s (R_L + R_s)$ and the signal noise ratio is now:

$$\left(\frac{S}{N}\right)_{R_L} = \frac{E_s^2 R_L}{4 KTB R_s (R_L + R_s)}$$

"The noise power relative to signal power has increased $(1 + R_s/R_L)$ times because of the presence of the load R_L . The noise factor, in other words, is $1 + R_s/R_L$. For correct matching, the loading must

equal the source impedance, or $R_L = R_s$, making the noise factor 2.

"Turning now to Mr. Land's equation, with $R_{eq} = 0$, the noise factor becomes $1 + R_T/R_D$. It is clear that R_T and R_s are identical, and we would expect the same to be true of R_D and R_L , but Mr. Land treats R_D as including only the dynamic impedance of the tuned circuit, and gives a separate symbol, R_1 , to the valve loading. Moreover, he gives a further equation which covers the matched case, but which can only be made equal to 2 if R_D is negligibly small.

"In order to avoid complete dependence on mathematics, it may help to recall that the power transfer to the load when the matching is correct is 50 per cent. efficient. In other words, half the signal power is lost. It is therefore reasonable to expect the signal/noise ratio to be halved, corresponding to a noise factor of 2.

"In raising the detailed working of the noise factor expressions, Mr. Land has taken on something I preferred to avoid. Since he has raised the matter, I think it is only fair to ask him to justify the equations he gives by explaining why the input impedance of the valve is not included in R_D . It loads the input circuit, and thereby reduces the input power in exactly the same way as the dynamic impedance of the tuned circuit. I am prepared to believe that there may be some reason for his interpretation of R_D , but I cannot see it.

"The basic equations from which the expressions I gave were derived would be identical with that quoted by Mr. Land if $R_s = R_T$ and $R_L = R_D$. If matching is sacrificed, and R_D is made large compared with R_T , the noise factor $1 + \frac{R_{eq}}{R_s}$ becomes possible. This case is mentioned in the original article, but, as Mr. Land points out, there is appreciable loss due to the mismatch. The resulting low signal level makes low-noise design necessary in the second amplifier stage as well, and the technique is not easy to apply.

"Well, there it is. If Mr. Land will produce a convincing reason why his interpretation of R_D does not appear to fit the reasoning given above, I will gladly submit to his figures. I would like to point out that this matter only affects the grounded-grid stage, since in other cases the effect of the valve loading is relatively small."—D. W. THOMASSON (Exeter).

A COMBINED TELEVISION-BROADCAST RECEIVER

SIR.—In the constructional articles dealing with the above I omitted to mention the value of R_{S1} in the text. Normally, this resistance is not required in the circuit, but if slight cramping on the left-hand side of the picture is experienced which cannot be corrected by the linearity control, then R_{S1} should be included. The value required is found by experiment, but it may be anything between 10 k Ω and 100 k Ω . It may, of course, be combined with R_{S2} as a single resistance.

Also, in the list of resistance values, R_{S3} is given as 2.2 Ω . This should be 2.2 k Ω .—S. A. KNIGHT (Chelmsford).

BUILDING THE "PRACTICAL TELEVISION" RECEIVER

Price 3/6, or 3/9 by post

From GEORGE NEWNES, LTD., Tower House,
Southampton Street, Strand, London, W.C.2.

WANTED, home-built T.V. Set; P.W., E.E., Premier, etc. Working order, not essential. Box No. 111, c/o PRACTICAL TELEVISION.

VIEWMASTER Valves as specified, all guaranteed brand new and boxed, comprising 5 EF50, 2 KT61, 1 EBBC33, 1 EB91, 2 6K25, 1 6P28, set of 12 6B9/9/6/- Brand new, boxed, EF50, 7/6 each. ECH35, X61M, CCH35, 13/6; EY51 18/6; 6AM6, EF91, 10/6; 6AL5, EB91, 9/6; EBCC33, EF39, 6K7G, 6K7GT, HVR2A, KT2, EF8, 9D2, 7/9. Miniature all-dry battery types: 1S5, 1R5, 1T4, 354, 8/9 each, set of 4 34/-; all valves brand new and boxed. P.M. Speakers, leading makes, 24in. and 3in., 13/6; 5in. 12/6; 6in., 13/6; 8in., 14/9. C.W.O. Post paid 20/- READERS RADIO, 24 Colberg Place, Stamford Hill, London, N.16.

ELECTRICAL TEST METERS, all makes single or multi-range repaired and standardised. THE ELECTRICAL INSTRUMENT REPAIR SERVICE, 329, Kilburn Lane, London, W.9. (Tel.: Lad. 4168.)

THOUSANDS enjoyed them this summer. Did you? Build your own "Personal Portables" or even make "A Portable Television" and beat the Budget. "Personal Portables" 2/8, "A Portable Television" 3/2, post paid, from BRADBROOKS, Sennen, Penzance, Cornwall.

SOUND Vision Chassis, Haynes time bases, Scarf coils, PM focus, power pack, tube; cost £60, no surplus; accept best offer or separate. S.A.E. details. Box No. 110, c/o PRACTICAL TELEVISION.

IMMEDIATE DELIVERY.—Rainbow T.V. Pre-amplifiers, 2-valve model. A.P. S.C. or H.M. £7/10/- complete. HARMONY HOUSE, 116, Cambridge Road, Southampton.

VALVES, new, boxed and guaranteed. 6K8, £36. 6E1, 7S7, EF55, 12/6; 6AM6, 12/6; 6A25, 6AK5, 11/6; 5L6, 50L6, 12K7, 354, EC91, 807, 6N7, 5U4, 10/6; 6V6, 9/6; 1R5, 1T4, 1S5, 15/4. 5Z4, U14, 5Y3, 9/-; HVR2A, VR91, 8/6; 6H6, 4/6; VR92, 3/6; etc. Clearance offer: VR91, VR136, soiled tested O.K., 4/6 ea. 5 for £1, post free. Coax Cable, 80 ohms, 10d. yd. M'core Solder, 3/6 reel. .002 mfd. 8 kv Mica, 2/6. Post 6d. extra under £1. T.R.S. 71, Meadvale Rd., E. Croydon. Callers: 307, White Horse Rd., W. Croydon. (THO 1665.)

CO-AX CABLE, 80 ohms., 12/- doz. yds.; 26/36 twin rubber Cable, 7/6 doz yds.; new red EF50s, 7/9; EL32, 7/9; 6SN7, 9/-; 6SL7, 8/6; EF91, 10/-; EBCC33, 8/6; EF36, EF39, EK32, 9/6 each; KT63, 9/-; 6J7, 7/6; 6J5, 5/-; 2D2, 4/6; 6K6, 7/6; 6K7, 6/6; 12A5, 7/-; 5P61, 5/6. Mains Trans., 350-0-350, 6v. 5v. 100 m/a. 23/-, post 2/-; V-controls, 1/sp., 10K to 2 meg., 2/9. W/s.w., 4/6. P.M. Spkrs., 24in., 15 ohm., 11/-; 3in., 11/6; 3in., heavy, 12/6; 1/weight, 14/6; 5in., 12/11; 6in., 11/6; 8in., 15/6; 10in., 29/6. Pent. o/trns., 4/3. New list available. RADIO UNLIMITED, Elm Rd., London, E.17. (KEY 4813.)

TELEVISION AERIAL COMPONENTS, Alloy Tube drawn in A.W.10.G.; Mast-head Brackets alloy and wood masts, Chimney Brackets, Corner Plates and Lashing Cable, J. Strainer Bolts, U Bolts, etc. WALTER CRANE, Electrical Engineers, Wakefield. (Telephone: 2172.)

PRACTICAL TELEVISION.—Latest Broadcast/T.V. Set, complete set of formers and cans, L. F. L18, £1. RF coils wound chassis made to order, condenser kits supplied. Trade supplied. BEL, Marlborough Yard, London Archway, N.19. (ARC 5078.)

RATES

3/- per line or part thereof average five words to line, minimum 2 lines. Box No. 6d. extra. Advertisements must be prepaid and addressed to Advertisement Manager, "Practical Television," Tower House, Southampton St., Strand, London, W.C.2.

MAKE THESE RECEIVERS. Concise books of instructions, 1/6 ea. for TRF 2WB £5/10/-, MSS S'het £6, LMS S'het £6/5/-, complete with cabinet and valves. Thousands of components available. TRF Coils, 5/3 pr.; 1 x 350v. Tub. 2/9 doz; Dial Drum, 2 1/2in., 6d.; Microphones, 1/6; ex-R.A.F. 40.1 Trans., 6d.; etc., etc. 3d. stamp for latest list. SUSSEX ELECTRONICS LTD. (T.), Princes St., Brighton.

ALADDIN Coil Formers, 2d. each; miniature wire-wound T.V. Chokes, 6d.; Valveholders, B7G 1/-, B9G 6d.; 100 pf. midget moulded Mica, 4/6 per doz.; Block Condensers, 6 mfd. 1.000v., wkg. 5/3; Split Stators, 5 pf. Ceramic, 2/6; heavy duty Screened Cable, single 9d., 2-way 1/-, 3-way 1/3 per yd. Valves: 6J4, 6J6, 15/-; 6AK5, 12/6; 6AG5, 6A35, 9/6; 6C4, 7/6. Special offer, 9003 (ideal for sound I.P.), only 4/-. All goods new and guaranteed. Many other Valves. Components and Surplus Units at bargain prices. S.A.E. for list. Please add 9d. p. & p. on all orders. (Note new address.) ELECTRAD RADIO, 69, High St., Belfast, N.1.

COMBINED T/V Broadcast Receiver. All parts, including coils and B.V.A. Valves supplied. JARVIS, 12, Chatsworth Rd., Manchester, 21.

HANNEY OF BATH offers: P.W. and P.T. Television, set of coils with VF choke, 10/6 L'don, 18/- B'ham; E.E. Television, vision chassis, 22/6; sound chassis, 18/9; power unit chassis, 25/-; T.B. chassis, 17/6; these chassis complete with valve-holders, screens, coil formers, etc. W.W. TV S'het, coils available for all 5 channels, wound exactly to specification, 45/- Viewmaster, everything in stock, coils available for L'don, B'ham and Holme Moss (Wearite). We hold comprehensive stocks of TCC condensers, Eric and Morganite resistors, Colvern and Reliance pots, Bulglin, Elac, W.B., etc., etc. Send 3d. stamp now for lists covering all the above receivers. New goods only, no surplus. L. F. HANNEY, 77, Lower Bristol Rd., Bath. (Tel.: 3811.)

VIEWMASTER and EE Televisors. All parts in stock. Model on show. H.G. RADIO, 1350, Stratford Rd., Birmingham, 28. (SPR 2369.)

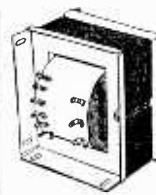

Mains Transformers UPRIGHT-DROP THROUGH AS ILLUSTRATED.

Two Types Only. Guaranteed. No. 1: 250-0-250v., 80 mA., 0-4-6.3v., 5 amp. 0-4-5v., 2 amp. No. 2: Same but 35v. Both 15/-, post 1/- for 1 to 3. **HILLFIELDS RADIO**, 8, Burnham Road, Whitley, Coventry

MAINS TRANS. R1355 Conversion type 200-250v primary 250-0-250v 100ma, 6.3v. 6a, 5v. 3a, 25/9. Electronic Eng. Televisor type 250-0-350v 250ma, 6.3v. 6a, 4v. 8a, 0-2-6v. 2a, 4v. 3a Primary 200-250v, 63/-, Brand New T.C.C. 0.1 plus 0.1 mfd 3500v, 8/9. Closed Field P.M. Speakers, 64in, 2-3 Ohms, 15/6; ditto, 5in. P.M., 14/9. Ex-Govt. Valves (unused): D1 1/3, EA50 2/9, SP61 2/11, VU133 3/9, VU120A 2/9. Manufacturer's Surplus Mains Trans., 200-250v Primaries, 300-0-300v 80ma 4v. 4a, 4v. 3a, 10/11; 320v 70ma, 6.3v. 3a, 7/6. Output Trans., 8000 ohms to 3 ohms, 4/6. Ex-Govt. items: Smoothing Chokes, 40ma 10h 450 ohms, 2/6; 60ma 10h 250 ohms, 3/11; 80ma 10h 250 ohms, 100ma 10h 400 ohms, 4/3. Condensers, .25 mfd 1250v 1/3, .5 mfd 3500v 2/3. All goods guaranteed. Full list of bargains 4d. C.W.O. or C.O.D. over £1. Post 1/3 under £3. RADIO SUPPLY CO., 15, Wellington Street, Leeds.

£20 or near offer. Premier, TV "Electrostatic" model, working, complete with cabinet and enlarger. Phone: 1158 Littlehampton, Sussex.

T.V. CABINETS!! We are pleased to announce that further orders can now be accepted for our Standard Console Cabinets (with full or half length doors), suitable for all popular kits. We also construct cabinets of all types to customer's own requirements. Send s.a.e. for full information to: D. CHURCH, ESQ., 13a, Harrow Rd., Wembley, Middx.

GUARANTEED VALVES: 807, 6L6, 5Z4, 6V6G, 5U4G, all at 8/6 each; 6K7G, 6J7G, 6C6, 6D6, 1A5, 0Z4, all at 8/- each; 12A6, 6B8, 3D6, 1LN5, all at 9/6 each. C.O.D. or C.W.O. Postage 6d. ELECTRO-SERVICES & CO., 28, Eichelburga St., S.W.11.

VALVES.—New and boxed. VU111, 5/-; VR91 (EF50), 8/11; VR85 (SP61), 6/6. Ex-equip.: VR91, 5/-; VR65, 5/-; Twin 7/36 PVC Flex (brown), 2d. a yd. 50ft. PVC Covered Aerials, 1/- Special: Generous Parcels of Components from Stripped Equipmt., 1/6 each. Kit Receivers, Amplifiers and Pre-Amps assembled, 7/- per valve stage. All work guaranteed. Please include sufficient for postage. R. E. HOPE, 1, Stoopers Hill, Bennington, Herts.

SITUATIONS VACANT

AN EXCELLENT OPPORTUNITY occurs in the service department of a large manufacturing company for a man keenly interested in radio and television to be trained as a technical correspondent. Successful applicant will need to be a good letter writer and will work in the South London area. Full details to Box No. 112, c/o PRACTICAL TELEVISION.

EDUCATIONAL

FREE! Brochure giving details of Home Study Training in Radio, Television, and all branches of Electronics. Courses for the hobby enthusiast or for those aiming at the A.M. Brit.I.R.E., City and Guilds Telecommunications, R.T.E.B., and other professional examinations. Train with the college operated by Britain's largest electronic organisation. Moderate fees. Write to E.M.I. INSTITUTES, Postal Division, Dept. P.T.28, 43, Grove Park Rd., London, W.4. (Chswick 4417.) (Associated with H.M.V.)

TELEVISION Servicing and Theoretical (postal) Courses at extremely moderate fees are available from the Institute of Practical Radio Engineers, either for study or as reading matter only. Syllabus post free from the Secretary, I.P.R.E., 20, Fairfield Road, London, N.8.

TRADE TOPICS

Rainbow Frequency Converter

HOLME MOSS viewers are catered for by a new frequency converter produced by Rainbow Radio Manufacturing Co., Ltd. This is intended for Sutton Coldfield receivers—superhet or straight—and is for A.C. mains only. The converter is of the double frequency-changer type employing two Mullard EF91 valves. The I.F., as well as the input and output circuits, are arranged to give wide-band response, and balanced as well as coaxial input and output connections are provided. The converter is contained in a ventilated, grey crackle finished steel case and measures 8 $\frac{3}{8}$ in. by 4 $\frac{1}{2}$ in. by 2 $\frac{1}{8}$ in. and may be mounted on the back of most receivers. The price is £8 complete with all plugs, etc.

Rainbow Radio Manufacturing Co. Ltd.,
Mining Lane and Mill Lane, Blackburn, Lancs.

R.C.A. 21in. Rectangular Metal Picture Tube

THE 21AP4 announced by R.C.A. is a new, short, directly viewed, rectangular picture tube of the metal-shell type for use in television receivers. It has a picture size of 18 $\frac{3}{8}$ in. x 13 $\frac{1}{2}$ in. with slightly curved sides and rounded corners.

Its design incorporates a high-efficiency, white fluorescent screen on a high-quality faceplate made of frosted Filterglass to prevent reflection of bright objects in the room and to provide increased picture contrast. Employing magnetic focus and magnetic deflection, the 21AP4 has a maximum high-voltage rating of 18,000 volts; an ion-trap gun for use with an external single-field magnet for eliminating ion-spot blemish; a diagonal-deflection angle of 70 deg.; a horizontal-deflection angle of 66 deg.; a neck length of 7 $\frac{3}{8}$ in., and substantially less weight than a similar all-glass tube.

Further particulars of the above tube, including a data sheet, can be obtained from:

R.C.A. Photophone Ltd., 36, Woodstock Grove, London, W.12.

Conversion of G.E.C. Television Receivers for Holme Moss Transmissions

THE General Electric Co. Ltd. announce their arrangements for the conversion of their existing television receivers for reception of the Holme Moss transmissions.

For receivers which employ the superheterodyne technique, e.g. models BT.3443, BT.3839, BT.9144, BT.1091, BT.1093 and BT.4640, conversion kits are available to G.E.C. dealers at a nett price of 7s. 6d. each, with full instructions. The modification consists of substituting aerial and oscillator coils, etc., and can easily be done in the dealer's workshop.

For receivers which use the tuned radio frequency technique, e.g. models BT.2147, BT.5144 and BT.4541, the modification is extremely simple and can be carried out on site. It consists of the replacement of the existing R.F.

sub-chassis with another which can be obtained by G.E.C. dealers at a nominal cost of £7 each, less valves. Then, provided that the old sub-chassis is returned to the G.E.C. supplier within three weeks and in good condition, a credit of £5 will be passed, which will thus make the cost to the dealer £2 nett.

G.E.C. Ltd., Magnet House, Kingsway, W.C.2.

Modern Metal Finishes

MANY small and larger parts of highly intricate wireless or television sets, electrical equipment and electronic instruments are liable to suffer from rust and corrosion through frequent changes in temperature which cause condensation of the moisture content of the air on various metal parts.

A large number of manufacturers in the wireless, electrical and electronics industry have for many years found the various modern finishes of Messrs. Metal Processes Ltd., of Erdington, Birmingham, 24, to be a vital link in the chain of their finishing process. This firm specialises in metal finishes which can be imparted without the use of precious and semi-precious metals, or by the use of an electric current. These finishes are the result of many years of research and experience and in these days when all plating, except for armaments, has been officially banned, people are turning to them as the only effective alternative.

In the wireless industry many leading firms are using no fewer than three different finishes all developed by Metal Processes Ltd. in the finishing sections of their factories. Mark II Black may be used for the chassis and steel parts, whilst the Niklit (imitation nickel plating) Finish, S.G. (steel grey) or Brass (black on brass) process may be applied to all brass parts. These processes are by simple immersion in mild steel tanks and can be carried out by unskilled labour. Small parts, such as, for instance, brass soldering tags, may be immersed safely 5-6,000 at a time in baskets without shaking. Sound or T.V. aerials can be treated with Niklit as well.

Metal Processes Ltd.,
Kingsbury Road, Erdington, Birmingham, 24.

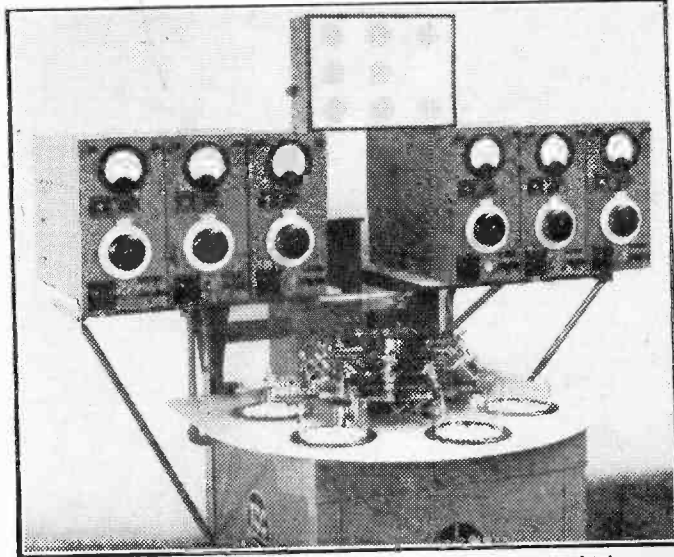

The ingenious machine used by T.C.C. for the measurement and tolerance grading of silvered ceramic condensers. It selects capacities from 10 pF to 20,000 pF and tolerances from 0.5 per cent. upwards.

YOUR Problems SOLVED

Whilst we are always pleased to assist readers with their technical difficulties, we regret that we are unable to supply diagrams or provide instructions for modifying surplus equipment. We cannot supply alternative details for construction, articles which appear in these pages, WE CANNOT UNDERTAKE TO ANSWER QUERIES OVER THE TELEPHONE. If a postal reply is required a stamped and addressed envelope must be enclosed.

SEPARATE SOUND RECEIVER

"I have been making my own receiver and have adapted several of your circuits, but always find the greatest difficulty is in getting rid of sound on vision or vice versa. I have tried various schemes, including coupling windings, small value fixed condensers, etc., but not having a signal generator, and being unable to borrow one, can never get the best on each channel. If the sound is good the picture is not so hot, and when I get a really good picture there is a noise on sound which cannot be tolerated. Can you assist me to get over this trouble without having to use a generator?"—J. Tomroy (Edgware).

There is a very simple solution of your trouble as you are so close to the transmitter. We suggest you use a separate receiver for each channel and avoid the common stages. Simply connect a 68-ohm half-watt resistor between the aerial socket on your vision receiver and a tapping on the sound input coil, with two stages of H.F. before the detector on sound. You can then adjust this easily for best sound and set your vision trimmers for best picture, avoiding double sideband tuning and adopting upper sideband reception, thus doing away with the need for the first stages to cover both sound and vision. At your address this should be quite satisfactory and will remove all difficulties in tuning without a generator.

16in. TUBE

"I have been thinking of buying one of the 16in. new metal tubes to replace my 12in. one, but have been told by a dealer that it will not work in my Viewmaster. Can you confirm this as I do not want to lay out the money unnecessarily?"—T. Burton (Wembley).

The 16in. tubes have a different deflection angle from the standard glass tubes now in general use and, therefore, your present scanning coils will have to be replaced, which may mean that the time bases would also have to be changed. Furthermore these tubes are intended for a much higher E.H.T. and although this might not be difficult it would mean that the line time-base amplifier would have to be changed. Additional H.T. could be obtained by a normal boosting circuit so this would not be difficult, but owing to the different diameter of the neck of the tube you would also have to obtain a new focus unit, and also a special magnet for the ion trap with which the tubes are provided.

153 UNIT

"I have been told that the ex-Government unit 153 is a very suitable unit for conversion to a vision receiver, and should be glad if you would confirm whether or not this is so. Has it any other name as I have not seen a single advertisement for a unit of this type? Does it

want much modification, and could it be used for the Holme Moss station?"—J. Preston (Hull).

The unit is generally known as the "Pye 45 Mc/s strip," and as such is readily convertible for use for the London transmitter. The coverage of the cores should enable it to be used for Holme Moss, although it is possible that additional trap circuits may have to be fitted in your area as Holme Moss is a single-sideband transmitter. The modifications needed are fairly extensive if really high-class results are required, although in the London area this strip has been used for good reception with very little modification. You will find that one or two advertisers in our pages feature this receiver, together with circuits and modification details.

FRAME AMPLITUDE

"My home-made receiver has now given me a fault which I should like to try and remedy. It takes the form of a narrow picture—that is, the objects are all crushed down and the clock in the introductory signal is oval instead of round. There is about half an inch of dark at the top and the bottom of the picture and I cannot open out to cover this with any of the three frame controls. What is the most likely cause of this please?"—H. Grantor (Tring).

As the receiver has been working correctly it is obviously a failure of some part of the frame circuit. As hold or frequency seems to be satisfactory it is almost safe to rule out the oscillator stage and this leaves either the amplitude control or the amplifier valve itself. If there is a similar valve in the circuit they should be changed round, but if not, and you have no suitable meter, you should have the valve tested, or try a replacement. Alternatively, if the emission is failing in the valve you could reduce the value of the cathode biasing resistor for that stage and thereby increase the anode current. If these do not prove effective it may be possible that turns are short-circuited in the frame scanning coil.

E.H.T. FLASHOVER

"I have just finished my receiver and on testing it I find that now and again there is a 'frying' noise and large white blobs appear on the screen in the form of wide bands. On looking to the back of the set I found that sparks were flying from the E.H.T. lead to the nearby screened amplifier input lead. They were about an inch away from each other and I moved them and it stopped the trouble. What can I do to make sure this does not occur sometime when the set is on and I am not about, in case it results in damage? Incidentally, I have used some standard motor-car ignition cable for the lead."—B. Fairburn (Croydon).

The voltage present is high enough to result in flash-over through quite large distances if adequate insulation is not provided. Car ignition cable should be satisfactory if new, but if it is old material it can prove useless for E.H.T. leads. Ordinary ex-Government coaxial would be better, with the outer screened covering removed as the insulating material there is much safer. In addition some care should be taken to ensure that all other leads are so fitted that they cannot come near the E.H.T. lead, and the latter should, if possible, be fitted in a rigid manner.

AERIAL INPUT

"I have been using an old, home-made receiver with home-made aerial and twin feeder input. I have recently invested in a commercial dipole and length of coaxial as I got a lot of car interference. I find, however, that by

connecting the two ends of the coaxial screen and lead to the two input sockets I get different results according to the way round I connect it. Should I use some form of matching device as I have changed the input impedance?"—J. H. Webb (Watford).

If your original aerial coil was designed for a twin-feeder input you should certainly modify it to get correct matching. All that is necessary is to remove the present primary winding which is certain to be fitted to the input coil and tap the secondary or grid winding about $1\frac{1}{2}$ turns from the earthy end. The inner wire of the coaxial is then taken to that tapping and the outer screening to earth. To preserve the utmost screening effect of the coaxial it is preferable to fit a proper coaxial plug and socket, and if the latter cannot be mounted on the chassis very near to the aerial coil any lead inside the receiver from socket to coil should also be of coaxial lead.

MICROPHONY

"I get very bad sound breakthrough on picture and have fitted two traps in the vision circuit which fail to cure the trouble. I have now found that it is not due to sound frequencies coming in the vision circuits but to the sound from the speaker on the video valve, and I can get almost the same effect by tapping the valve with a pencil. I find there are no anti-microphonic octal valveholders now available like there used to be and wonder if you can tell me the best way to overcome the difficulty."—D. R. Eames (N.7).

One way might be to stick a piece of plasticene or similar material on the glass bulb, but probably it is not merely the valve but the wiring or components also which are causing the trouble and we, therefore, suggest, if you have room, that you insert a piece of sponge rubber under each corner of the chassis, assuming, of course, that the chassis is standing on a shelf in the cabinet. Alternatively, the speaker should be removed from the cabinet front and thick "washers" of sponge rubber inserted between the bolts which hold the speaker to the cabinet so that actual vibrations from the speaker assembly do not cause the cabinet to vibrate. The sides of the cabinet might also need damping with felt or similar material.

MOIRÉ EFFECT

"I have spent a lot of time experimenting and building receivers and have noted a peculiar effect on nearly all of them and cannot find any reference to this in any of the articles I have read. It is only noticeable on the tuning-in signal when the clock is present. Down the middle of this there are some ruled lines very close together, and if you look steadily at the screen from a short distance these lines seem to 'twinkle' or flicker. Can you explain this? Is it a fault or merely an optical illusion?"—N. C. Prescott (Guildford).

We think it almost certain that it is a fault and is due to poor interlacing. American tuning signals carry a special ruled "wedge" designed to make more evident that effect which is known as the "moiré or watered silk" effect. It is due to the two sets of lines not appearing in exactly the same place on subsequent scans and although this is so small that no actual movement of the images can be seen on normal pictures, when a stationary ruled screen with very close spacing is being transmitted the effect is that there is a very slight displacement of adjacent lines and this gives the apparent movement. More efficient filtering in the sync separator stage or the

use of a frame sync separating diode may be recommended to improve the interlace.

INSTABILITY

"Would you please let me have some indications which would enable me to identify instability in a vision receiver? I am finding it difficult to get a home-design working satisfactorily and, being my first attempt at television, I am afraid I am a little in the dark, and this problem of instability is the one which I am up against at the moment."—F. Roderick (Hemsby).

Instability in a vision receiver can take several forms, but they are easily identified. In the first place the usual test may be carried out on R.F. or I.F. stages, namely, the inclusion of a current meter in the anode circuit of the suspected stage and the shorting of the grid to earth. In the case of the set being connected to the tube, usually oscillation in an early stage will give a pattern on the screen which will take different forms according to the setting of the time-base controls. Oscillation in the video stage—the most common form of trouble, will result in a "flaring" screen upon which no picture details will be seen. If you are adopting your own layout, great care should be taken to prevent feedback from the video stage and screening should be carried right up to the diode.

FAULTY VALVE

"My commercial receiver (circuit enclosed) has developed a peculiar fault which takes the form of a white line across the screen just below the centre. It looks like a car interference spotting run together but does not move up and down and remains stationary. I have tried all sorts of tests and my dealer has also had a go but we cannot find anything outwardly wrong. Have you any clue to offer in this case before we communicate with the makers?"—G. Whitwell (Canonbury, N.).

We have heard of this particular trouble and in the cases which have come to our notice the trouble was due to a faulty valve in the frame time base. It was apparently due to faulty cathode-heater insulation in the valve and replacement of the valve should cure the trouble.

COIL WINDING

"I am trying to make up the coils for the Compact Television and find that the screens are in short supply. Would you advise me to make my own, and, if so, as I cannot get aluminium but can obtain thin sheet copper, would the latter do? What is the best way of winding these coils, as I find that the turns tend to slip, even using thin strips of medical plaster tape to hold them?"—R. F. T. Davies (Scarborough).

You could make the screens from the sheet copper, soldering the joints. We have actually tried screens made up in this way and there is no detectable difference in performance between the two types. The supply position should, however, improve very shortly and the screens should soon be available. Regarding the coil winding, we refer you to the article in this issue on the subject and we think this will solve your problem.

REFRESHER COURSE IN MATHEMATICS

8/6, by post 9/- 4th Edition By F. J. CAMM

From: GEORGE NEWNES LTD.

Tower House, Southampton Street, Strand, W.C.2

CLYDESDALE

Bargains in Ex-Services Radio and Electronic Equipment

INEXPENSIVE T.V. ITEMS THE R3170A RECEIVER UNIT

A 16-valve radar receiver chassis, with 5 I.F. stages, R.F. section, high cycle power section. Valve types 8/EF50, 2/EA50, EC52, 5Z4, VU111, CV118. Housed in metal case, 18in. x 9in. x 8in. Finish grey
CLYDESDALE'S PRICE ONLY £4.12.6 CARRIAGE PAID

THE R3601 RECEIVER UNIT

A 14-valve dual chassis radar receiver, with 85 Mc/s and 45 Mc/s I.F. strips, R.F. section, high cycle power section. Valve types 5/SP61, 4/EA50, 2/EF54, EF50, EC52, 6V6 and VU39A rectifier, plus antenna switch, relay, etc., etc.
Housed in metal case, 18in. x 9in. x 8in. Finish light blue.
CLYDESDALE'S PRICE ONLY £4.12.6 CARRIAGE PAID

THE R3547 RECEIVER UNIT

A 23-valve Radar Receiver chassis, with detachable 45 Mc/s I.F. strip. Valve types 15/EF50, 3/EB34, 2/EF36, 2/V672, EA50, plus 24 v. motor, 700:1 gear box, etc., etc. Housed in metal case 18in. x 13in. x 7 1/2in. Finish black.
CLYDESDALE'S PRICE ONLY £5.19.6 CARRIAGE PAID

THE 5-SPICATHODE RAY TUBE

A 6-in. electrostatic tube. Heater vtr. 6.3 v., 0.6 A. H.T., 4,000 v. max., intensifier gives high definition. Trace colour green, short persistence.
CLYDESDALE'S PRICE ONLY £1.15.0 POST PAID

CAT. NO H524.—INDICATOR UNIT TYPE 6. IN MAKER'S ORIGINAL CASE

Containing a VCR97 Cathode Ray Tube, with mu-metal screen, 4/VR91's (EF50), 3/VR54's (EB34), various v.w. pots., switches, H.V. conds., resistors, etc., built in metal chassis to fit into metal box, 10in. x 8in. x 7 1/2in. All controls are brought to front panel beside viewing screen.
CLYDESDALE'S PRICE ONLY £4.9.6 CARRIAGE PAID

Order direct from:

CLYDESDALE SUPPLY CO. LTD.

2, Bridge St., Glasgow, C.5. Phone: SOUTH 27061/9
Visit our Branches in Scotland, England and N. Ireland.

SUCCESS!

In Radio, Television, and Electronics, there are many more top jobs than engineers qualified to fill them. Because we are part of the great E.M.I. Group we have first-hand knowledge of the needs of employers, thus our Home Study courses are authoritative and based upon modern industrial needs. Alternatively, our courses will prove equally valuable to you in furthering your hobby.

POST THIS COUPON NOW

E.M.I. INSTITUTES, Postal Division, Dept. 130, 43 GROVE PARK ROAD, CHISWICK, LONDON, W.4.

Please send, without obligation, your FREE BROCHURE. (I have marked the subjects which interest me).

- Mechanical Eng. Electrical Eng. Draughtsmanship.
 Radio. Television. Production Eng. Automobile Eng. Aeronautical Eng. General Cert. of Education (Matric). Civil Service.

Also courses for A.M.I. Mech. E., A.M.I.C.E., A.M. Brit. I.R.E., A.F.R.Ae.S., CITY and GUILDS EXAMS. in Mech. Eng., Elect. Eng., Telecommunications, etc.

Other Subjects

NAME

ADDRESS

E.M.I. INSTITUTES—The College backed by an Industry



ALPHA OFFERS

VALVES

KT30	12/-	6J7G	7/9	6AL5	11/6
Y63	9/6	6AC7	7/9	6K7GT	6/6
5Y3GT	9/-	EL32	7/9	6S47	9/-
EF33	8/6	EA50	2/9	NT40	11/6
955	3/-	6AM6	11/6	6SK7	7/-
Z68	11/9	B36	13/-	VP4	13/6
TP22	12/-	6Z4G	10/6	EBC3	11/-

SPRAGUE CONDENSERS

.01 mfd., 1,000 v., .25 mfd., 350 v., 7/- doz.
.001 mfd., 1,000 v., .25 mfd., 350 v., 6/- doz.

METAL RECTIFIERS

300 v., 80 m.a., 1 wave 5/9 each
280 v., 60 m.a., 1 wave 5/6 each
12 v., 1 amp. 1/- each
2 v., 1 amp. 5/- each

SEE OUR OTHER ADVE.

ALPHA RADIO SUPPLY CO.
5/6, Vince's Chambers, Victoria Square,
LEEDS, 1

TELEVISION COMPONENTS

FOR THE
"Practical Wireless"
VIEWMASTER AND
E. E. TELEVISORS
IN STOCK

Price lists of specified and alternative components available on request.

Prompt Postal Service

J. T. FILMER

MAYPOLE ESTATE, BEXLEY, KENT
TEL. Bexleyheath 7267

DUKE & CO. OFFER

TELEVISION & RADIO VALVES. New, tested, guaranteed. At 6/9 each: 6SL7, 6N7, 6K6, 6K7, 6B8, 12SK7, EBC33, 7H7, 7C5, 7S7, 7C6; and at 3/9: SP61, SP41, 954, 955 and many others. Full list on application.

TELEVISION LENS. Magnifier, enlarger, half normal price, best manufacture, 8in., 9in. and 10in., 55/-; 10in. and 12in., 75/-.

CHASSIS 251196 and 1124. We have been lucky to purchase a limited number of these popular chassis. First Come, First Despatched. 251196 details. NOTE PRICE, 12/6 each. With free drawings. These convert easily to A.C., Universal or Battery all-wave receivers. 465 I.F.'s, 4 tuning conds.; 24 fixed conds.; 32 resistors, trans., switches, vicontrol, v. holders, and all the usual parts. less valves post 1/6. 1124 details. 30 fixed condensers, 36 resistors, 24 trimmers (ceramic), 3 I.F.'s, 3 tuning coils, 5 Yaxley 8-way switches, vicontrols, vccaps, 2 trans. (OP and IV). If made to work set tuning. Television, Police, F.M., etc. 9/6. plus postage 1/6.

"SOLO" Soldering Irons. Pencil Bit, 15/- Under half today's price. 110v. easy to fit element for 230v. Brand New. Bargain. Last a lifetime.

NICKEL-CHROME WIRE. 50 yds. spool of .014 wire for only 4/6, or 25 yds. .032 same price. These prices are a fraction of today's prices (if you can buy it!).

LATEST MIDGET RADIO. In plastic cabinet, walnut or ivory, 4-valve T.R.F. Universal or A.C. for only £5/12/6. Assembled, 35/- extra. New and improved circuits. An amateur can build this set with practically no knowledge. THE ONLY set now available at this price. Post and packing 2/6.

* Money back guarantee. Cash with Order, please, or C.O.D. Stamps ONLY for Lists.

621, ROMFORD ROAD, MANOR PARK LONDON, E.12.

Phone: GRANGEWOOD 6677 for postal service. Or 219, Hford Lane, Hford, Essex. Hford 0295. Personal shoppers.

BERNARD'S HAVE BEEN ACQUIRED BY COLE - BERNARD PRODUCTIONS LTD.

TELEVISION, RADIO, AMPLIFIERS, Repairs, rebuilds, modifications or built to order; home-built equipment adjusted, aligned and tested. Despatch with full instructions for quotation without obligation. No ex-Govt. equipment accepted. All the above are available on hire-purchase terms.

All Enquiries to New Address
295, MUNSTER ROAD, FULHAM, LONDON, S.W.6.

ALUMINIUM, DURAL, BRASS, COPPER, BRONZE

ROD, TUBE, SHEET, BAR, STRIP, WIRE

3,000 STANDARD STOCK SIZES

No Quantity too small. List on Application.

H. ROLLET & Co. Ltd.

London: 6 Chesham Place, S.W.1. Kirkby Estate SLOane 3463.
Liverpool: Simonswood 3271.

16 INCH METAL C.R. TUBE

suitable for AC/DC operation

BRITISH MADE BY

'ENGLISH ELECTRIC'

FOR MANUFACTURERS AND HOME CONSTRUCTORS

The tube offers the following advantages:

- *Magnetic focus and magnetic deflection, 6.3 Volt, 0.3 Amp. heater.*
- *High efficiency, white fluorescent screen.*
- *Brilliant picture of uniform focus on an almost flat screen, final anode voltage 14 KV.*
- *Full-screen diameter picture 11" x 14 $\frac{5}{8}$ " or rectangular picture 10" x 13 $\frac{1}{2}$ ".*
- *Short overall length — suitable for shallow cabinets — 70° Deflection Angle.*
- *Metal cone envelope gives lightweight and robust construction.*
- *Ion trap fitted to prevent ion burn discolouration and prolong tube life.*
- *Small-shell duodecal 5-pin base.*



PRICE **£24.6.5** TAX PAID

For full technical details and price for quantities write to:

The ENGLISH ELECTRIC Company Limited

TELEVISION DEPARTMENT, QUEENS HOUSE, KINGSWAY, LONDON, W.C.2