

Tips, guides and reports for people

...tions and electronic equipment

TELEVISION

TELEVISION

PLQ

JEE

cl PLQ

AND HOME ELECTRONICS REPAIR

SEPTEMBER 2002 £3.10

Test report:

Promax MC377+ signal analyser

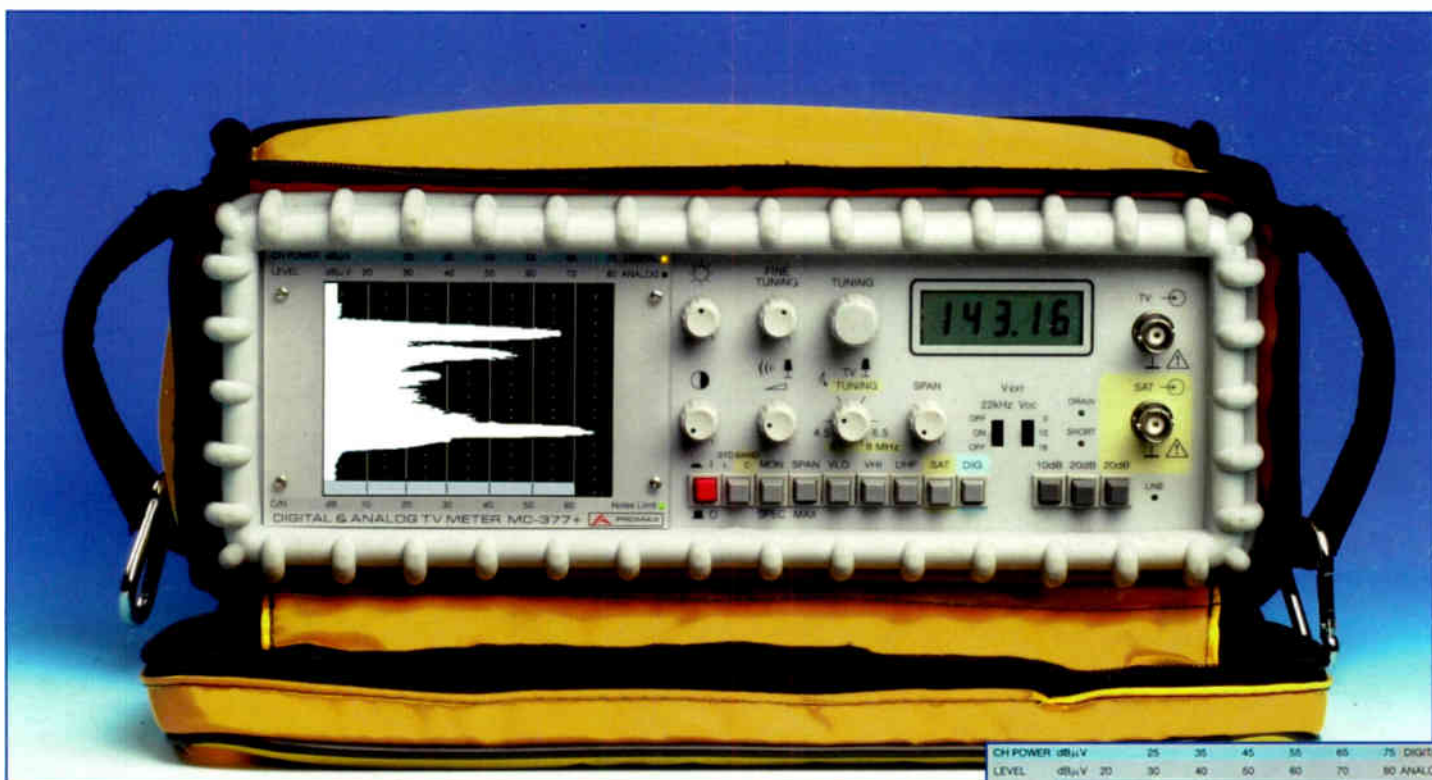

Servicing the

Sony FE-1 chassis

Nanotechnology, the future for electronics



Satellite, PC, Monitor, TV, VCR and DVD faults



A big part for a leading performer...

Eldor transformers are the most widely used LOPTXs in the European TV manufacturing industry, fitted as original product to over 70% of all sets produced. A leading role you could say.

With manufacturers such as Alba, Bush, Beko, Daewoo, Matsui, Goodmans, Proline, Philips, Samsung and Toshiba to name but a few, all trusting in Eldor to perform for them its worth remembering that the very same Eldor transformers are now available from your Classic distributor at very competitive prices. Simply quote the Eldor part number as shown on the transformer label.

Can't find the part number!

Eldor transformers are easily recognised by the Eldor logo shown on the transformer body. The Eldor part number format consists of two sets of 4 numbers which may also have an alpha character as a suffix. (On the example label to the right the Eldor part number is 1372.0031C)

For more information on the Eldor range, a copy of our transformer catalogue or details of a distributor near you, simply call 01635 278678 or visit us on the web; www.classic-electronics.co.uk



Technical helpline 01635 278678

CONTENTS

September 2002

Vol. 52, No. 11

643 Comment

The convergence myth

644 Teletopics

DTT licences awarded, digital TV update, scrap TV hazard, interactive TV, disc technology and other news items.

646 Test report: the Promax MC377+ signal analyser

Hugh Cocks finds that this receiver, signal-strength meter and spectrum analyser, for analogue and digital terrestrial and satellite signals, is well suited to the day-to-day needs of an active aerial installation business.

650 The way forward for electronics: a look at nanotechnology

There are limits to the possibilities with conventional silicon semiconductor technology. What might follow? The future could well lie with the carbon-based nanotube. Ralf Buckstone takes a look at a newly-developing technology that could be the basis of the next era in electronics.

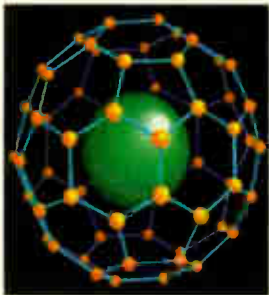

653 Help wanted

654 Servicing the Sony FE-1 chassis

The FE-1 was introduced in 1998 as Sony's core chassis for 50Hz Nicam models. It has much-simplified circuitry and physical layout in comparison with its predecessors. Giles Pilbrow describes the technical features of the chassis and provides fault-finding guidance, including a list of known faults.



665 Thomson's ICC17 technology

Part 3 of Mark Paul's description of the circuit technology used in this chassis deals with the tuner, IF and video signal processing sections.

668 Servicing the Mitsubishi TFS6705K monitor

The concluding instalment in Donald M. Henry's series on this 17in. monitor describes the operation of the digital control system.

674 DX and satellite reception

Terrestrial DX and satellite TV reception reports. News on TV broadcasting and satellite band changes. Moon-bounce reception. Roger Bunney reports.

677 Test case 477

678 Satellite notebook

An LNB problem, a satellite receiver fault and the latest digital channel update.

680 Monitors

Guidance on repairing monitors and related equipment.

682 VCR Clinic

684 Audio faults

Hints and tips on repairing professional and consumer equipment.

686 TV fault finding

690 Web service

Useful websites for TV professionals, technicians and enthusiasts.

692 Letters

Viruses. Mains switch problems. Sanyo spares. The interference danger from power-line telecommunications. Knife-edge signal refraction. Telephone checks. The Sharp 59DS03H.

695 Bench notes

Adrian Gardiner on storm damage, Vestel 11AK19 chassis fault-finding and a test equipment tip.

696 What a life!

A meddler, a Sony TV repair, camcorder and CD trouble and a Philishaver tip. Don Bullock's servicing commentary.

698 Next month in Television

Editor

John A. Reddihough

Advertisement Sales

Reuben Guronlian

0208 722 6028

Fax 0208 722 6096

Publishing Director

Tony Greville

Managing Director

Roy Greenslade

Note that we are unable to answer technical queries over the telephone and cannot provide information on spares other than that given in our Spares Guide.

Disclaimer

We work hard to ensure that the information presented in *Television* is accurate. However, *Television's* publisher - Highbury Business Communications - will not take responsibility for any injury or loss of earnings that may result from applying information presented in the magazine. It is your responsibility to familiarise yourself with the laws relating to dealing with your customers and suppliers and with safety practices relating to working with electrical/electronic circuitry - particularly as regards electric shock, fire hazards and explosions.

Next issue, dated
October, on sale
September 18th

The convergence myth

A few visionaries left over from the dot.com age are probably still going on about convergence. The general idea was that the various media – broadcasting, films, publishing, PC systems, telecommunications and of course the internet – would converge. There's a sort of initial plausibility, lots of synergy and all that sort of thing, about the idea: until you think about what ordinary people, the customers, might be able to make of it. After all they are the ones who have to pay the bills. A lot of money has been lost chasing after a sort of virtual world of interactive facilities: by virtual I mean that the facilities are there but no one takes much notice of them.

There are two ways of looking at the possibilities of media/communications convergence, from the point of view of the user and that of the service provider. Convergence is certainly easy enough to arrange for the user: TV sets can be used as monitors for web surfing, PCs can be turned into entertainment centres, and so on, but this doesn't mean that such technology mingling is ever likely to become the norm. TV is basically about entertainment, also news and information. You switch the set on and expect it to deliver: you don't expect to start cross-examining and tomfooling with it. Distractions are not what most people want once they've switched the set on. For effort-based screen-centred activity the PC is and will remain the logical tool.

One basic factor that separates active and passive screen use is the screen itself. The TV screen is based on broadcasting requirements. It's bright, and the resolution is set by TV transmission limitations. The monitor screen is a different animal. For one thing the phosphors differ, so does the brightness – a monitor is designed for close viewing, not projecting an image across the room. And the resolution is quite different: you don't need to be able to read small print on you TV screen. TV looks odd when displayed on a monitor screen – because that's not what it's for.

All this is pretty obvious, but was easy to overlook by those who got taken in by the convergence hype. And a lot of money can be lost getting this wrong. Alba lost quite a few million on its Bush Internet concept. It was a bright idea in some respects, but in practice was a compromise between different requirements. I can't help feeling that it is rather like the debate years ago about electricity and gas. You can do all you need with electricity, so why bother to distribute gas? But of course gas is superior for some purposes, particularly heating. So the two are likely to coexist in our homes for the foreseeable future. The TV/PC situation is similar: we need them both. The confusion comes from the fact that once you digitise TV all sorts of things become possible. But this doesn't mean that convergence is inevitable: what it means is that there are additional TV

possibilities that can be exploited.

The other way of looking at all this is from the information source. Broadcasters are still good at what they do, though we might not find all their offerings to our taste. They have to be, or they would go out of business (well, not in the case of the BBC, but the Corporation still has to provide a reasonable performance to justify its licence revenue). Broadcasters have to aim at large audiences: what has been called narrowcasting is not their function. The latter is ideally catered for by the internet, which you can use for the most obscure requirements.

Yet huge organisations have got it wrong. Take AOL Time Warner, which seems to be falling apart. Some bright sparks, actually Roger Pittman of AOL and Gerald Levin of Time Warner, were carried away by convergence hype. What they felt was needed was a combination of on-line distribution (AOL) and the huge input of "content" that Time Warner could provide. So, two years ago, there came about the biggest merger in the history of the media, when AOL took over Time Warner, with its substantial cable TV amongst many other interests, for some \$105bn. There would be "internet-fuelled profit growth", and "cross-platform synergy". Sounds good, doesn't it? The merger was completed early last year, but it didn't turn out as hoped.

Those of us who felt that it didn't seem to make much sense have been proved right.

COPYRIGHT

© Highbury Business Communications. All rights reserved. No part of this publication may be reproduced, stored or transmitted in any form or by any means without the written permission of the publishers.

All reasonable precautions are taken by *Television* to ensure that the advice and data published are reliable. We cannot however guarantee it and we cannot accept legal responsibility for it.

CORRESPONDENCE

All correspondence regarding advertisements should be addressed to the Advertisement Manager, *Television*, Highbury Business Communications, Anne Boleyn House, 9-13 Ewell Road, Cheam, Surrey, SM3 8BZ. Editorial correspondence should be addressed to *Television*, Editorial Department, Highbury Business Communications, Anne Boleyn House, 9-13 Ewell Road, Cheam, Surrey, SM3 8BZ.

INDEXES AND BINDERS

Indexes for Vols. 38 to 50 are available at £3.50 each from SoftCopy Ltd., who can also supply an thirteen-year consolidated index on computer disc. For further details see page 698.

Binders that hold twelve issues of *Television* are available for £6.50 each from *Television Binders*, Pringle, Street Blackburn, BB1 1SA. Make cheques payable to "Television Binders".

Newstrade Enquires

Distributed by COMAG

Telephone: 01895 444055

ISSN 0032-647X

AOL Time Warner

Broadcasters have to aim at large audiences: what has been called narrowcasting is not their function.

The addition of Time Warner was not able to transform AOL, whose internet business subsequently became a big problem. It was assumed that increased advertising revenue would generate on-line profit growth, but this didn't happen. In April, AOL Time Warner announced a first-quarter loss of \$54bn, the largest ever recorded, and the share price collapsed. Gerald Levin quit as chief executive late last year. Robert Pittman resigned as chief operating officer in July. Executives from the Time Warner side of the business are now trying to clear up the mess. It seems that the two sides of the company wish they had never become involved with one another. Oh, and another thing: the Securities and Exchange Commission and the US Department of Justice have both started enquiries into AOL Time Warner's accounting practices.

SUBSCRIPTIONS

Wyvern Subscription Services, Link House, 8 Bartholomew's Walk, Ely, Cambridge CB7 4ZD. Telephone 01353 654 431 Fax 01353 654 400 E-mail cbm@wyverncrest.co.uk Please notify change of address.

Subscription rates:

UK 1 year £33.00, 2 years £53.00, 3 years £69.00.
Republic of Ireland 1 year £38, 2 years £61, 3 years £76.
Mainland Europe 1 year £48.00, 2 years £77.00, 3 years £95.00.
Rest of World 1 year £62.00, 2 years £99.00, 3 years £130.
Cheques should be made payable to *Television*.

BACK NUMBERS

If available issues are £3.50 each.



HIGHBURY
Business Communications

A SUBSIDIARY OF HIGHBURY HOUSE COMMUNICATIONS PLC

TELETOPICS

DTT licences awarded

Following the collapse of ITV Digital the ITC has awarded the licences to broadcast digital terrestrial TV in the UK to the consortium headed by the BBC. The other members are Crown Castle, which owns the transmitters, and BSkyB, which will be providing three channels. The initial plan is for 24 free-to-view channels, including the analogue ones, ITV2, Turner Classic Movies and five news/sports news channels, plus interactive and radio services. A music and a general entertainment channel are planned. Nine channels will be provided by the BBC, with the other channels being funded by advertising. The full ser-

vice is expected to start in October.

Existing ITV Digital set-top boxes should continue to be usable, though some retuning may be required, and units such as the Pace DTVA adapter are readily available at about £99. The interactive TV company TVCompass plans to release a DTT STB for £29, complete with remote-control unit, early next year. This is less than the cost of manufacturing the equipment, but the idea is to generate funds from deals with companies that offer interactive services, which would be accessed via the remote-control unit.

The modulation standard for DTT has

been changed from 64QAM to 16QAM. This provides a more robust signal, increasing the service area and reception reliability. The change should not affect existing receivers and STBs.

In a survey conducted by Taylor Nelson Sofres for Pace, 38 per cent of respondents agreed that more choice of free-to-air channels would encourage them to switch to digital: 44 per cent would be encouraged to switch by latest-release movies, 36 per cent by big sporting events and 36 per cent if offered a free-to-view package with a possible pay-TV upgrade.

Digital update

Pace started downloading MHEG functionality to its DTVA (digital TV adapter) customers on July 22, giving them access to a range of free-to-view interactive services and digital teletext channels, including BBCi, ITV Text+ and FourText.

The download was transmitted via the BBC Engineering Channel. DTVA users should have received notification on a BBC channel that their adapters were ready to receive the software download. A set of simple on-screen instructions guided the user through the step-by-step process of receiving the download. There was also a telephone helpline and a dedicated free-

to-view website – details of these were included with the on-screen instructions in case of any problems. The download takes approximately five-ten minutes to complete, after which the screen reverts to normal broadcast material.

Pace says that the downloads will be repeated twice in the near future to ensure that all adapters in the retail chain are updated.

BSkyB is to introduce new functions with its Sky+ box later this year. Thomson Multimedia has bought Grundig's South Wales based STB business Digital Intermedia Systems.

Disc technology

Philips has announced the development of a 3cm optical disc that can store 1GB of data using blue laser technology, and a 56 x 34 x 7.5mm drive to go with it. Applications envisaged include digital cameras, mobile phones, PDAs and portable internet devices. A prototype is being field tested to determine parameters – which applications might need what capacities. The technology conforms to the Blu-ray laser standard. Key items are thinner active-focusing mechanics and a new objective lens to reduce the thickness of the drive.

The DVD Forum has set up two sub-groups to study different approaches to developing the next generation of blue laser DVD formats. One will study an approach based on 0.6mm cover thickness technology, the other studying 0.1mm cover thickness technology. The Forum has also approved an optical specification for 3x DVD-RAM drive speed.

Teletest's move

Teletest Ltd., supplier of the neat little Ozan hand-held TV and PC test pattern generators, has moved to 4 Shelley Road, Bournemouth BH1 4HY. The phone number is 01202 646 100, fax number 01202 646 101 or you can e-mail purchasing@teletest.co.uk. There's a website at www.teletest.co.uk



National retailer Crazy George's has been rebranded BrightHouse. Set up by Thorn in 1994 to provide credit facilities for anyone, regardless of financial status, to buy premium-brand products and services with affordable weekly or monthly payments, it continues to offer the same shopping experience. The range of products available includes TV sets, VCRs, audio equipment, computers, white goods, bedroom furniture and upholstery. Payment can be weekly in store or by direct debit, there are cheque-cashing facilities and a Payzone – a new electronic top-up service for mobile phones and utility payments.

BrightHouse currently operates 101 stores in London, the Midlands, North East, North West, Yorkshire, Scotland and Wales, employing a staff of 1,000 nationwide. Store expansion is to continue, with another ten openings planned for the current year. The retailer offers an optional Service Cover package, providing full technical support in the event of product failure.

Scrap TV sets a hazard

By the end of the year scrap TV sets will be classified as hazardous waste, which means that they will have to be recycled or taken to specially-designated landfill sites. The problem is caused mainly the lead in the CRT, about 20 per cent of the content. It's used to provide X-ray protection, strength and clarity, but can cause ground pollution when the glass is consigned to a landfill site. Unfortunately there's no simple way of extracting the lead. The DTI has provided funding for research into techniques that involve smelting and electrolysis, but the ICER (Industry Council for Electronic Equipment Recycling) points out that the energy required could make this processing unacceptable. The CRT screen phosphor is

Video news

Sharp has announced an LCD digital ViewCam, Model VL-DD10, which is a combined camcorder, digital still camera and TV unit. Use of a modular system called a camera unit exchange enables the three units to slot into one. The TV tuner is optional. The main unit has a 3in. LCD monitor. There are several ways to connect to a home PC. Digital video can be transferred using the built-in i-link port, while still photos can be downloaded via the USB port or by using an SD Memory or MultiMedia card. Production is running at 10,000 units a month, but no price details have been announced and there is so far no suggestion of a European launch.

Panasonic has introduced the first combined DVD and hard-disk recorder to go on sale in the UK. Model DMR-HS2 can record up to 52 hours on its hard disk in the EP mode, twelve hours on a 9.4GB double-sided DVD-RAM disc and six hours on a DVD-R disc. The user can watch programmes recorded on the hard disk or a DVD-RAM disc while recording on the other. A time-slip function enables a live programme to be viewed from the beginning while the rest of the programme is being recorded. Other features include a JPEG photoviewer, high-speed copying (up to twelve times) from the hard drive to a DVD-RAM disc, an IEEE 1394 (FireWire) input terminal, two scart sockets (composite video and RGB), an S-video socket and phono audio sockets. Price is about £1,000. Panasonic has also launched the DMR-E30 DVD-RAM recorder, which can record on DVD-R as well as DVD-RAM discs. Price is about £550.

Philips has launched two lower-priced DVD+RW recorders, Models DVDR880 and DVDR890, at £499 and £399 respectively. They use blank DVD+RW or

another pollutant. In addition components and PCBs contain a number of dangerous heavy metals and halogenated substances.

The Environmental Agency has estimated that the number of landfill sites able to accept hazardous waste could fall from 240 to fewer than a "couple of dozen" by 2004.

Disposal costs are likely to rise from the current £8-10 a tonne to £30-50. As a result, dealers are unlikely to be willing to take away old sets – about 2.5 million TV sets a year are scrapped in the UK. The Waste Electrical and Electronic Equipment (WEEE) directive, expected to come into force next year, will make it obligatory to recycle 75 per cent of the weight of every TV set.

write-once DVD+R discs and include an IEEE 1394 (FireWire) interface, MP3-CD playback and compatibility with Super Video CD, Video CD, audio CD, CD-R and CD/RW discs.

The latest Sony portable DVD player, Model DVD-PQ1, uses the new Precision Drive 2 system. This has a new high-speed stepping motor and helps to compensate for disc warp and other imperfections. The dynamic tilt compensation mechanism is designed to provide more accurate tracking.

Satellite news

According to SES, 10.3 million households in the UK are now receiving broadcast and broadband services from the company's Astra satellites. The breakdown is 6.5 million via DTH/SMATV and 3.85 million via cable.

BSkyB installation charges were increased in early June, from £50 to £60 for subscribers to the top-tier Sky World package and from £70 to £100 for other subscribers. Installation charges were last increased in the summer of 2001. The STB and dish remain free as part of the

Interactive TV

NTL is to add Two Way TV's ArkT technology to its digital network, following a licensing deal between the two companies. The Ark system enables digital TV viewers to join in by voting, playing along with game shows and interacting with live programmes such as sports events and awards shows.

MTV launched WimblePong, an interactive tennis game based on the 1980s computer game Pong, during the Wimbledon fortnight. NDS technology was used to drive the system. It was the first time that gaming was introduced in UK TV during advertisement breaks. Access to the service was via the red interactive button on the SkyDigital remote-control unit. The simple linear graphics represented two 'rackets', with one player able to control them against the TV set with the two sides of the screen as the ends of the court. Ball powering was via the remote-control unit's arrow keys. A set lasted as long as the advertisement break.



Philips has launched this 42in. plasma-display TV set, Model 42PF9964. Features include a 1,200-page hyper-text and wordsearch (advanced tele-text navigation functions), a dual-screen mode for watching two different channels at the same time, Mosaic Screen which shows the main picture surrounded by eight smaller pictures from other channels, and Philips Digital Natural Motion, Digital Crystal Clear and Active Control technologies. The latter is designed to provide optimum picture quality from a variety of video sources such as TV, DVD or a games console. Price is likely to be about £5,800, without table stand. Philips plans to launch a 50in. version, Model 50PG9964, later this year.

installation/subscription. BSkyB expects to have seven million subscribers by the end of the year.

BT has been carrying out broadband internet trials via satellite throughout the UK. The service would be sold to internet service providers at about £15 a month, suggesting an end-user charge of £20-£30 a month. The dish needed for reception would be likely to cost about £400.

Test report:

Promax MC377+ signal analyser

Hugh Cocks finds that this receiver, signal-strength meter and spectrum analyser, for analogue and digital terrestrial and satellite signals, is well suited to the day-to-day needs of an active aerial installation business

We've been using a Promax Prolink 3 signal analyser for some time now – I reviewed it in the March 2001 issue – and needed a second unit for day-to-day satellite dish and TV aerial alignment. Some of the more complex functions provided by the Prolink 3 wouldn't be required, so we decided that the simpler Promax MC377+ would be suitable.

Table 1 shows the basic specification for the MC377+. It's the same size physically as the Prolink 3, and comes with similar shock-absorbing rubber fittings and a rugged yellow carrying case. There isn't a separate mains adaptor, as with the Promax 3: the mains lead plugs directly into the lower right-hand side of the MC377+.

Controls and displays

Photo 1 shows the control and display panel of the MC377+. There are a lot more knobs and buttons than with the Prolink 3, but operation is straightforward.

The red button at the left-hand side switches the unit on and off, the signal input sockets being mounted at the right-hand side. The three attenuator buttons are at the bottom, near the input sockets. All three attenuators can be used with terrestrial signals. With satellite signals only the right-hand button can be used – it's coloured yellow to indicate this. There's a colour-code for the controls: yellow indicates a satellite-only function, blue anything to do with digital signal measurement.

Switches that control the 13/18V LNB supply and 22kHz tone switching for high-band universal LNB operation are mounted just to the left of the satellite input socket. Strangely, power is supplied to both input sockets simultaneously, though the short-circuit LED flashes to remind you to switch off the supply when a terrestrial aerial connection is made. It's useful to have a DC voltage supply at the TV socket as this can be used to power a mast-head amplifier to measure its output without having to connect the companion indoor power-supply unit.

There are blue digital channel-power and grey signal-level scales, in dB μ V, above the CRT display. Below the screen there is a grey carrier-to-noise scale

Photo 1: The front control and display panel.

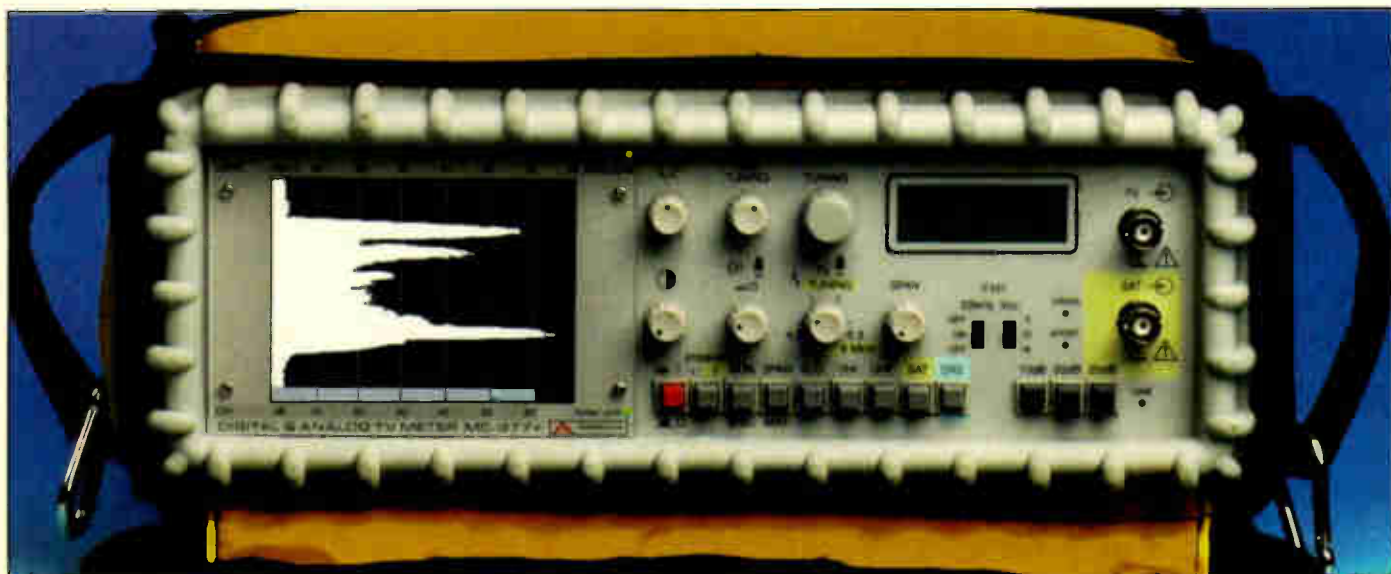

(dB) that's used in the spectrum-analyser mode only.

The two knobs nearest the CRT screen are for brightness and contrast control. The smaller knob to the right of the brightness control is for fine tuning, with the larger main tuning knob to the right of this.

The knob to the right of the contrast control is for volume adjustment. When this is pulled out analogue TV sound is available: when it's depressed an audio tone that varies with signal level can be heard from the speaker. To the right again there's the TV audio tuning knob, which gives fixed terrestrial audio when depressed and variable satellite audio when pulled out. The right-most knob in this row varies the span of the spectrum-analyser display.

The buttons in the row at the bottom are fairly straightforward. For digital signal measurement you depress the right-hand button with the blue surround. The four buttons to the left of this one select the low or high VHF, the UHF or the satellite band. To the right of the on/off switch there's a button (STD BAND) for video polarity selection. Next to this there's the TV monitor/spectrum analyser selection button. The final button selects maximum or partial spectrum-analyser display span.

The digital display indicates the frequency of the TV channel being received. Alternatively, when the spectrum-analyser display span is switched to maximum the tuning knob moves a cursor to the required part of the band then, when the span button is depressed, a frequency readout is obtained. A disadvantage is that there's no reference anywhere to TV channel numbers, just to frequency, so you have to be familiar with the local TV frequencies.

Physical features

The unit is well built. Photo 2 shows the internal arrangements. The satellite and terrestrial TV tuners can

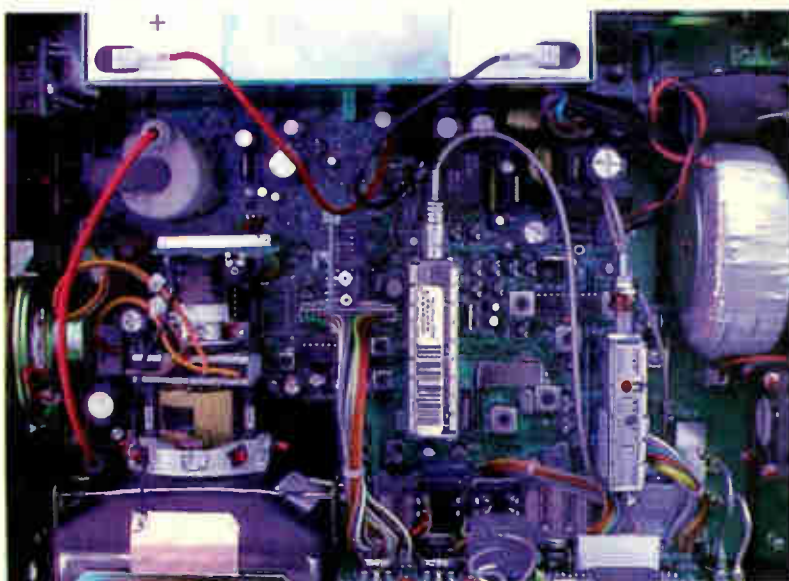

Photo 2: Internal view of the unit, showing the solid construction.

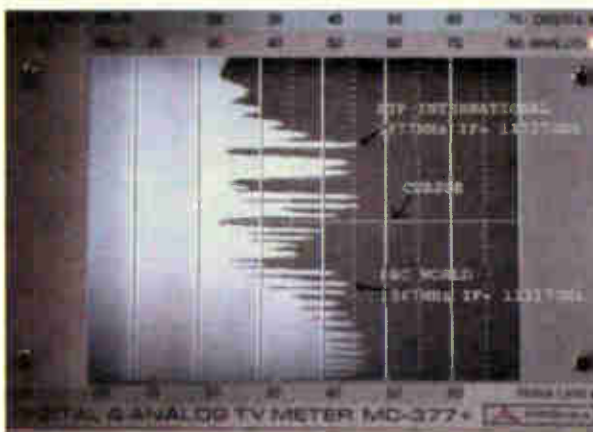

Photo 3: Full low-band, vertical spectrum for Eutelsat at 13°E.

Table 1: Basic specification for the Promax MC377+ signal analyser

Tuning ranges: Terrestrial 48.25-168.25MHz, 175.25-447.25MHz, 455.25-855.25MHz. Satellite 950-2,050MHz (IF). Extension to 2,100MHz available with option OPT-377+/63.

Resolution: VHF/UHF 10kHz. Satellite 100kHz.

Sensitivity: Terrestrial analogue 20dB μ V (10 μ V) - 130dB μ V (3-16V). Terrestrial digital 35dB μ V-125dB μ V. Satellite analogue 40dB μ V-100dB μ V. Satellite digital 45dB μ V-95dB μ V.

Attenuation: TV bands 50dB in 10 and 20dB steps. Satellite band 20dB.

Inputs: Separate BNC sockets for terrestrial/satellite bands. Belling Lee socket to BNC plug and F socket to BNC plug adaptors supplied. 0/13/18V selectable DC output at sockets with maximum current drain 350mA. LED on if current drain above 50mA and short-circuit warning. 22kHz selectable on/off.

Accuracy: TV bands \pm 4dB, satellite band \pm 6dB. Unit is supplied with measurement correction chart for all bands.

AV connections: Video and audio in/out via scart socket on side of unit. Input automatically selected with voltage applied to pin 8. Output is demodulated analogue video/audio (video 1V p-p at 75 Ω).

Video: Switchable normal/inverted for C/Ku band analogue satellite and French terrestrial signals. 4.5in. monochrome

CRT display. Signal level and video sync pulse representation can be superimposed on analogue picture, and carrier-to-noise ratio available in the spectrum-analyser mode for analogue and digital signals.

Audio: Model MC377+ has terrestrial analogue preset to system B/G/H (5-5MHz). Model MC377+/4 switches between system I (UK, 6MHz) and system L (France, 6.5MHz AM). Model MC377+/1 has 4.5MHz audio (systems M, N). Model MC377+/2 has 6.5MHz audio for systems D/K. Terrestrial and satellite analogue audio tuneable 5-8MHz. Output switchable to tone that varies with input signal level. Loudspeaker output 0.2W.

Spectrum-analyser mode: Spans entire band in max mode or between one third and very small amount in the span mode.

Mains input: 110-125 and 220-240V AC (selectable). Consumption 55W.

Battery operation: 12V 2.6A/hr. At full charge will run for one hour without LNB connected or about 60 per cent of this when supplying power to an LNB. Low battery voltage indicated by blinking colon in LCD display. Auto low-voltage shut-off. Recharge time 8 hours with totally flat battery.

Physical details: 31cm wide x 11.5cm deep x 26cm high (battery and rubber surround included). Weight 5.73kg.



Photo 4: C-band reception of Argentina ATV channel 7.



Photo 4: C-band reception of Argentina ATV channel 7.



Photo 6: Close-up view of TVE-2 reception in ch. 45.

be clearly seen, near the front of the PCB, with the battery at the rear and the mains transformer at the right-hand side of the chassis. The main tuning control is the large, blue multiturn potentiometer to the right of the CRT.

The unit switches to battery operation when no mains voltage is present. Battery time is as claimed: about an hour when there is no connection to an LNB, forty minutes when an LNB is connected.

The monochrome CRT provides good brightness and contrast outdoors. If need be the top of the carrying case can be used as a hood to screen out daylight.

Satellite operation

The spectrum-analyser scanning is vertical, which is the opposite to the Prolink 3, but one soon becomes used to the change. Photo 3 shows the full low-band vertical spectrum for Eutelsat at 13°E, with the RTP

(11.727GHz, IF 1.977MHz) and BBC World (11.117GHz, IF 1.367MHz) analogue services marked. The cursor is at the middle of the range, which would be displayed as expanded if the span/max button was pressed, with the span knob controlling the amount of expanded spectrum displayed.

Interestingly, the block of signals just above BBC World is of considerably lower strength. These are mainly analogue RAI (Italy) signals from the older Hotbird 1 satellite, which produces weaker signals here in southern Portugal. Some digital transponders can be seen above 11.727GHz, but the level from the LNB when switched to low band drops off sharply – it's intended to go to only about 11.7GHz.

Photo 4 shows Argentina ATV Channel 7 TV received from the NSS 800 series satellite at 40.5°W. This is a C-band signal at about 4.175GHz, which results in an IF at 975MHz. Fortunately Argentina still uses the FubK test card a lot during our morning hours – it's so rare to see a test card these days! The level display has been activated by pressing the volume control knob. To help with dish alignment an audible tone is available along with the level display. The analogue LED at the top right is lit to indicate that the lower, analogue scale at the top of the screen must be used.

With a C-band LNB the local oscillator frequency is above that of the wanted signal, rather than below as with Ku-band operation. The IF spectrum is therefore inverted, with the high-frequency signals producing lower IFs. As a result the video is inverted, so the standard/band switch has to be pressed to receive a picture.

LNB skew setting is simple. Find a suitable signal from the satellite and adjust the span of the spectrum-analyser display so that the signal occupies most of the screen. Select the opposite polarisation and rotate the LNB slowly until the signal disappears from the display.

Terrestrial operation

Use of the unit with terrestrial signals is very similar to satellite operation. Photo 5 shows ch. 21 reception of Moroccan TV with the signal level at just below 70dBµV and the frequency display showing 471.25MHz (ch. 21).

The line sync pulse outline can be seen superimposed on the newsreader's face (the colour burst is not displayed): when the signal starts to become noisy, 'grass' begins to appear on the outline. I've found the sync pulse useful when adjusting the video level input to some RF modulators. Crushing when the level is too high is immediately obvious, as the pulse becomes shorter and distorted.

To obtain the maximum bar reading at the top of the screen for accurate signal measurement I found it necessary to adjust the fine tuning for maximum signal once the main tuning control had been used to find the signal.

Photo 6 shows a close-up view of Spanish TVE-2 (second network) reception in ch. 45. or 663.25MHz as the MC377+ likes to call it, with the signal level at 65dBµV.

The readings obtained should be checked by referring to the correction chart that's supplied with each unit, see Photo 7. This shows that 1dB needs to be added to the 65dBµV reading obtained at 663.25MHz whereas 1dB should be taken off the 70dBµV reading obtained for Moroccan TV in ch. 21 (471.25MHz).

Photo 8 shows a Spanish ch. 48 (687.25MHz) terrestrial digital TV signal. We've no DTT

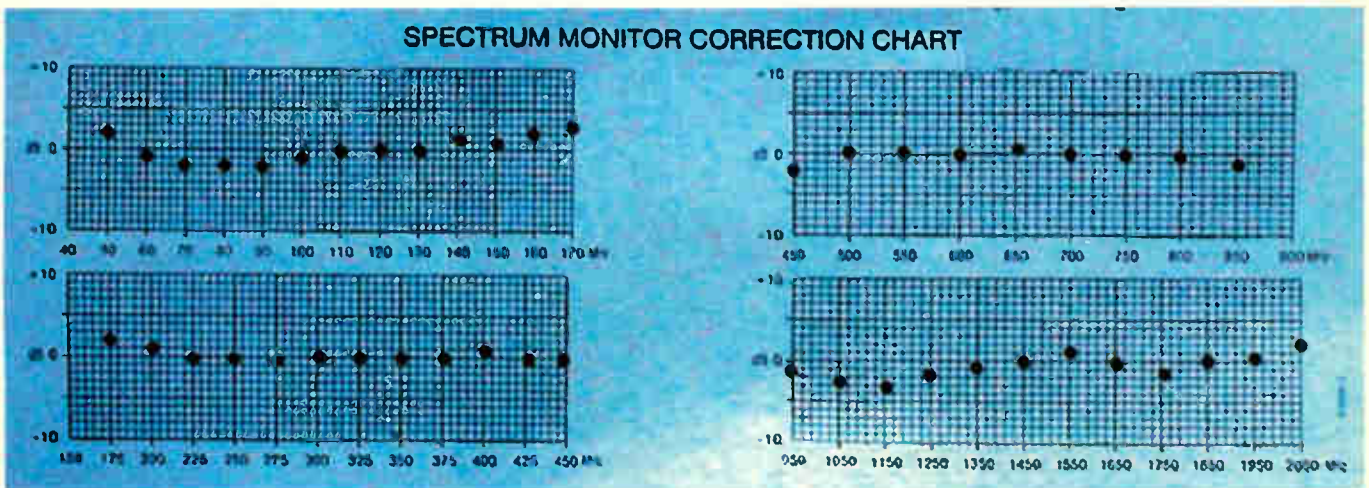

transmissions at present here in Portugal, so I've no experience of local reception. To measure the signal, press the blue digital button. The digital channel power can then be read directly from the top scale. In this example it's just over 55dBμV. Virtually no correction is required.

The bottom dark blue bar display indicates the carrier-to-noise ratio of the signal, at just over 25dB in this case. The noise-limit LED at the lower right-hand side of the screen is lit, which according to the manual indicates that the noise floor is below that of the receiver, so the actual C/N ratio is greater than that displayed. Digital signal measurement in the satellite band is identical.

Photo 9 shows four slightly weaker Spanish digital terrestrial TV channels in chs. 66-69. The topmost channels are slightly stretched in comparison with the lower ones. This may be because the terrestrial tuner has reached its tuning limit and requires higher tuning voltages to tune in the higher frequencies.

Video input

Video and audio signals can be fed into the unit via a scart connector. This is helpful, though I've never had to use the feature on site with the MC377+. It has proved very handy at times with the Prolink 3 however.

Unfortunately the facility is activated only when the control voltage at pin 8 of the connector goes high, as is normal practice with TV sets. Often one wants to know if video is present at the output from a scart lead, and there may be no switching voltage at pin 8. You can force the Prolink 3 into the AV mode via an on-screen menu. I'm tempted to make up some sort of switching arrangement to apply voltage to pin 8 of the MC377+ to force it to switch to an external source.

Demodulated video and audio are available at the MC377+'s scart socket, though not when in the spectrum-analyser mode. This could be useful in some circumstances.

Verdict

We've found that the Promax MC377+ fulfils our daily requirements very well and that there are not many occasions when we need the Prolink 3 to measure a signal that the MC377+ is not able to handle.

The MC377+ is available from Alban Electronics Ltd., the current list price being £895 plus delivery and VAT. This is a lot less than the Prolink 3. As a special offer to readers Alban can supply the MC377+ at £800 plus delivery at £10 and VAT at 17.5%. The price includes the carrying case, mains lead, calibration chart and manual. It's money well spent if you are in the

TV/satellite aerial business. Alban provides a back-up service should any problems be experienced.

More information can be downloaded from the Promax website (www.promax.es). Questions can be e-mailed to sales@promax.es - I've found that you get very prompt replies.

The UK agents are Alban Electronics Ltd., 6 Caxton Centre, Porters Wood, St. Albans, Herts AL3 6XT. Phone number is 01727 832 266, fax number 01727 810 546, or you can e-mail albanelectronics@cs.com

Photo 7: Signal-strength correction chart for the four bands (VHF/UHF/satellite).

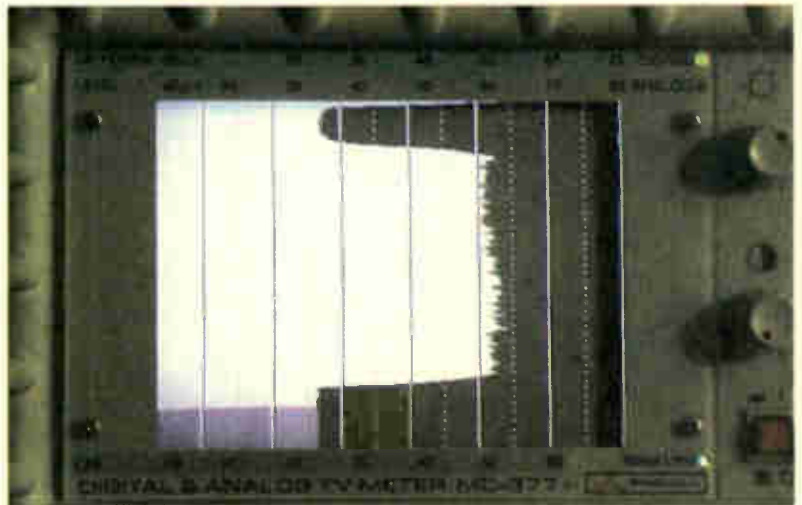

Photo 8: Reception of a Spanish DTT signal in ch. 48.

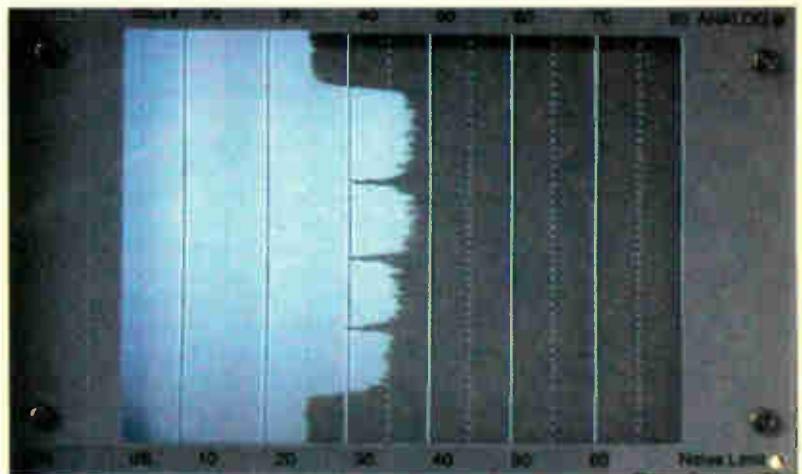
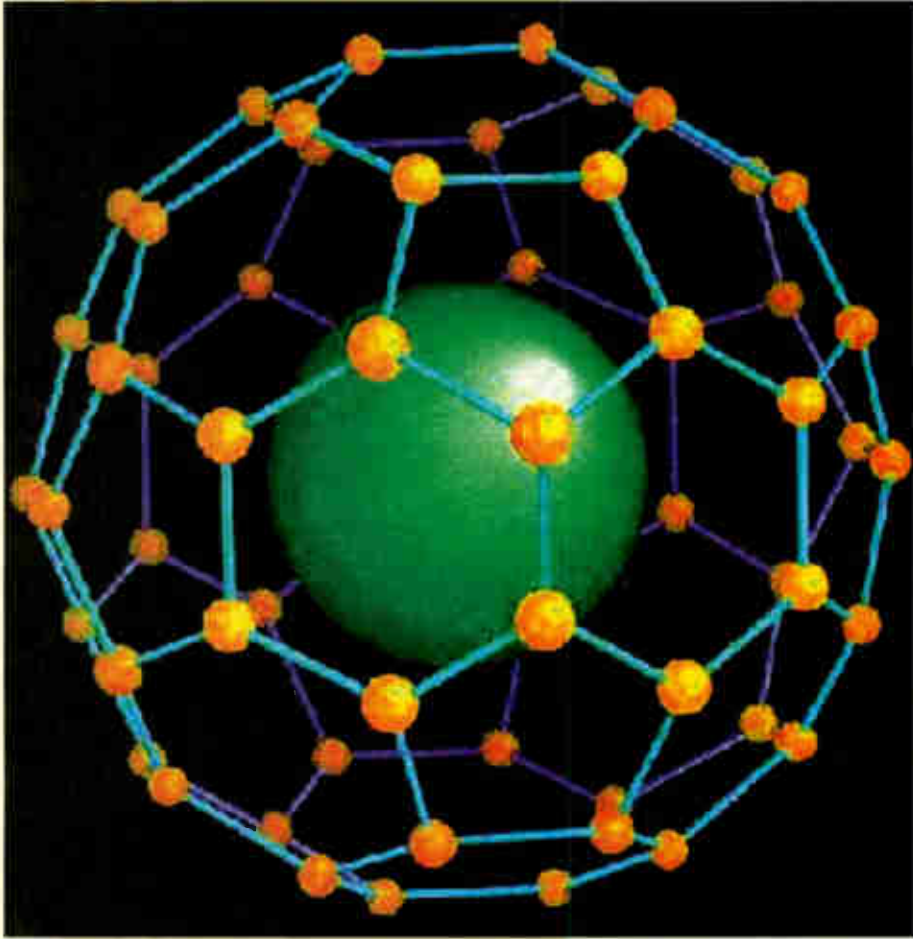

Photo 9: Spanish digital TV signals in chs. 66-69.

The way forward for electronics:



There are limits to the development of conventional silicon semiconductor technology. What might follow? The future could well lie with the carbon-based nanotube. Ralf Buckstone takes a look at a newly-developing technology that could form the basis of the next era in electronics

Photo 1: Basic carbon molecular fullerene structure.

A look at nanotechnology

Over the past few decades semiconductor manufacturers have been getting more and more on to their ICs, basically by managing to fabricate smaller and smaller transistors. But there's a physical limit to this reduction process. Beyond a certain point, a different technology will be required. We already know the direction in which the technology is likely to develop, because a lot of research and development work is being carried out on it. I'm referring to what has come to be known as nanotechnology. The carbon nanotube, which can emulate the action of transistors at molecular level, was first devised by Sumio Iijima of NEC in 1991.

Definitions

Nanotechnology is loosely defined as the study of functional structures with dimensions in the 1-1,000 nanometre range. It is rapidly emerging as a distinct and very promising field of research. A nanometre is a thousand million times smaller than a metre (10^{-9}). You can

envisage what's involved in this way. If a tennis ball could be expanded to the size of the earth, its individual atoms would become visible and would be about the size of a grape. Some three-four atoms, lined up together, fit inside a nanometre.

Organic chemists have for a number of years been designing and fabricating nanometre structures, using chemical synthesis. During the last decade however developments in surface microscopy, silicon fabrication, biochemistry and computational engineering have converged, providing remarkable ways of understanding, fabricating and manipulating structures at the atomic level. Research in nanoscience is advancing rapidly, partly because of the intellectual interest in constructing matter and molecules one atom at a time, and partly because of the prospect of new technical capabilities, devices and materials and the business prospects they could bring.

While nanotechnology is rooted in chemistry, other disciplines are now contributing to the research. At present

there appear to be three distinct though highly interdependent nanotechnologies, as follows.

(1) Wet nanotechnology. This is the study of biological systems that exist primarily in a water-based environment and have self-assembly attributes. The nanometre-scale structures of interest here are genetic material, enzymes and other cellular components. In fact the very stuff of life!

(2) Dry nanotechnology. This relates to surface science and physical chemistry, focusing on the fabrication of carbon structures (fullerenes and nanotubes, about which more later), also silicon and other inorganic materials. Unlike wet nanotechnology, dry techniques can involve metals and semiconductors. Electron conduction in such materials will not allow operation in a wet environment. It is electron activity that makes dry nanostructures so promising, as electronic, magnetic and optical devices. An objective is to develop dry structures that possess

some of the self-assembly characteristics exhibited by wet ones.

(3) Computational nanotechnology, which refers to the modelling and simulation of complex nanometre-scale structures. This predictive and analytical computational power is critical to the success of nanotechnology, by reducing the development time required to achieve working dry technology.

Over the past couple of years or so there has been a steady trickle of announcements about 'things nano', bringing back memories of how we initially heard about the development of the transistor, then ICs, then processors, memories and incredible advances in these fields, and subsequently the internet. All this is now everyday technology. Nanotechnology is likely to evolve in a similar way. It could be a time before the technology has an impact on day-to-day electronics – which is as well, as it will give us time to adapt to the changes involved. It's too early to be talking about practical systems and devices, but there is already some history and we can report on the latest developments in this field.

Fullerenes

During the last decade of the twentieth century two major discoveries that are at the heart of nanotechnology were made. These are fullerenes and nanotubes. What exactly are they?

We've known about carbon for as long as we've known about fire. But the element keeps revealing new secrets. The fullerene is one such. It has implications for physics, chemistry and engineering, and the potential is only just becoming apparent. The rather odd name comes from the architect R. Buckminster Fuller, who designed and built the first geodesic dome structure for Expo '67, Montreal. The geodesic dome contains pentagons as well as hexagons, and in this respect resembles the carbon structure now known as a fullerene.

Natural carbon is the basic element of all living substances. Two pure forms are well known: graphite and diamond. Fullerenes are a third type. The fullerene is a large, carbon-cage molecule with a highly symmetrical structure, see Photo 1. It's hollow inside, the surface consisting of regular polygons of atoms – this closed molecular structure has been given the name 'atomic microcluster'.

By far the most common fullerene carbon structure is C_{60} , which is often referred to as a 'buckyball' – another reference to Buckminster Fuller. But C_{60} is only one molecule in the family of fullerenes: C_{28} - C_{240} have so far been detected. These molecular cages are very small, having a diameter of about a billionth of a metre, or six-ten times the size of an average atom. A C_{60} molecule consists of sixty carbon atoms, each of which has the same number of neighbours, all bonded together at the

same relative angles in a structure rather like the shape of a football. The shape is called a 'truncated icosahedron', which is another way of saying that it consists of twenty hexagons and twelve pentagons.

There was much excitement when fullerenes were first discovered, because of some practical applications that were envisaged. There was speculation for example that buckyballs would make great lubricants, acting like small ball bearings between other molecules. Then there was the thought that drugs could be held inside the cages, targeted at various areas inside the body when released by a triggering mechanism. Another prospect is held out by the fact that when a single atom of gadolinium is inserted inside a buckyball its electrical resistance changes. Further, when pure C_{60} is doped with certain other atoms it becomes superconducting at high temperatures. So far however commercial applications of fullerene-cage molecules have yet to appear, despite efforts by research giants such as IBM, Xerox and DuPont.

Nanotubes

Nanotubes are a designed variant of the fullerene. The latter tend to form when a graphite sheet is 'rolled up', adding pentagons that create curvature. Each molecule becomes a cage (soccer-ball) structure. Carbon nanotubes – see Photo 2 – can be considered as elongated fullerenes with the ends cut off. This arrangement is referred to as a single-walled nanotube (SWNT). Instead of the combination of hexagons and pentagons that form a ball, the atoms in a straight-sided nanotube are arranged as sheets of hexagons. The result is a material that's quite different from the fullerene type, with extraordinary properties. A vital feature is that the properties depend on how the sheets are rolled.

If the sheet is rolled so that the hexagons line up straight along the nanotubes' axes, the tubes act as electrical conductors – like metal. If the sheet is rolled on the diagonal, with the hexagons spiralling along the axes of the nanotubes, they become semiconductors, with similar properties to the material at present used to make transistors and diodes. These unusual mechanical and electrical properties occur because each carbon nanotube is one giant molecule.

Photo 3 shows a comparison between various carbon molecular structures – diamond, graphite, C_{60} fullerene and 10, 10 nanotube.

Development work

Electronics is still overwhelmingly silicon-based, and it will take time for corporate thinking to get around to the new molecular upstart in the form of carbon nanotubes. Initial developments will probably be in specialised fields such as biological applications, or space technology where weight and durability are

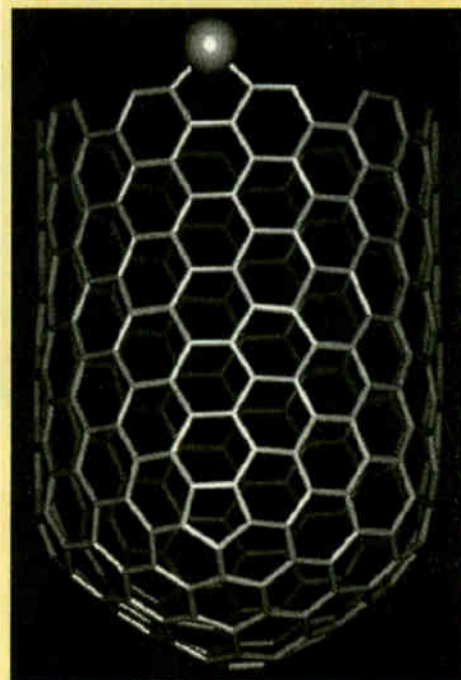

Photo 2: Basic carbon nanotube structure.

more important than cost.

The nanoscale science group at the IBM Research Centre in the US is one of those at the cutting edge of this new technology. It has developed ways of manipulating nanotubes so that they work as electronic devices, but there are still many problems. For example the current passing through a nanotube semiconductor can vary with environmental conditions – a vacuum say, or when exposed to oxygen, or even when there is contact with another surface. When the shape of a nanotube is altered its electrical characteristics change, which may be the reason for such problems. Although the theoretical model of a nanotube has beautiful symmetry, practice may be somewhat different. It's possible that at present nanotubes routinely have defects, making specific electrical performance difficult to determine. So practical nanotube semiconductor device manufacture may be some time off. Nevertheless the IBM researchers have created a simple logic circuit based on a carbon nanotube field-effect transistor. The claim is that such transistors are powerful enough to make large-scale ICs worthwhile.

Metal atoms can be added to the carbon structure to produce metal-carbon tubes, which have some interesting characteristics such as switching from insulation to metallic depending on the shape of the cylindrical region. Tubes don't have to be rolled 'straight', with the carbon chains forming circles to produce a cylindrical surface. They can be rolled with a twist, so that the carbon chains spiral along the cylinder, looking rather like a twisted bread stick. As the tube twists, it alternates between metallic (conducting) and insulating states.

Current nanotubes, smaller than strands of DNA, can be further reduced in size.

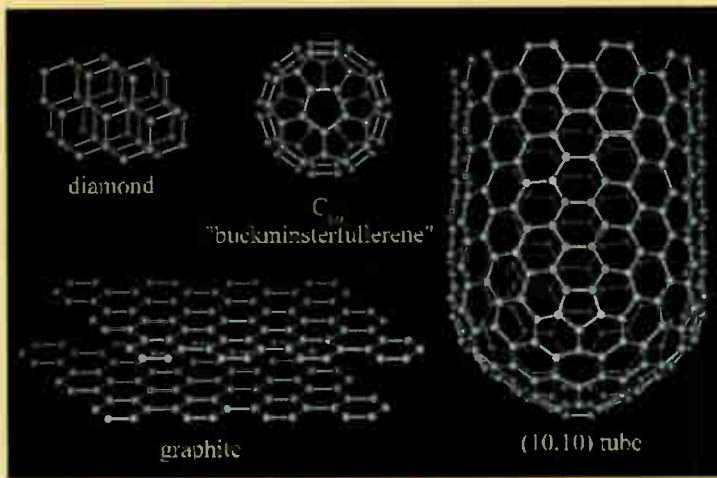

Photo 3:
Various
molecular
carbon
structures
compared
– diamond,
graphite,
C₆₀
fullerene
and 10, 10
nanotube.

NEC researchers in Japan have achieved an 0.4 nanometre width, which represents the theoretical minimum limit.

Possible applications

Quite a number of possible applications, in various fields, have been suggested. Chemists hope to construct what are referred to as 'bioreactors'. A nanotube could serve as a tiny test tube to hold a reagent (a substance with certain characteristic reactions) that could be used to carry out chemical analysis. Nanoscale machines such as pumps might be used to squirt the chemical where needed. A military application could be as a detector of poison gas or chemical weapons. Similarly, in the environmental field, water, soil or air could be monitored in the field to save sending samples to the laboratory for analysis. A device called a 'nanogenerator' has been devised and tested on mice. The tube holds a single highly-potent radioactive atom attached to an antibody that serves as a homing device to a cancer cell. Once it's inside the cell, the atom breaks down, releasing high-density particles that destroy the cell.

Nanotubes can store hydrogen by absorbing it and packing it more densely than with present gas-compression methods. This could be the basis of a fuel-cell powered vehicle. There is hope that a string of metal atoms could be inserted down the centre of a cylindrical carbon cage, thus producing a 'nanowire' with incredible strength – the ultimate carbon fibre.

Chemists at Harvard have developed what they refer to as a 'crossed-nanowire field-effect transistor' which is readily applicable to high-density integration without using lithography. While it's likely that by the end of the present decade lithographic processes might make it possible to produce a billion transistors on a chip, potentially a trillion carbon-nanotube transistors could be formed in the same space.

Nanotube transistors and SRAMs

Early attempts at producing a nanotube transistor resulted in a gain that was usually well under unity. The technology has moved on however, with

improvements in thinning the oxide layer used as the gate area. This makes possible a gain of between 10 and 20, with transistors that can be used for making things like and or gates and standard flip-flops (the basic memory unit).

Molecular logic has long been an aim in computer research. A research team at Delft University, the Netherlands, has claimed success in this field, with the prospect of logic circuits that run at speeds from MHz to THz (terahertz).

Various organisations have announced the development of carbon-nanotube transistors (CNTs). Current work aims at reducing the relatively large contact areas with their consequent high capacitance, which reduces operating speed.

When two Bell Labs scientists discovered the transistor effect in 1947 the device they created was as tall as the face of a wristwatch. Now a three-member Bell team at Lucent Technologies, consisting of physicist Hendrik Schon and chemists Zhenan Bao and Hong Meng, has made a single-molecule transistor – small enough for ten million to fit on the head of a pin. It was made of an unconventional organic semiconductor material using a novel fabrication technique, the channel space being one molecule.

The Bell team created what they termed 'conjugated molecules' from a carbon-based organic semiconductor material, known as thiols, that includes hydrogen and sulphur. Clearly the main problem in making nanotransistors is fabricating electrodes that are separated by only a few molecules, and then attaching electrical contacts. The Bell researchers overcame the problem by using a self-assembly technique and clever design.

A notch was carved in a silicon wafer and a layer of gold was deposited at the bottom to function as one of the three electrodes. The wafer was then dipped in a solution that contained a mixture of thiol molecules and some inert organic molecules – the inert molecules were added to dilute the concentration of thiols. This solution was allowed to dry. As it evaporated, a film exactly one molecule thick was left on the gold electrode. By careful adjustment of the ratio of thiol to inert molecules, it was possible to ensure that just one active molecule was present in the area on top of

the gold electrode. A second gold electrode was deposited on top of the film, with the transistor's third electrode at one side of the notch.

This self-assembly technique creates devices that are a hundred times smaller than those produced today, using the most advanced lithographic techniques, with a distance of about 1.3 nanometres, the size of a single molecule, between the transistor's electrodes. Compare 1.3nm, or 0.0013µm, with the size of today's latest commodity-chip lithography process, at 130nm – quite a difference! It's claimed that the chemical self-assembly technique is relatively easy to implement, is inexpensive and, unlike silicon, does not require the clean-room technology currently used by chipmakers.

The Bell team has demonstrated molecular-scale transistor switching and amplification, and a two-transistor arrangement that acts as a voltage-inverter circuit.

An Infineon team led by Dr Wolfgang Honlein, senior director of nanoprocessing research, has modified a standard silicon IC production line to enable CNTs to be fabricated at predefined locations. Previously it was difficult to combine methods used to produce CNTs, such as laser ablation and arc discharge, with normal semiconductor manufacturing technology. According to Dr Honlein, "it's very possible that nanotube technology could completely replace silicon-based semiconductor technology". The low resistance of CNTs allows current flow up to three orders of magnitude higher than would melt copper. This is particularly important, as semiconductor scientists expect that within ten years the current densities in IC conductors will approach the point at which they fail thermally. CNTs would then be a saviour.

Even smaller

When it comes to atomic physics, a molecule is quite a large thing. In time, it may be possible to go a step farther. California Nanosystems has reported that it can now continuously control the spin of an electron. According to the company the way to appreciate this is to think in terms of "spin engineering semiconductors" as opposed to current "charge engineered" devices. Spin-engineered electronics would be extremely fast and very dense, with low heat dissipation because only the spin of an electron changes. The heat required to flip the spin of an electron is infinitesimal in comparison to moving the charge in wire back and forth. Logic control could be achieved by spin variation, and could be stored in a semiconductor system that runs at far higher frequencies than today's technology, working at room temperature.

When you consider the heat generated by millions of transistors in current chip design, a limiting factor with regard to future development, the spin-control approach could be the solution and take us into a totally different electronic world. ■

HELP

The help wanted column is intended to assist readers who require a part, circuit etc. that's not generally available. Requests are published at the discretion of the editor. Send them to the editorial department – do not write to or phone the advertisement department about this feature.

WANTED

Wanted: Owner's instruction book for the Nokia 780IRD analogue decoder. D.E. Beeke, 30 Foxwood South, Soham, Cambs CB7 5YP. 01353 721 809.

Wanted/for disposal: Require a U1 C7907 four-terminal TO220 device that's used for motor control in the Philips N4520 reel-to-reel tape recorder. Anyone know a source? Have for disposal a Philips three-tube V300 video camera with power supply and an N1520 electronic-edit VCR with many tapes, both free to collector. Phone Steve Ball on 01733 347 678 (Peterborough).

For disposal: An Alba mono TV Model T1924 (Thorn 1500 chassis) with original stand. Has new tube and is in excellent working order. B.Borrow, Borrow TV, 27 Russell Rise, Luton, Beds LU1 5ES. Phone 01582 734 501.

Wanted: Circuit diagram for the Matsui 14in. TV Model 1407. P. Guarini, 31 Alderson Avenue, Rawmarsh, Rotherham S62 7DE. 01709 371 188.

Wanted: Circuit diagrams for the Goodmans MS388 Micro System Hi-Fi reference HM0180103032, or details of where these could be obtained. Len Winstanley. Please e-mail: lenwink@blueyonder.co.uk

Wanted: Remote-control unit for the JVC VCR Model HRJ400EK, with LCD panel. Michael J. Levy, 19 Totternhoe Close, Kenton, Harrow, Middx HA3 0HS. 020 8907 3620.

For disposal: 26in. ITT TV set in perfect working order complete with remote-control unit. The chassis is probably either the CVC20 or CVC30. The set is housed in a large wooden cabinet with stand, and features tambour doors. It's offered free to a museum or good home, but must be collected from Witney, Oxfordshire. Phone Morris Curtis on 01993 774 454.

Wanted: Service manual for the Panasonic Model TX2450. Also instruction manuals for the Epson Stylus Colour 300 and Olivetti JP192 printers. Originals or photocopies. D. Lee, 16 Devonshire Place, Cloughton, Birkenhead, Cheshire CH43 1TU16.

Wanted: Jungle chip for the Harwood Kyosho KTV41R. It's IC001, part no. 13-P47C434NP (ICPMP47C43AN-CTS-140). Either a replacement or one sal-

vaged from a faulty motherboard will do. Phone Dick Hagan (Home Electronics) on 01689 830 036 (Orpington, Kent).

For disposal: As I'm moving abroad I have reluctantly to dispose of *Television* magazines from Vol. 29 (1979) to the current copy, all in binders with indexes. Phone Ray on 01268 697 622 (Essex).

Wanted: Help with an intermittent remote-control problem with the Panasonic VCR Model NV-HD685. The handset seems to be OK, checked with TV sets. Could it be the sensor in the VCR and, if so, has anyone the type/part number? David Forfar, 26 Noel Gate, Aughton, Nr Ormskirk, Lancs L39 5EG. Phone 01695 420 950, e-mail forfar@uclan.ac.uk

Wanted: Motor assembly for a FIBO 90cm motorised satellite dish and any associated mounting parts. Would prefer in working condition, but interested in whatever you may have for this equipment. Phone Dave Robinson on 01295 814 367 (work) or e-mail dav.j.robinson@lineone.net

For disposal: Sony KV32WS2U complete. Micro panel damaged by water. rest of set and tuner OK. Phone Martin Scobie on 01803 293 157 (Torquay).

Wanted: Service manuals for the Thorn (Ferguson) 850 and 950 chassis, and any Decca monochrome, K-B and RGD TV manuals. Harry Todd, 12 Oakhurst Close, London E17 3PZ. Phone 020 8520 8003.

Wanted: Line output transformer for the Dell 1025HE monitor, part no. FM0638-1292-8001. Allan Horsfield, 2 Church Street, Baston PE6 9PE. Phone 01778 560 274 or e-mail a_horsfield@hotmail.com

Wanted: A number of the now obsolete Global ADX Plus Astra 1D converters, for a project. Must be the type with internal slide switch fitted. Phone Peter Atkinson, Camber Television Centre, on 01797 225 457 (East Sussex).

Wanted: Line driver transformer (L537) for the Pye Red Box Model 25KX1201/05L. Phone John Horswill on 01244 579 123 (Chester) or e-mail chorswillandco@ndirect.co.uk

For disposal: Vintage copies of *Radio Constructor*, *Practical Electronics*, *Radio & Electronics World*, *Electronics Today*

International, *Do It Yourself*. Details from Alan Bray on 020 8907 2920 (Harrow, Middx).

Wanted: Remote-control unit for the Samsung VCR Model SI3260. Programmable remotes will do everything – except put the machine in the standby mode. Phone Arthur Tomkinson on 020 8903 5574 (Wembley, Middx) or e-mail arthur@atomkinson.demon.co.uk

Wanted: Mains transformer for the Advance OS240 oscilloscope, part no. AI/34289, new or second-hand. Duncan T. Kidston, 102 Fergus Avenue, Livingston, West Lothian EH54 6BG. Phone 01506 433 371.

Wanted: Band selector/tuning control processor type TMS3757ANL, as used in the Loewe-Opta C8500 chassis and Philips Model 10CX1120. Phone Brian Treleaven on 01603 738 236 (Norfolk).

Wanted: Focus potentiometer for the Fidelity Model CTV14R (ZX2000 chassis) – Egen type 875 90001 or 876 90001. Alternatively does anyone have the kit referred to by S. Simon in the April 1986 issue of *Television*, or details on using the LOPT from the ZX3000 chassis? Mike Cooper, The Belfry, 53 Trethosa Road, St. Stephen, St. Austell, Cornwall PL26 7PZ. Phone 01726 822 280.

Wanted: A visor for the Sinclair Microvision early mono portable and a playback head for the Sony TC355 open-reel tape recorder. The latter is marked # PP30-2902. Can anyone explain line output transistor overheating with the Hitachi Model CPT2278 (NP83CQ Mk 2 chassis)? All relevant capacitors and the line driver transistor have been replaced and several LOPTs have been fitted. Replacement line output transistors last only about five hours. W. Milne, 20 Graham Road, Wimbledon, London SW19 3SR. Phone 020 8543 9542.

For disposal: B&O TV Model 4402 (with 26in. 20AX tube and ultrasonic remote control), Philips VR2334 VCR (V2000 type) and various B&O audio equipment from the Sixties and Seventies. Tim Jarman, 7 Cadet Way, Church Crookham, Fleet, Hants GU52 8UG. Phone 01252 616 938 (evenings).

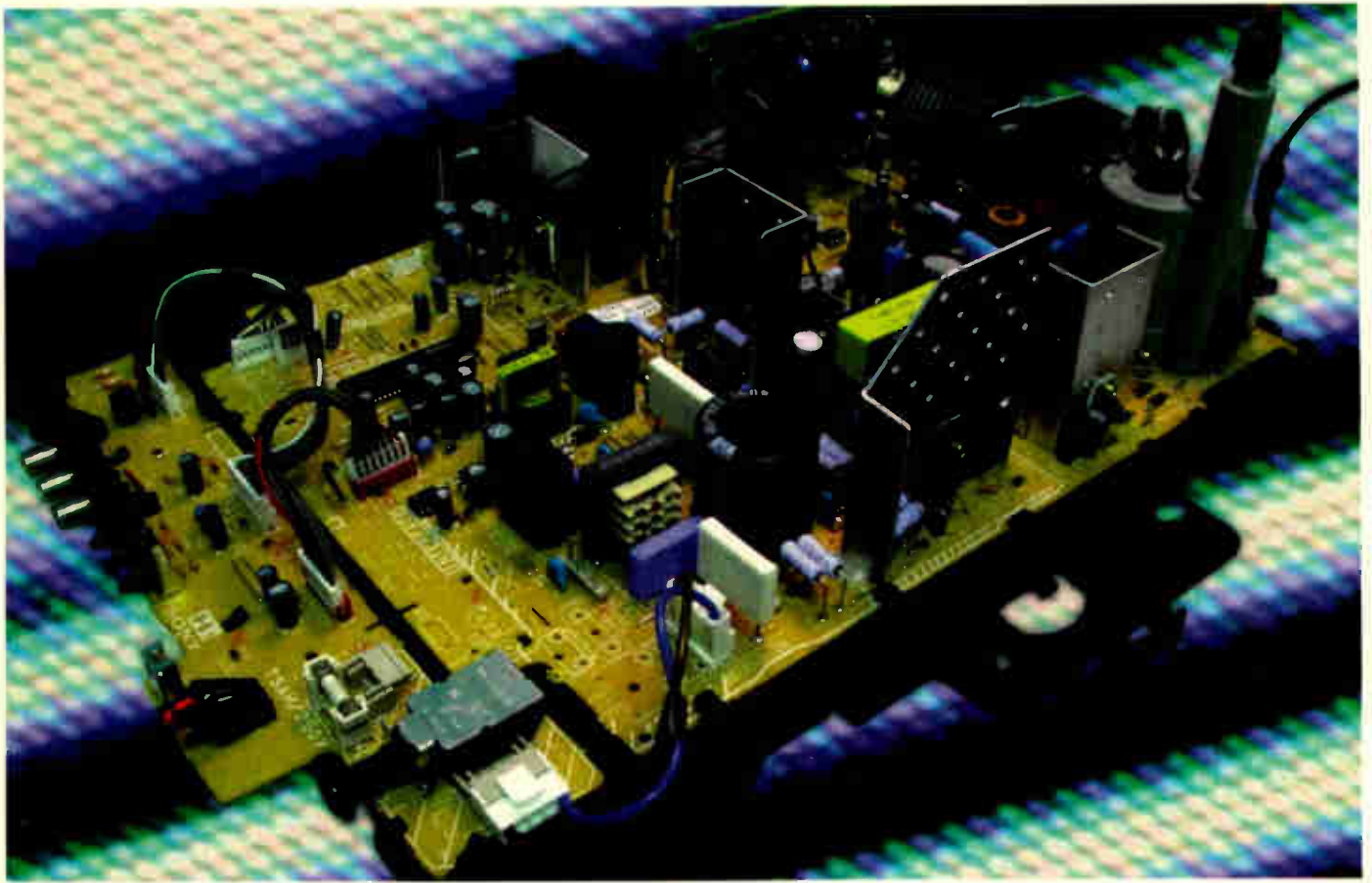

Servicing the Sony FE-1 chassis

The FE-1 was introduced in 1998 as Sony's core chassis for 50Hz Nicam models. It has much-simplified circuitry and physical layout in comparison with its predecessors. Giles Pilbrow describes the technical features of the chassis and provides fault-finding guidance, including a list of known faults

The FE-1, introduced in 1998, became Sony's core chassis for 50Hz Nicam models, taking over from the BE3D and BE5 chassis for 4:3 sets. It's much simplified in comparison with the BE3D, most of the circuitry being housed on the single main board A. The RGB output stages are on board C, Nicam decoding is carried out on board S1, while the small front PCB H1 is used for the control buttons and front AV inputs.

To date, the following models incorporate the chassis: KV21X5U, KV25K5U, KV25X5U, KV29K5U and KV29X5U. The remote-control unit for all these models is type RM883. In addition Model KV29FX20U, with remote-control unit type RM887, is fitted with the FE-1A chassis. This has some circuit variations to drive a Wega-type flat-faced CRT.

Standby operation

One major difference from previous Sony designs is the use of two separate power supplies. A small, efficient standby power supply keeps the consumption in this mode to less than 1W. Thanks to the TOP209 chopper chip (IC609) from Power Integrations Inc. the standby power supply, see Fig. 1, has a very low component

count. IC609 contains all the active circuitry, including a 700V MOSFET power transistor.

The mains input is half-wave rectified by D626 and D621 (type ERC04-06S), producing about 180V across the reservoir capacitor C638. This supply is fed via the surge-limiting resistor R627 to pin 2 of the standby chopper transformer T602. Pin 1 of the transformer is connected to IC609's drain connection, at pin 5. A snubber circuit consisting of D629, D628 and C646 is connected between pins 1 and 2 of the transformer to limit spikes that might damage IC609.

Operation of IC609 is governed by the voltage at pin 4. This is used for both regulation and start-up. At switch-on there will be no voltage at pin 4. A comparator within IC609 detects this condition and connects an internal resistor between pins 4 and 5, charging C640 and C639. Once the voltage at pin 4 has risen to 5.7V, the internal resistor is disconnected and drive is applied to the internal chopper transistor. During normal operation D627 provides the voltage for pin 4 of IC609, derived from winding 3-4 on the transformer. The voltage at pin 4 is then used to control the duty-cycle of the supply. It should be

Fig. 2: How to enter the service mode.
Press the keys shown while the set is in standby.

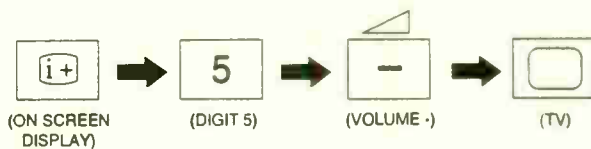

Secondary excess-current protection

Additional protection is incorporated to shut the set down in the event of a problem in the line output stage. The feed to the line output transformer T511 is via R572. Any increased loading will increase the voltage developed across this resistor. Once the voltage exceeds about 1.2V Q571 will conduct, in turn switching on Q574, which is connected to pin 18 of the colour decoder/timebase generator chip IC301. As a result its line drive output will be disabled.

The excess-current signal produced by Q571 is also fed to pin 52 of the microcontroller chip IC001, which reacts by putting the set into standby via Q601/R5601 and indicating the presence of the fault by flashing the standby LED twice. To avoid false triggering, the microcontroller chip ignores the voltage at pin 52 for the first two seconds after switch on. Should the excess-current circuit be triggered during that time, the error code (LED flashes) produced will not be 2 but a code associated with no line drive, such as 4 (vertical protection) or 5 (no auto grey-scale feedback).

Fault finding

Once the excess-current circuit has operated it can be difficult to determine the cause, as the microcontroller chip has switched off the main power supply. The best way to tackle this is to disconnect pin 3 (HT) of the line output transformer. In this condition the trip should not operate and, if the problem is in the line output stage, the LED will no longer flash twice. It might flash four times to indicate that the field scanning no longer works.

If the standby LED continues to flash twice with pin 3 of T511 disconnected there may be a problem with the protection circuit. The resistors around Q571 occasionally change value, giving rise to an error code of 2. Check R541, R573 and R575, which are all 100k Ω , and R543 (47k Ω).

If the line output transistor or transformer has failed the current-sensing resistor R572 (1 Ω , 2W) may have gone high in value. The result will be spurious shutting down.

Field output stage

The field output stage is based on an STV9379 chip, IC501, a device that Sony has used for some years. It gives little trouble, the usual cause of problems in this area being dry-joints.

Q501 and Q575 are incorporated to detect

field collapse. Should the field flyback pulses disappear Q575 will switch on, taking pin 15 of the jungle chip IC301 low. Pin 15 is connected to the internal V-protect register, which is regularly checked by the microcontroller chip. When the microcontroller chip detects a field problem it will mute the picture and flash the standby LED four times. Unlike previous Sony models, the set will remain on and not go to standby. If the line output stage is not running and the LED flashes four times, investigate other possibilities such as the excess-current trip circuit or no operation of the main power supply.

The line timebase

The line timebase is straightforward. IC301 produces a 5V peak-to-peak line drive signal at pin 19. This is fed to the base of the 2SC2688 line driver transistor Q535, which is coupled to the base of the 2SD2539 line output transistor Q533 via the driver transformer T531.

It is always a good idea to check the soldering in this area, as dry-joints at Q535 and T531 can be the cause of line output transistor failure.

East-west correction

A 2SK2251-01 MOSFET, Q532, is used to drive the EW diode modulator circuit. To reduce heat dissipation, the input to Q532 is a pulse-width modulated signal that's generated by an LM393N comparator chip, IC531. This IC receives a parabolic waveform input at pin 5 and line-frequency pulses at pin 6 (from pin 1). The duty cycle of its output therefore varies on a line-to-line basis, depending on the amplitude of the parabolic waveform. To stabilise the width, pin 5 of IC351 is also connected to the ABL output from the line output transformer (pin 11).

When there are width or pincushion-distortion problems it's a good idea to try the service-mode adjustments first (after noting down the existing values!) as some problems could simply be the result of misadjustment or memory corruption.

If Q532 becomes excessively hot, check/replace L535, C547 (750nF, 200V), C536 (1 μ F, 200V), T532 and L537. Not all these components will be fitted – it depends on the tube. Some of the coils may be linked out. The coils may show signs of overheating after a short period of use, possibly being warm to touch. This indicates shorted turns. The capacitors are a little harder to check: a capacitance meter may well give them a clean bill of health when they are actually faulty!

Audio

Audio signal detection is carried out by the IF chip IC101 (the exact type varies with model). The demodulated 6MHz mono audio output should be present at pin 8, the 6.552MHz Nicam carrier output at pin 12. Both signals are passed to IC1101 (TDA9875P) on board S1. IC1101 also receives audio from the AV inputs as follows: from scart socket 1 at pins 33/34, and from scart socket 2 plus the front AV inputs at pins 36/37. This chip has a crystal (X1101) connected between pins 18 and 19: no adjustment is needed, as X1101 is trimmed by varicap diode D1101 whose control voltage is derived from the Nicam error rate.

L and R audio outputs appear at pins 61 and 60 respectively of IC1101. As this IC operates from a single 5V supply, there is insufficient audio voltage swing to drive the audio output chip. So an audio preamplifier chip, IC1102, is included. The output from this is passed to IC201 (TDA7495) on the mainboard.

The jungle chip

IC301, a Sony CXA2060AS chip, carries out colour decoding/video processing and timebase signal generation. There are two RGB inputs and two video inputs, and the chip can decode any colour standard signal. It's operated at 9V under the control of the I²C bus.

RGB output stages

The RGB output stages are on the CRT base panel (board C). In each channel there's a cascode stage consisting of a 2SC1740 transistor driving a BF871 transistor. The output from this is fed to a BF421 emitter-follower transistor that's also used for auto-greyscale sensing. The collectors of these emitter-follower transistors are connected to a common line which is labelled IK. This abbreviation is found in many Sony circuits: I means current and K cathode. The IK line is connected to pin 21 of IC301.

If the IK signal is missing or distorted, here will be no picture. To indicate that there's an IK problem, the microcontroller chip flashes the standby LED five times (IK faults do not shut the set down). It's rather difficult to check the operation of the IK circuit, as any problem on board C is likely to result in a blank screen. The best method is to connect one channel of an oscilloscope to the IK line and the other to the R, G or B input to the board, then connect the trigger input to stable field-frequency pulses, from the field scan coils for example. It should be possible to see the individual R, G and B test lines produced by IC301. The test pulses fed to the board should be more or less identical, separated only by time. A correct IK signal will contain all three of these test lines. If there's a problem with the IK circuit, one line will be missing.

Table 1: Useful TT codes

Code	Meaning
00	Cancel service mode and return to normal operation
08	Shipping condition (resets customer settings to 'as new' values)
11	Sub-contrast adjustment
12	Sub-colour adjustment
13	Sub-brightness adjustment
14	Teletext horizontal position adjustment
18	Disables/enables inter-station muting
24	Sets sound IF and tuner band for UK
31	Disables/enables 15 minute auto-standby function
34	Toggles teletext character set between east and west (UK = west)
35	Toggles between wide and 4:3 CRT
36	Enables/disables velocity-modulation circuitry
49	Reprograms EEPROM to factory defaults (program 59 only)

Main power supply starts up but shuts down very quickly: IC603 (SE135N) faulty.

Set shuts down at start-up with 2, 4 or 5 flashes from the standby LED:

Check R541, R573, R575 (all 100k Ω) and R543 (47k Ω). These are all 5%, 1/10W chip resistors.

Set shuts down intermittently with 2, 4 or 5 LED flashes after displaying a bright red, green or blue raster: The CRT is faulty.

Set continually changes channels or adjusts the volume: S900, S901 or S902 on board H1 or IC005 (CD4052BCM-FL63) on board A is faulty.

Dark or no picture: R516 (56k Ω , 5%, 0.5W) or R517 (27k Ω , 5%, 0.25W) is high-resistance or open-circuit.

Excessive picture width: Q532 (2SK2251-01) is short-circuit. Check the other components in the EW circuit before returning the set to the customer.

A vertical band of interference is visible on the left-hand side of the screen with dark scenes: Add a 1,000pF, 2kV capacitor (part no. 1-161-731-81) in parallel with D539 in the EW diode modulator circuit.

A vertical purple line is visible on the picture: Replace IC301, type CXA2060AS, part no. 8-752-082-35.

Pressing the screen-format button displays wide, smart, zoom and 4:3 modes yet these settings have no effect on the picture: Enter TT35 in the service mode to select a 4:3 CRT.

One colour missing with teletext and on-screen displays: Check Q009 (red), Q007 (green) or Q008 (blue) as appropriate. These transistors are all type 2SC2412K.

No teletext, P100 only: Q405 (2SC2412K) is short-circuit.

No sound from cold: Check C618 (2,200 μ F, 25V).

No sound: Enter TT24 in the service mode. Alternatively Q202 (2SC2412K) could be leaky.

No remote-control operation: Check the remote-control sensor IC900 (type SBX1981-51, part no. 8-742-014-11) and D907 (MTZJ-9.1A) on board H1 and D023 (MTZJ-5.6B) on the main board as necessary.

Table 2: Error codes

LED flashes	Problem
2	Secondary excess-current protection
4	No field deflection
5	No auto-greyscale feedback
6	I ² C clock or data low at power-on
7	EEPROM (IC004) gives no I ² C bus acknowledgement at power on
8	Jungle chip (IC301) gives no I ² C bus acknowledgement at power on
9	Tuner gives no I ² C bus acknowledgement at power on
10	Nicam decoder chip (IC1101) gives no I ² C bus acknowledgement at power on

Geometry and grey-scale adjustments are carried out by pressing the handset's 'menu' button then choosing the appropriate option. Once an item has been adjusted it's memorised automatically.

EEPROM reset

The EEPROM's contents can be returned to factory-default settings by selecting programme 59, entering the service mode then, at the TT-- prompt, entering 49 followed by 24 (for the UK) and 08. Finally, switch off at the mains.

Error codes

Table 2 lists the LED-flash error codes and their meanings.

The error-history display

Some intermittent faults fail to occur when a set is brought into the workshop. The set is able to count the number of times any particular error code has appeared. To display this information, put the set in standby then use the key sequence shown in Fig. 4.

The resulting display shows the number of times a fault code has occurred, up to a maximum count of 255 for each code. If the set has been in use for some time, there may be error counts in some or all locations. To reset the error count enter 8 then 0 on the remote-control handset.

Known faults

The following is a summary of fault conditions that have been experienced with this chassis.

No power at all (standby power supply not working): IC609 (TOP209) faulty. Also check C640 (47 μ F, 25V), D631 (MTZJ-12B), D628 (P6KE200), D629 (UF4005PKG23) and R627 (4.7 Ω , 5%, 0.25W).

No power but relay operates (main power supply not working): IC606 (STR-F6654) faulty. Also check R659 and R660 (0.33 Ω , and 0.39 Ω respectively, 5%, 3W), R603 (0.1 Ω , 0.5W fusible) and C625 (100 μ F, 25V).

Fig. 4: How to obtain the error-history display. Use the key

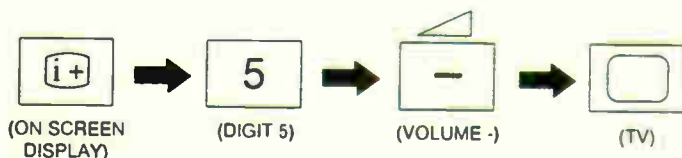

Grandata Ltd

distributor of electronic components

Special Offers and New Arrivals !!

Sky™ Digital Remote & TV Link Eye Combination

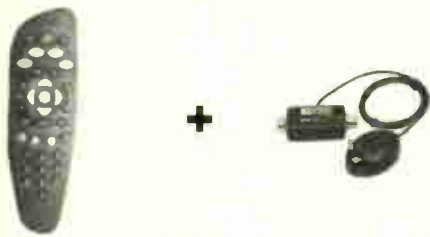

Price : £ 16.00 + vat each
5 +
£ 14.50 + vat each

Sky™ Digital Remote Controls



Order Code : RCSKY
1 + 5 +
£ 7.95 + vat each £ 7.45 + vat each
10 +
£ 6.95 + vat each

Sky™ Digital Remote & SLX Link Eye Combination

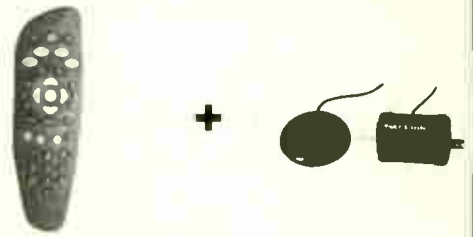

Price : £ 13.00 + vat each
5 +
£ 11.50 + vat each

Fully Shielded , Foil Wrapped & Individually Shielded 21 Pin Connected Scart Lead

Length : 1.5m Width of Cable : 12mm

Order Code : PLG26

Box of 25
Special Price : £ 32.00 + vat

Fully Shielded 21 Pin Connected Scart Leads

Length : 1.5m Width of Cable : 8mm

Order Code : PLG23

Box of 50
Special Price : £ 30.00 + vat

Coax Fly Lead Plug to Socket Length : 2m

Order Code : COXCABLE

Box of 50
Special Price : £ 20.00 + vat

Audio / Video Cable Bulk Box

The Box contains the following

25 pieces



1.5m 21 Pin Fully Connected Scart Cable

25 pieces



2m TV to Video Lead

25 pieces



1.2m 2 Phono Plug to Phono Plug Lead

Price when bought seperately £ 48.50 + vat

Order Code : AVCBLBOX Special Offer Price : £ 35.00 + vat

TV Fault Finding Guide Part 2

This book has been introduced as a supplement to issue 7 (December 1998) and contains over 2500 additional faulty entries. This edition is not intended as a replacement for issue 7 but as an addition.

Revised model/chassis listing of about 2000 models.

A5 in size with a total of 192 pages

Order Code : BOOK02/A
Price : £ 15.00 - No VAT
(plus £ 2.00 + vat Postage)

New Arrival

New Arrival

Jaeger 2002 Semiconductor Comparison Book

This A5 book contains vital reference information on 39,200 type on semiconductors , together with alternatives , descriptions and base connections

Order Code : BOOK04
Price : £ 20.00 - No VAT
(plus £ 2.00 + vat Postage)

New Arrival

New Arrival

Semiconductor Comparison CD

A database of over 100,000 devices
Lists transistors , diodes , thyristors and IC's
Contains pin assignments for discrete semiconductors
Permits searching and selecting according to type , casings ...etc
System requirement
Pentium PC , 16Mb memory , Windows 3.1/95/98/NT and a CD Rom Drive

Order Code : VRTCROM
Price : £ 35.00 + vat

New Arrival

New Arrival

Jaeger 2002 Semiconductor Comparison Large Book

Now with Hard Back Cover
This A4 book contains vital reference information on about 120,000 type on semiconductors.
42,000 Transistors , 15,400 FETs
25,000 Diodes , 4,300 Thyristors
30,500 Intergrated Circuits
Order Code : BOOK06
Price : £ 47.00 - No VAT
(Plus £ 5.00 + vat Postage)

New Arrival

New Arrival

All Special Offers valid until 31 August 2002 or while stocks last !!

K.P. House , Unit 15 , Pop In Commercial Centre , Southway , Wembley , Middlesex . HA9 0HB England

Tel : (020) 8900 2329

Email : sales@grandata.co.uk

Fax : (020) 8903 6126

Website : http://www.grandata.co.uk

Grandata Ltd

distributor of electronic components

CD Pick Ups and Mechanisms

Part No	Price	Part No	Price	Part No	Price
CDM12.1 Mechanism	£14.00	KSS 213 C	£9.50	OPTIMA 6 S	£11.50
KSS 210A Original	£11.00	KSS 213 D	£16.00	OPTIMA 5	£11.50
KSS 210A Replacement	£9.50	KSS 213 F	£12.00	RCTRTH8151	£20.00
KSS 210 B	£15.00	KSS 240 A	£30.00	RCTRTH8112	£14.00
KSS 213 B	£8.75	NKS 240 A Replacment for KSS240A	£20.00	RCTRH8147 Mech	£ 10.00

Special Offer

Part No	1+	10+
KSS 210A Replacement	£ 9.50	£ 8.25
KSS 210A Original	£ 11.00	£ 10.00
KSS 213B Original	£ 8.75	£ 8.00
KSS 213C Original	£ 9.50	£ 8.50
CDM12.1 Mechanism	£ 14.00	£ 12.00

Special Offer Prices valid until 31 August 2002 or while stocks last

CD Spindle Motors



22.5 mm Shaft
8mm Shaft

Order Code : CDMOT1
Order Code : CDMOT2

Price : £ 2.00 + vat
Price : £ 2.00 + vat



105°C Radial Electrolytic Capacitors

VALUE	CODE	PRICE	PER
PACK			
10 Volts			
100uF	.CAP118	£0.45	10
470uF	.CAP29	£1.20	10
1000uF	CAP119	£1.50	10
2200uF	.CAP120	£2.10	10
16 Volts			
22uF	.CAP121	£0.35	10
33uF	.CAP122	£0.35	10
47uF	.CAP123	£0.35	10
100uF	.CAP124	£0.60	10
220uF	.CAP125	£0.80	10
330uF	.CAP30	£1.75	10
470uF	.CAP31	£1.75	10
680uF	.CAP32	£2.10	5
1000uF	.CAP33	£2.10	10
2200uF	.CAP34	£5.25	10
3300uF	.CAP35	£5.00	5
4700uF	.CAP36	£6.10	10
25 Volts			
10uF	.CAP37	£0.45	10
22uF	.CAP38	£0.45	10
33uF	.CAP126	£0.40	10
47uF	.CAP39	£0.48	5
68uF	.CAP127	£0.55	10
100uF	.CAP40	£0.70	10
120uF	.CAP128	£0.85	10
150uF	.CAP41	£0.95	5
220uF	.CAP42	£1.20	10
330uF	.CAP43	£1.40	5
470uF	.CAP44	£1.90	10
680uF	.CAP45	£3.15	5
1000uF	.CAP46	£3.65	5
101500uF	CAP47	£3.90	5
2200uF	.CAP48	£2.00	2
3300uF	.CAP49	£2.20	2
4700uF	CAP50	£3.65	2
6800uF	CAP51	£3.90	2

VALUE	CODE	PRICE	PER
PACK			
35 Volts			
1uF	.CAP130	£0.40	10
3.3uF	.CAP131	£0.40	10
4.7uF	.CAP132	£0.45	10
10uF	.CAP52	£0.50	10
22uF	.CAP53	£0.45	10
33uF	.CAP54	£0.50	5
47uF	.CAP55	£0.85	10
68uF	.CAP133	£0.55	10
100uF	.CAP56	£0.85	10
150uF	.CAP57	£0.95	5
220uF	.CAP58	£1.45	5
330uF	CAP134	£1.60	10
470uF	.CAP135	£1.75	10
680uF	.CAP59	£6.50	10
1000uF	.CAP60	£4.35	10
2200uF	.CAP61	£2.45	2
3300uF	.CAP62	£10.00	5
4700uF	CAP136	£3.50	2
50 Volts			
1uF	.CAP137	£0.35	10
2.2uF	.CAP138	£0.35	10
3.3uF	.CAP139	£0.35	10
4.7uF	.CAP140	£0.35	10
10uF	.CAP63	£0.50	10
22uF	.CAP64	£0.70	10
33uF	.CAP141	£0.85	10
47uF	.CAP65	£0.85	10
68uF	CAP142	£0.90	10
100uF	.CAP66	£0.85	10
220uF	.CAP67	£1.75	10
330uF	.CAP68	£2.45	10
470uF	.CAP69	£4.35	10
680uF	.CAP70	£4.90	5
1000uF	.CAP71	£5.25	10
1500uF	CAP143	£4.50	5
2200uF	.CAP72	£3.25	2
3300uF	CAP144	£3.25	2

VALUE	CODE	PRICE	PER
PACK			
63 Volts			
0.22uF	.CAP145	£0.45	10
0.47uF	.CAP73	£0.35	10
1uF	.CAP74	£0.35	10
2.2uF	.CAP75	£0.35	10
3.3uF	.CAP76	£0.50	10
4.7uF	.CAP77	£0.35	10
10uF	.CAP78	£0.50	10
15uF	.CAP79	£0.95	5
22uF	.CAP80	£0.75	10
33uF	.CAP81	£0.85	10
47uF	.CAP82	£0.95	10
68uF	.CAP83	£1.30	5
100uF	.CAP84	£1.20	10
150uF	.CAP85	£2.80	5
220uF	.CAP86	£2.80	10
330uF	.CAP87	£4.00	10
470uF	.CAP88	£5.25	10
680uF	.CAP89	£5.00	10
1000uF	.CAP90	£5.40	5
100 Volts			
0.47uF	.CAP91	£0.50	5
1uF	.CAP92	£0.85	10
1.5uF	.CAP93	£0.70	5
2.2uF	.CAP94	£0.50	5
3.3uF	.CAP95	£0.50	5
4.7uF	.CAP96	£0.50	5
10uF	.CAP97	£0.95	10
22uF	.CAP98	£1.05	10
33uF	.CAP99	£1.55	5
47uF	.CAP100	£1.75	10
100uF	.CAP101	£2.10	10
220uF	.CAP102	£6.00	5
470uF	.CAP103	£6.00	5
160 Volts			
2.2uF	.CAP146	£0.45	10
10uF	.CAP147	£1.40	10

VALUE	CODE	PRICE	PER
PACK			
160 Volts... continued			
22uF	.CAP148	£1.80	10
33uF	.CAP149	£2.30	10
100uF	.CAP150	£3.25	5
200 Volts			
100uF	.CAP151	£3.25	5
250 Volts			
1uF	.CAP152	£0.60	10
3.3uF	.CAP104	£1.75	10
10uF	.CAP105	£2.60	10
22uF	.CAP153	£2.30	10
47uF	.CAP106	£4.35	10
100uF	.CAP154	£4.50	5
220uF	.CAP155	£2.00	2
350 Volts			
1uF	.CAP156	£0.70	10
3.3uF	.CAP157	£1.50	10
10uF	.CAP158	£2.25	10
22uF	.CAP159	£3.40	10
400 Volts			
1uF	.CAP107	£2.15	5
2.2uF	.CAP108	£2.25	5
4.7uF	.CAP109	£3.15	5
10uF	.CAP110	£4.00	5
22uF	.CAP111	£2.50	2
47uF	.CAP112	£3.50	2
100uF	.CAP160	£4.00	2
220uF	.CAP161	£7.00	2
450 Volts			
1uF	.CAP113	£2.80	5
2.2uF	.CAP114	£3.20	5
4.7uF	.CAP115	£4.95	5
10uF	.CAP116	£5.50	5
22uF	.CAP117	£4.15	2

Digital Capacitance Meter



3.5 Digit LCD 1999 Count
9 Selectable ranges from 200pF to 20mF
Supplied with Holster
High Accuracy
(0.5% < 2000uF, 1%:2000uF, 2%:20mF)
External control for zero adjustment
Overload indication
Safety designed test probe
Powered by 9V battery

Order Code : 24504S
Price : £ 28.00 + vat
Postage : £ 3.00 + vat

K.P. House , Unit 15 , Pop In Commercial Centre , Southway , Wembley , Middlesex . HA9 0HB England

Tel : (020) 8900 2329

Email : sales@grandata.co.uk

Fax : (020) 8903 6126

Website : http://www.grandata.co.uk

Grandata Ltd

distributor of electronic components

Television Repair / Mod Kits

MAKE & MODEL	KIT TYPE	CODE
ALBA		
1452T	PSU	ONWAKIT
1427T	PSU	ONWAKIT
1402	PSU	ONWAKIT
1455T	PSU	ONWAKIT
1456T	PSU	ONWAKIT
1458T	PSU	ONWAKIT
1459T	PSU	ONWAKIT
1499Y	STANDBY	MODKIT37
2002	PSU	ONWAKIT
2009B	PSU	ONWAKIT
2052T	PSU	ONWAKIT
2152T	PSU	ONWAKIT
2099TX	STANDBY	MODKIT37
BTV17	STANDBY	MODKIT37
CTV501	PSU	ONWAKIT
CTV701	PSU	ONWAKIT
CTV840	PSU	ONWAKIT
CTV841	PSU	ONWAKIT
CTV485	PSU	ONWAKIT

MAKE & MODEL	KIT TYPE	CODE
AKAI		
CT1417	PSU	ONWAKIT
CT2159U	PSU	ONWAKIT
CT2162UNT	PSU	ONWAKIT
CT2863UNT	PSU	ONWAKIT

MAKE & MODEL	KIT TYPE	CODE
DECCA/TATUNG		
TVC563	STANDBY	MODKIT37

MAKE & MODEL	KIT TYPE	CODE
GOLDSTAR		
CF25A50F	FRAME	MODKIT36
CF25C22C	FRAME	MODKIT35
CF28A50F	FRAME	MODKIT36
CF28C22F	FRAME	MODKIT35
CF28C28F	FRAME	MODKIT36
CF29C42F	FRAME	MODKIT35

MAKE & MODEL	KIT TYPE	CODE
GOODMANS		
147TT	PSU	ONWAKIT
149T	PSU	ONWAKIT
1430RA	PSU	ONWAKIT
1430RS	PSU	ONWAKIT
1430RW	PSU	ONWAKIT
1450T	PSU	ONWAKIT
1455TS	PSU	ONWAKIT
2019R	PSU	ONWAKIT

MAKE & MODEL	KIT TYPE	CODE
GOODMANS..Continued		
2029T	PSU	ONWAKIT
2029TA	PSU	ONWAKIT
F16 CHASSIS	FRAME	GOODKIT1
F16 CHASSIS	LINE	GOODKIT1
F16	PSU	GOODKIT1
F16	VIDEO	GOODKIT1

MAKE & MODEL	KIT TYPE	CODE
GRUNDIG		
CUC 7350		GRUNDIGKIT1
CUC 7301/3		
(BUZ90)	PSU	GRUNDIGKIT2
CUC 7301/3		
(MJF18004)	PSU	GRUNDIGKIT3

MAKE & MODEL	KIT TYPE	CODE
HINARI		
HIT14RC	PSU	ONWAKIT

MAKE & MODEL	KIT TYPE	CODE
JVC		
AV29SX1EK	FIELD O/P	JVCKIT1
AV29SX1EN	FIELD O/P	JVCKIT1
AV29SX1EN1	FIELD O/P	JVCKIT1
AV29SX1PF	FIELD O/P	JVCKIT1
AV29TSIE1	FIELD O/P	JVCKIT1
C14E1EK	PSU	ONWAKIT
C14T1EK	PSU	ONWAKIT
C21ET1EK	PSU	ONWAKIT
CS21M3EK	PSU	ONWAKIT

MAKE & MODEL	KIT TYPE	CODE
MATSUI		
1455	PSU	ONWAKIT
1498	PSU	ONWAKIT
2086	PSU	ONWAKIT
2098	PSU	ONWAKIT
21V1N (BUZ90)	PSU	GRUNDIGKIT2
21V1T (MJF18004)	PSU	GRUNDIGKIT3
TVR180R/T/2080	STANDBY	MODKIT37

MAKE & MODEL	KIT TYPE	CODE
MITSUBISHI		
AV1 SERIES	PSU	MITSKIT3
CT1M5B	PSU	MITSKIT3
CT21M5BT	PSU	MITSKIT3
CT25M5BT	PSU	MITSKIT3
CT21A2STX	TDA 8178S	MITSKIT1
CT21AX1B	PSU	MITSKIT3
CT21A3STX	TDA 8178S	MITSKIT1

MAKE & MODEL	KIT TYPE	CODE
MITSUBISHI..Continued		
CT21AV1BS	PSU	MITSKIT3
CT25A2STX	TDA 8178S	MITSKIT1
CT25A3STX	TDA 8178S	MITSKIT1
CT25A4STX	TDA 8178S	MITSKIT1
CT25A6STX	TDA 8178S	MITSKIT1
CT25AV1B	PSU	MITSKIT3
CT25AV1BS	PSU	MITSKIT3
CT25AV1BD	PSU	MITSKIT3
CT25AV1BDS	PSU	MITSKIT3
CT28AV1B	PSU	MITSKIT3
CT28AX1BD	PSU	MITSKIT3
CT28AV1BDS	PSU	MITSKIT3
CT29AS1	TDA 8178S	MITSKIT2
CT29A4	TDA 8178S	MITSKIT2
CT29A6	TDA 8178S	MITSKIT2
CT29B2	TDA 8178S	MITSKIT2
MAKE & MODEL	KIT TYPE	CODE

CT29B3	TDA 8178S	MITSKIT2
CT29B6	TDA 8178S	MITSKIT2
CT33B3	TDA 8178S	MITSKIT2
M5 SERIES	PSU	MITSKIT3

MAKE & MODEL	KIT TYPE	CODE
NEI/NIKKAI		
CE25 CHASSIS	PSU	NIKKAIKIT1
C289FTXN	PSU	NIKKAIKIT1
C28F41FXN	PSU	NIKKAIKIT1

MAKE & MODEL	KIT TYPE	CODE
PANASONIC		
IC561	TDA 8175	PANKIT1
TX25XD60	VERT OUTPUT	PANKIT2
TC28XD60	VERT OUTPUT	PANKIT2
TX28XD70	VERT OUTPUT	PANKIT2
TX29XD70	VERT OUTPUT	PANKIT2
TX-W26D3	VERT OUTPUT	PANKIT2

MAKE & MODEL	KIT TYPE	CODE
PHILIPS		
310.10708		PHILKIT3
310.20491		PHILKIT2
310.20496		PHILKIT10
310.31994		PHILKIT6
310.32252		PHILKIT5
310.32253		PHILKIT4
310.32254		PHILKIT9
310.32255		PHILKIT7

MAKE & MODEL	KIT TYPE	CODE
PHILIPS..Continued		
310.32262		PHILKIT8
310.62264		PHILKIT1
ANUBIS A	SOPS	PHILKIT2
CP110 CHASSIS	SOPS	PHILKIT8
G90A CHASSIS	SOPS	PHILKIT10
G90B CHASSIS	SOPS	PHILKIT10
G110 CHASSIS	SOPS	PHILKIT3
GR2.1 CHASSIS	SOPS	PHILKIT1
GR2.2 CHASSIS	SOPS	PHILKIT1
D-16 CHASSIS	SOPS	PHILKIT5
HSM VIDEO	SOPS	PHILKIT6
JSM VIDEO	SOPS	PHILKIT4
KSM VIDEO	SOPS	PHILKIT9
LSM VIDEO	SOPS	PHILKIT7

MAKE & MODEL	KIT TYPE	CODE
SAMSUNG		
CI5944	FRAME	SAMKIT2
CI6844	FRAME	SAMKIT2
VIK310	PSU	SAMSUNGKIT
VIK320	PSU	SAMSUNGKIT
VIK350	PSU	SAMSUNGKIT
VI375	PSU	SAMSUNGKIT
VI395	PSU	SAMSUNGKIT
WINNER 1	PSU	SAMSUNGKIT

MAKE & MODEL	KIT TYPE	CODE
SHARP		
51CS03H	PSU	SHARPKIT1
51CS05H	PSU	SHARPKIT1
59CS03H	PSU	SHARPKIT2
59CS05H	PSU	SHARPKIT2
59CS08H	PSU	SHARPKIT2
59DS03H	PSU	SHARPKIT3
66CS03H	PSU	SHARPKIT2
66CS05H	PSU	SHARPKIT2
66CSD8H	PSU	SHARPKIT2

MAKE & MODEL	KIT TYPE	CODE
THOMSON		
35029400		THOMKIT2
35065920		THORNKIT1
FV70	PSU	THORNKIT1
ICC7 CHASSIS	TDA 8178FS	THOMKIT1
ICC7 CHASSIS	FRAME	THOMKIT3
ICC8 CHASSIS	TDA 8178FS	THOMKIT1
JCC8 CHASSIS	FRAME	THOMKIT3
ICC9 CHASSIS	EASTWEST	THOMKIT4
R3000	PSU	THOMKIT2
R4000	PSU	THOMKIT2
TX92F CHASSIS	EAST/WEST	THOMKIT4

ORDER CODE	PRICE
GRUNDIGKIT1	£ 10.50
GRUNDIGKIT2	£ 10.50
GRUNDIGKIT3	£ 10.50
GOODKIT1	£ 11.00
JVCKIT1	£ 11.00
MITSKIT1	£ 3.00
MITSKIT2	£ 15.00

ORDER CODE	PRICE
MITSKIT3	£ 6.00
MODKIT35	£ 9.50
MODKIT36	£ 5.00
MODKIT37	£ 6.50
NIKKAIKIT1	£ 12.00
ONWAKIT	£ 12.00
PANKIT1	£ 11.00

ORDER CODE	PRICE
PANKIT2	£ 9.00
PHILKIT1	£ 7.60
PHILKIT10	£ 8.50
PHILKIT2	£ 2.50
PHILKIT3	£ 4.00
PHILKIT4	£ 4.25
PHILKIT5	£ 5.75

ORDER CODE	PRICE
PHILKIT6	£ 5.50
PHILKIT7	£ 7.60
PHILKIT8	£ 4.25
PHILKIT9	£ 7.50
SAMKIT2	£ 8.00
SAMSUNGKIT	£ 16.00
SHARPKIT1	£ 11.00

ORDER CODE	PRICE
SHARPKIT2	£ 11.00
SHARPKIT3	£ 9.00
THOMKIT1	£ 7.00
THOMKIT2	£ 12.00
THOMKIT3	£ 9.00
THOMKIT4	£ 4.00
THORNKIT1	£ 12.75

Remote Controls

Brand Replacement Remote Controls

*Codeless set-up

*Teletext and Fastext

*Pre-Programmed for the latest models

* Replaces broken and lost remotes

Brand
Panasonic TV
Sony TV
Philips TV
Hitachi TV
Mitsubishi TV
Nokia TV
Samsung TV
Toshiba TV
Ferguson TV
Grundig TV

Order Code
RCUNI01M
RCUNI02M
RCUNI03M
RCUNI04
RCUNI05
RCUNI06
RCUNI07
RCUNI08
RCUNI09
RCUNI10

Brand
Grundig TV
Sanyo TV
Sharp TV
Goodmans/Alba/
Bush TV
Matsui/Hinari/Orion TV
Sky Digital
On Digital
Satellite

Order Code
RCUNI10
RCUNI11
RCUNI12

RCUNI13M
RCUNI14M
RCUNI15
RCUNI16
RCUNI17

Price : £7.50 + vat each

Buy any 5 of the above and get a Special Price of £ 7.00 + vat each

We stock Replacement Remote Controls for over 23,000 different models

Prices start from £ 5.50 + vat each

Please call for a copy of our latest Remote Control Catalogue on 020 8900 2329

Grandata Ltd

distributor of electronic components

KONIG
ELECTRONIC

Konig Electronic
Spares

KONIG
ELECTRONIC

To mark our new association with Konig Electronics we are glad to offer the following Konig Remote Controls at Special Prices !!!

<u>Konig No.</u>	<u>Model/Part No.</u>
BANG & OLUFSEN	
IR 9248	BEOLINK100
BEKO	
IR 9398	RC51321 , RC51331 , RC61331
DAEWOO	
IR 9840	DMQ14A1 , DMQ20A1 , DMQ2195
FERGUSON	
IR 9584	RCU1734 , RCU1742 , T742 , T752 , T758
IR 9594	RH880 , T789
IR 9325	RH885
IR 9259	RHT01 , RHT30
IR 9639	RHT10
FUNAI	
IR 9719	30T1 , 30T2 , 31T1
GOLDSTAR	
IR 9403	105-068 , CBT2190E , CBT4902 , CBT9905
IR 9854	05-219J , 105-224V , 105-229H , 105-230C
GRUNDIG	
IR 9529	CUC5301 , CUC5302
IR 9614	CUC5200 , CUC5303 , CUC5310
IR 9749	TP715 , TP770 , TP771 , TP800 , TP900
IR 9715	TRC1 , TRC2
HITACHI	
IR 9602	CLE871A , CLE871B , CLE874A , CLE874B
IR 9476	CLE876A , CLE876B , C1405 , C1414 , C2114 C2514 , CT2116
IR 9477	CLE876C , CLE876D , CLE876E , CLE876G
IR 9982	CLE922A , CLE922B
IR 9576	CPT1556 , CPT1557 , CPT1560 , CPT1561 , CST1430 , CST1435 , CST1560
IR 9575	CPT2155 , CPT2164 , CPT2558 , CPT2564 , CPT2566 , CPT2669 , CPT2785 , CPT2870
MATSUI	
IR 9490	076L067240 , 2076R , 2092T
NOKIA	
IR 9573	FS4/1 , FS4/2 , FS5/1 , FS9 , FS10
ORION	
IR 9640	RC37 , RC56 , RC565633 , RCQ
PANASONIC	
IR 9826	EUR37211 , EUR50100 , EUR50370 , EUR51140 TNQ8E421 , TNQ8E0422 , TNQ8E0428
IR 9834	TNQ8E0461
PHILIPS	
IR 9510	RC5002 , RC5140 , RC5154 , RC5240 ,

<u>Konig No.</u>	<u>Model/Part No.</u>
PHILIPS..continued	
IR 9553	RC5410 , RC5420 , RC5801
IR 9556	RC5901 , RC5902 , RC5903 , RC5904 , RC5905
IR 9710	RC7507 , RC8205 , RC9057 , RC9133
IR 9864	RC7512 , RC7535
SAMSUNG	
IR 9546	RM100
IR 9432	RM104 , CX532WT , CX534WT , CX5312W
SANYO	
IR 9457	JXBA , JXFF , RC307 , RC317 , RC318 , RC321 , RC612 , RC625 , RC628
IR 9530	JXCL , JXCR , RC258 , RC642
IR 9139	JXGA , JXGE , RC700 , RC702
IR 9460	JXGT , JXGW , JXGY , JXLB , JXLG , RC711 , S02
SHARP	
IR 9487	C1421 , C2021 , CV2121 , CV3707 , CV3709 , CV3710 , DV1416 , SV2044 , SV2145
IR 9711	RRMCG0739BMSA , G1014BMSA RRMCG1023BMSA , G1036BMSA
IR 9788	RRMCG1031BMSA , G1046BMSA RRMCG1048BMSA , G1050BMSA
SONY	
IR 9321	RM640 , RM641 , RM641A , RM642A
IR 9336	RM650 , RM651 , RM652 , RM654
IR 9448	RM656 , RM677 , RM687B , RM687C , RM717
IR 9123	RM670 , RM671 , RM672 , RM673
IR 9442	RM681 , RM682 , RM683 , RM684 , RM685 , RM686 , RM698
IR 9452	RM694 , RM820 , RM828 , RM834 , RM841
IR 9441	RM689 , RM816 , RM817 , RM826
IR 9443	RM830 , RM831 , RM832 , RM842
IR 9451	RM833 , RM837
IR 9511	RM615 , RM620 , RM625 , RM630 , RM631 , RM632 , RM633 , RM634 , RM635
IR 9871	RM836 , RM839 , RM883 , RM886
TELEFUNKEN	
IR 9624	FB330 , FB340 , FB345 , FB1330 , FB1340 ,
THOMSON	
IR 9639	14GM53 , 14GM56 , 14MS70 , 21DS70 , 21MG51 , 21MS76
TOSHIBA	
IR 9853	CT9493 , CT9511
IR 9953	CT9626 , CT9784 , CT9785 , CT9859

£ 6.50 + vat
each

Buy 5 or more
£ 6.00 + vat each

Grandata Ltd

distributor of electronic components

KONIG
ELECTRONIC

Konig Electronic
Spares

KONIG
ELECTRONIC

Replacement Line Output Transformers

Make	Part No.	Konig No.	Our Code	Price
Ferguson	..06 D-3-093-001 , 06 D-3-512-001	FAT 3837	...LOT204	...£ 14.00
Hitachi2433291	FAT 3664	...LOT172	...£ 13.50
Hitachi2434002	FAT 30095	..LOT226	...£ 14.50
ITT/Nokia	..4515 0340 , D 059/37 , ME/6237-00	FAT 3727	...LOT200	...£ 12.50
ITT/Nokia	..4515 0345 , 4515 0378 , D070/37 , D071/37	FAT 3790	...LOT328	...£ 16.00
ITT/Nokia	..4515 0348 , D 076/37	FAT 3843	...LOT330	...£ 16.00
Panasonic	TLF 14584 F , TLF 14586 , TLF 14586 F	FAT 30106	...LOT41	...£ 15.50
Philips1352.5003 , 4822 140 10544 , 4822 140 10566 , OV 2094/40	FAT 30186	..LOT433	...£ 12.00
Philips3111 258 30021 , 4822 140 10474	FAT 30192	..LOT562	...£ 15.50
Philips37770 , 37771 , 37772 , AT 2079/15	FAT 30184	..LOT129	...£ 14.00
Philips4812 140 10294 , 4822 140 10294	FAT 3820	...LOT125	...£ 16.00
Philips4812 140 10325 , 4822 140 10325	FAT 30167	..LOT132	...£ 15.00
Philips4822 140 10353 , 4822 140 10356	FAT 3830	...LOT284	...£ 14.00
PhilipsAT 2079/21 , AT 2078/21 , TFB 4090 AD	FAT 30179	..LOT395	...£ 12.00
PhilipsAT 2079/17	FAT 30171	..LOT288	...£ 14.00
PhilipsAT 2079/23	FAT 30170	..LOT289	...£ 13.00
Sony1-439-332-42	FAT 3925	...LOT100	...£ 12.00
Sony1-439-493-11 , 1-439-423-11 , 1-439-423-12	FAT 30089	..LOT369	...£ 15.50

This is just a selection of Konig Line Output Transformers .
Please call us on 020 8900 2329 for any that are not listed.

Replacement Television Mains Switches

KN658304



For Sony and Sony
Price : £ 2.50 + vat

KN668500



Replacement for Grundig 29703-291.07
Price : £ 2.50 + vat

KN668800



For Daewoo
Price : £ 2.50 + vat

If you cannot find the Konig Spares you want in this advert please call us on
020 8900 2329 as this is just a small selection

Grandata Ltd

distributor of electronic components

Aerial & Digital Satellite Accessories

SLx Aerial Amplifiers

Now with built in Digital ByPass - Operates with Sky™ DigiEye

Class leading noise figure of 4dB or less

6dB signal amplification on all models

25mA line powering for masthead amplifier

(Only on SLX4B, SLX6B, SLX8B)

Description	Order Code	Price
2 Way - No Bypass	SLX2	£ 8.00 + vat
2 Way - With Bypass	SLX2B	£ 9.25 + vat
4 Way - No Bypass	SLX4	£ 13.00 + vat
4 Way - With Bypass	SLX4B	£ 14.00 + vat
6 Way - No Bypass	SLX6	£ 18.00 + vat
6 Way - With Bypass	SLX6B	£ 19.00 + vat
8 Way - No Bypass	SLX8	£ 18.50 + vat
8 Way - With Bypass	SLX8B	£ 20.00 + vat



**Integrated
Digital
By Pass**

SLx Masthead Amplifiers

UHF TV antenna pre amplifier designed for the professional aerial installer

15dB gain masthead amplifier ideal for majority of domestic installations

26dB gain masthead amplifier for longer cable runs (loss of more than 3dB) or if connected to passive splitters

Requires 12V DC power supply via download either via dedicated power supply unit or from a distribution amplifier with line powering

SLx 15dB Gain Masthead Amp
Order Code : 27830R Price : £ 4.30 + vat

SLx 26dB Gain Masthead Amp
Order Code : 27831R Price : £ 4.50 + vat



Coax Plug Aluminium



Order Code : PLG51
Bag of 10
Price : £ 1.25 + vat
Bag of 100
Price : £ 9.00 + vat

Screw Type Coax Plugs



Order Code : PLG62
Bag of 10
Price : £ 1.60 + vat
Bag of 100
Price : £ 12.50 + vat

Twist On F Connectors



Order Code : PLG101
Bag of 10
Price : £ 1.00 + vat
Bag of 100
Price : £ 6.00 + vat

Coax Coupler Socket to Socket



Order Code
PLG54
Bag of 10
Price : £ 1.50 + vat

Coax Coupler Plug to Plug



Order Code
PLG55
Bag of 10
Price : £ 1.50 + vat

Y Splitter Inductive 3 way



Order Code
YSPLITTER
Price : 40p + vat
Bag of 10
Price : £ 3.00 + vat

SLx Link Eye

Allows control of Sky™ Digibox via the signal feed for second TV

Order Code : 27833R
1 - 9
£ 6.50 + vat each

10 - 24
£ 5.50 + vat each



Sky™ Digital TV Link Eye

Order Code : TVLINKEYE

Price
£ 10.75 + vat
5 +
£ 7.99 + vat each
10+
£ 6.99 + vat each



SLx Amp By Pass Kit

For use with aerial amplifiers and Sky™ Digibox

Allows for operation of Link Eye in conjunction with a distribution amplifier

Order Code : 27829R
Price : £ 5.00 + vat



Amstrad DRX100

Tuner Repair Kit

Order Code
SATKIT35

Price
£ 1.40 + vat

Amstrad DRX100

Power Supply Reliability Kit

Order Code
SATKIT36

Price
£ 12.00 + vat

Amstrad DRX100

Power Supply Repair Kit

Order Code
SATKIT37

Price
£ 13.50 + vat

Grundig GDS200

Digital Satellite Receiver Repair Kit

Early psu
MODEL : DSO - 0385 REV C

Order Code: SATKIT34A
Price : £ 10.00 + vat

Grundig GDS200/300

Digital Satellite Receiver Repair Kit

LATER psu TYPE REV 03
DSO - 0375 REV A
DSO - 0385 REV 5

Order Code: SATKIT34B
Price : £ 10.00 + vat

Check out our New Online Catalogue at

www.grandata.co.uk

This advertisement is just a selection of our stock.
Please contact us if you cannot find the part you are looking for.

* Please add £1 p+p and VAT to all orders (Unless Otherwise stated) * All components are brand new
* We accept payment by Access, Switch, Visa, Cheque and Postal Order
* All prices quoted are subject to availability and may be changed without prior notice

E & OE

K.P. House, Unit 15, Pop In Commercial Centre, Southway, Wembley, Middlesex. HA9 0HB England

Tel : (020) 8900 2329

Email : sales@grandata.co.uk

Fax : (020) 8903 6126

Website : <http://www.grandata.co.uk>

Thomson's ICC17 technology

Part 3 of Mark Paul's description of the circuit technology used in this chassis deals with the signal-processing sections

In this third instalment in the series we will take a look at the signals-processing arrangements. The final part next month will cover the microcontroller, audio and signals-switching sections.

Multiband tuner

The Thomson CTT5010 tuner used in this chassis is quite complex, with a TUA6010X IC that carries out, under the control of the I²C bus, band switching, oscillator selection and frequency-synthesis tuning. The chip incorporates an I²C interface and has separate VHF and UHF inputs. It operates with a 4MHz reference crystal that's connected to pins 13 and 14. Use of this reference frequency enables the tuning to be controlled to within 62.5kHz. The IF output is fed to a bipolar buffer transistor whose output is capacitively coupled to pin 11 of the tuner. There are also three gain-controlled MOSFET RF amplifier transistors in the tuner, one for each band. Band coverage is 48.25-112.25MHz, 119.25-399.25MHz and 407.25-863.25MHz.

The I²C bus is connected to pins 4 (SCL) and 5 (SDA) of the tuner which requires two supplies, 5V at pin 6 and the 33V tuning supply at pin 9. There's an AGC input at pin 1, the IF output appearing at pin 11. The tuner's power consumption is approximately 375mW.

The IF strips

The IF output from the tuner is filtered to separate the vision and sound signals. Processing is then carried out by a 64-pin, flat-pack

Philips TDA8855H chip, IV01, which incorporates separate vision and sound IF strips, a multi-standard colour decoder and, as mentioned in Part 2, the timebase generators. The IF section is multi-standard, using carrier-regeneration signal demodulation. This enables all standards used in Europe, including BG/H/LL/DKK', to be accommodated. Switching control is via the I²C bus. AM sound demodulation covers 4.5-6.5MHz. IV01 provides tuner AGC with roll-over control and AFC via the I²C bus. Fig. 1 shows in simplified block diagram form the signals sections of IV01.

The vision IF input at pins 1 and 2 of IV01 comes via a SAWF, FI10, which provides a balanced output. The signal is then amplified and demodulated, using a PLL carrier-regeneration technique. The carrier reference frequency is produced by a frequency and phase detector circuit that controls a voltage-controlled oscillator which operates at twice the IF. An inductor (FI30) connected to pins 13 and 14 is used for tuning. The resultant carrier is divided and used by both the video demodulator and the AFC detector, the AFC information being sent to the microcontroller chip IR01 via the I²C bus. AFC filtering is carried out by an RC network that's connected to pin 15.

The demodulated video is amplified and passed through a muting circuit before it appears at pin 16 of IV01. A feed between the amplifier and mute circuits goes to the AGC detector, which checks the sync pulse amplitude and peak white video to set the AGC voltage

fed back to the tuner. The AGC reservoir capacitor is connected to pin 6.

The video output at pin 16 is fed via a buffer transistor to a sound trap and is then AC coupled by CI63 (10µF) to pin 24 of IV01.

A SAWF, FI20, is also used to provide in the sound IF feed to pins 8 and 9 of IV01, again with a balanced output. Prior to this there's a trap which can be switched between 32.4MHz and 40.4MHz by means of transistor TI10, which is controlled by IR01 (pin 42). The incoming sound IF signal is fed to two gain-controlled differential amplifiers. An AGC detector looks at both the AM and FM carriers and controls the gain of the two differential amplifiers to ensure that a constant IF signal is fed to the AM demodulator and the single-reference QSS (Quasi Split Sound) mixer. The reaction time of the AGC detector is set to 'slow' for normal video conditions. If the vision IF signal drops however the reaction time is set to 'fast'. In the FM mode the reaction time is set to fast via the I²C bus.

A phase-multiplier technique is used to demodulate the AM sound, which is then passed through a low-pass filter to remove any trace of carrier harmonics. The output from this demodulator appears at pin 27 of IV01. It's not relevant with UK transmissions of course.

The FM sound carriers (6MHz mono and 6.552MHz Nicam) are generated by the QSS mixer. In this stage the FM sound is mixed with the vision PLL reference frequency. The output is then passed through a high-pass filter to reduce the

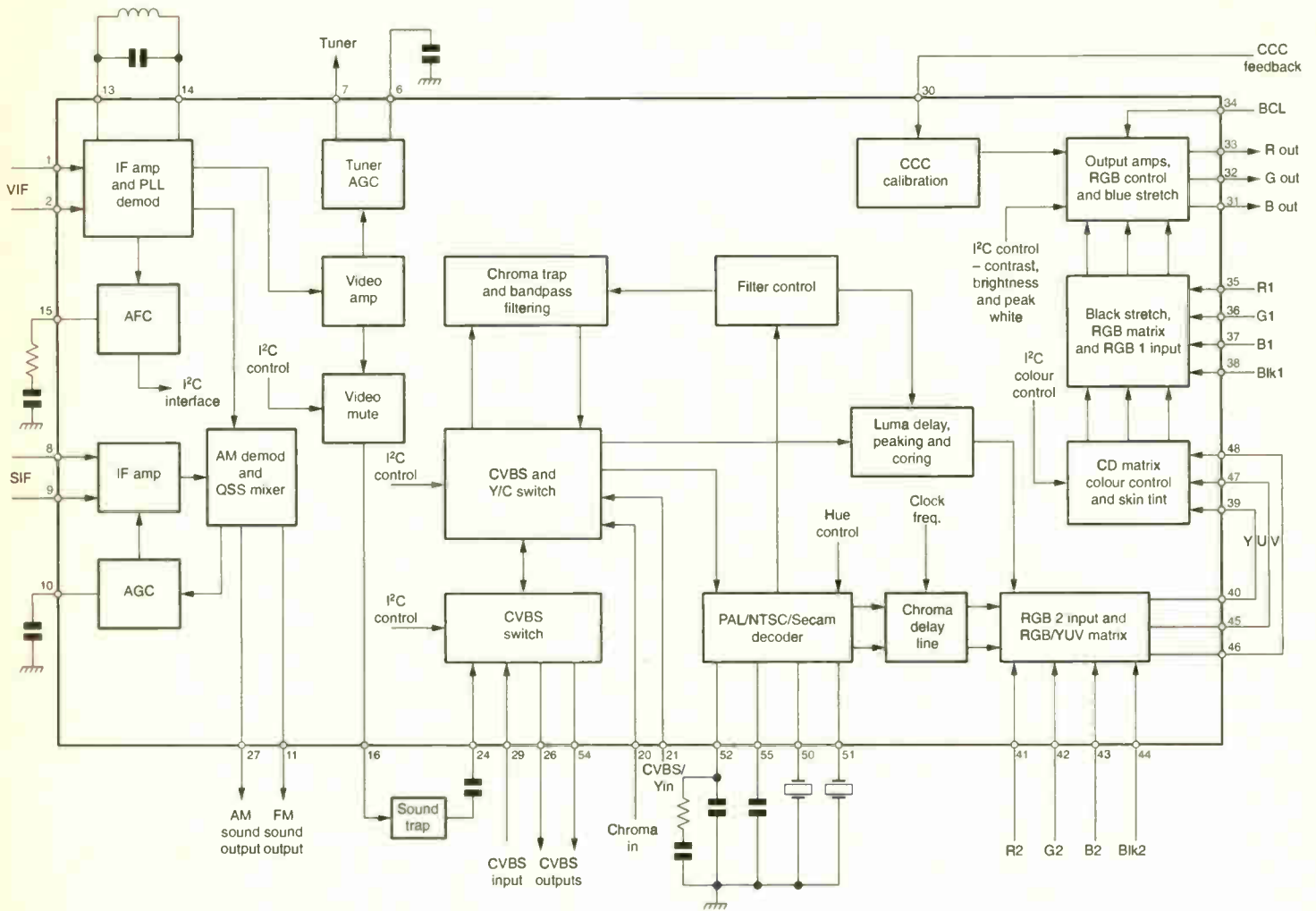

Fig. 1: Simplified block diagram of the signal-processing sections of the TDA8855H chip IV01.

residual video-signal components and finally appears at pin 11 of IV01.

The audio outputs from IV01 are fed to IS40 for further amplification and processing. We'll return to this next month. The output from pin 11 is level-adjusted by transistor TS01 before application to IS40.

Video processing

IV01 contains all the circuitry required to decode the selected video signal to produce RGB drive outputs. It includes the following: Two video input selector switches for internal video and video from the AV1, AV2 and front-panel connectors (AV3). Two luminance/chrominance to CVBS mixers. Luminance and chrominance separation circuitry. A variable luminance delay line with peaking and coring compensation. A multi-standard chroma decoder: once the signal has been identified, decoding needs only two crystals, 4.43MHz for PAL/NTSC/Secam and 3.58MHz for 60Hz NTSC. Two RGB input selector switches for AV1 and OSD/text inputs. Continuous CRT

cathode-current calibration circuitry, and RGB drive preamplifiers.

There's an I²C bus transceiver for interfacing with the microcontroller chip IR01. The tuner, AV1 and AV2 video signals and the Y/C signals from AV1 and the front-panel connector are fed to the input selector switches. These, under the control of IR01, are selected and processed into Y/C components then converted to RGB. Selection is then made between the processed RGB signals and the external AV1 RGB inputs. Further processing occurs before the RGB outputs are sent to the CRT board.

A new circuit has been introduced in the video processing – blue stretch, which adjusts the level of the red and green signals to improve the white performance.

The switched 8V line is connected to pin 23 to supply the video processing circuitry, with CV02 (100nF), CV03 (100µF) and LV02 for filtering.

Several integrated alignment-free filters and traps must be set and calibrated prior to any processing. Before the centre frequency of these traps and filters can be set, an

initiation process must be carried out under the control of IR01.

IR01 downloads data relating to the two crystals QC01 and QC02, which are connected to pins 51 and 50 of IV01 respectively. Once this data has been logged, IV01 verifies the presence of the filters. On identification, the required crystal oscillator is calibrated and its frequency is used as a reference for the filters, traps and colour-difference signal demodulators. The line output drive at pin 56 is disabled while this process is taking place.

The decoded/switch-selected RGB signals are fed to a black-stretch circuit that monitors the incoming luminance – it looks for differences between the darkest point in the signal and the back-porch blanking level (during the burst period). Black level is detected by means of an internal integrating capacitor. Once detected, a correction value is added to the luminance signal to increase the overall grey-scale range. The value added depends on the luminance signal level. The black-level stretch circuit can be made inoperative via the I²C bus and customer menu.

Contrast and brightness control are applied following the black-stretch operation, also beam-current limiting (BCL) and average white level (AWL) compensation.

The beam-current information fed to pin 34 is detected at the earthy end of the EHT system in the line output transformer, across RL07/CL08 (see Fig. 6 last month, page 603). RL09 and CL09 provide integration while zener diode DL09 provides protection.

Blue-stretch is the next step in the signal processing. When the incoming RGB level exceeds 80 per cent, the red and green signals are reduced by approximately 17 per cent. This gives improved white rendering.

Continuous cathode compensation

The final processing before the RGB outputs leave IV01 is continuous cathode calibration (CCC), or automatic cut-off (black-level) adjustment. Information from the CRT base panel circuitry is fed back to pin 30 of IV01 via a simple T filter (RV08/RV15/CV14) to provide this black-level compensation/calibration. The action of the CCC loop is based on two test signals which are generated within IV01 on alternate fields to check beam-current leakage and black levels.

The process can be controlled by IR01 via the I²C bus, or by IV01 itself in the automatic mode. The RGB outputs are blanked while black-level detection is taking place. This is relevant when a no-picture fault is being investigated. CCC provides compensation for variation in certain CRT gun characteristics.

CCC operation is quite complex.

The loop has to be initialised before any adjustment takes place. First, IV01's RGB outputs are blanked off. The +8V supply is then switched on and a 1.5-second counter is started. At the end of the allotted time the feedback current from the CRT base panel is checked until either 8 or 20µA is detected. When either of these currents is detected a 2.5-second counter is started. Once the timer period has elapsed, the RGB outputs are switched on and the CCC-loop carries out the alignment process. This routine is called 'cold start'.

Normal CCC-loop operation then starts. The system generates the first of two test lines, and measurement and adjustment procedures are activated. At line 18 the CRT's leakage current is measured. Next, the black level for each of the CRT's three guns is checked – at line 20 for red, line 21 green and line 22 blue. A second test line is generated in the next field. The same measurements are carried out on lines 330, 332, 333 and 334.

The results are compared with internal reference currents and are used to control the black-level current and driver stage gain for optimum tube performance, virtually during its life. To provide a good grey scale the black level is set at almost the CRT's cut-off level.

The important feature of this type of two-point stabilisation is that both the offset and the gain of the RGB signal paths is controlled by feedback. The maximum cathode drive currents are fixed by the relationship between the internal reference current, the test pulses and the gain setting in each path.

A 'CRT Warm Detect' block monitors the 'warm-start' condition.

When the incoming current exceeds 130µA, the RGB driver stages are released and normal two-point stabilisation is activated.

High-pass filter networks are included in each RGB output path from IV01.

CRT base board

Fig. 2 shows the circuitry on the CRT base board. The RGB output stages are incorporated within a Philips TDA6107Q chip, IB01. This contains three independent high-voltage amplifiers whose gain and DC offset voltage are fixed, feedback resistors, input resistor networks and a voltage-reference source. Pin 6 is used for the HT supply, pin 4 is connected to chassis and pin 5 provides the CCC feedback information. The outputs at pins 7, 8 and 9 are connected to the CRT cathodes via series inductor-resistor networks, with diodes connected to the junction of these components to protect the IC against tube flashovers.

CRT switch-off spot suppression is provided by transistors TB01, TB02 and the associated components. In normal operation the base of TB02 is held high by the PO line, from pin 39 of IR01 via inverter transistor TR60. Thus TB02 and in turn TB01 are held conductive, and CB03 is charged via RB08 and DB04. The diode clamps the CRT's grid voltages at +0.7V. At switch off the PO line goes low and TB01/2 switch off. The voltage across CB03 reverses, a large negative potential appearing at the CRT's grids. The screen is therefore blanked and, because DB04 is reverse biased, the voltage remains negative for several minutes – until CB03 discharges via RB08 and RB07.

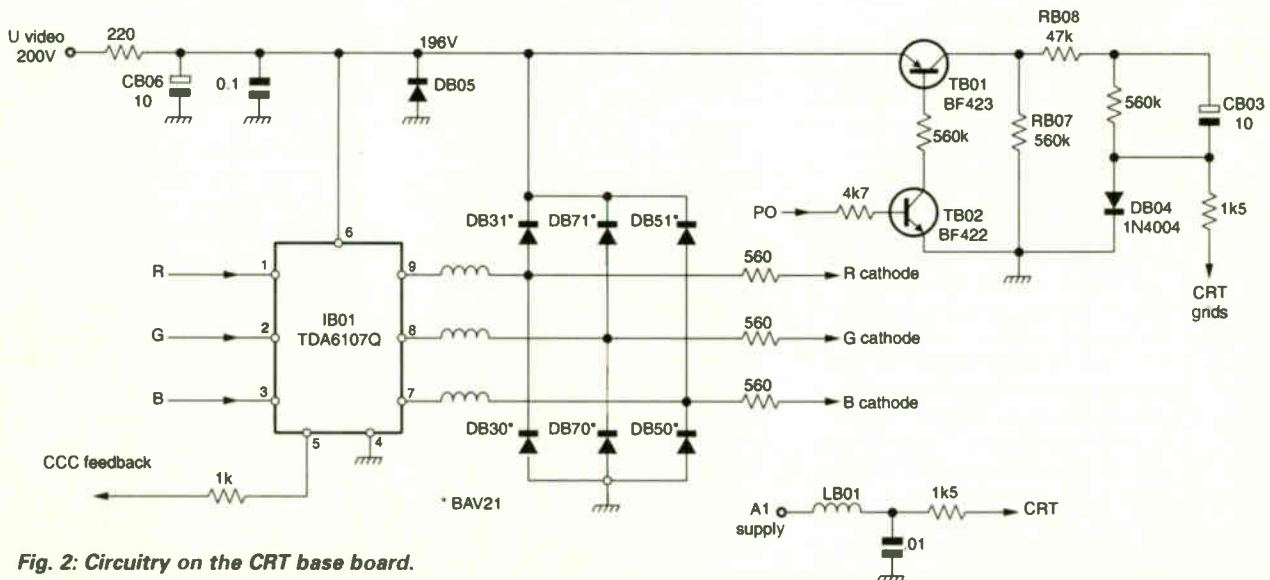

Fig. 2: Circuitry on the CRT base board.

Servicing the

Mitsubishi TFS6705K monitor

This 17in. Trinitron-tube monitor's production run lasted for several years. Large numbers were sold as the Dell VC7EN. In the concluding instalment in his series Donald M. Henry takes a look at the digital control system

In this concluding instalment we'll take a look at the circuitry on the processor board and what it all does. Fig. 1 shows this area in block diagram form. There's a processor (microcontroller) chip, IC101, an EEPROM (IC102), and many inputs and outputs: control of various functions is carried out via MUXes (multiplexers) and DACs (digital-to-analogue converters), with direct control of a few items.

The microcontroller chip IC101, type M38002M2, contains a central processor unit (CPU), registers galore, baud-rate generators, timers, serial and parallel ports, an area of working RAM and a ROM that contains the program code. It's an 8-bit, 64-pin quad flat-pack device that's also available in DIP (dual in-line) form. If you like data sheets, the web can be a fantastic source of information – sometimes too much! I downloaded a data sheet on the M38002M2 from www.mitsubishichips.com/data/datasheets/mcus/mcupdf/um/e3800um.pdf and ended up with 173 pages! At least, using the free Acrobat Reader software, you can print off individual pages of interest.

There's a useful section on the software watch dog timer (SWDT), which helped to explain the purpose of the TA8030F chip IC103, which is a hardware WDT. There's also some explanation of reset delays, and informative design hints on counter measures against noise. A lot of detail can be

extracted: I discovered that the 2M2 part of the device's number indicates that it has 384 bytes of RAM and is a mask-ROM version with 8,192 bytes of ROM.

Generating a display

At power-on or reset the CPU starts to read the code in the chip's program ROM. It uses this program code to check the H- and V-rate inputs (at pins 6 and 17) and their respective polarities (at pins 51 and 52). These signals are derived from the H and V sync outputs from the PC's graphics card. For a refresh on this, refer to Fig. 1, Part 2 (May issue, page 404). If the CPU detects a legitimate timing signal (within the limits described later) of identifiable H and V frequency, the program extracts certain data from the ROM. This data defines the various switch-selectable scan-control components that have to be brought into circuit. The data is neither factory-mode nor user adjustable. It's classified as display-mode-dependent fixed data.

The microcontroller chip then activates the appropriate output port pins. For example, when looking at EHT generation in Part 3 we saw that C607 is open-circuited with H-rate signals above 38.8kHz. This switching is controlled by pin 49 of IC101. Similarly the s-correction capacitors C521-4 are brought into circuit in accordance with the H frequency: this is controlled by the outputs at pins 42-

45, via buffer chip IC104 and the multiplexer chip IC502. The AFC network components are similarly controlled, by the outputs at pins 46-7. Line linearity relay RY501 is activated by the ROM data when the frequency is above 44kHz. This control is exercised at pin 48. Depending on the V frequency detected, the vertical linearity components C404/5 and R404 and the precise resistor values connected to multiplexer IC450 are switched in and out of circuit under the control of pins 4 and 5 of IC101. Multiplexer IC7V3, which also operates at frame rate, shares pins 4 and 5.

Multiplexed operation

The multiplexer chips that control the display-mode-dependent fixed components are addressed via pairs of select lines. For example with IC502, the multiplexer that selects H-osc and AFC network components, addressing is via buffers in the TD62504F chip IC104. The select line pair for the vertical linearity multiplexer is not buffered on the processor board: instead, Q452 and Q453 on the PWB-DEFL-SUB board provide buffering. Thereafter the pair is connected to the MC14052 multiplexer IC450, which in turn selects the relevant components (see Part 2, May).

IC450 shares its multiplexer select lines with IC7V3, which is part of the frame-rate sine-genera-

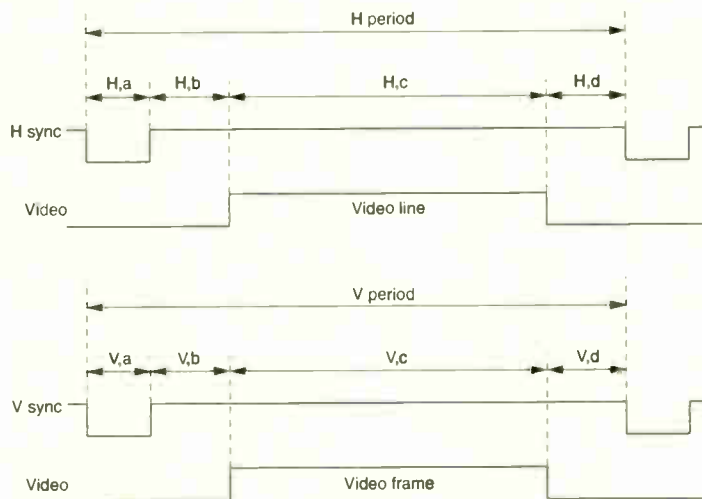

Fig. 2: Signal timing diagram, see Table 1.

tor. If, in some early production monitors, you don't find IC7V3 on the PWB-DEFL-SUB panel it may be on a small piggy-back board, PCB-SINE.

Non-multiplexed control

The s-correction capacitors and the line linearity coil are directly connected, i.e. there is no multiplexer chip, though the buffer chip IC104 also plays a part here. The tuning capacitor in the EHT generator circuit (switched in/out by Q605), and 'fan-out', the shut-down circuit that activates Q953 should the fan speed fall, are buffered by transistors Q104 and Q103 respectively.

IC101 also controls the degaussing circuit, at pin 41 via Q102 to the PWB-POWER-SUB board, where Q951 energises RY901 to pass AC through the degaussing coils for a few seconds.

Display-mode selection, cont

If the detected H and V frequencies match a recognised timing, the next step is determined by the H and V polarity. As previously mentioned, the exact display mode is determined by the combination of sync frequency and polarity. IC101 examines both to find out whether

the signal conforms to one of six standard modes, see Table 1 and Fig. 2. In their manuals manufacturers usually specify timing in μsecs and msecs : I've added frequency figures as these may mean more to TV engineers.

When a standard mode has been confirmed, IC101's ROM program selects predetermined memory locations in the EEPROM chip IC102 (type M6M80021F - see later). IC101 then reads in the contents of these memory locations and loads them into its RAM area. Data on the RAM values is sent via the two serial ports to DAC chips to achieve the appropriate height, width, pincushion, keystone etc. settings.

When the monitor is new from the factory, the stored EEPROM values ensure that the timing of the line and frame scanning is such that the video appears to be centred on the screen - so long as the mode generated by the PC's graphics card is standard. I've mentioned this point in earlier articles in the series, but it seems to be one that can never be made often enough. The microcontroller chip doesn't care what the video content is, or even the time when it arrives, so there's no need for RGB informa-

tion to be presented to IC101. Timing tables are provided by manufacturers to show design and signal alignment conformity.

Where the timing is found to be non-standard, the microcontroller chip allows for four sets of user-defined modes. Four user areas are reserved in the EEPROM for this. The user is free to adjust the picture as required for the non-standard mode, the results being stored in the EEPROM.

Common variables

Finally, brightness, contrast, RGB gain, RGB bias, DBF etc. are variables that are common to all modes. Brightness and contrast are very much user preferences, and the settings must be remembered between the last power-off and the next power-on - hence they are also stored in the EEPROM. Gain, bias and DBF, though not user adjustments, are factory-mode adjustable and must similarly be stored in the EEPROM.

Thus the adjustable items common to all modes, called non-mode-dependent variables, are stored in the EEPROM alongside the mode-dependent variable data. They are also read into the CPU and stored in RAM, and are fed out via the serial ports, in this case to DACs IC302, IC708 and IC452, IC304.

DAC connections

The multiplexer connections and those for other devices mentioned above have a nearly 1:1 relationship. That is, a pin from the microcontroller chip can be traced through to a specific item, and finding the cause of a particular digital-control fault is often possible using an ordinary meter. A DAC's connections are in stark contrast.

When fault-finding in microcontroller and DAC circuitry it can be useful to think of certain groups of devices as being under the control of a particular output port. The DACs in the circuitry being consid-

Table 1: Signal timing for the six standard display modes

Mode	H period μsec	H frequency kHz	H,a μsec	H,b μsec	H,c μsec	H,d μsec
VGA 640 x 480	31.778	31.47	3.813	1.907	25.422	0.636
VGA 640 x 400	31.778	31.47	3.813	1.907	25.422	0.636
VGA 640 x 350	31.778	31.47	3.813	1.907	25.422	0.636
Apple Mac 1	28.570	35.00	2.120	3.170	21.160	2.120
Apple Mac 2	20.676	48.37	2.092	2.462	15.754	0.360
Apple Mac 3	17.710	56.47	1.810	1.920	13.650	0.330

ered control all the adjustable items such as width, brightness, gain, bias, height, DBF etc., so it helps to list adjustable functions related to each DAC, then map the set of functions to the relevant port.

In this circuit two serial ports, each with three connections (load/clock/data), address two separate pairs of cascaded DACs, from pins 53/4/5 and 56/8/9 respectively. These six interconnections control about two dozen functions.

Pins 53/4/5 are connected to the DACs IC302 and IC708, both type DAC8840 (see Fig. 1). The items they control are shown in Fig. 1. IC302 and IC708 are 8-channel, 8-bit CMOS devices for use with a three-wire serial interface: they are able to emulate eight variable-resistance controls. Some control operations, which work like a volume control, e.g. pincushion amplitude, have a signal applied to the relevant input. With others, e.g. RGB gain control, only a DC output control voltage is required: these use a reference-voltage input. Fig. 3 shows a functional block diagram of the DAC8840.

Pins 56/8/9 are connected to DACs IC452 (type M62358P) and IC304 (type M62359P). The former is an 8-bit, 12-channel DAC with buffered outputs, the latter an 8-channel version. The main difference between the Analogue Devices' DAC8840 and these Mitsubishi DACs is that the latter provide only DC-control outputs and cannot emulate a variable-resistance trimmer – because there are no independent signal inputs. The analogue output range is variable between two reference levels, upper and lower.

To find data sheets, I'm in the habit of going to www.google.com and then launching a search based on the part number. Unless looking for spares, I head for the first .pdf file I see and, if the manufacturer's name is in the title, I nearly always end up with what I am looking for. So why not try your own search for

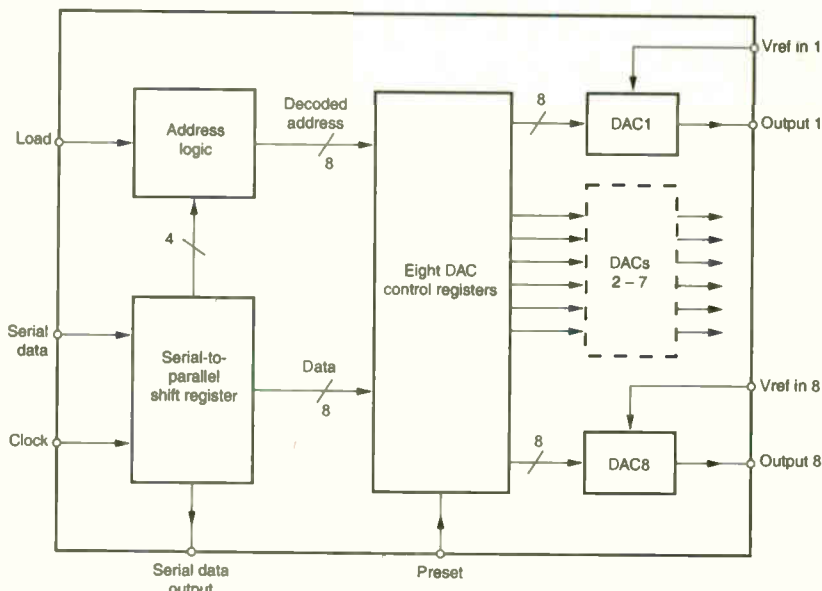

Fig. 3: Block diagram of the DAC8840 digital-to-analogue converter chip.

IC452 and IC304, then print out your own block diagram!

Microcontroller inputs

Apart from H and V sync inputs for analysis, the other inputs to IC101 are straightforward. There are ten push-button inputs, including reset and degauss, which are connected to pins 20, 21 and 25-32. The fan strobe input is connected to pin 11: the microcontroller responds by shutting down the power supply when this input is missing. Toggle switch SW951, on the PWB-POWER-SUB panel (see Fig. 3, Page 544, July), is earthed and is not connected to IC101 in normal use. The two active-low positions are connected to pins 39 and 40 of IC101, providing the factory mode (pin 39) or allowing the line oscillator to run without sync for setting up (pin 40). IC101's clock crystal is connected to pins 22 and 23. A flyback pulse that represents the blanking interval arrives at pin 7, from IC305 via Q107.

Finally, the watch-dog timer chip IC103 (type TA8030F) provides a reset signal for the microcontroller

chip and a couple of the DACs at power on, or in the event of IC101's internal SWDT failing, or a fall in the voltage on the 5V rail. Further information can be obtained from

www.sumisho.co.kr/product/search/pdf/15001/TA8030F.pdf

The EEPROM

The EEPROM chip IC102, type M6M80021F, is a 2Kbyte MOS device with chip-select, clock, data in and data out connections. It's simplest to think of it as a 'memory map' that has distinct areas for various uses, see Fig. 4.

First there's an area which is common to all the six standard display modes and the four user-defined modes that are allowed. It contains values for RGD gain and bias, DBF H and V correction, contrast and brightness. None of this data alters when the user changes from one application to another, even though this might call for a different resolution. A technician can adjust the gain, bias, DBF etc. and establish new reset values in the factory mode. The user will

V period msec	V frequency Hz	V,a msec	V,b msec	V,c msec	V,d msec	H sync polarity	V sync polarity
16.683	59.94	0.064	1.048	15.253	0.318	-	-
14.268	70.09	0.064	1.112	12.711	0.318	-	+
14.268	70.09	0.064	1.906	11.122	1.176	+	-
15.000	66.67	0.086	1.114	13.714	0.084	-/comp	-/comp
16.667	60.00	0.124	0.600	15.880	0.063	-	-
14.272	70.07	0.106	0.513	13.599	0.094	-	-

	Factory Adjustments	Working area – user adjustable
Area common to all display modes	R, G, B gain, R, G, B bias, DBF-H, DBF-V, brightness, contrast	Brightness, contrast
Area for standard display mode 1	V position, H phase, height, width, H and V static convergence, H osc, pincushion, keystone, pin balance, key balance, etc.	V position, H phase, height, width, H and V static convergence
Area for standard display modes 2 – 6	As above	As above
Area for user-defined mode 1	As above	As above
Area for user-defined modes 2 – 4	As above	As above

Fig. 4: EEPROM memory map concept.

want the monitor to remember the contrast and brightness settings when the monitor was last in operation. So, in this first area, there is factory-mode adjustable and user-adjustable data.

Next there are areas, used by the CPU, for the standard display mode settings and the user-defined mode settings. In each there is a table of values for line drive, H-osc control voltage, width (common with the HT), height, V position, H position (phase), pincushion correction, pincushion balance correction, keystone correction, V and H static convergence etc. The user has command over the width, height, H and V position and static convergence. The rest are technician-only adjustments.

The reset button restores the 'factory settings', which are in rewritable areas and are adjustable by a technician in the factory mode.

When the CPU reads data from the EEPROM and loads this into its RAM, it reads from the working part of the table then produces a screen display. A user who makes an adjustment tells the CPU to change the relevant RAM value. The CPU follows up by writing this new value into the EEPROM's working area. Pressing the reset button restores from the factory-adjustable table, writing this into the EEPROM's working table. The CPU then reads IC102 again and, finding the new factory data in the working section, loads it into the RAM and continues as normal. When an adjustment is made in the factory mode, the working data held in the RAM is stored in the EEPROM's working and factory areas. This is how new reset data is created.

Purpose of IC105

The 74LS508 chip IC105 is a latch that can isolate the H-rate signal feed to the deflection chip IC501, allowing the line oscillator to run free. The H-rate signal arrives at pin 2 of IC105 and, depending on the control input at pin 1 from pin 8 of IC101, the same signal may appear at pin 3 and pass to IC501 (this was dealt with in Part 2, May).

IC105 can also be controlled by the small toggle switch (SW951) at the front of the power supply board. When this is in the mid position, IC101 detects a low at pin 40 and its output at pin 8 prevents the H-rate signal passing through IC105. In normal operation, IC105 prevents the H-rate signal passing to IC501 when illegal timing signals are encountered. These are as follows: H-frequency less than 28.3kHz or more than 66kHz; V-frequency less than 45Hz or more than 135Hz; absence of either H- or V-sync; where the V- or H-frequency varies by more than 4Hz or 1.5kHz respectively. Otherwise the timing, whether standard or user-defined, is considered to be valid and IC101 leaves IC105 in the closed state.

Fault-finding

When it comes to fault-finding and repairs in the digital area of a monitor, relevant experience with TV sets applies. Check for damaged user buttons, defective crystal oscillator connections and confirm that the +5V and +12V supplies are present and correct. Ensure that the ICs aren't overheating.

Carry out scope checks to ensure that the H-rate signal is being

passed by IC105. This device has on occasions turned out to be faulty. The symptom is that the line scanning runs without line lock. If you doubt the toggle switch, which tells the microcontroller chip to continue or suspend the passage of the H signal via IC105, simply waggle it back and forth to see if there's any change on the screen.

List DAC chip functions, identify serial ports, and use a scope to check for activity on the bus lines while pressing buttons. If you find that some functions don't respond, see if they belong within a group. Check that data is being passed between one cascaded DAC and the following controlled device.

In one case the display had small, dark horizontal bands at the edge of the screen. It looked as if the line oscillator was behaving oddly but, by substitution, the processor panel was found to be the cause of the fault. The degaussing circuit was permanently on, the screen pattern being caused by the small residual current flowing through the posistor. Surface-mounted transistor Q102 had gone short-circuit collector-to-emitter. Fortunately IC101 was OK.

The CRT

Before I close my book on the TFS6705K, a few points should be made about the Sony M41/KNP16X CRT. With Sony Trinitron tubes there are usually two thin horizontal lines visible on the screen, spaced about two inches from the top and bottom of the screen. They are caused by supports that provide stability for the aperture grille. I've had customers complain about them, suggesting that they are "phosphor burns". It's worth explaining this prior to sale of a monitor.

On one occasion a peculiar fault 'developed' after a repair. There was a thin black line down the centre of the screen. When I looked very closely I could see that two of the aperture grille wires had crossed and become tangled. Taking a new roll of solder, I whacked the side of the monitor's bezel quite hard. Hey presto, the display was back in full. The same thing happened with another of these monitors next day. Weird and scary I thought. Then I noticed the junior technician having fun with the manual degaussing wand. After a short lesson the problem, strangely enough, never returned! ■

Special Offer Sale – 20 Remote Controls £20.00 (mixed all well known brands)

<p>NEW TYPES MAIN SWITCHES</p> <p>10 MIXED £2.00 VT311-VT210-VT311 REEL DRIVE £2.00 ZSK2761 600v/10amp N FETS £1.00 TDA 8362N £5.00 24CO2 15p TDA8178S £5.00 TDA2653A £3.00 TDA4866 £3.00</p> <p>MITSUBISHI VIDEO HEAD & DRUM 948B231820 £10.00 HEAD 928B654080 £5.00 UNIT GUM IDLER £2.00 LOPT CT2145 £5.00 CT246 £5.00 PHILIPS TUNERS NTSC FS936E £3.00 PHILIPS TUNER U1343/5 31-39-147-15281 £3.50 10 OFF NEW TYPE HAND SETS MITSUBISHI £5.00 + £5.00 POST NEW CHASSIS TUNER ALL COMPONENTS AND LOPT CT21AVIBS £6.00 POST £5.00 CT28AVIBS CAR IMMOBILISER WITH KEY £5.00 TUNER UE25-B56D £3.00 FERGUSON ICC 7 HAND SET £3.00</p> <p>FERGUSON VIDEO FV90 LV HAND SET £3.00 FV80 LV HAND SET £3.00 BRIDGE RECTIFIERS 10 FOR £1.00 CAMCORDER-UNIVERSAL BATTERY 9.6V - 1400MA FOR JVC-PANASONIC-PHILIPS £5.00 DESOLDER PUMP £2.00 FILTERS - 455 & 480 EACH 10p GAS SOLDER IRON-PORTASOL HOBBY £10.00 INFRA RED DETECTOR WIDE/SHORT ANGLE WITH RELAY £5.00 INFRA RED RECEIVER-MATSUMI MINIATURE £1.00 PANEL-1K2-FM2211 STEREO £5.00</p> <p>PSU AC 9V 1A £1.50 QUARTZ HALOGEN - 500W 200V FOR OUTDOOR LAMPS £1.00 RELAYS-SUB MINIATURE 25p SATELLITE TUNER UNIT -2427611 ... BASE BAND/VIDEO OUT £3.00</p> <p>HITACHI AC ADAPTOR 19v DC 2.5A SW MODE £3.00 ULTRA COMPACT COLOUR VIDEO CAMERA £35.00 + £3.00 POST SCART TO 4 PHONO LEADS 1.5M £3.00 SCART TO 6 PHONO LEADS £3.00 SCART TO "D" PLUG £1.00 SCART TO SCART LEADS - ALL PINS CONNECTED - 1.5 METRES MODULATORS £2.00 SOUND 5.5MHZ MPM 1000T £1.00 SOUND 6.0MHZ MPM 1040 £1.00</p>	<p>FERGUSON ADAPTOR - VPT - TEXT - VA354 £2.00 CAMCORDER BATTERY HIGH CAPACITY 9.6V 1800MA-VA310 £3.00 CAMCORDER BATTERY CHARG- ER 9.6 VOLTS VAZ65 EACH £6.00 CAMCORDER CAR ADAPTOR CHARGER - AND BATTERY- VA308 £5.00 CAMCORDER LENS 20FF - TELE-CONVERSION LENS x1.4 & x0.7 £1.00 CARDIOID CAMERA MICRO- PHONE-VA SUPER 218 TELE- SCOPIIC BOOM & STAND £5.00 CHROME BOARD-ICCS I/Cs U4647TKF OR HA11498 £6.00 DECK AND CAPSTAN MOTOR: FV61LV~ FV62LV, FV67LV FV68LV EACH £30.00 FV70B, FV71LV, FV72LV, FV74LVX EACH £30.00 FV77HV £30.00 FV31R £12.00 HEAD AND DRUM MODULATOR-SATELLITE-T1040- SRD3/4 £2.00 PANEL-TI228B TEXT FOR TX89, TX98, TX99, TX100 £6.00 PANEL-TUBE BASE-ICCS £5.00 PANEL-TUBE-BASE-TX89, TX98, TX99 £5.00 PANEL-TUNING 1509G-TX9, TX10 £5.00 PUSH BUTTON UNIT-TX85, TX86 - 8 BUTTONS £5.00</p> <p>HITACHI DECODER-TELETEXT PC232A5 - ISSUE 4 £15.00 HEAD AND DRUM - 620E £12.00 TELETEXT CONVERSION KIT £3.00 CORE 2 90° ITT TEXT PANEL £3.00 1996/7 MATSUI VIDEO CHASSIS WITH TUNER-IR POST £4.00 £5.00</p> <p>MATSUI - ORION DECKS WITH HEADS - D1096 VXA110 VP 9401 £16.00 HEAD-VSR 1500 = ORION D2096 £5.00 PANEL-MAIN-VSR 1500 P/P £5.00ea £3.00</p> <p>SAMSUNG TECUS983 VA24A VHF-Tuner with Aerial Socket UHF Fit most new TV's £5.00</p> <p>FERGUSON NICAM MODULE III Art No 989 591-E00 £5.00</p>	<p>VIDEO DECKS AIWA 1500 } MATSUI VXA 1100 } MATSUI 1500 } £5 £9 POST ORION D1094 } ORION D1096 } ORION D2096 ETC } CAPSTAN MOTOR FOR ABOVE DECKS £8.00 20 HIGH VOLTAGE CAPS 1500V - 2000V MIXED £1.00</p> <p>HANDSETS 3 IN ONE PHILIPS UNIVERSAL HANDS SET £5.00 DECCA £4.00 NICAM LCD £4.00 FERGUSON BSB £1.50 FV41R/3V59 £10.00 FV41R/FV42-FV51-52 } ICCS £7.00 IK2000, IK7000 EACH £4.00 SRD2, SRD3, SRD4 EACH £1.00 T780 £2.00 TV/SATELLITE WITH FST £3.00 HITACHI CPT2158 (NO REPLACEMENT) £5.00 VIDEO RM933E VIDEO PLUS £30.00</p> <p>MATSUI 1500 £5.00 VSR 1500 £4.00 VX3000 £3.00 3000/ORION - TV AND VIDEO £2.00 RC = PACE 900, FERGUSON, SONY, GRUNDIG £5.00 MITSUBISHI RM35 - VIDEO £5.00 NOKIA RC202 £4.00 VP9401 D1096 VXA 1100 AND VIDEO PLUS SAMSUNG HANDSETS, TV & VIDEO - 12 TYPES EACH £3.00 COMPLETE REPAIR KIT, CLUTCH AND PINCH ROLLER. IDLER D2906 MATSUI £7.00</p> <p>TUNERS IF TERC8-022A TBJZA-00ZA-ALPS £3.00 SATELLITE SXT2302 180968 £3.00 SATELLITE WITH BASE BAND MIN SXT2302234 £4.00 SMALL UNF/VHF £3.50 VHF/UHF - TEKE4- 112A £4.00 4944 U321, U341, U342, U343 } U344, U411, U412, U944 } EACH £2 U743, 7744</p>	<p>AMSTRAD UE33-BO 1 £3.00 MRF7-7E33 MATSUI ORION VIDEO TUNER IF £5.00</p> <p>FERGUSON 1F2105-RE £5.00 MTP2011-AP00 £5.00 UHF - ICC5 £5.00 VHF - ICC5 £5.00 TX85, TX86, TX89, TX90 TX98, T99, TX100 EACH £4.00</p> <p>ORION 1500 - UE33 BO9 £4.00</p> <p>PANASONIC SMALL UHF/VHF £3.00</p> <p>FERGUSON DOUBLE SIDE NICAM £10 ICCS NICAM SINGLE BOARD ICCS £10</p> <p>TATUNG UNIVERSAL 205 OR EQUIVALENT WITH AERIAL SOCKET £3.00</p> <p>MOTORS HITACHI CAPSTAN 150E £3.00 MATSUI CAPSTAN I/C NO. M56730 ASP £15.00 2 TYPES 1995 TO 1997 MODELS MATSUI VIDEO DECKS WITH CAPSTAN MOTOR AND HEAD P/P £5.00 £20.00</p> <p>MITSUMI MOD MRF7-UF32 £5.00 MOD TMUG3-103A £5.00 MITSUBISHI CAPSTAN-HSE41-I/C MSI782ASP £2.00</p> <p style="text-align: center;">12vto 15 D.C.</p> <p>TV MODULATOR WITH LEADS VIDEO IV 75R AUDIO IV 10K HV100 £3 EACH</p> <p>TV AERIAL AMPS VHF /UHF 1 WAY 20dB EACH £5 2 WAY18dB EACH £5 4 WAY10dB EACH £5 8 WAY4dB EACH £5 240v MAINS</p> <p>COMPUTER 3 PIN MAINS LEADS 2 1/2 METRES LONG - GREY EACH £1.50 2 METRES LONG - BLACK EACH £1 SCART TO SCART - ALL PINS -1 METRE EACH 60p</p>
---	---	---	--

No accounts

SENDZ COMPONENTS

No Credit Cards

63 BISHOPSTEIGNTON, SHOEBOURNESS, ESSEX SS3 8AF

Tel: 01702 332992 Fax: 01702 338805

Specific P/P charges are PER ITEM ● For UK addresses add P/P to order then 17.5% VAT to total.

This applies to EC unless VAT No. is given ● Exports – P/P at cost ● Postal Order/Cheque with order.

Unless otherwise specified add £1.70 P/P to SMALL ORDERS ●

Additional P/P for HEAVIER GOODS. Technical information by telephone only Government/School Orders on official headings.

Callers to shop – 212 London Road, Southend-on-Sea

Open Saturday Only 10-12 noon – 2-5pm.

PLEASE ADD 17.5% VAT TO BOTH THE GOODS TOTAL AND P/P CHARGE



DX and Satellite Reception

Terrestrial DX and satellite TV reception reports. News on TV broadcasting and satellite band changes. Moon-bounce reception. Roger Bunney reports



NASA-TV, via NSS K at 21.5°W, is the signal to watch for space action.

June was a funny old month for DX-TV reception. Conditions during the late May-early June period were quite active but, as the month progressed, reception gradually declined. At least TVE (Spain) is still transmitting in Band I, despite various announcements to the contrary over the past year. Sporadic E propagation tended to be mainly along a north-south path, with lots of signals received in the UK from Italy. Spain and Scandinavia. Here's the SpE log for the month:

- 1/6/02 NRK (Norway) chs. E2-4; SVT (Sweden) chs. E2-4; DR (Denmark) ch. E3; RAI (Italy) chs. IA, B; Tele-A (Italy) ch. E2-; TVE (Spain) chs. E2. 3; RTP (Portugal) chs. E2. 3; RTL Klub (Hungary) ch. R2; HRT (Croatia) ch. E4; IRIB (Iran) ch. E2; C+ (Canal Plus, France) chs. L2, 3; ARD (Germany) ch. E2; TVM (Moldova) ch. R2.
- 2/6/02 RTP E2, 3; TVE E2-4; Tele-A E2-; TVA (Italy) E3; PTP (Russia); LRT (Latvia) R2; RTL Klub R2; HRT E4; RTS (Serbia) E3; SVT E2.
- 3/6/02 RAI IA, B; Tele-A E2-; SLO (Slovenia) E3; ARD E3; C+ L3, 4; HRT E4; RTP E3; TVE E3; RTL Klub R2; ORT (Russia) R2; NRK E3; unidentified Arabic ch. E3 signal at 1345 hours.
- 4/6/02 ETV (Estonia) R2; SVT E2-4; LRT R2; NRK E2, 4; ORT R2; RAI IA, B.
- 5/6/02 NRK E2, 3; SVT E2, 3.
- 6/6/02 NRK E2-4; SVT E2-4; TVE E2.
- 7/6/02 ORT R2; TBK (Belarus) R1; C+ L2, 3; RTP E2. 3; RAI IA, B; Tele-A E2-; TVE E2-4; NRK E3; YLE (Finland) E4.
- 8/6/02 TVE E2-4; RAI IA, B; C+ L3.
- 9/6/02 ORT R2; SVT E3; RAI IA, B; Tele-A E2-; HRT E4; RTL Klub R2; TVE E2-4; RTP E3.
- 10/6/02 TVE E2, 3; RAI IA, B; Tele-A E2-; SVT E2.
- 11/6/02 RTP E2, 3; TVE E4; TBK R1, 2.
- 12/6/02 TVE E3, 4; RTP E3; RAI IA, B; Tele-A E2-.
- 14/6/02 RAI IA; TVE E2-4; HRT E4; ORT R2.
- 15/6/02 TVE E2-4; Tele-A E2-.
- 19/6/02 RTL Klub R2; HRT E4.
- 20/6/02 NRK E2; RTL Klub R2; ORT R1.
- 24/6/02 NRK E2; ORT R1.

I've heard that chs. A2 and A3 (North America) were received in the UK on June 14, and will provide more details about this when obtained. The Russian (ORT) ch. R1 signal received on June 24, in the early evening, was very strong and spread through to ch. E3, with inverted video. Odd! It obliterated the local 49MHz baby-alarm signals. Peter Schubert (Rainham, Essex) also commented on this signal.

Cyril Willis (King's Lynn) has just returned from a holiday in Cyprus, where he received Syria ch. E3 and Arabic Band III and UHF signals daily.

June 3 was Jubilee time of course. BBC Radio Jersey and Radio Guernsey transmitted announcements that their normal UK network feed had failed and that in view of the day's significance a DTH satellite feed from Astra digital at 28°E was being used. This source included an on-screen interactive red button, which BBC viewers were told was inoperative.

Satellite sightings

June was a relatively quiet month for those who monitor the Clarke Belt. It opened in fine Jubilee style, with the festivities around Buckingham Palace. An NTSC OB feed via NSS K (21.5°W) to the US on June 2 turned into more of a news item however. I found UK1-195 at 11.547GHz H (SR 5,632, FEC 3/4), with a reporter and friend discussing the events of the day inside a temporary glass-fronted Portacabin studio overlooking the Palace. A fire engine was driving through the gates and clearly something was happening. The fire in the State rooms was quickly put out, though the smoke from the roof suggested an early

start to the fireworks!

Sky News reported from the Palace for two days, using UK1-784 to uplink via Eutelsat W2 (16°E) at 12.522GHz H (SKY NEWS DSNG SKY 3). Sky took the output at each hour, inserting it into the rolling news. Interesting that the service identification "UK1-784 cl 4.2.2" suggested MPEG 4:2:2, though in fact MPEG-2 was being used.

As an aside on this, the regional downlinks used by Anglia (TES-42) and Meridian (South TES-43, South East 'Meridian 8MBT-TES-9') have in recent weeks used MPEG-2. Occasionally the Southampton/Newbury TES-43 at 10.988GHz V jumps to MPEG 4:2:2, the result being either a "signal encrypted" message with blank screen or a mass of multi-coloured squares depending on MPEG-2 receiver design. These regional feeds are all carried by Intelsat 801 (31.5°W). During the evening of June 25 TES-42 was seen in an East Anglian gravel pit, reporting on the discovery of a mammoth's tooth.

World Cup action came via C-band (4GHz) Intelsat capacity, with no Ku-band reports.

Whilst scanning across the empty wastes of Intelsat 801 I encountered activity at 11.487GHz V. The service identified itself as "Weiterstudio Gais". This was at 1830 BST. There was no picture, just a blank raster, which disappeared at 1845. Intelsat 801 tends to be used for French/UK feeds, with German feeds found at the Astra-3 (previously Kopernikus) slot - 23.5°E. For the record, Astra 1A has been moved into active retirement at 5°E, the Sirius slot.

There was much to see in the middle of the month on the latest Shuttle flight to the ISS. The station is still being built, and vivid pictures were downloaded from on-board cameras and those in space-suit helmets. NASA-TV is usually carried at via NSS K from the Johnson Space Centre. Houston in the evening. Tune to the three-channel multiplex at 11.590GHz V (20.145, 3/4). Good news with NSS K: "WNS-LONDON" at 11.566GHz H has dropped encryption. So Reuters news exchanges are in the clear - WNS is Reuters World News Service.

Dave Dyson (Accrington), who uses an RSD-300 (CI) receiver, reports that Vatican TV CTV (21.5°W) has moved to 11.618GHz V with the unusual SR 6.670. CTV-1 is encrypted, but CTV-2 is in the clear. CLN-ELPITEL has also been seen at this frequency, with SR 6.116, also Globecast NE with SR 5.700. CLN occasionally appears at 11.628GHz V, with SR 6.110. The common 6,110 SR may also be used at the former frequency - the pull-in range of the RSD-300 can read slightly off the correct parameter, particularly when the signal is strong.

On June 11 the Afghan feeds via Europe*Star-1 (45°E) were brought into action to report on political developments. The former King decided not to stand, and a temporary head of state was appointed. The events of the day took place in large tent. Three uplinks were active during the afternoon: Taridan Scopus at 11.556GHz V, and Fox News at 11.675GHz V and also at 11.471GHz V, all using 5.632 and 3/4. There was a jumble of identifications at the latter frequency, including 'Globecast Newsforce UK1-579 BBC Kabul' and 'APTN Kabul'.

Edmund Spicer (Littlehampton) is now using an 80cm dish. One new catch he reports is IRN (Independent Radio News) at 11.459GHz H (3.149, 3/4) via Intelsat 707 (1°W). "A little or a lot" will be present here depending on the time of day and part of the hour. When it's busy there are the main news feeder, a tone (test whistle), commercials and other programming. He also found BFBS radio services (British Forces Broadcasting Service) at 11.561GHz V (6.000, 1/2) via Telstar 11 (37.5°W). In recent weeks this downlink has been either encrypted or in the clear.

The CNN and the Balkans air-surveillance downlinks from this satellite were still present, in the clear, at the end of June (11.495GHz H, 19.500, 2/3). There has been comment in the media about this surveillance. The US Military considers that there is no security problem with the civilian-operated service, which provides unclassified pictures.

Telstar 12 (15°W) has been seen carrying the Iranian propa-



Despite recent media comments on US air surveillance in the Balkans the satellite signals continue to be received - and Aircscan has a new clock, shown above.

ganda channel NITV in the clear at 12.608GHz H.

A final note this month. BBC News 24 has been seen in the clear at 11.324GHz V (27.500, 3/4) via Eutelsat W3 (7°E). This satellite carries considerable EBU news traffic, news exchanges, two-ways, unilaterals etc. All EBU traffic now uses MPEG 4:2:2, which is impossible for us impoverished MPEG-2 receiver owners to decode!

Broadcast news

DTT: Digital terrestrial TV transmissions in Latvia are to start

www.Aerial-Techniques.com

THOMSON Multi-Standard 21" and 25" Nicam Televisions



Silver cabinet only

- PAL/Secam/NTSC colour TV.
- Multi-system reception (8 systems).
- 21" Model - £299.00 inc VAT
- 25" Model - £329.00 inc VAT

- International fast text.
- Nicam stereo sound.
- On screen menu.
- Infra red remote control.
- Scart connection.
- Front connector jacks.



Silver & Black cabinets available

Covers VHF (Bands 1, 2 & 3) UHF, plus in between channels. PAL system 1 (for UK), PAL, Systems B/G (for Europe), PAL, System D (for China), Secam L, For France, Secam D/K, (For Eastern Block), Secam B/G including NTSC 3.58 MHz via the scart.

THOMSON 14"/36cm Multi-Standard Colour TV with Integrated VCR



NEW

- Covers VHF/UHF/PAL/Secam For use in the UK, France, & Europe
- Two integrated tuners.
 - International Teletext.
 - Built in TV guide.
 - Video plus.
 - NTSC play back.
 - On screen menu.
 - Silver cabinet.
 - Infra red remote control

Only £399.00 inc VAT
Including a FREE inverter enabling you to run it off 12v DC.

Overnight delivery for all items by insured courier £10.00

NEW GRUNDIG GDS-3000 Digital satellite receiver

Complete digital satellite system available for only £399.00

This includes:

- 60cm mesh dish kit.
- Plus all connection cables & plugs.
- Free viewing card accessing: BBC1, BBC2, ITV-1, Channels 4 & 5, all the BBC radio stations.
- Plus many other channels.

Additional extras available,

- New collapsible tripod - £49.95.
- Satellite signal finder - £29.95.
- Folding 64cm dish (including digital LNB) - £79.95
- Folding 88cm dish (including digital LNB) - £89.95 all inc VAT

MULTI-STANDARD SPECIALISTS

FULLY COMPREHENSIVE 35 PAGE CATALOGUE AVAILABLE BY RETURN OF POST FOR £1.50

59 Watcombe Road, Southbourne, Bournemouth, Dorset BH6 3LX

Tel: 01202-423555 Fax: 01202-425055

E-mail: atech@dircon.co.uk Est 1979





These small, cigar-tube sized containers are filled with human cremation ashes, to be placed in Earth or Lunar orbit following a funeral service provided by Celestis Inc. of Dallas, Texas. The top right container carries the name of the deceased and the message "have a great flight Dad".

early next year. Up to 36 channels are expected eventually in Riga and about 24 nationally, a mixture of FTA and subscription. The French broadcasting authorities have postponed the closing date for DTT applications until October 31, pending resolution of how the future administration of DTT is to be organised. Sweden is shortly to have a DTT channel dedicated to children's programming. It will also be available via satellite and cable.

Channel news: The main Russian TV channel NTV nearly lost its transmission licence after breaching programme guidelines. The Federal Tender Committee has discussed the problem with management and it seems to have been resolved – the NTV licence has been extended until 2007.

An analogue entertainment channel for youth, called Tango TV, is being transmitted in the Vilnius region of Lithuania. TVS (or TV Sektr) started to broadcast on June 1 as a replacement for the previous TV6, which was banned. It's devoted to news and light entertainment.

A dedicated news/current affairs channel was started by Pakistan Television on July 1.

Germany: The SFB-Berlin and ORB-Brandenburg broadcasting networks are to merge. The aim is to improve finances and enhance their position within the ARD operation.

Iran: A recent updated transmitter list shows a high level of



The Celestis Inc. logo.

broadcasting activity in Band I. There are five ch. E2 transmitters with ERPs from 6-100kW, eight ch. E3 transmitters with ERPs over 6kW and five ch. E4 transmitters. New Band I transmitters were being installed as recently as summer 1996. The E2 channels include Pishin at 316kW and Kuh e Nuh at 200kW ERP.

Portugal: State funding for RTP-2 is to end, having built up debts of over £600m. The service will either be closed or sold to a commercial broadcaster.

Isle of Wight: The ITC has received three bids for the island's RSL-TV licence – the successful candidate will be announced in early July. Current holder TV 12 is confident that its licence will be renewed, from October 31. The other bids were from Solent TV and Wight TV.

Satellite news

Launch of the new 905 Intelsat craft into orbit at 24.5°W will provide 72 C-band and 22 Ku-band high-power transponders covering Europe, Africa, the Middle East and the Americas. The slot was first used by Intelsat 1 (Early Bird) in 1965. Intelst 603, which was previously stationed at 24.5°W, has been moved to 178°E – over the Pacific.

The Spanish Via Digital DTH service is to introduce a set-top box that incorporates a hard-disk recorder with a programme storage capacity of sixteen hours. Consumer trials are to be carried out at Malaga, Alicante and Tarragona.

Moon-bounce reception

Hugh Cocks (Algarve, Portugal) has drawn my attention to investigations by Anthony Mann (Perth, Western Australia) into the possibility of moon-bounce DX-TV. Radio amateurs have for some years used moon-reflected transmission at VHF/UHF, with fairly high powers and very high-gain aerial systems. Not much has been published on this transmission mode, which is sometimes referred to as EME (earth-moon-earth). Basically, a high-power incident signal that reaches the moon's surface can be reflected back to earth, during a calculable time 'window' (access period) for the outward and back paths. Over such huge distances, with reflection involved, there is likely to be polarisation shift, suggesting the need for a circular-polarisation feed at the reception site.

Anthony noted that many UHF transmitters in the US use very high ERPs, typically up to 5MW. The signals travel outwards towards the horizon, and continue beyond. If the moon is suitably positioned they will arrive at its surface, in very much weakened form, and will be reflected and scattered. The scattered signal information may arrive back on earth, now severely weakened. Anthony has managed to receive and identify such signals.

We're not talking about noise-free pictures, in fact there are no pictures. What Anthony has received is very, very narrow parts of the audio signal spectrum, with bandwidths down to a few Hz. The received signal is processed and fed into a computer. The signal 'blip' then appears on the monitor screen as a waveform pulse. As previously mentioned in this column, it's now possible to measure TV transmission offsets to a few kHz. By using a PC, a suitable program and a stable radio scanner measurement can be taken down to a few Hz. Given just a sniff of a signal, its origin can be established by checking the nominal carrier, with any offset present, against transmitter parameter listings.

Anthony has calculated the send and receive angles, and thus the 'window of opportunity', for several high-power US UHF transmitters. The optimum condition is when the moon sinks down to the horizon and maximum transmitter power is 'aimed' at it. Anthony is not using a large dish. Instead he uses a standard long UHF Yagi array, similar to a Fuba XC391/Triax Unix 100. A GaAs FET head amplifier with a gain of 20dB and a noise figure of 2dB (sounds high to me) is mounted next to the dipole, and low-loss coaxial cable connects its output to an Icom R7000 scanner. This is a comprehensive though perhaps rather

mature receiver. I have one, and can confirm that it's a truly solid piece of gear! It incorporates SSB, and a very weak signal can usually be resolved when this is switched into circuit – that's how I first located the 250MHz domestic radio downlinks via the US Fleetsatcom craft at 20°W, see report in this column last November.

Anthony mounted the aerial on a 5ft high tripod and can adjust it to align with the moon. The exact carrier frequencies used by the selected US transmitters are known to the last Hz and can, with the calculated time window, be tapped into the scanner. But a further calculation is required. The earth and moon are both moving and, like a moving train with its whistle frequency that changes as it passes you, so a frequency variation needs to be calculated – to take into account the moon/earth movement and frequency shift (Doppler effect). Doppler correction is only a few Hz but changes during the receiving window period, which can be from four to 25 minutes. With a bandwidth of a few Hz, accuracy is essential.

This is an incredible technical exercise with extremely weak signals. Anthony has managed it using a basic aerial, head amplifier, scanner and computer. WNDU-16 (South Bend, Indiana), WAPT-16 (Jackson, Mississippi), KXTX-39 (Dallas, Texas), KDTV-14 (San Francisco, California), WFTT-50 (Tampa, Florida) and KWBT-19 (Muskogee, Oklahoma) were among the eleven transmitters he had received and identified by early June.

Printout spectrum scans show the DX signal sitting on top of the residual noise – an example can be seen in Fig. 1. But remember that it's a spike a few Hz wide. Our familiar DX-TV signals that provide a very poor-quality image with bandwidth limiting are over 1MHz wide. Nevertheless Hugh Cocks is attempting moon-bounce reception with a 2.8m dish and a helical aerial feed. Reception of the 860MHz signal from the Indian ATS-6 TV satel-

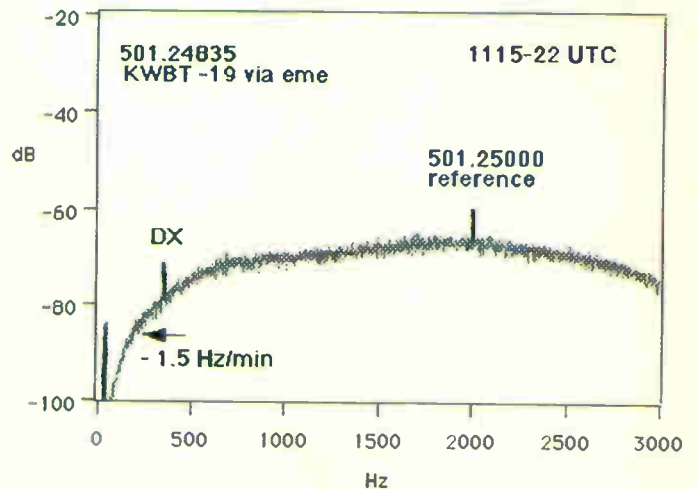

Fig. 1: Spectrum analysis showing the audio signal spike (DX) with KWBT-19 moon-bounce reception by Anthony Mann in Perth, Australia on May 26.

lite in 1975-6 was more successful with home-constructed dishes than Yagi arrays.

I'll report further as more information and reception reports become available. Meanwhile my congratulations to Anthony on demonstrating a dramatic DX-TV propagation mode and the considerable effort he has put into what, for most of us, would seem to be something that's impossible. For updated information check the GM4JJJ moon-bounce program (www.gm4jj.co.uk) and the Perth University site (www.physics.uwa.edu.au/~agml.JPG).

Test Case 477

The number of service calls generated by our rental equipment far exceeds the chargeable calls. Many of these call-outs are unnecessary – caused by customer 'finger trouble', low batteries in remote-control units, temporary reception problems and so on. But they all have to be attended to, and today's field technician may well spend a whole day without having to use any tools or bring anything back to the workshop for repair.

Our field technician is Colin Doc, but on this particular day he was unable to do any driving because of a wrist injury. So he spent the day in the workshop, de-cluttering the computer and sorting out bugs, while Service Manager himself took to the road in the big white van, with a road map and a list of seven service calls.

The first of them was to a customer who rented a big, posh stereo TV set. His complaint was that he couldn't get stereo reception with the satellite channels, though it came through well enough with analogue terrestrial programmes. Sure enough an on-screen "stereo" caption appeared with everything except the sixth button, which gave access to the feed from the Sky set-top box. Service Manager soon had this one sorted out, though it required a trip back to the van and Colin Doc's box of goodies just behind the seat. An easy one to start with for SM – and, hopefully, for you!

The second job was not quite so simple. The problem concerned a DVD player which was part of a cheap rental package, the complaint being that it didn't play discs. Sure enough it didn't, the effect being rather like that with a DVD player whose laser lens is in need of a clean – some clicks and whirs, followed by a "no disc" caption. Once again SM rooted

around in Doc's goodie box, and came up with a cleaning disc. In it went, and afterwards the player worked all right. Dead easy, this job, SM thought! But the customer produced another disc, loaded it up and showed that the TV screen produced a "wrong region" message. You could hardly blame Test-Case Rentals or the cheap n'cheerful player for that: the DVD was an American one.

There followed a rather heated argument! It appeared that Mr Customer had a friend whose identical player was quite happy with this disc. SM was invited to terminate the rental contract there and then if a solution couldn't be found.

A hasty phone call to the workshop ensued. Sage came up with the answer, helped by Doc Colin who was already at the computer and connected to the internet. Would you know what to do in this situation, more specifically which websites to visit to get information? Sage did, Doc Colin does now, and the vital information was passed back over the RT to Service Manager. And it worked! SM left Mr Customer watching his American disc on what had now become a multi-standard player.

The contract was thus saved. Or was it? We won't follow the rest of Service Manager's day, interesting though it was, but fast-forward two weeks to the point where Mr Customer came on the phone again. Some US (Region 1) discs would play all right, but others wouldn't, he said. By now Doc Colin was back on the road and, with scribbled instructions from Sage, was able to solve the problem once and for all. Could you have done the same and upheld the good name of Test-Case Rentals? The solution is on page 698.



SATELLITE NOTEBOOK

Reports from
Christopher Holland
and Carl Owen

Channel freezing

Mrs Gray phoned to complain that after a while some channels would freeze into "large squares", others remaining fine. She mentioned that the BBC and Discovery channels in particular were affected, while Sky News, CNN and TCM were OK. From this it was clear that the horizontally-polarised channels were affected, the ones with vertical polarisation being all right. So the cause of the problem lay with either the 18V horizontal-polarisation supply or the low-/high-band 22kHz tone selection system.

A replacement LNB cured the problem. But before installing the new one I connected the output from the old one to

a spectrum analyser. This showed that over a few minutes the horizontally-polarised, high-band signals slowly reduced in level to nothing. The horizontally-polarised low-band signals remained constant and, once the change to low-band had been carried out by deleting the 22kHz tone, switching back to high-band produced signals again for a few minutes.

I've noticed that LNBs are sometimes prone to breakdown, either partially or completely, when there's a change of temperature over a relatively short time period. C.H.

Humax IRC15400

If the power supply is tripping with the red light on the front panel flashing, replace C7 (33µF, 50V), C9 (1,000µF, 10V) and C21 (1µF, 50V). Sometimes the 30V zener diode and the 100Ω, 1W resistor in the 30V line also fail. C.O.

Digital channel update

The latest channel additions at 28.2°E are listed in Table 1 – where assigned, the EPG number is shown in brackets after the

Table 1: Latest digital channel changes

Channel and EPG (GHz)/pol	Sat	TP	Frequency
Akash Radio (918)	2B	33	12.344/H
Alpha TV Punjabi (818)	2A	14	11.973/V
ESPN Classic Sports Italy	2B	33	12.344/H
Nick Toons TV (606)	2B	34	12.363/V
Setanta Sports (435)	EB	D9S	11.623/H
Shop 24/7 (659)	2B	33	12.344/H
Tell Sell	EB	D9S	11.623/H

TP = transponder, 2A = Astra 2A, 2B = Astra 2B, EB = Eurobird.



Photo 1: The Sky new channels menu.



Photo 2: Nick Toons TV trailer.



Photo 3: Adding ESPN Classic Sports Italy.

channel name. The following EPG numbers have recently been assigned: 232 Rapture TV; 235 Avago TV; 455 Vibe TV.

Some Sky channels are being used to test transponder 31 (12.304GHz horizontal) aboard Astra 2B. Reception is not at present possible when these channels are added via the New Channels menu (see Photo 1) as it's blocked when a domestic Sky viewing card is used.

Nick Toons was due to start on July 22 via transponder 34, see Photo 2.

ESPN Classic Sports Italy has to be added manually via the New Channels menu: this can cause confusion as it at present has no name in the programme identification banner. C.H.



**OFFICIAL
DISTRIBUTORS**

WILTSGROVE LTD

35/38 River Street, Digbeth, Birmingham B5 5SB, UK.

Tel: 0121 772 2733 Fax: 0121 766 6100
e-mail: sales@wiltsgrove.co.uk http://www.wiltsgrove.co.uk



DIGITAL SATELLITE RECEIVER



- Provides high quality video and sound.
- Automatic digital satellite signal detecting functions.
- Provides various switch types, various LNB types & NTSC/PAL Monitor types.

Order code: AE-7255

£99.00

DECK MECHANISM ORION/MATSUI



- Complete Mechanical Deck.
- Model: C1499.
- Videohead.
- IDLER.
- Cassette Housing.

Order code: SPV-5000

£19.95

DIGI-KIT



Enables you to operate your digital box from anywhere in the house.

NEW

Qty

1 **£11.75**

5+ **£11.25**

10+ **£10.45**

Order code: IR-1086G+DIGIEYE

NEW

FLYBACK TRANSFORMERS

MODEL	PRICE (£)	MODEL	PRICE (£)	MODEL	PRICE (£)	MODEL	PRICE (£)
AIWA		2896	13.65	1455	10.75	SEG	
VXD1420K	10.85	2898ST	13.65	1408T	10.85	CT7800	14.45
ALBA		28128	13.65	C1499Y	10.85	TELEFUNKEN	
CTV6682	14.45	CP775	13.65	1409R	12.35	418B	12.95
CTV5984	14.45	DMQ2594	13.65	1408T	12.35	A420C	12.95
AMSTRAD		DMQ2896	13.65	28N03	12.75	A430	12.95
WSTV7128N	15.95	DTL25G7	13.65	MITSUBISHI		A520N	12.95
BEKO		GB2889ST	13.65	CT2531	10.90	A530	12.95
17125NX	13.75	GB2898ST	13.65	CT2532	10.90	A420V	12.95
17125T	13.65	KN2827TXT	13.65	CT2533	10.90	A430NV	12.95
17325T	13.65	DANSAI		CT2534	10.90	A520V	12.95
28128NX	13.65	CT1400	10.75	CT2531BM	10.90	A530NV	12.95
28128T	13.65	CTV1477	10.75	CT2532TX	10.90	A530PV	12.95
30128NX	13.65	DECCA		CT2552STX	10.90	FS430V	12.95
352228PD	13.65	D25N44025BKA	12.75	CT2553STX	10.90	FS530V	12.95
NR17125NX	13.65	DEFINITION		CT2554TX	10.90	TENSAI	
NR28128	13.65	DT114R	10.75	CT555STX	10.90	TCT382BK	10.75
NR28128NX	13.65	DT114V	10.75	CT2555STX	10.90	TCT382GBG	10.75
20212T	15.75	FIRST LINE		NIKKAI		QUELLE	
20212R	15.75	FL7213951	15.95	TLG1409	10.75	Q15105	10.75
20212TV	18.75	GOODMANS		TLG1450	10.75	066364	10.75
NR20212T	18.75	R1400	10.75	NORDMENDE		FK1006	10.75
BLACK DIAMOND		GTV257	12.75	3408	12.95	T839GRZ	10.75
BD28WS	15.95	255NS	13.65	F2311	12.95	VESTEL	
BOOTS		285NS	13.65	2666A	12.95	CHASIS11AR19	15.95
1417R	10.75	255NS	13.65	3405IMC	12.95	OEM NO.	
CTV1414R	10.75	KNEISSEL	13.65	S770V	12.95	PRICE (£)	
CTV1417R	10.75	KN2527XTST	13.65	6405VT	12.95	CF65A	10.75
BUSH		KN2590	13.65	ORION		154-164A	10.75
BTV17	10.85	KNN2890	13.65	C1499Y	11.85	043213012	10.85
1352-5006	12.75	GB2898ST	13.65	PICFIC		334P18506	10.90
282KF	12.75	GTV288	14.45	PTV2701	12.45	FC14B025A	12.35
282KFWST86	12.75	GTV66N1	14.45	PROTECH		3214029	12.35
3463NTX	12.75	GTV66W1	15.95	7206	14.45	13525033	12.45
3472NTX	12.75	GTV69W3BLU4	15.95	PTV7001	12.45	13525058	12.45
34BK03472NTX	12.25	GRUNDIG		PROLINE		13525086	12.75
5065621400	12.75	TVR3725	12.35	1485T	11.90	11425109	12.90
CHASSI 4400	12.75	FERGUSON		1485R	11.90	40153200	12.95
WST68	12.75	B59N	12.95	REOC		40153201	12.95
2871NTX	14.45	B68NX	12.95	NRTT2	16.75	13525008	13.65
2868NTX	14.45	A59N	12.95	SABA		M12-96	13.85
2863NTX	14.45	B59NX	12.95	A6303	12.95	003311124	13.65
2871NT	14.45	C59NX	12.95	A6303VT	12.95	13420086	14.45
2571NTX	14.45	C68NX	12.95	M5524VT	12.95	1372 0006	15.95
2872NTX	14.45	68SL2	12.95	M6323VT	12.95	4030001918	15.95
2568NTX	14.45	A68N	12.95	M6328	12.95	11421845	16.75
2890D	14.45	A59F	12.95	M7030VT	12.95	0033071083	16.75
2874NTX	14.45	B59F	12.95	M7077	12.95	13525016	18.25
217NTX	15.95	B59M	12.95	M7223VT	12.95	MODEL	
2028T	18.95	B68N	12.95	M7228	12.95	PRICE (£)	
2031T	18.95	HARVARD		T6307	12.95	KSS210A (FR)	8.25
2164NTX	15.95	CTV1488IR	10.75	T6347NT	12.95	KSS213B (FR)	8.35
2071NTX1ST	15.95	JMB		T6348VT	12.95	KSS213F (FR)	11.95
2568NTX	15.95	JMB1499A	10.85	T6355	12.95	KSS240A (FR)	16.75
2863NTXA	15.95	JMBTV028WS	15.95	T7006VT	12.95		
2871NTX	15.95	JMBV028WSS	15.95	T7047VT	12.95		
32BKWS667	15.95	VO28WS	15.95	T7048VT	12.95		
CTV4859	15.95	LOEWE		T7055	12.95		
CTV4809	15.95	CTV37	10.75	T7055VT	12.95		
RC2040	15.95	MATSUI		SCHNIEDER			
WS6871	15.95	209T	10.75	CHASSITV9	12.45		
CROWN		1422	10.75	CTV2780	12.45		
CTV37	10.75	1450	10.75	CTV2816	12.45		
DAEWOO				NTV2701	12.45		
2594	3.65			STV2802T	12.45		
2594ST	3.65			STV2801T	12.45		
2596ST	3.65						
2598ST	13.65						
28G2	13.65						

DIGITAL VOICE RECORDER



DIGITAL VOICE
ACTIVATED RECORDER

- Up to 9hrs Recording Time.
- Records up to 396 messages.
- Recordings uploaded to PC.
- 2 Recording Mode (LP/SP).
- Sleep Mode (power saving mode)

£69.95

Order code: DVR-1000

COLOUR QUAD OBSERVATION SYSTEM



- 4 Camera Capability.
- Manual / Automatic Switching between multiple cameras (1 to 60 sec adjustable).
- Built-in condenser microphone & speaker for 2 way audio.
- 4.3mm fixed lens.
- Built-in alarm sensor & Picture In Picture (PIP) Function.
- On-Screen Display (OSD) & Remote Control.
- Freeze & Zoom function for close-up study of events.
- Rolling free using digital lock & Multiple monitor expandable.
- Stand by function to save the screen power & Switching Mode Power Supply (SMPS).
- RCA input / output connection & BNC type available.
- VCR recordable and playback.

Order code: AV-1500

£369.95

EXTRA CAMERA

AV-1500A

£69.95

****TRADE ONLY****

*THIS OFFER IS VALID UNTILL THE END OF OCTOBER 2002

*PRICES SUBJECT TO AVAILABILITY, VAT & CARRIAGE.

CALL US NOW ON 0121 772 2733 - WHILE STOCKS LAST!!

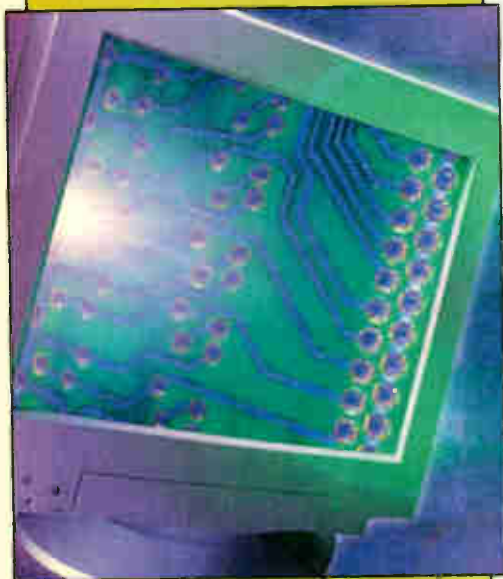

MONITORS

Fault reports from
Gerry Mumford
and **Ian Field**

We welcome fault reports from readers – payment for each fault is made after publication.

Reports can be sent by post to:

Television, Fault Reports,
Anne Boleyn House,
9-13 Ewell Road,
Cheam,
Surrey SM3 8BZ

or e-mailed to:
tessa2@btinternet.com

Acer 7299SL

This monitor would power up with a green LED light but no display. There was no EHT because the line drive was missing. Checks showed that there was no activity on the I²C bus that connects the scan processor chip to the microcontroller chip. So the cause of the fault was likely to be in the microcontroller area. A few checks in this area brought to light the fact that the 12MHz clock crystal Y801 was inactive. A new crystal restored the display. G.M.

Dell D1028LR

This monitor was dead with no LED illumination or display. Checks at the primary side of the power supply showed that it was actually tripping, though silently, and that the UC3842 chopper-control IC was driving a short-circuit. This turned out to be the 2SK1940 chopper FET Tr6115, which was short-circuit gate-to-source. Strangely, there was no other damage and a replacement restored normal power supply operation and the display. Incidentally this monitor is fitted with a Philips chassis. G.M.

FI Europe 1410

This strange monitor from the Netherlands had no front badge at all. In fact the front was completely blank, the model information being obtained from a sticker on the rear cover. It was to all intents and purposes dead – the power supply shut down almost instantly at switch on. I was not surprised to find that there was a short-circuit across the 90V line. Checks showed that the cause was the MR35 rectifier D857. The unit happily accepted an SF35 as a replacement, which cured the fault. G.M.

Iiyama Vision Master Pro21 (Model MT-9021T)

This huge monitor powered up with green LED illumination but no display. A loud squealing noise could be heard coming from inside it. It's a very complicated monitor that requires a major strip-down to gain access to the chassis. There are separate line output and EHT drive circuits, and checks in this area revealed that the 2SK2487 EHT driver transistor Q5C5 was leaky. Replacement of this device restored a very fine display. G.M.

Hewlett-Packard Pavilion M50 (Model D5258A-60008, 520X chassis)

This monitor gave the impression that it was totally dead. In fact the power supply was tripping slowly, though no short-circuits could be found anywhere. I decided to concentrate on the primary side of the power supply, and discovered that resistor R024 (2.2M Ω , 0.5W) was open-circuit.

It's part of a biasing circuit for a signal-type transistor that delivers a low voltage to pin 3 of the UC3842 chopper-control IC to turn the monitor off. Pin 3 is the excess-current sensing pin, and in this design the soft-start switching makes use of it. Hence the tripping when the transistor's biasing was upset because R024 was open-circuit. A replacement resistor cured the fault. G.M.

Hewlett-Packard Pavilion M50 (Model D5258-60011, C5B chassis)

This monitor was totally dead because the start-up resistor R848 (470k Ω , 0.5W) was open-circuit. A replacement resistor restored normal operation. Note that although this monitor looks exactly like the one mentioned above, and has an almost identical model number, the chassis is completely different. G.M.

Dell P791 (PG chassis)

This smart black monitor powered up with a green LED light but there was no display. As the EHT supply was present and correct, attention was turned to the CRT base board. I found that the grid voltage was at -188V, which muted the video drive. When I carried out some checks on the main board I discovered that there was no line scanning. The 2SC5584 line output transistor Q405 and the SFP9634 B+ regulator FET Q406 were both short-circuit, while feed resistor R480 (2.2 Ω , fusible) was open-circuit. Replacement of these items restored a perfect display – use an IRF9634 to replace the SFP9634. G.M.

Elonex MN009 (Philips TY619323 006545)

The complaint with this monitor was no line sync. When I tried it I found that the display was also over bright, and that the user control didn't vary the brightness. Adjustment of the master line hold control, which is a few inches in-board from the vertical output stage heatsink, was attempted but line lock seemed to be outside its range. So I ran the TVGA Modetest program supplied with the Trident video card. At mode 55 I was able to find a point where the display just drifted through.

There's a small subpanel with a few presets at the other side of the chassis. Now some of these might be for frequency-to-voltage discriminator calibration, needing a manual, which I didn't have, for correct setting up. So I gave each preset just enough torque to disturb it and returned it to its original position. Each one made a faint click as it was disturbed, which proved that no one else had been tampering with them. When disturbed, one of the last

two presets produced line lock. A run through the Modetest program then proved that none of the modes had been lost.

The cause of the excessive brightness turned out to be a crack in the PCB, next to the line output transformer. The tracks to pins 3 and 4, and one nearby track towards the rear of the board, had been cut. Once these had been repaired the monitor worked as it should. A long soak test proved that all was now well. I.F.

Huyundi HL4850

This monitor was brought in after it had "blown up". I was told that there had been a strong smell of burning. To say that the soldering required attention would be a gross understatement. The BUH517 line output transistor Q503 and the IRF9610 B+ step-down buck regulator transistor Q714 were both short-circuit. L703, the inductor in the regulator circuit, looked somewhat charred.

Once the line output transistor has been replaced the next step is to isolate Q714 from the 180V supply and check the LOPT by running it from the 66V supply. This wasn't possible because D716/735 (type S2L3D), which had been dry-jointed with early signs of arc erosion, were both short-circuit. Being unable to find any data on these devices, I replaced them with a pair of MR856s. As the power supply still didn't work, I checked the voltages around the UC3842 chopper control chip IC701. The pins were all at 0V! When I unsoldered pin 7, the start-up components produced a voltage across C714 (100 μ F, 25V), so the chip was short-circuit. I replaced the IC and, while I was at it, checked the ESR of C714. It was OK.

This time the power supply started up when tried. After confirming that its output voltages were close to the values indicated alongside the transformer pins, I connected a flylead from C741/J41 to C743/J55 to feed 66V directly to the line output stage. The monitor then produced an almost full-scan display with severe pincushion distortion, proving that the LOPT was OK.

The last time I got unexpected width with a reduced B+ supply I wasted time looking for flyback tuning faults and shorts in the EW correction circuit. It turned out that the servo-type EW error amplifier was so good that it almost managed to correct the extreme lack of drive! As I had more than enough prime suspects for the blow-up, I continued without this distraction.

An exact replacement inductor wasn't readily available, so I opted for one from a Samsung chassis with a very similar type of step-down B+ buck regulator. The

Samsung inductor is shorter and fatter: removing the white, square cover enabled it to fit more easily. Once it had been fitted, I replaced the buck regulator transistor. On test everything was found to be OK.

If the IRF9610 fails to conduct, check the zener diode ZD703 across its gate and source – this may be short-circuit, removing the drive. Its failure could indicate a severe breakdown in the line output stage – possibly the LOPT. But ZD703 was OK, so I had no reason to check on this. The MOSFET has a gate-oxide withstand voltage of 20V, and requires at least 12V (preferably 15V) of gate drive. The zener diode value most often found in this position is 18V. It's rarely less than 16V. I.F.

Elonex/AST TE1464G

The problem with this monitor I had for refurbishment was no display with the power supply pulsing. I soon found that the BU2520AF line output transistor Q513 had failed. As a replacement I fitted a 2SC3688, which has a very similar specification but seems to be more robust. When the monitor was powered again it produced a distorted raster with kinks at the top of the scan, suggesting a faulty HT reservoir capacitor. The distortion started to reduce as the monitor warmed up, but the 2SC3688 blew after about five minutes.

These monitors turn up frequently, and quite often the CRT is broken. As luck would have it I had one I'd intended to scrap in the store room. So I decided that the simplest course would be to swap over the main PCBs. I had a nagging thought in my mind that if I was wrong about the faulty HT electrolytic the cause of the problem could be faulty scan coils, but after the swap the monitor powered up with excellent display geometry, needing only a grey-scale set-up.

The CRT base PCB in the scrap monitor had been badly damaged by the force that had broken the CRT. The PCB wasn't broken, but the metal screen's solder pads had been pulled off. The monitor for refurbishment was no better – it had arrived with the CRT base screen hanging off! The solution is to 'hem' the PCB slots with 20 or 22 SWG tinned-copper wire. Start by cleaning off the green varnish at either end of the slots. Bend a right-angle of TC wire and feed it through the slot: solder the end down, then 'sew' the wire through the slot, like winding a single-layer coil. The turns must be pulled as tightly as possible, without snapping the edge off the PCB, otherwise the turns will block the slot so that the screen won't fit. With care, the turns of wire can be made to form a neat,

even layer along the accessible side of the slot, and the screening can be securely soldered to this.

In many cases where the screening has pulled its solder pads off the CRT base PCB enough copper track is pulled up to result in an open-circuit earth route. If both ends of the wire binding are secured, it serves the dual purpose of repairing the earth return as well as replacing the screening solder points.

A further point is that there were distinct 'track marks' burnt into the dust around the CRT's final anode connector. Two of these zigzagged their way to the Aquadag coating, but one tracked under the scan yoke. This could have resulted in damaged semiconductor devices in the line timebase, but the replacement main PCB took care of this possibility. It could of course have been the cause of the original transistor failures. It's important to clean pollution deposits from around any EHT components.

Mass resoldering is also worthwhile with this chassis, even if the soldering doesn't look that bad. I.F.

AST LR14

I examined this monitor before applying power. To make a change C332 (680nF, 400V) instead of C322 (8.2nF) had burst. These capacitors were both resin-dipped types, which seem to last longer than the moulded-plastic type. No other damage was found, and after a quick resolder the monitor was reassembled and worked well. I.F.

Gateway 700-069EV

When this monitor was switched on the EHT rustled up but there was no display. A few quick checks showed that all the main circuit sections were working. When the heater voltage was measured at the CRT base however the reading was only 5.74V. So the tedious business of dismantling the chassis tray was undertaken to inspect the smoothing components in the 6.3V supply. The rectifier is already a Schottky-barrier type, so I had to be content with renewing all the electrolytics along the track and adding 1 μ F, 63V multilayer ceramic capacitors in parallel.

With the heater voltage a little nearer the correct value I carried out checks to determine whether the cathodes had been degraded. They hadn't. The cause of the missing display was the fact that the class A transistors in the RGB output stages were cut off. Their common base-bias supply was low, and a quick search for dry-joints brought me to IC321. Its three pins were all dry-jointed. Once fresh solder had been applied the monitor powered up with an excellent display. I.F. ■

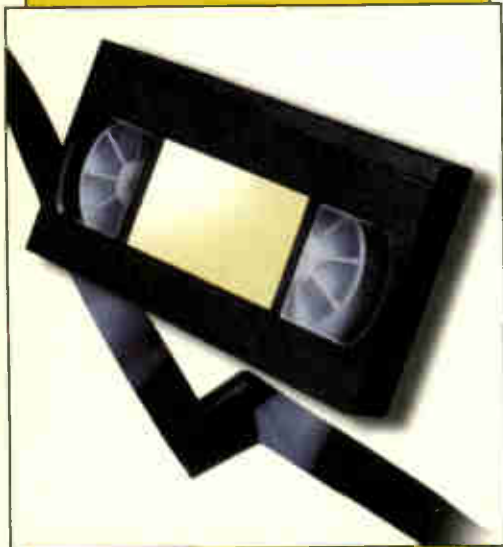

VCR CLINIC

Reports from
Bob Flynn
Carl Owen
Martin Cole
J.S. Ogilvie
and **David I. Scott**

We welcome fault reports from readers – payment for each fault is made after publication. See page 680 for details of where and how to send reports.

Akai VSG781EK

This VCR wouldn't accept a tape. Motors could be heard spinning, but no attempt was made to draw the cassette in. No broken parts were seen when the mechanism was removed, and manually loading a tape was OK. Nothing amiss was found when the connections to the end sensors and the centre LED were examined, but they were resoldered anyway.

I removed the mode-switch assembly and found that it was far from clean inside. Once it had been cleaned and lubricated the machine accepted tapes. **B.F.**

Panasonic NVHD605B (K deck)

A cassette that wouldn't eject was stuck in this VCR. The machine would just go into rewind for a while then switch off, with F03 in the display. After a few attempts the cassette did eject on its own, avoiding the need for a delicate removal operation.

The loading-motor coupling was OK, and there was nothing obviously wrong with the other gears. While looking at the main board for possible dry-joints at sensors I noticed that one of the four copper contacts on the mode switch connector had come out of its casing. This would give poor contact with the mode switch of course, and cause intermittent operation. Once the contact had been refitted in its casing and the contacts had been cleaned the machine worked correctly – a long soak test proved that all was now well. **B.F.**

Sharp VCA43HM

Sometimes this machine wouldn't start up – it would just produce a high-pitched whistle from the power supply. Removal of the power supply didn't reveal anything that was obviously wrong, but when C907 was moved it was found to have an unsoldered leg. Reliable operation was obtained by resoldering C907. C906 and the plug connections at PA, and replacing C913 (47 μ F, 16V) on the primary side of the power supply. **B.F.**

Ferguson FV61

This machine was lifeless apart from the loading motor, which was pulsating. The power supply output voltages were correct except for those at pins 1, 2 and 3 of BP03. The voltages at pins 1 and 2, which should be 13.6V and 21.8V respectively, were both missing. The voltage at pin 3 was high at 20V instead of 5.9V. The cause of the fault was IT25 (U2559BFP), a small IC on the large servo board. All was well once it had been replaced. **B.F.**

JVC HRD960

When this machine went into fast wind or rewind it would switch off. The brief slow

wind or rewind before it unlaced and speeded up was OK. As no mechanical faults could be found, attention was turned to the power supply where C19 proved to be the culprit. **B.F.**

Sharp VCH84/86

If the tape plays back at high speed, check the amplitude of the waveform at pin 3 of the capstan motor. It should be 2V peak-to-peak. If it isn't, try moving the sensor on the motor closer to the edge of the pulley. In this machine the sensor was loose. Alternatively you could replace the motor, but the cost would probably mean that the VCR was not worth repairing. **C.O.**

Samsung C15A chassis (tele-video)

There was a cassette stuck in the VCR section of this combi unit. After releasing the cassette and cleaning the mode switch the unit no longer remained in standby. **C.O.**

Philips VR948

This top-of-the-range S-VHS machine had a cassette stuck inside. At power up a whirring sound was heard, which indicated that the gear was loose on either the loading shaft or its associated worm gear. A kit is available to deal with this, part no. 4822 310 10657. Replacing the shaft and worm gear did indeed cure the fault.

But other strange faults were found to be present when the machine was tested. Playback was OK, but when fast search was selected the capstan took several seconds to reach the normal "scanning + 9" speed, and when play was pressed to return to the normal speed the capstan took about ten seconds to gradually slow down to normal. When reverse search was selected, the capstan stopped and the picture froze – despite the fact that the display showed "scanning – 9". And when the audio was switched to mono the display bargraphs went to maximum with no sound. During playback of any tape, including prerecorded films, the mono soundtrack was erased.

I decided to tackle the speed fault first, which was a wrong move! A replacement capstan motor made no difference. Then I thought that the UPD78134 microcontroller chip IC7060 might be faulty, as it controls the capstan motor directly. It's a difficult chip to replace, so I had to be pretty certain that a replacement would clear the problems. I went ahead, but the faults remained exactly the same.

I left the machine for a day, then spent ages checking the reset circuitry. After that I decided to tackle the sound fault. As I suspected, the mono linear sound bias/erase oscillator was on all the time. The cause was the BC848B surface-mounted transistor Tr7242, which had collector-emitter

leakage. After fitting a replacement I tested the machine again, and was surprised to find that the faults had all been cured!

The only link between the two circuits is the reset line, which is connected to the emitter of Tr7242. It must have been corrupted somehow, affecting the micro-controller chip.

After reassembly and a final test I had to work out what to charge. Fortunately the customer was very understanding and very fond of the machine! M.C.

Goodmans VN6000

If the display is flashing, the power supply produces a slight buzz and the machine loads but doesn't play, replace the main reservoir capacitor (82µF, 400V) in the power supply. Also clean the mode switch – a loop of tape may be left if this is not done. J.S.O.

Matsui VX1105/VXA1100

I've had several of these machines recently with the tape creasing complaint. Check the retainer clips on the take-up and supply guide poles – they can slip down, with the result that the guides don't locate in the V blocks. Refit

and add a small spot of Evostick to prevent the fault recurring. It pays to check both clutches and clean the mode switch while the deck is out. J.S.O.

HTC TVR402

I've repaired several of these 10in. TV/VCR combi units for a local caravan hire firm. All have had the same fault – no functions when the tape has loaded. The cure is to remove and clean grease from the mode switch. The deck is similar to that usually found in Daewoo models and other budget machines. It's a straightforward job with this deck. J.S.O.

Thorn VR202LV

The owner of this machine complained that the picture was intermittently unstable, with tracking noise at the top of the screen. When I removed the cover I saw that the back-tension band's felt pad had parted company with its backing, so I was fairly confident that a replacement and adjustment would cure the fault. But although there was an undoubted improvement when this had been done, the picture stability still left a lot to be desired. A look at one of the owner's tapes provided the vital clue – there was

slight crinkling along its edges. Correct operation was restored by cleaning the capstan and replacing the pinch roller. D.I.S.

Panasonic NVHD620B

There had been a gradual deterioration of playback of tapes recorded by this well-used VCR. The owner had tolerated this until tape-loading problems arose. He then asked me to look at both problems. Although I was rather concerned about the very evident head-drum surface wear, I had to tackle the loading problem first. I suspected yet another split loading-motor coupling, but this proved to be OK. The cause of the trouble was slow operation of the loading mechanism, which prevented full loading. Much time was spent cleaning and lubricating the mechanism before suspicion fell on the loading motor itself. Substitution of a known good loading motor proved the point.

Unfortunately the poor picture quality was down to excessive head-drum wear. At this point the owner declined the repair and bought a new VCR from Tesco – for slightly less than the cost of the head drum and loading motor from Panasonic. D.I.S. ■

How to pay

(VCR Fault Finding Guide) paperback

I enclose a cheque/bank draft for £ _____
(payable to *Television*)

Please charge my credit/charge card

Mastercard American Express Visa Diners Club

Credit Card No:

Expiry Date:

Signature of Cardholder _____

Cardholder's statement address: (please use capitals)

Name _____

Address _____

Post Code _____ Tel: _____

Television magazine's VCR Clinic column is a unique forum for practical servicing tips, with the UK's leading service engineers and servicing writers contributing their observations and recommendations month by month. But try finding those faults reports for the Amstrad XYZ123 that's on your bench. Even with an index you will be chasing through a pile of magazines... until now. Peter Marlow's VCR Fault Finding Guide is a distillation of the most used fault reports from 11 years of Television magazine. Arranged by make and model the information is extremely easy to access, and the book is a convenient size for the bench or to carry with you. This will undoubtedly become one of the service engineer's most useful tools. Unlike other fault guides, this one is based on top quality information from leading authorities, and genuine repair case studies. This is real-life servicing information, not just a compilation of manufacturers' manuals.

Approximately 2,000 reports on 193 models from 35 different manufacturers Instant on-the-spot diagnosis and repair advice Television magazine's leading writers' wit and wisdom available for the first time in book form.

**Post orders to: Jackie Lowe,
Highbury Business Communications,
Anne Boleyn House, 9-13 Ewell Road,
Cheam, Surrey SM3 8BZ**



VCR Fault Finding Guide

Peter Marlow

This book is an essential repair tool, not just another volume for the shelf

Pages: 464pp

Price: £22.50



AUDIO FAULTS

Reports from
Robin Beaumont
and Geoff Darby

We welcome fault reports from readers – payment for each fault is made after publication. See page 680 for details of where and how to send reports.

Sony CDPXB930E

This upmarket CD player has an unusual mechanism – the optical pickup is fixed, the spindle motor moving sideways to track the disc. In addition the whole mechanism moves out on a tray so that the disc can be loaded.

The problem was that after about fifteen minutes the sound would start to skip, then playback would stop completely and the machine would refuse to work again until it had cooled down. I tried a replacement optical unit first, then used heat and freezer on the servo PCB, but it was an elusive fault.

Subsequent tests showed that the clock and data lines that feed the servo board became inactive when the fault occurred. When tracing the clock feed back I arrived at IC203 (7WU04F) on the main board. This IC is labelled “amp” on the circuit diagram but is in fact a clock-pulse multiplier: it takes 5.6MHz from the DA converter and triples this to 16.9MHz for the servo circuits. When I eventually discovered this surface-mounted chip on the back of the board it was dry-jointed all round. Resoldering cured the fault. **R.B.**

Denon UPRC30

This mini system appeared to be running but there was no sound because the speakers were muted. The speaker relay is operated by a switch at the back of the headphone socket. This switch had failed, though the socket had never been used. As the customer never used headphones I wired out the switch – to avoid the delay involved when ordering a replacement. **R.B.**

Pioneer PDPC520T

A fault you can get with this and some other Pioneer CD players is that the lens falls out of the optical pickup which, of course, then fails to read discs. I have tried to fix the lens back, on those occasions when I could find it in the bottom of the cabinet, but have never succeeded. A new laser pickup is always required. **R.B.**

Sony HCD-H1600

The operation of this old-timer's CD drawer was very erratic. In addition when it didn't respond to use of the open/close button, or a power-off reset, the laser wouldn't home. At other times the unit would work all right for a while. The clue to the cause of the trouble was the fact that when the fault was present there was a clearly audible hum on the output.

C285 in the power supply, located on the audio board, was the cause of the problem. When I removed it from the PCB

there were signs of leakage. A replacement cured the fault. **G.D.**

Goodmans 1385

The only sign of life from this little hi-fi system was a red standby light. A quick scope check on the front-panel microcontroller chip's clock crystal showed that there was no activity. More out of forlorn hope than anything else – I don't normally take on low-end Goodmans micro systems – I grabbed the nearest crystal, which happened to be a 10.245MHz radio synthesiser type, and connected it across the in-circuit 7.2MHz crystal. I was shocked to find that the display then appeared, the on/off switch worked and basic functionality had been restored.

I couldn't leave the wrong crystal in circuit of course. But I didn't have a 7.2MHz crystal in stock and couldn't obtain one quickly. So I tried the old dodge that has worked on many occasions in the past with crystals that don't rattle and are thus not broken internally: I turned the crystal around so that its legs were in the opposite holes to the initial ones. The crystal then burst into oscillation and a long soak test, with many unpowers and repowers, proved that all was now well. **G.D.**

Sony HCD-CP33

These units have a see-through LCD panel, mounted on the cassette door, for system-status reporting. As it's transparent the display is lit from the sides, using high-intensity amber LEDs. In the standard form there are two small bars, each containing two LEDs. They should be half lit in standby. When the unit is fully on they should be brightly lit.

It's quite common for them to become intermittent, giving various symptoms such as no standby illumination or only half of the display lit when fully on. Tapping will make the symptoms come and go, but don't waste your time looking for dry-joints. The cause is the LEDs themselves.

A lot of dismantling is required to get at them. The tape deck has to come out to gain access to two of the door screws. When all four screws have been removed the door can be dismantled, revealing the LCD panel and its LEDs. The PCB is also printed and silk-screened to take four LEDs instead of two LED bars. Interestingly, only the four-LED option appears in the manual. So I always replace both bars with four discrete diodes. The Sony part no. for these is 8-719-075-51. **G.D.**

Need a picture tube?

We stock tubes from Thomson, Philips, and Panasonic to name a few.

14" to 32" Widescreen in stock for next day delivery. No old glass needs to be returned and all are supplied with a one-year warranty.

Call

D'Lec Components Ltd

(Sole UK agents for Vista Electronics in the UK, and Ekranas Joint Stock Co, Lithuania)

Tel: 01474 361276

Fax: 01474 335228

E-mail:

david@dlecsales.freemove.co.uk

3 Manor Court, Sole Street,
Cobham, Kent DA13 9BU England

14, 20 and 21 inch tubes urgently required in large quantities for export, other sizes considered, please contact us if you have any available

TELETEST

Video & Computer Test Equipment



£159.95 ex VAT

OZT1500: TELETEST PC
8 test patterns
VGA, S-VGA outputs
9V battery powered

OZT1110: TELETEST 2
6 test patterns, 1kHz audio
Composite, S-video, RF outputs
9V battery powered



Optional accessories

Tel: 01202 646100

Fax: 01202 646101

Intl: +44 1202 etc



£159.95 ex VAT

Free Info Pack
www.teletest.co.uk

Possibly largest
& oldest est. in
the UK
Est for
29 years

42" - 56"
Rear
Projection TV's
Now in stock
From only!
£849.99

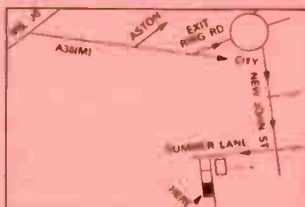

**COLOUR
TRADE**
Wholesale Distributors & Export Agents

TV's with
integrated
DVD's
Now in stock

**FULL RANGE OF
FACTORY GRADED
TV'S
DVD / VIDEO
HI-FI**



**SMALL AND LARGE
DOMESTIC GOODS**

WE ARE MAIN DEALERS OF

BEKO AND **SANYO**

AND MANY OTHER BRANDS

Over
1000
different
lines



Nationwide next day delivery service. Visitors by appointment.
Tel: 44 (0)121 359 7020 Fax: 44 (0)121 359 6344
Phoenix House, 190 Bridge Street West, Newtown, Birmingham B19 2YT
colourtrade@btinternet.com



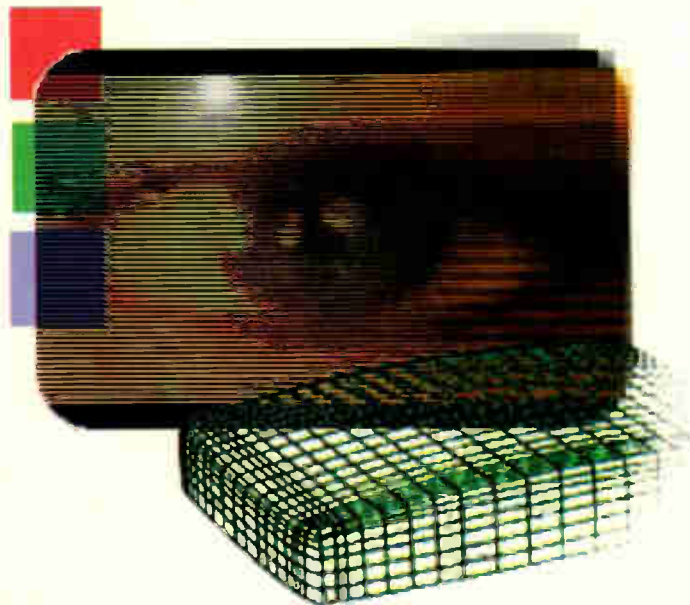

TV FAULT FINDING

Reports from
Michael Dranfield
Philip Salkeld
Martyn S. Davis
Gary Laidler
Dave Gough
Robin Beaumont
and
Glyn Dickinson

We welcome fault reports from readers – payment for each fault is made after publication. See page 680 for details of where and how to send reports.

Fidelity CTV3221NF

For intermittent line faults, such as a double image, line transformer screeching or wrong line drive, replace Q601 (BF422) even if it tests OK. Sometimes an intermittent transistor in this position will result in the chopper FET going short-circuit. **M.D.**

Tatung T32W441S

Field collapse plus lack of width was caused by failure of the TDA8350Q chip ICF1. When you get this fault you will also have to replace the two 2.2Ω safety resistors RF8 and RF9, and the 33Ω safety resistor RF10.

The chassis is also used in a variety of inexpensive sets, for example Bush models. A common fault is failure of the line output transistor, the cause being a pinhole in the insulation of the line output transformer. **M.D.**

Sharp DV5161 (4BSA chassis)

Beware of sets that display a poor picture – one that looks as if the CRT is worn out. The cause of the fault is likely to be data corruption in the EEPROM chip. There may be another symptom, excessive or lack of height. The poor picture can be cured by resetting the colour drives in the EEPROM, but if you simply reset these the problem will return at a later date. To prevent a recurrence, check R601 (0.68Ω) – it's connected to pin 9 of the chopper transformer. If its value has risen, replace it. Also replace the 5V regulator chip

IC1003 (L7805), C604 (2,200μF), C1011 (47μF) and C1012 (10μ). **M.D.**

Samsung CI6644N

The cause of field collapse is usually the TDA8350Q field/EW output chip. If, after fitting a replacement, you find that the six RGB test lines are visible at the top of the screen, the cause is loss of the 46V flyback supply. Check the 10Ω safety resistors R307 and R409. One or both of them will be open-circuit. **M.D.**

Grundig TVR3700

This TV/VCR combi unit was brought in by another dealer. He had fitted a new pinch roller then, when he reassembled the unit, he found that there was partial field collapse which varied with the picture brightness. Luckily for me he forgot to bring the remote-control unit along, so I tried to use the A1 preset to vary the brightness. As I did so the field scanning fell from about an inch to total collapse.

To provide picture breathing compensation, the beam current monitoring point at the earthy end of EHT system is linked via R3202 to the ramp generator within the TDA8362 chip. A check at pin 42 of this IC revealed that there was no field ramp generator supply via R3201 – the only feed was from the BCL line. In stripping the unit down the dealer had caught the print with something sharp, the result being a cut between the 33V supply and R3201. Once this had been repaired the unit produced correct field scanning. **M.D.**

Amstrad CTV3128

The customer said there was line collapse, and I could see a nice little earner. How wrong! I noticed a large dry-joint at the scan-coupling socket, attended to this and switched on. I then found that the EHT was low and that R711 on the stand-up EW PCB was cooking. R711 was replaced, along with the TDA8145 EW correction chip and the EW bridge coil L679 (10mH). The latter was burnt and had shorted turns – I found a suitable replacement in an old Vestel chassis. But the set still failed to work. To cut a long story short, the scan-correction/coupling capacitor C620 (470nF, 250V) was open-circuit.

Don't unplug the EW board with the set in the fault condition. When I tried this the line output and chopper transistors both blew.

So much for it being a nice little earner! **M.D.**

Decca D20TKG5 (Tatung K chassis)

The EEPROM in this new set was corrupt. As a result, the sound was stuck in the

wrong system and there was lack of height. You don't have to use a complicated button-pressing sequence to enter the service mode with this chassis. Just order a dealer service remote-control handset from Tatung. M.D.

Philips 29PT6433/05 (MD1.2EAA chassis)

There was a strange fault with this set. The customer complained about blue fly-back lines on teletext. The field engineer had called twice and had each time reduced the setting of the first anode pre-set on the line output transformer. As the fault persisted, I decided to replace the LOPT (part no. 4822 1401 0584). A long soak test proved that it had been the cause of the problem. P.S.

Bush 2871NTX (11AK19 chassis)

We seem to get a lot of these sets in for repair. When you consider that stores like Tesco, Aldi and Asda have been selling them this is probably not surprising. This one's picture was too wide, with east-west distortion. It's becoming a common fault. All that's required is to resolder the dry-joint on the BUK444 EW driver transistor Q603, which is on a metal heatsink next to the line output transformer. P.S.

JVC C14ET1EK

I've repaired many of these portables in the past but have never before had a no red problem. There are two 2SC2482 transistors in the red output stage, Q502 and Q503. Both were short-circuit emitter-to-base. P.S.

Goodmans 206NS

There was a picture shift problem with this set – it was up from the bottom. Geometry adjustment is carried out electronically, by going into the service menu, but I couldn't get into it using the customer's remote-control unit. A call to Comet revealed that a service remote-control unit, type DAEW48B1530SVC, is required. This did the trick. P.S.

Sharp 66FW-53H (DA50W chassis)

Stuck in standby is a common problem with these sets, the optocoupler IC705 being the usual cause. To my surprise however the HT was low at 35V – when IC705 is faulty it goes sky high. While carrying out checks in the power supply I found that D722 (1N4934) was short-circuit. It makes a change! P.S.

Samsung CI20S20BT (S15A chassis)

This 20in. set went through the motions of auto-tuning but no stations were found.

Operation was correct with a scart input. The 33V supply to zener diode DZ903 was missing because R810 (18k Ω , 2W) had gone open-circuit. Its part no. is 2003 000527. M.S.D.

Thomson 28WT25US (ICC17 chassis)

There was a problem with this TV/DVD combi unit's line scanning. A folded vertical line was present about two inches in from the left-hand side of the screen. The effect was as if a magnifying glass had been placed over this part of the display. Visual inspection of the line output stage quickly revealed the cause. RL26 (1k Ω , 0.5W, which damps the line linearity coil, had burnt and was shattered – in half. The original cause of the problem appeared to be poor soldering to this component. It's shown as 'safety critical' on the circuit diagram, but not in the parts list! The part no. is 10393870. M.S.D.

Sharp 66DS-03H (CA10 chassis)

It's not unusual to get one of these sets with a short-circuit line output transistor because of dry-joints around C613. In a couple of them the mains fuses had also blown. In both cases a major power supply repair was required. The following items had to be replaced: Q701, R716, D712, R720 (surface-mounted), Q702 and Q703. You should also check R713/4 and R704/5 which can prevent start-up. M.S.D.

Philips 28PW9512/05 (MD2.12AA chassis)

This set was tripping, with flashes from the LED. Suspecting failure of the line output transformer, I carried out a quick check across the transistor. Sure enough there was a very low resistance reading. The transistor checked OK when measured out-of-circuit, and the short was still present when the transformer was disconnected. I then started to check the capacitors in the line output stage, as they seem to fail on a regular basis in today's large-screen sets. Sure enough when C2433 (390nF, 250V) was checked it produced a reading of only a few ohms. The only clue that it was faulty was a very small amount of wax substance where the capacitor's legs go through the board. Once a replacement had been fitted another very large, very heavy widescreen set departed from the workshop. G.L.

GoldStar CF28C22F (PC33J chassis)

There were lines at the top of the screen when this set was switched on. The obvious thing to do seemed to be to replace

the TDA8350Q field/EW output chip IC301, but this made no difference. The chip has separate supplies at pins 4 and 8, both derived from the line output transformer. R304 (10 Ω , 0.5W) in the 'fly-back' supply to pin 8 was open-circuit. There was correct scanning once a replacement had been fitted. G.L.

Fidelity CTV3228NF

The problem with this set was line collapse. Some checks with a capacitance meter revealed that C609 (0.47 μ F, 250V) was open-circuit. G.L.

Ferguson A10R (TX80 chassis)

This colour portable worked all right with a 240V mains supply but was dead with 12V operation. The DC-DC converter circuit is on a separate panel, and it didn't take long to find that the two transistors here, TD701 and TD702 (type 7416-1), also diode DD707 (1S1888), were short-circuit. Once these items had been replaced and a new 8A fuse (FD702) had been fitted all was well.

According to most stockists the 7416-1 transistor is obsolete and is no longer available. Fortunately we had a few, but our supply is getting low. Does anyone know of a source or a suitable alternative, as we repair quite a lot of these sets. G.L.

JVC AV29SX1EK (JA chassis)

I was called to see this set because of a no-picture fault. In view of its size, I hoped to be able to fix it in the customer's home. When I replaced the TDA8350Q field/EW output chip IC401 there was a good picture, but four days later the customer was on the phone to say that the picture had gone again.

This time I had to take the set back to the workshop for tests. I eventually found that a DMM check on FR552 (1.8 Ω , 2W) produced a reading of 9 Ω . It's the surge-limiter resistor in the rectifier circuit that provides the supply for pin 4 of IC401. Much to my relief, replacing FR552 cured the problem. G.L.

Bush 6671 (11AK19 chassis)

When this set was switched on the only result was a faintly audible pulsing from the power supply. The BU2508AF line output transistor Q605 was faulty. A replacement restored normal operation. D.G.

Beko 14.1 chassis

This widescreen set was dead. Checks showed that F1 (2.5A) was open-circuit and T601 (2SK2545) short-circuit. All was well once these items had been replaced. D.G.

Samsung CI5937AN (Z68 chassis)

There was partial field collapse – a black band about an inch deep at the top of the screen. As there are no controls to tweak/adjust, I decided to replace the TDA8350Q field/EW output chip IC301. This action restored full field scanning. D.G.

JVC CS2180M

This model has PAL/Secam/NTSC decoding capability. But there was tuner drift with all selected channels. Not unexpectedly, the cause of the trouble was on the tuner board, which is clearly marked SBX-M00ZA. There are four surface-mounted capacitors, C104-7, on this board. Replace them all and you will be rewarded with pictures that remain locked on channel. D.G.

Bush 1407 (Onwa chassis)

The customer complained that the sound became very distorted when the volume level was increased. I've had the problem before with various sets that use this chassis. The cure is to fit an 0.5µF electrolytic capacitor between output pin 5 of the TBA820M audio chip IC201 and a nearby chassis point. This will cure the distortion. D.G.

Grundig CUC5301 chassis

If you get one of these sets with sound but no raster, check the soldered joints at the scan coil plug on the main PCB. They have a habit of drying out, the result being these symptoms. D.G.

Samsung CI541ZG (P585H chassis)

This set would power on, the relay would click then, after a few seconds, the standby light would fade away. The chassis uses a TDA4601-based chopper power supply. As I expected, ESR checks on the electrolytic capacitors in this part of the chassis produced many high readings (C800, C811, C813, C820, C822 and C829 all read high). To achieve a reliable repair, I decided to replace all the electrolytic capacitors in the power supply and through to the line output stage. The result was a working set. D.G.

Philips 32PW9631/05 (GFL2.30 chassis)

This widescreen set would start up only intermittently, because the EW protection circuit was operating. After spending some time chasing around in the line timebase without result I disconnected the protection line. The result was a cloud of smoke from a faulty 510nF S-correction capacitor. I also had to replace the series switch – the IRF620 MOSFET in the HT feed to the line output stage – as it was short-circuit. Although failure of this item would not otherwise stop the set from working, it's used to shut down the line

timebase under certain fault conditions. The microcontroller chip checks the switch when the set is started up: if the check fails, the set is placed in the protection mode. R.B.

Toshiba 3357DB

Two of these impressive 33in., 4:3 CRT sets came in during one week. The problem with the first one was no UHF reception: scart operation was OK. A new tuner was required. The second one tripped when brought out of standby because the audio output IC was short-circuit.

These were straightforward repairs, but the size and weight of the set makes each job a serious undertaking. R.B.

Philips 46PP912A/05 (FL1-PTV chassis)

There was a convergence problem with this 46in. projection set. Horizontal red and green lines at the top and bottom of the screen were regularly jumping – the effect was rather like poor interlace. In this chassis the convergence 'power amplifiers' have their own switch-mode power supply, which provides ±16V outputs from a separate PCB at the rear of the cabinet. Checks showed that the positive output was low with severe 50Hz ripple.

I at first suspected a capacitor problem on the primary side of the power supply, but the cause of the fault turned out to be the CNR50 feedback optocoupler. The ripple was caused by the large 50Hz component in the current drawn by the field convergence circuitry. R.B.

Philips 28PW6305/05 (A10 chassis)

The picture was OK when this set was cold, but after about ten minutes the contrast gradually decreased, leaving a dark picture with crushed whites. The teletext and on-screen graphics displays were always satisfactory. Careful use of heat and freezer brought me to the 1µF, surface-mounted capacitor C2246 on the small-signals panel. It couples the video signal to the input of the comb-filter 7405 and was slightly leaky when warm. R.B.

Philips 32PW9523/05 (MD2.25 chassis)

The picture took on a red cast intermittently, sometimes with red flyback lines. This could have been caused by incorrect first-anode voltage setting but, while I was attempting to adjust this, I found from the cathode voltages that the emission of the CRT's red gun appeared to differ from that of the other two guns. The red problem was still present when the red and green cathode drives had been swapped over, so the cause of the fault was proved to be in the tube.

A replacement CRT and readjustment of the A1 voltage produced an excellent picture. R.B.

Sony KVX2972U (AE2B chassis)

This set worked normally until the channel was changed or the aerial was disconnected. The loudspeakers then cracked. A Sony technical information sheet directed me to the mute circuit in the audio power amplifiers. Two new TDA7052 power amplifier ICs were required. R.B.

Sharp 56FW53H (DA50W chassis)

This set was dead with just light from the orange neon. Excessive HT problems can occur with this chassis, and seemed to be the cause of the trouble as the crowbar avalanche diode D735 across the 150V line was short-circuit. I replaced the diode and the feedback optocoupler IC705 but the power supply still refused to start. The two surface-mounted transistors Q702 and Q703 on the primary side were leaky and had to be replaced. R.B.

Philips 32PW9616/05 (MG3.1E chassis)

The sound from the centre speaker of this Dolby Pro-Logic set was badly distorted. Sound from the left, right and surround channels was OK. After some time spent checking the Dolby processor and power amplifiers, which all seemed to be OK, I decided to check the obvious thing: the drive unit was out of centre and had to be replaced. R.B.

JVC AV24WT2EK

This small widescreen set had exhibited field collapse before it went off. On inspection I found that the LA7841 field output chip IC401 had been overheating. Replacement resulted in brief screen illumination, then the set tripped off. IC401 is fed from split ±14V supplies, and the -14V supply was missing. Feed resistor FR553 (1Ω, 1W) was open-circuit because capacitor C407 (100nF) was short-circuit. FR552 in the +14V feed had also risen slightly in value, so this item was also replaced. After that there was a very good picture. G.D.

Ferguson C49F (Thomson TX90 chassis)

After repairing an arcing fault in the line output stage I was left with very low sound. The cause is usually CS14 (1µF) in the IF unit, but not this time. The volume-control voltage reached only 3V, though the bar-graph indication increased. I then found that there was no access to the tuning function. I assume that the set was in the hotel mode, corrupted as a result of the arcing, but the manual doesn't mention this. As I happened to have a scrap chassis I simply replaced the microcontroller chip, which cured the fault. Someone is sure to know how to unlock the micro! G.D. ■

Campion Electronics Ltd.

**Ex-Rental
TV's and Videos**

From £5

**FREE Delivery Service to
Most Areas of the UK**

**WORLDWIDE EXPORT
SERVICE**

Experts in UHF/VHF Conversions

Tel: 01299 250880

Fax: 01299 250889

**Unit 17c Hartlebury Trading Estate
Kidderminster, Worcs DY10 4JB**

Just 10 mins from M5 - Junction 6

ONLINE SHOPPING CHEAPER AND EASIER

www.elclondon.co.uk

TV, VIDEO SPARES AND ELECTRICAL ITEMS



**ELC EAST LONDON COMPONENTS
63 PLASHET GROVE, LONDON E6 1AD.**

TWO MINUTES WALK FROM UPTON PARK TUBE STATION

TEL: 020 8472 4871 FAX: 020 8503 5926

E-mail: sales@elclondon.co.uk

SPECIAL OFFERS



**TEKTRONIX 2445A 4 Ch
150MHz Delay, Cursors etc
Supplied with 2 Tektronix probes** **ONLY £425**

TEKTRONIX 2232 Digital Storage Scope, Dual Trace 100 MHz, 100ms with probes £525
H.P. 54501A Digitizing Oscilloscope 100MHz, 4Ch £425
H.P. 3312A Function Gen 0.1Hz-13MHz AM/FM Sweep/Trig/Gate/Burst etc £300
LCD Display £180
CIRIUS CR254 Sound Level Meter with Calibrator, 80-120dB, LEQ £150
FARNELL AMM255 Automatic Mod Meter 1.5MHz 26Hz Unused £300
FARNELL DSG1 Low Frequency Syn Sig Gen 0.001Hz to 99.99kHz, Low Distortion TTL/Square/Pulse Outputs etc £95
FLUKE 8060A Handheld True RMS DMM 4 1/2 digit As new £150 Used £95
BECKMAN HD110 Handheld 3 1/2 digit DMM, 28 ranges with battery, leads and carrying case £40

H.P. 3310A Function Gen 0.005Hz-5MHz Sine/Sq/Tri/Ramp/Pulse £125
FARNELL FLM4 Sine/Sq Oscillator 10Hz-1MHz low distortion TTL Output Amplitude Meter £125
H.P. 545A Logic Probe with 546A Logic Pulser and 547A Current Tracer £90
FLUKE 77 Multimeter 3 1/2 digit Handheld £60
FLUKE 77 SERIES II £70
HEME 1000 LCO Clamp Meter 0-1000A In Carrying Case £60

BLACK STAR ORION PAL/TV VIDEO Colour Pattern Generator £1000
THURLBY/THANDAR TG210 Function Generator 0.002Hz-2MHz TTL etc £80
THURLBY THANDAR PSU PL3200MD 0-32V 0-2A Twice (Late colours) £200

Datron 1061
High Quality 5.5 Digit Bench Multimeter True RMS/4 wire Res/Current Converter/IEEE **£150**

Datron 1061A
High Quality 6 1/2 digit Bench Multimeter True RMS/4 wire/Current Converter **£225**

Racal Receiver RA1772
50KHz - 30MHz LED Display Basically Working **£250**

STEWART OF READING

110 WYKEHAM ROAD, READING, BERKS RG6 1PL

Telephone: (0118) 9268041 Fax: (0118) 9351696

www.stewart-of-reading.co.uk

Callers welcome 9am-5.30pm Monday to Friday (other times by arrangement)

MARCONI 2019A



AM/FM synthesised signal generator 80KHz - 1040MHz **NOW ONLY £400**

MARCONI 893C AF Power Meter, Sinad Measurement Unused £100 Used £60
MARCONI 893B - No Sinad £30
MARCONI 2610 True RMS Voltmeter Autorangin 5Hz-25MHz £195
GOULD J3B Sine/Sq Osc 10Hz-100kHz Low distortion £75-£125
AVO 8 Mk6 in Ever Ready Case, with leads etc £80
Others Avos from £50
GOODWILL GVT427 Dual Ch AC Millivoltmeter 10mV in 12 Ranges Freq 10Hz-1MHz £100-£125
SOLARTRON 7150 DMM 6 1/2 digit True RMS - IEEE £95-£150
SOLARTRON 7150 PLUS £200

HIGH QUALITY RACAL COUNTERS

9904 Universal Timer Counter, 50MHz £50
9916 Counter, 10Hz-520MHz £75
9918 Counter, 10Hz-560MHz 9-digit £50
WAYNE KERR B424 Component Bridge £125
RACAL/AIM 9343M, LCR Databridge Digital £200
Automeasurements of R L C Q O.
HUNTRON TRACKER Model 1000 £125
MARCONI TF2015 AM/FM sig gen, 10-520MHz £175
FLUKE 8050A 4.5 Digit, 2A True RMS £75
FLUKE 8012A 3.5 Digit, 2A £40

Racal 9008
Automatic Modulation Meter AM/FM 1.5MHz-2GHz **ONLY £95**

Portable Appliance Tester
Megger Pat 2 **ONLY £180**

H.P. 6012B OC PSU 0-60V, 0-50A 1000W £1000
FARNELL AP60/50 1KW Autoranging £1000
FARNELL H60/50 0-60V 0-50A £750
FARNELL H60/25 0-60V, 0-25A £400
Power Supply HPS3010 0-30V, 0-10A £140
FARNELL L30-2 0-30V, 0-2A £80
FARNELL L30-1 0-30V 0-1A £60
Many other Power Supplies available.
Isolating Transformer 240V In/Out 500VA £40

GOULD OS 300 OSCILLOSCOPE



DUAL TRACE 20MHz TESTED WITH MANUAL **£95**

OSCILLOSCOPES

TEKTRONIX TDS350 Dual Trace 200MHz 1G/S unused £1500
TEKTRONIX TDS320 Dual Trace 100MHz 500M/S £1200
TEKTRONIX TDS310 Dual Trace 50MHz 200M/S £950
LECROY 9400A Dual Trace 175MHz SG/S £1500
HITACHI VC6523 Dual Trace 20MHz 20M/S etc unused £600
PHILIPS PM3092 2+2Ch 200MHz Delay £800 As New £950
PHILIPS PM3082 2+2Ch 100MHz Delay etc £700 As New £800
TEKTRONIX TAS465 Dual Trace 100MHz Delay etc £750
TEKTRONIX 2465B 4Ch 400MHz Delay Cursors etc £1500
TEKTRONIX 2465 4Ch 300MHz Delay Cursors etc £900
TEKTRONIX 468 Dig Storage Dual Trace 100MHz Delay £450
TEKTRONIX 466 Analogue Storage Dual Trace 100MHz £250
TEKTRONIX 485 Dual Trace 350MHz Delay Sweep £550
TEKTRONIX 475 Dual Trace 200MHz Delay Sweep £400
TEKTRONIX 465B Dual Trace 100MHz Delay Sweep £325
PHILIPS PM3217 Dual Trace 50MHz Delay £200-£250
GOULD OS1100 Dual Trace 30MHz Delay £150
HAMEG HM303 Dual Trace 30MHz Component Tester £275
HAMEG HM203 7 Dual Trace 20MHz Component Tester £200
FARNELL DTV20 Dual Trace 20MHz Component Tester £125

MANY OTHER OSCILLOSCOPES AVAILABLE

MARCONI 2022E Synthesised AM/FM Sig Gen £525-£750
10kHz - 1.01GHz LCD Display etc
H.P. 8657A Syn 100kHz - 1040MHz Sig Gen £2080
H.P. 8656B Syn 100kHz - 890MHz Sig Gen £1350
H.P. 8656A Syn 100kHz - 990 MHz Sig Gen £995
R&S APN62 Syn 1Hz - 250kHz Sig Gen £425
Balanced/Unbalanced Output LCO Display
PHILIPS PM5328 Sig Gen 100kHz - 180MHz with 200MHz £550
Freq Counter IEEE
RACAL 9081 Syn AM/FM Sig Gen 5kHz - 1024MHz £250
H.P. 3325A Syn Function Gen 21MHz £600
MARCONI 650D Amplitude Analyser £1500
H.P. 4192A Impedance Analyser £5000
H.P. 4275A LCR Meter 10kHz - 10MHz £2750
H.P. 8903A Distortion Analyser £1000
WAYNE KERR Inductance Analyser 3245 £2500
H.P. 8112A Pulse Generator 50MHz £1250
MARCONI 2440 Freq Counter 20GHz £1000
H.P. 5350B Freq Counter 20GHz £2000
H.P. 5342A 10Hz - 18GHz Freq Counter £800
H.P. 1650B Logic Analyser 80 Channel £1000
MARCONI 2305 Mod Meter 500kHz - 2GHz £750

RADIO COMMUNICATIONS TEST SETS

MARCONI 2955/2955A from £1500
Robu & Schwarz CMT 01 - 1000MHz £2000
Schlunberger 4040 £800

JUST IN

H.P. 6063B DC Electronic Load 3-240V/0-10A 250W P.O.A
H.P. 66312A PSU 0 - 20V/0-2A £400
H.P. 66311B PSU 0 - 15V/0-3A £400
H.P. 66309D PSU Dual 0 - 15V 0-3A/0-12V 0-1.5A £750
H.P. 6632B PSU 0 - 20V/0-5A £500
H.P. 6623A PSU Triple Output ranging from 0-7V 0-5A to 0-20V 0-4A £850
H.P. Agilent 34401A DMM 6 1/2 digit £400/£450
H.P. 3478A DMM 5 1/2 digit £275
FLUKE 45 DMM Dual Display £400
KEITHLEY 617 Programmable Electrometer £950
KEITHLEY 617 Programmable Electrometer £1250
H.P. 4338B Milliohmometer £1500
RACAL Counter type 1999 2.6 GHz £500
H.P. Counter type 5313/A 3GHz £350
H.P. Agilent 33120A Function Gen/VARB 100micHz - 15MHz £900/£1000
SONY/TEKTRONIX AFG320 Arbitrary Function Gen £1250
H.P. 8904A Syn Function Gen DC - 600kHz £1000/£1250
BLACK STAR JUPITOR 2010 Function Gen 0.2Hz - 2MHz with Frequency Counter £140
H.P. 8116A Pulse Generator 1mH-50MHz £1950
H.P. 8657B Syn Signal Gen 0.1-2080MHz £2500
CO-AXIAL SWITCH 1.5GHz £40
IEEE CABLES £10

SPECTRUM ANALYSERS

H.P. 8561B 50Hz - 6.5GHz £6500
H.P. 8560A 50Hz - 2.9GHz Synthesised £5000
H.P. 8594E 9kHz - 2.9GHz £4500/£5000
H.P. 8591E 1MHz - 1.8GHz 75 ohm £3500
H.P. 853A with 8559A 100kHz - 21GHz £2250
H.P. 8558B with Main Frame 100kHz - 1500MHz £1250
H.P. 3565A 20Hz - 40MHz £3000
H.P. 3580A 5Hz - 50kHz £800
AOVANTECH R4131B 10kHz - 3.5GHz £3500
EATON/Aitech 757 0.001 - 22GHz £1500
MARCONI 2382 100Hz - 400MHz High Res £2000
MARCONI 2370 30Hz - 110MHz from £500
H.P. 182 with 8557 10kHz - 350MHz £500
H.P. 141T Systems
8553 1kHz - 110MHz from £500
8554 500kHz - 1250MHz from £750
8555 10MHz - 18GHz from £1000
TEKTRONIX 491 10MHz - 12.4 GHz £500
H.P. 8443 Tracking Gen/Counter 110MHz £250
H.P. 8444 Opt 059 £750
B & K 2033R Signal Analyser £750
H.P. 5372A Frequency & Time Interval Analyser £2250
H.P. 8754A Network Analyser 4MHz - 1300MHz £1250
H.P. 3577A Network Analyser 5Hz - 200MHz £3000
H.P. 53310A Modulation Domain Analyser Opt 001 803 £5000
ONO SOKKI Portable FFT Analyser £1500

USED EQUIPMENT - GUARANTEED. Manuals supplied.

This is a VERY SMALL SAMPLE OF STOCK. SAE or telephone for lists. Please check availability before ordering. CARRIAGE all units £16. VAT to be added to total of goods and carriage.

WEB SERVICE

To reserve your web site space telephone
Tel: 020 8722 6028 Fax: 020 8722 6096
E-MAILS r.gurunlian@highburybiz.com



Alltrade Aerials & Satellite Ltd

<http://www.alltrade.co.uk>

Phone 01273 413798 Fax 01273 425700
Full e-commerce site with over 1500 products with in-stock quantities!! We supply everything associated with Digital/Analogue Terrestrial & DTH/Motorised Satellite reception. All Antennas. All Brackets. All Cables. All Connectors. All Amplifiers. We provide a free MATV/SMATV planning service as well.

A.R.D. Electronics Plc

<http://www.ardelectronics.com>

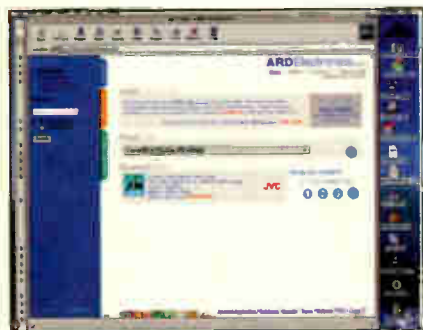

A.R.D.'s Website details all the information you need to know about this new and exciting electronic component distributor. It shows how to: open an account (credit or cash), obtain a trade catalogue and place orders (both online and direct).

Cricklewood Electronics

<http://www.cricklewoodelectronics.co.uk>

Cricklewood Electronics stock one of the widest ranges of components, especially semiconductors including ICs, transistors, capacitors, resistors. all at competitive prices.

Charles Hyde & Son Ltd

<http://www.charleshyde.co.uk>

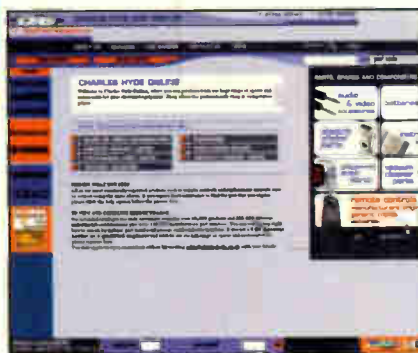

Search for both original and copy spare parts in our extensive database covering Akai, Alba, Bush, Ferguson, Goldstar, Hitachi, LG, Matsui, Nokia, Saisho, Sanyo, Sony, Sharp, Thomson, Panasonic, Philips, Samsung, Tascam, Teac, Toshiba, Yamaha and many more. In addition huge ranges of Lasers, Lopts, Remote controls and Semiconductors may be accessed.

Dönberg Electronics

<http://www.donberg.ie>

<http://www.donberg-electronics.com>

<http://www.electronic-spare-parts.com>



As the leading distributor for the TV, Video and Audio trade in Ireland, we supply over 2000 shops & service dept with Audio-Video and TV spares, Semiconductors, Test Equipment, Service Manuals, Remote Controls etc. At present we stock over 35,000 different lines. We hold agencies for: Panasonic, Sharp, Mitsubishi, Sanyo, Beko, Ersa, Müter, Diemen HR, Philex, PRF, König-

electronics. We specialise in parts for all continental sets and obsolete semiconductors.

EURAS International Ltd

<http://www.euras.co.uk>



This website offers you a comprehensive online Repair Information System, including Technical Repair Information, Discussion Forum, Tech-Chat and a valuable Pinboard System. Visit the site and apply for a free 30 day trial (no deposit required)

J W Hardy Communications

<http://www.jwhardy.co.uk>



R.F. Network Specialist. Shop online - for R.F. network components. We supply a full range of TV, radio reception equipment to receive analogue/digital signals from both terrestrial and satellite sources. We provide a free planning service for your R.F. networks, MATV and SMATV etc

Holderness Solutions Ltd

<http://www.digisatsolutions.com>

Suppliers of over 3000 lines of equipment to the aerial and satellite trade. All major brands stocked from coax plug to 1.8mtr + dishes.

Matrix Multimedia Ltd

<http://www.matrixmultimedia.co.uk>



Matrix Multimedia produces courses in electronics and PICmicro programming. Products include a flexible PICmicro development board and Flowcode - which converts flowcharts into PIC programs.

M.C.E.S.

<http://www.mces.coo.uk>

The MCES site gives details of our range of service including Tuners, Video Heads, RF & IF Modules plus latest prices offers.

MMWafercards

<http://www.mmwafercards.com>



Smartcards and programmers for all access-controlled applications. Incorporating www.satstore.co.uk The Enthusiasts Satellite Store. Tel 01386 48731 Fax 01386 765875

Radio Restoration Company

Edinburgh

Specialist repairs to Hacker & Roberts radios, postal service if required. All valve and transistor radios & rebuilds undertaken. Free estimates - trade welcome, large selection of radios large & small Etc, from 1920s on always available.

Contact:- Jamie Gillan 0131 2251475

Service Engineers Forum

<http://www.E-repair.co.uk>

The forum is now visited by Thousands of engineers every week, over 3000

pages of content including new repair tips, servicing articles, circuits, help, for sale, wanted & industry news sections, open access to the site is free to all engineers.

Our product mailing list is also available free of charge for engineers without net access, ring Mike on 0151 522 0053 with your address details.

Switch-it-on

<http://www.switch-it-on.co.uk>



We sell multi-region dvd players to trade and public, also tv, videos, hifi and playstation 2. We design our own upgrades on dvd and we sell all spare parts. All makes and most models stocked.

Swires Research

<http://www.swires.com>



Swires Research produce high quality instruments for the television industry, including portable signal level meters and spectrum analysers for digital and analogue RF signal measurements.

Televés

<http://www.televés.com/ingles/ingles.htm>

Televés website was launched as an easier way to keep in contact with our World-wide Network of Subsidiaries and Clients. This site is constantly updated with useful information/news plus you can download info on our



range: TV Aerials & accessories, Domestic and Distribution amplifiers, Systems Equipment for DTT and Analogue TV, Meters and much more.

Transworld Satellite

<http://www.transworldsatellites.co.uk>

Fifteen years experience serving enthusiast hobbyist, broadcasters, trade, complete range receivers, cams, programmers, cars, dishes, motors. with excellent technical support and friendly service. Telephone 01947 820999

Vintage Wireless Co London

<http://www.vintagewirelesslondon.co.uk>



Phone 0207 2583448 Fax 0207 2583449

Supplies of vintage hi-fi, wireless, sales & service, spare parts, valves, components, transformers, knobs, ceramic cartridges, stylus and more. Vintage hi-fi literature, magazines, circuits. Wanted tannoys & early hi-fi audio valves for cash.

To reserve your web site space phone

Reuben Gurnlian

Tel: 020 8722 6028 Fax: 020 8722 6096

E-MAILS r.gurnlian@highburybiz.com

LETTERS



Send letters to "Television", Highbury Business Communications, Anne Boleyn House, 9-13 Ewell Road, Cheam, Surrey SM3 8BZ or e-mail tessa2@btinternet.com using subject heading 'Television Letters'.

Please send plain text messages. Do NOT send attachments. Be sure to type your full name, address, postcode, telephone and e-mail address (if any). Your address and telephone number will not be published but your e-mail address will unless you state otherwise. Please send ONLY text intended for the letters page. Correspondence relating to subscriptions and other matters must be sent to the office address given above.

Viruses

There have been letters and articles in the magazine recently about e-mails and viruses. I've had several e-mails with virus-infected attachments from commercial organisations that ought to have known better. I've also had a 6.4Mb e-mail that completely clogged my mailbox. Because of this I now use a freeware program called MailWasher. It gives access to the server and enables me to check who the e-mails are from, their size and if they have any attachments. I can then opt either to download, delete from the server or bounce them. Bouncing gives the sender the impression that the e-mail address is invalid, and is a useful way of dealing with spam and other unwanted messages. If the message reappears, it can be deleted.

*Alan Jones,
Pontrug, Caernarvon.*

Mains switch problems

In connection with David Smith's letter on burnt mains switches in Philips TV sets (August), I covered the problems

with switches that arc and burn in Philips sets in my article in the February 2001 issue of *Television*. The problem is not just to do with the switch, but with the fact that the only electrical protection for the switch and PCB is the 5A fuse in the mains plug – assuming of course that the customer hasn't replaced this with a 13A fuse or a piece of silver foil! The point here is that the mains input fuse is on the wrong side of the switch, i.e. after the switch.

SEME can supply blank OEM PCBs for these sets. The boards are made of fibreglass and are therefore probably fire-resistant. Order codes are SWPCB1, SWPCB2 and SWPCB3.

With regard to the legalities of a set catching fire because of the switch, if you can show that the switch is a genuine Philips item then Philips is surely responsible? As these switches normally last for a couple of years, your customer may be hard-pressed to prove that you were the cause of such a fault. If you are unfortunate enough to get caught up in such a situation, my advice would be to place the matter in the hands of your public liability insurers who, I'm sure, would be happy to pass the case to Philips.

*Michael Maurice,
Wembley, Middx.*

Three failed switches found by one repairer in a short period of time suggests a common problem. Official Philips

dealers may know about a bad batch of switches, and there might be a free-issue replacement scheme. But burn-ups as described shouldn't happen, even after four years. Power switches are made with safety in mind: the demands of the safety standard EN 60065 are quite severe.

Incidentally the report of the Media Fusion distribution scheme (Power-line communications, page 588) indicates, if accurate, that the company claims knowledge hitherto unknown to science. It's likely to remain so!

*John Woodgate,
Rayleigh, Essex.*

Power-line communications

J. LeJeune's article on power-line communications (August) was an interesting read. Pylons have already been used for nationwide fibre-optic communications – it's possible to see the fibre-optic cable wound around the uppermost earth wire. But suggestions that power lines should be used for telecommunications traffic is not good news at all.

The Radio Society of Great Britain and others, including radio broadcasters, have registered concern over the real possibilities of RFI caused by power-line telecommunications (PLT). Measured interference has been noted, particularly at MF and HF, during PLT tests. It could well disrupt MW, SW and related HF communications services. The potential problems have been described in *RadCom's* bi-monthly EMC column during the past year-eighteen months (see in particular the October 2001 issue), and the subject is on the ITU's agenda for discussion.

If PLT gets the go-ahead, the national grid would in effect be a vast aerial system radiating interference, disrupting radio communications at up to mid-HF. Perhaps the technology should be laid to rest now.

*Roger Bunney,
Romsey, Hants.*

J. LeJeune discussed several problems with PLT systems in his article on Power-

Sanyo spares

In the August issue VCR Clinic, Eugene Trundle mentions the loading motor in the Sanyo VHR777E. I would like to point out that this company has for the past twelve years been the official Sanyo spares distributor in the UK, and that we can supply the item in question at an appreciably lower price than that quoted by ET. We currently stock over 15,000 different original Sanyo parts, and deliver anywhere next day.

Those who don't have an account with us can use our credit/debit card ordering facility. For details, phone 01759 303 068.

*John Hyde,
Charles Hyde and Son Ltd.,
Pocklington, Yorkshire.*

line communications in the August issue, but omitted reference to the most significant problem. Any data transmission system that uses totally unshielded and unbalanced cables will radiate the signals into the surrounding area and beyond. If this radiation is not to cause interference with licensed radio services in the MW and HF spectrum, the levels on the lines must be reduced to the extent that the system won't work.

Commercial broadcasters, the Radiocommunications Agency, Amateur Radio societies worldwide and others have for a number of years lobbied the proponents of PLT to prevent the widespread disruption of services that would arise if PLT became widespread.

I understand that this problem was one of the main reasons why NWEB abandoned its trials last year. There is at present a system in operation in Germany with radiation levels far in excess of what would be allowed in this country.

*Dave Sergeant, G3YMC, B.Sc., C.Eng., MIEE,
Bracknell, Berks.*

Grundig GDS capacitor kits

In the July issue *Satellite Notebook* Pete Haylor mentioned power supply capacitor kits for Grundig GDS digiboxes. Kits have been available from SatCure for over a year. C1 (220µF, 400V) is at present not included, as we've never known one to fail. But we monitor repairs and, as equipment ages, additional parts are included in our kits as required. Our capacitors are slightly larger physically than the originals, in order to ensure the lowest possible ESR and best reliability.

*Martin Pickering, Technical Director,
SatCure.*

www.satcure.co.uk

Knife-edge refraction

I was very interested to read Roger Bunney's account of signal refraction effects (DX and Satellite Reception, August). Years ago I used to install aerials on a fixed-price basis for a rental shop in Barnsley. The name of the game was to obtain acceptable reception as quickly and cheaply as possible, so every installation was limited to a basic ten-element array on a standard fixing.

There were a lot of customers in one particular pit village that was very close to the Emley Moor transmitter. Normally in that district the only problem would be the cost of an 18dB attenuator, but unfortunately the massive colliery waste tip obstructed the line-of-sight to the transmitter. The tip towered above the village, and reception from Emley Moor seemed at first sight to be a hopeless prospect. Because of the cost limitation, use of a high-gain aerial pointing at an alternative transmitter, with a masthead amplifier and all the trimmings, was out of the question.

To my surprise, I found that Emley Moor reception was in fact possible, but the height of the array was critical. The trick was to angle the array slightly upwards, so that it pointed at the ridge of the tip in the direction of the transmitter, then move it bodily up and down on the mast without changing the upward tilt or the direction. Regularly-spaced nulls and peaks would be found as an array was raised or lowered, and a peak for one channel would generally work for the other two. Two? Yes, this was a long time ago! Signal levels would at best be 25dB below the line-of-sight figure, but this was good enough and, as there was nothing much to the rear to reflect the signal, the ghosting wasn't too bad.

The smooth top of the waste tip was undoubtedly refracting the signal, and it seemed that a pattern of field strengths was produced, with shallow, horizontal zones of fairly strong signal interspersed with identical zones of little or no signal. Once the critical height had been found, it was possible to fit another array at the same height on the other side of the chimney and get similar results. Sometimes the zone of maximum signal would be at the base of the chimney and the array had to be at the bottom of the mast, below the chimney bracket.

We have a very good view westwards towards the high Pennines where I live in South Yorkshire, but we certainly don't have line-of-sight to the Winter Hill transmitter "on the other side of the hill". Winter Hill reception is to all practical intents impossible in this area but, since

the view in that direction is so clear, curiosity made me try it. I found that a very weak signal is available, but only at a certain height. Since our village is on the side of a hill, this contour is at roof height in one place and at ground level in another. But it doesn't matter where the aerial is located, as long as it is at the critical height. Reception is possible across a vertical distance of about 2m.

My own roof is much higher than this 'fuzzy contour'. There is no Winter Hill signal whatsoever up there. It's the same at the top of the tallest tree at the highest point in our garden, but an array on a short mast on the back shed works quite well – see accompanying photograph. This seems a bit bizarre, because the signal path must be under the branches of a nearby tree! The aerial is an Antiference XG21CD. Granada ch. 59 is received at 38dBµV, with a signal-to-noise ratio of 26dB. If the aerial is fixed much more than a metre higher or lower, the signal disappears under the noise.

The roof-mounted aerial at a nearby bungalow is at the critical height and, despite it being for the wrong channel group, it receives a very faint signal from Winter Hill. I conclude that the Winter Hill signal is refracted across the far-away Pennine hill tops and that the angle of refraction is very well defined. Since this is a coal-mining district, it seems appropriate to describe the phenomenon as being like a "seam" of relatively high field strength. The effect has been consistent for many years.

I have occasionally been troubled by



Bill Wright's Antiference XG21CD array critically mounted for reception from the Winter Hill transmitter in South Yorkshire.

signals that are refracted by trees. It seems that the tree, when in full leaf, re-radiates the signal. Whether this is true refraction or something else I don't know. Typically the phenomenon occurs when there's a small group of trees something like 300m away, standing slightly to one side of the direct signal path. The result is not ghosting, because the delay is not sufficient, but instead signal-cancellation because of the out-of-phase condition. It can seem very strange to have perfect line-of-sight to a high-powered transmitter yet receive very low signal levels. The first time this happened I was slapping the meter under the impression that it was faulty! Slight sideways or forward/backward movement of the array will usually restore almost-normal signal levels, but unfortunately the effect is unpredictable and the low signal levels may recur. I have come across this situation only in summer near broad-leaved trees.

Incidentally my learned friend Alan Pemberton points out that we should be talking about knife-edge diffraction rather than refraction. The latter occurs when a wave passes through the interface between two media of differing refractive

index. With the knife-edge phenomenon this is clearly not the case. Instead the signal passes close to an obstruction which "perturbs" it so that it arrives in the shadow area of the obstruction.

*Bill Wright,
Micklebring, Rotherham, S. Yorkshire.
wrightsaerials@aol.com*

Telephone checks

Do you need to test your phone bell ring, exchange line or caller ID display unit? Quite by accident, I've stumbled across BT exchange/telephone automatic test equipment. I'm not sure whether it's a national number, but in my phone area – 0151, Merseyside – you just dial 175 and follow the instructions.

The answer you get is a female voice which says "you are connected to XXXX, your phone no. XXXX: start the test". Replace the handset and wait for approximately thirty seconds. The phone will then automatically ring back, testing your phone bell. Answer, and you will hear "line testing OK" or "earth fault A". Dial "next test", then there's a dial tone. Press 1 "start test" then dial a few digits. It seems to come back with "dial fault"

(unsure, maybe someone could explain – new phone!). Dial next test, dial tone, press 1 and replace handset. If you have a caller ID display unit, a test data burst is sent and you should get the display 0123456789. If one is fitted, the ring LED flashes.

You need to experiment, but the service is free. Maybe a BT engineer could provide further information?

*Alan Cranford,
Birkenhead, Cheshire.*

Sharp 59DS03H

In the July TV fault-finding section there was a report about the 28in. version of this set being stuck in standby because of a short-circuit line output transistor caused by a dry-jointed capacitor. I've had a few of the 59cm sets with the same problem, but the transistor is a BUH515 and the dry-joint is at the adjacent capacitor C613. The transistor seems to go very low resistance (100Ω or so) base-to-collector rather than totally short-circuit all ways round. The result is the same though!

*Nick Beer,
Bideford, Devon.*

How to order (Closed circuit television)

I enclose a cheque/bank draft for £ _____
(payable to Television)

Please charge my credit/charge card

Mastercard American Express Visa Diners Club

Credit Card No: _____ Expiry Date: _____

Signature of Cardholder _____

Cardholder's statement address: (please use capitals)

Name _____

Address _____

Post Code _____ Tel: _____

Closed circuit television

Closed Circuit Television (CCTV) surveillance is one of the fastest growing areas in the security industry. This book is an essential guide for all security professionals and CCTV installers. However, unlike most existing books on CCTV, this is not just a discussion of security issues, but a thorough guide to the technical side – installation, maintenance, video recording, cameras and monitors, etc.

This book provides the underpinning knowledge required for the level 3 NVQs from SITO / City & Guilds. The concise, accessible text makes it an ideal coursebook, and this accessibility also makes it ideal for hard-pressed practitioners.

Contents: The CCTV industry; Video signal transmission; Light and lenses; Television fundamentals; The camera; Monitors; Video recording; Switchers; Telemetry; Motion detection; Commissioning and maintenance.

**Post your order to:- Jackie Lowe,
Highbury Business Communications, Anne Boleyn House,
9-13 Ewell Road, Cheam, Surrey SM3 8BZ**

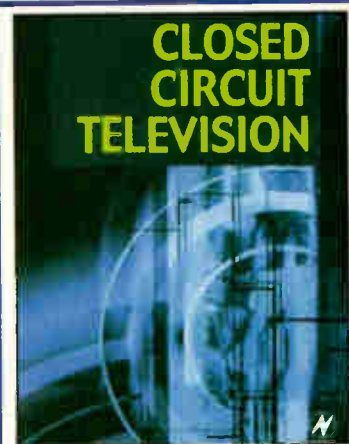

**Practical information needed by
system designers and installers**

**Price: UK £22.50 Europe £24.50
ROW £25.50**



Bench Notes

Adrian Gardiner
provides helpful
workshop hints and tips

Stormy times

Many engineers seem to shy away from items that have been damaged during electrical storms. In my experience however these can provide profitable repair work. I always quote for a couple of hours' labour, and allow a reasonable sum for parts. A total estimate of about £70 plus VAT should cater for most situations. As many such repairs are paid for by insurance companies, this is considered a reasonable sum.

When tackling the consequences of lightning damage, I always start with the power supply. Regardless of whether they have actually failed, I replace the chopper transistor, any driver transistors and the control IC. I then carry out cold checks on all the resistors in the primary side of the circuit, and check the optocoupler.

After replacing the main items in a Panasonic NV-HD660 VCR however there was still no operation. Quick checks in the primary side of the power supply revealed that there was no drive from the chopper control chip. After extensive tests and the replacement of many parts, I finally discovered that Panasonic provides a repair kit for this series. The part number is VUE4125KIT, and it contains 18 items. After fitting the kit I switched on and waited for the bang! To my relief the kit had provided a complete cure.

Another couple of storm-damaged items arrived recently, this time 28in. TV sets. They were both the same model, Matsui 28M1MK111, which is fitted with a Sanyo chassis. In each case the 2SC4429 chopper transistor was short-circuit, though no series resistor or fuse had blown! The first set was brought back to life by replacing the chopper transistor and its 2SC3807 driver transistor. The second one remained dead after this action however. R620 (120k Ω) in the start-up circuit had to be replaced.

If you still have problems after attending to the power supply in storm-damaged equipment, first check any protection circuits on the secondary side of the power supply. After that, suspect the microcontroller chip and the EEPROM. If you still have problems,

remove the tuner unit and try again. Finally, if necessary, replace any jungle chips.

By now you should have achieved a successful repair, be within budget for parts and have made a healthy profit on your labour. Very rarely are line or field output stages affected by storm damage. I've only ever been caught out twice. The first time was with an older Ferguson set fitted with the ICC5 chassis. After carrying out all the above measures, the line output transformer turned out to be shorted. The second case was with a Panasonic TV set that, after repair, had a very low-emission tube!

The Vestel 11AK19 chassis

I service a large number of sets that are fitted with this chassis, many of them under warranty. They are popular with a number of distributors and can be used with a wide range of CRTs, both 4:3 and widescreen. Here's a list of common problems I've encountered.

Failure of the line output transistor is quite common, especially when a 2SD2579 is fitted. I always fit a BU2508AF, which most Bush sets use, as it's more reliable. On several occasions I've had one of these sets that continued to trip after it had been to another dealer for attention. In each case I found that a BU2508AW had been fitted. As this transistor is not isolated, it shorts the line output stage to the heatsink. This is one to look out for.

If you encounter one of these sets with a blown-up power supply, suspect the TDA8351/8356 field output chip as being the cause. Its failure seems to take out a large number of components in the power supply. For a lasting repair, replace the chopper MOSFET Q802, R825 in its HT feed, diode D807 in the snubber network and diodes D826 and D827 which are in series with the tuning capacitor.

No picture is commonly caused by the RGB output chip IC901 on the CRT's base panel, but can also be caused by the TDA884X IF/colour decoder/timebase generator chip IC401. Another cause of no picture is C604 (47nF, 63V) in the beam limiter circuit. It can become leaky. I have had R617 (220k Ω) go high in value, the

result being a washed-out picture.

EW problems are very common, particularly with widescreen sets. The usual culprit is a dry-joint at C630. This leads to the EW driver MOSFET's drain circuit safety resistor R629 going open-circuit. Use a 2.7 Ω fusible resistor in this position in 4:3 aspect ratio sets, or a 27 Ω resistor in widescreen sets. On several occasions I've had to replace C630 because it has burnt while arcing. Various values are fitted depending on model. Make sure that you fit the correct replacement.

Although this is rare, I've come across sets that won't accept a scart input. The cure has been to replace the TEA6415C video switching chip IC050.

Finally, don't be put off repairing sets that are physically damaged. Bush is very reasonable when it comes to replacement cabinets. I recently ordered a front cabinet for a 28in. 4:3 model; the trade price was only £10 plus VAT.

Test equipment

Before I close this month, here's a useful test equipment tip – but forgive me if you already use this method and I've been slow to catch on! I recently replaced my multimeter with an auto-ranging model that includes all the usual refinements plus several extras. Amongst these are a capacitance meter and a frequency counter.

Previously I would often fire up my scope to check the line drive with TV sets and monitors and the switching action with power supplies. One day however I accidentally connected my meter, while on its frequency-counter range, to the base of a line driver transistor. Hey presto, I was provided with a reading of 15.625kHz. I now always use the frequency-counter for these tests and find this much quicker for fault-finding. In fact I haven't switched on my scope for over six weeks!

To follow

Next month I'll take a look at cheap Daewoo VCRs and provide a roundup of faults experienced with the Beko C14 chassis, which has superseded the AK19 in many Bush models. ■

WHAT A LIFE!



A meddler, a Sony TV repair, camcorder and CD trouble and a Philishaver tip. Don Bullock's servicing commentary

Paul was on duty when our first caller of the day came in. It was Mr Meddler, a friendly little fellow with itchy fingers and a pocketful of money that he likes to spend on his hobby, which is pulling things to bits. He had a shopping trolley with him, and started to natter away as he struggled to open it.

"Hello Mr Bullock. Now, I've something in here. Where is it? It's catching. Why won't it come out? Ah, here it is now. This is it, Mr Bullock. It was all right, but it don't work now. Dunno why, really don't."

He had extracted a half-dismantled JVC video recorder. As he fished about for more bits he continued his commentary.

"Ah, there's the rubber drum thing, Mr Bullock. Came off. Dunno why. And this pulley thing. Funny, innit, the way these bits come off like."

Paul stood impassively and stony-faced until all the bits had been put on the counter. He then sent Mr Meddler on his way and started on the reassembly job.

"I wouldn't do it for anyone else" he said, "But he's such a polite and vulnerable chap, and he doesn't mind paying."

Paul soon had the machine working again. The cause of the trouble had been the usual one with this series of machines. There's a brass retaining boss on a shaft under the lacing guides. It's not supposed to move, but can slip down. The mechanism then seizes.

"Some engineers insert a bit of Rizla paper between the shaft and the boss to make a tighter fit" Paul commented, "but I use Araldite.

Most of Mr Meddler's bill will be for all the extra work he caused. He doesn't seem to mind and, since he pays, I don't either."

When Mr Meddler returned he was beaming and happily reached for his wallet. "Is it done, Mr Bullock?" he asked. "What was it then? One of the parts? Which one was it? The rubber drum thing, or maybe the pulley?"

Paul gave him a brief explanation, and off he went.

A massive Sony

We had a 29in. Sony set in later that day, Model KVE2922U (AE1C chassis). Its owner struggled in with it. "I'm Tim Breeze" he told us, "the sets seem to get bigger and heavier as I get older. This one is stuck in standby, and so am I."

Steven was in at the time and decided to take it on. It was dead, not stuck in standby. The 2SD1548LB chopper transistor Q602 had a base-emitter leak and the 4A mains fuse was blown. After checking for any obvious shorts, Steven fitted replacements and switched on. The fuse blew immediately, and the new transistor died. On further investigation Steven found that there was a dry-joint at the TEA2260 chopper control chip IC601 and that the 47 μ F, 50V base-drive coupling capacitor C611 was leaky. He decided to replace the chip as well as the capacitor and the other items. After that the set was OK.

"I expect you're wondering what I doos for a livin'" Breeze said when he returned. "I'm a carpenter by trade, and sticks up the skittles

at the Twelve Bells on Wednesday nights. I've had some cards printed – look."

He handed a card to Steven. It said "Timothy Breeze, carpenter and sticker up". Steven nodded and handed it back.

Camcorder trouble

A couple of weeks later he was back, this time with an Hitachi Model VME5688E camcorder which had a cassette jammed inside. Steven had gone out to have a look at the vicar's TV set, so Paul had a go at it.

He tried to eject the cassette but, although we could hear the motor, the carriage didn't move. He set about stripping the unit down and found that the loading motor, which is mounted vertically, just to the left of the video heads, had popped out of its flimsy plastic holder.

"I can only do what I've done before with these units" Paul said. He reinserted the motor and used a plastic cable tie to strap it in place.

Timothy Breeze had more news to impart when he called to collect it. "You know that the BBC was inviting viewers to write and send in plays, don't you?" he said.

We didn't.

"Well, they wuz" Breeze continued, "so I wrote one and sent it in. Got a nice letter back from them saying 'nice try'." He then reached into his inside pocket and pulled out a visiting card. "Just 'ad these done" he said, handing it to Paul. "Timothy Breeze" it said, "carpenter and sticker up, and BBC playwright."

Interlude

Just then Greeneyes came in with

our tea. "I'm not having tea myself today" she told me, "just lemon juice. So I'll stay slim enough for that pale peach costume."

"What pale peach costume?" I asked.

"The one you're going to buy me at Marks and Spencer" she replied. "Here, hold this glass while I squeeze some lemon juice into it." I got a dose of it in my eye.

Faulty equipment

In a previous article I mentioned the very cheap Cookworks K8396 electric kettle that I obtained from Argos for only £8.95. We have found it very useful, but it's developed a couple of annoying traits. First, the water-level float tends to stick near the bottom of the visible water column, giving the impression that the kettle needs to be filled when it doesn't. Secondly its on/off switch tends to stick in the off position, so that if you want a cup of tea you have to rattle it up and down until the light in its little window comes on. Small things, I suppose, that might happen with any kettle.

I've also mentioned the compact and tidy little Aiwa digital audio system, a quite expensive Model NSX999, that I bought a year or so ago. The first thing I noticed about this was that it was so packed with unnecessary, gimmicky sound-effect features that getting it to provide even acceptable sound, particularly a decent top response, was virtually impossible. Letters to Aiwa about it were ignored. Anyway, I decided to relegate it to Greeneyes' kitchen and pinched her Woolworths £25 audio-cum-CD player, which provides much cleaner sound quality.

CD trouble

But Greeneyes soon complained that in addition to the Aiwa's thick sound (ideal for Wogan) it misbehaved when she played CDs. There was intermittent playing, skipping, long gaps between tracks and premature closing down. The CD performance with the Woolworths unit was much better, but occasionally dicey.

Now Paul specialises in VCR and audio rather than TV repairs, so I asked him to look at both players during his next visit to us. He popped a CD into the Aiwa machine first and tried it. "The usual TOC trouble" he announced, "almost every job I get with this trouble is an Aiwa. Got a cotton bud and a scope?"

"Scope?" I replied, "not here I haven't. I even hide the screwdrivers in this house. But I can probably manage a cotton-bud stick. Would you need a drop of alcohol as well?"

"Just a small glass of wine would be nice" he said. "I don't use any spirit on the cotton buds. It can cause blooming when used on some laser lenses, and there's the added risk of loosening certain cements."

He cleaned the laser then played a CD, gently tapping the top of the cabinet with his fingernails to encourage the machine to skip, while carefully adjusting the beam-focus potentiometer. Within a minute or so the unit played the CD perfectly in spite of the tapping, and Paul pronounced it OK.

"But not for ever" he added. "It'll need doing again in a few months' time. They always do, these Aiwas."

He then tried the Woolworths machine, using the same technique. This one also played up as he tapped it, but he was again able to get it going reliably by adjusting the laser-beam focusing potentiometer.

"How did you know what the trouble was?" I asked.

"By looking at the display as I put the CD in" he replied. "If the TOC reading is uncertain or absent, focusing is usually the trouble."

Greeneyes was looking at him in admiration. Then she looked at me, pointedly. "Didn't you know about that?" she asked.

"Of course I did" I replied, "in fact I think it was I who originally told Paul how to do it..."

Philishavers

But here's something I did discover recently, all by myself, though rather late in life. I've used Philishavers for years, and regard them as the single exception to my conviction that while Philips is tops for electronics the company's mechanical products tend to be inept and flimsy. Perhaps this is because of the miseries I suffered during my salad days trying to service Philips autochangers, which were so full of bits of tin and thin-wire rods. Anyway, I'd come to the conclusion that the gradual deterioration with continued use of a Philishaver was caused by head wear. So, when my latest one got to providing me with a less than perfect shave, I decided to lash out on a new set of heads.

Sure enough they did the trick. Shaving became a pleasure again. But only for a week or two, despite my rigorous cleaning with the brush

provided. Then I saw a big Philishave advertisement in a national newspaper, announcing a new Philishaver whose head assembly, it was said, could be washed out under the tap.

"But why only the latest Philishave head assembly?" I asked myself, "surely all Philishave head assemblies are basically alike?"

So, after shaving, I thoroughly washed the head under the pressure of water from the cold tap, allowed it to dry thoroughly, then refitted it to the shaver. Next time it gave me a perfect shave, as good as a new head assembly. I've been doing this for a couple of months now. It certainly works for me! ■

Make sure of your copy of *Television*

It can be difficult finding a copy of *Television* at local newsagents. The number of magazines being published keeps increasing, which means that newsagents have less shelf space for the display of individual titles. Specialist magazines in particular get crowded out.

There's a solution to the problem. Most newsagents provide "shop-save" and/or home-delivery services. There's no charge for a shop save. You simply ask your newsagent to order a copy for you: it will be kept on one side each month ready for you to collect. Home-delivered copies are ordered in the same way, but generally incur a delivery charge.

A newsagent can order any magazine for you, whether or not the shop normally stocks it.

If you buy your copies of *Television* from a newsagent and want to make sure you get every issue, just ask at the counter.

Tips, guides and reports for people repairing televisions and electronic equipment

TELEVISION

AND HOME ELECTRONICS REPAIR
SEPTEMBER 2002 £3.10

Test report:
**Promax MC377+
signal analyser**



Servicing the
Sony FE-1 chassis
Nanotechnology,
the future for electronics

Satellite, PC, Monitor, TV, VCR and DVD faults

Answer to Test Case 477

- page 677 -

During the rest of the day Service Manager's belief that field servicing is money for old rope was to change for good - especially after he scraped the van on a wall and picked up a parking ticket in Hawkfield high street. The first problem was easily solved. Satellite TV was being delivered to the TV set via its aerial input socket, and digiboxes don't incorporate a Nicam encoder! The solution was to link the two via a scart lead. There was still no "stereo" caption on the screen with satellite TV - this happens only when a Nicam carrier is present - but there was certainly stereo sound.

The solution to the DVD disc-rejection problem was a bit more involved. Sage got Colin Doc to call up websites dvdreviewer.co.uk and dvddebate.com. There's a great deal of information there on adapting DVD players for multi-region use. 'Handset hacks' are available for many cheap DVD players, and the player concerned was amongst them. Service Manager followed the instructions to put it into the 'bypass' mode, after which all was well - until the customer inserted a Region 1 RCE (Region-Code-Enhanced) disc, which will not work with a 'code-bypassed' player. Colin Doc ensured that 'Region 1' rather than 'bypass' was selected with US-sourced RCE discs. Peace then reigned once more!

NEXT MONTH IN TELEVISION

A guide to the Panasonic Euro-7 chassis

The Euro-7 chassis was introduced in late 2000 for use in high-performance, large-screen TV sets, replacing and updating the ageing Euro-5 chassis. It has a number of features that were new to the Panasonic range, including progressive-scan technology, twin RGB inputs and twin UHF tuners. Other features include 3D on-screen graphics displays, advanced 100Hz processing, flash upgradeable on-board operating software, and AC3 and DTS audio processing. Brian Storm provides a description of the technology involved.

PIC-based TV pattern generator

Use of a PIC microcontroller chip has enabled Denis Mott to come up with this relatively simple (just three ICs and a handful of transistors) portable pattern generator, which is easy to use and produces a range of patterns for TV set assessment. It includes a modulator to provide a UHF output, and can be powered by four AA batteries or a 240V AC mains input.

DVD fault reports

Return of our DVD player page, with practical tips and fault-finding guidance.

The 3-D IC memory

Getting more into less space has been the story of IC development to date, particularly with memory devices. But a fundamental limit will be reached: when gate size is as small as electron wavelength, transistors don't work! One technique that could be used to increase storage capacity is to adopt 3-D instead of 2-D fabrication. Ralf Buckstone describes past work on this possibility and some recent advances.

TELEVISION INDEX & DIRECTORY 2002 Plus hard-copy index and reprints service

Here's the essential repair information you need! The **Television Index & Directory 2002**, in CD-ROM form, contains the text of over 14,000 high quality fault reports on TVs, VCRs, Camcorders, DVD players, Monitors, Satellite TV units, Audio equipment and CD players, searchable by make and model, plus the text of 168 Test Cases and over 200 major servicing articles, from fourteen years of Television magazine. It also contains a full fourteen year index of Television, a Spares Guide, a directory of Trade and Professional Organisations, an International TV Standards guide, a satellite TV Channel Finder, a TV transmitter list and a compendium of internet resources for service engineers. The software is quick and easy to use, and runs on any PC with Windows 95, 98, ME, NT or 2000.

Television Index & Directory 2002 CD-ROM, £199

Television Index & Directory 2002 CD-ROM upgrade, £46 (to qualify for this upgrade you need to have purchased a previous version of the Television Index on floppy disk or on CD-ROM)

A six-month update of the index and fault reports will be available in May 2002. If you wish to take advantage of this, £10 should be added to a full update order.

Television Index only, 1988 - 2001, £36

Television Index only upgrade from previous versions, £16

Hard-copy indexes of Television magazine are available for Volumes 38 (1988) to 51 (2001) at £3.50 per volume.

Reprints of articles from Television back to 1988 are also available, at the flat rate of £3.50 per article - you can order through our web site, or write to the address below.

The above prices include UK postage and VAT where applicable. Add an extra £1 postage for non-UK EC orders, or £5 for non-EC overseas orders, although Channel Island residents do not need to add any extra postage. Cheques should be made payable to SoftCopy Ltd. Access, Visa or MasterCard Credit Cards are accepted. Allow up to 28 days for delivery (UK).

SoftCopy Limited,
1 Vineries Close, Cheltenham, GL53 0NU, UK

Telephone 01242 241 455 Fax 01242 241 468

e-mail: sales@softcopy.co.uk web site:

<http://www.softcopy.co.uk>

Published on the third Wednesday of each month by Highbury Business Communications, Anne Boleyn House, 9-13 Ewell Road, Cheam, Surrey SM3 8BZ. **Highbury Business Communications** is a division of **Highbury Communications PLC**. **Filmsetting** by G&E A1 Parkway, Southgate Way, Orton Southgate, Peterborough PE2 6YN. **Printed** in England by Polestar (Colchester) Ltd., Newcomen Way, Severalls Industrial Park, Colchester, Essex CO4 4TG. **Distributed** by Comag, Tavistock Road, West Drayton, Middlesex UB7 7GE (tel. 01895 444 055). **Sole Agents** for Australia and New Zealand, Gordon and Gotch (Asia) Ltd.; South Africa, Central News Agency Ltd. **Television** is sold subject to the following conditions, namely that it shall not, without the written consent of the Publishers first having been given, be lent, resold, hired out or otherwise disposed by way of Trade at more than the recommended selling price shown on the cover, excluding Eire where the selling price is subject to currency exchange fluctuations and VAT, and that it shall not be lent, resold, hired or otherwise disposed of in a mutilated condition or in any unauthorised cover by way of Trade or affixed to or as part of any publication or advertising, literary or pictorial matter whatsoever.

What's On?

at

www.mces.co.uk

Amstrad, Pace, Grundig.

Digital set Tuner / PSU fault £35.00 plus VAT
top Box Major fault £65.00 plus VAT

Amstrad DRX 100 tuner repairs £12.50 plus VAT
Fault symptom "No Satellite Signal Received"

Pace "ZIF" tuner repairs £18.00 plus VAT
Fault symptom "Picture freezes" or "No Satellite Signal Received"

Grundig Power Supply repairs £16.00 plus VAT
Fault symptom "missing channels" and "No Satellite Signal Received"

M.C.E.S. Digital

E-mail: sales@mces.co.uk

Phone: 0161 746 8037

Fax: 0161 746 8136

GAMMA UK LTD

1501-1503 Pershore Road Stirchely
Birmingham B30 2JH

RE-FURBISHED VIDEO RECORDERS BY A MAJOR UK COMPANY

On release to the trade minimum quantity 10

PRICES START AT £17 + VAT

All videos come boxed with instructions and fly lead.

**HITACHI, FERGUSON, SANYO,
TOSHIBA, PANASONIC, AKAI,
PHILIPS, SHARP.**

Graded 28" televisions also available.

(Export enquiries welcome)

Tel: 0121 459 2221

0121 458 4093

Fax: 0121 458 5558

Email: gammaukLtd@yahoo.co.uk

Trade Electronix

30/34 River street Digbeth B'ham B5 5SA

Tel: 0121 773 3300 Fax 0121 773 2300

TV'S

14" R/C FROM	from £39.99
20" TEXT FROM	from £54.99
21" NICAM/TEXT FROM	from £59.99
24" WIDE/NICAM/TEXT FROM	from £159.99
28" 4:3 NICAM/TEXT	from £89.99
28" WIDE/NICAM/TEXT	from £124.99
32" WIDE/NICAM/TEXT	from £299.99

Plus wide range of Makes in stock
at unbeatable value



VCR'S

VCR BASIC from £34.99
VCR NICAM from £39.99
**Hitachi, Sony, Thomson,
Toshiba & Daewoo
In stock**

Dvd Basic Multiregion
From £59.99
Special offer Hitachi
CvD Multiregion £74.99
Hitachi home cinema Dvd
x5 speakers multiregion £169.99

www.TradeElectronix.com
GRADED STOCK
GOOD AS NEW



AUDIO

SONY PORTABLE CD/TAPE/RADIO	from £42.50
SONY PORTABLE/RECORDABLE MD PLAYER	from £79.99
SONY STR-DE375 AMP 50w PER SPEAKER	
BRAND NEW!!	from £119.99



MORPHY RICHARDS

Breadmakers	from £19.99
2 Slice Toasters	from £6.49
4 Slice Toaster	from £8.99
Deep Fat Fryer	from £19.99
Cd/Clock/Radios	from £13.25

Full range of PANASONIC & SONY graded products in stock

All Goods are subject to Vat, carriage & availability Prices subject to change without prior notice



14" RC FROM £45.99
21" TEXT FROM £65.99
24" WIDE NICAM TEXT
FROM £165.99
28" WIDE NICAM TEXT
FROM £199.99
28" 4.3 NICAM TEXT
FROM £99.99
32" WIDE NICAM TEXT
FROM £315.99
BASIC VCR FROM £39.99
NICAM VCR £49.99
DVD FROM £79.99

13 Old Marston Road,
Oxford OX3 0JR
Tel: 01865 726827 or
07753 746667

TUBES

Widescreen:-

28" Thomson	W66EGV
28" Panasonic	W66EHK
28" LG	W66QBD
28" Thomson	W66EJU
28" Philips	W66ESF/ECK
32" Thomson	W76EDX
32" Thomson	W76EGV
32" Philips	W76ESF

Standard:-

25" Panasonic	59ECF
25" Philips	59EAK
25" Samsung	59KPR
26" Panasonic	66ECF
26" Thomson	66ECY, 66EHJ
29" Philips	68ESF

Ring Irene for prices

We also de-scratch tubes

EXPRESS TV

The Mill, Mill Lane,
Rugeley, Staffs WS15 2JW

Tel: 01889 577600 Fax: 01889 575600

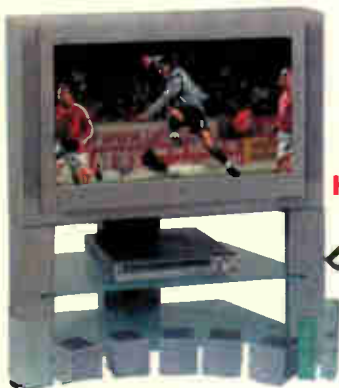

Widescreen TV's

Electronicworld

TV AND VIDEO LTD

The very Latest Style in Home Entertainment

HITACHI JVC SONY SANYO TOSHIBA

Hi-fi's from £35
DVDs from £40



Sony
32DX30 £500
32DX40 £525

Panasonic
32PK2 £300
28PK2 £200

Toshiba
36ZP18Q £800
32ZP18Q £500

CRAZY LOW PRICES!!!



Pro-logic DVD kit
£70



DVD Hi-fi's £90



We CANNOT be beaten on our prices,
that's a promise!

THE VERY BEST STOCK AT BARGAIN PRICES

All prices are Exclusive of VAT

BIRMINGHAM

208 Bromford Lane, Erdington, Birmingham
 B24 8DL

Tel: 0121 327 3273 Fax: 0121 322 2011

LONDON

221 Kenton Road, Middlesex HA3 0HD
 Tel: 020 8907 9387

PRESTON

Unit 434 Rangler Road, Walton Summit,
 Preston PR5 8AR

Tel: 01772 316066



Televés

World Leader Manufacturer of Satellite & Distribution Equipment



Meters Aerials & Accessories Satellite Receivers
Outlet plates Dishes & Accessories Coaxial Cable Atticbox Flange

Systems Equipment for Analogue & Digital TV

Televés UK Ltd. 01633-875821 01633-866311 e. televés.uk@televés.com www.televés.com

WATCH SLIDES ON TV MAKE VIDEOS OF YOUR SLIDES DIGITISE YOUR SLIDES (using a video capture card)



"Liesgang diatv" automatic slide viewer with built in high quality colour TV camera. It has a composite video output to a phono plug (SCART & BNC adaptors are available). They are in very good condition with few signs of use. For further details see www.diatv.co.uk
£91.91 + vat = £108.00

Board cameras all with 512x582 pixels 8.5mm 1/3 inch sensor and composite video out. All need to be housed in your own enclosure and have fragile exposed surface mount parts. They all require a power supply of between 10 and 12v DC 150mA.

47MIR size 60x36x27mm with 6 infra red LEDs (gives the same illumination as a small torch but is not visible to the human eye).....£37.00 + vat = £43.48

30MP size 32x32x14mm spy camera with a fixed focus pin hole lens for hiding behind a very small hole.....£35.00 + vat = £41.13

40MC size 39x38x27mm camera for 'C' mount lens these give a much sharper image than with the smaller lenses.....£32.00 + vat = £37.60

Economy C mount lenses all fixed focus & fixed iris

VSL1220F 12mm F1.6 12x15 degrees viewing angle.....£15.97 + vat = £18.76

VSL4022F 4mm F1.22 63x47 degrees viewing angle.....£17.65 + vat = £20.74

VSL6022F 6mm F1.22 42x32 degrees viewing angle.....£19.05 + vat = £22.38

VSL8020F 8mm F1.22 32x24 degrees viewing angle.....£19.90 + vat = £23.38

Better quality C Mount lenses

VSL1614F 16mm F1.6 30x24 degrees viewing angle.....£26.43 + vat = £31.06

VWL813M 8mm F1.3 with iris 56x42 degrees viewing angle.....£77.45 + vat = £91.00

1206 surface mount resistors E12 values 10 ohm to 1M ohm 100 of 1 value £1.00 + vat 1000 of 1 value £5.00 + vat

866 battery pack originally intended to be used with an orbital mobile telephone it contains 10 1.6Ah sub C batteries (42x22dia the size usually used in cordless screwdrivers etc.) the pack is new and unused and can be broken open quite easily.....£7.46 + vat = £8.77



Please add 1.66 + vat = £1.95 postage & packing per order

JPG ELECTRONICS

Shaws Row, Old Road, Chesterfield, S40 2RB

Tel 01246 211202 Fax 01246 550959 Mastercard/Visa/Switch

Callers welcome 9:30 a.m. to 5:30 p.m. Monday to Saturday

EURAS

IS.....

AVAILABLE ON CD-ROM

AND

THE INTERNET

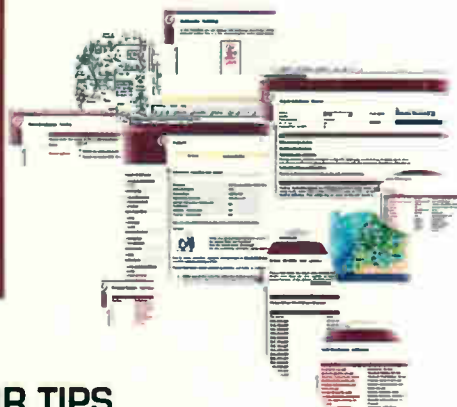

PINBOARD SYSTEM

DISCUSSION FORUM

TECH-CHAT

WEEKLY UPDATES

ALMOST A MILLION REPAIR TIPS
FOR OVER 700 MANUFACTURERS

..... **THE ANSWER**

We offer a **FREE TRIAL** on both systems, and require a £50 refundable deposit for the CD-ROM version only.

For trial details contact us now on
0117 9860900 or e-mail sales@euras.com

Economic Devices

PO Box 73, Oakengates TF2 8WR

Tel ++44 (0)1952 273130

Fax ++44 (0)1952 405478

Remote Controls ^{from} £5.95 each

Stock held for over 53000 different models

SEMICONDUCTORS

Over 34,000 types of transistors, IC's, diodes etc. or equivalents stocked

We take your hassle Some suppliers just won't help. We will work really hard to find those difficult parts - just ask and let our 'no holds barred' enquiry hound work for you!!!

...and look at the special offers....

BUT11A @ ~~29p~~ each BUT11AF @ ~~47p~~ each
 BU508A @ ~~45p~~ each Fully wired scart lead ~~39p~~

a slight inconvenience....

....you must buy more than one.

BU208A	X 5	75p ea	TEA2018A	X 5	99p ea
BU508A	X 5	79p ea	UC3842	X 5	59p ea
BU508AF	X 5	85p ea	CNX62A	X 5	29p ea
BU508D	X 5	89p ea	S2000AF	X 5	84p ea
BUT11A	X 5	29p ea	TDA3653B	X 5	55p ea
BUT11AF	X 5	47p ea	TDA3654	X 5	82p ea
Philips type 1.2 volt		Back up battery	X 5	59p ea	
Philips type 2.4 volt		Back up battery	X 5	120p ea	
Scart - Scart lead		1.5m Fully wired	X 2	89p ea	
Posipor PT37, TH98009		(White)	X 5	59p ea	
Thom TX100 Chassis		110 DGR LOPTX	each	£11.24	
Philips GP90 Chassis		LOPTX	each	£11.63	

...and now ask about our value for money full price list. Remember £1.50 post & handling. All major credit cards accepted

www.telepart.co.uk

The web page here you can look up the price and order all items. TV, VCR and Set-Top-Box. Web search by model for video parts, remote controls, LOPTX etc. overseas enquiries particularly welcome

New CCTV catalogue out NOW cameras, monitors, switches, quads, multiplexers, the lot.

FRUSTRATED!

Looking for ICs TRANSISTORS?

A phone call to us could get a result. We offer an extensive range and with a World-wide database at our fingertips, we are able to source even more. We specialise in devices with the following prefix (to name but a few).



- 2N 2SA 2SB 2SC 2SD 2P 2SJ 2SK 3N 3SK 4N 6N 17 40 AD
 ADC AN AM AY BA BC BD BDT BDV BDW BDX BF
 BFR BFS BFT BFW BFX BFY BLY BLX BS BR BRX BRY BS
 BSS BSV BSW BSX BT BTA BTB BRW BU BUK BUT BUY
 BUW BUX BUY BUZ CA CD DX CXA DAC DG DM DS
 DTA DTC GL GM HA HCF HD HEF ICL ICM IRF J KA
 KIA L LA LB LC LD LF LM M M5M MA MAB MAX MB
 MC MDA J MJE MJF MM MN MP'S MP'SA MP'SH MP'SU
 MRF NJM NE OM OP PA PAL PIC PN RC S SAA SAB
 SAD SAJ SAS SDA SG SI SL SN SO STA STK STR STRD
 STRM STRS SV1 T TA TAA TAG TBA TC TCA TDA TDB
 TEA TIC TIP TIPL TEA TL TLC TMP TMS TPU U UA
 UAA UC UDN ULN UM UPA UPC UPD VN X XR Z ZN
 ZTX + many others

We can also offer equivalents (at customers' risk).

We also stock a full range of other electronic components.

Mail, phone, Fax, Credit Card orders & callers welcome.



Cricklewood Electronics Ltd
 40-42 Cricklewood Broadway, London NW2 3ET
 Tel: 020 8452 0161 Fax: 020 8208 1441
 www.cricklewoodelectronics.co.uk
 E-mail: sales@cricklewoodelectronics.com

Use this coupon to order your copy of Pandora's drums

Please send me CD(s) at £11.99 each including VAT

Cheque

Credit card details tick as appropriate

Name _____

Address _____

Phone number _____

Total amount £.....

Make cheques payable to TELEVISION
 Or, please debit my credit card.

Card type (Master/Visa)
 Card No _____
 Expiry date _____

Please mail this coupon to TELEVISION, together with payment. Address orders and all correspondence relating to this order to Pandora's drums, Television, Highbury Business Communications, Anne Boleyn House, 9-13 Ewell Road, Cheam, Surrey, SM3 8BZ

Pandora's drums

Unique and atmospheric music recorded in the early 1900s - the days before 78s.

£11.99
Available exclusively from Television
 All tracks on this CD were recorded on DAT from cylinders produced in the early 1900s. Considering the age of the cylinders, and the recording techniques available at the time, these tracks are of remarkable quality, having been carefully replayed using modern electronic technology by historian Joe Pengelly.



21 tracks - 72 minutes of recordings made between 1900 and 1929. These electronically derived reproductions are no worse than - and in many cases better than - reproductions of early 78rev/min recordings - some are stunning...

Unit 15 Marks Hall, Margaret Roding, Dunmow, Essex CM6 1QT
Telephone: 01245 231684 Facsimile: 01245 231862

NEW B GRADE STOCK AT BELOW TRADE PRICE

LARGE 28in wide screen 16 x 9 format televisions .. from **£190.00**

LARGE 32in wide screen 16 x 9 format televisions .. from **£275.00**

LARGE rear projection televisions 52" from **£1,000.00**

WE ALSO CARRY A **LARGE** SELECTION OF
TELEVISIONS & VIDEOS ALL AT **BELOW TRADE PRICES**

- 36cm portables from **£50.00**
- 51cm televisions fast/t from **£100.00**
- 59cm televisions nicam from **£135.00**
- 68cm televisions nicam from **£150.00**
- 78cm televisions nicam from **£350.00**
- videos 2 head mono from **£50.00**
- videos 4 head nicam from **£60.00**
- videos 6 head hi-fi nicam from **£110.00**
- 36cm combined TV & video from **£100.00**
- dvd players **£108.00**

25cm televisions with DC 12/24 volt suitable for caravans - mobile homes - cars - kitchen use **FROM £85.00**

IN ADDITION WE ALSO CARRY:

- Microwaves from **£39.00**
- Upright/cylinder/bagless vacuum cleaners from **£23.00**
- A large range of audio/Hi-Fi equipment from **£23.00**

LARGE QUANTITY DISCOUNTS AVAILABLE
ALL PRODUCTS ARE FULLY GUARANTEED

We stock a great many other items in the TV, Video and domestic appliance range so if you don't see what you are looking for give us a call, we will save **YOU POUNDS.**

Visitors by appointment only

PERIFELEC

MC 30 A Spectrum Analyser



- Synthesized satellite cable and TV field strength meter with panoramic reception on 14 cm (5.5") screen and digital carriers measurement.
- Complete microprocessor and lisp/lil logic control.
- Continuous frequencies from 46 to 860 MHz and from 920 to 2150 MHz on 4 bands.
- Selectable 4, 1 and 0,2 MHz spectrum band-width, picture measurement 1 MHz.
- Display of picture of selected synthesized channel.
- FM (Radio) LA', B/G, L D/K/K', M/N TV standards and Ku and C satellite standards.
- Possibility of 32 programs memorized per frequency band.
- Display (2 Lines of 16 characters).
- Range of measurement of signal strength from 20 to 120 dBµV, manual or automatic attenuator.
- Battery life about 1 hour 20 minutes, weight 5,8 Kg.

• Display of full-band and 4 possible expanded spectrums.
• Channels and frequency plans of cable and TV standards memorized.
• Frequency signal strength in dBµV or bargraph, displayed on a digital display (2 lines of 16 characters).
• Voltage of remote power supply in 14v or 18v and 22 KHz in satellite - DiSeq C1™ v1.2 switching.



Due to its weight and size, the TC-402 A/D is the ideal instrument for the installation of FM and terrestrial TV aerials as well as CATV systems.

- Peak detection.
- Built in loudspeaker for AM and FM reception.
- Frequency indication with 4 digit LCD display.
- Analogue and digital measurement.
- Multi-turn potentiometer to enable tuning.
- Weight including batteries: 1,9 Kg.



TC 80 A/D

The TC 80 A/D has been designed for the reception of TV Satellite systems.

- Analogue and digital measurement.
- Full Band Frequency Sweep.
- Switchable 14 v or 18 v LNB power supply + 22 KHz tone switching
- Rechargeable 12 v / 2,6 Ah Battery.
- Weight including batteries: 3,3 Kg.

The TC80 A/D has been designed to aid the installation of analogue and digital satellite systems. This high quality meter has video and audio output via scart socket on rear and video only via BNC socket on front panel. The built in speaker delivers demodulated audio from any analogue satellite signals.

Full catalogue of meters available, please phone for details.

COASTAL AERIAL SUPPLIES

Unit X2, Rudford Industrial Estate, Ford, Arundel BN18 0BD
Telephone: 01903 723726 Fax: 01903 725322 Mobile: 0976 241505

Sole Import Distributors

Available Now...



The **NEW**
SALI 9
CD Catalogue

Over 750,000 products.
Brown Goods...
White Goods...
Spares & Accessories
Finished Products.
CCTV.
Over 7,000 colour pictures.
Exploded View Diagrams.

Order Code **SALICD**
Benefit from...
Stock & Price Check prior to order submission
SALI's Account Information page
Giving you access to your Account Status, Parcel Dispatch Information & Outstanding Back Orders.

Note: Users of SALI 8 will automatically receive SALI 9

If you would like **SALI 9** including the **Seme General Spares Catalogue** please contact sales and add **CAT2002** to your next order.



FREE CARRIAGE* on all **SALI** orders of £12.00 or more as well as **NEW SALI Pricing**
*Applicable to Electronic orders only, excluding credit account customers
*Carriage rates exclude Seme Trade Supplies



Tel: 01664 484000
Fax: 01664 563976
email: sales@seme.co.uk

ADVERTISERS INDEX

Aerial Techniques	675
Alban Electronics	OBC
Campion Electronics	689
Colourtrade	685
Coastal Aerial	703
Cricklewood Electronics	702
D'Lec	685
East London Components	689
Electronics World TV	700
Euras	701
Express TV	700
Gamma UK	699
Grandata	659-664
Homevision	700
JPG Electronics	701
LA Electronics	703
MCES	699
Peak Electronics	IBC
Seme	703
Senz Components	673
Stewart of Reading	689
Teletest	685
Televest	701
Trade Electronix	699
TW Electronics	IFC
Vision Aids	702
Visiontech	642
Wiltsgrove	679

Service Link

PHONE 020-8722 6028. FAX 020-8770 2016

BUSINESS

FOR SALE

ESTABLISHED BUSINESS FOR SALE

TV, VIDEO, HI-FI,
MICROWAVE, SATELLITE
SALES AND SERVICE

Prime position, Croydon (Surrey) area. free parking in front of shop, fully equipped workshop, rear entrance.

Rent only £4,700 pa, 12 year lease

Tel: 07763 217366

TELEVISION SHOP

TV, audio, VCR repair business
T/O 24K

In a good area of the East Midlands. Well established with lots of potential for more sales.

Fitted shop, workshop and storage. On a new lease with friendly landlord.

For sale due to emigration at £6,000

Phone: 0115 9584828 evenings

FOR SALE

inStore ELECTRICS LIMITED

1043 LEEDS ROAD, BRADFORD BD3 7DB
TEL: 01274 665670/660196
FAX: 01274 665246

MANUFACTURERS NEW GRADED STOCK. MINT IN ORIGINAL PACKING EVERYTHING FULLY GUARANTEED

AUGUST SPECIAL
4 x 28" 6515 SILVER TV
50HZ. REAL FLAT VIRT. DOLBY
COMPLETE WITH STAND
DELIVERED FREE UK

OTHER MODELS IN STOCK
PLEASE CALL FOR A LIST AND PRICES

AUDIO • DVD • CDR • Cameras • Fax • MWD
CREDIT CARDS WELCOME • 48 HR DELIVERY

For a FREE consultation on how best to market your products/services to a professional audience contact REUBEN on 020 8722 6028

REPAIRS

Trade repairs to Sky digiboxes

Pace, Amstrad, Grundig, Panasonic, (including Fluid Ingress).

All makes repaired at a fair fixed price.

Scan Digital Services

For details

Give Alan a ring on

Tel/Fax: 01633 25 40 50

E-Mail: alan@scansat.globalnet.co.uk

SKY DIGIBOX REPAIR CENTRE

Same day collection.

Large stocks of refurbished boxes.

From £150 - call for details.

SERVICE DEPT
S.D.S 01237 425999 / 470333

SALES DEPT
The Digital Centre,
Howard Avenue, Barnstaple,
Devon, EX32 8QA
01271 325777 / 325888

accént

TECHNIC ANALOGUE AND DIGITAL CAMCORDER REPAIRS

Collection anywhere in the UK.

All makes, ultra fast service.

Phone: 01905 77105

www.accent-technic.co.uk

LINEAGE

CHEAPEST: CABLETIES, FUSES, plug-tops, crimps, tapes, tv/video, remote handsets, extension leads, time lapse video, printers. Tel: 020 7232 2266. Fax: 020 7232 2288.

PANASONIC, MITSUBISHI, SONY, TOSHIBA, PHILIPS ETC, fully refurbished TVs. Trade only. Pearsons Television. Tel: 01484 863489

PRIVATE RETAILER has excellent part exchange colour televisions and videos to clear. Tel: 01494 814317.

SERVICE DATA

SERVICE SHEETS AND MANUALS

For most makes and models of TV - Video - SAT - CD - Audio

Complete S/Man	Service Sheet
CTV - 10.00	4.00
VCR - 15.00	6.00

Service sheets include circuits and essential electrical/VCR mechanical set-up information.

All other items - price on application.

Add P/P of £2.00 to order total. No VAT.

Payment by cheque or P.O. only please.

D-TEC

PO BOX 1171, FERNDOWN, DORSET BH22 9YG

Tel: 01202 870656

Service Information **FES** Circuit Diagrams

Fryerns

TV's, VCR's SATELLITE AUDIO & HI-FI
Most Models Covered
Prices are from £4.75 + £2.75 P/P
1 item - total £7.50 inc
2 items - total £12.25 inc
3 items - total £17 inc etc
note: some items priced individually
Payment by credit card. P.O. or cheque
Tel/Fax: 01206 211570
e-mail: colin@fryerns.fsbusiness.co.uk
2 The Lodge
Easthorpe Green
Marks Tey, Colchester
CO6 1HA

NEED HELP NOW?

Then ring the

★ ELECTRON TECHNICAL HELPLINE ★

Genuine help available to all repairers of
T.V. - V.C.R. - SAT - AUDIO (Inc Valves)
- MICROWAVE - MONITOR AND
MOST ELECTRONIC EQUIP
Over 30 years experience and vast data base

0906 470 1706

Calls cost 60p per minute

Hours of Business Mon to Fri
9.00 am-12.30 pm : 2.15 pm-5.30 pm
Sat Morn 9 am-12 noon
ELECTRON G.T.
9 CHAPEL ST, DONISTHORPE,
SWADLINCOTE, DERBYSHIRE DE12 7PS

WANTED

BEST CASH PRICES PAID

For ALL valves especially KT88, PX4 and other audio types.

Tel: 01403 784961

Billington Export Ltd
Sussex RH14 9EZ
Fax 01403 783519
Email: sales@bel-tubes.co.uk
Visitors by appointment

OPEN 6 DAYS TV/VCR CIRCUITS (WE DO NOT STOCK AUDIO OR MONITOR INFORMATION)

From

CTV Circuits	£5.00
VCR Circuits	£7.00
CTV Manuals	£10.50
VCR Manuals	£14.50

(P/P add £2.50 to each order)

419 LANGSETT ROAD,
SHEFFIELD S6 2LL

MANUAL COLLECTIONS.
PURCHASED POST (1995)

atlas

component analyser

Check your semi's

£50!

fully inclusive UK price
Great overseas price too!



- Automatic component identification
- Pinout identification
- Transistor gain measurement
- MOSFET gate threshold measurement
- PN junction characteristics measurement
- Shorted Junction identification
- Just connect the part anyway round and press the button!
- Auto power on/off

Supports:

- Bipolar transistors,
- Darlingtons transistors,
- Diode protected transistors,
- Resistor shunted transistors,
- Enhancement mode MOSFETs,
- Depletion mode MOSFETs,
- Junction FETs,
- Low power triacs and thyristors,
- Diodes and diode networks,
- LEDs (+bicolours)

Television Special

LOW PRICES

limited period only

If you don't love it, you get your money back!

Test CAT 5/5e/6 Connections **atlasit**

network cable analyser

Just plug one end of your cable into the Atlas IT and the other into the Atlas Terminator and press "test". In seconds the unit will identify the cable type (straight through, crossover or token ring) and verify every connection. If there are any faults then they are clearly explained on screen.

Socket testing is possible too thanks to the special patch cables included in the outfit.

Swapped lines, missing lines, shorted lines are all uniquely identified together with the full connection pattern!

What's more, if you want to know how to make up a special network cable, the Atlas can instruct you, even down to cable colours!



The Atlas IT is supplied in a robust carry case complete with a spare terminator and spare battery.



£79!

fully inclusive UK price

Buy online!

Visit www.peakelec.co.uk to download the data sheets, user guides and copies of independent reviews.

You can pay using a cheque, postal order, credit or debit card and even pay securely online. Please contact us for overseas or volume orders - you will be pleasantly surprised.

Also available from



PEAK

electronic design Ltd

Atlas House, Kiln Lane
Harpur Ind. Est., Buxton
Derbyshire, SK17 9JL, UK

www.peakelec.co.uk
sales@peakelec.co.uk

Tel. 01298 70012 Fax. 01298 70046





TELEVISION TEST PATTERN GENERATORS

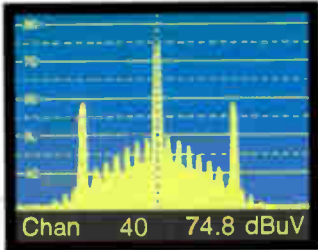

The new pattern generators **GV 798** and **GV 898** offer advanced features at realistic prices. They produce 16:9 and 4:3 formats, output level set in 1 dB steps, multistandard, VITS, WSS, VPS, PDC, Teletext and much more. GV 898 uses vestigial side band modulation.

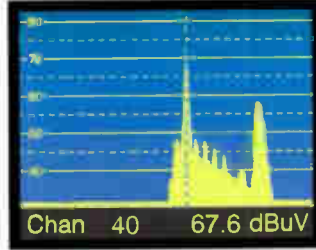

PROMAX GV SERIES

- ◆ Choice of 12 instruments
- ◆ NICAM and Teletext
- ◆ 4:3 and 16:9 Formats
- ◆ Full field and VITS
- ◆ Computer Controlled
- ◆ Front panel memories
- ◆ Multi Standard, PAL, NTSC, SECAM
- ◆ Own Company Logo
- ◆ Computer Monitor testers
- ◆ Hand Held Models
- ◆ High Quality Construction
- ◆ Attractive Price Levels
- ◆ Full After Sales Service
- ◆ Available from Stock



**FOR TELEVISION PATTERN GENERATORS,
THERE'S NO WIDER CHOICE THAN WITH PROMAX**



SELECTED ITEMS FROM THE PROMAX RANGE OF TEST EQUIPMENT



MS 250
Analogue and Digital Satellite Detector.



PRODIG 1
Satellite Dish Installer's Meter
Does more than just BSkyB



PRODIG 2
Analogue & Digital Aerial Meter
Measures digital channel power and C/N



MC 377+
Analogue & Digital, Satellite & Terrestrial
Measures channel power and C/N



PROLINK 3 SERIES
Satellite & Terrestrial, Analogue & Digital,
Spectrum Analyser with Optional BER

Alban

ALBAN ELECTRONICS LIMITED
THE PROMAX SERVICE CENTRE
6 Caxton Centre, Porters Wood,
St. Albans, Hertfordshire, AL3 6XT.

TEL : 01727 832266
FAX : 01727 810546

EMAIL : albanelectronics@cs.com
SALES + SERVICE + CALIBRATION



AA-930
Audio Analyser



TA-901
CRT Rejuvenator



TA-903B CRT Rejuvenator