

PRACTICAL MECHANICS AND SCIENCE 2/-

NOV 1962

CARS FOR
A PURPOSE

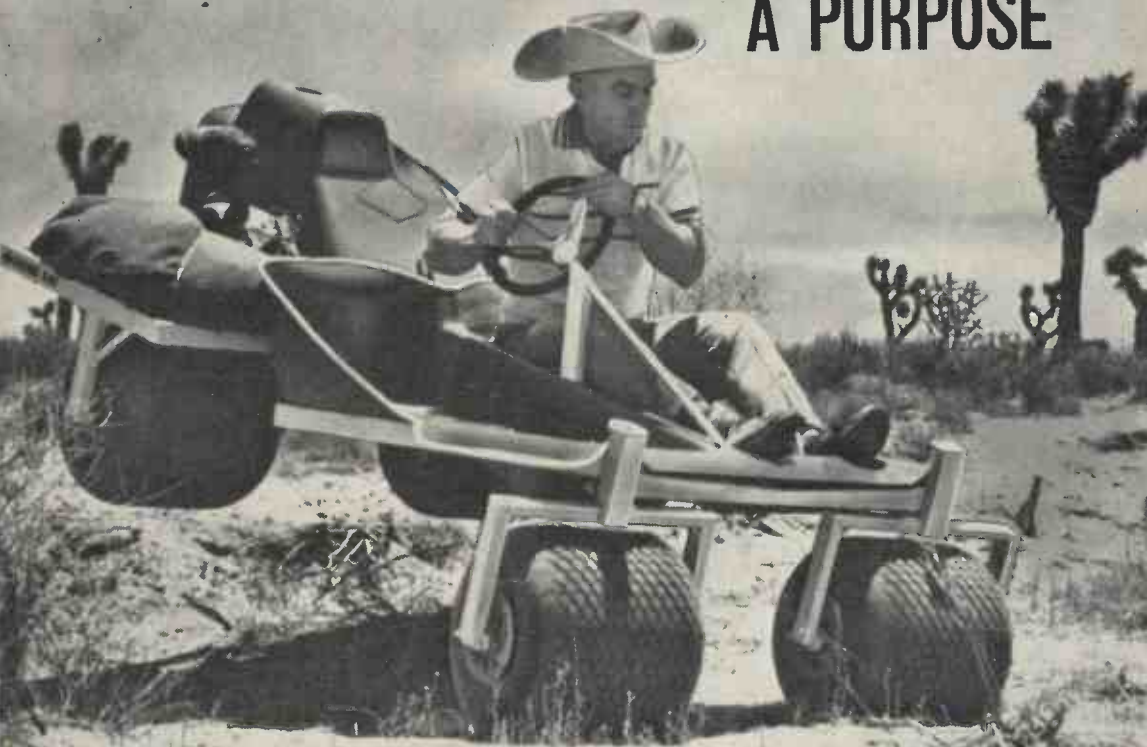

Special Inside

**TRANSISTORISED STETHOSCOPE
HIGH-EFFICIENCY CONVECTOR HEATER
INFLATABLE SPACE STATIONS**

SAVE MONEY AND ENJOY YOURSELF



BUILDING ANY OF OUR MODELS

Even if you are an absolute beginner, you can build any Heathkit model!



S-33

6 W. STEREO AMPLIFIER. Model S-33. A versatile, high-quality, self-contained STEREO/MONAUURAL Amplifier. 3 watts per channel. 0.3% Distortion at 2.5 w. per Channel. Inputs for Radio (or Tape). Gram ... **£13.76**

6-TRANSISTOR PORTABLE Model UXR-1. Pre-aligned I.F. Transformers, printed circuit and a 7 x 4in. high flux speaker. Covers both Med. and Long Wavebands. Has attractive leather case. **£14.30**



UXR-1

AUDIO SIGNAL GENERATOR. Model AG-9U. 10 c/s-100 kc/s, switch selected. Distortion less than 0.1%. 10 v. sine wave output metered in volts and dB's ... **£21.96**

VALVE VOLTMETER. Model V-7A. Measures volts to 1,500 (D.C. and R.M.S.) and 4,000 pk to pk. Res. 0.1Ω-1,000 MΩ. D.C. impedance. 11 MΩ. With test prods, leads and standardising battery. ... **£13.18.6**

TELEPHONE AMPLIFIER. Model TTA-1. "Free-hand" operation; portable and self-contained. 9 v. battery. Elegant ivory cabinet ... **£7.96**

5in. OSCILLOSCOPE. Model O-12U. Wideband amplifiers ideal for TV servicing. F.M. alignment, etc. Vertical frequency response 3 c/s-5 Mc/s without extra switching. T/B covers 10 c/s to 500 kc/s. ... **£38.10.0**

PORTABLE SERVICE SCOPE. Model OS-1. A compact, portable oscilloscope, ideal for servicing and general laboratory work. Uses printed board circuitry, 2½in. CRT. Size 5 x 8 x 14½in. long. **£19.19.0**

SHORTWAVE TRANSISTOR PORTABLE. Model HSW-1. Two short bands, trawler and medium. **£22.8.0**

SINGLE CHANNEL AMPLIFIER. Model MA-12. 10-12 watt Hi-Fi amplifier. Extremely low distortion and wide frequency range ... **£11.9.6**

HI-FI AM/FM TUNER. Tuning range: FM: 88-108 Mc/s. AM: 16-50, 200-550, 900-2,000 m. Tuning heart (£5.5.6 incl. P.T.) and I.F. amplifier (£20.13.0) sold separately. Printed circuit board ... **Total £25.18.6**

HI-FI 18W STEREO AMPLIFIER. Model S.99. 9 w. per channel. Ganged controls. Stereo/Monaural. Gram, Radio, and Tape Recorder inputs. Push-button selection. Grey metal cabinet. Printed circuit construction ... **£27.19.6**

TAPE RECORDING/PLAYBACK AMPLIFIER
Stereo (TA-1S) **£24.10.0** Monaural (TA-1M) **£19.2.6**



O-12U



S-99



AM/FM Tuner



TA-1S

THE "MOHICAN" GENERAL COVERAGE RECEIVER. Model GC-1U. Fully Transistorised. Frequency coverage, switched to 30 Mc/s. ... **£39.17.6**

AMATEUR TRANSMITTER. Model DX-40U. From 80-10 M. Crystal controlled. Power input 75 W., C.W., 60 W. peak, controlled carrier, phone. Output 40 W. to aerial ... **£33.19.0**

SINGLE SIDE BAND ADAPTOR. Model SB-10U. May be used with most A.M. Transmitters with certain provisions ... **£39.19.0**

HI-FI F.M. TUNER. Model FM-4U. Available in two units which for your convenience are sold separately. Tuner unit, **FMT-4U £3.2.0** Amplifier and P.S. **FMA-4U £11.11.0**. ... **Total £15.8.0**

ELECTRONIC WORKSHOP KIT. Model EW-1. Will help your child to understand electronics, by making at least 20 exciting experiments, including Transistor Radios, Intercom, Burglar Alarm, etc. **£7.18.0**

VARIABLE FREQUENCY OSCILLATOR. Model VF-1U. Calibrated 160-10 m. Output on 160 and 40 m. ... **£11.17.6**

TRANSISTOR INTERCOM. Models XI-1U and XIR-1U. Ideal for office or home. Each Master operates up to 5 remotes. 9 v. battery operated. **Model XI-1U (Master) ... £10.19.6**
Model XIR-1U (Remote) ... £4.7.6

HI-FI SPEAKER SYSTEM. Model SSU-1. Easily assembled. Twin speakers and balance control in a ducted port reflex cabinet, suitable for STEREO or MONO. (Legs 14/6 optional extra). ... **£11.5.0**

STEREO CONTROL UNIT USC-1. Luxury model with inputs to suit any pick-up ... **£19.10.0**

Assembled models also available - prices on request.



MALVERN

HI-FI EQUIPMENT CABINETS. Range available to meet various needs. Details on request. (MALVERN equipment cabinet illustrated on the left) from **£11.12.6** to **£18.10.0**.

STEREO HEAD PREAMPLIFIER USP-1. Ideal for boosting tape-head output and low output pick-ups (e.g. Decca ffs) **£7.7.6**

"COTSWOLD" HI-FI SPEAKER SYSTEM. Acoustically designed enclosure "in the white" 26 x 23 x 15½in. 12in. bass speaker with 2in. speech coil, elliptical middle speaker. Pressure unit covers the full freq. range of 30-20,000 c/s., complete with cross-over unit, level control, etc. **£23.4.0**

AUDIO & DO-IT-YOURSELF accessories also available



COTSWOLD

Deferred terms available over £10. Free Delivery U.K.

FREE BRITISH HEATHKIT CATALOGUE

Please send me FREE CATALOGUE (Yes/No).....
Full details of model(s).....
NAME
ADDRESS

PM-11

DAYSTROM LTD.

Dept. PM.11, GLOUCESTER, ENGLAND

A member of the Daystrom Group, manufacturers of the
WORLD'S LARGEST-SELLING ELECTRONIC KITS

The FLAKE with the FLAVOUR



4'9½
PER OZ



**IN THE DARK
ABOUT
DEVELOPING?**

It is much easier than you think to develop your own films and this new UNIVERSAL tank from Johnsons makes it easier still. You only have to load the film in the dark, the rest of the job—developing, fixing and washing—is carried out in the light. Everything has been designed for ease of manipulation and the tank is adjustable for several widths of film—120/620, 127, 35 mm./828 or 16 mm. (6 feet.) With fully illustrated instruction book. At your dealers' now, 32/6.

JOHNSONS
OF HENON, LTD

WHETHER YOU SOLDER to—
(a) make things FLY



(b) make things FLOAT

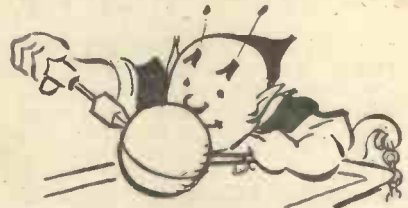

(c) make things ZOOM

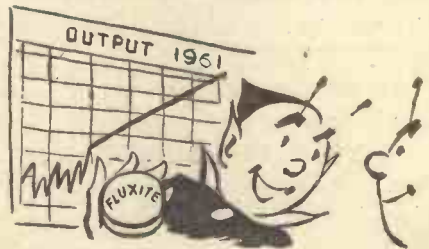

*success is certain
with*

FLUXITE

A touch of Fluxite sets the seal on every soldering job—it's the sound, simple way to success. Fluxite, famous for fifty years, is as popular today as the best deserves to be—it's the automatic choice of engineers and mechanics the world over!



Obtainable from all good-class
Ironmongers and Hardware Stores

MP.96

VALUABLE NEW HANDBOOK FREE TO AMBITIOUS ENGINEERS

Have you had *your* copy of "Engineering Opportunities"?

The new edition of "ENGINEERING OPPORTUNITIES" is now available—without charge—to all who are anxious for a worthwhile post in Engineering. Frank, informative and completely up to date, the new "ENGINEERING OPPORTUNITIES" should be in the hands of every person engaged in any branch of the Engineering industry, irrespective of age, experience or training.

**We definitely Guarantee
"NO PASS—NO FEE"**

This remarkable book gives details of examinations and courses in every branch of Engineering, Building, etc., outlines the openings available and describes our Special Appointments Department.

WHICH OF THESE IS YOUR PET SUBJECT?

MECH. ENGINEERING
Gen. Mech. Eng.—Maintenance Eng.—Diesel Eng.—Press Tool Design—Sheet Metal Work—Welding—Eng. Pattern Making—Inspection—Draughtsmanship—Metallurgy—Production Eng.

RADIO ENGINEERING
General Radio—Radio & TV Servicing—TV Eng.—Telecommunications—Electronics—Sound Recording—Automation—Practical Radio—Radio Amateurs' Exam.

CIVIL ENGINEERING
General Civil Eng.—Municipal Eng.—Structural Eng.—Sanitary Eng.—Road Eng.—Hydraulics—Mining—Water Supply—Petroleum Tech.

WE HAVE A WIDE RANGE OF COURSES IN OTHER SUBJECTS INCLUDING CHEMICAL ENG., AERO ENG., MANAGEMENT, INSTRUMENT TECHNOLOGY WORK STUDY, MATHEMATICS, ETC.

Which qualification would increase your earning power? A.M.I.Mech.E., A.M.S.E., A.M.I.C.E., A.M.Brit.I.R.E., A.F.R.Ae.S., B.Sc., A.M.I.P.E., A.M.I.M.I., A.R.I.B.A., A.I.O.B., A.M.I.Chem.E., A.R.I.C.S., M.R.S.H., A.M.I.E.D., A.M.Mun.E., CITY & GUILDS, GEN. CERT. OF EDUCATION, ETC.

BRITISH INSTITUTE OF ENGINEERING TECHNOLOGY
410A COLLEGE HOUSE, 29-31 WRIGHT'S LANE, W.8

ELEC. ENGINEERING
General Electrical Eng.—Installations—Draughtsmanship—Illuminating Eng.—Refrigeration—Elem. Elec. Science—Elec. Supply—Mining Elec. Eng.

AUTO ENGINEERING
General Auto. Eng.—Auto. Maintenance—Repair—Auto. Diesel Maintenance—Auto. Electrical Equipment—Garage Management.

BUILDING
General Building—Heating & Ventilation—Plumbing—Architecture—Carpentry—Painting & Decorating—Specifications & Quantities—Surveying—Architectural Draughtsmanship.

THIS BOOK TELLS YOU

- ★ HOW to get a better paid, more interesting job.
- ★ HOW to qualify for rapid promotion.
- ★ HOW to put some letters after your name and become a "key-man" . . . quickly and easily.
- ★ HOW to benefit from our free Advisory and Appointments Depts.
- ★ HOW you can take advantage of the chances you are now missing.
- ★ HOW, irrespective of your age, education or experience, YOU can succeed in any branch of Engineering.

156 PAGES OF EXPERT
CAREER - GUIDANCE

You are bound to benefit from reading "ENGINEERING OPPORTUNITIES," and if you are earning less than £25 a week you should send for your copy now—FREE and without obligation.

POST NOW!

TO B.I.E.T. 410A, COLLEGE HOUSE, 29-31 WRIGHT'S LANE, W.8.

Please send me a FREE copy of "ENGINEERING OPPORTUNITIES." I am interested in (state subject, exam., or career).

NAME _____

ADDRESS _____

WRITE IF YOU PREFER NOT TO CUT THIS PAGE



2½d. stamp
if posted in
an unsealed
envelope.

THE B.I.E.T. IS THE LEADING INSTITUTE OF ITS KIND IN THE WORLD

PRACTICAL MECHANICS AND SCIENCE

Vol. XXX

November, 1962

No. 343

TALKING POINT

The Planet Venus

IN view of world interest in the planet Venus, with spacecraft now endeavouring to gather information of interplanetary phenomena during a trip to Venus and in the vicinity of the planet, it might be of interest to review what is at present known.

Venus, our closest planetary neighbour, is in an orbit between the earth and the sun. Travelling at a speed of 78,300 miles per hour it has a sidereal period (or year) of 225 days. Its average distance from the sun is 67,200,000 miles. During its normal circular orbit, Venus comes within 26,300,000 miles of the earth at closest approach or inferior conjunction. At superior conjunction, or points at which the earth and Venus are at opposite sides of the sun, it is 162,000,000 miles away. Inferior conjunction occurs every 584 days. As Venus approaches inferior conjunction, the U.S. spacecraft Mariner 2 was launched to intercept the planet three to four months after launching.

One of the puzzling features of Venus is the changeable dark and light markings that appear on its cloud layer. Scientists have speculated that these markings could be breaks in the cloud cover, but as yet there seems to be little evidence of any regularity.

One of the outstanding features of Venus is its brightness. Because it is close to the sun, and has a reflective cloud layer, Venus is the third brightest object in our sky, after the sun and moon. Its reflectivity is measured about 60%, as compared to 70% for our moon. Because it was not observed throughout the night, but appeared in morning and evening skies, ancient astronomers thought Venus to be two bright stars.

Venus has been referred to as the earth's twin. It has an estimated diameter of 7,800 miles, as compared to 7,926 miles for earth. Also, it is believed to have a mass and gravitational field similar to that of earth.

Spectrographic studies (identification of materials by presence of absorptive features, lines or bands in the spectrum) seem to indicate that Venus contains carbon dioxide, and nitrogen, but probably little free oxygen or water vapour. Measurements taken in the infra red region of the electromagnetic spectrum indicate that temperatures of -38° Fahrenheit exist somewhere in the atmosphere. The micro wave regions, however, show temperatures of 615° Fahrenheit at, or somewhere near, the surface. The surface temperature is still in doubt.

Scientists are not in agreement as to the altitude from which these temperatures emanate. Indeed, there is one theory that a Venusian ionosphere, with thousands of times the electron density of the earth, gives the impression that the planet is extremely hot. Another explains that the high temperatures are due to the "greenhouse" effect in which the sun's energy is trapped between the dense clouds. A third theory holds that the surface of Venus is heated by friction produced by high winds and dust clouds.

Recent radar measurements suggest that Venus rotates at a slow rate, perhaps once every 225 days, which is the length of the Venusian year. This would mean that Venus always keeps the same side facing the sun, much the same way our moon keeps the same side facing the earth.

Maybe more positive Venusian information will be forthcoming shortly, if the U.S. Mariner 2 spacecraft completes her adventurous voyage successfully.

Editorial and Advertisement Offices
"PRACTICAL MECHANICS"
George Newnes Ltd., Tower House,
Southampton Street,
Strand, W.C.2.

© George Newnes Ltd., 1962
Phone: Temple Bar 4363
Telegrams:
Newnes, Rand, London

SUBSCRIPTION RATES
including postage for one year
Inland - - - £1 8s. per annum
Abroad - - - £1 6s. 6d. per annum
Canada - - - £1 5s. per annum

Copyright in all drawings, photographs and articles published in "Practical Mechanics" is specially reserved throughout the countries signatory to the Berne Convention and the U.S.A. Reproduction or imitations of any of these are therefore expressly forbidden.

CONTENTS

Talking point	51
N.S. Savannah	52
Lathe gadgets	55
A transistorised stethoscope	57
Inflatable space stations ...	58
Water powered microscope	60
The Magnus effect	62
Picture news	64
Amateur climatological station	66
Space age metals	70
High efficiency convector heater	71
Bush separating funnel	75
Cars for a purpose	78
Farnborough 1962	80
L.B.S.C.'s "Evening Star" ...	82
A teaching board	85
An economical set of punches	86
Photographic dry mounting press	87
Flexagons	89
Trade news	92
Your queries answered	94

CONTRIBUTIONS

The Editor will be pleased to consider articles of a practical nature suitable for publication in "Practical Mechanics". Such articles should be written on one side of the paper only, and should include the name and address of the sender. Whilst the Editor does not hold himself responsible for manuscripts, every effort will be made to return them if a stamped and addressed envelope is enclosed. All correspondence intended for the Editor, should be addressed: The Editor, "Practical Mechanics," George Newnes, Ltd., Tower House, Southampton Street, Strand, London, W.C.2.

The Dec. 1962 issue will be published on Nov. 30th, 1962. Order it now!



N.S. Savannah

the first atomic merchant ship

by Donald S. Fraser

MANY years ago when steam was the marvel of the age, a frail 320-ton craft was the first ship to use steam in the course of an Atlantic crossing. Her name was the Savannah. She relied on wood for fuel, but could only carry sufficient to supply requirements for four days steaming. The balance of the 29-day voyage from Savannah, Georgia, to Liverpool, was completed under sail.

Today, 143 years later, another Savannah is making maritime history. This vessel is a 12,000-ton nuclear-powered passenger and cargo ship. The first merchant ship of the atomic age. Using uranium-235 fuel, she requires only 130lb of it to travel 300,000 miles. Sufficient, in other words, to meet cruising requirements for three-and-

a-half years without refuelling. The new Savannah ushers in entirely new concepts on shipping generally. At present, she is a "floating laboratory" for scientists, marine engineers, and all who "follow the sea". While much has been learned from such atomic vessels as the submarine Nautilus, different techniques are required to operate atomic surface vessels. For one thing, a new-style seaman is required who must be a marine nuclear specialist.

The new Savannah will carry 9,400 tons of cargo, accommodate 60 passengers, and have a crew of approximately 100. Her speed is 20 knots sustained sea speed. Her cost—including the nuclear propulsion system—was in the region of 40 million dollars. For the first 18 months at sea, most of the passengers will be nuclear scientists and engineers studying the operation of the nuclear reactor and power plant.

The Savannah's nuclear plant, including the containment and shielding, is located amidships. The superstructure has been placed just aft of the

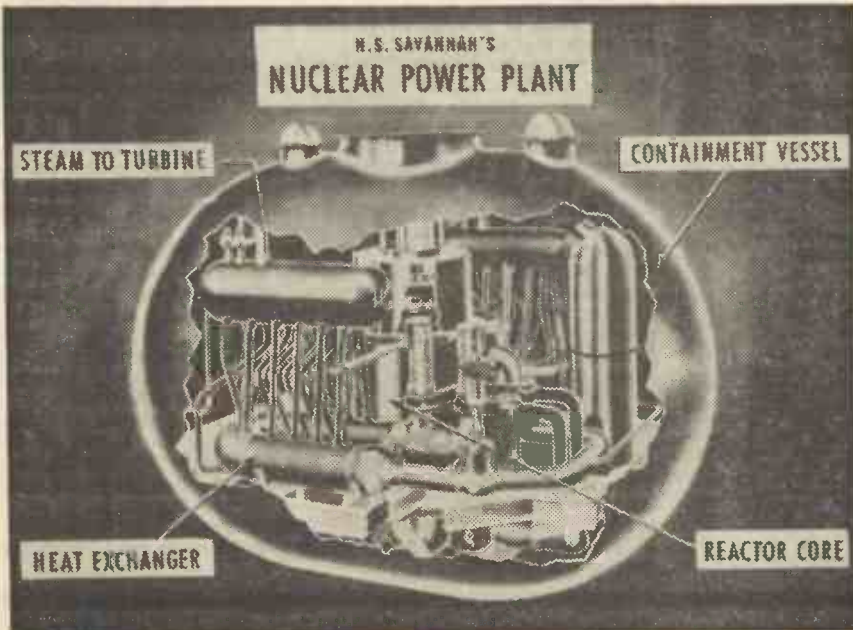

Drawing of the nuclear plant of N.S. Savannah. Intense heat is produced by fission of uranium in the reactor core. Reactor coolant is used to generate steam in heat exchangers, which then drives conventional turbines.

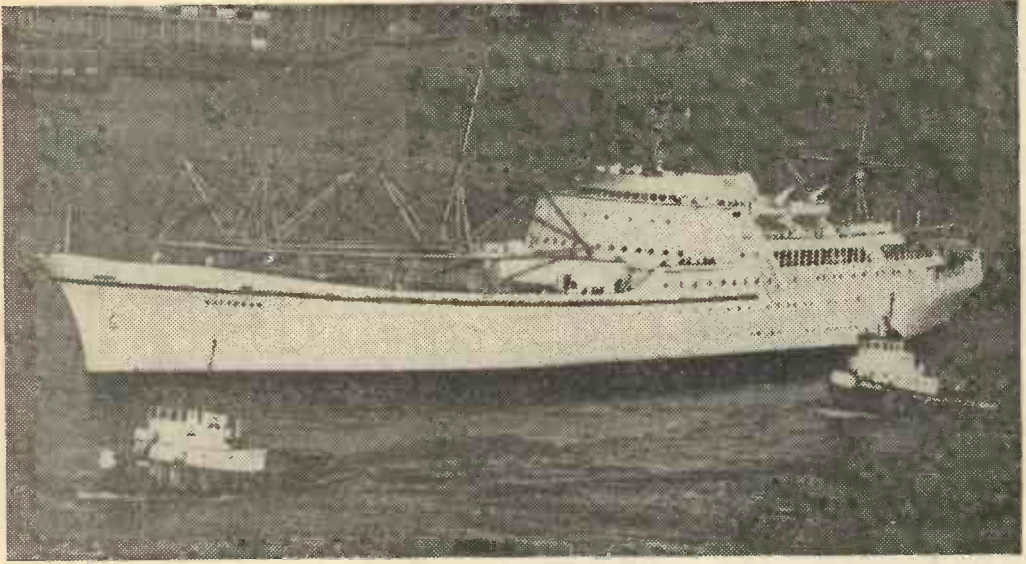

The *Savannah* under auxiliary steam power on her maiden voyage to Yorktown, Virginia, for full-power reactor operation and initial sea trials. These trials will be continued for the rest of this year.

nuclear plant to minimise shielding weights, and to avoid having to provide access to the reactor containment vessel through the superstructure. Her pressurised water reactor is an advanced version of the type that powers the submarine *Nautilus*. The primary shield consists of steel with a lead tank of water surrounding the pressure vessel. The containment vessel is made of steel plate, and the secondary shield of polyethylene plastic, lead, concrete and steel. Wood and steel, in alternating layers, act as a collision pad. The reactor system, containment and shielding have a gross weight of 2,500 tons.

The whole reactor system of the *Savannah* comprises, as well as the reactor itself, the cooling system, the steam generators, the pressuriser, and the intermediate cooling, purification, control and instrumentation systems; all of which are enclosed in the containment vessel which is 50½ft long and 35ft in diameter. The reactor core consists of an assembly of 32 fuel elements, each containing 200 stainless steel tubes, ¼in. in diameter and filled with uranium oxide enriched to about 4% U-235 content. The pressure vessel is a 26ft cylindrical shell, 8ft in diameter, made of carbon steel, clad on the inner surface with stainless steel, as are all the surfaces exposed to primary cooling water. The level of reactivity of the core is controlled by 21 boron steel control rods. The primary system, consisting of the reactor with two main coolant loops and two steam generators, operates at a pressure of 1,750 pounds per square inch, at an average temperature of 508°F for the primary cooling water. Steam is produced in generators at 473 pounds per square inch and 360°F at normal power, and provides up to 22,000 shaft horsepower delivered to a single propeller. Two natural-circulation type generators supply the steam to operate the propulsion turbines and auxiliary turbine generators and the five-bladed, nickel-manganese-bronze propeller is driven through double-reduction gears.

In this ship, 60ft of space is needed for the reactor and auxiliaries and another 55ft for the steam plant and auxiliaries—all placed amidships. The containment vessel, however, and consequently the secondary shielding also, has its long axis fore and aft. This of course improves stability and helps space utilisation. By the same token, the *Savannah* does not have to carry ballast to maintain stability. In a conventional ship of the same size, only about 70ft of the ship's length would be required for the engines and auxiliary plant.

The equipment designed to control the radioactivity created by the ship's reactor has undergone extensive, and most extreme, tests. So much so in fact that the carefully designed and constructed *Savannah* has been declared by experts to be the world's safest ship. If America's atomic submarines, on their performances to date, are any criterion, this may well be so. It has been stressed that no seaport need be concerned about contamination from the ship, as full precautions have been taken against all possible risks from collision or sinking. The escape of radiation from the nuclear reactor, although practically impossible, has been effectively guarded against. Any failure of any part of the ship's power system, at once causes a complete shutdown of the reactor. In addition an automatic radiation monitoring system keeps a constant check on the radiation intensity throughout the vessel. Any increase above the safety level will at once automatically cause the shutdown of the reactor. Even if something happened to the reactor itself and it generated enough heat to melt its core, there would still be no real danger. The containment vessel has been designed and constructed to prevent the escape of both molten metal and radioactivity.

Personnel from the *Savannah's* engineering crew have undergone extensive training. Subjects such

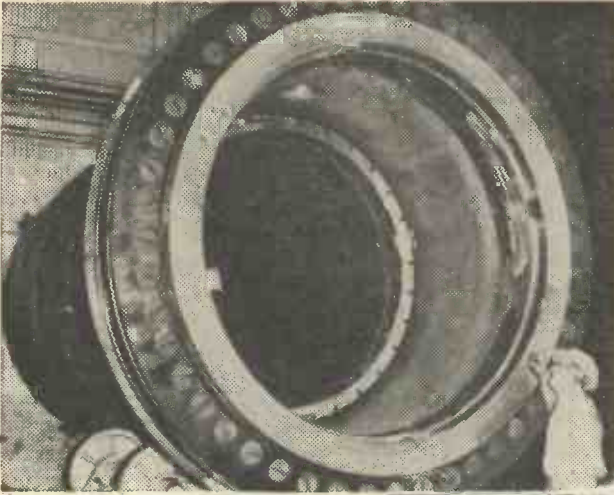

The giant, 105-ton steel vessel is shown undergoing a pressure test. The vessel, $6\frac{1}{2}$ inches thick, 28 foot tall and 9 foot in diameter, successfully completed a hydrostatic pressure test of 3000 pounds per square inch—equivalent to the pressure it would take to shoot a column of water one inch thick approximately 900 feet into the air. The test was one of more than 2500 quality control inspections.

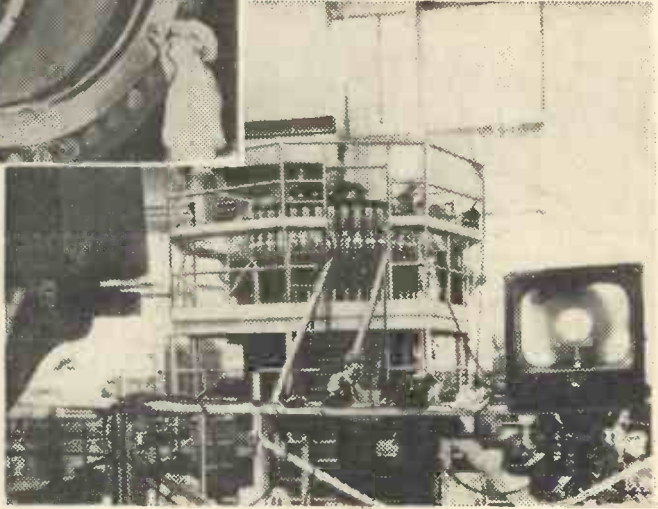

Shown here is the interior of the "atom furnace" in which nuclear fuel will be "burned" to propel the *N.S. Savannah*. The precision-built, 105-ton reactor vessel took over a year to build at the Babcock & Wilcox Company's big boiler works. Because corrosion is a particularly pressing problem in nuclear reactor pressure vessels, the entire inner surface is bonded with a thin layer of stainless steel, by a special patented process.

as atomic physics, electricity, mathematics, chemistry and health physics were part of their preparatory schooling. They then spent considerable time at an Atomic Energy Commission site for on-the-spot training. There, working with scientists and engineers of the commission, they took over the operation and maintenance of an atomic power plant. They also worked with a full-scale working model of the reactor of the *Nautilus*. Having gained a grounding in the fundamental principles and operation of pressurized water reactors they were then ready for duty aboard the nuclear-powered ship.

The Nuclear Ship *Savannah*—a joint project of the U.S. Maritime Administration and the U.S. Atomic Energy Commission—will eventually be plying trade routes and visiting ports all over the world. She is expected to demonstrate the many

advantages which nuclear power can bring to shipping and, which is probably equally important, allay the fears of those who worry about this use of atomic energy.

The chief specifications of the *N.S. Savannah* are as follows:

Length:	545ft between perpendiculars; 595ft 6in. overall.
Beam:	78ft (moulded).
Displacement:	21,840 tons (full load at design draught of 29ft 6in.). 11,850 tons (light ship, at 18ft 6in. draught).
Deadweight:	9,990 tons capacity (9,400 cargo dwt.).
Horsepower:	20,000 S.H.P. normal. 22,000 S.H.P. maximum.
Speed:	20-25 knots sustained sea speed.
Bale cubic:	746,200 cu. ft cargo capacity.

A Refresher Course in Mathematics

By F. J. Camm

A helpfully written book covering a wide range and containing the distinctive features of the "Refresher Course" series—separate exercises at the end of each section to enable progress to be noted.

5th Edition 8s. 6d. by post 10s.

From Geo. Newnes Ltd., Tower House, Southampton Street,
London, W.C.2

LATHE GADGETS

Part 11

KNURLING TOOL

By L. C. MASON

KNURLING in the lathe is one of those operations which is rarely absolutely essential, yet is used surprisingly often once the necessary equipment has been acquired.

Its most obvious use is in the finishing of heads of screws or nuts for finger adjustment, and several of these have already appeared in lathe accessories described in this series. Another useful application is for increasing the diameter of a round piece which has been accidentally produced slightly too small. If a shaft which should be a tight press fit in a wheel or ball race, for example, has been turned slightly on the slack side, a ring of knurling round the seating where the press fit is required will generally raise enough metal in a regular pattern to provide an adequately tight fit. This in fact, makes the knurling tool as near as one is likely to get to the impossible "putting-on tool"!

Knurling used to be produced by presenting a hardened and patterned knurling wheel to the job rotating in the lathe, indenting the work by the heavy pressure of the wheel. This imposes a load which is best avoided in the comparatively light lathes such as most model engineers would use. A much better procedure is to produce the knurled pattern by the use of a pair of matched wheels, mounted in such a way that the pressure required is applied by a squeeze between the wheels, which relieves the mandrel and its bearings of all side strain.

The knurling tool shown works in this way, utilising a pair of wheels mounted in a holder made up from mild steel bar. The wheels are available commercially in matched pairs, each resembling a cigarette lighter wheel on a larger scale. They are dead hard, and the sharp ridges across them which form the pattern are angled on each, to form a left and right handed pair. The resulting impressed lines on the job cross over each other to form the familiar diamond pattern.

The shank of the holder is a plain piece of square bar of the maximum size that can be held in the adjustable toolpost already described. It can of course, be equally well held in any other type of toolpost. To one end of this bar is tightly riveted a vertical piece on which the wheel arms swing. If thought desirable, a series of pivot holes could be provided to allow the arms to be more nearly parallel over a range of job sizes, although the single hole fixing for each arm as shown has worked very well over a range of sizes from 0—2½ in. diameter.

The arms themselves are plain filing and drilling jobs from mild steel bar. Mark out one side and drill the end holes ¼ in. B.S.F. tapping size, then bolt the marked-out side, via the holes, to the other blank for that pair, keeping the two bolted together till the pair have been completely shaped. The crescent shaped bearing for the clamp bolt can either be carefully filed or machined out. In the example shown, the pair of arms was mounted in a machine vice and fed straight on to a ⅜ in. endmill. Note that the holes for the wheel pins are not on the centre line of the arms. The heavy load is all one way, so most of the metal is used to resist it. The wheel pins are of silver steel, resembling partially threaded grub screws, the hole in the arm which takes the head of the pin being drilled clearance size to take the plain part of the pin. The two side members comprising each arm are held together as a unit by a round spacer between them, riveted over into lightly countersunk holes outside and filed flush. Machine the length of the centre portion of the spacers so that the arms allow no side play on the wheels—which means of course, obtaining the wheels and checking with them before final assembly of the arms.

Each pin should screw into the arm in the direction in which the normal rotation of the wheel tends to tighten it. As both wheels revolve in the same direction and the arms are upside down in relation to each other, left and right handed arms are called for. For the same reason, a neater appearance

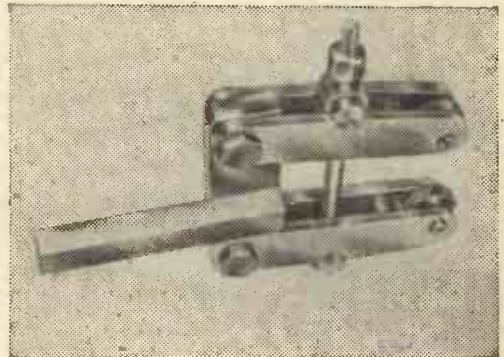

The double wheel knurling tool complete.

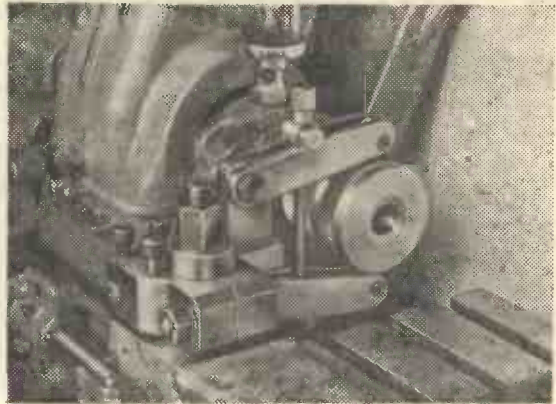
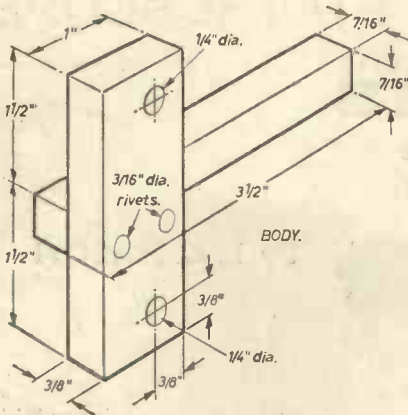

The tool in use in the adjustable toolpost.

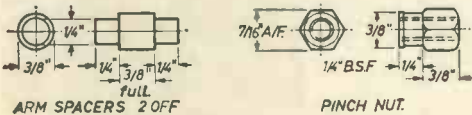
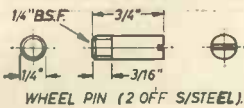
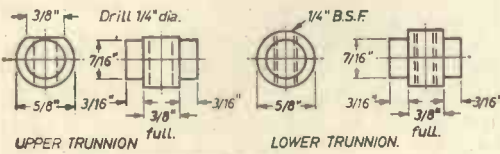
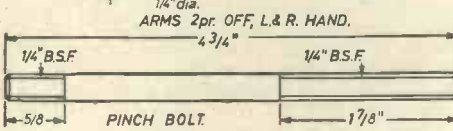
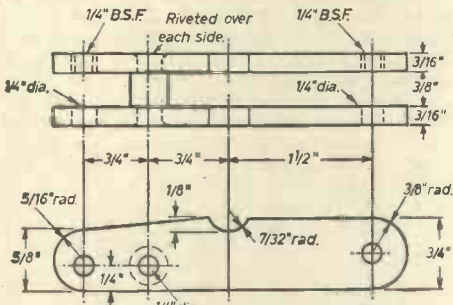

results if the holes for the pivot bolts are also handed. The bolts are commercial 1/4 in. B.S.F. hex. head bolts screwed through the farther side of the arm and lock-nutted outside. By this means a stiffly moving fit of the arms on the vertical bar is easily obtained. There should be no side play at all. With the shaping of the arms complete, open up one tapping size hole at each end of the

appropriate side in both arms to clearance size and tap the remaining holes 1/4 in. B.S.F.

The pinch bolt is a length of plain round rod threaded 1/4 in. B.S.F. at each end as on the drawing; the fine B.S.F. thread providing maximum pressure on the knurls. The two little trunnion pieces through which the bolt passes are plain turning jobs, having the centre larger than the bearing ends to locate them between the side members of the arms and, in the case of the lower one, to provide maximum length of screw anchorage for the bolt. Thread the lower end of the bolt for a length equal to the diameter of the trunnion centre and screw it tightly into the trunnion up to the end of the thread. The nut is a plain turning and tapping job from hex. steel bar of a convenient spanner size across the flats. Alternatively, file up the hex. from round stock to fit a handy size spanner. File a true flat on the upper surface of the top trunnion for the nut to bear on, which will avoid raising burrs through the pressure.

In setting up for use, adjust the opening of the arms for the job size and mount the holder in the toolpost. If any width of knurling is required it is advisable to clamp the tool by all the screws that can be brought to bear in the case of a four-tool turret or the adjustable height toolpost. Run the clamp nut down till both wheels just touch the job and adjust the wheel position by the cross slide so that the wheel and job centres are in a straight vertical line. Position the tool along the job by using the saddle. Put the lathe in slowest open gear and have the clamping spanner to hand. As the lathe starts, put the pressure on with the spanner really hard, giving it a generous half turn or so. If the length of knurling required is longer than the width of the wheels, get the wheels cutting a proper pattern in a ring of their own width, then very slowly feed along via the saddle. There is considerable resistance to a sideways feed of the wheels, so let the tool settle its own rate of feed or it will be slewed round in the toolpost, resulting in a spoiled pattern.

The wheels shown are medium coarse. The heavy initial clamping pressure is necessary to make them cut a pattern matching their own. If the pressure is too light, they will cut a "fractional-pitch" pattern, very much finer than their own

(Continued on page 90)

A TRANSISTORISED STETHOSCOPE FOR ENGINE DOCTORS

BY CLIFF MORGAN

THE need for such an instrument was brought about mainly because of the difficulty of trying to locate a hidden fault in a car engine that defied detection by any normal means. Unless the engine was stripped down, diagnosis of the fault had to remain by guess work. Stripping down would have involved a lot of time, trouble and expense, with the added chance that the fault would not then have turned out to be where the local "experts" expected.

The simple instrument described on this page, can very accurately locate mechanical faults in moving parts. So much so, that the stethoscope was capable of finding, and following, a cracked ball in a slowly turning ball race of a roller press.

The probe

This is simply the case of a worn out ball point pen, complete with the ink tube. Mounted on the top of the case is a hearing aid earpiece. These can be purchased in almost any radio shop that deals in kits of radio parts, and the price is reasonable, less than 10s. The plastic ear plug that is fitted to the earpiece is taken off and the top of the pen is then drilled to take the spigot of the earpiece, making a tight fit.

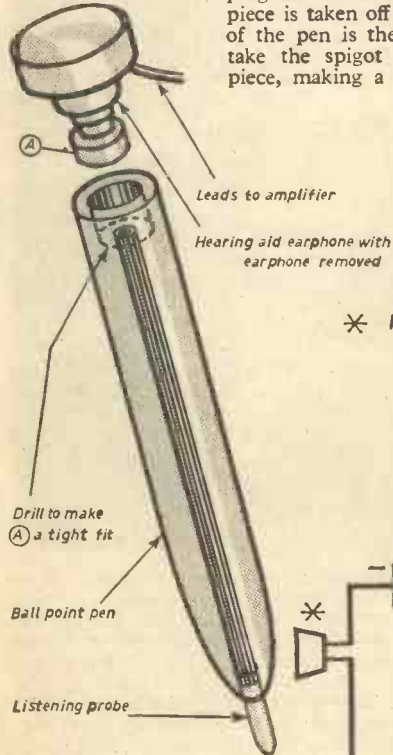

If it is found that the stethoscope needs to be used in an almost inaccessible place, a length of rubber, or preferably plastic, flexible tubing can be substituted for the pen. The length of the tubing can be as much as 14ft without loss of sound, providing that the tube is kept free of kinks and sharp bends. Even then it will transmit a signal, but of lower signal strength. A case in point where the use of such a long length of tubing was required was on a fishing boat propeller shaft connecting gland. The space provided did not enable the owner to make a proper inspection of the sealing gland with the engine running so the flexible stetho-

(Continued on page 77)

- | | |
|----------------------|--------------|
| C1 8 μ F, 3v wkg | R3 6.8k ohms |
| C2 8 μ F, 3v wkg | R4 6.8k ohms |
| C3 8 μ F, 3v wkg | T1 OC-71 |
| R1 100K ohms | T2 OC-72 |
| R2 1K ohm | B1 3 volts |

* Hearing aid earpieces, 50-100 Ω

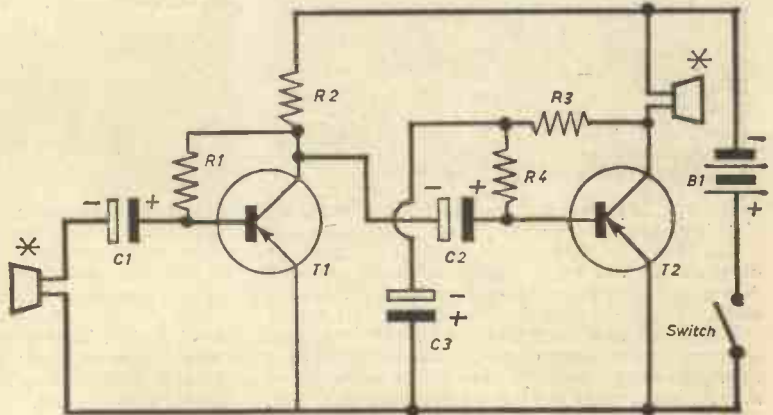

INFLATABLE SPACE STATIONS

By our science correspondent

A FULL scale research model of an inflatable space station was shown at the Lewis Research Centre of the National Aeronautics and Space Administration, in August. The three-storey-high structure, shaped like an American doughnut with a canister at its core, was designed and built by Goodyear Aircraft Corporation. Resembling a giant circular tube, the space station is connected to its central metal hub by a tunnel-like rubber spoke. Constructed of rubberised fabric, the expandable structure is a larger version of a 24ft model fabricated by Goodyear for NASA testing purposes at Langley Field, Virginia.

Mission requirements and human factors would set the criteria for the size of future versions, but it is understood that this type of space station

could be built 100ft in diameter, or larger. One of the major advantages of course, is that it can be packaged in a relatively small container, thus reducing aerodynamic drag and instability. Both of these factors present difficult problems when bulky payloads are placed atop the upper stages of booster systems.

In orbit, artificial gravity can be produced by rotating the station. This is accomplished by using compressed gas or solid propellant jets on the periphery of the rubberised ring. Larger versions could easily simulate 1g, the normal tug of gravity at the earth's surface. The hub would remain at 0g, and would be used for rendezvous docking, entry and exit, and for scientific experiments requiring no gravity.

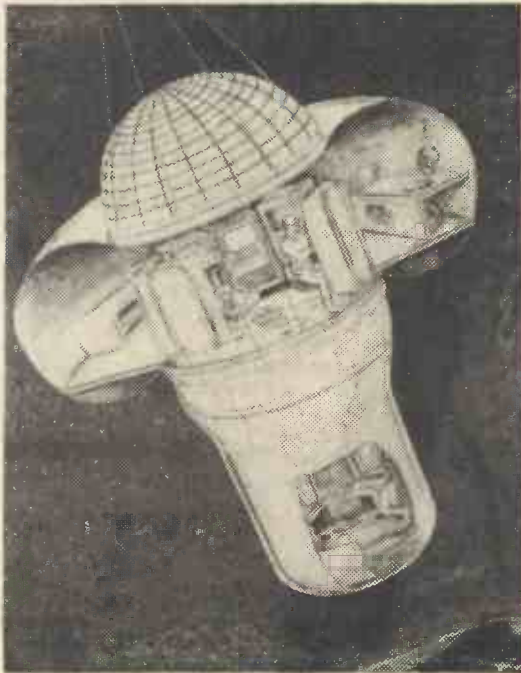
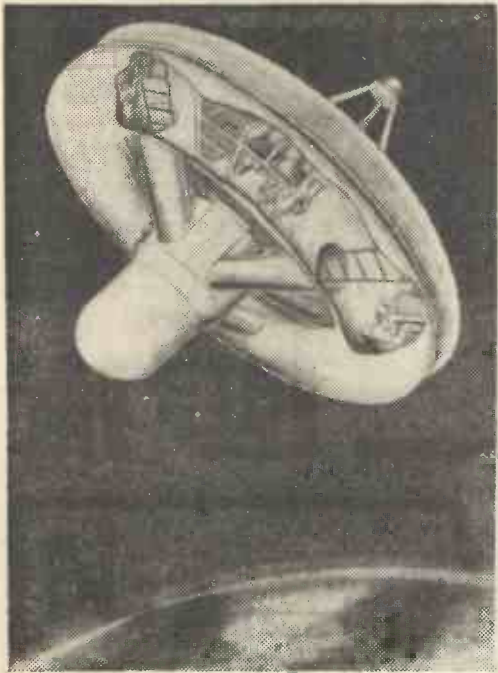

The artist's drawings show two types of expandable manned space stations that engineers and scientists are claiming might be established in orbit, using presently-available rocket boosters to get them there.

The three-man station (left), which is similar in appearance to a spoked wheel, is 40ft in diameter and has a 7ft cross-section. The ring and spokes are inflated from the rigid central structure which is fired into orbit by rockets. A capsule contained in the rigid section is provided to bring the astronauts back to earth at the end of their mission.

The work area of the space station (right) is also expanded by inflation. The roof is raised and the "new room" is then outfitted with equipment previously packaged in the rigid structure below. Fibres and woven metal cloth, impregnated with suitable materials to make them leak-proof and resistant to high temperatures, are available now for space usage and make these ideas more than a designer's pipe-dream.

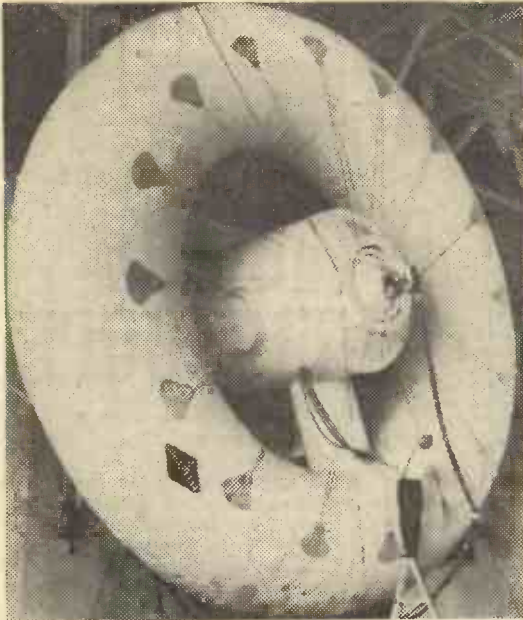

An engineer inspects the 30ft diameter expandable space station during inflation tests.



Two engineers test the inflatable furniture in a quarter section mock-up of the 30ft space station.

The expandable structure is designed to be packaged around the hub during launching. After being lofted above the earth's atmospheric blanket, where there is little or no resistance, the station would be erected automatically by pumping air into the circular structure. Once the space station had been placed in an earth-orbit, the crew would be ferried to it by the rendezvous docking technique. Housed in a Gemini-type (two man) or Apollo-type (three man) capsule, the astronauts would be lifted into a similar orbit to hook up with the station's hub. From there they would enter the expanded ring. This area contains bunks, a galley, controls, communications and equipment for performing scientific experiments.

Power for the space station would be generated by solar energy which could be converted directly into electrical energy. To return to earth, the crew would re-enter the capsule and de-orbit to the earth's atmosphere in the same manner used by the Mercury astronauts to make their landing.

The furniture is the result of space-age ingenuity. The built-in furnishings, made of Airmat rubberised fabric, and supported from the sides of the 7ft high ring, are inflated at the same time that the station is expanded. To conserve space, some of the furniture serves a dual purpose. For example, the air-filled bunks are easily converted into work tables. Chairs and desks are also designed to make the fullest use of the interior space.

The problem of providing a varied, tasty diet for the crew, with a minimum of preparation, has been solved by using dehydrated foods encased in flexible plastic containers. Merely by the addition of hot water to the packages, astronauts can have breakfast of ham and eggs, luncheon of chicken and rice, and dinner of beef and gravy.

Extensive experiments have been conducted to test the ability of the rubberised fabric to withstand bombardment of micrometeorites. A 2in. thickness of foam rubber sandwiched between two layers of fabric was peppered with pellets, at a velocity in the range of 20,000ft/sec. Engineers reported that the results showed that the expandable rubberised skin was comparable to rigid types of similar weights in its puncture-preventing ability.

This space station, the product of two years of research, engineering and development by GAC Space Systems Division, could be the forerunner of larger and more sophisticated versions which would serve as roadhouses for deep space explorers.

**Don't forget to buy the
December issue of our
companion journal
PRACTICAL WIRELESS,
price 2s., and receive your
FREE double-sided blueprint
giving details of the
Berkeley Loudspeaker
Enclosure and The Luxembourg
Tuner.**

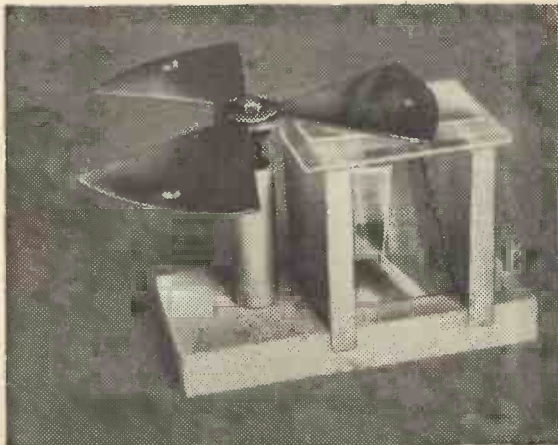

A WATER POWERED MICROSCOPE

By W. R. SPENCE, M.A., B.Sc.

MICROSCOPES are expensive to buy, with the exception of those which are little more than toys, but the unorthodox model described here, although not very attractive in appearance, is both cheap and serviceable. A maximum magnification of around 100 diameters is obtainable at a cost of only a few shillings. It is so simple that patience more than skill is required to construct it but, properly assembled, its performance will be found to match that of an instrument costing many pounds.

The lens

In order to understand the principle underlying the design it must be remembered that the early microscope consisted of a small metal plate in which was mounted a tiny lens, often formed from a drop of molten glass. The idea of this unsophisticated model based on that primitive magnifier is to induce an ordinary drop of water to perform the same function as the early glass lens. Water, of course, both transmits and refracts light but, being a liquid, it possesses no inherent shape of its own. The magnification which we can obtain by using the refractive properties of water therefore depends upon the shape which a drop of it can be persuaded to assume. This, in turn, is determined by the manner in which it is held.

The lens-holder

The drop of water is placed in a shallow depression which has a hole drilled through the bottom, this hole being small enough to permit the natural surface tension of the water to hold the drop intact. The more spherical the drop remains the greater will be the magnification obtained and the ideal at which to aim is shown. The success of the microscope depends largely on the care exercised in preparing the lens-holders, although some magnification will result even from an indifferent mount.

General assembly

The wooden frame presents no difficulties to anyone possessing even a slight knowledge of wood-working and the fitting of the glass top (or stage) and the sub-stage mirror is obvious from the illus-

trations. It should be at 45° to the horizontal, although this is not critical. No dimensions are given as the microscope can be constructed to any size desired. It is, however, important to check that the lens-holder can be brought right down until it touches the stage and the length of tubing to be used is governed by this consideration. The diameter of the tube must also accommodate the focusing bolt and its nut, which should be bushed into it or soldered to it. Standard electrical conduit should serve this purpose excellently. The only technical part of the entire construction is the attachment of the rotating disc to the bolt head. The most efficient way of doing this is to drill and tap the bolt head to take an 8B.A. screw. The depth is not critical and washers may be fitted to take up any slackness.

Forming the lens-holders

If segments are removed from the disc as shown in the diagrams, these waste pieces may be put to experimental use to discover the appropriate size of hole to be drilled. This will vary not only with the type of material employed but also with the nature of the water supply. A depression not

The lens-holders and focusing mechanism.

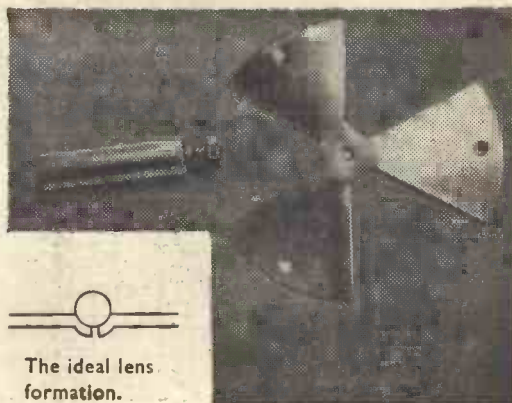

The ideal lens formation.

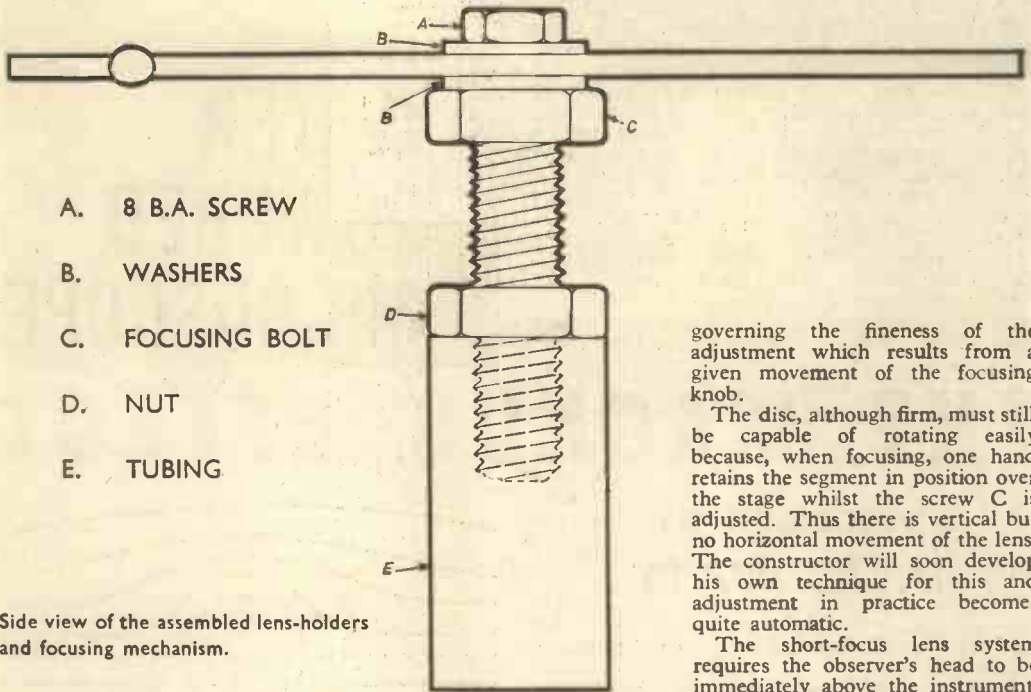

- A. 8 B.A. SCREW
- B. WASHERS
- C. FOCUSING BOLT
- D. NUT
- E. TUBING

Side view of the assembled lens-holders and focusing mechanism.

exceeding $\frac{1}{16}$ in. across should first be made with a round-ended punch. A small hole should next be drilled in the centre of the depression. A $\frac{1}{16}$ in. drill may be large enough to start with. The hole may be gradually enlarged with a small rat-tail file if necessary, the optimum size being found by trial and error.

The metal disc need not be segmented if the constructor wishes to dispense with preliminary trial and error and a greater number of holes may then be made in the disc to ensure that more than one reaches perfection. In any case it is useful to have slight variations in the holes and the punched cups so that different "powers" of lenses may be tried in a manner similar to that of a triple nose-piece in an orthodox instrument. 16-gauge brass or aluminium will be found to be most suitable for shaping and is easily cut with tinman's snips or a fretsaw. A medicine dropper is invaluable for inserting the water drop cleanly, for if the drop spreads the lens is useless.

Using the microscope

As the lens is composed of water it will eventually evaporate and, in the process of doing so, its shape (and consequently focus) will undergo a perceptible change. It is to counteract this, as well as to allow for variations in the sizes of individual drops, that a focusing arrangement is necessary. However, the range of effective distance between lens and object covers only a small fraction of an inch so the method of making the adjustment has to be fairly precise. A screw thread, as used here, is the most accurate means available, the pitch

governing the fineness of the adjustment which results from a given movement of the focusing knob.

The disc, although firm, must still be capable of rotating easily because, when focusing, one hand retains the segment in position over the stage whilst the screw C is adjusted. Thus there is vertical but no horizontal movement of the lens. The constructor will soon develop his own technique for this and adjustment in practice becomes quite automatic.

The short-focus lens system requires the observer's head to be immediately above the instrument, thus causing shadows in the area where light is most needed. The 45° mirror does much to overcome this but a universal mounting for the mirror would be superior in permitting a more precise control of the lighting. If the mirror is replaced by an M.E.S. bulb, operated through a transformer or from a battery, the illumination will be more constant, especially if a polished reflector is fitted. The light may also be placed above the stage for observations on opaque specimens.

Several models, constructed under the present writer's guidance, have been in use in a school science department for several years without losing their initial efficiency.

The wooden body of the microscope.

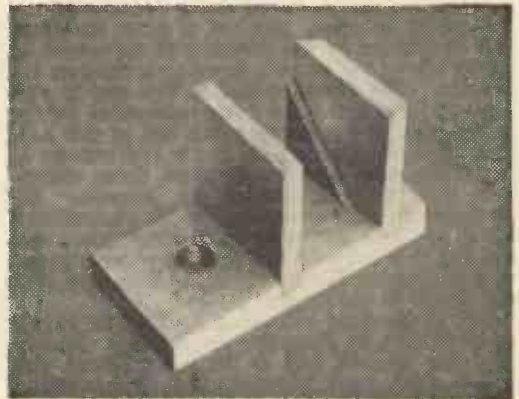

A YOUNG Peruvian at Stanford University has recently proposed a new principle for vertical take-off and landing of aircraft and has revived interest in the Magnus Effect. This latest development in the search for a simple means of achieving vertical take-off uses a rotating cylinder and hinged flaps and is claimed to be capable of turning the entire propeller slipstream through 90°. Fig. 1 shows how this is achieved by a rapidly rotating cylinder installed along the joint of a wing flap and flows along the surface of the flap to create an upwards thrust on the wing. At first sight this appears to be impossible and in fact many aeronautical experts would not believe it until they had seen it demonstrated. However, this is really just another application of the Magnus Effect which has been known for many years and was first put to practical use by Anton Flettner in the 1920's. He

With flap lowered and cylinder rotating slipstream is turned as shown.

With flap raised and cylinder stationary wing acts as a normal aerofoil.

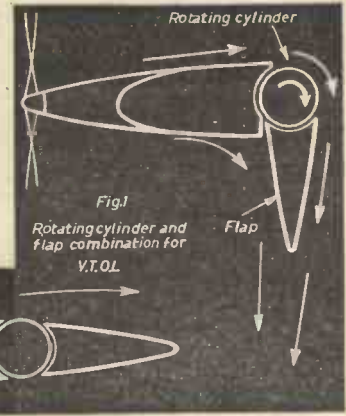

THE MAGNUS EFFECT

DESCRIBED BY
D. A. WATT

used rotating cylinders to drive ships and to power windmills.

In order to understand exactly what the Magnus Effect is, let us study the forces acting on a rotating cylinder placed in a moving air stream. Fig. 2a is a section through a cylinder stationary in a moving air stream and shows how the stream lines are deflected around the cylinder. Considering next a cylinder rotating in still air, the boundary layer of air will tend to travel around with the surface as shown in Fig. 2b. If now the cylinder is rotated in a moving air stream as in Fig. 2c the velocity of the boundary layer at the top of the cylinder will be the sum total of wind velocity and cylinder surface velocity, while at the bottom of the cylinder the resultant velocity will be the difference between these velocities. Associated with the region of high air velocity is a low-pressure zone and, conversely, a high-pressure zone is created at the bottom of the cylinder where the air velocity is low. The pressure difference between these two zones is sufficient to cause a vertical thrust upwards on the cylinder as indicated. Reversal of either the direction of rotation or the direction of movement of the air stream will cause a downwards thrust on the cylinder. The thrust created in this way is surprisingly large and is the factor responsible for the curved path of a spinning tennis ball or golf ball. This effect was first noticed in the 17th century in connection with inaccuracies when firing cannon balls and was investigated by Magnus. He developed a theory to account for this phenomenon but it has been shown by other investigators that this theory is not valid and that the true mathematical explanation is very complex. However, it is still known as the Magnus Effect.

One of the most interesting applications of this principle was in Flettner's rotor ships. Shortly after the 1914-18 war it became apparent that sailing ships were becoming less economical to

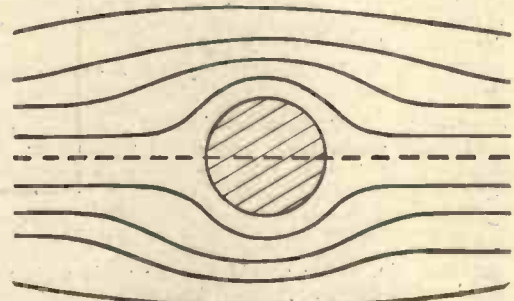

Fig 2(a)



Fig 2(b)

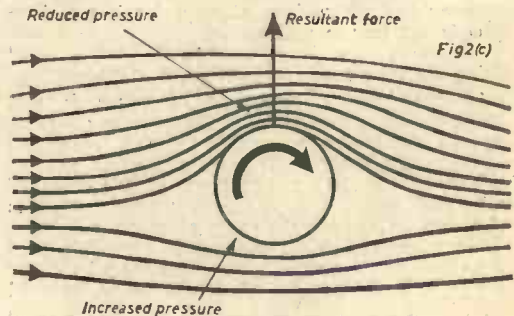

Fig 2(c)

operate than steam ships because of the time lost when adverse winds were encountered and because of the large crew required to set the numerous sails. Flettner reasoned that with such an abundance of free wind power available the discovery of a simple and more efficient way of using this power would give the sailing ship a new lease of life. After various experiments using aerofoil-type sails, without much success, he hit upon the idea of trying to utilise the Magnus Effect. Experiments with a model in a wind tunnel were so promising that he was able to persuade his sponsors to agree to convert a sailing ship, the "Buckau", into a rotor ship. The "Buckau" was a three-masted topsail schooner with auxiliary diesel-driven propeller. She was 170ft long, 29ft beam and had a displacement of 680 tons.

Further experimental work was carried out on a scale model of the "Buckau" to provide data on which to base the design of the rotors. These tests showed that the ratio of peripheral speed of the rotor to wind velocity is important and, as shown in Fig. 3, the optimum ratio is about 3.5:1. Having established this he was then able to determine the size of rotor and speed of rotation required to give the same thrust as the original sails. In fact he decided to use two rotors each 60ft high and 9ft in diameter, rotating at 120 revolutions per minute. With these details determined he carried out more experiments on his scale model and compared the rotors with the original sails. Fig. 5 compares the effective thrust of the rotors with that of the sails and shows clearly their superiority. Flettner had observed that the thrust on the rotor is not exactly at right-angles to the air flow due to frictional effects, thus maximum forward effect on the hull is achieved with a wind at slightly more than a right-angle to the desired direction of motion. Fig. 4 is a polar diagram showing how the forward effect depends on the desired direction of motion. The inner diagram of Fig. 4 shows the forward effect of a sail of the same projected area as the rotor. Except when travelling very close to the direction of the wind the rotor is far more effective.

The "Buckau" was eventually converted into a rotor ship, the rotors being arranged as shown in Fig. 6. She was ready for trials in 1926 and exceeded all expectations, being faster than she was before and able to sail much closer to the wind. Her first commercial use as a rotor ship was to carry a cargo of lumber from Danzig to Grangemouth, near Edinburgh, returning with coal. Because of the success of the "Buckau" the Transportation Department of the German Navy ordered the construction of another rotor ship, the "Barbara". She was 1,700 gross tons, 300ft long, 43ft beam and was fitted with three rotors each 56ft each, 13ft 2in. diameter, driven at 150 r.o.m. by a 35 h.p. electric motor. She was also fitted with a propeller and two diesel engines of 530 h.p. each.

The "Barbara" carried 3,000 tons of cargo and a few passengers and plied between Hamburg and Italy for six years. Operating experience confirmed Flettner's predictions and showed that the rotor ship was a sound practical proposition. However, when the saving in fuel cost was balanced against the extra cost of installing rotors and maintenance costs the rotor ship was only marginally better than a steam ship.

(Continued on page 77)

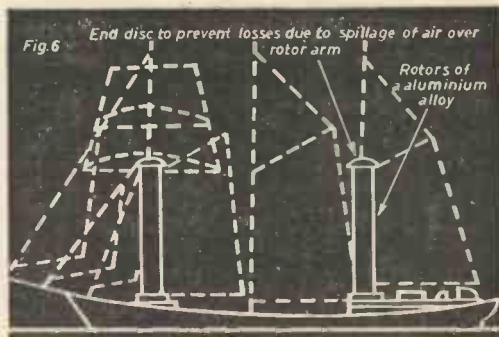
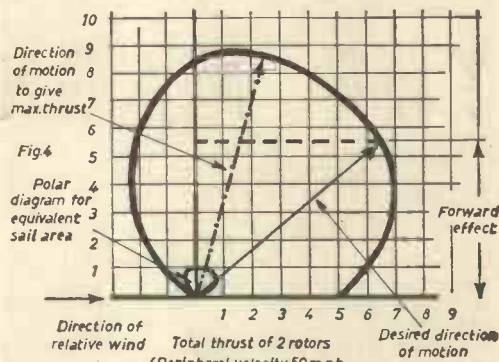
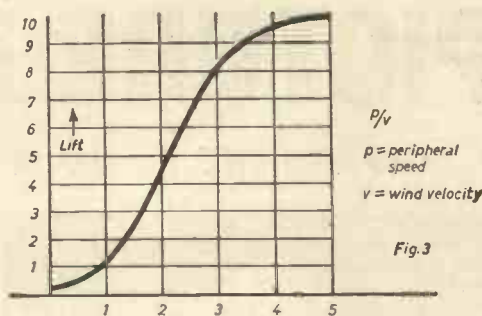

The "Buckau" before and after conversion. (Later renamed "Baden-Baden".)

PICTURE NEWS

FROM THE WORLD OF SCIENCE



A test for synthetic rubber

SCIENTISTS have found that a laboratory test of 20 minutes duration proved conclusively that the life of products made with a new synthetic rubber can be increased by months, or even years, it has been announced.

The test results, when projected to scale, compare closely with those obtained from actual product tests.

After a 20 minute run at 180 rev/min, on a highly abrasive wheel, small, tyre-like rubber rings, made of Butene synthetic rubber, are weighed to determine actual loss from wear. The tests have shown, according to Goodyear scientists, that 50-50 blends of the new synthetic with conventional synthetics improve wearing qualities as much as 50%.

Thousands of ring abrasion tests, with hundreds of compound variations, have shown the new synthetic to be useful in numerous products subject to hard wear.

The new polybutadiene type of rubber also improves resiliency, ageing and low temperature properties of rubber compounds. Even at low temperatures, Butene retains a high degree of flexibility. The unusual properties of the man-made material provide a degree of end product quality improvement unattainable prior to its development.

The persistence of the scientist is nearly always rewarded.

Keeping an eye on the astronaut

GIVE us the tools and we'll finish the job", was possibly one of Sir Winston Churchill's most famous remarks. The same thing arises again, today, in the scientific world. Without tools, scientists would be sadly handicapped. However, judging by some recent space achievements, the tools required to "finish the job", are very much in evidence.

Take the track radar, for instance, used in the Mercury-Atlas launchings of American astronauts. It is one of the world's largest precision instruments and "locks on to" a signal from the soaring vehicle and relays a continuous flow of data, not only regarding the spaceship's position, but regarding the astronaut's condition. It is a key part of the overall General Electric radio-command guidance system which controlled the flight of boosters placing John Glenn and Scott Carpenter in orbit. The tracker, located inside a radome, adjacent to a building housing related electronic consoles and computers, moves imperceptively on a 48in. dia. powered base ring that was machined to a tolerance of 50 millionths of an inch.

The words "science" and "precision" are very much allied.

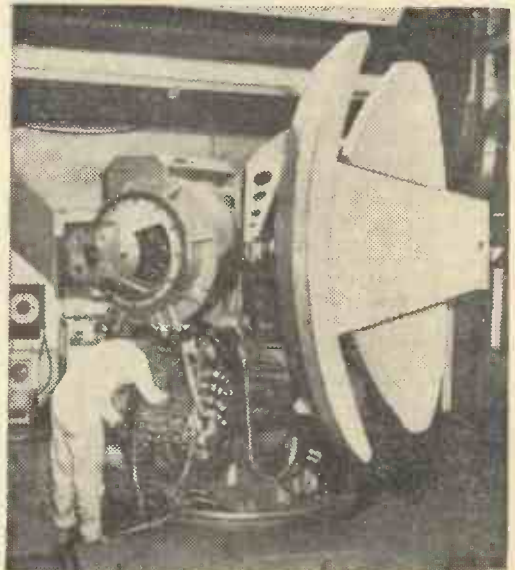

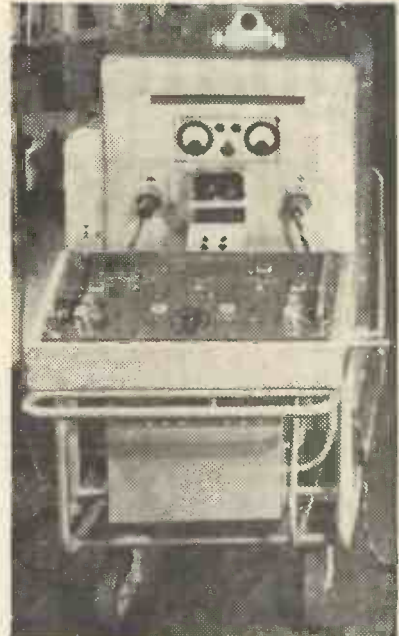
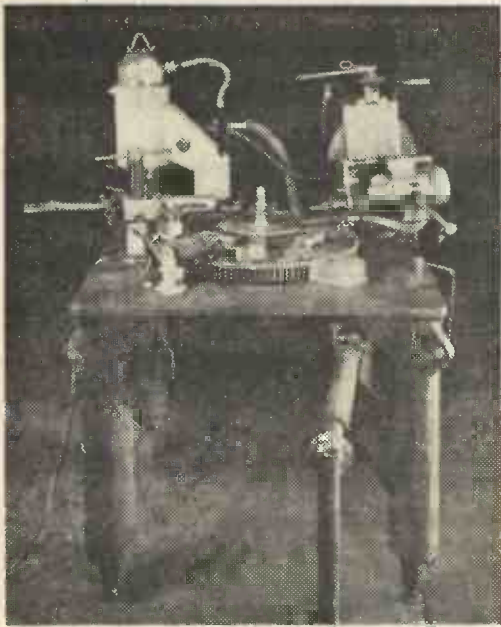

Automatic welding for atomic use

A SPECIAL milling and welding machine for opening and re-closing welded containers for radioactive material has been completed by Pye Limited, Royston, Herts., for the Belgian Atomic Energy Authority.

The machine, designed for operation behind thick concrete shield walls, consists of a substantial fabricated steel base mounting a number of units which can be operated by Master Slave Manipulators (mechanical "hands") to perform the necessary tasks. Facilities include a power driven turntable with variable speed drive, a milling head, with vacuum swarf removal, an argon arc welding head with arrangements for automatic arc striking and tracking, and means for removing and replacing a screwed cap on the container if required. The machine is designed to accommodate containers up to 8in. diameter, with a maximum weight of 1,500lb. The units are readily adaptable for a wide range of special applications.

Ease of servicing and simplicity of operation have been prime considerations and where possible controls and drives are taken outside the shield wall. Master Slave Manipulators manufactured by Pye Limited are used to carry out operations where this has not proved practicable.

3,900 Watts under the sea

POWERFUL new sealed-beam projector lamps made by U.S. General Electric take to the water as easily as this aqua-lunged beauty obviously does. The 650W lamps (six are in use here) have operated, completely submerged, up to 84 hours, more than five times their rated life. Ideal for underwater photography, they are equally apt for the landlubbing amateur cinematographer. This has not proved practical by other methods.



Amateur Climatological Station

Part Three

MAKING THE WIND DIRECTION RECORDER

By A. Crawfoot

NOW that your station is operating visually, it is time to think about keeping records of the various phenomena that you have been watching. Records give an hour to hour picture of what is happening and enable the present to be compared with the past. Research is nearly always based on past facts, which are then applied to present theories. As mentioned last month, if you have purchased a thermograph and barograph, you will have a station that will compare with almost any professional station. Remember though that a station of this nature is far too valuable to play with. It must be worked consistently and methodically. One reading lost or not taken will upset the whole sequence, seriously reducing the value of the remaining records. Below is shown a suitable form of station log sheet on which your readings should be entered. Completed sheets should be carefully filed and kept in a safe place so that they can be referred to in later years. Much interesting information on trends in the weather can be obtained by plotting graphs of readings over long periods of time. Even if you do not make serious use of your readings you will eventually be able to scientifically prove or disprove the statements of your friends who say it has been the wettest or driest summer for years! One reading which is difficult to take is wind direction as this is continually varying and a single reading is almost meaningless. Thus it is

well worth while to construct the wind direction recorder as described below.

The wind direction recorder

This recorder is coupled to the centre of the indicator, and is driven by the grub screw that locks the pointer to the drive from the wind head. The action of this recorder is the reverse of most recorders in so far that the drum turns in either direction without any lateral movement, whilst the pen traverses the length of the drum to give the time indication.

First obtain a suitable size tin with the lid fitted in the end, not over the end. It should preferably be 9in. long by 3in. diameter, as any variation from this size will mean that the other dimensions given will have to be amended to suit. This is not difficult, neither will it make any difference to the effectiveness of the recorder. A spindle, of $\frac{1}{2}$ in. diameter brass rod, 12in. long should be cut, and at one end a groove, $\frac{1}{8}$ in. deep, to clear $\frac{1}{2}$ in. wide should be turned, $\frac{1}{4}$ in. from the end. This forms the locating groove. The spindle should then be mounted through the middle of the drum, great care being taken to ensure that the spindle is exactly central so that the drum runs truly on its spindle.

SUGGESTED LAYOUT OF STATION LOG SHEET

NAME		ADDRESS				LATITUDE			LONGITUDE			YEAR	
						deg.	min.	sec.	deg.	min.	sec.	MONTH	
day date	wind		rain point	evap. point	temp		rel. hum. %	bar.	cloud		REMARKS		
	dir.	vel.			wet	dry			type	height			
Sun. 17th	SE	15	nil	12	56	64	59	30.1	nim.	2500	cirrus at est. 10,000 ft		

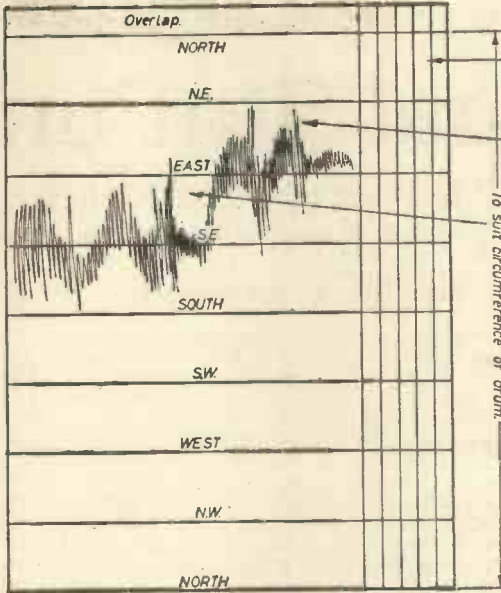

Hour marks, 28 to allow 4 hours over run.

Wind changed to East.

Type of record to be expected from S.E. wind.

The lid of the drum should then be soldered in place and the spindle also. The coupling unit from the drum shaft to the indicator shaft should be turned from a piece of 1in. diameter brass rod. The end should be recessed to $\frac{3}{4}$ in. diameter by $\frac{1}{2}$ in. long. The whole unit is 1in. long. It should be slotted so that it will slide over the grub screw of the indicator pointer, which also acts as the drive. The centre should be drilled to fit on the drum shaft and should then be soldered in position.

Two supports should be made from $\frac{3}{4}$ in. x $\frac{1}{2}$ in. metal, either brass or iron. One end should be bent at right angles for $\frac{3}{4}$ in. and should be drilled to take two No. 6 woodscrews. The vertical part is cut off $2\frac{1}{2}$ in. above the base line. A slot, down from the top, should be cut in each to take the spindle. One should be cut $\frac{1}{2}$ in. clearance, the other $\frac{3}{4}$ in. clearance. The two supports are then mounted so that they hold the drum by its shaft, the narrow slot engaging with the locating groove in the spindle. The base and the drum are then mounted firmly so that the coupling unit engages with the direction indicator. To remove the drum, all one has to do is to lift the end furthest from the indicator, then slide it off. If your indicator grub screw is lined up with the centre of the pointer, a line can be scribed along the length of the drum in line with the screw to give the position of the edge of the paper. If you have placed the grub screw elsewhere, turn the pointer and the drum to North, then scribe the line along the top of the drum. Unless the paper is located in the correct position on the drum you will get incorrect directions recorded.

Next make and mount the ink reservoir. This is a tank 10in. x $\frac{3}{4}$ in. x $\frac{3}{4}$ in. made from any suitable material. Tin is probably the cheapest and easiest to work. It must of course be watertight. It should be mounted by means of flat strips screwed to the edge of a piece of $\frac{3}{4}$ in. thick wood, 10in. long. The height of the wood should be such that when

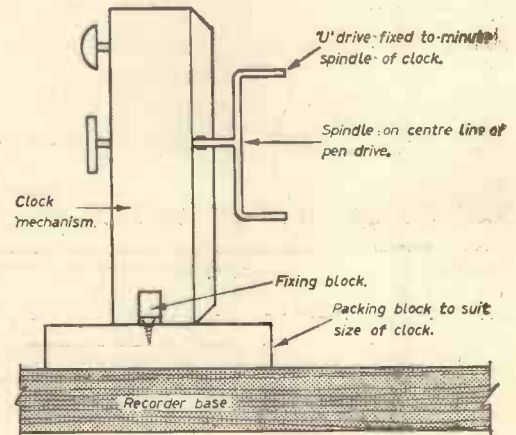
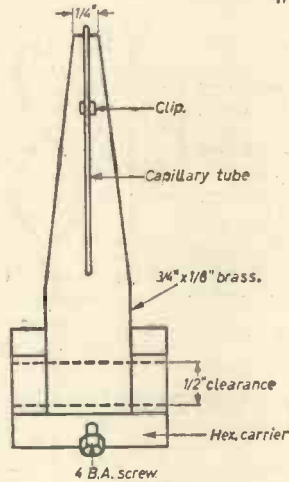

mounted, the top of the reservoir is level with the top of the drum. Next make the pen drive. First, however, it would be advisable to obtain the capillary tube. This can be made for you by any scientific manufacturing firm at small cost. It consists of a fine glass tube, with a very minute hole right through the middle. The tube is $2\frac{1}{2}$ in. long, turned down $\frac{3}{4}$ in. at the intake end and $\frac{1}{2}$ in. at the writing end. This end must be well rounded as the pen must write equally well in both directions. It is

DRUM TO INDICATOR COUPLING UNIT

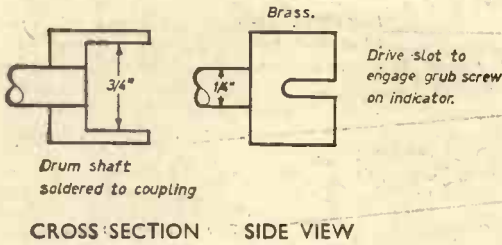

best to be guided by the makers as to the best internal diameter to be used. The line should be as fine as it is possible to get as the writing is continuous and close. If it is heavy it will use far too much ink and produce a very blotchy record.

The pen should be mounted on a piece of $1/8"$ wide brass, $1/4"$ thick. This should be drilled at $2 1/2"$ from the front to take the intake end of the tube. The brass should be tapered from the back to the front, or writing, end to help reduce the weight on the pen. The pen should be clipped on to the top of the carrier. The carrier in turn should be soldered to a piece of hexagon rod, drilled in the centre with a $1/8"$ clearance hole. The hexagon rod should be cut to $1"$ long, and should be drilled to take a 4B.A. screw as shown. This 4B.A. screw, fitted with a wing nut and having the thread turned off at the ends, is used as the drive screw.

The drive shaft for the pen should be made from a piece of $1/8"$ diameter brass rod, $11"$ long. Each end should be turned down to $1/16"$ diameter for a distance of $1"$. Half an inch from each shoulder a groove to clear $1/8"$ should be turned, to a depth of $1/8"$. Two mounting brackets, similar to those supporting the drum, carry the drive rod. The height of these should be such as to lift the pen so that it has a very slight slope down to the paper. The rod should have a screw thread with a pitch of four threads to the inch for its full length of $9"$. The drive for this screw must turn it at a speed of one revolution per hour. This can be achieved either with a clock mechanism or by means of a small motor. I have found that the clock is very satisfactory and easy to install. The glass and hour

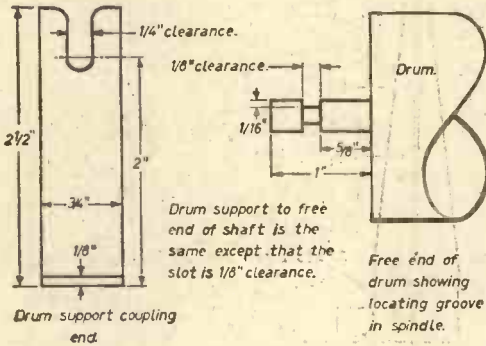

DRUM SPINDLE AND SUPPORT BRACKETS

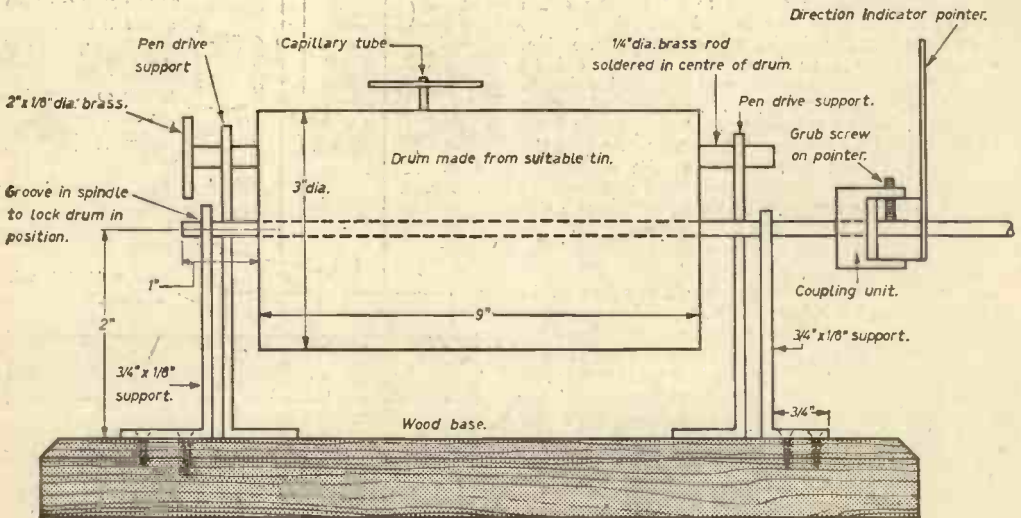

WIND DIRECTION RECORDER
GENERAL ARRANGEMENT, FRONT VIEW

hand should be removed and the minute hand should be cut off close to the centre boss. A piece of stout copper wire about 2½ in. long should be soldered to the centre of the boss with each end bent at right angles for a distance of ¼ in. as on page 67. To the end of the screwed rod a piece of the same wire 2 in. long should be soldered. The clock should be mounted with the hand spindle in line with the screwed drive rod. With the pen in position and the drive screw engaged in the thread, the pen will traverse the length of the drum. In 24 hours it will actually travel less than the full length but this over-run is advisable in case you are not able to change the paper at the right time. The record chart should be stuck on with a narrow strip

of transparent tape. This must cover the joint as the pen is liable to lift the paper if the drum is turning when the edge of the paper comes up to the pen. To remove the chart, cut along the tape with a razor blade. The chart should be drawn up as shown on page 68, with the hour lines the same distance apart as the pitch of the drive thread, i.e., ¼ in. Do not expect your record to have a straight line unless there is a dead calm. The idea of the small vane on the anemometer head is to reduce the unwanted variations as much as possible, but this is never fully achieved. An average is taken along the length of the record. The chart shown gives an idea of the kind of trace produced by a South Easterly wind, changing to an Easterly wind.

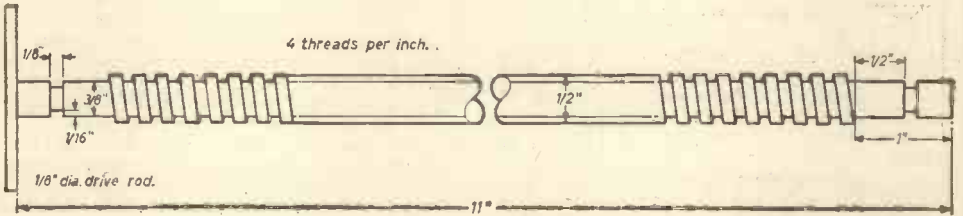

CAPILLARY PEN DRIVE SHAFT DETAILS

WIND DIRECTION RECORDER
GENERAL ARRANGEMENT, SIDE VIEW

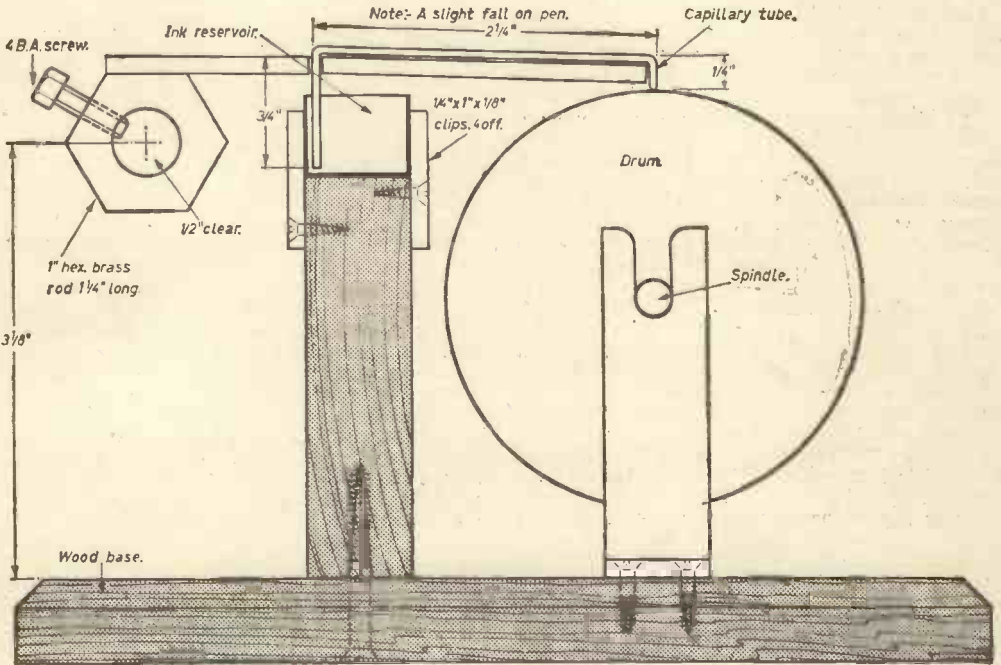

SPACE AGE METALS

ARCHAEOLOGISTS have traced man's progress through the various metal ages—those of copper, bronze and iron—since the primitive Stone Age. Today the Age of Metals is slowly changing. Old metals are being replaced by new ones—Space Age metals.

There are now metals with peculiar electrical properties such as germanium; new metals like the uranium family which produce radiation; and metals with unfamiliar names—tantalum and molybdenum, beryllium and zirconium, tungsten and vanadium—all of which resist the new and extreme conditions found both in outer space and in the heart of nuclear reactors. Even old metals like lead are finding new uses, such as protecting us from radiation.

Today's space-age metals must withstand the heat and corrosion of the rocket fuel's flare and retain the strength and resistance necessary to perform usefully in outer space. One of the most promising of these new space-and-speed metals is columbium.

The first major production of columbium concentrates, in North America, is being undertaken by the St. Lawrence Columbium Company at Oka, Quebec, Canada, where rock containing the metal is being broken with Canadian Industry Limited explosives "Amex" and "Cilgel B".

Scientists, naturally, have put in a great deal of metallurgical research on columbium, the results of which have revealed the development of a new family of space-age alloys. Columbium, according to Westinghouse Research Laboratories, is a "key" space-age material. The alloys of no other metal show greater promise as structural materials for manned space vehicles and nuclear-powered spacecraft of the future, and the new family of columbium alloys show the best balanced combination of properties yet achieved with this important refractory metal.

High strength at high temperatures is attained without drastic loss in the workability and the low-temperature ductility inherent in the pure metal itself. Both properties are crucial for space applications. Without workability the fabrication of a spacecraft would be extremely difficult and costly; without low-temperature ductility the intense cold of outer space would render the structure brittle and unsafe.

Compared to most refractory metals the new alloys are light in weight with a density about equal to stainless steel. Yet they can operate at temperatures in the range of 1,800 to 3,000 degrees Fahrenheit or about 1,000 degrees above the operating temperatures of such steels. These are the basic requirements of structural space metal. For example, light weight simplifies the launching of a vehicle into space. High-temperature operation makes possible smaller, more efficient engines to power it, and permits its safe return to earth in spite of the terrific heating by friction with the atmosphere.

It was R. T. Begley, a metallurgist, headed by a group of scientists and engineers from Westinghouse, that developed the materials. The research and development leading to the alloys was performed, in part, under contract with the U.S. Air

Force Directorate of Materials and Processes, Aeronautical Systems Division.

Alloys to go into production

So promising are the properties of the family of columbium alloys that three of them are being placed into pilot plant production. First to be produced will be a columbium-vanadium alloy called B-33. B-33 has moderate strength, is easily fabricated and welded. It has unusual resistance to corrosion by liquid metals. One application being considered immediately for it, is in heat exchangers or radiators for spacecraft. The only means of getting rid of waste heat in space is by radiating it away at high temperatures. When unfolded in space such a radiator might be as large as a football field. Only a strong, light, high-temperature and easily fabricated metal would be feasible.

B-33's corrosion resistance and its tendency not to absorb the neutrons which sustain a nuclear reaction also make it a logical candidate for key components in nuclear-fired spacecraft and in nuclear auxiliary power plants for space vehicles.

From the metallurgist's viewpoint the new family of columbium alloys are remarkably easy to handle, it is understood. The processing of alloys of the "exotic" metals has always been something of a metallurgical nightmare. Seldom can high-temperature, high-strength alloys of metals such as tungsten or molybdenum be treated by conventional techniques.

In contrast these new columbium alloys can be forged, rolled, sheared and handled directly, often at room temperature. Usually such processing must be carried out at high temperatures and in an inert atmosphere or within the protective cladding of a less active metal. The new alloys require such protection only during melting and hot-forming. Simple, inexpensive, well-known processing techniques are used thereafter.

The two additional columbium alloys to be pilot produced are B-66 (a columbium, vanadium, molybdenum, zirconium alloy) and B-77 (a columbium, tungsten, vanadium, zirconium alloy). Both show unusually high strength while retaining ease of working and fabricating.

The open-pit method is being used to mine the rock which contains columbium. The pit goes down to about 550ft (as the depth from the surface increases so does the proportion of pyrochlore, columbium-bearing ore, which runs something below 1 per cent.). First the ground is broken with great blasts of explosives and the large chunks of rock are broken up with pneumatic drills. This broken rock is taken by truck to the crushing plant, where it is processed mechanically to isolate the valuable pyrochlore. The remainder of the rock is composed roughly as follows: calcite, 78-80 per cent.; diopside, 6-10 per cent.; small and varying proportions of apatite, magnetite, mica and pyrite. The rock is pulverised and the magnetite removed first by passing the wetted powder through a drum equipped with magnets. Then flotation is used to separate the other minerals. They are passed through oils or liquids (such as

(Continued on page 90)

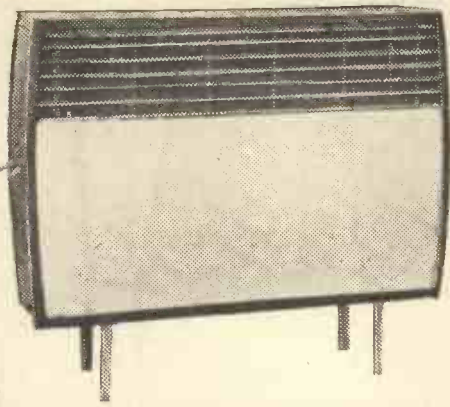

A HIGH-EFFICIENCY CONVECTOR HEATER

BY W. GROOME

FOR a given electrical input the conversion of power to heat is the same for all heaters, but the efficiency of distribution is an important consideration. With convectors, which should deliver a large amount of moderately warm air over a wide area (in contrast with the local intensity of the radiant heater), any heat that rises immediately on leaving the vent—a common fault—is wasted. A brisk, well-directed movement of air must be generated for the desirable forward projection and this should not be impeded by resistance at the vent.

The 2,000-watt appliance described is unusual in having an inner chamber (Figs. 2 and 3) where thermal expansion compels the air to rise with growing velocity. Further acceleration occurs in the tapered "throat", a device used in every domestic chimney but rarely found in electric heaters. Smoke tests have shown that the air sweeps round the bend with a high velocity that carries it well forward into the room without the ceilingward drift evident in some convectors. Enclosing this basic appliance in another casing causes further convection currents to flow, as indicated by broken arrows in Fig. 2, transferring more heat to atmosphere and leaving the metalwork cool enough to be touched safely after several hours' running at full heat.

Easy-to-work 20S.W.G. aluminium sheet can be used to make the inner chamber (mild steel of thinner gauge if you are an experienced metal-worker). Assemble with round-head $\frac{1}{16}$ in. No. 4, Type Z, self-threading screws, which are used like wood screws in screw holes 0.093in. diameter (No. 44 drill) with clearance holes 0.116in. diameter (No. 32 drill). Fig. 3 illustrates the construction, as well as the dimensions and flanging details for the front, back and two shaped ends. Form the straight flanges by simple score-and-bend; clamp between shaped hardwood to hammer the curved flanges over. Bend at the broken lines, the bottom flanges to be turned outwards and all others inwards. Cut the rectangular hole in the left-hand side panel only. The front panel is 24in. long and is screwed to the flanges. The back panel measures 24in. across to fit from flange to flange and its other dimension, nominally 20 $\frac{1}{2}$ in., should be checked by trial fit in case tolerance is needed.

The element carrier (Fig. 4) comprises two 20S.W.G. sides with $\frac{1}{16}$ in. flanges turned inwards, assembled to end insulators by No. 4B.A. round-head screws, nuts and lock washers. Six channel-shaped struts (three above and below) are screwed to the flanges to brace the assembly and to retain the three intermediate insulators in their correct positions. A bracket, shown in Fig. 4, carries the pilot bulb holder and should be screwed to the lower flanges to position the bulb (a 15-watt, amber-coloured pygmy type) at the mid point.

All insulators must be of high-grade electrical quality asbestos compound, $\frac{1}{16}$ in. thick; alternatively you may be able to obtain a bonded mica material. In either case the material must be heatproof and non-hygroscopic, of good mechanical strength and high electrical insulation resistance. Asbestos building board and ordinary plastic sheets are not suitable. Ceramic bush insulation was rejected only because of the difficulty of obtaining small quantities. Referring to Fig. 5, the left-hand insulator, measuring 4in. x 5in., is seen by the same face visible in Fig. 4. Ignoring for the time being the heavy lines indicating the external wiring, drill the two larger holes $\frac{1}{8}$ in. diameter and all others 0.161in. (No. 27 drill) to clear 4B.A. screws. The other end insulator measures 4in. square and includes all the holes that are fully included in the top 4in. of the left-hand one, drilled in the same positions.

Three identical intermediate insulators, 3 $\frac{1}{2}$ in. x 4in. with $\frac{1}{16}$ in. x $\frac{1}{16}$ in. cut-outs at the corners, have holes of a diameter that will give adequate but not excessive clearance for the spirals, probably $\frac{1}{16}$ in. to $\frac{1}{8}$ in. These insulators are retained in the carrier by the channel struts.

The elements are ordinary 1,000-watt electric fire replacement spirals. Connected in series pairs, their rating falls to 500 watts per pair, and when stretched and exposed to moving air the pair will run at "black heat". Each series pair is arranged to form four parallel lines along the carrier; four such 500-watt banks give a total loading of 2,000 watts, switched for alternatives of 500, 1,000 and 2,000 watts. Altogether eight spirals are needed at a cost of about 1s. each. They require simple preparation. Put two nails in the bench about 18in.

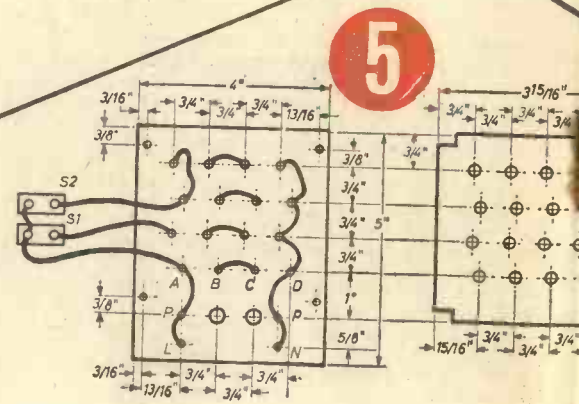
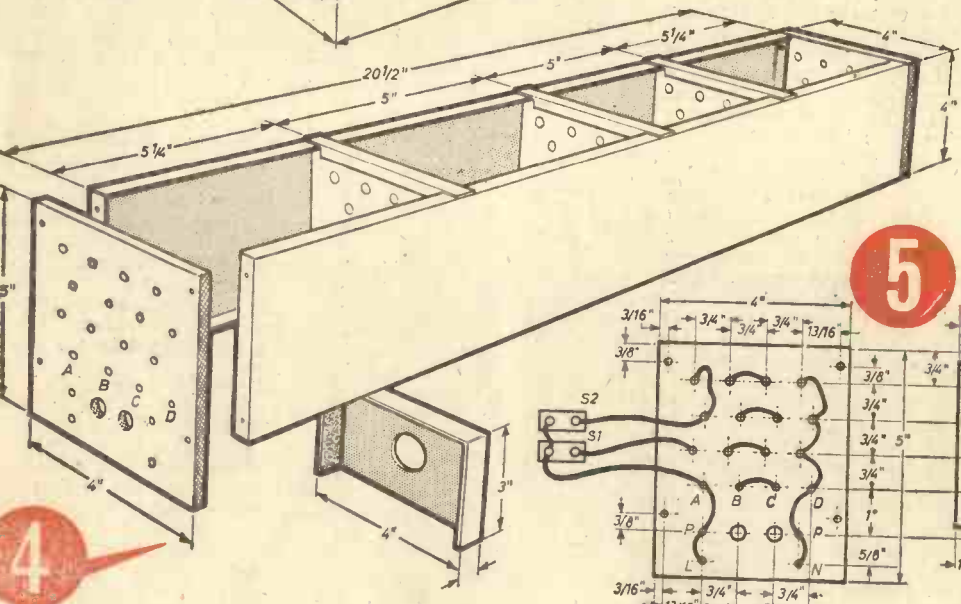
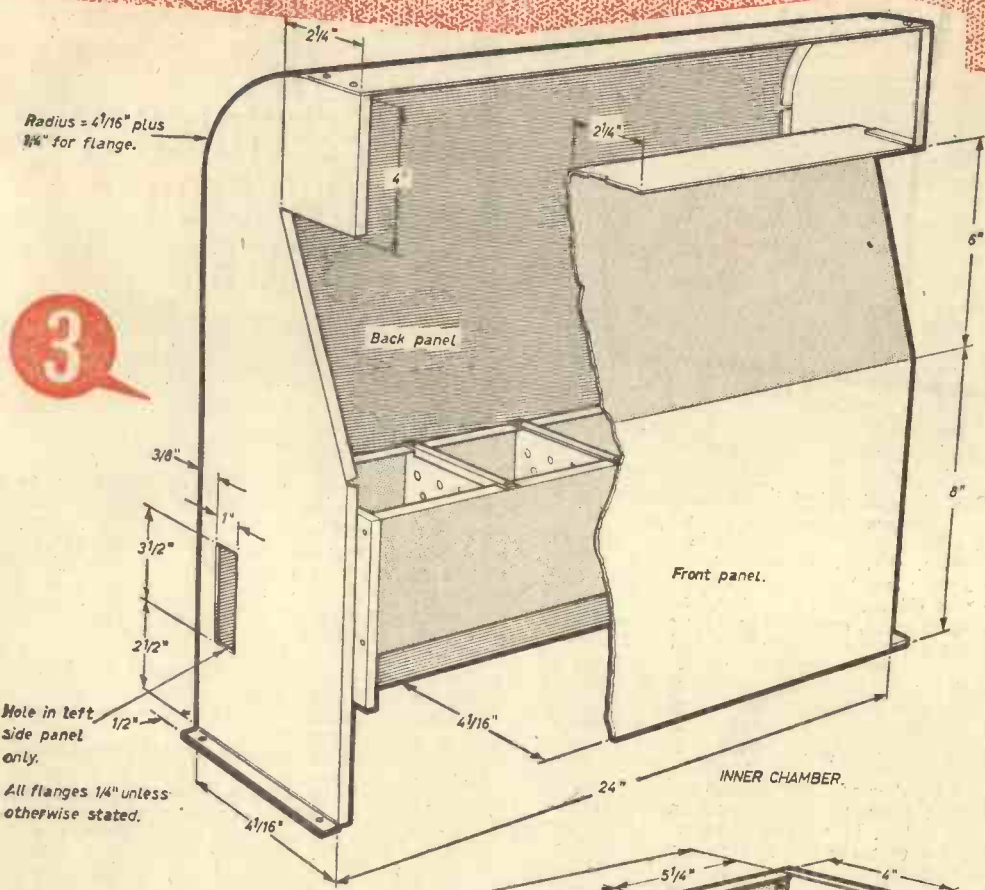

4

5

HIGH-EFFICIENCY CONVECTOR HEATER CONSTRUCTION DATA

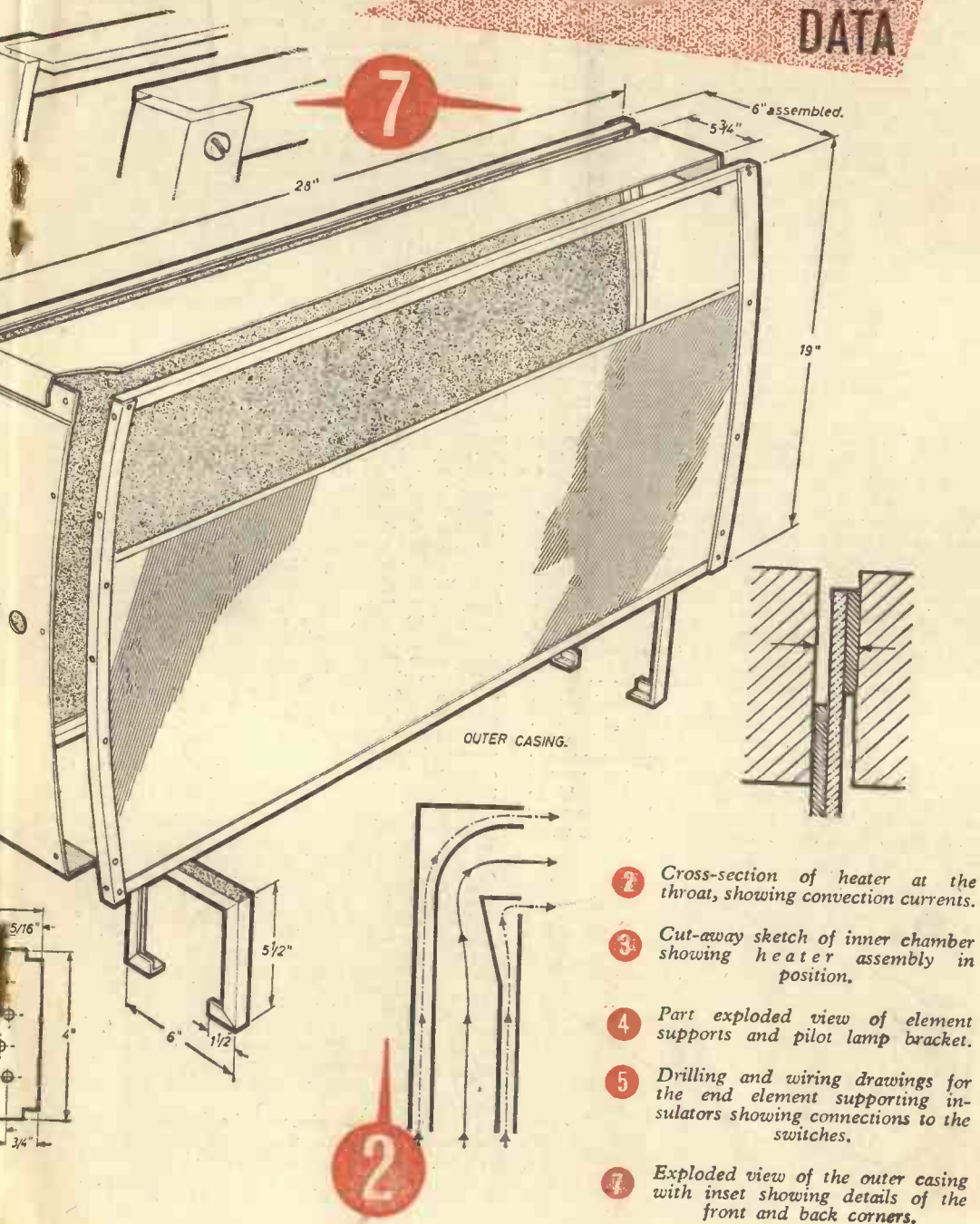

apart and mark the mid-point. Stretch an element spiral between the nails and retain by twisting the tail ends round the nails while you straighten equal turns each side of the mid-point to form a straight middle length of 2½ in. Remove from the nails and stretch each half to a permanent length of 15 in. This is shorter than the length as fitted in the carrier because some reserve stretch is required to provide tension. Treat all eight spirals in the same way.

With the carrier assembled fit a 4B.A. x ½ in. cheese-head steel screw to each screw hole in the two end insulators, each screw having two plain steel washers under the head on the inner side, a lock washer and nut on the outside, all left loose at this stage. Each half-spiral stretches from end to end of the carrier, passing through the intermediate insulators and anchored by the screws and washers at the ends. Fig. 6 is a compressed scrap view with the intermediate insulators omitted so that the run of the bottom element bank can be understood.

The first spiral has one end wound one turn between the washers at A and the screw and nut are tightened firmly. Stretching through the intermediate insulators, the spiral is secured by its straightened middle part to the opposite screw and washers and continues to the next (opposite to B); then its remaining half stretches back to B at the left-hand insulator. At all screws the wire should be wound one turn between the washers and at the left-hand insulator any excess ends of wire should be snipped off. Tighten all screws and nuts firmly.

Use another prepared spiral in exactly the same way at C and D to complete the bottom bank. The other three banks are identical. Handle the spirals carefully to avoid crushing or tangling and make sure they have enough tension to prevent drooping. To avoid dragging the entire spiral through all holes you can begin by fitting the middle portion at the right-hand insulator and feeding each half to the left for its end termination.

Bare 24S.W.G. copper wire connections must be made on the outside of the left-hand insulator as indicated by the heavy free-hand lines in Fig. 5. Use additional washers and nuts for these connections rather than attempt to cram more than one wire together. The three wires leading to the switches are connected thereto later and should be left about 8 in. long for subsequent tailoring to meet the switches fitted to the outer casing. These wires

must be protected by ceramic "fish-spine" tubular insulators or fibreglass sleeving; those which lie against the end insulator can remain bare. The pilot lamp holder, fitted by its shade ring to the bracket, is connected by flex passing through the two larger holes in the end insulator to the terminals P. Terminals L and N are for the line and neutral leads of the supply respectively.

Electric fire switches of 10 amp. rating can be bought from electrical stockists or sometimes very cheaply at surplus stores. The type required are bushed for one-hole fixing. Do not test the element assembly before it is fitted into the convactor as it needs the moving air stream to keep its temperature down to black heat. Red heat would soften the spirals and cause them to lose their tension and to droop. Fit the element assembly into the inner chamber or duct by screwing through at points that avoid all risk of the screws fouling the elements. There should be a 1½ in. clearance at each end and the bottom flanges of the carrier should be 3 in. above the bottom of the casing and parallel with it. Bring the three switch wires out through the rectangular hole.

The pleasant "custom-built" appearance of the outer casing is due partly to making the frame an external feature instead of concealing it. Identical front and back frames, illustrated in Fig. 7, have straight horizontal rails of ½ in. x ½ in. x ½ in. aluminium angle and curved sides of the same material. Although the curvature is distinct the actual "set" in the prototype is only ½ in. This slight bend can be made by hand over a wooden former. Cut the angles 20 in. long and trim, after bending, to obtain the vertical dimension of 19½ in.

Assemble with screws, nuts and lock washers, heads countersunk and covered with metal filler if you dislike the round heads visible in the prototype. The top panel (5½ in. wide) and side panels (6 in. wide) should be tailored to suit the actual assembled dimension of your frames. Bend the sides more than needed so that they will pull back tightly to the frame on assembly. A slight set at the top ends allows the top panel to make a neat flush lap. The small sketch in Fig. 7 shows how the piece is clamped in the vice with two other pieces of the same thickness. Tightening the vice displaces the top end by its own thickness. Cut two round holes in the left-hand side panel to suit the bush size of the switches.

Frames and panels are put together with 4B.A. screws, nuts and lock washers, the heads to be countersunk and filled over with metal filler. Link the bottom rails by screwing two strips of aluminium 1 in. x ½ in. x 5½ in. across the casing at points 24 in. apart and equally spaced from the ends. These are the strips (not shown in the drawings) on which the inner chamber will stand and they can be drilled before fitting, two holes in each to line up accurately with the holes in the bottom flanges of the chamber. All joint surfaces in this convactor must be clean and bright to ensure good electrical earth bonding. Cutting and bending details of the legs, which are of angle section, are given in Fig. 7. Add corner stiffener plates inside the bends if necessary.

Use the inside edges of the frame as a marking guide for the front panel but cut ¼ in. larger all round. Flange the top edge for stiffness and

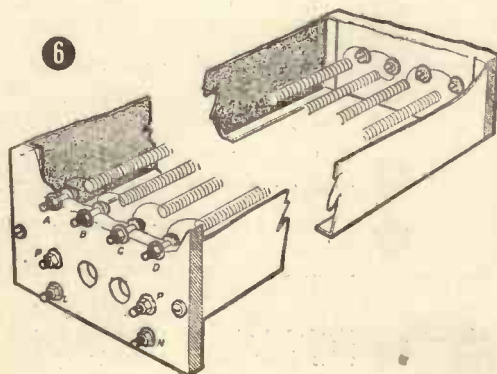

(Continued on page 77)

THE BUSH SEPARATING FUNNEL

BY
F. COLIN SUTTON, B.Sc.

ANYONE who has studied organic chemistry must have used the conventional pear-shaped separating funnel or its variants, the spherical and the cylindrical funnel (Figs. 1, 2, 3), when effecting the separation of two liquids one of which usually is a solvent. It will also be remembered that if

ether or some other volatile solvent was being used—as for example in the extraction of fats from milk—pressure would build up during the process of shaking the liquids owing to the transfer of warmth from the hand to the funnel. This pressure had to be released by placing a finger against the stopper, inverting the funnel and then opening the stop-cock to allow the vaporised ether to escape.

After a lapse of over 100 years this difficulty has been overcome by a simple but ingenious modification known as the Bush Separating Funnel. All the normal liquid/liquid extractions that can be carried out in ordinary separating funnels can be performed with the Bush funnel. The only modification is that because of the incomplete separation of the upper phase when taking it off by the side arm it is not convenient to carry out the older type of conventional extraction in which a lower phase of large volume (e.g., water) was extracted a large number of times with a very small volume of solvent (e.g., ether).

Fig. 4 shows a Bush Separating Funnel divorced from its stand but in the normal filling position. The working level of the combined liquids is shown by the thin line A—B; i.e., about half the capacity of the cylindrical body. The inclined tube at the end remote from the stop-cock enables the liquids to be retained while shaking the funnel through a rocking motion imparted to the stand and also, because the contents are open to atmosphere all the time, avoids

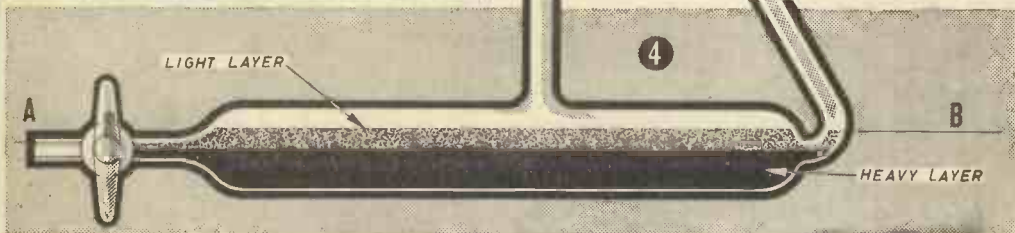
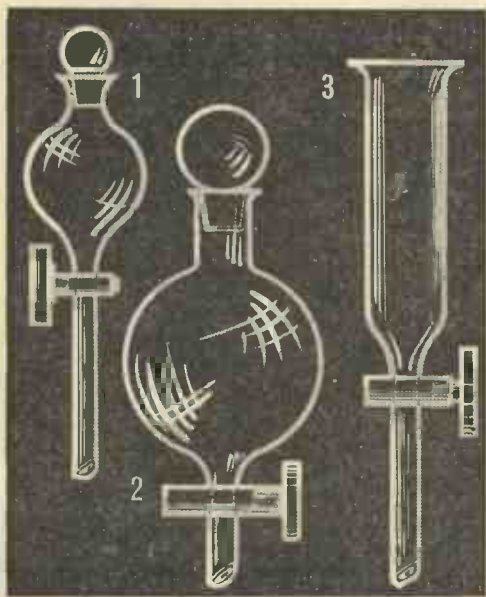

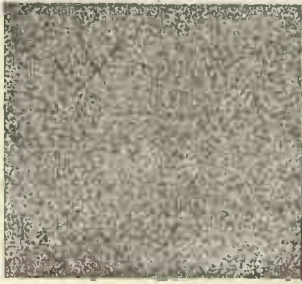

5

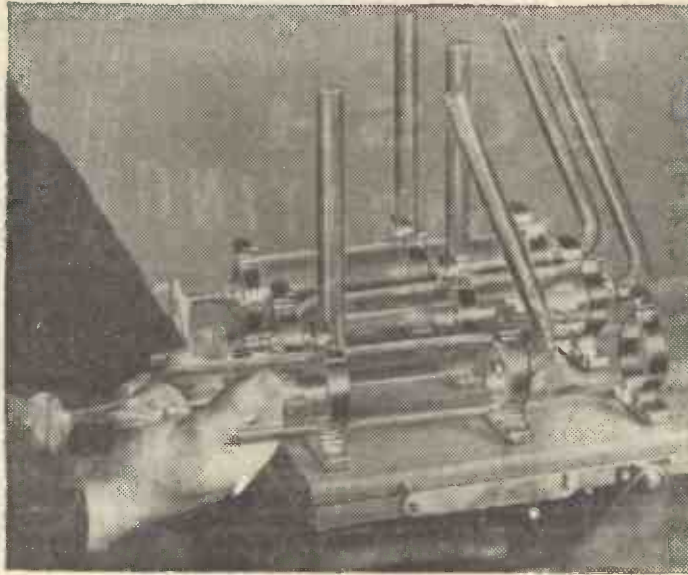

all possibility of pressure build-up. It will also be appreciated that this design eliminates the need for a ground-glass stopper and the necessity for finger control in the conventional design.

The two illustrations, Fig. 5 and 6, show the complete unit, consisting of three Bush funnels mounted on their individual hinged slats. These slats are permanently secured to the tilting platform, by rocking which, the liquids are mixed prior to separation of the two layers. If the lower, heavier portion is required the funnel is locked in the vertical position by a metal clip. If the upper layer is required the clip is released and the funnel is tilted over backwards and the lighter layer decanted through the midway side arm. Any reasonable number of single units can be linked together. If desired the apparatus can be mechanised and the tilting to-and-fro movement effected by motor.

In the extraction of many natural samples such as milk, other foodstuffs, blood or urine the older methods are relatively inefficient due to emulsification and it has become customary in the past ten years to use relatively large volumes of upper phase organic solvents in order to avoid emulsification. The Bush Separating Funnel is of particular use where many routine separations have to be carried out, such as in biochemical laboratories; physiological laboratories; foodstuffs laboratories; the oil industry; essential oils, paints, enamels and lacquers industries; the man-made fibres industry and research laboratories.

6

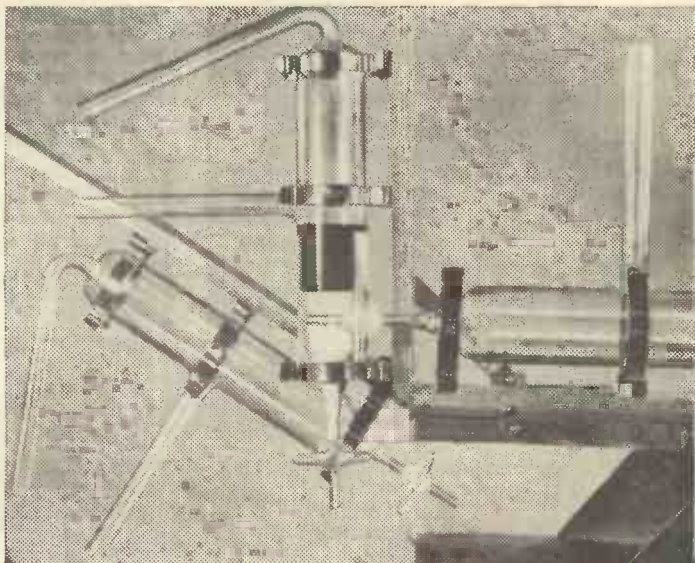

HIGH EFFICIENCY CONVECTOR HEATER

(Continued from page 74)

appearance and fit the panel with countersunk screws, nuts and lock washers. Mark the back panel in similar fashion but cut only $\frac{1}{4}$ in. larger all round.

The grille shown in the photograph was made from strip metal with epoxide resin-bonded joints. I will not describe it in detail as its construction could be held to be contrary to good earth continuity practice, although the element is remote and well surrounded by earthed metal. Attractive grilles can be made more easily with flattened, expanded metal or woven or welded mesh, all obtainable in interesting finishes. The aperture area must not be so small that the flow of air is impeded. Fit the grille to the inner chamber vent by screws and large plated washers.

Fit the inner chamber, complete with grille, through the back of the outer casing, screwing its bottom flanges to the two frame-to-frame struts. There should be a minimum of $\frac{3}{16}$ in. clearance between inner and outer casings at all points except at the grille. Shorten the three switch wires so that they reach their terminals with neither too much slack nor excessive tightness, thread on the ceramic fish-spine insulators and connect to the switches, making sure that no wire can possibly touch metal. Screw on the back panel and then the legs.

Next comes the important bottom guard. The spaces from the ends to the legs are closed with sheet aluminium screwed to the undersides of the bottom rails, one having a hole and rubber grommet to admit the flex cord. For the larger space between legs use metallic mesh or expanded metal having apertures not larger than $\frac{1}{2}$ in. square but not so small that air flow is restricted.

Flex cord connections are: Red to terminal L, which should have an identifying dab of red paint near to it, and black to N, for which black paint is the recognised colour code. The green earth core should be clamped to the lower metalwork of the inner chamber by screw, nut and washer. The cord should be held firmly by a non-chafing cable grip screwed to a bottom rail with a little slack cord between it and the terminals to protect the connections from tugs and strains.

As the convector delivers most of its heat to the room and itself remains cool it need only be painted with an enamel able to withstand mild heat, such as "Valspar". Check your workmanship and electrical connections before putting the appliance into permanent service and test for free air flow. A mouthful of dense cigarette smoke emitted gently towards the bottom opening should seem to be snatched into the convector and to emerge as a swift, rarefied cloud moving forwards. With both switches off the heater operates at 500 watts immediately it is plugged in; the switch S1 brings in the second element bank to make 1,000 watts total, and both switches on together bring all banks into service with the maximum loading of 2,000 watts. This is conventional $\frac{1}{2}$, $\frac{1}{2}$ and total heat switching, but another combination, S1 off and S2 on gives a fourth alternative of 1,500 watts. As with all electrical apparatus it is essential that the mains supply be connected with the correct polarity and that efficient earthing should be maintained.

A TRANSISTORISED STETHOSCOPE

(Continued from page 57)

scope probe was inserted into the top oiler socket, the engine was started and the fault located. The advantage of such an instrument is that the hands can be kept free to do other work while listening for a possible fault with the probe strapped into position on the machine in use.

The amplifier

This is a normal straightforward two stage transistor circuit for portable work. If the intending mechanic wishes to dispense with the cost of buying transistors and a second hearing aid earpiece then the local radio can be used as an amplifier. The method is simplicity itself provided the radio has a pick-up socket. First construct the probe end of the stethoscope, then take the two wires leading from the earpiece to the pick-up socket of the radio, switch the radio to "Gram" or "Pick-up", and set the volume control to the desired level when testing. The results of the test will then be heard over the radio's speaker.

The construction of the transistor amplifier calls for very little guidance, the circuit is in no way fussy as to how it is laid out. The main item to remember is to use a heat shunt when soldering in the transistors to prevent heat from damaging them. One way to do this is to clamp the jaws of a pair of pliers over the wires, next to the transistor. Another way is to cut a slice of potato and thread this over the wires between the transistor and the soldering iron. The circuit will operate from a 3V cell, and the life of the battery is almost the same as its shelf life. It is advisable to construct a simple case for the amplifier. If miniature components are used, it is even possible to fit it in a match box.

THE MAGNUS EFFECT

(Continued from page 63)

It may interest some readers to know that Flettner also designed and built at least two rotor yachts. The details of one of these was as follows:

6-m. racing hull:	Length	37ft 0in.
	Depth	6ft 4in.
	Draught	5ft 1in.
Rotor:	Height	19ft 2in.
	Diameter	3ft 6in.
	Weight	196lb
	Skin thickness	$\frac{1}{2}$ in.
Engine:	Speed	1,000 r.p.m.
	Horsepower (propeller)	4 h.p.
	(rotor)	1—2 h.p.

In a 16 m.p.h. wind this vessel could make a speed of about 11 knots. Flettner claimed that the rotor yacht has several advantages over normal yachts. There are no sails to dry and repair or stow away after each outing, handling is simplified and the risk of capsizing by an unskilled yachtsman is much less. These advantages do not detract from the sporting character in any way. The demands on the skipper are much the same; he still has to choose the correct course with respect to the wind and to determine the best turning speed of the rotor to give the greatest possible forward speed of the yacht. Tacking and landing manoeuvres require just as much skill as with a sail yacht. The rotor yacht must have caused quite a stir among yachtsmen at the time, but unfortunately no one was willing to sponsor such a revolutionary device.



The Rib Caddie Master.

CARS FOR A PURPOSE

by Donald S. Fraser

THE lure, and often the necessity, of going beyond the "end of the road" has led to some unique designs in motor car manufacture. Such colourful names as Desert Rat, Maverick, Sidewinder, Terra-Kart, Terra-Gator, and the Rib Caddie Master, are among some of the recent American innovations. All go where ordinary vehicles either cannot, should not, or do not dare. And most are built for genuine practical purposes.

The Desert Rat was the original "go anywhere" motor car, and was designed by Cole Williams, a Californian engineer, who obtained his idea from a photograph and article describing equipment being used in a Central American banana grove. As the car's name implies, it is for use in the desert, which more often than not produces a pretty rough ride.

The Sidewinder is another new vehicle for "roughriding" territory. It is being developed by Lee Oertle, who describes himself as "an amateur tinkerer with a love of the desert". The car is a three-wheeler that will have three-speed transmission, disc brakes, a tiller-type steering, and will be capable of climbing a 45 degree slope. It will be supplemented with an optional three-wheel trailer that can be towed with extra camping equipment and supplies. Mr. Oertle also designed the three-wheel Maverick which weighs less than 300lb.

The Terra-Kart was designed for sports and recreational use and also for work on the farm. It is a very low-slung vehicle and popular with younger people. At present it is undergoing extensive tests on cattle and alfalfa ranges, where it is used for transporting baled hay to livestock.

The Terra-Gator has been built for crossing mud-flats and lakeside weed-beds to reach duck decoys. As the vehicle floats as easily in water as it rides on land it is of considerable interest to duck shooters. The Terra-Gator is a six-wheeler and has a water-tight glass fibre hull.

No description of "go anywhere" cars would be complete without mentioning a golfer's delight, the Rib Caddie Master, and the U.S. Marine's two-piece amphibious vehicle the Gamma Goat. The former can intrude anywhere—even on a green when no one is looking, where it would leave less indentation than a person's footstep. The Gamma Goat can go anywhere too, whether anyone is looking or not. It's a six-wheeled job and is powered by an air-cooled engine. It is claimed to do 50 m.p.h. on land. In water a propeller at the rear takes over.

All the vehicles, with the exception of the Gamma Goat, use a special low-pressure, extra-wide tread tyre, have two-seater moulded glass-fibre bodies, air-cooled engines in the U.S. 7 h.p. category and have top speeds between 20 and 25 m.p.h.



The Gama-Goat.



The Sidewinder.



The Terra-Gator.

The Terra-Kart.



THE Sunday at Farnborough was clear, with very little cloud, almost ideal conditions for an air show. Set among the exhibition tents stood Blue Streak, the most-talked-about rocket ever built in this country. It has been proposed that Blue Streak, together with two other rockets, be used for Europe's first satellite launcher, the other two parts to come from France and Germany. Other rockets at the show were Black Knight and Skylark.

The first main item on the flying programme was the now-famous Olympus Vulcan, famous because of its experimental turbo-jet. The aircraft is normally powered by four Olympus turbo-jets but this new engine is designed by Bristol Siddeley for use in high-speed airliners. No details of performance have been released but at a guess I would say that a modern airliner would cruise at about 1,200 m.p.h.

Flying in neat formation, line astern, came three de Havilland Tridents, the world's first three-engined airliner. This aircraft was described in some detail in PRACTICAL MECHANICS (April issue). The development of this aircraft has advanced so much that on 10:1 September one of the first passenger-carrying flights took off from London Airport; it was, I hasten to add, carrying airline chiefs to Paris.

Flying at 1,500 m.p.h. at sea level and as docile as a light aircraft on a calm day, the Blackburn Buccaneer powered by two Bristol Siddeley Gyron Junior turbo-jets of something like 15,000lb thrust each, has now become the Royal Navy's standard strike aircraft, able to carry any stores, nuclear or otherwise, under the radar net. All controls are blown to relieve strain on the pilot, and the aircraft

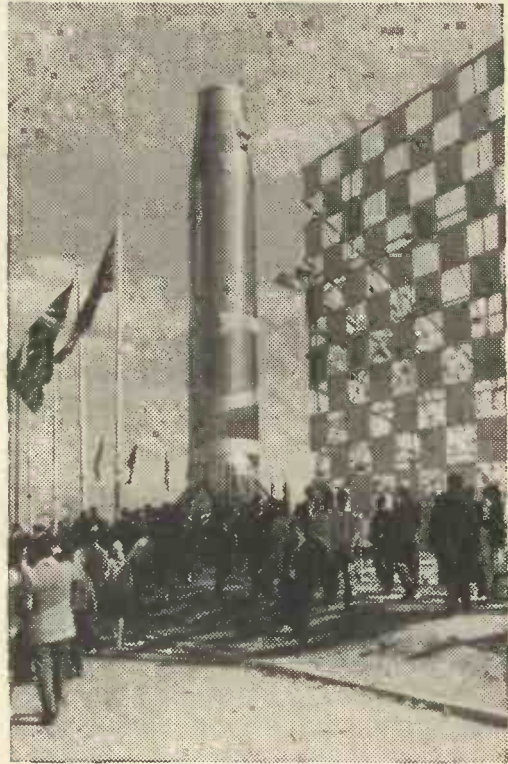

**DAVID BEAVOR
REPORTS ON—**

FARNBOROUGH

itself is very rugged to take the stresses of flying at these speeds.

The slim dart-like shape of the H.P.115 constitutes the shape of things to come in the way of airliners. This aircraft is a low-speed research job designed to reveal the problems of landing and flying such a slender delta-wing plane. Not much is known about it at the present time.

By far the most interesting aircraft at the show was the Hawker P.1127. At present this is being tested for N.A.T.O.; some have already been delivered. It is worth noting that this aircraft is far ahead of any other this side of the Iron Curtain. It is what is known as a V.T.O.L. and S.T.O.L. aircraft, relying on one B.S.53 turbo-fan engine and lifting by vectored thrust. Four nozzles which rotate get the aircraft off the ground in either a short run or vertically. A faster version known as the P.1154 will prove an interesting aircraft.

Avro 748 and 748M.F., powered by two Rolls-Royce Dart turbo-prop engines, is one of the latest aircraft to go into service with both airlines and the Royal Air Force. It is able to take off in very short distances even on a ploughed field. The military version has a few modifications—the rear ramp is one example—but the main feature of the M.F.

version is the adjustable undercarriage which comes in handy for off-loading freight into lorries, etc.

The Whirlwind helicopter, now jet powered, sounds a lot quieter than its predecessor and is at the moment in service with the R.A.F. and the Royal Navy.

The Lightning is a 1,500 m.p.h. fighter equipped with two Firestreak air-to-air missiles plus two Aden guns and with a lock-on gun sight is more or less a manned missile. A fine show of what can be done with this aircraft was given by No. 74 Squadron R.A.F.; in fact they went through their display like greased lightning.

Buddy-Buddy refuelling carried out by Sea Vixens of the Royal Navy was also a very fine display, giving the crowd the impression that it was dead easy until someone dropped the drop tank.

If you have the money to spend then I would suggest the D.H.125 jet-powered executive aircraft. This is indeed a lovely little aeroplane, just right for the business man in a hurry. The engines, like its big brother (or should I say sister) are in pods at the rear of the fuselage, leaving the wing clear to do the job it was designed to do.

(Continued on page 90)

TRIDENT.



VULCAN.

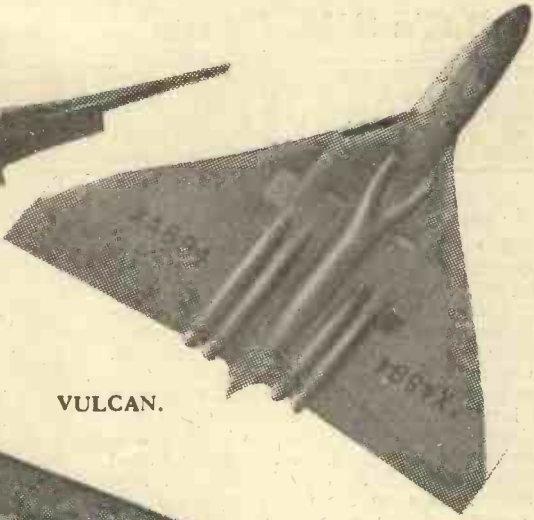

H.P. 115.

P. 1127.

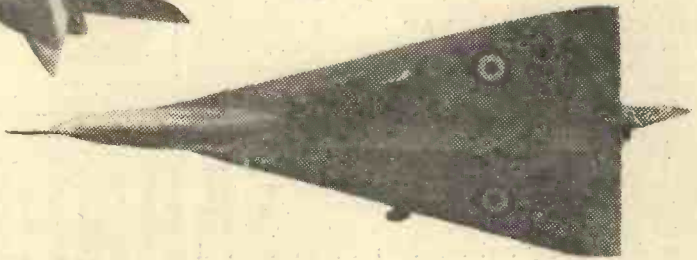
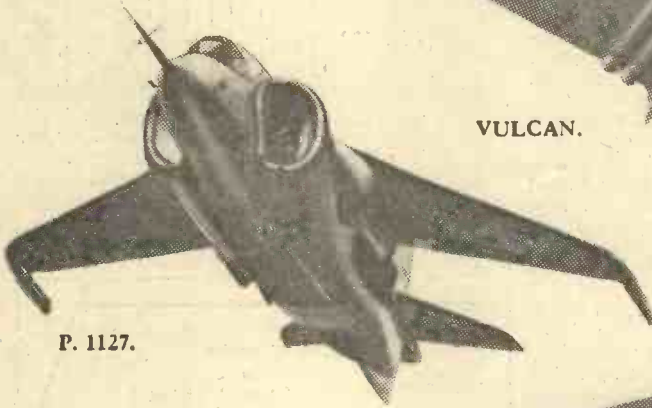

1962

BUCCANEER.

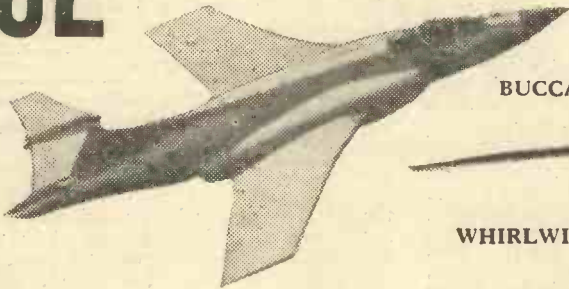

WHIRLWIND.

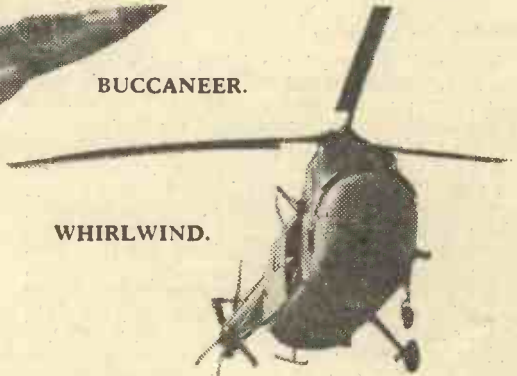

GNAT TRAINER.



V.C. 10.



L.B.S.C.'s 3½ in. Gauge

EVENING STAR

PART 21.

BOILER CONSTRUCTION
(continued)

Water-tube struts

The flat top of the combustion chamber is stayed by the six slightly-inclined water-tubes, which not only add to the heating surface in a really hot place but keep the water in lively circulation. Scribe a line along the middle of the top of the chamber and a parallel line at each side $\frac{3}{4}$ in. away. On each of the latter make a centrepop $\frac{7}{8}$ in. from the end of the chamber and two more at $1\frac{1}{4}$ in. intervals. On the underside scribe two parallel lines at $1\frac{1}{4}$ in. each side of the lap joint and centrepop them likewise. Drill the whole bunch first with a $\frac{1}{8}$ in. drill, then open them out with a $\frac{3}{32}$ in. drill, then bring them to size with a $\frac{3}{8}$ in. parallel reamer. Ream each hole singly at first to true it up, as drills usually make polysided holes in sheet metal, then put the reamer through each pair of holes at once, which will line them up to receive the tubes. Countersink all the holes slightly, which will help the brazing material to flow easily all around the ends of the tubes. To countersink holes on a curved surface use a small half-round file.

The water-tubes are seamless copper, $\frac{3}{8}$ in. diameter x 16 gauge. Saw off six $2\frac{1}{4}$ in. lengths and drive them through the holes in the combustion chamber as shown in the cross-section of the firebox. Leave the ends as sawn for the time being; just see that they project an equal amount from the top and bottom of the chamber. They should fit tightly and the ends should be well cleaned.

Brazing the assembly

First we'll cover all the joints and seams with wet flux, putting a good dose all along the crownstay flanges where they are attached to the top of the firebox and plenty around the firehole ring. Fill up the interstices where the throat and door plates are riveted to the firebox sides. Now stand the assembly on end in the brazing pan with the combustion chamber tubeplate resting on the coke. There should be a good fillet of wet flux all around the flange. First play the blowlamp flame over the whole assembly to get it well warmed up and also to dry the moisture out of the flux, which should then stick to all the joints. If it doesn't they will oxidise and the brazing material won't "take".

Next concentrate the flame on the tubeplate flange and the end of the combustion chamber. The part which the flame licks should become bright red in a matter of seconds as the red-hot coke will help matters. Dip the end of the brazing strip in the flux, apply it to the flange in the flame and, if the heat is O.K., the strip will melt off and the molten metal will flow into the joint between flange and chamber. Work your way slowly and carefully right around the flange, feeding in the brazing strip as the metal becomes red, and don't forget to keep dipping the end of the strip into

Fig. 128.

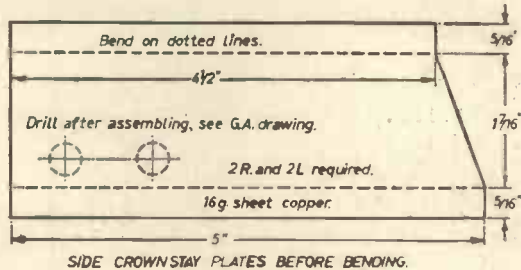
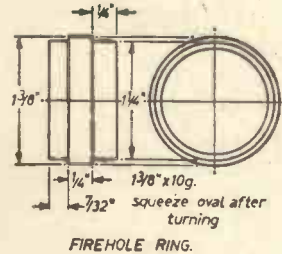

Fig. 129.

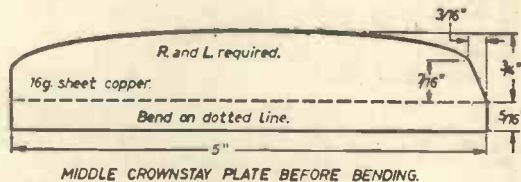

Fig. 130.

the flux. Beginners have nothing to fear; as soon as the first bit of brazing material has melted and flowed into the joint the "technique" comes naturally to anybody of average intelligence and they find themselves manipulating the flame and feeding in the strip as though they had served an apprenticeship with a professional coppersmith. On completing the circuit and arriving back at the starting point give an extra blow so that the molten metal flows easily and makes the joint continuous. There should be a nice even fillet all around the joint.

To avoid shifting the hot firebox more than necessary the doorplate can next be tackled. As the whole box of tricks is now well heated, just play the flame on the near-side bottom corner. As soon as it glows bright red apply the brazing strip, and when it melts and flows, work your way right around, slowly and carefully, to the off-side bottom

corner. Halfway around you'll meet the firehole ring. Concentrate the flame on it and when it and the surrounding copper glows bright red apply the strips and a fillet of molten metal should flow right around it. Alternatively, a strip of coarse-grade silver solder could be used on the ring joint, as this runs like water at a dull red heat and penetrates more deeply into the joint than regular spelter.

Next by aid of the big tongs, turn the assembly the other way up, letting the doorplate rest on the coke. Then get to work on the throatplate, starting at the near-side bottom corner, working up to the combustion chamber, going along the "belly" joint and then down the other side. Two warnings here: Make sure that the molten brazing material flows into and seals each end of the cut between firebox and combustion chamber. Secondly, feed enough strip into the "belly" joint to ensure a fillet not less than $\frac{1}{4}$ in. deep right from one end to the other. The firebox will then have an ample margin of strength and will never sprout Welsh vegetables.

Turn the assembly the right way up and lay a strip of coarse-grade silver solder along each of the crownstay flanges. As mentioned above, this material melts more easily and penetrates better than regular spelter and so I recommend it for this particular job. Play the blowlamp flame on the flanges and the firebox top until the bits of silver solder melt and flow in between the flanges and the crown sheet. This will also seal the rivets. Now go along to the projecting bits of water-tube. Play on each separately until it and the surrounding copper becomes bright red, then run a fillet of spelter around each, which should completely fill the countersink and project a little above it. Coarse-grade silver solder can also be used here if preferred. Finally, turn the assembly upside down and give the other ends of the water-tubes a dose of the same medicine, sealing the lap joint at the same heating.

Let the lot cool to black, take a look at the joints and seams and make sure that nothing has been missed, then put the assembly in the pickle for about 20 minutes. Wash it well in running water and clean it up with steel wool or scouring powder. Saw off the projecting ends of the water-tubes and finish with a file until they stand about $\frac{1}{2}$ in. proud of the combustion-chamber.

Brazing by blowpipe

Although the foregoing instructions deal with doing the boiler-brazing jobs by aid of a blowlamp, they apply equally to the use of an air-gas blowpipe. This should be of ample size for the job, with a nozzle of at least $1\frac{1}{4}$ in. dia. and should be blown by a fan in preference to foot-bellows. The fan gives a steadier flame. If a bellows is used, a balancing chamber of some sort should be rigged up. In the far-off days of long ago, I used an old five-gal. oil drum, with a pipe between it and the bellows, and another between drum and blowpipe. If an assistant, such as an interested kiddy, can be persuaded, cajoled, or bribed to do the footwork, the operator can concentrate his whole attention on the job of manipulating the blowpipe.

The technique is much the same with an oxy-coal-gas blowpipe; but as the flame of this is much hotter, only a small nozzle, of about $\frac{1}{4}$ in. dia. is needed. The patch of red-hot copper under the flame will be smaller, but hotter, and care must be taken to avoid overheating. If smoke and a greenish flame comes up from the molten spelter, go easy, or else you'll have had it. Burnt copper is unsafe for boiler work. In technical books dealing with brazing and bronze-welding, a nozzle of about $\frac{3}{8}$ in. dia. is specified for oxy-coal-gas blowpipes on copper work similar to the *Evening Star* boiler, but as this needs a fairly high oxygen pressure, the risk of a beginner burning the copper is greater than if a larger nozzle with lower oxygen pressure is used. This gives a more diffused flame, and if the flame is "lined up" with the job (see Fig. 131) the risk of burning is small.

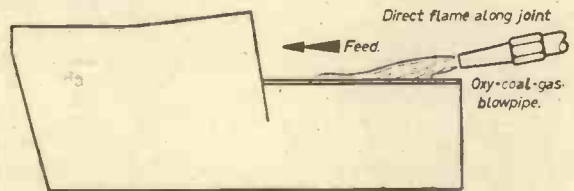

BRAZING A LAP JOINT.

Fig. 131.

Oxy-acetylene boilersmithing

In January 1932 I purchased a No. 2 "Aida" oxy-acetylene outfit, and as a famous stap advertisement used to say, "since then I have used no other" for all my boiler work. While a five-pint blowlamp does the job all right, there is no denying that the sight and sound of it in full blast is rather awesome; and the contrast between it and the small bluish flame with the white cone at the root, plus the sibilant hiss, is most marked. The great advantage is that the most heat can be put exactly where you want it, and as there is little heat radiated back on the operator, the job can be done in comfort. In my blowlamp days, the buttons on my overall often became too hot to touch when doing the final brazing job on a boiler, and on one occasion, a fountain-pen inadvertently left in the top pocket, assumed the shape of a sausage.

There are two ways of operating the oxy-acetylene blowpipe. The first, as recommended by the text books, is to see that the complete joint is clean and well fluxed, then preheat the whole bag of tricks, either with a blowlamp, or the blowpipe itself. Then apply the flame at the beginning of the joint, and when it becomes bright red, hold the end of a welding rod (Sifbronze, or similar) in the flame right over the hot spot, and very close to it. A little blob will melt off the end of the rod, and drop into the joint. Repeat process, but hold the welding rod so that the second drop overlaps the first; then ditto repeat the full length of the joint, so that it presents a rippled appearance. Dip the welding rod in flux at each application. I did plenty that way, and they all turned out O.K.

However, there was just one point that didn't satisfy me, viz, that the molten metal did not run right through a lap joint, nor penetrate the full depth of a flanged joint, such as that between the

boiler throatplate and the wrapper sheet. To get over this, I tried a larger nozzle and lower gas pressure, and heated the end of the joint a wee bit above the melting temperature of the welding rod. The latter was then applied in the flame and touching the bright-red metal, so that the end melted off and ran clean into the joint, which it penetrated. The flame was moved slowly along, and the welding rod applied continuously, so that it ran instead of rippling. This did the trick. The nozzle I used for the boiler joints of my *Britannia*-type 4-6-2 is $\frac{1}{8}$ in. dia. The boiler is similar to that specified for *Evening Star*. I hope that beginners and other inexperienced workers will find the above information useful; now let us get on with the job.

sure that the clamp is tight enough to prevent former and plate shifting while drilling. then put the No. 30 drill through the holes in the former, and carry on right through the tubeplate. Remove the former, and open out all the holes as described for the combustion-chamber tubeplate; but this time, put the reamers right through the holes, so that the tubes will fit easily. Slightly countersink the holes on both sides; those on the flanged side help to guide the tubes into position when fitting the tubeplate, and those on the outside form channels for the silversolder, ensuring a sound job.

On the vertical centreline at $\frac{1}{4}$ in. from the top, drill a $\frac{1}{8}$ in. hole, and tap it $\frac{1}{2}$ in. x 32 for the steam-pipe flange. At 1 in. to the left, on the same level, drill a $\frac{3}{32}$ in. hole and tap it $\frac{1}{2}$ in. x 40 for the blower union nipple. At $\frac{1}{4}$ in. below these, set out the four holes for the longitudinal stays as shown in Fig. 132, drill $\frac{9}{32}$ in. and tap $\frac{1}{8}$ in. x 40.

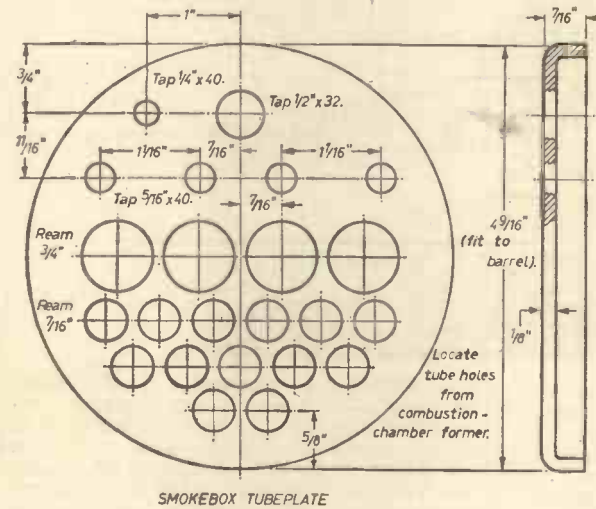

SMOKEBOX TUBEPLATE

Fig. 132.

Smokebox tubeplate

Although the next stage of assembly is fitting the tubes, it will be necessary to make the smokebox tubeplate first, so that it can be used as spacer and support while silversoldering the tubes into the combustion-chamber tubeplate. Saw out a circle of 10-gauge ($\frac{1}{8}$ in.) sheet copper 5 1/2 in. dia., well anneal it, and flange it over a former 4 1/2 in. dia. I don't usually bother about cutting out special formers for circular flanged plates, but press into service anything that is handy and of the requisite size, such as an old chuck plate, wheel casting, pulley or similar. Chuck the plate, flange outwards, in the outside jaws of your three-jaw chuck, and face off the ragged edge left by the flanging process; then mount the plate on the outside of the same jaws, gripping by the inside of the flange, and turn the outside of the flange to a tight push fit in the boiler barrel. You can't use the inside jaws for this job, unless the chuck is an outsize one—you'll see why if you try it!

Scribe a line right across the middle of the side opposite to the flange, and another at right angles, at $\frac{1}{2}$ in. from the edge. On this line, at $\frac{9}{32}$ in. each side of the crossing point, make a good centrepop. Clamp the combustion-chamber tubeplate former to the flanged plate with these two centrepops showing through the two bottom holes in the former. Make

Tubes and flues

Four pieces of $\frac{1}{2}$ in. x 20-gauge seamless copper tube will be required for the superheater flues, and 13 pieces of $\frac{1}{8}$ in. x 22-gauge ditto for the firetubes. These must be squared off at the ends, to an overall length of 9 1/2 in. Most of the lathes used in home workshops have a hole through the mandrel big enough to admit the smaller size, so the tubes can be pushed in until only $\frac{1}{2}$ in. or so projects from the chuck jaws, and facing off is easy. Don't forget the cutting oil! If the mandrel won't admit the larger tubes, hold the free end in a steady. If the lathe hasn't one, just nail or screw two pieces of wood together at right angles, put a $\frac{1}{2}$ in. drill in the check or mandrel nose, hold one angle of the wood down tightly to the lathe bed, and press the other against the drill.

The drill will soon put a hole through at the correct height! Put a tube in the chuck, put the improvised steady over the end so that about $\frac{1}{2}$ in. projects through the hole, clamp the base part to the lathe bed with a coach bolt and a big washer Fig. 133.

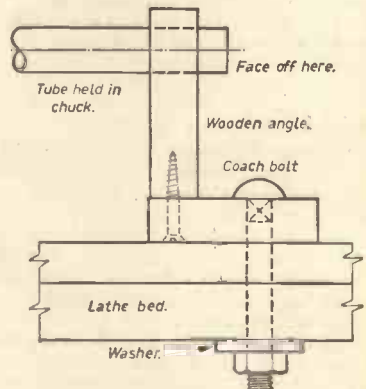

IMPROVISED TUBE STEADY

Fig. 133.

A Teaching Board

by Schoolmaster

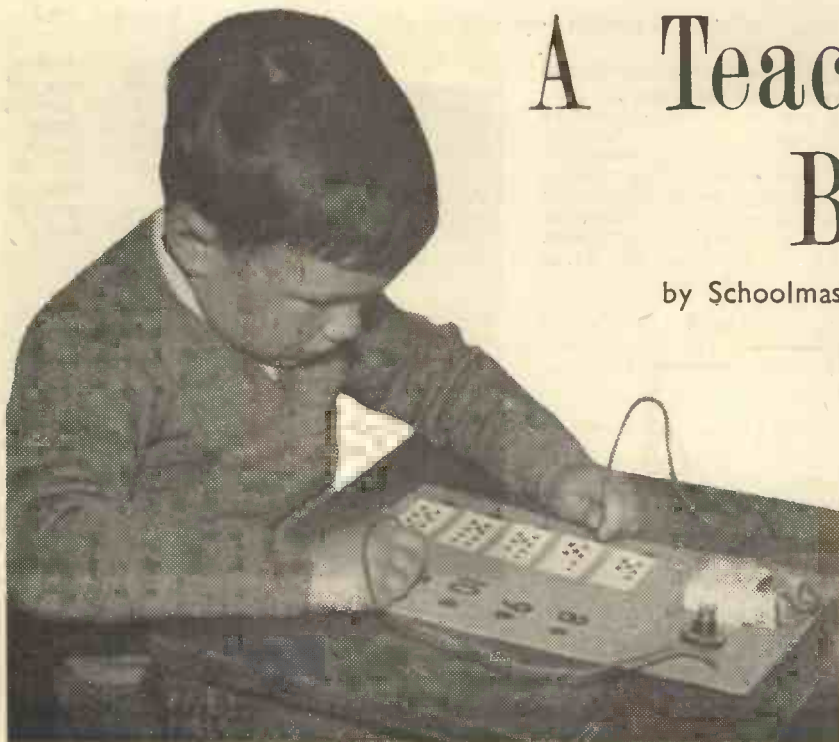

THE simple apparatus described here can be made up in an evening by any parent who wishes to help his youngster who is entering school for the first time. The board is simply a means of introducing the five-year-old to reading and "sums" (as arithmetic is called in the infant class).

The heading picture shows a youngster using the board with a teaching card in position. Down the left-hand side of the card there are questions and down the right-hand side the appropriate answers, but in a different order to the questions. If the prods in the child's hands touch the correct studs (i.e. one prod on a question and the other on the correct answer) then the light will go on indicating a correct response. However, if the child makes an incorrect move, nothing happens.

A five question and answer board, as shown, is about the maximum number of questions and answers for a child of five. Any number of cards can be used as they are simply lifted on and off the pins on the teaching board. The teaching material supplied to the youngster is only limited by the ingenuity of the teacher. A selection of cards is shown in Fig. 2; this may give a guide to the educator who has constructed this apparatus.

Reading cards

The introduction to reading can start off by matching pictures, then matching words and finally matching words with the appropriate pictures. By this means a child will quickly associate pictures with the correct word symbols. For example, the letters COW will be immediately associated with the picture of a cow.

Suitable pictures and letters can be purchased from educational suppliers very cheaply. This obviates the home made picture and lettering and is less of a strain on the constructor. Philip and Tacey Ltd. of Fulham, London S.W.6 supply packets of coloured pictures and words on gummed paper. Their catalogue references are as follows:

Ref. TRG-35 "Vocabulary miniature pictures".

Consists of 112 pictures of common objects, animals, birds etc. 2s. 6d.

Ref. TRG-78 "The Renown miniature gummed stamp words and pictures". Consists of 69 pictures in duplicate. 4s.

Ref. TRG 84-3 "The work and play vocabulary picture stamps". Consists of 334 pictures. 8s. 6d.

Ref. TRG 68-3 "The early word picture and word stamps. Gummed and varnished stamps, 240 pictures. 5s. 3d.

I feel that the last set mentioned above gives best value for money, especially so when they are also used in J. Noel's "Early word picture dictionary". These prices do not include postage.

Arithmetic cards

The introduction to "sums" can be made by having domino patterns (representing numbers of objects) down one side of the card and the appropriate number symbols, not in order, of course, down the other side of the card. The next step is the domino pattern with the written word and finally the number symbol with the written word. Two sets of cards are necessary, one set showing 1 to 5 and the other 6 to 10. Going a stage further, a revision set of five can be taken from the numbers

1 to 10. If a large number of domino patterns is required then a stencil should be cut for each number pattern. This saves time and trouble and gives uniformity to the finished cards.

The electrical circuit

Fig. 1 shows the simple electrical system. The studs are half-inch brass drawing-pins pushed through the cardboard base and connected in pairs with thin, insulated copper wire. The connection is made by flattening the pin round a loop of wire. A soldered joint can be used if desired but this is not really necessary.

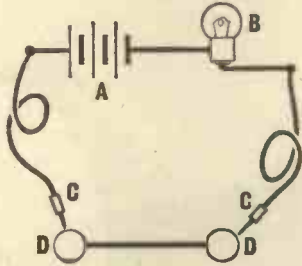

Fig. 1.

- A.—4½V Torch battery.
- B.—Torch bulb.
- C.—Test prods on flexible leads.
- D.—Studs linked by insulated wire.

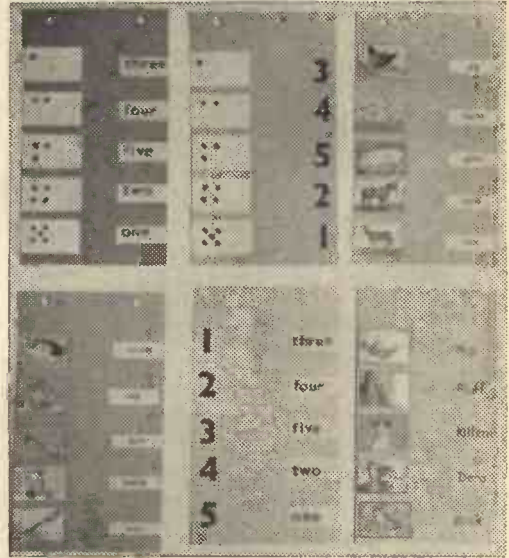

Fig. 2.—Selection of cards.

An Economical set of Punches

by Toolmaker

IT is often the case that when a drill has been broken while in use, the same size drill is not to be found in the drill stand, and in most cases, the job has to be completed with a round file, or await the purchase of a new drill. This is never very satisfactory, as the round file, even though used in skilled hands, never produces exactly the shape desired. The remedy is to use the shank of the broken drill.

Break, or grind off the remaining fluted portion, taking care to keep the work cooled by frequently dipping it in water. Then when a flat end has been produced carefully grind a "V" in the end of the shank.

It will be found that if the work is supported on a block of hard wood, and the punch is given a sharp tap with a hammer, the cutting edge will slice through the metal and leave a neat round hole.

If all broken drills are saved and treated in this manner, a simple stand can be made from a piece of wood to hold them. The punches will soon be found to make many a tedious drilling job a pleasure to do.

Care should be taken that the work is supported from underneath while being punched, also that the material in use is not too thick for the punch. The writer has found, that a ½ in. drill treated in this manner will easily penetrate a 1 1/8 in. thick mild steel plate, and has no hesitation in dealing with greater thicknesses of softer metals.

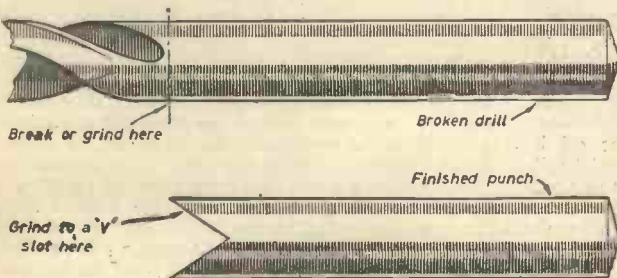

Drawing left shows where to cut and how to re-grind broken drill shank.

making a PHOTOGRAPHIC DRY MOUNTING press

by
A.L. Marshall

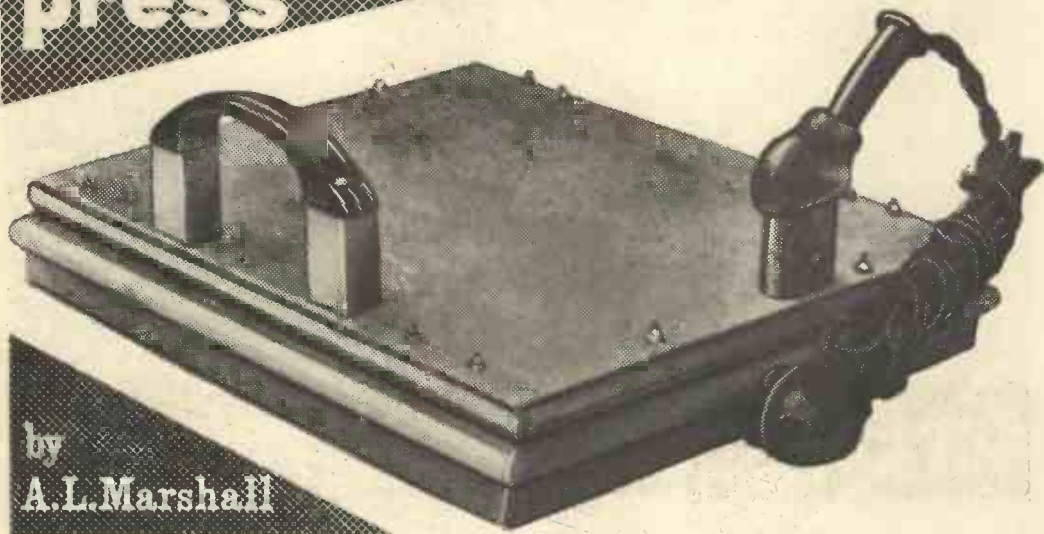

YOU WILL NEED

- 1 piece 12in. x 9in. x $\frac{1}{4}$ in. plywood.
- 3 pieces 12in. x 9in. x $\frac{1}{4}$ in. hard asbestos.
- 1 piece 12in. x 4in. x $\frac{1}{4}$ in. soft asbestos.
- 1 250V, 450W spiral hair dryer element.
- 1 piece 3in. x $\frac{1}{2}$ in. x $\frac{1}{4}$ in. wood.
- 1 4in. handle.
- 1 iron cord socket adapter.
- 2 male plug contact pins (see text).
- 1 pair 1in. hinges, countersunk bolts, nuts and washers to suit.
- 8 $\frac{1}{4}$ in. x $\frac{1}{8}$ in. countersunk head bolts, nuts and washers.

FIRST make the base of the press. Take one of the pieces of hard asbestos and drill and countersink two screw holes in each of the long sides and one at the centre of each short side. Fix the asbestos to the $\frac{1}{4}$ in. plywood with wood-screws. Apart from attaching the hinges, this completes the base.

The press top contains the heating element and is made as follows. Take the piece of soft asbestos and with a sharp knife cut out two strips 10in. x $\frac{1}{2}$ in. and two strips 9 $\frac{1}{2}$ in. x 1in. Mark out the top of a sheet of hard asbestos for drilling, as in Fig. 1. Lay the soft asbestos strips on top of the remaining hard asbestos sheet, taking care not to break them as they are rather fragile. Place the marked sheet on top to form a sandwich. Drill the holes right through the sandwich and countersink all but the hinge holes.

Also drill, but do not countersink, the two holes for the male plug contact pins, shown in Fig. 3. Only drill these holes deep enough to pass through the top sheet and partly into the soft asbestos. The contact pins can either be obtained from a 15A round pin plug or it may be possible to obtain spares for a domestic iron.

Insert all the $\frac{1}{4}$ in. countersunk head bolts, at the same time placing the hinges in position. Note that the screw heads are on the inner face of the press

and that the hinges should be fitted to this face. Lay the assembly face-down on a flat surface and lift the top sheet off the bolts to expose the interior, again as in Fig. 1. The heating element is contained in the recess as shown in Fig. 2 and is fitted as follows. Draw a pencil line $\frac{1}{4}$ in. from the inside edge of the short end-strips. Prick small holes through the soft asbestos to take copper wire loops which will hold the element in position as shown in Fig. 2. With a piece of string measure from point A to the first loop on the other side, thence back to the first side and so on to point B. This will give the length to which the element must now be stretched, leaving sufficient at each end to be straightened out as connections to the plug pins.

Next cut recesses in the soft asbestos to clear the nuts on the contact pins, using the drill marks as a guide to position. Also cut narrow channels through the asbestos from points A and B, to take the wire ends from the element (Fig. 2). Take care that the channels pass well clear of the two fixing bolts in this end of the press, and also clear of the copper loops. Fasten the plug contacts through the top sheet of asbestos by means of their securing nuts and washers. Pass the end of the element under the soft asbestos at point A. Secure the element in position with the copper wire loops and pass the other end under the asbestos at B. Attach the

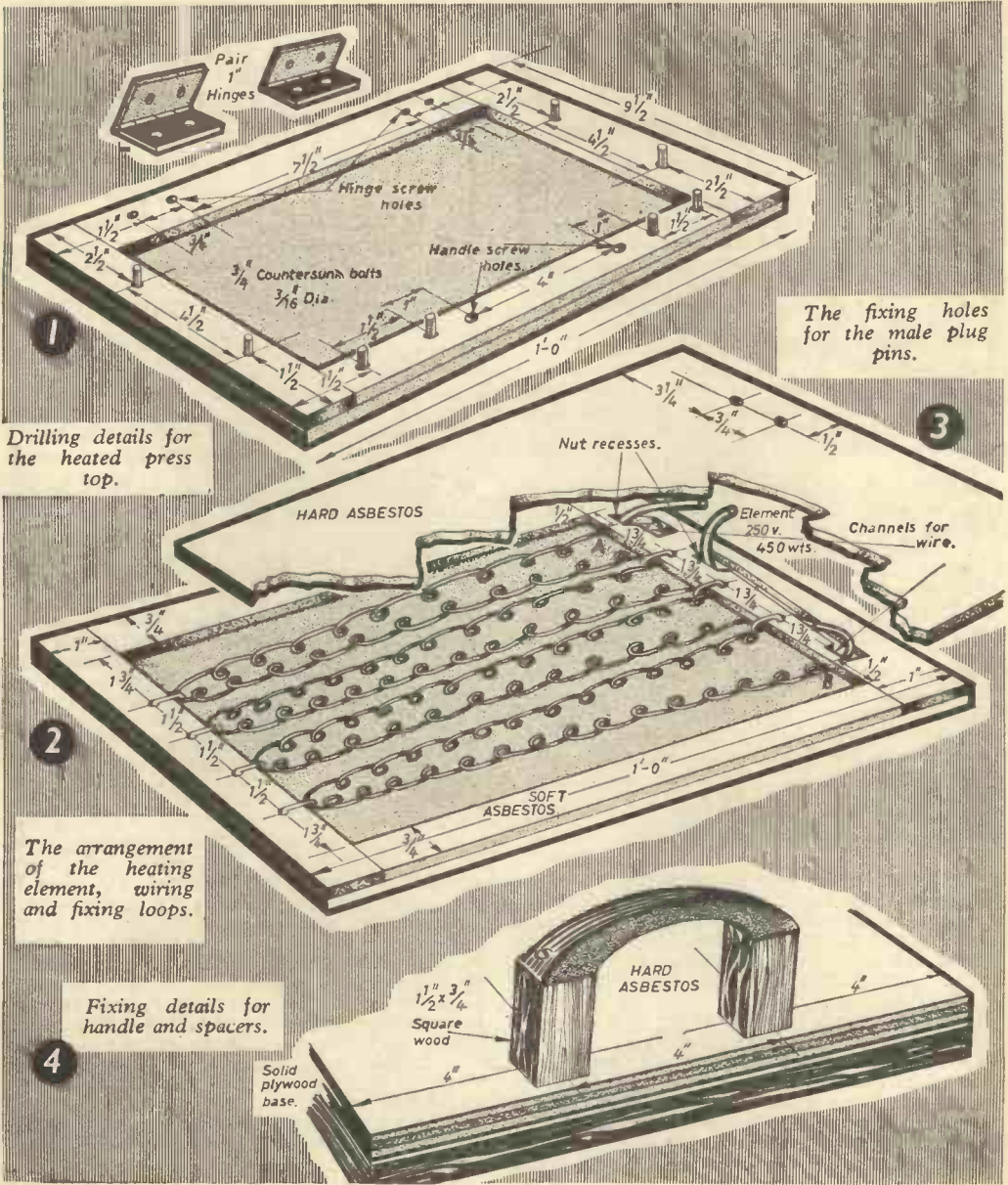

wires to the plug contacts and place the top sheet in position over the bolts. Secure with nuts and washers, including those fastening the hinges in position. Screw the handle in position, using the 3/4 in. square wood to make two spacers.

Place the top in position on the base and mark the positions for the hinge screws. Fix in position using woodscrews. Wire up the iron cord adapter and a suitable two-pin plug. A two-pin plug is satisfactory for this appliance as any exposed metal

is well insulated and the body of the press is made of asbestos with no risk of shocks.

The method of using the press is as per the instructions supplied with the dry mounting tissues, but as it is not thermostatically controlled, experiments will have to be carried out to determine the required time to fix a print to a folder or card mount. A good tip is to place a piece of card under the mount to give added and even pressure when the press is closed.

FLEXAGONS

BY GRAHAM TRITT

AN interesting puzzle may be formed from a strip of paper or cardboard which, when folded or flexed, has the property of changing its faces. Actually it must have a peculiar fascination of its own because its discovery and development occupied much of the spare-time activity of some top-flight American mathematicians, statisticians, physicists and topologists such as its discoverer Stone, as well as Feynman, Turkey and Tuckerman, some of whom are now electronics and computer experts. But it would be an error to assume that it has little entertainment value for the amateur.

Oddly enough, what has already been published about flexagons covers only a portion of this interesting family and perhaps not the most attractive at that. For instance, only the variety called "Hexaflexagons" is discussed in Gardner's "Mathematical Puzzles and Diversions", although it is claimed that the complete theory of flexigation was worked out in 1940. The Hexaflexagons dealt with in that book are those based on the equilateral triangle and no hint is given that forms might exist based on other geometrical shapes. Flexagons are given names according to the total number of faces that can be brought into view; trihexaflexagons have three six-sided faces; hexahexaflexagons have six six-sided faces; and Tuckerman even made a working model having 48 faces!

This article is a description of an original model based on the square and the half-square, which is an isosceles triangle. So it may be called a "quad-rflexagon" as it has four different faces, one of a

square, two of half-squares and the fourth hidden away in "pockets" and only discernible by correct flexing. Actually a further four faces may be found as well, formed by a composite of two squares and two half-squares. What helps to make this model so amusing and perplexing is the difficulty of finding the correct sequence of flexing to get the desired result. At times one may be trapped in an annoying cycle that keeps returning the same face again and again. But there is no truth in the rumour that an American investigator, trapped in the intricacies of a dodecahexaflexagon, was released later in Scotland!

To make a quad-rflexagon you start with a strip of light cardboard or paper. It is almost certain that later you will want a more durable model, for they always get a severe thrashing. This can be made from pieces of heavier cardboard, or even light metal, connected together by tape to allow room for flexing. Mark off eight squares plus a length for flexing. Bending into position is done as follows: Hold square 1 in left hand and fold triangle 3 under triangle 2 as shown in Fig. 2a. Then fold the remainder of the strip forward and over, bringing another number 1 square above 2 as in Fig. 2b. Repeat again by folding 3 under 2 and swinging over as in Fig. 2c. Lastly finish by folding the last 3 under 2 and bring up the fourth 1. Be sure to fold the last 3 under 2 on the back before gumming down. The complete model looks like Fig. 2d.

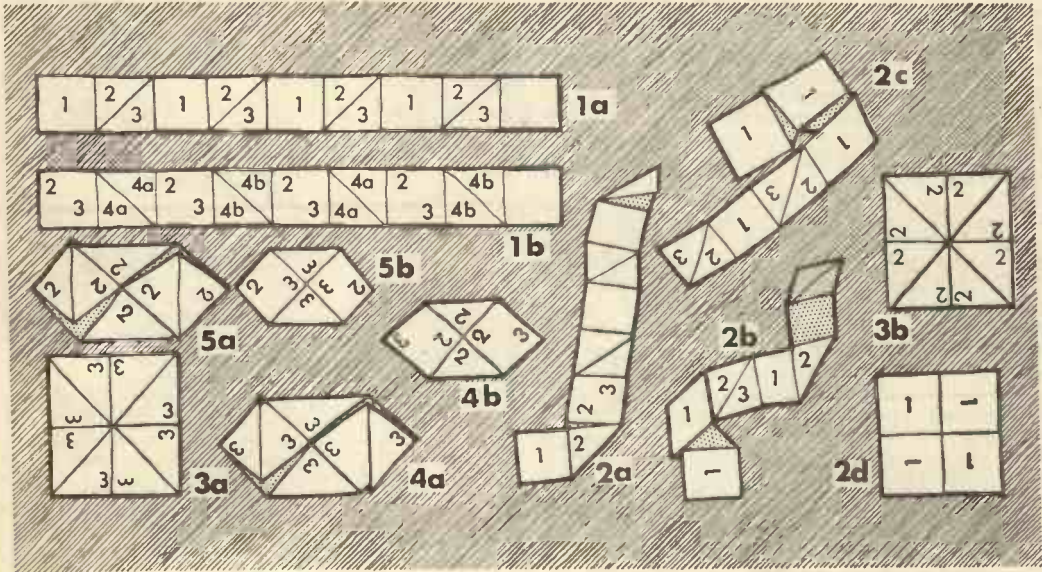

The back of this model shows eight 3's as in Fig. 3a. For an initial exercise see if you can flex it to get eight 2's on the back. Later you can try, but without success, to get 2's on one side and 3's on the other! By flexing the model in other ways and flattening out you can get front and back faces as in Figs. 4 and 5. So far the fourth side of this quadra has not appeared and indeed is difficult to locate because it is so well hidden inside the model and only appears as two pockets that refuse to flatten out. It can be brought to light by folding any one of the "squashed" forms in Figs. 4 and 5 along one diagonal, when a slight twist will disclose one of the two pockets. If such folding does not disclose a pocket it will be necessary to go back and fold along the other diagonal. Each of the four forms in Figs. 4 and 5 will give a pocket but two are just duplicates upside down.

Directions for operating

The starting position shows four square faces, all marked 1. Check that the back is formed of eight triangles marked 3. The first problem is to cause, by bending or flexing, the back to show four 2's. This is done by folding downwards, leaving the 1's on the outside. Then, which is rather tricky, pull out the two sides to form an open box and squeeze the sides together the other way. On flattening out four 2's will be seen on the back.

A second problem begins from the same initial starting position. Turn the model over with the 3's up and 1's at back. Fold downwards and flatten out, which brings six triangles of 3's upwards. The back is now two squares and two triangles, consisting of a mixture of 3's and 2's.

A third problem begins at the end of the first problem where the back is formed of 2's. With the 2's upwards fold downwards and flatten out. One side will be seen to be composed of 2's and the other of 2's and 3's but different from the second problem.

The most interesting problems—and the most baffling—are the finding of the two hidden pockets. Begin with the position at the end of the second problem.

For the fourth problem, with all 3's upwards, fold downwards. This discloses one pocket by slight squeezing. Should this fail you have used the wrong diagonal to fold, so try the other.

For the fifth problem flatten, turn over and fold the other side. This discloses the same pocket but upside down.

The sixth problem follows from the end of the third problem with all 2's upwards. Fold downwards. This will disclose the other pocket. This can also be found from two positions.

All this sounds complicated but is really not so. After a little practice it will be found easy to follow each instruction. But it must be remembered that all this is for *entertainment only*. The author will not be responsible for nervous breakdowns!

"Practical Mechanics and Science" Advice Bureau. COUPON

This coupon is available until November 30th, 1962, and must be attached to all letters containing queries, together with 6d. Postal Order. A stamped addressed envelope must also be enclosed.

Practical Mechanics and Science. Nov. 1962

LATHE GADGETS

(Continued from page 56)

markings and correspondingly shallower. This can, in fact, be quite acceptable for small instrument screws, and by adjusting the pressure either pattern can be produced to suit the job. Lubricate both wheels and job liberally before starting up. If a long length of knurling is being produced, brush off the fluffy swarf from time to time with an old toothbrush or something similar, or the swarf will feed on to the job further on and deface what should be a clear-cut diamond pattern.

SPACE AGE METALS

(Continued from page 70)

amides and xanthates) which attract one or the other.

And so we come to the "Space Age" in metals. Like other metals so excitingly important today, columbium hid unsought beneath the ground until our own time. The site at Oka, Quebec, where it is starting to be mined and processed is the same quiet corner of the Quebec countryside where, more than 80 years ago, the silence-bound Cistercian Order sought a quiet place to establish a new monastery. Adjacent to the monastery's 1,000 acres metallurgical history is now being made.

FARNBOROUGH

(Continued from page 80)

Another aircraft with the same type of engine layout is the V.C.10 and, while we are on the subject of wings, take a look at that flap area. This aircraft was flying in B.O.A.C. colours and it was announced at the show that 60 of these giants had been ordered by Sunday, 10th September. Many other aircraft, including some real old-timers, were at the show, as well as the do-it-yourself Druiene Turbulents from the Tiger Club. They were later to give a display at Biggin Hill for Battle of Britain Day, but I am afraid that space will not allow any more news in this issue, so I will sign off by saying: "If you went to the Farnborough Air Display I hope you enjoyed it. If you did not go then maybe this news has been of some consolation".

SEND A "PRACTICAL" CHRISTMAS GIFT!

You must have friends who would enjoy PRACTICAL MECHANICS AND SCIENCE too! Why not send them a year's subscription for this invaluable magazine? It's a present you know they'll appreciate—whether they're beginners or experts. Each issue will be a renewal of your best wishes too, every month of the year! Send friends' names and addresses, together with your own and remittance to cover each subscription, to The Subscription Manager (G.I.), "Practical Mechanics and Science," Tower House, Southampton Street, London, W.C.2. We will despatch first copies to arrive before Christmas, and send an attractive Christmas Greetings Card in your name to announce each gift.

RATES (INCLUDING POSTAGE) FOR ONE YEAR (12 ISSUES): U.K. 28s., OVERSEAS 26s. 6d., CANADA 25s.

SURPLUS BARGAINS

Low Speed Motors. Low Voltage Motors and Gearbox, with Two output shafts giving approx. 4 r.p.m., and 16 r.p.m. at 12 v. DC and 6 r.p.m. and 24 r.p.m. at 24 v. DC. Dimensions approx. 7 1/4" x 5" x 3" overall. Each 25/-, post 1/9.

Telephone Handsets. Two in series with battery give two-way intercom, 35/- pair, post 2/3. Mains Motors from 25/-, post 3/-; Low Voltage Motors from 12/6, post 1/6. Battery Charger Transformers 15v. and 9v., 1 1/2 amp., 16/-, post 1/9; Rectifiers to suit above for 6 and 12v. Charging, 6/6, post 1/-; Send 3d. stamp for illus. list of interesting bargains. Money Back Guarantee.

MILLIGAN'S

2 HARFORD ST., LIVERPOOL, 3

NEW POCKET MANUAL

"PRACTICAL STEAM TRAPPING"

New unique guide to correct selection and installation of steam traps for mains drainage, heating systems, process steam units of all kinds; including best condensate-lifting installations. Concise directions; clear illustrations. Copies free on request to:

SPIRAX-SARCO LTD.

(TECHNICAL DEPT.) Cheltenham, Glos.

HIGHSTONE UTILITIES

38 NEW WANSTEAD, LONDON, E.11

Accumulators, 2-volts, unspillable, 7" x 4" x 2", brand new, 5/6, post 2/-, 3 for 15/-, post 3/6, 6 for 28/6, post 5/-.

Ex-R.A.F. 2-valve (2 volt) Microphone Amplifiers, as used in 'plane intercom., in self-contained metal case; can be used to make up a dead aid outfit intercommunication system, or with crystal set, complete with valves and fitting instructions, 20/-, post 3/6. Hand Microphones, with switch in handle and lead, 5/6. Tannoy 7/- Similar Instruments, moving coil, 8/6. All post 1/6. Mask type with switch, 3/6, post 6d. Turbot Mikea, 5/-, post 7d. Mike Buttons (carbon), 2/- Moving coil, 3/6, post 4d.

Meters, 20 amp. 2in. m/c, 8/6; 3.5 amp., 2in. T.C., 6/- 100 mA 2in., m/c, 7/6, all post extra. Meter (L. & R.) containing 2-500 micro-amp movements, 9/-, post 1/6.

Bell Transformers.—These guaranteed transformers work from any A.C. mains giving 3, 5 or 8 volts output at 1 A. operate bulb, buzzer or bell. Will supply light in bedroom or larder, etc., 9/-, post 1/- Similar Transformer but output of 4 8 or 12 volts, 18/-, post 1/9. BUZZERS for use with above or batteries, 4/6, post 1d.

G.P.O. Telephone Hand Comb. Sets, 12/6, post 1/8. Telephone Hand Generator, 8/-, post 2/6. Telephone Bell, 3/6, post 9d. S.E.C. Neon Indicator Lamps, for use on mains to show "live" side of switches, etc., 2/-, post 4d. Diodes, 1/6. .0005 Variable Condensers, 2/6, post 9d. Headphones in Good Order, 6/-. Better Quality, 7/6 and 10/-. Balanced Armature Type (very sensitive), 13/6. All post 1/6. New Single Earpieces, 3/6. Bal. armature type, 4/6, can be used as transistor set loudspeaker, two of these will make an intercom, set, Ex R.A.F. earpiece, 2/6, post 6d.

Money refunded if not completely satisfied. New illustrated list sent on request with 3d. stamp and S.A.E. Letters only.

Handy Taper Pin Reamers, 3/32" to 1/4" dia., 4 assorted 12/6, actual value nearly £2.

20,000 Metal Slitting Saws 1 1/2" dia., 5/8" hole, 0.015" to 0.060" thick, 6 assd., 8/9, dozen 15/- Still cheap at double this price.

5,000 Hardened and Ground H.S. Tool Bits, 1/4" square, 2 1/2" long, 15/- doz., 5/16" square, 3" long, 20/- doz., 3/8" square, 3" long, 26/- doz., 7/16" square, 3 1/2" long, 30/- doz.

3,000 H.S. Straight Shank End Mills, approx. 3/32" - 1/2" dia. outstanding value, 8 assorted, £1 the lot.

3,000 Ball Races, 3/16" bore 2/-; 3/8" 2/6 each.

8,000 Circular Split Dies, 1" dia. cutting 1/4", 3/16", 3/8", 7/16", 1/2" Whit. B.S.F. and American N.F. 12/- per set of 5 sizes, 2 sets 22/6. Taps to suit 12/6 per set, either taper or second or plug. 1" dia. stocks 6/- each.

Hexagon Die-Nuts in Case, sizes, etc., as above, 15/- set, three sets 42/6. Brand new, £2 orders P.P. except abroad.

J. BURKE,

192 BASLOW ROAD, TOTLEY, SHEFFIELD

INTRODUCING A NEW PORTASS LATHE

3 1/2" x 16" B.G.S.C. bench lathe complete with faceplate, catchplate and backplate, change-wheels, etc., flat or vee drive. Complete satisfaction or retittance refunded in full. Ex-works write:

CHARLES PORTASS & SON
Buttermere Works, Sheffield 8
Est. 1889 Cash or terms

ROGERS 31/33 NELSON ST. SOUTHEPORT

Fibre Washers, 144 Assorted	3/6
Meter Rectifiers. A.C. to D.C.	3/9
Sell Tap Screws, 100 Assorted	3/-
Rectifiers 6/12 v. at 6 amps.	18/-
Winker Units, 6 or 12 volt.	6/6
Motorised Water Pumps,	95/-
Instrument Cases, 12in. x 8in. x 6in. New	7/3
Thread Gauges	4/9
Races, Belts, Valves, Pulleys, Pumps, Brass, Steel, Aluminium, etc.	

10 PAGE LIST FREE, STAMP PLEASE

A NEW-PRACTICAL WAY of UNDERSTANDING

RADIO • TELEVISION • ELECTRONICS

Including: Transistors; VHF/FM; Hi-Fi equipment; Computers; Servo-mechs; Test instruments; Photo-electrics; Nuclonics, etc.

Radiostructor—an organisation specialising in electronic training systems—offers a new self-instructional method using specially designed equipment on a "do-it-yourself" basis. You learn by building actual equipment with the big kits of components which we send you. You advance by simple steps, performing a whole series of interesting and instructive experiments—with no complicated mathematics! Instructional manuals employ the latest techniques for showing the full story of electronics in a practical and interesting way—in fact, you really have fun whilst learning!

POST NOW

To RADIOSTRUCTOR (Dept. G28) READING, BERKS. Please send brochure, without obligation, to—

*Name.....

*Address.....

11/62

(We do not employ representatives) *Block Caps Please

FREE THIS BOOK WILL INTEREST YOU!!

FOR

- .. Your Career
- .. Your Own Business
- .. An Absorbing Hobby

Radiostructor
EQUIPMENT COURSES

RADIOSTRUCTOR

LEADS THE WORLD
IN ELECTRONICS TRAINING

TRADE NEWS

New Wolf Drill Guide Attachment

WOLF Electric Tools have introduced a depth gauge and drilling guide attachment for use with their home power tools—it is known as the "Drillrite" No. 31 Set.

The "Drillrite" clamps on to the front of the power unit gear box and provides a portable means of accurately positioning the twist drill at right angles in relation to the material. It enables holes to be drilled in doors, timber etc., to a definite pre-set depth and therefore can be set to prevent the drill point completely piercing the material being worked on, if desired. It will, of course, ensure straight drilling, in every plane, prior to dowelling. Spirit level type gauges only ensure accuracy in one plane whereas the "Drillrite" gives complete accuracy in both planes.

The front end of the unit has V grooves to give a centering guide and a better grip to the twist drill when drilling into rods, tubes etc.

The "Drillrite" is suitable for use with any standard drill bit. Retail price 19s. 6d.

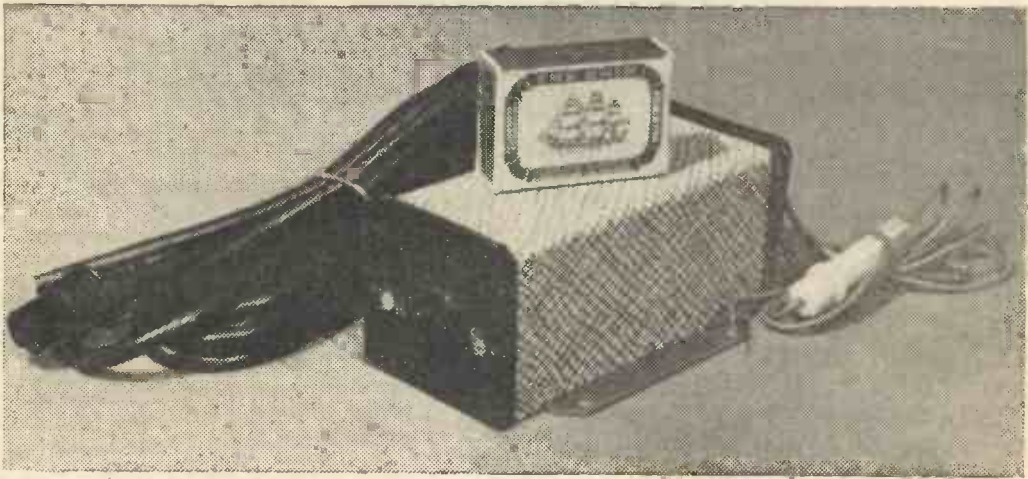
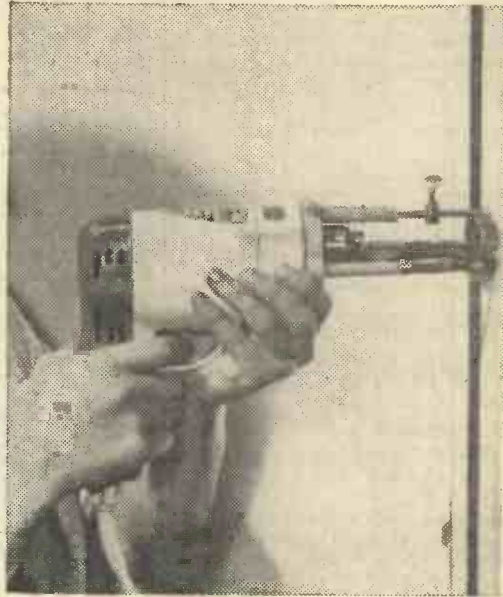

Bambi Battery Charger

THE new Bambi-charger is a miniaturised automobile battery charger, designed specifically to be mounted in the interior of the vehicle and permanently wired into the electrical system.

Working from standard 300/250V A.C. Domestic Supply, the Bambi charges 1½ amps at either 6V or 12V. A built-in light diminishes in brightness as the battery reaches full charge.

Soundly constructed and in an attractive two-tone P.V.C. coated steel and toughened styrene case measuring only 5in. x 2in. x 2in., and using a heavy duty transformer coupled with a Westinghouse selenium rectifier, the Bambi-charger retails for 65s., complete with fixing screws, fused connecting leads and 9ft of 3-core-cable with plug.

Double Off-set Screwdriver

TO cope with awkward-to-get-at screws Stanley Tools have produced a double off-set Phillips screwdriver costing 2s. 6d.

One end has a No. 1 point tip and the other end a No. 2 point tip, enabling the screwdriver to deal with the most popular sizes of Phillips screws in general use. The over-all length is 4in.



New Power Tool Accessory for Sanding

WOLF have introduced a new foam cushion sanding pad which is suitable for use with any make of home power tool. It is known as the Wolf "Flexidisc" No. 30 Set.

The unit comprises a 4½in. dia. x ½in. thick cellular foam cushion pad—the working face of the pad is covered with linen reinforced rubber to which a self adhesive sanding disc may be affixed.

The "Flexidisc" is ideal for fine finishing on all types of material—it can be used completely flat on the work thereby eliminating the possibility of swirl marks.

The unit is supplied complete with a packet of 12 assorted self adhesive sanding discs, and ¼in. arbor for fitting to a drill chuck. Retail price 19s. 6d.

New Tool Splits Corroded Nuts—Without Damaging Bolt or Thread!

THE problem of the corroded nut, permanently rusted or frozen to its bolt, is universal. It may occur in factory, garage or home, on the farm or an board ship; anywhere in short where nuts have to be removed from bolts.

The Nut Splitter consists of a chrome-molybdenum steel cutter which fits into either of two cast steel bodies. Each body has a hollow tapped shaft, down which the cutter moves, and an opening (¼in. or 1⅜in.) to receive the nut to be split.

Simple to Use

Operation is easy. Choose the body with most convenient hole size, insert the cutter and slip the unit over the nut. Finally, turn the hexagonal rear end of the cutter with a spanner.

With every turn the cutter head penetrates further into the body opening, splitting the nut cleanly away from its bolt. The whole operation takes less than two minutes. There is no damage to the thread, and no risk of even minor injury to the operator.

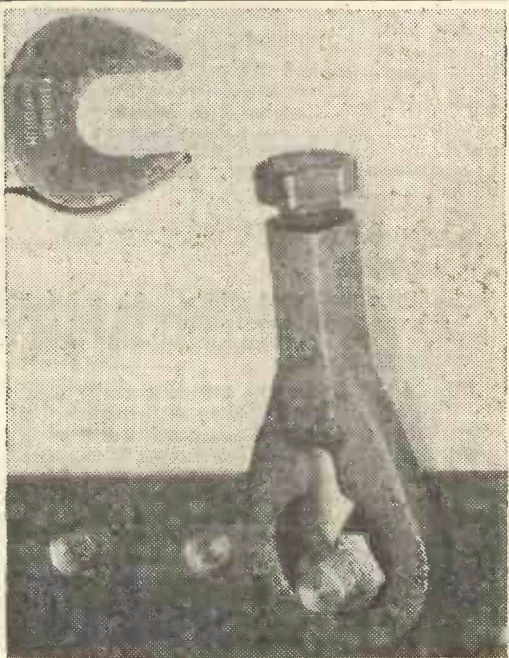

YOUR *Queries* ANSWERED

RULES

Our panel of experts will answer your query only if you comply with the rules given below.

A stamped addressed envelope, a sixpenny crossed postal order, and the query coupon from the current issue which appears at the foot of page 90, must be enclosed with every letter containing a query. Every query and drawing which is sent

must bear the name and address of the reader. Send your queries to the Editor, PRACTICAL MECHANICS, Geo. Newnes Ltd., Tower House, Southampton Street, Strand, London, W.C.2.

Sound-proofing a flat

MY problem is sound penetrating my flat from my downstairs neighbour's flat. I have put down a layer of $\frac{1}{2}$ in. Cellotex fibre-board, then linoleum and carpet on top but though this has a muffling effect it is less than I had hoped. Do you consider the sound absorbing quality of Cellotex justifies the space it takes up? I would be prepared to take it up and replace it with something else more effective. The maximum thickness must not be more than $\frac{1}{2}$ in. as I cannot take more than this off the bottom of the doors without damaging the mortices.—J.R.W. (Scotland).

THE sound conductivity of $\frac{1}{2}$ in. Cellotex is 0.36 whereas that for a material known as "Cabot's Quilt," which is only $\frac{2}{10}$ in. thick, is 0.24. It would thus be an advantage to replace the Cellotex with one, or better two, thicknesses of this material. As the Cellotex is only laid on the floor it is bound to be loose to some extent and can thus vibrate and transmit the sound. "Cabot's Quilt" is flexible and will lay close to the floor and thus cannot vibrate. Your other floor covering can be laid on top satisfactorily. Messrs Huntley & Sparks Ltd, De Burgh Road, South Wimbledon, S.W.19, can supply this material. A better but more difficult method of using this material would be to lift the floorboards and drape the quilt over the joists and spaces between, before nailing the boards back again. The spaces between the joists could also be filled with a thick fibre glass blanket or one of the granular substances, as used for heat insulation of lofts etc.

Using 110 volt motor on 240 volts

I HAVE a tool post grinder with a 0.4 h.p. 110 volt ac/dc motor. Can I use this with a suitable series resistance, on 240 volts?—T. Underhill (Bucks.).

WE do not advise the use of a series resistor for this purpose. When thus used the voltage across the motor will rise considerably on light loads, and may result in breakdown of the insulation. This is because the voltage dropped by the resistance falls as the current becomes less (Ohm's law). Furthermore the motor would run at a very high speed under no-load conditions. This might cause damage to the armature windings or cause the grinding wheel to burst, owing to the increased centrifugal stresses which are proportional to the square of the speed. It would be much safer to supply the motor through a suitable step-down transformer.

Welding transformer

CAN you give me a specification for a small welder to work on a 250V A.C. supply I have a 15sq.in. core which I would like to use, if suitable. The stampings are of the E and I type and each winding space is 8in. by $1\frac{1}{2}$ in. I would like to be able to use 10 gauge electrodes which will require about 100A welding current.—M. Sloan (Ayr.).

YOUR core is rather small for the output required and very careful winding would be required in order to accommodate the number of turns required, in the available space. The primary should have 125 turns of 8s.w.g. double silk covered wire, and the secondary 40 turns of copper wire with a cross-sectional area of about 0.05sq.in. A layer of 0.06in. thick leatheroid should be placed between the primary and secondary windings and the transformer should be oil cooled. A choke coil would be necessary between the secondary and the electrode to reduce the arc voltage after striking and to control the welding current. On a 100A welding load this transformer will take about 30A from single-phase mains. We would mention that details of a 50A, oil-cooled welding set was published in PRACTICAL MECHANICS, February 1954 issue. The article included details of a suitable choke. This issue is now out of print but Photostat copies can be obtained from Shoreditch Public Library, Pitfield Street, London, N.1. at a cost of 1/6 per page.

Making reflecting telescopes

I WISH to grind, polish, figure and silver my own mirror for a 6in. reflecting telescope. I have mislaid your previous articles on this subject. Can you please give me details?—A. Allington (Norfolk).

COMPREHENSIVE articles on making a 6in. telescope mirror were published in PRACTICAL MECHANICS for January and February, 1958. Details of a telescope and mounting for such a mirror were given in the May and June issues, 1959. Unfortunately these are all out of print, but see the reply above under "Welding Transformer." Two other excellent publications are "Amateur Telescope Making" and "Amateur Telescope Making (Advanced)" published by Scientific American. The British Astronomical Association also publish a very fine journal for members. Our contributor J Cousins, 235 Bilton Road, Greenford, is willing to propose applicants for membership if they get in touch with him personally.

SALES AND WANTS

The prepaid charge for small advertisements is 9d. per word, with box number 1/6 extra (minimum order 9/-). Advertisements, together with remittance, should be sent to the Advertisement Director, PRACTICAL MECHANICS, Tower House, Southampton Street, London, W.C.2.

PERSONAL

INVENTORUS LIMITED

Our team of consulting experts is available to advise and assist you in all technical and commercial phases of the successful development of your inventions.

Write to:
The Commercial Director
INVENTORUS LIMITED
278/282 High Holborn, W.C.1.

ELECTRICAL

ALL TYPES of Electrical Goods at extremely competitive prices, e.g., 5-amp Twin Cable, 35/- 100 yards; Lampholders, 7/- doz.; 5ft. Batters, 49/-. Quality and immediate dispatch guaranteed. Request list. **JAYLOW SUPPLIES**, 93 Fairholt Road, London, N.16 (Tel.: Stamford Hill 4384).

SMALL ELECTRIC CIRCULATING PUMP

for hot or cold water, fish tanks, ornamental fountains, waterfalls, milk cooling, greenhouse watering, pot washers, etc., comprising 120 watt unshrouded type, shaded pole, A.C. motor, coupled to centrifugal die-cast pump. Output 250 g.p.h. Maximum head 6 feet, 220/250 volts. Silent continuous running.

New Price £23.0. Post paid.
H. MIDDLETON, 639 ABNEYDALE RD., SHEFFIELD, 7.

12 VOLTS CONVERTER to 250 VOLTS Run all your mains a.c.-d.c. equipment from your car battery, shavers, record players, radios, etc. New type vibrator, low battery drain, not to be confused with heavy battery drain Rotary transformers. Spare fuses, Vibrator, battery clips, etc. 12 volts to 250 at 100 m.a.

BRAND NEW tested in water-proofed cartons, **ONLY 23/6**, carr. 7/6 (few only). (DEPT. F), J. T. SUPPLY, 309 Meanwood Road, Leeds, 7.



WOODWORKING

ANGLIAN RANGE Saw Spindles, 10in. R/F Sawbenches, 8in. and 8in. Planers, 8in. Sawplanes and Wood-working Lathes. Send 6d. postage for brochures and price list to: **THE EAST ANGLIAN TRADING COMPANY**, 5 Guardian Road, Norwich, Norfolk. NOR55A.

HOME BOAT BUILDING

FULLY PREFABRICATED Kits to assemble a boat at home, for two-berth Cabin Cruisers, fast Runabouts, Canoes, Frams, Enterprise Signet Sailing Dinghies. Leaflets from: **WYVERN BOATS (WESSEX) LTD.**, Milborne Port, Sherborne.

BROMLEY BOATS, Kits, Mahogany, Silver Spruce American Boat plans, 3d. list. Southlands Road, Bromley, Kent.

HOBBIES

NEWTONIAN TELESCOPE making 6in., 8in., 11in. Glass discs. Grinding Kits, Aluminised Parabolic Mirrors, Optical Flats, Ramsden Eye-pieces, Barlow Lenses, S.A.E. for list. **L. J. MAYS**, 20 Clover Road, Timperley, Altrincham, Cheshire.

HANDICRAFTS

MARQUETRY VENEERS 12 assorted 6/- post free. List 3d. **FRANK COLES (VENEERS) LTD.**, 76 Rivington Street, EC2.

JEWELLERY SIMPLY MADE. Rings, Brooches. Catalogue free. **WEBBS**, 105 Upminster Road, Hornchurch.

TOOLS

PAINT LINING TOOL



Do your own expert lining on bikes, cars and toys. Rolls stripes in any kind of paint. Can be used in any position. With 3 wheels, rolls 1/32", 1/16" or 1/8" Stripe.

Price 5/6 post free with full instructions.
P. Wren Mfr. Co., Wollaston, Wellingborough

WATCHMAKERS

NEW WATCHES, watch movements, Watchmakers' tools and materials, instructional books, etc. at unbeatable prices. Also watch repairs undertaken. Send 1/- for Bumper Bargain Catalogue. **THE WATCHMAKERS' SUPPLY COMPANY**, "Time House", Carterton, Oxford.

FOR ALL makes of Watches, Tools, Instructional Books, etc. Special Kits for beginners, send 6d. for "Super Bargain Catalogue". **T. G. LOADER**, (Dept. B), **WATCHMAKERS' MAIL ORDER SERVICE**, Milestone Road, Carterton, Oxford.

PHOTOGRAPHY

PROJECTORS. Home Assembly Kits, all types and sizes and stereo from £6/2/6. Fan Base Kit £3/7/6. Optical Screens, S.A.E. **MARSHALL SMITH LTD.**, 64 Norwich Avenue, Bournemouth.

RADIO

RADIO, TELEVISION Service Sheets. All types Valves. S.A.E. list. **JOHN GILBERT TELEVISION**, 1b Shepherds Bush Road, London W.6. SHE 8441.

MISCELLANEOUS

AQUALUNG AND COMPRESSOR Equipment, Ballraces and Miscellaneous items. Lists 3d. **FRYCE**, 157 Maiden Road, Cheam, Surrey.

FOR SALE

SCREWS, NUTS, washers. Grand assortment brass and steel. Mainly B.A., few E.S.F. and Whit. 3lb. 10/-, 6lb. 18/- in storage tins. **R. G. MCCLELLAND**, Dept. P.M., 1 Beulah Road, Epping.

WASHING MACHINE Spares new and second-hand. **J. AND D. ELLISON**, Barkerhouse Road, Nelson.

ASTRO TELESCOPE making. Standard Ramsden push-in eye-pieces, 1in., 1in., 1in. focus 35/-; with F.A.S. thread 42/6 each. S.A.E. list. Object Glasses, Newtonian Mirrors, Diagonal Mounts, Focusing Mounts, Altazimuth Mountings and Tripods for Refractors and Reflectors. **W. BURNET**, 99a West St., Boston, Lincs.

CABINET STANDS for 3, 4in. Lathes. Leaflet. **TELEMAX PRODUCTS**, Kimridge, Thorpe Rd., Great Clacton.

OXY-ACETYLENE Home Welder. Build your own, instruction 2/6. **DRESDENA**. The Harrow Way, Basingstoke, Hants

Make your own 2in. Sq. Slide Projector, Leech 3in. Lens with Focusing Mount £21.6.0. post 1/6. Pre-Four Lampholder 6/-, post 6d. Double Condenser Assembly with Carrier 15/-, post 1/6. Lamphouse with Mirror 10/-, post 1/6.

All the above parts are removed from Brand New Ex-Government Ellis & Newton 85mm. Strip Projector. The projector complete lens lamp, containing all the above parts and many more can be purchased for £4.15.0. Post 4/-. Similar but Heavier Built Strip Projector Adioscope by Metasair, 3 Element Condenser system, Beck 3 1/2in. lens, Lighting by 120 volt, 200 watt pre-focus lamp, inbuilt transformer to operate from 200-220 volts A.C. in wooden carrying case, used but good condition. £5.15.0, plus 6/- carriage (spare lamps 8/- ea. plus 1/- post).

Ex A.M. G45 Gun Camera, 24 volt, 2in. fixed focus lens 50 ft. magazine loading, complete with magazine, new £21.6.0 ditto used £2. Both post 2/6. Brand new Kodak (ex Admiralty) 7 x 50 Prismatic Telescopes, focusing in fitted wooden case, used but good condition. £5.15.0, plus 6/- carriage (spare lamps 8/- ea. plus 1/- post). Brand new (ex A.M.) 12 volt 25 amp. batteries. These are E.A.F. general purpose lead acid accumulators, and are similar in construction to normal car battery. Very suitable for cars and vans, will start any vehicle. Never been filled and in original tropical packing. First charge instructions included, cost about £10, only £7.10.0 each, carriage 6/-. All Metal Projector Stands. Lightweight, fold flat when not in use. Model 1. Height 3ft. Table 20 x 13in. Grade 1 £4. Grade 2 £2.10.0. Both plus 7/6 carr. Model 2. As above but height variable between 2ft. 9in. and 3ft. 3in. Platform 21 x 13in. Grade 1 £5. Grade 2 £3. Both carr. 7/6. All are in good condition, used but paintwork is very good on Grade 1 models.

Ex R.A.F. Aerial Film. 9 1/2in. x 300ft. Pan. £3. 160ft., 35/-, 5 1/2in. x 47ft., 8/-, 24ft., 5/-. Ideal for cutting to smaller sizes. Perfect condition. Post 1/6. Ex A.M. GGS Mark 2 Recorder Camera, 10mm. made by Specto. Latest model with three shutter speeds, 2 or 16 1/3s. bloomed 1 1/2in. lens F1.9 with iris to F1.6, 24 volt 50ft. magazine loading, complete with magazine in original tropical packing, absolutely brand new, only £25, post 2/6. Ditto used £3.10.0. post 2/6.

All goods supplied on 14-day money back guarantee

R. SANKEY Regal Cinema, ASTERSTONE

WARWICKS. Tel. Atherstone 2220, 3210

(continued)

FOR SALE

(continued)

BLACKSMITH'S PORTABLE FORGES !! Brand new Government from £5/15/- carriage paid. Thousand bargains catalogue free. Greens, 893 Albert Street, Lytham.

PROJECTOR SCREENS. Matt white plastic, 26in. x 24in. Ideal for making miniature screens. Clear brilliant pictures. 4/6 each, 1/6 p & p; 2 for 10/- post free. R. G. McCLELLAND, Dept. F.M., 1 Beulah Road, Epping.

CATALOGUE No. 44. About 5,000 items. Materials, Electrical and Mechanical Gear. Very interesting. **K. R. WHISTON** (Dept. FMS), New Mills, Stockport.

EDUCATIONAL

$$X = \frac{-b \pm \sqrt{b^2 - 4ac}}{2a}$$

DON'T FUMBLE with Formulae. Master Mathematics quickly and easily the Understandable Way.



The Dryden School of UNDERSTANDABLE MATHEMATICS

11y Dryden Chambers, Oxford St. London, W.1.

Name _____
 Address _____

"HOW AND WHY" of Radio and Electronics made easy by a new maths practical way. Postal instructions based on hosts of experiments and equipment building carried out at home. New courses bring enjoyment as well as knowledge of this fascinating subject. Free brochure from Dept. 12, P.M. **RADIOSTRUCTOR**, Reading.

POSTAL TUITION in Technical Drawing, tracing and blueprint reading. Drawing and design in wood or metalwork for Handicraft Teachers Examinations. Details from: **O. PANNELL**, 145 The Crossway, Portchester, Hants.

It's MADE

By repairing Radio and TV Sets as a job or as a spare time business. Our practical course will show you the way. No previous experience is required.

SEND FOR FREE BOOK TO-DAY

RADIOSTRUCTOR

Dept. 080 READING, BERKS.

SITUATIONS VACANT

A.M.I.Mech.E., A.M.Brit.I.A.E., City and Guilds, G.C.E., etc. bring high pay and security. "No pass—no fee" terms. Over 95% success. For details of exams and courses in all branches of engineering, Building, Electronics, etc., write for 148-page handbook, free. B.I.E.T. (Dept. 967B), London W.8.

SKILLED PRACTICAL Engineers and Craftsmen are eligible for associate membership of **THE INSTITUTE OF ENGINEERS, PRACTICAL**, 118 Westwood Park, London S.E.23. Write for details.

PATENTS

PATENTING SERVICES. Advice qualified Agent. **C. L. BROWNE**, 114 Grenhayes Avenue, Banstead, Surrey.

THIS BOOK IS FREE!

"How to get your G.C.E."

G.C.E.

AN AUTHITATIVE GUIDE

A complete up-to-the-minute guide—all you want to know about G.C.E. How, when and where to apply. Subjects & Syllabuses at all levels. Exemptions. Career Requirements. "No Pass—No Fee" Home Study Courses . . . how you can get the G.C.E. and choose your own subjects. Send for this unique book today—FREE! School of Careers, Dept. 160, College House, London, W.8.

"NO PASS-NO FEE!"

New, revised 2nd edition . . .



RADIO SERVICING POCKET BOOK

edited by **J. P. Hawker**

The fully-revised second edition of this popular pocket manual and data book contains much new information. Of particular interest will be the practical guidance on the servicing of transistor receivers and the repair of printed wiring panels.

It provides the essential information and data needed in the day-to-day work of servicing the whole range of modern A.M. and V.H.F./F.M., valve and transistor radios. Experienced engineers, trainees and newcomers to servicing work will all find that this book shows an understanding of their real needs, and will repay its cost time and time again.

CONTENTS

Modern A.M. Valve Receivers . Principles and Practice of F.M. Receivers
 Transistor Receivers . Car Radio Receivers . Mono and Stereo Record Reproduction
 Workshop Organisation and Practice . Servicing Equipment . Fault-Finding and Replacements . Receiver Alignment . Receiving Aerials and Earths . Electrical Interference . Useful Formulae . Colour Codes . Broadcasting Stations . Valve and Transistor Data . Battery Equivalents.

198 pages of facts, many line drawings and circuit diagrams.

12s. 6d. FROM ALL BOOKSELLERS

. . . or in case of difficulty, 13s. 6d. by post from **GEORGE NEWNES LTD.**, Tower House, Southampton Street, London, W.C.2.

**ANY ITEM SUBMITTED
ON APPROVAL—
WITHOUT
OBLIGATION**

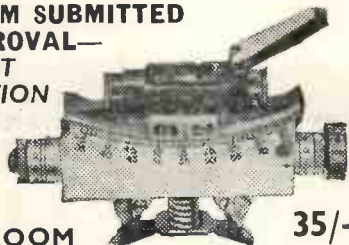

**TOOLROOM
CLINOMETERS** (Micrometer Bubble Type) **35/-**

An Engineer's Clinometer of great precision. Main scale is divided 0.20° in 1° divisions. Angles can be read on the micrometer thimble to within 5 minutes. For their original military purpose a clip was fitted to the base but this clip can easily be removed in the Machine Shop. Net weight 22 ozs. Length of base 3 1/8 in.

- GERMAN DRAWING INSTRUMENT SETS** £2-19.6
Brand new in velvet lined case
- WALTHAM TIME & MOTION STUDY STOPWATCHES** 33/6
Current value approx. £10. Offered at £3-15-0.
With decimal dial, £4-10-0. Fully guaranteed.
- OPTICAL EXPERIMENTAL SET** in Transparent Pack. Type A contains 30 graded lenses. Type B contains 30 selected lenses, prisms and polaroids. Either type 42/- per set.
- The **NEW RUSSIAN MICROSCOPE** as shown at the Soviet Trade Fair. £27-10-0
- GBL 516 16mm. SOUND PROJECTORS**—perfect £59-10-0
- EX—R.A.F. ADJUSTABLE BENCH LAMPS** 33/6
- EX—R.A.F. ILLUMINATED MAGNIFIERS** with 3 1/8 in. dia. lens. 38/6
- EX—M.O.S. HARDENED CHESTERMAN COMBINATION SET** No. 92, with 12" rule. Brand new condition. £6-15-0.

CHARLES FRANK LTD. Phone: BELL 2106/7 Grams: BINOCAM Glasgow

67/75 SALTMARKET, GLASGOW, C.I. Est. 1907
Britain's greatest stocks of new, used and Ex-Government Optical and Scientific Equipment. Send for Illustrated Catalogue

SLIDE PROJECTOR KITS. 35 mm. (2 x 2). Triple condenser and projection lens in mounts ready assembled. Only need lamp house and slide carrier to complete. £4-19-6, with plans. This kit guaranteed to give brilliance and definition from 100 or 150 w. lamp equal or better than 300 or 500 w. commercial types costing £90 or more. Demonstrated to callers. Other Enlarger and Projector kits from 35 mm. to 2 1/2" sq. from £3-13-6. See our lists.

ASTRO TELESCOPE KITS. 6" parabolic with mounting. £35. Carr. £5. See our lists.

FOR LENSES and PRISMS and OPTICAL EQUIPMENT OF ALL KINDS, see our NEW LISTS free for S.A.E.

RECORDING TAPE. Scotch Boy. 1,200 ft. HI-FI standard 22/6.

GOODMANS 12" SPEAKERS. 15 ohm. 20 w. Weight 16 lbs New and Boxed £8. World £12.

INFRA RED MONOCULARS. Tested O.K. 37/6 ea. Unused but not working. 12/6 ea. Large leather cases approx 12" x 6" x 3" New. 4/6 ea. Carr. 3/- 48/- doz. post free.

GEARED CIRCUITS. Divided 360 mic to 5 min. Geared 62 to 1. 17/6 ea. Carr. 4/-

ROTARY CONVERTERS. Runs 110 v or 230 v. A.C.-D.C. shavers, etc. from 6 or 12 v. battery. 25/- ea. Carr 5/-

GEAR PUMPS. PLESSEY. Type 27/CYHC. 1" outlets. New. 35/- ea.

ROTARY VANE VACUUM PUMPS. 24 v. motor driven. 1" outlets. Brand New. £3-10-0 ea.

24 v. D.C. motors (run well on 12 v.) fitted fan. 12/6. Ditto with blower housing. 27/6, suitable for cooling projectors, etc.

IMPULSE COUNTERS. 4 fig. 1300 ohm 5/- REV COUNTERS. 3 fig. 3/6.

LARGE TWIN GONG FIRE ALARM BELLS. 230 v. A.C. 25/- ea. Carr. 5/-

COMPRESSORS. Piston type. Ex R.A.F. with spline shaft. 35/- ea.

24v **GEARED MOTORS.** GEARED mechanism swines arm through 90 degrees. Complete with automatic switchgear. Adaptable for opening doors and such like. Brand New. 17/6.

RELAYS. Siemens H.S. 1000 x 1000 ohms, adjustable. 12/6. Open type 3 v. working at 1 ma. D.P.S.T. fully adjustable. 6/6 ea. Assorted relays. 36/- doz.

LAMPS. 12 or 24 v. 350 w. 5/- ea. 36/- doz. 24 v. 80 w. S.B.C. 1/6 ea. 15/- doz. 24 v. 18 w. 8/- doz. Mercury Vapour. 200-230 v. 125 w. 15/- ea. Pointolite 100-250 v. 500 w. 15/- ea.

SMILED PROJECTION SYSTEMS. 6 1/2" Surface aluminised mirror and flat with corrector plate in mount. Brand New. £3-10-0. ea.

RIFLE SIGHTS. 50/- ea. Cost £20. 30X 3 draw Telescopes. Brand New. 90/-

BOOKLETS. How to use EX GOV. Lenses & PRISMS. Nos. 1 & 2. 2/6 ea.

H. W. ENGLISH



469 RAYLEIGH ROAD, HUTTON, BRENTWOOD, ESSEX



Screwdrivers

* PRECISION BUILT FOR CRAFTSMEN

Manufactured to exacting standards by Moore & Wright (Sheffield) Ltd. world famous for precision and hand tools.

WRITE FOR OUR
LEAFLET NOW

Please send me details of your
SCREWDRIVERS.

NAME _____

ADDRESS _____

MOORE & WRIGHT (Sheffield) LTD.
Handsworth Road, Sheffield, PA.

HW 68 PA

Published about the 30th of each month by GEORGE NEWNES LIMITED, Tower House, Southampton Street, London, W.C.2, and Printed in England by Watmoughs Limited, Idle, Bradford, and London. Sole Agents for Australia and New Zealand—Gordon & Gotch (A/asia) Ltd. South Africa and Rhodesia—Central News Agency Ltd. East Africa; East African Standard Ltd. Subscription Rate (including postage): For one year: Inland £1.8s., Overseas £1.6s.6d., Canada 19s. Registered for transmission by Canadian Magazine Post.

EARN

There's plenty of room at the top for technically trained men—room for YOU if you want quick promotion or a better-paid more interesting career. N.I.E. can quickly give you a *guaranteed* spare-time Postal Training, in the comfort of your own home and open up a whole new world of opportunity for you.

Find out, as thousands of others have done, how *easy* it is to learn at home with N.I.E. Send for *Success in Engineering*—136 pages of information you can use—and details of pay-winning Courses in all branches of Engineering, Building, Local Government, etc. Get your copy today—FREE!

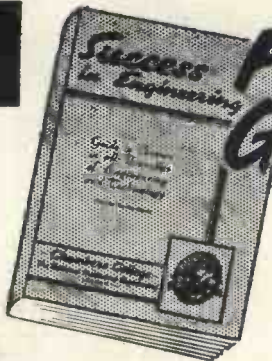

FREE GUIDE!

One of the following Courses taken quietly at home in your spare time can be the means of securing substantial well-paid promotion in your present employment, or entry into a more congenial career with better prospects.

MORE

This remarkable **FREE GUIDE** explains:

- * Openings, prospects, salaries, etc., in Draughtsmanship and in all other branches of Engineering and Building.
- * How to obtain money-making technical qualifications through special **RAPID FULLY-GUARANTEED COURSES**.

A.M.I.Mech.E., A.M.I.M.I., A.M.Brit.I.R.E., A.M.I.Prod.E. A.M.I.C.E., A.M.I.Struct.E., A.M.I.Mun.E., M.R.S.H., A.M.I.E.D., A.F.R.Ae.S., London B.Sc., Degrees.

Fully guaranteed postal courses for all the above and many other examinations and careers. Fully described in the *New Free Guide*.

SOON

We definitely guarantee that if you fail to pass the examination for which you are preparing under our guidance, or if you are not satisfied in every way with our tutorial service—then your Tuition Fee will be returned in full and without question. This is surely the acid test of tutorial efficiency.

If you have ambition you must investigate the Tutorial and Employment services we offer. Founded in 1885, our success record is unapproachable.

ALL TEXTBOOKS ARE SUPPLIED FREE PROMPT TUTORIAL SERVICE GUARANTEED NO AGENTS OR TRAVELLERS EMPLOYED



BECOME A DRAUGHTSMAN - EARN BIG MONEY

Men and Youths urgently wanted for well paid positions as Draughtsmen, etc., in all Branches of Engineering. Our Guaranteed "Home Study" courses will get you in. Those engaged in the General Drawing Office should study some specialised Branch, and so increase their earning capacity.



NATIONAL INSTITUTE OF ENGINEERING

THE GATEWAY TO BETTER LIVING

A.I. POSTAL COURSES

ENGINEERING, RADIO, AERO, ETC.

Aero, Draughtsmanship	Elec. Draughtsmanship
Jig & Tool Design	Machine " "
Press Tool & Die Design	Automobile " "
Sheet Metalwork	Structural " "
Automobile Repairs	R/F Concrete " "
Garage Management	Structural Engineering
Works M'gmt. & Admin.	Mathematics (all stages)
Practical Foremanship	Radio Technology
Ratefixing & Estimating	Telecommunications
Time & Motion Study	Wiring & Installation
Engineering Inspection	Television
Metallurgy	Radio Servicing
Refrigeration	Gen. Elec. Engineering
Welding (all branches)	Generation & Supply
Maintenance Engineering	Aircraft Mainten. Licences
Auto Engine Technology	Aerodynamics
Diesel Engine Technology	Electrical Design

BUILDING AND STRUCTURAL

A.I.O.B.	A.I.A.S.	M.R.S.H.
A.M.I.P.H.E.	A.A.L.P.A.	A.I.O.S., A.R.I.C.S.
Building Construction	Costs & Accounts	Builders' Quantities
Surveying & Levelling	Clerk of Works	Carpentry & Joinery
Quantity Surveying	Building Inspector	Building Draughtsmanship
	Heating & Ventilating	

GENERAL, LOCAL GOVERNMENT, ETC.

Gen. Cert of Education	A.C.I.S., A.C.C.S.
Book-keeping (all stages)	A.C.W.A. (Costing)
College of Preceptors	School Attendance Officer
Woodwork Teacher	Health Inspector
Metalwork Teacher	Civil Service Exams.
Housing Manager (A.I.Hsg.)	

POST COUPON FOR FREE BOOK

Please send me a FREE copy of "Success in Engineering".

NAME

ADDRESS

Subject or exam of interest

NATIONAL INSTITUTE OF ENGINEERING
(Dept. 29) 148-150 Holborn London EC1