

AN A.C.-D.C. TEST UNIT

NEWNES

PRACTICAL MECHANICS

9^d

EDITOR: F. J. CAMM

APRIL 1950



The HAYDEN
PLANETARIUM
PROJECTOR

SEE PAGE 224

PRINCIPAL CONTENTS

A Novel Lathe Drive
New Hobbies for All
Making a Drilling Stand

The Hydrogen Bomb
Model Engineering Practice
Bridges and Bridge Design

World of Models
Queries and Enquiries
Cyclist Section

YOU NEED CLIPS

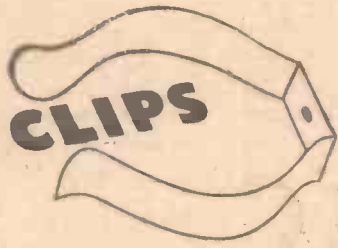

TERRY'S MAKE CLIPS

in every shape and size—steel clips, bronze clips, stainless clips, etc., etc.
 Here we show a tiny selection from the enormous range we have produced.
 Our Research Department can design any clip to your own specification.
 (94 years of clip-making experience is at your disposal.)

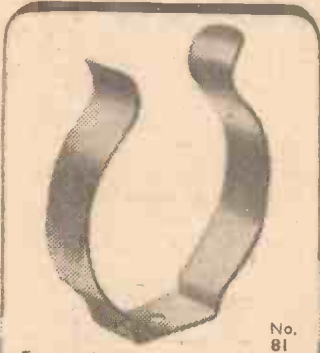

No. 81

Two popular types. In a range of sizes to grip from 1" to 2". Delivery from Stock.

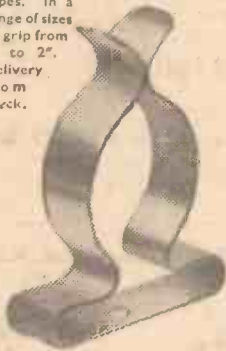

No. 80



No. 300

A drawing board clip. Plated finish, delivery from Stock. 4/- doz. plus P.T.

The most comprehensive and informative text book on springs yet published. 10/6 post free.

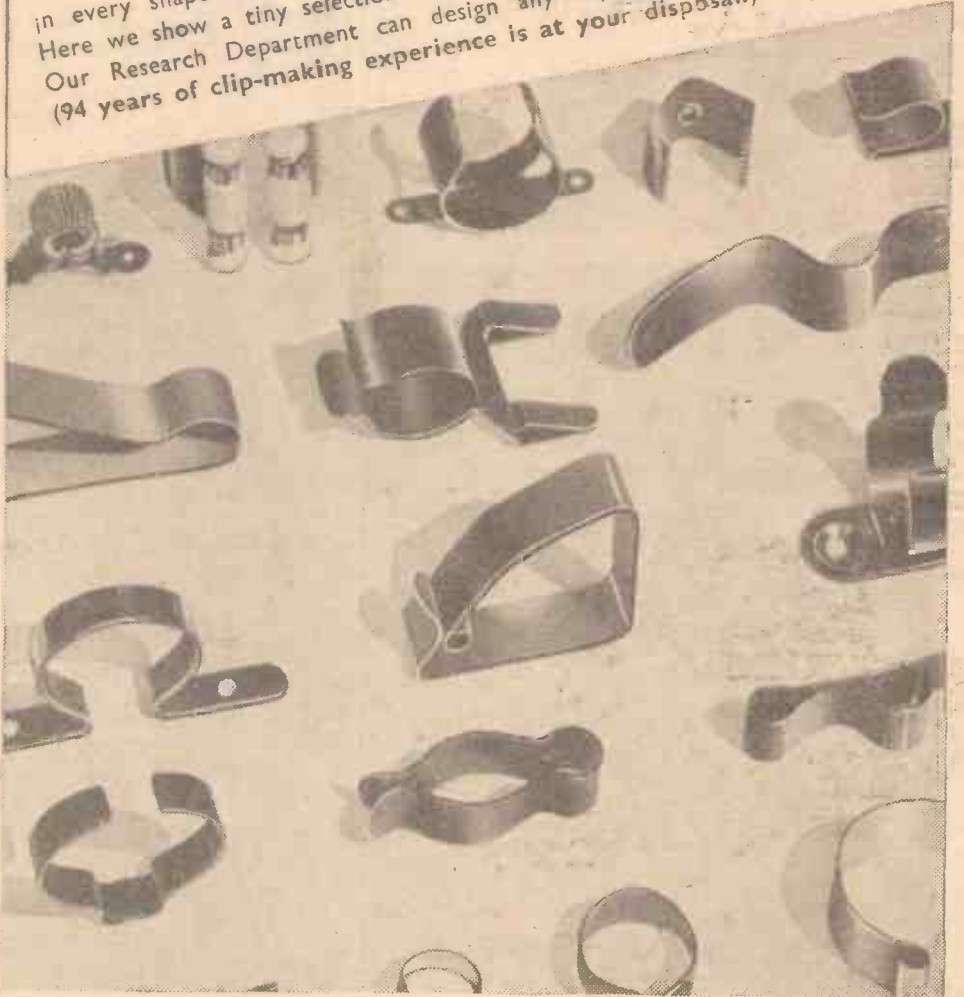

TERRY



Sole Makers:

HERBERT TERRY & SONS LTD. REDDITCH. London · Birmingham · Manchester

THE 'Zyto' 3³/₈ in. LATHE

BACK GEARED : SCREWCUTTING : SLIDING : SURFACING GAP BED : SET-OVER TAILSTOCK : COMPOUND SLIDE REST : ETC.
12¹/₂ in. BETWEEN CENTRES BRITAIN'S FINEST LATHE VALUE

£6/10/0

FIRST PAYMENT AND TWELVE PAYMENTS OF 35/10

CASH PRICE £25/10/0

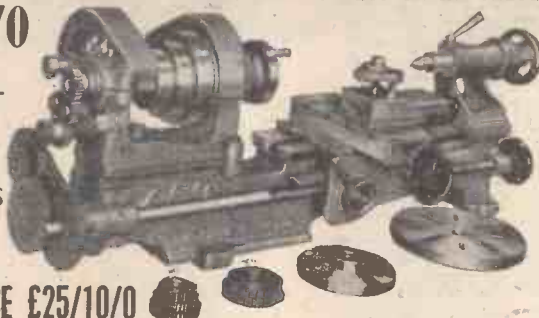

BRIEF SPECIFICATIONS :

HEIGHT OF CENTRES 3³/₈ in. DISTANCE BETWEEN CENTRES 12¹/₂ in.
HEADSTOCK MANDREL ADMITS 3/8 in. TAILSTOCK BARREL ADMITS 1/2 in.
HEIGHT FROM SADDLE 2 in. HEIGHT FROM GAP 4 1/2 in.



BOOK YOUR LATHE NOW

MOTORISED MODEL (complete on Stand)

FIRST PAYMENT £11/10/0
TWELVE PAYMENTS OF 62/4

Cash Price £45/10/0

Illustrated Leaflet and full details free on request.

MAY 8-19
CASTLE BROMWICH
BIRMINGHAM

SEE OUR EXHIBIT
STAND No. B.714

S. TYZACK & SON LTD.

WOODWORKING & METALWORKING TOOLS & MACHINERY MANUFACTURERS

341, 343 & 345, OLD STREET, LONDON, E.C.1

Telephone : CLERKENWELL 8301 (10 lines) Telegrams : TYZGAR AVE. LONDON

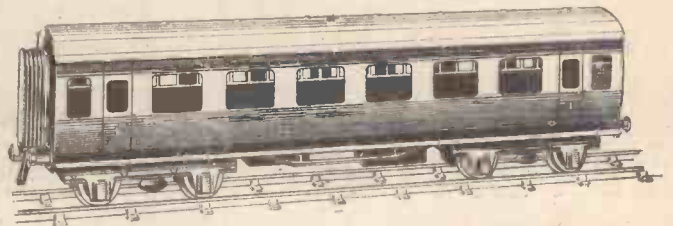

PASSENGER COACHES & ACCESSORIES

for your Gauge "O" Model Railway

BRITISH RAILWAY PASSENGER COACHES. First or Third-class corridor coaches and third-class composite brakes, finished in British Railways' colours. A new design compensating bogie is fitted, and the vehicles are supplied with corridor connections. These are the finest low-priced Gauge "O" passenger coach post war models and will be an attractive feature of your railway system. Price £2 4s., inc. P.T.

GOODS ROLLING STOCK IN STEEL. We have introduced three L.M.S. types, the brake van, a covered van, and a standard van. Fitted with correct type axle boxes, anti-friction metal wheels and standard couplings.

PRICES

Open van, 7/6, plus 1/8 purchase tax.
Covered van, 8/9, plus 1/11 purchase tax.
Brake van, 10/-, plus 2/2 purchase tax.

SIGNALS. Upper Quadrant Signals. All metal with balance-weights for hand or lever operation.

Single Arm, Home or Distant, 7/5, including purchase tax.
Double Arm, Home and Distant Arms, 9/11, including purchase tax.

Double Arm Signal, Home or Distant, 15/5, including purchase tax.
(These are supplied with either right- or left-hand brackets.)

COLOUR LIGHT SIGNALS, LOADING GAUGE, ETC. For details of these and all other accessories write for Gauge "O" Model Railway Catalogue, price 1/-, or call at our London or Manchester branches.

BASSETT-LOWKE LTD.

Head Office and Works :

NORTHAMPTON

London : 112, High Holborn, W.C.1
Manchester : 28, Corporation Street



If you have a camera send for this Trial Set of Chemicals

Doing the work yourself is half the fun of photography. You save money and have no end of a thrill in making the negatives and getting a few prints from them. It's quicker too. You see the results within a few hours of taking the snaps. Start, right away, by sending for this five shilling trial set. It comprises :—

- * 1-oz. (25 cc.) bottle of AZOL developer.
- * 4-oz. tin of Acid Fixing salts.
- * M-Q Pactums, print developer.
- * 1-oz (25 cc.) bottle of 142.
- * 25 sheets of Contact paper, 2 1/4 x 3 1/2 and the easy-to-follow HOME PHOTOGRAPHY instruction book which tells you how it is all done.

PRICE 5/-

Enclose P.O. Write your name and address in block capital letters and mark the front of the envelope PRACTICAL MECHANICS OFFER.

includes the purchase tax, packing and full postage.

HOME PHOTOGRAPHY

This 64-page book is sent separately if desired. It tells you how you can develop your films and how to make the prints from them. Gives all sorts of hints and dodges for getting good results. Send for a copy to-day. Enclose three penny stamps and mark your envelope PRACTICAL MECHANICS H.P. BOOKLET.

JOHNSONS OF HENDON, LTD., LONDON, N.W.4

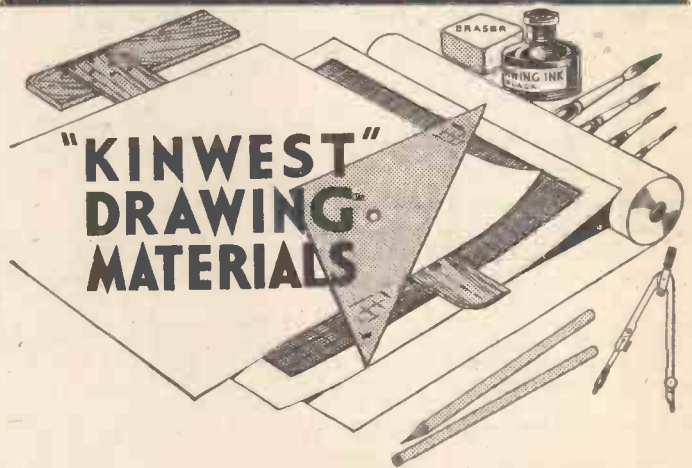

"KINWEST" DRAWING MATERIALS

We are the largest manufacturers of high-grade Drawing Instruments and Slide Rules in the British Empire, and our Kinwest Drawing Materials have gained a reputation throughout the world for superb quality and accuracy. Insist on using only Thornton's for complete satisfaction.

Our illustrated Catalogue, which includes particulars of Drawing Boards, Tee and Set Squares, Scales, Drawing Instruments, Curves, Protractors, etc., is sent Post Free on request.

A. G. THORNTON LTD

Drawing Instrument Specialists
WYTHENSHAW, MANCHESTER

Tel: WYThenshawe 2277 (4 lines)

I.C.S. TRAINED MEN are in Greater Demand than Ever—Maximum production depends on high technical skill, such as that acquired by I.C.S. Students

TENS OF THOUSANDS MORE
TRAINED MEN ARE URGENTLY
NEEDED NOW—BUT THERE IS
NO WORTH-WHILE PLACE FOR
THE UNTRAINED

*Ambitious men everywhere have succeeded through
I.C.S. Home-Study Courses. So also can you.*

The man with an I.C.S. Training in any one of the subjects listed below knows it thoroughly, completely, practically. And he knows how to apply it in his everyday work.

- | | | |
|-------------------------|--------------------------|-----------------------|
| Accountancy | Diesel Engines | Mining Engineering |
| Advertising | Draughtsmanship | Motor Engineering |
| Aero Engineering | Drawing Office Practices | Motor Mechanic |
| Air and Vacuum | Electrical Engineering | Motor Vehicle Elec. |
| Brakes | Electric Power, Light- | Municipal Eng. |
| Air-Conditioning | ing, Transmission | Plastics |
| Architecture | Traction | Plumbing |
| Architectural Drawing | Eng. Shop Practice | Quantity Surveying |
| Auditing | Fire Engineering | Radio Engineering |
| Boiler Engineering | Foremanship | Radio Service Eng. |
| Book-keeping | Free-Lance Journalism | Refrigeration |
| Building Construction | Fuel Technology | Sales Management |
| Building Specifications | Heating and Ventilation | Salesmanship |
| Business Training | Hydraulic Engineering | Sanitary and Domestic |
| Business Management | Hydro-Electric | Engineering |
| Carpentry | Illumination Eng. | Sheet-Metal Work |
| Chemical Engineering | Industrial Management | Short-Story Writing |
| Chemistry, I. & O. | Joinery | Steam Engineering |
| Civil Engineering | Lettering | Structural Steelwork |
| Clerk of Works | Machine Designing | Surveying |
| Coal Mining | Machine-Tool Work | Telegraph Engineering |
| Colliery Examiner's | Marine Engineers | Television Technology |
| Colliery Overman's | Mechanical Drawing | Welding, Gas and Elec |
| Commercial Art | Mechanical Engineering | Woodworking Drawing |
| Concrete Engineering | Mine Surveying | Works Engineering |

And most of the Technical, Professional, Commercial and Civil Service Examinations; also U.C.T.A. Exam. in Salesmanship.

(I.C.S. students preparing for Examinations are coached till successful)

If you need technical training, our advice on any matter concerning your work and your career is yours for the asking—free and without obligation. Let us send you our special free booklet on the subject in which you are specially interested, DON'T DELAY. Make ACTION your watchword

The successful man DOES to-day what the failure INTENDS doing to-morrow. Write to us TO-DAY

Use this Coupon

INTERNATIONAL CORRESPONDENCE SCHOOLS LTD.

Dept. 95, International Buildings, Kingsway, London, W.C.2.

Please send me the free booklet describing your Courses in

Name..... Age.....
(USE BLOCK LETTERS)

Address.....

Addresses for Overseas Readers

- Australia: 140, Elizabeth Street, Sydney.
- Egypt: 40, Sharia Abdel Khalek Sarwat Pasha, Cairo.
- Eire: 13, Anglesea Street, Dublin, C.4.
- India: Lakshmi Bldgs., Sir. Pherozsha Mehta Rd., Fort Bombay.
- New Zealand: 182, Wakefield Street, Wellington.
- N. Ireland: 26, Howard Street, Belfast.
- South Africa: 45, Shortmarket Street, Cape Town.



M.O.S. MAIL ORDER SUPPLY CO.

AC REVERSIBLE INDUCTION MOTORS

Illustration shows a 50 v. 50 c/s. 3 phase motor rated at 1/2 h.p., sturdily constructed and rated for continuous use. By means of the resistor and condenser included with the motor, it can be operated from the standard 200-250 A.C. mains supply.

Full wiring instructions are given together with details of securing rotation in either direction. Reversing switch 2/- extra.

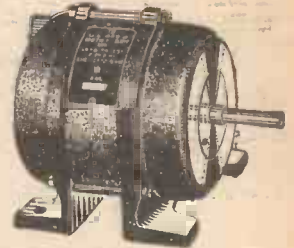

Price 30/- Carr. Paid

MORSE PRACTICE OSCILLATOR

A battery-operated Morse training unit complete with modulation and interference circuits, incorporating note selector control, phone, key, and interference jacks. Size 9in. by 8in. by 8in. Power supply required: H.T. 60 v., G.B. 4 1/2 v., L.T. 2v. Provision for fitting batteries inside case, complete with 2 valves, and 12 months' guarantee. 27/- packing 2/6

D.C. 'STEP-UP' GENERATOR

A universal purpose motor generator, fully guaranteed, brand new, and in original maker's cartons. This unit can be driven from D.C. voltages from 2 v. to 14 v. and will give varying outputs according to the input voltage. For example: at 6 v. D.C. input an output of 240 v. 30 m.a. will be obtained; at 4v. D.C. input—180 v. 25 m.a.; at 12 v. D.C. input—480 v. 40 m.a. The motor will also provide sufficient power for use as a grinder, polisher, etc., as spindle protrudes 1in. from the casting—sufficient length for mounting these. Approximate r.p.m. at 12 v. D.C. input is 2,000 (varying according to the applied voltage). The cost of manufacturing these useful motor generators was approximately 25 to 29. EACH ONE CARRIES FULL GUARANTEE.

PRECISION LIFTING GEAR

A worm-driven unit originally designed for lifting bombs into aircraft. Can either be operated by hand or motorised. A non-slip clutch is incorporated in the gear unit and the steel lifting hawsers are capable of carrying a load of over 12 cwt. with a lift of over 7ft. The whole unit is brand new and is supplied complete with cables and shackle bolt in original packing. Motor, aircraft, and engineering organisations have a host of uses for this lifting gear, which was built for the Air Ministry regardless of cost. Prices on application according to quantity.

USEFUL HEADLAMP SET

Fits comfortably round the head like a miner's lamp, with long lead and battery box to clip on belt, or slip into pocket, leaving both hands free. Works off standard 4.5 v. battery. Complete with bulb, clips, headband, etc.

NEW and UNUSED 5/11 post free or with battery, ready for use, 7/11

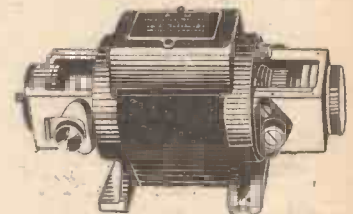

OUR PRICE 8/11 Post and packing 1/1

Mail Order Supply Co., 33, TOTTENHAM COURT ROAD, LONDON, W.1. 'Phone: MUSeum 6667-8-9

For Perfect Playing



Steel needle after one playing.

S. G. BROWN Precision SAPPHIRE NEEDLES

The ideal reproducing medium for gramophone records. They give high fidelity reproduction with the minimum wear on the record.

The enlarged photographs were taken after laboratory tests using a standard light-weight pick-up with a pressure at needle point of one and one third ounces.

There are five types available and they are designed and manufactured to suit all types of pick-ups.

TYPE NO. 5. "Miniature Solid Sapphire" Needle for use with light-weight pick-ups.

This S. G. Brown needle gives a definite improvement in fidelity of reproduction due to its homogeneous nature.

PRICES. Nos. 1-4 10/1 each. No. 5 13/4 each.

Your local dealer can supply. In cases of difficulty, apply direct.
* * * * *

A "TIP" WORTH TAKING

An interesting and instructive Brochure giving technical details, valuable information and advice on the choice of an S. G. Brown Sapphire Needle to suit your pick-up, will be sent on request. Write Dept. "N".



Sapphire needle after two thousand playings.

Telephone: Watford 7241.
S. G. Brown, Ltd.
SHAKESPEARE STREET, WATFORD, HERTS.

10 Halden Branches are ready to deal with your Photo Copying on the spot

Every Halden branch is fully equipped and ready to produce photo copies of plans, deeds, documents, etc., by any of the usual processes. To the larger user, Haldens offer a range of the most modern equipment for the production of their own photo copies. In connection with the production of maps, Haldens are licensed by the Controller of H.M. Stationery Office to reproduce Ordnance Survey Maps in one colour.



J. HALDEN & Co., 8, Albert Square, MANCHESTER, 2
Branches at : London, Newcastle-on-Tyne, Birmingham, Glasgow, Leeds and Bristol.

One plastic material

MAKES MANY PERMANENT MODELS

and utility objects, from simple instructions in illustrated Booklet—please read below.



ONLY 4D IN STAMPS BRINGS BOOK

... showing how such models as those above, and many others, can be made, without skill or special tools, from Sankey's PYRUMA Plastic Cement. Ready for immediate use in its plastic state, Pyruma sets or bakes to stone-hardness, and can be painted or enamelled in all colours according to instructions. Therefore realistic natural-colour models can be made from Pyruma, including

HOUSES, BUILDINGS FOR MODEL RAILWAYS, DOCKS AND AIRPORTS, SHIPS, MODEL FURNITURE, ANIMALS, FIGURES, RELIEF MAPS, Etc. as well as utility objects such as ASH TRAYS, BOOKENDS, MENU HOLDERS, PAPER WEIGHTS, ORNAMENTS and DECORATIVE OBJECTS.

Pyruma is inexpensive, and easily obtainable in tins from Iron-mongers, Art Material Dealers and Hobbies Shops. Send 4d. in stamps to the address below for illustrated Instruction Book.



Dept. 4

J.H. SANKEY & SON, L^{TD}

ILFORD

EST. 1857

ESSEX

5 YEARS' GUARANTEE

Given with all our panel heaters which will give a lifetime of comforting service in your home or business. Safe as hot-water radiators. Size 14in. x 12in. x 3in. Will stand on floor or can be mounted on wall or moved from room to room—suitable for A.C. or D.C. mains—cast construction finished Black Japan. **GENERAL MODEL** (90 watts) consumes just under one unit per hour. Ideal for shops, garages, stores and offices, workshops, cabins, greenhouses, etc. **MEDIUM MODEL** (50 watts), 1-unit per hour. Ideal for bedrooms, nurseries, halls, etc. **FOOT-WEARMER MODEL** (200 watts), real morate raiser if fitted under desks, or for airing cupboards, etc. Unrepeatable Value, 23/6 each, plus 4/6 carriage.

HOUSE TELEPHONES WALL OR DESK MOUNTING

Suitable for intercommunication between Offices, Workshops, Stores, Garages, big Houses, Kitchens, etc. Each station consists of normal size Bakelite handsets as illustrated, and desk or wall mounting cabinet with built-in Selector switch, buzzer and push. All stations can communicate with one another independently. Each installation is absolutely complete and internally wired. All you do to instal is to run the multi-core cable between stations. 3-station installation complete with 50 yds. 5 core cable, £6/10/0. Ref. 318. 4-station installation complete with 50 yds. 6 core cable, £8/10/0. Ref. 319. 2-station installation complete with 35 yds. 4 core cable, £3/17/6. Ref. 320.

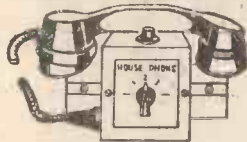

TELEVISION We have two proved circuits to offer. (a) V.D. Mark II This is built from ex-R.A.F. units and total cost is £15/5/0. Data only 7/6. Knowledge of theory necessary. (b) The H & O Magnetic Television—uses Standard Black and White—9, 10 or 12in. magnetic tube and all basic components—cost is £20 plus tube. Data are available for the novice who knows nothing. Price 5/-. Leaflet Free.

ALL MAINS TWO-VALVE RADIO To receive medium waves (Home and Light programmes) and short waves. Ex-R.A.F. Unit "T" contains 2 valves and all necessary parts—only extra is Headphones. Full details and mods. for Loudspeaker free. Send to-day 19/6 (plus 2/6 post and insurance) for Unit "T." Headphones 6/6 per pair.



6-VALVE BATTERY RECEIVERS complete with 2 H.F. pentodes—3 triodes and 1 output valve—in good condition. Ready to operate soon as batteries and phones are connected. Cover short wave band 4-9 mc/s. 23/6, plus 2/6 carriage.

MAINS/BATTERY MOTOR FITTED WITH GEARBOX Ideal for driving large-sized models or with gearbox removed for operating a small buffing wheel, or similar. These motors measure 7in. x 3in. high. they will run off D.C. between 6 and 24 volts or from A.C. or D.C. mains, any voltage. Speed is 2,000 revs. approximately. Price 15/- post free. Order item No. 134.

VALVES AND SPARES. Big range available at cut prices. Absolute satisfaction guaranteed or money refunded.

ELECTRONIC PRECISION EQUIPMENT

(I Electron House)

WINDMILL HILL, RUISLIP MANOR, MIDDLESEX.

GALPINS

ELECTRICAL STORES

408 HIGH STREET, LEWISHAM, LONDON, S.E.13

Telephone: Lee Green 0309 Near Lewisham Hospital. THURSDAY EARLY CLOSING. TERMS: CASH WITH ORDER. NO C.O.D.

PRE-PAYMENT II-SLOT ELECTRIC LIGHT CHECK METERS, all electrically guaranteed, 200/250 v. 50 cys. 1 ph. A.C. input, 2 1/2 amp. load, 27/6 each; 5 amp. load, 35/- each; 10 amp. load, 42/6 each; 20 amp. load, 50/- each; carriage 2/- extra, in quantities of 1 dozen or more a special discount of 10 per cent.

MAINS TRANSFORMERS, 200/250 v. 50/11 ph. in steps of 10 v., output 500/1500 v. 300 Mlamps., 6.3 v. 8 a., 6.3 v. 8 a., 6.3 v. 4 a., 5 v. 4 a., 4 v. 4 a. at 47/6 each, another same input, outputs, 450/1450 v. 300 Mlamps., 6.3 v. 8 a., 6.3 v. 8 a., 4 v. 4 a., 5 v. 4 a., at 42/6 each.

ELECTRIC LIGHT CHECK METERS, quarterly type, for sub-letting garages, apartments, etc., all fully guaranteed electrically, for 200/250 v. A.C. mains, 50 cys. 1 phase, 5 amp. load, 17/6 each; 10 amp. load, 20/-; 20 amp. load, 25/- each; 50 amp. load, 37/6 each; 100 amp. load, 45/- each, carriage 2/- extra on each. Special discount of 10 per cent. on quantities of 1 dozen or more.

RESISTANCE (DIMMERS) 700/750 watts, worm wheel control, as new, 27/6 each, carriage 2/-, total resistance 60 ohms. **MAINS TRANSFORMERS INPUT 200/250 VOLTS**, 50/11 in steps of 10 v. output tapped 0, 12 at 24 v. at 10/12 amps., 47/- each; ditto as above, but at 25/30 amps. output, 68/6 each.

MAINS VARIABLE SLIDER RESISTANCES protected type by well-known makers, 450 ohms 9 amps., 22/6 each; ditto 1,500 ohms to carry 45 amps., 22/6 each, not protected, 0.4 ohms to carry 25 amps., 10/- each; 14 ohms to carry 1.4 amps., 12/6 each; 5.7 ohms to carry 8 1/2 amps., 15/- each; 60 ohms to carry 1 1/2 amps., 15/- each.

PRE-PAYMENT II-SLOT METERS for 230 v. D.C. Mains 10 amp. load calibrated 3d. p.u. as new, electrically guaranteed, 38/- each cfl.

CELL TESTING VOLT-METERS, moving coil reading 3-0-3 v. by well-known makers, complete with test leads, 7/6 each. **STUD SWITCH-ARM VARIABLE RESISTANCES**, 2,700 ohms to carry 0.27 amps., 17/6 each; another 10 ohms to carry 9/18 amps., 35/-, both these can be used as dimmers. Fixed wire wound Resistances 350 ohms to carry 1/2 amp., a slider can easily be fitted, 5/- each.

EX - GOVERNMENT AUTO - WOUND TRANSFORMERS (as new) 1,000 watts output, 115/230 v. or vice versa, £4/10/- each, carriage 5/-. Another 1,000 watts from 5 to 230 v. with 32 various tappings inclusive of 110, 150, 60, 90, etc., etc., all tapping at 1,000 watts, £5/10/- each, carriage paid.

D.C. MOTORS, 110/230 v. rated at 1 1/2 h.p., with laminated fields, suitable when fields are rewound for A.C. mains, 17/6 each; ditto half the above size, 10/- each; another 100 v. D.C. approx. 1/8 h.p. shunt wound solid field 1,500 r.p.m., 10/- each.

EX-R.A.F. MICROPHONE TESTERS, these contain a 2 1/2 in. scale 0 to 450 Micro-amp Meter shunted to 1 Mamp. calibrated 0 to 10 v. Moving Coil, complete with 1 M/a Rectifier. "Mike Transformer," etc., all contained in polished wood box, as new, 17/6 each.

EX-NAVAL SOUND POWER TELEPHONE Hand-sets comprising earphone and microphone, no batteries required, complete with wall brackets, as new, 15/- per pair, 1/6 post.

MAINS TRANSFORMERS, 230 v. A.C. 50 cys., input 17 1/2 v. 50 amps. output, 52/6 each, carriage 5/-. Another auto wound, output 14 and 17 v. output at 30 amps., 35/- each, carriage 3/6. Another with 2 1/4 v. 20 amp. windings, 25/- each, Pfl.

EX-NAVAL ROTARY CONVERTERS 220 v. D.C., input 50 v. 3 phase, 50 cycles, at 3 1/2 amps. output, 55/- each, carriage 5/-. **MAINS TRANSFORMERS**, 230 v. 50 cys., 1 phase input, 700/1700 v., 70 Mlamps., 4 v. 2 amps., 12 v. 1 amp. output, 25/- each, post 1/6. Another Auto wound "Booster" Transformer tapped 0, 200, 215, 235, 250 and 465 v. at 1.25 amps., 16/6 each, carriage 1/-.

ALL GOODS SENT ON 7 DAYS' APPROVAL AGAINST CASH; all letters answered. We regret we have no lists available at present. We would be pleased to quote.

BRASS DIVIDERS

Heavily made. Will stand 8in. 6in. lifetime's use. At less than half-manufacturer's price. **3/6 2/9** Post 6d.

RHEOSTAT TYPE K

High quality circular rheostat suitable for 6-24 V working. Makes a good control for electric model railways and all other low voltage work. Is a useful dimmer. **5/3** Post 9d.

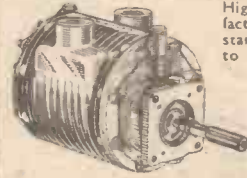

VACUUM PUMPS
High quality Air Ministry pump by leading British manufacturers 2in. Splined shaft 1in. diameter, inlet and outlet standard gas thread. Weight 5 1/2 lbs. Requires at least 1 h.p. to drive. Flange mounting and has numerous industrial and workshop uses. Dimensions approx. 6in. x 4in. x 4in. (Post and Packing 1/6). **25/-**

TANK COMMANDER'S PERISCOPE

Ideal for race meetings, etc. 10ins. long. Large wide-angle object glass giving fine field of view. Light construction, easy to hold up. Good finish. A fine, high quality optical instrument with binocular vision. (Post 1/6) **15/6**

CHARTBOARD

Parallel arms, rule and protractor, 17in. square. Makes a handy small drawing machine and is constructed to rigid A.M. standards. A hinged perspex cover for tracing, etc., is included. **25/-** Post 1/3.

DISTRIBUTOR PANEL

This instrument makes high quality timing device for dark rooms, laboratories, experimental works, etc. All gears are of the finest quality and intervals between impulses can be adjusted over a large range; limited quantity only. Supplied in fitted wooden transit case together with blueprint for its conversion to a dark-room (Carriage Paid) **26/6**

230V. MINIATURE MOTORS

These motors will run from 200/250 v. 50 cycle, A.C. mains. Made by Sangamo for electric meters, and now surplus to meter manufacturers' requirements. Dimensions of motor 1 1/2 ins. diam. by 1 1/2 ins. depth. Weight only a few ounces, but rigidly constructed. Self-starting, no shunt or resistance necessary in circuit. Motor supplied with 1in. geared shaft and three small feet for fixing, or mounted on base-plate, 2 1/2 ins. sq. with long chain of reduction gear wheels. Brand New. Motor only 12/6, or with base-plate and reduction gearing (as illustrated), post free. **15/-**

AERO SPARES CO.

(Dept. 78), 71, HIGH HOLBORN, LONDON, W.C.1
Write today for our list 202
Tel.: AMBassador 2871-2 (all depts.)

MYFORD WOODWORKING LATHE

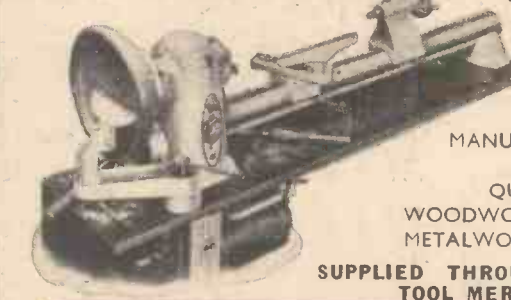

TYPE ML8

MANUFACTURERS OF QUALITY WOODWORKING AND METALWORKING LATHES. SUPPLIED THROUGH LEADING TOOL MERCHANTS

MYFORD-ENGINEERING COMPANY LIMITED
BEESTON NOTTINGHAM Phone: 54222 (3 lines)

08.101

YOU

can become a first-class RADIO ENGINEER

We are specialists in Home-Study Course in Radio Engineering, Servicing, Transmission, Television, Mathematics and Radio Calculations.

T. & C. RADIO COLLEGE

To: R. Heath Bradley, T.C.R.C., 50, Harland Road, Southbourne, Bournemouth.

Name.....
Address.....
M.58

(Post coupon in unsealed envelope -1d. Postage.)



TABLE FANS

By G.E.C., brand new, 200 to 240 volts A.C. 0.125 amps, with guard. Weight 16lbs., 12in. sweep, overall diameter 14in. Complete in all respects, including speed control. Worth £7 each. A.C. Carriage and Packing, 2/6. **70/-**

Modelmakers,

there is something of interest to all of you in the

MODEL CRAFT MAGAZINE

JUST OUT No. 13, Vol. 3

Contents include:

- Why do I make models? by K. N. Harris
- Origin of the Junk & Sampan by James Hornell
- The Vertical Method of Yacht Hull Construction by B. Reeve
- Flags on Ship Models - Part IV: Naval Flags and Codes by Alec Purves
- A West Midland Loco Yard by Edward Beal
- Magnetic Miniatures

Issued Quarterly. Price 11/-, or 4/6 per annum post free. From your Model shop or direct.

If you have not yet seen this informative little magazine, send 6d. for a specimen back number.

MODEL CRAFT LIST. Price 11/-. Lists over 600 plans, planbooks, kits and accessories, and includes a 1/- refund voucher for use in purchasing 'Modelcraft' goods.

MODEL CRAFT LTD.

77 (L), Grosvenor Rd., London, S.W.1.

FRACTIONAL H.P. EX-R.A.F. 1 1/2 H.P. BRAND NEW, ELECTRIC MOTORS made by Hoovers.

EACH ONLY 37/6 Carr. 2/6

Not to be confused with smaller cheaper types. Size 1 1/2 in. x 5 1/2 in. x 5 1/2 in. Weight 18lb. Volts 200, 250 A.C. or D.C. 2,000 r.p.m. Ideal for Polishing, Grinders, etc. Existing Spindle 1/2 in. diam., 1 1/2 in. long. All-purpose Extn. Spindles to screw on, 7/6 pair extra.

EX-ARMY HEADPHONES, BRAND NEW AND BOXED. Ideal for Crystal or Valve Sets, Hospitals, etc. Post Free 5/6. **10/-** Per Pair. Insts: Bal. Arm Units; Reed Drive Corrug. Diaphragms; Dble. B. Bands; 8ft. Cords and Plug. Worth about 42/- pr. Also makes Boys' Tel. Set by connecting earpieces to flex. Send id. S.A.E. for Radio Elec. List.

EX-GOVT.

ELEC. LAMP BULBS

Brand New, ex-R.N. and R.A.F. Ring makes, less than half price. Abbreviations: v. = volts; w. = watts; T. = tubular bulb; R. = round bulb; Os. = Osram; Maz. = Mazda; Sle. = Siemens; Ed. = Ediswan. Postage extra.

Fitted Medium Prefocus Cap.:
10v. 240w. R. Os.; 11v. 264w. R. Os.; 12v. 240w. R. Sle.; 20v. 240w. R. Sle.; 24v. 240w. R. Maz.; 24v. 250w. T. Maz.; 28v. 240w. R. Sle.; 32v. 250w. R. Maz.; 110v. 240w. R. Maz.; ALL AT 10/- each.
12v. 100w. T. Sle.; 12v. 100w. R. Ed.; 30v. 100w. T. Maz.; 100v. 100w. T. Os.; 110v. 100w. T. Os.; 220v. 100w. T. Os. ALL AT 7/6 each.

Fitted Goliath Prefocus Cap.:
350w. R. Maz.; 12/6; 24v. 400w. T. Os.; 10/-; 28v. 350w. R. Maz.; 12/6; 110v. 1,000w. T. Ed. 15/-.

Fitted Sperry Prefocus Cap.:
2,500w. T. Sle. 20/-; 80v. 1,600w. T. Maz.; 7/6; 105v. 500w. T. Sle. 15/-.

ALDIS (Spec. Ftg.): 12v. or 24v. 36w., 2/6. Also 80v. 3,000w., or 10,000w. G.E.S. Os., £2 or £5; 230v. 3,000w. Bipse Maz. £2. Send 1d. S.A.E. for List of 150 other types, 2v. to 230v., for Boats, Cars, Mines, Workshop, etc.

AUTO COLLECTIONS LTD.

15, Lawrence Street, Northampton.

"DUREX" AIDS ASSEMBLY AND REPAIR



"DUREX" HELPS IN THE DRAWING OFFICE — ALSO REPAIRS TORN & DAMAGED PLANS



"DUREX" Tapes it easy! Holds tracings to the board! Mends torn plans invisibly! Aids the model builder in assembly or repair! Clean to handle, transparent as glass, and housed in its own self-dispenser!

Trade enquiries:
Durex Abrasives Ltd., Birmingham, 8

"DUREX" Cellulose TAPE



ANTI-VIBRATION MOUNTINGS

Rubber Metal - bonded



A useful mounting that will be found invaluable in the installation of machines, equipment, instruments, electrical apparatus, motors, etc., and wherever complete elimination of vibration is essential.

Can be mounted to take an 8lb. load in any position.

Gives flexibility in all directions.

Box of 10 Mountings
2/6 Post Free
(Dept. P.M.)

WIRELESS INSTRUMENTS (LEEDS) LTD
54-56, The Headrow, Leeds
Tel: 22262

PAINT SPRAYING

"COMPTON"

PORTABLE OUTFITS FOR FLAT OR GLOSSY PAINTS, ENAMELS, DISTEMPERS, etc.



Type D.P.F.

| | |
|---|---------|
| AS ABOVE, A.C. MOTOR WITH J.A.P. PETROL ENGINE | £31.0.0 |
| D.C. OR UNIVERSAL MOTOR | £43.0.0 |
| 2 GALL. PRESSURE POT | £35.0.0 |
| MARK II SPRAY GUN FOR CELLULOSE MI HAND-OPERATED SPRAYING OUTFIT | £2.1.6 |
| GFA SPRAY GUN. Gravity Feed with 1/2 pint aluminium container. Handles stains, cellulose, enamels, ordinary paint, etc. | £8.1.6 |
| SPARK PLUG SPRAY. OUTFIT. Works from motor car engine, complete and ready for use with MARK II.H. Spray Gun | £6.5.0 |
| PRESSURE GAUGE. 1 1/2 in. dia. 0-75 lbs. sq. in. | £3.1.0 |
| | 12.6 |

Details of other spray guns, air compressors and vacuum pumps gladly sent on request —direct or from your local dealer.

STOCK DELIVERY

ONE YEAR'S GUARANTEE • EXPORT ENQUIRIES INVITED

DAWSON, McDONALD & DAWSON
COMPTON WORKS, ASHBOURNE, ENGLAND

Telephone: ASHBOURNE 113

CHEMICAL APPARATUS CATALOGUE

POST 2/6 FREE

The Abridged Chemical List S.A.E.

VICSONS LTD
148 PINNER RD. HARROW, MIDDLESEX.
FOR ALL LABORATORY APPARATUS

Contractors to Education Authorities and many of the large industrial laboratories

SCHOOL and RESEARCH LABORATORIES

have you yet had our illustrated catalogue?

If not write for a copy to-day (free)

HAND BENCH DRILLING MACHINES

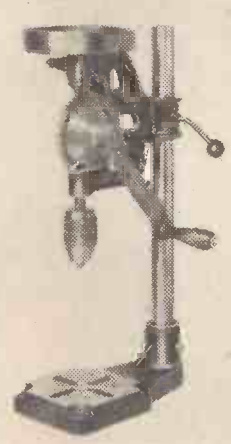

These British machines have adjustable automatic feed to spindle, with quick return. The precision ground spindle is fitted with ball thrust and 0-1/2 in. chuck. The large gear runs on self-oiling bearing. Chuck to machined base, 0-9 inches. Weight 18 lbs.

Price 39/6
Carriage 2/6

R. ELLIOTT,
86, GOULD RD., TWICKENHAM

MONTHLY NEWSLETTER



Redbrook Works,
Gawber,
BARNLSLEY.

April, 1950.

HUMAN STORIES

Through the various channels we traverse in the course of modern business we have made many friends in the true sense of the word. Their letters tell us of their ambitions, work and even frustrations; every post adds another chapter to the fascinating daily log of contacts everywhere.

During recent months these confidences have taken a new turn, a more intimate note of domesticity has crept into our post bag. The reason is not far to seek—our Personal Hire Purchase Plan. These unsolicited confidences serve to make us feel very humble, they give one a heavy responsibility in sharing another's hopes. To the cynical they may not seem very world-shaking—"A" cannot see his way to paying for his lathe and the required accessories at one time; "B" knows he can manage "EX" every month, but is not sure about "EY"; "C" doesn't see why he should make heavy inroads on savings which are so hard to replace.

Fortunately, our P.H.P. Plan is a flexible instrument and well able to cope with all rational proposals. Perhaps you can now appreciate why we prefer to give individual quotations against customers' own list of requirements.

Another excellent service is our express delivery to customers overseas. Every day sees a batch of Air Mail Quotations going out for equipment and machinery to all parts of the world. Nearer home we have another innovation—EXPRESS CASH SALE SERVICE—this began quietly in December last and is proving a great success. Briefly, providing your order is for stock items and is accompanied by remittance (including carriage) we guarantee to despatch the same day. Experience shows that some 85 per cent. of orders are enjoying this rapid handling.

A final reminder—do send for those new MYFORD price lists today—they're quite free.

Yours Sincerely
T. GARNER & SON LIMITED
G. Adkins
Hand & Machine Tool Division

FREE! TO AMBITIOUS ENGINEERS

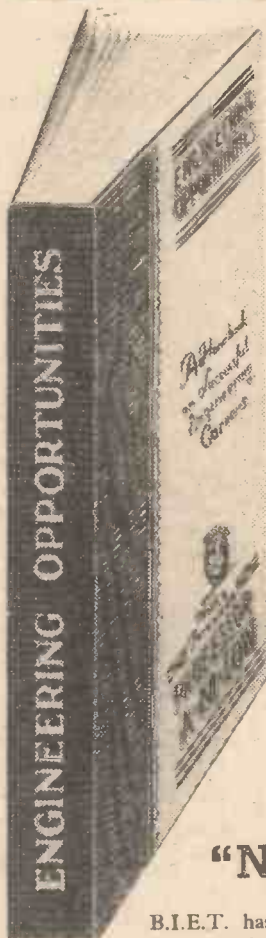

This enlarged and entirely new edition of the valuable Handbook "ENGINEERING OPPORTUNITIES"

For 21 years this unique book has been a guiding light to Engineers all over the world. More than 1,000,000 copies have been distributed . . . there have been 104 editions. Still the demand continues! After months of research, we have been able to produce a better and even bigger "ENGINEERING OPPORTUNITIES" packed from cover to cover with vital, up-to-the-minute information that every engineer requires—information you must have if you want rapid promotion, higher pay, and one of the many worth-while appointments open to technically trained men.

176 PAGES OF PRACTICAL GUIDANCE

"ENGINEERING OPPORTUNITIES" explains the modern, quick way of preparing in your spare time for recognised engineering examinations, outlines hundreds of examination and non-examination courses in all branches of Engineering, describes the benefits of our Employment Dept., and enables you to visualise a secure, better paid and more important position for yourself.

We definitely Guarantee "NO PASS—NO FEE"

B.I.E.T. has helped thousands of ambitious men. We can and will help you. It will cost you no more than a stamp to inquire, and in any case "ENGINEERING OPPORTUNITIES" is well worth having. It will reveal many opportunities you are now missing and, if you are earning less than £10 a week, will be of special interest to you. Make sure of your FREE copy by posting the coupon now.

POST THIS COUPON TODAY!

(Write if you prefer not to cut page)

Please send me FREE and entirely without obligation a copy of the new and enlarged edition of "ENGINEERING OPPORTUNITIES."

NAME

ADDRESS

I am interested in

(State subject, exam., or type of appointment that appeals to you.)

BRITISH INSTITUTE OF ENGINEERING TECHNOLOGY
410A Shakespeare House, 17-19 Stratford Place, London, W.1

WHICH IS YOUR SUBJECT?

Mechanical Engineering
A.M.I.Mech.E.—CITY & GUILDS—General Mechanical Eng.—Maintenance Eng.—Diesel Eng.—Sheet Metal Work—Welding—Metallurgy—Machine Drawing & Design—Refrigeration, etc.

Electrical Engineering
A.M.I.E.E.—CITY & GUILDS—General Electrical Eng.—Installations—Illuminating Eng.—Electrical Science—Electricity Supply—Meters & Measuring Instruments—Mains Eng., etc.

Radio & Television
A.M.Brit.I.R.E.—SERVICING CERTIFICATE—C. & G. Telecommunications—General Radio Eng.—Radio Servicing—Television Servicing—Sound Film Projection—Electronic Eng., etc.

Production Engineering
A.M.I.P.E.—Works Management—Foremanship—Staff Supervision—Planning Eng.—Costing, etc.

Automobile Engineering
A.M.I.M.I.—CITY & GUILDS—General Automobile Eng.—Automobile Repairs—High Speed Diesels—Garage Management, etc.

Building & Civil Engineering
A.M.I.C.E.—F.R.I.C.S.—L.I.O.B.—General Building—Architectural Drawing—Sanitary Eng.—General Civil Eng.—Surveying—Specifications & Quantities—Heating & Ventilating—Painting & Decorating—Plumbing—Carpentry & Joinery—Timber Technology, etc.

PLASTICS—DRAUGHTSMANSHIP—AERONAUTICAL ENG.—FORESTRY
SOME LETTERS AFTER YOUR NAME
A.M.I.Mech.E. A.M.I.E.E. A.M.I.C.E.
F.R.I.C.S. A.M.I.Struct.E. L.I.O.B.
A.M.Brit.I.R.E. A.F.R.Ae.S. A.M.I.P.E.
HUNDREDS OF OTHER COURSES
(Tell us what interests you)

BIET

THE B.I.E.T. IS THE LEADING INSTITUTE OF ITS KIND IN THE WORLD

PRACTICAL MECHANICS

EDITOR
F. J. CAMM

APRIL, 1950
VOL. XVII. No. 198

Owing to the paper shortage "The Cyclist," "Practical Motorist," and "Home Movies" are temporarily incorporated.

FAIR COMMENT

"PRACTICAL TELEVISION"—OUR NEW COMPANION JOURNAL

THE first issue of our new companion journal, PRACTICAL TELEVISION, which costs 9d. monthly, was published on March 23rd. Hitherto issued as a monthly supplement to PRACTICAL WIRELESS, its issue as a separate identity coincides with the commencement of television developments throughout the country, of which the opening of the Sutton Coldfield station on December 17th, 1949, was the precursor. At present there are about one million viewers in this country located within an area of five thousand square miles, divided between Alexandra Palace and Sutton Coldfield areas. Although this service area is considered to be bounded by a circle of twenty-five miles radius with the transmitting stations as the centre, good reception has been recorded from localities outside the fringe area. Within the next five years many other stations will be erected so that finally the whole country will be able to enjoy the benefits of this modern marvel of science.

It is a remarkable fact that as long ago as 1884, Paul Nipkow demonstrated the practicability of the scanning disc as a basis for radio vision. He used shadowgraph transmitters and his experiments showed that although he was ahead of his time, television was a possibility of the future. These experiments he continued until the end of the last century, but it was not until twenty years later that the late John Logie Baird carried the experiments further, being enabled to do so by the developments in neon lamps, electric motors and radio, which were not available to Nipkow.

The first television programmes in the world were radiated under the Baird system on thirty lines. High definition television as used to-day employs, of course, a totally different technique, and for all practical purposes the Baird era is at an end. Baird did, however, awaken interest in radio vision and, but for his experiments, it is doubtful whether we should have had television to-day. The science has reached the stage where it is as good as a home cinematograph from the point of view of reproduction. It is true that, perhaps, in these early days the programmes have not the same high quality as a film, but that is a matter which is rapidly being remedied.

PRACTICAL TELEVISION, therefore, commences its career with a twofold mission. It will faithfully record the technical developments in this new field of scientific endeavour, it will teach its readers how to build their own television receivers, it will review the latest products of the industry, it will provide a valuable news service, it will record the developments of television in other countries, it will explain what goes on inside the studio, it will explain how to service television receivers, and answer readers' problems concerning the installation, operation and choice of a television receiver. That is its main mission at the present time, but it has another and equally

By THE EDITOR

important purpose to fulfil. It will endeavour by informative articles to educate the rest of the country in the subject of television, so that they will be prepared when stations are erected to serve their various localities. The first issue of PRACTICAL TELEVISION contains an article on how to build a television receiver, one on the production of a play at Alexandra Palace, the Chief Engineer of the B.B.C. contributes an article on the B.B.C. transmitting system, a service engineer explains television troubles and their remedy, Mr. F. J. Camm commences a series of articles on television principles and practice, a guide to the selection of a television receiver, and numerous other articles of topical interest.

The leading experts have been retained as contributors to this new journal, which is lavishly illustrated in line and half-tone, and takes its place amongst the Newnes Practical Group: PRACTICAL WIRELESS, PRACTICAL ENGINEERING and PRACTICAL MECHANICS. Its editor is Mr. F. J. Camm.

Paper rationing, as far as periodicals are concerned, was abolished on March 1st, but owing to the difficulty in the supply of pulp, it is still necessary for readers requiring copies to order them well in advance. The new journal will be preserved as a record, a text-book and an instruction manual. Your newsagent, if you go to him now, will reserve a copy for you.

EINSTEIN'S THEORY OF GRAVITATION

ALBERT EINSTEIN has exerted an influence on scientific thought since 1905 unequalled by anyone since Isaac Newton. It was in 1905 that Einstein published his Theory of Relativity, in which space and time were related and regarded as co-existent. This opened up a new philosophical outlook on space and the universe, and in his development of the theory he found that mass and energy were equivalent, and he thereby laid the practical foundations for the development of nuclear energy which we are witnessing to-day. His famous

formula is $E=mc^2$, in which E is energy, m is mass and c is the velocity of light, which is over 186,000 miles a second. As in the formula this large figure is squared it will be apparent that energy is of immense magnitude. Indeed, the energy equivalent to one kilogramme of a substance would equal about the total output from all the electrical generating stations in Britain for over a year. This alone would have ensured Einstein's place in the world of physics, but in 1916 he produced his general theory of relativity which gave new life to physics and astronomy. Briefly, this showed that inertia and gravity were equivalent, thus bringing into one concept energy, mass gravity and inertia. There was, however, one phenomenon unaccounted for, namely, electromagnetism, which, whilst it can be defined quantitatively, has not provided a clue to its origin or how it fits into the general scheme of things. All attempts to fit it into the theory of space-time-mass-inertia concept have failed, but Einstein believed that there was a theoretical connection. The English physicist, Clerk Maxwell, had shown the electro-magnetic nature of light in the latter part of the nineteenth century and it was this important fact which provided Einstein with the clue, and his recently announced unified field theory has at last brought electro-magnetism into line with gravitation, a theory which one of our contributors expounded many years ago as explained in the February issue.

The discovery means in effect that atomic phenomena can be related to terrestrial phenomena, and we are provided with a continuous theoretical concept extending from the smallest division of matter to the universe of matter. Einstein said that his new theory is highly convincing, but it still requires to be proved by experiment. There is little doubt that this will be done within the next few years, for Einstein's theories up to date have always been proved right. His classical equivalence of mass and energy, his fundamental equation for viscosity, and many other theoretical treatments are examples. Einstein says that his latest work is the last but one of the great chapters to which he has devoted his life. He is now working on the final one under the care and patronage of Princetown University, where he has been working during the past fifteen years.

SCHOFIELD TRAVEL SCHOLARSHIP

AN outstanding event in the history of the I.P.E. was the decision to award travel scholarships to the two outstanding graduates in the institution.

It was decided that these travel scholarships would be an annual competition with the object of offering a valuable prize to promote interest and develop the type of production engineer so valuable to British industry and national prosperity. It was this objective which was visualised by Mr. E. W. Hancock, M.B.E., vice-president of the institution, when he proposed that such a scheme should be considered.

SUBSCRIPTION RATES

including postage for one year

| | |
|--------|---------------------|
| Inland | 10s. 6d. per annum. |
| Abroad | 10s. 6d. per annum. |
| Canada | 10s. per annum. |

Editorial and Advertisement Office: "Practical Mechanics," George Newnes, Ltd., Tower House, Southampton Street, Strand, W.C.2
Phone: Temple Bar 4363.

Telegrams: Newnes, Rand, London.
Registered at the G.P.O. for transmission by Canadian Magazine Post.

Copyright in all drawings, photographs and articles published in "Practical Mechanics" is specially reserved throughout the countries signatory to the Berne Convention and the U.S.A. Reproductions or imitations of any of these are therefore expressly forbidden.

Marvels of the Planetarium

Particulars of this Remarkable Instrument and How it Operates

By THE MARQUIS OF DONEGALL

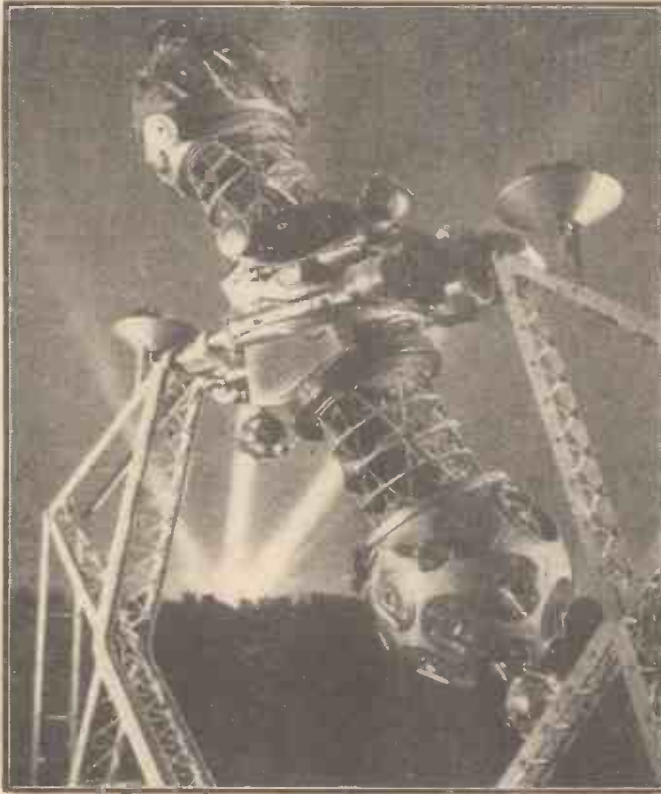

The Projector in the Hayden Planetarium.

IT is most unlikely that we will get a planetarium for the Festival of Britain of 1951!" This was told me when I was talking to Dr. H. R. Calvert, of the Science Museum, South Kensington, in his roomy office. Dr. Calvert has been trying since his first "agitation" in 1925 to get a planetarium for this country. Time after time he has had bad luck, culminating in his last effort to get the projection machine that was recently sold by Sweden to America, of course, owing to red tape in two British Government Departments.

I asked Dr. Calvert why the Swedish had decided to sell the machine. His guess was that Stockholm is not a large enough city to produce sufficient interest for a planetarium to maintain itself on an economic basis. London is quite a different proposition, and it is a scientific disgrace that there should not be one in this country.

General Remarks About Planetaria

The "Britannica" says that a planetarium is a name given to an arrangement made by Zeiss of Jena for producing an artificial sky. By optical methods images of the sun, moon, planets and stars are projected on a large hemispherical dome, and by mechanical and electrical means the apparatus can be revolved so as to show the principal motions. This is different from a solarium, which only shows the stars.

According to Dr. Calvert, some Americans are marketing solaria and calling them planetaria.

The first planetarium in the world was opened in Munich in 1924. The instrument or projector was ordered from Zeiss in 1913, and the suggestion was that an astronomical

model might be made, depicting the heavens as seen from the earth, and that the heavenly bodies might be represented by electric bulbs, fixed or moving, on a rotating dome.

It was Dr. Baurfeld who thought of projecting the images on to a dome. His idea was adopted, and Zeiss designed the planetarium projector as we know it.

Some readers may be astonished, as I was, at the number of planetaria which were in existence in 1939; and it is even more astonishing that Britain—prosperous as she then was—did not have one. Here is the list: Jena (two), Munich, Barman, Leipzig, Dusseldorf, Berlin, Mannheim, Nuremberg, Vienna, Stuttgart, Hanover, Hamburg, Rome, Milan, Moscow, Stockholm—the one recently sold

to America—The Hague, Brussels and Budapest.

American Planetaria

So much for Europe. In America, there are planetaria in Los Angeles, New York, Chicago and Philadelphia. The Zeiss factory being in the Russian Zone, one does not know exactly how many of the projection instruments for planetaria have been

made since the war. It is believed that 23 of these instruments existed before the war, and the first planetarium to be opened in America was the Adler Planetarium in Chicago, the dome of which measures 68ft. in diameter, and the chamber seats about 600 people. In the same way as the planetarium in New York is called the Hayden Planetarium, the Chicago one is called the Adler, because the generosity of Mr. Adler and Mr. Hayden enabled their two respective cities to be provided with these highly instructive and entertaining assets. The Chicago Planetarium was erected in 1930 and was a great benefit to the Chicago Fair of 1933 and 1934 where thousands of people visited it.

The second in America was the Fels, connected with the Franklin Institute in Philadelphia, and was opened in November, 1933. This is smaller, and measures 66ft. across the dome and seats about 450 people. The third in America was the one at Griffith Park, Los Angeles. It was made possible by the will of the late Colonel Griffith J. Griffith, and was opened in May, 1935. The fourth in the United States was opened a few months later in 1935 and was the Hayden Planetarium in New York.

This is the one that I know best, and I will describe it as briefly as possible. First of all it is situated on an "island site" on the west side of Central Park, and, including the gardens surrounding it, cost just on one million dollars. Of this, Dr. Hayden, after whom it is named, contributed \$150,000.

Apart from being a planetarium, the whole building is an astronomical museum, and the Zeiss projection instrument is installed in an hemispherical dome, 75ft. in diameter, and lined with perforated stainless steel painted white. The instrument, in the centre of the room, is a series of projectors which throw on the artificial sky the fixed stars, the sun, moon, planets and the Milky Way. There are, of course, no columns, and therefore the illusion of depth of space is perfect. The projection apparatus itself is a weird-looking instrument, about 12ft. long. At each end of it there is a large globe, and it



The entrance hall in the Hamburg Planetarium.

looks more or less like a giant dumbbell.

The two ends of the dumbbell contain the projectors of the fixed stars, one globe for the Northern Hemisphere of the sky and one for the Southern. The lantern slides or diapositives are so shaped that their images fit together to make a complete picture of the heavens without overlapping and without gaps.

The representation of the fixed stars, including the Milky Way, is a comparatively simple part of the performance of the instrument. Yet it is certainly most impressive. Whether the audience is made up of children or grown-ups, the emotional experience is always the same. The light is gradually dimmed, bringing on the darkness of night in the dome and the stars are then switched on. The audience gasps at this sight whenever it happens.

The projector itself is complicated enough, but there is also the unique quality of the fundamental conception of the machine and the room. The credit for that is due again to Dr. Walter Bauersfeld, of the Zeiss firm of Jena.

Functions of the Apparatus

The main structure containing all the projectors is so mounted that it may turn independently about any one of three axes. First, it may turn about the axis which is parallel to the Polar axis of the earth. When this motion is used with other motions, the effect naturally is to transport the images across the dome-sky in exactly the same way as the daily rotation of the earth on its axis apparently moves the real heavenly bodies across the sky each 24 hours.

Secondly, the machine may rotate about an axis perpendicular to the plane in which the earth moves about the sun. Without the other motion in use, the effect of this is to swing the North Pole of the sky around the circle which it makes each 26,000 years with precessional "wobbling" of the earth's axis. Thus, one can go backward or forward in time. For instance, the lecturer can set the instrument back some 5,000 years to 3,000 B.C., when Alpha Draconis, a star in the constellation of the Dragon, was our North Star. Or by putting the instrument ahead some 12,000 years, we can see Vega, marking the North Pole of the heavens, and the Southern Cross visible from the latitude of New York. The axis of this precessional motion of the instrument intersects the daily motion of the axis at the centre of the room.

Thirdly, through the same intersection runs the axis for the remaining motion of the machine, horizontally from east to the west point and, rotating about it, transports the images on the dome as though the viewer of the skies were travelling along a meridian of the earth from Pole to Pole. This is used to demonstrate the changed appearance of the skies from different latitudes of the earth, thus one may go to the land of the Midnight Sun, or to the North Pole, and observe the apparent movements of the sun, moon and stars from there; or, travelling south, one may see Magellanic Clouds, Canopus and the Southern Cross.

Varying Speeds

The whole apparatus has several different speeds, all of which are many times faster than the real motions. This makes it possible to condense very long astronomical stories so that anyone can get a clear understanding in a few minutes of the seemingly intricate, though actually simple, workings of the heavenly bodies.

Nearby objects, such as the planets and the sun and moon, which appear to move relative to the stars day to day are provided for by separate projectors of independent

motion on the main part of the machine. From the standpoint of the inventor, these projectors, which show the "wandering" of the planets, including their periodical retrograde motion, phases of the moon and the apparent motions of the sun, were the most difficult to perfect.

Illuminations and Drive

The illuminants used in the projectors are all high-efficiency tungsten filament electric lamps. In nearly all cases the lamps are a

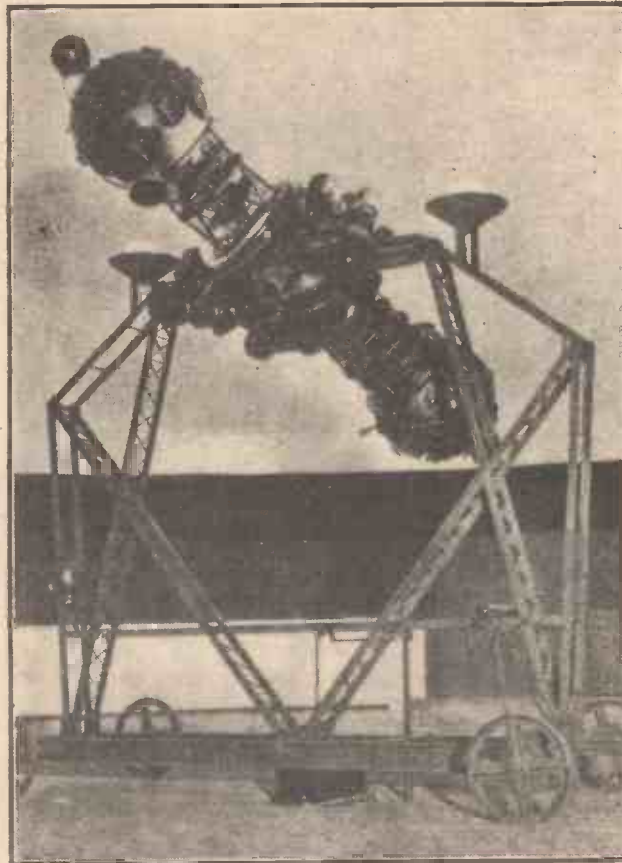

The Hamburg Planetarium projector.

part of a straightforward projection system consisting of a light source, a condensing or light-gathering unit, a diapositive or equivalent illuminated by the two previous units, and an objective or projection-lens system which focuses on the dome an image of the illuminated diapositive.

The prime movers for the machine are small three-phase alternating current motors. Reversal of a phase accomplishes reversal of direction of rotation. They are all mounted on the main moving part and transmission and inter-connection is accomplished by gearing. Motions which are additive are joined through planetary transmissions. The motions and lamp circuits are all controlled remotely by the lecturer from a switchboard in a speaker's stand near the wall of the room. Here on the horizontal part of the board is a labelled switch for every motor or lamp, while on the vertical portion are handles of the rheostats for controlling the brightness of the lamps in use.

If one can criticise such an apparatus at all, one would start by saying that the three planets farthest from the sun, Uranus, Neptune and Pluto, are not included in the apparatus. This is, of course, because of their enormous distances. Pluto would have to be placed about 40 times as far from the sun as the earth, 280 feet. On the scale used in the model, moreover, the nearest star would be approximately 400 miles

distant—about as far as from London to Edinburgh.

The Planetarium used for Instruction

The whole performance is, of course, accompanied by a lecturer who gives a short lecture before the performance and a short lecture after the performance. In this he directs the attention of the visitors to the motions of the bodies in the Solar system and gives a short talk on the important and interesting facts concerning them. He indicates their different velocities and discusses our present knowledge of conditions in these planets while, by means of electrical transcription, he throws these bodies individually on to the dome.

Well, apart from Boy Scouts, cadets of the three Services and a few prospective young specialists, who studies the heavens in Britain to-day? I have a suspicion that astronomy taught in the schools, even to-day, is about as effective as the French or German taught in those schools—a thing to be assimilated quickly for an examination and even more quickly forgotten. However, it is certain that if we had a planetarium in this country, no small boy or small girl, between the ages of four and eighty years, could fail to be fascinated by this ocular demonstration of what is going on around our small earth-planet.

Recently, I visited Hamburg on business and inquired about the planetarium. Yes, it was working and the Curator would be pleased to give a lecture for my friends and myself on the Sunday morning—a private party.

There is practically nothing but destruction all round the planetarium. It escaped—although the steps up to it did not—and it is a high building compared with the one in Central Park. The curator gave us his lecture and demonstration in very good English.

Newnes' Engineer's Reference Book

Edited by F. J. Camm

THE third edition of this important work is now ready. It contains nearly 300 pages of new matter in addition to complete revision. The new sections cover Fan Engineering; Centreless Grinding; Induction Heating; Plain Bearings; Belt Transmission; Investment Moulding; Lapping and Honing; Hobbing; Surface Finishing; Properties of Plastics; Air Compressors; Compressed Air Data; Corrosion Treatment; Mirror Finishing; Polishing and Buffing; Gas Welding; Weights; Additional Screw Thread Tables; Weights of Materials; Use of Rubber in Presses; Shafting; Pipe Flanges; Lighting of Buildings.

The book comprises over 1600 pages, fully cross-referenced, and hundreds of diagrams, tables and formulae of great value to mechanical, civil, structural, automobile, and aeronautical engineers, designers, draughtsmen, works managers, gauge and toolmakers, time and motion study engineers.

It costs 45s., or 46s. by post.

Making a Drilling Stand

Constructional Details of a Useful Unit for the Workbench

By G. A. POOLER

THIS drilling stand is intended for use with one of the well-known type of breast drills having a length of plain spindle at the end remote from the drill chuck.

The base for the stand is composed of a piece of hard wood, 12in. x 7½in. x 1¼in. thick, care being taken to ensure that it is flat. The column is preferably of the same material, being 2in. square section and 20in. long. The column is tenoned into the base as shown in Fig. 3, ensuring that the column is square both ways with the base.

The two angle brackets (Fig. 2) can be secured to the base and column by means of wood screws (Fig. 3); these will give added strength, and provided that the

be slightly under ½in. The ends of the tube are faced or filed until they are a good fit inside the bracket. A ½in. bolt is then passed through both the bracket and tube

The complete bracket can be bolted to the column of the stand by means of two 5/16in. bolts.

Hand Lever

This is made of M.S. and constructed as shown in Fig. 5. The elongated hole is filed to suit on assembly, so as to allow for the

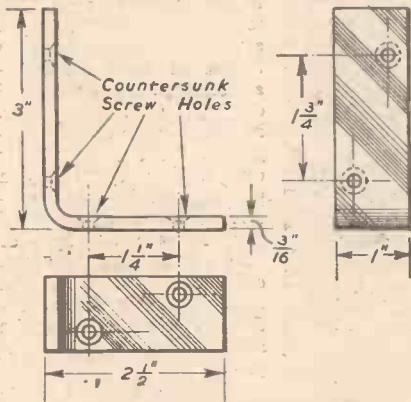

Fig. 2.—Details of angle brackets.

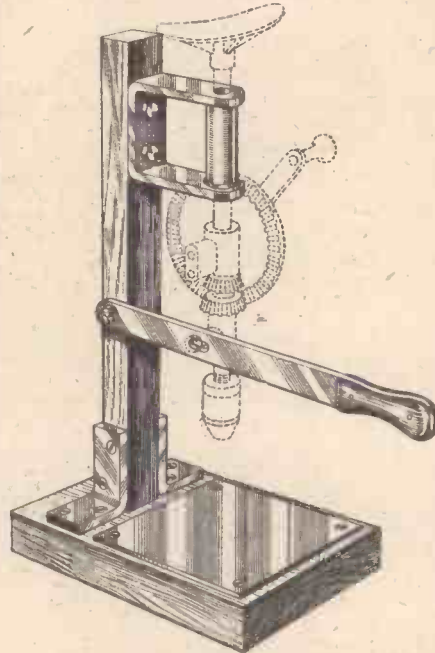

Fig. 1.—The completed drilling stand.

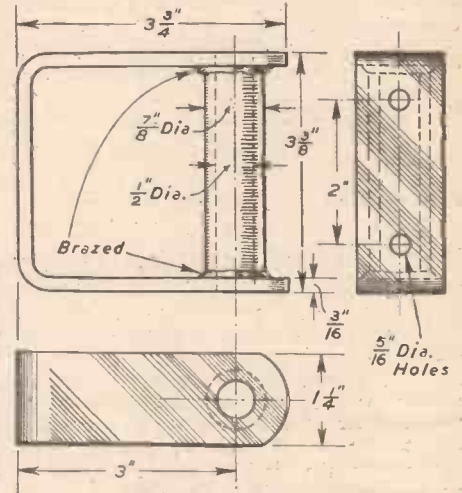

Fig. 4.—Three views of the guide bracket.

angularity of the hand lever when operated to give the necessary movement up or down.

Assembly

Care must be taken on assembly to leave enough room between the chuck and table to allow for the largest drill used and also a medium-sized job.

When drilling with short drills, the job will have to be packed up to the required height by means of wooden blocks.

and tightened. Due to the small bore, the bolt may have to be filed down slightly to suit.

The tube can now be brazed to the bracket as indicated in drawing. After brazing, the bolt can be removed and the bore reamed out with a ½in. reamer so as to form a good fit on the breast drill spindle.

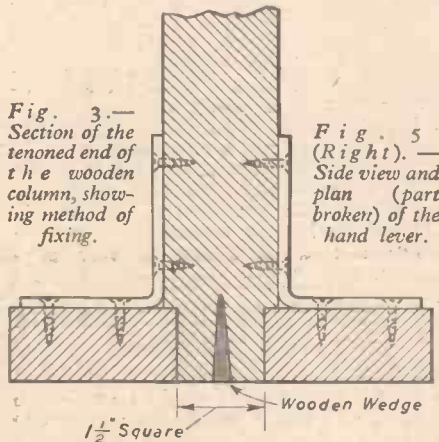
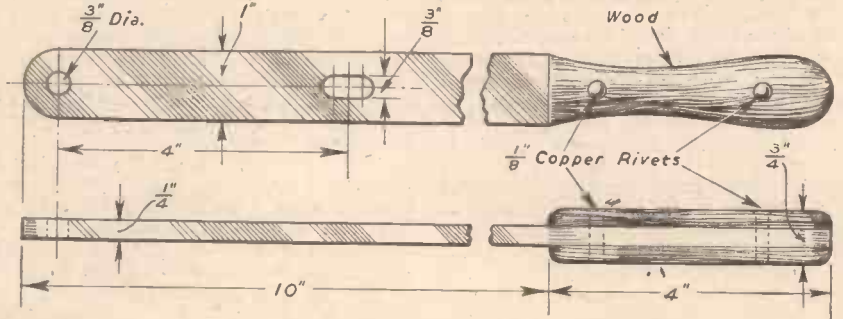

Fig. 3.—Section of the tenoned end of the wooden column, showing method of fixing.

Fig. 5 (Right).—Side view and plan (part broken) of the hand lever.



brackets have been squared up accurately they will ensure that the column remains square to the base. A piece of 3/16in. M.S. plate is screwed on to the wooden base to form the drilling table, as indicated in Fig. 1.

Guide Bracket

This is made by bending a piece of M.S. to the shape and dimensions shown in Fig. 4, the two guide holes being drilled after bending. Whilst drilling, the bracket should be packed with a piece of wood to avoid springing; the two holes are drilled slightly under ½in.

The guide tube is composed of brass and can either be turned or a piece of brass tube used, but in either case the bore must

BOOKS FOR ENGINEERS

By F. J. GAMM

- Screw Thread Tables, 5/-, by post 5/3.
- Refresher Course in Mathematics, 8/6, by post 9/-.
- Gears and Gear Cutting, 6/-, by post 6/6.
- Workshop Calculations, Tables and Formulae, 6/-, by post 6/6.
- Dictionary of Metals and Alloys, 10/6, by post, 11/-.
- Wire and Wire Gauges (Vest. Pocket Book), 3/6, by post 3/9.

- Screw Thread Manual, 6/-, by post 6/6.
- Newnes Metric and Decimal Tables, 3/6, by post 3/9.
- Newnes Electrical Tables and Data, 10/6, by post 11/-.

Published by

GEORGE NEWNES, LTD., TOWER HOUSE, SOUTHAMPTON STREET, STRAND, W.C.2

Bridges and Bridge Design—2

The Evolution of Some of the World's Most Famous Bridges

By G. W. McARD, A.M.I.Mech.E.

(Concluded from page 190, March issue)

THE Menai Suspension bridge was replaced in 1941 by a modern structure, capable of carrying full Ministry of Transport loading, the new bridge being shown in Fig. 9. The main span measures 580 feet, and affords a clear height of 100 feet above water level.

In later designs of suspension bridges, stout steel wire cables are used instead of eyebar cables used by Telford, with special clamping brackets secured at intervals to the cables from which hang the members carrying the roadbed. The main cables pass over rollers mounted at the top of the side towers, and thence down to safe anchorages on the shore sides, where they are secured to withstand the pull due to the load carried.

The height of the roadway above high-water level in bridges which cross main waterways like the Thames, Tees and Tyne, etc., is sometimes too low for normal river traffic to pass beneath, and a special design of bridge is then involved. In the Tower bridge, London, shown in Fig. 10, a pair of



Fig. 9.—Menai Suspension Bridge.—Dorman Long and Co.

ways. An excellent example of such a structure is the Tyne Swing bridge shown in Fig. 7. This is the fourth bridge on this site, and was opened in 1876, having been

built at the Elswick Works and erected on the site by Sir W. G. Armstrong and Co., as the firm was then named. The swing portion of the bridge is 278½ feet, and weighs approximately 1,300 tons, affording a clear waterway on each side of 103 feet. When traffic is passing across the bridge the ends are supported on cast iron blocks, which are withdrawn by hydraulic cylinders before the bridge is swung. A hydraulic engine (see Fig. 11) with three single acting oscillating cylinders developing 57 h.p. at 37 rpm. turns the bridge through a train of gearing and a rack on the swinging portion of the bridge. The bridge is designed to carry a load of 60 tons on four wheels, and has the record of never having delayed shipping, although it has rotated well over 200,000 times since its erection.

The Transporter Bridge

Another example of the designer's ingenuity in maintaining road traffic as well as affording a clear way for shipping is known as the transporter bridge, a specimen of which is the Middlesbrough Transporter bridge shown in Fig. 12, and having a total length of 850ft., including approaches, with



Fig. 10.—Tower Bridge, London.—Sir Wm. Arrol and Co.

bascules or hinged half-spans are provided and raised by hydraulic machinery housed within the towers. When the bascules are elevated to allow the passage of a steamer or other vessel, pedestrian traffic must either wait or cross by the towers and elevated roadways reserved for this purpose.

The Swing Bridge

In other cases a swing bridge will be preferred, and erected on an island platform which divides the span into two; the width of the island is slightly greater than that of the bridge itself which, when fully open, permits traffic to pass up and down stream simultaneously through independent water-

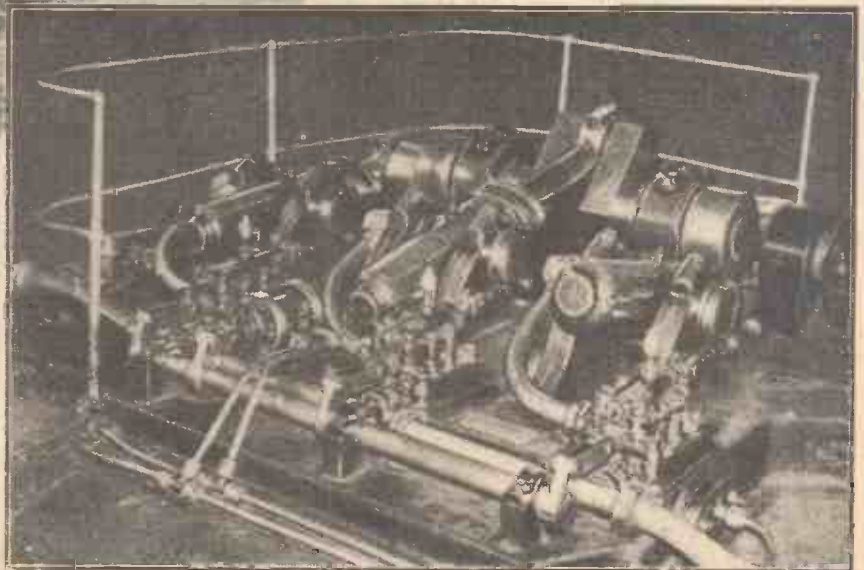

Fig. 11.—Hydraulic operating motor for Tyne Swing Bridge.—Vickers-Armstrongs.

a river span of 470ft. between towers. The bridge structure, as will be seen, is of cantilever design with the outer extremities secured by steel wire ropes to anchorages in concrete. A travelling car capable of conveying 600 passengers and six vehicles is slung by steel wire ropes from bogies which run under electrical power along tracks carried by the main girders.

Yet another unusual type is the Tees (Newport) bridge at Middlesbrough shown in Fig. 13, in which the complete centre span is raised by two 325 h.p. electric motors in approximately 1½ minutes. The span, which has a clear opening for shipping of 250ft. in width, with a vertical clearance of 120ft., is so carefully balanced that it may be operated by hand if necessary, notwithstanding the tremendous weight of the movable span, viz., 5,400 tons.

A design of bridge in which the rolling principle is used for the lifting span is the Corporation Road bridge at Grimsby, shown in Fig. 14. Its total length is 283ft., the lifting span being 45ft. long.

Timber bridges are usually restricted to-day to secondary roads, the span rarely exceeding 200 feet. In a district where trees are abundant such a structure is more in harmony with its surroundings than the metal bridge can ever be, and where ample road or river clearance is available the design may be either an inverted arch or a parallel beam

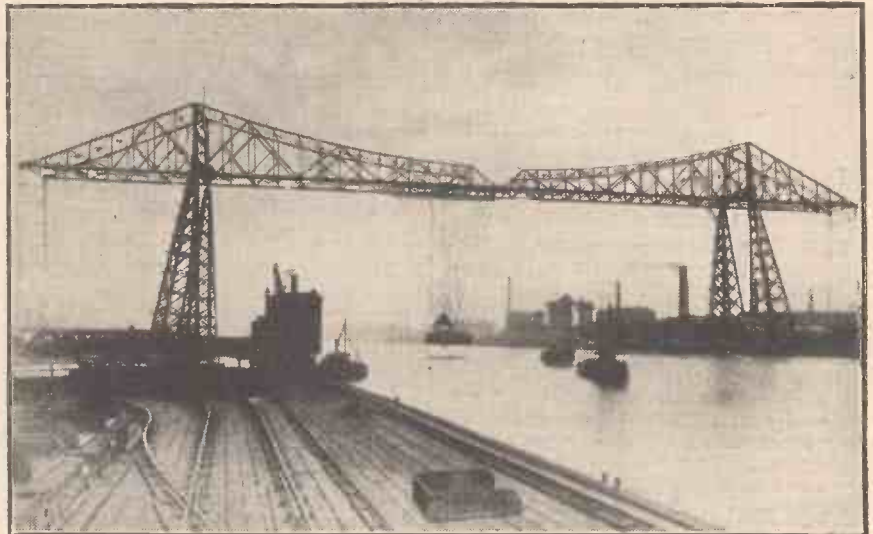

Fig. 12.—Middlesbrough Transporter Bridge.—Sir Wm. Arrol and Co.

in Fig. 15, that at "A" being known as a split ring connector, at "B" a toothed ring connector, and that at "C" a double-sided "Bulldog" connector. More recently, designs for timber bridges have been put through

in which a laminated form of construction is employed, using adhesives of the synthetic resin type, especially for the arch formation of the main side members, and this method enables maximum strength to be attained with a more economical use of timber.



Fig. 13.—Tees (Newport) Bridge.—Dorman Long and Co.

with the lower edge of the beam either level with the road or some distance below. One of the problems which the timber bridge designer has to face is to find some method of obtaining a connector for adjacent ends of the different members which will enable the fastening to transmit a load equivalent to that which the material in the member itself will sustain. Typical examples are shown

Foundations

Two problems face bridge engineers on many occasions, and call for serious consideration. The first concerns the foundations necessary for carrying the piers upon which the superstructure will be supported. Where it is not possible to build on solid rock, piles may be driven into the river bed, and a concrete platform formed at the head of these, upon which the piers may be built. But where it is possible to build direct on solid rock, caissons will be sunk through the river bed at selected points until the solid rock is reached. As these caissons are frequently sealed compartments into which air is forced at pressures varying according to the depth at which operations are to be carried out, it follows that the workers will be required to function under higher atmospheric pressure

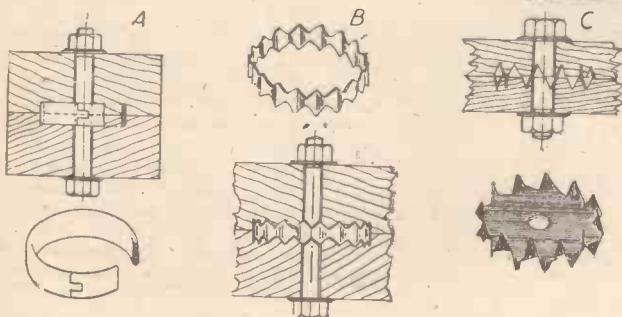

Fig. 14.—(Above). Corporation Road Bridge, Grimsby.—Sir Wm. Arrol and Co.

Fig. 15.—(Left). Connectors for linking individual members in a timber bridge.—Timber Development Association.

than normal, and they are, therefore, selected men with good constitutions. As the pressure used at times may be as much as three to four times normal atmospheric pressure, great care must be taken when coming off duty to allow the lungs and respiratory organs ample time to become adjusted to the outside conditions. Through carelessness and impatience, many workers have lost their lives, and others developed serious disorders which incapacitated them for long periods, sometimes permanently. Two hours' work under the higher air pressure is the usual safe maximum, and this obviously increases the number of workers and the cost of the contract.

New Hobbies for All

In which Latent Inventive Ability will Find Full Scope

By PROFESSOR A. M. LOW

GREAT technical developments in industry, many of them due directly to the war, are going to mean that, in the future, if we arrange our affairs well, every man and woman can enjoy far more leisure than in the past. Automatic machines and controlling devices will do more and more of the "donkey work" and when the period of making good the damage of war is over, they should enable us to have a comparatively short working week. For the ordinary man and woman this implies much more time for hobbies and sports. We may expect to see new pastimes being developed in response to the demand.

One man's work is another man's play, and this fact may well be the basis of the development of new hobbies. I have often defined "work" as something you do in your employer's time and "play" as something you do in your own time. I think many of the new hobbies will be "work" done for pleasure. Much of the joy of a hobby comes from the exercise of skill which takes time and study to develop. The amateur gets real pleasure out of something which, if he had to do it for his living, would lose much of its attraction.

Technical Skill

Many of the new hobbies will be based on the exercise of technical skill in the sciences. Let me give an example. The making of fine lenses for telescopes is a highly skilled business, requiring theoretical knowledge and a certain ability in the manipulation of instruments, as well as great patience. Of course, the easiest way to get a telescope is to go to a shop and buy one with lenses made by craftsmen who spend their life at it. But the amateur astronomer gets far greater pleasure out of grinding his own lenses. Many have mastered this art. In America, where, perhaps, highly technical hobbies are more widespread, for reasons not hard to understand, there are some hundreds of amateur telescope makers. Incidentally, their skill was shown during wartime when, in response to an appeal, they made very fine lenses for a particular purpose, in their spare time, for the use of the U.S. forces.

One of the essentials of a good hobby is that it should not have limitations. You do not want something that is fairly easily mastered completely and then offers no further interest. The advantage of scientific hobbies is that there is no finality about them. You may begin experiments in chemistry

with a score of cheap chemicals and a few test-tubes. You can proceed to the most intricate piece of research; the answering of some question, perhaps, that you have posed for yourself. Believe me, there are plenty of unanswered questions in chemistry and it may well be that they will be answered in the future by amateurs (as in the past) working in their home laboratories. The amateur is disinterested. He can afford pure research and his interpretation of whether an experiment pays is whether it gives him pleasure and not whether it gives financial return. It is interesting to remember as an example that all Perkins' great discoveries of synthetic dyes were based on his experiments as an amateur in trying to make synthetic quinine.

In the future, therefore, I expect scientific hobbies to gain thousands of adherents, for thousands of homes to have their workshops well equipped with lathes, tools and chemicals



A 7-ft. model diesel-engined aircraft in flight, tethered on the end of control-lines.

according to the special line being pursued. The new possibilities in mass production should enable the ordinary man to possess mechanical equipment which only a few years ago would have been restricted to the wealthy amateur or the factory. I shall expect to see increasing numbers of amateurs making or adapting motor cars, motor wheelbarrows and other novel forms of transport; perhaps new mechanical tools for the garden or small holding, and working models of all kinds.

Amateur Inventors

The amateur, of course, will not primarily be concerned in profit or fame, but a proportion of useful inventions should result. We must not neglect our amateur inventor. I should like us to become a nation of amateur inventors, because that means a high standard of technical skill. And I know from experience what a wealth of talent in this direction is latent in Britain. I hope we shall see facilities for the exercise of this talent. In America they have "clubs" where people, and especially boys in their teens, with any inclinations towards scientific hobbies get all the facilities they need in their evenings and holidays. Incidentally, American industry has benefited by many pieces of research and inventions made by these amateurs.

New Games!

What about new games? The competitive instinct inherent, apparently, in human beings is as important a factor as the creation instinct which is the basis of artistic and scientific hobbies. More leisure will probably mean more games. Those who have thought on this subject will have noticed the tendency for games to become more scientific. The new sports which "caught on" after the last war were scientific in origin—greyhound racing depends upon the mechanical hare, the electric totaliser and other mechanical devices; speedway racing was a combination of mechanical and personal skill. In every sport there is the tendency to reduce the element of chance by science—from the preparation of golf-greens and design of balls with better ballistic characteristics to the refrigeration of tennis balls to ensure an even bounce or the scientific preparation of cricket pitches to prevent wear. Even footballs are now to have their bounce standardised by scientific measurement of pressure.

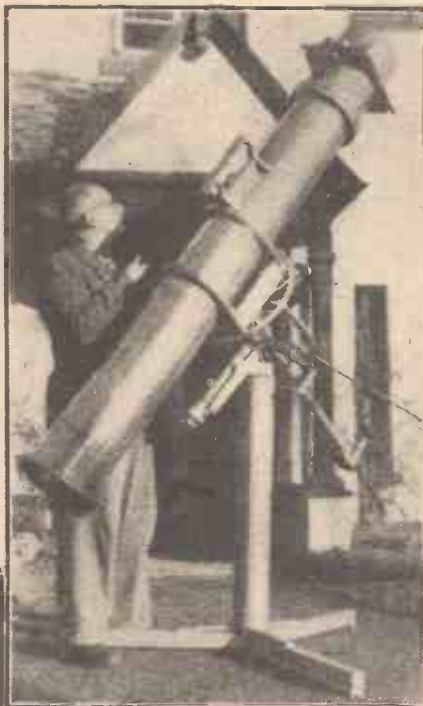

(Above) A reflector telescope made by a reader, Mr. H. L. Pugh.



(Left) Grinding an astronomical telescope mirror.

This tendency will continue and we shall probably see new sports based on new scientific developments. Aeroplane racing presents difficulties in organisation, but may become important as a spectacle as well as a test of aircraft—the part played by racing in the development of aircraft is very great. As everyone knows the Spitfire was a direct “descendant” of the craft that won the Schneider Trophy race, owing many improvements to experience gained in this way. We may have “mechanised” races testing the skill of pilots which can be watched in a large hall by an audience. The pilots would “fly” on the Link-trainer system, where the cockpit remains stationary, but the course would be marked out exactly as if they had been flying.

Obviously the speeds attained by modern vehicles and aircraft, especially with jet-engines, is going to make racing difficult as a spectacle. Here we may see the develop-

ment of sports based on “midget” engines, where the skill of the designer, the mechanic and the pilot or driver will combine to get results. Quite apart from the spectacle they provide, these forms of racing are as valuable in “developing the breed” as is horse racing. Ultimately the test must come in action, and with a mechanical device—as with a racehorse—the final test is on the racecourse, however much theoretical considerations may suggest perfection. Aircraft races for miniature planes, wireless controlled, may become popular, skill being shown by the “pilots” who would, in fact, remain seated in front of a control board on the ground while the aircraft circled the pylons.

In all sports and pastimes our capacity to produce anything in quantities very cheaply should help. For instance, if our hobby is reading, we should have better books much more cheaply—and we shall certainly have micro-books so that it will be possible to

have an extensive library in even a tiny modern flat.

Educational Hobbies

The outlook for educational hobbies and pastimes in the post-war world is very bright—time, money and materials should be abundantly available, and it is up to us to take advantage of them. We shall continue to have people—like myself—whose work has been their hobby, but highly mechanised factories will offer less possibilities in this direction for the majority. Their aim should be to find in their hobbies satisfaction for the creative instinct, whether it is in scientific breeding of improved poultry or new flowers, in inventing electronic devices which will have the additional advantage of making much household work “automatic” or labour saving, or in becoming experts, either as participants or spectators, in the new sports.

The Hydrogen Bomb

A Brief Account of a Development of the Uranium Bomb

By “TECHNICUS”

FROM recent reports coming from the U.S.A. and other countries it seems that an attempt is being, or has been, made to break open the hydrogen atom to release its energy. This, indeed, is a logical development of the uranium fission, but this new source of energy holds much more significance for the world. The magnitude of atomic energy will be realised by the fact that the break-up of one ounce of matter completely would release a million horse power for more than a month. This state of affairs is, perhaps unfortunately, no longer a theoretical possibility without any hope of practical fulfilment.

In the use of uranium 235 for the production of atomic energy one commences with a substance having a large number of electrons, and comparatively unstable. By upsetting, as it were, the equilibrium of the many electrons and their nucleus, the whole system breaks up suddenly, with the release of much energy. There is a loss of mass, which, Einstein declared many years ago, should be accompanied by the release of a great deal of energy, his reasoning being amply confirmed by the events since 1944. Just as it has been known for a long time that the destruction of mass releases a huge amount of energy, so it has been known that the most profitable of nuclear reactions, as atomic disintegration is called, would be the creation of a helium nucleus out of the protons and neutrons of hydrogen.

Hydrogen and Helium

To understand why hydrogen is so important as a source of atomic energy, one must understand that its atom is made up of a single proton, which composes the nucleus, and one electron. Now helium, which, like hydrogen, is a light gas, is the next atom of matter in the order of size. It has four protons and two electrons in its nucleus and two electrons, as it were, revolving around the nucleus. The two atoms are shown, diagrammatically, in the accompanying illustration.

We now come to the important question of their masses, or atomic weights, bearing in mind what has been said above about the loss of mass resulting in the production of large amounts of energy. Hydrogen has an atomic weight of 1.008, and the significance lies in the last figure, for it indicates an odd bit in the atom. Helium, again, has an

atomic weight of 4.003. The nuclear physicist has for many years considered that if one could build up a helium nucleus, or atom, from hydrogen there would be left over a little mass, which cannot exist independently,

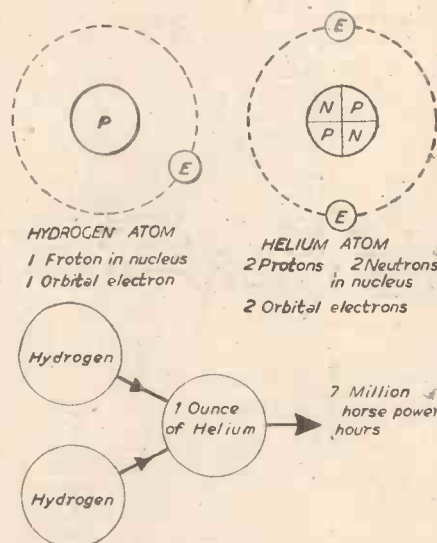

The disruption of the nuclei of hydrogen atoms and their reformation into helium atoms releases a prodigious amount of energy.

so to speak, and would release a quantity of energy.

From what has been said above, a little mass goes a long way, as far as energy is concerned, and so one has only to make a few ounces of helium from hydrogen to release a prodigious amount of energy. But there are practical difficulties in this seemingly simple switch from hydrogen to helium. In the first place the reaction can only, as far as at present known, be initiated by extremely high temperatures, of the order of millions of degrees. It is considered that the heat emitted by the sun is due to the break-up of hydrogen atoms to form helium atoms, the reaction being maintained by the heat formed. The temperature of the interior of the sun has been estimated to be in the vicinity of twenty millions of degrees, and careful observation of the spectra emitted

has given rise to the thought that a continuous break-up of hydrogen atoms to form helium is taking place. Fifty years ago such ideas would have been considered as fantastic, but the advent of atomic energy has served to confirm much of the theory upon which these ideas about the sun are based.

Heat for Hydrogen Disintegration

Until the development of the practical method of uranium fission there was no way of creating heat of sufficient magnitude to break-up atom cores or nuclei. The atomic bomb developed by America, from ground-work done in Europe, produces a temperature of millions of degrees, and suggests itself as an initiator for the change of hydrogen into helium. In other words, we already have the source of heat. The next practical difficulty is: how can one sustain that heat sufficiently long to cause two or more hydrogen nuclei to combine to form a helium atom? Once the reaction has been started the rest of it would go off with shattering violence. This problem sent the physicists looking for hydrogen nuclei, or atom cores, in a more reactive state, as it were, so that the heat to initiate the reaction need be sustained for the minimum time.

Heavy Hydrogen and Lithium Hydride

Two possible answers have suggested themselves in the form of heavy hydrogen, and hydrogen combined with the light metal lithium, lithium hydride. The former is made up of hydrogen with a double core, which means that instead of four hydrogen atoms being required to make helium, only two of the heavy variety are required. It has been suggested that lithium hydride might provide a cheaper and more effective form of atomic energy than uranium 235.

There is also a rare form of hydrogen called tritium, which is a half-way stage to helium, and this might assume importance in the future work on the development of a hydrogen bomb.

Having gone thus far with the explanation of the possibilities of hydrogen, one is now forced to admit that the reaction is of considerably greater violence than the atomic bomb made with uranium. It is hoped that before the new bomb is made a way may be discovered of slowing down the reaction so that the energy released can be used for industrial purposes, or for the benefit of mankind.

A Novel Lathe Drive

A Method of Driving a Small Bench Lathe by Pedal Gear

By E. G. HARTWELL

There must be many amateurs who, like the writer, have to operate their lathe in a workshop remote from an electric supply. The following description is of a method of driving a lathe which the user will find not only less tiring than the conventional treadle, but affords more control over the job in hand. This is particularly so with screw cutting, as the work may be screwed up to a shoulder, the lathe tool withdrawn, and the lathe rotated backwards to bring the tool to the starting point. This method is particularly advantageous when cutting odd or metric pitches, and makes chalking the chuck, bed and leadscrew unnecessary. In fact, when cutting metric threads with an English leadscrew and a conversion wheel, it is the only way; even a

Constructional Details

The main frame is built of 4in. x 2in. timber, two 3/4in. coach bolts being used in each joint or, where conditions do not allow bolts, coach screws may be used. A couple of 3in. wire nails driven in each joint before drilling the bolts will hold the members in their respective positions.

First make up the side frames, one right and one left, keeping the three feet of each side the same length. The two frames are now secured at the correct distance apart by the lathe bed plank and the front and rear members. The rear member should be of sound timber and free from knots—as the weight of the operator is taken mainly on this. Two cross-braces are fixed to the two vertical timbers for extra rigidity.

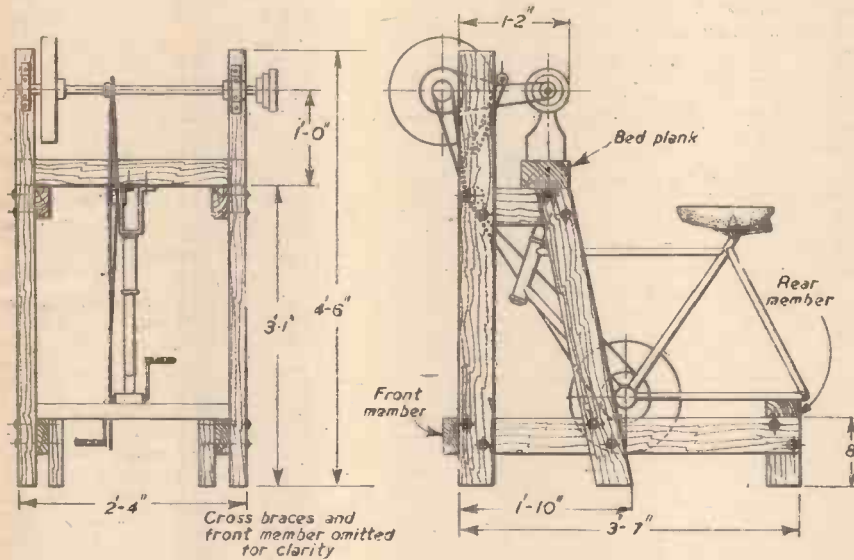

Fig. 1.—Rear and side elevations of the lathe stand and pedal driving gear:

screwcutting indicator fails in this case.

It will be noted that the materials required are readily obtainable, for the most part from the scrapyard. Angle iron may be substituted for the wooden frame, but no difficulty should be experienced in getting enough second-hand or home-grown timber for the job.

The Cycle Frame

This should be stripped of all parts with the exception of the bottom bracket assembly, saddle and rear stays. Now clamp the rear forks on the rear cross member of the wooden frame as shown in Fig. 1. A piece of 1/16in. steel plate between the forks and the timber will stop the frame from sinking into the wood after use.

The distance between the top head race and the underside of the lathe bed plank in a line with the rake of the head should now be measured. Cut off the front fork blades 1 1/4 in. longer than this, flatten, drill and bend outwards as shown in Fig. 2. This dimension has been omitted as in all probability other frames will vary slightly from the writer's.

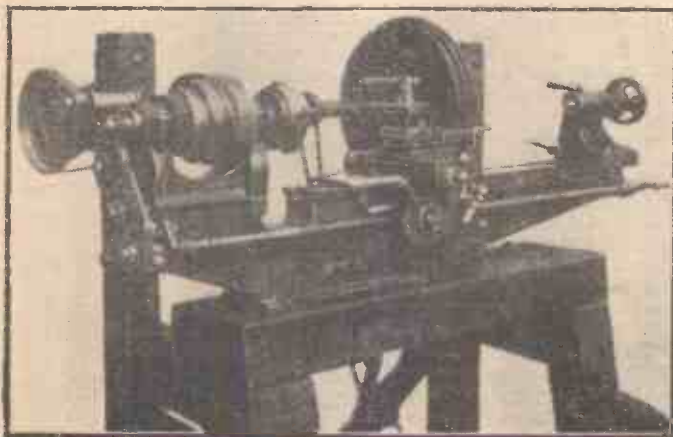

Close-up view showing the countershaft pulley and flywheel.



General view of the lathe stand and pedal driving arrangement.

The forks are finally fixed in the frame, upside down, using the head races, minus the balls, as spacer washers, and bolted to the underside of the lathe bed plank by two 3/4in. coach bolts.

The Countershaft

This may be of any convenient diameter and consists of two plummer blocks (ball or plain), a cone pulley to match that on the lathe, two collars, a driving sprocket and a flywheel. The driving sprocket is a 14-tooth fixed chainwheel which when used in conjunction with a 48 or 52-tooth driving wheel will give ample speed for most model work. This sprocket is screwed on to a collar turned down to receive it and fitted with a locking ring. The thread is 1 1/4 in. dia. 24 T.P.I. The collar should be securely fixed to the shaft by means of two 3/4 in. Allen grub screws, at 90°.

The flywheel was taken from a 12 h.p. car engine, and is bolted back to a flat-sided pulley, while the bore is located on a collar stepped down to suit, as shown in Fig. 3. There is no reason, however, why the reader

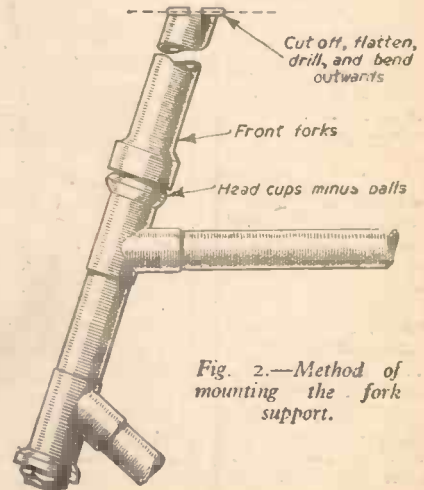

Fig. 2.—Method of mounting the fork support.

should not use a flanged boss to carry the flywheel. A local garage would probably machine these parts for a few shillings.

The Idler Sprockets

To obtain the correct rotation of the lathe when pedalling naturally the driving chain is crossed, which, although strictly speaking is not good practice, puts no more side strain on the chain than a derailleur gear.

To keep the crossed chains from fouling and also to provide a means of adjustment a double sprocket is used. This consists of two cycle free-wheels, minus the pawls, screwed face to face on a bottom bracket cup, which is in turn bolted to a piece of 1 1/2 in. x 1 1/2 in. x 3/16 in. angle 12 in. long, as shown in Fig. 4. A narrow collar should be fitted over the bolt to bring the diameter up to that of the hole in the bracket cup.

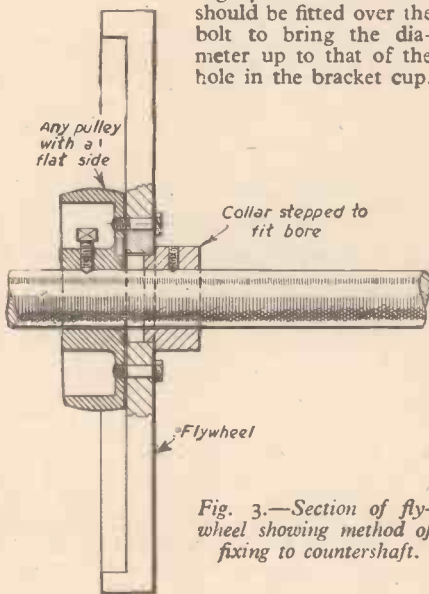

Fig. 3.—Section of flywheel showing method of fixing to countershaft.

Lining Up

The chain sprockets should be carefully lined up, bringing the two idlers one on each side of the chain line. The bolt holes in the angle carrying these idlers should be elongated to provide a means of adjustment for the chain, and the assembly bolted up underneath the lathe bed plank between the forks.

The lathe can now be firmly secured to the bed plank in line with the rear countershaft, and the cone pulleys brought into position.

The Belt Tensioner

The tensioner shown in the illustration will greatly improve the pulling power of the lathe when using a flat belt, some types of which are very susceptible to climatic changes.

It is made from a cycle hub (front or rear), but with the oil nipple removed and the hole plugged. If the bearings are packed with soft grease on assembly, no further attention will be needed for a considerable period. The arm is made from 1 in. x 3/16 in. mild-steel strip and may have to be cranked as shown in Fig. 5 to bring the working face of the hub in the correct position relative to that of the belt.

General Remarks

The wooden structure can now be given

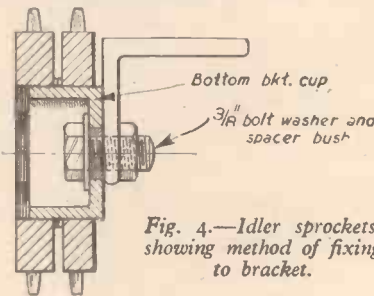

Fig. 4.—Idler sprockets, showing method of fixing to bracket.

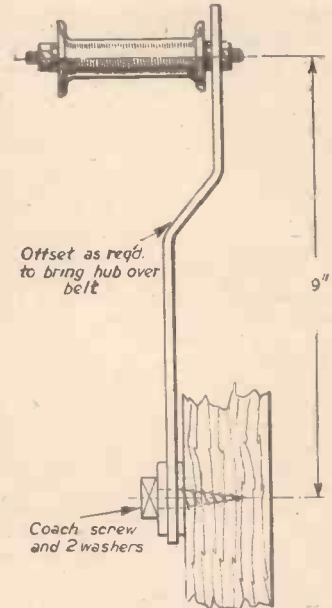

Fig. 5.—The belt tensioner.

a coat of some wood preservative; creosote is satisfactory provided there is no objection to the smell in the workshop.

Handles

The reader may find that a pair of handles, or indeed a handrail fitted to the front edge of the lathe bed plank will assist him in pedalling when using the self-traverse on a heavy cut.

The above described unit has the advantage that, if at some future date one is fortunate enough to have electric power made available, the stand may, by the cutting off of the bottom rails and the removal of the cycle frame, be converted into a self-contained motor drive.

The Law About Patents

5.—What Can I Patent?

YOU have a mind fertile in ideas—for a mechanical device, for a story, for a poem. Is there not, you wonder, a means of eliminating that annoying delay when I switch on the wireless? Can I not devise a water tap needing no periodic renewal of washer? The idea is remote from the patentable device; and most ideas for achieving a desirable result die in their birth or after a feeble and short life.

Plants Patents

EVEN when the idea does blossom into a discovery, you may have nothing patentable. For your original work in prose or verse—for what Shakespeare called “the heirs of my invention”—you look to the Copyright Act for protection, not to the Patent Acts. Ever experimenting in your garden you may produce a new and choicer apple, a new and more resplendent rose. You cannot take out a patent for it here. You could if you were in the United States. There the Plant Patent Act, 1930, is in operation. The grower satisfies the patent examiner that the fruit or flower is a new and distinct variety. Doing so, he becomes, for seventeen years, the sole owner of the plant and all cuttings from it; and he can give licences to other growers to exploit the plant commercially, collecting royalties on all his licences.

“New Manufacture”

OUR law shrinks from a precise definition of what is patentable; it contents itself with “a manufacture new within the realm,” leaving the interpretation of this to the Courts. In effect, the Courts have made it mean “a discovery that enables the production of a new and useful thing”; and the utility must have a money’s worth. This includes a tangible device, but also a method enabling the public to do something they could not do before.

New Processes

THAT is, “manufacture” is not confined to an article or a material made by physical power or mechanical force: it is extended to new manufacturing methods. Thus, nearly a hundred years ago—in 1856—Bessemer patented his process, the first for producing steel cheaply on a large scale. And in 1877 Sidney Gilchrist Thomas took out the patent for his method of making steel out of phosphoric iron. But scientific discoveries themselves, however important and far-reaching in their subsequent applications, cannot be patented and made a monopoly. It is the successful application that is patentable.

In the judgment of *Welsbach Incandescent v. New Incandescent* (Ch. 1900), this explanation occurs: “A very small amount of utility is enough to support a patent. For instance, an invention is useful when the

public are thereby enabled to do something which they could not do before, or to do in a more advantageous manner something which they could do before.”

Chemical Products

British patent law allows, too, though in a hesitating way, patents for chemical products, for foodstuffs, and for medicines. The test is: “Are these produced by new processes set out clearly in the specification lodged by the would-be patentee?” In most countries, however, a monopoly on a food-stuff or medicine is refused on the ground that such a monopoly is against public interest.

Important Announcement

MORE COPIES AVAILABLE

WE are happy to announce that more copies of PRACTICAL MECHANICS are now available. This means that many PRACTICAL MECHANICS enthusiasts who for the past 10 years have had extreme difficulty in obtaining copies will, from now on, be able to obtain the journal as in pre-war days.

Fourth Edition

REFRESHER COURSE

IN

MATHEMATICS

By F. J. CAMM

8/6, by post 9/-

The Elements of Mechanics and Mechanisms—30

Gear Tooth-forms (contd.)

(ALL RIGHTS RESERVED)

NOW, if two teeth are in contact, their lines of intersection with the tangent plane are the same straight line, which is therefore the line of contact between the teeth.

Hence the line of contact between two teeth of helical gears of equal base spiral angle on parallel shafts is a straight line lying in the tangent plane to the base cylinders.

It is clear that there can be no contact between the teeth at any point outside the tip circle of either gear or at any point on the tangent plane outside its lines of contact with the base cylinders. Thus in Fig. 55, CD represents the end view of the tangent plane and contact cannot occur at any point on it above C or below D.

In the case shown, contact is more restricted than that, as it cannot occur outside the tip circles 1 and 2 and is therefore limited to the part of the tangent plane between F and E. If the points corresponding to F and E in the other end plane of the gears are F' and E', contact is limited to the rectangle EFF'E', and this is the "zone of contact."

Zone of Contact

In a pair of gears of any type the zone of contact is the limited area upon which every point of contact between any pair of teeth must always lie. It is not necessarily a plane (although it always is so in involute spur and helical gears), but in any particular case its shape and position are fixed. The line of contact between any pair of teeth changes its position (and perhaps also its length) as the gears revolve, but it always lies on the zone of contact.

Motion of Line of Contact on Tooth of Helical Gear

In the upper part of Fig. 56 A and B are the nearer and farther end profiles of a helical gear tooth and EF is the end view of the tangent plane cutting A and B in C and D. The points of contact of A and B with the mating profiles are therefore C and D, C being nearer to the tip of A and D near to the root of B.

The lower part of Fig. 56 shows an approximate view of the tooth looking directly at its flank. The line of contact is the line joining C and D and this has already been shown to be straight.

Now if the gear moves through a small angle in the clockwise direction, A and B take up the positions shown dotted in the upper diagram, and C and D move to C' and D'. This movement is towards the tip of the profile in each case and the new line of contact C'D' is shown dotted in the lower view.

The line of contact on a tooth may thus be regarded as moving bodily parallel to itself up or down the tooth as the gears rotate.

When C has reached A in the lower view, further rotation causes shortening of the contact line in positions such as GH until finally the line shrinks to zero length and disappears at B. When the tooth re-enters the contact zone, contact is established at K, spreading into a line parallel to CD, one end moving from K to A and the other from

K to L, and the cycle of movements is repeated. The gradual growth of the line of contact from a point and its later shrinking and disappearance at a point are characteristic of helical gear tooth contact and provides the reason for the smooth action of that type of gear.

Spiral Gears

Helical gears of equal normal base pitch may be set to mesh together with the angle

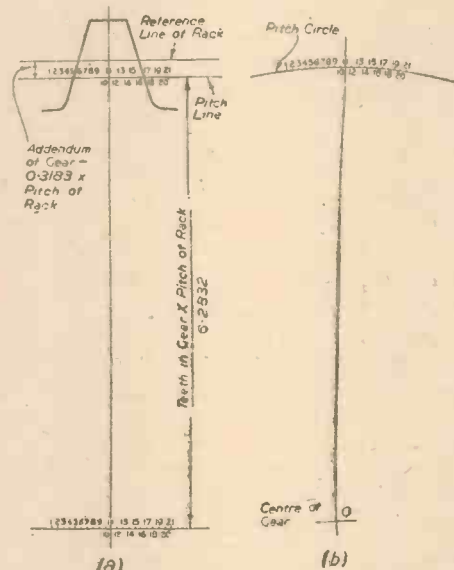

Fig. 57.—(a) The basic rack shape (b) Tooth form of the gear.

between their shafts equal to the algebraic sum of their spiral angles. If the spiral angles are equal but the spirals are of opposite hand, the shaft angle is zero, i.e., the shafts are parallel. If the spiral angles are such as to make the shafts not parallel, the gears are known as "spiral gears." This is a difference only in name, as the same gears when meshed with others on parallel shafts would be called "helical gears."

Although helical gears and spiral gears are individually identical, there is an important difference between them in respect of contact conditions. When in mesh, each of them may be regarded as also meshing with a common imaginary rack, any tooth flank of the rack making straight-line contact with a tooth of each gear at the same time. As the shafts are not parallel the two contact lines on the

rack tooth flank are not parallel and therefore cannot coincide, although they intersect. The actual contact between the two gear teeth is therefore confined to the point of intersection of the imaginary lines of contact with the imaginary rack tooth.

If the shafts are parallel the imaginary contact lines coincide and become an actual contact line between the gear teeth, confirming the previously established fact that helical involute gears have straight-line contact.

The path of the point of contact between teeth of spiral gears is a straight line whose position cannot be simply defined beyond saying that it passes through the pitch point, which is the point of contact of the pitch cylinders of the gears.

The fact that spiral gears have only point contact means that the load capacity of such gears is very much less than that of gears of comparable dimensions operating on parallel shafts.

End Thrust on Helical Gears

When two helical gears on parallel shafts are meshing together, the useful force exerted by one on the other lies in the common tangent plane to the pitch cylinders, perpendicular to the shaft centre lines. Owing to the helical tooth formation, however, the actual tooth load does not lie in this direction, and equal and opposite end thrusts are exerted on the two gears. If there were no thrust bearings or equivalent provision, the gears would slide endwise out of mesh when torque is applied to them.

The magnitude of the end thrust is the tangent of the spiral angle multiplied by the torque on either gear divided by the pitch radius of that gear. The direction of the end thrust is determined by the direction of the torque on the gear and the hand of the tooth spirals. If the torque exerted on a gear by the mating gear is in the clockwise direction, and the tooth spiral is right hand, the end thrust exerted on the gear by the mating gear is towards the observer. If the direction of the torque or the hand of the helix is reversed, then the thrust is away from the observer. A counter-clockwise torque with a left-hand helix introduces a thrust towards the observer.

On an intermediate shaft, for example, in a double reduction gear train, there may be two gears, one of which is a driving gear and the other a driven gear. If it is desired to minimise the end thrust on the intermediate shaft, it is necessary to use the same hand of spiral for both gears. This is because the torque exerted on one gear by its mating gear is in one direction (clockwise or counter-

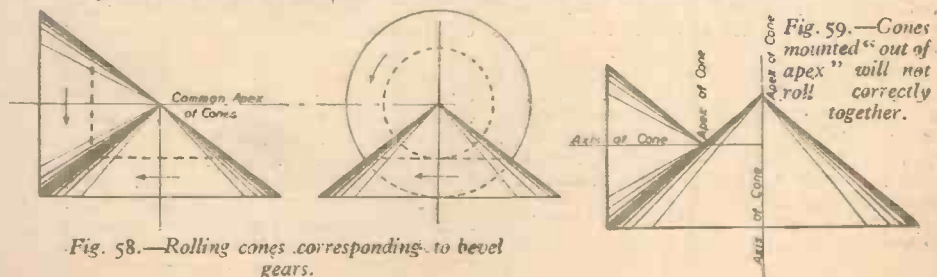

Fig. 58.—Rolling cones corresponding to bevel gears.

Fig. 59.—Cones mounted "out of apex" will not roll correctly together.

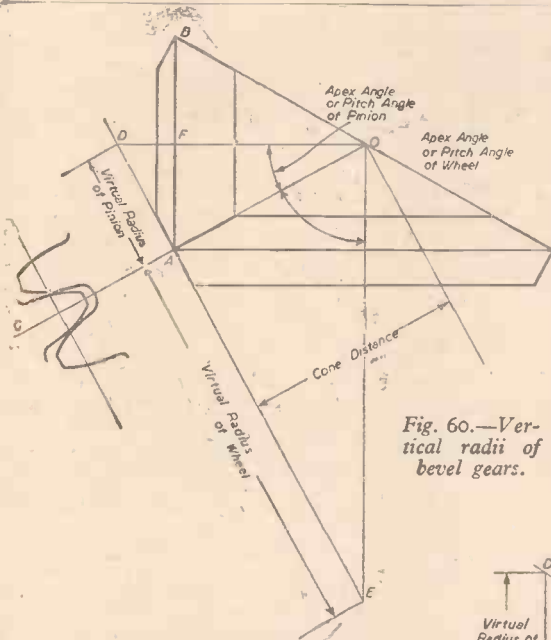

Fig. 60.—Vertical radii of bevel gears.

process using a straight-edged cutter representing a tooth of the crown wheel and formed at its tip to produce the fillet, the fillet will be the same size, or nearly the same size, at all sections, whereas true similarity of the teeth would require it to be smaller at the small end. This lack of exact similarity does not affect the accuracy of meshing of the teeth because the fillet does not make contact with the mating tooth. It does, however, make it necessary to limit the face width of the gear to a certain fraction (usually about one-third) of the radius of the imaginary crown wheel. If this were not so, the fillet would tend to be too large in relation to the depth of the tooth at the small end.

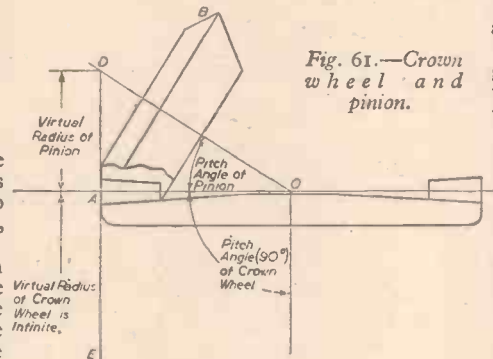

Fig. 61.—Crown wheel and pinion.

clockwise), whilst the torque exerted on the other gear on the intermediate shaft by its mating gear is in the opposite sense. To make the end thrusts equal, as well as opposite, the two gears should have the same lead.

This condition neglects friction, which cannot be exactly predicted, and therefore some provision for axial location of the intermediate shaft must be made, but the end thrust exerted on it will be small if the helices are of the same lead and hand.

Mounting of Double Helical Gears

In order to eliminate end thrust on parallel shafts connected by a pair of helical gears, the double helical tooth formation is adopted, each half of each gear being similar to the other half, except that the hand of helix is opposite. Thus the end thrust produced on one half of either gear is balanced by the end thrust on the other half of the same gear. If, however, double helical gears are mounted on shafts which have axial location, it is possible for them to be set up so that the driving load is transmitted through one half of each gear. This is undesirable, first, because the teeth are overloaded, and, secondly, because end thrust is set up, the object of the double helical tooth form having been defeated. To make sure that this condition does not arise, one shaft, preferably that carrying the larger gear, should be mounted with fairly close axial location, and the other shaft should have no means of location beyond that afforded by the gears themselves. In operation, the second shaft will set itself axially so that the end thrusts on the two helices are equal, thus equally sharing the load between the two halves of the gears and eliminating the end thrust from both shafts.

The crown wheel with straight-sided teeth has the same importance in connection with bevel gearing as the rack has in connection with spur and helical gearing. Its straight-sided tooth form has the characteristic of simplicity that is advantageous in spur and helical gearing, together with another equally important one. This is the fact that whilst a tooth of the crown wheel, like any other bevel gear tooth, tapers towards the apex, the profile at the small end, being straight, is simply a part of the profile at the large end. It is thus possible for a straight-edged cutter to "match" a crown wheel tooth at both the large and small ends. (See Fig. 61.) This is not possible for any but a straight-sided profile.

In practice, the profile is not entirely straight because a fillet is provided at the root of the tooth. If the bevel gear is cut by a generating



Fig. 62.—Straight-edged cutter fits crown wheel tooth at both ends.

Generation of Bevel Gear Teeth

Just as a spur gear can be generated by a rack-shaped cutter moving backwards and forwards so that its cutting edges sweep out the surfaces of the teeth of a rack which "rolls" with the gear blank, so can bevel gear teeth be generated by cutter blades sweeping out the surfaces of the teeth of a crown wheel "rolled" with the gear blank.

Because the teeth of a rack are parallel and similar throughout their length, a single cutter in one piece can represent several rack teeth at once. The teeth of the crown wheel are not of uniform section and are not equally spaced at different points in the face-width, and consequently no single cutter can represent more than one flank of a tooth of the crown wheel. (As has already been mentioned, unless the tooth profile is straight a cutter cannot represent even one flank.)

In a straight bevel gear generating machine the cutter is carried in a box moving backwards and forwards along a slide which can swivel about a centre line representing the axis of the imaginary crown wheel. (See Fig. 63.)

The cutter is set so that its tip travels along a straight line passing through the apex, which is the point where the centre line of the blank and the swivelling axis of the slide meet each other.

A second slide fixed in suitable relation to the first one guides a cutter which generates a different tooth flank. It is not practicable to make a machine to use more than two cutters in this way.

In connection with Fig. 60 it should be emphasised that tooth action cannot strictly be said to occur in the plane represented by DAE or, for that matter, in any other plane. It can, however, be considered to take place on the surface of a sphere whose centre is at o and which contains A. For points on the sphere not very far from A the distances between the sphere and the plane DAE are very small and only a slight error is caused by regarding the tooth action as taking place in the plane. Ignoring that error, the bevel gear teeth which mesh with straight-sided crown wheel teeth are of involute form.

The basis is used in setting out the tooth forms of bevel gears cut by the planing process which uses former plates. Bevel-gear cutting machines which work on the generating principle use cutter blades shaped to correspond to the teeth of the crown wheel and automatically to produce teeth of the right forms to mesh with such a crown wheel. These forms, not strictly involute, are described as "octoid."

The pitch cones of engagement of bevel gears are those imaginary cones which, when placed with their axes coinciding with those of the bevel gears, will roll together without slip.

If we consider any point on the line of contact of the cones, the speeds of the surfaces of the cones at A must be equal. As the rotational speeds of the cones are the same as those of the bevel gears, the perpendicular distances AB and AC of A from the axes of the cones must be proportional to the numbers of teeth in the gears.

$$\text{Now } \frac{\sin \angle AOB}{\sin \angle AOC} = \frac{(AB/AO)}{(AC/AO)} = \frac{AB}{AC} = \frac{t}{T}$$

where t and T are the numbers of teeth in the gears.

$$\text{Also } \angle AOB + \angle AOC = \text{angle between shafts} = S.$$

Writing $\angle AOB = P$ and $\angle AOC = Q$

we have $P + Q = S$ or $Q = S - P$

$$\text{Therefore } \sin Q = \sin (S - P) = \sin S \cos P - \cos S \sin P.$$

$$\text{Also } \sin Q = \frac{T}{t} \sin P.$$

$$\text{Therefore } \left(\frac{T}{t} + \cos S \right) \sin P = \sin S \cos P$$

$$\text{or } \tan P = \frac{\sin S}{\frac{T}{t} + \cos S}.$$

This enables P to be determined when the shaft angle and the gear ratio are known.

If $S = 90^\circ$ (as is usual) the equation reduces to $\tan P = \frac{t}{T}$.

(To be continued)

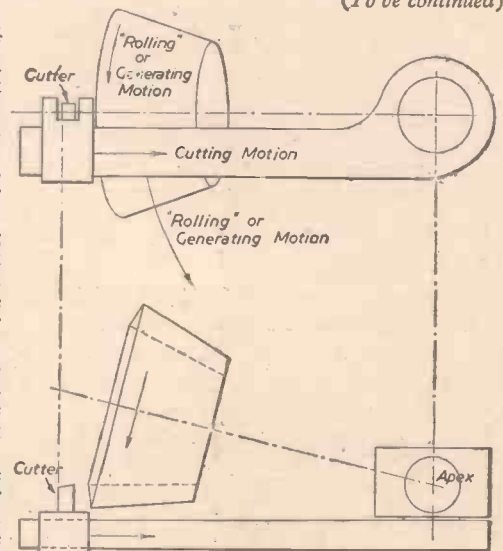

Fig. 63.—Principle of bevel gear generating machine.

A Model Aircraft of Loaded-elevator Type

Further Constructional Details of a Novel Model Monoplane

By E. W. TWINING

Main Plane

I THINK it rather unlikely that the making of this model will be undertaken by anyone who has never previously built a model plane, and a skilled aero-modellist will know as much about the construction of wings in balsa wood as I do, therefore I shall say little about this portion of the design or construction. Nevertheless, I cannot neglect to give some attention to these most important items. In Fig. 8 I show my suggestion for the structure of the main plane. This is built entirely of balsa with the exception of

(Concluded from page 194, March issue).

ticularly from sailplanes. I do not wish it to be understood that I apply the foregoing remarks to all aero-modellists, but taken in the aggregate they do apply.

Referring again to Figs. 8 and 9, the reader will find that the undersides of both the wings are perfectly flat. In the main, the maximum camber is $\frac{3}{8}$ in. and in the elevator it is $\frac{1}{2}$ in.: there is no need for me to give diagrams of ordinates; if these figures are adhered to the finished wings will not be far wrong.

Propellers

The propellers may very well be dealt with next, and I consider that balsa is a wood which is totally unsuitable for this. It cannot be carved as it should be: it is so fragile that the blades have to be thick, and

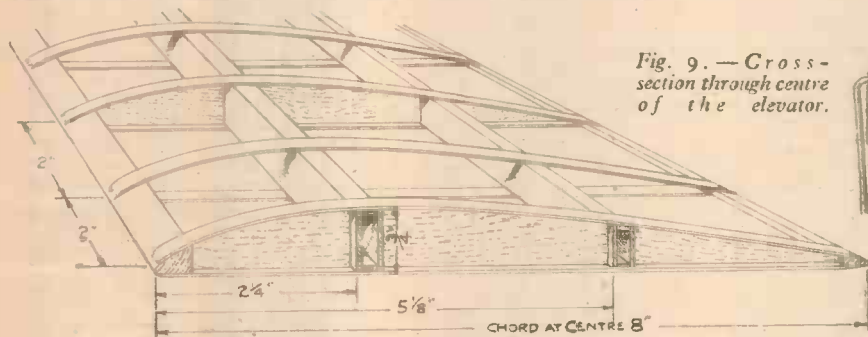

Fig. 8.—Cross-section of main plane.

the vertical members of both the spars, which should be made of spruce for the sake of strength and toughness. Every alternate rib only is filled with a web.

The maximum chord at the wing root is 8 in., at the tip 6 in., and the mean chord is therefore 7 in. As the span is 38 in., the superficial area is 266 sq. in.

The leading plane or elevator is drawn in Fig. 9 and has a span of 16 in., a mean chord of 4.5 in. and area of 72 sq. in. The entering edge spar can here be of hard balsa, the centre spar of spruce and balsa like the main wing. This drawing shows the angle adjusting wire with its cross member let into a groove in the front spar. Both this and the piece of tinned plate should be bound to their respective spars with tinned wire and soldered.

The wing section which I have adopted, it will be seen, is not like that usually put on model aircraft; still less is it like that of the fast high-powered full-size machine, but I have striven for a high lift at low-speed section. In my opinion there is, in the model aircraft world, far too great a craze for copying full-size practice and ignoring efficiency. There is a studied indifference to the mathematical and scientific conditions of model flight. It may sound very fine to be able to say "my model has a 'Clark Y' section wing, or a R.A.F. so and so," but is a thought ever given to the question as to whether this, that or the other section is the best for a little feather-weight affair that flies at, perhaps, only one-tenth, or even only one-twentieth, of the speed for which the section was designed? If efficiency in wings is expected it is not a bit of use to ape the high-powered aircraft; much more can be learned from gliders and par-

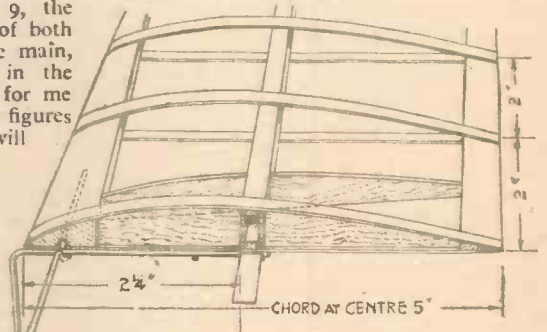

Fig. 9.—Cross-section through centre of the elevator.

often the pitch, if there is any definite pitch, of one blade is different from that of the other. Skin friction on balsa blades is enormous, for balsa cannot take a high surface finish unless it is doped, varnished or enamel painted, and then it becomes as heavy as a propeller carved from some other soft wood, such as pine.

Pine is the wood which I am suggesting to the reader for the propellers of this machine. The pair of them are shown in Fig. 10. They are each of 12 in. diameter with a pitch of 24 in. The left-hand propeller is to be of left-hand pitch and the right hand of right-hand pitch.

Two pieces of either yellow or soft pine will be required, each 12 1/2 in. long by 2 1/4 in. wide and 1 1/2 in. thick, finished sizes. At any rate these are the measurements for ordering from an engineer's pattern maker, from a timber dealer, if he has such a wood, or from any other source which may be available. If the angles are not square they should be made so by planing.

I strongly recommend the reader, before commencing to cut the wood for the shaping of the propellers, to make a full-size drawing from the portions of Fig. 10 which show the cross-sections of the blade and one blade of each

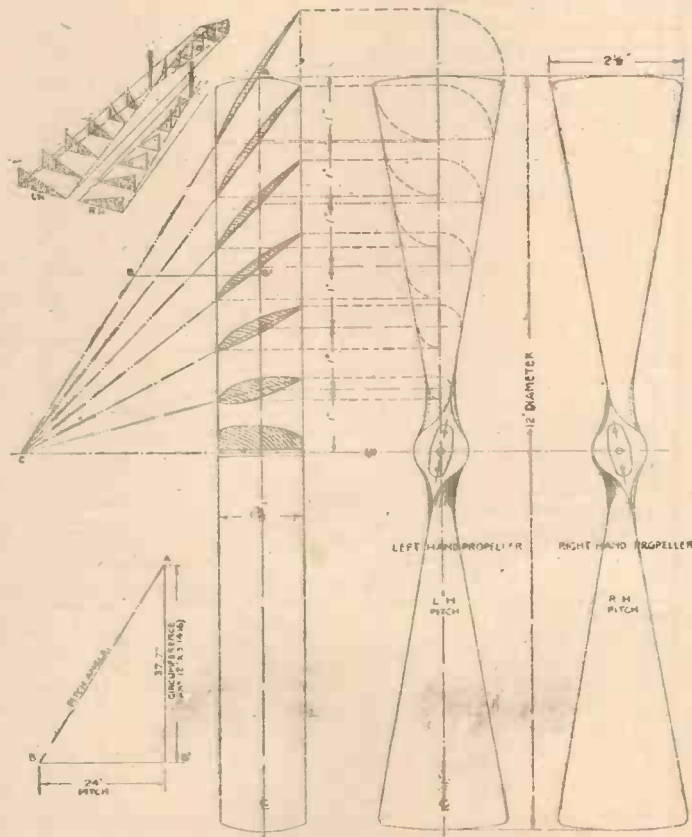

Fig. 10.—Details of the propellers.

propeller; this at least should be done though it may be no disadvantage to make an exact copy of the whole drawing. The diagram in the bottom left-hand corner shows how the pitch angle at the blade tip is set out. Draw a base line, B, B₁, by a convenient scale, say, one twelfth, and mark off points 24in. apart. From B₁ erect a perpendicular and by the same scale put a mark at A 37.7in. from B₁. The 24in. represents the pitch and the 37.7in. the circumference. Draw a line from A to B and this will give the angle of pitch at the end of the blade. In Fig. 10 I have repeated this angle A, B, B₁ on the side view of the propeller. On this view a line drawn through A, B, cutting the axial line of the screw, gives a point, C, from which all other pitch angles will radiate. The cross-sections of the blade can be drawn by means of a french curve.

Having made the drawing, paste it down upon a piece of true and flat board; draw rectangles 12in. by 2½in. around each of the face views of the propellers and draw diagonal lines across each rectangle. Where each diagonal crosses the other, drill holes in the board dead square in all directions with the board and knock into each a piece of stout wire of the same gauge—about No. 16—as the propeller spindles.

Next cut from some thin board or thick cardboard four templates for each of the

following these suggestions will be nearly as light as the usual balsa kind and far more efficient.

Wheels

The upper details of the undercarriage have already been shown in some of the drawings so it only remains for me to give

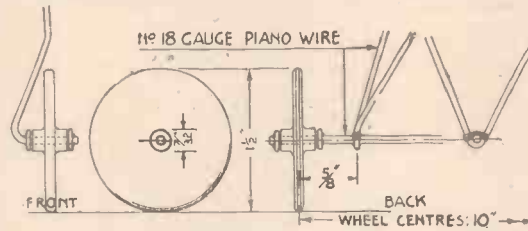

Fig. 11.—Undercarriage, wheels and axles.

a sketch of the wheels. These—three in number—are each made of three thicknesses of Bristol board with a hardwood bush through the centre. They must be well doped and shellac varnished. To serve as stops on the axles, rings of copper wire may be bent around the steel wire and soldered, as shown in Fig. 11.

Fuselage

The last item to be dealt with is the fuselage and, as was the case with the wings, the skilled aero-modellist should take the

lower half which is made a fixture with the upper half fitting over the lower, like a box lid.

It will be seen that the main longerons at the sides are in three pieces, but only the lower and the inside strips are cemented together. The joint is broken between the inside strip and the upper one; consequently the upper half of the fuselage could be lifted off or may become lifted in flight if some temporary or detachable fastening were not provided. Neither hooks nor any other mechanical device is possible, the material to which attachments would have to be made is too fragile. There are only two alternatives; elastic bands encircling the whole fuselage or some detachable adhesive. The bands are objectionable because they break the streamlined

contour of the fuselage and may bend or break the lighter stringers, so I think the most simple plan is to adopt an adhesive material. Fortunately, there is a suitable self-adhesive cellulose tape, which can be bought in a roll at any good stationer's shop; it is largely used in drawing offices to take the place of drawing pins. Its application to our model aircraft lies in running strips of it along the joints between the upper and lower middle longerons. Each strip need not be in one piece nor need it be continuous. About four pieces, each about three inches long, equally spaced on each side, should suffice. When the fuselage has to be opened it is a simple matter to peel these off and afterwards to put new ones on.

Beyond a passing mention of them, I have said nothing about the rubber motors. The quantity required for each is largely a matter of trial, but I should start off with skeins

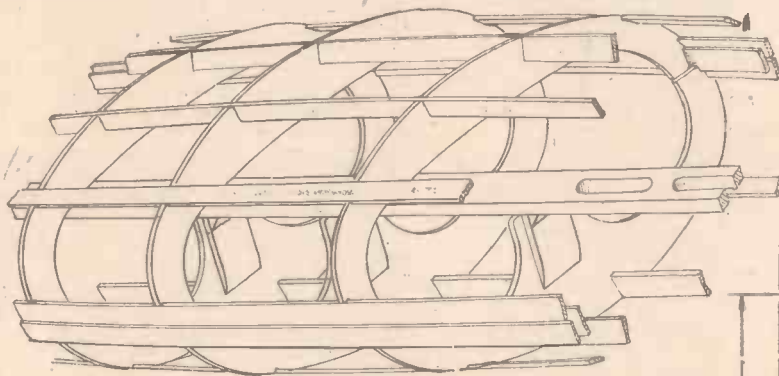

Fig. 12.—Details of fuselage.

blade angles shown on the drawing; 24 templates in all. These are to be glued on edge, six on either side of the vertical wire for each airscrew; bearing in mind that for one propeller the templates will be mounted the opposite way round to the other. I think that my small perspective sketch at the top left-hand corner of Fig. 10 will convey what is meant. The board will now constitute a jig by means of which the screws can be carved. Before carving, however, it will be necessary to drill the holes in the centres of the pine blocks for the propeller shafts. As carving proceeds, these holes are passed from time to time over the pins in the board or jig, as it now is.

It will be noted that the back or working faces of the blades, for the four outermost inches and four outermost templates on the jig, are flat, and it is these working faces which will be carved first. After these are finished on both screws the positions of the templates can be lightly marked with pencil on the faces, and the various thicknesses of the blades gauged either with callipers set from the drawing or with six specially cut gauges. This latter method is the better because the curvatures, or cambers, of the forward sides of the blades can be gauged as well as the thickness. Gauges can be cut out of Bristol board.

When carving and fine glass-papery are finished give them a thin coat of cellulose dope or lacquer and two coats of shellac. Such propellers as should be the result of

design and arrangement shown in Fig. 12 as a suggestion only. Every bit of the framing, formers or frames, longerons and stringers, can be of very thin balsa with a skin of the usual doped paper. It will have to carry no stresses except those set up in handling the machine and passage through the air. It must, however, be secured to the main compression spar of the machine and must render it possible for the motors to be reached for attachment, for renewal and for lubrication; therefore it will have to be built in two halves, an upper and a lower, and, as both planes are detachable and the undercarriage is not, it had better be the

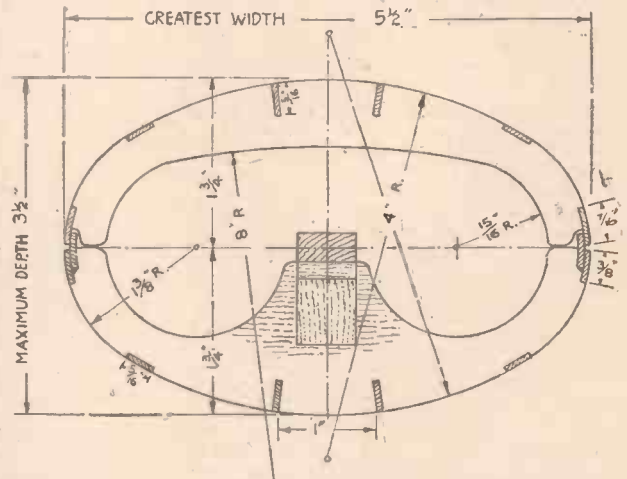

of eight strands each, of 3/16in. wide flat strip; it is an easy matter to increase to 10 or more if they are needed. Do not have the skeins much longer than the distance between the hooks; no increase in power is gained by so doing and it is absurd to carry a lot of useless weight of rubber in the machine.

THE MODEL AEROPLANE HANDBOOK

An Important New Work: 312 Pages, 303 Illustrations, 12/6, by post 13/-

By F. J. CAMM

A Short History of Model Aeronautics; Principles of Design: Airscrews; Wings; Undercarriages; Folding Airscrews—Retractable Undercarriages; Fuselages; The Elastic Motor; Gearing and Special Mechanisms; Making Model Wheels; Gearing Winding Devices; Model Aeroplane Stability; Downthrust; Model Petrol Engines; Adjusting Model Petrol Engines; Compressed Air Engines; How to Form and Run a Model Aero Club; F.A.I. and S.M.A.E. Rules; S.M.A.E. Com-

petition Cups; A Lightweight Duration Model; A Wakefield Model; A Farman Type Model Monoplane; A composite Model; Ornithopters—or Wing-flapping Models; A low-wing Petrol Monoplane; A Duration Glider; Winch-launching-Model Gliders; A streamlined Wakefield Model; A Model Autogiro; A Super Duration Biplane; Flying Model Aeroplanes; A Flash Steam Plant; Model Diesel Engines; Weights of Wood; Piano Wire Sizes, Areas and Weights; Schedule of British Records.

GEORGE NEWNES LTD., TOWER HOUSE, SOUTHAMPTON ST., STRAND, LONDON, W.C.2

An A.C.-D.C. Test Unit

A Useful Instrument for Radio and Electrical Testing

By W. L. WILLIAMSON

THIS unit has been designed for flexibility and compactness, and so arranged that quite a number of useful tests can be carried out, such as valve testing, resistance and condenser measurements, tests and comparisons, leakage tests using 0.5 watt neon lamps (A.C. or D.C. supply), electric iron, radiator or vacuum cleaner circuits, as a mains supply unit for a radio receiver and, in addition, a section has been incorporated for testing microphones and amplifiers which could be used for home broadcasting.

Having obtained the wood for the stand, the component parts may be purchased reasonably cheap from dealers in Government surplus radio equipment. The stand should be made next, and the accompanying list of materials gives the finished sizes of the various pieces of wood required.

Constructional Details

First screw the eight support pieces for the trays to the legs, as indicated in Figs. 1 and 2, and then obtain assistance and fix the trays and moulding. See that the stand is square and the legs even, and then fit the control and test panels in position and sandpaper all the wood work. The two panels should now be removed after marking the correct positions, and the control panel drilled ready for the switches, sockets and indicator light fitting, and then given a final sandpapering. All the woodwork should now be stained, varnished and left to dry. The next job, which should be very carefully carried out, is making up the test panel. The positions of the components shown on the wiring diagram, Fig. 3, are approximate but some idea is given as to the lay-out most suitable to the wiring. Care should be exercised in cutting the holes for the meters, especially if the panel is cut from Perspex sheet. Tinned copper wire, 18 S.W.G., and insulating sleeving is used for wiring. Regarding the terminals it is well worth while to use the insulated type as these give a neat appearance to the panel. At this stage a few remarks concerning some of the components will prove beneficial. On studying the wiring diagram (Fig. 3) it will

be noticed that plugs and sockets are indicated for meter shunts and series resistance tappings, these may be replaced by using stud type switches similar to those shown as H.T. voltage selector switches. In the A.C. voltmeter circuit the condenser shorting

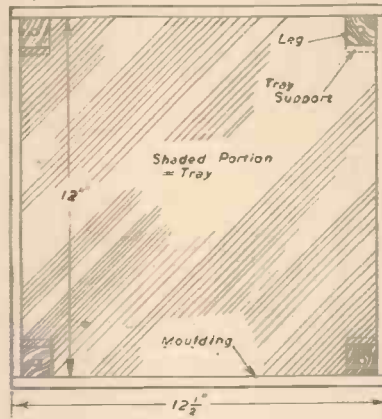

Fig. 2.—Plan of tray and mouldings showing position of legs.

terminals marked L.T., it will be seen that the wiring from the L.T. winding of the mains transformer for this circuit does not go direct to the terminals, one wire goes to one of the terminals, the other to the filament rheostat, and from this to the other terminal thus giving a variable voltage control when testing valves with 4-volt filaments, as the L.T. winding is 6.3 volts. To set this voltage operate the press switch for the A.C./D.C. voltmeter whilst adjusting the filament rheostat. If at any time 2-volt battery valves are to be tested, connect a 2-volt accumulator direct to terminals 3 and 4 on the second row leaving the L.T. terminals out of use.

Microphone Section

The microphone section will prove useful as previously stated, all that is required are two pairs of flex leads, one to the microphone and one to the amplifier or receiver. The battery for the microphone is connected as shown and placed on the top tray; the 450 ohm potentiometer on the test panel controls the volume. It should be noted that the microphone transformer should be suitable to work in conjunction with the microphone being used or tested. The next points of interest are the neon lamps with a choice of A.C. or D.C. supply. Insulated prods should be used during these tests; they are connected to the two terminals above the A.C. lamp for A.C. testing, and in the case of D.C. tests to the terminals on the bottom row marked + and - D.C. neon test. The neon lamps are used for leakage tests on valves, conden-

switch is used for cutting out the condenser when ganging a radio receiver and using the lowest range of the meter, otherwise the switch is left in the "off" position. Regarding the L.T. filament supply, bottom left-hand

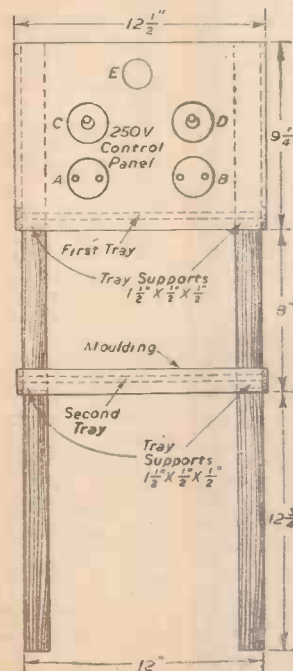
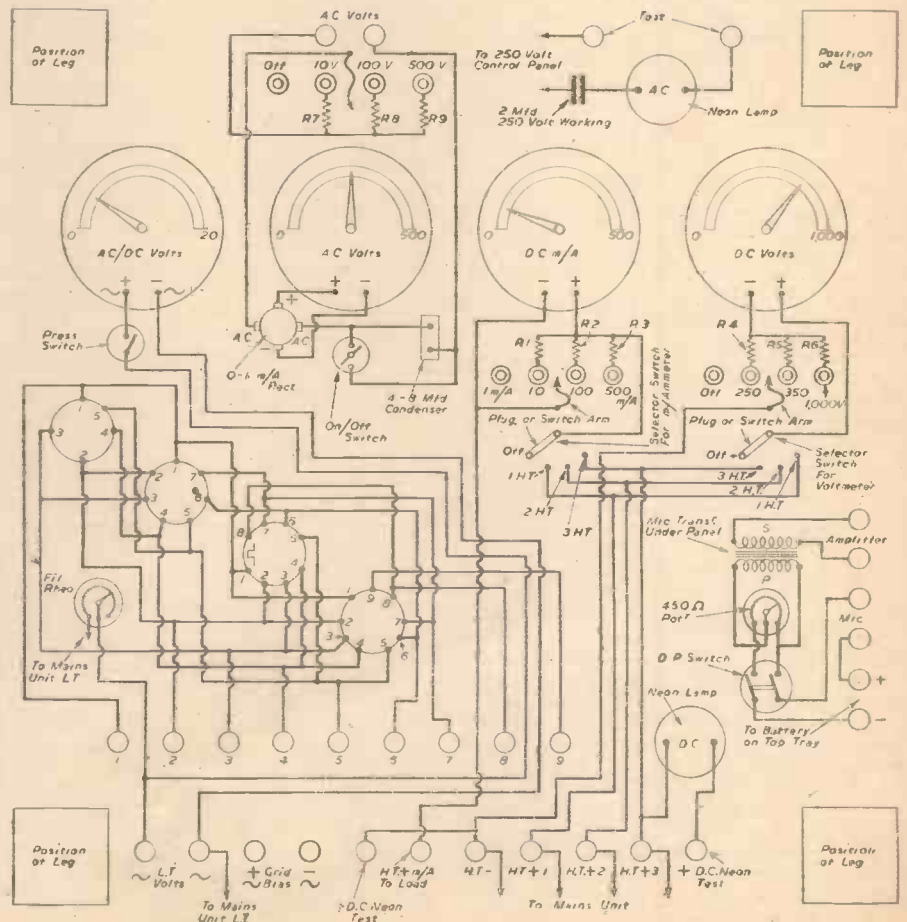

Fig. 1.—(Left) Front view of test unit stand showing control panel and position of trays and supports.

Fig. 3.—(Right) Wiring diagram of test panel showing the layout of components including plugs and sockets for the meter shunts and series resistance tappings.



sers, transformers, etc. When electrolytic condensers are being tested the D.C. neon lamp only must be used, and the supply voltage must not exceed that shown on the condenser. The voltage may be controlled by using the variable resistance which controls H.T.+3 terminal voltage, and if it cannot be dropped low enough, say to 100 volts, put another fixed resistance in series with one of the prods, the voltage can then be checked by setting the D.C. tapping switch to 250-volt range and the H.T. selector switch to H.T.3. To test an electrolytic condenser switch on the supply and touch the terminals with the prods when the lamp will flash once or commence flashing at about 14 times per second; in this case the condenser can be considered in good condition. If the flashes are much more frequent than the condenser is leaky and should be discarded. If the lamp glows continuously the condenser is short circuited and should not be used. The A.C. neon lamp circuit should not be used in testing electrolytic condensers, but is very useful for testing for leakage between L.F. transformer windings and to the metal case; bad contact between the arm and resistance of a potentiometer or variable resistance shows up when using the neon lamp test, and this fault is very often the reason for bad crackling in a wireless receiver. This test is applied to compare capacities of fixed condensers, by counting the flashes given by a known condenser capacity and comparing it with another. The neon lamp test can also be used for checking the continuity of electric iron and radiator elements, vacuum cleaner motor circuits, field coils, etc.

Shunt Resistances

Now to continue with the constructional details of the test unit. The shunt resistances for the D.C. milliammeter should be made up. This is not at all difficult, as it is carried out by measurement. Actually we measure off a certain length of resistance wire and divide this length by the number of times by which we wish to multiply the meter range less 1; it is quite simple and the results, if this procedure is carefully carried out, are fairly accurate.

Our first job is to obtain some resistance wire such as was used for filament resistances in the early wireless days, and next we must find out the resistance of the 0-1 milliammeter by measurement. To do this, obtain a variable resistance of not less value than 4,000 ohms (5,000 ohms would do) and a 3-volt battery (in good condition); connect the battery, variable resistance and meter in series, making sure that the resistance arm of the variable resistance is in the "off" position and the positive terminal of the battery is connected to the positive terminal of the meter. Next, move the resistance arm until the meter pointer shows just about 1 milliamp (almost full scale) and then clean the resistance wire and connect one end to the meter terminal, still leaving the battery and variable resistance connected and adjusted; now move the resistance wire across the other meter terminal and watch the pointer. When this indicates 0.5 milliamps (half scale) mark the point of contact on the resistance wire (this may be 6ft. or 7ft. from the connected end), and then measure between the two points; this length represents the resistance of the meter and from which we carry out our calculations. The formula used is $R_s = \frac{R_m}{N-1}$,

the symbols are R_s —the required resistance of the shunt, R_m is the resistance of the meter (in our case a certain length), and $N-1$ is the number of times the full scale is multiplied minus 1. It has been decided to multiply the 1 milliamp range by 10-100-500, therefore, as a guide, we will take an example, and although the length of the resistance is fictitious it will show how to proceed in making the three

shunts. Take a length of resistance wire 6ft. 6in. long for the example; for the 10 mA. range we get $N-1$ which is 9, therefore for this range we required $1/9$ th of 6ft. 6in., which is 8.6in. Now allow $1/4$ in. at each end for connecting, which gives the total length of 9.6in.; mark the $1/4$ in. at each end, as we must allow the 8.6in. between connections, otherwise the readings will not be correct. For the 100 milliamp range $1/99$ th of 6ft. 6in. is required—that is, 0.787in. + $1/4$ in. at each end, and finally

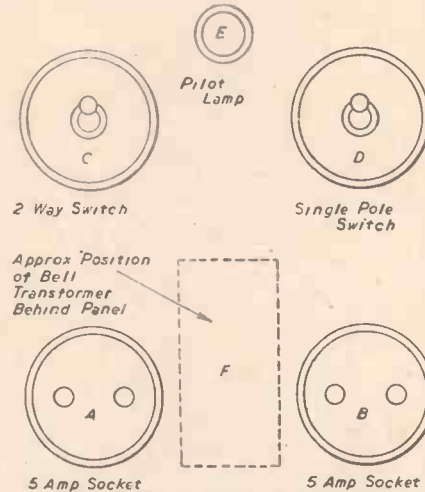

Fig. 4.—Front view of 250 volt A.C. control panel.

the 500 milliamp range required $1/499$ th of 6ft. 6in., which is 0.156in. This length is too short to use or measure satisfactorily, therefore we multiply 0.156 by 6, which is 0.936in., which is not difficult to measure using the tenths section of a rule. To reduce this length to its effective resistance length of 0.156in. we cut six lengths each 0.936in. + $1/4$ in. for each end and bind each set of six ends with fine copper wire and then solder the joints again, taking care that there is 0.936in. clear on each wire between the binders.

Connecting the Shunts

When the shunts are completed connect them to the sockets, or if switches are used to the studs as shown in the wiring diagram (Fig. 3). It will be noticed that there is no connection to the socket marked 1 mA., therefore with plug or switch arm on this point the meter range must not be exceeded. The only time the 1 mA. range would be

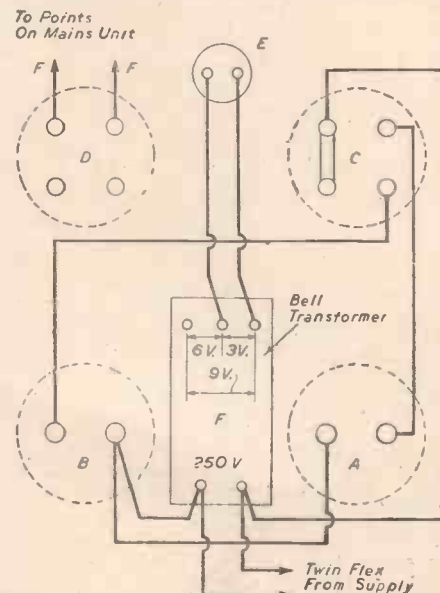

Fig. 5.—Wiring diagram and back view of A.C. control panel.

used would be when measuring the screen current of a screened-grid valve, which will hardly ever be necessary. One further point, in dealing with the shunts is that the resistance wire for the 10 mA. range shunt should be wound on a piece of $1/8$ rod in the form of a spring so that the turns do not touch.

Our next meter to deal with is the D.C. voltmeter, and in this case we use an 0-500 range microammeter as this will give us a meter, the resistance of which works out at 2,000 ohms per volt, which is satisfactory for a home-test unit. This meter (Government surplus) has a resistance of 500 ohms. The series resistances for the 250-350 volt and 1,000 volt ranges are 500,000 ohms ($1/2$ megohm), 520,000 ohms and 2,000,000 ohms (2 megohms) respectively. These resistance values are the nearest in value to those as calculated to be required, but the meter will be sufficiently accurate for our requirements, providing we purchase good quality resistors, which should be of the type guaranteed by the makers to be within 5 per cent. of the rated value.

Connect the resistances as shown, and then proceed with the A.C. voltmeter section. The meter used here is a 0-1 milliammeter with three-series resistances for the 10-100 volt and 500 volt ranges; these are 8,250 ohms, 90,000 ohms and 450,000 ohms respectively, and are connected together with the rectifier, condenser and switch as in Fig. 3. The A.C./D.C. voltmeter is connected in the normal manner. Complete any remaining wiring and, finally, carefully check the wiring as a mistake may cause damage to the meters and to equipment being tested later on. It would be a good idea at this stage to take the test-panel to a friend in the electrical or radio trade and have the meters checked and the scales marked off accordingly, and when you are satisfied that they are O.K. put the panel on one side so that the meter shunts are not disturbed or damaged.

Control Panel

The 250-volt control panel should be fitted up next. Assemble the switches, sockets and pilot light fitting; the bell transformer is screwed to the back of the panel as indicated in Fig. 4. Proceed with the wiring (Fig. 5), bearing in mind that the supply is 250 volts. The twin flex for the supply to this panel is secured at the back by means of an insulated saddle clip, and the flex should be long enough to be run safely to the source of supply socket in the room and not be laid on the floor.

The last constructional job is the mains unit, and the component parts for this should be screwed to the top tray, making sure that the mains transformer and the choke are not fitted directly under the meters. The wiring is carried out using 18 S.W.G. tinned copper wire and insulating sleeving; all joints should be soldered where possible. Regarding the voltage-dropping resistances, etc., the constructor may wish to decide for himself what voltage tappings he requires to suit his own purpose, so with this in view the author has indicated what may be termed "provisional resistances," giving a rectified output voltage of 150-250 volts and a variable voltage at terminals H.T.+1-2-3 with a load of 4 milliamps. The bleeder resistance has not been allowed for, but the writer would suggest here that the constructor reads the "Radio Engineer's Pocket Book" and the "Radio Training Manual" which will be found a mine of useful information on voltage-dropping resistance values, wattage ratings, valve base connections (useful when using this test unit), radio receiver testing and mains unit data. Incidentally, the formula for voltage-dropping calculations is: resistance required

$$= \frac{\text{Volts to be dropped} \times 1,000}{\text{Current in circuit in mA.}}$$

On completing the mains unit, several connections (Fig. 6) are required to interconnect the three sections.

Flex leads are desirable for this wiring and lighting flex would do nicely. The point-to-point connections are as follows: from the 6.3 volt winding of the mains transformer run a twin flex to the test panel, one wire going to the L.T.~ terminal (either will do) and the other wire to the filament rheostat, and from the rheostat to the other L.T.~ terminal. The next twin flex is run from the mains unit, connected at points F, F to switch "D" (Fig. 5) on the control which controls the H.T. supply. Again, from the mains unit four single flex leads are connected between point "G" to H.T.~ on the test panel, also from H.T.+1-2-3 to similar terminals on the panel.

Mains Supply

Finally, for the supply to the mains unit from the control panel a short twin flex with a plug at one end and connected to the 250 volt supply terminals of the mains transformer at the other end, the plug is used in

LIST OF MATERIALS AND COMPONENTS.

- Stand and Trays (all dimensions are finished sizes). Four legs, each 2ft. 6in. long x 1 1/4in. square.
- Two trays, each 12in. square x 1/2in. (1 1/2in. x 1 1/2in. cut out at each corner).
- Four pieces for moulding, each 12 1/2in. x 1 1/4in. x 1/4in.
- Six pieces for moulding, each 12in. x 1 1/4in. x 1/4in.
- Eight pieces for tray supports, each 1 1/2in. long x 1/2in. square.
- Countersunk wood screws.
- Stain and varnish.

Mains Unit

- One mains transformer, input 250 volts primary. Output secs. 350-0-350 (120 mA), 4-0-4 (1 amp.), 6.3 (2 amps.).
- One choke (20 henry).
- Two 8 mfd. condensers, 500 volt peak, T.C.C.
- Three 2 mfd. condensers, 300 volt D.C. working, T.C.C.
- Three fixed resistances. R10=50,000 ohms 1 watt. R11=25,000 ohms 1 watt. R12=50,000 ohms variable 5 watt.
- Quantity 18 S.W.G. tinned copper wire.
- Quantity insulating sleeving.
- One 4-pin valveholder (base board mounting).
- 1 rectifying valve, anode volts 500, filament volts 4.0.

250-Volt Control Panel

- One plywood panel, 12in. x 9in. x 1/4in.
- One 250-volt 5 amp. 2-way tumbler switch.
- One 250 volt 5 amp. single pole tumbler switch.
- Two 250 volt 5 amp. sockets.
- Three 250 volt 5 amp. plugs (two to suit sockets and one to suit socket in use in house).
- One Bulgin indicator light fitting (with red glass).
- One 3.5 volt M.E.S. lamp.
- One bell transformer, 250 volts to 3-6.9 volts.
- Quantity of flex, tinned copper wire and insulating sleeving.

Test Panel

- One panel, 12in. square x 1/2in. thick, black Perspex or ebonite.
- Two 0-1 moving coil milliammeters (Government surplus).
- One 0-500 moving coil microammeter (Government surplus).
- One 0-20 moving iron voltmeter, A.C./D.C. (Government surplus).
- One 9-pin valveholder (chassis mounting).
- One octal valveholder (chassis mounting).
- One 7-pin valveholder (chassis mounting).
- One 5-pin valveholder (chassis mounting).
- One 0-1 mA Westinghouse instrument type rectifier.
- One 450 ohm panel mounting potentiometer.
- One 4 or 8 mfd. T.C.C. condenser (500 volt D.C. working).
- One panel mounting press switch.
- One panel mounting "on-off" switch (single pole).
- One panel mounting double pole switch.
- One microphone transformer (to suit microphone used).
- Thirty insulated type terminals.
- Twelve plug sockets and three plugs to suit or two stud type switches, or shunts and resistances.
- Two stud type switches for H.T. selectors.
- Three fixed resistors for microammeter as voltmeter (R4=500,000 ohms; R5=520,000 ohms; R6=2,000,000 ohms) (2 megohms).
- Three fixed resistors for 0-1 milliammeter as voltmeter. (R7=8,250 ohms; R8=90,000 ohms; R9=450,000 ohms.)
- Three fixed shunt resistors for 0-1 milliammeter as milliammeter with range extensions (shunts to be made).
- Two L.B.C. cordgrip lampholders, bakelite—with skirts.
- Two 250 volt 0.5 watt L.B.C. neon lamps.
- One 5 or 10 ohm panel mounting rheostat.
- One pair test prods (may be home-made).
- One pair crocodile clips.
- Twenty-four spade terminals and flex for linking terminals.
- One reel 18 S.W.G. tinned copper wire.
- Quantity of coloured insulating sleeving to suit 18 S.W.G. wire.
- Quantity of lighting flex.

socket "A." The two panels may now be screwed in position, and after a final check to see that all is in order insert the rectifier valve in the mains unit valve-holder, and the 3.5 volt lamp in the indicator lamp fitting when the unit will be ready for a preliminary test. Before starting this test, proceed as follows: see that the plugs or switches for the meter shunts and resistances are set at their highest ranges, i.e., D.C. voltmeter 1,000 volts, D.C. milliammeter 500 mA, A.C. voltmeter 500 volts. The H.T. voltage selector switch is set in the "off" position, and the mA selector switch also left in the "off" position. On the control panel set the switch levers of switches "A" and "D" in the up position and then plug in the supply at the room socket and switch on. The red indicator light should

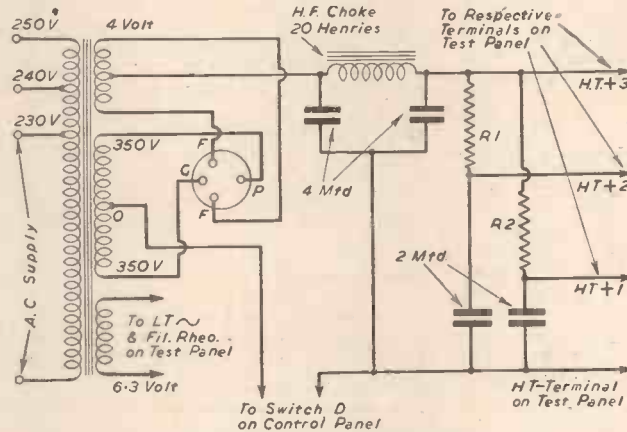

Fig. 6.—Mains unit wiring diagram.

be lit and after a few moments the rectifier valve in the mains unit should be warm; if O.K. close the switch "D" and move the H.T.+ selector switch arm to H.T.3 position and move the variable resistance arm on the mains limit and note that the voltage readings change, but will not vary much owing to no load being placed on the mains transformer. Next try the switch arm on H.T. 2 and 1 studs, noting the different readings; should all prove satisfactory reverse the switching procedure, leaving all supply "off" as at the start of the test. We should now prepare for a load test by making ready to test a valve; a mains triode is a good valve to start with, and one in fairly good condition would be preferable, rated at, say, 250 volts on the plate; plate current 4 milliamps and a grid bias, voltage of 3 volts. A good start can be made by using what is commonly called free grid bias, and to calculate this the formula $\frac{\text{Volts Grid Bias Req.} \times 1,000}{\text{Anode Current in mA.}}$ is used, therefore we require 3 volts G.B., so $3 \times 1,000 \div 4 = 750$ ohms resistance. Obtain this resistor and proceed as follows:

Connect two flex leads from L.T.~ terminals to Nos. 3 and 4 terminals in the second row; from H.T.+ mA load terminal connect a flex to terminal 1; to terminal 5 connect our 750 ohm grid bias resistance, and from the other end of the resistance connect a short flex lead which in turn goes to the H.T.~ terminal on the bottom row. A 0.1 mfd. condenser may be connected across the resistance and the valve then plugged into the five-pin valve-holder. All now being ready for our first real test. Repeat the switching procedure of our preliminary voltage test and this time also close the H.T. mA selector switch, moving the arm to H.T.3. Read the voltmeter and adjust the variable voltage at the mains unit until a reading of 250 volts is obtained, and note the milliammeter reading which should be about four milliamps; the meter range plug or switch should be set before this test on the 10 mA range. Should readings be similar to those expected the unit would appear to be quite satisfactory.

Valve Testing

A few hints regarding testing of valves with this unit should be helpful. It will be seen that there are nine terminals each connected to a valve socket representing the various numbers, and this allows flexibility of connecting when testing various types of valves, as the particular electrode in a valve is not always connected to a socket in another valve-holder for a different type of valve. Another point to note is that where the top cap on a valve is connected to its plate a connection from the cap to H.T.+mA load terminal should be made. When testing a battery valve, say a four-pin type with a two-volt filament, a two-volt accumulator is connected direct to terminals 3 and 4 on the second row thus giving the D.C. filament supply voltage required, as in this case the 6.3 volt A.C. filament supply is not needed. A point to be noted here is that when testing a four-volt filament valve (A.C.) the filament rheostat is adjusted until the A.C./D.C. voltmeter reads the required voltage. The terminals marked grid bias \pm can be used for connecting a grid bias battery, if required, or for a grid bias resistance connecting point for "free grid bias." Very little more need be said regarding this test unit as when it has been used a few times its usefulness and flexibility will lend itself to varied testing operations.

Johnson's Photographic Competition

MESSRS. JOHNSONS OF HENDON have just issued a list of prizewinners in their photographic competition which closed on December 31st, 1949. The interest in these competitions is still increasing, and this time there were three classes. In each class a first prize of £10, a second prize of £5, five third prizes of £2, and five fourth prizes of £1 were awarded. There were also twenty-five consolation prizes taken from all classes. Two further competitions are being held this year, during the spring and autumn, for

which an increased number of prizes are offered. A leaflet giving full particulars can be obtained free on application to Johnsons of Hendon, Ltd., Hendon Way, Hendon, London, N.W.4.

NEWNES' RADIO ENGINEER'S POCKET BOOK
By F. J. CAMM
5/-, or by post 5/6

Obtainable from booksters, or by post from George Newnes, Ltd. (Book Dept.), Tower House, Southampton Street, Strand, W.C.2.

10th Article of a New Series

MODEL ENGINEERING PRACTICE

by J. J. Camm

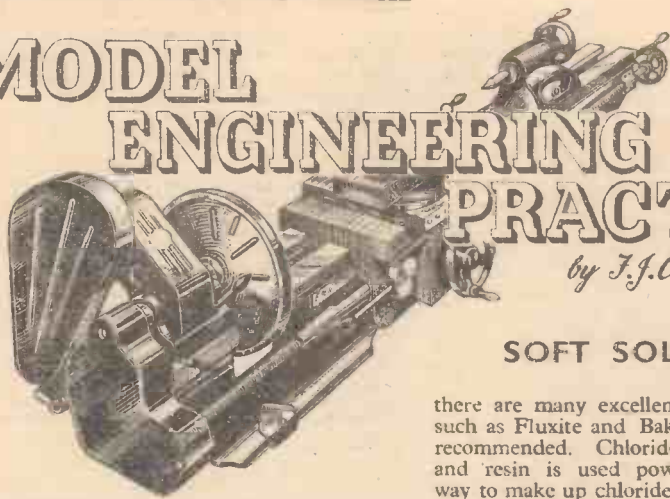

SOFT SOLDERING

SOLDERING is an easy process if simple rules are observed. Cleanliness is important, but not more so than a hot iron and the right flux. It is unreasonable to expect hot solder and flux to remove refractory material whose melting-point is above that of the iron or adhere to material which oxidises when heated.

there are many excellent commercial fluxes, such as Fluxite and Baker's fluid, which are recommended. Chloride of zinc is a liquid, and resin is used powdered. The easiest way to make up chloride of zinc is to dissolve thin strips of zinc in commercial hydrochloric acid. Do this slowly in an open porcelain basin until the acid will no longer "act" on the zinc. When cool, the solution is ready for use, and it should not be adulterated

and flux. It is not easy, and is often unsatisfactory. An excellent preparation based on zinc chloride is a good soldering fluid. It is better and cleaner than the home-made product and equally as cheap in the long run.

Resin is a difficult flux at all times, therefore Fluxite or Baker's fluid are far better for general use in every way, and are mentioned because they are non-corrosive and ideal for all electrical joints. Cored solder is useful for most small jobs

Tinning the Iron

To "tin" an iron with either of the fluxes the bit should be cleaned up with a

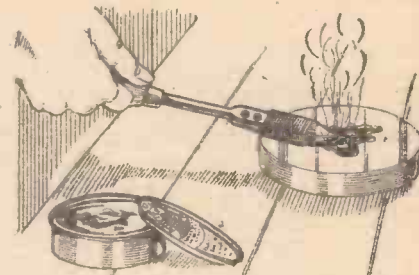

Fig. 90.—How to tin the soldering iron.

COMPOSITION OF SOFT SOLDERS

| Solder | Composition | Melting-point |
|--------------------|--|---------------|
| Fine | 1½ parts tin, 1 part lead | 334 deg. F. |
| Tinman's | 1 part tin, 1 part lead | 370 deg. F. |
| Plumber's | 1 part tin, 2 parts lead | 440 deg. F. |
| Pewterer's | 1 part tin, 1 part lead, and 2 parts bismuth | 203 deg. F. |

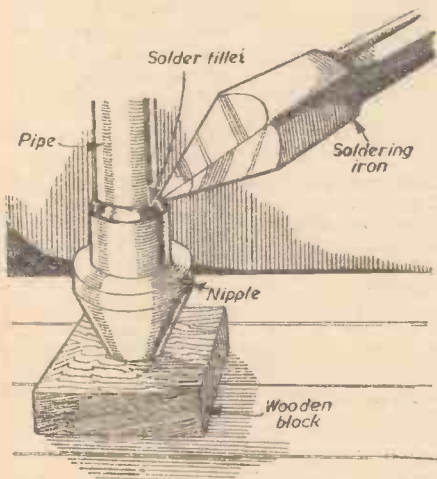

Fig. 88.—The correct method of soldering a nipple to a pipe.

Fluxes

Oxygen is the enemy of all forms of uniting metals, as nearly all metals absorb oxygen readily on the temperature being raised, and it is to protect the metals from being oxidised that fluxes are used. An excellent flux for one metal is not so effective on another. Acid fluxes must not be used on electrical connections. The electrical flow sets up some form of electrolysis definitely aided by the minute imprisoned particles of acid, which particles are never entirely removed, however efficient the washing of the part in question.

Chloride of zinc and resin are the two main fluxes used on repairs, although

with water. The action of this flux helps to clean the job, and the moment the hot iron touches it it entirely covers the spot without further trouble. When cold it rests on the surface in isolated globules, but the heating transforms it into a liquid coating, thus excluding oxygen from the air—that is, unless the heat is too great and the flux is evaporated. As an iron too cold will not run the solder, so an iron too hot will counter the effect of the flux. A small iron overheated will not, and cannot, take the place of a larger iron which, if anything, is on the cold side. This flux is used on all tinned goods and articles,

until the copper is bright. Heat it on the gas-ring until the copper is about to change colour, and rub with a stick of solder which has previously been dipped in the flux. Apply it quickly to all sides, afterwards wiping the solder over evenly with a piece of rag. The iron is now "tinned" and ready for use, but there is another method which is equally as good, and that is to have a small piece of tinned steel on the bench on which to rub the iron instead of wiping it with the rag. Both methods apply to both fluxes. When the iron is "tinned" it should still be carefully heated, as a "burned" iron ruins the tin on the surface, turning it into a very brittle dark mass that will neither convey heat nor hold the solder.

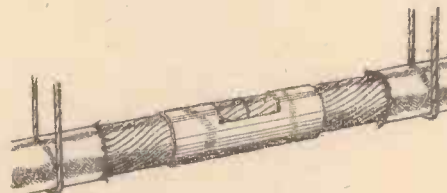

Fig. 89.—When soldering two wires together, an efficient joint can be made by using sleeving over the two ends, as shown.

such as petrol tanks, autovacs, lamp bodies, and petrol pipes, which are "tinned" before soldering. Don't try to solder chromium plating: the chromium must be removed before the solder will take, whatever the flux. Aluminium is only successfully soldered by the professional, and then with special solder

Examples of Soldering

Many failures are due to the iron cooling off before it can do any effective work, the job carrying off the heat when the iron is applied. The larger the iron the better, as it must hold more heat, also repeated application of a small iron means that the applied heat is flowing away whilst the second heat is being added. Hold the iron still when once applied and watch the effect of the molten solder around it. The solder cannot be rubbed in—it must flow of its own accord. Solder has little strength as a metal, therefore always remember it as the "glue" that holds the work together only. Piling it on the job in the hope that it will overcome the difficulty

FLUXES FOR SOLDERING

| Metals | Fluxes | Fluxes generally used |
|----------------------------|--------------------------|-----------------------------------|
| Iron | Chloride of zinc | Chloride of zinc (killed spirit). |
| Steel | Sal-ammoniac | |
| Copper | Chloride of zinc | Resin. |
| Brass | Resin | |
| Zinc (new) } | { Sal-ammoniac | |
| Zinc (old) } | { Chloride of zinc | |
| Lead (with fine solder) .. | Hydrochloric acid | |
| Lead (with coarse solder) | Tallow and resin | |
| Tin | Tallow | |
| Pewter | Resin and sweet oil | |

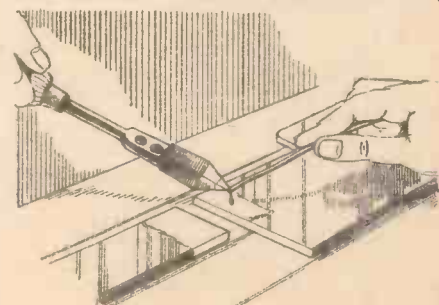

Fig. 91.—Tinning the work.

of your poor workmanship is no use and only failure will result.

Suppose a nipple is to be soldered on a copper pipe; first, the end of the pipe must be clean and really fit the nipple. The pipe should just slide into the nipple with slight pressure. Dip the end of the pipe into the liquid flux, and apply some solder with the

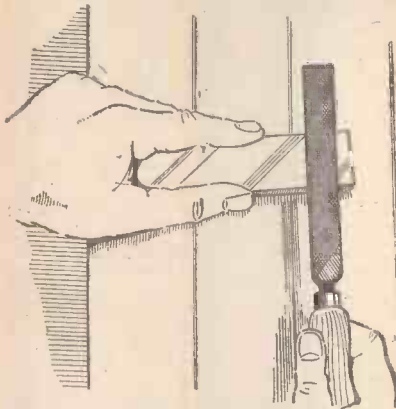

Fig. 92.—File the article to be soldered, or clean it with emery cloth.

hot iron. It will now be "tinned" and will have to be cooled off somewhat. Again dip the end in the flux and tap on the nipple. This "tinned" end will act as a small iron and save the trouble of having to "tin" the small interior of the nipple. Hold the pipe vertically on a piece of wood with one hand and apply the iron with the other hand. As the iron has again been charged with solder, it flows from the iron on to the pipe, where it is already tinned, and so passes down between the nipple and the pipe.

Should the pipe have been a bad fit in the nipple, the hot solder will not only have penetrated between the pipe and nipple, but up the inside of the pipe also, not being able to run out at the bottom on account of the wood acting as a washer. Should this happen, the pipe must be drilled and the shavings from the drill blown out. If too much solder is applied it is possible to wipe it off before

cooling, but it leads to "blobs" where they are not wanted, such as on the cone of the nipple, and perhaps a leaky union. With practice the right quantity of solder can be gauged, and if not enough the iron can, in this instance, be applied again the second time, such process doubly assuring a right soldered joint.

A patch on a tank is also an excellent example of heat transmission by the soldering iron. As usual, clean the place on the tank thoroughly, and "tin" the place to be operated upon about 1/4 in. all round the patch to be applied. The patch should be tinned both sides, as the hot solder on the outside helps to convey the heat from the iron to the patch proper, and so to the solder under the patch. The hot iron, supplied with solder, should be slowly and systematically moved over the whole of the patch so that it sticks to the tank at every point, and towards the end the iron is applied to the edges when, if there is still any air under the patch, it will be seen to bubble out through the molten solder. The iron should only be applied to the edges last of all, mainly to make a neat job and to prove the exclusion of all air. Again, the largest iron possible should be used, especially as it is not always possible to do the job with one application.

In dealing with all electrical repairs it is again pointed out that a non-corrosive flux must be used, and it is preferable to keep a special iron for such repairs. An iron continually dipped in the liquid flux is bound to impart some of the acid to the electrical joint, eventually leading to trouble. Smear a little Fluxite on the parts to be soldered, as too much is not only a waste but the surplus paste has a tendency to mess up the nearby insulation. Cleanliness here is a definite injunction; and do not forget to clean the parts to be joined as the old wires that have become blackened through burned solder

must be cleaned with fine emery cloth until they are bright. Dipping the wires in acid is fatal for the same reason mentioned concerning the liquid flux.

Fig. 89 shows the sleeve bored out so that the prepared wires just slide into the hole. The ends of the wires will be seen at the centre of the sleeve, where a slot has been filed so that the hot solder can be applied. Place a little Fluxite on the centre of the sleeve where the wires meet, and immediately the hot iron and solder are introduced the Fluxite will run freely along the inside of the sleeve and between the stranded wires.

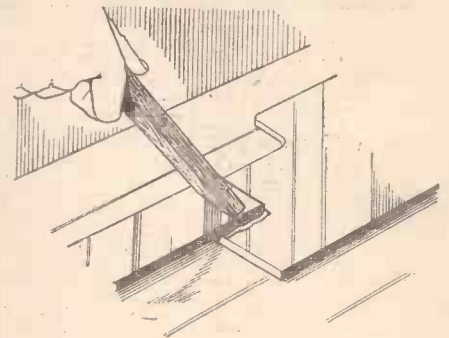

Fig. 93.—Use a piece of stick to hold the soldered pieces together until the solder has set.

A mixture of 1 1/2 parts tin and 1 part lead fuses at a lower temperature than any other mixed proportion of the metals shown in the first table on page 240.

Wood's Metal

A special soft solder used for joining delicate pieces. It consists of 1 part tin, 4 parts bismuth, 1 part cadmium, and 2 parts lead. It melts at about 60 deg. C.

COMPOSITION OF HARD SOLDERS

| Solder | Composition |
|----------------------|---|
| Hard brazing | 3 parts copper, 1 part zinc. |
| Hard brazing | 1 part copper, 1 part zinc. |
| Softer brazing | 4 parts copper, 3 parts zinc, and 1 part tin. |

Mathematics as a Pastime

Two First-rate Inventions

By W. J. WESTON

A CROOKED figure may attest in little place a million; so Shakespeare, mathematically-minded for a moment, points out. Indeed, where a figure stands in our notation a deal more to be considered than what the figure is. Have you ever thought over this notation of ours, our method of counting in tens? Well, look at another notation.

For the fun of it multiply CXXXVI by LIX using the Roman notation of numbers. You flounder and soon give up in exasperation, counting yourself lucky that you have at your disposal the positional notation and the zero sign. Both of these we owe to the Hindoo mathematicians; and both must be looked upon as first-rate inventions. You learnt the Hindoo notation easily, so easily that you perhaps underrate its worth. Yet the notation, in which the position of a number affects its value, makes 136 x 59 child's play when compared with the disconcerting Roman problem.

Things might have been easier for us in our calculations if there had been six, not five, fingers on each hand. For then we should have dealt in dozens not in tens; and our notation would have been more in keeping with the facts of daily life. We must, however, be grateful for the decimal notation even

though we should think the duodecimal an improvement on it.

In your dealings with mathematics you are, usually without being aware of it, in communion with great Hindoo thinkers. The Romans could, indeed, solve problems where no complicated calculation was needed. Here is one that caused long litigation. *A dying man wills that if his wife, being with child, gives birth to a son, the son shall receive 2/3 and she 1/3 of his estate; but if a daughter be born, she shall receive 1/2 and his wife 1/4. Twins are born, a boy and a girl. How should the estate be divided in order to satisfy the will?* The testator, you see, had not provided for the contingency that did happen, and the Court having to gather his intention from the will, decided that the son should get 4/7, the mother 2/7, and the daughter 1/7; for he had intended the mother to get half the son's share but twice the daughter's share.

Among their other mathematical inventions the Hindoos introduced the method of reasoning about a number before you know that number. They called this unknown number—our *x*—*yāvattāvat*. Here is one of their problems solved by using a symbol for a number—that-we-don't-yet-know-but-are-on-our-way-to-find: *The square root of half the*

number of bees in a swarm has flown out upon a jessamine bush; 8/9 of the whole swarm has remained behind; one female bee flies about a male that is buzzing within a lotus-flower into which he was allured in the night by its sweet odour, but is not imprisoned in it; tell me the number of bees. *Y*, the initial of *yāvattāvat*, is the number. And the bees outside the hive are 1/9th of the swarm and two were out all night. And these bees outside are also the square root of half the num-

ber—that is $\sqrt{\frac{y}{2}}$ —together with the 2 about the lotus flower. So

$$\frac{y}{9} = \sqrt{\frac{y}{2}} + 2$$

$$\frac{y}{9} - 2 = \sqrt{\frac{y}{2}} \quad (\text{transferring the 2})$$

$$\frac{y^2}{81} - \frac{4y}{9} + 4 = \frac{y}{2} \quad (\text{squaring both sides})$$

$$\frac{y^2}{81} - \frac{17y}{18} + 4 = 0 \quad (\text{transferring } \frac{y}{2})$$

$$2y^2 - 153y + 648 = 0 \quad (\text{removing fractions})$$

$$(2y - 9)(y - 72) = 0 \quad (\text{factorising})$$

Our unknown number, our *yāvattāvat*, is now known to be 72. Problems like that, calling for exercise of the detective faculty, were propounded at their social gatherings; the Hindoos did regard mathematics as a pleasing pastime.

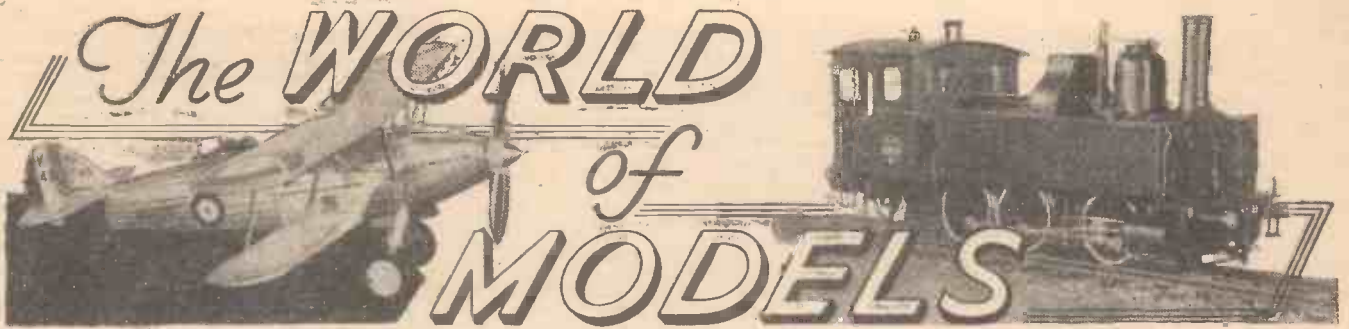

A 1½ in. Scale Locomotive : Scale Model Dredger : Model of H.M.S. "Vanguard"

By "MOTILUS"

I WAS fortunate, a short time ago, in coming across a beautifully made, old model of a 4-4-0 locomotive, No. 60, of the North London Railway. This model was built by the craftsmen at Bow Works during the Boer War, the original locomotive having been built there in 1888. So every facility was available for constructing the model with accurate detail. The reason they undertook the work was to raise funds in aid of those whose relatives had been lost in the Boer War, and they certainly gave of their best workmanship to this end.

The model is to a scale of 1½ in. to 1 ft. for 7½ in. gauge. All engineering details have been accurately modelled, including cross heads, sliding bars, big end, valve motion, full Stephenson link motion, etc. The model (Fig. 1) has the full number of boiler tubes and the boiler fittings include starting lever, two water gauges, injectors, blower, link motion reversing gear and sanding gear. A miniature headlamp hangs in front of the locomotive.

The model is mounted on correct bullhead rail section, and is operated by a friction drive on the wheels from an electric motor (Fig. 2) in the base that supports the model

Scale Model Dredger

An unusual ship model of a single-tube sand suction dredger was recently built to the order of Messrs. Lobnitz and Co., Ltd., of Renfrew, Scotland, for the Mexican Government. A close examination of this model (Fig. 3) would show the details of construction and machinery for operation of the suction tube and for depositing the sand: in fact, an exact scale replica of the actual vessel.

Built for the specific purpose of dredging, this boat is certainly of curious appearance. The forward part of the hull is formed in two sections, with a tunnel running fore and aft in which the suction tube is accommodated. The tube can be lowered to the sea or river bed and is con-

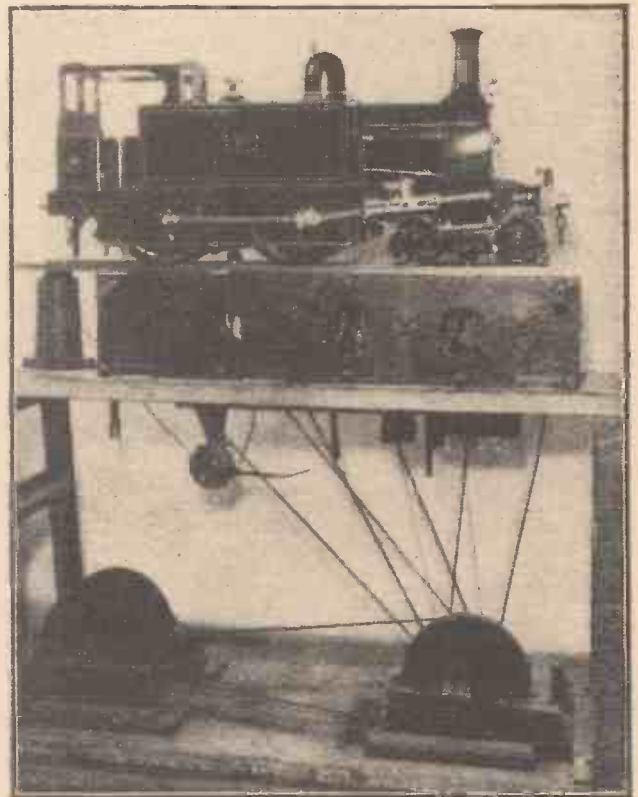

Fig. 2.—The North London locomotive model on its original base, with the pedestal casing removed, showing electrical equipment that drives the friction wheels for turning the wheels of the model.

trolled from a special compartment on the bridge. The sand is drawn through the tube and deposited into the hopper. The model shows the hopper, complete with hydraulic gear for opening the doors situated in the bottom of the hull, while aft of the hopper is the deckhouse over the engine room, in which reciprocating engines for propulsion are housed. The scale of the model is ¼ in. to 1 ft.



Fig. 1 (Above).—An historic model of a 4-4-0 locomotive, No. 60, of the North London Railway. Built by craftsmen at Bow Works during the Boer War, it is to a scale of 1½ in. to 1 ft.

Fig. 3 (Right).—Exhibition model of suction dredger, Campeche, to a scale of ¼ in. to 1 ft. Made to the order of Lobnitz & Co., Ltd., for the Mexican Government.

in its glass case. The whole is now in the care of the Public Relations and Publicity Department of the London Midland Region of British Railways.



Of all the vessels that sail the seas, the warship is probably the most frequent to show advances in improved design and equipment. Britain, the maritime nation, always endeavours to be in the lead with up-to-date equipment in the ships for her Royal Navy. I suppose the most famous British battleship at the present time is H.M.S. *Vanguard*, probably the finest warship afloat. Our Royal Family sailed on her to South Africa and back in 1947.

This magnificent ship, designed by Sir Stanley Goodall, K.C.B., O.B.E., and built by Messrs. John Brown and Co., Ltd., was laid down at Clydebank in October, 1941, and completed April, 1946. She was refitted

range of gauge 0 steam and electric locomotives has now been augmented still further by the addition of new ones in British Railways livery, making a total of 23 locomotives in all. Mr. Elliott has also attached to his exhibition a comprehensive bookstall, stocking almost every handbook, pamphlet and catalogue on the many phases of model-making and particularly those devoted to model railways. Should Elliott Model Railway Exhibition visit your own town you will find the display well worth seeing.

A large layout of such dimensions as Mr. Elliott's also demonstrates the adaptability of this gauge for all three prime movers: clockwork, steam and electricity,

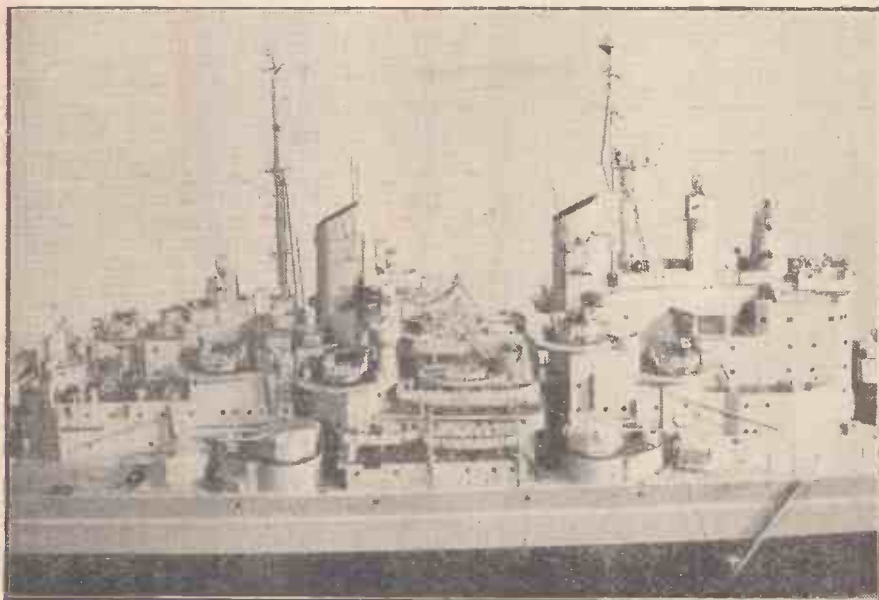

Fig. 4.—Amidships photograph of a model of the latest British battleship, H.M.S. *Vanguard*, to a scale of 3/16in. to 1ft., and finished in peacetime naval colouring.

at Devonport in 1947-8. Her length is 814ft. 4in., with a beam of 107ft. 6in. and a standard displacement of 42,500 tons. The ship is driven by Parsons single reduction geared turbines, with four shafts, and has S.H.P. of 130,000 and a speed of 29 knots or more.

Model of H.M.S. *Vanguard*

A fully detailed model of H.M.S. *Vanguard* was built by Messrs. Bassett-Lowke, Ltd., last year, to the order of Messrs. John Brown and Co., Ltd. The model is to a scale of 3/16in. to 1ft. and shows in detail (Fig. 4) the new features and deck equipment of this up-to-date fighting ship, being finished in light battleship grey, with black boot topping and red bottom.

While on the subject of modern warships, readers will no doubt be interested to see the accompanying illustration (Fig. 5) of a model battleship tripod mast, with its mass of intricate detail. The size of the model mast is indicated by comparison with the half-crown piece at the foot.

Northampton Model Railway Exhibition

Northampton residents and model railway fans had an opportunity, last February, of seeing Mr. H. Elliott's Model Railway Exhibition, to which I have made reference on previous occasions. The opportunity was certainly not neglected and during the eleven days the exhibition was open a steady stream of enthusiastic viewers visited the Guildhall, where Mr. Elliott had hired a room for his fine display (Fig. 6). The already large



Fig. 5.—Intricate detail model of a battleship tripod mast: the coin at the foot of the model is a half-crown piece.

even though Mr. Elliott does not run clockwork himself. The constant use of the gauge 0 locomotives in steam and electric is an excellent test of their durability for hard work. Practically all the locomotives, coaches and rolling stock, as well as the track,

for this model railway exhibition was purchased from Bassett-Lowke, Ltd. One of the steam locomotives has done fifteen years' service and another, a steam "Mogul," runs an average of an hour to one filling of water and spirit.

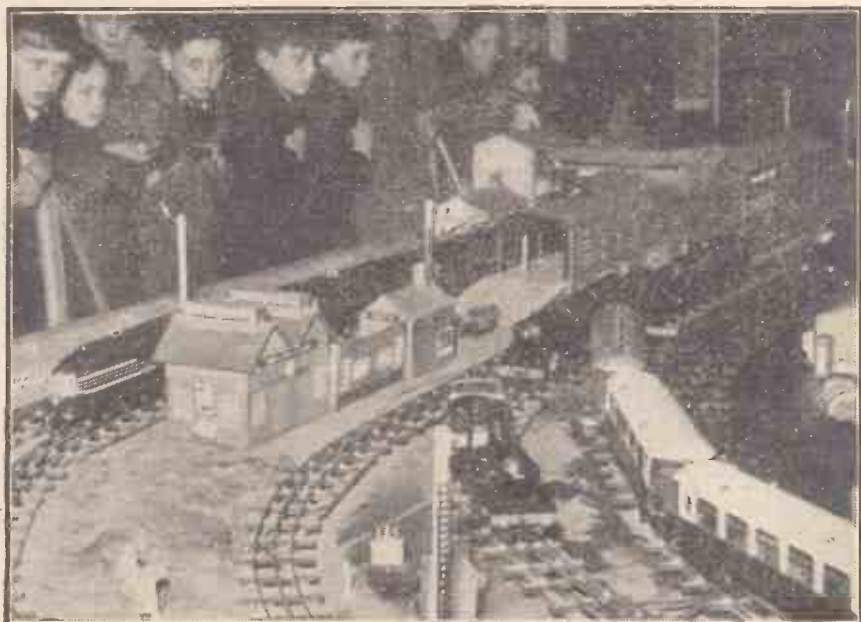

Fig. 6.—A scene on Mr. H. Elliott's well-known model railway, during its stay in Northampton this year. This photograph shows particularly well the realism of the line-side buildings, as well as some of the large selection of rolling stock.

Standardisation

In view of the increasing interest in gauge 1 among model railway owners, I am pleased to note that the standards for this gauge have at last been agreed, after being under consideration and discussion for a long time. Messrs. Bassett-Lowke, Ltd., have placed on the market a complete diagram of all dimensions, including those for buildings and accessories connected with a model railway: this has been carried out in a similar form to gauge 0 standard dimensions and is available at the same price, 2s. 6d.

On this question of agreed standards, the Model Engineering Trade Association have now produced a book on standard dimensions, by the British Railway Modelling Standards Bureau. This includes gauges Ho, 00, EM, EMF (fine scale), 0, 0F (fine scale) and 1. Rail sections are dealt with, both bullhead and flat bottom: also wheel dimensions, from gauges Ho to 1. There are many other

detail measurements that are so useful to the model builder. The book is priced at 1s. from all model dealers.

The Model Engineering Trade Association held their annual general meeting once more this year at the Charing Cross Hotel, London, and members put in a good attendance. Mr. George Dow, Public Relations and Publicity Officer to the London Midland Region of the Railway Executive, was chairman both at the meeting and at the dinner which followed. Mr. H. E. Walker, of Walkers and Holtzapffel, Ltd., was appointed patron for the forthcoming year on the retirement of Mr. W. J. Bassett-Lowke. Lord Garnock proposed the toast to the Association and also gave a most interesting account of his recent visit to the U.S.A. He related stories of the modelmakers he met over there and also made some amusing references to some of the methods of American railroad operation. Lord Garnock had spent two

years on the Santa Fé Railway in U.S.A. studying railroad operation.

This annual gathering is most useful to both manufacturers and retailers in the model trade. It gives an opportunity for the manufacturer and retailer to be in direct personal contact and hear each other's points of view. The retailer often finds it difficult to obtain certain items that are in demand, both by amateur modelmakers who want "bits and pieces" for their workshops and by customers requiring finished articles. The manufacturer, on the other hand, is equally troubled by difficulties in obtaining the right raw materials and sufficient skilled labour for model engineering, and has to face the constant Government urge to send the maximum amount of production for export to hard currency countries. Nevertheless, recent improvements in home market supplies are most promising, and we can look forward to increased supplies in the near future.



Converting Ex-aircraft Generators

SIR,—Referring to the February issue of PRACTICAL MECHANICS, Mr. Wadson (Kenton) will find that if he removes the brushes from the H.T. armature (Fig. 3) he will have a synchronous motor which does not get hot and which also provides a fair amount of power.

I have a similar type of motor and it gives good service. The connections are as shown in the accompanying diagram.—R. L. GOTHARD (Leeds).

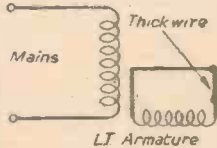

Modified wiring diagram for ex-aircraft generator.

Violin Bow Rehairing

SIR,—How refreshing it is to see space devoted to such an unusual subject as rehairing of bows allied to the violin family. I am sure Mr. Kitchener's article in the February issue will be appreciated by many readers, and particularly by those who, even if they are not conversant in detail with the delicate construction of the bow, do understand that it is the embodiment of scientific construction, coupled with skill and minute exactness and character.

May I suggest that a pair of pliers is a most unsuitable instrument for removing the silver ferrule, because of the possibility of damage to the ferrule and also to the tongue of the frog itself. In my opinion the better method is the use of a broad-bladed knife from which the cutting edge has been removed. The tapered edge is introduced between the ferrule and the ebony frog, and by using a rocking and gently persuasive motion the ferrule may be easily removed without fear of damage.

Great care must be exercised in securing the ends of the new hair. Cut off the existing sealing wax, retie the ends with silk, press firmly in powdered resin and burn back to 1/16 in. from the silk tie.

The utmost sensitiveness of touch should be evident in fitting the hair back in the bow head and in replacing the keeper wedge

to avoid damage to the often thin walls of the head pit.

May I suggest that new hair should be soaked in warm, clean water for a sufficient period to allow it to stretch and become soft and pliable. Thus it is that the manipulation of the hair becomes easy, and one is assured that after drying out all hairs and obtaining even tension, "loops" are avoided without damage to the finished work.

Incidentally, the parts of the body of the bow are known usually as tip, head, throat, stick and point, the latter being the "handle end."—R. SEYMOUR OLIVER (Rudgeway).

"An Ingenious New Escapement"

SIR,—In the article on page 155 of the February issue of PRACTICAL MECHANICS the advantages of this escapement are stated, and I suggest that certain disadvantages which occur to me should also be stated:

1. By comparing Figs. 2 and 5 it will be seen that the impulses given to the balance wheel 8 differ appreciably in the two directions, which fact may be of importance in measuring small intervals of time; in this respect the escapement is apparently inferior to the old Maetzel metronome escapement.

2. The escapement does not satisfy what I understand to be one of the conditions for good timekeeping, i.e., a balance wheel, except near the centre portion of its swing, must be completely free from the actuating train. This one has a roller, with lubricating conditions unknown, always in contact with the balance wheel.—G. H. CHILD (Hove).

SIR,—With reference to the "Ingenious New Escapement" described in the February issue of PRACTICAL MECHANICS, while appreciating the value of this for certain applications such as timers for industrial processes, there are two points which may mislead readers.

First, the implication, particularly in the sub-title of the article, is that the escapement is applicable to watches and clocks. There appears nothing to recommend this escapement for use in ordinary timepieces. "A precision of plus or minus 2 per cent. is guaranteed." A simple calculation shows that this means a "precision" of plus or minus 29 minutes per day, which gives a better idea of the degree of accuracy achieved.

The second point is the claim that this escapement is new. A similar escapement was made years ago by the late Earl of Meath, and even then this was not claimed as new. A description and illustration of Lord Meath's escapement was given in the January, 1949, issue of the *Horological Journal*, and it is quite clear that the escapements are the same, differing only in that Lord Meath's is applied to a pendulum, whereas the one under discussion is applied to a balance wheel.—H. G. JOLLYMAN (Box, Wilts).

Aluminised Telescope Mirrors

SIR,—In the November issue of PRACTICAL MECHANICS, and also in one of a few months ago, you have published inquiries concerning the surfacing of telescope mirrors with more enduring qualities than those of silver.

I have not seen any mention of aluminised mirrors which, in my opinion, are better than either silver or rhodium surfaced mirrors. Aluminium reflects more light than silver, and it does not corrode or blacken in a normal atmosphere. The surface is reasonably hard, and will stand a fair amount of vigorous though careful cleaning if it should accidentally become dirtied.

Unfortunately for amateurs the deposition of aluminium on glass is carried on by a vacuum process, which requires more apparatus than is readily available to most amateurs. There are, however, several firms with vacuum plant who will surface mirrors for amateurs at a cost, which is well worth while in comparison with the expense of continually renewing silver surfaces and the lower efficiency of the latter.

This process has been known for at least twelve years. It was originally developed for the Mount Palomar telescope, and is now widely used for such articles as motor-car headlamp reflectors.—IAN M. LAMBERT (Edinburgh).

Cycle-dynamo Lighting

SIR,—I should like to question the argument put forward by Mr. V. Butler in a recent issue of PRACTICAL MECHANICS.

May I point out that the cycle dynamo is merely a single-phase alternator with a "fixed" field. As such it behaves very much

like a transformer, D.C. generator or, for that matter, a battery in so much as the application of load lowers the terminal voltage.

The only time a load can actually increase the terminal voltage of an alternator or

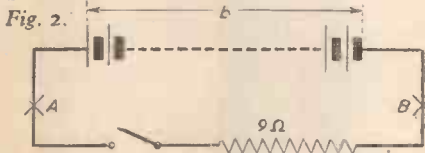
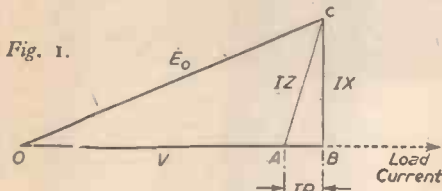

transformer is when that load is capacitive and of high enough reactance to nullify the inductive reactance of the alternator stator.

In the case of a dynamo supplying a system of lighting bulbs the load is purely resistive (for all practical purposes) and the vector diagram holds (Fig. 1):

AB is the IR drop in the dynamo stator. BC is the voltage drop due to the inductance of the dynamo.

AC is the vector sum of these, i.e., the impedance drop of dynamo stator.

V is the vector subtraction of IZ from E_0 (open circuit voltage).

V is the terminal voltage on load (current I).

On studying the diagram it can be seen that V (the voltage on load) must always be less than E_0 (the terminal voltage at no load) as long as the load is resistive or inductive.

A similar effect occurs with a battery due to its internal resistance.

For example (Fig. 2): b is a battery of e.m.f. 20 v. and internal resistance 1Ω open circuit voltage across $AB=20$ v.

$$\text{On load } I = \frac{20}{9+1} = 2A.$$

P.D. across $AB=18$ v. (i.e., 2×9).

Thus there is a drop of 2 v. in the battery (IR) which is analogous to the IZ drop in the dynamo.

On substituting two bulbs in series for two bulbs in parallel it is necessary not only to balance the voltage but also the power consumption in order that the dynamo or battery, or what you will, will operate under the same conditions (i.e., the same load).

Considering the following case (Fig. 3): power of each bulb = 1.5 watts (i.e., 6×0.25)

total power = 3 watts.

\therefore total $I = 0.5$ amp.

Replacing the above by two bulbs in series (Fig. 4):

total I must be = 0.5 amp for same conditions to prevail.

\therefore power of each bulb = $3 \times 0.5 = 1.5$ watts.

This is, of course, a special case in that the front and rear bulbs are of the same wattage.

In the more general case we have a rear bulb of wattage WR and a front bulb of wattage WF connected in parallel on a supply (dynamo or battery) of V volts (Fig. 5).

$$\begin{aligned} \text{Total load resistance} \\ \frac{1}{R} &= \frac{WF}{V^2} + \frac{WR}{V^2} \therefore R = \frac{V^2}{WF+WR} \\ \therefore I &= \frac{WF+WR}{V} \end{aligned}$$

To obtain the same powers in series case and also balance voltage and load current

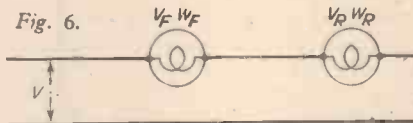
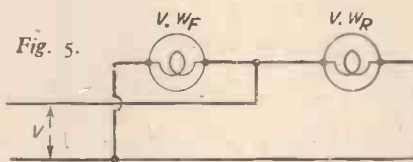

(Fig. 6) then current must be $I = \frac{WF+WR}{V}$

and $VR + VF$ must be $= V$

$$\therefore VR = \frac{WR}{I} = \frac{WRV}{WF+WR}$$

$$\text{and } VF = \frac{WF}{I} = \frac{WFV}{WF+WR}$$

In the special case considered before, it can be seen that when $WF = WR$, $VR = \frac{V}{2} = VF$,

$$\text{i.e., } 3V = \frac{6}{2}V.$$

As it is not always possible to obtain bulbs of the correct wattage and voltage to suit these equations, approximations must be used at the cost of efficiency.

It is better that the dynamo should be slightly overloaded rather than underloaded. If the dynamo is underloaded its voltage will rise and if it is seriously underloaded the voltage will rise sufficiently to burn out the bulbs. Overloading will drop the voltage and

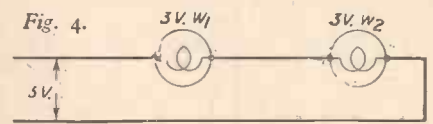
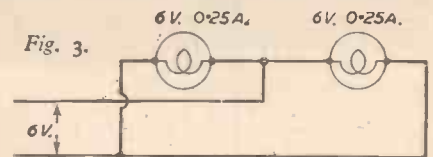

cause the lamps to burn at a lower efficiency.

A 3 -watt dynamo should be loaded to at least 2.5 watts.—P. WIGGINS (Glasgow).

Hot-water System

SIR,—With reference to the inquiry in the March issue concerning a domestic hot-water system (G. Lindley) the second part of the question, viz., "will the hot tank always remain full?" does not appear to be completely answered.

As the draw-off pipe to the taps from the hot tank is above the level of water in the hot tank, and assuming the cold tank to be now empty, there will be no head of water from the cold source. Now should a tap over the bath, basin, or sink be opened no supply will be received though the hot tank still remains full of water.

This being so (assuming water to be frozen only in the rising main) why is it not safe to light the boiler fire, as the water circulation "via boiler, flow pipe, hot tank and return pipe" is normal? This, of course, is subject to the boiler draw-off cock not having been opened.—E. M. WYLIE (Upper Norwood).

SIR,—With reference to the query concerning hot-water service, it can only be assumed that the storage tank will not be emptied by drawing off at the taps, since the dead leg is above the level of the tank. Syphonic action can be ruled out, as the vent pipe will prevent this. The only way in which this particular system could be completely emptied is via the drain-cock.—S. G. HOWELL (London, S.W.).

The B.L. Model Uniflow Engine

(Concluded from page 165, February issue)

IN the February issue dimensioned drawings were given of several component parts for this unique engine, and below we give

the drawings of the final parts for constructing the model, including the cylinder head and flywheel. The tolerances given

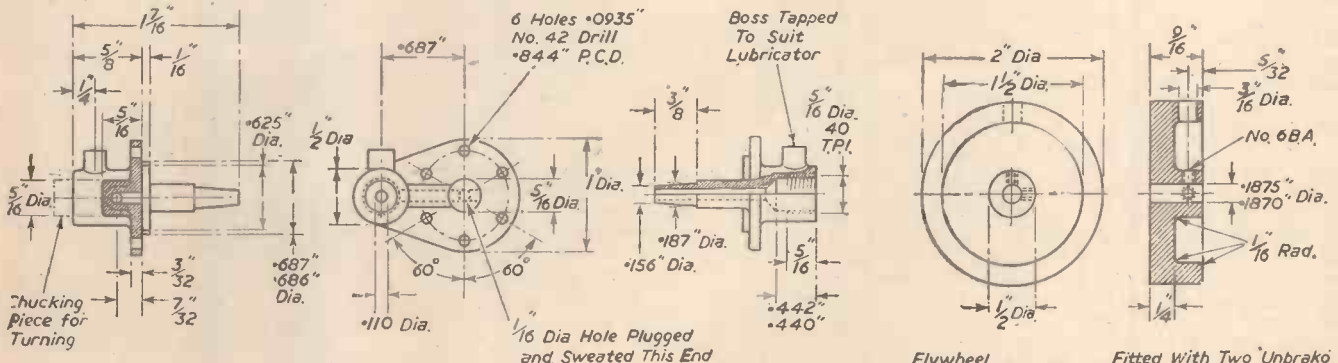

Cylinder-Head

Material:- Phos. Bronze

Details of the cylinder head and flywheel.

Flywheel Material:- Brass

Fitted With Two Unbrako 6BA Set Screws On Assy.

will enable the constructor to machine the castings to the necessary accuracy. Interested readers are also referred to the January issue of PRACTICAL MECHANICS in which was published a photograph of the complete plant, together with the result of a test run, and prices of castings and finished parts.

Trade Notes

Wolf Electric Solderguns

A NEW introduction by Wolf Electric Tools, Ltd., the well-known manufacturers of portable electric tools, is a range of electric solderguns which they claim will overcome the hitherto common criticism of this type of equipment.

Industrial soldering requirements have long called for soldering tools which will reach operating temperature quickly, will maintain a correct constant heat, prove economical in current consumption and are "easy in the hand" for long production periods.

The accompanying illustration shows two irons from their range of six hand models, and particular attention is directed to the off-straight hand grip which lends to much more comfortable control. By ingenious arrangement within the heating element the heat is localised around the copper bit, and with the elimination of wasted heat areas considerable economy in current consumption has been effected. At the same time, tendency towards excessive temperature rise is avoided, and this in turn prolongs heating element life and saves oxydisation of the copper bits.

Wolf solderguns can be supplied for the following voltages: 24, 50, 100/110, 115/130, 200/220, 225/250, and each gun is

fitted with six feet of 3-core cable. Models are available for a wide range of purposes, from fine instrument soldering to heavy-duty work. Full details are obtainable from the Wolf Electric Tools, Ltd., Pioneer Works, Hanger Lane, Ealing, London, W.5.

Sciex Bulletin

SCIENTIFIC EXPORTS (GT. BRITAIN), LTD., of Buckingham House, Buckingham Street, Adelphi, London, W.C.2, have recently issued an attractive brochure intended especially for the information of customers and agents throughout the world. The contents include a short account of the activities of the new Canadian division which is successfully marketing the latest British scientific

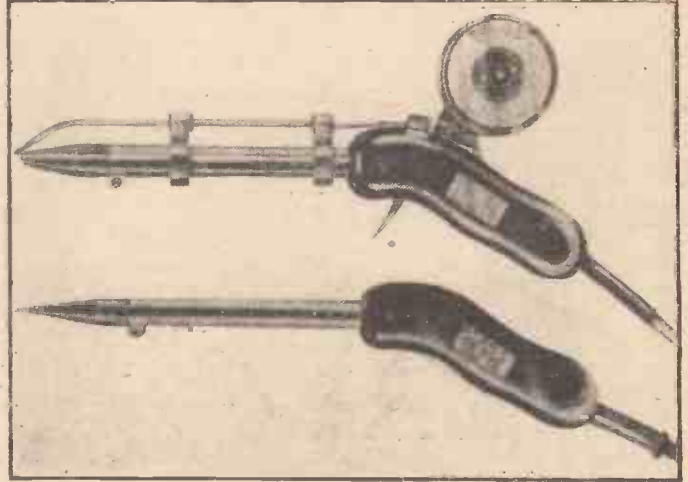

Two models from the range of Wolf solderguns.

Club Reports

Model Railway Exhibition

THE Model Railway Club is holding its annual exhibition in the Central Hall, Westminster, from Tuesday, April 11th until Saturday, April 15th inclusive.

This year the number of models will exceed 3,000 and will include a comprehensive display of models of each of the former railway groups. The exhibits will include models of locomotives, coaches, wagons, stations, building and lineside gadgets. Other sections will show points and track lay-outs, free-lance models and models under construction so that methods and craftsmanship may be studied.

Many steam locomotives built to larger scales will be on view and visitors may ride free of charge behind some of these on the passenger-carrying track.

In the basement there will be a number of interesting exhibits including: A large working model railway staged by British Railways and many other working track lay-outs of different gauges.

Electrical Apparatus

A stand devoted to all branches of electricity as used on a model railway will show not only finished items, but, by drawings and parts, how all types of electrical apparatus can be constructed and how difficulties may be overcome.

Visitors are invited to submit any problems they have to the stewards in charge of the stands, who will do their best to be of assistance.

The prices of admission are 2/6 for adults and 1/- for children under 14, but

on application to Mr. R. C. Panton, 162a, Strand, London, W.C.2, special arrangements can be made for parties of not less than 12 at 1/- per head irrespective of age.

City of Leeds Society of Model and Experimental Engineers

THE above society holds its meetings in the Salem Chapel, Hunslet Road, Leeds, every first and third Thursday in the month. On April 6th Mr. Barber, of Bradford, is to give a short talk on his model engine.

Any interested readers are cordially invited to attend any of the meetings, all of which commence at 7.15 p.m.—Hon. Sec., R. G. COLBRAN, 9, Churchwood Avenue, Headingley, Leeds 6.

Club Secretaries are asked to note that the latest date for receiving copy is the first of the month for the following month's issue.

Excellence in Model Loco. Construction



These two fine examples of scale model locomotives show the high-class workmanship put into them by their builders, particularly with regard to the details. Both models were exhibited at one of the Model Engineering Exhibitions.

**AT LAST—
The Perfect
Precision Cutter**

MULTICRAFT

with the 4 in 1
**PAK - A - WAY
BLADES**



The Ideal Tool for every hobbyist and craftsman.
4 Sheffield steel blades housed in handle. Inter-
changed in a moment. A shape for every job.
From all good Hardware, Art and Hobby Shops.

Including 4 Blades, **5/-** Clip 4d. extra.

Send for leaflet and name of your nearest dealer to :

MULTICRAFT TOOLS

29 BOLSOVER St., London, W.1

TRADE ENQUIRIES INVITED

IMPORTANT ANNOUNCEMENT
to all readers of "Practical Mechanics"

**PRACTICAL
TELEVISION**

Edited by F. J. Camm - 9d. Monthly

As announced elsewhere in this issue, the first number of a great new "practical" monthly—PRACTICAL TELEVISION—is now on sale everywhere. It is edited by F. J. Camm, and will henceforward be published approximately on the 22nd of each month.

PRACTICAL TELEVISION, price 9d., will be devoted exclusively to the interests of television enthusiasts everywhere.

Although paper for publications is now unrationed, it is still difficult for newsagents to assess the requirements of their customers unless they are informed of them in advance. The demand for PRACTICAL TELEVISION has already been great, and the only way to make sure of your copy every month is to place a regular order with your local newsagent to-day.

PRACTICAL TELEVISION

Edited by F. J. Camm - 9d. Monthly

No. 1—NOW ON SALE EVERYWHERE

**No Engineer or Home
Mechanic should miss these
TOOLS!**

★ **SPANNER KIT.** These tool kits are of finest quality and, once equipped, you'll always have a spanner of the right size on hand for the job.

- Each set consists of 50 spanners:—
- 5 Whitworth ring spanners, 1 to 1in.
- 5 American ring spanners, 1 to 1in.
- 6 Double-ended set spanners, Whitworth, 1/2 to 1in.
- 6 Double-ended set spanners, American (5/16 to 1).
- 3 Whitworth obstruction wrenches (1 to 7/16).
- 3 American obstruction wrenches (1 to 1 1/2).
- 6 B.A. ignition spanners (1 to 8 B.A.).
- 6 American ignition spanners.
- 4 Small B.A. fitters' spanners.
- 3 Small American fitters' spanners.
- 3 Small Whitworth fitters' spanners.

This extensive range of sizes will service all kinds of ignition, electrical, refrigeration and aircraft work, motor-cycles, cars, lorries, tractors, agricultural implements, and general machinery of both British and American manufacture. **£5.17.6**

The complete kit as above. Quick-service tray, if desired, 10/- extra.

★ **B.A. SOCKET SPANNERS.** Covering sizes 0 to 6 B.A. for the radio mechanical or model engineer. Price 5/6 complete.

★ **QUADRANT SCRIBERS.** Indispensable for marking out sheet-metal work. Usually 7/6. Special price 3/9.

★ **POLISHED B.A. SET SPANNERS.** Covering sizes 1 to 6 B.A. double-ended spanners, one end set at 90 degrees, the other straight through each B.A. size. 6/- per set.

PORTABLE CAR HEATER

Made for the Services these portable heaters will save freeze-ups and prevent your car being ruined by a cracked cylinder block. Just place one of these heaters under the bonnet and plug into the mains. Absolutely safe, being flame-proof there is no fire risk, and no messy filling with fuel. All motorists should order right away whilst stocks last. 500 w. 220/230 v. Price, 17/6. Plus 2/6 carriage.

Write to Dept. K

INSTRUMENT Co.

11, GUNNERSBURY LANE,
ACTON, W.3.

Send 2d. stamped, addressed envelope for our latest list.

**THE
"Gala"**



WOOD TURNING LATHE

MODEL A.
Work up to 18 inches
£9.0.0

MODEL B.
Work up to 28 inches
£9.10.0

Trade enquiries invited.

In two sizes : Model A—2ft. 6in. bed (18in. between centres). Model B—3ft. 4in. bed (28in. between centres). Suitable for turning hard woods, plastics, etc. Headstock : best quality grey cast iron with steel spindle ; precision ground all over. Four-step cone pulley for 1/2in. Vee belt. Height to centre 3 1/2in. Tailstock : of grey cast iron with steel barrel, bored No. 1 Morse taper, carrying hardened steel centre. The Lathe is adaptable for treadle, countershaft or direct motor drive.

SCOTTISH PRECISION ENGINEERING CO.
27 Cadogan Street, Glasgow, Scotland.

PLASTICS (MANCHESTER) LTD.

11 Whitworth Street, Manchester, 1. Tel: Cen. 0272-1725.

BUY YOUR SUPPLIES FROM THE LEADING PLASTIC STOCKISTS FOR THE MODEL MAKER AND HOBBYIST

As Official Stockists for
IMPERIAL CHEMICAL INDUSTRIES LTD.
ERINOID LTD., and UTILEX LTD.

WE STOCK!!!

"PERSPEX" (Acrylic sheet). Clear and all colours sheet and rod. From 1/16in. thick upwards (Standard I.C.I. prices).

"CRINOTHENE" (Brand of Polythene). This is a ductile embossed sheet about .015 thick in all colours. Sold by the yard, 34in. wide. Used for lampshades, bags, etc., etc.

"CASEIN" Sheet, Rod and Tubes, etc.
CAST RESIN in a variety of shades and forms.

P.V.C. SHEETING (Admiralty Specification) for Curtains, Aprons, Rainwear, Shower Curtains, etc.

ACETATE FILM and SHEET. All colours plain and embossed, for Lampshades, Fabricating, etc.

Lacquers and Dyes for "Perspex" (Acrylic Resin). Cements, Polishes, Luminescent Powders, Transfers, Instructional Manuals, etc.

Specialists in fabrication, injection moulding and engraving.
FREE PRICE LISTS and INFORMATION ON REQUEST.

Get extra M.P.G. by fitting a new set of Plugs.

Standard Sparking Plugs—14 and 18 mm.—made by Siemens-Bosch for the German Army. New and Boxed, 4 for 7/-, 6 for 10/-. Short Reach.

200/250v. A.C. or D.C. Motors, about 1 h.p., fitted with 2 1/2in. x 1/2in. Medium High-grade Grindstones made by Nortons. 20/- each.

New Brown's Moving Reed Headphones. Best in the world. 6/6.

Moving Coil Microphones. 3in. diameter, with Pressel Switch, 5/6. Matched Transformer, 5/-.

New Carbon Microphones. U.S. made for the Type 58 Walkie-Talkie, 3/-.

Army Morse Keys complete with double action buzzer mounted on boards, 4/6.

Headphones with Breast Plate Microphones. Packed in wooden boxes. Operate with 4 1/2v. Battery. 10/- a set.

Meters, 4 1/2in. 0-200 Microammeters. First Grade. 42/9 each. 2in. 0-500 Microammeters, 8/-, 2in. 0-300v. M/c., 10/-, 0-40v. M/c., 7/6.

Miniature Slow Motion Dials. 100-1 worm geared. 2 1/2in. x 2in. Beautifully made. 4/- each. Dial 0-180°.

24v. A.C./D.C. Motors, 5in. x 3in. Fitted with powerful blower fan. 10/6 each.

250 watt Double Wound Transformers, 240-110v. Made by G.E.C. With Steel Shroud. New. £2 7s. 6d. each.

All Carriage Paid. Money Back Guarantee from :

THE RADIO & ELECTRICAL MART.

253B Portobello Rd., London, W.11. Park 6026.

For your Bungalow, Caravan Workshop or Radio BUILD YOUR OWN WIND-CHARGER

- with (1) Slow running Propeller,
- (2) Geared 3:1 to 1 Shaft Drive to
- (3) Car dynamo at ground level.

Every part accessible. NO sliding contacts or excessive top weight. Ample speed for ANY Car dynamo. SET OF CLEAR DIAGRAMS AND INSTRUCTIONS for building same complete from easily and readily obtainable parts ONLY. PRICE 3/6. P. M. BARHAM BRIDGE AVENUE ST. SAMPSONS GUERNSEY, C.I.

CHEMISTRY APPARATUS
Send Stamp for COMPLETE PRICE LIST



- Booklets:
- "Experiments" 7d.
 - "Formulas" 10d.
 - "Home Chemistry" 2/3
- Post Paid.

BECK (Scientific Dept. A)
60 HIGH STREET,
Stoke Newington, London, N.16

TARGET BLOWPIPES

The "Target" FINE FLAME Gas Blowpipe (self-blowing) is ideal for all those small and delicate soldering and brazing jobs essential to model making. Fine intense flame easily melts small copper rivets. Soldering and small brazing jobs done in no time. PRICE 2s. 6d. each. POST FREE.

The "Target" FIERCE FLAME Gas Blowpipe (self-blowing). For soldering and brazing LARGER jobs. Gives a fierce roaring 4-inch flame. Guaranteed to melt 1 lb. copper tube. PRICE (with full instructions) 3s. 6d. each. POST FREE. Retailers Enquiries Welcome. TARGET MFG. CO., Wollaston, Wellingborough (Dent. P.M.)



CARAVAN CHASSIS

and chassis undergear 8 to 33 cwt. Lightweight Camping and Commercial Trailers. Towing Hitches, Jockey Wheels. Brake Operated Leds. Aluminium Sheets 6ft. x 3ft., 24, 22, 20, 18 and 16 g.; 6ft. x 4ft., 22, 20 and 18 g.; Comprehensive stocks of Beading, Angle, J Drain, T Door Plate and Strip. Veneered Oak panels, Insulation Board, Glass Wool, Sinks, Windows and Roof Ventilators. Stockists for Caravan Gas, Bortozas and Latofam Cushioning. Plithers Stoves and Eisan Chemical Closets. Send for our detailed illustrated list and visit our Showrooms. Open all day Saturday.

WATFORD WHEEL & TRUCK WORKS
173-175, Queens Road Watford, Herts.
Phone: Gadebrook 2983

MASTER THE PIANO EASILY, QUICKLY, ENJOYABLY

To learn to play really beautifully is not difficult—it is easy—with proper teaching! Even if you start at middle age not knowing a note you quickly learn from Ordinary Music, no freakish methods, to play easily Solo, Songs, Rhythms and Genres from the great masters. By Post, Succinct fascinating lessons enabling you to read and play at sight any standard musical composition. My class is seldom less than 2,000 pupils. I have taught over 81,000 and I CAN TEACH YOU and I guarantee to please and even surprise you with your rapid progress. Send for free book and advice. Say Moderate, Elementary or Beginner.

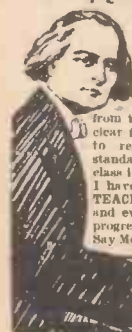

MR. H. BECKER
(Dept. 9581)
69, Fleet St., E.C.4.



The Soft Block with the **FIRM GRIP**

Yes—it's the new soft FIBRAX red brake block—specially designed to be kind to alloy rims! Just as tough and hard-wearing as the FIBRAX black block, it gives safe stopping and smooth action at any speed. Coloured red for easy identification—an ideal partner for alloy rims. NOTE.—The new FIBRAX red block is made for a special job—for steel rims the black block is still the best.

FIT Fibrax BRAKE BLOCKS

and get there safely!

FIBRAX LTD. 2 TUDOR ST., LONDON, E.C. 4

A new solder FOR WORKSHOP AND HANDYMAN

- CONTAINS 2 CORES OF FLUX
- NO EXTRA FLUX REQUIRED
- REPLACES STICK SOLDER, FLUID AND PASTE FLUXES
- IF DESIRED FLUX RESIDUE READILY WASHES OFF WITH WATER
- SO FAST THAT IT WILL EVEN SOLDER BLUED SPRING STEEL WITHOUT PRE-CLEANING



No. 10 KIT 2/- each

SIZE 8 CARTON 5/- each



Available in 5/- retail cartons (4 specifications) or 2/- Multicore Solder Kit contains 2 specifications Arax Multicore Solder and 2 specifications Ersin Multicore Solder for electrical wire to tag joints. Now obtainable from many stores. In case of difficulty 5/- cartons or 2/- Multicore Solder Kits sent post free on receipt of postal order or stamps.

MULTICORE SOLDERS LTD., MELLIER HOUSE, ALBEMARLE STREET, LONDON, W.1

Jubilee PATENTED WORM DRIVE CLIP



Absolutely leakproof joints on Air, Water, and Oil lines, are swiftly and easily made by using "Jubilee" Worm Drive Clips. They stand up to any pressure.

Write for details R.P.12. THE FINEST CLIP BY THE WORLD.

L. ROBINSON & CO. (LIM.) LTD. Billingham, Kent.

Ex-W.D. ENGINEERS' BENCH VICES 4 1/2"

Quick Release
Weight 40-50 lbs.
For Heavy, Hard Work
Will Last a Lifetime

NEARLY NEW 55/- CARR PAID.

CASH WITH ORDER
Satisfaction Guaranteed or Money Refunded

DEES (Dept. P.M.), 50, Rolls Park Avenue, South Chingford, London, E.4.

REFILL YOUR OWN BALL PEN

VISCOID REFILL KIT
Post Free 3/8 inc. tax.

COMPLETE WITH TOOL AND ILLUSTRATED FILLING INSTRUCTIONS
CONTAINS SUFFICIENT INK FOR 15 AVERAGE REFILLS

AVAILABLE IN BLUE AND RED
TRADE ENQUIRIES INVITED
VISCOID INKS, (P-M)
6, SHERLOCK MEWS, BAKER ST., LONDON, W.1

Experimenters! Build the MATCHBOX RADIO SET.

With the aid of our full instructions you can build a complete radio set in a matchbox, using parts easily obtainable from your radio dealer. This is made possible by the use of the Crystal-Valve Radar Detector—a wartime discovery. Tunes the B.C. wavelengths, and works off a short indoor aerial in many districts. Powered entirely by the incoming signal, no batteries are required. Full step-by-step instructions, working drawings, and theoretical wiring diagram.

Price 2/9 Post Free.
JOHN O'BEIRNE (P.),
137, Cotham Brow, Bristol, 6.
Post Orders Only.



FORREST PRESS LIMITED

240 Holloway Rd., London, N.7

Telephone - - NORTH 2004

QUERIES and ENQUIRIES

A stamped, addressed envelope, three penny stamps, and the query coupon from the current issue, which appears on page 56 (THE CYCLIST), must be enclosed with every letter containing a query. Every query and drawing which is sent must bear the name and address of the reader. Send your queries to the Editor, PRACTICAL MECHANICS, Geo. Newnes, Ltd., Tower House, Southampton Street, Strand, London, W.C.2.

Cleaning Britannia Metal

PLEASE inform me how to clean Britannia metal? I have a coffee-pot and teapot made in this metal which are very badly tarnished. I have tried polishing with the standard metal polishes but without any success. Both pots are heavily engraved on a fluted background.—K. R. Burns (Birkenhead).

MAKE up a paste of fine emery powder and oil. Rub this on to the surface of the Britannia metal. If you cannot obtain fine emery, use, in its place, the finest grade of carborundum powder similarly made into a paste with a little thick oil.

This is the best method of getting the surface tarnish off Britannia metal or pewter. Admittedly, the process is a slow one, but provided that you use only the finest emery or carborundum (the "flour" grade), the metal surface will not be scratched. It will be matted—uniformly dulled to a greyish colour. If the appearance is too dull, you can bring it up with normal metal polish.

For a quick removal of the long-standing tarnish on Britannia metal or pewter, you require strong hydrochloric acid containing 10 per cent. of stannous chloride. This acid treatment is a drastic one, but it can give some very good results. It is normally reserved for only the very worst of cases.

Laying a Terrazzo Hearth

CAN you give me some hints as regards "Terrazzo"? Is there any special substance used in it, when making a fireplace, which keeps it from cracking? I would also like to know how to lay and polish it.—J. Dunsmore (Greenock).

TERRAZZO is not the name of a substance. It is the name of a decorative scheme or method of laying a floor of other surface. A surface laid "in terrazzo" is merely one in which decorative or coloured fragments are embedded in a surrounding matrix or medium, the decorative fragments being level with the surface of the medium and showing in some contrast against it.

To make a terrazzo hearth, obtain a quantity of coloured stone chippings of a pleasing aspect. Lay the hearth in ordinary concrete, and before the latter has had time to set, scatter the decorative chippings on to the concrete or cement surface. The chippings should have been thoroughly wetted before they are scattered. Then flatten them gently into the cement or concrete matrix. When the concrete has hardened, take a flat stone, dip it into water and wet the area of concrete. Scrub the concrete with the stone, the idea being to grind the concrete and the decorative chippings embedded in it to a dead level. This is a tedious process but the more carefully it is done, the better the appearance of the terrazzo.

You cannot very well polish the terrazzo hearth by means of applied polishes. If the embedded chippings are of a glazed ceramic nature, they will usually present all the polish which is required.

Using a Camera for Enlarging

CAN you inform me if it is possible to convert a folding camera into an enlarger. The camera is a "Kodak Eastman" 120 autographic folding Brownie. Lens U.S.4 (equivalent of F.8). Focal length 4in., taking a negative 3 1/2in. x 2 1/2in. If it is possible can you give me details of the components needed, the assembly of same, and the degree of enlargement that is possible with the above camera?

I have a 3 1/2in. diameter lens out of a gun sight and wondered if it would be suitable for a condenser lens.—A. Phillips (Manchester).

IT is quite possible for you to convert your camera into an enlarger for negatives of the size made by the camera.

Merely set up a vertical board or easel on which you can pin a sheet of bromide paper. Remove the back of the camera and fit to it a wooden frame to take the negative. The frame must have a double groove in which a piece of ground glass can be held behind the negative. A 60-watt electric bulb is then positioned behind the camera, the camera lens pointing to the easel. By racking the camera front in and out, and by moving the camera to and from the easel, the negative image on the easel may be focused. The light is now switched out. The bromide paper fixed in position, and the light is then switched on for the

necessary brief exposure (usually a few seconds).

You will get better results if you fix a 4in. or a 3 1/2in. condenser closely behind the negative but, with careful working and positioning of the light you will be able to get very satisfactory results with the ground glass diffusion screen alone. The gun sight lens which you mention would not be suitable for use as a condenser. The condenser should consist of two plano-convex lens put together with their convex surfaces almost touching.

Approximate distances between negative and lens, and between lens and easel are given by the formula:—

$$d = f + \frac{f}{n}$$

$$D = (n+1) \times f$$

where
 n = Number of times of enlargement required
 f = Focus of lens
 d = Distance between negative and lens
 D = Distance between lens and easel

Please note that the above distances should be measured from the centre of the lens, not from its front or back surfaces.

You will be able to obtain any enlarging frames, easels or other similar equipment by calling personally at Exors. of J. Billecliffe, Camera Works, Richmond Street, Boundary Lane, C.-on-M., Manchester, these premises being situated just behind the University Medical School.

Readers are asked to note that we have discontinued our electrical query service. Replies that appear in these pages from time to time are old ones, and are published as being of general interest. Will readers requiring information on other subjects please be as brief as possible with their enquiries.

Soap Substitute

I WISH to make up a compound which can be used in place of soap. I believe there are some chemicals in the alkyl-aryl-sulphonate group which reduce the surface tension of liquids.

Could you tell me the exact name of the chemicals used and from where they can be obtained? —J. E. Smith (Heckington).

THE material to which you refer is marketed under the trade-name of "Teepol." In its normal form, it is a yellowish liquid, but it may also be had in solid form as a white powder and, also, as a paste containing lanoline. The liquid form ("Teepol-X") is evidently

THE P.M. BLUEPRINT SERVICE

- 12 FT. ALL-WOOD CANOE.* New Series. No. 1. 3s. 6d.
- 10-WATT MOTOR. New Series.* No. 2. 3s. 6d.
- COMPRESSED-AIR MODEL AERO ENGINE.* New Series. No. 3. 5s.
- AIR RESERVOIR FOR COMPRESSED-AIR AERO ENGINE. New Series. No. 3a. 1s.
- "SPORTS" PEDAL CAR.* New Series. No. 4. 5s.
- F. J. CAMM'S FLASH STEAM PLANT.* New Series. No. 5. 5s.
- SYNCHRONOUS ELECTRIC CLOCK. New Series. No. 6. 5s.*
- ELECTRIC DOOR-CHIME. No. 7. 3s. 6d.*
- ASTRONOMICAL TELESCOPE. New Series. No. 8 (2 sheets). 7s.*
- CANVAS CANOE. New Series. No. 9. 3s. 6d.*
- DIASCOPE. New Series. No. 10. 3s. 6d.*
- EPISCOPE. New Series. No. 11. 3s. 6d.*
- PANTOGRAPH. New Series. No. 12. 1s. 6d.*
- COMPRESSED-AIR PAINT SPRAYING PLANT. New Series No. 13. 7s. 6d.*

- £20 CAR.* (Designed by F. J. CAMM), 10s. 6d. per set of four sheets.
- MASTER BATTERY CLOCK.* Blueprints (2 sheets), 3s. 6d. Art board dial for above clock, 1s.
- OUTBOARD SPEEDBOAT 10s. 6d. per set of three sheets.
- SUPER-DURATION BIPLANE.* Full-size blueprint, 2s.
- The I.C.C. TWO-STROKE PETROL ENGINE.* Complete set, 7s. 6d.
- STREAMLINED WAKEFIELD MONOPLANE—3s. 6d.
- LIGHTWEIGHT MODEL MONOPLANE Full-size blueprint, 3s. 6d.
- P.M. TRAILER CARAVAN.* Complete set, 10s. 6d.
- P.M. BATTERY SLAVE CLOCK—2s.

The above blueprints are obtainable, post free, from Messrs. George Newnes, Ltd., Tower House, Southampton Street, Strand, W.C.2.

An * denotes constructional details are available, free, with the blueprint.

the substance which you require. It is obtainable from Shell Chemicals, Ltd., 112, Strand, London, W.C.2, price about 14s. per gallon. This liquid is a complex mixture of the higher alkyl sulphonates, and is being much used at the present time as a synthetic detergent and a constituent of washing preparations.

Another material of a like nature is a white powder known as "Tergitol." This material is a mixture of higher secondary alcohol sodium sulphonates, and is marketed in three or four different grades by General Metallurgical and Chemical, Ltd., 120, Moorgate, London, E.C.2.

Alabaster Castings

I AM interested in alabaster modelling and casting and recently received as a present an ashtray with a translucent finish labelled "Guaranteed Pure Alabaster."

Can you tell me how this transparency was obtained? Also some of my casts are inclined to be chalky and easily chipped. Is there any method of hardening them?—J. Atkinson (Belfast).

TRUE alabaster is a natural mineral product. It is not manufactured in any way. The translucent appearance which you describe is a well-recognised characteristic of the mineral. It is not "put on" or applied to it as a finish in any way. Hence, the fact that the article possesses this appearance is evidence that it is a true alabaster.

If you are using alabaster powder or some type of whitening for your modelling, you may be able to get a more translucent finish to them by incorporating a little stearic acid with your casting mixture, but we are afraid that you will never be able to get the soft, translucent, sometimes horny appearance of the true rock alabaster. Such material is one of Nature's products, and usually Nature's materials cannot be exactly duplicated by man-devised methods.

You can, of course, harden your castings if they are porous, by brushing them over with a hot solution made by dissolving 5 parts of ordinary gelatine in 95 parts of water. The gelatine will be absorbed into the pores and will set therein, giving additional strength to the casting. If, after drying, the casts are brushed over with commercial formalin solution, the gelatine itself will be hardened and rendered completely insoluble in water, so that the casts will then be water resistant.

Stained Optical Glass and Perspex

(1) I have a piece of flat, optical glass, about 1/10in. thick, and 1 3/10in. diameter, which I desire to stain a medium yellow in order to use it as a photographic filter. Would you please inform me of the best method of producing a transparent stain with the least possible interference with the optical qualities of the glass?

(2) Also, can you inform me of a method of producing a similar effect on sheet celluloid or Perspex, in thicknesses up to about 1/16in.? —E. Warwick, (Wakefield).

(1) We assume that your circular glass is an "optical flat," in which case you will not be able to stain it intrinsically, because any attempt to do so will certainly have a deleterious result and will affect the surface "flatness" of the glass. Even if you deposit a coating of dyed solution on the glass there will be a tendency for the drying film to pull the glass out of flatness. If, however, you are prepared to take this risk, dissolve 4 parts of clear gelatine in 96 parts of water, and stir into the solution about 2 parts of yellow water-soluble dye. Pour the resulting dyed gelatine solution on to the glass surface and set it aside to set in a dust-free and perfectly level position.

Another method is to dissolve scrap celluloid in a mixture of equal parts of acetone and amyl acetate so as to produce a clear solution of varnish consistency. Obtain some surgical spirit and dissolve about 2 per cent. of a spirit-soluble yellow dye in it. Then add the dyed solution to the celluloid solution, the dyed solution not to exceed 10 per cent. of the volume of the celluloid solution. This will give you a clear dyed solution of celluloid. This is floated on to the glass surface as before and allowed to dry.

Bear in mind always that, as previously mentioned, this technique may interfere or upset the accurate flatness of the glass disc. The orthodox way of making these precision light-filters is to have two optical flats and to cement a separate disc of dyed gelatine film between them, using Canada Balsam cement or some other suitable transparent cement medium for the purpose. It is altogether a very highly-skilled job, needing much practice to get a good result, especially with optical flats.

(2) To produce a similar effect on sheet celluloid, you will have to employ the above "dyed celluloid solution method," applying the celluloid solution very thinly. Even here, the task is a difficult one to get good results, and we would not recommend it. It is better to coat the dyed celluloid on to a highly-polished glass surface, and then to strip it off after drying. This will give you a thin cellulose film, which has been coloured throughout its mass.

To do the same thing with Perspex you will have to dissolve the Perspex in trichloroethylene and then to dye the trichloroethylene solution by means of a suitable dye. The dyed solution is then coated on to highly-polished glass, and finally stripped from it when dry.

Yellow dyes soluble in trichloroethylene are: oil yellow, oil fast yellow, E.G., and oil yellow N. Whether such dyes are spectroscopically suited for light-filter work is more than we can say, since this method is not used commercially, and there is no published information about the spectroscopic characteristics of these dyes.

You will have difficulty not only in obtaining such dyes but also in obtaining trichloroethylene, which, on

account of its anesthetic properties, is subjected to commercial restrictions. Yet there is no other suitable solvent for Perspex. You might, however, try Messrs. Reynolds and Branson, Ltd., of Leeds, for supplies of these materials.

Fluorescent Screen: Trimming Slate

I SHALL be glad to know of a method of treating glass to make a fluorescent screen or a fluoroscope for use with an X-ray tube.

I should also be obliged for any information regarding the cutting and facing of 1/16 in. thick slate from which I wish to cut the beds for a set of dimmers for a school stage.—M. Lehr (Wallasey).

YOU can make a simple fluorescent screen by preparing a cellulose clear varnish by dissolving clear scrap celluloid in equal parts of amyl acetate and acetone. Alternatively, you can make such a clear varnish by dissolving polyvinyl acetate in warm, methylated spirit. The best grade of polyvinyl acetate to use for this purpose is "Gelva" resin No. 7, which is marketed by Messrs. Shawinigan, Ltd., Marlow House, Lloyds Avenue, London, E.C.3.

The fluorescent material is now very finely powdered and worked into the clear lacquer prepared as above. It is coated on to the glass surface with a very soft, flat brush, every endeavour being made to obtain a coating of uniform thickness. After a few hours' drying the screen is ready for use.

Various fluorescent materials may be used. The barium and magnesium platinocyanides are, of course, excellent, but extremely expensive. More ordinary materials are natural zinc silicate, calcium and/or magnesium tungstate, zinc phosphate, zinc sulphide, cadmium tungstate and, occasionally, potassium dichromate.

Thin slate may often be trimmed to size with the edge of a half-round file, but this, we are afraid, will not work in the case of a 1/16 in. slate, such as you describe. The best method of cutting this would be by means of a carborundum saw, which comprises a carborundum-tipped disc revolving at a high speed and lubricated by water. Failing any such device, you will have to rely on an ordinary small-toothed hand-saw, together with either water or turpentine lubrication, but the job will be a very tedious one, calling for much patience. For trimming up any rough edges use a fine grindstone.

Bichromated Glue

CAN you supply me with the formula for making and using bichromated glue?—C. King (Birmingham).

WEIGH the glue in its dry state before dissolving in water in the usual manner. Then weigh out potassium bichromate equal to 2 per cent. of the weight of the dry glue.

Dissolve the glue. Then dissolve the bichromate in a little water and stir the solution into the glue solution. This should be done in artificial light, because the bichromated glue solution will now be sensitive to daylight, and very sensitive to direct sunlight. The effect of light action on the bichromated glue is to insolubilise it. Bichromated glue which has been exposed to light (particularly sunlight) for a few hours will resist even hot water.

Polishing Stone

WHAT is the correct method and materials used for polishing pieces of stone, or rock, in the making of small ornaments such as is done quite a lot on the Cornish coast?—C. Kitchen (Preston).

THE art of the lapidary—the cutter and polisher of ornamental stones—is a large and a tedious one. It cannot possibly be described in all its branches within the confines of a necessarily short reply, so that our first advice to you must be that you should look up the whole subject of lapidary work in your local library.

In general, you will be able to cut your stones and minerals with a fine hacksaw, lubricated with a little turpentine. The most suitable side of the specimen is then ground level by rubbing it on a coarse-grain flat stone. A piece of your local Longridge stone will do, but a piece of Yorkshire gritstone would be better.

When the stone surface has been ground level, spread a little emery or carborundum powder (not too fine) on a sheet of iron. Wet the stone face and the emery powder with water and rub the stone backwards and forwards in one direction only. Repeat the process with a finer grade of emery or carborundum in a direction at right angles to the first. By using successively finer and finer grades of emery or carborundum you will get a dull polish on the stone.

The stone should now be ground with the finest possible emery on a thick sheet of lead. This will heighten the polish.

When no scratches are visible, grind the stone with putty powder on a piece of felt or leather. All grindings must be done wet.

This is the most tedious process of all. Professional lapidaries use the "lapidary's wheel" for this purpose. It consists merely of a 12 in. diameter flat-edged wooden wheel around which is cemented a strip of leather. The leather is daubed with putty powder paste and revolved at high speed, the stone or mineral being held against it. You should be able to make one of these wheels for yourself. Alternately, you might be able to get one from Messrs. Philip Harris and Co., Ltd., Birmingham.

Carborundum and emery powders are obtainable from most engineering stores. Try, for example, Messrs. Slingers, Corporation Street, Preston. Putty powder is usually obtainable from paint shops, and you might be able to get it from Messrs. Bilboroughs, of Lune Street, Preston.

In general, you can use any abrasive powder which you may have handy, but you must always begin with a coarse powder and gradually work down to a very fine powder. The Carborundum Company, Ltd., Trafford Park, Manchester, might be able to supply you direct with their carborundum and alloxite (aluminium oxide) abrasives.

Lapidary work is rather unique in that it does not require expensive materials. As such, it makes a useful and interesting hobby—but it does require a very large amount of patience, since hand grinding and polishing is always a tedious process.

Projecting Colour Slides

I HAVE an enlarging lantern as shown in the accompanying sketch. I want to project Dufay colour slides (35 mm.) to 2ft. by 2ft. I cannot get pictures bright enough or large enough unless at a great distance from the screen; the light is then worse. I have borrowed a lantern bellows from Aldis lens 8in. focus with a 500-watt lamp. This is better than my own but still not good enough for a small hall. Can you suggest any improvements? Also, what can I do to minimise

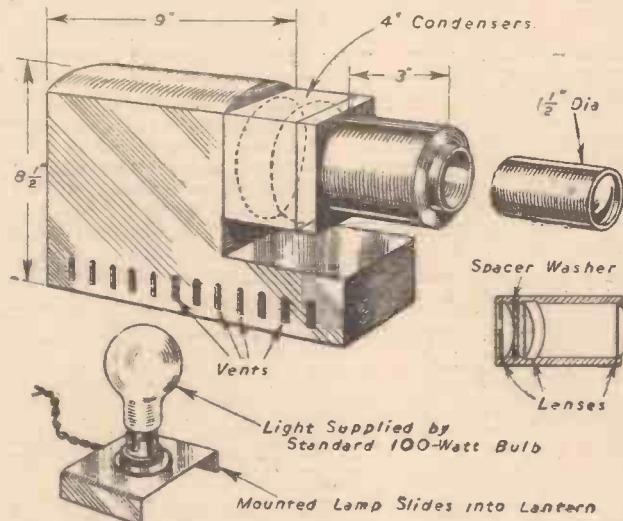

Details of an enlarging lantern—(H. A. Chapman).

the heat, as the slides get very hot, and I am afraid this will damage the films?—H. A. Chapman (Stapleford).

FOR a given size of projected picture, the shorter the focal length of the lantern objective the nearer must the lantern be to the screen. If, therefore, your illuminant cannot be raised above a maximum brilliance, you must use a short-focus objective in order to keep the lantern fairly near to the screen and, at the same time, to obtain a picture of reasonable size.

There are many lantern operators who consider that the focal length of the objective should be so short that it enables the distance between lantern and screen to approximate to the diagonal of the screen. In private rooms and very small halls, this is a good general rule, yet, for more general lantern work, it is usually considered that a lantern objective of, say, 8 in. focal length is about the best. This enables the lantern to be placed as far back as 35 ft. from the screen, which will usually be at the back of the hall. For ordinary rooms, however, a 4 1/2 in. focal length objective will be more convenient.

An ordinary 100-watt electric bulb is hardly a powerful enough illuminant for serious lantern work. A 500-watt "projector" type of lamp is much more satisfactory. These high-wattage lamps do give out intense heat, and this can only be counteracted by keeping the lamp as far back from the condenser as possible, and, also, by providing efficient ventilation of the lamphouse. Your lantern, as sketched does not appear to have adequate ventilation, its ventilation holes only being placed at the bottom. You must have ventilation holes at the upper part of the lamphouse, so that the heated air, rising, can escape therefrom. Holes arranged at top and bottom of the lamphouse, provide a continuous flow of air through the lamphouse, which does much to prevent overheating. Naturally, enough such holes must be suitably light-screened, but this is usually effected by providing internal light-baffles. This matter of overheating is certainly a very important one, and if you do not attend to it, you are very liable to get cracked slides, or slides on which the emulsion has actually melted.

Pickling Iron Castings

CAN you supply me with information dealing with the pickling of iron castings in order that the small quantity of deep-seated rust left after hand fettling is converted into a non-active chemical compound? I believe the method is known as hot phosphating, and consists of some form of acid bath. I would also like to know what temperature the compound so formed would stand before it is destroyed or becomes unstable.—W. Nettleton (Leeds).

IN order to derust and phosphatise your iron castings the following pickling bath is needed:

| | |
|---|--------------------|
| Ortho-phosphoric acid (technical grade) | 15 parts (by vol.) |
| Water | 85 |

Heat this solution to 80-90 deg. C. in a non-metallic container. Immerse the castings in it and allow them to remain therein for 5 to 30 minutes, according to the depth of scaling. Then remove them, and without rinsing; allow to dry in a warm place. It is most important not to wash the acid away previous to drying the casting, for a resistant coating of ferro-ferric phosphate is formed during the drying. This coating is highly resistant to moisture and corrosion, but it will not withstand immersion in water. The coating will withstand any temperature below dull red heat, but not an actual red heat, since, under such circumstances, the composition of the coating would be materially changed.

The above bath can be used over and over again until its strength has been exhausted. Strange as it may seem, the addition of a little soot (a teaspoonful to a pint of liquid) is beneficial to the bath, since it regularises its action.

You should be able to obtain ortho-phosphoric acid locally from Messrs. Reynolds and Branson, Ltd., of Leeds. It is not necessary to obtain the chemically pure "B.P." grade of acid. The technical grade (which is much cheaper) will amply suffice.

Processing Seaweed

WHAT is the process of dyeing white weed or sea moss? I understand it has to be preserved first, but I do not know the preservative, or the oils and dyes used.—W. Polkinghorn (Prittlewell).

WASH the seaweed or moss in fresh water in order to remove all the sea salts. Then spread it on trays to dry, without heat.

Now take a small quantity of the dried weed. Boil it with water. If it does not become soft and gelatinous it may be dyed in the ordinary manner. If, on the other hand, the weed gelatinises, it must be spirit dyed.

Ordinary dyeing is effected, by dissolving 5 parts of dye in 95 parts of water. The weed is immersed in the cold dyebath thus prepared, and the bath is then heated slowly up to near boiling-point during one hour. It is maintained at this temperature for five minutes, after which

the weed is removed from the bath, rinsed in water and allowed to dry. Spirit dyeing consists of dissolving the dye in alcohol or methylated spirit and then by soaking the dried weed in the spirit solution of dye until it has gained sufficient colour. The weed is then removed from the spirit dyebath, drained and spread out on frames or trays to dry.

You can often get a fuller effect (in the case of water-dyeing) if you soak the weed overnight in a solution of tannic acid or alum, of strength about 3 parts of tannic acid (or alum) to 97 parts of water. This "mordants" the weed tissue and gives it an added affinity for the dye.

Antique Finish on Woodwork

CAN you tell me how to obtain on woodwork the dark reproduction antique oak finish which can now be seen on many pieces of furniture for sale in shops.—E. J. Leigh (Leeds).

THE dark oak antique colouring of woodwork is very easily accomplished, although, of course, no surface treatment can give the true patina of age.

The simplest method is to obtain a quantity of "Antique Brown" spirit stain and then to dissolve it in methylated spirit so that a fairly strong solution is obtained. This is then brushed on to the woodwork, allowed to dry, and a coating of shellac polish is applied.

A rather better method which is more under control is to brush a green stain over the woodwork. Use a solution of brilliant green in methylated spirit—say 5 parts of the dye in 95 parts of the spirit. This will give a flat green coloration on the woodwork. You then make up a solution of a brown dye (Bismarck brown) in methylated spirit, and you should also add a small amount of spirit red to give a slight warmth to the dye solution. This is brushed over the green stain. It will produce a good dark brown. Control on the actual shade is attained by varying the strength of the brown spirit stain and by modifying the amount of red in it.

Having attained the shade which you desire on the wood surface, the wood, after drying out, is merely polished over either with a wax polish (to give a "satin" finish) or with a shellac polish which gives a bright finish. Some people prefer to use a wax polish, and then periodically to rub the stained woodwork surface with a rag charged with raw linseed oil. This treatment, applied persistently, is excellent. The linseed oil film on the wood oxidises, producing a resin film which gives to the wood a beautiful semi-gloss surface. The treatment, however, takes time—at least 12 months, and the older the wood the better the finish.

In general, there is no difficulty about producing the "antique" dark oak finish on woodwork.

You should be able to obtain the above-mentioned dyes from Messrs. Reynolds & Branson, Ltd., Chemical Suppliers, of Leeds.

MIDLAND INSTRUMENT CO.

For Govt. Surplus Stock, Etc.
ELECTRIC PUMPS, centrifugal self-priming immersible type, delivery 10 g.p.m., lift approx. 25ft., suitable for water supply, bilge pumps, garden fountains, etc., etc., 7 models, 12v. A.C./D.C. or 24v. A.C. brand new in original containers, either model 25/-, post 1/4. **ROLLS PACKARD AIR COMPRESSORS**, piston type, develops 450lb. sq. in. at 1,200 r.p.m., bore 1in. and 1 1/16in., stroke 1in. and 3/16in., splined shaft fittings, high grade manufacture; brand new, boxed, 25/-, post 1/3. **MAINS TRANSFORMERS**, input 230v., 50 cycle, 1 phase, output 50v. at 11 amp., or with little alteration, 100v. at 51 amp., bargain, 25/-, carriage 5/-. **MAGSLIF MOTORS**, 3in. transmitter Mk. 2-2 of these motors can be wired in series for 100v., or in parallel for 50v. A.C., 1 phase, in this way when the shaft of one motor is rotated, the other will follow in perfect step, clockwise, or anti-clockwise; motors are fitted 1in. long, 5/16in. shaft, unused condition; 2 motors (worth £10) supplied with wiring instructions for 15/-, post and packing 1/6 extra. **HOOVER BLOWER MOTORS**, suitable for 230-250v. A.C. (intermittent duty), motors are fitted enclosed centrifugal fan blower, giving powerful air delivery or vacuum, 15/-, post 1/-. **FLEXIBLE DRIVES**, outer spiral casing approx. 1in. dia., screw end fitting, suitable for light power transmission, speedometer drives, etc., all brand new stock, 5 different sizes, 1ft. 1/6, 3ft. 2/6, 6ft. 3/6, 8ft. 4/6, 12ft. 5/6, post 9d. **MAINS MOTORS**, 200-250v. A.C., approx. 1 h.p., shaft fitted with 2-pulley, speed approx. 2,000 r.p.m., size approx. 10in. long, 5 1/2in. dia., fitted on stout metal table, size 16in. by 8in. by 6 1/2in. deep, the ideal workshop motor, unused condition, bargain, 32/6, carriage 2/6. **AIR MINISTRY R.A.E. SEXTANTS**, Mk. V, used condition, supplied in leather-lined polished wood cases, exceptional bargain, 15/-, post 1/3. **MICRO SWITCHES**, 4 assorted brand new, 5/-, post 3d. **MOVING COIL HEADPHONES**, Electro-Tone, Mechanical, SERIES MOTORS, 12v. 20 amp. D.C., 1/2 h.p., fitted 1in. shaft, the ideal motor for an electrically-propelled vehicle, brand new, 15/-, post 1/4. Also hundreds of other interesting Radio, Electrical and Mechanical items. Send for a copy of our new 1950 lists. Our C.O.D. service is cancelled for the time being.
MOURPOOL CIRCLE,
BIRMINGHAM, 17.
 Tel.: HARborne 1308 or 2684.

ALL THE BEST!!

UNIVERSAL MOTORS WITH GEARBOX, 1 1/4", inc. post. Can be used for many jobs, such as slow rotary turning for operating window signs, or by altering connection for electric fan, mixing machine, windmill generator, insulation tester, etc. Instructions supplied with each.
ROTARY TRANSFORMERS, 1 1/4", inc. post. From 6v. in. give 250 v. at 25 m/a., 12v. in. give 490v. at 65 m/a. Ideal for home-made car radios, country houses with low-voltage lighting plants, etc. From 230v. in. (D.C.) will give off low voltage for charging radio accumulators; 230v. metal rectifier to change A.C. mains to D.C. for above, 13/3, inc. post.
METAL RECTIFIERS.—Of reliable make. 6v. at 1 amp., 5/3; 12v. at 1 1/4", 13/3; 12v. at 5a., 17/6. Transformers to suit: for 6v. type, 5/3; for 12v. at 1 1/4", 29/6; for 12v. at 5a., 34/6. All prices inc. post.
SELF-AMPLIFYING MICROPHONES, together with waterproof speaker for seaside kiosks, sea-front hostmen, cricket clubs, religious meetings, etc. Needs only 12v. battery for power (but one from local garage!); needs no separate amplifier, sufficient volume to address 100 people without raising voice. 50/- complete, plus 5/- carriage.
MAGNETIC RECORDERS.—Make up a simple loop-recorder to keep saying such things as "Lovely day." "This way for the Ghost Train." "Tea is ready," etc., over and over again. All parts and instructions from us; 230v. motors, 55/-; 12yd. lengths of "Diamond" recording tape, 2/6. Use above self-amplifying microphones to obviate need for amplifier.
RADIO REMOTE CONTROL for Model Aircraft and Boats. Our new, revised data on Tx, Rx and Servo equipment now ready at 4/- complete; whole outfit can be made for less than £5. All parts in stock, including tiny 2oz. sensitive relays at 15/9; Tiny Trigger Valves, smallest and lightest on market, 17/6; Actuators, 25/-; Send 3d. for List of all model kits and accessories.

PARK RADIO OF MANOR PARK

678-8, ROMFORD ROAD, LONDON E.12

"DE LUXE" SLIDE RULES

AMAZING VALUE

12 inch log-log sin-tan rule, 9 scales, for all problems. Celluloid faced on polished hard wood. Multiplication, division, proportion, percentages, discounts, roots, weights, measures, currencies, etc.

10/6

Post and Packing 6d.
 Complete In Case
 Also
 5in. scale model complete in case. (As illustrated.)

ONLY 5/6 Post & Packing 4d.
 Including Comprehensive Slide Rule Book.

Approval or money refunded.

MARINE & OVERSEAS SERVICES (1939) LTD.

(DEPT. P.M.11.)

16, BARTER STREET, HOLBORN, LONDON, W.C.1



RAPID ANGLE INDICATOR

Solves at a glance all angles, sides of a right angled triangle 2/- Post 3d.

THREAD CHART

Threads per inch. Whitworth, B.A., and Gas tapping—clearing sizes for threads. Standard sizes, decimals, wire gauge, millimetres, etc. 1/9 Post 3d.

THE TONEMASTER AMPLIFIER.

Sensational new domestic amplifier by N.R.S. The most flexible on the market today. Three channels; bass lift, treble lift, middle lift, treble cut, negative feedback. For A.C. 100-250 v., 5 w. output—impedance to suit your speaker (please state) Input for magnetic, crystal and hi-fi pickup, full provision for tuner. Price (fully guaranteed and tested), £8 19s. 6d. Immediate delivery.
No. 1 HIGH QUALITY TUNER, specially recommended for above amplifiers and Leak L. Williamson & Charles Amplifiers. L. & M. wave T.R.F. Infinite impedance detector. Absolutely complete, built & tested. £5 10s. Ditto Kit, £4 10s.
No. 2 L. M. and S. wave SUPERHET TUNER, special quality bandwidth, beautiful full-vision dial assembly (10in. x 4 1/2in. scale), £8 10s. Ditto Kit, £7 10s.
LATEST GRAM UNITS: COLLARO RC49 A.C. mixed 8-record changer, crystal pickup, £14 6s. 8d. **MARCONI AC100** non-mixed 10-record Changer with hi-fi lightweight pick-up & transformer, £10 10s. 7d. **COLLARO AC504** single record player, with max. pick-up, £5 3s. 2d. **COLLARO AC47** centre-drive motor with 12in. non-magnetic turntable, £5 18s. 4d.
FULL BARGAIN CATALOGUE 21d.
TERMS: C.W.O. or C.O.D. any amount.
NORTHERN RADIO SERVICES,
16, KING'S COLLEGE RD., SWISS COTTAGE, LONDON, N.W.3.
 Primrose 8314.

THE NEW Electrix 'HANDYMAN'

THE LIGHT INDUSTRIAL
 SANDING AND POLISHING MACHINE

PRICE

£9-19-6

S. A. E.

for

illustrated

Leaflet.

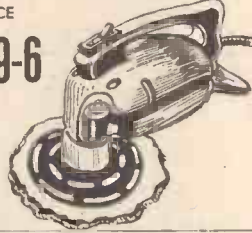

- COMPLETE 1 SANDER 2 HEADS
- INCORP. RADIO SUPPRESSOR
- STANDARD VOLTAGES
- ONE HAND OPERATION
- WEIGHT ONLY SIX LBS.

TRADE SUPPLIED

Order from **UNICO WHOLESALE CO.**
 (Dept. P.M.)
 51 THE MALL, LONDON, W.5

AN INEXPENSIVE TWIN GRINDER

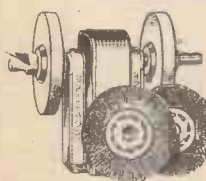

35/-

Carr. Paid

Fitted with two Grinding Wheels, one medium and one fine grit. Two 4in. dia. Scratch Brushes, one steel and one brass. Dual Driving Pulley for "V" or round belt drive. An efficient little machine at a reasonable price from:—
MORTONS, 13, CAMDEN ROAD, WALTHAMSTOW, LONDON, E.17

MODEL ENGINEERS

FOR THE TURNER:

Lathes from 1 1/2in. to 5in. Bench Millers. Drilling Machines. Hand Bench Shaping Machines.

FOR THE WOODWORKER:

Wood Turning Lathes 3 1/2in.—5 1/2in. centre height. 4 1/2in., 7in. and 10 1/2in. Ball Bearing Planers at competitive prices. 6in. and 12in. Saw Benches, Sanders, Grinders, Jigsaws.

Perspex, Catalin and Acetate Sheets always in stock.

NUTTALL'S (LATHES) LIMITED, MANSFIELD, NOTTS.

It Pays to Purchase ELECTRADIX BARGAINS

MOTORS. Special offer of new A.C. Motors, 1/2 H.P., 230 volts, 50 cy., 1,400 r.p.m., £5/10/0; 1 1/3 H.P., 230 volts, Capacitor start, 50 cy., S.P. 1,425 r.p.m., £7. Reconditioned S.P. Motors, G.E.C., 1/2 H.P., 230 volts, 50 cy., 1,425 r.p.m., £3/10/0.
MOTORS. A.C. 3-phase 1/2 H.P., new, 400 volts, 50 cy., 1,400 r.p.m., £6/10/0.
MOTORS. D.C. 110 volts, 1/8th H.P., 1,400 r.p.m., A.E.G., £1/10/0.
MOTOR PUMPS for garden Fountain, 230 volts, A.C., Stuart Turner, £5/15/-; foot valve and strainer, 16/- extra. 12 volt D.C. Motor Pump for Caravan or Motor Boat, lift 2 ft., throw 10 ft., capacity 100 g.p.h., £5/10/0. Rotary Suds Pumps, 1/2 H.P. Motor, 200 or 400 volts, 3 ph., 50 cy., 1,425 r.p.m., 10 ft. head, 600 g.p.h., £8/10/0. Rotary Suds Pump, only 8 ft. lift, capacity 50/60 g.p.h., speed, 750 r.p.m., delivery 35 ft., new, £5, with pulley.
RESISTANCES, variable wire wound, laminated brushgear, 1.2 ohms 15 amps., 7/6. 10 ohms 3 amps., 21/-, 300 ohms 1 amp., 15/-. Isenthal Geared Lab. Resistance, 60 ohms 2.8 amps., 25/-. Stage Lighting Dimmers, 500 watts to 2 kW. send us your enquiries.
SMALL DIMMERS. Panel type. Totally enclosed 100 ohms, 1/2 amp., wire wound, 2/-; 50 ohms, 1/2 amp., 2/-, postage 6d. extra; open type 10 ohms 1 amp.; 2/6, postage 6d.
BUZZERS. The high note tiny Townsend Buzzer, plat. contacts, 5/-. Morse Practice Buzzers in metal case, tunable note, 2/-, G.P.O. twin coil Buzzer, double contact for distant signals, 3/6.
MICROPHONES. The famous Lesdix Micro Button, lin. dia. brass body forms the granule chamber, thin mica diaphragm, needs only small 1/2 volt battery 3/6 ea. with diaphragm. Transformer, 2/- extra, postage 9d. G.P.O. Hand Mikes in bakelite case, fitted the latest carbon inset, 4/6. Siemens torpedo shape Mikes, bakelite case, 4/6. Transformers, 2/6. Tannoy Hand Mike, multi-carbon cells, metal clad, for announcers or recording, service type with switch in handle, as new, 5/-; special transformer, 12/6.
G.P.O. wall type Telephone Constructors' Parts, with diagram, comprising Bracket Mike, Mag. Bell, Transformer and Condenser, Switch-hook with contacts and G.P.O. Long Magnet Bell Receiver, connection strip and polished box, 8in. x 6in. x 3 1/2in. hand magneto generator, 35/-, plus 5/- carriage charges. Useful for House or Factory and simple to wire.
SWITCHES. Dewar Key Switches, 7-pole C.O. with top plate, 3/6. Yaxley 3-pole, 3-way, 2/6; 1-pole, 8-way, 2/6. G.P.O. Lab. reversing Switch, 2/6. Lucas 8-way Switchbox, 3/6, post 6d. Toggle Switches D.P.C.O., 250 volt 1 amp., 3/-, S.P.C.O., 2/-.
METERS. Ironclad A.C. Switchboard type, G.E.C., 4in. voltmeter 60 volts.
AMMETERS. 40 amps. Precision Instruments, Crompton Switchboard type, square, 6 1/2in. x 6 1/2in. x 4in. back connections, 4 1/2in. scale, with lampholder on top to illuminate dial, 0-50 amps., A.C., 40/-; 0-75 volts, A.C., 35/-; A.C. Ammeter, 7 in. dia., reading 1,000 amps., with current transformer, £4/10/-, carriage 5/-.
D.C. DYNAMOS.—12 volt 10 amp., totally enclosed, 1,400 r.p.m., 40/-. Cut-out 12 volt 1 amp., 4/6, 12 volt 50 amp., £4/10/0; 24 volt 100 amp., £5; 30 volt 5 amp., 35/-; 27-32 volt 9 amp., £5/10/0-. Carriage on any Dynamo, 5/- extra.
MAGNETO BELLS in polished wood box, 8in. x 6in. x 3 1/2in., with condenser, Transformer and connection strip, Switch Hook and Contacts, 5/-, postage 1/-. G.P.O. Candlestick Telephone with Receiver and cords, 12/6, postage 1/6.
HAND MAGNETO GENERATORS. P.M. Steel Magnet, wound armature, driven by gearing in handle, output approx. 70 volt 25 mA. A.C., useful for A.C. Experiments, bell circuits, shocking coils, etc., 8/6 each, postage 1/6, few only mounted in polished wood box, 10/- each, postage 1/6.
RELAYS. G.P.O. stock bank of 20 relays 100 ohms 2 1/2 volts 15 mA., in new condition, 15/-.
MAGNETS. Swift Levick S.L.36 instrument type, circular horseshoe 1 1/2 in. dia., 1/2 in. thick, 1/2 in. polar gap drilled poles, weight 2 ozs., lift 3 lb., 2/6 each, or 12/6 for six. The Alni disc magnet, the wonder midget magnet, 1/2 in. dia., 1/2 in. thick, 3/16 in. hole in pot with keeper, 3/6. D.C. Electro Magnets, weight 10 oz., lift on 2 volt 1 1/2 lb., 4 volt 3 lb., 6 volt 4 lb., 5/-. Permanent flat bar magnets, 2 1/2in. x 1in. x 1/2in., drilled two holes each end, 2/- pair.
 Send for special leaflet P.M.
 Please include postage for mail orders.
ELECTRADIX RADIOS
 214, Queenstown Road, London, S.W.8
 Telephone: MACaulay 2159

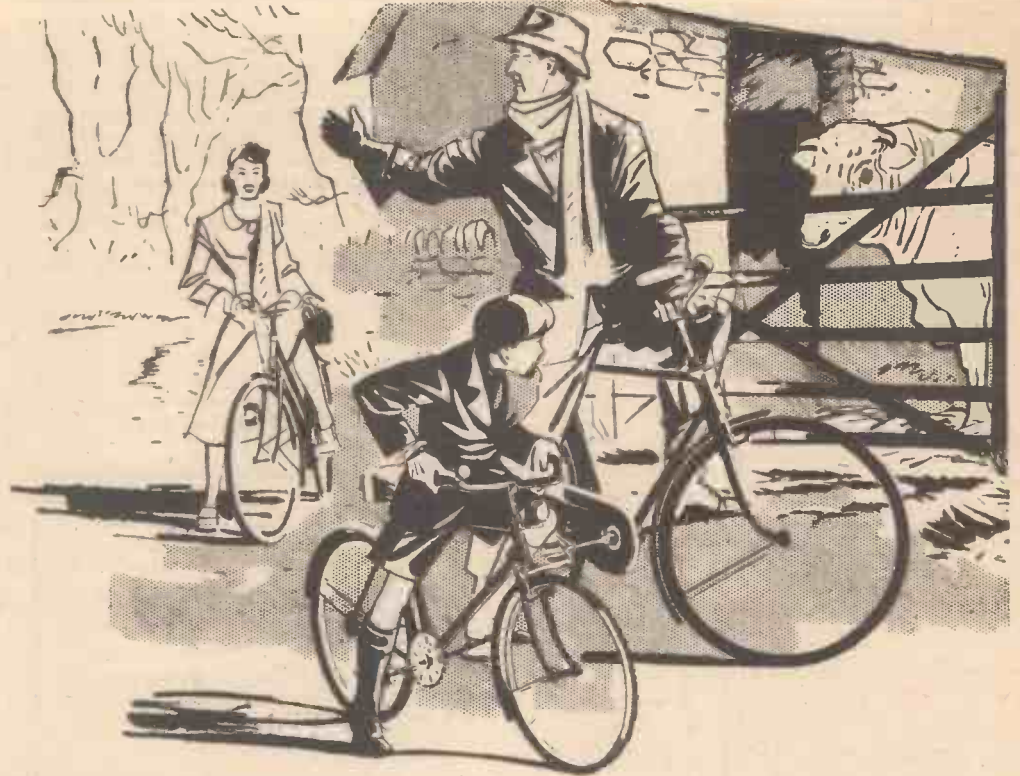

The
Family
relies
on

DUNLOP

CAR TYRES · CYCLE TYRES & SADDLES

50H.301

THE WORLD'S
GREATEST BOOKSHOP

FOYLES
★ FOR BOOKS ★

New and secondhand Books on every subject. Stock of 3 million volumes
Large Dept. for Technical Books
113-125 CHARING CROSS RD. LONDON, W.C.2
Gerrard 5660 (16 lines)
Open 9-6 (inc. Sats)

TELEPHONE SETS, comprising 2 G.P.O. hand-phones, 2 bells, 2 pushes and 80ft. twin wire. Price 48/6, post free. Makes an excellent inter-office, works or domestic installation. Really professional instruments. Brand new, not rubbish. Single instrument, 11/6.
BATTERY CHARGERS for A.C. mains. For charging 2-volt accumulators at 1 amp. Parts with diagram, 15/-. Complete, 21/6. Postage 10d.
FOR TRICKLE CHARGING CAR CELLS, parts with diagram. Output 11 amps. for 6c. cells, 28/6 set. For 12v. cells, 28/6 set. Post 10d.
PHOTO-ELECTRIC CELLS—For all sound films, high fidelity production, speech and music. Small tube size. 2in. x 2in. dia., 28/6. Midjet tube, 1in. x 1in., 22/6.
COMPLETE OPTICAL SYSTEM for 35 or 16 mm. sound film. 2in. long. 1in. diam., projects 0.0005in. light. Price 22/6.

ECONOMIC ELECTRIC CO.,
64, London Road, Twickenham.

CYCLOP

STOP-THIEF PUMP CLIPS
COMPETITION. These clips prevent snatching of cycle pumps—and falling off. Buy a pair and enter free 22 a week slogan, joke or cartoon competition. Details with clips.
NICKEL 13 De LUXE CHROME 21—From Halfords & good cycle dealers or post free KORTING LTD. (P.M.) 12 Dale St., London, S.W.1

RECOMMENDED BY EXPERTS

“**Cantilevers**” (REGD.)

HALL-MARK THE QUALITY BICYCLE

FIT
OUR
LOCK
LEVERS
AND

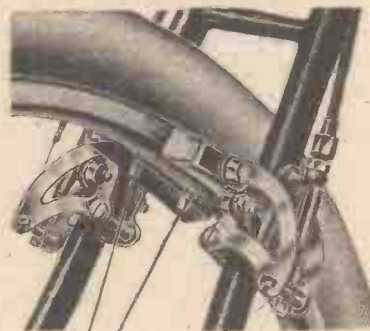

MAKE
YOUR
MACHINE
THIEF-
PROOF!

**MOST POWERFUL and SMOOTH ACTING
CYCLE BRAKES in the WORLD**

Your SAFETY depends on your Brakes. Thousands of Cyclists have had good reason to be thankful that they had the foresight to fit CANTILEVERS before risking the hazards of present-day traffic and gradients. Many have written to us of their efficiency and of the complete confidence with which ANY EMERGENCY can be faced and with which the steepest hills can be approached in the knowledge of a safe descent. If you are buying a new bicycle specify CANTILEVERS or CANTILETTES, otherwise fit them to your old machine. CANTILETTES are specially designed to provide at lower cost an efficient brake based on CANTILEVER principles. 12-month Guarantee with all new Brakes.

Our special LOCK LEVER can be supplied with all Brakes, or separately for use with ANY existing Cable Brake. WHEN THE BRAKES ARE LOCKED ON, IT IS IMPOSSIBLE TO RIDE OR WHEEL THE BICYCLE AWAY.

NOTE.—Brakes are supplied with ordinary or Lock Levers in Straight or “C” Shape. Special length Cables for Frames over 21in. Alternative fittings for various shapes and sizes of forks and stays. Brake Blocks for Steel or Alloy rims in three thicknesses for correct clearance. It is essential to obtain the alternatives best suited to your requirements. New and reconditioned Cables and all Spare Parts readily available. If in any difficulty, write to us. Leaflets and Price Lists on request.

THE RESILION CO., LTD., 200 LIVERPOOL ROAD, LONDON, N.1

MATRIC.

WHY needlessly handicap yourself and watch other people winning success and security? Whatever your age, you can now prepare for the all important Matriculation Examination at home on “NO PASS—NO FEE” terms. Write now for our valuable “GUIDE TO MATRICULATION” which explains the easiest and quickest way to matriculate—FREE and without obligation.

BRITISH TUTORIAL INSTITUTE.
(Dept. 160), 356, Oxford Street, LONDON, W.1.

“NO PASS—NO FEE”

Build Your Own
**Motorized
Workshop**

This Famous Book Shows How to DO IT!



Easy to Make
**40 Different
Power Machines**

Lathes, drill presses, sanding machines, shaper, circular, band and scroll saws, etc.—from wood, pipe and parts that cost little or nothing. Send 12/6 for immediate post-paid delivery of “40 Power Tools You Can Make.” Money back if dissatisfied. List of handicraft books free.
A. THOMAS & CO. (FPPM).
111, Buchanan Street, Blackpool.

PICADOR POLISHING HEADS

★ Min. Cap. Chuck.
★ Dual Driving Pulley
★ Oil Impregnated Bushes
★ Shrouded Safety Case Only 22/6, plus 1/6 post and packing.
MORTONS, 13, CAMDEN ROAD, WALTHAMSTOW LONDON, E.17



All letters should be addressed to the Editor, "THE CYCLIST," George Newnes, Ltd., Tower House, Southampton Street, Strand, London, W.C.2.

Phone: Temple Bar 4363

Telegrams: Newnes, Rand, London

VOL. XVIII

APRIL, 1950

No. 337

Comments of the Month

By F. J. C.

Second Thoughts about Black Clothing

WE dealt last month with the illegal "Annual General Meeting" of the R.T.T.C. when a resolution was passed that all cyclists taking part in time trials must wear black clothing. This "ruling" was keenly resented by the clubs and indeed some of the District Councils of the R.T.T.C. advised clubs to ignore the proceedings of the so-called A.G.M. In view of the widespread criticism of the manner in which this meeting was conducted we took Counsel's opinion and we circulated the following letter generally to the cycling press:

"Apropos the National Council Meeting of the R.T.T.C. we have taken Counsel's opinion on the validity of that meeting and Counsel's opinion is that the meeting was undoubtedly out of order and that clubs can ignore any resolutions passed at that meeting in the certain knowledge that disciplinary action could not legally be enforced as a result. In other words, a meeting which is out of order cannot rule itself in order and especially is this so in the case of a meeting which is not truly representative of the membership nor held in accordance with the rules, as was so in this case."

The meeting was indeed *ultra vires* and the delegates attending therefore *non locus standi*.

Now comes the news that the Council has decided to suspend the operation of its rule to some later date and it stands adjourned as the lawyers would say, *sine die*. The fact is that they cannot even suspend a rule which does not exist and their proper course was to have admitted that the rule is invalid. Instead of withdrawing it they have merely suspended it. We have no doubt that its sponsors will endeavour next year at some properly constituted meeting to resuscitate it. If the Council will accept our advice, however, they will let the matter drop, as they will sacrifice all authority if they persist in it. There will be many break-away movements.

Clubs will continue to operate under the rules printed in the 1949 Handbook.

N.C.U. Deficits

The N.C.U. 1949 expenditure exceeded income by £2,161 12s. 10d. This is a heavy deficit in relation to its comparatively small turnover, and it should indicate that something is wrong in the N.C.U. camp. An attempt to solve the financial problem was implied in the suggested amalgamation of the N.C.U. with the C.T.C., an idea with which the two bodies have been toying for many years. It has, however, again been shelved. It cannot be said that the Herne Hill track has been a profitable investment, but as the N.C.U. continues to lose its hold on cycling clubs it may be expected that next year the profit and loss account will show an even more unfavourable figure in the debit column. The main problem, therefore, of the N.C.U. is how to increase its membership and therefore its revenue. It has made strenuous efforts in the past few years to add to its

numbers, but it has hardly gone the right way about it. It has antagonised large numbers who might have been brought within its ranks and it has embittered many of its own members. The position raises the important question: has the N.C.U. outlived its period of usefulness and has the need for its existence passed? What useful purpose does it fulfil when its main object is only to control track racing on closed circuits? It is well known that this does not pay and, taking a realistic view, the fortunes of the N.C.U. must, therefore, decline since it is not practicable greatly to increase its membership. It has attempted to flirt with the massed starters and the speedsters in an effort to rope them into the fold, but there is no particular reason why either of these two bodies should feed the mouth that bit them, so little is likely to come of that. It is unlikely that the C.T.C. will take it over and so we fall back on the suggestion we have made that there is need for an entirely new body to take over cycle racing and record racing whether on the highway or on the track. The N.C.U. is now reaping the harvest resulting from the seeds of dissension it planted half a century ago. An entirely new body could profit from the mistakes of the past and it could be formed from the nucleus of the R.T.T.C., the R.R.A. and the liveliest of the officials of the N.C.U. Such a unified control would eliminate the old-men proprietors of the movement who have caused so much trouble within it and who ought now gracefully to retire; they are not wanted. They can, of course, if qualified, join the Fellowship of Old Time Cyclists and natter to one another at the once-yearly meeting and bask in mutual admiration of their deeds in the 'eighties! Sooner or later the cycling world will come round to this point of view and decide that it should serve only one master, not several. There is no reason why cycling clubs should be affiliated to the N.C.U. It does practically nothing for them except airily to pretend to "defend the rights of cyclists," a phrase now which is too hackneyed to carry any weight amongst the present-day intelligent cyclists. The N.C.U. should go into voluntary liquidation and distribute its funds amongst its members.

cycle show will be held in the autumn of 1951. As previously announced the reason is that manufacturers are too busy with their extensive production and export programme for 1950, particularly for the hard currency and dollar markets to spend time and money preparing for an exhibition.

Mr. C. Douglas Terry has been re-elected President of the Union which reached this decision.

The F.O.T.C.

The Fellowship of Old Time Cyclists to which we referred in a previous paragraph has a present membership of about 300. These pioneers of cycling must all have been born in 1873 or earlier and must have owned or ridden an Ordinary or Tricycle prior to 1890. It is obvious, therefore, that the youngest of them will be 77 this year. They meet usually once a year and this year they met in February, 50 of them turning up. The President, of course, is Tom Norton, of Radnorshire.

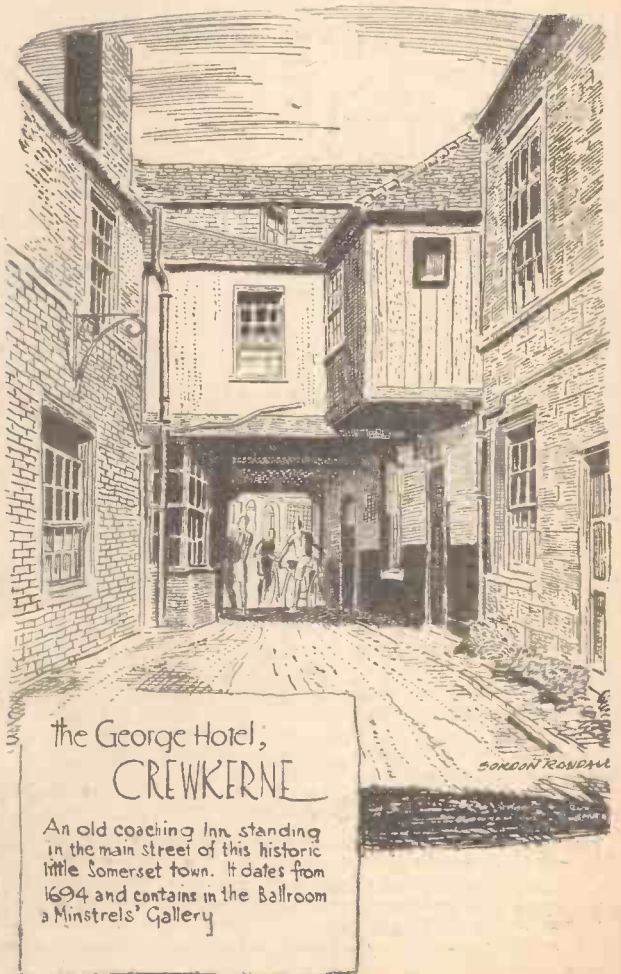

The George Hotel;
CREWKERNE

An old coaching Inn standing in the main street of this historic little Somerset town. It dates from 1694 and contains in the Ballroom a Minstrels' Gallery

Cycle Show—1951

The next bicycle and motor



A sunny summer day in
MICKLETON
Close.

A pretty village surrounded
by orchards three miles
from Chipping Camden.
Its church has a lovely
14th cent. broach spire.

Paragrams

Club Founder Dies

THE death has taken place at the age of 79 of Mr. Walter Hodson, of 94, Houghton Road, Grantham, who at one time was a prominent cyclist in the town. He played a great part in the establishment of the Grantham Clarion Cycling Club, and in his younger days was a keen rider and did much work for the sport locally.

Almost a Record

AFTER going for 10 months of 1949 without a single fatal accident, England's smallest county, Rutland, has had its chance of seeing a whole year pass without a fatal accident in its boundaries disappear. In spite of its smallness, Rutland has its share of busy roads, for the Great North Road passes through the county, as also does one of the main Leicester roads which carries heavy traffic to the East Coast.

At Last

AT long last at least one magistrates' bench is beginning to get tough with careless lorry drivers who shed their loads all over the road. Drivers of sugar beet lorries in country districts are persistent offenders, and at Norman Cross (Hunts) magistrates' court the chairman, announcing a £3 fine on a driver for failing to secure his load, said that warnings had been issued about such offences "times without number," and added: "Nets are obtainable for such loads and are cheap. If people will not use them they will have to pay for it."

Keeping the Roads Clean

WHEN Leicestershire County Council considered a proposed new by-law to prevent vehicles leaving mud or clay or similar obstructions on the roads in the county one councillor suggested that this by-law would be "just one more regulation to create new criminals." This gentleman, who is obviously no cyclist and has never collided in the darkness of a country road with lumps of clay as big as footballs from farm lorries, or an assortment of sugar beet or turnips, was overruled by his fellow-councillors and the by-law was approved. The new by-law does not cover the scattering of coal on the highway as this can be dealt with by a by-law which is already in existence.

Setting a Good Example

MR. S. A. MOTTRAM, secretary of the Central District of the Road Time Trials Council, speaking at the annual dinner and dance of the Falcon Road Club, Loughborough, congratulated members on being good cyclists in the broadest sense, and not merely within the narrow bounds of their club. Proposing the toast of "The Club," Mr. Mottram said he considered it to be one of the best managed of the 35-odd clubs in the area. The club has made very considerable progress during the

past three years and members organise a comprehensive programme of social activities when outdoor events are impossible.

New South Yorks League

ARRANGEMENTS are being made for the South Yorkshire Track League, which came into being this year, to split and form a new league, with racing meetings every Wednesday night next summer on the Welfare Track, Brodsworth. The grass track league will continue to have events on alternate Tuesday nights as during last summer. The fixtures in the new league will consist of four or five events at each meeting, and the league placing of each club will be determined by the points scored in the finals.

Football Cyclists

NOW in full operation in Doncaster and the neighbourhood is the Lindley Football League, which is composed of members of local cycling clubs. It was felt that such a league would receive considerable support when the weather made it impossible for cycling events to be held, and so it is proving.

Looking Back

A LINK with the early days of cycling is provided by Mr. Cecil Threadgould, of Scunthorpe, whose father, Mr. William Threadgould, was one of the first cycle makers in North Lincolnshire. In his workshop at Gainsborough over 70 years ago, Mr. Threadgould used to build up cycle wheels from specially imported American hickory, fit them with iron tyres and build his own frames. About 1874 he moved with his family and his cycle business to Scunthorpe, and ever since that time there have been enthusiastic cyclists in the Threadgould family. Mr. Cecil Threadgould, who is 69 years old, remembers all the old machines and rode most of them. His brother used to ride an American penny-farthing which had the big wheel at the back and the small wheel in front, which gave the impression that he was riding backwards.

Northern Woman Speedster

MARY MARTIN, Doncaster Wheelers' star woman rider, failed to win the Club's "Best All Rounder" championship shield for the 25, 50 and 100 miles and the 12-hours rides, but as runner-up she had an average speed of 20.393 m.p.h. Her times

were, for the 25-miles, 1 hr. 9 mins.; 50-miles, 2 hrs. 20 mins. and 100-miles, 5 hrs. 4 mins., while in the 12-hour event she covered 227 miles. This year's winner of the championship shield was Noah Kinsey, a most consistent rider for the Wheelers.

Home From Home

A NEW type of first-aid kiosk invented by a German for erection in busy streets, seems to have almost everything. There is a full first-aid kit, a folding stretcher on two wheels with pram-type hood in case it is raining, public telephone, fire alarm, police telephone to the nearest police station, a wall mirror and an illuminated clock and a blue light on top of the kiosk. If the kiosk had only had a cooking stove, and a few refreshments in a cupboard it would have been perfect!

Doing the Job Properly

WHEN 17-year-old George Hill, of Scunthorpe, decided to concentrate on cycle-stealing, he really got down to the job properly. The police spent months enquiring about, and searching for, the stolen machines, and when they eventually caught Hill they found cycles at his house and parts hidden in hedges and fields all around. When they had collected up all the cycles and bits and pieces they filled a police van almost twice over. Hill was bound over for two years when he appeared before Scunthorpe borough magistrates, and was told by the chairman: "If you had been an older man we should have sent you to prison without any doubt whatsoever."

"Operation Peak"

AFTER their successful completion of a cycling trip in the Peak District of Derbyshire, the ten boys of Huntingtower Secondary Modern School, Grantham, and their master, have been holding an exhibition covering their trip and called "Operation Peak." Each boy filled an exercise book with details of the trip, such as the mileage covered and height of hills climbed, notes of minor details that might be altered for a subsequent trip, details of small troubles that arose with the cycles and could have been avoided and similar useful items. They also took samples of local rocks, and the master claims that this trip taught the boys a good deal of geology, geography and history—not to mention road courtesy and road safety. A similar trip to the Lake District is planned for next year.

On to the "100"

THERE were no founder-members present at the annual dinner of Peterborough Cycling Club in January for the simple reason that it was the 75th anniversary of the club that was being celebrated, but there were a number of old stalwarts present. At the dinner were eight riders in the club's first open "50," 26 years ago, and 14 who had been members for 25 years and over. Six of the guests had ridden over 50 miles to attend the festivities. Now the club is off for its last "25" to finish its century.

Anyone Seen a Ghost?

A BIRMINGHAM man, Mr. A. P. Scholes, of Ladywood, is busy looking for a ghost. The particular ghost in which he is interested is that of an R.A.F. officer who was killed on the Great North Road just before the war. Anyone riding along the North Road who suddenly rides through a ghostly figure wearing the ghost of an R.A.F. uniform is requested to take the ghost's number, rank and name and communicate at once with Mr. Scholes!

Around the Wheelworld

By ICARUS

Bidlake Memorial Prize

THE F. T. Bidlake Memorial Prize for 1949 has been awarded, for the second time, to Reg. Harris, Manchester Wheelers, for his victory in the Professional Sprint Cycling Championship of the World at Copenhagen, on August 28th, 1949, during the first year of his professional career. He is the first Englishman ever to win this title.

Harris at Whitsun Race Meetings

REG. HARRIS is to ride in the Whitsun race meetings which are being sponsored by Dunlop. He will have against him Astolfi, Italy's professional sprint champion; Pauwels, professional sprint champion of Belgium; Gosselin, European winter champion; Senftleben, former professional sprint champion of France; and Iaconopelli, winner last year of the Grand Prix of the Union Cycliste Internationale. All of them are appearing at the Butts, Coventry, on the Thursday evening; at Herne Hill on the Saturday afternoon; and at Fallowfield, Manchester, on Whit Monday afternoon.

Major Watling, President of I.F.M.C.M.

CONGRATULATIONS to Major H. R. Watling, O.B.E., J.P., on his election to the presidency of the International Federation of Motor Cycle Manufacturers in succession to Count Rene de Latour. Major Watling is, of course, the Director of The British Cycle and Motor-Cycle Manufacturers' and Traders' Union.

R.T.T.C. Sees Red Light!

THE Road Time Trials Council has seen the red light—ahead this time and not from the rear. It has agreed to withhold the rule regarding black clothing passed at its illegal "A.G.M." Cyclists, therefore, will continue to operate under the rules according to the 1949 handbook. Agreeing to withhold the rule, however, does not go far enough, for it remains, so to speak, on the statute book and could be put into action. It should be withdrawn and a fresh annual general meeting called. I am glad to know that one or two district councils are defying the R.T.T.C.

What a pity it is that these squabbles, caused by the high-handed proprietors of the cycling movement, continue. Anyone who cares to consult the files of cycling journals for the past fifty years will find that it has been a continuous series of petty squabbles due to intrigues, and the intrigues are largely sponsored by the older men of the movement, who, because they rode bicycles fifty years ago, consider that they own the sport. If the various bodies could be purged of these cantankerous people peace might descend. These old men pass on a sort of heritage of hate, and it is significant that they have been interested in cycling for about fifty years and that we have had fifty years of squabble.

A Modern Machine for the Modern Generation

TO cater for the ever-growing demand of young cycle-speedway riders—now in their fifth year as officially recognised sportsmen—J. A. Phillips & Co., Limited, of Smethwick, have for the first time introduced

a specially designed speedtrack machine. It is a brightly coloured model with the essential specifications and design for this rigorous and rapidly growing sport, and club colours are featured as standard in the form of chevrons. Well within the reach of these discerning riders, the "Speedtrack" retails at £8 16s. 5d. plus purchase tax £2 1s. 1d.

A 22in. frame, angled at the seat lug down to 20in., has a curved top tube to obviate all "whip," and allow correct positioning of the saddle as determined by expert riders. Handlebars—of the well-tried Canadian pattern—are regulation width, i.e., 24in., and are constructed to permit of maximum movement when cornering at speed, combined with perfect control. A "Quickfit" rear brake is provided, but this is primarily for use on the highways, and is so designed as to be easily detachable for track work. The front and rear wheels, of different types, give an unorthodox appearance, but the 26in. x 1½in. Endrick front, equipped with Dunlop Sprite tyre, is conducive to speed, whilst the Rear Westwood 26in. x 1½in., with Dunlop Roadster studded tyre, is conducive to minimum skid.

The machine is geared at ratio 52, which has been carefully worked out to provide the best performance on the track. The saddle

An important characteristic of this new tyre, which makes it particularly desirable for this type of service, is the extra thick tread, constructed with a specially prepared, tough-tread compound to withstand the extra wear and strain occasioned by driving power being transmitted through the tyre itself.

The tread pattern of this new tyre lends itself admirably to the "motor" drive and at the same time is a protection against skidding. The strong, high-grade fabric carcass incorporated in the tyre gives maximum resistance to road shocks and incidental damage.

Massed Start and the N.C.U.

THE N.C.U. has seldom reflected the opinions of its centres and further evidence of this was provided by the agenda of the general council meeting in March. The Newcastle delegates pressed for a limited number of massed start races on the open roads with the approval of the massed start committee. There was a joint proposition by Manchester and Newcastle which sought to have the regulation removed, which bans road events other than on enclosed circuits. The Newcastle centre also

wished to see the current N.C.U.-R.T.T.C. agreement dropped and negotiations started to invoke a new joint agreement which will allow massed start races to be held on the open road. The Leicester centre proposed, "That in view of the lack of cohesion between the R.T.T.C. and the N.C.U. and the rank and file members of the clubs, the N.C.U. give the R.T.T.C. notice to terminate their agreement, and, furthermore, that the general council authorise the general secretary or the general manager to apply to all N.C.U. members by post for their mandate that the N.C.U. shall become the sole controlling body of all competi-



The Phillips "Speedtrack" Cycle

tive cycling, and that a set of rules shall be framed to cover time trials and events associated thereto." Another centre wanted compulsory insurance for riders dropped in view of the present National Health Service. I am surprised that someone did not propose that the N.C.U. be abolished.

As it is essential that a speedtrack machine be light as well as strong, the "Phillips Speedtrack" has been designed in such a manner as not to exceed a weight of 30lb.

Type for Power-assisted Bicycles

THE power-drive de luxe tyre is the latest addition to the Firestone range of cycle tyres. This new tyre has been specially developed by Firestone to meet the fresh demands created by the use of "motor" power in bicycles.

N.C.U. Balance-sheet

THE salary of the headquarters' staff of the N.C.U. amounted in 1949 to £5,182 6s. 3d., which compares with £4,546 15s. 9d. for 1948. Track hire, receipts, cycle-park receipts and sale of training tickets at Herne Hill track brought in £2,331 12s. 8d., and rents, advertisement revenue and catering receipts added £967 14s. 5d. General expenses were £2,308 5s. 11d.

Some may think the salary bill is high!

Wayside Thoughts

By F. J. URRY



GORDON RANDALL

Sun and shadow on
Dartmoor.

The road over the moors
sketched from the top of the
hill overlooking Two Bridges,
with Princetown on the extreme
right.

Keep the Spirit

NOT long ago there was some criticism in a big provincial daily of the Y.H.A. Its membership has slightly declined, and the idea at the back of the comments was to seek the reason why. I am a life member of the Youth Hostel Association because I like the right to walk into one of these gay little gatherings, and remember all the things I missed as a youth, which are now available to the younger generation, and one of the greatest is undoubtedly the services of the Y.H.A. I doubt if I shall ever use the hostels for accommodation, for the simple reason that as one grows older community sleeping loses its appeal, but that individual trait does not blind me to the fine value of this organisation to the country lover, walker and cyclist. It seems that the correspondence following this public comment disclosed the fact that the hostels have been used of late years by the type of people who walk or ride as little as possible, and only seek the cheapest means of accommodation, and many ardent hostellers would be glad to be rid of this kind of company, and therefore look upon the slight decline in membership without consternation. I can easily understand that point of view, for the movement was started for the young people to encourage their love of country and grant them the means of indulging that desirable characteristic at a cost well within reach of the young wanderer. Some keen hostellers would conserve the commencing austerity in accommodation that marked the start of the movement, but I see no reason why limited amenities should not be added to the regime without any invasion of the charter. After all, it is natural for wardens to do their very best for their hostel guests, and I know some of them take a real pride in such performance. I have little or no sympathy with the individual who uses the hostels for cheap accommodation, and just lacks the real spirit of wandering, but it would almost seem—from the replies published by the real hosteller—that this type is disappearing from the roll.

The Loud Days

THE wind was in the sky, and swooped to earth in vigorous gusts strong enough to stagger the steering. I was out on that noisy morning watching the bare branches dancing a mad fandango, and their broken bits careering down the road with the roar of the tempest after them. How good it

would have been to see the waves come ashore on some west-facing beach or springing at the gaunt rocks of the Pembroke coast. But it was also good to be out in the Warwickshire lanes, to see a whirlwind of half-dried leaves rise from their decay and take fierce wings for a journey. Overhead the sky was splashed with flying cloud that occasionally spit a quick spate of rain on me and passed rapidly over, letting down a column of pale sunshine like a primrose curtain of gargantuan proportions. I went sweeping over the lanes with the wind and the twigs and the leaves, with the sunshine in my lap. It was great fun to be out, to be hurried along without effort, and on the way to hear the ancient oaks and elms groan with the pressure on their limbs, and see the startled crows rise into the gale, climb and with a flick of the wing turn and hasten the other way. Mid-winter, yes, and not too cold to take joy from the journey, for there was even promise of spring in the western gale, and you could almost smell it. In a dozen miles I found that which I sought in addition to a drink of tea, and then dodged into the lanes and escaped the direct attacks of that slanting breeze. But not all of it, for it bounced the hedges and came roaring round the corners with force enough to stagger me and tear a lightly held mud-flap from the front guard. It is on such occasions that variable gears present their full value, and I made such use of mine that the luncheon appointment was kept, and the provender promptly put into good service.

The Refresher

THAT was one morning; I went home from work just prior to that scamper, in a night black with storm and rain, when the streets were almost deserted and there was an eeriness about the town. Swathed in macs, with the wind battering at me from the west I just turned a 54 gear quietly over and came home but a few minutes late. "What an awful night for you," they said, and I had been thinking how wonderful it was to make seven miles of storm in a few minutes over forty-five, and feel refreshed as a result. To me that is the point. It is not an exaggeration to say I felt refreshed, just a fact, for the journey was far enough to make me glow, and not too far to make

me weary. I suppose the average car, train or bus traveller will never understand; they do not believe cape and leggings can keep a man dry and comfortable for at least an hour's riding, or that the exercise is of real benefit after a day of telephones and trouble. The old habit, when many a business man rode a bicycle to work, has gone and it will probably never return. But the business man is none the better for that; indeed he is worse in that he eschews exercise for ease, and in very many cases pays the penalty in health. I am fully aware this health question concerned with cycling may be a fetish to me, but the fact remains that I am an old but fit man, and the latter condition is of my own making, I believe, even though the former one is the dictatorship of time. I shall never persuade the old fellows to follow this example, but I do hope that the younger ones now riding will be wise enough to keep on doing that very thing when their grandchildren begin to ask them when they can have a bicycle. Then, indeed, they will be happy people.

Looking Forward

AT the moment of writing I have made no Easter arrangements; events in the early part of the year having rather upset my plan of taking "time-off" when I felt the inclination and when conditions subscribed to it. The years go on and I have not yet begun malingering at work; but I shall as soon as I can, in order to enjoy my remaining activity in the manner I like best. Whether I shall start at Eastertide on this crusade of the easier way and so make a respectable total of cycling miles remains to be seen. I begin to think how pleasant it will be during the coming weeks to "knock-off" fairly frequently at mid-day and go wandering round the old haunts of my youth, with tea laid out at the house of some friend, where we can chatter of the days when we piled up the miles in days before the motor car in its barbarous outline offended our sense of beauty when compared with the horse and trap or the patrician brougham. It is a long while ago; but I was riding in 1889, and by the mid-nineties considered myself a practised cyclist, though now I know full well how much I had yet to learn and enjoy.

Changes in Outlook

EASTER is fairly early in the year, which is a good thing, for it seems to make the season longer. There was a day in my time when earnest cyclists and famous club lads had no winter season except in the social sense. Cycling started at Easter—like cricket in May—and stopped when the ways became muddy and there appeared to be more wet than fine days. Occasionally, few brave fellows went out if the roads were frozen, but it was not until towards the close of last century that regular winter riding came into vogue. Because my friends and I fitted guards and found joy in our winter week-ends we were looked upon as a trifle mad, and the madness, as far as I am concerned, has persisted. I make no claim to pioneering winter riding; I did it because I liked it, and I suppose other people found the nonsense of danger and darkness grossly exaggerated compared with the pleasure and convenience. It should, of course, be remembered that the tarmac road was unknown, and when the rains of late autumn fell on the land the old mud-pie macadam was usually converted into a quag, from which condition it did not recover until the frost came to stiffen the curly mud or the spring winds to dry it out. The car brought the water-bound road and made winter cycling as easy as summer travel unless the gales blew into our laps. Let us be duly thankful for the change, for it is something the car has presented to cycling.

The STEPPING STONES TO SUCCESS!



Don't hesitate about your future! Go forward, confident that The Bennett College will see you through to a sound position in any career you choose. The Bennett College methods are individual. There's a friendly, personal touch that encourages quick progress and makes for early efficiency. Take the first important step NOW and fill in the coupon below.

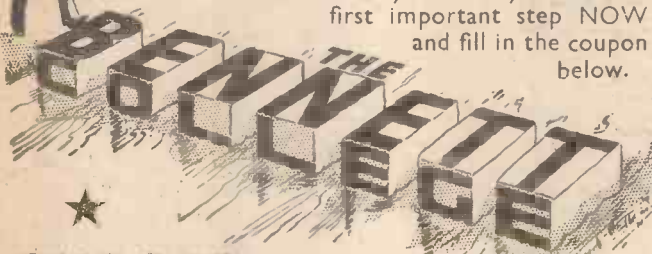

CHOOSE YOUR CAREER

Accountancy Examinations
 Agriculture
 A.M.I. Fire E. Examination
 Applied Mechanics
 Auctioneers and Estate Agents
 Aviation (Engineering and Wireless)
 Blue Prints
 Boilers
 Book-keeping, Accountancy and Modern Business Methods
 Builders' Quantities
 Building, Architecture and Clerk of Works (A.R.I.B.A. Exams)
 Cambridge Senior School Certificate
 Carpentry and Joinery
 Chemistry
 Civil Engineering
 Civil Service
 All Commercial Subjects
 Commercial Art
 Common Prelim. E.J.E.B.
 Concrete and Structural Engineering
 Draughtsmanship, all Branches
 Engineering, all Branches, Subjects and Examinations
 General Education
 G.P.O. Eng. Dept.
 Heating and Ventilating
 Institute of Housing
 Institute of Municipal Engineers
 Journalism
 Languages
 Mathematics
 Matriculation
 Metallurgy

Mining, all Subjects
 Mining, Electrical Engineering
 Motor Engineering
 Naval Architecture
 Novel Writing
 Plastics
 Play Writing
 Plumbing
 Police, Special Course
 Preceptors, College of
 Press Tool Work
 Pumps and Pumping Machinery
 Quantity Surveying—Institute of Quantity Surveyors Exams.
 Radio Service Engineering
 Radio (Short Wave)
 Road Making and Maintenance
 Salesmanship
 Sanitation
 School Attendance Officer
 Secretarial Examinations
 Sheet Metal Work
 Shipbuilding
 Shorthand (Pitman's)
 Short Story Writing
 Social Welfare
 Structural Engineering
 Surveying (R.I.C.S. Exams.)
 Teachers of Handicrafts
 Telecommunications (City and Guilds)
 Television
 Transport Inst. Examinations
 Viewers, Gaugers, Inspectors
 Weights and Measures Inspectors
 Wireless Telegraphy and Telephony
 Works Managers

If you do not see your own requirements above, write to us on any subject. Full particulars free.

COUPON. CUT THIS OUT

IF YOU ATTEND TO THIS NOW IT MAY MAKE A WONDERFUL DIFFERENCE TO YOUR FUTURE

To DEPT. 76, THE BENNETT COLLEGE LTD.
 SHEFFIELD, ENGLAND

Please send me (free of charge)

Particulars of
 Your private advice about

(Cross out line which does not apply.)

PLEASE WRITE IN BLOCK LETTERS

NAME.....

ADDRESS.....

(1.4.50)



PRECISION CONTROL

Exact in size, correct in frictional characteristics, and unvarying in quality, Ferodo hub brake linings give ample stopping-power, *precisely controlled*. They are supplied in boxed sets, complete with rivets, for all makes of hub brake, or in roll form if preferred.

FOR ALLOY RIMS— SPECIAL BRAKE BLOCKS

If you use alloy rims, ask for the special soft quality Ferodo brake blocks, now available, which do not score the light metal. Ferodo blocks for rim brakes of every type give safe, smooth stops in any weather.

The price of standard sizes is

6^D A PAIR

FERODO

HUB BRAKE LININGS AND ALL WEATHER BRAKE BLOCKS

FERODO LIMITED, CHAPEL-EN-LE-FRITH
 A Member of the Turner & Newall Organization



Someone's
mighty proud of his
Hercules

THE FINEST BICYCLE BUILT TO-DAY

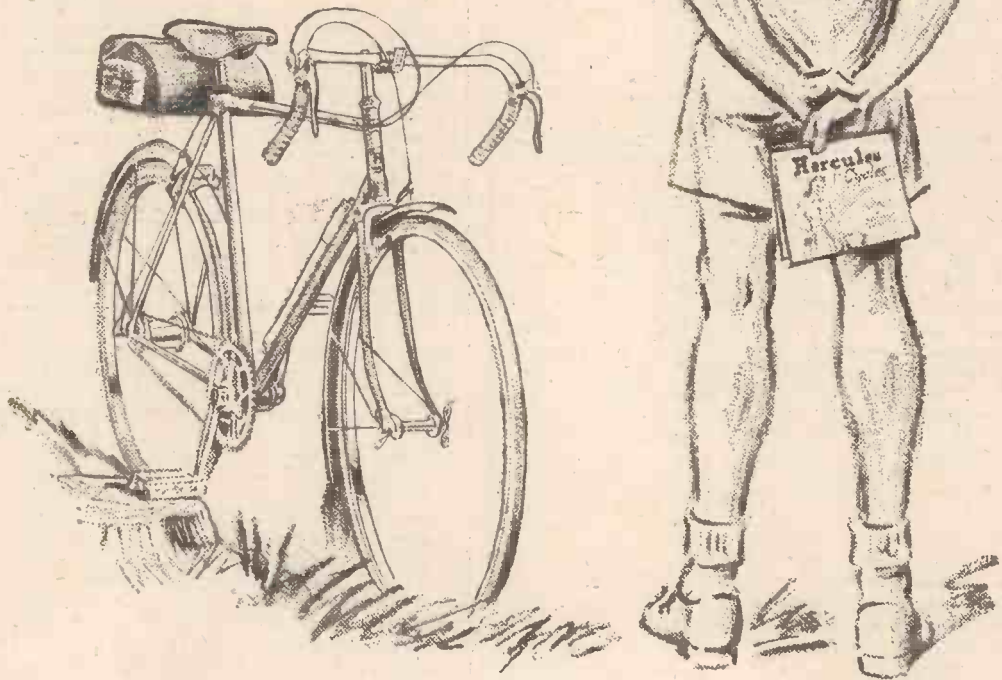

NEW—Additions to the famous Kestrel family (with Reynolds "531" frame tube) are the Kestrel Club Ladies' Models and the Gent's Lightweight Tourist Model. See your local Hercules Cycle Dealer

The Hercules Cycle & Motor Co. Ltd., Aston, Birmingham



The Langdale Pikes
Ambleside
Westmorland

Where Do Cycles Go in the Winter Time?

I ASKED the question, because it does seem to me that far too many cyclists regard the bike as a means of locomotion in summer-time only. What a fallacy! Apart from the fact that the utility of the bike is unimpaired by wet roads, and leaden skies, and muddy tracks, it is the fact that winter cycling is one of the greatest of all pleasures. I speak from recent experience, for this past winter I have used my cycle regularly, and found, on a crisp January day, a tremendous joy in riding along the hard road, feeling the keen wind on my face, and admiring the peculiar beauties of the winter countryside. Beauties? Yes!—for there is as much beauty in a winter landscape as a summer . . . and the lanes where, in July, one rode under a canopy of trees, and revelled in the myriad wild flowers of the hedges and ditches, are just as lovely in grey December. The bare trees are particularly lovely—stark and revealing with their dark arms outstretched. And the reddish-brown ploughland is as picturesque as the green meadows where in May the cowslips bloom.

Cycling is the all-weather pastime, and we should ride every day. It is the easy way to health and happiness.

The Veterans Still Write In!

YES! my remarks about old cycles, and old cyclists, continue to bring me interesting letters from "old stagers" and it is good to hear of these veteran enthusiasts for whom cycling is still the greatest game of all. Mentions of machines which bring back good memories . . . Premiers, Swifts, Meads, Champions, Monopoles . . . some of them still going strong after long years of service: it is all a great tribute to the excellence of British manufacture, and the enduring qualities of these bikes which were so famous in their day. Really, the National Health Service ought to adopt a new slogan—"Cycle for Health"!

The Lure of Inn Signs

OFTEN, in these notes, have I written about the charm and allurements of the inn and its sign. And I have said that it is passing strange that more inns in England do not bear names associated with cycling and the bicycle. There are some I know . . . but not many. "The Black Swan," "The Roan Mare," "The Coach and Horses" and "The White Hart" are good and pleasing, but why not "The Free Wheel"—or "The Tandem"—or "The

CYCLORAMA

By
H. W. ELEY

Happy Cyclist?" Our brewers might well give some thought to this matter—and one can visualise the artistic signs which could be painted and displayed on the inns which dot our roads, and grace our villages and the streets of our old towns. I love the English inn . . . and its sign . . . and it will be a sorry day for England when the picturesque signs disappear; we must never have the "standardised" inn sign, designed by some "Ministry of Refreshment"—conforming to some State pattern! Meantime, I shall continue to love nothing better than a pause at some village inn, with a village green near by, and a little tap-room where I may drink my ale, and smoke my pipe, and muse upon the glories and hazards of the road.

Easter Cavalcade

THIS smiling month of April brings us Easter . . . which I always regard as the "cavalcade of the road." All through the years, cyclists have looked forward to the Easter "break" and it has ever been the signal for bringing out the bike, and making the first real tour of the year. I look back to many happy Easters on the road—to Easters which began with fine sunny weather, and ended in snowy blizzards, like the one when I cycled into Cheshire, and, returning through pleasant little Alsager, was caught in a snow-storm which would have done credit to the wildest January! But my recollections of Easter touring are, in the main, happy ones, and I am pondering over rides into fair Herefordshire, where the big white-faced cattle graze in lush meadows; over rides through pleasant Wiltshire, where the lovely thatched cottages abound, and where one may see the sun rise over historic Stonehenge; and of tours through wild Wales, with the majesty of Snowdon to remain a memory to treasure, and the Pass of Aberglaslyn to beckon with insistence all through the years. . . .

The Genuine Article

HOW good that our tyres are now made from natural rubber . . . and that the war-time substitutes have gone! "War grade" tyres were a necessity during the dark war years, but I rejoice that good natural rubber is again in free supply, and that my tyres are of "pre-war" quality . . . good for all the miles I care to ride over

my Derbyshire roads. But . . . to harp upon an old topic . . . even to-day's tyres need air! And a host of cyclists rob themselves of mileage by neglecting to inflate their tyres in accordance with the manufacturers' schedules; this is no myth, for I did not spend long years in the tyre industry without learning that the pump should be used, and used regularly!

Eastward Ho!

EAST ANGLIA is the cinderella of our touring areas . . . and I always wonder why. So many cyclists, loyal to the "golden west" fail to enjoy the peculiar charms of Suffolk and Norfolk and Huntingdon and Cambridgeshire . . . yet these eastern lands are full of beauty, rich in history, and ideal for the cycling holiday. The Suffolk scene enchants me, and I hope to go again this year to that delectable land where Constable painted his masterpieces; where the great Suffolk Punch horses draw the big waggons along the quiet lanes; where, as in Bury St. Edmunds, one may browse in an England unspoilt by the scarring hand of commerce, untouched by the

grimy hand of King Coal. When June comes, and the wild roses deck the hedgerows, and the roses are in bloom in the cottage gardens, it will be "Eastward Ho!" for me . . . with a stay, maybe, at old Southwold on the coast, where old fishermen love to yarn, and smoke a pipe, and sip a tankard of ale with the tourist as he takes a rest on his journey.

A Dunlop Veteran

THERE died, recently, one of the best-loved officials in the Dunlop organisation . . . Walter Parsons, the chief of the company's service department. Walter was a lovable personality, of imperturbable temperament, of great ability, and enormous knowledge in connection with everything connected with tyres. I knew him in the old days when the company's main works were at Aston Cross. He saw the coming of the motor-car, and "lived" with those first motor-tyres with canvas casings, and treads which did well if they survived five thousand miles. He witnessed the evolution of "cord construction," the introduction of "balloons"—and I suppose had inspected more tyres than any man in the organisation. It was Walter who controlled the section which dealt with "claims"—and no man could have known more about the behaviour of tyres in all the differing circumstances of usage . . . and abuse. Dunlop men mourn the passing of a staunch and lovable colleague, and the tyre industry loses a great figure.

WORKSHOP CALCULATIONS
TABLES AND FORMULÆ

Ninth Edition

by F. J. CANN

A handbook dealing with methods of calculation, solution to workshop problems and the rules and formulae necessary in various workshop processes. It contains all the information a mechanic normally requires.

From all booksellers, 6/- net,
by post 6/6 from the publisher,

GEORGE NEWNES, LTD. (Book Dept.),
Tower House, Southampton Street, W.C.2.

My Point of View

By "WAYFARER"

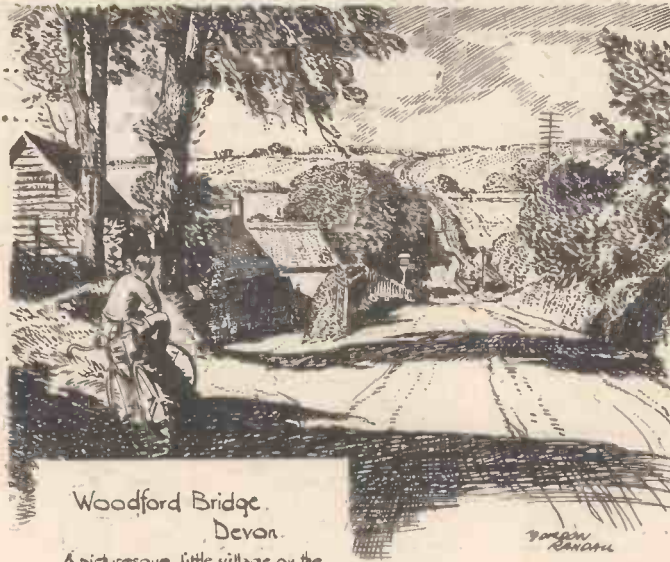

Woodford Bridge.
Devon.

A picturesque little village on the lonely road from Bideford to Halsworthy. It lies on the River Torridge.

The Right Spirit

A HOTEL at which I recently booked for a couple of nights sent me a postcard of acknowledgment "thanking you for your patronage and hoping that your stay will be enjoyable." In other words: "Welcome." That's the right spirit.

Remunerative Care

AS a Birmingham cyclist discovered to his cost the other day, a very unpleasant accident can result from an insecure lamp-bracket carried on the front fork. The tendency is for this flimsy to foul the wheel and for the rider to be thrown on his head, as happened in the case under notice. The ideal remedy, of course, is to have the bracket brazed on the fork, but, where this is not readily possible—I am now but emphasising the obvious—a regular and frequent examination is called for.

Not Fictional

THE closing words of a story, in the monthly publication of one of the cycling clubs to which I adhere, of a strenuous and very moist autumnal jaunt in difficult country characterises the expedition as "one of the happiest and wettest week-ends for years." This is not fictional: it is a deliberate statement of fact—and all true cyclists will appreciate it. If the dictum seems to some people, unfamiliar with the challenging delights of "hard going," to be a contradiction in terms, it is not so: it is plain, unvarnished truth.

The story mentions a very cold evening—more rain—"we were soaked"—hard work—the grassy carpet of the track clambering steeply to the sky-line—the downward track "apparently" rideable in parts and ultra-muddy in others—the party rushing across streams or paddling through them—one member of the expedition going down to the knee in slime—a cloud-burst—a main

road hill so treacherous that it had to be walked down—more heavy rain: these things (and others) combining to produce "one of the happiest and wettest week-ends for years."

No! it is not fictional: it is not an affectation: it is not a case of making a virtue of necessity. We cyclists are mad creatures. We go out in these austere climatic conditions, eschewing the easy way, and seeking the hard places where the roads (or "roads"—much virtue in those inverted commas!) stand on their hind legs, and we do it for pleasure. So we say! We enjoy ourselves. So we say! We proclaim

this mass of difficulties and discomforts as constituting the best-ever week-end. I know enough about this type of cycling to assure any Doubting Thomas that we do indeed enjoy such conditions of travel. We accept the challenge they contain. We freely and willingly—and gladly—"put our fortune to the touch," and are content to abide by the results. And what a sense of triumph we possess at the day's ending when, all our difficulties set behind us and some of our wetter garments removed, we gather around a laden supper table in front of the glowing log fire of the distant inn, and do justice—and more than justice!—to the welcome food which comes our way! And one other thought: what a lot the orthodox cyclist, the smooth-running cyclist, the main-road cyclist, misses because he does not adventure off the beaten track, and because he "gives it best" on a day of the not-so-good type!

Significant Figures

IF one is inclined to resent any thought of interference with cyclists and cycling, as it must be admitted that I am, some justification for butting in is to be found in the rather alarming figures emerging from the examination of juvenile bicycles. In the Midlands a recent test of school children's machines produced the following deplorable statistics: 35 per cent. possessed brake defects; 30 per cent. had soft tyres; 24 per cent. had loose chains; 24 per cent. had loose hub bearings; 16 per cent. had loose bottom brackets; 16 per cent. had improperly adjusted saddles; 8 per cent. had loose pedals. Of course, not all these features add to the dangers of the road, but defective brakes on over one-third of the bicycles examined is startling, and a combination of the faults stresses the point that undue risks are being taken and that neglect flourishes. In the

riding tests, 16 per cent. failed to stop at "Halt" signs—there should be no failures in that respect!—and 92 per cent. lost marks through failing to look round before turning to the right. There is much food for thought in these significant figures, and parents (and guardians) would be well advised to take an interest in the bicycles of those youngsters for whom they are responsible. The mechanical faults mentioned may add nothing to the sad toll of road accidents, but, in bulk, they mean that unnecessary risks are being accepted. The cause of the deplorable tragedies which disfigure the national conscience must be sought elsewhere.

Freight Carriers

I SAW surprise expressed, the other day, that "so few cyclists, especially tourists, take the trouble to carry a first-aid outfit," the cyclist who voiced this view going on to suggest that such an outfit was as essential as spanners and puncture-repairing material. Perhaps our friend is nearly right. We carry our tools and our puncture outfit in case of need, and that need—in my experience—very rarely arises. The call for a bandage or a spot of iodine is rarer still. In the course of some 60 years of cycling, I can recall only two occasions when a first-aid outfit would have been an advantage. Its absence made no difference, because I was in a shopping area and was very quickly fixed up by a chemist in each case.

Minimum Baggage

HAVING regard to the fact that a cyclist's storage accommodation is limited, and that he, and he alone, has to push whatever freight he elects to carry, I always feel that there must be a good deal of compromise in connection with our luggage. For that reason I have always cut my impedimenta to the bone. I sometimes have found that I miss this or that—but it is always something non-essential, and I readily get over the lack of it. I am fond of comfort: I can easily endure discomfort for a fortnight or three weeks, especially when it is discomfort on a small scale and when the avoidance price involves cramming more and more things into the bag and pushing them for miles and miles.

So no first-aid outfits for me! And nothing for me that can be done without. Long years ago my movements were temporarily obstructed by the collapse of a spring which held the brake block off the rim. I prepared against a repetition of that incident by carrying a spare. On another occasion some miscreant helped himself to one of my valve stems. Henceforth, I had a spare in my kit. I also carted about with me a spare spring link for my chain. This was most useful—for giving away to brother cyclists! These trifles bulked small and possessed no weight and I did not mind carrying them. Beyond that, however, I am not prepared to go. As regards first-aid outfits, I prefer to do everything I can to avoid becoming involved in trouble calling for the use of the aforesaid bandage and spot of iodine. If I am not successful in this—and, without boasting, I have enjoyed a remarkable immunity from bother—then I am quite ready to take my chance. After all, we live in a fairly civilised country and can usually obtain what we want—perhaps after a slight delay.

"Practical Mechanics" Advice Bureau COUPON

This coupon is available until April 29th, 1950, and must be attached to all letters containing queries, together with 3 penny stamps. A stamped, addressed envelope must also be enclosed.

Practical Mechanics

April, 1950

Published about the 30th of each month by GEORGE NEWNES, LIMITED, Tower House, Southampton Street, Strand, London, W.C.2, and Printed in England by W. Spearlight & Sons, Ltd., Exmoor Street, London, W.10. Sole Agents for Australia and New Zealand—Gordon & Gotch (A/sia), Ltd. Sole Agents for South Africa—Central News Agency, Ltd. Subscription Rate (including postage): For one year, Inland and Abroad, 10s. 6d. (Canada 10s.). Registered at the G.P.O. for transmission by Canadian Magazine Post.

CONDITIONS OF SALE AND SUPPLY: This periodical is sold subject to the following conditions, namely, that it shall not, without the written consent of the publishers first given, be lent, re-sold, hired out or otherwise disposed of by way of Trade except at the full retail price of 9d.; and that it shall not be lent, re-sold, hired out or otherwise disposed of in a mutilated condition or in any unauthorised cover by way of Trade; or affixed to or as part of any publication or advertising, literary or pictorial matter whatsoever.

**THE LATEST TYPE
FIXED CRYSTAL DETECTOR
THE CRYSTAL VALVE**

as used in radar receivers.

Overall size 3/4 in. x 1 in.
AMAZING RESULTS

3/6 each, postage 2/4d.
Protective Tube and Fixing Brackets,
3d. extra.

Wiring instructions for a cheap, simple
but high quality Crystal Set included
with each Detector.

These Crystal Valves or Diodes are not
Government Surplus but brand new
goods manufactured by one of the
largest and most famous Radar Equip-
ment Manufacturers in the country.
They can be used in any Crystal Set
circuit and are fully guaranteed.

**CRYSTAL SET
INCORPORATING THE LATEST
CRYSTAL VALVE**

Adjustable Iron Cored Coil
RECEPTION GUARANTEED

Polished wood cabinet, 15/- post 9d.
A satisfied customer writes—"I should
like to thank you for the headphones
received 24-12-49, which combined
with your crystal set really do give
amazing results."

Send S.A.E. for lists of copper wires,
screws, nuts, paraffin tubes, ebonite,
tufinol rod and panels, etc.
Copper wires, 14 s.w.g.-48 s.w.g., in
stock.

POST RADIO SUPPLIES
33 Bourne Gardens, London, E.4

**NO MAN CAN KNOW TOO
MUCH OF HIS PRODUCT**

For the close scrutiny of every conceivable object, metals, tools, fabrics, fibres, minerals, precious stones, paint, print, manu-
scripts, biological and botanical specimens, cutting edges, fractured surfaces, raw materials, powders, granules, and innumerable other purposes, the **ULTRA LENS** is invaluable, and presents in many instances hitherto unsuspected data which can be used to advantage.
PRICE £4 15s. 0d., complete in case with spare bulb, battery and transparent measuring scale.

**THE ULTRA LENS COMPANY,
75, Finsbury Court, Finsbury Pavement, London, E.C.2.**

**EXCLUSIVE HOME
STUDY COURSES BY T.I.G.B.**

for A.M.I.Mech.E., A.M.I.E.E., A.M.I.Chem.E., City & Guilds, etc.

The Technological Institute of Great Britain offers private and exclusive postal instruction for A.M.I.Mech.E., A.M.I.C.E., A.M.I.Chem.E., City and Guilds, etc. Those who are seriously interested in obtaining a recognised technical qualification or desire a Diploma Course in any branch of engineering should consult T.I.G.B.—The Professional Engineering Tutors.

THE INSTITUTE'S PROSPECTUS

An outline of Study Schemes, method of enrolment and fees are contained in the Programme of Studies freely obtainable on application to the Registrar, T.I.G.B., 218, Temple Bar House, London, E.C.4. Please state subject of interest and training to date (if any) to assist in the suggestion of suitable studies. Every enrolment application is closely vetted before acceptance.

**The Technological Institute
of Great Britain**

218, Temple Bar House, London, E.C.4



42/6 GREAT SURPLUS OFFER
PARATROOP BINOCULARS
Monthly Terms Arranged

Compact 7 oz. crystal-clear lenses. Ideal holidays, sporting events, 42/6d. W.D. model full-size Binoculars, £3 10s. Very special 6-lens achro model, £5 10s. 6d. Both complete in case, etc., all Post 1s. Also TELESCOPES.

TENTS, MARQUEES, TAR-PAULINS, CAMPING EQUIPMENT.
Send for Bumper List.

HEADQUARTER & GENERAL SUPPLIES LTD. (Dept. P.M.), 196-200 Coldharbour Lane, Loughborough Junc., London, S.E.4.

Open all Saturday. Closed 1 p.m. Wed.

ADANA PRINTING MACHINES

Print in the odd hours with an Adana—still the most absorbing of crafts. No. 1 H/S Machine £4.10.0. No. 2 H/S Machine £9. 15. 0. Will quickly pay for itself. Send for illustrated folder to Dept. P.M. 33 ADANA (Printing Machines) LTD., 15-18 Church St., Twickenham, Middx.

RATCHET & REVOLUTION COUNTERS

Ask for Leaflet No. 18/6 Speed up to 8,000 r.p.m. **B. & F. CARTER & Co., Ltd., Bolton 5** Members of B.E.S.T.E.C. Organisation.

1 H.P. A.C. MOTORS, CAPACITOR INDUCTION Type, totally-enclosed and dustproof, self-starting; 200-240 volts, 1-phase, 50-cycles, 1,400-1,450 r.p.m.; reversible rotation, no radio interference, compact size. These are new motors of high quality and good appearance, delivered under written guarantee and on purchasers' approval first 7 days. With single- or double-end shaft, 70/- carriage paid. Double-end type fitted as bench-gear with adaptors for stone and mop, 11/3 extra. Bartex Engineering Co., 24, Watson Yard, N.W. Circular Road, London, N.W.2.

REWINDS AND REPAIRS to vacuum-cleaners, portable electric tools and all types of electric motors. Trade invited.—**Omega Electrical Rewinding Co., 318, High Road, Willesden, London, N.W.10.** Willesden 0769.

PHOTO-ELECTRIC METER COMPONENTS

Selenium Light Cell .. 6s. 6d.
Microamp Meter Movement .. 10s. 6d.
Moulded Perspex Case .. 9s. 0d.
Assembly Instructions .. 2s. 6d.

**G. R. PRODUCTS,
78, REPTON ROAD, BRISTOL 4.,**

BOMB SIGHT SIGHTING HEADS

Numerous Gears Lenses in steel case.
Carr. paid 7/6 ea., to clear.
H. BROWN, 102, CLEVELAND ST., DONCASTER

THOMPSONS TRANSFORMERS In steady demand for Home Cinés, Trains, Motors, Chargers, Ground Heating, Clocks, etc.
In any odd voltage to order :-
12 volts 2 amps., 26/-
12 volts 5 amps., 32/-
20 volts 2 amps., 28/-
25 volts 6 amps., 42/-
Made in many other sizes : List 2/4d. stamp.
T. W. THOMPSON & CO., 178, Greenwich High Road, Greenwich, S.E.10

SAILOR SAM'S SECRET How to Make **SHIPS IN BOTTLES** Kits, 5/6 and 6/-
OLD TIME GALLEONS Kits 6in. to 22in. From 6/- to 27/-
Stocked by Model, Sports and Toy Stores
Please write for details
COOPER - CRAFT, LTD.
The BRIDWELL, NORWICH

The 'Adept' Bench Hand Shaper
Length of stroke of ram, 3 1/2 in.
No. 2B.H. Shaper, 6 1/2 in. stroke.
Price, £13 13s. 0d.
"Ask your dealer."
Manufactured by:
ADEPT WORKS,

The SUPER 'ADEPT' LATHE
1 1/2 in. centres, 6 in. between centres.
The "Adept" 2 1/2 in. 4-Jaw Independent Chuck. Reversible Jaws, 2/-.
A Good Range of Accessories is Available.
F. W. PORTASS, SELLERS STREET, SHEFFIELD, 8

BOOKS :
"Railway Modellers Handbook" ... 2/6
"British Passenger Locomotives" ... 3/-
"Freight & Mixed Traffic Locomotives" ... 3/-
"Planning and Layout" ... 3/-
"Garden Railways" ... 10/6
Graham-Farish 00 Trains Sets in Stock.

USEFUL PARTS :
Green Grass Paper, 22in. x 11in. 1/- 1/6
Scale Station Figures ... 4d. 7/4d.
Ex-R.A.P. 16 SW Boards ... 5/6 5/6
20 v. Lamps for Hornby ... 1/2d.
Bakelite Wagons ... 2/11 7/6
Bakelite Vans ... 3/6 8/6

DOLLS' HOUSE PAPERS :
Brick, Tiles, Wallpaper, 1in. scale, per sheet ... 6d.
Postage extra. "00" or "0" Parts List. 3d. per post.
TYLDESLEY & HOLBROOK (M.E.T.A.)
109, DEANSGATE, MANCHESTER, 3.

1/16 H.P. MOTORS
230v. A.C. 50 Cps.
SQUIRREL CAGE, TOTALLY ENCLOSED, BALL BEARINGS, PRECISION MADE BY G.E.C.

BRAND NEW 15/6d.
K. LOGAN
WESTALLEY, HITCHIN, HERTS.

RADIO is interesting. With a D5 Coil you can build this crystal set, or 1, 2, and 3 valve sets. The most comprehensive radio coil for simple circuits. With full blue-print and circuits, 5/-.

HILLFIELDS RADIO, Dept. M, 8, Barham Rd., Whitley, Coventry.

Designs and Models for Patentees. Low cost. Confidential. Development Specialists, Box No. 101, c/o "Practical Mechanics."

'SPARKS' DATA SHEETS

Now recognised as the Safest, the Simplest and the Finest Constructional Sheets obtainable. The Full-size Plans and Detailed Descriptive matter, plus Component List with all Values and Prices, and the fact that all the Designs are Fully Tested and Guaranteed, make these Sheets second to None. While discriminating Constructors in the Five Continents use and praise them, the veriest beginner, without any knowledge of Radio, can use and follow them with complete confidence.

ALL-DRY BATTERY DESIGNS
The "POCKET PAK" One-valve Portable, Med. waves. Frame aerial and batteries self-contained. Fine 'phone signals. Carry it in your pocket. 2/9

The "ONE-VALVE PORTABLE." Slightly larger than the above but covers medium and long waves 2/6

The "TINY TWO" Portable. Med. waves. Self-contained frame aerial, batteries and 2 1/2 in. Speaker. For "local" station "Individual Listening." 2/6

The "THREE-VALVE PORTABLE." This model is 9 x 6 x 4 ins. and has a 3 1/2 in. Speaker. Covers medium and long waves. Good speaker results on the "locals." 2/6

The "FOUR-VALVE PORTABLE." Slightly larger than the above. Med. waves. 5in. Speaker. T.R.F. Circuit. Has greater range than the 3-Valve model 2/6

The "CORVETTE." A 4-Valve Superhet covering S., M. and Long waves. Midway valves. Chassis approx. 5 1/2 x 2 ins. Ideal for Portable or House model. Fine range in any area 3/-

The "CRUISER." A 3-Valve T.R.F. circuit designed for use with a short aerial. Very efficient in any area. 2/6

The above are only a few of the 40 designs available.

SEND STAMP FOR COMPLETE LIST. PLEASE NOTE NEW ADDRESS.

L. ORMOND SPARKS (M)
48A, HIGH STREET, SWANAGE, DORSET.

The "THAMES VALLEY" BATTERY CHARGER

2 - 6 - 12 VOLTS 1 AMP. with AMMETER for 200-250 volts 50 cycle mains for 47/6 post free
Thames Valley Products (P)
28 Camden Ave. Feltham, Middx.

MODELMAKERS

1 h.p. Motors, £5.10.0d. Vee Pulleys, 1 1/2 in., 2/2. 5in. 7/6. 4-Groove Cone Pulleys, 5in. 9/3. Plummer Blocks 3/3. Shafting. 4-speed Lathe Heads, 1in., 3/6-. Modelmakers' Lathes and Spares. 4in. Hardboard 9d. sq. ft. Racecar and Aircraft Kits. Metal Cutting Saws, 1/3d.
Send 6d. for fully illustrated Catalogue.
BEVERLY PRODUCTS,
28, Oakwood Avenue, Leeds. 8.

Multicraft CATALIN Material

Rods, Cylinders, Sheets, Sections. The most versatile of all materials. Beautiful colours, easily worked. Special Offer to Turners, assorted rods from 1in. up. 40s. 25/-; 8in. 48/-; Sample Box 10/-. Assorted parcels 25/- & 50/-. Stock List and Samples 6d.
Dept. PM, COULDEN & SMITH,
17, The Mead, West Wickham, Kent.

Instrument Wire, Insulation Materials, Leatheroid, Mica, Fibre, Varnish, etc. 1/3 h.p. Capacitor Motors Single Phase £4.15/- each New. Packing & Carriage 10/- extra. Rev. Counters 3/6, postage 4d. Many other Radio, Electrical and Mechanical bargains. Send S.A.E. for list.
L. C. NORTHALL, 16, Holly Road, Quinton, Birmingham, '32.
Tel. : WOO 3166.

WEBLEY AIR PISTOLS

Meticulously accurate for target practice. No licence required to purchase.
Senior Mark I Junior Webley Air Rifle
Write for List. **WEBLEY & SCOTT LTD.,** 106, Weaman Street, Birmingham, Eng.

Free Guide - "Success in Engineering"

One of the following Courses taken at home in your spare time can definitely be the means of securing substantial promotion in your present calling, or entry into a more congenial career with better prospects.

ENGINEERING, AERO, ETC.

Plastic—Radio—Aero Engines—Aircraft Design—Welding—Aerodynamics—Electrical Engineering—Television—Electric Wiring—Diesel Engineering—Generation and Supply—Works Management—Metallurgy—Refrigeration—Planning. Estimating. Rate-fixing—Time and Motion Study—Aero Inspection—Automobile Engineering—Sheet-metal Work—Engineering Draughtsmanship—Aero Draughtsmanship—Jig and Tool Draughtsmanship—Press Tool and Die Draughtsmanship—Structural or R/F Concrete Draughtsmanship—Sanitary Engineering.

GENERAL

Matriculation—College of Preceptors—A.C.C.S.—A.C.I.S.—Aircraft Apprentice.

MUNICIPAL SERVICE

School Attendance Officer—Handicraft Teacher—Registrar—Housing Manager—Sanitary Inspector—Weights and Measures Inspector—Inst. of Mun. Engineers—A.R.I.C.S.—L.A.B.S.S.

"PRACTICAL ENGINEERING" said—

We recommend all readers interested in improving their position to apply for a copy of this valuable book. "Success in Engineering" is not a pamphlet. It is a 132-page book, containing valuable and vital information on all branches of engineering. . . . There are many engaged in engineering who owe their success to The National Institute of Engineering.

The FREE GUIDE explains :

- Openings, prospects, salaries, etc., in Draughtsmanship, Inspection, and opportunities in all other branches of Engineering and Building.
- How to obtain money-making technical qualifications through special RAPID FULLY-GUARANTEED COURSES.

Write - now for your copy of this remarkable publication.

A.M.I.E.E., A.M.I.Mech.E.,
A.M.Brit.I.R.E., A.M.I.P.E.,
A.M.I.C.E., A.M.I.Struct.E.,
A.M.I.Mun.E. M.R.San.I.,
A.M.I.E.D., A.F.R.Ae.S.,
London B.Sc., Degrees.

Fully guaranteed postal courses for all the above and many other examinations. Fully described in the Free Guide.



THE BUILDING BOOM— SECURE YOUR SHARE!

The Free Guide also gives particulars of our extensive range of modern Building and Structural Courses, Building Draughtsmanship, etc. The great post-war Building programme offers unlimited prospects to technically trained men.

BECOME A DRAUGHTSMAN— QUALIFY AT HOME AND EARN BIG MONEY

Men and Youths urgently wanted for well paid positions as Draughtsmen, Inspectors, etc., in Aero, Jig and Tool, Press Tool, Electrical, Mechanical and other Branches of Engineering. Practical experience is unnecessary for those who are willing to learn—our Guaranteed "Home Study" courses will get you in. Those already engaged in the General Drawing Office should study some specialised Branch such as Jig and Tool or Press Tool Work and so considerably increase their scope and earning capacity.



THE ACID TEST OF TUTORIAL EFFICIENCY SUCCESS—OR NO FEE

We definitely guarantee that if you fail to pass the examination for which you are preparing under our guidance, or if you are not satisfied in every way with our tutorial service—then your Tuition Fee will be returned in full and without question. This is surely the acid test of tutorial efficiency.

If you have ambition you must investigate the Tutorial and Employment services we are able to offer. Founded in 1885, our success record is unapproachable.

Why not fill in and post the attached Coupon NOW for further details and Free Authoritative Guide to openings in Engineering and Building? This book contains a mine of valuable and exclusive information and may well prove to be the turning point in your career.

PROMPT TUTORIAL SERVICE GUARANTEED

FREE COUPON

To NATIONAL INSTITUTE OF ENGINEERING
(Dept. 29), 148, Holborn, London, E.C.1.

Please Forward your Free Guide to

NAME.....

ADDRESS.....

My general interest is in : (1) ENGINEERING (Place a cross against
(2) AERO (3) RADIO (4) BUILDING the branches in which
(5) MUNICIPAL WORK you are interested.)

The subject or examination in which I am especially interested is

To be filled in where you already have a special preference.
(1d. stamp only required if unscaled envelope used.)

NATIONAL INSTITUTE OF ENGINEERING

(Dept. 29)

148, HOLBORN, LONDON, E.C.1

OVER SIXTY YEARS OF
CONTINUOUS SUCCESS

SOUTH AFRICAN BRANCH : E.C.S.A. P.O. BOX 8417 JOHANNESBURG.

FOUNDED 1885—FOREMOST TODAY—OVER 100,000 SUCCESSSES