

GAS WATER HEATERS *Palin*

NEWNES

PRACTICAL MECHANICS

9^D

EDITOR: F. J. CAMM

AUGUST 1948

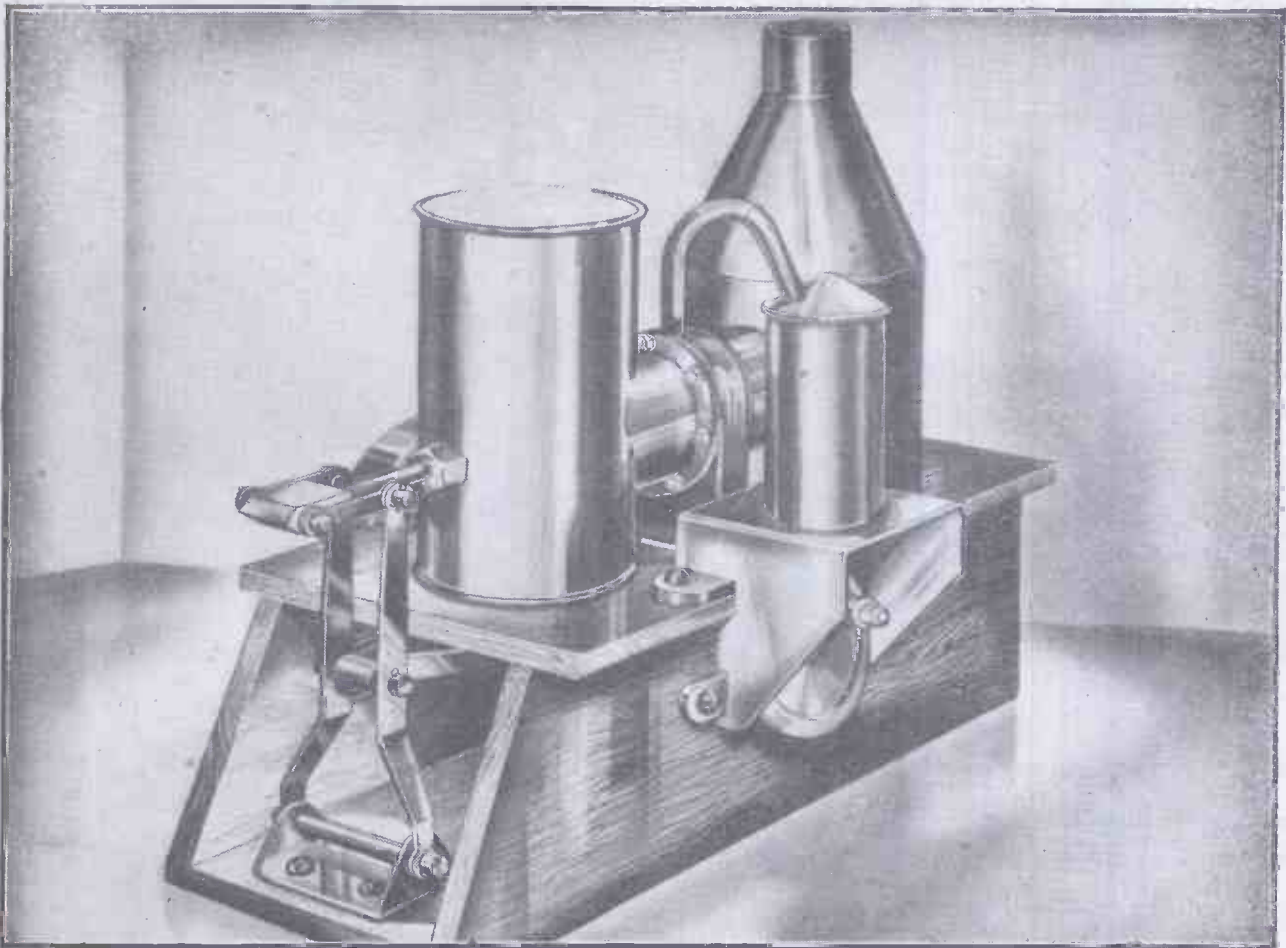

A COMPACT HOT-AIR ENGINE. FOR CONSTRUCTIONAL DETAILS SEE PAGE 352

PRINCIPAL CONTENTS

Circular-saw Attachment.

Swiss P.O. Underground Railway.

Musical Boxes.

World Air News.

Analysing Electrical Circuits.

New Spring-wire Clockwork Mechanism.

World of Models.

Elements of Mechanics.

Cyclist Supplement.

LET **TERRY'S**

SOLVE YOUR *Clip* PROBLEMS

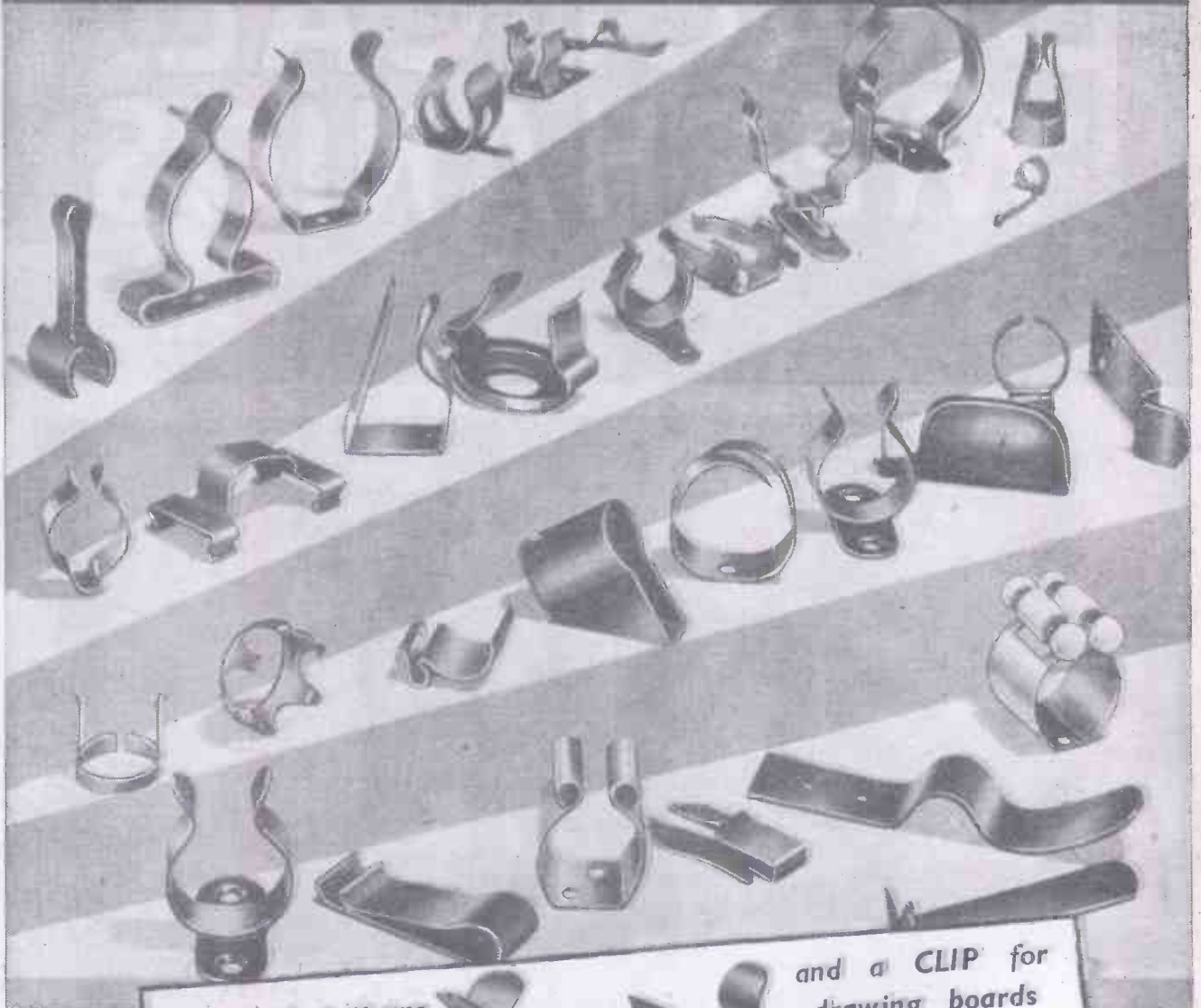

Two stock patterns
always in supply
— 80 and 81—
made in a range
of sizes to grip
from
 $\frac{1}{4}$ " to 2"



and a **CLIP** for
drawing boards
(No. 300)

The most
authoritative
text book
on springs
published.
10/6 post
free.



★ We show here just a few from our enormous selection of specially made clips our research department can design any clip you require to your own specification (93 years of clip-making is at your disposal).

HERBERT TERRY & SONS LTD. REDDITCH · London · Birmingham · Manchester

THE "ZYTO" TEN MOTORISED SAW BENCH BALL BEARING



For crosscutting, ripping, grooving, mitring, bevelling, etc. Takes 10in. saw. Spindle runs in heavy ball-bearings, parallel rise and fall Table with rackfeed and tanting for bevelling, etc. Right and left hand mitre slides, approved saw-guards. Vee belt-drive, built-in dust chute, swivel motor base.

Supplied A.C. 200-220, 230-250.
Three-phase 400-440.
Direct Current.

Price and illustrated leaflet free and post free on application.

We stock all types of woodworking machinery. Please send us your enquiries.

Double ended electric grinders, specially suited for numerous jobs in every workshop and home. Sharpening drills, tools, knives, grinding and finishing Perspex, etc. Universal motor A.C./D.C. 200-250 volts 1-20 h.p. Speed 15,000 r.p.m. non stalling, ball bearing. Carborundum grinding wheel 2½in., polishing mop 2in., weight 4½lbs. Price, complete with Flex, post paid.



£6/10/6

Delivery from Stock.

S. TYZACK & SON, LTD. TOOL AND MACHINERY SPECIALISTS
341-345 OLD STREET, LONDON, E.C.1
 Telephone: Clerkenwell 4004-5-6. 2694-5
 Telegrams: Tyzgar, Finsquare

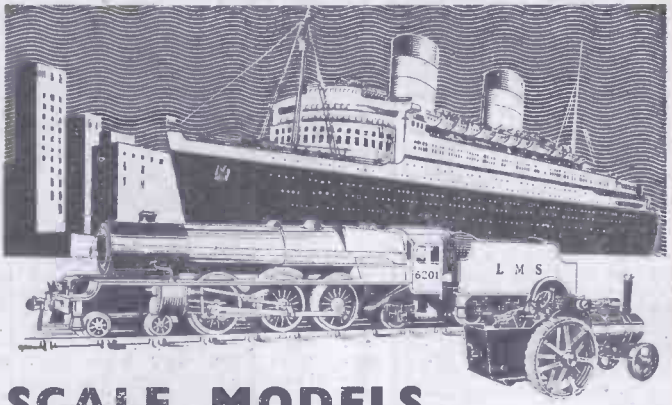

SCALE MODELS of every description for every purpose

Are you INTERESTED in . . . Model locomotives, railway equipment, ships (full-hull and waterline), motor-boats, sailing yachts, engines and boilers ; architectural, display and museum models ; drawings, castings and parts for the amateur model-maker ?

If so . . . send 1d. stamp for (BP/12)
"BASSETT-LOWKE PUBLICATIONS"
 a NEW Brochure giving details of all catalogues, booklets etc. devoted to models and modelmaking.

BASSETT-LOWKE LTD NORTHAMPTON

LONDON SHOWROOMS: 112, HIGH HOLBORN, W.C.1.
 MANCHESTER: 28, CORPORATION STREET.
 Visit our London and Manchester Branches, where our staff is at your service.

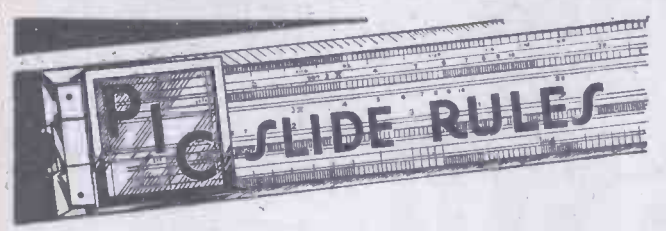

Manufacturers of
**DRAWING and
 SURVEYING
 INSTRUMENTS**

SLIDE RULES

DRAWING MATERIALS

DRAWING OFFICE
 STATIONERY

A. G. THORNTON LTD
Drawing Instrument Specialists
 41 GARTSIDE ST. MANCHESTER 3.

EVERY AMATEUR PHOTOGRAPHER SHOULD OBTAIN ONE OF THESE USEFUL TRIMMERS.
 AN ENTIRELY NEW PRODUCTION

Johnson All-Metal Print Trimmer



DIE cast, light alloy baseplate, 9in. square, with a steel shear plate. Spring-loaded, cast steel cutting blade with polished hardwood handle. Blade is removable for sharpening. Knife brackets cast in one piece with the baseplate. Rustless 9in. rule squared to the blade. Spring loading of cutting blade not only acts as return spring but also maintains pressure of the blade against the shear plate. This **JOHNSON ALL-METAL TRIMMER**, finished in a non-slip black ripple stove enamel, is a beautifully made and most useful accessory which every photographer will value. See it at your dealers.



JOHNSONS OF HENDON
 PHOTOGRAPHIC CHEMICALS AND APPARATUS

MOTOR GENERATORS

15/- (Carriage & Packing 6/-)

A first-grade rotary transformer easily convertible to an $\frac{1}{2}$ h.p. fractional horsepower motor, complete with full smoothing and regulation as illustrated.

Type 32, Input 12 v., Output 1,200 v., 200 m/a. Type 33, Input 24 v., Output 1,200 v., 200 m/a. Type 34, Input 12 v., Output 225 v., 170 m/a., 6 v. 13 amps. Type 35, Input 24 v., Output 225 v., 170 m/a., 6 v. 13 amps. Each one supplied in a black steel cabinet, black crackle enamelled. New.

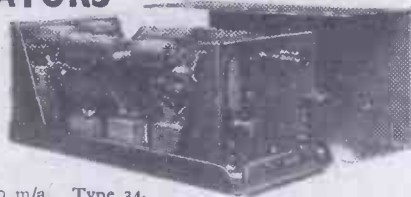

AMPLIFIERS TYPE A 1134

A battery operated 2 stage pre-amplifier complete with two valves in transit case. Batteries required 120 v. H.T. and 2 v. L.T. Valves supplied L.D. 210 and QP220. Ideal for microphone, pick up, or loud speaking inter-com., 12/6 (carr. and pkg. 2/-).

RADIO COMPASS UNITS BC433G

The original U.S.A. Bendix Navigational aid to aircraft. A 15 valve selective super-het receiver convertible for general broadcast use. Circuits supplied. Frequency coverage 200-1,750 kc/s. In 3 wavebands. Designed for remote control tuning. 15 valves supplied: 4 6K7, 1 6N7, 1 6SC7, 1 6L7, 1 6J5, 2 6B6, 2 6F6, 2 205T, and 1 5Z4. Size 2ozin. x 1zin. x 8in. Weight 47lbs. Power supply 115 v. 400 c/s. incorporated. Mounted on shock absorbing rack mount. Brand new, £5/10/0 (carr. and pkg. 10/-).

MOTORS

A 12 v. A.C./D.C. Berkshire motor totally enclosed in case 4 $\frac{1}{2}$ in. x 4 $\frac{1}{2}$ in. x



CALLERS to 24, New Rd., London, E.1.

Money refunded if not satisfied.

ENGINE DRIVEN GENERATORS

A D.C. Dynamo with cooling air-ducts, four bolt fixing flange, totally enclosed in cylindrical metal case 13in. x 6in. diameter. Length of coupling shaft 1in. Weight about 37lbs. Supplies 24 v. 1,000 watts, 30/- (carr. and pkg. 7/6).

TRANSMITTER-RECEIVER UNITS R3090

A Radar I.F.F. unit complete with 10 valves and motor generator and covering frequency of 38-220 mc/s. Valves supplied 2 6J5GT, 4 SP41, 1 EB34, 2 6T148, 1 EA50. Motor generator supplied 24 v. input, 480 v. 40 m/a. output fully smoothed. Double decker chassis, totally enclosed in steel cabinet. Only 25/- (carr. and pkg. 7/6).

MAIL ORDER SUPPLY Co.,

Dept. P.M.,
3, Robert Street, Hampstead Road,
London, N.W.1.
Stepney Green 2760-3906.



Output suffers as soon as you have one severe case of dermatitis. Workers lose confidence—and with reason. Don't wait until oils have started oil rash or other skin troubles among your operatives. Give them the protection of Rozalex, the barrier-cream of proved efficiency. Rozalex is easy to apply, saves soap, and is most economical.



Rozalex Limited, 10 Norfolk Street, Manchester, 2

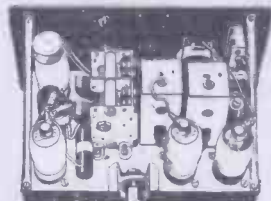

Send Stamped, Addressed Envelope for complete list of Bargains.

4-VALVE SUPERHET RECEIVER for short waves, complete. Needs only batts. and 'phones. Packing and insurance 2/6. Suitable H.T. Battery, 9/-.
Matched 'phones, 9/- pair. **29/6**

TRIPODS. 3ft. high when erected. Fitted brass thread and cap, web sling for carrying. In wood or metal. Suitable for Surveyors, projectors, cameras, display purposes, etc. **14/6**



PHOTO-ELECTRIC CELL. Dozens of applications, e.g., burglar alarms—counting—door-opening, etc. etc. **14/6**

24-VOLT MOTOR. Shunt wound, small size. These motors also run quite well at reduced speeds from 6 to 12 volts. Post free. **7/6**

12 Assorted **ELECTRO-MAGNETIC RELAYS and CONTACTORS.** **12/9**

PUMP for exhausting, compressing or liquid pumping—heavy brass construction—spring loaded—fitted non-return valve and manual valve. Length 6in., 7/6 diameter, 1in. **7/6**

0-1 MILLI-AMMETER. Bakelite case, flush mounting. Diameter 2in. Moving coil. **13/6**

MULTIMETER. 17 ranges. A.C./D.C. volts, m/amps & ohms. New and perfect. **£7**

TELESCOPIC DINGHY MAST. Extended, 9ft. Ideal fishing rod, etc. Post free. **10/-**

Carriage Paid Write (Dept. K)
INSTRUMENT CO.,
244 Harrow Road, London, W.2

Make your **JUNEERO**
a precision tool
with the "**XAKTO**"

SLIDE GAUGE & PROTRACTOR

Accuracy guaranteed, quickly and easily fixed, it gives **INSTANT VISUAL LOCATION OF EXACT MEASUREMENTS FOR ALL CUTTING, PUNCHING AND BENDING.**



No marking out required. Get an "XAKTO" today and be sure of greater precision for the "one off" job plus a real saving of time in repetition work.

From All Registered Dealers
PRICE

7/6

JUNEERO LTD.,
Stirling Corner,
Boreham Wood,
Herts.

RIGHT IN THEORY

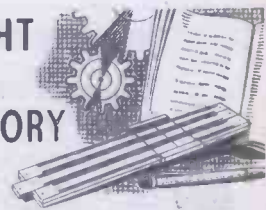

... means **RIGHT** in Practice

Theoretical Knowledge and Practical Knowledge you must have if you are to "make the grade" as a qualified technician. Through the medium of special postal courses, the Pitman College of Technology can provide you with the right theoretical training which will not only materially assist your progress on the practical side, but will enable you to qualify more easily for a well-paid technical post when your apprenticeship is completed.

- | | |
|---|------------------------------------|
| Elementary Engineering Course | Single Subject Courses include: |
| Workshop Calculations | Wireless Engineering |
| Workshop Training | Motor Engineering |
| Engineering Science (Mechanical & Electrical) | Diesel Engines |
| Engineering Drawing | Plastics |
| Mechanics | Radio Communication |
| General Science | Elements of Structural Engineering |
| Electricity & Magnetism | Elements of Quantity Surveying |
| Heat, Light & Sound | |

Write at once for free prospectus to:

PITMAN COLLEGE OF TECHNOLOGY

177 SOUTHAMPTON ROW, W.C.1
Principal: H. R. Light, B.Sc.(Lond.), F.C.I.S.

You have only to press the trigger!

No longer is it necessary to go about jobs of painting, distemping, whitewashing, etc., in the old laborious way.

Now you only need to connect the "Crystal" Spray Gun to your electric cleaner, and press the trigger, to complete such jobs without mess or effort and at the same time obtain a much superior finish. For re-cellulosing cars, cycle frames, etc., it is ideal.

The "Crystal" Spray Gun will be forwarded by return, post free, on receipt of remittance with order stating make and type of cleaner. A special connector, desirable with all and essential with some cleaners, is available at 316d. extra.

75/-
complete

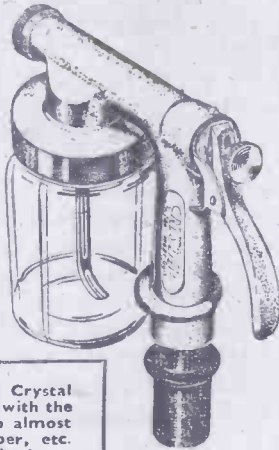

Write for full details of the NEW Crystal "Flock" Gun. You will be intrigued with the finish imparted by this new process to almost any material—wood, glass, metal, paper, etc. Many HOME uses—no skill required.

Dept. P.M.
DOMESTIC SUPPLY COMPANY
341, REGENT'S PARK ROAD, LONDON, N.3
(Near Finchley Central Station) Tel: FINchley 5190



GLENAVON

The Unforgettable Gift



How fortunate that you can bestow, at such low cost, a present of such high intrinsic and lasting value as a Smiths Clock. This happy fact is solving the 'gift problem' everywhere today. Obtainable from your local Smiths Stockists.

SMITHS ELECTRIC
CLOCKS



SCM 1281

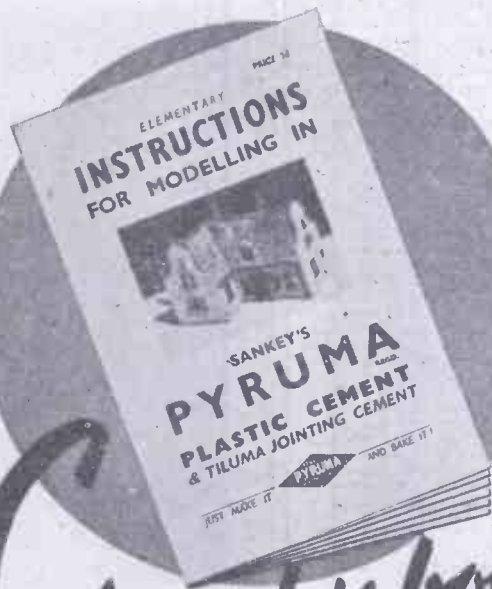

*Get this book
- make these
MODELS*



HOUSES · SHIPS · ASHTRAYS · BOOK-
ENDS · SIGNAL CABINS · RAILWAY
STATIONS · AIRPORTS · DOCKS
RELIEF MAPS · PLAQUES · MODEL
FURNITURE · INKSTANDS · PAPER
WEIGHTS · MODEL FIGURES AND
ANIMALS ETC.

SIMPLE TO HANDLE · INEXPENSIVE

The Instruction Book illustrated tells you how to make such models as above, without special tools or skill, in Sankey's "Pyruma" Plastic Cement. This material, modelled while plastic, dries or bakes to stone-hardness, ready for painting according to instructions. Obtainable at local ironmongers, hobbies shops and art material dealers.

Get Instruction Book by sending 4d. in stamps to the address below



Dept. 4

J.H. SANKEY & SON, L^{TD}

ILFORD

Est. 1857

ESSEX

GALPIN'S ELECTRICAL STORES408, HIGH STREET, LEWISHAM,
LONDON, S.E.13.

PHONE: LEE GREEN 0309.

TERMS: CASH WITH ORDER. (NO C.O.D.)

EX-R.A.F. IFF UNITS. As new, these units contain 10 valve S.P. 41s, EF 50s, EA 50s, etc., also approx. 100 resistances and condensers, also complete with motor generator, 12 or 24 volts input, 450 volts at 50 mlamps, output. To clear, 24-volt type, 35/-; 12-volt type, 37/6, carriage 3/6.

EX-R.A.F. CRYSTAL CALIBRATORS UNITS. Type 18, R.A.F. serial No. 10a/15237. These units contain 100 kcs. xstal 2-EF 50 valves and numerous other items all new and unused, 35/- each.

ELECTRIC LIGHT CHECK METERS (Watt Hour). A.C. 50 cys., 200/250 volts, 5 amp. load, 18/6, post 2/-; 10 amp., 21/-, post 2/-; 20 amp., 25/-, post 2/-; also a few only Pre-payment 11-slot type, 20 amp. load, less coin box, complete with synchronous Motor, 35/- each, carriage 3/6.

EX-GOVERNMENT MAINS TRANSFORMERS. Auto wound, input 200/250 volts, 50 cycles, 1-phase; output tapped 14½ and 17½ volts at 30 amps., 75/- each, carriage 3/6. Another, with two 4 volts at 20 amps., 22/6 each, post 2/6. Double wound, 230 volts input, 12 and 20 volts at 2 amps, output, 25/-; Another 12 and 20 at 4 amps., 35/-, post 1/-.

MAINS TRANSFORMER, EX-GOVERNMENT. All 50 cycles input, 230 volts input, 50 volts at 30 amps. output, 75/- each, carriage 6/-. Another two L.T. windings, 6½ volts at 10 amps., 27/6 each. Another 230 volts input, 700 volts at 150 mlamps., 4v. 2a., 4v. 1a. output, 27/6 each, carriage 3/6. Another 700/10/700 volts, 80 m/a., 12v. 1a., 4v. 2a. output, 30/- each.

MAINS TRANSFORMERS (new), input 200/250 volts, 50 cycles, 1-phase, output 350/0/350 volts at 180 mlamps., 4v. 4a., C.T. 6.3v. 4a., C.T. 5v. 3a., 37/6 each, post 1/6. Ditto, 500/0/500 volts, 150 mlamps., 4v. 4a., C.T. 5v. 3a., 47/6 each, post 1/6. Another tapped 6, 12 and 24-volts at 10/12, amps., 45/- each, post 1/6. Auto-wound Voltage Changer Transformers, tapped 0, 110, 200, 220, and 240 volts, 250 watts, 45/-; 350 watts, 55/-; 500 watts, 70/- each, carriage 1/6. (Please note these transformers can be delivered ten days from receipt of order.)

EX-NAVAL CATHODE RAY RECTIFIER UNITS. These units are new and weigh 90 lbs. Consisting of high voltage condensers, 15 volume controls, chokes, approx. 100 resistances and condensers all coloured, coded or marked, valve and tube holders (no valves), transformers are included but are for 500 cys., price to clear, 42/6 each, carriage paid.

EX-R.A.F. POWER UNITS, TYPE 225 (new). Containing the following components: 3-V.U.111 Rectifier Valves, 1-5U4G2-EB 34s, 3 Multi-Contact Relays, High Voltage Condensers, Chokes, Transformers, etc. To clear, 50/- each.

EX-R.A.F. RF UNITS (new) packed, containing 6 valves, all 6.3 heaters, including grounded grid triode, also a miniature 24-volt motor (universal) and approx. 80 resistances and condensers, all mounted on silver-plated chassis, to clear, 37/6 each, carriage paid.

L.T. RECTIFIERS (NEW), 12 volts at 1½ amps. output, 10/6 each; 12 volts at 6/8 amps. output, 45/- each. Transformers can also be supplied for charging 6 or 12 volts (delivery 10 days from date of order), prices respectively 25/- and 45/- each.

MAINS VARIABLE RESISTANCES (slider type), new, ex-Govt., 14 ohms, carry 1 to 4 amps., graduated, useful as dimmers, etc., 25/- each; another, 0.4 ohms, carry 25 amps., 25/- each, post 1/6. Ex-Govt. Moving-coil Cell Testers; 3-0-3 volts (new), 25/- each.

EX-R.A.F. MICROPHONE TESTERS (new). These consist of a Ferranti 0 to 450 mlamps., 2½-in. scale meter shunted to 1 m/a. incorporated Westinghouse Rectifier, the whole encased in polished teak case, calibrated at present 0 to 10 volts, 32/6 each.

SPECIAL OFFER! METERS, all new boxed. Moving Coil, first grade instruments, 0 to 20 volts, 10/- each, or 3 for 25/-; 0 to 40 volts, 12/6 each; 0 to 10 amps., 15/- each, all 2-in. scale. 0 to 20 volts, A.C., calibrated, 50 cycles, 25/- each, 0 to 4 amps., thermo-coupled, 25/- each.

MAINS TRANSFORMERS, as new, input 230 volts, 50 cycles, output 12 volts at 8½ amps., A.R.P. shelter transformers, 25/- each, post 2/-.

EX-NAVAL (SELF ENERGISED) TELEPHONE HANDSETS, 10/6 each, post 1/-, or Complete Telephones, Magneto-Ringing and Neon Light, 35/- each, post 2/6.

EX-GOVERNMENT (G.E.C.) ELECTRIC FANS, 12 volts, A.C./D.C. laminated field, complete with 5-in. impeller. New, boxed, 20/- each, post 1/-; Transformer to suit, 230 volts input, 12/16 volts at 4 amps. output, 32/6 each.



EVER MADE A TELESCOPE?

It's by no means too ambitious for an enterprising amateur to build himself a mirror-type astronomical telescope, and a good one at that. All he needs is a capable pair of hands, the know-how* and the right materials. If

you think you can provide the first two commodities, we'll supply you with the glass—Chance White Crown in precision annealed disc form. We can also supply blanks for making achromatic objectives for astronomical telescopes of the refracting type. The Astronomer Royal could not obtain better glass.

* See the March and April issues of Practical Mechanics.

CHANCE BROTHERS LIMITED Glass-makers since 1824

Head Office: Smethwick 40, near Birmingham. London Office: 28 St. James's Square, S.W.1. Branch Works at Glasgow, St. Helens and Malvern.

PLASTIC MOULDING!

An INTRIGUING HOBBY or a PROFITABLE BUSINESS!!

Any Plastic articles—from Brooches to Radio Cabinets can be moulded in a beautiful range of colours by means of "PLASTICAST"—a liquid Thermo Setting Plastic. The necessary moulds are readily and easily made from "PLASTIMOULD." This material forms perfect flexible moulds by pouring over the required pattern.

Send 2½d. stamp for full details and instructions.
"PLASTIMOULD"—12/6 per lb.
"PLASTICAST"—2 oz. 2/-, 4 oz. 3/6, 8 oz. 5/6, 1 lb. 9/6, 10 lb. orders 7/6 per lb.

ACCELERATOR. For setting PLASTICAST—2/6 (sufficient for 1 lb.), 5/6 (sufficient for 3 lbs.).

Please allow 1/6 extra on orders for carriage.
Now available: The British equivalent of the Dynajet, £6 13s. 6d., including carriage, weight 20 ozs. Static thrust £3, 2 h.p., 125 m.p.h.

SOLCRAFT PRODUCTS;

372, Portland Road, Hove, Sussex. Phone: PORTSLADE 7204.

MYFORD TYPE ML7

3½" HEAVY DUTY LATHE
The finest Lathe in its class.

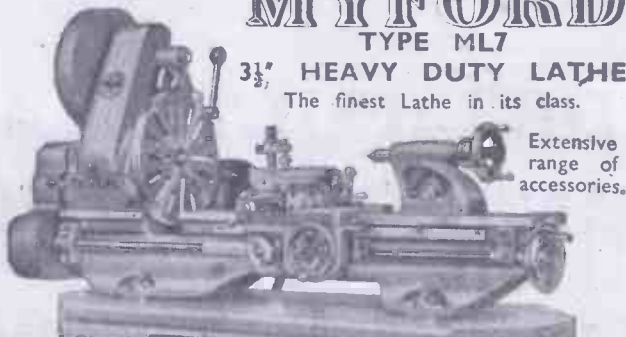

Extensive range of accessories.

MYFORD ENGINEERING COMPANY LIMITED
BEESTON · NOTTINGHAM · Phone: 54222 (3 lines)

17.148B

TAKE UP PELMANISM and Eliminate That Frustration Complex

THOUSANDS of people to-day are living frustrated lives. Day after day they are haunted by a sense of frustration. They feel they are being balked in their desires to do the things they really want to do. They feel they are not living the lives they really want to live.

They feel discontented, disgruntled, dissatisfied. They are uneasy and unhappy. And, as a result of suffering from frustration, they often become the victims of other mental evils as well. They become Irritable and Morose. They have fits of bad temper; their thoughts become Morbid. They feel Depressed and Pessimistic.

This leads to inefficiency in business and to friction and unhappiness in the home. It makes men and women a misery to themselves and all around them; their condition is purely mental. It has its root in certain known and definite causes which can easily be removed by correct treatment and training.

Half fees for serving and ex-Service members of His Majesty's Forces.

(Apply for Services Enrolment Form.)

Mental Science is conquering this modern curse, and this feeling of frustration is easily and swiftly removed by a course of Pelmanism as directed through the post by the experienced instructors of the Pelman Institute.

Pelmanism eliminates the feelings of Frustration and Inferiority (and many other weaknesses as well) and develops and strengthens your Will-Power, your Determination and your powers of Initiative and Concentration.

So why suffer from these failings any longer? Whatever your age, whatever your occupation, Pelmanism will free your mind from these unhappy conditions and change for the better your whole outlook on life.

The general effect of the training is to induce an attitude of mind and a personal efficiency favourable to the happy management of life.

The Pelman Course is fully described in a book entitled "The Science of Success." The Course is simple and interesting and takes up very little time; you can enrol on the most convenient terms. The book will be sent you, gratis and post free, on application to:—

PELMAN INSTITUTE

(Established over 50 years)

130, Norfolk Mansions,
Wigmore Street, London, W.1

Callers welcomed.

PELMAN (OVERSEAS) INSTITUTES: PARIS, 176 Boulevard Haussmann. AMSTERDAM, Damrak, 68. NEW YORK, 271 North Avenue. New Rochelle MELBOURNE, 386 Flinders Lane. DURBAN, Natal Bank Chambers (P.O. Box 1489). JOHANNESBURG, P.O. Box 4328. CALCUTTA, 102 Clive Street. DELHI, 10 Alivore Road.

“The MODEL ENGINEER” EXHIBITION

Displays of the latest developments in model engineering include:—

- ★ *Model Car, Boat and Aircraft Trials.*
- ★ *Jet propelled Models in action.*
- ★ *Demonstrations of Workshop Procedure.*
- ★ *Club Stands; Competition Section. International Models Section.*
- ★ *Numerous stationary working models in action.*
- ★ *Model Passenger-Carrying Railway.*
- ★ *Trade Stands showing the latest models, workshop appliances, Tools and publications.*

AUGUST 18th-28th

**NEW HORTICULTURAL HALL
WESTMINSTER LONDON SW1**

**Mon. - Sat. 11a.m. - 9p.m. ADMISSION 2/3
CHILDREN UNDER 14 1/-**

"ENGINEERING



OPPORTUNITIES"

PREPARE FOR COMPETITION—NOW!

As the Engineering Industry swings into its normal stride, the inevitable competition for the secure and well-paid posts will return. It is the man who stands out from the rest because he is *technically trained* who will be in the happy position of taking over the more responsible, more secure, and better paid positions. "ENGINEERING OPPORTUNITIES" will show you how to get this all-important technical training quickly and easily in your spare time. This 100-page book is full of valuable information and explains the simplest way of preparing for recognised Examinations. Among the courses described are :

MECHANICAL ENGINEERING GROUP

A.M.I.Mech.E.
A.M.I.E.D.
City & Guilds
General Mechanical Eng.
Diesel Engines
*Draughtsmanship & Tracing
Works Management
Press Tool Work
Pattern Making
Foundry Practice

Mining Practice
Estimating
Foremanship
Jig & Tool Design
Viewing & Inspection
Welding
Sheet Metal Work
Maintenance Eng.
Metallurgy
Refrigeration

COMMERCIAL ENGINEERING GROUP

A.M.I.P.E.
Commercial Eng.

Cost Accounts
Languages

CIVIL ENGINEERING GROUP

A.M.I.C.E.
Inst. Mun. Engineer
A.M.I.Struct.E.
M.R. San.I.
City & Guilds
Sanitary Inspector
Specification
Structural Design

Mining Surveying
Road Eng.
Hydraulics
Municipal Eng.
General Civil Eng.
Structural Eng.
Reinforced Concrete
Railway Eng.

SURVEYING AND BUILDING GROUP

A.R.I.B.A.
F.R.I.C.S.
A.M.I.H. & V.E.
L.I.O.B.
F.A.I.

Costing & Valuations
Heating & Ventilating
Clerk of Works
Surveying & Levelling
Building (all branches)

ELECTRICAL ENGINEERING GROUP

A.M.I.E.E.
City & Guilds
General Electrical Eng.
Alternating Currents
Power House Design
Traction
Mains Eng.
Mining Electrical Engineering

Electricity Supply
Electrical Meters
Electrical Design
Illumination
Installations
Telegraphy
Telephony

WIRELESS GROUP

A.M.Brit.I.R.E.
C. & G. Telecommunications
General Wireless
Short-wave Wireless

Advanced Wireless
Radio Servicing
Television
Sound-film Projection Eng.

AUTOMOBILE ENGINEERING GROUP

A.M.I.M.I.
City & Guilds
Automobile Repairman
Course

General Automobile Eng.
Garage Management
Electrical Equipment
High Speed Diesels

AERONAUTICAL ENGINEERING GROUP

A.F.R.Ae.S.
R.A.F. (Maths.)
Pilots' Licences
A.R.B. Licences

Aero Engines
Navigators' Licences
Aeroplane Design
Meteorology

UNIVERSITY DEGREES

London Matriculation
School Certificate

University Entrance
Intermediate B.Sc.

* Our Diploma is accepted for Graduateship of the Inst. of Engineering Draughtsmen and Designers.

**WE DEFINITELY GUARANTEE
"NO PASS—NO FEE"**

If you are earning less than £10 a week you cannot afford to miss reading "ENGINEERING OPPORTUNITIES"; it tells you everything you want to know to *make your future secure*, and describes many chances you are now missing. In your own interest we advise you to write for your copy of this enlightening guide to well-paid posts NOW—FREE and without obligation.

BRITISH INSTITUTE OF ENGINEERING TECHNOLOGY

410A, SHAKESPEARE HOUSE, 17, STRATFORD PLACE, LONDON, W.1

THE B.I.E.T. IS THE LEADING INSTITUTE OF ITS KIND IN THE WORLD

SUBSCRIPTION RATES*

(including postage)

Inland	- - -	10s. 6d. per annum.
Abroad	- - -	10s. per annum.
Canada	- - -	10s. per annum.

Editorial and Advertisement Office: "Practical Mechanics," George Newnes, Ltd.
Tower House, Southampton Street, Strand, W.C.2
Phone: Temple Bar 4363

Telegrams: Newnes, Rand, London.

Registered at the G.P.O. for transmission by Canadian Magazine Post.

Copyright in all drawings, photographs and articles published in "Practical Mechanics" is specially reserved throughout the countries signatory to the Berne Convention and the U.S.A. Reproductions or imitations of any of these are therefore expressly forbidden.

PRACTICAL MECHANICS

Owing to the paper shortage "The Cyclist," "Practical Motorist," and "Home Movies" are temporarily incorporated.

Editor: F. J. CAMM

VOL. XV AUGUST, 1948 No. 178

FAIR COMMENT

BY THE EDITOR

More About Inventions

IN our issue for June I dealt with the Development of Inventions Bill, and suggested that the machinery of the Patent Office needed overhauling. I also dealt with the delays in granting a patent, and I have since taken up this matter with the Government Departments concerned.

In 1939 the Patent Office was able, as a general rule, to issue the Examiner's Report within three months of the date of receipt of the Complete Specification. Since the outbreak of war this period has gradually increased to the present level of approximately 18 months. This is due to a number of contributory factors.

Upon the outbreak of war and during its continuance the staff of the Patent Office was seriously depleted by enlistment in the Forces and by transfer to other departments. Applications, however, for patents did not decrease in proportion to staff losses, and arrears of work began to accumulate. When the war ended many thousands of applications were made for patents, which both in this country and abroad had been held up because of the war, but were then released and lodged at the Patent Office. This heavy flood of applications with a still depleted staff aggravated the position to a marked degree.

The examination of patent applications is highly technical and involved work. After such a long delay and the careful examination by skilled technicians, inventors should be assured of a valid patent, be free from further payments, and State-barred from litigation resulting from the patent. At present an inventor may have his patent set aside in the law courts and may be involved in expensive lawsuits. The Patent Office cannot be sued for negligence. It is a very risky proceeding to manufacture an article until the patent is granted, because of risk of actions for infringement. I suggest that there should be an eliminating com-

mittee which will first of all examine patents and classify them in some order of priority so that frivolous inventions do not choke the machinery of the Patent Office to the detriment of more important inventions.

In reply to a question asked in Parliament it was stated that there had been difficulties in recruiting suitable staff but that the latter had now been augmented. I am now informed that the stage has been reached when arrears at the Patent Office are no longer mounting and have actually started to recede, despite the fact that the volume of work being received is still above the pre-war level.

The Departmental Committee on Patents, on the question of renewal fees, stated:

"We have received several suggestions for the reduction in the present scale of renewal and other fees; suggestions have also been made for the abolition of renewal fees, and the adoption of a system such as that which exists in the United States of America, where an application fee and a fee for sealing secure for the patentee exclusive rights for a period of 17 years from the date of issue. We have also received suggestions for increasing the fees at present charged, with a view to discouraging worthless applications.

"After considering the arguments in support of these various proposals, we do not recommend any change in the present scheme, which appears to be acceptable generally to industry, under which the continuance of the monopoly after four years depends upon the payment of renewal fees. This scheme has two important advantages, viz.: (1) it enables the applicant to obtain a patent for four years at a fee substantially below that which would have to be imposed if there were no renewal fees, and (2) inventions covered by these patents which the patentee does not

think it worth his while to keep in force become available to the public at a much earlier date.

"Nor do we recommend any change in the present scale of renewal fees, which have been unchanged for over 50 years (except for the addition of the renewal fees in respect of the 15th and 16th years of the term of the patent) in spite of fluctuations in the value of money. . . ."

We have in this country the Institute of Patentees and we suggest that greater use could be made of their services in acting as a clearing house for inventions.

The Model Engineer Exhibition

THE Model Engineer Exhibition this year will be held at the New Horticultural Hall, Westminster, between August 18th and the 28th, and it will be opened to the public from 11 a.m. to 9 p.m. A cordial welcome is extended to all our readers to visit us at Stand No. 30.

The interest in this exhibition is not confined to the British Isles but has become world wide. This is shown by the remarkable response to an invitation to model engineers abroad to show the best of their work at this exhibition.

Movement and action will be found everywhere; from the circular track, the steam locomotive railway, the workshops and test benches down to the smallest model.

For the first time in this country displays of jet-propelled models will be given.

As in former years the leading members of the engineering trade will be showing latest developments in models and equipment.

This show has come to be a standard for the model enthusiast and there is not an exhibit which does not meet close inspection by the public.—F.J.C.

Making a Hot-air Engine

An Efficient and Compact Small Power Plant of Novel Construction

By "HANDYMAN"

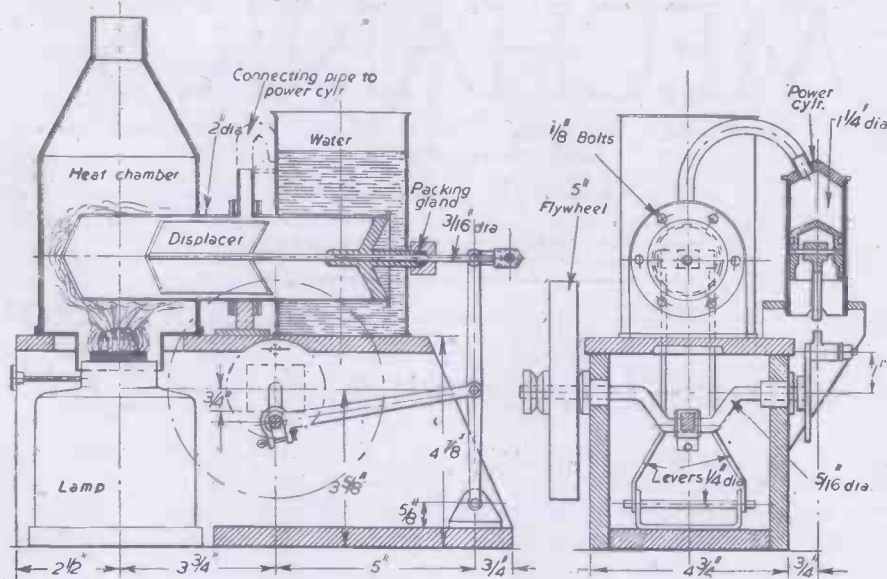

Fig. 1.—Sectional views of the completed hot-air engine.

THE type of engine which goes under this name was invented in Watt's day, and in 1840 Ericsson, a famous engineer of his time and the builder of the engine which competed with Stephenson's "Rocket," fitted a very large hot-air engine to a large sea-going vessel.

The weight of a hot-air engine is over 15 cwt. per horse power, against the 1 1/2 lb. per horse power of quite an average petrol aero engine.

The Principles Involved

In the first place, only a given amount of air is dealt with in a Stirling type of "closed cycle" hot-air engine. This air is successively heated and cooled, and therefore, like nearly all other substances, alternately expands and contracts. When the air expands and is kept within the apparatus, it exerts a pressure, and when, on the next stroke, it contracts, this pressure is removed. The essentials to success are: (1) that the air cannot leak out from the cylinders to the atmosphere; (2) as the pressure involved is small, somewhere in the neighbourhood of 2 or 2 1/2 lb. per square inch, the largest capacity that can be obtained for a given weight and strength of metal is desirable.

The Cycle of Operations

The diagrams, Figs. 2, 3 and 4, show the cycle of operations. In the first sketch the engine is on its power stroke. The power piston is receiving expanding air from the displacer cylinder, and exerting a pressure, through its connecting rod, on to the crankshaft. The next diagram shows the hollow displacer pushing the air in the displacer cylinder from the heated end to the water-cooled end. This operation is completed in Fig. 4, and the power piston being on its return stroke, is being assisted by the contracting air. This state of affairs will go

on so long as the cold water and flame are applied to their respective ends of the displacer cylinder. The moving parts will require a little oil, of course.

The Design of the Hot-air Engine

As specially designed, the form of the

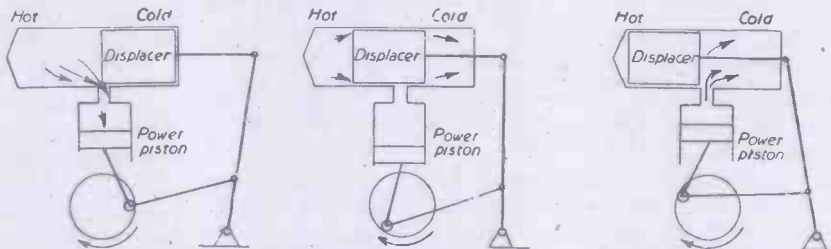

Figs. 2 to 4.—The cycle of operations. Reading from left to right:—The power stroke, "air-transference" stroke, and the "return" stroke.

engine is quite new, and also very compact (Fig. 1). The sizes given provide a horsepower of about 1-60th, and, so long as the area of the displacer and power cylinders are made in the proportion of about 1 1/2 to 1, with the same stroke for each, readers may alter the dimensions of the engine to suit materials that come to hand. The cylinders are actually arranged with a 2 in. diameter tube for the displacer cylinder and a piece of 1 1/4 in. diameter thin steel (cycle) tube for the power, or working cylinder. The displacer cylinder must have a blind

end at the heated portion, and should be of thin material. It is suggested that this cylinder should be made in two halves, joined by a thick ring with heat-insulation material (asbestos joint washers) in between (Fig. 5). The idea of this is to prevent the heat travelling by conduction from the hot end to the water-cooled portion, and being wasted. Another important feature of the engine is the lamp. As such an engine would be used where other convenient sources of power are non-existent, and once started will not stop until the fuel is exhausted, an ordinary paraffin lighting lamp can be used, less the glass globe, as the heating element. Alternatively, a lamp burning methylated spirit would answer the purpose. Any reservoir may be impressed into service, and the design of the wooden base may be altered in shape or dimensions to suit the available lamp. A duplex burner is better than a single one, if paraffin is used. The hot chamber, which is a sheet-iron box holding in it the heated end of the displacer cylinder, and fits over the latter, in the collar provided for the more usual glass chimney

Base Frame

The base frame may be made of hard wood 1/2 in. or 3/4 in. thick, arranged without a floor at the lamp end, and made generally as shown in the sketch, Fig. 6. A hole in the top to suit the diameter of the burner is also required, as well as 3/4 in. diameter holes in the sides for the axle bearings.

The Hot and Cold Chambers

The chamber which must be made round the heated end of the displacer cylinder may be built up, in a cylindrical shape in plan, out of thin sheet iron or tinned plate. As it must be reasonably airtight, except for the top and bottom openings, to prevent the lamp from smoking—the effect of a hole in a paraffin lamp glass is well known—the displacer cylinder should be an accurate fit in the hole formed in the side wall of the chamber. Further, the bottom should be provided with a ring or collar which will push on to the particular paraffin burner employed. The chamber must be of riveted or seamed construction, as solder is of no use in this case for uniting the joints and seams in the metal.

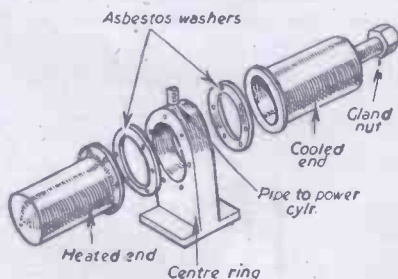

Fig. 5.—The parts of the displacer cylinder.

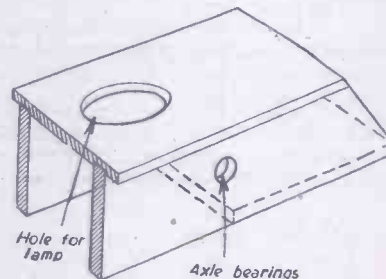

Fig. 6.—The base frame.

For the water-cooling tank any tinplate container will serve, so long as the joints are soldered up quite watertight. The cold end of the displacer cylinder may be soldered in place with the spigot holding the packing gland nut projecting beyond the water space at the outer end. This arrangement, whereby the end of the cylinder, except for this spigot, is entirely immersed, provides increased cooling area. Further, the gland is kept quite cool.

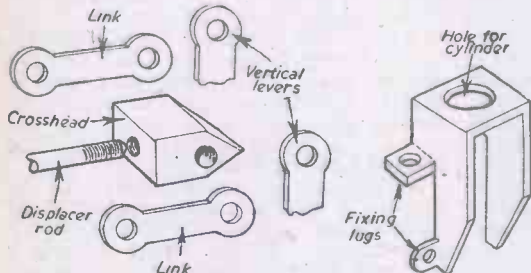

Fig. 7.—The displacer rod connections.

Fig. 8.—The power cylinder support.

The Displacer

The function of the displacer is to move the air from the heated portion of the displacer cylinder to the cooled end, and vice versa. It is usually made in the form of a light hollow metal container, like the float of a petrol engine carburettor. Any kind of hollow tubular box which fits inside the displacer cylinder with not more than $\frac{1}{16}$ in. clearance between it and the wall of the displacer cylinder will serve, and failing a metal displacer a plug of hard wood will suffice. The stroke, which in the present engine is about 2 in., may be varied by altering the pin position of the connecting rod on the vertical links, and should be the maximum the lengths of the chosen cylinder and displacer will allow. The gland end of the cylinder cover should be very long to provide the maximum support for the displacer itself.

The Crankshaft

This may be a piece of bright steel rod $\frac{1}{8}$ in. diameter, heated and bent in the centre to make a crank of about

$\frac{1}{2}$ in. throw. The bearing bushes should each have a flange which may be drilled for small screws to provide for their attachment to the wooden frame. The outer (power) crank is of the disc type and should have its crank pin set directly opposite, or at 180 deg. to the inside displacer crank.

To make a compact engine the connecting rod is attached to a vertical lever, a pair of levers really (see Fig. 1), which increase the motion of the displacer in the proportion of nearly two to one. The top ends of the levers are connected by short links to the cross-head (Fig. 7) fixed to the outer end of the displacer piston-rod.

The power piston is made from a piece of cycle tube with a light trunk piston turned from a piece of brass rod. The cylinder has a solid head soldered into it, and is fixed on to a sheet metal support fixed to the base frame (see Fig. 8).

The flywheel is $\frac{1}{2}$ in. in diameter, and need not be of a very heavy pattern. Diameter is more important than mere weight. By the side of the flywheel a small grooved pulley for a light driving belt should be fixed to the shaft, as shown in Fig. 1.

Domestic Heating Research

The Calorimeter Building at the Fuel Research Station

RESEARCH into the properties and utilisation of domestic fuels has been carried on at the Fuel Research Station, D.S.I.R., for many years. Towards the end of the war this work was extended to include research into the performance of new domestic heating appliances, designed to use fuel economically and to fulfil the improved heating standards recommended for post-war housing by the Heating and Ventilation Reconstruction Committee (the "Egerton" Committee), and the Fuel and Power Advisory Council (the "Simon" Council).

Within a short time it became clear that a well-equipped testing installation was required for more elaborate investigations, to supplement the ordinary testing facilities then being provided. The calorimeter building at the fuel research station has been built to provide the more comprehensive facilities required for these investigations.

The Calorimeter Building is not a research laboratory in the ordinary sense. It is really a scientific instrument designed for a special purpose—measurement of heat. No one has so far succeeded in accounting completely for all the heat in the fuel burned in a domestic heating appliance. The heat is very difficult to trace. It may be transmitted by radiation, by conduction or by convection: it may reach other rooms in the house; much undoubtedly is lost.

General Principles

The main feature of the building is the provision of calorimeter cabinets in which domestic appliances can be installed and operated. The cabinets are about the same size as living rooms in small houses, and are designed so that the heat passing through the walls, floor and ceiling is automatically recorded. They are of air-tight construction with specially balanced-draught arrangements to eliminate leakage and to enable the amount of incoming air to be recorded. The total useful heat from the appliance can therefore be determined by direct measurement. It is also possible to measure separately radiant heat, warmed air from convection jackets, and heat to the boiler water.

Layout of the Building

The Calorimeter Building is a four-storey structure occupying a ground area of about 3,000 sq. ft.

The four calorimeter cabinets are each

12ft. square and 9ft. high. Each cabinet is mounted centrally in a constant-temperature chamber, 20ft. square and 26ft. 6in. high. These chambers occupy the four corners of the building extending from the ground floor to the underside of the smoke-testing floor and give easy access to the whole of the outside of the cabinets.

The smoke-testing rooms are on the third floor, above the constant-temperature chambers. The chimneys from the cabinets pass through these rooms, which are equipped for smoke measurement.

Calorimeter Cabinets

The cabinets are constructed of $\frac{1}{2}$ in. plywood panels, covered on both sides with copper sheeting divided into separate sections each 2ft. by 1ft. Differential thermocouples are embedded at the mid-points of the copper sections directly opposite each other on the inside and outside of the plywood, so that the temperature difference across the walls, floor and ceiling can be measured and recorded electrically. The rate at which heat is flowing through the plywood can be determined from a knowledge of its thermal conductivity and the temperature difference between the inner and outer surfaces. The thermocouple wiring system is arranged in such a way that the heat flow can be measured through any of the individual sections or any group of sections such as a complete wall. The material used in the construction of the cabinets was selected to give as low a heat capacity as possible, consistent with suitable thermal conductivity and mechanical strength.

The flow of the air entering the cabinet is controlled automatically in such a way that the pressure is the same inside as outside. The appliance then operates under conditions of natural draught, and risk of leakage is reduced to a minimum. The rate of air flow into the cabinet is automatically recorded.

Constant-temperature Chambers

The conditions of air movement and temperature in the chambers surrounding the cabinets must be kept constant. In each chamber there are two fans, one in an enclosed space underneath the cabinet, and one above it. These fans produce an air flow around the cabinet. Air leaving the upper fan can pass through a duct to the lower fan to be re-circulated, or can be rejected to the atmo-

sphere, in which case air from the outside is taken in by the lower fan.

For summer-time use and for appliances of high heat output, cooling is provided by a refrigeration plant, which feeds cooling batteries in the ducts leading from the input fans in two of the chambers. The air can thus be chilled when it passes through the fan ducts.

The temperature of the air around the cabinet is maintained constant by means of inter-connected dampers in the air ducts, which control the proportions of fresh and re-circulated air, and by the thermostatically controlled, cooling batteries.

Control Room

The control room is on the first floor and is 52ft. long by 10ft. wide. It is connected by means of air-locks to each of the four cabinets.

As far as possible all of the instrument readings are automatically recorded in the control room. A separate wall-mounted control panel is provided for each cabinet, each panel having a complete set of instruments and controls. These comprise a six-line recording potentiometer, the controller for the constant-temperature chamber, remote control switches, indicator lamps and other instruments. The recording potentiometer can be linked to instruments inside the cabinet and to the wall thermocouples through suitably placed terminal boards.

The Smoke-testing Rooms

The chimneys, which are lined with stainless steel throughout their length, are accessible on all sides in the smoke-testing rooms.

In order to measure the smoke, a beam of light is projected across the flue, and its intensity on the opposite side is measured by a photo-cell. The windows, through which the light beams pass, are heated to prevent smoke depositing on them. Two sets of apparatus are mounted on each flue; one, with a direct light-path across the flue, for dense smokes; the other, with an oblique path, for the lighter smokes. The outputs from the photo-cells are amplified and fed to a recording potentiometer.

The electrical supplies to the light projectors and the photo-cell amplifiers are specially stabilised, so that the record of smoke density is unaffected by variations of mains voltage or frequency.

A Circular Saw Attachment

A Useful Accessory for a Wood-turning Lathe

By H. A. ROBINSON

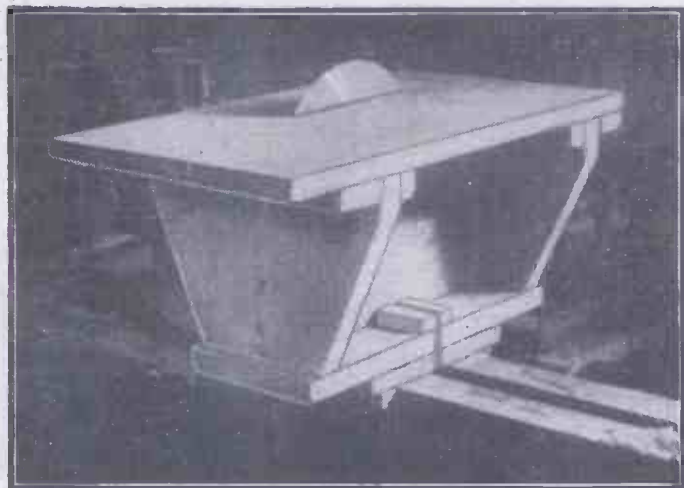

Fig. 1.—The saw and cutting table assembled on a lathe.

THE accompanying illustrations, Figs. 1 and 2, show a detachable circular saw designed for use on an amateur's wood-turning lathe.

The saw is fastened rigidly to the lathe spindle and a cutting table, fitted over it, is held by a bolt to main horizontal members, upon which the table rests.

Fig. 3 indicates how the saw (which is 8 in. diameter) is secured to the spindle. The main item in effecting this is the adapter (a) which is made of brass, and is bored out and internally threaded at one end to take the externally threaded spindle. At the

hinged at one end, rests on the two truncated uprights (g), which are 6 ins. high, 10 ins. wide at the upper end, and 6 ins. at the lower. A spacer (h) is fitted between these two, keeping them about 10 ins. apart, and the whole is made into a strong framework by the base (k). Below this is fitted another but

table are given in Fig. 5. The whole job is very sturdy, 1 in. wood being used in most cases. The top (w), however, is of 3/4 in. plywood, as this gives a perfectly flat surface virtually impervious to warping or distortion.

together by two bolts (c) in either side, which gives extreme rigidity with very little trouble in fitting. The uprights are held by suitable screws through (k), and by screws through into the spacer (h). The spacer itself is held by these screws and one or two up through (k).

Hinged Cutting Table

At either end of the table top are the strips (x), 1 in. x 1 1/2 in. x 10 ins., secured on the underside and by screws up from below. At the near side to the operator are two hinges, as shown, these being secured to the under-

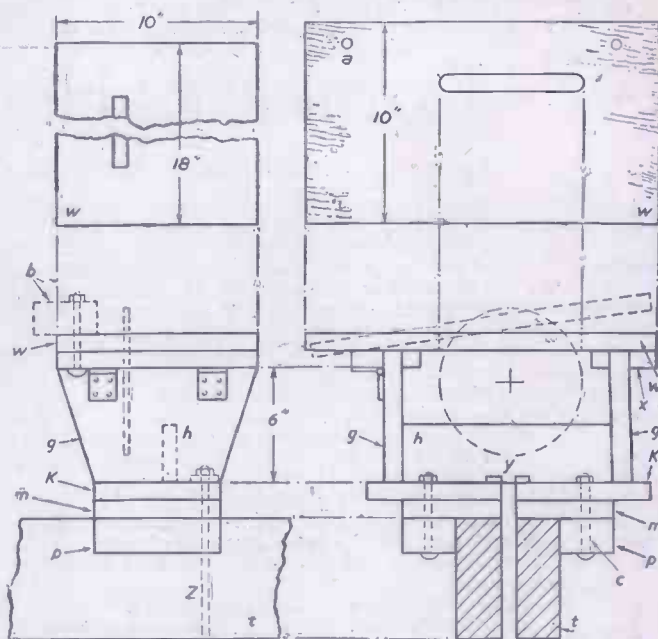

Fig. 5.—Details of the hinged cutting table and method of fixing to the lathe bed.

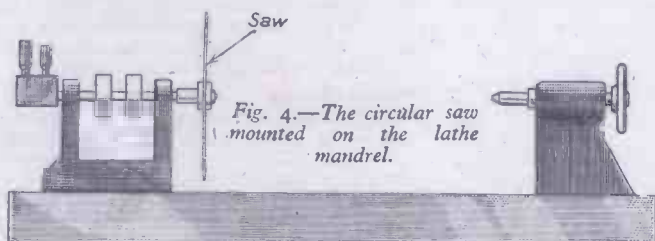

Fig. 4.—The circular saw mounted on the lathe mandrel.

other end it is shouldered down to a smaller diameter (b) which just passes through the opening in the centre of the saw (c). This end is also threaded to take the nut (e), which keeps the saw tightly in position with the additional aid of a washer, as shown, which helps to distribute the pressure. Fig. 4 shows the saw mounted on the lathe mandrel.

narrower base (m) and secured down the sides of this are the strips (p), 1 1/2 in. deep, which allows of the frame being fitted tightly over the main bed members (t) of the lathe. The three levels (k), (m) and (p) are held

side of the strip and to the upright. These hinges allow of the top being raised at an angle, as indicated by the dotted lines, so that the amount of saw protruding above the cutting surface can be adjusted as desired.

Constructional Details

The constructional details of the cutting

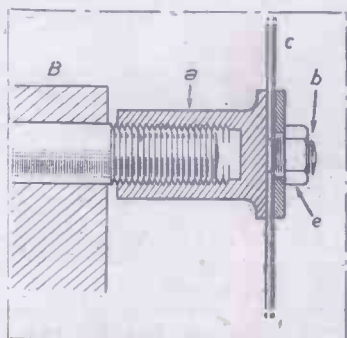

Fig. 3.—Section showing how the saw is screwed on the end of the lathe mandrel.

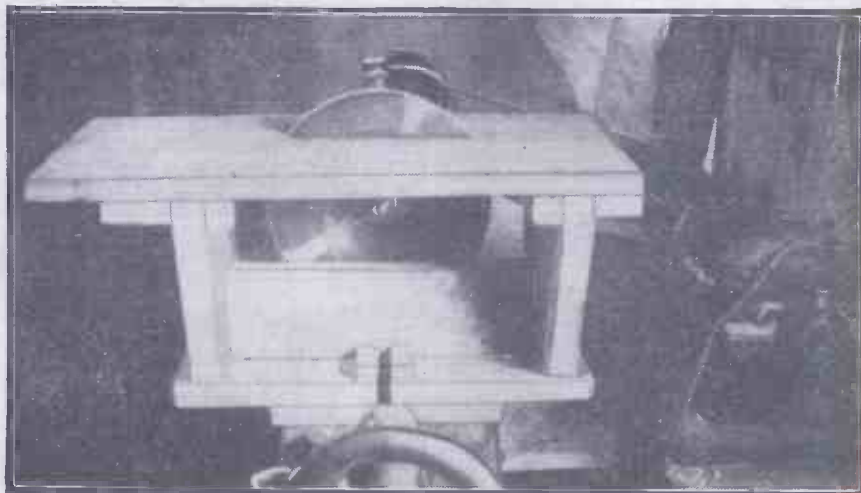

Fig. 2.—End view of the saw and cutting table.

This is useful for grooving purposes or for making cuts which must only go a certain distance into the material. Temporary packing under the end which lifts up has been found quite satisfactory in giving the table the desired tilt.

For a short distance in the base, pieces are slotted as at (y), this being to take the 10in. bolt (z) which goes down between the halves of the bed of the lathe (which in this case is built up of two sections), so holding the table rigidly in position, washers above and below giving the necessary bearing on the wood.

In actual practice it has been found that the table is so solid and fits so snugly over the horizontal members that for light and even medium weight work the putting in of the bolt is quite unnecessary, the table being perfectly firm just as it is laid on. Without exceptionally firm fitting, however, the bolt or other locking device would be essential.

The "Fence"

On the table top the two bolt holes (a) allow of the fitting of a "fence" (b). This is merely a block of wood, well trued and bored

with several pairs of bolt holes which agree with the holes in the top. This enables it to be set in several different positions. Its purpose is to act as a base line when cutting

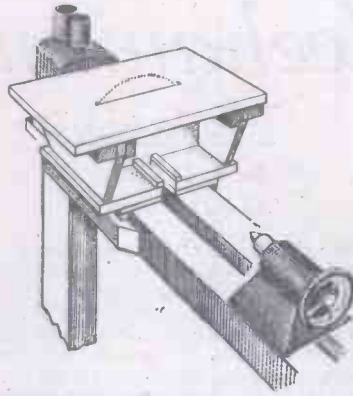

Fig. 6.—General layout, showing the saw and table in position on the lathe bed.

a series of similar strips of wood, or for when one cut has to be taken to a right angle with another. The use of the block becomes more apparent as more jobs are carried out with the saw.

In practice it is found that adapting the lathe for circular saw operations is only a matter of a few minutes' work, while removing things so that turning may be resumed is equally as easy.

The whole outfit is very efficient and enables a wide range of cutting jobs to be undertaken with little effort, and some quite big cutting jobs too if patience is used and a little coaxing brought to bear as the top capacity of the saw is reached.

This particular lathe is driven by a 1/4 h.p. electric motor, belt connected to the spindle, the control switch being close under the table, fitted to the side of the main lathe members, where it is within easy reach of the operator.

For full efficiency it is essential that the saw be well set and sharp. The writer has two saws, one being re-conditioned, and rested, while the other is in use.

A New Spring-wire Clockwork Mechanism

Particulars of a New Spring-driven Unit for Driving Models and Other Appliances

THIS new spiral spring mechanism utilises ordinary "piano" or any other gauge of spring wire.

The wire—which takes the place of the old-fashioned flat spring—is coiled on an expanding winding driver which acts concertina-wise, opening out lengthways as the coil of wire is "wound up" or coiled and closing as the spring unwinds; thus the coil

speed motors for gramophone or cine work and the like, or heavy duty types for such purposes as model locomotives to haul heavy loads.

Size for size, the new spring gives a bigger power output than the flat spring type, the weight for any given duty is less, and, above all, the power output curve is flat in character, giving a steady and more even output over the whole range of the spring's effective range than the flat spring type.

Any motor for any duty can be supplied to meet any specified conditions.

The accompanying illustration, Fig. 1, shows the application of the new spring mechanism and clockwork gearing to the driving wheels of a model locomotive. Figs. 2 and 3 are sectional views of the expanding drum showing the spiral spring at rest and in its wound position.

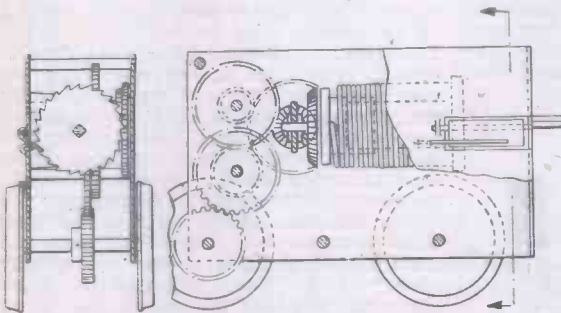

Fig. 1.—The new spring mechanism applied to a model locomotive.

of wire is relieved of all end tension or pull, saving energy, cannot deform, and has a long life. Breakage is substantially impossible, and a "winding detent" prevents any chance of "overwinding" or overstressing the spring.

Efficient means of pre-loading the spring reduce the number of turns when "winding up" to attain any given loading.

The power output from the spring itself is practically 95 per cent. of the available energy put into the spring by the elimination of all losses due to the patented expanding drum on which the wire is coiled.

Various Uses

The coil of wire may have any reasonable form—e.g., large diameter and short length—to fit into the space formerly used by a flat spring, or may be of even ratio—diameter and length equal—or may be relatively small in diameter and long in length. Wire of any gauge can be used—suitable for any type of spring motor for any class of duty or work. For example, a cheap mechanism for low-price toys, constant

key. The dotted line CD represents the energy required to drive the train, and the point where the curve cuts the said line represents the ultimate effective drive power to sustain motion, hence the energy of one and a half turns of the winding key contributes nothing to the effectiveness of the motor, and is, in fact, waste energy as shown by the distance A. If, however, the spring be pre-loaded by one turn, the power output curve then becomes that shown by the upper curved, marked "Pre-loaded 1 turn," and shows that only six turns of the winding key are required to produce the same results as that obtained with seven turns on the plain spring. It will be observed that the residual energy is just sufficient at the end of the run to maintain motion, and some

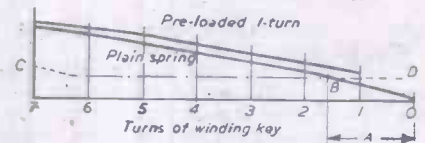

Fig. 4.—Characteristic output curve of a simple spring motor.

Output Curve

The diagram, Fig. 4, shows a characteristic output curve of a simple motor suitable for small model railways, cars and similar models.

The curve marked "plain spring" shows the curve for seven turns of the winding

further movement occurs due to residual momentum, particularly as the design of the mechanism is such that the model can over-run the motor, as the energy of momentum causes the spring drum to rotate bodily and freely and over-runs the ratchet.

High Efficiency

It is therefore possible and practicable to design a motor to perform some definite task, since the starting point is the energy needed to sustain motion, that is the point B on the power output curve, and from that point to attain the desired duration of run by suitable proportions of the gauge of spring wire and the length diameter rates of the coil itself. The practical result is a motor of very high efficiency, with the minimum winding turns.

Further particulars of this new spring-driven mechanism can be obtained from G. Oxenford and Company, Fulwood House, Fulwood Place, High Holborn, W.C.1.

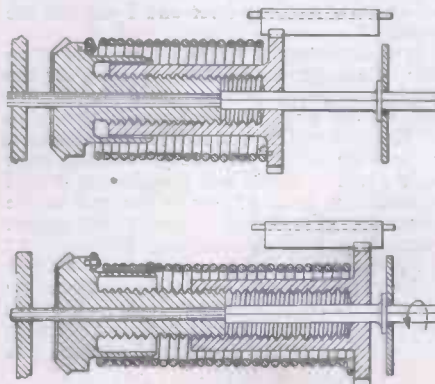

Figs. 2 and 3.—Sectional views showing the spiral spring at rest and its wound position.

The Elements of Mechanics and Mechanisms—10

THE LEVER

By F. J. CAMM
(All Rights Reserved.)

IT is impossible entirely to eliminate air resistance, which is a cardinal problem with rapidly moving bodies such as aircraft. An aeroplane or a locomotive must push the air out of its way as well as propel the aircraft or train, and this makes a considerable difference to the weight either is able to draw. Of latter years considerable attention has been given to streamlining bodies which move through the air so that the amount of power lost due to head resistance, drag, etc., is reduced to a minimum.

There is also the skin friction of bodies moving through the air to be considered. Obviously, a smooth body will have less skin friction than a coarse one. Anything which moves through the air, or in the air at high speed must have highly finished surfaces for a minimum of air resistance.

With vehicles which move on the ground or on the railway track there is the question of tractive resistance, and rolling friction to be considered.

The Lever

A lever is a stiff bar capable of rocking about a fixed point known as the fulcrum. Of course, no material is perfectly rigid, but if a lever is correctly designed it is sufficiently so for practical purposes.

If a flexible lever were used a great deal of the force would be dissipated in bending it before the force of leverage overcame the resistance. That part of a lever between the fulcrum and the point of application of the power is called the power arm, and the distance between the fulcrum and the point of application of the resistance or weight is called the weight arm.

Relation Between Power Arm and Weight Arm

If the power and the weight applied to any lever are equal to one another the lever will balance, and equilibrium exists. This would be so when the lengths of the weight arm and the power arm are exactly equal.

If, however, we require a small force to balance a greater force it is necessary to

increase the length of the power arm. As a general rule, in order to produce equilibrium, the power multiplied by the length of its arm must equal the weight multiplied by the length of its arm. Thus a weight of 2lb. will balance a weight of 14lb. if the ratio between the power arm and the weight arm is 7 to 1. In other words, if the length of the power arm is 7 times that of the weight arm. But then

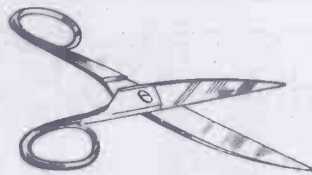

A pair of scissors is an example of a double lever of the first order.

it will be observed that the 2lb. weight is 7 times as far from the fulcrum as the 14lb. weight.

By ordinary arithmetic it can be seen that 2lb. x 7ft. = 14. Also, 14lb. x 1ft. = 14. The least additional weight added to the 2lb. weight will be adequate to raise the 14lb. weight.

It was Archimedes who really discovered the law of the lever, for whilst it had been in use for many centuries before his time its principle was not known until he defined

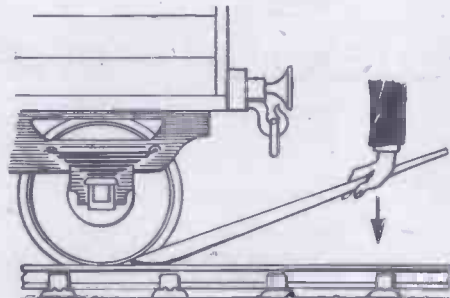

Another example of a lever of the first order. A lever is used to move a heavy railway truck.

it in the famous phrase: "Give me a fulcrum on which to rest my lever and I will lift the world!"

It is necessary to explain that there is no gain of energy when a lever is used, for the longer the power arm is made the greater will be the space through which the force applied to it will have to move. For example, in the case of the 2lb. weight already dealt with it will be found that the distance moved is exactly 7 times greater at the end of the power arm than it is at the end of the weight arm. It is, indeed, invariably the case that: the power multiplied by the distance through which it moves equals the weight multiplied by the distance through which it moves. In other words, what is gained in power is lost in speed, and when an increase in speed is gained it is only at the loss of power.

No mechanical power or machine can at the same time give an increase in both speed and power.

The Three Orders of Levers

It is customary to classify levers into three orders, and these are shown at the top of page 357. There is really no difference between them and they are so classified merely as a matter of convenience.

In the first order of levers it will be seen that the fulcrum is situated near the central part of the lever, somewhere between the power and the weight.

In the second order of levers the weight occupies the middle space, the fulcrum being at one end of the bar and the power at the other end.

In the third order of levers the power is in the middle space, the fulcrum being at one end as in the second order, and the weight at the other.

Briefly, the fulcrum, the weight and the power in the first, second and third order of levers occupy the middle position in turn.

Fulcrum Pressure

We have already dealt with Newton's Third Law of Motion which states that action and reaction are equal and opposite. From this it will be seen that in all levers there are two actions or forces, applied respectively by the power and the weight. The reaction or opposing force to these two is supplied by the fulcrum. Let us take the case of the first order of levers. Here the lever is pressed downwards at one end F by the power, and downwards at the other end by the resistance or weight W. It is also pressed upwards by the fulcrum C, and the lever is in equilibrium because these opposing forces are equal to one another. In such an example the power and the weight are exerting pressure in one direction, and in order to find their joint effects or their resultant we must add them together. Thus in the case already cited 7+2=9. There will thus be, if we ignore the weight of the lever, a pressure of 9lb. on the fulcrum.

It will be noticed that in the second and third orders of levers the power and the weight act in opposite directions, the power tending to pull one end of the lever up and

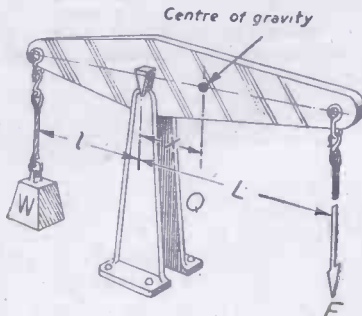

In this lever of the first order,
Q = Weight of the lever,
x = distance from centre of gravity of lever to fulcrum,

$$F = \frac{Wl - Qx}{L}$$

$$W = \frac{Fl + Qx}{l}$$

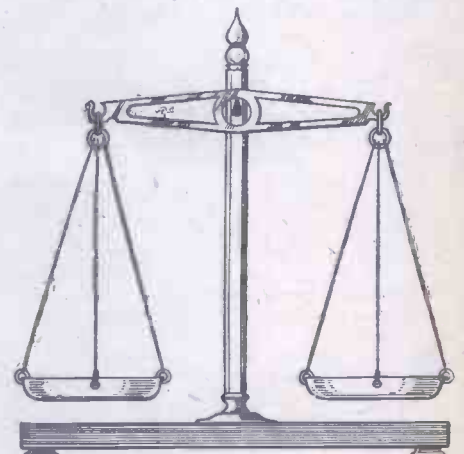

A pair of scales is a further example of a lever of the first order.

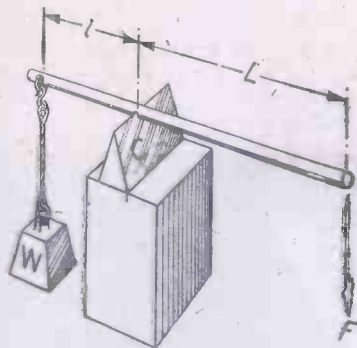

A lever of the first order.

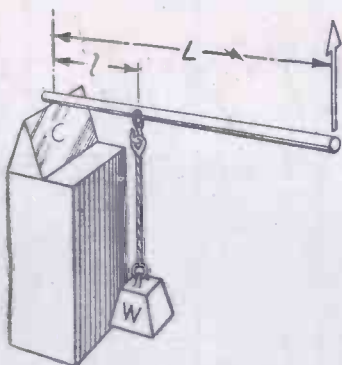

A lever of the second order.

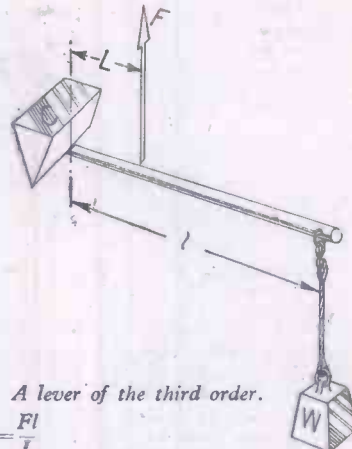

A lever of the third order.

In these three cases : $F : W = l : L$, $FL = Wl$, $F = \frac{Wl}{L}$ and $W = \frac{Fl}{L}$

the weight trying to move the lever down, or vice versa. Thus the pressure on the fulcrum will be equal to the difference between the weight and the power. Hence if the power is 2lb. and the weight 5lb., the pressure on the fulcrum will be 3lb.

Bent Levers

It is not necessary for a lever to be straight. In fact, in some mechanisms which employ bell cranks and articulating levers they are bent. It is often very convenient to bend a lever in order to conserve space or to clear some other part of the mechanism. In the case of a curved or bent lever it is necessary, in order to calculate the leverage ratio, to measure the lengths of the arms, not along the curves of the lever but on perpendiculars drawn from the fulcrum to the lines of direction of the forces, as shown in the diagram on the centre of the page. In this diagram the true arms of the lever are represented by the lines FP_1 , FR_1 .

The Weight of the Lever

In the foregoing we have assumed that the lever is without weight, but as all levers must have a weight the latter must be taken into consideration when making calculations. We have already seen from earlier articles that the weight of a body may be considered as concentrated about its centre of gravity.

The centre of gravity will be at the centre of the bar of a common lever such as a straight iron bar of uniform thickness. The weight of the bar will aid either the power or the resistance according to the position of the centre of gravity in relation to the fulcrum. If the centre of gravity in a lever of the first order is at the fulcrum it will make no difference to the action either of the power or the weight. But if it is between the fulcrum and the power it will assist the power, and if between the fulcrum and the weight it must be regarded as an additional weight to be raised.

For correct estimation it is necessary to ascertain the work of the lever and then measure the distance of the centre of gravity from its fulcrum. The formulæ relating to this are shown in one of the diagrams.

The reader will recognise in everyday life hundreds of examples of the application of the lever. It is not necessary for it to be a straight rigid bar. Indeed, it is only essential that it shall be freely capable of turning on some point called the fulcrum.

A simple example is the ordinary see-saw in which the plank on which the children sit is the lever with its fulcrum somewhere in the middle. The child at each end represents in turn the power and the weight. If a child is seated at one end of the see-saw and a man at the other it is obvious that the fulcrum will be placed nearer to the man, so that the longer leverage on the child's side will compensate for the greater weight on the man's

side. If the see-saw is 10ft. long, the man weighs 200lb. and the child 50lb., the fulcrum will need to be placed 2ft. from the man's end, because $200 \times 2 = 400$ and $50 \times 8 = 400$. In other words the child at a distance of 8ft. from the fulcrum will just balance the man at a distance of 2ft. from the same point.

A crowbar used by railwaymen to propel heavy trucks is an example of the use of the lever. A claw hammer is an example of the lever of the first order. In this case the nail represents the resistance, the head of the hammer resting on wood is the fulcrum, and the hand applied to the end of the hammer

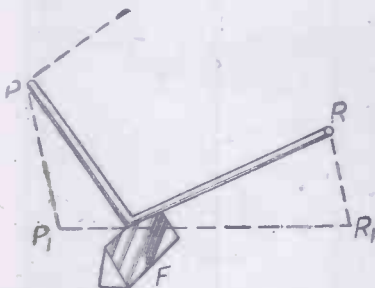

The bent lever, in which the forces are acting along the lines PP_1 and RR_1 . There is thus no mechanical advantage, because $FP_1 = FR_1$.

shaft exerts the power. The crank to which the wires are attached for ringing the old-fashioned house bell is an example of the bent lever.

The balance or scales and the steelyard belong to the first order of levers.

Lever of the First Order

An increase in power is the result when the power is applied to the end of the longer arm of a lever of the first order. The weight raised or the resistance overcome may be greater than the power applied. But when the power is applied to the end of the shorter arm an increase of speed is obtained. We know that it is impossible to gain in both power

and speed because a gain in one is only attained by a reduction in the other.

Lever of the Second Order

When the ground is used as the fulcrum to support the end of the lever it becomes a lever of the second order because the weight moved rests on the bar above the fulcrum, while the power is applied to the other end.

An oar is another example of the second order of levers. The water in this case forms the fulcrum, the boat is the weight, and the man is the power. In the case of a door the hinge forms the fulcrum, the door is the weight, and the power is applied to the handle. In a wheelbarrow the fulcrum is the point at which the wheel touches the ground. The power is applied to the handle and the weight is represented by the barrow and its contents.

As the weight in a lever of the second order is nearer to the fulcrum than is the power it is obvious that the power arm must always be longer than the weight arm. It will be seen, therefore, that such a lever gives an increase in the power but at the expense of lost speed.

Lever of the Third Order

The human frame provides many examples of the third order of levers. The lower part of the arm is raised by the contraction of the biceps muscle, the upper ends of which are farther from the shoulder while the lower end is joined to one of the bones of the lower arm. The elbow joint forms the fulcrum, while the hand and anything it is holding constitutes the weight. In the case of a pair of tongs, the joint is the fulcrum, power being applied midway by the hands and the material between the claws constituting the weight.

Lever of the third order provide an increase in speed only, because the power is nearer to the fulcrum than to the weight. The power arm is shorter than the weight arm and there is hence a loss of power. To compensate for this, however, the weight is moved over a greater distance and hence there is a gain in speed.

Double Levers

A pair of scissors provides a good example of the double lever of the first order. In this case the pin or rivet forms the fulcrum while the power is applied to the handle. The material to be cut provides the weight or resistance.

It must be remembered, however, that there is a varying leverage in that the force exerted is greatest nearest the rivet and least at the tip of the blades. Pliers, pincers, etc., are further examples of double leverage of the first order.

Nutcrackers are an example of the use of two levers of the second order hinged together at one end. The resistance or weight is provided by the nut, and hand supplies the power, at a greater distance from the hinge joint which is the fulcrum.

(To be continued)

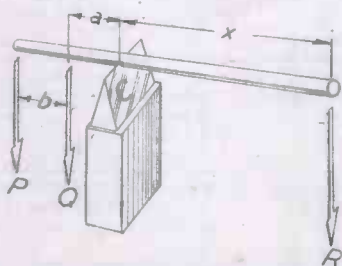

Three forces acting on one lever. To find fulcrum C when three forces act on one lever:

$$Rx = Qa + P(b+a)$$

$$x = \frac{Qa + P(b+a)}{R}$$

New Series

World Air News

A Monthly Review of Progress
in the Field of Aeronautics

By KENNETH W. GATLAND

TWO events that have taken place recently in these isles have fairly rocketed British prestige in the air world. They are, of course, the raising of the altitude record to 59,492ft. by John Cunningham in the increased-span Vampire (Fig. 1) and the new 100 km. closed-circuit record of 605.23 m.p.h., set up by John Derry in the tailless D.H. 108 (Fig. 2).



Fig. 2.—The D.H. 108 in which John Derry, D.F.C., recently set up a new 100 km. International Closed-circuit record at 605.23 m.p.h. Speculation is now current on the machine becoming a challenger for the absolute speed record.

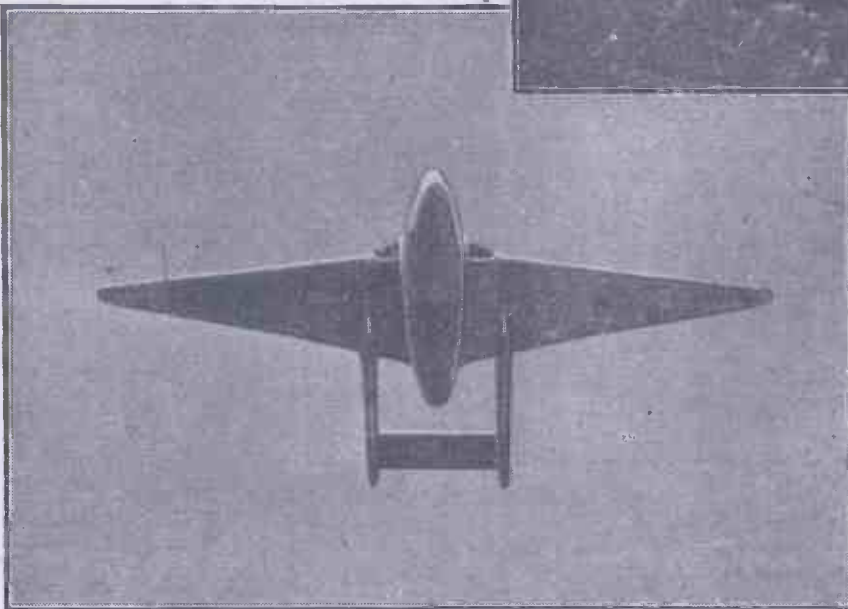

Fig. 1.—The Vampire fighter in flight.

Both records, it will be noted, were established with de Havilland machines and de Havilland engines, a double triumph which should reflect favourably on the sales manager's export chart. Not that de Havilland foreign sales are particularly in need of stimulant! The firm is already supplying the air forces of Switzerland, Sweden, Norway and several of the Commonwealth countries with the latest mark Vampire fighter and is Britain's foremost joint exporter of military and civil aircraft.

The D.H. 108 is the only really high-speed research aircraft giving results at the moment and there is talk that it may become a challenger for the absolute speed record.

Meanwhile, in the realm of new fighters, prototypes of the Hawker N7/46 and the Gloster E.1/44, both in the 600 m.p.h. plus class, are undergoing proving trials and it should not be long before the swept-back wing version of the Vickers Attacker makes its appearance.

Transonic Failure

On the debit side of the account must now be placed the Vickers transonic programme which, under the Ministry of Supply, has repeatedly misfired during the past year. A great deal of time, effort and money have been given to the development of the models concerned and after months of flight testing

it now appears that the rocket motor was not adequate for the job. Whether or not the programme will eventually be resumed must depend on the outcome of redesign and a lengthy series of bench tests, but the technicians concerned will have their work cut out to pack much more power than is presently available within the limited space of the small fuselage. (See PRACTICAL MECHANICS, April, 1947, pp. 228-231.)

The lack of a proper transonic research programme must severely limit the ability of the design firms to plan the radical fighting machines with which to maintain the efficiency of our air forces in the years ahead. Remember, too, that the fighters that grace our skies to-day will be second-line standard within one to three years and that replacements will be drawn from types which are actively being planned now.

Whereas the fighter producing firms once had only to draw on their experience to design the next logical type, something extra is needed in face of present conditions. We are approaching a critical phase in development due to the close proximity of aircraft speeds to the speed of sound, when existing aerodynamical laws break down with the onset of compressibility, and original flight data is urgently required for which a properly balanced programme of research and development is the only answer.

A more realistic attack on the problem has been pursued in America, where it was officially confirmed recently that the piloted Bell XS-1 (see PRACTICAL MECHANICS, March, 1947, pp. 192-4) has flown above sonic speed.

THE PRESENT STATUS OF INTERNATIONAL AIR RECORDS

Record Class (Aircraft)	Firm and Pilot	Machine	Engine	Record performance	Date
Absolute speed	Douglas A/c. Incorporated. Major M. E. Carl, U.S.M.C.	D-558-1 Skystreak	T.G.-180 4,000 lb. static thrust	Speed, 650.6 m.p.h.	25.8.47
Closed circuit (100 km.)	de Havilland Aircraft Co., Ltd. John Derry, D.F.C.	D.H. 108 tailless research	Special de Havilland Goblin, 3,000 lb. plus static thrust	Speed, 605.23 m.p.h.	12.4.48
Altitude	de Havilland Aircraft Co., Ltd. John Cunningham, D.S.O., D.F.C.	Special Vampire with increased wing area	de Havilland Ghost, 4,400 lb. static thrust (fitted in lieu of Goblin)	Altitude, 59,492ft.	22.3.48



Fig. 3.—A Republic P.84 Thunderjet seen over Long Island.

No one will deny that U.S. research in this important field is far in advance of our own, though once the lead given by Miles held promise of keeping British design in the forefront (see PRACTICAL MECHANICS, February, 1947, pp. 156-158). It will be recalled that the contract for the Miles M.52 piloted transonic aircraft was cancelled in February, 1946, when the detail design was 90 per cent. complete, with assembly jigs finished and component assembly well under way and the special Power Jets engine ready for installation in the airframe. The project was abandoned "for reason of economy," but the model programme that has gone so badly has cost £500,000 and piloted research, based on the American, now seems an absolute necessity.

Several other piloted transonic and supersonic machines await test in the U.S., among them the enterprising Douglas D-558-2 Skyrocket which combines jet and rocket power and, unlike the XS-1, which has to be carried up for test beneath a Super-Fortress, it will take-off and land under its own power.

Defence Fighter

Foremost U.S. jet-machine in the role of fighter is the Republic P.84 Thunderjet, now in quantity production—a sleek mid-wing type built around a 4,000lb. thrust General Electric J-35 turbo-jet in the fuselage (Figs. 3 and 4).

Excellent visibility is afforded from the piloting position forward of the wing, and as the intake is in the nose, the air is taken by two ducts which run outside the cabin and converge behind it into the compressor. The exhaust gases leaving the turbine are ducted straight through the aft fuselage to exit from the tail.

All indications are that the Thunderjet is a pleasant aeroplane to fly, and its control at all speeds and altitudes is improved by the use of an automatically adjusted booster aileron system which varies in the application or force to the air speed at which the plane is flying. Thus, even at the highest speeds (and standard models have flown faster than 620 m.p.h.), the pilot manoeuvres his aircraft with ease and does not have to exert unusual force on the "stick."

So snugly does the pilot fit into this machine that he wears a crash helmet because of the closeness of the bubble-hood above his head and the bumping around experienced at near sonic speeds. The cabin is pressurised,



Fig. 4.—The Thunderjet is America's foremost home-defender. In the 600 m.p.h. class, it has a range of over 1,000 miles and a service ceiling above 40,000 feet.

with automatic air conditioning at all altitudes of operation, and a pilot-ejection seat.

Armament comprises four .50-calibre guns

mounted in a bay above the air intake which fire at the rate of 1,200 rounds per minute.

In addition to the speed performance thus far revealed, the machine's service range is said to be in excess of 1,000 miles, with a service ceiling above 40,000ft. External dimensions are: wing span, 36ft. 5in.; overall length, 37ft. 3in.

Joy Rides at London Airport

News that the Ministry of Civil Aviation have granted permission to Island Air Services (London) to operate pleasure-flying aircraft from London Airport will be welcomed by many. Two or three Rapides will be available on Sunday afternoons only, and the cost per person will be £1 for a flight of fifteen

minutes or 30s. for twenty-five minutes. Bookings can be made from a booth in the public enclosure.

Blower and Fireplace Screen

OXYGEN is the breath of life to a domestic fire. In Victorian days the glow on the hearth was usually vivified by means of a pair of bellows.

A metal blower was at times adjusted to the grate to increase the draught. In some places a shutter has been fitted in a frame in such a manner that it may be drawn down or lowered so as to cover the opening of the grate.

A shutter of this description furnishes a means whereby draught can be easily, rapidly and considerably increased. When this increased draught is no longer required the shutter can be dispensed with.

In addition, the shutter may afford a screen for a grate in the summer or when the fire is not burning.

An improved device relating to this type of fireplace has been submitted to the British Patent Office. It includes a fitting for incorporation in a fireplace comprising a pair of vertically slidable upper and lower plates which are movable one from behind the

other, to cover or uncover the opening to the fireplace.

This invention is characterised in that the adjacent side edges of the plates are slidable separately in parallel tracks formed in each of a pair of vertical tracked members spaced apart.

Another characteristic feature is the fact that the plates are adapted to be lowered together by the release of a single retaining member. The downward movement of the upper plate to cover the upper part of the opening being determined by the limit of the tracks in which the side edges of the upper plate engage, whilst the lower plate continues to move to cover the remaining lower part of the opening.

The lower plate, when raised, slides behind or in front of the upper plate. It is constructed so that continued upward movement of the lower plate will raise both plates into a housing above the guides and practically equal to the height of one plate. The retaining means then acts to hold the plates in their raised position.

Analysing and Testing Electrical Circuits

The Rudiments of Control Circuits and the Nature of Faults Which May Occur

By H. REES, A.M.I.E.E.

THE heading to this article suggests a somewhat vast field of electrical knowledge, ranging from the elementary examples shown in Fig. 1 or the more complicated version in Fig. 3 to, let us say, the elaborate network for power distribution or an automatic exchange system.

However elaborate, the important thing is that there is always a system. The most complex networks reduce to relatively straightforward circuits (at least, for testing purposes), and these into still simpler circuits. If it were not so, fault-locating would be insuperable.

Our immediate task will be one of outlining a few basic ideas. While it remains true that skill at testing is acquired by experience—or long familiarity with certain types of equipment—knowledge can help a great deal: indeed, it can compensate to some extent for lack of experience, if by “experience” is meant acquaintance with rule of thumb methods.

For it is one thing to learn things by rote: seeing them done and memorising the sort of results to be expected. When an unusual type of fault happens which departs from the well-worn “rules,” this form of experience is apt to fail, when many take the view that it is a job for the man who is “paid for thinking”!

Obviously there is such a man in every engineering or electrical shop. Unfortunately, he may sometimes discourage too much initiative on matters which he regards as his own province—and often rightly so, if the “rule of thumb” routine is being too rigidly followed.

However, in writing, there are no such restrictions. The aim is necessarily to inculcate “thinking” on electrical matters. So let us proceed with our task.

Is “Theory” Necessary?

As regards “testing,” it is an important mark of skill to know when *not* to test. Most faults reveal themselves, or call for nothing more than observation. Others, not so apparent, require the application of a little “electrical sense” coupled with the ability to make quick deductions—the rapid elimination of unlikely causes.

A danger of too much theory is that it tends to suggest the far-fetched or unlikely cause—if not tinged by experience or practical common sense. The same thing is sometimes noticeable when a highly academic mind sets out to “simplify” a theoretical problem—it is apt to become many times as complicated!

Is that proof of the oft-quoted adage, “theory is useless”? If for theory we substitute *knowledge*, the statement is surely sweeping. No doubt much theoretical knowledge is useless—for the purpose in hand—though it may be of great use, say, in research work. In branches of applied science the adage is demonstrably false.

Suppose an attendant or operator had learnt how to synchronise alternators by manipulating a number of push-buttons in the correct order and watching a synchroscope, with but hazy notions regarding the a.c. conditions to be fulfilled—and it is possible to perform such rote operations most

efficiently; though unwilling to admit it, he could scarcely be said to know what he is doing.

On the other hand, let a d.c. generator fail to “excite.” Too much theory and too little first-hand acquaintance with brush and contact troubles may lead the textbookish amateur to see only one possible cause, e.g., “loss of residual magnetism”!

I know not what attraction this magic diagnosis has. Set a question to young students on “the dynamo that failed to generate,” and up pops “residual magnetism” in nine answers out of ten. Occasionally, there are original ideas such as those of a tyro who would “rub the armature with sandpaper”!

The point of all this should be evident. Probably as many as 70 to 80 per cent. of electrical troubles call for neither theory nor tests. But it is necessary to be forearmed for the remaining 20 or 30 per cent.—these figures will obviously depend upon the type of equipment.

Simple Contactor Controls

In Fig. 1a is shown a basic contactor circuit for starting a small motor—with starting resistances, reversing features, etc., omitted.

A “contactor” is merely an electromagne-

However, while self-evident in Fig. 1, a useful mental “label” or classification of all contactor systems is: into (a) the “main circuit” (or motor circuit), and (b) the contactor “operating circuit.” Thus a fault such as a contactor dropping-out occasionally would not be sought for in the motor circuit unless there is reason to think an overload release is operating. Without testing, common sense suggests a bad contact or connection in the operating circuit.

In fact, operating circuits usually embody quite a number of “contacts,” as shown in Fig. 1b and Fig. 2, and may be complicated in other respects. For example, a starter for a given machine may be interlocked with other machines or devices at points in another part of a building, or at control positions.

Reference has already been made to an objection to tumbler-switch control as in Fig. 1a: Unless there is some other means of protection, the contactor will drop out in case of supply failure, but will close again and start the motor when conditions are restored—if S has been left “on.”

This would have no electrical disadvantage, since contactors even for a large motor would still close in the right sequence to cut-out starting resistances, etc. Otherwise, it is obviously most undesirable.

Fig. 1b shows “Start” and “Stop” push-buttons connected in series in the conventional manner, one being of the “circuit-closing” type, and the other (the “Stop” button) being normally closed, and opening the contactor operating circuit.

But a slight addition is necessary when push-buttons are used. The “Start” button makes only a momentary contact, then is released—in which case the motor would stop again if no provision were made to maintain the supply to oc once the contactor has closed. This provision consists of “maintaining

contact” (or “back contact”) mc operated mechanically by the contactor itself as it closes. For convenience in drawing, all auxiliary contacts in the diagrams are shown as the “rod and disc” pattern, either “normally open,” or “normally closed,” but actual designs vary considerably.

The maintaining contact short-circuits the “Start” button once the contactor has closed, as clearly indicated in Fig. 1b.

Fig. 2 is a next step in the development. A second auxiliary contact c “breaks” when the contactor closes, inserting a limiting resistance R (sometimes called an “economy resistance”) in series with oc. Contactor coils are not generally rated to carry the full closing-current continuously. When enough “pull” has been exerted to close the contactor, contacts c reduce the current to the “holding” value. Where such resistances

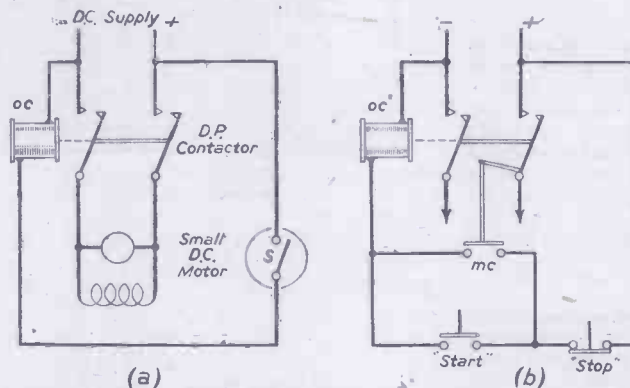

Fig. 1.—Basic contactor circuits for motor-starting, etc. When push-buttons are used as in (b), “holding” or “circuit-maintaining” contacts mc are operated by the contactor to provide a circuit independent of the “Start” button.

tically-operated switch—in this case, a double-pole type which puts the motor directly across the supply when the remote starting-switch S is actuated. The operating-coil oc is energised off the mains, i.e., from the live side of the contactor, via switch S.

Alternatively, this double-pole contactor may be the “main switch” initiating a series of other contactor operations for automatically running-up a large motor. In Fig. 1 the motor is supposed to be small enough not to require any starting resistance.

Two obvious advantages of even the simplest contactor arrangement are: (1) remote control is easily accomplished and (2), “No-Volt” protection is inherent in the system—if the supply fails, the contactor automatically drops out, though a permanently-closed starting switch S would defeat this feature.

are employed, an important maintenance point is that oc would probably be burnt out if an attempt were made to use a contactor of this type without its appropriate resistance—unless for short-period service where it drops out of circuit after some switching sequence has been completed.

“Interlocks”

In Fig. 2 are also indicated a number of other possible “breaks” in the operating-coil circuit; these are *interlocks* which will prevent the main supply being closed via the contactor until all essential precautions have been taken.

Two are shown as “gate interlocks” (not to be confused with “magnetic locking” of gates and doors). In lift circuits, for instance, or electric trains, all doors must be properly “home” to close these interlocks and ensure the main contactor can get its operating supply. This applies also to electrical equipment incorporating dangerous voltages—opening a single door will automatically break the main supply.

In many semi-automatic motor starters an interlock may be fitted to the manual starting-handle to ensure that this is in the normal “off” position before any starting can be done. A field resistance (“speed regulator”) may similarly have to be turned into the “all out” (maximum field) position.

Another electrical interlock, normally closed but opened by the action of a coil, is the *overload release, OR*. The complete circuit connections are not shown, but overload relays are coils of relatively few turns of thick wire connected in series with either of the two main supply leads to the motor. Hence the armature current has to traverse the coil, and, if excessive, will draw up the plunger (set to operate at some predetermined overload current) and open the contactor oc circuit.

Notebook “Schematics”

Compare now Fig. 2 with the much more complicated-looking layout in Fig. 3. Installation diagrams are generally drawn so as to show the actual positions of various devices, interlocks, terminals, etc. Usually these parts will be lettered or numbered, though any convenient “tags,” such as “Init. 1,” “Init. 2,” etc., may be employed to denote the interlock series.

If the basic diagram (Fig. 1a) is kept in mind, developments, however complicated, should not be difficult to follow. Because interesting in themselves, we have chosen contactor circuits for our illustrations. They also afford useful exercises at simplification and drawing schematics, and should be of interest to electrical readers, to whom such circuits may appear unusually complicated.

Many are fairly complicated, of course, but they always reduce to one main circuit, together with an operating or control circuit which may incorporate any number of interlocks, automatic starting devices such as “float switches,” thermostatically operated switches, etc. The contactor itself may be fitted with a number of auxiliary contacts to serve various purposes.

There should be no difficulty in drawing schematics, such as in Fig. 1, which show at a glance where trouble is likely to arise in the motor or control circuits. Apparent complications about “interlocks” quickly disappear when it is clearly understood that all are *in series* in a contactor operating circuit.

Studying Fault Conditions

When engaged upon practical maintenance of a large number of motors and their control gear a few years ago, the writer found it an excellent exercise to consider “imaginary” faults in his notebook schematics—many of which became real faults later.

It became an absorbing hobby to inquire:

what will be the results of a “break” here or a “short” or an “earth” there? What symptoms will invariably indicate a particular type of trouble. Assuming the fault to occur in inaccessible wires or terminals, e.g., inside a starter or in cable ducts, is there some temporary remedy which might be effected to keep works production going?

Such a pastime paid good dividends when it came to a question of getting an important machine back into service in the minimum of time. In particular, temporary expedients (though often not in accord with the best electrical practice!) justified themselves again and again—and, after all, skill in applying emergency measures is by no means an acquirement to be neglected.

To take the simplest case: suppose on actuating the “start” button in Fig. 2, “nothing happens”—the contactor does not close. Obviously, if it did close, but the motor did not start, it shows (a) that there is a main “supply” via the main D.P. isolator switch, fuses, etc., and (b) that there

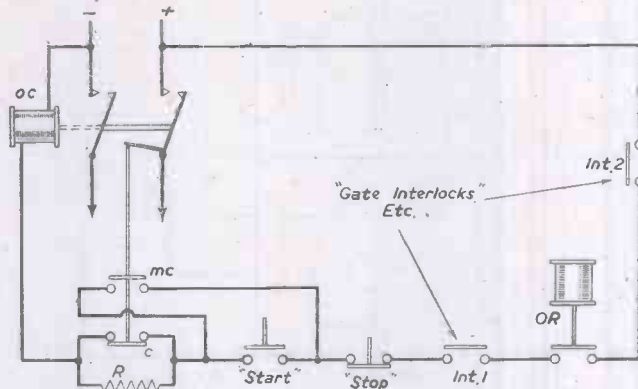

Fig. 2.—Development of the simple contactor circuits, to provide other protective features, etc.—all in the operating-coil connection. (Compare with Fig. 3.)

is no fault anywhere in the operating or interlock circuit.

But the contactor does not close. Probably interlock trouble, but it may be as well first to make sure there is a supply by putting a voltmeter or test lamp across two accessible points, such as the top pair of the D.P. contactor contacts. I will say more about that presently. Just one brief word of caution at this point.

Great care should be exercised in holding the leads attached to a lampholder across the terminals of heavy-current circuits. In the event of an accidental “short,” the current necessary to blow the main fuses may be enormous, the resulting arc burning and melting everything in its path. Then, again, a 230/250v. lamp must not be used for testing motor installations where the pressure may be 440/500v.! In skilled hands a test lamp can be a most useful device, but enough has been said to show it is not a thing to employ without considerable caution.

However, assuming it has been established the supply is O.K., it is evident at once that we must look for our trouble in the contactor operating circuit. Let us enumerate the causes in their order of probability:

- (1) Dirt, grit, grease, wear, loose nuts, loose terminal connections, or mechanical faults on any one of the interlocks (Fig. 2), including perhaps the contactor auxiliary contacts or those of the overload release;
- (2) if of the hand-reset type, the overload release may have tripped—or, even if self-resetting, mechanical “stiffness” or other cause may prevent the plunger dropping back to the normally closed position;
- (3) broken connections in the interlock circuit or an internal “break” in the contactor coil—in installations where separate pieces

of control gear may be interlocked some of the wires may run outside the actual contactor panel, to other panels, through conduit or cable ducts.

Although not shown in Fig. 1, small-current fuses are often inserted in the operating circuit, usually next to the points of connection to the + and - mains. While they should, of course, receive attention, experience indicates that they seldom blow unless there is an “earth” somewhere in the operating circuit. We shall consider an example in a moment.

Auxiliary-Contact Troubles

But to proceed with our hypothetical analysis: suppose on actuating the “start” button the contactor did close, but dropped out again when the push-button is released.

It should be apparent what to look for, from what was said in reference to auxiliary contacts mc in Fig. 1b and Fig. 2. These “holding contacts” short-circuit the “start” button once it has been “made,” and it is clear that any contact trouble at mc would cause precisely the effect described.

Next, suppose the contactor did a “make and break” act—closing and opening successively as long as the “start” button is held down. How is this type of performance to be accounted for?

Well, consider auxiliary contacts c, Fig. 2. No contact troubles at these points would explain matters, because the interlock breaks contact, inserting the economy resistance R in the operating-coil circuit. But what if R had burnt out or had developed an internal break?

Everything will be in order to effect closing of the contactor since R will be short-circuited across contacts and disc c. But when the closing operation is completed, c breaks, inserting resistance R in the oc circuit. Then there is no circuit through R; it is broken or burnt out! So the contactor drops out again, when c will cut-out R, giving a normal closing-circuit once more as long as the “start” button is held down etc.

One more simple instance of contact troubles which was not explicitly mentioned in the above list. The contactor fails to close on actuating the “start” button. The supply is found O.K., and all external interlocks and their connections—we will suppose—have been examined. Furthermore, on making a continuity test around the whole operating circuit with a galvanometer, everything is found in order; yet the contactor fails to close?

Easy as the answer is, I once found a fault of this type causing a great deal of puzzlement—and unnecessary testing. It is one of those things where a little “theory” helps.

In the normally-open position of the contactor, there was some wear on the auxiliary contacts c, giving a “break” and inserting R in the oc circuit. A continuity test would show everything in order—except for a somewhat higher resistance which might well pass unnoticed. With R in circuit, the coil is not getting sufficient current to pull-in the contactor, though quite sufficient normally to hold it closed.

As a final “exercise” on the possible effects of bad contacts, let us stretch our imagination a bit. Let contacts c “stick,” or fail to insert the limiting resistance R after the contactor has operated. What would be the probable result? I will leave the reader to answer that one.

"Earths"

An "earth" in any part of an electric circuit—especially if it occurs internally in motors or starting equipment—should always be regarded seriously as something which will cause extensive damage if not cleared.

The constant danger is an "opposite earth" (i.e., on the opposite main) in another part of the system. I am referring, of course, to insulated systems where neither side is normally connected to earth. The result would be a dead-short carrying considerable short-circuit current, and so causing an extensive burn-out of parts at two or more points.

Thus suppose the insulation broke down to earth somewhere near the "+ side" in the armature or field system of a motor. Evidently, the whole supply network is no longer "insulated," but earthed at this point. As long as no opposite earth occurs on the "- side," serious trouble will not arise. When it does, we shall have a "short" carrying perhaps a few hundred amperes—depending upon the settings of fuses or overload trips in the respective circuits—and the resulting arc will mean a major burn-out of armature or field coils, etc.

In earthed systems, such as three-wire d.c. distribution or three-phase four-wire A.C. systems, an earth on the "live side" will always have the effect described, i.e., it will "blow-out" in the form of a dead-short to neutral.

Such are the results of earths at their worst. From our standpoint, however, an additional earth, *even on the earthed side* if such exists, can give rise to somewhat mystifying types of fault in control circuits like the ones we have been discussing.

For example, suppose the + main in Fig. 1 is the neutral of a three-wire d.c. supply, being therefore earthed by the supply authority. The interlocks, overload-release contacts, "start" and "stop" push-buttons, and the contactor auxiliary contacts are all connected in the lead returned to the earthed main.

From one point of view this is as it should be. All these movable and fixed contacts are virtually at earth potential, hence there is little or no electrical cause for insulation breakdown. But that is not to say they need not be insulated from earth; whilst, even though the insulation is not stressed electrically, dampness, steam or acid fumes, etc., can account for a degree of leakage quite as serious in its effects as a direct connection to "ground." I have known a few cases where metallic veins in slate panels gave trouble.

Hence, from another point of view this interlock circuit at earth potential could "pick-up" a supply via the earth, thus cutting-out a few or all of the protective devices used. Apart from leakage currents, it is possible to have a mechanical breakdown of insulation in a push-button or interlock.

As an experiment, suppose we deliberately connected to ground various points in the operating circuit—remembering our + line is supposed to be at earth potential. If to the left side of the push-buttons in Fig. 2, the contactor would close, and remain closed, quite independently of the push-buttons; if to the left side of the "stop" button, but not including the "start" button, we should be unable to stop the

motor except by opening the main isolator switch; in both cases all the interlocks to the right—including the overload release contacts—would be out of circuit!

Mention was made earlier of fuses blowing in the operating circuit as a result of an earth. The presumption there, of course, was that the interlock circuit was on the live side, or, in the case of an insulated system, had developed an earth opposite to one in another part of the system.

Evidently, there is no end to the possible complications which can arise when we consider the results of earths in complicated networks—including contactor operating circuits many times more complicated than the simple ones we have been discussing.

Mention was made earlier of fuses blowing as a result of earths, which would be the

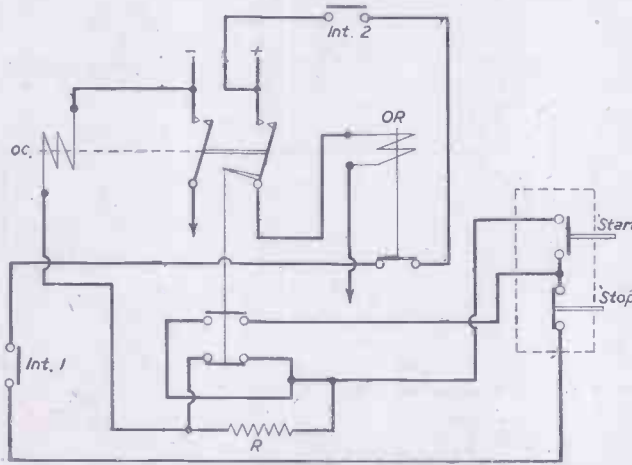

Fig. 3.—The simple schematic of Fig. 2 gives quite as much information as a complicated-looking diagram of this type.

case in an interlock system if an opposite earth developed somewhere else. Evidently, all sorts of complications may arise from this cause, but it is hoped our brief exposition of principles will be helpful.

Testing Devices

Ordinary continuity tests, as well as for "earths," may be carried out efficiently on dead circuits by the battery-galvanometer method—or a battery and a voltmeter, a milliammeter with a high resistance in series, etc.

There is little need to discuss them. Two leads are brought out from the meter (and battery), and the continuity of any single cable, a coil, or a line of interlocks is immediately observed by noting whether the instrument gives a deflection. The idea then is to test similarly smaller portions of a circuit until the part where there is "break" is located. Long cables running via underground ducts, etc., are tested, usually in pairs. For example, if there should be a complete circuit through the armature or field of a motor, that will be revealed by putting the two meter leads across the far ends whilst two cables belonging to independent circuits may be temporarily looped at a distant end.

The simple battery "detector" is equally efficient for indicating earths of any serious magnitude. One lead is connected to "ground" (or the metal framework of a starter or motor) and the other lead applied to the metallic parts of the circuit whose insulation is to be observed. If some part is earthed, it will generally be necessary to disconnect various items again until we come down to the smallest part—note that this can easily be done in interlock circuits by opening the various interlocks, e.g., insulating them with bits of paper.

As explained earlier, earths will soon reveal

themselves by a major breakdown if not attended to, and if a megger is available it will always be sound policy to carry out periodical routine insulation measurements, keeping records of any items of equipment which show deterioration.

Testing Live Parts

The battery-detector is not so useful for rapid maintenance work when it is a question of checking whether there is a "supply" available to a circuit with the main switch closed.

One hesitates to advocate the use of voltmeters or lamps to those not fully conversant with all the risks of sticking leads across live parts. An accidental "short" across circuits of large current-capacity may have extremely serious consequences, whilst dangerous shocks have been known to occur through films of moisture or acids on testing leads—to mention only one possibility.

At pressures above 230/250 v., risk of a lethal shock becomes such that, amateur electricians, at any rate, should not hold testing leads across any live points. The main switch or isolator should be opened first, and the voltmeter leads temporarily attached to the terminals to be tested.

In most types of motor-starting equipment fitted with a self-contained D.P. switch-isolator, the doors will be mechanically interlocked to prevent access to any live parts whilst the isolator is "on." There are ways and means of getting over the difficulty, but it would be unwise to suggest them. If a check has to be made on live parts, methods should be contrived for attaching the voltmeter leads when the circuit is dead whilst retaining the normal protective facilities.

Electricians do make wide use of "test lamps" instead of voltmeters—sometimes two in series for pressures above 250 v. They can be most informative in the right hands, especially for quick location of earths. It is felt, however, that no good purpose could be served by giving directions on methods of testing attended by considerable risks to the inexperienced.

The present article will have served its purpose if it has helped a little in showing the rudiments of control circuits and the nature of the faults which can occur.

"Flying Milk Van"

BULK air delivery of milk over certain U.K. air routes at a transport charge of about 2½d. a quart is revealed as a commercial possibility by engineers conducting research for the Bristol Aeroplane Company.

Plans for the conversion of a New Type 170 aircraft as a "flying milk-van" are being prepared by the company following inquiries from interested business organisations. Engineers consider the ideal method of air-lifting milk would require the use of a specially constructed cylindrical tank measuring 5ft. in diameter and 9ft. in length, occupying about a third of the aircraft's hold. It would be lined with glass, mounted on a wheeled chassis for easy, rapid loading and unloading, and would contain about 1,100 gallons of milk.

Use of standard milk churns is being considered as an alternative loading method, although it is not favoured. While it might permit even quicker loading and "turn-round" at air terminals, it would reduce the milk load to less than 1,000 gallons, with a proportionate increase in transport charges.

WIRE AND WIRE GAUGES

3/6, or 3/9 by post

From George Newnes Ltd., Tower House,
Southampton Street, Strand, London, W.C.2

Gas Water Heaters—1

Their Construction, Operation and Installation

By C. LANGFORD

THIS short series of articles will be confined to water heaters of the so-called instantaneous type, and the range of sizes dealt with will cover those generally regarded as domestic. That is, the amount of water heated up ranges from $\frac{1}{2}$ to 3 gallons per minute. These heaters have, of course, many uses apart from the purely domestic, also the principle of construction is such that their output may, if desired, be greatly increased. The word instantaneous is really a misnomer, for a period ranging from $\frac{1}{2}$ to 1 $\frac{1}{2}$ minutes is needed before the required outlet temperature is reached, but some easy means of recognition is needed between the storage and non-storage types of heater. Instantaneous and storage are now generally accepted as the best words to use when attempting to differentiate between these two methods of heating water.

is then varied within certain limits by a water throttle to obtain the required temperature rise. Except for the special "boiling water"

Fig. 2 (Right).—The single-point sink heater.

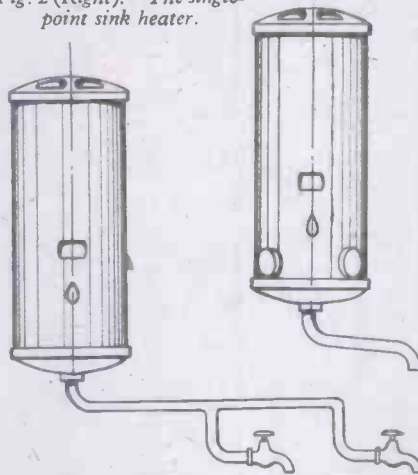

Fig. 3.—The two-point sink heater.

type of heaters the maximum outlet temperature is controlled at 160 deg. F. mainly to obviate scaling difficulties in the body.

The Body

So much for the water and gas sections. What of the body? In Fig. 1 this is shown as a water receptacle with a heat exchanger at the top. In just so many words this sounds simple enough, but the repair departments of water heater firms will only too readily confirm that it is not quite as simple as that! However, the illustration serves as a means of understanding the principle of operation. Water is passed into the body from the water section at the desired rate and after heating flows from an outlet into a sink, basin or bath. The heat exchanger consists of a number of copper fins which extract heat from the hot gases (the products of combustion of coal gas and air) passing upwards from the burner. This heat is passed by conduction into the water flowing through the body.

The foregoing is a brief description of the principles of construction and operation of the instantaneous type gas water heater. In future articles an attempt will be made to describe its construction and operation in more detail.

Types of Heater

A matter which will be of interest to many people is the types of heater which can be purchased. The gas and water rates fall broadly into two groups, one for sink heaters, the other for bath heaters. The sink heaters have a gas rate of from 60 to 80 cu. ft. per hour and a water rate of from 30 to 60 gallons per hour. The bath heaters have a gas rate of from 180 to 200 cu. ft. per hour and a water

rate of from 90 to 180 gallons per hour. For the sake of accuracy it must be pointed out that the gas rate figures vary considerably, due to variations of the calorific value of towns' gas all over the country.

Flue Outlets

Gas and water rates apart there is the manner of distribution of the heated water to be considered, and also the equally important matter of disposal of flue gases. Fig. 2 will be of some assistance here. Firstly, the illustration shows a sink heater with integral water taps and water outlet attached to the heater. Flue gases are allowed in the room providing there is adequate ventilation available and providing the gas rate does not exceed 60 cu. ft. per hour. A maximum operating period of 10 minutes at any one time is advisable. Fig. 3 shows a remote type sink heater operable by taps over one or two sinks. Flue gases are allowed into the room with conditions as above. Fig. 4 shows a bath heater with integral water taps and outlet attached to the heater. In many installations this type of heater is used both for a bath and hand-basin in a bathroom. A properly designed flue outlet is essential for this heater. Fig. 5 shows a heater capable of handling two sinks and a bath (not simultaneously). Its extra output enables a bath of about 25 gallons to be obtained in 10 minutes. Here again, a flue outlet is absolutely essential. A draught diverter for use with a flue outlet is built into the heater on the types shown in Figs. 4 and 5.

In passing, it is perhaps as well to mention that a great deal of work is done in the very small space occupied by these heaters. Taking gas of calorific value 500 B. Th. U./cu. ft., and gas rates of 60 and 180 cu. ft. per hour respectively, and 80 per cent. running efficiency, the horsepower of these heaters works out as follows:

Sink heater:	$\frac{500 \cdot 60 \cdot 778 \cdot 80}{60 \cdot 33,000 \cdot 100}$	= 9.42 h.p. output.
Bath heater:	$\frac{500 \cdot 180 \cdot 778 \cdot 80}{60 \cdot 33,000 \cdot 100}$	= 28.3 h.p. output.

(To be continued.)

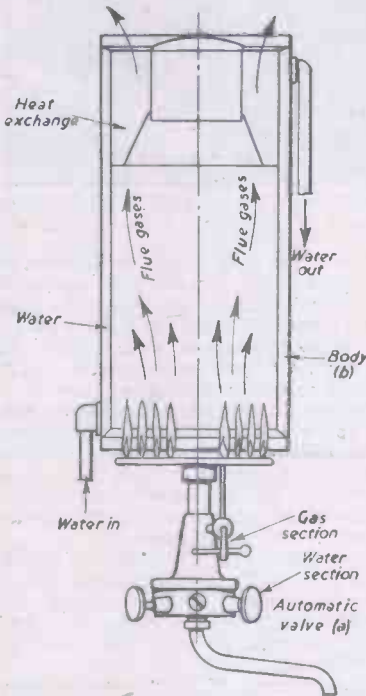

Fig. 1.—General constructional details of the instantaneous type gas water heater.

Automatic Valve

A very general idea of the construction may be gathered from Fig. 1, from which it can be seen that there are two main operational mediums. These are (a) the automatic valve and (b) the body. The automatic valve consists of a gas section and a water section. The gas section provides a means of controlling the amount of gas admitted to the burner for combustion; the burner is regarded as part of the gas section. The water section offers a means of controlling the amount of water admitted to the body for heating. In operation, the two sections, water and gas, are interlinked in such a manner that gas cannot be ignited unless water is flowing. This is achieved by means of a venturi, a diaphragm and a spring-loaded gas valve. A more detailed discussion of this construction will be given later.

The inquiring mind will observe at once that there must, in addition, be some means of correlating the quantities of gas and water admitted to each section. Very broadly this is achieved by deciding on a gas rate which is kept more or less constant. The water rate

Fig. 4 (Left) —The multi-point bath heater.

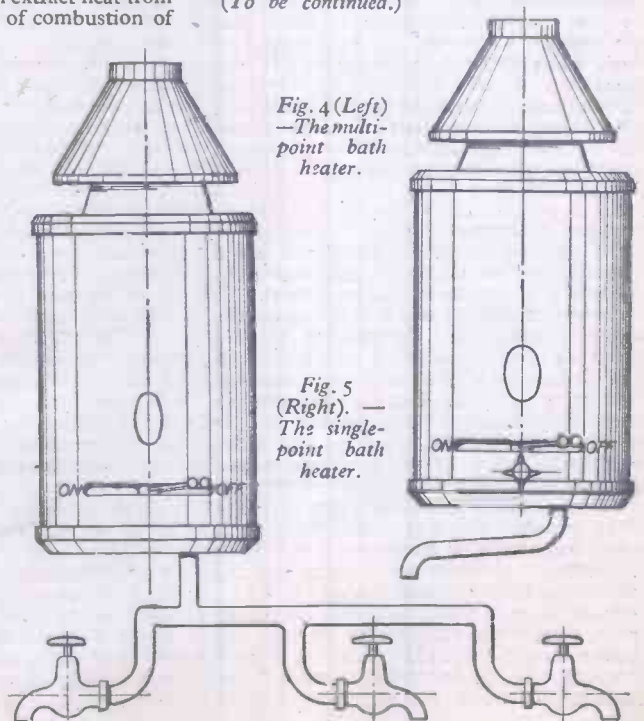

Fig. 5 (Right). —The single-point bath heater.

Musical Boxes

Their Origin, Construction and Operation

By G. W. BENNET, M.A.

THE origin of the musical box is surprisingly obscure considering that it was a mechanism of world-wide popularity between 1820 and 1890.

Several writers have stated that it was invented by someone called Favre, a name as easy to identify in Switzerland as Brown would be in England, but a little research shows that this is a mere legend first mentioned in a book on bells by Blavignac, published in 1877. If we reject this mythical character it seems likely that the invention of the musical box is derived from the straight steel gongs used instead of bells in watches and clocks by Julien Leroy in the middle of the eighteenth century.

In 1802 Piguet of Geneva made a small five-tone musical box to replace the movement of a ring watch and this is probably the first of which any reliable record exists. Within ten years a number of firms had started and the trickle of production began to gather momentum until, by the end of the century, it had become a flood with the staggering total of 350,000 pieces per annum of an aggregate value of four million francs.

Conditions in Switzerland at the beginning of the last century favoured the growth of the new industry; the demand for lace was falling off, and the same producers, working in their own homes, could make musical boxes. The meagre resources of the soil and the long harsh winters made some additional livelihood a necessity for the agriculturists in the remoter villages and the difficulty of communication in winter encouraged work at home.

At first the only factory work was the casting of the brass, the steel comb being built up from separate groups of three to five teeth screwed to a block. About 1820 the single-piece comb was introduced by the Lecoultrés, and a factory was set up to manufacture them for the trade. This was the most important invention in connection with musical boxes and an achievement of which many technicians to-day might well be envious. A really high-class, small musical box of a hundred years ago might have 80 teeth on a comb 2½ in. long with as little as .006 in. between each tooth, not at all an easy piece to harden and temper without distortion (Fig. 1).

Marking Out the Barrel

The marking out of the barrel was not a new technique since barrel organs and organ clocks had been made in Switzerland and elsewhere for many years and books on the subject were available; the machine invented by the versatile Dr. Gagnebin was adapted to mark out the smaller and more accurate barrels now required. Once marked out the barrel was handed to the women of the family for drilling and pinning; the holes were from .008 in. to .01 in. diameter and might run into thousands. A layer of resinous compound inside stiffened the brass shell and helped to retain the pins which were then topped in the lathe by means of a simple filing jig. Finally the movement was assembled and the playing checked before boxing up.

About 1840 the complications began to appear, some being intended to improve the quality of music, some the quantity and some the variety. In the first category we find the "forte-piano" effect obtained with a loud

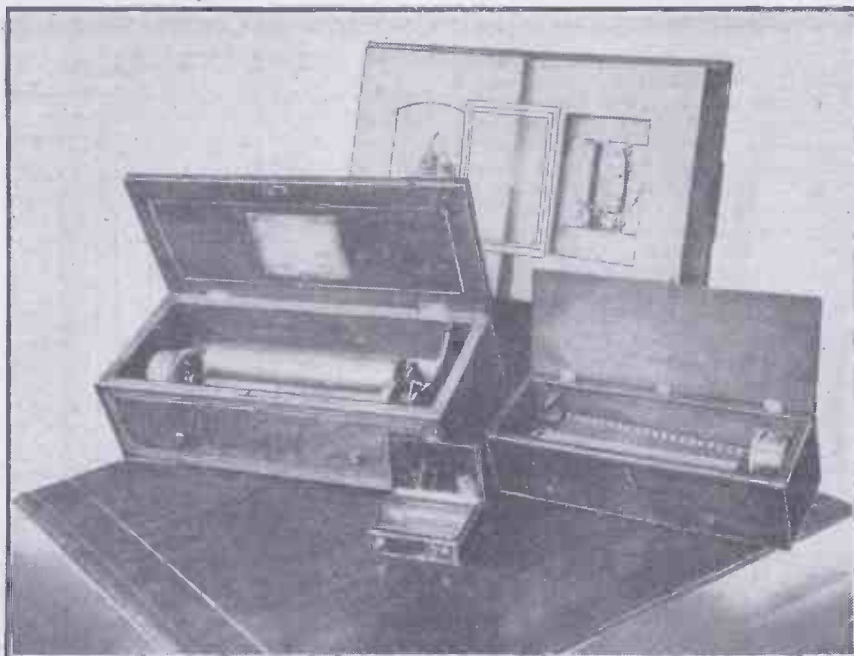

Fig. 1.—In the background is a musical album of 1880 with 3 in. movement. (left) A medium-sized forte-piano of 1850. (Right) An early built-up comb. (Front) Small tortoiseshell box.

and a soft comb, and others known as "harp," "mandoline" and "sublime harmony," using as many as four combs of different strengths. The mandoline was imitated by rapidly repeated notes which necessitated combs with many keys playing the same note.

Change roller boxes were introduced, the repertoire of which could be indefinitely extended, and extra mainsprings were added to increase the playing time. One astonishing machine had four change rollers mounted on a rotatable frame, so that any one could be brought into action by simply pulling a lever. Bigger and bigger apparatus appeared with tables to match fitted with drawers to hold the extra rollers. For variety the musical box was allied to a reed organ and bells, drums, castanets, whistles and even singing birds were attached.

These were mainly popular in the Oriental market, but quite a number found their way to this country, where riches were increasing and music was declining. Such instruments were not cheap; one advertisement quotes £120 and £15 for each additional roller and the one here illustrated (Fig. 2) must have cost at least £300, equivalent to over £1,000 of our present money. At the same time little so-called snuff-box sizes were relatively inexpensive, probably because the design had become almost standardised; a good one could be bought for £3 10s.

By the middle of the century the most expensive small type had died out; this was the disc pattern as used in musical watches. It is sometimes erroneously stated that this was the earliest system, but it is most unlikely that anyone familiar with the barrel organ would adopt an entirely different arrangement except to save space, which is its only merit. The pins project from both sides of the disc parallel to the axis, sometimes giving two tunes by disengaging one set and engaging the other and sometimes one tune with both sides in action at once. In order that the free ends of the teeth of the comb shall not foul one another, they are laid out along a parabolic curve instead of a radius, so each pin is travelling at a different linear speed from a different starting point. To add to the difficulty the

comb, consisting of single teeth separately attached, is usually all screwed to the front of the frame, which means that every second tooth is cranked to reach the back of the disc. Small wonder that these were seldom made after 1830, or that later musical watches embodied miniature barrels.

Sometime about 1860 the larger boxes began to be provided with a ratchet key for winding, the simple clock key being inadequate for the stronger springs. This in turn gave way to the ratchet fixed permanently in position inside the case, though a few later boxes are found with crank keys.

The inventors next produced an arrangement to prevent the disastrous damage caused by a "run-down" which occurs when accident or carelessness allows the fly to become disconnected with the mainspring still wound up.

It consists either of a spring-loaded weight which flies out and jams when centrifugal force overcomes the spring, or else of a rocker like a clock escapement which locks if over-driven. Neither method is very reliable and either is more than likely to break a wheel or pinion, but without them a rundown causes teeth and pins to fly about like quills from a fretful porcupine.

A number of minor embellishments are found on the later boxes such as tune indicators and selectors, speed regulators and devices for pushing a piece of paper down onto the comb to give a buzzing effect known as the zither, but no very serious improvement was introduced except nickel plating to protect the brass parts.

Finally, about 1883, there emerged from Leipzig the machine that was to kill the musical box proper: the Polyphon. It could be called a musical box in the sense that it used a comb but it played from interchangeable metal discs which could be stamped out mechanically; it became the public-house juke box of its day.

How it Works

The clockwork of a musical box is a simple train of three to five wheels terminating in a worm and fly acting as a governor to enable

it to dissipate the reserve of power without undue changes of speed. The torque on the barrel must be sufficient to play the largest chord in the score without a jerk. Tune changing is accomplished by sliding the barrel along its arbor about .02in. for each change by means of a "snail" or face cam indexing at the end of each revolution.

The approximate relation of comb and barrel is shown in the sketch (Fig. 3), the comb being above the line of centres and the pins having a slight forward rake in most cases. The pins must lift the teeth and let them fall cleanly without any tendency to slip sideways, which would affect the tone, and without exceeding a lift of 1/16in. In the small pocket sizes the lift is less; 1/32in. is about right for a 3in. movement.

For tuning the bass end of the comb lead is added to lower the pitch, and in the treble the point of flexure can be altered by filing for the same purpose. Increasing the effective length lowers the pitch and lightening the end of the tooth raises it.

In the sketch the little curved spring underneath the tooth is a damper to prevent the oncoming pin from striking direct against a vibrating tooth and thereby producing an unmelodious squeak. Dampers are only needed for about two-thirds of the comb, the high pitched notes not being capable of sustained vibration. Flat steel wires like watch balance springs are pinned to the teeth and formed into dampers with special tweezers; the free ends come as near as possible to the points of the teeth without actually touching. On small movements the dampers are more often made of quill. Even with dampers it is impossible to repeat the same note rapidly unless several teeth sound it, thus the comb has groups of teeth tuned alike, notably those for the common chord of its principal key.

How to Treat a Musical Box

It must be obvious from the foregoing that dampers are easily damaged, whence it follows that the pins should not be allowed to come against them sideways as will happen if the barrel slides along its arbor at any point other than the end of a tune. Therefore never leave the large type of box stopped in the middle of a tune lest it be handled and the

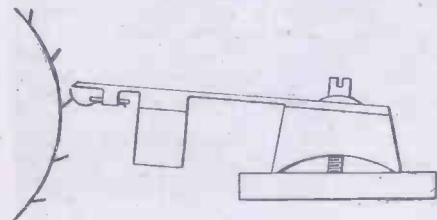

Fig. 3.—Showing the relation of comb and barrel.

weight of the barrel overcome the light spring which holds it against the snail. Equally important it should not be handled when playing and should stand on a level surface. Small boxes are less particular in the matter of handling, but the change lever should be shifted only when the movement is stopped at the end of a tune if automatic tune changing is not fitted. If a box has to travel the barrel should be wedged with cork and it is safer to let down the mainspring; this only applies to the large types since small ones have such a light barrel that it is unlikely to move unless very violently handled.

Only the best clock oil should be used for musical boxes and it should, as in clocks, be applied only to the pivots. The exception is the worm which must be oiled as it is subject to sliding as well as rolling friction.

If at any time you wish to dismantle a musical box, make quite sure that the mainspring is let down before you start. A sur-

prising number of good boxes have been ruined and their owners injured by neglecting this apparently obvious preliminary. Remember also that these mainsprings are often very powerful, at least twice as strong as the same sized barrel would carry in a gramophone

speed adjustment, but if they are at all stiff it is safer to dismantle them before forcing them for fear of breaking the worm. If you clean the pin-barrel be careful not to let any polish or alcohol get inside as this will dissolve the resin filling, which will eventually



Fig. 2.—Large musical box with two mainsprings and speed regulator. The extreme ends of the comb work the bells, drums and castanets. In the middle are the trackers for the organ which is also connected to the keyboard.

phone, so practise on a clock or gramophone spring if you are not acquainted with the art of getting them in and out of their barrels. On account of their strength the mainsprings are best lubricated with clock oil; graphite and oil makes them hard to handle the next time they have to come out.

The blades of the fly are moveable for

cause the barrel to stick on the arbor.

Many a musical box has undoubtedly been put out of action in the misguided belief that it wears a precious jewel in its head like Shakespeare's toad. The unromantic fact is that the jewelled endstone is only glass and can be replaced by a piece of hardened and polished steel.

30 Million-volt Synchrotron

FOLLOWING their operation of the world's first Synchrotron in 1946, the Electronics Group of the Ministry of Supply's Atomic Energy Research Establishment has now made a larger machine, producing 30 million-volt X-rays.

The machine was designed by scientists at the A.E.R.E. and constructed in association with industrial firms, prominent among them being the English Electric and General Electric Companies.

The Synchrotron is a new form of machine for accelerating electrons or nuclear particles to very high speeds. The present machine accelerates electrons until they are travelling so rapidly that their mass increases to sixty times its normal value.

The 30 million volts which such accelerated electrons can produce would give a spark some 50 yards long in normal air. Yet nowhere in this apparatus is an accelerating voltage used greater than that of a normal wireless battery.

This small voltage is, however, applied more than two million times in the thousand-miles long path of the electrons through the machine. Despite this very great distance travelled by the electrons the machine is quite small, since the electrons are caused to travel round an 8in. diameter track by the field of a magnet. They complete the entire course in 1/200th of a second.

150-ton Machine

The 30 million-volt Synchrotron has been developed for two main purposes. First it is acting as a model to provide information for the design of the very high energy machines now being constructed in Britain. Among these is the 300 million-volt, 150-ton Synchrotron being constructed by Metropolitan Vickers in association with the A.E.R.E. and the University of Glasgow.

This machine will be used for fundamental research in nuclear physics at the University of Glasgow, where a special building is to be erected to house it.

To pave the way for the use of this larger machine, one of the smaller 30 million-volt machines has already been despatched to Glasgow University from the A.E.R.E.

The second use of the Synchrotron is a medical one. The X-rays which are produced by the 30 million-volt electrons are so penetrating that they should make it possible to treat malignant tumours deeply seated within the human body, and at present not easily accessible to external radiation.

Machines are already being constructed to enable the Medical Research Council to experiment with these penetrating rays, but it will be some time yet before the medical potentialities of the rays are fully investigated.

Swiss P.O. Underground Railway

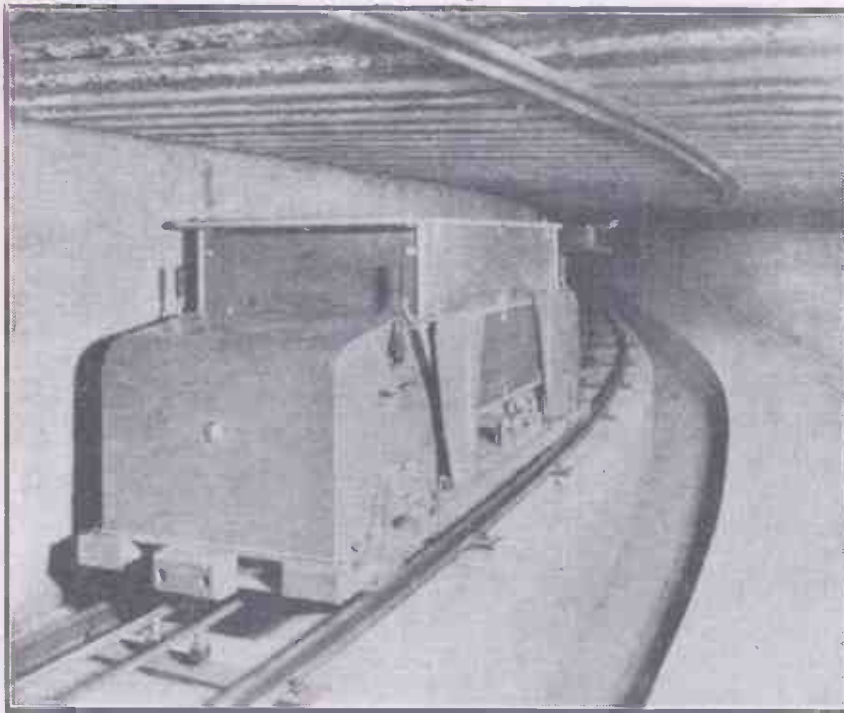

A loaded car travelling through the tunnel of the Zürich Underground Railway. Note the two central conductor rails and the inspection trench. The space for a second track can also be seen. (Photo by courtesy of the Swiss Post Office (PTT), Bern.)

A SHORT underground railway with some unusual features is being operated by the Swiss Post Office (PTT) in Zürich. Owing to its specialised use it is as little known as the G.P.O. (London) underground railway which was built for a similar purpose.

In 1927 PTT constructed a new office in Zürich near the Central Railway Station. Plans for a new branch office in the station itself were also made at the same time. To obviate the need for road transport and to save time in the transfer of mail in both directions it was decided to provide an underground railway connecting both offices. A tunnel, 370 yds. long, was built between 1927-1929. The new station branch, how-

How the Swiss Post Office at Zürich Deals With the Transfer of Mail

By W. H. R. GODWIN

forms part of the bridge construction over the River Sihl. At the Central Station office the tunnel terminates in a lift. This is arranged for automatic operation and takes the mail-carrying motor truck 9 feet up to the ground floor of that office. A second lift has been provided which enables mail containers to be unloaded in the basement in case of a breakdown, etc. of the auto-lift. The track is laid on steel sleepers set in concrete. Two conductor rails, in the form of copper bars of special profile, and additional control circuit rails in the stations are mounted between the running rails.

Three-phase Motors

A.C. at 500 volts, 50 cycles, is fed by

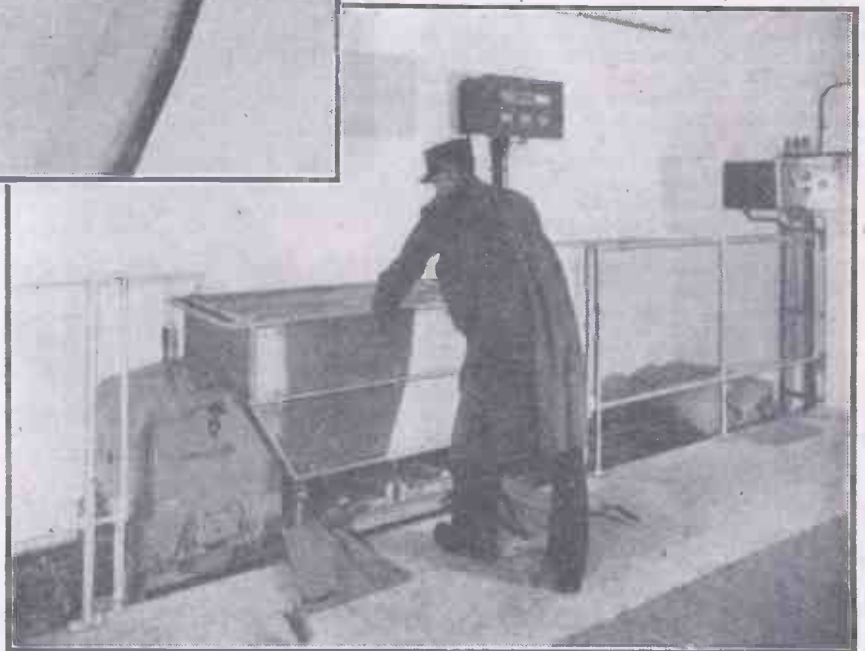

A car being loaded at the "Sihl Post" station. The operating panel and signal board can be clearly seen. (Photo by courtesy of the Swiss Post-Office (PTT), Bern.)

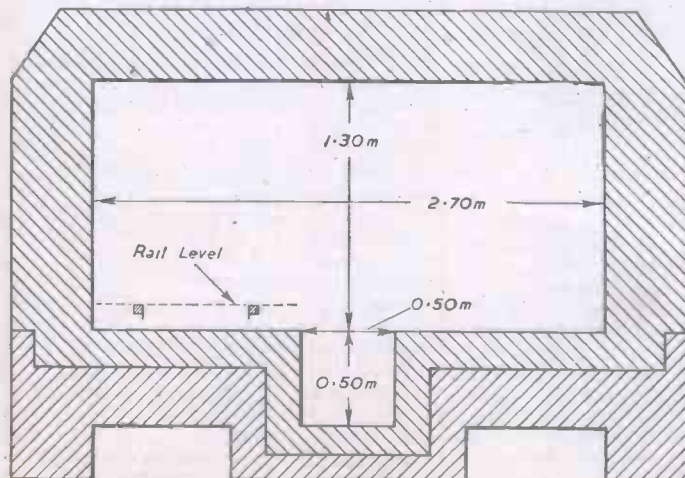

Section of the tunnel, giving dimensions

ever, was not taken into use until 1938 and the railway therefore only then commenced operation.

The tunnel is of a height of 1.30m. and was built wide enough to accommodate two 60cm. gauge tracks. The second track has not been laid up to the present. In the centre of the tunnel there is an inspection or control pit of a depth of 50 cm. This runs through the entire length of the railway except where the tunnel

cable from the "Sihl Post" building to a switchboard and transformer with two secondary windings supplying 220 volts, 3-phase, 50 cycle current to the railway. This system of electrification was chosen in preference to D.C. or single-phase A.C. as it does not require rectifier equipment, and consequently there is no uneconomic idling of rectifier or converter when no traffic is being operated. It also allows of simple motors to be used, reversal of running being effected by changing over two phases. One phase is connected to earth, that is, the running rails.

Only one motor car is in use at present. This is arranged for driverless operation by remote control. The car is 2.40m. long and weighs 550 kg. It consists of a platform frame, which takes the mail container weighing up to 250 kg., carried on two axles. One of the axles is connected through gears to a 3.5 h.p. motor. This motor gives the car a speed of 14.4 feet/sec. The other axle is driven by a 1 h.p. motor giving the car a speed of 0.98 feet/sec. This motor is brought

into operation on the station sections by means of an electro-magnetic clutch which then cuts out the other motor. The clutch is controlled by a change-over switch actuated by a lever arm working on special ramps between the running rails. There are no springs but the wheel centres are rubber mounted to absorb shock. Four collector shoes are provided under the car. The loading flaps, when closed, complete the motor circuit so that if they should open when the car is in motion the motor is switched off and the brake applied.

Operation

There are "send and receive" panels and indicator boards at both stations. Assuming

the loaded car is ready for despatch to the "Central Station Branch" operation will be as follows: The operator at "Sihl Post" will push button "send." This causes a contactor to close and energise the current rails and to "make dead" the braking section at the receiving station. The car begins to move at the slow speed until its control lever leaves the ramp when the other (3.5 h.p.) motor takes over. The car travels through the tunnel at a speed of 10 m.p.h. until it reaches the braking section which is dead. The brake is applied by strong springs and the speed is reduced. The car then runs on to the control ramp, the slow speed motor is switched on and a solenoid pulls the brake off again. The car comes to a stop in the lift, which,

after a time lag of approx. 3 seconds begins to rise. When the ground floor level is reached a warning hooter is sounded which is stopped only when the lift doors are opened. Should the lift not be in the correct position to receive the car the latter will come to a dead stop and can then be unloaded in the basement.

The time taken for a journey is approximately 2½ minutes, which includes the time in the lift. Some 150 single trips are made in a day.

The electrical and mechanical equipment was supplied by Oerlikon of Zürich, with the exception of the lift installation which was built by the Carriage & Lift Works, Schlieren.

Mathematics as a Pastime

The End of His Tether: Pure and Applied.

By W. J. WESTON

A GREAT mathematician says this of his subject: "Pure mathematics consists entirely of assertions to the effect that, if such and such a proposition is true of anything, then such and such another proposition is true of that thing. . . . Thus mathematics may be defined as the subject in which we never know what we are talking about, nor whether what we are saying is true." Indeed, from time to time you are asked to imagine all manner of unlikely things in your mathematics. Here is an instance. The field of three and one-third acres is in the form of a perfect equilateral triangle, its three sides of the same length, its three angles each of 60 deg.; the owner of the donkey bargains for grazing right over half the field, over one and two-thirds acres, that is; the farmer, clever calculator, makes a tether of such length as will prevent the donkey, fastened to one angle of the field, from exceeding the stipulated allowance. Well, how long is the tether?

The donkey—as we do when we exhaust our resources—goes to the end of his tether and, but that he is restricted by the sides of the field, his grazing space would be the area of a circle with a radius as long as the tether. As things are, however, one-sixth only of the circle is at his service. For, since you divide the circumference into 360 deg., the sector having 60 deg. at the centre has an area of one-sixth of the whole.

Your problem, therefore, resolves itself into this: the circle has an area of 10 acres (six times ⅔ acres, that is), how long is its radius? So, since the area of a circle is πr^2 , you have the identity

$$\pi r^2 = 10 \text{ acres} = 48400 \text{ square yards}$$

$$\text{so } r^2 = \frac{48400}{\pi} \text{ square yards}$$

$$\text{so } r = \sqrt{\frac{48400}{\pi}} \text{ or } \sqrt{\frac{220}{\pi}} \text{ yds. or just over}$$

124 yards.

Will you give your mind for a while to another most unlikely combination of things? You are to assume that the world is a perfectly smooth sphere and that a rope tightly encircles the equator. That rope would be a long one, 26,000 miles—no less. But now assume another rope 2 yards longer raised to a uniform height above the equator. How to keep it raised were a problem for Archimedes; but, there you are, the two ropes enclose a ring. Can you creep through the ring?

The answer is "Yes, unless you are stout indeed." For consider: the diameter is the circumference divided by π . The difference between the diameters of the two circles (one of 26,000 miles circumference, the other

of 26,000 miles and 2 yards) is 2 yards divided by π . This is roughly 24 inches. The clearance between the ropes is therefore

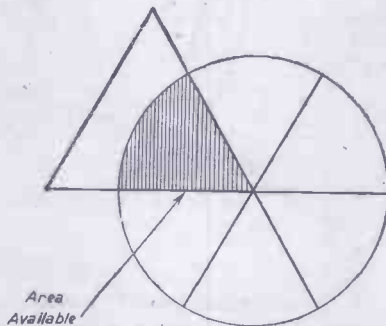

Area Available
How to find the length of the tether.

12 inches; and you have got through that many a time in your obstacle races. The circumferences themselves have no bearing upon the problem: it is the difference that counts.

Pure and Applied

Wisecracks at the Board of Education would have scholars taught on practical lines. There should be no dealing with figures for their own sake, but only for the sake of ability to calculate the price of bacon, and so on. Mathematics should be applied, not pure. And teachers, loyally trying to do what the Board wanted, found that scholars were quite as eager to wrestle with problems that could have no possible application to life as with problems pretending to such application. Nothing surprising here; for so it has ever been. The great mathematicians made mathematics their pastime as you do; they studied numbers because they gloried in something craggy to break their minds open. The practical benefits from the studies came as an appendage, an accidental outcome of the mental exercise. Exhilarating it is to build up strength of mind, whether by solving cross-words or playing chess or working problems in numbers; results of the building up can wait.

A problem like this, for instance, is remote from real life; no sane person, seeking to learn the length of the sides, would measure in the way suggested. The problem is remote in time, too; for its original is, so far as is known, on a Babylonian tablet of about 2000 B.C. Purely academic, you may say; but not to be rejected therefore. No tangible prize attends the right solution—only the delight of achievement in a mental gymnastic.

Here it is: "A piece of land covering 1,000 square feet is the sum of two squares.

Two-thirds of the number of feet in the side of one square exceeds by 10 the number of feet in the other square. What are the lengths of the sides of the squares?"

Pondering over this as over a chess problem and without setting anything on paper, you might well hit upon the numbers wanted: "a large square and a small one," you say, "the small side a good deal less than the large side; the sum only 1,000; why, 30 squared comes to 900; the numbers must be 30 and 10."

Perhaps you rejoice in getting the answer in this intuitive way more than in the formal: Let a = the length in feet of the large square.

Then $(\frac{2}{3}a - 10)$ = the length in feet of the small square.

$$\begin{aligned} &\text{and} \\ &a^2 - (\frac{2}{3}a - 10)^2 = 1000. \\ \text{or } &a^2 + \frac{4}{9}a^2 - \frac{40}{3}a + 100 = 1000. \\ \text{or } &\frac{13a^2}{9} - \frac{40a}{3} - 900 = 0. \\ \text{or } &13a^2 - 120a - 8100 = 0. \\ \text{or } &(a - 30)(13a + 270) = 0. \\ \text{or } &a = 30 \quad \text{or } -\frac{270}{13}. \end{aligned}$$

And, since numbers justly dealt with never give such an absurdity as a negative length,

you neglect the $-\frac{270}{13}$ and assert that 30ft. is the longer side, 10ft., therefore, the shorter side.

Don't despise pure mathematics. The ideas in merely academic problems may issue in unforeseen experiences in real life. And even the most devoted adherent to applied mathematics has, perforce, to make use of ideas that have no counterpart in actuality. A line, he says, is length without breadth; but you have never seen, never will see, such a line. It is a creature of the imagination.

**WORKSHOP CALCULATIONS
TABLES AND FORMULÆ**

Eighth Edition
by **F. J. GAMM**

A handbook dealing with methods of calculation, solution to workshop problems, and the rules and formulae necessary in various workshop processes. It contains all the information a mechanic normally requires.

From all booksellers, 6/- net,
by post 6/6 from the publisher,

**GEORGE NEWNES, LTD. (Book Dept.),
Tower House, Southampton Street, W.C.2.**

Letters from Readers

"Electric Light and Power Installation"

SIR,—With regard to the fourth instalment of your excellent series on "Electric Light and Power Installation," I feel one point should have been made as a warning.

Mr. Corner states:

"Lead-covered cable . . . , but there is nothing to preclude its being sunk in the plaster . . ."

In this connection there is one danger, that at some time subsequently, either through the ignorance of a handyman or forgetfulness on the part of the electrician, nails, especially picture fasteners, may be driven into the wiring—to its detriment.—D. L. HAWKINS (Harrow).

Light-sensitive Cells

SIR,—Reading through the "Queries and Enquiries" in the June issue, I was interested in the one by W. J. Sadd on photo cells.

Some years ago I read in a U.S.A. publication details of a photo cell which I at that time constructed.

The cell was of the copper oxide type, the plate being sensitised by the method you state but in the dark. Other methods of producing such a surface are: (1) heating the plate and dipping it in water, (2) heating until black with oxide and then soaking in ammonia until all the black oxide has been removed.

The other electrode is made by cutting a strip of lead about $\frac{1}{16}$ in. wide and $\frac{3}{16}$ in. long, the copper electrode being about $\frac{1}{2}$ in. wide. The two electrodes should then be mounted and suspended in a jam jar or other container. The electrolyte is lead nitrate. I cannot remember the concentration but it is not important.—I. J. CONIBEAR (Gloucester).

An Electric Alarm

SIR,—As my alarm clock rings neither loud nor long, I looked around for some idea to boost it up a little.

My plan was to use the clock for switching on an electric bell; and, since the winding key for the alarm unwinds when the alarm rings, this was obviously my ready-made switch.

All that remained to be found was some springy metal for the other contact, and my junk-box provided this in the shape of a burnt-out electric iron element.

I clipped off a piece of mica about an inch square complete with a connecting strip, and fastened this by means of a nut and stud, which were placed conveniently near to the alarm key.

The connecting strip was twisted until it came into the radius of the alarm key (see sketch).

Next I took a piece of flex, twisting one wire round the base of the connecting strip and one under a nut on the case of the clock, the other two ends going to an adapter.

This completed the work on the clock, and next I screwed my electric bell to the lid of a cigar box (for additional noise) and stored my twin-cell cycle battery inside. One pole of the battery was connected to a terminal of the bell, while the remaining pole and terminal were taken to a lampholder which is coupled to the adapter on the clock when in use.

When the alarm rings the circuit to the bell is closed and opened intermittently, giving a "burr-burr" similar to an auto-exchange telephone, and finally, when the alarm has run down sufficiently, the circuit is held closed.

When winding the alarm, the strip can be bent back a little and replaced within the

radius of the alarm key afterwards. It is necessary to ensure that the key is wound short of or past the strip on the final turn

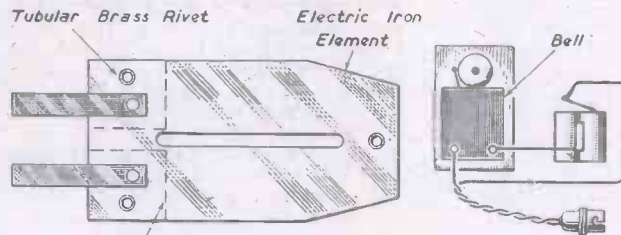

Cut Out Along Dotted Line One Only Required

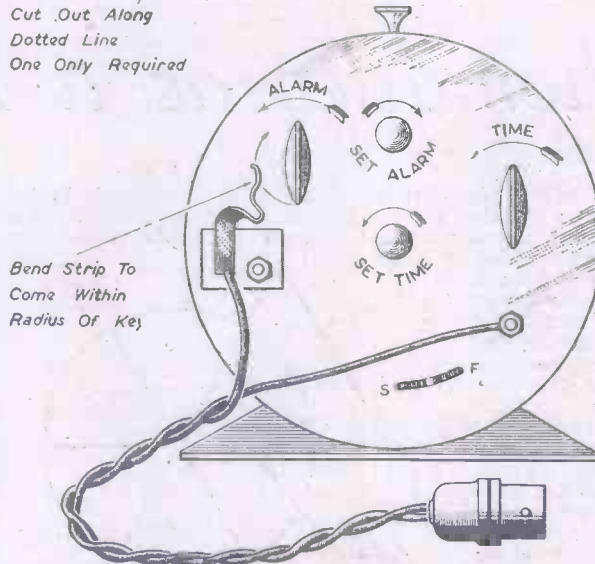

Converting a clockwork alarm clock to an electric (S. Tordoff, Bradford.)

to keep the circuit open until the alarm rings. —S. TORDOFF (Bradford).

Making Imitation Pearls

SIR,—In a recent issue of your PRACTICAL MECHANICS, a reader asked you for a suitable recipe for making imitation pearls. Here is a simpler recipe than the one given:

Dissolve 4½ ozs. of barium chloride in 12 ozs. of water.

Dissolve 4½ ozs. of sodium hyposulphite (hypo) in 25 ozs. of water, in separate glass beakers.

Filter both solutions and heat the sodium hyposulphite solution to 80 deg. C. (176 deg. F.) and add it to the barium chloride solution. A precipitate of barium hyposulphite will form. Pour off the surplus solution and fill the beaker again with water; pour off the water again. Do this with 10 separate lots of water. Now spread the precipitate on a blotter and allow it to dry.

Give the glass beads (clear ones) a coat of enamel (white or tinted) of the type that is soluble in acetone and allow to dry.

Now place some of the barium hyposulphite in a small dish and cover it with acetone.

Dip a soft brush into the mixture and stir and pick up a good amount. Quickly in one stroke apply the brush to the pearl. Repeat this until the pearl is finished, then coat it with thin, clear lacquer.

If enamel that is soluble in acetone cannot be obtained here is a recipe:

Coat the pearl with hard white enamel and allow to dry. Now dissolve 1 oz. of celluloid in 12 ozs. of acetone and apply on the white enamel. Allow it to dry and proceed as before.

This recipe gives very good results and it is fairly cheap.—R. SCHEMEL (Andover).

Another "Famous" Locomotive Model of 1903

SIR,—The photograph and particulars of the 2½ in. gauge L. & S.W. loco model (4-4-0, No. 593), on page 272 of the May issue of PRACTICAL MECHANICS, reminds me of another contemporary model of the same period which was much in evidence at that time, and this was the model (also 2½ in. gauge, I believe) of the Great Central Railway (inside cylinder 4-4-0, express engine No. 268, designed by Mr. Pollitt when loco engineer of the G.C.R.). The three models, viz., "Black Prince," L. & S.W. (Adams, No. 593), and the G.C.R., No. 269, were put on the market at about the same time.

The Great Central model (which may have been a Bassett-Lowke production, but which I believe was manufactured by a London firm) interested me at the time, as it was put on the market shortly after the Great Central had been opened through to London, and at that time, when I lived in Hull, these engines commenced to work through to Hull on the Liverpool-Hull express trains, and at that time were the largest engines to work into Hull Paragon station.

I wonder if any of your readers possess a working specimen of this excellent model to-day? Mr. Burton is certainly to be congratulated on having preserved his specimen of the one-time famous L. & S.W. "flyer."

—NORMAN DUNCAN (York).

Cutting Safety Glass

SIR,—We have read the letters in recent issues concerning the cutting of safety glass, and after reading the one from Mr. J. H. Turner, we feel that the following information would interest your readers.

Messrs. Triplex were quite in order when they stated that "Toughened" safety glass cannot be cut, but there is also an extensively used laminated safety glass which can be cut, and in which work we specialise.

"Toughened" safety glass is usually marked as such. Laminated safety glass is not always marked, but consists of an interlayer between two sheets of glass.—Everard and Co., Ltd., (Hove, Sussex).

Book Received

The Story of the T.T. By G. S. Davison. Published by The T.T. Special. 160 pages. Price 9s. 6d.

MOTOR-CYCLISTS and others interested in the sport will find this handy little book a mine of information on motor-cycle road racing. It gives a vivid picture of the evolution of the T.T. races, and interesting reminiscences of some of the pioneer riders. A noteworthy feature of the book is its excellent photographic illustrations.

DUSTBIN MENACE

Wastepaper thrown out as rubbish means dollars lost to Britain—so save every scrap.

THE WORLD OF MODELS

Society of Model and
Experimental Engineers'
Exhibition : Display of
Models at Sheffield
By "MOTILUS"

THERE were two important events in the history of the model world that made their appearance almost simultaneously: "The Model Engineer," and shortly afterwards, the formation of the Society of Model and Experimental Engineers, who had



Fig. 2.—A fully-detailed model of the "Mayflower," the pilgrim ship of 1640; model made by Mr. Richards, of the Lyons M.E. Club. Above, to the left, can be seen the model air-sea rescue launch, fitted with a Blakeney steam plant, the work of Mr. L. G. Warner, of S.M.E.E.

their first general meeting in November, 1898. The late Mr. Percival Marshall was unanimously elected chairman and treasurer of the society at that meeting. Since then the society has gathered strength steadily and increased in scope and popularity up to this year, the fiftieth anniversary of its inauguration. The anniversary was celebrated by an exhibition of members' work, covering the whole period of the society's activities and held in the Exhibition Hall of the Imperial Institute, South Kensington, London. This hall is a large, well-lit room, which enabled visitors to examine with ease the wonderful collection of models that were displayed.

Every visitor connected with the model world was pleased to see that our old friend, Mr. J. Crebbin, a veteran of the society, although he had been recently indisposed, was able to be present at the opening of the Jubilee Exhibition and join with the president, Lord Forres, and the chairman, Mr. J. Latta, in welcoming those attending on the opening day. During its run the exhibition was honoured by a visit from H.R.H. the Duke of Edinburgh, who spent about three-quarters of an hour there, showing great interest in all branches of the model work.

The hall was devoted entirely to work of the members of the society, without any trade exhibits or other diversions from concentration on what I think was probably the

finest display of amateur model work ever seen together in one place. The oldest exhibit was accorded a place of honour on top of a central pillar; this was a table engine made in 1830 by an Oxford professor of

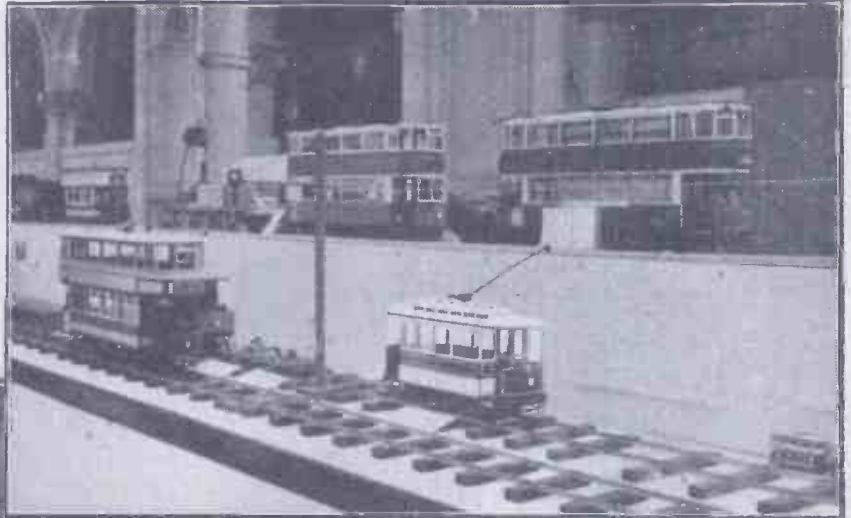

Fig. 1.—Examples of models of the Tramway and Light Railway Society, at the S.M.E.E. Jubilee Exhibition, to a scale of $\frac{1}{2}$ in. to 1 ft. and $\frac{3}{4}$ in. gauge. They include an L.C.C. Class E tramcar, by Mr. R. Elliott, and a free lance single-decker tramcar by Mr. K. H. Thorpe (both shown on the track.)

mathematics, who had formerly been a surveyor on some of the first railways. He built the engine on a home-made lathe and afterwards used it to drive the lathe. But it is impossible, in reviewing a comprehensive display of this kind, to deal with all the historic, ingenious and also the up-to-date models that were on view.

Probably the most attractive exhibit for many of the general public was the gauge "00" layout of the North London Society of Model Engineers. This was a two-rail layout raised 3 ft. 6 in. from the ground, measuring 18 ft. by 10 ft. 6 in. and operated from a central space. It represented an imaginary section of the ex-Great Northern main line, with a station, sidings, locomotive depot with running shed, yard and turntable, tunnels, an embankment, and shops alongside the track. A special feature was the electrically-operated points, constructed by members. This model railway was commenced in 1946 and is still incomplete, although now sufficiently

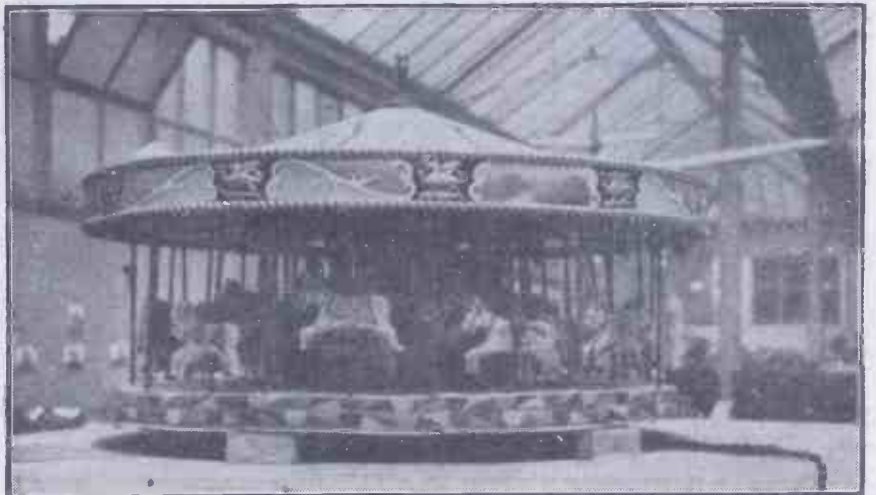

Fig. 3.—A model roundabout with a musical organ. A constructional working model by Mr. J. E. Bisley, of Enfield. This colourful model attracted much interest.



Fig. 6.—A model not often seen in exhibitions : that of a small drilling machine of $\frac{1}{2}$ in. capacity. This one is by Mr. W. H. Naylor, from a design of E. T. Westbury (Sheffield S.M.E.E.).

advanced for detailed working manoeuvres.

A most important item for the young people was the locomotive running track of about 30yds. Various types of locomotives were used for passenger-hauling, including an L.M.S. $3\frac{1}{2}$ in. gauge "Princess Elizabeth," built by Mr. E. J. Linden, and which was driven up and down the track, with a full load, by H.R.H. The Duke of Edinburgh during his visit to the exhibition.

Mr. J. Crebbin's famous locomotive, "Cosmor Bonsor," which has probably done more exhibition passenger-hauling than any model locomotive ever built, was the first to be tried on the new locomotive testing bench at the exhibition. This mechanism created much interest among locomotive builders and engineers, and is adapted to

take locomotives from $2\frac{1}{2}$ in. gauge to 5 in. gauge ; it gives drawbar pull readings at all speeds, and settings of the valvegear, and should enable brake horse-power measurements to be recorded.

Alongside the running track was arrayed a long procession of some 20 working model locomotives of various types and scales. One of these was a historic Midland Railway goods locomotive of 1867, to a scale of 1 in. to 1 ft., a model that is possibly some 60 years old. Unfortunately, the maker's name is not known. Among the other locomotive exhibits was a 4-4-0 old Midland type model (number 2631), $\frac{3}{4}$ in. scale, $3\frac{1}{2}$ in. gauge, designed by the late Henry Greenly for the firm of Bassett-Lowke, Ltd., with the idea of supplying a full set of castings for building a locomotive without any sheet metal except for the boiler. This idea was popular in its day and the model exhibited was one built in 1906 by Mr. A. W. Averill, of Alcester, who bequeathed the model to the society at his death. This model was a good milestone in the progress of model locomotive building. At that time it was an entirely new departure from the usual run of model-making, and was a successful attempt to place a working scale model within the reach of those who had little equipment

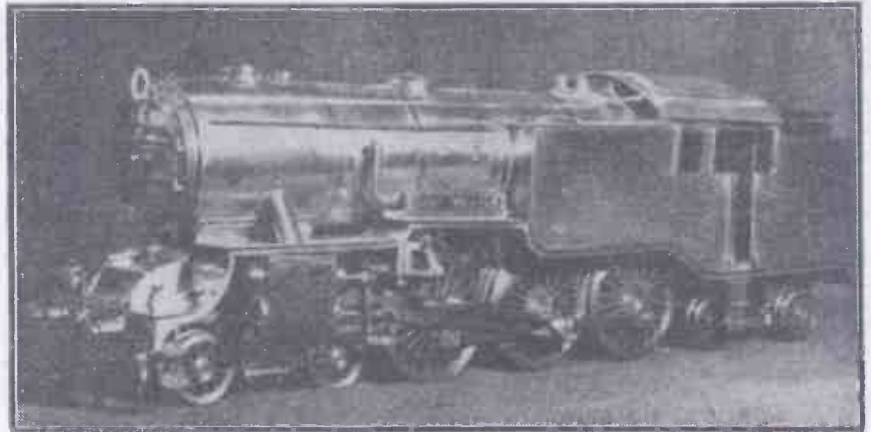

Fig. 5.—A fine locomotive model, "Just William." This $\frac{3}{4}$ in. scale, free-lance locomotive was made by Mr. W. Grange, of the Sheffield S.M.E.E., with the aid of hand tools and a $2\frac{1}{2}$ in. centre Portass lathe, hand operated.

for model-making. There were over 150 separate castings in the set, and the price at that time was £5, including a set of working drawings.

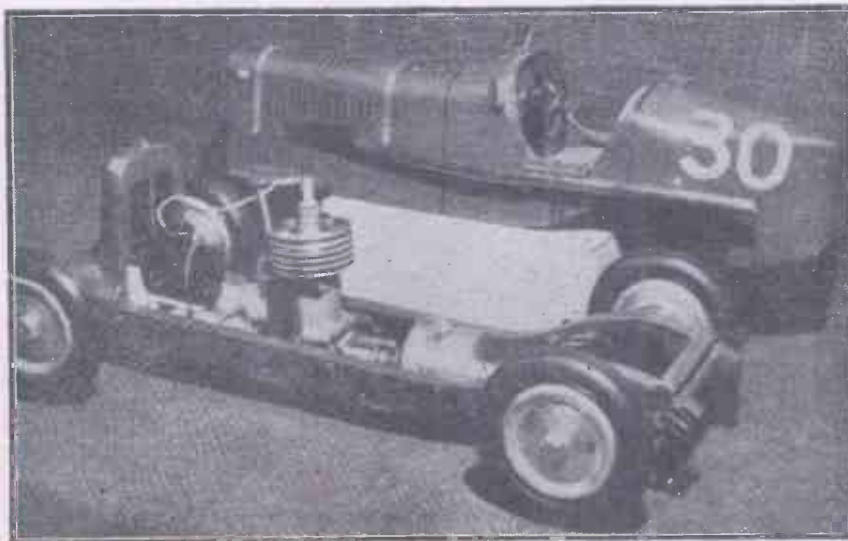

Fig. 4.—A striking model of a D-type E.R.A. car, fitted with a 6 c.c. Stenor petrol engine, the whole realistically modelled by Mr. L. Shaw, of the Sheffield Society of Model and Experimental Engineers.

Turning to another form of locomotion, the Tramway and Light Railway Society had a stand with a good selection of tramway models, and a running track. The models included an L.C.C. Class E tramcar, $\frac{3}{4}$ in. scale, $3\frac{1}{2}$ in. gauge, built by Mr. R. Elliott and another model to the same scale of a free lance single-deck tramcar, by Mr. K. H. Thorpe (Fig. 1).

Model ships were well to the fore, representing many periods from the *Mayflower* time to the present day. The *Mayflower* pilgrim ship of 1640 had been modelled by Mr. Richards, of the Lyons Model Engineering Club, and among the modern ships was air-sea rescue launch model of free-lance design, by Mr. L. G. Warner, of the S.M.E.E., the model being fitted with a Blakeney steam plant (Fig. 2). A unique piece of work was a motor cruiser, *Slickery*, made by Mr. R. O. Porter, of Victoria Model Engineering Club. This model is powered by lighter fuel and is one of the first models with an internal combustion engine fitted with magneto ignition.

A model that attracted much attention, and which has now been accepted by the Science Museum, was Mr. A. W. Marchant's single-cylinder diagonal surface-condensing paddle.

engine, to a scale of $\frac{1}{2}$ in. to 1 ft. Mr. Marchant, a member of the S.M.E.E. living at Worthing, won a championship at the Model Engineer Exhibition with this model. The prototype, of about 1870 to 1890, was built for a ship 210ft. long with a 24ft. beam and a speed of $16\frac{1}{2}$ knots, the original cylinder being 52 in. in diameter and having a stroke of 5ft.

An attractive and unusual exhibit was a model "roundabout," a showman's constructional working model with "three-abreast gallopers" (Fig. 3). This is entirely constructional, being composed of 389 parts, taking approximately three hours to assemble. The organ, which plays merrily, is a separate unit. The model was built by Mr. J. E. Bisley, of Enfield, and is a most realistic piece of work.

Model aircraft, stationary engines, boat engines, traction engines and numerous interesting working mechanical models made a visit to this exhibition a fascinating and memorable experience.

Sheffield Exhibition

More news of model exhibitions comes from Sheffield, which I mentioned last month. The Sheffield and District Society of Model and Experimental Engineers held their fifth exhibition during Easter week this year, at the Central Technical School. Their public relations officer, Mr. W. J. Hughes, writes to tell me that the venture was even more successful this year than last, with more

models on show and more visitors to enjoy the exhibits. Co-operating with the society in their exhibition were the Sheffield Ship Models Society, Aeromodellers' Club and Model Yacht Club, so the combined effort resulted in a varied and stimulating collection. I am indebted to Mr. Hughes for the compilation of some most interesting notes on the whole exhibition.

As well as a popular passenger-carrying railway, the society had a gauge "00" railway in operation, both being kept busy throughout the time the exhibition was open. The gauge "00" track covers an area 12ft. by 9ft. and was built for the society in 1939. It is a large oval of double track with two sidings, one of which branches into three sections. The layout is divided into insulated sections which can be switched in or out independently, points and signals being solenoid operated. The whole can be dismantled for storage and, as might be expected, it had to be packed away during the war. It was brought to light and renovated for the society's exhibition in 1946, and by this time one of the members, Mr. F. Hughes, is busy devising new features to make the layout more comprehensive and diverting; these include a road-bridge, a turntable, shops, etc.

The ranks of Sheffield amateur modellers must be expanding, as I notice several references to "first attempts" in the lists of exhibits in all sections. The model "D" type E.R.A. car, for instance, is Mr. Shaw's first effort, and a very creditable one, too (Fig. 4). The model is fitted with a 6 cc. Stentor petrol engine, but up to the time of the exhibition had not been tried out on a track. The radiator and chassis are of wood, faced with aluminium, and the body is of sheet balsa on plywood formers. The finish is green cellulose, brush-painted, with a polish of metal polish and wax.

Another remarkable first model, made in odd spare time over a period of 10 years, is Mr. J. H. Hatherley's "Annie Boddie," a 2½in. gauge locomotive. Being engaged on clerical work, Mr. Hatherley had no engineering knowledge, but was interested in model engineering and followed the series run by L.B.S.C., called "The Tyro's Lobby."

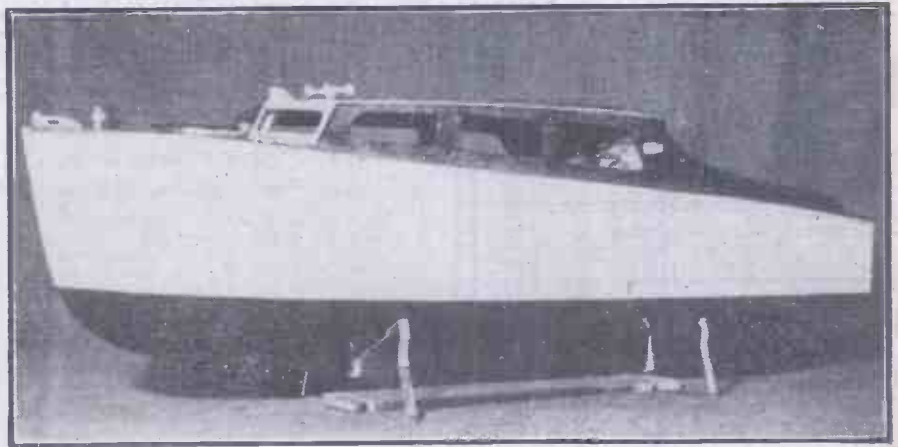

Fig. 7.—An unfinished 24in. model of a cabin cruiser, "Chiquita," by the Public Relations Officer of the Sheffield S.M.E.E., Mr. W. J. Hughes. The model is to Mr. Hughes's own design and represents a hard-chined 24ft. cabin cruiser to a scale of 1in. to 1ft.

Seeing the description of "Annie Boddie" in this series, he decided to make a start on it, and persevered, despite difficulties with his workshop equipment. Apart from the usual hand tools and a vice, Mr. Hatherley had only a treadle-driven 3in. Portass lathe. His hours of hard work were rewarded when he put his locomotive to the test and found she responded well, even on a primitive track of flat steel bars laid on the lawn.

Another triumph of perseverance displayed at this exhibition was a ½in. scale free-lance locomotive, "Just William" (Fig. 5), made by Mr. W. Grange, who adapted the design of L.B.S.C.'s "Helen Long" by omitting the last pair of coupled wheels. The wheels and cylinders were the only castings purchased, and the builder made all the fittings except the pressure-gauge. The boiler is to Mr. Grange's own design, and the locomotive has a Baker valve-gear with all parts fitted and drilled by hand. Mr. Grange only had a 2½in. centre Portass lathe which he purchased secondhand and had to adapt for his own purposes, which he did most ingeniously. He had to fit a handle as his only source of motive power,

so he can literally claim that the turning necessary for work on the locomotive was "hand-turning"! Even cylinders and wheels were turned and bored with this lathe.

The drilling machine of ½in. capacity, illustrated in Fig. 6, was made by Mr. W. H. Naylor, from a design by E. T. Westbury, and modified by the builder in the feed design, the job occupying some three months of Mr. Naylor's spare time in the evenings.

As public relations officer for the society, Mr. W. J. Hughes found himself so busy with organising work that his own contribution to the exhibits, a model cabin cruiser (Fig. 7) was unfinished. All the same, there was evidently sufficient to show what an attractive piece of craftsmanship the finished model will be. It is to Mr. Hughes's own design and represents a hard-chined 24ft. cruiser to a scale of 1in. to 1ft.

The model boat season is now in full swing and ship-modellers will be interested to know that the very efficient and popular "Remod" propellers introduced by Messrs. Bassett-Lowke, Ltd., are again available, for both right and left hand.

Trade Notes

Heavy Duty Loudspeakers

GOODMANS INDUSTRIES, LTD., announce the release of two new heavy duty loudspeakers which have been designed specially for use in theatres, rinks, dance



A Goodmans heavy duty loudspeaker.

halls, and similar places where public address installations are necessary. They are also suitable for use with electronic organs. These high-power reproducers are of robust construction and combine efficiency, clarity and dependability to a high degree. The larger instrument, which has an overall diameter of 18in., has an output of 50 watts, and a response of 35/4,000 c.p.s. The other loudspeaker, of 15in. diameter, has an output of 25 watts, and a response of 40/6,000 c.p.s. An illustrated folder, giving full particulars of these loudspeakers, is obtainable from Goodmans Industries, Ltd., Lancelot Road, Wembley, Middlesex.

"Burmors" Petrol Blowlamp

THIS handy lamp, which is of particularly robust construction, is marketed by Townson and Coxson, Ltd., Alliance Works, Essington Street, Birmingham, 15. It gives a very steady flame, which is easily adjustable by means of a heat-proof regulator knob. Pre-heating is carried out by filling the shallow

cup beneath the burner with methylated spirit and lighting it. When the spirit has almost burnt out, the burner valve is opened slightly by turning the regulator knob until the petrol vapour ignites. To extinguish the flame the regulator knob is simply turned in a clockwise direction as far as it will go. Spare parts for "Burmors" blowlamps can be obtained from most tool dealers.

WATCH YOUR DUSTBIN.

Waste paper, cartons, cardboard should be kept separate, dry and clean for salvage.

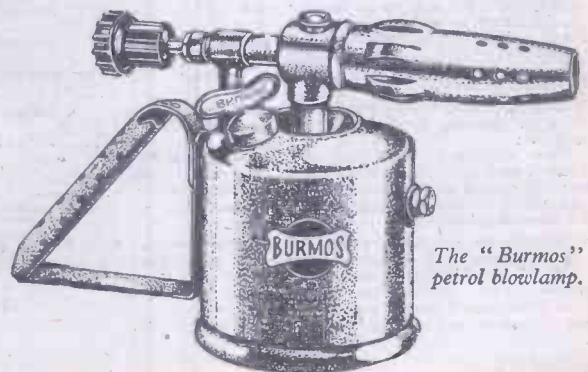

The "Burmors" petrol blowlamp.

QUERIES and ENQUIRIES

A stamped addressed envelope, three penny stamps, and the query coupon from the current issue, which appears on page 88 (THE CYCLIST), must be enclosed with every letter containing a query. Every query and drawing which is sent must bear the name and address of the reader. Send your queries to the Editor, PRACTICAL MECHANICS, Geo. Newnes, Ltd., Tower House, Southampton Street, Strand, London, W.C.2.

Extracting Sugar from Beet

CAN you please tell me how to extract sugar from sugar beet or mangolds, just on an experimental scale? Are there any books published on the subject?—E. J. M. Jones (Harpden).

IT is difficult to extract sugar from beet on a small scale, particularly so as the details of the process have been more or less kept secret by the large organisations concerned. However, the following is the gist of the process:

The beet is skinned, washed and cut into slices. These are subject to pressure and the expressed juice is heated with about 1 per cent. of its weight of milk of lime in order to neutralise any acids present and to coagulate the vegetable proteins which are always present and which would undergo putrefactive decomposition.

The resulting liquid is treated with carbon dioxide gas to precipitate any excess of lime. It is then slightly diluted with water and boiled with bone or animal charcoal in order to decolourise it as much as possible. It is then filtered, and evaporated (preferably under reduced pressure in a vacuum pan) until a syrup is obtained. Crystals will be deposited from this syrup, and the uncrystallisable syrup which is left may be used as treacle.

The following are books on the subject of beet sugar manufacture. In each case the pre-war published price (net) is given in brackets:

R. N. Dowling, "Sugar Beet and Beet Sugar" (15s.).

T. H. P. Heriot, "Manufacture of Sugar from the Cane and Beet" (24s.).

W. M. Krauze, "Practical Handbook for Beet Sugar Chemists" (10s. 6d.).

G. Maryineau, "Sugar: Cane and Beet" (3s.).

Casting Concrete Posts

I WANT to cast some concrete posts and shall be glad if you can inform me what proportion of sand and cement to use.

Also, what is the method used to prevent the mixture adhering to the wooden mould?

Is there any difference in the method of manufacture for posts of different height, and what is the method of casting in the wire holes?—V. Richardson (Gateshead).

A GOOD cement mix for your purpose will be Portland cement, 1 part, pit sand, 3 parts. Sea sand should not be used, since its particles are too rounded and since it contains salt and other unwanted contaminations.

The cement mix is moulded in wooden "boxes," the sides of which are knocked away with a mallet after the cement has set. No special lubricant is needed, although in this connection it is a good plan to give the interior sides of the "boxes" a brushing with a slurry of powdered limestone and water of creamy consistency.

The height of the posts is governed by the length of the boxes in which the cement is moulded. Otherwise, the process of formation is the same in all cases.

Wire holes are cast in the posts by standing wooden pegs upright in the cement mix before it hardens. After setting, the pegs are knocked out of the post with a mallet. To facilitate this, the pegs should taper very slightly, but it is by no means essential that they should do so, in which case ordinary wooden dowels cut to suitable lengths may be used for the purpose.

Chemical Treatment of Metallic Foils

I WOULD appreciate your recommendation of any books dealing with the following matter:

The chemical treatment of metallic foils (.004in. and .006in.), oxidation, bronzing, etc., and the utilisation of such foils on wooden formers as practised in the making of hearth furniture.—D. Powell (Redditch).

THERE are no books specifically written on the treatment and utilisation of metallic foils. Information on this specific matter would be best sought among the files of Patent Specifications in the Birmingham Reference Library, and, also, of course, among the various metallurgical monographs on the different metals which are available.

In general, however, the chemical treatment of

metallic foils by way of colouring, oxidation, sulphurisation, etc., is described in any volume dealing with the colouring of metals. Books such as the following will, we think, be of direct interest to you. In each case the (pre-war) publishers' retail price is appended in brackets:

S. R. Bonney and S. Field, "Chemical Colouring of Metals and Allied Processes" (10s. 6d.).

R. M. Barns and Schuh, "Protective Coatings for Metals" (32s. 6d.).

A. H. Hiorns, "Metal Colouring and Bronzing" (6s.).

H. Krauze, "Metal Colouring and Finishing" (21s.).

It may be possible that some American books obtainable now in this country deal with the subjects in which you are interested. To this end you should inquire of a good overseas bookseller, such as Messrs. Wm. Bryce, Ltd., 54, Lothian Street, Edinburgh.

Compression-type Refrigerator

I AM building a compression refrigerator using copper pipes. Can you please advise me what liquid can be used as I understand ammonia will attack the copper? Also, what metal can be used with ammonia?—A. Dowsey (Pinner).

THE ammonia used for your refrigerator must be perfectly dry, and, using this, tubes of stainless steel would be suitable. Note that the ordinary "ammonia" of the pharmacist is not used. Ammonia is a gas which, when compressed, becomes liquid. It is the gaseous or "anhydrous" ammonia which you require.

An inert refrigerant which can be used with copper tubes is dichlorotetrafluoroethane, commonly known as "Freon." This, we believe, can be obtained from I.C.I., Ltd., London, S.W.1.

Foaming Material

CAN you tell me the materials used to produce foam for cleaning carpets and upholstery, etc., also where they can be obtained?—G. Watt (North Ferrisby).

THERE are many varieties of foaming materials, but, for the purpose you name, these are mostly made up on a basis of saponin and a synthetic detergent, such as Teepol-X. No commercial formulae for these materials are available, all of them being maintained secret. Hence, it will be necessary for you to experiment yourself with the use of the above materials in aqueous solution.

For saponin, apply to any wholesale chemical supplier, such as Messrs. Reynolds and Branson, Ltd., of Leeds, Messrs. Griffen and Tatlock, Ltd., Keeble Street, Kingsway, London, W.C.2, or Messrs. W. & J. George and Becker, Ltd., 17-29, Hatton Wall, London, E.C.1.

Teepol-X and similar detergents are obtainable from Shell Chemicals, Ltd., 112, Strand, London, W.C.2.

Calculating the Pull of a Solenoid

WILL you please tell me what determines the strength (pull) of a solenoid? Is it the number of turns, gauge of wire or, as I suppose, the two combined?

Is there a formula or any book on the subject which is not very technical?—P. H. Prowse (Hemyock).

THE pull of a solenoid really depends on the magnetic flux density created by the current in the coil, and on the cross-sectional area of the core. The flux density is approximately proportional to the number of ampere turns (product of coil turns and current); the type and dimensions of the magnetic circuit and the length of pull also govern the flux density.

If a series connected coil is used in a D.C. circuit the current through the coil is more or less fixed by the voltage and the resistance of the circuit in which the coil is connected; hence the amp. turns is proportional to the number of turns. In a shunt connected D.C. solenoid the coil current depends on the voltage and on the resistance of the coil, the latter depending on the size of wire, length of mean turn, and the

number of turns. In a shunt connected A.C. solenoid the coil current depends on the inductance of the coil as well as its resistance. Inductance depends on the supply frequency, the number of turns, and the value of the magnetic flux.

The subject is thus rather complex and is too involved to allow being treated by a letter. The book "Electromagnets and Windings," by G. Windred (Geo. Newnes, Ltd.) would probably help you to work out solenoids and other electromagnets.

Graining Crayons: Removing Stains on Stonework

COULD you please supply me with a recipe for making black and brown graining crayon, which readily leaves a sap marking on a wet ground of linseed and turps.

Also will you advise me of a suitable material for removing brown fume stains from Portland stone over a fireplace?—C. N. Warneford (Brighton).

THE graining crayons which you mention are based on wax-pigment mixtures. They are made in the following manner:

Heat about 1 part of white wax with 4 parts of water until the wax has melted. Then stir in 1 part of caustic soda and gently simmer for about half an hour. Cool, and add about 1 part of gum arabic, or as much of the gum as will render the liquid very thick. Into this, stir lampblack (to make a black pencil) or Vandyke brown (to make a brown pencil). Work the pigment well in, and mould in suitable wooden, metal or plaster moulds of the size required. The pencils thus formed should be kept in a perfectly dry place. Since they can be used with either oil or water, they are suitable for all types of graining.

The brown stains on your fireplace stonework will not be easy to remove, since they consist of carbon derived from the smoke. There is no solvent for carbon. Your best plan will be to loosen the carbon particles by scrubbing over the affected stonework a hot solution of caustic soda (say 1 part in 5 of water) and rinsing off with hot water. This will remove all the grease and a good deal of the surface staining, but it cannot deal with minute black carbon particles which have been driven deeply into the stonework pores. Repeated treatments will go a long way towards this, however, although nothing but an entire re-facing of the stone by a process of grinding with another stone of the same nature will give the stonework a completely fresh and new appearance.

Non-metal Mould for Casting Aluminium

I WISH to make a permanent die (non-metal) for casting repetition work in aluminium.

I shall be obliged if you will inform me of any mixture that can be made up at a reasonable cost, which will withstand the heat and give good results.—W. J. Dower (Barking).

A SILICA mould would be about the best for your purpose, since you eschew metal moulds. Silica moulds have been used for precision casting. They are made from a hydrolysed solution of ethyl silicate. The method is, perhaps, rather expensive, but it is quite sound, and you can obtain particulars of the process from Messrs. Albright and Wilson, Ltd., 49, Park Lane, London, W.1.

Alternatively, you can produce fairly enduring casts by means of slaking calcined magnesite with a 40 per cent. solution of magnesium chloride (i.e., a solution made by dissolving 40 parts of magnesium chloride in 60 parts of water). The process is considerably cheaper than the previously mentioned ethyl silicate one, but, in this instance, magnesium compounds are, unfortunately, very difficult to obtain at the present time. After slaking with the magnesium chloride solution to mortar consistency, the magnesite material sets dead hard in about 30 hours, and because it very slightly expands on setting it gives very sharp and accurate casts. If desired, the magnesite may be mixed in any proportion up to 50:50 with fine white silica sand or other fine inert filler.

"Westminster" Chimes

I WISH to make a "Westminster" chime of four notes only, and would be obliged if you

THE P.M. LIST OF BLUEPRINTS

- "PRACTICAL MECHANICS" 12 FT. ALL-WOOD CANOE.* New Series. No. 1. 3s. 6d.
- "PRACTICAL MECHANICS" 10-WATT MOTOR. New Series.* No. 2. 3s. 6d.
- "PRACTICAL MECHANICS" COMPRESSED-AIR MODEL AERO ENGINE.* New Series. No. 3. 5s.
- "PRACTICAL MECHANICS" "SPORTS" PEDAL CAR.* New Series. No. 4. 5s.
- F. J. CAMM'S FLASH STEAM PLANT. New Series. No. 5. 5s.
- "PRACTICAL MECHANICS" SYNCHRONOUS ELECTRIC CLOCK. New Series. No. 6. 5s.*
- "PRACTICAL MECHANICS" ELECTRIC DOOR-CHIME. New Series. No. 7. 3s. 6d.*
- "PRACTICAL MECHANICS" £20 CAR. (Designed by F. J. CAMM). Full-size blueprint, 2s.
- 10s. 6d. per set of four sheets.
- "PRACTICAL MECHANICS" MASTER BATTERY CLOCK.* Blueprints (2 sheets), 3s. 6d.
- "PRACTICAL MECHANICS" OUTBOARD SPEEDBOAT. 10s. 6d. per set of three sheets.
- A MODEL AUTOGIRO.* Full-size blueprint, 2s.
- SUPER-DURATION BIPLANE.* Full-size blueprint, 2s.
- The 1-c.c. TWO-STROKE PETROL ENGINE.* Complete set, 7s. 6d.
- STREAMLINED WAKEFIELD MONOPLANE—3s. 6d.
- LIGHTWEIGHT MODEL MONOPLANE. Full-size blueprint, 3s. 6d.
- P.M. TRAILER CARAVAN.* Complete set, 10s. 6d.
- P.M. BATTERY SLAVE CLOCK.* 2s.

The above blueprints are obtainable, post free, from Messrs. George Newnes, Ltd., Tower House, Southampton Street, Strand, W.C.2.

An * denotes constructional details are available, free, with the blueprint.

will let me have data for the approximate length of tubes. The tubing I have is one inch outside diameter and 29/32in. inside solid drawn brass tube. The longest length is to be approximately 20in.—W. A. Palmer (Dublin).

THERE are several supposed "Westminster" chimes, but the authentic one is, as you state, on four notes only.

It is not possible to give you approximate lengths for the sounding tubes, but you will be able to work these out for yourself according to the following method.

The tubes must be open at each end. The longer the tube, the deeper its pitch. The shorter the tube, the higher its pitch. Actually, the musical pitch of the tubes varies according to the length, diameter and thickness, but with a tube of given thickness and diameter the above is correct.

You can start with a tube of any length and call its note the "tonic" or keynote of the scale. A tube half its length will give a note approximately one octave (eight notes) above the long tube.

Set these length measurements down full-scale on paper. That is to say, draw lines on paper exactly equal to both tube lengths. Then draw a slanting line from the lower end of the longer tube or line to the lower end of the other.

Now, at equal distances between the longest and the shortest tubes (or lines representing them), draw six more lines at equal distances apart, each line contacting the slanting line drawn from the longest to the shortest tubes. Number the lines thus obtained 1 to 8, counting upwards from the longest tube.

This diagram will give you the approximate length of the tubes to provide a complete octave of notes above the pitch of the longest tube (always provided that all the tubes are of the same metal, diameter and thickness).

The Westminster chime is played on notes 5, 7, 6, 2. Hence all you have to do is select the measurements of the tubes corresponding to these notes and prepare tubes to those lengths.

Note that the lengths so obtained are only approximate. The approximation, however, will be pretty close, but, if anything, each may require very slight filing or cutting down. They are best tuned in unison with the notes of a piano of the same pitch. The job is quite an easy one if you have a musical ear, but it calls for some considerable amount of patience.

Each tube should be drilled at its upper end (in exactly the same position) and suspended from silk, gut or leather lines. The distance apart of the suspended tubes is immaterial, but they should all be struck at precisely the same place (near the upper end), with a leather-faced hammer.

Purifying Carbonic Acid Gas for Soda Water

COULD you please inform me how to make carbonic acid gas purer, for use in making soda water? Also, is it just tap-water that is used with the gas?—A. Strickland (Northwood).

TO prepare a reasonably pure supply of carbon dioxide (carbonic acid gas) for soda-water making, place marble chippings (or chalk) in a bottle fitted with a thistle funnel and delivery tube. This latter tube should lead into another bottle containing a strong solution of sodium carbonate. A mixture of equal parts of water and pure hydrochloric acid is poured down the thistle funnel so as to cover the marble chips. Carbon dioxide gas will at once be generated. It is "washed" in the sodium carbonate bottle and any traces of acid clinging to it are neutralised by the sodium carbonate.

This, therefore, provides your source of the gas. But you cannot make soda water without dissolving the gas in water under pressure. It is no use merely leading the gas into water at ordinary pressures, for the gas will not dissolve in sufficient quantity to form soda water. Pressure-solution must be employed, and it is for this reason that the normal commercial way of preparing soda water on a small domestic scale is to use a wire-wrapped pressure bottle or syphon and to utilise carbon dioxide gas which has been stored in miniature steel "bulbs."

Ordinary tap water will suffice for soda water making, and it is an advantage if this has dissolved in it about half a gram of sodium bicarbonate per gallon of water used.

Electroplating Aluminium

COULD you inform me whether it is possible to electroplate aluminium with another metal? If not, will you please give the reason?—H. H. Wjtt (Holloway).

THERE are several reasons why aluminium has been found to be such a difficult metal to plate with other metals, chief among which is the fact that metallic aluminium is normally coated with a thin layer of oxide which adheres most tenaciously to it and which inhibits proper contact between the plating and the plated metals.

You do not indicate the precise metal you desire to deposit on aluminium, but probably the metals which are most satisfactorily plated on it are zinc and cadmium.

For this purpose, the aluminium should be carefully degreased by scrubbing it over with a paste of lime and water, after which it should be pickled for a few minutes in a solution of hydrochloric acid (1 part), water (3 parts). It is then rinsed and immersed at once in the plating bath, which, for zinc plating, should have the following composition:—

Zinc chloride	12 oz.
Sodium chloride (common salt)	20 "

Aluminium chloride	2 oz.
Water	1/2 gallon.

The inclusion of the aluminium chloride in the plating bath is not essential, but it gives white and smooth deposits on the metal.

The above bath should be used with a voltage of 4-6 and with a current-density (amperage) of 15 to 30 amperes per square foot of surface to be plated.

On the deposited zinc, any other metal, such as copper, nickel, chromium or silver can be plated subsequently.

High-power Magnetiser

COULD you please supply me with the electrical and mechanical details of a suitable apparatus for remagnetising magnets and magdynamos, and the application of same?—G. R. Jefferson (Hull).

A POWERFUL magnetiser could be constructed on a soft iron or mild steel core to the dimensions given in the accompanying diagram. The distance between the pole pieces should be equal to the inside

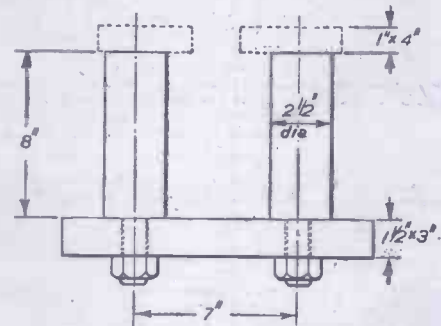

Details of magnet and pole pieces for a high-power magnetiser (G. R. Jefferson).

distance between the magnets to be treated. Each pole could have three coils, each with 55yd. of 16 s.w.g. The three coils on each pole should be connected in parallel with each other, and in series with the parallel set of coils on the other pole, for use with a large 12-volt accumulator. When viewed from the poles the current in the coils on one pole should circulate in the opposite direction to that in the other pole.

We suggest you switch on the current and lower the magnet on to the pole pieces. If the magnet is suspended with a piece of string it will swing so that its North pole rests on the South pole of the magnetiser and vice versa. With the magnet resting on the poles the current should be switched on and off a few times. In order to retain the maximum value of magnetism in the magnet a soft iron or mild steel keeper should be placed at the side of the poles of the magnetiser so that the magnet can be slid on to the keeper as it is removed. The keeper should be retained in position until the magnet is replaced in the magnet or magdynamo.

Methanol as a Car Fuel

I SHALL be very grateful for any advice you can give me upon the following subject:

- Can methanol be used as fuel in a motor-car, and, if so
- What adjustments, if any, must be made to the engine and its auxiliaries?
- Can methanol be bought a few gallons at a time and, if so, from whom? If not, what is the smallest quantity which can be bought? What is the price?
- What is the comparative consumption as compared with petrol?
- Is the use of methanol likely to harm the engine in any way?—R. M. Longstaff (Ealing).

METHANOL (methyl alcohol), can be used as a car fuel, although you would find that, if used alone, it would give rise to bad knocking. Since it contains combined oxygen, such a fuel would need a smaller air intake. Hence, an adjustment would have to be made to the carburetter in this respect, only about one-third of the air being required when compared to the amount of air necessary for ordinary petrol running.

Methanol will not harm the engine in any way, but it will not result in economies in running. Indeed, an engine designed for petrol will use up twice as much alcohol as it does petrol to develop the same amount of energy.

Alcohol fuels can be compressed much more than petrol. Hence, for economical and knock-free running you must have a higher compression when running with such fuels. Also, some form of pre-heating device is often necessary for the carburetter in order to vapourise the starting fuel in cold weather.

Methanol is not supplied for car fuel purposes, since, apart from mere experiment, it is hardly suitable. Also, it is in restricted supply. It can be obtained from British Industrial Solvents, Ltd., 4, Cavendish Square, London, W.C.1, from I.C.I., Ltd., Millbank, London, S.W.1, and from General Metallurgical and Chemical, Ltd., 120, Moorgate, London, E.C.2. We expect that, in small amounts, you would have to pay about 4s. per gallon for the liquid.

Small Pottery Kiln

COULD you please inform me how I can build, from readily available material, a kiln suitable for firing small clay models and pots? The clay to be used fires at 1,080 deg. C., and I intend to glaze at lower temperatures.

Can you please suggest any books dealing with this subject?—R. W. H. Marsh.

YOU do not say with what you intend to heat your proposed kiln; coke, electricity or gas? These fuels all require special designs of kilns or furnaces. Your best plan is to choose a gas-fired furnace, this being the most controllable. You require, essentially a series of blue-flame gas burners concentrically arranged around the kiln chamber in which the clay models are fired. The burners must heat the chamber from all sides. The furnace itself should be built up from refractory material such as fireclay slabs, unglazed "biscuit" or asbestos sheeting, and it must stand on a thick base of such material.

This, of course, is only a mere outline description, since your details are not sufficient to allow us to give any other. In any case, however, your best plan is to study the few volumes which are available on the subject of pottery modelling. Recommended books are: C. F. Binns, "The Potter's Craft," "A Practical Guide for the Studio and Workshop," H. and D. Wren, "Handcraft Pottery for Workshop and School," G. J. Cox, "Pottery for Artists, Craftsmen and Teachers," R. Lunn, "Pottery: A Handbook of Practical Pottery for Art Teachers and Students," B. A. Waldram, "Pottery for Beginners." Messrs. Dryad Handicrafts, Ltd., St. Nicholas Street, Leicester, may also be able to supply you with practical leaflets on the same subject, and, also, to supply pottery kilns.

Colouring Bronze Tubes

I WISH to blue or blue-black some bronze tubes by a chemical process that will not easily rub off. As the tubes are rather long I should prefer a "paint on" process if possible. Will you please tell me of some alternative methods I can try?—S. F. Pester (Christchurch).

THE following simple process will be effective for colouring your bronze tubes, but we cannot tell you the exact shade which it will give, since that depends on the composition of the bronze. However, the shade will be between a true black and a blue-black.

Dissolve 1lb. copper sulphate in about half gallon of water. Then add strong ammonia (with continual stirring), until the greenish precipitate of copper hydroxide which is first formed abundantly is nearly (but not quite) redissolved. The liquid should at this stage be slightly "muddy" in appearance. Then add about another quarter gallon of water, making a total bulk of three-quarter gallons.

The above liquid should be used hot, being painted on the bronze. The metal must, of course, be completely grease-free. This is best accomplished by brushing a weak caustic solution on to the metal beforehand and then rinsing it well afterwards. Use a solution containing one part of caustic soda dissolved in about eight parts of water, and, for preference, use it hot, or, at least, warm.

A rather darker shade may be obtained by using copper nitrate in place of the copper sulphate above-mentioned.

Again a suitable liquor can be made by dissolving copper carbonate in ammonia, but, in this case, the ammonia must not be in excess. That means that there must be more copper carbonate in the solution than the ammonia will dissolve, thereby resulting in a faintly muddy solution being obtained.

Other methods of obtaining bronze-blacks involve the use of arsenic, and these are likely to be too dangerous to use.

However, you can refer to many methods of metal colouring in a book entitled, "Metal Colouring and Bronzing," by A. H. Hiorns, price (pre-war) 6s. net. This may be available in your nearest reference library. Another book on the same subject is "Metal Colouring and Finishing," by H. Krause.

An article on the "Chemical Colouration of Metals" appeared in PRACTICAL MECHANICS for March, 1937.

Metallic Paint

COULD you suggest a medium suitable for mixing with gold, silver and coloured bronze powders?

I have tried various mediums such as cellulose and copal varnish gold size reduced with turpentine, but none of these have been of any use, either going greenish or gelatinous.

I want to be able to make it in quantity and possibly keep it for some period before use.—I. Bristow (Edmonton).

WE assume that you wish to prepare not a metallic ink but, rather, a metallic paint, enamel or lacquer.

For this purpose, the recognised medium is a plain cellulose solution. You can make this by dissolving clear scrap celluloid in a mixture of approximately equal parts of acetone and amyl acetate, or, alternatively, in cellulose, any of which liquids are to be obtained from the several large chemical supply firms in the London areas.

The procedure is to keep the solution separate from the metal powder and to mix them only before the painting is commenced. Nevertheless, the mixed material can be kept almost indefinitely if it is preserved in well-sealed containers. Needless to say, stirring of the medium will be required prior to use.

The above medium dries rapidly, since it does not contain any oil or resin. Any similar clear cellulose medium, such as can often be obtained from paint stores, could be used instead.

ELECTRADIX

FOR FINEST BARGAINS

MOTORS. 50 volt A.C. series wound, totally enclosed motors 11/2 h.p., 2,500 r.p.m., shaft ext., at both ends and fitted clutch, £3. 110 volt D.C. 11/2 h.p., 1,500/2,000 revs. needing minor repairs, 15/-.

Bulk-head Fan motors only. 110/220 volts, 35/-.

SEWING MACHINE MOTORS. 230 volts A.C./D.C. square construction, totally enclosed with pulley, belt and bracket, £4.10.0.

MOTOR BLOWERS, by Keith Blackman, 24 volts D.C. 5in. inlet and 5in. outlet, 85.

DYNAMOS. 12 volt 10 amp., enclosed, 1,400 r.p.m. as new, £2.5.0. 30 volt, 5 amp., 1,500 r.p.m., £4.10.0. 50/70 volt 10 amp., 1,000 r.p.m. shunt wound, £15. 12 volt, 30 amp., 2,000 r.p.m., £4. 24 volt, 30 amp., 2,000 r.p.m., 85.

HAND MAGNETO GENERATORS. 4 or 5 magnet type. Approx. output 120 v., 50 m.a. A.C. perm. Steel magnets, wound armature, driven by gearing in handle. As new, 12/6, postage 1/-.

METERS. Iron clad 4in. S/B. meters. 0-40 amps. and 0-50 volts A.C. by G.E.C., 45/- each. 5in. I/C ammeter, 0-14 A.C. S/B type, 50/-. Crompton I/C switch-board meters, 6 1/2in. x 6 1/2in. x 4in., with lamp on top to illuminate dial. 0-50 amps., 60/-; 0-75 volts, 55/-.

TELEPHONES. Wall type constructors' parts, ex-G.P.O., comprising cabinet Bin. x 6in. x 3in., bracket mike, transformer and condenser, mag. bell, switch-hook and contacts, hand mag., ringer P.O. type receiver terminals and connection diagram, 35/- per pair.

HAND COMBINATION TELEPHONES. Ex-P.O. stock mike and receiver as illustration, bakelite body with switch and long 4-way cord, 15/- each, 25/- pair. Ex-G.P.O. moulded bakelite sound power hand coms. with switch cord and plug, 21/- each, 40/- pair.

MAGNETS. D.C. Electric magnets, weight 10 oz., lift on 2 volts 1 1/2 lb., 4 volts 3 lb., 6 volts 4 lb., new, surplus, 7/6 each. Permanent powerful flat bar magnets, 2 1/2in. x 1in. x 1/2in., drilled 2 holes each end, and any pole pieces, 2/- pair. The wonder Midget magnets. Alni perm. steel disc: 1/2in. diam., 1/4in. thick, with 3/16in. centre hole, 3/6 each. Large stock of Horseshoe magnets. Send for special Magnet Leaflet, "P.M."

DIMMERS. Panel dimmers, totally enclosed, for valves, small light control or safety switches on test circuits, 100 ohms 1/2 amp. or 50 ohms, 1/2 amp., 2/6.

RESISTANCES. Panel mounting, wire wound 10 ohms, 1 amp., 2/6. R.I. 58 ohms, 1 amp. Radial type with laminated arm, carbon tip contact. Polished knob and dial, a precision job, 7/6. Variable slider resistances 6 1/2 ohms, 6 1/2 amps., 17/6, 14 ohms, 5 amps., 25/-.

WIRELESS CONTROL UNITS. ex-R.A.F., contain Yaxley switch and knob, connection strips, fuse and holder, coil socket and connections, 2/6, postage 9d. Larger model with 2 Yaxley switches and pilot lamp, 4/-, plus 1/- postage.

SWITCHES. Dewar Key switches, 7; pole C.O. with top plate, 5/-; Lucas 8-way switch box, 3/6, 6-way, 3/-.

MORSE KEYS. Here is the Key you have been waiting for, a solid job for the Transmitter, bakelite base 3 1/2in. x 1 1/2in. insulated arm and large knob, heavy adjustable back and front contacts, smooth action, beautifully made and scientifically designed with length of heavy insulated cord and Jack plug, 21/-.

We have also a lighter model of similar design with brass arm and insulated knob (without cord and plug), 15/-.

PARCELS. 10 lb. useful oddments for the junk box. All clean, dismantled from Government and other surplus apparatus, 7/7 post free. (Not for Overseas buyers.) Please include postage for mail orders.

ELECTRADIX RADIOS
214, Queenstown Road, London, S.W.8
Telephone: MACaulay 2159.

Air Ministry Surplus

BOMB SIGHT COMPUTER.

An absolute marvel of electro-pneumatic construction. Cost over £300 to make, contains an enormous quantity of parts useful to the amateur mechanic. Includes precision gyro instrument, four 'Sylphon' tubes, over 800 spring washers, nuts and bolts, repeater motor, two 24 volt motors with reversing clutch mechanism, slow motion dials, aneroid capsules, shafts, springs, metal and flex tubing, plus over ONE HUNDRED ASSORTED PRECISION GEAR WHEELS (variable pitch worm gear, bevels, spirals, rollers, ratchets, worms, skew-gears, etc.). All mounted on baseplate supported on carrying frame by four heavy anti-vibration mountings; weight approximately 90lb. Carriage paid 65/-.

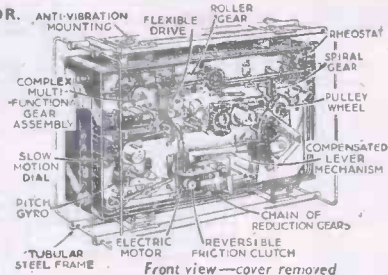

VISIT STAND No. 39, AT MODEL ENGINEER EXHIBITION

CAMERA GUN.

Beautiful lightweight instrument containing high-quality 2in. F3.5 lens, compact gate mechanism, shutter and magazine. 12 or 24 v. motor but can be modified for use as hand-operated cine camera or conversion to a projector. The robustly constructed magazine takes standard 16-mm. film. By using this camera as a basis a really first-rate 16-mm. cine camera can be constructed at very little expense. From the break-down aspect contains compact electric motor and chain of fine precision reduction gears. Amazing value. (Postage and packing 11/6) 35/-

CAPILLARY THERMOMETER.

An accurate thermometer suitable for dark-rooms, greenhouses, etc. Calibrated from 0 to 100 deg. C. With 30ft. of flexible capillary tubing, 2 1/2in. case with flange. (Post 1/-), 15/6.

GRID STEERING COMPASS.

Ex-A.M. pattern pilot's compass, luminous, 0-360 degrees with cardinal points. Ideal for small craft. 4in. dial diam. Spirit filled. In transit case. (Post and packing 1/-), 25/-



HAND BEARING COMPASS.

Ideal compass for bearings; suitable surveyors, speleologists, yachtsmen, etc. Spirit-filled with prism, battery handle, case. Cost over £20. (Post 1/3) 65/-

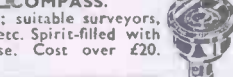

AERO-SPARES CO.

Head Office: 69, Church Street, Edgware Road, N.W.8
71, HIGH HOLBORN, W.C.1
Phone: (All Depts.): AMBassador 4856

Double-Ended Tail Stock Die Holder

DIMENSIONS:
Circular Dies .. 13/16 & 1/2 in. O.D. Length of Body .. 3 inches
 Morse Taper Shank .. No. 1 Total Weight .. 1 1/2 lbs.



Die-holder body knurled for cutting light threads. Knurled hand-grips for heavy threads. Accurately ground parallel guide and shank. High-class finish throughout.

For holding circular dies 13/16in. o.d. and 1/2 in. o.d. Fits into tail stock of Lathe. Die-holder body slides along parallel part of tapered shank, enabling threads to be cut accurately and squarely.

Price 18/6 net. Carriage Paid.

BENSON AND WARD

3-4, LINCOLN'S INN FIELDS, LONDON, W.C.2. HOLborn 3258

YOU

can become a first-class RADIO ENGINEER

We are specialists in Home-Study Courses in Radio Engineering, Servicing, Transmission, Television, Mathematics and Radio Calculations.

T. & C. RADIO COLLEGE,
KING EDWARD AVE., AYLESBURY.

Post coupon now for free booklet and learn how you can qualify for well-paid employment or profitable spare-time work.

(Post coupon in unsealed envelope -1d. stamp.)

Please send me free details of your Home-Study Courses in Mathematics, Radio and Television.

Name

Address

M.38

The MODEL CRAFT range of working models, plans and plan books

Model Oil Engine

(model runs on air)

The engine is constructed mainly of paper and strawboard toughened by a method outlined in the book. No unusual tools or materials needed. Price 2/2 post free.

The "Flipclock"

Most people think it quite out of the question for an amateur to make a clock which ever goes, let alone is accurate. But the Flipclock is simple, calls for no unusual tools or materials, and is fascinating to make. Price 3/9 post free.

Model Loom

On this model you can actually weave small articles such as ties or rugs and mats for a dolls' house. As well as giving you fun in the making, there's fun for the family (and instruction) in working it. Price 2/8 post free.

Stationary or Marine Steam Engine

(no lathe required)

This set of plans includes very detailed instructions of how to make this fairly powerful little oscillating type job with ordinary home tools and easily come-by materials. Price 2/8 post free.

Modelcraft Ltd., 77 (L), Grosvenor Road, London, S.W.1.

Save Pounds

and build your own first-class Radio set by using the famous "DORSET" CIRCUITS. NOVICE or EXPERT. These circuits are TOPS. Each manuscript contains very detailed instructions, easy to read black and white drawings, point to point wiring, every step and stage described. NO RADIO EXPERIENCE necessary.

DORSET 2/6 CIRCUITS

each A.C. or A.C./D.C. 5-valve three-wave superhet. with pick-up. ALL DRY BATTERY PORTABLE. 4-valve, med. and long.

BATTERY FOUR. Three-wave superhet. 14 or 2-volt valves. (A real humdinger on short.)

A.C./D.C. 6-valve AMPLIFIER for mike and pick-up, inc. pre-amp.

DORSET COMPONENTS specially designed for above. Chassis, Coil packs, Group Boards, I.F. Transformers, Chokes, Mains Transformers, Speakers, etc. "Hot Spot" battery soldering outfits. Send Id. for list. Theoretical circuits, 21d. each.

WELDONA RADIO ACCESSORIES LTD.
38, Gloucester Road, BRIGHTON.



EASILY MADE FROM OUR CASTINGS
J. HALLAM & SON
UPTON, POOLE, DORSET.
MINIATURE PETROL ENGINES for Aeroplanes, Boats and Race Cars.
Send 6d. for New List.



Higher and Higher

stands the reputation of Harbutt's "Plasticine." For more than fifty years it has been the only reliable material for model makers of all ages. Whether for home amusement — designing — experimenting — or the handyman, "Plasticine" is indispensable. Because it is ever-plastic and hygienic, "Plasticine" has hundreds of other uses, and it never deteriorates.

'Plasticine'

HARBUTT'S PLASTICINE LTD.,
BATHAMPTON, SOMERSET.
LONDON: 68, Victoria Street, S.W.1.

HEADPHONES WHICH UPHOLD BRITISH PRESTIGE



TYPE 'K'

S. G. BROWN, Type 'K'
Moving Coil Headphones, supply that High Fidelity Reproduction demanded for DX work, monitoring and laboratory purposes, etc.

OUTSTANDING CHARACTERISTICS

D.C. RESISTANCE 47 Ohms.
IMPEDENCE 52 Ohms at 1,000 c.p.s.
SENSITIVITY, 1.2 x 10⁻¹² watts at 1 kc.
.0002 Dynelcm².

PRICE **£5.5.0** PER PAIR

Your local dealer can supply.

Descriptive Literature on request.

For details of other S. G. Brown Headphones (prices from 30/- to 63/-) write for illustrated Brochure "P.M."

S. G. Brown, Ltd.

Telephone: Watford 7241

SHAKESPEARE STREET, WATFORD, HERTS.

MIDLAND INSTRUMENT CO.

R.F. UNITS TYPE 24 or 25, complete with valves, 10/-, post 1/-.
19 SET AE. VARIOMETERS MK-3, 3/6, post 1/-.
CRYSTAL VALVE RECTIFIERS, 3/6, post 3d.
MAINS TRANSFORMERS, 230 v., output 50 v. 11 amp., 25/-, carriage 5/-.
MOTORS, 12-24 v. A.C./D.C., fitted centrifugal pump, 35/-, post 1/4.
BALANCED ARMATURE INSERTS, 2in. dia., ideal as midget speakers, microphones, etc., 2/6, post 4d.
SWITCH BOXES, 7in. x 4in. x 2in., contains 16 toggle switches, rotary switch, etc., 7/6, post 9d.
ALTIMETERS, sensitive "K" type, 20/-, post 9d.
100 ASSORT. RESISTORS AND CONDENSERS, 10/-, post 9d.
VOL. CONTROLS, all 1/2 in. shaft, 1 doz. assort., 10/-, post 9d.

Also hundreds of other items; send for our current lists, 2d. with S.A.E. Post orders over 30/- post paid. Our C.O.D. service is temporarily cancelled.

MOORPOOL CIRCLE,
BIRMINGHAM, 17.

Tel.: HARborne 1308 or 2664.

ELECTRIC ENGRAVERS.—Powerful instruments in cylindrical case, on stand with spring attachment and switch. Suitable for dog collars, tool marking, etc., 4-6 volt model, price 50/-; A.C. Mains model, 200-240 volts, 60/-; A.C. Engraver only, 50/-.
TELEPHONE SETS, comprising 2 G.P.O. hand phones, 2 bells, 2 pushes and 80ft. twin wire. Price 85/-, post free. Single instrument, 25/6.
6 inch Brass Brackets, 1in. thread, 1/9.
S.B.C. Fancy glass shades, 1/9.
Circular resistances on china base 10 ohm, 2/-.
Screwplates for threading 0.24 B.A. 4/8.
MOTOR.—4-6v. dry battery driven, well made, powerful, 11/6. Illustrated list, 6d.
Carbon Diaphragm 1/- each and carbon granules 6d. packet.
BATTERY CHARGERS FOR A.C. MAINS. FOR CHARGING 2-volt accumulators at 1 amp. Parts with diagram, 12/6. Complete 21/6. Postage 10d.
FOR TRICKLE CHARGING CAR CELLS, parts with diagram. Output 11 amps. for 6v. cells, 30/- for 12v. cells, 35/- set.
Larger sizes quoted for **MINIATURE HEADPHONE.** Reproduces equal to best phone. Fits into ear, does not require headband. Two nipples, large and small, 10 ohm or 1,000 ohm. Black or flesh enamelled. 4ft. cord. Price 30/-.

ECONOMIC ELECTRIC CO.,
64, London Road, Twickenham, Middlesex. Tel.: POpegrove 1318

MODEL ENGINEERS

FOR THE TURNER:

Lathes, 3 1/2 and 4 1/2 S.S. Bench Millers. Drilling Machines. Hand Bench Shaping Machines.

FOR THE WOODWORKER:

Wood Turning Lathes, 2 1/2" and 5 1/2" centres. 4in. Planers. Saw Benches. Sanders. Spindle Moulders.

Pedestal Jig and Fret Saws.

Perspex—All sizes and colours in stock.

NUTTALL'S (LATHES) LIMITED, MANSFIELD, NOTTS.

CHEMISTRY APPARATUS

Send Stamp for COMPLETE PRICE LIST

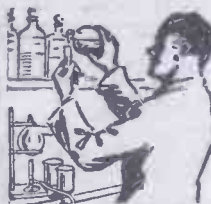

Booklets:
"Experiments" 7d.
"Formulas" 10d.
"Home Chemistry" 2/3
Post Paid

(Scientific Dept. A)
BECK 60 HIGH STREET,
Stoke Newington, London, N.16

"PERIMET" ELECTRODE SOLDERING AND BRAZING TOOL.
Operates from 4 or 6 Volt Accumulator or Transformer.

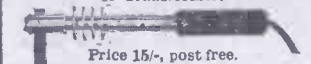

Price 15/-, post free.
MAINS TRANSFORMER. 3 Heats. 35/- delivered.
HOLOROW & CO., 71, Weymouth Bay Avenue, Weymouth.



MAINS / BATTERY MOTOR

Fitted reduction gearbox. Suitable for driving medium-size models. Runs off 6 or 12 v. batteries or 200-250 v. mains (A.C. or D.C.); overall measure—30/-
ments 8in. x 4in. x 4in. Post free, 16/6

ELECTRICAL EXPERIMENTERS ASSORTMENT. More than 100 parts, including Resistors, Switches, Relays, Plugs, Contactors, Terminals, 16/6 etc.

ROUGHY MASTS (ex-R.A.F.). Telescopic Aluminium, 15in. long, opens to 9ft. Very strong. Ideal fishing 10/6 rod, flag mast, etc. Post free, 10/6

MERRIBULL PRODUCTS,
44, Cromwell House, Wood End, Green Road, Hayes, Middlesex.

PERSPEX CRAFTSMEN
These easily constructed machines will streamline your hobby. Sets of clear drawings and instructions for:
(1) JOINTER and SHAPER, for flawless joints, etc. 2/6.
(2) BALLBEARING SANDER and POLISHER for a professional finish. 2/6. All Post Free.
No difficult processes involved. No hard-to-get materials required. Satisfaction Guaranteed.
T. SINCLAIR (Dept. M), 5, Buss Craig Road, Eyemouth, Berwickshire

POST RADIO SUPPLIES

OFFER FROM STOCK:—
COPPER INSTRUMENT WIRE.
ENAMELLED, TINNED AND FUSE.
COTTON AND SILK COVERED.
LITZ WIRES.

Most gauges available.

B.A. SCREWS, NUTS, WASHERS, soldering tags, eyelets and rivets.
EBONITE AND LAMINATED BAKELITE PANELS, TUFNOL ROD.
PAXOLIN TYPE COIL FORMERS AND TUBES, ALL DIAMETERS.
COVERED WIRES, FLEXES, etc.
PERMANENT DETECTORS, CRYSTALS, EARPHONES, etc.

Latest Radio Publications. Full Range Available.

Send stamped addressed envelope for comprehensive lists. Trade supplied.

POST RADIO SUPPLIES

33, Bourne Gardens, London, E.4.
Callers to 395, Queensbridge Road, Dalston, E.8.

JUBILEE WORM DRIVE HOSE CLIPS



The long-life clip with the ever-tight grip

The Best Known For Radiator Joints, Air, Oil and Water Hose Joints
We guarantee a Tight Joint

L. ROBINSON & Co.
25, London Chambers,
GILLINGHAM, KENT



PERFECT PASTIMES Modern Materials for CRAFTS AT HOME

Plastercraft — Leatherwork — Lampshade making — Plastics Models — Toys — Patterns.

Send 1/- for specimen copy of the Magazine Craftworker and Catalogue of instructions, tools and materials.

Homecrafts (Dept. 2),
Albion Street, Broadstairs, Kent

The sign of a Lighthouse

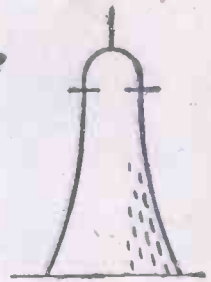
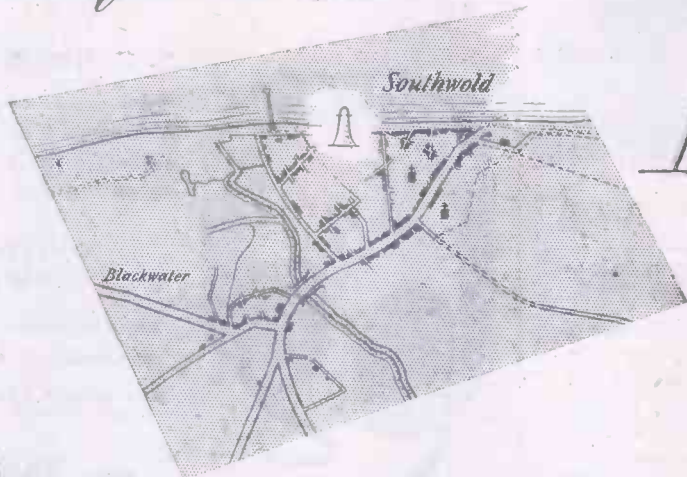

Have you ever seen a lighthouse away across the countryside, and wondered just how you could get to it? It's simple, of course, if you have an Ordnance Survey map, for it will be marked there with the lighthouse sign. When you're by the sea, you're never far from a lighthouse; and each one of the scores which beacon our coasts has some special point of interest. The one illustrated, for example, the Southwold Lighthouse in Suffolk, is the first light picked up by ships crossing the North Sea from the Baltic and Danish ports.

The sign of a good tyre - DUNLOP

EH/306

TOOL NEWS IS OUT

TOOL NEWS is now on sale and a limited number of new subscribers are invited. This handsome quarterly is something entirely new in house journals: chatty, informative and helpful.

To the beginner it offers a valuable guide to practical engineering and modern workshop practice. To the advanced it is a valuable herald of new products of the industry, providing a friendly forum for discussion of production problems. Unfortunately, circulation is limited and early application is essential—5s. Od. per annum, post free to any address in the world. Our latest Stock Bulletins are available for 2½d. stamp.

T. GARNER & SON, LTD.,
Redbrook Works, Gawber,
BARNSELY

Every time you have to STOP



Fibrax

famous
BRAKE BLOCKS

and LINERS
will pull you up
smoothly and promptly

Known to thousands of cyclists
in various patterns to fit all makes of machine. Supplied
over the past 40 years for their reliability and long wearing qualities. Ask your dealer.

FIBRAX LTD., 2 TUDOR STREET, LONDON, E.C.4.

RADIO - CYCLE - SERVICE

RADIO. We specialise in supplying complete kits and individual component parts for all circuits described in this journal, and other technical publications. Send 2½d. stamp for list of our Practical How-to-Build-it Books, complete instructions and designs for the HOME CONSTRUCTOR.

CYCLES. We undertake complete overhauls, cycles resprayed, bright parts replated. We carry large stocks of accessories; send S.A.E. for our cycle list.

NORTH ROAD Upturn Handlebars, complete with roller brakes. Chrome, 30/-; Black, 27/6.

PANNIER BAGS from 34/- to 60/-.

PHILLIPS' Rubber Pedals, 7/9 per pair.

ADJUSTABLE CYCLE STANDS, 3/-
NICKEL BELLS from 2/-.

UNIVICE. The vice with unusual features, specially designed for model makers, electrical and mechanical engineers, 25/-. Anvil base for above, 5/-.

SEWING MACHINE MOTOR, complete with foot speed control and

needle light, fits all standard machines, 28.

POCKET VOLTMETER, moving coil ranges 0/15 and 0/250 volts D.C., 18/6.

SPECIAL OFFER. Brand New P.M. Speakers, 5in. dia., 15/-; 8in. 21/-.

H.R.L. 2 VALVE S.W. KIT. A simple-to-build and efficient battery 2-valve short-wave receiver, covering 12 to 80 metres. Complete list of components, chassis, coils, valves and wiring diagram, £3/12/6.

Circuit, wiring diagram and component list for the H.B.L. 1 valve, S.C.3 or S.W.2 kits, price 1/-.

HENBEST BROS., LTD.

26 Green Lanes, London, N.13

Telephone: BOWes Park 6289

HIGHSTONE UTILITIES



Crystal Sets. Our latest Model is a real radio receiver, which is fitted with a permanent crystal detector. Why not have a set in your own room? 9/6, post 6d. De Luxe Receiver in polished oak cabinet, 18/6, post 1/-.

Spare Permanent Detectors, 2/- each. When ordered separately, 2/6, post 3d.
New Headphones, 10/- a pair, post 6d. Balanced armature type (very sensitive, and very suitable for use with crystal sets), 12/6 a pair, post 6d. **New Single Earpieces, 3/6.** Bal. armature type. 4/6: ex-R.A.F. earpiece, 2/-, post 4d. **Headphones, reconditioned and in good order, 5/6, post 8d.** (Better quality, 7/6.) **Headphone Cords, 1/3 a pair, post 3d.** **Replacement Bands, 1/3, post 4d.** **Wire Bands, 6d.** **Bell Transformers.** These guaranteed transformers work from any A.C. Mains, giving 3, 5, or 8 volts output at 1 amp., operate bulb, buzzer or bell. Will supply light in bedroom or larder, etc. **PRICE 8/-.** Post 6d. **BELLS** for use with either the above or batteries, 6/-, Post 6d.

Ex R.A.F. 2-valve (2-volt) Microphone Amplifiers as used in plane inter-com., in self-contained metal case; can be used to make up a deaf aid outfit, intercommunication system, or with crystal set, complete with valves (also unused), 20/-, post 1/6. Useful wooden box with partitions to hold amplifier, 2/- extra. Ditto, less valves, 10/-.

One valve amplifier, complete with valve, 9/6, post 1/-.

Hand Microphones, with switch in handle, and lead, 4/-. Similar instrument, moving coil, 7/6, post 6d.

Sparking Plug Neon Testers, with vest pocket-clip, 3/6, and with gauge, 3/6, post 3d.

Telephone Sets, with ringing hand generator, twin bells and G.P.O. type handcomb, 30/- each, carr. 2/6. 57/6 pair, carr. 3/6.

New handcomb sets, 7/6, post 6d. Telephone hand generator, with handle, 9/6, post 1/6.

Bell, 4/3, post 6d.

Meters. All brand new. 0-1 m/a. 2in. m/o. 10/-; 3.5 amp. 2in. T.C.C. 7/-; 4 amp. 2in. thermo coupled in case with switch, 7/6.

600 m/a. 3in., m/c, 15/-; Double readings 40/120 m/a. 2in., m/c, 8/-; 20 amp., 2in., 7/11, 9/6; 15 volt, 2in., m/c, 9/6; 30 amp., 6in., m/i, Switchboard mounting, 35/-; 6,000 v., 3in., m/c, 57/6. Post extra. Money refunded if not completely satisfied. Letters only. New Illustrated List enclosed with all orders on request, with 1d. stamp.

HIGHSTONE UTILITIES,
58, New Wanstead, London, E.11.



VOL. XVI

AUGUST, 1948

No. 317

Comments of the Month

By F. J. C.

Another Select Committee

ROAD users might be inclined to think that the Ministry of Transport has had all the advice it needs concerning their requirements. There have been Select Committees, deputations, memoranda, etc., from almost every association nationally recognised and which carry any weight. It may come as a surprise, therefore, to learn that Mr. Joynson-Hicks's motion for the appointment of a Select Committee to inquire into the requirements of vehicular traffic met with a considerable measure of support, no fewer than 140 Members of Parliament voting for it.

Whilst we are all in favour of a progressive road policy we must not lull ourselves into a false sense of security by believing that such a Select Committee when it is appointed would solve our ills. Select Committees are the convenient Government method of shelving awkward problems. Such a Select Committee could not possibly issue findings before one year, and by that time there may be more pressing problems occupying the attention of the Government.

There can be no doubt that the Government is concerned about our roads and our traffic problems, which successive Governments have failed to solve. A constructive road policy is wanted. Road authorities, national and local, should have made available to them sufficient funds and the necessary labour and material to bring our highway system back to its pre-war standard and to carry on the progressive schemes of development placed in abeyance by the war.

There are 180,000 miles of roads in this country, but a very high percentage of them are in a bad state of repair, and in other respects need modernising. These bad roads cause great damage to vehicles; they add many miles to place-to-place journeys, apart from being dangerous.

A progressive road policy can only be carried out by using the Road Fund for the purpose which it was introduced. Northern Ireland has realised the folly of diverting the road taxation to the general revenue and now spends all of it on road maintenance and repair. This country cannot afford bad roads.

Change in B.L.R.C. Affairs

THE chairman of the B.L.R.C. has taken up with the Ministry of Transport the open letter to M. Achilles Joinard on massed start racing. On behalf of the league the chairman placed the facts once again before Mr. H. R. Lintern, of the M.O.T. The chairman said, "Your letter was not so much the outcome of complaints to you from the police, or the public, so much as a complaint laid by an informant body desirous of eliminating the B.L.R.C. from existence for its own selfish ends. To say to you that in-line racing on the roads of Britain is a danger to the public is merely a lever calculated to provoke your Ministry into taking stronger measures." We shall refer to this italicised sentence [our italics] a little later.

The chairman went on to explain how massed start racing is run, pointing out that it was formed by N.C.U. and R.T.T.C. members who wished to improve the sport by promoting road racing. He explained the difference between massed start and time trials, dealt with the public interest and the success of the events promoted by the league.

He pointed out that the insurance premium charged by the underwriters is only 1s. 10d. per annum, and invited Mr. Lintern to follow the Glasgow to Brighton six-day race at league expense.

We were interested in this matter because we did not receive the open letter, referred to above, and so we wrote to Mr. Lintern independently asking why. We received the following reply from Mr. H. R. Lintern, and the italicised portion of his letter [our italics] should be compared with the italicised portion of the letter sent by the chairman of the B.L.R.C. to Mr. Lintern.

Here is Mr. Lintern's letter:

"Thank you for your letter of the 15th June. In order to get matters straight, you may like to know that it was at the request of M. Joinard that I saw him to discuss the question of massed start cycle racing on the highways of this country. He was introduced to me by the president of the National Cyclists' Union (who took no part in the discussion) and in order to help M. Joinard I promised to set out in a letter the views of my Minister which I had expressed to him at the interview.

"Subsequently, the National Cyclists' Union asked if I had any objection to the letter being published, and because I thought that it was likely the terms of the letter would find their way back to this country from Paris, and also because the National Cyclists' Union thought that publication would help negotiations between the union and the British League of Racing Cyclists, I agreed. I was not aware of the journals to which the letter was to be sent, nor of the publication intended by the National Cyclists' Union.

[From this it would appear that the N.C.U. circulated the letter, but deliberately refrained from sending it to The Cyclist—Ed.]

"Since I had the pleasure of seeing you some time ago on the question of massed start cycle racing, we have had from Chief Officers of Police a great deal of information about the dangers attaching to this form of racing on the highway, and the Government still hopes that the B.L.R.C. will take note of their views and act accordingly. There is, I understand, an arrangement in being at the moment whereby cycle races can take place on the perimeter tracks of a number of airfields, and I should hope that this would give members of the league the opportunities which they desire for massed start races.

"I may add that Mr. Durman came to see me on 18th May to discuss the whole matter with me. He expressed the view that the highway was not the right place for massed start cycle racing, particularly in view of the return to

All letters should be addressed to the Editor, "THE CYCLIST," George Newnes, Ltd., Tower House, Southampton Street, Strand, London, W.C.2.

Phone: Temple Bar 4363

Telegrams: Newnes, Rand, London

the roads of so much motor traffic, and that in his opinion the members of the league could find what they wanted if closed circuits off the highway could be made available to them. Signed, H. R. Lintern."

We accordingly wrote to Mr. Durman expressing surprise at this change in league policy, and asking whether when he visited Mr. Lintern he had been delegated to do so by his committee. At the moment of going to press we have not received a reply. If and when the reply is received, we shall, of course, accord it publicity.

A Collectors' Club?

THE suggestion made by a contributor that a Collectors' Club should be formed is a good one, providing that it is run on the right lines. Such a club would need a first-class committee of authorities to authenticate and homologate members' collections. Indeed, such a club should act as the Goldsmiths' Hall acts—it should mark the authenticity of old bicycles, cycling equipment, prints and photographs. It is a pity, for example, that Crown copyright photograph No. 54 of a copy of MacMillan's bicycle, which anyone can purchase from the Science Museum, should have been credited by an author to H. W. Bartleet, who did not take the photograph and bought it in the ordinary way from the Science Museum.

There is keen interest in old cycling books, photographs and prints, and such a club, if formed with county branches, could undertake valuable research work in unearthing some of the old machines, etc., which must still repose in attics, out-houses, and old country mansions. Indeed, it was in this way that the original Thompson pneumatic tyre fitted to a carriage wheel was located, 50 years after it was made, in a house at Guildford.

Gallup Poll on Sport

THE Gallup Poll recently sampled public opinion on its favourite sports, the question put being: "What is your favourite sport to watch?" In the result football, of course, headed the list, followed by cricket, tennis, racing, Rugby Union, Rugby League, dogs, speedway, swimming, hockey and ice-hockey, and boxing; with miscellaneous games the voting was too small to mention. Cycling was not even mentioned.

The second question put was: "Do you yourself practise any sport?" Apart from the ungrammatical construction of the sentence ("you yourself"; can you be anyone else but yourself?) it produced some surprising results. Two in every three said that they did not practise any sport, whilst amongst the men 50 per cent. said that their athletic days were over. Of the remaining 50 per cent., their preference was for swimming, soccer, tennis, cricket, rugger, golf and bowls, in that order. Only two per cent. mentioned cycling as being seriously practised, and a microscopical few acknowledged their preference for table tennis, billiards and darts.



New Club

THE March (Cams.) Branch of Butlin's Social Club has organised a cycling section and members have just had their first run. Various plans are being considered to extend the activities of this new venture.

Never Too Late—or Too Heavy!

AIDED and abetted by her daughter-in-law, a Gravesend woman who will never see her 53rd birthday again, has just learned to ride a bicycle. The bicycle has stood up well to the strain of the learner's 13 stones, and mother-in-law, now that a few bruises have gone down, thinks the effort she made was well worth while, and she wishes she had been persuaded to learn years ago.

Stayers

QUITE a few cycling clubs have founder-members still on the road, but if there were any founder-members of the Peterborough Cycling Club still riding they would be a trifle shaky at the handlebars. The Club was founded 75 years ago, being one of the oldest, or perhaps the oldest, in the country. And its members are just as enthusiastic now as the first members were when they set off on their heavy old machines in their natty club uniforms.

No Regrets

VERY few tears will be shed if the plans now under consideration for the abolition of the old Ferry Toll on the Somersham Road at Chatteris, Cams., come to fruition. The toll has long been a source of annoyance to road-users, who can see no reason whatever for its continuance. The Ministry of Transport have agreed to make a grant of 60 per cent. of the estimated cost of £6,700 for the purchase of the toll and Huntingdonshire County Council will pay half the balance of the cost after the 60 per cent. grant has been deducted. Negotiations with the owners should soon reach a satisfactory conclusion.

Not So Hot

A 16-year-old boy who was charged at Slough Juvenile Court with assaulting a policeman and wasting two-pennyworth of electricity by dialling 999 unnecessarily, was said to be a keen cyclist and able to build cycles from bits and pieces. But there his intelligence came to a halt, because when he was examined by a psychiatrist he did not know the letters of the alphabet or the months of the year, could not say where he was born nor name five large towns, and although he did have some faint idea that not so long ago there had been a Royal wedding he could not give the name of the bride.

Don't Push!

MARKET HARBOROUGH (Leics) magistrates have ruled that a person pushing a cycle at night without lights is committing an offence just as much as if he was riding without lights. Announcing that an offender would have to pay 4s. costs, the chairman of the Bench said: "This is the first case of its kind we have had and although the summons is good we shall dismiss it under the Probation of Offenders Act." So it would appear that if our lights fail on the road we must either dump the faithful steed in a ditch or carry it home.

Wait Another Twenty Years

THE Borough Surveyor of Doncaster, Mr. W. H. Price, thinks that it will be some 20 years before the proposed eastern and western by-pass roads can be built and the town's traffic problems, as they now exist, solved. In the meantime, however, he says a proposal is being considered for building a ring road to stop a good deal of the congestion and traffic jams. After the

traffic mix-up in the town; Mr. Price takes a very poor view indeed of the River Don which, he says, is "filthy and unattractive" when it could be made a source of delight to the citizens.

The Milton Wheelers

BECAUSE of the shortage of petrol, which is preventing them from playing golf and getting some necessary exercise, members of the Peterborough - Milton Golf Club - have formed themselves into the Milton Wheelers. They now cycle from their homes in Peterborough and the district to the course just outside the city, have a round or two of golf and then cycle back again. Perhaps by the time petrol is plentiful again they will have become such keen cyclists that they will refuse to tear along the roads in mechanical greenhouses.

What Shall We Do?

THE police at Daventry have decided to take action against cyclists who leave their machines in what the girls consider to be dangerous positions. When two girls were charged with causing obstruction to the footpath the police superintendent told Daventry magistrates: "These are the first cases of their kind brought in Daventry, and they have been brought in the public interest and for publicity. Complaints have been made of bicycles being left leaning on houses and in consequence of reduced street lighting people walking along the pavements have run into them after dark." If this is going to be the general attitude of the police everywhere, it is time that cycle parks were provided in every town.

Friendly Gesture

BOSTON (Lincs.) Town Council have been asked by the Boston Cycling and Athletic Club to accept a donation of £5 5s. for the training facilities given to Club members in the Central Park at Boston. The Council's reply was that the offer is much appreciated but the Council feel they cannot take advantage of it. Club members have been making considerable use of the track in the park and have found it a great help in their training.

Illuminated Address!

VERY annoyed, and with reason, because a sneak thief had stolen his front lamp, a cyclist inserted the following advertisement in his local paper: "Will the gentleman who cut the wires to my dynamo set and stole my lamp from the front of my ice cream factory on Sunday, please call next Sunday and I will make him a present of the cycle."

Electric Cycle

A GRIMSBY youth has built, and is now riding an electric cycle capable of a speed of some 20 miles an hour. On the cross-bar he has fitted two large car batteries which provide the power for an electric motor which drives the rear wheel. The machine has quite a useful range before the batteries need re-charging.

Strange Cyclists

BECAUSE he thought two cyclists seemed to be riding in a strange manner and unfamiliar with their machines, a Peterborough constable told them to stop. One of the men made off on his cycle while the other pushed his machine in the policeman's stomach and ran away. Both were later caught and charged with stealing the cycles and the constable was congratulated by the magistrates on "a very smart piece of work."

Cycling With An Object

TWO youths from Eye, near Peterborough, one aged 19 and the other 17, explained to Peterborough magistrates how they used their cycles for what the R.A.F. calls "recreational purposes." They said they had nothing to do at nights so they regularly cycle into Peterborough "to have a bit of fun fighting." Each youth, after receiving a talking-to from the Chairman of the Bench, was fined £5 and the younger of the two was put on probation. The Chairman suggested the youths should alter their "very stupid" outlook on life and not go around "smashing other people's faces."

Scissor-grinding Bicycle

A TRAVELLING scissors-grinder seen on a Lincolnshire road had brought his equipment up to date by fitting it to his bicycle. In a box on the handlebars he kept his few tools, and to it was attached a light emery wheel. When he wanted to start grinding he supported the rear wheel of the cycle on a spring-up rest, attached a cord from a pulley on the wheel to the emery wheel, and sat in the saddle pedalling and grinding until he had completed his orders. Then he closed the box, kicked up the wheel rest and rode away to the next job.

Former Champion Cyclist Dies

ALDERMAN REUBEN BLOWER, who has died at his home at Ellistown, Leics., aged 78, was in his younger days very well known in cycling circles in the Midlands. He took part in many events and once rode from Ellistown to London and back, a total journey of 240 miles, on a penny-farthing cycle. Alderman Blower served on the Leicestershire County Council and the Coalville Urban Council for many years until he retired in consequence of his age.

Over the Frontier

LITTLE Rutland, England's smallest county and a strong fighter for survival from the attack of the Boundary Commission, is anxious that there shall be some permanent signs erected to show where the roads from outside go into Rutland. Leicestershire, with which county it is proposed that Rutland shall eventually be amalgamated, has been approached with a view to the erection of the signs. In the early days of the fight, Rutland erected temporary signs saying proudly, "This is Rutland." The new signs will probably be in cast bronze and will incorporate the arms of each county. Rutland wants a sign on each of the 15 roads between Leicestershire and Rutland but it is very probable there will be a cut in the number.

Loveless!

ALTHOUGH the village of Mountsorrel, in Leicestershire, has been described by guide books as "dull" and by one writer even as "loveless," its inhabitants do show an interest in what they have. A fund is being raised for repairs to the Market House, one of the village's oldest and most notable buildings. At one time there was a market cross standing in the market place and erected in the reign of Henry III when the village received a market charter, but in 1793 Sir John Danvers, lord of the manor, took a fancy to the cross and had it moved into the grounds of his home, Swithland Hall. The cross is still standing and in a fair state of repair, which is probably more than it would have been had Sir John left it in the market place.

Leave It To Dad

WHEN a 12-year-old boy was charged at Loughborough with riding with another 12-year-old on one cycle, his father told the magistrates: "If the constable had only told me instead of issuing a summons, I would have given my boy such a hiding that he would have felt it for months." The boy was fined 5s., which caused him considerably less discomfort than the sentence suggested by his father.

School Bus—New Style

BECAUSE there is no transport and his four children have four miles to go to school, a father living in an ex-Army camp at Grafton Underwood, near Kettering, has built his own school bus. He has made a wooden truck large enough to take the children and has mounted it on two cycle wheels, in their original forks. The trailer is hitched behind his cycle by means of a strap-iron coupling, and away go the children in fine style. Often one or two other children find themselves without transport and they, too, hop into the trailer. Father, who provides the motive power, always gets there in the end, but he finds it a bit of a trial when there is a headwind blowing.

Lazy Parents?

THE fact that the cycle ridden by the average child was in such a bad state that the children did not like to have them examined was suggested as the reason why only 28 entrants took part in the safety cycle trials organised by Spalding Rural Road Safety Committee and held at Crowland, Lincs. An official of the Committee said: "One would have thought that a little effort in providing the necessary bell or brake blocks would have been well worth a parent's while." Of the 28 cycles ridden in the trials, 24 were found to be in very good condition.

Schoolboy Manners

A GRIMSBY constable who stopped Terence Allen, a schoolboy, of 116, Lacey Road, Grimsby, and told him he would be reported for riding 50 yards on the footpath, was told by this young hopeful: "I don't care. I've got plenty of money. Have we got a secret police force in Grimsby like they have in Russia? Because it seems to me that our uniformed policemen cannot get any further than petty cases of riding on the footpath or riding without lights." This young gentleman, who is apparently above the law, did not condescend to appear at Grimsby Borough Court, and escaped with a 10s. fine, although the magistrates severely criticised his insolence.

Shaft-drive Cycle

MR. E. N. ETTE, of Braunstone, Leicester, is still riding a cycle which was imported from America some 60 years ago. It is a Crescent, and its most unusual feature is that it has a shaft drive instead of the usual sprockets and chain. The Crescent was considered to be the Rolls-Royce of cycles, and cost about £20. The workmanship must have been of the best, as it has had very little wrong with it during its 60 years of life, and is still very comfortable to ride. Tyre replacements provide a headache now and again, but Mr. Ette has found a brand of tyre made to-day which fits almost as well as the original tyres. Mr. Ette is the second owner of this machine, which was well used by its first owner, another Leicestershire rider.

Around the Wheelworld

By ICARUS

Roadfarers' Club Badge

THE Roadfarers' Club has decided on a members' badge incorporating the St. Christopher motif. A great deal of consideration was given to the question of the badge design, which needed to symbolise the interests of all road users because the membership of the Roadfarers' Club is not restricted to any particular class of road user. Cyclists, pedestrians, motor-cyclists, motorists, in fact all those interested in using the roads are members, and membership is by invitation only.

St. Christopher, who has come to be



Full-size reproduction of the Roadfarers' lapel badge; and half-size reproduction of the car badge.



regarded as the Patron Saint of Travellers, was finally selected. The illustrations here show the lapel badge and the car badge.

St. Christopher was a third century martyr of Asia Minor. A man of enormous strength, he exhibited his belief in christianity by bearing pilgrims across the river of death. The legend is that one day Christ came to him in the form of a child to be borne across, and St. Christopher marvelled at the weight of the burden until the child said: "Marvel not, for thou hast borne Him who bore the sins of the world." Hence the name Christophorus, "Christ bearer." St. Christopher is usually represented as a giant with a child on his shoulder, and leaning on a staff. According to a pious and ancient belief, he who sees St. Christopher will not be hurt that day, hence the common use of medallions, picturing him, in automobiles. There are paintings of him by Fiorenzo (Rome), Antonio Pollaiuolo (Metropolitan, New York), and frescoes by Giovanni Bellini (Venice) and Titian (Venice). The feast of St. Christopher takes place on July 25th.

My Boneshaker

I HAVE always wished to own a boneshaker, but they so seldom come into the market, and when they do they are so eagerly snapped up, that I have not been able to gratify my desire until quite recently, when out of the blue arrived a letter from Mr. H. B. Constable, of Saline, Fife, offering one for sale. I promptly purchased it. I gather that it has not any particular history.

It was originally owned by a joiner on the estate of Mr. Constable's father, whose son gave it to Mr. Constable about the year 1900. I am unable to trace the date it was made, but possibly it was 1870 or earlier. It has frequently been borrowed for pageants and village festivals. It is in remarkably good, in fact, almost perfect order.

I have read about boneshakers but have not ridden one before. I was, therefore, pleasantly

surprised to find that on modern roads it does not shake the bones as much as might have been expected. No doubt it did so on the rough, loose, metal surface roads of the period in which it was originally used.

The seat is a real seat—not a saddle—and is quite comfortable. The machine, driven by pedals attached to the front wheel spindle, is quite easy to ride and requires no special knack. Of course, it is noisier than its modern pneumatic-tired counterpart, but not excessively so. On the few occasions on which I have ridden it it has attracted quite an amount of attention and admiration. So if you see your scribe Icarus pedalling out of the past along the Bath or Portsmouth Roads one of these week-ends, stop him and try it!

Two-colour Cycle Tyres

DUNLOP'S new two-colour cycle tyres, I am told by Sir George Beharrel, are having a very wide appeal. I learned that both production and sales of cycle tyres are substantially above pre-war level. The Dunlop Company are providing sprint tyres and rendering other assistance to British cyclists during their training for the Olympic games.

Another Club Journal

I HEAR that the B.L.R.C. is about to publish a journal of a format somewhat similar in size to the *Cycling Record*. It is to be published fortnightly. I am told that shares may be bought by any interested party, and this does not exclude the N.C.U. or the R.T.T.C. Each holder of a share will, of course, have a vote as to the policy of the paper, but as it seems possible that the

and 24,718 motor-cycles exported during that period was £6,178,737, or about seven times the value during the first four months of 1938, when the total was £838,719.

The U.S.A. is now one of our chief customers, and so is Switzerland. The African markets have absorbed 145,000 bicycles and British Malaya over 80,000.

"News of the World" Withdraws B.L.R.C. Support

THE *News of the World* has withdrawn its support of the Brighton to Glasgow race owing to the concern of its principals at the present unsatisfactory state of affairs within the League. Plans of an ambitious character had been prepared in keeping with this Olympic year. The Mayor of Brighton had submitted a special message and Charles Black, the sports and boxing promoter, was taking over the Scottish arrangements.

The newspaper concerned has, I understand, permitted the King of the Mountains Trophy to be open to competition again. The £500 in prizes are lost. I find it impossible to believe that the members can support the new policy that has put the League clock back five years.

By the way I notice that the League has some new notepaper headed "British League of Racing Cyclists National Executive." Also printed on it is the name of the Chairman and the Treasurer, but the National Secretary, I see, has to write his name in ink.

Bicycle Inns

MR. J. F. ASHFORD, of London, S.E.3, apropos a note by a colleague in our

July issue, draws my attention to the "Bicycle Arms," which is one mile north of Mayfield, on the Tonbridge Wells to Eastbourne road. Inn signs with a cycling interest are indeed few and far between, and, like my correspondent, I am often more interested in the existence of the inn than its name.

I shall be glad to receive further examples of inns with bicycle names.

Another Bartleet "Error"

ON page 5 of a reprint from the Gallovidian Annual for 1940, containing an interesting history of Macmillan and his first treadle-operated rear-driven bicycle, appears a photograph of a reconstructed version of Macmillan's bicycle, which reposes in the Science Museum, Kensington. The credit underneath the photograph says, "Photographed by H. W. Bartleet," and it is reproduced, it states, by courtesy of the cycling journal.

I am not in the least surprised to find that Bartleet has tried to filch the credit for a photograph, the copyright of which is owned by the Crown. For a small fee anyone can obtain a copy of the photograph from the Science Museum. It is Crown copyright photo No. 54. I have pointed out this "error" to the publishers.

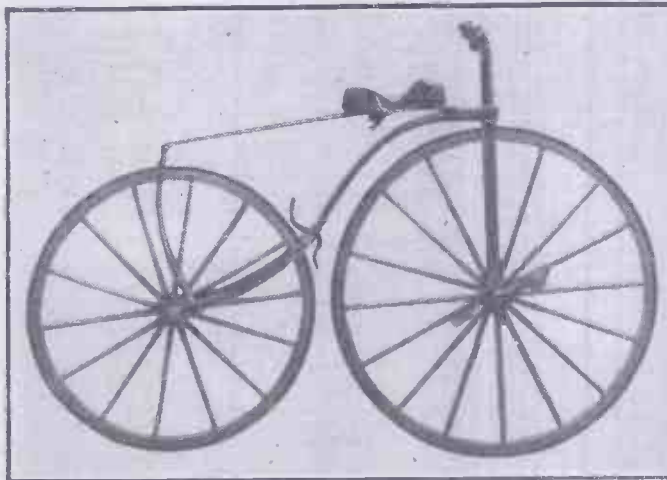

My latest steed—a boneshaker. See paragraph on this page.

B.L.R.C. will retain two-thirds of the shares the remaining third can easily be out-voted. I do not think that many of these shares will be taken up outside B.L.R.C. circles. You will not find my name amongst the list of shareholders! I have supported the League and its policy very fully, but I do not like its change of policy nor its present methods, which are an inversion of all that the League has stood for.

Dollars from Bicycles

BRITISH bicycles and motor-cycles brought 1,500,000 dollars to this country during the first four months of this year. The total value of the 561,937 bicycles

Wayside Thoughts

By F. J. URRY



Sumbury-on-Thames. The picturesque church and the weir.

A Long While

WHEN April passed into history, I completed 59 years of cycling, a record of happiness and health finding me as fit as I've any right to expect, and still full of hope that the best is yet to come. Of course, I go slower than of old, but the longer time taken over a journey merely adds to the joy of observation and a sense that life has little to give the liver when it is charged with urgency. Perhaps it was not always so, for in those faraway days when time turned the century I was as keen to ride as fast as those young folk who now pass me on the road, "dancing" up the hills in a manner which in my generation of cycling speed would have been considered poor form. Fashions alter, and that which was once taboo is now considered the final accomplishment of speed-cycling. Looking back at it all, as one is apt to do at the end of an annual period, I would not have had it otherwise, because life has been made happy for me as a cyclist, and nothing I can conceive in the longevity of activity could have given me greater joy. I ride a bicycle daily because I love the game; for me it embodies movement with ease and grace, active enough to keep a man fit, fast enough to give him width of roaming without detracting from the pleasures of sight, hearing and the sense of smell. And these last values are of great importance if a man is to live life fully, though they may only come to fruition as the years roll over him, and the charm and beauty of them pervade his consciousness. Possibly, saying these things to the young folk of to-day conveys but little of the gathered grandeur of the years, the thousand journeys and the thousand thrills, yet if the riders of to-day will allow the pastime to work its magic I can promise them a leisure life of simple enjoyment transcending all the glittering excitements that make up the tale of modern existence.

The Use of It

THERE is so much to be said for a bicycle quite outside its obvious travel value—if you are a cyclist. That's the point! The possession of the machine makes you use it. For instance, there is an hour of daylight left when the evening fades into a perfect night; and that spells twenty miles of quiet pleasure amid a countryside perfumed with the scent of young summer, half the time amid the saffron glow of sunset, a smoke by some wood where a nightingale might sing, and in any case the last stirrings of the birds and beasts will punctuate the dusk; and then a ride home under the stars, with the scattered lights stabbing the dark with silver. It is the extraordinary ease and mobility of a bicycle that has led me along such paths and charmed me with a glory wholly earthly, and a pleasure probably beyond my deserts. To-day that freedom is very precious, and its value is the greater as the years increase, for the spirit of independence grows in a man as he gets older, and when he can preserve it, as by this addition to cycling, he automatically preserves his happiness as well as his health. Some people seem to think cyclists—regular cyclists—must "scorn delights and live laborious days," but if walking is natural to us, cycling is easier and is, indeed, man's nimble invention of geared walking, with a seat to sit on and an instrument to carry the weight of his body. People also tell me this is a kind of romanticism resulting from love of the pastime; yet as far as I am concerned it is a fact that has added to life a habit, which in itself has added to life.

The Abiding Benefit

SOMEBODY ought to testify that cycling is not merely for the young folk but for all people hale and hearty, whatever their age or state. For the value

of the game is beyond price and far beyond status, even though too few folk are wise enough to believe either statement. So I am trying to do it, have been for many years, and shall go on until the end of the story because I know it to be true. Life holds many excitements but too few joys, and the latter are worth preserving for the happier service of the individual when the years gather around him, and cycling is one of them. Walking may be its equal if the physical effort is not too severe a strain on the body; and in any case its range is limited. Now, I do not want to suggest cycling is devoid of the exuberance of youthful zest, for it would not be true, and one has only to remember the dozens of holiday week-ends when the ride was but the introduction to the fun. My present point is to prove that cycling is more than that, more than the club-run or the collection of miles or the speed at which you can travel; it is a way of life, a constant introduction to beauty and that real love of country creating in you a sense of well-being and a joy of existence. That is why people should gravitate from the exuberance of youth to the mellowness of age, while still preserving for themselves the bright outlook of the former with the more intense and cultured pleasures of the latter. Yes, cycling is for all ages, and the more you practise it, the more evident that becomes. The fact needs stressing: Far too many people know not what they are missing, and far too many young riders are apt to forget the pastime is as fresh and delightful in age as in youth. All the former needs is a measure of fitness, and cycling will take care of that for you if you will give it the opportunity.

Halt to Travel

LOOKING through some old volumes I note that my prophecy of the years after the war was ever the suggestion that we should see more difficult times and that our way of life would need simplification. I was then thinking, I suppose, of how cycling could play a big part in the enjoyment of leisure time, not only of the masses, but also of that type of folk who, for some obscure reason, think they are a cut above the crowd. The time is with us, though it has come in a rather different manner from that which I expected, but its impact is similar. I had never thought petrol would be in short supply in the days of peace, but had imagined the cost of post-war motoring would be prohibitive. Actually, the latter is a fact that I think will become more potent as the days run on, for it will be quite a time ere we reach a standard comparable with the years before the war, even allowing for the upset in values following war. This restriction on travel has hurt many people, and my own love of roaming—even though their way is not mine—engenders a real sympathy for them, particularly the elderly and the halt; but to the younger and vigorous people I would say that if they really learned to cycle, on the right bicycle with the right gears, restriction and frustration in the personal travel sphere would almost disappear. It is well worth considering; we shall not be through with this trouble for some years.

Boy's Delight

AT the beginning of the year I took delivery of a new bicycle, a R.R.A. model Raleigh replete with a four-speed wide ratio hub gear, big saddle, and alloy bars and brakes. The only thing missing are light rims, and those are coming home to complete the ensemble when Dunlop makes them in the 1 1/2 in. section. The astonishing thing about this machine is its lightness—28 1/2 lb.—with steel rims and my specification of big tyres and big saddle; it is a real lightweight, rides like one, and is as rigid as a bicycle should be. Up to date I have ridden it about 1,200 miles, partly in hilly country

and over granite setts, and I say again that a first-class machine is the only wear for a man who mixes utility and pleasure riding. When the alloy rims are fitted I shall have the lightest full-roadster bicycle I have owned for years, and the joy of its possession will be great. At the moment it is shod with Tourist Sprites; I wanted to thoroughly try out this compromise between the open-sided Sprite and the roadster type of tyre, and, frankly, they are good, but not quite so lively as the skin wall cover. When the time comes for renewal I shall fit the open-sided, for their resilience, to me, is well worth the risk of an additional puncture. I like the layout of this machine; it gives me the perfect position, and its selection of gears with a normal of 60 in. allows me to lounge up long slopes with ease, and gives me a comfortable loping speed on the 7 1/2 in. high when the wind is friendly. Judged on pre-war prices the figure is high, on the £40 mark, but of that total well over £7 is Purchase Tax, and even in pre-war days £16 was not an extravagant figure for the very best, and few things we buy to-day are less than double the 1939 cost, so the price ticket is really not high. Apart from its running value, it really is a beautiful job from the shapely cranks and chain wheel to the neat bag support, and if this particular model lacks the sunshine finish now so fashionable, that is my desire, for I expect my sober black to still look beautiful a decade hence!

Declined with Thanks!

ON a recent week-end jaunt I was stopped by a man who claimed acquaintance with me as an old opponent at golf, and, before that period of declining activity, at football. We sat on a sunny bank and yarned for an hour, and being some years younger than I he expressed his surprise that I was still riding some 8,000 miles a year and thoroughly enjoying it. When I asked him why the surprise, he had no reply; he had just fallen out of the active game and was sorry about it; did not even now play golf, owing to a knee injury. He wanted to take me to his home within a mile of where we sat, so that I could persuade his wife that cycling would restore him to that sense of personal activity which a man should wear with decent pride; but I shied at that, for on far too many occasions I have been in the unenviable position of trying to prove to sundry dames that erstwhile active men need not grow old too rapidly even though they may get grizzled and bald; and it is always difficult to contradict a lady and remain peaceable. Far too many people are at the sympathetic mercy of their families, and too rapidly listen to the tale of their years, with the result that they are persuaded to forgo the delights of individual travel and come to believe they are beyond it. I told my companion this as gently as I could, and he agreed and regretted; and I believe this to be one of the main reasons why some elderly folk give up cycling. Part of this attitude of the domestic circle is due to a real fear for the individual who "might overdo it," and part to the mistaken notion that cycling is only for the young, and is hard work. It is, of course, nonsense, as any old rider can prove; but the feeling is in many a household, and it needs breaking down if the inherent values of cycling are to charm and embellish the latter end of life. So we parted on that sunny afternoon of spring, he promising to borrow a bicycle from my small group, and test my theory of wheeling joy; but I haven't seen him since, so I expect the domestic boss issued an edict.

PARAGRAMS

(Continued from page 82)

Prehistoric By-law

WHEN five cyclists appeared before Grimsby Borough Magistrates charged with taking their machines into Barrett's Recreation Ground, Grimsby, several of the magistrates criticised the by-law, made in 1946, which makes it an offence for a cyclist even to wheel his machine into this recreation ground, while motor coaches and cars are allowed to be driven through the pleasure ground to the cricket pitch. But if visitors to the recreation ground leave their cycles outside the railings and observe the by-law, will the Council be responsible if their machines are stolen?

Antique Bicycle Found

WHILE searching through a heap of oddments in an antique shop, Mr. J. Hobson, of Finkle Street, Thorne, Yorks, discovered an old Quadrant bicycle which once belonged to Dr. Arbuckle, a local doctor, who died many years ago. It is thought that the cycle was built about 1852. It has a solid iron frame with the rear wheel larger than the front wheel, and the drive is by pedals, which are adjustable, through a rim pitch block chain. Steering is by means of rods attached on either side of the front wheel, and the brake consists of a band working on a drum which is fitted to the bottom bracket axle. It is not thought that present-day rations would provide sufficient energy for any would-be rider to pedal this contraption.

Ask a Policeman's Son!

BOB ANDREWS, aged 16, of Esher, Surrey, is the son of a policeman and can usually give his father a few hints. He patrols his district on his bicycle, and if he sees any character who looks a bit suspicious he makes a few notes, and if a car is involved he jots down the car number. The other day he saw a strange car outside a house, so he scribbled down the number on the white patch on his rear mudguard. Later his father mentioned a local burglary, so Bob suggested the number of the car concerned might help. It did—and after the mudguard had been produced in evidence at London Sessions and the thief had been sentenced, Bob received a £3 reward for his ingenuity.

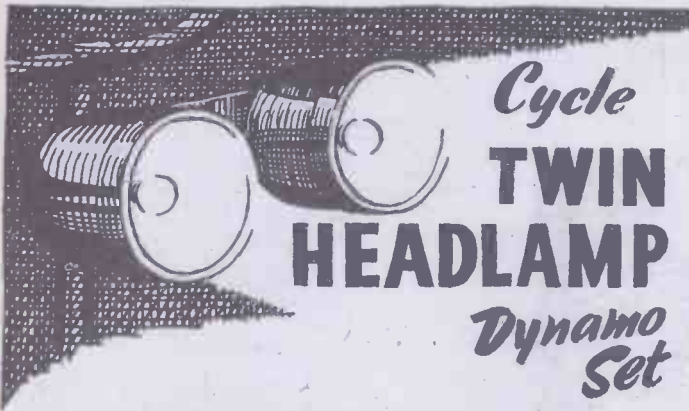

Cycle
TWIN HEADLAMP
Dynamo Set

Lightweight aluminium body with polished reflector, dynamo with rear lamp incorporated. Headlamps can be used singly or together, or one can be wired to separate battery, thereby providing a legal standby battery in case of emergency. Satisfaction or money refunded.

Twin Headlamp set complete

32/6

Single Headlamp set complete

27/6

Inclusive of postage and packing.

CASH WITH ORDER

PARKWAY PRODUCTS
79, PARK LANE, LEEDS

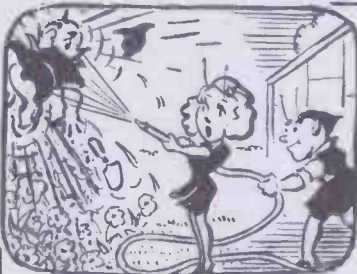

THE "FLUXITE QUINS" AT WORK

"This hose works a treat now it's mended

With FLUXITE—our trouble is ended."

Yelled O! "Can't you see? It's no treat for me!"

As high in the air he ascended.

For all **SOLDERING** work—you need **FLUXITE**—the paste flux—with which even dirty metals are soldered and "tinned." For the jointing of lead—without solder; and the "running" of white metal bearings—without "tinning" the bearing. It is suitable for **ALL METALS**—excepting **ALUMINIUM**—and can be used with safety on **ELECTRICAL** and other sensitive apparatus.

With Fluxite joints can be "wiped" successfully that are impossible by any other method

Used for over 40 years in Government works and by leading engineers and manufacturers. Of all Ironmongers—in tins, 10d., 1/6 and 3/-.

● TO CYCLISTS! For stronger wheels that will remain round and true, here's a time-tested tip. Tie the spokes where they cross with fine wire **AND SOLDER**. It's simple—with **FLUXITE**—but **IMPORTANT**.



THE "FLUXITE" GUN puts "FLUXITE" where you want it by a simple pressure.

Price 1/6 or filled 2/6

ALL MECHANICS WILL HAVE

FLUXITE

IT SIMPLIFIES ALL SOLDERING

Write for Book on the **ART OF "SOFT" SOLDERING** and for Leaflets on **CASE-HARDENING STEEL** and **TEMPERING TOOLS** with **FLUXITE**. Also on "WIPED JOINTS." Price 1d. Each.

FLUXITE LTD., Dept. P.M., Bermondsey Street, S.E.1

Firestone
BEST TODAY ★ STILL BETTER TOMORROW

Tailor-made CYCLE TUBES



'No other cycle tube really satisfies me now'

Firestone Cycle Tubes are made of finest quality rubber, processed to give long, tough service. They are circular moulded—tailor-made to avoid wrinkling—fitted with Rubber Base Valves.



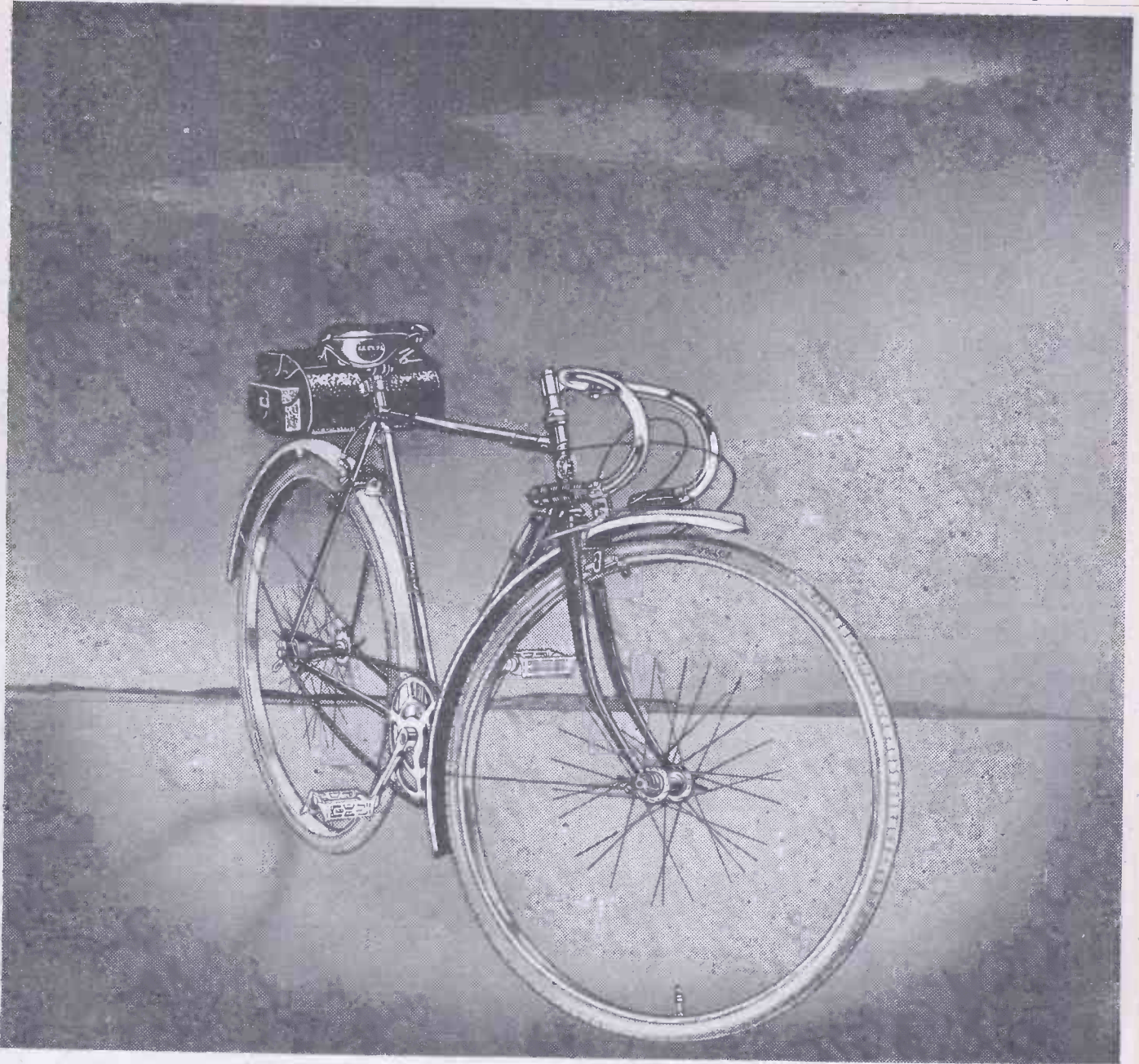

*For craftsmanship, style, finish and sheer
value for money, one cycle stands clearly alone*



Hercules

The **FINEST BICYCLE BUILT** *Today*

CYCLORAMA

By
H. W. ELEY



Leatherhead.

Surrey.

Looking across the fields to the
old church (partly 12th cent.)
To the left runs the River Mole.

Sojourn to the Sea

IN this old land of ours, where customs die hard and we are still rather the slaves of tradition, the great month for pilgrimages to the sea is August . . . and I do not think that all the spate of propaganda about staggered holidays has effected much change in our national holiday habits. In any case, most fathers and mothers, to whom holidays bring visions of buckets and spades and children's games on broad stretches of golden sand, are tied to "dates" because of the inflexibility of school holidays. So this month of August sees the great trek to the coast . . . and far more cyclists than one might imagine will go there by cycle, fitted with ingenious carriers for babies; tandems for mothers and fathers . . . and smart, gleaming singles for hefty boys and girls. Oh, yes! The cycle plays its noble part in conveying folk from the toil of towns to the sunlit sea. And, if a mountain of work on my desk will permit, I shall myself journey, by devious ways, to a part of the Cornish coast where I hope all will be sunshine and the waves a magical cure for the weariness of the flesh. . . .

"Roadfarers" Again

OFTEN have I written of the "Roadfarers" Club, and once again I have to record a visit to a most successful luncheon meeting, addressed by that vigorous and versatile M.P., Captain L. D. Gammans, who represents Hornsey. He was introduced by the president, Lord Brabazon, and gave a stirring address on "Can Europe Survive?" I admit that on leaving the Savoy that day I was slightly depressed, because Captain Gammans gave us a picture of gloom, and envisaged more trials and tribulations before we emerge from the valley and enter those "sunny uplands" so often referred to by Winston Churchill during the war. Still . . . he did predict that British grit and fortitude would win through in the end! On the evening of the day, as an antidote, I cycled through some Middlesex lanes, listened by an old farm gate to a nightingale singing . . . and recovered my poise. The bicycle is a blessed possession and a very good "doctor"!

Cycle Shops "Go Gay"

THERE is much more colour in the shop windows these days, and many "blitzed" shops have been repaired and restored to something like their old brightness.

And in the windows of quite a number of cycle dealers in the North London area I have been glad to see larger stocks of cycles . . . and of tyres. Gradually, and after much meritorious effort, production is gathering momentum, and we may look forward to the day when it will be a rare occurrence for the trader to tell us, "Sorry—but I've had none for months." And, talking of "going gay," how smart and colourful are those new sports models which abound! I recall the heavy, black cycles of my youth—quite funereal by comparison with the "jazzy" models of to-day. . . .

They Like Writing Letters

I AM referring to nature-lovers . . . and I am coming to the conclusion that I have many readers who appreciate my occasional comments on bird life and wild flowers, and the sights and sounds of the countryside. Recently, I made some references to the cuckoo—the "mysterious voice" of woodland and field—and some ardent nature-lovers wrote to me saying that not only had they heard the "voice" more often than usual this season, but had seen the cuckoo. Now, in all my rambles, and during the many years in which I have studied the ways of Mother Nature, I have but rarely seen the cuckoo . . . he is an elusive bird, tantalising us with the monotonous call, but rarely coming into our view. So I was glad to get these letters, and glad that some of my friends who love the fields and hedgerows

have been more lucky than myself in this respect.

Air is Not Rationed

NO—it is still free, and no coupons are needed before you may inflate the tyres on your bike. But to look at some of the tyres I see, one would imagine that air was a commodity "in short supply." Oh, those under-inflated tyres! One sees them everywhere—in the factory cycle sheds, outside country inns at the week-ends, and in the busy streets where cyclists go shopping. Now, lots of miles are lost through this neglect of correct inflation. And this is not a "bogy" of the tyre manufacturer, but a fact. Pump up your tyres hard, and the miles will be more—to say nothing of the increased comfort which will accrue. Personally, I detest riding on "soft" tyres, with the rims bumping on every uneven bit of the road. . . .

The Dunlop Book

SOME of my older readers will recollect the somewhat ornate and elaborate volume I have in mind—a leather-bound book which was first published about 1921, by E. J. Burrow and Co., of Cheltenham, for the Dunlop Company. The late A. J. Wilson ("Faed" of blessed memory) had a lot to do with the compilation of the book. Now, I have been asked many times recently whether this volume is still obtainable. The answer, unfortunately, is in the negative. It has been out of publication for some years, and I am afraid that paper difficulties will preclude its re-issue. It was distributed, in the early days, to many hotels, and I have often come across it, much thumbed and dog-eared, in the lounges of country hotels. It was a mine of information about places, roadside curiosities, roads, historic ruins, ancient earthworks, cathedrals and churches. Those who possess a copy should treasure it, for I fear that it will be many a long day before another such book is published.

It Isn't Far from London

JUST along the busy Watford by-pass . . . a turning to the right, and one comes to the pleasant village of Letchmore Heath . . . where there is a good inn, a pond whereon the ducks swim lazily, a green bench under an ancient tree . . . a village which might truly be a hundred miles from the Metropolis. And on a recent Sunday I cycled there and found an hour of peace and real joy. Several cyclists joined me as I sat and sipped a tankard of ale; two riders on well-groomed horses pulled up, dismounted, and joined the little gathering. Tawny-billed blackbirds popped in and out of the bushes by the inn garden; a grey squirrel slipped up the smooth bark of a beech tree; all was very peaceful and very good, and I was sorry to leave this haven so near to home. . . .

BOOKS FOR ENGINEERS

Screw Thread Tables, 5/-, by post 5/3.

Refresher Course in Mathematics, 8/6, by post 9/-.

Gears and Gear Cutting, 6/-, by post 6/6.

Workshop Calculations, Tables and Formulæ, 6/-, by post 6/6.

Dictionary of Metals and Alloys, 10/6, by post 11/-.

Wire and Wire Gauges (Vest Pocket Book), 3/6, by post 3/9.

Screw Thread Manual, 6/-, by post 6/6.

Compressed Air in Engineering Production, 17/6, by post 18/-.

Newnes Metric and Decimal Tables, 3/6, by post 3/9.

Plant Engineers' Pocket Book, 6/-, by post 6/6.

Published by

GEORGE NEWNES, LTD., TOWER HOUSE,
SOUTHAMPTON STREET, STRAND, W.C.2

My Point of View

By "WAYFARER"



Windsor Great Park.

The famous castle surrounded by its lovely trees and parkland. Sketched from just below the Copper Horse.

New Justification

MY policy of always carrying in my bag an unopened tube of rubber solution, additional to the one normally in use, was again justified at the tail-end of a recent holiday, when—for some reason best known to the powers that be—I picked up a horrid bit of metal which momentarily put paid to my front tyre. As a matter of fact, had I been a shade quicker on the uptake I might have prevented the trouble. All day long I had been annexing supplies of tarred chippings, thanks to the heat of the sun (and possibly to the poor workmanship of certain people), and when I saw this new foreign body going round with the tyre I presumed it to be a case of "business as usual." After half a dozen revolutions, however, it seemed to be a matter for investigation, and I dismounted. Hopefully, I removed the metal (as it turned out to be) and after a few moments the tyre went flat. Having uttered a few well-chosen words, I got down to the repair job, realising that things might have been worse. I was willing to bet that my tube of solution, last used some weeks before, would be as dry as a bone. It was! My reserve supply came to the rescue, and it was not long before I was on the move again, my serenity completely restored—after I had invaded a wayside cottage and obtained facilities for washing my hands.

The foregoing experience stresses again the importance of one being in possession of an emergency supply of rubber solution. In these days of infrequent punctures—with a mental reservation as regards the second spot of trouble I had three days later!—the danger is that a brand-new lot of solution will dry up after the first using. It is a bit galling that a tube of solution may serve only for a single puncture, thanks to the evaporation process, but that is rather better than a series of perforations, with never a bit of the solution wasted!

The Goodness of Folk

IN these rather hard and materialistic days it is very pleasant to find so much goodness of heart among the people one meets. . . goodness which impels them to do something, without reward, for their fellow-men. Here are two examples which occurred to me within less than a week. At the end of a week-end run I found myself, when the time came to light up, with a rear lamp battery which had gone on strike. I had only about four miles to go, but I did not want to walk the distance—nor would I have done so! At that moment a brother cyclist—a complete stranger—stopped at my side. When I explained the catastrophe which had befallen me he insisted that I should have his battery, he having only a mile to go. My resistance was futile, nor did my attempt to buy the battery from him meet with any success. He took the law into his own hands, transferring his battery to my container, crying "Cheerio!" and fading out of my life. A veritable Good Samaritan!

On the following Saturday my back tyre gave notice to quit, thanks to having absorbed a piece of broken glass. A young farmhand, who was passing in a float, inquired "Puncture?" and invited me into a farm building he was just about to enter. I got out my implements and turned the bicycle upside-down. He did the rest. When he saw the hole in the cover he opined that something ought to be done about it—I agreed!—and, laying violent hands on an old tyre which

was lying about the place, he fashioned a kind of gaiter. He placed this in position, pumped up the tyre and disappeared almost before I was able to record my most sincere thanks.

Another Good Samaritan! It certainly is pleasant to find so much goodness of heart in times when selfishness is rampant and such importance attaches to the process of looking after number one, and I cannot help hoping that when the position is reversed and I am given an opportunity of helping somebody who is mildly "under the weather" I shall not "let down the side." Our world would run so much more smoothly with co-operation—and a readiness to lend a helping hand.

Improving

RECENT experiences along the road impel me to the conclusion that conditions in relation to food supplies are definitely improving. On a Saturday a week or two ago I blew into a small country pub on the London-Aberystwyth road and inquired as to the possibilities of obtaining lunch. I was cheerfully received—a pleasant change from being mistaken for a burglar!—and was offered cold meat and salad, which I accepted with both hands. There was a mild apology because of the absence of a hot joint, but that did not worry me in the least. I was provided with an ample supply of meat and with a beautiful salad, accompanied by a large slab of butter and plenty of bread. Fruit tart and custard was followed by a big piece of cheese. At this point I asked for a little more bread, which request brought forth the reply: "Certainly! I'd better bring you some more butter, too." Actually, there was ample butter for even my extravagant requirements, but I did not resist the further supplies which were offered. This bountiful meal was served in a pleasant atmosphere of friendliness, which was most acceptable.

On the following day, at a house where you are allowed to help yourself, I had a gorgeous lunch of roast chicken and asparagus, followed by a sweet, which was "kneedeep" in cream, with unlimited supplies of biscuits, butter and cheese to complete the orgy. Yes: catering problems are losing some of their terrors.

Two days later, however, I realised that the improvement is not universal—and I obtained a glimpse of the manner in which the other half of the world lives. The boss of a little country inn was apologetic. He could not provide me with lunch; he could not manage even a plate of bread and butter. He had already served a dozen people with food of various sorts, and his supplies were exhausted. There was neither butcher nor baker in the village, and the grocer, not normally dealt with, was not exactly obliging over odd purchases. Bread supplies were brought round from an adjacent village once a week—on Thursdays, and this was Tuesday! I felt bound to accept the position, despite the fact that I was ready for food and that the next place on my homeward route was 14 miles ahead. But fancy, ye town dwellers; a weekly delivery of the staff of life! Who likes stale bread?

Opinion—of Sorts

ON one of the days when I was away from home I idly picked up a daily newspaper which I do not normally read, and there, under the headline "Opinion,"

I found this gem, in the course of a tirade against the limitation of petrol supplies for private motorists: "So if you want a breath of countryside air or a smell of the seaside briny, you will be forced into overcrowded railway carriages." Well, I had a five-day holiday, during which I achieved a moderate mileage of 296, obtaining in the process several breaths of countryside air and smells of the seaside briny, all without being "forced into overcrowded railway carriages."

Evening Joy

I DEVOTED a golden evening in early June to a prowling about some of the lanes of Warwickshire, in the neighbourhood of Solihull, Hampton-in-Arden and Eastcote, etc. One of Sir Arthur Conan Doyle's characters is made to speak of the Avon Valley as "the most English part of England." Without quarrelling with that dictum, I would like to suggest that there is certainly no more English portion of the country than that in which I wandered. It seemed to me—and the thought kept coming back with renewed force—that this was essentially England, in concentrated form.

The mosaic which I so thoroughly enjoyed was composed of these ingredients: Delightful lanes of the anything-but-straight type; an occasional water-splash; the liquid song of the birds; carpets of bluebells; exquisite scent of hawthorn; a perfect sky; the pure gold of the sun slanting across the countryside; a sense of remoteness from the noisy world (which was yet so very near); grand houses, old and new—the old ones of warm red brick, with oak insets in the outer walls, and matured gardens laid out in perfect taste, with magnificent turf and glorious flowers and ancient trees—the new ones, variegated and (many of them) charming, delicately poised on bits of land wrested from the old Forest of Arden. How well these houses, ancient and modern, fitted into a gorgeous picture! Come and look at the picture, my friends, some time when you are in the Midlands—especially (perhaps) in the springtime. It will please and delight you, as it pleases and delights one whose front door almost opens out to these thrilling scenes, and who revels in it week by week and month by month. In one respect, at least, familiarity does not breed contempt. Emphatically not!

The Obvious

THE other Saturday afternoon I emerged from my home wheeling a bicycle and clad in all the insignia of a cyclist—open-neck shirt, shorts and white (or near white) ice-cream jacket. This suggestive appearance prompted a neighbour to ask me a question in these terms: "Are you going for a ride on your bicycle?" Knowing that sarcasm would have been lost on the questioner, I kept myself well in hand and replied affirmatively. The temptation to say that I was going to conduct a high-class orchestra at the Town Hall, or that I was intent on doing a spot of coal-mining, was enormous! There are some things which are obvious. This is one of them. And when you encounter a cyclist at the roadside with his bicycle up-ended and a section of one of the inner-tubes exposed to view and a pump and repair outfit all conveniently placed, there is hardly any need to ask: "Have you got a puncture?"

Highlights

IF I were asked what were the highlights of a six-day road traverse which I recently carried out, with a total mileage of 415, I would say these (in no order of merit): The empty roads, the glorious enchantment of the countryside, beautified beyond description by "tons" of spring flowers; tea in an elevated garden at Aberdovey; the marvellous lucidity of the last day of the holiday. I was staving at Chirbury, in Shropshire, and roaming round from there. As I was moving in all directions the wind was alternately for and against me—though, on balance (for once in a way), I had the best of the bargain. On the last night of the holiday I was wakened up by Rude Boreas in his most angry mood, and I nearly crossed a bridge before it was reached. I decided that, if the wind were still in the east, where it had sat throughout the week-end, and was intending to blow on the following day as per current sample, then I was going to have a pretty gaudy ride home. In the event, as the wind had changed direction, there was no "bridge" to cross, and my 73-mile journey was "easy money." Which just stresses the folly of crossing bridges before you come to them, and of climbing over obstacles which are not there!

Rail Help

THE Aberdovey trip was achieved only with a spot of rail help, which I am always averse from taking. I was determined to go, however. During the outward ride, with a helping wind and a favouring gradient, I made inquiry, and found that there was just a possibility of my catching a train back for part of the way: otherwise the road journey would have been one of over 100 miles, involving a late arrival at my "digs." I caught that train (at Machynlleth)—the only one of the day—with a three-minute margin. It carried me over the hardest part of the itinerary and against a bleak wind, dumping me at Newtown, I electing to cycle the remainder of the journey.

"Practical Mechanics" Advice Bureau **COUPON**

This coupon is available until August 31st, 1948, and must be attached to all letters containing queries, together with 3 penny stamps. A stamped, addressed envelope must also be enclosed.

Practical Mechanics

August, 1948

Published about the 30th of each month by GEORGE NEWNES, LIMITED, Tower House, Southampton Street, Strand, London, W.C.2, and Printed in England by W. Speaight & Sons, Ltd., Exmouth Street, London, W.10. Sole Agents for Australia and New Zealand—Gordon & Gotch (A/Sia), Ltd. Sole Agents for South Africa—Central News Agency, Ltd. Subscription Rates (including postage): Inland, 10s. 6d. per annum. Abroad, 10s. per annum. Canada, 10s. per annum. Registered at the G.P.O.

for transmission by Canadian Magazine Post. CONDITIONS OF SALE AND SUPPLY: This periodical is sold subject to the following conditions, namely, that it shall not, without the written consent of the publishers first given, be lent, re-sold, hired out or otherwise disposed of by way of Trade except at the full retail price of 9d.; and that it shall not be lent, re-sold, hired out or otherwise disposed of in a mutilated condition or in any unauthorised cover by way of Trade; or affixed to or as part of any publication or advertising, literary or pictorial matter whatsoever.

For the Elementary Student

Book, "Easy Home Chemistry"	2	0
Beaker, with Lip	1	6
Bechline Shelves	1	0
Aspirator Bottle	4	0
Bunsen Burners	1/8	3
Corks (bark) best quality assorted	per doz.	8
Crucibles, porcelain	1	0
Filter Paper (packets of 100)	11	
Plaster (flat bottom or conical)	1	9
Gas Jar, with Plate	2	1
Pneumatic Troughs	5	2
Retort Stand, complete with Rings	8	8
Clamp and Boss for above	7	0
Spirit Lamp, glass	3	0
Test Tubes, assorted, per doz.	1	3
Tripod Stands	1/8	2
Glass Tubing, 120"	1	0
Wire Gauzes (plain), 4d. each; (Asbestos)	1	0
Blowpipes, nickel plated	1	3
Charcoal Blocks	8	

Mark all Orders E. S. Dept.
Add 1/- on 5/- for Carriage, 1/10 over 5/-.
Any 15 of the above items, CARRIAGE FREE.

For the advanced Chemistry Student, Detailed Price Lists of Apparatus and Chemicals sent on receipt of stamp.

VICSONS LTD., Pinner Road, Harrow, Middlesex.

Genuine Ex-Railway and Ship
TARPAULINS
Waterproof. Guaranteed Good Condition. 70 sq. ft., 20/- 140 sq. ft., £2 10s.; 280 sq. ft., £5. Approx. 360 sq. ft., £6. Approx. 720 sq. ft., £12. All include carriage.
Ex-W.D. Shovels, 3ft. overall, 3/9 each, carr. 1/3. Entrenching Spades, 18in. overall, 1/6, carr. etc., 9d. U.S.A. Waterproof Knee Boots, new, Rubber soles, 2/6, post. etc., 1/-. New Waterproof Gauntlets, 5 pairs, 2/6, or 4/8- gross, carr. free.
Tents, Marquees and all sorts camping equipment in stock. Send 1d. for Bargain List.
HEADQUARTER & GENERAL SUPPLIES, LTD., DEPT. FEIT,
196/200 Coldharbour Lane, London, S.E.5. 1 min. from Loughborough Junc. Station, London.

ZEOLITE
WATER SOFTENER REFILLS
Refills for water softeners at reasonable charge. This Zeolite is of a high exchange rate value and is guaranteed. Price of refill upon application. State gallons of water to be softened between regenerations. Refill sent from
HALL AND HAMBLIN,
BCM/ROS,
LONDON, W.C.1.

ADANA PRINTING MACHINES
Print in the odd hours with an Adana—still the most absorbing of crafts. No. 1 H/S Machine £4.10.0. No. 2 H/S Machine £9.15.0. Will pay for itself in a month or two. Send for illustrated folder to
Dept. P.M. 13,
Adana (Printing Machines), Ltd.,
15/18, Church St., Twickenham, Middx

TRANSFORMERS
Thompson's of Greenwich (Estb. 1897) can now supply their Guaranteed
TRANSFORMERS FOR TRAINS
12 or 20V. 11A. 25/-
12 or 25V. 21A. 25/-
Models to suit individual requirements. Step-up or down for American Radios 110V-220V., etc., and Chargers. Send stamp for estimate and List.
T. W. THOMPSON & CO.,
176 Greenwich High Road,
Greenwich, S.E.10.

NICKEL PLATING
Complete Equipment, including Nickel Anode, Plating Salt, etc. Full Instructions for Plating Ornaments, Car Fittings, and all Metal Parts. Flash-lamp battery only required.
Price 15/-, post free.
HOLBOROW & CO.,
71, Weymouth Bay Avenue,
Weymouth.

CATALIN
We hold large stocks of the wonder cast resin for Homecrafts, rods, sheets, cylinders, profiles, etc., in glorious colours. S.A.E. Lists. Sample Offer. Sufficient for beautiful Table Lamp, 9/- post free. NEW Plastic Resin Glue. Heat & Water proof. Sticks anything. 3/6 post free.
TOWN BOOKSHOP,
Enfield, Middx.

NO MAN CAN KNOW TOO MUCH OF HIS PRODUCT

For the close scrutiny of every conceivable object, metals, tools, fabrics, minerals, precious stones, paint, print, manu- scripts, biological and botanical specimens, cutting edges, fractured surfaces, raw materials, powders, granules, and innumerable other purposes, the **ULTRA LENS** is invaluable, and presents in many instances hitherto unsuspected data which can be used to advantage.

The Ultra Lens is a revealing eye of six actual diametrical magnifications, which brings out points of strength or weakness, and enables the most minute measurements to be gauged accurately. Whether you are engaged in manufacturing, buying or selling, it is an ally of real value. No instrument you can buy will more quickly justify and pay for itself.

FULL PARTICULARS ON REQUEST
THE ULTRA LENS COMPANY,
75, Finsbury Court, Finsbury Pavement, London, E.C.2.



PARK RADIO OF MANOR PARK Offers:

CRYSTAL DIODES, permanent detectors, no resetting; much louder than catwhisker-to-crystal. 2/6 each, circuit diagram 3d. extra.
0-60 MICROAMP. METERS, two in one case, per case of two, 7/6.
0-500 MICROAMP. METERS, fine for making up 2,000 ohms per volt meters, 7/6 each.
...0005 **TUNING CONDENSERS**, like one section of a twin gang, 3/6.
TWIN GANG CONDENSERS for short-wave work, 15pf. 2/6, 100 pf. 3/6.
MICRO-TELEPHONES, very sensitive, work up to five miles with no mains or batteries whatsoever; also make good under-the-pillow speakers, 2/6 each. Smaller and less sensitive type, 1/9 each.
CAR CUTOUPS—brand new—12v., 6/9 each.
CAR AMMETERS, 0-30 double reading, brand new, 6 or 12v., 6/9.
CAR IGNITION CONDENSERS, all types, reconditioned, 1/6 each.
+ **H.P. A.C. MOTORS**, 230v. 50 cycles, single phase, 2,800 r.p.m., £3 12s. 6d. plus 5/- carriage.
+ **H.P. D.C. MOTORS**, 230v., 2,800 r.p.m., £3 10s. plus 5/- carriage.
HEADPHONES, balanced reed to spun aluminium diaphragm, made by S. G. Brown or Plesseys, excellent for use with crystal sets, 4/11 pair plus 7d. postage.
"TOM THUMB" HEADPHONES, with small earpieces about the size of a large cherry, 7/6 pair. All valves and components in stock for television or radio use. Send for our lists of new and ex-Govt. goods.
Postage included in cost of goods except where otherwise stated.
Park Radio of Manor Park, 676/8, Romford Road, London, E.12

TOY-CASTING MOULDS —DEEP CUT

Soldiers, sailors, airmen, ships, planes, tanks, cars, farm animals, wild animals and keepers. Sample mould 3/6. Plastercraft Metal Moulds.—Wall plaques, galleons, brooches, dog ornaments, etc. Sample mould of brooch 3/6. German flat moulds from 3/6. S.A.E. for List. 9d. for Illustrated Catalogue.
NUTHALL, 69, ST. MARK'S RD., HANWELL, LONDON, W.7



STEAM ENGINE
Horizontal type for boats, etc., complete with brass osc. cylinder, safety valve, heavy flywheel, spirit lamp. 10 1/2in. long, 4 1/4in. high, 2 1/2in. wide, 60/-
RAIL PARTS
1/4in. Round Spring Buffers ... 9d.
3 Link Couplings (pair) ... 8d. 8d.
Screw Couplings ... 1/11 1/11
S/L Couplings per pair ... 6d. 8d.
Corr. Coach Kits ... 12/6 16/6
Imitation Grass per sheet 1/6 1/6

Exley, Mills, L.M.C. W. & H. "Gem",
Peco, Hambling Parts. Postage extra.
"00" or "0" Parts List 3d. per post.
TYLDESLEY & HOLBROOK (M.E.T.A.)
109, DEANS GATE, MANCHESTER, 3

Free Electricity from the Wind for Your Radio, Workshop, or Bungalow.
COMPACT WIND-CHARGER TURNTABLES (to fit any Car Dynamo). Complete with all parts required. EASILY MADE at very low cost from quickly obtained parts.
DIAGRAMS and INSTRUCTIONS, 3/3 per set
J. Maker, 22, Ditton Road, Surbiton, Surrey

Electric Soldering Irons, 12/8 and £1. Hand Drills, 1in. Cap. (Millers Falls, etc.), 7/8. 6in. Spring Dividers, 2/-, 12in. Steel Rules, 2/3. 4in. and 6in. Outside Common Callipers, 1/- Hack Saw Frames, 12in., Fixed, 1/6. Flat Scrapers, 1/- Feeler Gauges, 4in., 2/- Tinsnips, 14in., Bent, 10/- Postage extra. High Speed Milling Cutters, Slitting Saws, Drills, etc. Send for full list.
W. J. BELL, WATERLOO STREET, LINCOLN.

SPARKS' DATA SHEETS

Provide detailed Instructions with Simple, Full-size Constructional Prints of Tested and Guaranteed Designs.

THE "CRUISER"

An All-dry, High-efficiency 3-valve T.R.F. Circuit.
Three Pentodes, Fine range, power and quality. Low cost. Good selection of stations on M/L waves with short aerial. Designed for those wanting a compact, all-dry, trouble-free design for the home, caravan, camping, yachting, etc. ... 2/6

THE "OLD FOLKS TWO"

An A.C./D.C. 2-Valve Plus Rect. for those who cannot be bothered with tuning. 3 Station Selection by Switch. 1/M Waves. 34 Watts Output. ... 2/9

THE "CUB"

A Fine Little A.C./D.C. 2-Valve Plus Rect. M/L Waves receiver. Powerful. Inexpensive and Simple to Build. 34 Watts. Good response ... 2/6

THE "CADET"

A.C./D.C. AMPLIFIER. The youngest addition to my famous range of Amplifiers. A full 31 Watts Output. Vol. and Tone Controls. Ideal for F.U. ... 2/6

THE "CHALLENGER"

PORTABLE. An Amazing A.C./D.C. Portable. T.R.F. 3-Valve plus Rect. M/L Waves. Range and Quality ... 2/9

A.C. TWO-VALVE (Plus Rect.)

M/L Waves. 34 Watts Output ... 2/6

A.C. THREE-VALVE (Plus Rect.)

T.R.F. Circuit. M/L Waves ... 2/9

A.C. SUPERHET

3 Valves plus Rect. All-wave. 4 Watts Output. ... 2/6

A.C. 8 WATT QUALITY RADIO-GRAM

A.C. M/waves only. Quality rather than range. P.P. Neg. F/Bk. 3/6

BATTERY ALL-DRY PORTABLES

Tiny Two. Med. waves. Local station on 2 1/2in. Speaker ... 2/6

THREE-VALVE PORTABLE

M/L Waves. A very popular Set ... 2/6

THE PORTABLE FOUR

Med. waves only. T.R.F. Circuit ... 2/6

MANY OTHER DESIGNS for Sets and Amplifiers. Stamp for List and with order. Prompt Service.
COMPONENTS SUPPLIED.

L. ORMOND SPARKS (M),
9, Phoebe Road, Brockley, S.E.4
(Nearest Station: Ladywell, S.R.)
(Phone: Lee Green 0220.)

A KEYLESS PADLOCK

Built like a safe.
Hardened steel shackle cannot be filed or sawn. A really splendid thief-proof job.
Full instructions with each.

5/6 From
MORTON'S
13 CAMDEN ROAD
WALTHAMSTOW
LONDON E.17



COMPRESSORS!!

UNREPEATABLE OFFER!
SMALL AIR COMPRESSOR units suitable paint spraying, tyre inflation, etc. Can be driven by 1/2 h.p. motor or treadle. £3 18s. 6d. Post paid. **COMPETITION CAR, LTD.**, "The Old Maltings," Nayland, Nr. Colchester, Essex.

ELECTRIC "PIGMY" MOTORS

A.C./D.C. REVERSIBLE.
Specially Designed for Driving Models Size 2 1/2 x 2 1/2 in. shaft 3/16, weight 91 av. Model No. 1, 4 to 8 volts will drive a 2ft. motor boat on one or two twin cell gel batteries. New Price 20/-. Old 25/-
Ex-Govt. motors 12/24 v. 1/4 a. D.C. 2 1/2 x 1 1/2 in. h.p. 1/10, 12/8. A.C./D.C. 12/24 v. 2 1/2 x 1 1/2 in. h.p. 1/10 reversible, 19/8. Worm gears 10-1 in case 8/-, 10-1 no case 5/6, 40-1 no case 5/6. Stamp for leaflet. Satisfaction guaranteed.—E. M. Co., 120, Torrington Avenue, Coventry.

1 pint Spray Guns ...	£3 10 0
1/2 pint Spray Guns ...	£2 0 0
3 C.F. Compressors ...	£2 10 0
6 C.F. Twin Compressors ...	£2 10 0
Air Chambers with Gauges	£3 10 0
6" Saw Machines ...	£7 10 0
Heavy Duty Jig Saws ...	£20 0 0
Air Hose, V. Belts, Pulleys, Gauges, Valves, etc.	

Illustrated Lists.
H. HALL, 2, Glems Way, Greenford, Middlesex.

SAILOR SAM'S SECRET

(Reg. Trade Mark).
How to make
SHIPS IN BOTTLES
COMPLETE KITS, 5/6 and 6/-, from all good-class Model, Sports and Toy Stores (Dealers Write for Terms.)
COOPER - CRAFT, LTD.
The BRIDEWELL, NORWICH

WEBLEY AIR PISTOLS

Marvellously accurate for target practice.
No licence required to purchase.
Senior Mark I
Junior Webley Air Rifle
Write for List. **WEBLEY & SCOTT LTD.,**
106, Weaman Street, Birmingham, Eng.

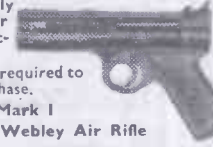

CRAIG'S LATEST

Radio-Circuit. Personally designed, tested and guaranteed. No experience needed to build this Super T.R.F. 4-valve set. M.W. A/C/D/C High Quality Output. Clear Diagrams. Detailed Instructions. Parts List, etc., 3/6.
H. CRAIG
64, CONYERS RD., STREATHAM, S.W.16.

Free Guide - "Success in Engineering"

One of the following Courses taken at home in your spare time can definitely be the means of securing substantial promotion in your present calling, or entry into a more congenial career with better prospects.

ENGINEERING, AERO, ETC.

Plastic—Radio—Aero Engines—Aircraft Design—Welding—Aerodynamics—Electrical Engineering—Television—Electric Wiring—Diesel Engineering—Generation and Supply—Works Management—Metallurgy—Refrigeration—Planning. Estimating. Rate-fixing—Time and Motion Study—Aero Inspection—Automobile Engineering—Sheet-metal Work—Engineering Draughtsmanship—Aero Draughtsmanship—Jig and Tool Draughtsmanship—Press Tool and Die Draughtsmanship—Structural or R/F Concrete Draughtsmanship—Sanitary Engineering

GENERAL

Matriculation—College of Preceptors—Chartered Institute of Secretaries—Aircraft Apprentice.

MUNICIPAL SERVICE

School Attendance Officer—Handicraft Teacher—Registrar—Housing Manager—Sanitary Inspector—Weights and Measures Inspector—Inst. of Mun. and Cy. Engineers—A.R.I.C.S.

"PRACTICAL ENGINEERING" said—

We recommend all readers interested in improving their position to apply for a copy of this valuable book. "Success in Engineering" is not a pamphlet. It is a 132-page book, containing valuable and vital information on all branches of engineering. . . . There are many engaged in engineering who owe their success to The National Institute of Engineering.

The FREE GUIDE explains:

- Openings, prospects, salaries, etc., in Draughtsmanship, Inspection, and opportunities in all other branches of Engineering and Building.
- How to obtain money-making technical qualifications through special RAPID FULLY-GUARANTEED COURSES.

Write now for your copy of this remarkable publication:

A.M.I.E.E., A.M.I.Mech.E.,
A.M.Brit.I.R.E., A.M.I.P.E.,
A.M.I.C.E., A.M.I.Struct.E.,
A.M.I.Mun.E. M.R.San.I.,
A.M.I.E.D., A.F.R.Ae.S.,
London B.Sc., Degrees.

Fully guaranteed postal courses for all the above and many other examinations. Fully described in the Free Guide.



THE BUILDING BOOM— SECURE YOUR SHARE!

The Free Guide also gives particulars of our extensive range of modern Building and Structural Courses, Building Draughtsmanship, etc. The great post-war Building programme offers unlimited prospects to technically trained men.

BECOME A DRAUGHTSMAN— QUALIFY AT HOME AND EARN BIG MONEY

Men and Youths urgently wanted for well paid positions as Draughtsmen, Inspectors, etc., in Aero, Jig and Tool, Press Tool, Electrical, Mechanical and other Branches of Engineering. Practical experience is unnecessary for those who are willing to learn—our Guaranteed "Home Study" courses will get you in. Those already engaged in the General Drawing Office should study some specialised Branch such as Jig and Tool or Press Tool Work and so considerably increase their scope and earning capacity.



THE ACID TEST OF TUTORIAL EFFICIENCY SUCCESS—OR NO FEE

We definitely guarantee that if you fail to pass the examination for which you are preparing under our guidance, or if you are not satisfied in every way with our tutorial service—then your Tuition Fee will be returned in full and without question. This is surely the acid test of tutorial efficiency.

If you have ambition you must investigate the Tutorial and Employment services we are able to offer. Founded in 1885, our success record is unapproachable.

Why not fill in and post the attached Coupon NOW for further details and Free Authoritative Guide to openings in Engineering and Building? This book contains a mine of valuable and exclusive information and may well prove to be the turning point in your career.

PROMPT TUTORIAL SERVICE GUARANTEED

FREE COUPON

To NATIONAL INSTITUTE OF ENGINEERING
(Dept. 29), 148, Holborn, London, E.C.1.

Please Forward your Free Guide to

NAME

ADDRESS

My general interest is in: (1) ENGINEERING (2) AERO (3) RADIO (4) BUILDING (5) MUNICIPAL WORK (Place a cross against the branches in which you are interested.)

The subject or examination in which I am especially interested is

To be filled in where you already have a special preference.
(Id. stamp only required if unsealed envelope used.)

NATIONAL INSTITUTE OF ENGINEERING

(Dept. 29)

148, HOLBORN, LONDON, E.C.1

OVER SIXTY YEARS OF
CONTINUOUS SUCCESS

SOUTH AFRICAN BRANCH: E.C.S.A. P.O. BOX 8417 JOHANNESBURG.

FOUNDED 1885—FOREMOST TODAY—OVER 100,000 SUCCESSES