

*Inside!* FREE 1-BLUEPRINT FOR MASTER BATTERY CLOCK

NEWNES

# PRACTICAL MECHANICS

OCTOBER

IN AUSTRALIA  
AND  
NEW ZEALAND

6<sup>D</sup>





LET ME HELP  
YOU  
INTO A KEY  
POSITION



DO ANY OF THESE SUBJECTS INTEREST YOU?



Accountancy Examinations  
Advertising and Sales Management  
A. M. I. Fire E. Examination  
Applied Mechanics  
Army Certificates  
Auctioneers and Estate Agents  
Aviation Engineering  
Banking  
Boilers  
Book-keeping, Accountancy and  
Modern Business Methods  
B.Sc. (Eng.)  
B.Sc. (Estate Management)  
Building, Architecture, and Clerk of  
Works  
Builders' Quantities  
Cambridge Senior School Certificate  
Civil Engineering  
Civil Service  
All Commercial Subjects  
Commercial Art  
Concrete and Structural Engineering

Draughtsmanship. All branches.  
Engineering. All branches. subjects  
and examinations.  
General Education  
G.P.O. Eng. Dept.  
Heating and Ventilating  
Industrial Chemistry  
Insurance  
Journalism  
Mathematics  
Metriculation.  
Metallurgy  
Mining. All subjects  
Mining, Electrical Engineering  
Motor Engineering  
Motor Trade  
Municipal and County Engineers  
Naval Architecture  
Novel Writing  
Pattern Making  
Play Writing  
Police. Special Course

Preceptors, College of  
Press Tool Work  
Pumps and Pumping Machinery  
Radio Communication  
Radio Service Engineering  
Road Making and Maintenance  
Salesmanship, I.S.M.A.  
Sanitation  
Secretarial Exams.  
Sheet Metal Work  
Shipbuilding  
Shorthand (Pitman's)  
Short Story Writing  
Structural Engineering  
Surveying  
Teachers of Handicrafts  
Telephony and Telegraphy  
Transport Inst. Exams.  
Weights and Measures Inspectors  
Welding  
Wireless Telegraphy and Telephon  
Works Managers



If you do not see your own requirements above, write to us on any subject. Full particulars free.

STUDY AT HOME IN  
YOUR SPARE TIME

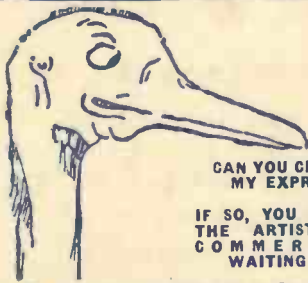

CAN YOU CHANGE  
MY EXPRESSION?

IF SO, YOU MAY BE  
THE ARTIST THAT  
COMMERCE IS  
WAITING FOR

*Jim Duck* Just try it for yourself. Trace or draw the outline and then put in the features

There are hundreds of openings in connection with Humorous Papers, Advertisement Drawing Posters, Calendars, Catalogues, Textile Designs Book Illustrations, etc.

80 per cent. of Commercial Art Work is done by "Free Lance Artists" who do their work at home and sell it to the highest bidders. Many Commercial Artists draw "retaining fees" from various sources, others prefer to work full-time employment or partnership arrangement. We teach you not only how to draw what is wanted, but how to make buyers want what you draw. Many of our students who originally took up Commercial Art as a hobby have since turned it into a full-time paying profession with studio and staff of assistant artists; there is no limit to the possibilities. Let us send full particulars for a FREE TRIAL and details of our course for your inspection. You will be under no obligation whatever.

*Jim Duck* ART DEPT. 76.

YOU CANNOT MAKE MONEY  
BY SAVING

If you save 10s. per week for 10 years you have only got £260, but if you spend 2s. 6d. per week for 12 or 18 months on a correspondence course, you give your brains a chance to earn thousands of pounds; then there is no need to save.

Savings are likely to vanish, but earning capacity is a permanent investment.

I HAVE HELPED THOUSANDS  
OF OTHERS

And when I say thousands, I do not exaggerate, as I can produce well over 10,000 unsolicited testimonials from grateful students who through our Postal Training, have achieved their life's ambition.

*J. Bennett*



Dept. 76, THE BENNETT COLLEGE, SHEFFIELD

EVERY DEPARTMENT IS A  
COMPLETE COLLEGE: EVERY  
STUDENT IS A CLASS TO  
HIMSELF

JOURNALISM  
Short Story, Novel and Play  
Writing

There is money and pleasure in Journalism and in Story Writing. No apprenticeship, no pupillage, no examinations, no outfit necessary. Writing for newspapers, novels or pictures is not a gift; it is a science that can be acquired by diligent application and proper guidance. It is the most fascinating way of making pastime profitable. Trained ability only is required; we do the training by post. Let us tell you all about it. DEPARTMENT OF LITERATURE 76

If you attend to this now, it may make a wonderful difference to your future.

COUPON—

CUT THIS OUT



To Dept. 76, THE BENNETT COLLEGE LTD., SHEFFIELD. Please send me (free of charge)

Particulars of.....  
Your private advice about  
(Cross out line which does not apply.)

PLEASE WRITE IN BLOCK LETTERS.

Name.....

Address.....

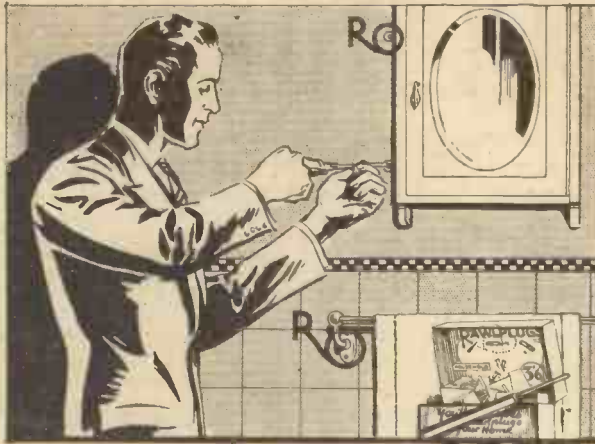

## When you Use a Screw Use a RAWLPLUG Tool



Millions of Rawlplugs were used on such famous engineering jobs as the Mersey Tunnel, the Shannon Electricity scheme, Grid Systems and thousands of other jobs where reliable fixing work is of the utmost importance. Yet Rawlplugs are so simple to use that anybody can make neat, firm fixtures with them in a few minutes—even if the user has had no previous experience. There is a Rawlplug for every size of screw. Every Electrician, Builder and Handyman should have a Rawlplug Outfit as part of his kit. Complete Outfits at 1/6, 3/6 and 5/6.

work is of the utmost importance. Yet Rawlplugs are so simple to use that anybody can make neat, firm fixtures with them in a few minutes—even if the user has had no previous experience. There is a Rawlplug for every size of screw. Every Electrician, Builder and Handyman should have a Rawlplug Outfit as part of his kit. Complete Outfits at 1/6, 3/6 and 5/6.

## Rawlplug DUROFIX

This is the finest of all adhesives because it is unaffected either by heat or water. Crockery repaired with Durofix can be washed in hot water or baked in an oven. In addition, Durofix leaves no ugly stain at the join because it is colourless. Sportsmen will find it ideal for repairing the binding on cricket bats, golf clubs, etc. Once it has set, the moisture of the hands cannot make it tacky again. Sold in orange tubes, ready for use, at 6d. and 1/-.



### Repairing Frayed ends of Electric Wire

Durofix will repair the frayed ends of electric wire covering, neatly and efficiently. Just put a little Durofix on the fingers and roll round the frayed ends. This ensures a neat finish and a permanent job.



## Rawlplug PLASTIC WOOD

### Wood in Putty Form



This product is wood in putty form. It is pliable and can be moulded to any shape desired. It is invaluable for filling holes and cracks in all kinds of articles, and in addition it is a powerful adhesive. The craftsman also will find dozens of uses such as designing mouldings, model making and so on. When exposed to the air, Rawlplug Plastic Wood quickly hardens, and can be cut, planed, painted and varnished—just like ordinary wood. Sold in tubes at 6d. and 1/-, and in tins from 9d. upwards.

Write for illustrated literature of these and other Rawlplug Products. Free on request.

**THE RAWLPLUG COMPANY LTD.,**  
Rawlplug House, GROMWELL ROAD, LONDON, S.W.7

B194A

## A Book Guide for the Electrical Engineer

# The Electrical Educator

Revised, Enlarged and Rearranged in Convenient Form

This Famous Work Now Covers

## Electrical Development, Telegraphy, Telephony

Television, Photo-Telegraphy, Wireless Telegraphy, etc., up-to-date

EDITED BY SIR AMBROSE FLEMING, M.A., D.Sc., F.R.S., WITH CONTRIBUTIONS BY THE GREATEST LIVING AUTHORITIES

### SOME OF THE SUBJECTS COVERED :

The Education of Electrical Engineers—Electricity and Magnetism—Electrical Measuring Instruments—Mechanics for Electrical Students—Electric Materials—Cables—House Wiring—Electric Fittings and Switches—Electric Lamps—Wireless Telegraphy and Telephony—Direct Current Measuring—The Institute of Electrical Engineers—What We Owe to the Arc Lighting Period—Armature Winding—Electric Traction—Central Station Steam Plant—Costing for Power Station Engineers—Power Station Records—Private Generating Plant—Drawing for Electrical Engineers—Electric Salesmanship—Education and Training for the Electrical Industry

—Accumulators—Automatic Telephones—Photographing Heart Beats—The Minor and the Super Power Station—Invention in Electrical Engineering—The Law of Electric Supply—Electrical Advertising—The Ether—Photo-Telegraphy and Television—Theory of Alternating Currents—Development of the Electrical Industry (by Colonel Crompton)—Electrical Condensers—Special Steels in the Electrical Industry—History of the Electrical Industry—Electricity from Sand—Electrical Calculations—Pioneers of Electricity (Biographies)—Co-operation in the Electrical Industry—The Future of the Electrical Industry, etc.

IF IT IS ANYTHING CONNECTED WITH ELECTRICAL ENGINEERING, YOU WILL FIND IT IN THIS WORK

Our FREE Pamphlet Will Tell You About It

This up-to-date Book-Guide will never fail you. It answers every question: it solves every difficulty. It pays for itself.

Once acquired, you can study the subjects listed above, making yourself more and more efficient in the difficult knowledge belonging to your chosen work without leaving your armchair. You may have the complete work for only 5/- first payment.

The New Era Publishing Co., Ltd., 12-14 Newton Street, High Holborn, London, W.C.2.

Send me, free of cost or obligation to order anything, descriptive booklet on THE ELECTRICAL EDUCATOR in its new, convenient form, with particulars as to popular price and easy terms of payment

NAME.....

ADDRESS.....

DATE..... P.M.100

# AMBITIOUS ENGINEERS

## THIS IMPORTANT HANDBOOK ON SUCCESSFUL ENGINEERING CAREERS

# FREE ON REQUEST



After months of intensive effort and research, we are pleased to announce that the New edition of our Handbook, "ENGINEERING OPPORTUNITIES," is now out of the publishers' hands and ready for *free distribution*. Containing 268 pages of practical guidance, this book is, beyond argument, the finest and most complete handbook on Successful Engineering Careers ever compiled. It is a book that should be on the bookshelf of every person interested in engineering, whatever his age, position or experience.

The Handbook contains, among other intensely interesting matter, details of B.Sc., A.M.I.C.E., A.M.I.Mech.E., A.M.I.E.E., A.M.I.A.E., A.M.I.W.T., A.M.I.R.E., CIVIL SERVICE, and other important Engineering Examinations: outlines courses in all branches of CIVIL, MECHANICAL, ELECTRICAL, AUTOMOBILE, RADIO, TELEVISION and AERONAUTICAL ENGINEERING, BUILDING, GOVERNMENT EMPLOYMENT, etc., and explains the unique advantages of our Employment Department.

**WE DEFINITELY GUARANTEE  
"NO PASS-NO FEE"**



If you are earning less than £10 per week you cannot *afford* to miss reading "ENGINEERING OPPORTUNITIES." In your own interests, we advise you to **write** (or forward the coupon) for your copy of this enlightening guide to well-paid posts—NOW. *There is no cost or obligation of any kind.*

### BRITISH INSTITUTE OF ENGINEERING TECHNOLOGY

410a, SHAKESPEARE HOUSE,  
17, 18 & 19, STRATFORD PLACE, LONDON, W.1

----- TEAR OFF HERE -----  
**FREE COUPON**

BRITISH INSTITUTE OF  
ENGINEERING TECHNOLOGY,  
410a, Shakespeare House,  
17-19, Stratford Place, W.1.

Please forward, Free of cost or obligation of any kind, your 268-page Handbook, "ENGINEERING OPPORTUNITIES"

NAME.....

ADDRESS.....

.....

.....

## SUBSCRIPTION RATES

Inland and Abroad 7s. 6d. per annum  
Canada - - 7s. per annum

Editorial and Advertisement Offices: "Practical  
Mechanics," George Newnes Ltd.  
Tower House, Southampton Street, Strand, W.C.2.

Phone: Temple Bar 4363.

Telegrams: Newnes, Rand, London.

Registered at the G.P.O. for transmission by  
Canadian Magazine Post.

*Copyright in all drawings, photographs, and  
articles published in "Practical Mechanics"  
is specifically reserved throughout the  
countries signatory to the Berne Convention  
and the U.S.A. Reproductions or imitations  
of any of these are therefore expressly  
forbidden.*

# PRACTICAL MECHANICS

Editor : F. J. CAMM

VOL. VI. OCTOBER, 1938. No. 61.

## The Civil Wireless Reserve

FOLLOWING the formation of the Civil Air Reserve to which we drew attention last month, Sir Kingsley Wood has now inaugurated the Civil Wireless Reserve, and thus given official recognition to the work of the amateur transmitter. Sir Kingsley appeals for amateurs to enrol as part of the reserve of the Royal Air Force Volunteer Reserve. In the meantime, accepted candidates will be enrolled as civilians. The main details for candidates are as follows: Candidates must be between the ages of 18 and 54 on the date of application, although exceptional consideration may be given to applicants over that age if they have special qualifications. All candidates must be British subjects and of pure European descent, and they must also be the sons of parents both of whom are or were British subjects, or naturalised British subjects. Candidates will be required to show that they have a reasonably good knowledge of wireless telegraphy and the morse code, and should preferably be holders of a G.P.O. transmitting and/or an experimental licence.

Candidates will be enrolled for a period of 5 years in the first instance, and on enrolment every member will be required to accept the following obligations: To place his services at the disposal of the Air Council in the event of an emergency; to transfer to the appropriate section of the Royal Air Force Volunteer Reserve, when called upon to do so; to undertake the prescribed training and to keep the Director of Signals informed of changes of address.

Members may be discharged from the reserve at any time on the grounds of medical unfitness, unsatisfactory conduct, or inability to reach the normal standard of proficiency. Training for the most part will be undertaken by the members at their homes on their own sets, and will consist of exercises

## Fair Comment By The Editor

broadcast from the Air Ministry and the Royal Air Force Electrical and Wireless School, Cranwell. In addition, lessons will be circulated to members from time to time, and members whose transmitters are used in connection with training will be allotted special call-signs. Members will be affiliated to the Royal Air Force units and they will be required to become acquainted with wireless equipment in use in the Royal Air Force by visits to their various units. When so required an allowance of sixpence an hour will be paid to members for each complete hour's training subject to a maximum payment in respect of 8 hours including meal-times for any one day's attendance. Applications should be made on Form 2170, and forwarded to the Under-Secretary of State, Air Ministry (Signals C.W.R.), Kingsway, London, W.C.2.

### The Gearless Car

AS usual the daily papers hailed with enthusiasm the announcement made at the British Association that an inventor had produced a successful gearless car. The newspapers saw in this the end of the present system of gear-changing, but I hasten to assure readers that it will be a long time before gearless cars are on the market, and that it is extremely improbable that the present system of gear-box will ever be abolished. It has fifty years of reliable public service to its credit. When it was first introduced the inventor stated: "It's brutal but it works." It has survived all these years, and now that synchromesh gears have made

gear-changing delightfully easy the necessity for a further attempt to get rid of it has vanished.

Most of the newspapers seemed to be under the impression that a gearless car was something entirely new. It may interest my readers to know that over 900 Patents have been taken out in the last few years for gearless cars. Most of them have been found impracticable, and nearly all of them, apart from the fact that they could not be produced commercially, introduced greater complications than those they sought to eliminate. Ships, railway engines, and buses, have made use of hydraulic devices for many years, and it was over 30 years ago that Dr. Föttinger produced a fluid coupling for ships. Most of these hydraulic devices have been found to be of low efficiency, due to loss of power and consequent production of heat. Apart from this a car was marketed a few years ago in this country which eliminated the gearbox, but it did not meet with success.

### Three New Handbooks

AS PROPOS the Civil Wireless Reserve we have just published a new handbook at 2s. 6d., by post 2s. 10d., entitled "Wireless Transmission for Amateurs". Intending applicants for membership of the Civil Wireless Reserve will find this volume of great use, in enabling them to acquire the necessary knowledge, not only of methods and principles, but of practical transmitters for amateurs. The second volume is entitled "The Practical Wireless Service Manual." It deals with the tracing of troubles in, and the servicing of all types of wireless sets. It costs 5s. by post 5s. 6d. The third volume is entitled "Workshop Calculations, Tables and Formulae". It is packed with just the information which every draughtsman, turner, fitter, mechanic and engineer requires. It costs 2/6, or 2/10 by post.

# "PRACTICAL MECHANICS" MASTER BATTERY CLOCK



PRESENTED FREE WITH "PRACTICAL MECHANICS" DATED OCTOBER 1938.

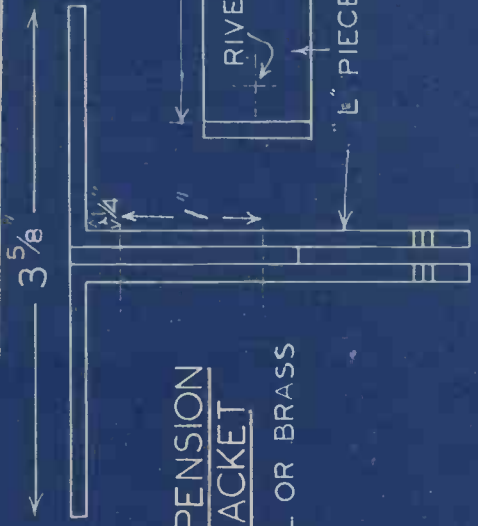

**SUSPENSION BRACKET**  
STEEL OR BRASS

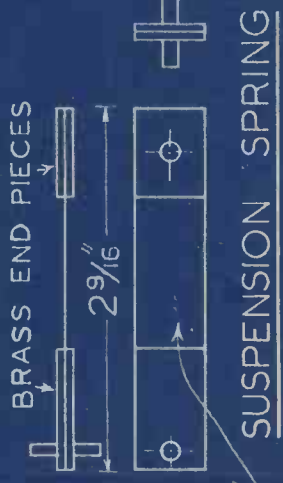

**SUSPENSION SPRING**



**ARMATURE**  
1 OFF. SOFT IRON



**YOKE, 1 OFF SOFT IRON**

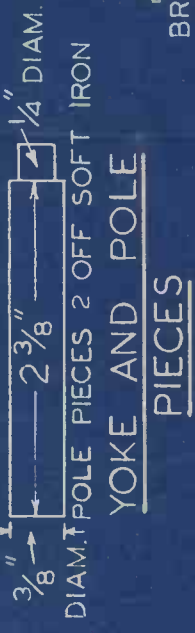

**POLE PIECES 2 OFF SOFT IRON**

**YOKE AND POLE PIECES**

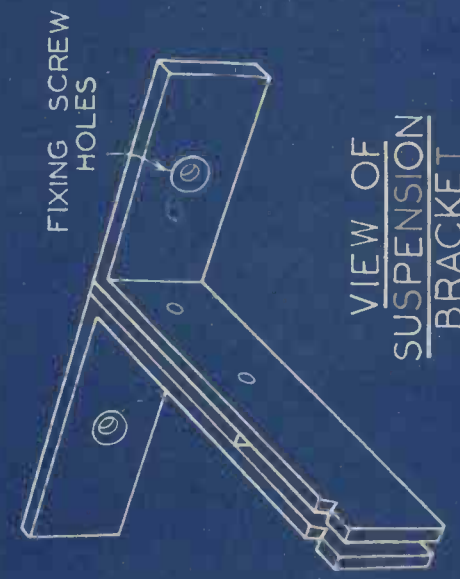

**VIEW OF SUSPENSION BRACKET**

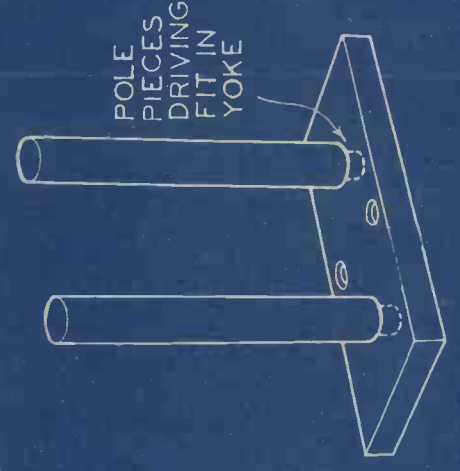

**THE COMPLETED MAGNET CORE**

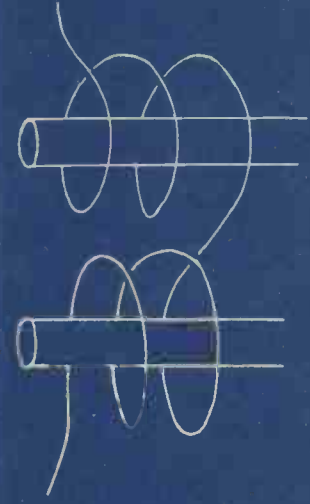

**COIL WINDING DIAGRAM**



**SECTION AT X-Y**

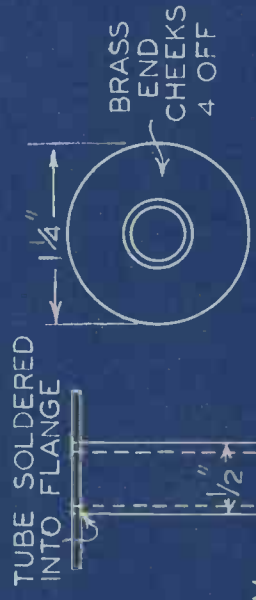

**COIL BOBBINS**

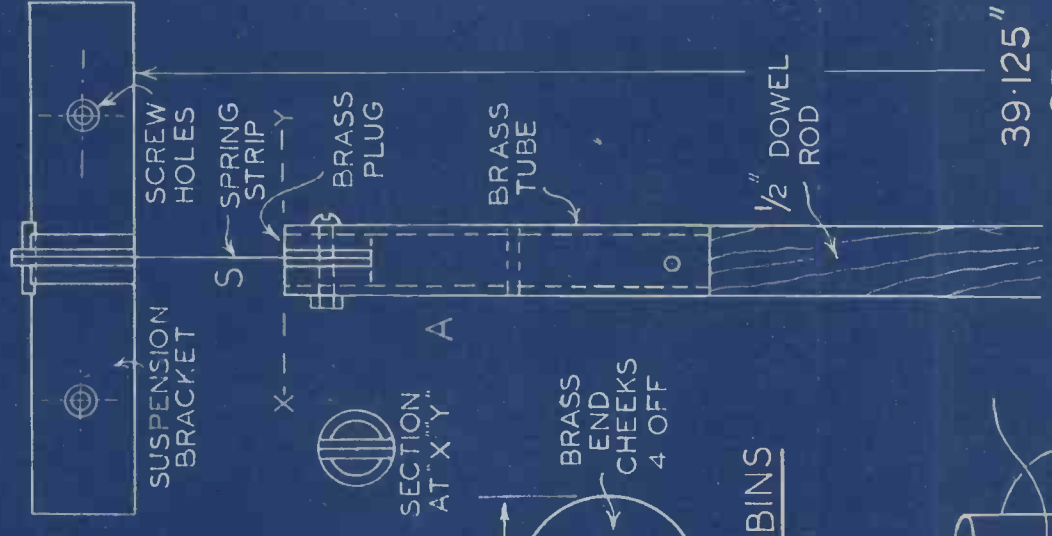

39.125"  
OR  
22.00"

THE PENDULUM WEIGHT MAY BE OF IRON DRILLED FOR THE ROD TO PASS THROUGH OR MAY CONSIST OF A CANISTER FILLED WITH LEAD SHOT

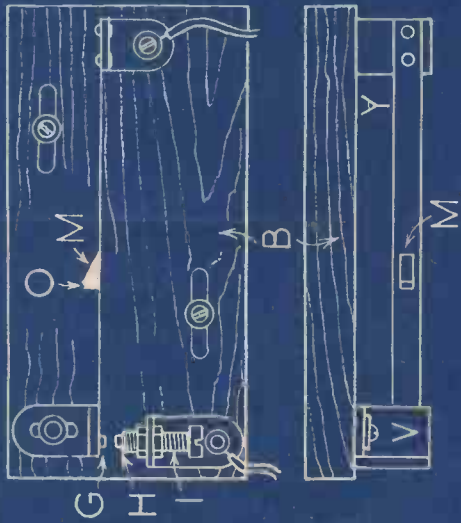
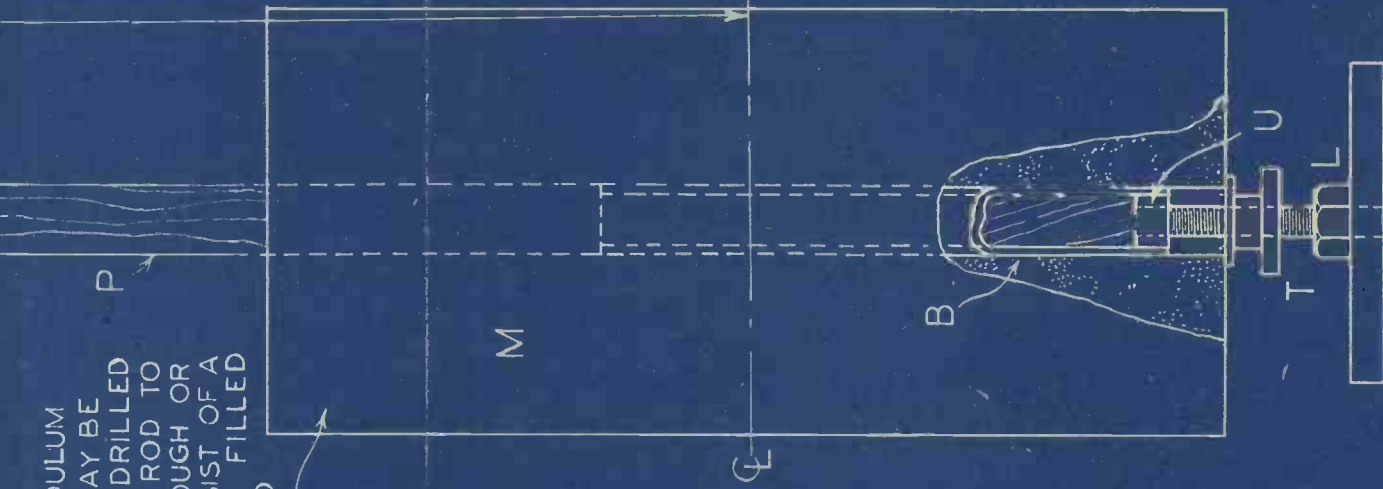

THE CONTACT MAKER

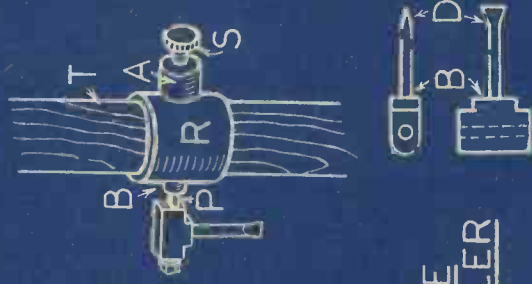

THE TRAILER SUPPORT

THE TRAILER

ALARM CLOCK MOTOR WITH ESCAPEMENT, BALANCE WHEEL, MAIN SPRING WHEEL & ALARM TRAIN REMOVED. THE MOVEMENT IS USED IN AN INVERTED POSITION

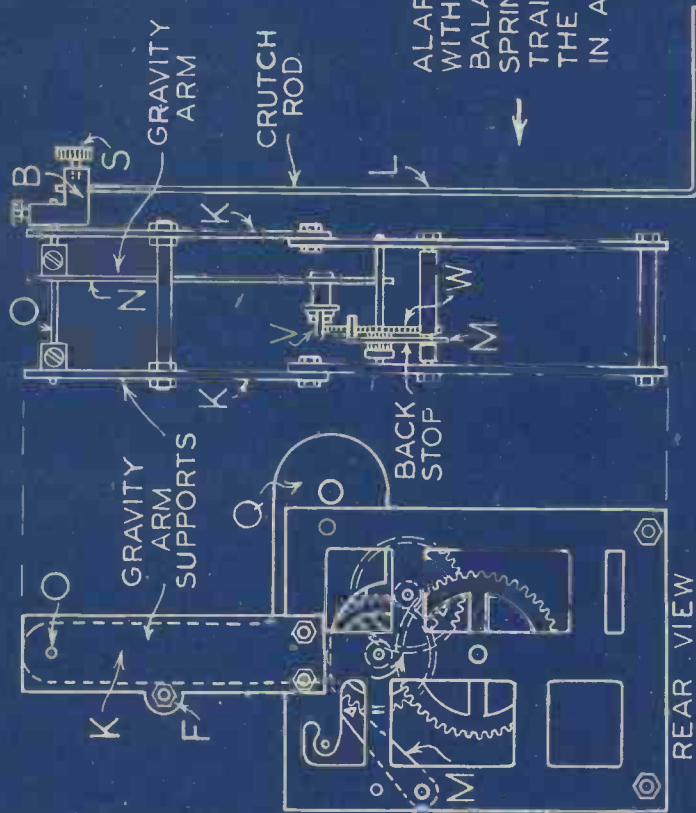
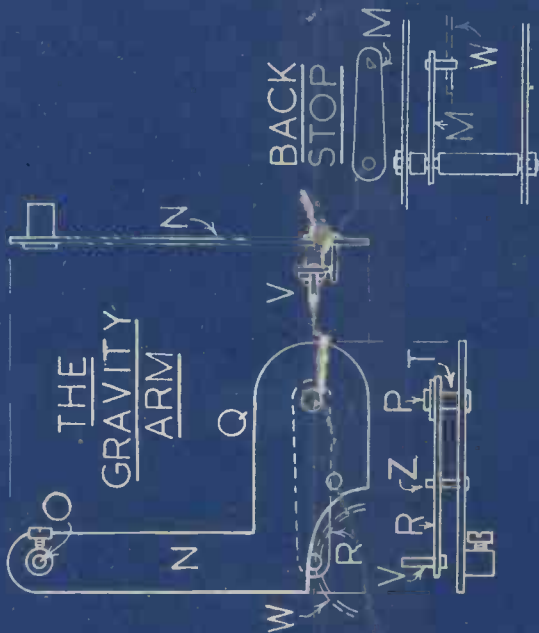

REAR VIEW

THE WHEEL MECHANISM

# PRACTICAL MECHANICS

## How to make a most Reliable Electric Clock Parts. It will control a "Slave" Clock

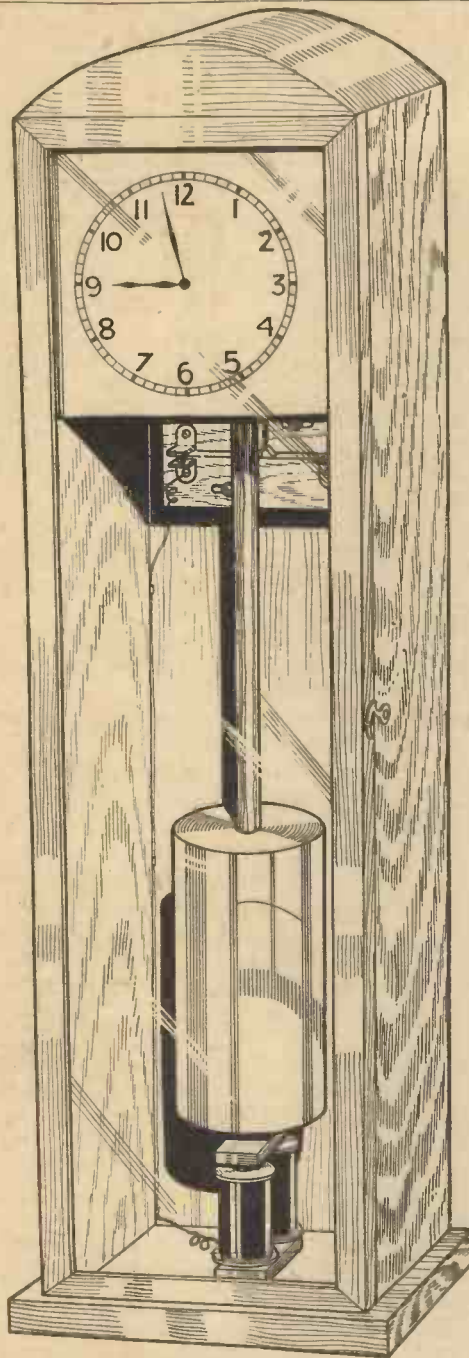

Fig. 1.—The finished P.M. electric clock. It may, of course, be housed in a variety of case styles.

**A**LTHOUGH mains electric clocks have become extremely popular, almost to the extent of rendering spring-driven clocks obsolete, at least 50 per cent. of the homes of this country are not wired for electric light and thus an immense market exists for battery operated devices. This is particularly so in connection with wireless, for official statistics prove that 60 per cent. of the total sales of wireless receivers are for battery-operated sets. We have described several battery-operated clocks in past issues, and those issues have rapidly gone out of print. We have received some thousands of requests for a battery-operated Master Electric Clock which would not only form an electric timepiece complete in itself, but one which would also operate a system of Slave Clocks serving every room of the house.

The basis of the present clock is the

movement of an ordinary cheap alarm, and by means of the addition of a few simple fittings easily made it is converted into the pendulum-operated clock shown in the blue print and in the drawings. It operates from a Leclanché cell, and consumes negligible current.

It will be as well to outline the principle underlying the action of the master clock, and so acquaint the reader with the arrangement of the mechanism and purpose of each part.

Fig. 6 shows diagrammatically the complete mechanism and the manner in which the hands receive their motion, whilst the sketch Fig. 1, is intended to give some idea of how the clock will appear when the components have been assembled. The reader can vary the design of the case to suit himself.

Referring to Fig. 6, A, B and C are three wheels mounted on independent arbors, the wheel C rotates once each hour, from whence it follows that the arbor carries the minute hand. Loosely mounted on the same arbor is the "cannon" J, carrying the hour hand, one end of J is attached to the wheel O, receiving motion through two similar wheels L and L and a pinion K; the wheel L is driven by the arbor which carries wheel C. This group of wheels constitutes the "dial wheels."

The wheel C meshes with the pinion which is mounted on the same arbor as the wheel B which meshes with the pinion D carried by the arbor to which is secured the ratchet wheel A, driven by the "gravity arm" through the medium of the pawl. The gravity arm is secured to an arbor oscillated by a crutch rod and which is engaged at every alternate swing of the pendulum T. The combined weight of the arm and crutch rod must be adequate to cause the pawl to propel the wheel A whilst returning to their initial position after displacement by the pendulum rod.

Matters are so arranged that when the pendulum swings to the left it displaces the crutch rod and gravity arm in the same direction, simultaneously the pawl is withdrawn and picks up a tooth of the wheel A. The pendulum now com-

mences to swing towards the right, but is now followed up by the crutch rod and arm. The energy stored in the arm is now utilised in driving the wheel A one tooth forward, the movement in turn being transmitted through the wheel-work to the hands of the clock.

### The Vibration of the Pendulum

The scheme for maintaining the vibration of the pendulum is as follows: An ordinary wooden pendulum, equipped with a heavy "bob" U has a threaded extension terminating in the armature W. Fixed rigidly beneath the armature is an electro-magnet X, so that the armature just swings clear of the electro-magnet. When, however, the arc of vibration becomes reduced to a predetermined value, a small "finger" or "trailer" Y pivoted to the upper portion of the rod T fails to swing clear of a light spring, one end of which is riveted to a bracket, whilst the free end of the spring is equipped with a contact engaging with a stationary contact. On the return swing of the rod T, the finger Y having previously dropped into a nick in the block Z levers down the spring and momentarily the contacts are closed, and the magnet X is energised. When the contacts close, the leading edge of the armature W is just about to pass over the magnet cores, consequently the excitation of X attracts the armature and the pendulum is impulsed. An increased arc of vibration

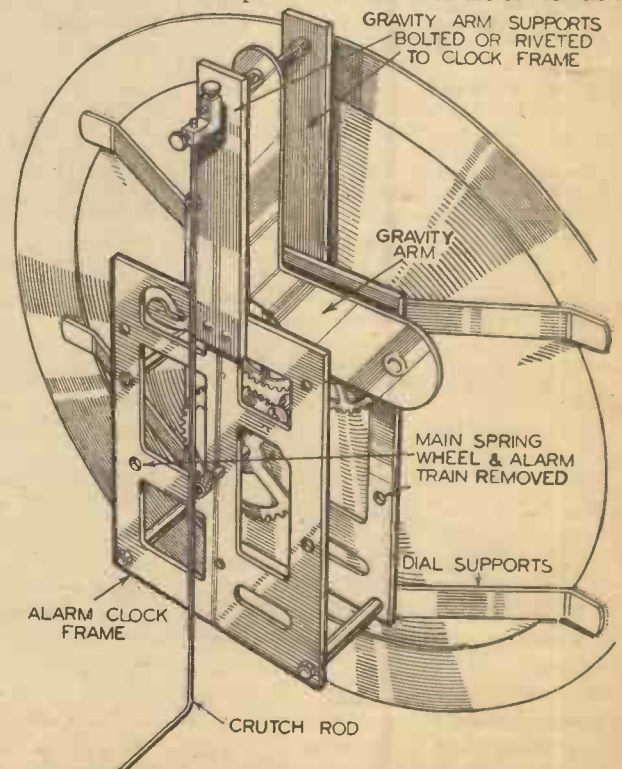

Fig. 2.—General view of the assembled clock unit and dial, seen from the rear. The crutch rod is operated by the pendulum.



# NICS MASTER BATTERY CLOCK

(See Blueprint in this issue) from Standard System serving every Room in the House

of the pendulum results, so that the finger Y is again carried clear of the block Z for several swings of the pendulum.

Gradually, however, the swing becomes reduced and the finger again fails to clear the block Z, when the contacts are again closed.

This simple means of impulsing the pendulum is automatic in action and economical as far as current consumption is concerned, and two or three quart Leclanché cells should run the clock for at least twelve months without any attention whatever.

### The Electro-Magnet

The soft iron yoke (Fig. 7) has riveted to it two soft iron cores, the ends of which are shouldered down and are a driving fit in the holes drilled in the yoke.

For securing the electro-magnet in position the yoke is drilled for two countersunk screws. Slipped over the cores are the bobbins Fig. 8; these are wound with the magnetising coils.

The bobbins are easily built up from thin brass tube of a size to fit the cores snugly, and are completed by soldering to the ends of the tube brass flanges in which a hole has previously been cut for the insertion of the tube. Before winding on the wire wrap a couple of turns of notepaper around the tubes, and well brush with shellac varnish. To insulate the flanges, cut some discs of paper, of course cutting the centre of the disc for the tube; cut through one side so that the discs can be placed on the bobbin, and then well brush with varnish. A couple of small holes may be drilled through one flange of each bobbin for threading the ends of the coil through.

Now proceed to wind on each bobbin as evenly as possible about 3½ ounces of No. 30 single silk-covered wire; cotton-covered wire may be used if at hand. Be particularly careful not to reverse the direction of winding during the process.

When the coils are wound slip them over the cores, and connect the finishing end of one coil with the starting end of the other. The two remaining ends of the coils should now be connected to a couple of dry cells, or Leclanché cells to ascertain if there are any breaks in the wire; also, to check the pull of the magnet with a piece of soft iron.

Assuming the test is satisfactory, finish off the coils with a coat of some insulating varnish, and to give a pleasing appearance the coils may be covered with a piece of black velvet.

### The Suspension Bracket

Two pieces of steel or brass, E and F, Fig. 13, are bent at right angles and drilled with two holes for attachment to the backboard. Inserted between E and F is a distance piece H, a shade thinner than the thickness of the brass at X, Fig. 3. After truing up the sides of E, and F coming against the piece H, the whole is drilled and riveted together, ensuring that the top and bottom edges of the bracket are square and parallel. Carefully cut a V notch in the top edge of E and F to receive the suspension pin Q.

If necessary file out the checks of the bracket until the brass blocks of the suspension spring are a snug fit, and will permit the pin Q to rest in the notches.

### Armature

For the armature (Fig. 7), use a piece of soft iron. A centrally drilled hole is tapped to suit the screwed rod attached to the end of the pendulum rod, and is locked in position by a nut. It is as well to anneal the iron by allowing it to remain in the fire overnight.

### The Pendulum

The pendulum is built up; a main portion P consists of a piece of half-inch wooden curtain rod, the ends being fitted into pieces of brass tube, A and B. (See blueprint)

The tube A is closed at one end with a piece of brass rod, slotted to receive the suspension spring S, a small bolt and nut being the means of attachment. The rod is reduced to fit into the tube and a couple of small holes are drilled through the whole to receive rivets made from soft wire.

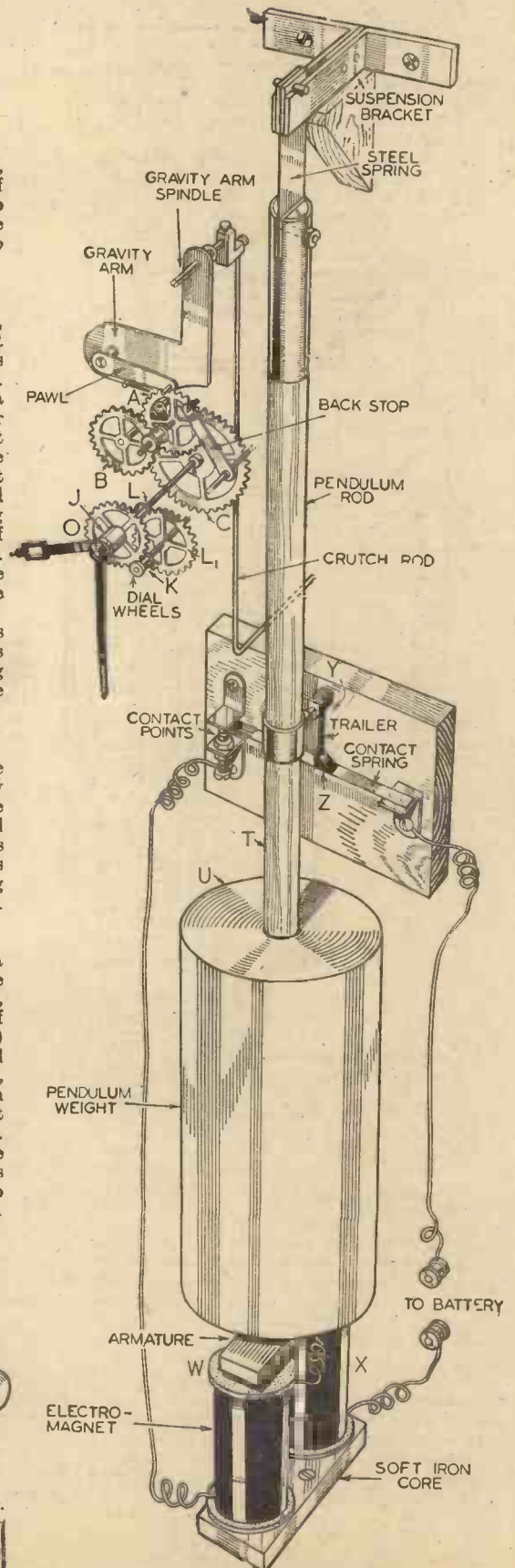

Fig. 6.—General layout of the electric clock.

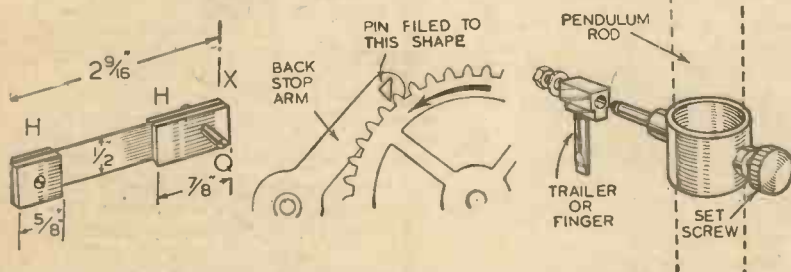

Fig. 3—Pendulum suspension spring. Fig. 4—Back stop or Detent. Fig. 5—Pendulum trailer.

A stout art. board dial can be obtained for 1s., post free, from the publishers, Geo. Newnes, Ltd., Tower House, Southampton Street, Strand, W.C.2.

The tube B is attached to the rod in a similar manner, but before attachment, a quarter-inch brass collar (or nut filed down), is driven into the end of the tube and soldered; screwed into the collar is a piece of threaded rod T, to carry the timing nut and the armature L. Sliding freely over B is the bob M, which should weigh from 10 to 15 lbs. and may be of iron or lead.

Fig. 3 shows the method of attaching the suspension spring to the brass chocks by small rivets.

Use steel ribbons or "feeler" blade steel for the spring, which should be from 3/1,000 ins. to 5/1,000 ins. in thickness.

The ends of the spring should be a good fit in the suspension bracket and the end of the pendulum respectively; the upper end of the spring has a pin Q that normally rests in the notches of the bracket. The length of the pendulum is measured from the bottom of the bracket to the centre of the bob; any slight error in length is easily corrected by altering the position of the bob by means of the timing nut.

#### Trailer or Finger

A piece of steel wire, D, is flattened at one end, the other end is driven into and soldered to the block B; the latter has a hole drilled at right angles to D to take the pin carried by the pendulum fitting.

The whole fitting should be as light as possible; to reduce wear, the flattened end of the wire D should be filed to a point and hardened.

To support the finger, the special fitting (Fig. 5) will have to be built up. This consists of a piece of thick tube R, to fit the pendulum rod T freely, and on opposite sides of the tube are soldered the bosses A and B; these are drilled and tapped to receive respectively the milled screw S and the pin P.

The screw S provides for adjustment of the finger up and down the pendulum rod relative to the contact-maker.

#### The Wheelwork

To reduce the amount of work and the tediousness of building up the wheelwork, necessitating the correct pitching of the holes for the pivots of the various arbors, it is proposed to utilise the movement of an alarm or other clock.

It will be appreciated that, although certain additions are made to the frames and wheels removed, yet the positioning of the wheels will not be affected.

If the movement has a seconds hand, remove all the wheels in the alarm train, then remove the "balance wheel" and "escapement"; after that, the large wheel carrying the main spring of the going train.

The next matter is to decide whether the clock is going to have a long or medium-length pendulum.

If a 2 seconds pendulum is used, its length will be 22 ins., and the number of teeth in the ratchet wheel will be 40, since a 2 seconds pendulum makes 80 swings per minute. On the other hand, if a long or seconds pendulum is preferred, with a length of 39.12 ins. the ratchet wheel will have 30 teeth. Frequently, on counting the number of teeth on the highest driven wheel of a movement, they will number 40, which is suitable for a 2 seconds pendulum.

In this case it is not absolutely necessary to substitute a ratchet wheel of 40 teeth, but the driving pawl will have to be carefully shaped to fit the teeth of wheel. If it is decided to replace the wheel by a ratchet wheel with either 30 or 40 teeth, a piece of sheet brass may be used in its construction.

The length of the pendulum will not

affect the other details of the clock, which can now be considered in detail.

#### The Frames

To support the arbor carrying the gravity arm it will be necessary to rivet or bolt to the frames two brass strips K. These are tied together at the upper ends by a length of 2BA threaded rod F; a piece of tube slipped over the rod serves as a distance piece when the nuts are screwed up. Viewing the movement from the back, it will be advisable to remove the top right-hand pillar originally fitted for keeping the frames the correct distance apart.

Holes are drilled in the strips K to take the gravity arm arbor O.

On account of clock frames varying in size, it may become necessary to modify slightly the dimensions given in the blueprint but no great difficulty will be experienced.

#### The Gravity Arm

This component is readily made from a piece of sheet brass, and should be of ample proportions to have the required weight to propel the ratchet wheel.

A projection Q on the lower end of N carries the pawl R, engaging with the teeth of the wheel W, whilst its upper end is fitted with a bush to suit the arbor O. On account of the clock frames varying in size, the dimensions on the gravity arm can only be given approximately; the constructor can modify this to suit his special requirements.

The pawl is built up from a brass strip it, mounted on and soldered to a piece of thick tube T, to act as a bush, which in turn oscillates on the pin P projecting from Q.

A pin V, riveted to the outer end of R, engages the teeth of the ratchet wheel; the pin should be filed to suit the shape of the teeth.

To prevent the pawl from dropping and picking up more than one tooth when withdrawn by the pendulum, a pin Z may be set in the arm on which the pawl may temporarily rest.

The back stop M can be manufactured in much the same way.

#### Contact Maker

The device takes the form of a light spring, riveted at one end to a brass bracket screwed to a wooden or ebonite base B. The free end of the spring is provided with a contact G, engaging with an adjustable contact H, carried by the bracket I.

To restrict the play of the spring, an adjustable stop V is introduced; thin strips of leather, etc., may be glued to it to silence the action when the spring is released.

The spring should not be too stiff, otherwise in depressing it a lot of unnecessary work will be thrown on the pendulum.

Riveted or otherwise mounted on the spring is a small wedge-shaped block M; the latter has a small nick cut at one end for the entry of the finger.

The baseboard B should be provided with slotted holes for adjusting purposes.

#### Crutch Rod Details

The connecting link between wheelwork and pendulum is the crutch rod (Fig. 2). To render the rod adjustable up and down the pendulum as well as on the gravity arm arbor O, a small fitting B will suit all requirements. The item is cut from a block of brass and has two holes drilled at right angles to take the arbor A and the lever L respectively; tapped holes receive set screws S for locking purposes.

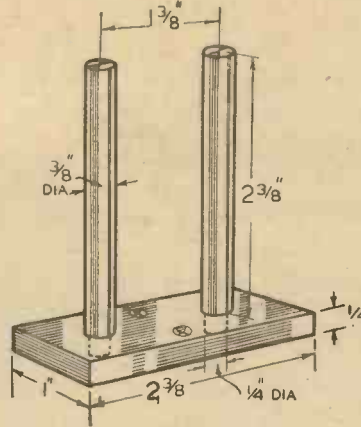

Fig. 7.—The magnet core.

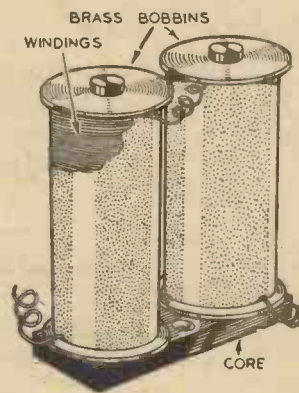

Fig. 8.—The complete electro-magnet.

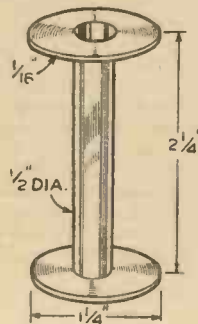

Fig. 9.—Details of the bobbin.

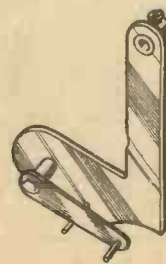

Fig. 10.—The driving piece, operated by the crutch rod.

**Hands and Dial**

The design of the hands and the dial are left to the constructor's taste; the former should be fairly light and correctly fitted to the movement. The dial may be of cardboard, brass, etc., and about 7 ins. across; suitable dials may, however, be purchased for a few pence, although there is no reason why it should not be home-produced.

There are various ways of mounting the dial (obtainable from us for 1s.); one is shown in Fig. 2, and shows the dial secured in position by metal brackets soldered to the clock unit.

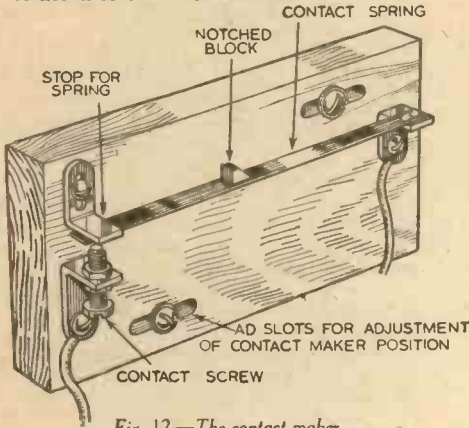

Fig. 12.—The contact maker.

**Mounting and Wheelwork, etc.**

All the components are erected on a substantial backboard, so that the whole may ultimately be placed in a suitable case; the batteries may also be housed in the bottom of the case. The clock frame is attached with brackets to the backboard.

The backboard should have drawn on

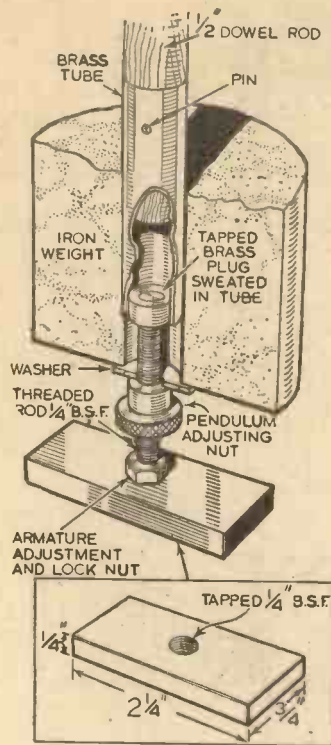

Fig. 11.—Details of the pendulum and armature.

it a centre line, and is then hung up or set so that the line is truly vertical. Screw the pendulum suspension bracket to the top of the board so that the pendulum hangs in front of the line on the board. Next place

the electro-magnet in position so that the cores are central with and about 1/16 in. below the armature; the gap can be reduced to a minimum later by packing up the magnet with a piece of cardboard. The magnet is best supported by a bracket or shelf.

The position of the contact-maker is found by experiment, mounting its base-board a little above the mid-position of the pendulum rod. The rod should hang

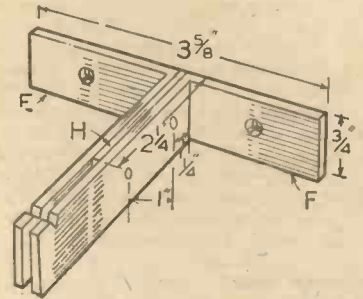

Fig. 13.—The pendulum bracket.

vertically at the time and the board set so that the nick in the steel block is on the left of the finger.

Now lower the finger attachment on the pendulum until the former is about 1/16 in. below the block. A little experimenting will be necessary to get the best results, raising the finger may be necessary if the spring is depressed more than, say 1/32 inch.

The Slave-Clock operating mechanism will be dealt with next month.

**New Paper Cup Handle**

PÂPIER-MACHÉ drinking vessels are not a novelty, but an inventor has thought there is room for improvement in relation to the handle of a paper cup. He has, therefore, provided what he claims to be a perfected collapsible handle. It is of simple construction and designed with a view to the convenient nesting of one cup within another. This paper drinking vessel will at least obviate the breaking of much crockery.

**Publicity Pennant**

THERE has recently been devised a streamer specially adapted for towing behind an aeroplane. In order to ensure that this streamer shall make the most of itself, it is furnished with a tapering air tube open at the front and rear. This will prove to be a lift-contributing element, causing the emblazoned advertisement or other display to expand into conspicuous legibility.

In this country, in some quarters, there is a feeling that the dome of heaven should not be converted into an advertisement hoarding. But, up to the moment of writing, no legal restriction prohibits an aeroplane playing the role of a comet with an advertisement on its tail.

**New Aeroplane Landing System**

A NEW aeroplane instrument landing system is to be tried out at the Municipal Airport, Indianapolis, Indiana, in an endeavour to find the ideal landing system for American Aviation conditions. If successful, it will be applied at principal airports as a means of defeating weather conditions unfavourable for landing.

The system consists of a trailer carrying main and spare localiser beam transmitters with means to connect to fixed localiser aeriels at four points. There will also be a

**NOTES & NEWS**

trailer bearing main and spare glide path beam transmitters with an aerial. Also four sets of "marker" beacons each consisting of an outer marker two miles from the field and an inner marker near the boundary of the landing field. Equipment will be provided for the airport control tower for remote control of the various transmitters and for visual automatic alarm in the case of trouble in any part of the system. The localiser beam establishes for the aircraft the direct line to the airport runway, the glide path beam provides the

exact line of descent to the runway, the outer marker establishes the beginning of the glide path, and the inner marker signals that the runway has been reached.

**A Useful Lawn Mower Hint**

I HAVE a lily pond situated in the centre of my lawn, and when cutting the lawn have experienced considerable difficulty in keeping the grass cuttings out of the water, especially on a windy day. I overcome this difficulty, however, fitting an extension to the grass box as shown.

It not only keeps the cuttings from the pond, but also from the flower beds, and holds twice as much grass.

Full constructional details of the attachment are shown in the small sketch on the left, and it is held in place on the grass box by means of four 1/4-in. bolts.—J.B.

**A Tip for Owners of Lily Ponds**

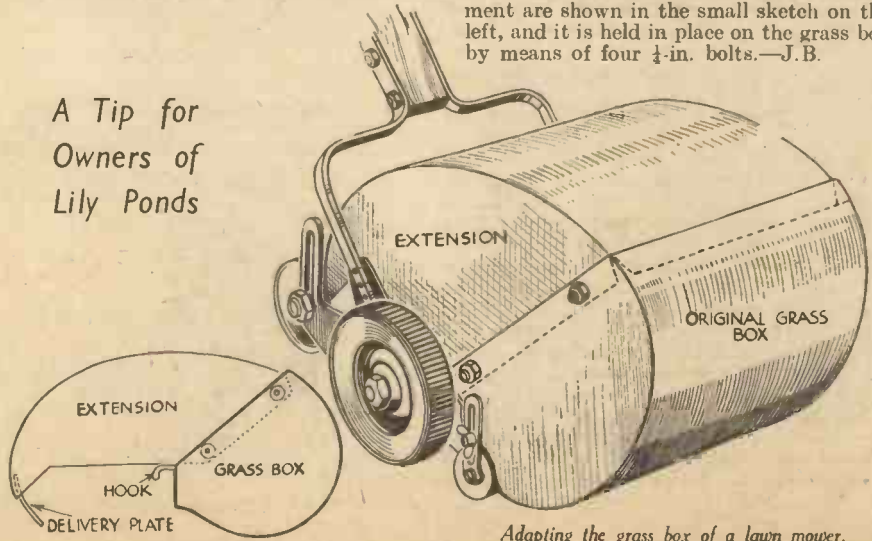

Adapting the grass box of a lawn mower.

# A SIMPLE MICROPROJECTOR

## A Device for Projecting Botanical and Biological Specimens on to a Screen

MUCH of the eyestrain involved in viewing and drawing microscopic botanical or biological specimens can be eliminated by the construction of a microprojector. The specimen must first be mounted on a slide in the customary manner for use with a microscope, and a much magnified image is then projected on to a screen in a darkened room.

An easy and perfectly satisfactory layout is shown in Fig. 1. The slide is held by elastic bands or strip springs against the side of a wooden box containing a 60-watt lamp, a hole being cut in the side of the box big enough to illuminate the slide. If available, a low power objective should be taken from a microscope and mounted on a wooden stand as shown in the illustration and the relative positions of lens and screen adjusted until a bright image is focused on the screen. The actual positions will depend on the objective employed. If an objective is not available, a substitute can be devised from two short focus convex lenses placed close together and preferably mounted as in Fig. 2, when light only passes through the centre of the lens system. A focal length of one inch is the most satisfactory. The wooden stand not only holds the lens system but also acts as a baffle, shielding the screen from stray light.

### Translucent Screen

For maximum convenience in viewing, a translucent screen should be made by stretching a piece of greaseproof paper upon a wooden framework of dimensions roughly 12 ins. x 12 ins., and the screen is then observed from the remote side. With this scheme a magnification of 30 to 40 diameters can be used for successively demonstrating the specimen to an audience in a darkened corner of the room.

It is fascinating to make photographic records of minute specimens, and with a microprojector this is fairly easy. If the screen is replaced by a photographic film, an exposure of an hour is necessary, but if, instead, gaslight paper replaces the screen, an exposure of three minutes is sufficient. The light and shade in the resulting print are reversed, but this is not really important since the specimen is usually stained to show up its structure

and so in any case the natural colour contrasts could not be obtained. What is important is that an accurate record of the

transparent red paper is held between the lens and the gaslight paper, the image can be focused directly on the gaslight paper. Exposure is effected by removing the Cellophane. The advantage of this method lies in the fact that the slide gets warm owing to its proximity to the lamp; if exposure were made by switching on the lamp, the glass slide would be heated up from cold and the consequent expansion would result in a blurred image. (The expansion of the specimen itself is negligible, it is the increase in thickness of the glass causing the very short distance from lens to specimen to alter that upsets the focus.)

### More Elaborate System

As mentioned above, the heating of the slide may cause inconvenience in certain cases, particularly if it is desired to exhibit the slide continuously for a long period, or if the specimen is likely to be damaged by heat. To overcome this the more elaborate system of Fig. 3 may be set up.

In the new scheme, the heat from the lamp is absorbed in passing through a solution of 5 grams of alum in 100 grams of water contained in a rectangular trough. This solution is extremely efficient in transmitting the light rays and absorbing

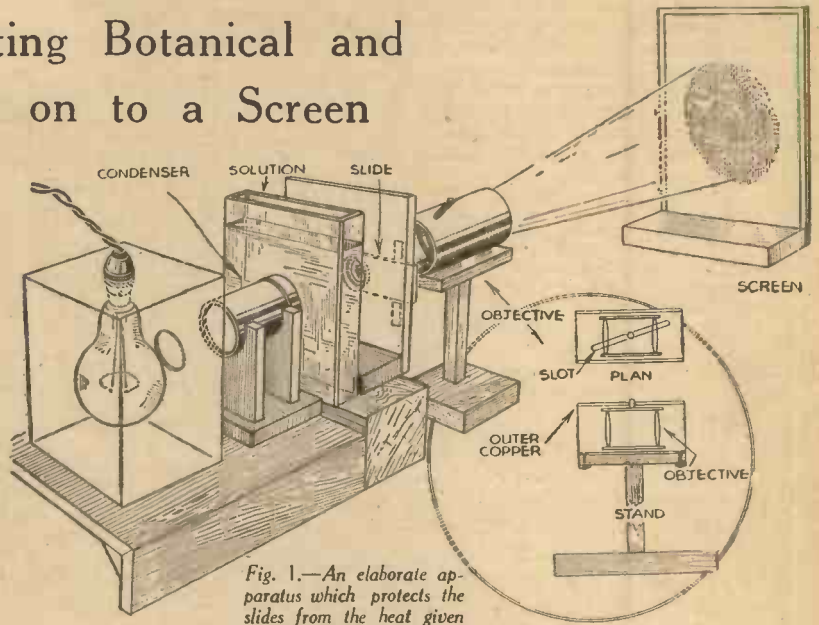

Fig. 1.—An elaborate apparatus which protects the slides from the heat given off by the lamp. Inset is shown the independent mounting for the objective.

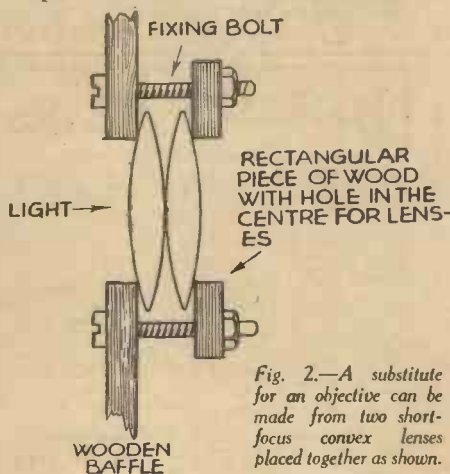

Fig. 2.—A substitute for an objective can be made from two short-focus convex lenses placed together as shown.

cell structure is clearly shown in black and white. The microphotographs of botanical specimens reproduced on this page were all obtained in this way.

If a piece of red Cellophane or other



(Left) Transverse section of a lily seed showing the ovaries.

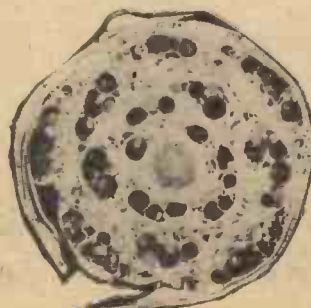

Typical transverse section of a stem.



Transverse section of host (right) and longitudinal section of parasite (on left)

the heat rays, but tap water may be used as a fairly good substitute. For the best effect the light should traverse about one inch of solution.

Because of the increased distance of the slide from the lamp, a bigger hole must be cut in the side of the lamphouse and a condenser used to concentrate the light on the slide. The size of the hole depends on the diameter of the condenser lenses, but in the writer's scheme the latter is  $1\frac{1}{2}$  inches so the hole has a diameter of 1 inch. As can be seen, the condenser consists of two short focus convex lenses mounted in a short length of tube so that the position can be easily adjusted.

**Mountings**

The slide is carried as before by strip springs mounted on a baffle. Thus an independent mounting can be arranged for the objective with an easy focusing adjustment if desired (Fig. 4). The objective is held in a tight-fitting copper tube roughly  $1\frac{1}{2}$  ins., long: this copper tube rides in a slightly bigger copper tube which has a diagonal slot cut in its upper surface. A  $\frac{1}{8}$  inch of brass rod soldered on the inner tube projects through this slot and as the rod is moved along the slot

it causes the objective to rotate and thus advance or recede from the slide. With this layout the components may be mounted rigidly on a baseboard.

*A simple and perfectly satisfactory layout which is not so elaborate as that shown in Fig. 1.*

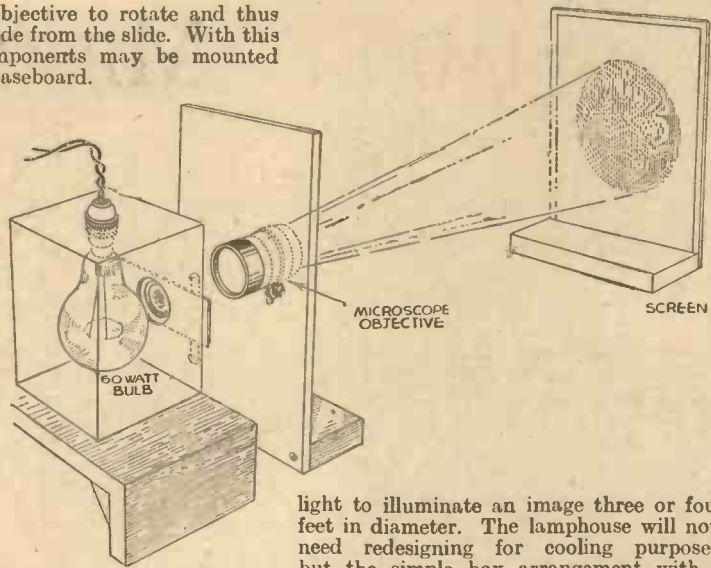

For exhibiting to large audiences, a higher power lamp such as a "pointolite" must be used in order to get sufficient

light to illuminate an image three or four feet in diameter. The lamphouse will now need redesigning for cooling purposes, but the simple box arrangement with a 100-watt lamp has met all the requirements of the writer. Alternatively, a 12-volt car headlamp bulb can be used in the box.

## Photomicrography With Simple Apparatus

**B**y utilising an old stand camera and a secondhand microscope, you can make up an efficient device for taking microphotographs.

Make a wooden stand, rather like the support of a vertical photographic enlarger, and near the top of the stand bore a hole to take a tripod-screw for holding the camera. Below the camera make a shelf to hold the microscope.

Place the microscope on the shelf, adjust the condensing mirror to the source of light and place the object-slide on the stage. Focus the microscope and select the part of the slide you want to photograph.

Remove the eyepiece from the microscope, fix the camera, with no lens in it, on to the upright support and extend the tube of the microscope until it meets, or slides inside, the lens-mount of the camera. Make the join between the microscope and the camera light-tight. A velvet sleeve with elastic both ends is a good way to make this join and exclude all light.

Now examine the image on the ground glass screen of the camera. It will be nearly in focus and it can be made completely

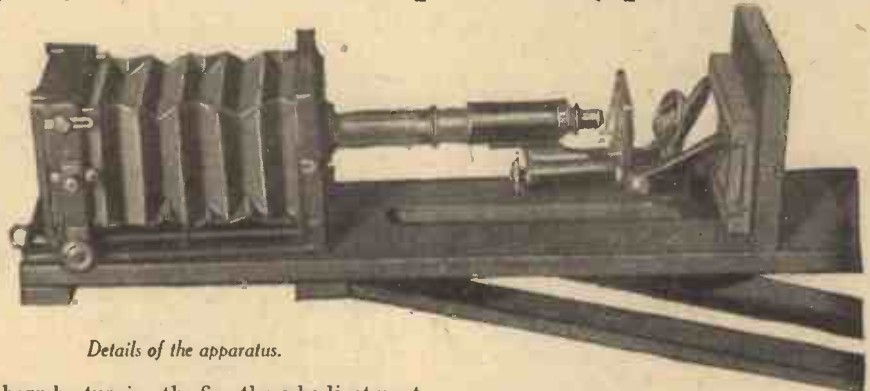

sharp by turning the fine thread adjustment of the microscope.

The only way to estimate the time for exposures is to make a trial exposure in strips. Pull out the slide of the plate-holder half an inch or so and leave it for, say, four seconds. Then pull it another half-inch and leave it for a further four seconds, and so on, until the shutter has

been drawn right out. The strips will have been exposed for four, eight, twelve, sixteen seconds etc., and when the plate is developed you will soon find the correct exposure.

Use fine grain sensitive material and then you will be able to add still more to the magnification by making enlarged prints.



*A section through the stem of a water lily.*



*The foot of a fly.*



*Hairs of a mouse.*

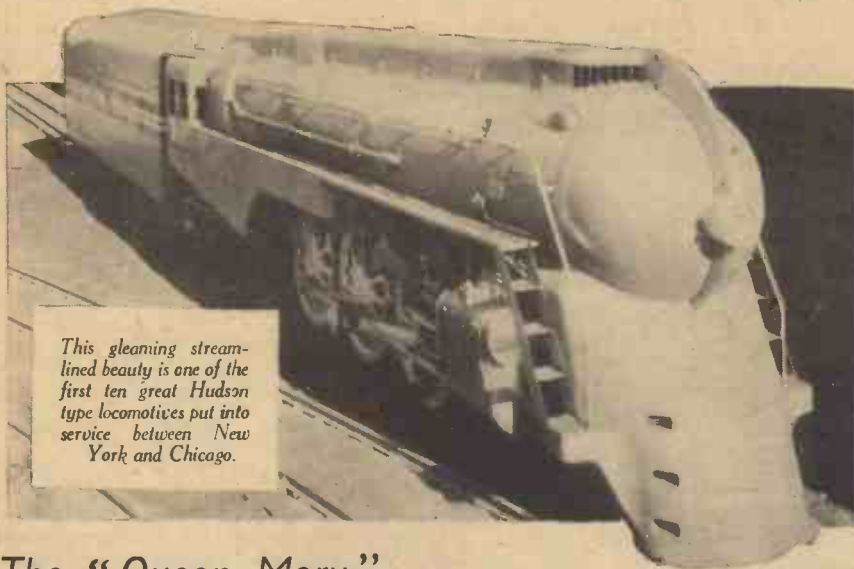

This gleaming streamlined beauty is one of the first ten great Hudson type locomotives put into service between New York and Chicago.

## The "Queen Mary"

THE *Queen Mary* is once again the proud possessor of the Blue Riband, as she has crossed the Atlantic in 3 days 20 hours 42 minutes, the fastest time ever made by a steamship. It beats the *Normandie's* time for the east-bound run by 1 hour 25 minutes.

It is interesting to note that the underbody of the *Queen Mary* has been coated with cement to eliminate the surface friction caused by the overlapping of the plates. As now cemented the hull presents a streamlined form offering minimum resistance to the water, and this factor may have helped her on her record run.

## Steel Coaches

BELGIUM'S Transport Minister recently announced that he is ordering a speed-up in the building of steel railway coaches to replace the 5,000 wooden carriages now used on Belgian railways.

## SOS

A DEVICE that will enable search parties to locate immediately any plane that has crashed or made a forced landing has been designed in Pasadena, California. It consists of an automatic wireless distress signal which is fitted in the plane. A heavy jolt will start it sending SOS signals.

## Railway Radio

THE installation of radio on the railway has brought many interesting problems into prominence and from a public address point of view the use of speakers in the average terminal station is not a simple matter. Reverberation, due to the domed roofs and general architectural design, is not easily overcome, but in Germany a new type of speaker has been developed, in which the sound is directed beam fashion just above

the heads of the people and it is claimed that very much greater powers may be used so that announcements are audible above the noise of general traffic work, with complete freedom from echoes and similar troubles.

## Aircraft Radio

EXTENSIVE claims are being made in America for a "new" type of micro-

# THE MONTH IN SCIENCE AND

phone which enables a pilot to speak to a listening point without any background from the engine or other flying noises. The mike is attached to a small strap placed round his neck so that the mouth need not be opened—the pilot merely voicing the words in his throat. The idea is, of course, not new, although the application to commercial aircraft may prove an interesting development of modern aircraft radio.

## Visual Conversations

DETAILS are now available concerning the German public television telephone which has been extended to Munich, a

distance of nearly 400 miles from Berlin, with which it is linked by cable. In spite of the standard of 441 lines, 50 frames interlaced to give 25 pictures which the Germans have chosen for their broadcast television service, they have deemed it advisable to adhere to the old 180 line picture, with sequential scanning at 25 pictures per second, for "visual conversations" between the cities mentioned above. The cost is only 8s. for a three-minute call, while the picture seen by each person is about 15 inches wide. If a higher definition was employed then the cable would have to be of a far more elaborate character, and cost correspondingly increased. By using infra-red scanning and a mechanical analyser, however, the resultant picture gives a poor colour effect; contrast is somewhat inferior, and those using the service are prone to complain of the flicker when comparing the results with modern television standards. This criticism must be qualified, for it is known that with close-ups of head and shoulders only, picture synthesis can be undertaken at much less than that demanded for ambitious studio scenes, and yet retain all the attributes of a recognisable face. The Post Office authorities responsible for this development considered that this was the principal function of the television telephone, and it must not be forgotten that similar services have been in operation between Berlin and Nuremberg (280 miles), and Berlin and Leipzig (100 miles), for nearly two years now, and a steady income derived from the subscribers content with the results obtained.

## An Ingenious Device

AN idea has just been propounded for use in connection with television transmissions which, if it proves successful in practice, should alter very materially the present methods for producing certain scenes. It is really a form of composite television whereby any type of background can be superimposed on the picture with, if necessary, the actors performing before a blank back cloth. Back projecting a film

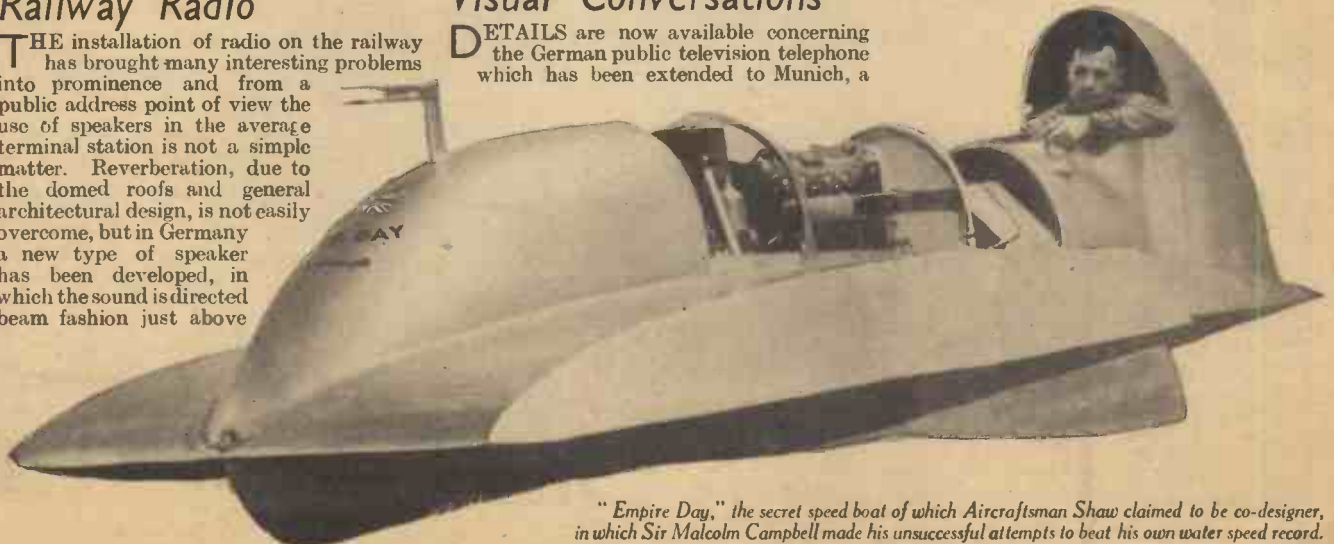

"Empire Day," the secret speed boat of which Aircraftman Shaw claimed to be co-designer, in which Sir Malcolm Campbell made his unsuccessful attempts to beat his own water speed record.

on to the screen before which the actors undertake their normal parts has often been tried, and a single camera is employed to give the combined scene. With this new idea, however, any form of stage set, mob scene, or even a miniature battle can be laid out in one studio with its own television scanner, while in a second studio the principal artistes execute their own particular performance before another scanner. This new equipment then merges the performers and the background into one composite picture without any ethereal effects. That is to say, where a principal actor has to fit into the background picture, by means of a blacking out amplifier scheme the electrical signals of the background scanner are eliminated entirely at the points where they would coincide with the image signals of the actors. This "electrical hole" must be effected exactly, otherwise the final result would appear somewhat like an unregistered two-tone block, and it is in this connection that no doubt the major difficulties will be encountered.



One of the first pictures of the Miles Monarch cabin monoplane, a speedy, though inexpensive air car that Phillips and Powis, Ltd., are planning to produce in large numbers.

### A Modern Lightship

ONE of the latest types of lightship has recently been stationed at Tongue in the North-Sea. It is made of steel and has a high candle-power electric flash. Instead of nine burners it has only one, and is fitted with submarine detectors and wireless telephones and transmitters. The United States Lighthouse Service are planning a chain of lightships along the Atlantic and

to be equipped, and it is proposed to fit 250 engines with the apparatus.

A non-contact inductive apparatus is included in the Hudd system which is to insure that when a distant signal is passed

defence purposes, will be buried and will carry oil to subterranean reservoirs.

### Fool-proof Landing

A NEW type of light aircraft has recently been built by Phillips & Powis, and is illustrated above. The machine is powered with a 130 h.p. inverted De Haviland Gipsy Major engine and embodies many new features in design. It is known as the Miles Monarch, and its outstanding feature is that it is virtually foolproof when it comes to landing as the glide in can be controlled by flaps which can be actuated with the throttle. An exceptionally wide undercarriage, Bendix brakes, and Lockheed air-draulic struts which are designed to withstand a vertical drop of 15 ft. a second, also assist in landing. The machine can easily maintain a cruising speed of 125 m.p.h.

# THE WORLD OF INVENTION

Pacific coasts, to be operated by radio, whilst the keepers of the light are installed on land many miles away.

### Automatic Train Control

THE Hudd system of automatic train control is to be installed by the L.N.E.R. Company on their main line between Edinburgh and Glasgow. This section of the line consists of 47 miles of track and carries a considerable amount of traffic, thus making it specially suited for the experiment. The whole of this section is

at "caution" a horn is sounded in the cab of the engine and a partial application of the brake is automatically made. Thus, the train is brought to a standstill before the home signal is reached.

### An Oil Pipe Line

AN oil pipe line, 280 miles long, which is stated to be the longest in Europe, is to be constructed in France. It will run from the port of Donges, near St. Nazaire, to the refining plant at Montargis. The pipe, which will be used for national

### The "Mauretania"

THE Cunard-White Star liner *Mauretania*, which was launched at the end of July, is the largest vessel built in an English yard. She will exceed her famous predecessor by more than 3,000 tons. A



A striking view of tugs towing the "Mauretania" to the fitting out yard after the launching ceremony.

ceremony believed to be unprecedented in the history of British shipyards, was performed before the launching. The name of the new vessel, which had been draped with the Union Jack and the Stars and Stripes, was unveiled as a tribute to the old *Mauretania*, which was scrapped three years ago. The new *Mauretania*, which is classified as an intermediate liner, will normally run between London, Havre, Southampton and New York.

## A Television Telephone

MR. A. M. NICOLSON, of New York, has recently patented a television telephone in Washington. At the moment the system is only suitable for inter-office use in a single building, but the inventor hopes to adapt it for long-range wireless so that it will eventually be possible to telephone from U.S.A. to Europe and see the person at the other end at the same time.

The system has a bell-shaped horn which contains a television scanner for both sending and receiving, as well as a microphone and loudspeaker.

## A New Automatic Rifle

A SEMI-AUTOMATIC rifle far superior both in speed and accuracy to the old bolt-action Springfield, which was developed by Mr. J. Garand, of Springfield Armoury, in January, 1936, after 30 years' experiments is to be used for rearming the United States Army. It is similar in appearance to the old weapon, but the bolt has been eliminated, and it is a little heavier. It fires an ordinary standard bullet, automatically ejecting the spent cartridge case and reloading. The clip containing eight cartridges is inserted into the magazine by hand. It will take several years before the army is completely equipped.

## A Non-magnetic Ship

THE Royal Research Society's ship, *Research*, which is designed for magnetic, atmospheric-electric, meteorological and oceanographical studies is now under construction at Philip & Son's yard, Dartmouth. It is believed to be the first vessel in which the non-magnetic principle

A general view showing the "Research" (nearest camera) nearing completion at the Dartmouth shipyard.

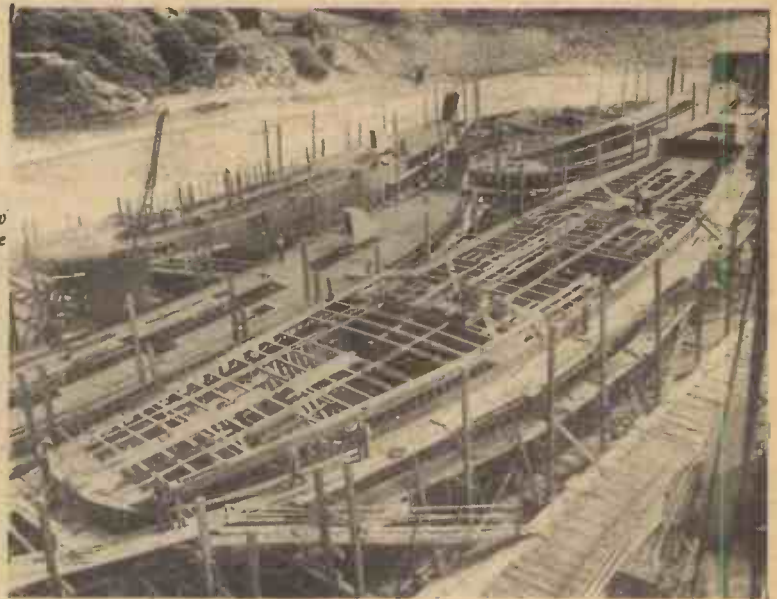

has been applied from truck to keel. The ship will be 142½ ft. in length, have a beam of 34 ft. and 770 tons load displacement. She is brigantine rigged, and, although fitted with a diesel engine, the *Research* will do most of her cruising under sail, the full sail area being about 12,000 sq. ft. A bronze alloy has been extensively used, to reduce the quantity of steel in the diesel engine, and the crankshaft is of a special non-magnetic steel. Even iron nails in packing cases, tin food containers, razor blades, typewriters, cooking utensils, cutlery and drums for paint and oil must be non-magnetic.

The launching of the *Research* is due to take place in February, and she should be ready for her maiden cruise in October, 1939.

## A Model Village

MR. L. GIERINGER, of Reading, Pennsylvania, has constructed a miniature village from scraps of wood, tin cans and other odds and ends which has grown until it now covers an area of 2,000 sq. ft.

and contains 105 buildings. The village has a railway, wagons and motor cars, and electric light and power has been installed. It took the designer several months to build the church, which has beautifully hand-painted windows, and music can be heard coming from it. The village is peopled by 1,220 figures, and Mr. Gieringer values his village at £3,000.

## The "Safest" Aeroplane

AN aeroplane, which the designer, Mr. P. N. Willoughby, claims to be the safest plane ever flown is now being constructed at Witney Aerodrome, near Oxford. It is a twin-engined version of a triple-engined, compound wing type whose chief features are light weight, high efficiency and safety. The machine will have a cruising speed of 255 m.p.h., and a top speed of 300 m.p.h. It will be virtually non-stalling. The plane would carry, as a transport machine, apart from fuel and oil, 20 passengers, their luggage and a crew of 6 for 2,760 miles.



After long negotiations, Southampton Water has been selected as the home port for the Empire flying boat service. Southampton will become the world's greatest marine airport. Above we show a flying boat being prepared in the "dock."



New Series

# TOOLMAKING AND TOOL DESIGN—I.

The Principles and Methods of Making Press Tools, Jigs, Gauges and Fixtures

By W. H. DELLER

**T**OOLMAKING is a term that may loosely be applied to a wide range of activities embracing the manufacture of all classes of tools including machine tools.

The particular phase of toolmaking with which these articles are concerned is that covered by the products of the engineering works department known as the Tool Room. Such a department forms an essential part of every engineering concern engaged on work of a repetition character. The actual nature of the work which the tool room is called upon to perform is dictated by the class of job to be produced within the works, but it may consist of the manufacture of any or all of the following devices: Jigs, Fixtures, Gauges, Special Cutting Tools, Press Tools, Moulds and Dies.

A tool room is completely equipped with machine tools, capable of producing accurate work, many of them being of a special character or specially equipped to cope with the machining problems peculiar to this particular class of work. Additional to this there is a fitting department and usually provision is made for effectively dealing with necessary heat treatment processes within the tool room. Accurate measuring instruments and standards are available for the purpose of comparison and checking work during the progress of manufacture. Thus it will be seen that the tool room is in reality a completely equipped and self contained works within a works.

Its purpose is to supply the manufacturing department with special tools and devices designed to assist production and made to such limits of accuracy as to ensure interchangeability for the products resulting therefrom. The repair and maintenance of such devices and small tools is also taken care of by this department.

### How Cost Affects Design

The basis of tool designing is a thorough knowledge of machine shop practice plus some practical toolmaking experience. In large establishments the designs are produced by a tool drawing office and the various stages of the work executed by specialists, whereas in smaller ones the matter of design may be left to the skilled toolmaker entrusted with the work. Where such a practice prevails the toolmaker must be capable of carrying the work right through from start to finish and is usually required to do this.

### Jigs and Fixtures

The question of tool design is governed to a considerable extent by the number of pieces to be, or likely to be, handled by the device under consideration. Thus it might well be that a proposed scheme, while admirable for the purpose intended, would be unwarranted on account of excessive cost against the total number of pieces required. Therefore it is apparent that an alternative arrangement while being inferior from the viewpoint of operating time, is superior to the more ambitious scheme when the ultimate total cost per piece is considered.

A jig is a device provided with one or more guides (for cutting tools) in which the work is located and held in correct disposi-

tion in relationship to the guides. Jigs are commonly associated with drilling and like operations and may consist in some cases where the holes to be drilled are in one plane, of little else than a flat plate in which are housed the tool guides. This arrangement presents the jig in its simplest form. Other circumstances such as where the holes lie in more than one plane or where the points of location are inconveniently situated dictate the conformation of the jig, which in many cases consists of a box-like structure.

A fixture is a work-holding device pure and simple and is intended to provide a means of mounting work on a machine for the purpose of performing an operation in correct relationship to a previously machined surface, or surfaces, without the necessity of setting-up the work. In order that the fixture itself may be located correctly on the working surface or table of the machine tool with a minimum of trouble, keys are provided in the base to engage with a table slot, or where the fixture is intended for use on a lathe or similar tool

a short spigot is provided on the back to correspond with a register turned in the face plate. Apart from machining, fixtures are also widely used in connection with assembling operations. Examples of a jig and a fixture both of simple design are illustrated in Fig. 1.

### The Elements of Jig and Fixture Design

For a jig to prove successful in use the following points must have been studied in the course of design. 1.—Correct choice of locating points. 2.—Making adequate provision for removing swarf from locating surfaces easily. 3.—The means of holding or clamping the part must be such that it will not cause distortion. 4.—Making provision to support the part where necessary to guard against cutting pressure causing distortion. 5.—Ease of loading and removing the work after completing the operation. 6.—Arranging the tool guides as near to the work as possible and making them of ample length. 7.—The elimination as far as possible of the likelihood of swarf preventing the jig from standing level on

Fig. 1.—Typical example of a Jig, and a Fixture

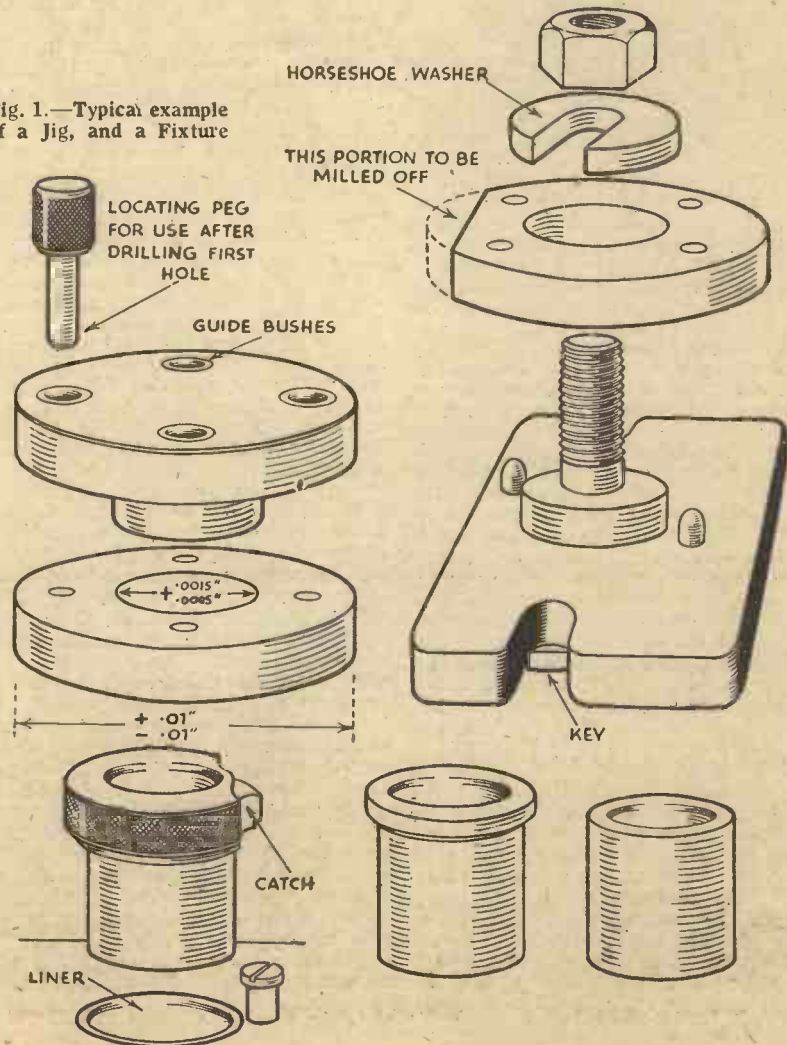

### TOOLMAKING (continued)

the machine table by raising the base on feet. 8.—Arranging the feet in such a manner that the cutting pressure cannot cause the jig to tilt and lastly that the jig is easy to keep clean during use. The same points arise where a fixture is concerned with the exception of those stressed in numbers 6, 7 and 8.

In order to amplify the foregoing points it will be as well perhaps to give examples of the results likely to accrue from having failed to observe any one of them. The locating points chosen i.e. the surfaces of the work which abut against or rest on stops placed in the jig to determine its position relative to the tool guides should be those which have to be maintained at a constant dimension and from which other main dimensions depend. As for instance it will be seen by referring to Fig. 1 that the jig is located in the centre hole of the work. Were the jig located on the outside dia. the drilled holes while right in themselves as regards spacing could lie on a pitch circle eccentric to the bore by as much as the tolerance allowable on the comparatively unimportant external diameter. This of course is an elementary example but it plainly shows the trouble that is likely to ensue from incorrect location in a more complicated piece of work or where perhaps more than one jiggling is necessary.

It is obvious that if the stops provided in the jig as location points are not kept free from metallic particles the work produced cannot be uniform. This liability is best frustrated by having the surfaces of the means of location visible to the operator and by the avoidance of sharp corners in which swarf may collect.

Clamping arrangements which cause distortion may permanently deform the work or allow the work to resume its normal shape upon removal from the jig, when an inaccuracy in the drilling becomes apparent.

The lack of proper provision where necessary against the work springing or distorting during machining will produce similar results. Where the design of a jig is such that the loading operation is made difficult the loss of machining time may seriously affect production. While the loading may be an easy matter the removal of the work can be rendered difficult by the failure to provide clearance for machining burrs. Such a happening will necessarily slow up the work and most likely cause damage to the work by having to apply force to assist in its removal.

Unless the tool is guided almost to the point where it makes contact with the work inaccuracies are liable to creep in on account of "drill run." A guide that is too short in comparison with its internal diameter can also produce similar results. Jigs that are made to stand on a flat base can cause constant trouble by reason of drillings or metal chips becoming embedded therein thus leading to inaccuracy and tool breakage. An improper arrangement of the feet provided to counteract this objection will have the same effect.

#### Tool Guides, Bushes and Liners

The nature of the service that tool guides have to perform demands that they be made from material not easily damaged by the cutting edges which come into contact with them. These guides are made in the form of bushes, cast steel being employed for making the smaller sizes. Larger ones are usually made from case hardening Mild Steel. After suitable heat treatment the bores are finished by lapping or grinding to suit the "land" sizes of the cutting tools for which they are intended.

The external diameters are then ground to size to ensure that the bushes are truly concentric.

Various types of bushes are used according to the nature of the work to be done. It may be that in certain instances the use of a headed bush is precluded. In such cases a flush type of bush is employed. Where a hole requires reaming after drilling a slip bush is used. Here the hole in which the bush or bushes fit is provided with a liner to guard against the jig body becoming worn by the constant insertion and removal of the slip bushes. The question of whether a separate bush is required for guiding the

reamer will depend upon the positional accuracy demanded. A slip bush is also necessary where a counterboring or spot facing operation follows the drilling. Where this occurs the internal diameter of the liner requires to be such that it will guide the body of a pilotless cutter or if otherwise to clear it. Provision has to be made to prevent the slip bushes from lifting out or turning in the liner when in use. This is accomplished in a variety of ways, but most usually by the provision of a bayonet catch arrangement. The various types of bushes mentioned are illustrated in Fig. 2.

(To be continued)



**WORKSHOP PRACTICE**, by F. Johnstone Taylor. 760 pages, 542 illustrations. Technical Press, Ltd., London. 16s. net.

This practical text book is a revised and enlarged edition by E. Pull's "Modern Workshop Practice," and in revising the work Mr. Taylor has maintained the scope of the original book as far as possible. The present work, which is intended for the use of young engineers, improvers, and candidates for examinations for entry into the Royal Navy as engine-room artificers, and for fitters and machinists in the Royal Air Force, covers the whole field of practical engineering workshop practice in a very comprehensive manner. A chapter on measuring-tools and measuring-machines includes descriptions and methods of using some of the extremely accurate measuring-machines recently introduced by British manufacturers. Gauges, and gauge systems, so important in the modern engineering workshop, are dealt with in detail, while the chapter on workshop tools contains illustrations and descriptions of most of the tools usually employed in the engineering workshop. The heat treatment of metals is explained in a very concise manner, while cutting speeds and feeds and screw cutting, are fully dealt with. There are also chapters on turret-lathes, plain and universal milling machines, gears and gear cutting, boring and slotting machines, grinding machines, drop forging and stamping, and modern welding methods. The appendix contains several useful tables and a 17-page index. Engineering students will find this book a mine of useful information on all the phases of modern workshop practice.

**DICTIONARY OF MECHANICAL ENGINEERING TERMS**, by J. G. Horner, A.M.I.M.E.; and E. H. Sprague. 508 pages. Technical Press, Ltd., London. 12s. 6d. net.

About eight thousand definitions are given in this book which should prove invaluable to the pattern-maker, engineer's pupil, amateur workers, and others connected with the engineering and allied trades. It often happens in the drawing office or works, that a young draughtsman or student comes across terms of which they do not know the meaning, and in such cases they would find it profitable to turn to this useful work of reference for definite information. In the present edition the appendix has been enlarged by some six hundred and fifty additions to the definitions relating to the latest engineering practice. Only those terms which are of universal application are included in the book.

**"Man in a Chemical World,"** by A. Cressy Morrison. 292 pp. Scientific Book Club, London. 2s. 6d. net.

The object of this book is to present to the man in the street a clear account of how the activities of the chemical industry convert the discoveries of science into day-to-day necessities of our daily lives. The amazing workings of science, as applied to the problems of living, are clearly presented in the book, which reveals the fascinating romance of modern industrial developments. Included in the contents are chapters on Nature Points the Way, Keeping Well, Wheels and Wings, From Papyrus to Television, The Comforts of Home and The More Abundant Life. To the student who is considering a career in science, and many others interested in the subject, the book should prove a real help.

**"Money-Making Made Easy,"** by L. Harvey Wood, 114 pages; published by C. Arthur Pearson, Ltd., 2s. 6d.

**PERSONS** on the look-out for opportunities for increasing their income in their spare time, or who wish to branch out in a new line, will find this book profitable reading. Written in simple language, 101 spheres of activity are explored in a practical manner, and helpful advice is given on the choice of new and well-tryed lucrative occupations.

There are 13 chapters, each dealing with different subjects. For instance, chapter one tells the reader all about Clubs and Agencies, and how they should be run. Chapter two deals with Profit from Your Garden, and tells you how you can make money by growing mushrooms, making fertilisers, garden ornaments, etc. Various money-making ideas are discussed in the next chapter, while chapter four deals with Money in Entertaining. How to make money from photography is explained in chapter five, and such subjects as Seasonal Money Making, Money from Hobbies, Odd Jobs for Motorists, Property as an Investment, and Money in Games and Sports are among the other subjects dealt with in the remaining chapters of this interesting book, which also includes an index.

### Bind Your Copies of "Practical Mechanics"

**T**HE binding case for Volume V, complete with title page and index, is now ready and costs 3s. 6d. by post from the Publisher George Neumes Ltd., Tower House, Southampton Street, Strand, London, W.C.2. The index can be obtained separately if desired for 7d., post free. All readers should have their copies of Volume V bound, and thus be able easily to refer to the contents by means of the fully cross-referenced index.

# MASTERS OF MECHANICS

No. 38. Galileo Galilei

**M**ANY of the principles upon which the science of mechanics is based owe their first elucidation to the penetrating insight of that curious old Italian philosopher and scientist, Galileo Galilei, or "Galileo" as he is nowadays more usually called.

Born at Pisa, in Italy, on February 15, 1564, the eldest son of one Vincent Galilei, Galileo Galilei, or "Galileo" as we shall henceforth call him, showed at a very early age a decided leaning towards matters mechanical. Thus, before he arrived at his teens we hear of him constructing ingenious wooden models which actually worked, toys which he distributed to his friends round him and which, no doubt, caused his parents to express wonderment at the precocity of their ingenious son.

It was decided that the young Galileo should adopt medicine as a career. Accordingly, he entered the University of Pisa as a medical student in 1581, and forthwith gave himself up to the wholehearted study of the healing art.

Not for long, however, did Galileo pursue his medical studies. He was one day sitting in the great cathedral at Pisa listening, no doubt, to the oratory of some famous preacher, when his attention was arrested by the slow swinging of one of the massive sanctuary lamps. The lamp, as it swung slowly and heavily from side to side, exerted a curious fascination upon the mind of the youthful Galileo. So much so, that he actually timed its swings, not by means of a watch, for there were no suitable portable timepieces then, but by means of his own pulse beats. To his surprise, he discovered that, although the great sanctuary lamp gradually oscillated less and less, the actual period of time which each oscillation took remained the same.

## Galileo's Pendulum

Based upon these observations, Galileo invented a small pendulum instrument which he used for timing the pulses of patients. The device proved quite successful in actual practice and it constituted the world's first pendulum instrument.

It was about this time, also, that Galileo chanced to attend some lectures on mathematics, Euclid and geometry. They appealed to him so powerfully that, almost, on the spot, as it were, he made up his mind to relinquish medicine as a career and to devote the whole of his energies to the study of mathematical and physical sciences.

*The famous "Leaning Tower" at Pisa, from the upper balcony of which Galileo conducted his famous experiments on falling bodies.*

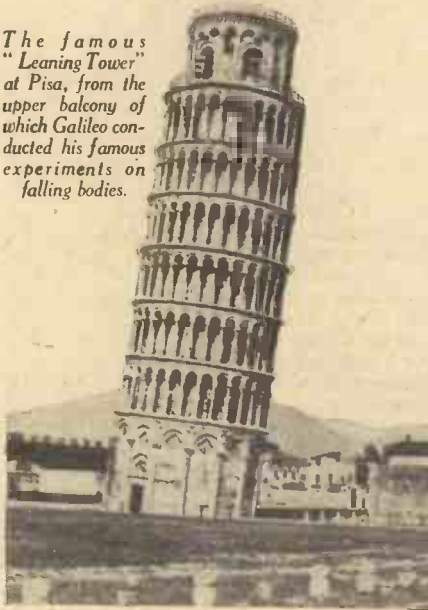

Galileo seems to have had an ample measure of success during his early career as a mathematician, for, a few years afterwards, he became a professor of mathematics in his own University of Pisa.

The scientific world, such as it was, at this late seventeenth century period was in a condition of turmoil and perplexity. The whole trouble lay in the fact that the philosophers and, in fact, almost all the learned men of the period, lay as well as ecclesiastical, habitually and invariably

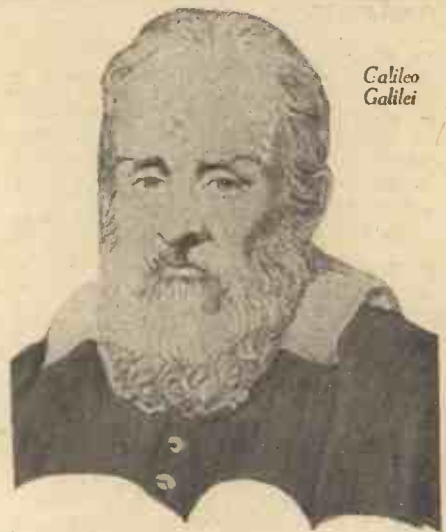

Galileo Galilei

persisted in regarding the writings of the Greek philosopher, Aristotle, as the last word which could be said upon almost any subject of human knowledge.

## Two Great Authorities

The idea of experimenting and of ferreting out facts for themselves quite scandalised the majority of these early philosophers. There were two, and only two great authorities of the day, the Church, in matters religious, and the writings of Aristotle, in temporal, philosophical and what we should nowadays term "scientific" affairs.

In order to illustrate the almost unbelievable hold which the assumed authority of Aristotle had upon the educated mind of the period, mention may be made of the scientist, Scheiner, who appears to have discovered the existence of sunspots independently of Galileo. Scheiner, who was a Jesuit, submitted his thesis on the subject for the approval of his Superior. Back, however, it came from the latter individual with the following comments:

"I have read Aristotle's writings from end to end many times, and I can assure you that I have nowhere found anything similar to what you describe. Go, my son, tranquillize yourself. Be assured that what you take for spots on the sun are the faults of your glasses, or of your eyes."

It was this Aristotelian obsession which so characterised the period in which Galileo lived which lay at the root of much of the scientific troubles of the day. "Authorities," philosophers, learned men and others would persist in regarding Aristotle as the final judgment upon any piece of natural science, whereas, a minority of scientists, such as Galileo himself, began to perceive that much of the Aristotelian writings were, to use a modern phrase, nothing other than "sheer bunk."

## Rather Tactless

It was into the middle of this seething mass of unsettled opinion that the young and ardent Galileo stepped when he took up his first professorship in the University of Pisa. Unfortunately, Galileo, although possessed of a clear and reasoning mind, was not gifted with tact. He attacked the cherished belief of his opponents, sometimes even with ridicule. Consequently it was that he made a host of enemies, many of them very powerful ones.

One of Galileo's historic experiments of this period was his dropping of two unequal weights from the upper balcony of the famous "Leaning Tower" at Pisa,

*An "orrey" or mechanical model of the solar system. Such working models were very popular in former days.*



and noting that they both hit the ground at the same time.

Now, according to Aristotle, any such notion was sheer heresy, for that philosopher had always taught and generations after him had always believed that a heavier body fell more quickly than a lighter one.

Galileo invited many of his opponents to witness for themselves his experimental denunciation of this so-called "law" of Aristotle. Some of them accepted the invitation; others refused it. But, seemingly, those who were present at these famous Pisa experiments upon the velocity of falling bodies came away with the conviction that Aristotle, like the great Homer, had nodded, at least on this particular matter.

Galileo next gave himself over to the study of the mathematical relations in which bodies fall to the ground. The velocity of a falling body was too great for him to measure directly. Consequently, he measured the time taken for metal balls to roll down an inclined plane. Experimenting with different angles of slope of his inclined plane, he found that the distance through which the ball rolls is proportional to the square of the time in which it moves.

#### A Quaint Timekeeper

There were no serviceable clocks and watches in Galileo's day. As a measure of time, he allowed water to run out of a bucket, carefully collecting and weighing the liquid afterwards.

Galileo's experiments with inclined planes enabled him to perceive that when a ball runs down one slope it will ascend another almost to the height from which it started. This observation, incidentally, forms the basis of all the many varieties of switchback railways and similar joy-ride installations with which the modern entertainment caterer attracts the holiday crowds.

Aristotle had said that in order for a body to be kept in motion, it must be continually pushed. Galileo, however, pursuing his experiments further, found that such was anything but the case. The application of extra force to a moving body is only necessary to change its rate of motion. The planets revolve in their orbits without being continually pushed. Hence, said Galileo, if one could do away entirely with the effects of friction, a body, once moving would go on moving at a constant speed for ever without the necessity of being pushed.

One of the world's first thermometers was invented by Galileo. It consisted of a glass tube terminating at its upper end in a bulb. This dipped below the surface of a liquid contained in another bulbous vessel. A portion of the liquid ascended the tube and, under the thermal expansion and contraction of the air in the upper bulb of the tube, the level of the liquid in the tube was raised or depressed.

#### Astronomy

Galileo's many opponents made Pisa too "hot" a place for him. He relinquished his appointment as Professor there, and took up a similar post in the University of Padua. It was here that he became acquainted with the astronomical doctrines of Copernicus, a medieval astronomer, who had asserted that the earth and the planets moved round the sun.

The prevailing astronomical notions of the Universe in Galileo's time were summed up by the doctrine introduced by Ptolemy of Alexandria, who flourished between 126 and 161 A.D. This doctrine, the Ptolemaic theory, held that the earth was utterly and entirely fixed in a central position and that the sun and the planets revolved around it

It was the philosophical theory of the Universe which was held by the majority of the learned men of the medieval period, and it was the one which even Galileo, in his capacity of Professor at Padua, found himself under the necessity of teaching.

But clearly and still more clearly, Galileo saw that the old Ptolemaic theory of the Universe was utterly false. In 1604, a new star had blazed forth in the sky and had excited the interest of many. According to the doctrines of Aristotle, there was nothing new in the heavens, but here, indeed, was a change made manifest.

Four years afterwards, a Dutchman named Lippershay, produced what was then a marvellous type of "spy-glass," which had the property of making distant objects appear nearer. Galileo was able to learn some details of Lippershay's instrument, and at once he set to construct one for himself.

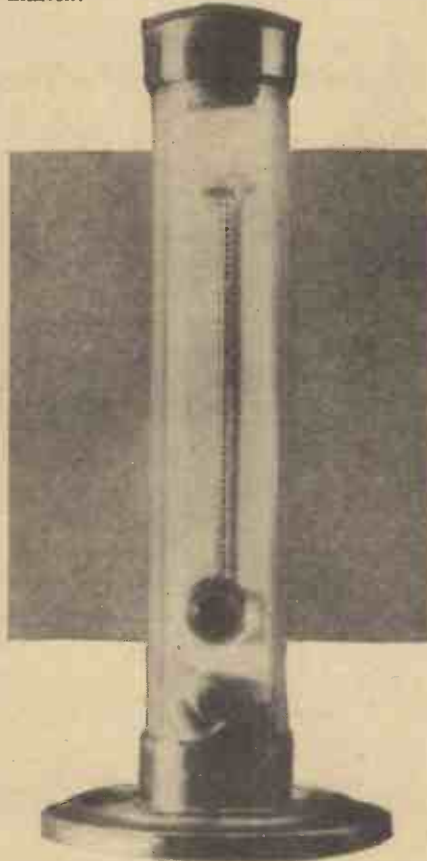

The earliest thermometer in England. It was made in the 17th century at Florence, in Italy, being one of the first radical improvements on Galileo's original models.

The first of Galileo's telescopes, consisting of a simple lens mounted at opposite ends of a leaden tube, magnified about three times. Eventually, however, he succeeded in producing one which had a thirty-times magnification. This he trained upon the sun, the planets and the other heavenly bodies. Not only did he discover sunspots, but he also actually observed the rotational movements of some of the planets of Jupiter.

#### The Famous Treatise

Here was evidence for the much assailed Copernican theory of the solar system which held that the earth and the planets revolve around the sun. But such was the obsession for Aristotle that many philosophers refused to look through Galileo's telescope, lest they might become convinced

against their wills.

Galileo's famous Treatise, "The System of the World" was published after he had been summoned by the Pope to Rome in order to explain his views. Galileo had been received quite well by the Pope, but he had promised not to give expression to his views.

In his book, Galileo purported to explain both the Ptolemaic and the Copernican theories. This he did by putting the rival theories into dialogue form. Unfortunately, he did so with such caustic wit that his book was condemned by the ecclesiastical authorities and, worse still, he was summoned to appear before the Court of the Inquisition at Rome on a charge amounting to heresy.

The findings of the Roman Court are well known. The Holy Office or Inquisition gave its celebrated verdict to the effect that "the proposition that the sun is the centre of the world and does not move from its place is absurd and false philosophically, and formally heretical, because it is expressly contrary to Holy Scripture."

Galileo's enemies were now many. He was thoroughly disliked in University circles and the attitude of the Cardinals of the Holy Office was, in general, much approved. Galileo was sentenced to a period of detention and made formally to abjure his revolutionary thesis.

#### A Deplorable Act

Although the condemnation of Galileo by the Roman authorities instituted a deplorable act which no individual in his senses can hope to defend, it must be remembered that, before him, the astronomer, Kepler, had been thoroughly condemned; also, by the Protestant theological Faculty of the University of Tübingen for enunciating a similar doctrine.

The whole trouble was, of course, that Galileo, like Kepler, had offended not merely the authorities of the Church, but also that he had gone completely counter—and very untactfully so—to the philosophical beliefs of the day. Indeed, even at the present day, an individual who insisted on declaring that the Astronomer Royal was propagating a false scientific doctrine and that the English universities were guilty of aiding and abetting him would not exactly attain to a degree of popularity.

But quite apart from his astronomical career, Galileo gave much of his time up to a careful examination of the working of many natural laws. He pointed out the necessity of being able to measure, weigh and express in concrete terms and numbers the things and entities with which science deals. Galileo has been called the "father of modern physics." Even more so, however, is he the father of modern measurement, for by means of his insistence upon mathematical accuracy in experimental work, he laid much of the foundations upon which engineering and mechanical science has since reared itself.

#### His Death

Blind and enfeebled, Galileo died on January 8, 1642, some nine years after his condemnation by the Church authorities. But, although the latter were able to suppress the further efforts of the old philosopher, they were powerless against the rising tide of inquiry which was then setting in.

Indeed, on the day old Galileo died, there was born on a Lincolnshire farm an immature infant, who, under the name of Isaac Newton, was to astonish the world with his genius and to bring to a conclusion the observations for which Galileo had been so unjustly condemned.

# A Household Ozoniser

**O**ZONE is one of the most powerful disinfectants known. As a deodorant and a means of freshening up the atmosphere of rooms it is unexcelled, since, owing to the extremely simple method of its generation, it at once diffuses into the air of a room or apartment, penetrating to every corner of the room.

Ozone is an invisible gas which possesses an extremely characteristic odour. Every amateur experimenter who has worked with electrical apparatus in which sparks are produced must, at times, have noticed a peculiar smell in the vicinity of the apparatus, an odour which is not unpleasant despite its unusual pungency. This odour is due to the formation of small amounts of ozone by the electrical apparatus.

In composition, ozone is nothing more nor less than a condensed form of oxygen. This is, of course, its great virtue, for it readily oxidises all impurities in the atmosphere, reverting afterwards to ordinary oxygen.

### Preparing Ozone

There are several methods of preparing ozone, but the most useful one and that utilised by the apparatus described in this article consists of subjecting a current of air to the silent electric discharge. Air, as we know, consists, for the most part, of oxygen and nitrogen and it is the oxygen of the air upon which the electric discharge

### Constructional Details for making Apparatus to Purify the Atmosphere of Rooms, etc.

directly off the mains, since, in the latter instance, the transformer output circuit

contact is inadvertently made with its output circuit.

### An "Ozone Tube"

To form the "ozoniser" we require what is termed an "ozone tube." This, fortunately, is very easy to make. In its simplest form, it consists merely of a narrow piece of glass tubing about a foot or eighteen inches in length. Down the tubing is pushed a straight length of bare copper wire, this wire being connected to one of the output or secondary terminals of the induction coil. On the outer side of the glass tube is wrapped a spiral of bare copper wire, this wire being connected with the other secondary terminal of the induction coil. On passing a current of air or oxygen through the glass tube and operating the induction coil at the same time, the air issuing from the tube will contain three or four per cent. of ozone, a concentration which is amply sufficient to act as a disinfectant and deodoriser.

A better form of ozone tube consists of a narrow glass tube about a foot long containing within it a spiral of bare copper wire which runs along almost the entire length of the tube. This tube is supported concentrically within a wider glass tube approximately two-thirds or half an inch larger in diameter than the smaller tube. On the outside of the outer tube a layer of tinfoil is cemented with shellac varnish, flour paste or any other suitable adhesive. Contact from the secondary terminals of the induction coil is taken to the spiral wire running through the interior of the inner glass tube and to the tinfoil on the exterior of the outer tube.

If, under these conditions, the induction coil is operated and a current of air is passed between the two glass tubes, the air will issue from the tubes charged with ozone to the extent of from four to seven per cent.

For constant service in a household it is, of course, necessary to have the ozonising apparatus conveniently mounted on an

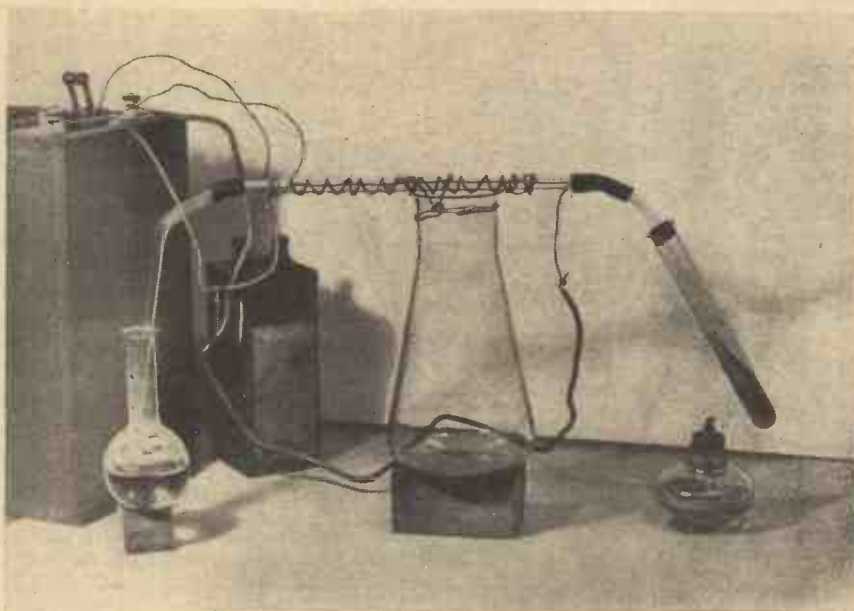

Ozonising pure oxygen. In this simple bench apparatus which employs the ozone tube shown in Fig. 1, oxygen is generated by heating a mixture of potassium chlorate and manganese dioxide in the test tube attached to the right of the ozone tube, the ozone generated by the passage of the oxygen through the tube being dissolved in water.

would require careful earthing for purposes of safety, whilst, at the worst, the H.T.

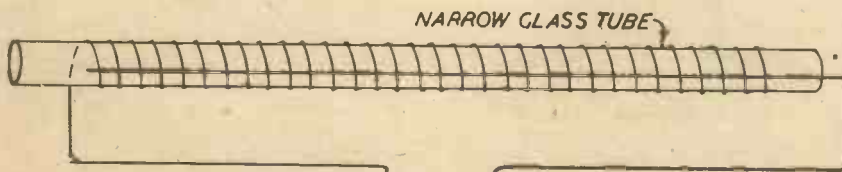

Fig. 1.—A simple form of ozone tube, consisting of a straight length of wire with the tube and a spiral of wire on its outer surface.

operates, converting a proportion of it into ozone.

For the production of the necessary high-tension current, we can employ either a step-up transformer giving at least a 1,000 volt output when operated on an ordinary A.C. supply, or, alternatively we may use a small induction or spark coil operated by means of an accumulator or through a small step-down transformer working off the mains. An ordinary bell transformer is quite suitable for working a small induction coil, particularly if it is only used intermittently.

On the whole, it is better to employ H.T. current from a small induction coil than from a step-up transformer operated

current from a small induction or spark coil can only give one a sharp shock if

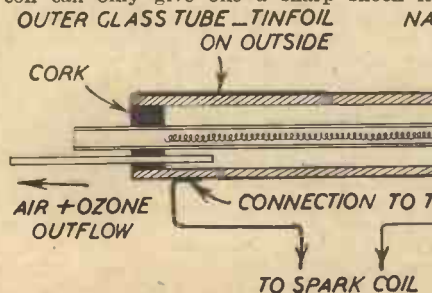

Fig. 2.—A more serviceable form of ozone tube. Air is passed between the two concentric tubes.

ebonite or wooden wall panel screwed firmly in position to the wall of a room; better still, perhaps, the apparatus could be mounted upon a substantial baseboard in order that it may be carried about from room to room.

**Layout of Apparatus**

The diagram accompanying this article shows clearly the disposition of the ozonising apparatus upon its baseboard or wall panel. Note particularly that the ozone tube and its H.T. leads must be well insulated, otherwise current-leakage will occur, with diminution of the ozonising efficiency of the apparatus.

In order to operate the apparatus efficiently, it is necessary to cause a current of air to flow through the ozonising tube. The air may be sucked through, pumped through or blown through by means of a small electric fan placed near the air-intake tube of the apparatus. The current of air passing through the tube should not be a swift one, a moderately slow air stream producing the greatest proportion of ozone.

If any rubber tube connections are made to the ozone tube, they must be well varnished, for ozone attacks rubber in all its forms and quickly perishes it. The two corks supporting the inner glass tube within the outer one should be well impregnated with paraffin wax.

**A Precaution**

Operated for a period of fifteen or twenty minutes, the household ozoniser described above will completely charge an ordinary sized room with ozone, disinfecting it thoroughly, fully deodorising it and freshening up its atmosphere.

Ozone, however, should not be liberated

in rooms in which there are valuable oil paintings, since the gas sometimes tends to attack the pigments of paintings, causing them to undergo slight colour changes. Apart from this precaution, however, the employment of ozone as a household disinfectant and deodorant and its generation by means of a simple ozonising apparatus such as the one

parts of powdered potassium chlorate and one part of manganese dioxide.

As a means of testing for the presence of ozone in a room, there is nothing better than the simple "starch-iodide" test. Make up a five per cent. solution of potassium iodide and add to it about half its volume of starch solution. Immerse several pieces of white blotting paper in this

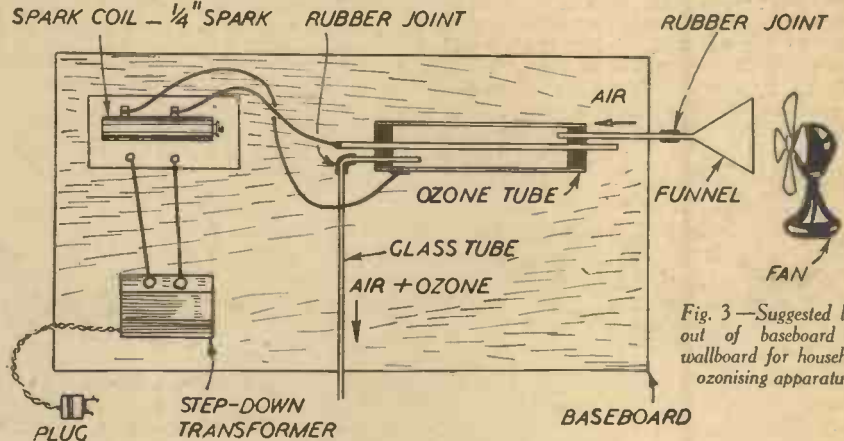

Fig. 3—Suggested layout of baseboard or wallboard for household ozonising apparatus.

described above, is a perfectly safe procedure and one which is invaluable for the purpose of freshening up sick rooms, food stores and other apartments in which bacterial contamination is likely to occur.

As much as eight per cent. of ozone can be generated by passing pure oxygen through the ozone tube instead of ordinary air.

Oxygen may readily be prepared by heating in a test tube a mixture of two

mixed solution for a minute or two and then hang them up to dry.

Preserve these "starch-iodide" papers in a box provided with a well-fitting lid.

When it is desired to test for ozone, merely moisten one of the starch-iodide papers and wave it about in the air. The slightest trace of ozone in the atmosphere will manifest itself by the appearance of a pale blue colouration of the starch-iodide paper.

# ELIMINATING MAINS INTERFERENCE

**M**ANY amateurs, when using all-electric receivers or mains H.T. units, experience certain kinds of interference with radio reception which does not manifest itself with battery driven receivers. The reason for this is that some interference is picked up via the supply mains from faulty electrical apparatus in the neighbourhood. This form of interference is usually identified by a series of annoying clicks, or crackles, or a continuous "frying" noise, depending on the nature of the electrical apparatus producing the offending disturbance. There is also another form of interference known as "modulation hum" which manifests itself as a hum

By "ELECTRON"  
Simple precautions that will help to improve Radio Reception and cut out "Modulation Hum."

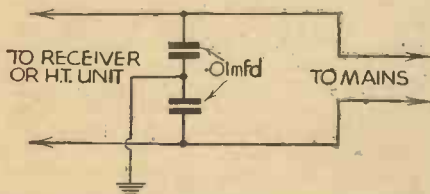

Fig. 1.—Connecting two fixed condensers in series across the mains.

and appears only when the receiver is tuned to a station or is oscillating.

**Simple Precautions**

It is, however, impossible to eradicate completely the interference produced by faulty electrical apparatus. A few simple precautions, however, will reduce it to some extent, and will entirely remove the annoying "modulation hum."

The simplest remedy is to connect a

condenser, which may be anything between .005 mfd. and .1 mfd. in capacity, between one side of the mains and earth. This will be found quite effective in the majority of cases. Slightly more effective results, however, may be obtained in some cases by connecting two such condensers in series across the mains, the junction between the condensers being earthed, as shown in Fig. 1. These condensers should be of the non-inductive type and capable of withstanding the full mains voltage. .01 mfd. mica condensers are generally most suitable. On D.C. mains supply, however, a slightly more elaborate filter may be required, as shown in Fig. 2. An H.F. choke is inserted in each mains lead, and a condenser bridge, with centre point earthed, is connected between them.

**H.F. Choke**

The H.F. chokes, which may easily be made by the amateur, comprise about 100 turns of 24 gauge D.C.C. wire, single layer wound on paxolin or bakelite tubes about 1½ in. diameter.

The chokes may be mounted quite close together, but the leads running to the input side of the filter should be well separated from those proceeding from the output side. The filter should preferably

be mounted close to the receiver.

This arrangement will provide considerable reduction of the severe background

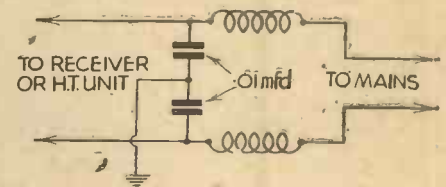

Fig. 2.—A more elaborate filter for D.C. mains.

noise often experienced when operating sensitive receivers from D.C. mains.

**POSTAGE STAMPS**

**W**HITFIELD KING & CO., Ipswich, England, have just produced the new 1939 edition of their Standard Catalogue of Postage Stamps of the World. Some 66,600 separate varieties of postage stamps, together with nearly 7,400 illustrations, are recorded.

An interesting feature is that the catalogue complies with the new regulations made by the United States Treasury Department on postage stamp illustrations and this is the first occasion for many years upon which a new edition of a stamp catalogue containing reproductions of United States stamps has been made available to collectors in that country. The retail price remains at 5s.

# Watch Repairing and Adjusting—2

## Types of Glass and Cases, and How to Dismantle the Works



AS soon as a watch comes in for repair it should be thoroughly examined. It is a good plan to ask the owner a few questions about the past history of the watch. Answers to such questions as "Has it kept time in all positions?" "Have you had a new mainspring fitted recently?" will all help towards a quicker diagnosis.

Before opening the bezel, examine the glass, which should be a perfectly tight fit. Frequently the bezel is fitted with an unsuitable glass. If the bezel is one with only a very narrow inner flange to keep it away from the dial it will need a higher glass than one with a deep inner flange. Fig. 1 shows various kinds of watch-glass: A the flat crystal, B the miconcave crystal, C the empire, D the lunette (medium height shown), E the hunter (inside glass), F centre convex.

### Glasses

It is surprising how many glasses carry a circular scratch made by the minute hand. Usually this indicates a low glass. By placing the nail upon the glass above the minute hand some idea can be gathered of the distance between the hand and the glass. If the watch is not working the ear test is quite effective. Pull out the winder to the set-hands position, place the glass close to the ear and turn the winder. A light scraping noise will be heard if the hand is touching the glass. With small watches this test may not be effective, so something more positive is necessary. Mix a spot of rouge with a spot of oil and apply it to the highest point of the minute hand, snap down the bezel, and set the hands. Open the bezel and examine the glass. If there is a red ring it will prove that the hand is too high. The hands should be both parallel to each other and to the dial in all positions.

### Thin Cases

Modern cases are tragically thin. They should be carefully inspected for broken hinges, cracks, torn loops and last but not least tiny pin holes in the bezel. Mirage and other fancy shaped bezels having a number of sharp corners give endless trouble in this way. The holes are often very minute, but they allow a considerable amount of dust to enter, and unless they are covered it is useless to clean the movement. The easiest way to fill the holes is to remove the glass, apply a little flux and a tiny piece of soft or tinman's solder at each hole and gently warm the bezel over a low gas or spirit flame. Well oil the hinge before warming

the bezel for the heat may affect its action.

The winding button and shaft should also receive careful attention. If this is worn, there will be plenty of room for dirt and dust to enter through the shaft hole. As well as the possibility of losing the complete winder undue strain will be placed upon the shaft and the internal winding and hand-setting mechanism. Continuous operation of the winder in this condition will finally end in a breakage. If the wear is excessive a new oversize shaft will be necessary. First remove the dial by unscrewing the dial feet screws. In some watches the screws are placed in the edge

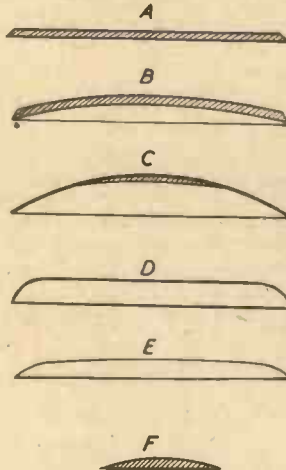

Fig. 1.—Various types of watch glass. A, flat crystal; B, miconcave crystal; C, empire; D, lunette; E, hunter, and F, centre convex.

of the bottom plate and only accessible when the movement has been removed from the case. In others, the screws are provided with a semi-circular flange at the base and screwed into the top surface of the bottom plate. If the minute hand is a good fit take care in levering it off, otherwise it may jump away. If the "seconds" hand is a tight fit, carefully raise the dial which will also act as a lever and remove the band. The hour hand will come away with the dial bringing with it the hour wheel.

### Dismantling the Works

When the dial has been removed unscrew the cover piece which keeps the spring return lever—a small lever working in the groove of the castle wheel—and the hand-setting wheels in place, remove the castle and crown wheels, and everything is ready for fitting the new winding shaft. Fig. 2 shows the crown and castle wheels. Select a "rough"—in other words a partly finished winding shaft—that is a little larger than the hole between the plates, as most of the wear will have taken place here and in the pivot hole. With the old shaft as a pattern mark off the length to the end of the pivot. Place the shaft in a suitable lathe chuck and turn down the shoulder and the pivot. When the new shaft has been turned down a little try the fit. To do this there is no need to remove the shaft from the chuck, simply take the

plates to the shaft and there will be every opportunity of making a moderately tight fit. Leave the shaft a little tight to turn as final buffing will reduce it to a smooth action.

### The Crown Wheel

As the squared part of the shaft is always smaller than the shoulder for the crown wheel it will be quite safe to mark the position of the crown wheel shoulder and turn the shaft down until it just fits the crown wheel. When the shaft has been turned to fit the crown wheel, remove it from the lathe chuck and place it in a hand chuck. It is most important that the squared section should be square. Failure to do this may cause the castle wheel to have an uncertain action. Most watch-makers use a boxwood block for filing purposes—a small cube of boxwood. Although box is a hard wood, steel pieces will become firmly embedded.

If you feel a little uncertain with regard to your filing capabilities, reverse the crown wheel and place it upon the shaft. It will act as a guide and prevent filing the crown wheel shoulder. Use a fine file with a safety edge. Try the castle wheel on each square to make sure the action is smooth. When the square is finished replace the winding wheels in the watch, and put the shaft in place and try the forward and backward action. Lightly screw up the pull-up or bolt piece which retains the shaft, and mark the position of the slot. Care should be taken in making the sides of the slot straight as a V-shaped slot will be inclined to force the bolt out. Fig. 3 shows the effect of a badly made slot.

### Sharp Corners

Whilst the shaft is still in the lathe turn the pivot to a point as this will make entry easier. The corners of the lower end of the square can be turned off too. Sharp corners have a nasty habit of cutting away the brass plate and upsetting the winding. Put the winding shaft in place and screw the bolt piece tight. Mark off the position of the end of the shaft a little beyond the pendant—the tubular extension on the side of the case—remove the shaft and cut it off. Always remove a shaft before cutting it off, as the shock is quite sufficient to break a balance pivot. If the end is already screwed, attach the winding button. If the end is plain turn it down to a suitable size for threading. Fig. 4 shows a finished shaft.

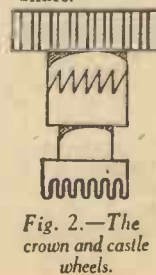

Fig. 2.—The crown and castle wheels.

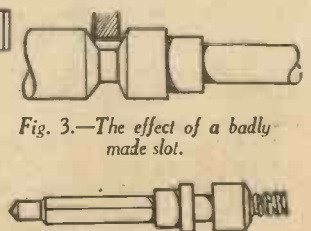

Fig. 3.—The effect of a badly made slot.

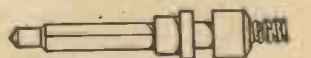
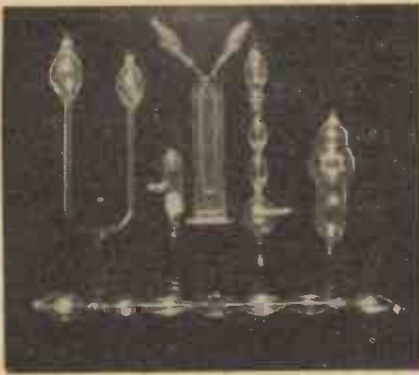

Fig. 4.—A finished shaft.

# MAKING GEISSLER

## This Month we Deal with the Decorative Effects Obtained by using



A group of vacuum tubes of high and low vacuum. Two of these have jackets containing fluorescent solutions. The star cathode tube on the right is highly evacuated and the cathode scintillates in a myriad of flashing lights.

UP to the present our Geissler tubes have been small, due to the limitations of the blow-pipe, which cannot very well heat large masses of glass. However, such a factor does not interfere with the length of a vacuum tube, and this can be made as long as you wish by making it in sections and joining up. Such procedure is almost necessary when a Geissler tube has bulbs of soda glass, and the decorative part made from small bore tubes of entirely different glass, say uranium or lead glass. In a case like this the bulbs are blown first between supporting spindles and the electrodes fused in; one of the bulbs carrying the seal off tube and prepared seal. A length of small-bore tube is chosen and bent to the required design, and the bulbs are joined to it. It is important that the two joints should be made as neatly as possible and it is best to finish a joint between two dissimilar glasses by blowing into a small bulb. Such a method adds greatly to the decorative effect and at the same time lessens the danger of spontaneous fracture due to the uneven rates of contraction.

### Uranium Glass

Fig. 1 shows how such a Geissler tube is made. Lead glass gives a very fine blue fluorescence and uranium a bright yellow-green. Sometimes two or more of these glasses are incorporated in a single Geissler tube to good effect. Uranium glass is easily fusible with soda glass and the writer has experienced no trouble in this regard even with internal joints or seals. The colour of the glass is greenish by ordinary daylight, but a yellowy green should not be too pronounced as some kinds of uranium glass contain a proportion of copper oxide to heighten the colour; a quality not desirable in vacuum tube work for we wish our colours to show up by fluorescence and not by pigmentation. It costs about ten shillings a pound, so that it should be used sparingly; and if you buy any, see that the colour in daylight is a delicate shade of green, and this produced for the most part by fluorescence. You will easily see the difference if you look

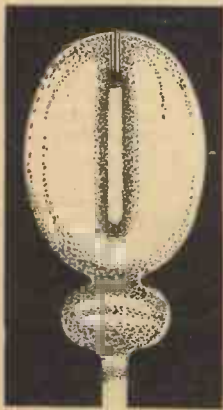

Fig. 3.—Maximum conductivity as well as fluorescence.

at a piece by transmitted and reflected light. When uranium glass is heated it turns a brownish yellow, but quickly assumes its characteristic green on cooling. Lead glass is a problem for the amateur glass-blower in that it easily blackens; that is, the flame reduces part of the glass to metallic lead unless precautions are taken. The blow-pipe flame has essentially two zones, an

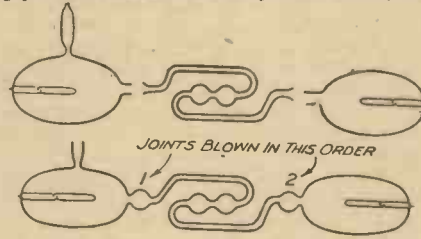

Fig. 1.—How a Geissler tube is made.

inner reducing flame and an outer oxidising flame, and lead glass should be worked at the extreme tip to prevent reduction. If the experimenter wishes to try this difficult glass, it is recommended that a discarded electric bulb be broken and the stem

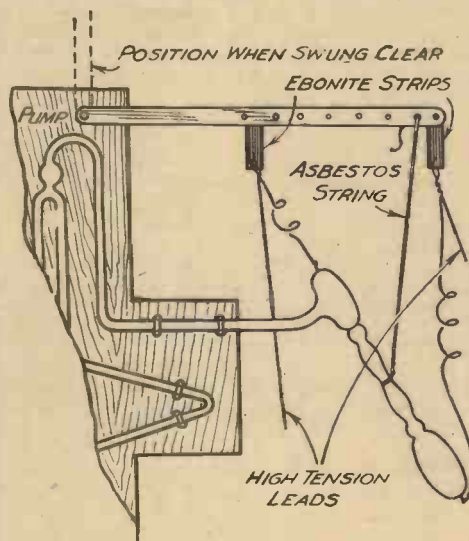

Fig. 2.—A fitment for holding a large tube on the exhaust pump.

holding the seal wires and filament tried in small pieces in the blow-pipe flame. If one manages to get the knack of manipulation, then vacuum tubes incorporating lead glass can be attempted. Bends can sometimes be done by using a smoky bunsen flame, the heat not being sufficient for reduction, but hot enough for bending. Soft lead glass is an excellent substitute for the blue enamel glass used for sealing the electrode wires.

### Exhausting a Large Tube

Before we attempt to exhaust a large tube it is necessary that we have some extra mechanical support for it whilst on the pump, and the fitment shown in Fig. 2 is a useful addition. It will be seen that

it consists of a piece of wood about eighteen inches long; the cross section not being important, but should be strong enough without bending. Holes are drilled through at intervals of 1½ in. or so, and two or more pegs made to fit these so that a piece of asbestos string, with a wire hook at one end, can be trapped in position at the required length. Two strips of ebonite are also fixed at the back and a hole drilled in each to take the high tension leads from the induction coil. The fitment is secured to the backboard of the pump by a screw at the left-hand side, and the weight taken by another screw driven near the edge of the backboard and underneath the strip of wood. This arrangement allows the whole fitment to be pushed up into a vertical position, and out of the way when not in use. The induction coil should be remotely controlled and another reversing switch or commutator made and fixed some distance from the high tension leads and in a convenient position. I have an unhappy recollection, whilst working in a dark room, of the high tension leads falling from the tube on my hands. The experience stimulated the foregoing piece of ingenuity. Needless to say, the Geissler should be strung first of all at the correct height and then sealed to the pump. The degree of exhaustion should not be too high and by observing the Crookes dark space at the cathode and sealing off when this is about ¼ in. thick, we get maximum conductivity as well as fluorescence. Fig. 3 shows the characteristic appearance.

### Fluorescent Solutions

Many solutions of organic substances have, along with various minerals, dry chemicals, etc., the peculiar property of changing the short-wave invisible rays of light, natural or artificial, into longer and visible rays. This property, called fluores-

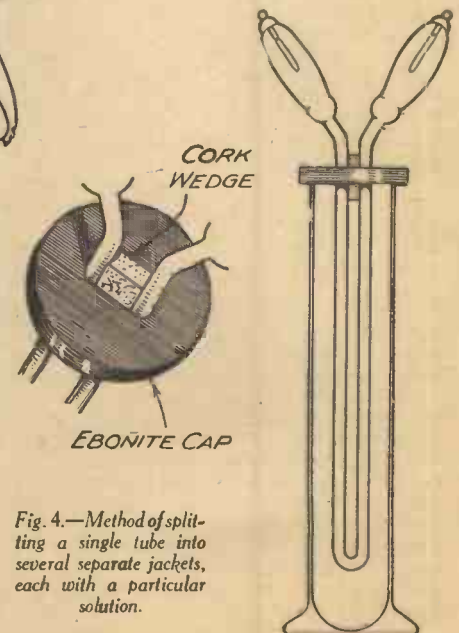

Fig. 4.—Method of splitting a single tube into several separate jackets, each with a particular solution.



# AND VACUUM TUBES—No. 3

## Construction of Long Tubes and Different Types of Coloured Glass.

cence, is immediately apparent as a colour, differing from the dye or natural colour and appearing round the edges of a solution. It has an oily look, as it were, and this is true, for most mineral oils fluoresce in some slight degree. If we have a test tube containing a slightly acid, and very dilute solution of sulphate of quinine, a bright blue colour is apparent even in dull daylight. One should look at the tube against a dark background with one's back to the window or source of light. This test should be our guide in estimating the degree of fluorescence of any solution.

three. Concentration does not seem to have any bearing on the degree of fluorescence; indeed, they are brightest when diluted. A good chemist will make up the first four of these solutions at little cost. Chlorophyll can be extracted from green leaves with alcohol, but is not very dependable as it turns murky after a time. Æsculin has a bright blue fluorescence and can be made at home by cutting a few twigs of horse-chestnut, stripping the bark and boiling this for a few moments in an aluminium pan. The water should be filtered and will be strongly fluorescent.

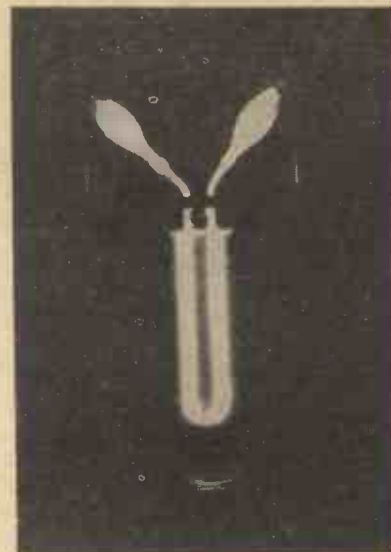

Experimenting with fluorescent solutions. The solution shown is bright green and is dilute acriflavine. The colour contrasts well with the light pink of the positive column.

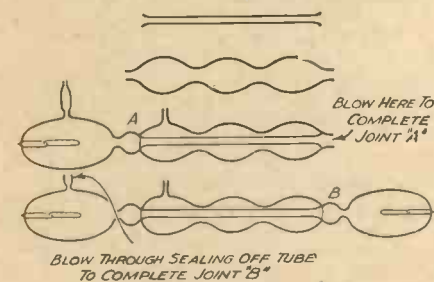

Fig. 5.—Making internal seals.

Many Geissler tubes are made with a glass jacket surrounding the decorative parts and this contains solutions of various kinds, each fluorescing a different colour. Here again, the total length of the tube

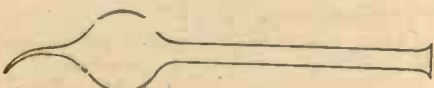

Fig. 6.—A bulb-pipette

may be split into several separate jackets, each with a particular solution. For this fascinating field of experiment the piece of apparatus shown in Fig. 4 should be made. The Geissler tube is of a special U-shape, designed to fit into a test tube on foot, or a small sample jar, etc., and solutions can be changed at will. The U-shaped portion should be made of soda glass of small bore, as lead glass, apart from its own fluorescing properties, is pretty well opaque to the shorter wave lengths. The method by which the special Geissler tube is made calls for no comment as the various parts have been fully dealt with. It is held in the required position by a disc of ebonite or waxed wood having a slit in the centre and trapped by a wedge of cork. The following are the best solutions :

Name of Solution	Colour of Solution	Colour of Fluorescence
Acriflavine	Yellow	Green
Æsculin	Colourless	Blue
Sulphate of Quinine	Colourless	Blue
Fluorescein	Slightly red	Green
Chlorophyll	Green	Red
Fluorene	Colourless	Violet

There are dozens of others, but these give the brightest effects, especially the first

### Jacketed Tubes

Here we must deal with an important operation in glass-blowing; the making of internal seals, or sealing one tube within another, in the manner seen in a Leibig condenser. It is important that both tubes be of the same kind of glass so that we get even contraction when cooling. The annealing should also be thoroughly done. The jacket in one type of Geissler can be made from 6-mm. bore tube, which is blown as a series of bulbs, elongated or otherwise, with the central tube drawn from the same kind of glass and rimmed or bordered at the ends. Assuming the two bulbs carrying the electrodes and sealing off tube to be made, the method of procedure is as follows :

The jacket is arranged with a short length of 6 mm. tube at each end, and the inner tube is slipped in and placed in a central position. The flame is applied to the outer tube at one end and the glass fused down over the trumpet shaped end of the inner tube. As soon as possible take the electrode bulb with the sealing off tube and join this to the end of the outer tube, and when thoroughly fused blow into a small bulb. While this region is still hot

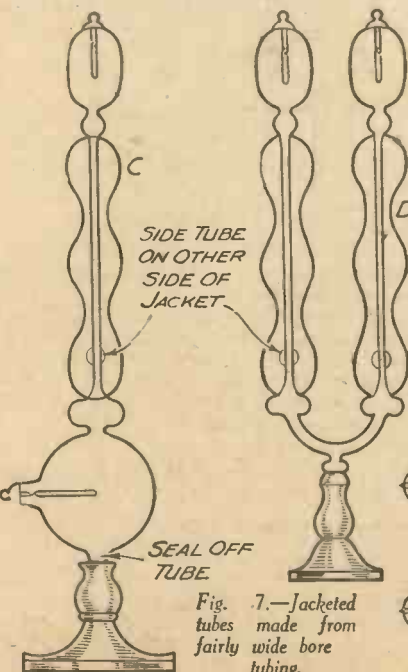
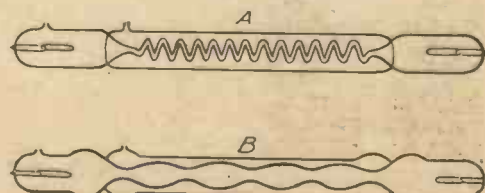

Fig. 7.—Jacketed tubes made from fairly wide bore tubing.

draw out a side tube on the bulb of the jacket; this can be used for blowing purposes when completing the other end of the jacket and joining on the second electrode-bulb. Fig. 5 shows the whole sequence of this interesting operation. The tube should be exhausted in the usual way and when sealed off is ready for the fluorescent solution, which should be squirted into the jacket by a bulb-pipette shown in Fig. 6. This pipette is easily made. When the jacket is full, allow the blow-pipe flame to graze on the extreme tip of the side tube which will close by capillarity. The jacketed Geissler tube is now finished and will well repay the work expended, for it will last a lifetime with care.

Other jacketed tubes are made from fairly wide bore tubing, say 1 centimetre, but these are difficult to do without blow-pipe and bellows. If we look at A, Fig. 7, it will be seen that the two end bulbs and jackets are in one piece; the tube being constricted at XX to fuse in the central tube which can be a spiral or a series of small bulbs. Sometimes the outer tube is not constricted, and the inner tube is bordered out into a trumpet shaped enlargement to nearly the full bore of the outer one. When the inner is sealed in, the outer tube is blown at each side of the seal as B. For fairly obvious reasons it is best to keep the seal-off tube and jacket side tube at one end of the Geissler tube, and at one side. One of the best types of jacketed tube is shown at C; the seal tube sliding into a base of wood which can be made by properly turning to shape or  
(Continued on page 45)



# MODEL AERO TOPICS

CURRENT NEWS FROM THE  
WORLD OF MODEL AVIATION

## New Records

THE record claimed by Mr. Sayer of the North Kent Model Aero Club for a R.O.W. flying boat duration of 22 secs. was passed, as also were the flights of Mr. D. A. Pavely of T.M.A.C. of 1 min. 37.1 secs. for a R.O.G. for a 11PO model and the flight of Mr. C. W. Needham of the Bristol Club of 1 min. 6.2 secs. for a OIPI model.

## The Wakefield Competition

I GAVE the results of this competition briefly last month. There were in all 67 entries from 15 countries, the New Zealand entry being cancelled because the model did not conform to the regulations—leaving 66 competitors. Although Len Stott was 41st in the contest, very few other competitors made better flights. He was unlucky in losing his model during its first flight of 4 min. 25 secs. Of the five models lost in the contest two belonged to Great Britain! In timing the 32 min. 5 secs. flight of Cahill, the 13 min. 31 secs. of Bougueret, the 17 min. 3 secs. of Magnusson, field glasses were used. All the British machines with the exception of Mr. Stott's and Mr. Bullock's landed in or near the aerodrome. On the two British fly-away flights field glasses were not used. Had they been undoubtedly these two models would have had greater duration to their credit.

The times of the individual competitors are given below:—

1	Cahill	654 secs.	United States
2	Bougueret	418 "	France
3	Chabot	402 "	France
	Magnusson	402 "	Sweden
5	Klose	375 "	Germany
6	Almond	357 "	Gt. Britain
7	Chasteneuf	319 "	Gt. Britain
8	Bullock	307 "	Gt. Britain
9	Milligan	296 "	Canada
10	Beatty	285 "	S. Africa
11	Schmidtberg	274 "	Germany
12	Fullarton	267 "	Australia
13	Smith	240 "	Gt. Britain
14	Degler	203 "	Poland

Had the Wakefield been flown this year as a contest in the same manner as the King Peter's Cup, England would have won the Wakefield Cup.

## The King Peter's Cup

ENGLAND obtained a sweeping victory in the King Peter's Cup held in Yugoslavia. Not only did the British team win



Our model Hawker "Hurricane" contest. The winning model, made by Mr. O. M. Wareham. It is a very faithful reproduction, even to the colour scheme, of the full-size machine.

the King Peter's Cup, but British competitors won all the first prizes, Mr. R. Copland making a flight of 32 min. 9 secs. which the S.M.A.E. is claiming as a world's record. The model attained a height of nearly 6,500 ft.

The general placing of the Nation teams is the following:—

- 1, Great Britain, with 36,145 points, obtains the Royal Cup.
- 2, France, with 14,307 points, obtains cup given by the War and Navy Minister.
- 3, Jugo-Slavia, with 10,825 points, obtains cup given by Minister of "Education Physique."
- 4, Czecho-Slovakia, with 9,200 points, obtains cup offered by Minister of "Instruction Publique."
- 5, Germany, with 8,282 points, obtains cup offered by the Commander of Military Aviation.
- 6, Hungary, with 5,634 points, obtains cup offered by Union of Aeronautic Industries.
- 7, Switzerland, with 1,797 points, obtains Hispano-Suiza factory "Statuette."
- 8, U.S.A., with 1,795 points.
- 9, Egypt, with 465 points.
- 10, Bulgaria, with 0 points.

## Individual Prizes as per General Classification

- 1, England, Mr. Copland, with G-3 model (silver cigarette case) from Moster Zagreb factory.
- 2, France, M. Poulain, with F-4 model, (watch) from Yugoslavia Aeronaut Industries of Aviation motors.
- 3, England, Mr. Chasteneuf, with G-10 model (Mikron watch).
- 4, England, Mr. Copland, with G-11 model, (watch) Jasenice factory.
- 5, Switzerland, M. Degain (Knebl and Ditrich factory watch).

## Protest to the C.F.M.R.A.

PROPOS my criticism of the conduct of the C.F.M.R.A. in this year's Wakefield contest, the Council of the S.M.A.E. have decided to send a letter drawing their attention to the following points: (1) Inefficiency and inadequate number of timekeepers. (2) During the greater part of the day most of the French models were not in the French pen, but were kept in another part of the field. (3) The

S.M.A.E., although responsible with the French for running the competition, were not allowed to assist in the control. (4) The arrangements for retrieving models were not up to promises and statements made. (5) The food supplied to competitors was not up to the standard expected.

## The Hallam 1 c.c. Model

THE illustration at the bottom of page 643 of "Practical Mechanics" for Sept. is of the 1 c.c. Hallam model and not the 2.5 c.c. as described.]

## Results of Model Engineer Concours d'Elegance

- |   |             |                     |
|---|-------------|---------------------|
| 1 | L. B. Mawby | Ealing and District |
| 2 | H. Simmonds | Blackheath          |
| 3 | G. Foden    | Chelmsford          |

## Results of National Cup

	Av. of team	No. of team
1 Northern Heights	412.275	4
2 Luton ...	406.475	4
3 North Kent	404.87	4
4 Blackheath	351.6375	4
5 Bristol and West	327.1	4
6 Hayes and Dist.	313.925	4
7 Wembley ...	302.425	4
8 Stanmore ...	286.7375	4
9 Barnes ...	277.95	4



A low-wing petrol model caught in the air.

# Model Aircraft Supplies Ltd.

THE FAIRY FACULA



### BUILD A MODEL THAT REALLY FLIES

Our comprehensive kit contains full-size drawings, ready cut out wing ribs, block, sheet and strip balsa, cement, dope, lacquers. Price 13/-, Carriage Paid. Specification of the Fairy Facula: Span, 54 inches; chord, 7 inches; length, 38½ inches; weight, 8 ounces; power, 12 yards ¾ rubber. Wing is built in halves; rear of fuselage and undercarriage are detachable for transport. Average duration, 1 to 2 minutes; best flight, over 5 minutes.

This and dozens of other models are illustrated in our Green Book Catalogue, 4d. Post Free.

171, NEW KENT ROAD, LONDON, S.E.1  
OPEN UNTIL 8 P.M. SATURDAYS.

## AN OPPORTUNITY YOU CANNOT AFFORD TO MISS

As a reader of PRACTICAL MECHANICS we offer to send you for seven days' free approval a three-volume work that teaches thoroughly every branch of metalworking a New, Complete, Up-to-the-Minute Workshop Guide.

# THE NEW PRACTICAL METALWORKER

NEW EDITION—PUBLISHED SEPTEMBER 1st

3 Volumes . . . 1,140 Pages  
Over 2,300 Illustrations

HERE is an entirely NEW edition of a recognised standard work on metalworking, revised line by line, and brought up to date in every detail at a cost of over £2,000. Every new and modern process of metalworking is described fully by specialists.

All the great advances made recently in workshop engineering, particularly in such sections as gear and screw cutting, lathe work; milling, precision grinding and shaping, the making of gauges and jigs, in welding and fuslon cutting and many others, are included in THE NEW PRACTICAL METALWORKER.

Progressive workers, craftsmen and practical mechanics of all grades will realise that here, in this new, up-to-the-minute work, they have the newest and best handbook of machine shop practice ever issued. The cream of the experience of practical working specialists in every branch of metalworking is presented in these volumes. THE NEW PRACTICAL METALWORKER is the book for every progressive engineer and ambitious workman.

If you wish to fit yourself to take part as a metalworker in the work of the armament or aircraft industries, you should certainly obtain these volumes which will give expert help and guidance.



- A SHORT CLASSIFIED LIST OF THE MAIN SUBJECTS COVERED:
- Tools
  - Workshop Equipment
  - Drawing for the Metalworker
  - Workshop Calculations
  - Preliminary Operations
  - Metals and Other Materials
  - Heat Treatment of Metals
  - Casting Practice
  - Forging and Smith's Work
  - Pipe Fitting and Manipulation
  - Soldering, Brazing, Welding
  - Wire Working
  - Sheet Metal Work
  - Lathe Work
  - Precision Grinding
  - Gear Cutting
  - Screw Cutting
  - Milling, Planing and Shaping
  - Stripping, Polishing, Colouring, Lacquering and Plating
  - Gauges, Templates, Jigs and Fixtures
  - Fitting, Erecting, Boiler Work
  - Making Tools, Instruments and Appliances
  - Etching, Engraving, Letter Cutting

## MAKE WHAT YOU WANT WITH UNIT 'X'

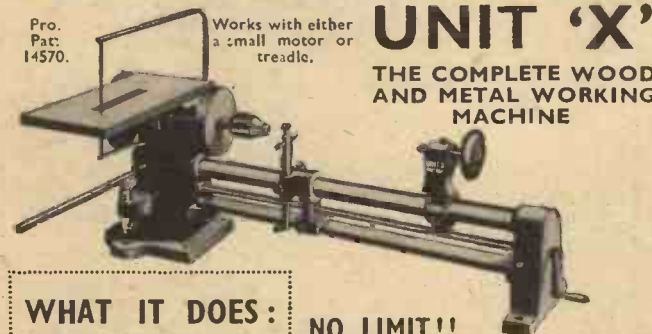

Pro. Pat. 14570. Works with either a small motor or treadle.

THE COMPLETE WOOD AND METAL WORKING MACHINE

- WHAT IT DOES:**
- URNS—Wood or Metal.
  - DRILLS—Press drills ¾ in.
  - MOULDS & GROOVES.
  - SURFACE GRINDS.
  - SANDS.
  - JIGSAWS.
  - RIVETS.
  - CIRCULAR SAWS.
  - POLISHES.
  - MILLS.
  - PUNCHES.
  - SPINS.
  - DOVETAILS.
  - GRINDS TOOLS.
- Clean accurate work, to fine limits.

**NO LIMIT!!**  
There is no limit to the number of operations possible on this marvellous machine. It is an engineering education in itself and will develop the mechanical ingenuity of the user.  
Full length 26 ins. Turns objects 4 ins. diameter and certain wood patterns to 12 ins. diameter.

**EQUIPMENT INCLUDES**  
Circular Saw, Grinding Stone, Buff, Jigsaw and Blades, Sanding Drum, One Tilting Table, ¾ in. Chuck, Punch, Tool Post and Cutting Tool, Spanner, Oil-Can

**95/- COMPLETE**  
or 15/- cash and 9 monthly payments of 10/-

**TRIANGLE PRODUCTS LTD.**  
Blake Street, Hulme, MANCHESTER, 15



### Send TO-DAY for this Splendid New Work

Just sign and post the form below and on acceptance we will send you these three volumes, carriage paid, to examine for one week, free. You may either return them to us within 8 days to end the matter, or you may keep them on the very easy terms outlined.

**"PRACTICAL MECHANICS" FREE EXAMINATION FORM**  
To the WAYERLEY BOOK CO., LIMITED,  
96 and 97 FARRINGTON STREET, LONDON, E.C.4.

Please send me, carriage paid, for seven days' FREE examination, "THE NEW PRACTICAL METALWORKER," complete in three volumes. It is understood that I may return the work on the eighth day after I receive it, and that there the matter ends. If I keep the books I will send you on the eighth day a First Payment of 2/6, and, beginning 30 days after, ten further monthly payments of 4/- each and a final one of 2/6, thus completing the purchase price. (Price for Cash on the eighth day, £2 2s. 0d.)

Name .....

Address .....

Occupation ..... State if Householder .....

Parent's Signature ..... Date .....

required under 21 P.M.17. PLEASE FILL IN ALL PARTICULARS ASKED.

# GET A MODEL RAILWAY INTEREST



"STEAM-ENTERPRISE," GAUGE "O"



"SUPER-ENTERPRISE"



STANDARD LOCOMOTIVE "OO"

## "O" GAUGE

A customer from Nottingham writes of our "O" gauge steam "Super-Enterprise" and "Enterprise" locomotives:—

"To say these engines have given every satisfaction is to understate facts. Their work is nothing short of marvellous. Even hardened model-railway men have raised their eyebrows at the performance of the 'Enterprise.'

"Under test she ran 1 hour 10 minutes light, hauled 26 Bassett-Lowke wagons for 52 minutes, and started no less than 35 vehicles—some bogie—without apparent effort. She couldn't be tested with a heavier load, as there was no more available rolling stock at the time! I certainly consider you are well on the 'safe' side with your five bogie coaches for 50 minutes statement in the catalogue.

"Of the 'Super-Enterprise' I would say that she seems steadier-running and is a much better-looking machine."

## "OO" GAUGE

The wonderful Twin Train Table Railway has developed yet further this season, with the introduction shortly of the new 4-6-2 Pacific type British Locomotive "Princess Elizabeth" and "Flying Scotsman." Both are fitted with the new magnetic uncoupling device, and have scale model coaches in three types to suit the trains.

Illustrated is the standard Express Loco and Tender, price 18/-, and the standard sets from 30/- upwards are THE BEST THINGS YET IN "OO" GAUGE RAILWAYS.

Write for latest Catalogue TT.12. Price 2d.

## WHICH PARTICULAR PART OF THIS HOBBY ATTRACTS YOU!

Are you a model maker or a model owner? Which is your gauge? Do you favour the "OO" gauge Table Railway, or the other extreme of the powerful man-drawing "live steamer"? Your favourite Railway Grouping or Company?

There are dozens of other questions we might ask you about Model Railways, for the hobby is the most fascinating one in the world to thousands of boys and men, but if you are hesitating on the brink, why not write for our latest MODEL RAILWAY CATALOGUE A.12 (now in the printer's hands) which describes all types and gauges, as well as every accessory you will need. NOW is the time to be thinking of improvements and additions to existing layouts, so send right now for

A. 12., Complete Model Railway Catalogue 6d. post free

LONDON: 112, High Holborn, W.C.1  
MANCHESTER: 28 Corporation St.

## BASSETT-LOWKE LTD., NORTHAMPTON

### INDUCTION MOTORS



A "WILCO" GEARED MOTOR

This motor has many useful applications for model constructors and experimenters. It operates direct from 200-250 v. A.C. supply and has phosphor-bronze bearings with grease cups ready filled for 12 months' use. Will run smoothly, day and night indefinitely. Can be fitted with turntable for display work. Price 27/6. Special Turntable model with 8-in. green baize covered plate. Carrying capacity 33 lbs. Speed 5-6 r.p.m.

L. WILKINSON, 204 Lower Addiscombe Road, CROYDON, Surrey.

Some examples of "WILCO" Value 1/40th h.p. for A.C. 200-250 v. Excellent for model driving, sign display mechanism, etc. Self-lubricated bearings, bronze impregnated with graphite. Enclosed type as illustrated. 21/- Post Paid.

Open type 18/6  
TWO GEARED TYPES also supplied for 96 and 47 r.p.m. 32/- Each.

New 44 page Catalogue 4d. Post Free



21/- Post Paid.

### THE "LONDON B" 3-in. CENTRE LATHE

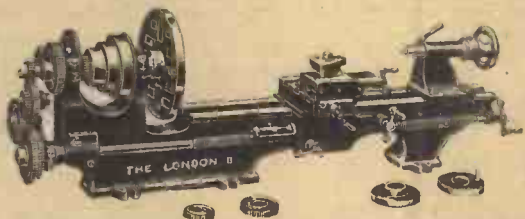

Back Gear  
Screw-cutting

Distance between Centres 20-in. Fully compound Slide Rest set over Tailstock, Quick Traverse Action, Hollow Mandrel. Complete with Face Plate, Catch Plate.

Price £5-17-6 Carriage Paid.

Specification Free on Application. Have you had our Lathe Accessories List?

● This Model must not be confused with any other Model of similar design on the market.

DENNIS & SMITH, 83 Goswell Rd., London, E.C.1  
Tel.: Clerkenwell 4457. Telegrams: Feretor Barb, London

# READY TO BUILD EXACT SCALE SHOW MODELS



FLYING CLOUD. Length 12 ins. Fascinating model with all rigging details. Kit is complete with balsa wood for hull, masts, cement, lacquers, etc. Carriage paid 2/6

● Ship Fans will be fascinated by building these models. All the hard work and drudgery is removed by the clear full size plans. Everything comes ready for you to make an immediate start. Think how fine the finished model will look in your room.

Ready built Spanish Galleons. Very decorative and colourful for "period" rooms. Three masts, coloured sails. Length overall 12 ins., height 10 ins. 4/6 Post free for

Send 1½d. stamp for finely illustrated catalogue giving full details of 17 kits. (Abroad all kits 2/- postage extra.)

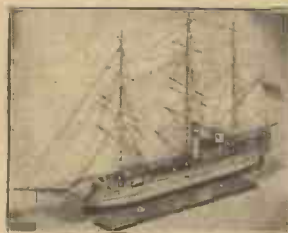

CITY OF NEW YORK. Length 14 ins. Very detailed model of sailing ship with auxiliary motor. Kit has all wood needed, etc. Carriage paid 4/-



CUTTY SARK. Length 23 ins. Exceptionally detailed model. Large clear plan, shaped balsa hull, many finished fittings, cement, lacquers, etc. Wonderful value, for carriage paid 15/6

SEND YOUR ORDER NOW  
P. M. SWEETEN LTD., Bank Hey St., BLACKPOOL

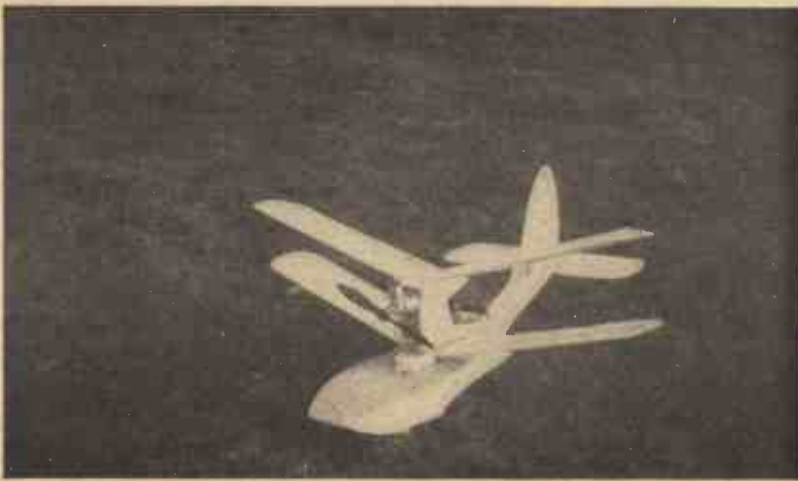

Fig. 1.—The 2.5 c.c. flying boat.

# NOTES ON PETROL-DRIVEN MODEL AEROPLANES

## Smaller Petrol Models

**R**EGULAR readers of PRACTICAL MECHANICS will remember that in a previous number a description of my British record-holding, rise off water, petrol-driven flying boat was given; it was produced from a series of experiments carried out with hydroplanes and experimental flying boats. The two subjects are interconnected. Recently I obtained two engines of 2.5 c.c. These are fitted with platinum points. One was an aero engine, and the other fitted with a fly-wheel and transmission to my ideas for hydroplane work. I was so impressed by the power output of these very little engines that I decided to design and build three models for them—firstly a really midget hydroplane, then a very small flying boat on the lines of my large record holder, but of biplane form, in order to keep the hull as small as possible to lessen water drag for the take-off. The third model was to be a small land biplane to use the wings and tail unit of the flying boat.

These models have now been built.

## A Midget Hydroplane

It will be recalled that some years ago my 15 c.c. hydroplane "Jildi Junior" put up a record for this class of boat, and from that date the speeds of the "C" class have soared rapidly. I then built "Jildi Junior II" almost completely from thin balsa wood. The result was a very light hull indeed, and of streamline form. I con-

detachable plugs and leads so that the engine could be started up on an accumulator, and when warm, switched over to the flash-lamp battery in the hull, for its water run. A small 2-oz. aero type time switch was also fitted, so that the engine could be switched off at any predetermined length of run. Thus the little hydroplane could be allowed to run straight down the lake or pond and be automatically switched off before reaching the far end.

I was pleased with the first test runs, as they proved to me that the hull was very stable, planed perfectly, and ran at about 12 m.p.h., with the engine by no means giving off full power, probably due to the exceptionally cold weather. These tests have been most encouraging, and, I feel, prove that a great deal of fun and success can be obtained from a standard 2.5 c.c. engine if it is a good example of its class. I have also constructed a hydroplane called the "Jilda Midgé." When the next season arrives and pole racing recommences I can

see no reason why this little hull should not be used around a pole provided a light fishing line is used instead of the usual double thick lines. In fact, I can see distinct possibilities of a new class for racing, i.e. 2.5 c.c. and below that size. Speeds around 15 m.p.h. should be obtainable.

I am only sorry that I am now serving abroad (at Gibraltar, of all places) and, therefore, shall have to content myself with further experiments by myself for some time, but I can assure anyone interested that there are great possibilities for this size of hull, also for controlled straight running, a great deal of fun and satisfaction can be obtained.

For those interested, below are the main dimensions of the hull:

Length, 21 in.; beam, 6½ in. at step; step, 1½ in. from stern; propeller, 1½ in. diameter; 2½ in. pitch.

The hull is built as shown in my article in the November, 1937 issue of PRACTICAL MECHANICS and is covered with ¼-in. sheet balsa. A silk covering is then added which is doped and finally painted and varnished.

---

By C. E. B.

---

sidered that a similar type of hull, but considerably smaller and somewhat modified, would suit the 2.5 c.c. engine, except that the ignition would have to be operated on a 4-oz. 4-volt flash-lamp battery as in the case of petrol-driven model aeroplanes, because of the necessity for weight reduction. As model petrol engines at present cannot be regularly started up on flash-lamp batteries, I determined to fit two



Fig. 3.—A very small landplane with biplane arrangement of lifting surfaces.



Fig. 2.—The 2.5 c.c. miniature flying boat snapped after a hand launched glide.

# Wealth From The Ocean



*The valuable elements contained in even a restricted area of sea-water would make a small fortune for the individual who could economically extract them.*

**M**UCH of the mineral wealth of the earth finds its way ultimately into the sea. Rivers wash down to the oceans the more soluble contents of the land's surface, the never-ceasing phenomenon of coastal erosion results in the sea constantly obtaining an increase of mineral content and even man himself is in modern times responsible for depositing much valuable mineral matter into the sea in the form of sewage sludge.

The vapour which arises from the sea in hot and dry weather is almost pure water. This, of course, is taken up to higher levels of the atmosphere and eventually deposited in the form of rain over the land. The rain water dissolves further quantities of minerals out of the land's surface, which minerals, in a state of solution, ultimately find their way into the sea.

It is clear, therefore, that the oceans of the world must be getting more and more full of dissolved matters, although, of course, the actual rate of this increase of sea-water content is very slow.

## Sea-Water Content

At the present time, sea-water contains, on an average, approximately 3.5 per cent. of dissolved solids in solution. The bulk of this solid matter, as we know, consists of common salt—chloride of sodium—which amounts to nearly 77 per cent. of the dissolved matter.

Next to this are the chloride and sulphate of magnesium which account for some 16 per cent. of the dissolved solids in sea-water.

From time immemorial, common salt has been recovered from the sea merely by collecting the water in shallow pans and allowing it to evaporate under the heat of the sun. Along the shores of the Mediterranean, this primitive process of salt extraction is carried on even at the present day.

It will be obvious that mankind will never be short of the elements sodium and chlorine,

for they can readily be extracted from sodium chloride (common salt) simply by electrolysing the fused material.

Sea-water contains potassium chloride as well as sodium chloride, and since potassium compounds are relatively costly and are of high industrial importance, several schemes have from time to time been mooted for the recovery of potassium salts from sea-water. Unfortunately, how-

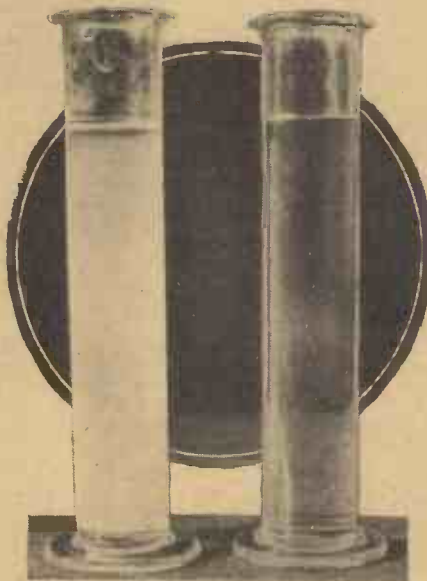

*Showing the solvent power of natural water. On the left is a vessel full of spring water, and on the right is a sample of the same water which has been boiled in order to throw a proportion of its dissolved constituents out of solution. By the ceaseless pouring of these river waters into the sea, the latter is continually increasing in mineral content.*

*Immense Resources of Natural Wealth Lie Latent in the Seas of the World, and their Commercial Extraction is now Becoming a Practical Possibility*

ever, sea-water contains only about .04 per cent. of potassium, and this amount is too small to permit of the economic working of any such process, particularly at the present day, when, within the last few years, enormous deposits of potassium salts have been located in Russia. It is very possible, however, that in the distant future most of the world's supplies of potassium salts may have to be obtained from the vast reservoirs of the oceans.

## Recovering Magnesium

Far more important in modern times, however, is the question of recovering magnesium from the oceans of the world. Yearly, magnesium is becoming a more and more important metal, for, suitably alloyed, it can be given great tensile strength with little diminution of its characteristic lightness.

The average magnesium content of sea-water is only about .14 per cent., yet, despite the fact that this valuable metal occurs in far greater abundance in a variety of minerals, there is at the present day a factory operating near San Francisco which is daily producing approximately 10,000 lbs. of magnesium compounds from water drawn from the Pacific Ocean. By means of this pioneer extraction plant 1 lb. of magnesium (in the form of oxide) is obtained from every 100 gallons of water treated.

The notion of extracting gold from the sea has a long and a romantic history attached to it. Many of us, indeed, are inclined to regard all such ideas as purely fanciful. Actually, however, gold does exist in all the sea-waters of the world, one grain of the metal per ton of water being an average gold content of the various oceans.

Unfortunately, or, perhaps, fortunately for the economic stability of the nations, there is yet no worthwhile method of extracting gold from sea-water, for the cost of such a process would considerably exceed the value of the gold recovered.

## Copper

Copper is another metal which exists in sea-water, but which, at the present time, cannot be recovered therefrom by any economical means. Yet in the years to come it may be found urgently necessary to investigate the possibilities of extracting

copper from this source, for, at the present day, the estimated world's reserve of copper ores is but equivalent to some 81,000,000 tons of the metal, a supply which, at the present rate of industrial consumption, will only last for about another 70 years.

Now, although copper does not occur in sea-water to an extent greater than one part of the metal in a million parts of water, it can be calculated, that, even at this high dilution, the world's oceans contain about two trillion tons of pure copper. How such metal can be economically extracted forms a problem for another generation to deal with. Possibly, however, the task may not turn out to be as difficult as it looks, for there is a marine organism—the common oyster—which seems to act as a copper filter and which, in some unknown manner, is able to extract copper from sea-water and to accumulate it in its body. Many oysters contain two or three

"ethylised" anti-knock petrols sent up, within a few years, the bromine consumption from 2,000,000 lbs. to 9,000,000 lbs. per annum. The price of bromine shot up and for some time it appeared as if that commodity were going to be absolutely unobtainable.

The problem of obtaining industrial bromine, particularly for motor use, was a pressing one. But after a period of intensive research a little group of American technologists and chemists solved it by devising a process of bromine extraction from sea-water.

Sea-water contains .008 per cent. of bromine, mainly in the form of sodium and magnesium bromides. In order to liberate this valuable element from the water, the latter is made acid in suitable chambers by the addition of a small amount of sulphuric acid. A definite amount of chlorine gas is then passed into the acidified water.

iodine, from which the element is recovered merely by heating the burnt ash with sulphuric acid in a suitable retort.

Just as the oyster acts in some mysterious manner as a copper filter, so, also, seaweeds perform the function of iodine filters in the world's oceans. The proportion of iodine in sea-water is, however, too small to permit of its *direct* recovery being economically undertaken.

#### Other Metals

Other metals which exist in traces in sea-water are silver, zinc, titanium, beryllium, nickel, cobalt, manganese, lithium and aluminium. All these occur in exceedingly minute amounts which make their extraction forever an uneconomical aim, unless, by chance, an intense scarcity of any of them suddenly arose.

Iron and calcium are metals which occur in sea-water to a rather greater extent, but it is highly unlikely that these metals will ever be regarded as a portion of the ocean's wealth. It is interesting, however, to note that the calcium in sea-water is present as calcium sulphate or *gypsum*, and that if, at any time, a sulphur shortage were threatened—and such, indeed, is well within the bounds of possibility—it is to the dissolved gypsum in the ocean that mankind would have to turn for its sulphur supplies.

Finally in our survey of the oceans' mineral wealth there is radium, that in-

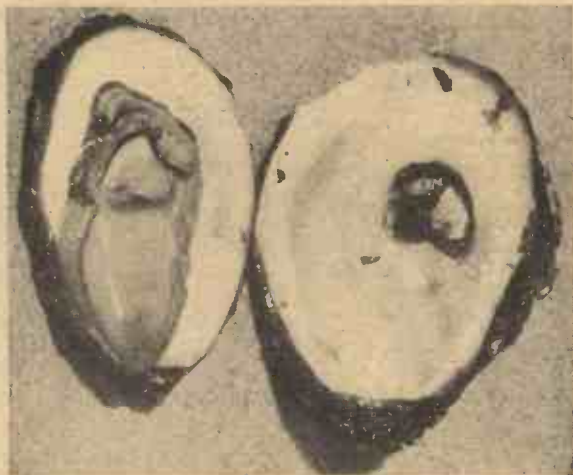

(Left) The common oyster possesses the secret of copper extraction from the ocean. Could we put its mysterious principle into large-scale operation, copper, gold and other metals might readily be gained in large quantities from the seas of the world.



(Right) Recovering iodine from seaweed ashes by distilling them with sulphuric acid. An experiment on a laboratory scale.

hundred parts of copper per million in their bodies. The problem, therefore, of dealing with the sea's latent copper resources would seem to consist of devising some form of oyster-like filtering mechanism which would selectively retain the copper content of all the sea-water which was passed through it.

#### Gold

Possibly, also, the effective extraction of gold from the sea might be brought about by some such device.

Turning now from probabilities to practical possibilities, it is of interest to note that one of the most recent spectacular achievements of chemical science is to be seen in the continuous process for extracting bromine from sea-water, which has been carried on at a chemical factory situated near Cape Fear on the North Carolina coast of America.

Bromine, which is a heavy, dark-red fuming liquid, is an element of much commercial and industrial importance. Formerly, the bulk of the world's supplies came from German sources, most of these being worked up into potassium bromide and various other salts for medicinal, photographic and other purposes.

#### Pure Bromine

With the coming of the various "anti-knock" motor spirits, however, the demand for pure bromine suddenly increased. Petrols of this nature contain, among other materials, a small percentage of a substance known as ethylene dibromide which is made directly from bromine.

In America alone, the advent of the

This liberates the bromine, which is then blown out of the water by currents of compressed air and absorbed in alkaline sprays. From the resulting concentrates the extracted bromine is obtained merely by acidifying the liquid and by blowing steam through it.

#### 45,000 lb. Daily

The North Carolina bromine plant, which is continuous in action, when working at full capacity produces no less than 45,000 lb. of bromine daily from the waters of the Atlantic Ocean. Yet such is the demand for this valuable element in connection with the treatment of modern motor spirits that the plant has seldom been stopped since its erection a couple of years ago.

A similar bromine plant is now being erected in the Dutch West Indies and more are said to be under consideration in other parts of the world.

Iodine is an element which has been extracted from the sea through the medium of marine vegetation ever since its first discovery more than a hundred years ago.

The carefully made ashes of seaweeds contain anything up to .5 per cent. of

tractable and unique element which has provided the key to so many mysteries of atomic constitution.

#### Radium

Radium and radioactive substances are to be found everywhere, but, of course, in quantities so minute that their detection is usually a matter of the utmost difficulty. Radium and its allied elements definitely occur in sea-water, so much so that it has been estimated that the oceans of the globe contain between them as much as 20,000 tons of radium alone. But the extraction of this modern form of wealth is, so far as our present-day scientific knowledge is concerned, quite an impossibility.

That the minute traces of radium present in the seas of the world have assigned to them by Nature an enormously important role is not to be doubted, for, very probably, they aid the conservation of the earth's heat. Whether, however, Nature will ever allow us to take from her vitally necessary store of marine radium and other radioactive elements is a problem which only a future age is likely to elucidate.

# COOLING WATER

Water Vapour Refrigeration—the Cooling System Commonly Used with Air Conditioning Plants in Theatres, Offices, and Modern Stores

By

Stuart Young

*One of London's most modern cinemas, the Odeon, Leicester Square, has recently had a water refrigerating plan installed*

absorbs quite a lot of heat or B.T.U.'s without any rise in temperature. Each pound of water passing off as steam takes in 970 B.T.U.'s without there being any corresponding rise in temperature. The water and the steam are both at 212° F. temperature. This extra heat, which is not evident to a thermometer, is called latent heat—hidden or concealed heat.

### Under Pressure

So far we have only concerned ourselves with water boiling under atmospheric pressure. If the water is contained in a pressure vessel and sealed so that the steam as it is formed raises the pressure within the vessel, then the boiling point will be at a temperature higher than 212° F. When the pressure is 50 lb. per sq. inch gauge, or  $50 + 14.7 = 64.7$  absolute, the temperature will have to be raised to about 298° F. before boiling takes place. With a pressure of 100 lb. the boiling temperature is 338° F.; 200 lb.—388° F. and so on. The latent heat also changes, the amount going down as the pressure is increased. At 50 lb. gauge the latent heat per pound of water passing to steam is 912 B.T.U.'s; at 100 lb. gauge—880 B.T.U.'s; at 200 lb. — 836

### Reducing Pressure

Supposing we reduce the pressure in the vessel to only 1 lb. pressure absolute (actually this condition is usually called a vacuum, or partial vacuum). At this pressure the water would boil at 102° F. and the latent heat per pound of water evaporated would be 1,036 B.T.U.'s. Let us reduce the pressure still further and consider an absolute pressure of  $\frac{1}{2}$  lb. The water will now actually "boil" at 60° F. and the latent heat of the "steam" or water vapour will be 1,058 B.T.U.'s per lb. If the water in the vessel was at a temperature of 60° F. when we started the experiment, it follows that when the pressure is reduced to  $\frac{1}{2}$  lb. the water will "boil" without any external heat being required—but where will the "steam" obtain its latent heat? It will absorb heat robbed from the rest of the water and cause a drop in its temperature. Thus we have water "boiling" without the application of external heat, and in so doing, being cooled due to the "steam" robbing it of the latent heat that it requires when changing its state from water to vapour. This system of cooling—water vapour refrigeration—is not new having been invented by Dr. William Cullen in 1755, but it was not until very recent years that certain difficulties were overcome and the system became practicable for commercial plant designed for cooling large quantities of water. These refrigerating units have been installed in public buildings, hotels, apartment houses, stores, theatres, and hospitals.

### In Commercial Use

Let us now consider the difficulties that have to be overcome when we try to use this system commercially, and afterwards visualised as one tenth of a gallon, or about  $1\frac{1}{2}$  tumblers. When vaporised at 50° F. (that is at a pressure

**D**O you believe that by boiling water you can cool it? This may sound a little strange; however, it is not only possible but is actually employed commercially where large quantities of water have to be cooled a few degrees below the normal temperature.

Under normal atmospheric conditions (atmospheric pressure 14.7 lb. per square inch) water boils, when heat is applied, at 212° F. and if the heat is continued, some water will pass off as steam. In order to discuss how much heat is required for this process it is necessary to know what quantity of heat makes up one heat unit. The heat required to raise one pound of water one degree Fahrenheit is called one British Thermal Unit, or B.T.U. This is the standard heat unit in most countries using the Fahrenheit temperature scale.

Now to raise 1 lb. of water from 60° F. to boiling point, 212° F. will require 152 B.T.U.'s. This is known as sensible heat, since it can be measured quite easily. When the water reaches boiling point some of it passes off as steam and we know that during the change of state from water to steam it

B.T.U.'s. We therefore see that as the pressure rises the boiling point rises and the latent heat in the steam diminishes.

Now let us examine what happens when we try to raise steam at pressures below atmospheric pressure. Suppose we place some water in a pressure vessel and apply heat, also connect up the top of the vessel to a suction pump that will draw off the air from the top of the vessel, reducing the pressure below normal. The suction pump should be large enough to not only reduce the pressure before boiling but also draw off steam as it is formed and so prevent the pressure being raised to, or above normal. This would be similar to boiling water at an altitude—atmospheric pressure being reduced at altitudes. At 10,000 feet above sea level the pressure is only 10.1 lb. per sq. inch, and the corresponding boiling point is 194° F. As might be expected, the latent heat is increased at pressures below normal; at 10.1 lb. it is 980 B.T.U.'s per lb. The lower the pressure on the surface of the water the lower will be the boiling point and the greater the latent heat absorbed as the water changes to steam.

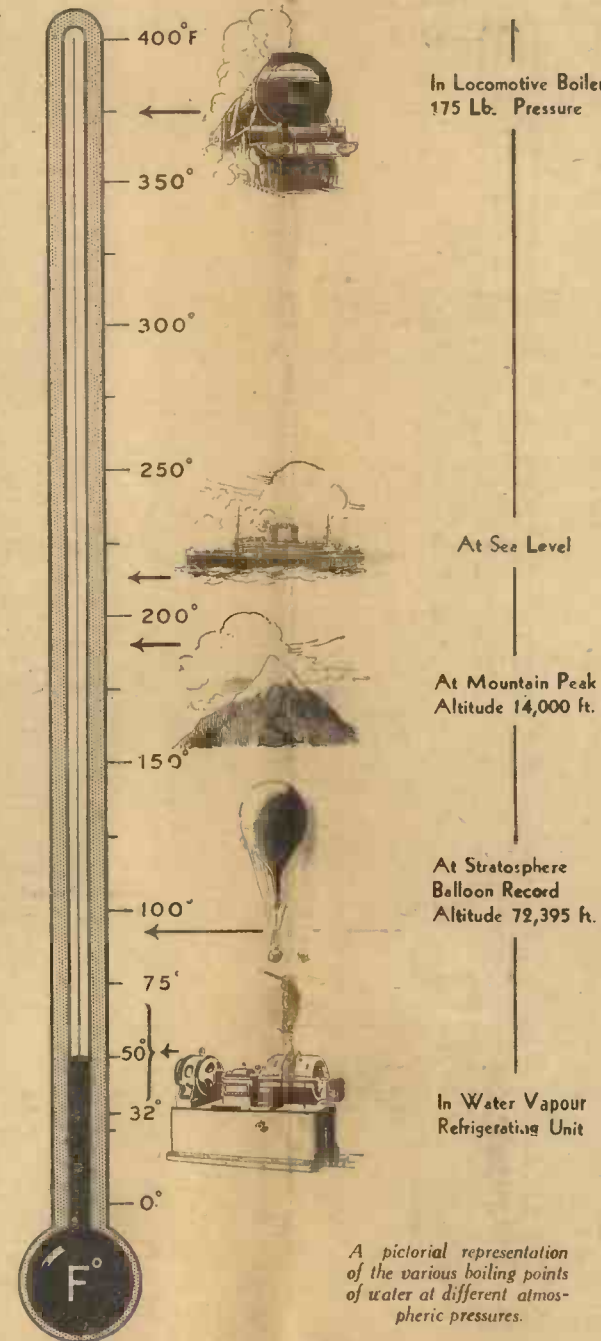

*A pictorial representation of the various boiling points of water at different atmospheric pressures.*



# BY BOILING IT

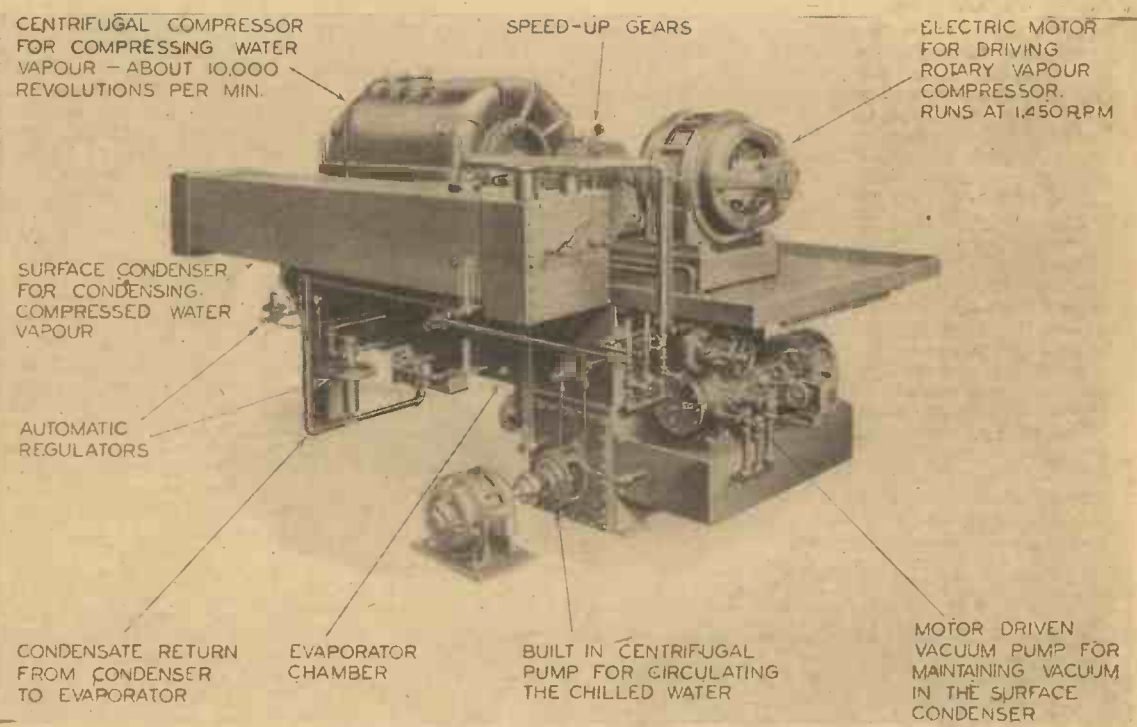

A photograph of the plant showing the method of working.

of .178 lb. absolute), it will have a volume of 1,705 cubic feet. This will mean that the pound of water will expand to fill a large room—17 ft. long, 10 ft. wide, and 10 ft. high. To evaporate any quantity of water requires suction pumps large enough to handle big quantities of vapour. From the explanation given it will be appreciated that vacuum vapour refrigeration, whilst quite satisfactory for cooling water is not suitable for producing very low or freezing temperatures. It was only with the introduction of air conditioning with its summer time "comfort cooling" that there was a demand for some system that would cool large volumes of water say 8-15° F. This demand also called for a safe refrigerant that need not be drawn off during the winter months when the plant would probably not be in operation, and would cost little or nothing to replenish. In air conditioning some of the chilled water from the evaporator is allowed to flow over banks of piping

through which the air is passing thus cooling the air and transferring the heat to the water. So much for the application; now for a description of the plant in which they "cool water by boiling it."

**The Plant**

The diagrammatic section, and possibly the photograph, will assist in following the description. In the base of the plant there is a "kettle" or evaporator partially filled with water, the level being maintained by a float valve on the water inlet pipe. The make-up water is sprayed down from the top of the evaporator. Mounted on top of the evaporator is a large centrifugal compressor; this pulls off and compresses the vapour or steam as it is formed and maintains the very low vacuum necessary for boiling at low temperatures. As already pointed out, this compressor has to deal with many thousands of cubic feet of vapour each minute. Although it only compresses the vapour from about 1/4 lb. to 1 lb. this

requires quite a lot of power and considerably raises the temperature of the vapour. This vapour then passes from the compressor discharge to a condenser in which it is condensed back to water, giving up the latent heat and some of its sensible heat to the cooling water circulating through the large banks of tube inside the condenser. The condenser has to be furnished with a powerful vacuum pump to maintain the vacuum and to dispel any air or other gases that may "come over" in the vapour. This pump however, is quite small and requires only a small motor since it does not cope with large volumes. The condensed water is usually about 15° F. above the temperature of the circulating water in the condenser, and may be returned to the system or fed into the regular cooling water system. When the plant is working some of the water in the evaporator is pumped to the air cooling screws where it becomes warm and is again returned to the evaporator to

(Continued overleaf)

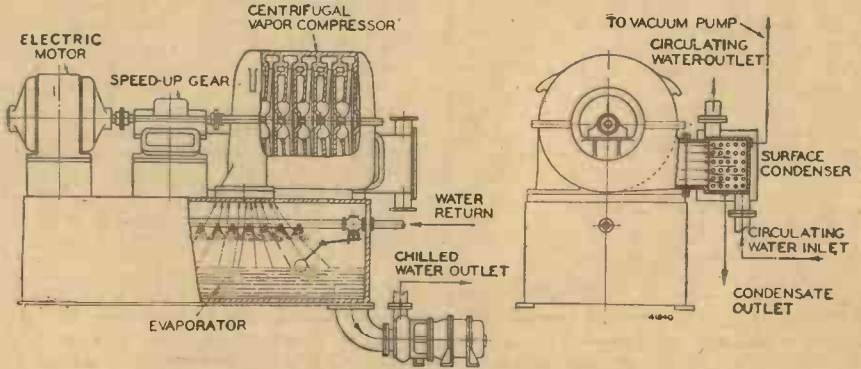

A diagrammatic drawing illustrating the operation of the I.R. centrifugal water-vapour refrigerating unit.

be sprayed from nozzles distributed over the surface of the water in the evaporator.

**A Vacuum Refrigeration Plant**

Let us suppose that we are just about to start up a vacuum refrigeration plant, but so that we may follow the exchange of heat units from the water in the evaporator to the condenser cooling water, we will take the following conditions: Water available is at 60° F. The evaporator contains 10 gallons (or 100 lb.) of water.

The small vacuum pump will be started first, drawing all the air possible from the condenser, the compressor, and the evaporator. This will continue till the pressure within the plant falls to about 1/4 lb. The main compressor can then be started up so that it will deal with the "steam" as soon as it starts to form. The vacuum pump continues reducing the pressure lower and lower until a point is reached when the pressure in the evaporator is .256 lb.; at this point the water at 60° F. starts to "boil." Suppose one pound "flashes" to steam—this amount of water requires 1,058 B.T.U.'s of latent heat that we know it can only get from the remainder of the water. We have said there is 100 lb. of water in the evaporator—one pound has "flashed" to steam leaving 99 lb. of

water to deliver up 1,058 B.T.U.'s; this results in the water in the evaporator being cooled by 10.3° F. giving a chilled water temperature of approximately 50° F. but it requires a lower pressure than .256 lbs. to "boil" water at the lower temperature of 50° F. Actually, in order that the process be continuous, the evaporator pressure must be reduced to .178 lb. being the "vacuum" or pressure at which water boils at 50° F. Under these conditions a percentage of the chilled water will flash to steam all the time the plant is in operation. As we have already mentioned, some of the chilled water in the evaporator can be drawn off by a small centrifugal pump and passed over screens employed for cooling the air. When the water is returned to the evaporator it is probably at 58°-60° F. depending on the heat transferred from the air it has cooled.

**An Important Point**

It is important that the "steam" or water vapour formed in the evaporator is drawn off as fast as it is generated and without allowing any rise in pressure within the "boiler." The vapour is drawn into the rotary compressor at about .178 lb. (3 oz. per square inch) and compressed to .8 lb. (13 oz. per square inch). During compression the volume of vapour has been reduced

to about 1/4 of its original volume and the temperature considerably increased. It then passes into the condenser where it is forced to flow up and down over a nest of tubes containing cold water, thus causing it to condense from steam to water. The condenser robs the steam of its latent heat, also the heat it acquired in the compressor, and some of the sensible heat due to cooling the condensed vapour from 212° F. to the temperature at which it leaves the condenser, say 95° F. All this heat is carried away by the condenser circulating water. This water will most probably be cooled back to 60° F. in a cooling tower or by some similar means outside the building. In short, air is pumped into the building, cooled down as desired, the heat extracted is conducted outside the building by the cooling water and finally returned to the atmosphere outside the building.

A water vapour refrigerating plant has recently been installed in London's most modern cinema, the "Odeon," Leicester Square. The system has become so popular in Canada and America, where it is installed in many famous skyscrapers, theatres, and public buildings, that we may expect many more installations of this latest and novel cooling system as Air Conditioning becomes more general in Great Britain.

# A PIERCING BEAR AND RIVETING TOOL

A Useful Device for Drilling Thin Metal. It is an Ideal Tool for the Workshop.

**P**RODUCING holes in thin metal is always a difficult job; drilling will make a burr, and, unless the drill is correctly ground, an irregular-shaped hole will result.

A much better method is to use a piercing punch. Such a tool is illustrated in Fig. 1.

In principle, the piercing bear is similar to the common "C" clamp consisting of the

frame A, screw B and the tommy-bar C.

**The Frame**

The frame is made from a piece of mild steel 3 in. by 3 in. by 1 in. and is shaped by boring a 1 in. dia. hole on the centre line, as shown, and removing the surplus metal by sawing to the hole, and finally filing to shape.

This is then set up on an angle plate on the face plate, one side drilled and tapped 1/2 in. B.S.F., the other side bored 1/2 dia. and recessed 1/2 in. dia. and 1/2 in. deep, and a 1/2 dia. hole is drilled and tapped to receive a grub screw to retain the die inserts.

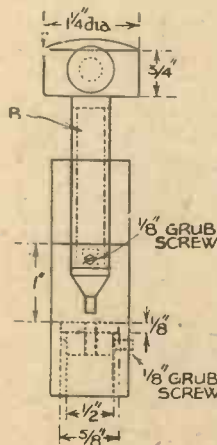

Fig. 1.— Details of the piercing bear and riveting tool.

mild steel with a retaining knob each end.

**Piercing Tools**

The piercing tools shown in Fig. 2 are turned from silver steel hardened and tempered, and held in position by the grub screws. The rivet snaps, Fig. 3, are similarly made from silver steel, the cup being formed

by drilling a shallow recess, and forcing a ball bearing of the correct size into this recess to give the correct form.

In operation the piercing punch and die is assembled in the bear, the metal to be pierced is placed in its correct position between punch and die, and by turning the screw, the punch is forced through the die, taking a piece of metal with it, and producing a perfectly round hole free from burr.

Much depends upon the punch and die being a good fit and that the two working faces—i.e., the top of the die and bottom of the punch—be perfectly sharp.

For riveting, all that is necessary is to replace the piercing tools by rivet snaps and repeat the process.

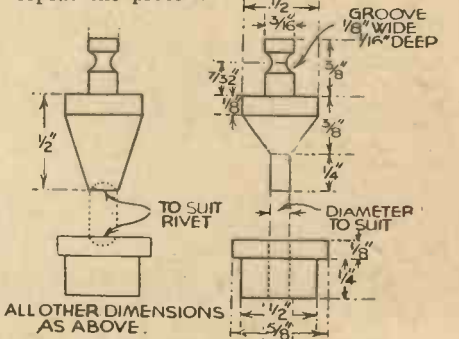

Fig. 3.— Method of making the rivet snaps.

Fig. 2.— The punch and die.

**Ready Shortly—A NEW BOOK**  
**WORKSHOP CALCULATIONS,**  
**TABLES AND FORMULÆ**  
 BY F. J. CAMM.

An invaluable handbook for the Fitter, Turner, Mechanic and Draughtsman. 2/6, by post 2/10, from the Publisher, Geo. Newnes, Ltd., Tower House, Southampton Street, Strand, W.C.2.

"PRACTICAL MECHANICS" WIRELESS SUPPLEMENT

# AUTOMATIC TUNING

Details of the Methods of Automatic Tuning Now in Common Use, with Especial Reference to the Receivers Now or Shortly to be Available to the English Listener



Fig. 1.—This is the new Cossor "Teledial" receiver.

**Push-button Tuning**

IN 1933 we gave in our companion paper, *Practical and Amateur Wireless*, details for incorporating an automatic tuning device in an existing receiver so that either the National or the Regional station could be obtained without the necessity of operating the tuning condenser. The arrangement consisted of the incorporation of two pre-set condensers wired across the tuning circuit and each tuned for one of these stations. A simple single-pole change-over switch enabled the desired condenser to be included and the ordinary variable condenser was thus dispensed with. The circuit is reproduced in Fig. 3. It will be obvious from this, that by using a three-way switch a further condenser may be included, and this may be another pre-set for the selection of another station, or a variable for normal tuning purposes. This is the basis of the modern tuning devices which are now being incorporated in up-to-date receivers and which provide push-button tuning for a dozen or so stations.

**Superhet Circuits**

In the superhet receiver it is necessary to tune not only the grid circuit of the frequency-

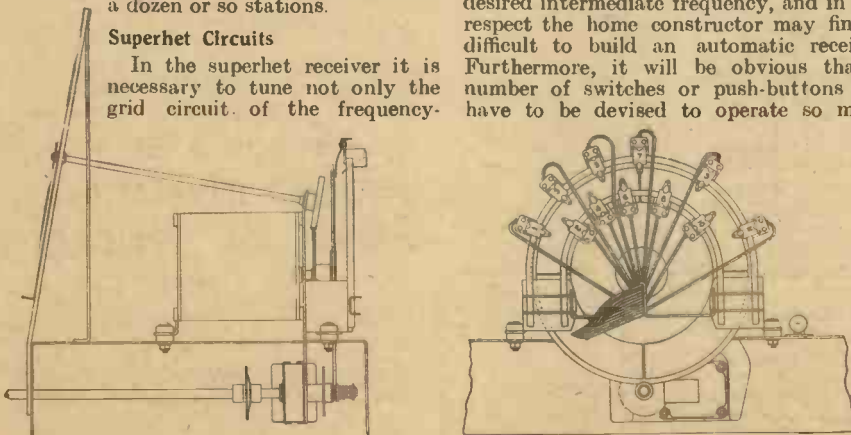

Fig. 4.—These illustrations show the Ekco mechanism and the arrangement of the motor and selector clips.

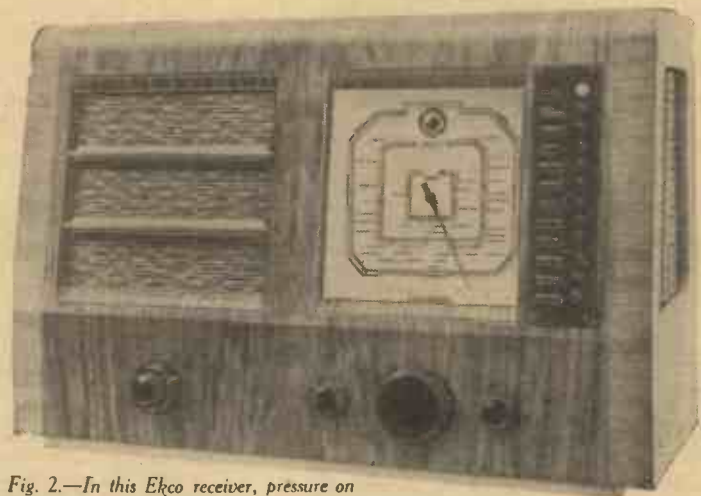

Fig. 2.—In this Ekco receiver, pressure on the buttons starts an electric motor, which turns the tuning condenser.

changer valve (and any pre-H.F. stages which are used), but also the oscillator circuit, and there has to exist in this a frequency difference dependent upon the intermediate frequency employed in the receiver. It will, therefore, be rather difficult to adjust pre-set condensers for all of

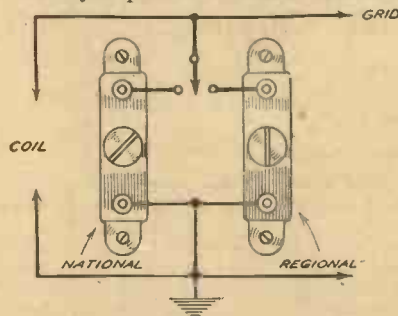

Fig. 3.—The basis of automatic tuners—pre-set condensers, each tuned to a different station and brought into circuit by a switch.

these circuits unless a suitable test apparatus is available with which to adjust correctly the oscillator circuit to obtain the desired intermediate frequency, and in this respect the home constructor may find it difficult to build an automatic receiver. Furthermore, it will be obvious that a number of switches or push-buttons will have to be devised to operate so many

circuits, and interaction will have to be avoided. This, then, is in outline the main arrangement which has to be incorporated, and the following are the principal constructional details as used in certain commercial receivers and which may be incorporated by the home constructor.

Firstly, the change-over switch must be converted into a switch which operates by the pressure of a button, and each button must be linked up with the remaining controls, so that when changing stations the button which is already depressed will be raised for subsequent operations. One very simple way in which this may be done is shown in Fig. 6. Each button is fitted to the top of a flat strip of brass or other metal on the side of which is a small cam, and above this a shallow saw-cut. A flat strip of metal is pressed against the edge of each of these rods or bars by means of a weak spring. When the buttons are all raised, the pressure bar will rest just below the cam or projection. When a button is pressed down, the contact at the bottom of the rod will operate the requisite condenser, and the pressure rod or locking bar will drop into the saw-cut, keeping the button depressed and the condenser in circuit. As soon as another knob is depressed the raised portion will push the locking bar out from the slot in the depressed bar and thus it will be released, the button being raised by the small spring at the end. The second button will enable the appropriate rod to be locked in a similar manner. At the bottom of the push rod or bar a strip of metal may be affixed to operate the contacts for each condenser, and in this respect each constructor will no doubt have his own preference for making the necessary contacts. One very important point is that each circuit should be kept isolated. That is, the fixed (or pre-set) condensers should be arranged in sets, each stage being screened in a separate compartment or a small metal box, and leads to such parts of a circuit as the oscillator of a superhet should be screened to avoid interaction.

**Automatic Frequency Control**

To avoid difficulties due to an inaccurate adjustment of the condensers and other circuit losses, the modern receiver incor-

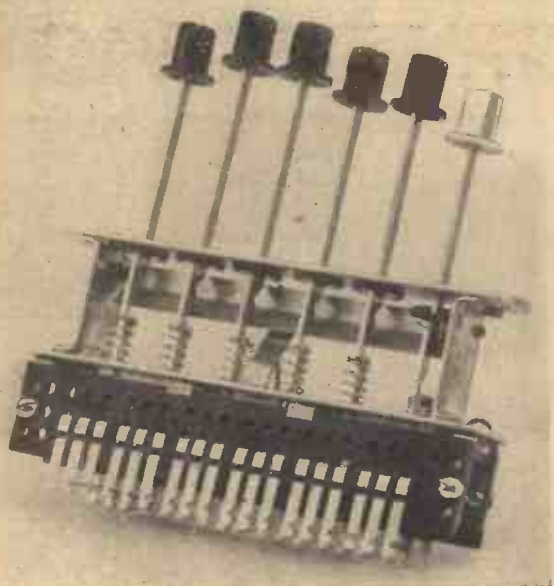

Fig. 5.—A push-button unit supplied for the home-constructor. It is available as a 6-or an 8-pole unit.

porates what is known as automatic frequency control. This brings the oscillator circuit into exact resonance to provide the correct intermediate frequency, and this is accomplished in several different ways.

A modification of the push-button tuner just described is now being adopted to avoid the use of a number of pre-set condensers and to avoid the need of an A.F. control circuit. This is effected by causing the push-buttons to operate a motor which drives the ordinary ganged tuning condenser. The spindle of this is lengthened and projects at the rear, to be there linked to the shaft of a motor of the reversible type. The coupling is generally of the "slip" type, so that a switch may be operated at the same time, or the motor is of the type having a forward armature movement (thrust) when switched on, which will also carry out this feature. At the other end of the motor spindle a number of metal cams are assembled, and on each of these is an insulated section. The current to the motor is fed to brushes bearing against the edge of the discs and thus, when an insulated section comes against the brush of the appropriate disc, the current will be interrupted and the motor will stop. In one system all of the discs are locked by the buttons in the "out" position. Depressing a button switches on the current and

the motor revolves, taking with it the disc released by the depressed button. This turns the condenser and so tunes to the various stations. When the insulated section arrives at the brush the motor stops and the condenser is tuned to a predetermined station. It will be seen by this arrangement that each disc has to be set when the receiver is first trimmed up, and, furthermore, that some form of automatic reversing mechanism must be employed as it may be desired to tune a station at one end of the dial when the last station to be selected was at the other end. What happens is that when a button is depressed the motor commences to turn in the direction in which it was last going, and when it gets to the end of its travel (determined by the 180 degrees movement of the condenser) a contact is operated and the motor is reversed. It thus continues to move until the desired contact is met. Coupled with the disc is a silencing switch for the circuit

so that no signal is heard from the loud-speaker until the condenser comes to rest. This arrangement—which is incidentally similar to that used in the American R.C.A. receivers—is shown diagrammatically in Fig. 9. An alternative arrangement incorporates a relay which is operated

will be very rapid in action, as the ordinary motor which is used will turn at quite a fast rate, and in practice the action of station selection becomes almost instantaneous. The buttons are interlocked as in the first example quoted, and thus it is only necessary to depress the required button when any other button which is already down will be returned to its "off" position.

A modification of this form of tuning is seen in the dials similar to automatic telephone systems, except that the rotation of the dial operates the motor in a similar manner to the pressure of the buttons.

One of the main drawbacks which has been experienced with one type of selector, however, is that the pre-sets are liable to go out of adjustment from many various causes. Temperature, vibration and humidity are only three of the things which can upset an adjustment to ordinary types of pre-set condenser, and accordingly steps have to be taken to prevent tuning shift due to these things. In the Decca receivers a special type of pre-set condenser has been developed and it is claimed that this is of such a nature that it may be placed in extremes of temperature without modification in the capacity and a novel looking device ensures that it will not be thrown out of adjustment due to vibration.

**Invariable Pre-set**

The body of this particular condenser is made from a ceramic material and is circular in shape. It is slightly recessed and a centre hole is provided and has a number of serrations round its edge. One half of the recessed portion is provided with a metallic deposit, and a similar section of the material is similarly treated. When the two halves are placed face to face the two metallic portions are separated by the projecting edge of ceramic material and as the upper half is turned the two metallic portions are varied in regard to their overlap. Consequently, by providing a central bush in the form of an adjusting screw the capacity may be varied, and when the screw is locked up the serrations will ensure that the two halves cannot shift. There are two pre-sets to each station adjustment in the Decca receivers, one for the aerial circuit and one for the oscillator, and there are eight push-buttons on the receiver.

**The Ekco System**

The well-known Ekco receiver was the  
(Continued on page 35)

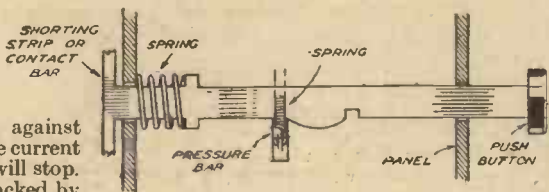
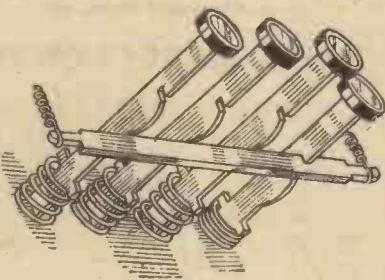

Fig. 6.—How you can build a push-button tuner—with a detailed illustration of the separate push rods.

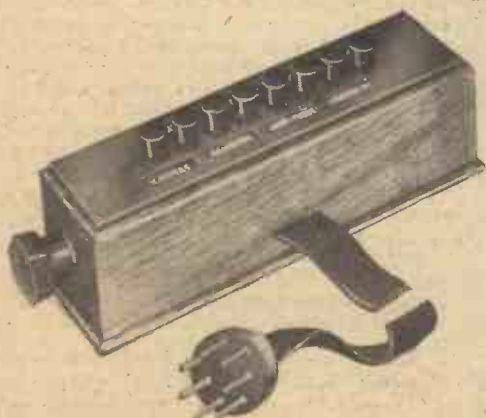

Fig. 7.—The new R.G.D. remote control unit.

when the contact opens or closes for each station, and this relay operates the A.V.C. and "silent" tuning contacts which are assembled on the tuning unit. The motor in these devices is of the low-voltage type, operated from a small winding on the ordinary mains transformer, and a separate switch is usually included in this winding so that the motor may be switched out of circuit when ordinary or manual tuning is to be used. It will be seen that this device

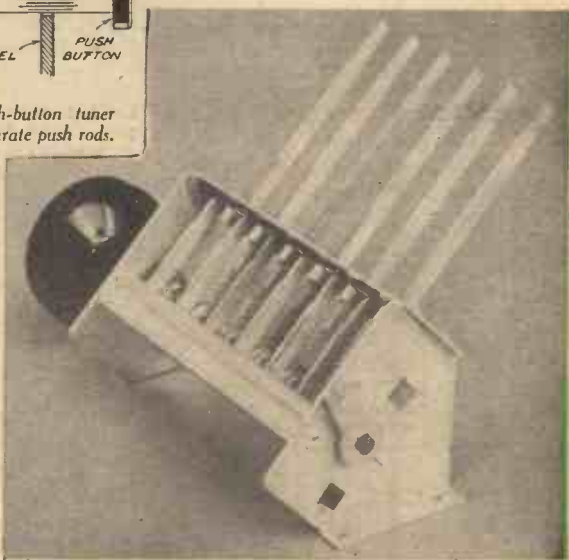

Fig. 8.—Another form of push-button control, produced by British N.S.F.

# SUCCESS IN ENGINEERING

One of the following Courses taken at home in your spare time can definitely be the means of securing substantial promotion in your present calling, or entry into a new and more congenial career with far better prospects.

We have helped thousands of others to success. Why not let us do the same for you—you should at least investigate the opportunities we can place within your reach—it will cost you nothing to enquire.

## ENGINEERING

- Inst. of Electrical Engineers, A.M.I.E.E.
- Inst. of Wireless Technology, A.M.I.W.T.
- Inst. of Civil Engineers, A.M.I.C.E.
- Inst. of Structural Engineers, A.M.I.Struct.E.
- Inst. of Builders, L.I.O.B.
- Inst. of Sanitary Engineers, A.M.I.S.E.
- Royal Sanitary Institute, M.R.S.I.
- Inst. of Mechanical Engineers, A.M.I.Mech.E.
- Inst. of Automobile Engineers, A.M.I.A.E.
- Royal Aeronautical Society, A.F.R.Ae.S.
- London B.Sc. Degrees
- Wireless—Telegraphy—Telephony
- Electrical Engineering
- Television—Electric Wiring

- Talking Picture Work
- Works Management
- Building Construction
- Sanitary Engineering
- Sheet Metal Work—Refrigeration
- Motor Engineering
- Engineering Draughtsmanship
- Electrical Draughtsmanship
- Jig and Tool Draughtsmanship
- Die and Press Tool Draughtsmanship.
- Structural Draughtsmanship
- Building Draughtsmanship
- Clerk of Works
- Building Inspection

Weights and Measures Inspector  
M. & Cy. Engineers

## GENERAL

- Matriculation—Bookkeeping
- College of Preceptors
- Chartered Institute of Secretaries
- Massage—Institute of Hygiene

## CIVIL SERVICE

- Clerical (age 16-17)
- Executive (age 18-19)
- Tax Inspector (age 21-24)
- Patent Office (age 20-25)
- G.P.O. Engineering (age 18-23)
- Typist (age 16½-25)
- Customs (age 19-21)
- Board of Trade (age 20-24)
- Police College (age 20-26)
- Police Force (under 27)

## MUNICIPAL SERVICE

- School Attendance Officer
- Handicraft Teacher
- Registrar—Relieving Officer
- Sanitary Inspector

If you do not see your requirements above just explain what they are. We are able to advise on all branches of Engineering, Civil Service, Municipal Work, etc.

### Become a Draughtsman

AND EARN BIG MONEY



Numerous vacancies are now available in Electrical, Mechanical, Structural and other Branches of Engineering, Building, Civil Service and G.P.O., etc., for men age 17-40. Practical experience is unnecessary for those who are willing to learn—our Guaranteed "Home Study" courses will get you in. Those already engaged in the General Drawing Office should study some specialised Branch such as Jig and Tool or Die and Press Tool Work and so considerably increase their scope and earning capacity.

increase their scope and earning capacity.

### THE ACID TEST OF TUTORIAL EFFICIENCY:

SUCCESS — OR NO FEE

We definitely guarantee that if you fail to pass the examination for which you are preparing under our guidance, or if you are not satisfied in every way with our tutorial service—then your Tuition Fee will be returned in full and without question. This is surely the acid test of tutorial efficiency.

If you have ambition you must investigate the service we are able to offer. Founded in 1885, our success record is unapproachable.

Why not fill in and post the attached coupon for further details and free authoritative guide to openings in Engineering, Civil Service or Municipal Work? These books contain a mine of valuable and exclusive information and may well prove to be the turning point in your career.

## NATIONAL INSTITUTE OF ENGINEERING

(Dept. 29)

STAPLE INN BUILDINGS  
LONDON, W.C.1

FIFTY-THREE YEARS  
OF  
CONTINUOUS SUCCESS

SOUTH AFRICA BRANCH: E.C.S.A., P.O., BOX 8417, JOHANNESBURG.

### COUPON

To NATIONAL INSTITUTE OF ENGINEERING (Dept. 29),  
Staple Inn Buildings, London, W.C.1.

Please forward your FREE Guide to :—

NAME .....

ADDRESS .....

My general interest is in : **ENGINEERING,** (Place a cross against  
**MUNICIPAL WORK,** the branch in which  
**CIVIL SERVICE** you are interested.)

The subject or examination in which

I am especially interested is.....  
(To be filled in where you already have a special preference.)

**Founded 1885 - - - Over 85,000 Successes.**

(½d. stamp only required if unsealed.)

SOUTH AFRICA BRANCH E.C.S.A., P.O. BOX 8417, JOHANNESBURG

# Great New Part Work—AIRCRAFT From A to Z

# "AERONAUTICS" 1/-

WEEKLY PARTS

THE WHOLE WORLD OF AIRCRAFT AND FLYING SIMPLY EXPLAINED

HERE, for the first time, is a Part Work produced for all who are interested in flying—the Civil Air Guard thirsting for aerial knowledge, the civilian and military pilots, men in the aircraft industry, and the youth who looks to the aeroplane as his father looked to the motor-car! Previously only the very popular or the highly technical engineering side had been covered—but to-day AERONAUTICS is published to give you in simple language flying from start to finish, the theory and practice, airmanship on the ground, aerial communications and operations, servicing and upkeep, military flying . . . in fact, AERONAUTICS is the how-it-is-done and the how-to-do-it of the whole world of modern aircraft.

**PART 1**  
*Out To day*  
 TO BE COMPLETED IN ABOUT 32 WEEKLY PARTS

**FREE**  
 IN EVERY PART VALUABLE AERODROME DATA SHEET Part 1—  
**CROYDON** Giving Photo, Scale Maps and useful details relating to landing, etc.

A Few Of The Subjects Dealt With In This Thoroughly Practical Work :

Civil Air Guard Scheme Explained. Learning to Fly. Advanced Flying. Aerobatics. Training Schools. Instrument Flying. Flying with Automatic Controls. Automatic Landings. Joining a Flying Club. Continental Touring by Air. Servo Controls. The Magnetic Compass. Directional Gyro. Liquid Levels. Blind Flying Panel. Wind and Time Calculators. Voltage Regulators. Fog Landing Systems, Airport Aids to Flight. Parachutes. De-icing Equipment. Care of Electrical Systems. Clothing and Goggles. Radio Navigation and Services. Electrical Interference in Flying. Map Reading. Mathematics of Navigation. Weather. Accidents and their Avoidance. Radio Direction Finding. Tracing Troubles. Overhaul Work. Fuels. Oils. Hydraulic Systems. Certificates of Airworthiness. Handling large aircraft on the Ground. A.R.P. (Aerodromes). Airport Regulations. Choosing a Landing Ground. Night Flying. Air Tactics. Helicopters, etc.

### WRITTEN BY EXPERT PILOTS

Engineers and Designers and men in the closest touch with specialised branches of aeronautics. Thousands of photos, drawings, plans, tables, data, etc.

GET YOUR COPY OF PART 1 AT ONCE

Of Newsagents and Bookstalls or by post 1/21d. each part from the Publishers, George Newnes, Ltd., Tower House, Southampton Street, London, W.C.2.

TO BE COMPLETED IN ABOUT 32 WEEKLY PARTS  
 PRICE 1/-  
**NEWNES' AERONAUTICS**  
 A COMPLETE GUIDE TO CIVIL AND MILITARY FLYING  
 Advisory Editors  
 Sqd. Ldr. H. NELSON, M.B.E.  
 Wing Commr. G. W. WILLIAMSON, O.B.E. M.C.



AN AUTHORITATIVE WORK dealing with THEORY AND PRACTICE OF FLYING MECHANICAL AIDS TO FLYING AIRMANSHIP - EQUIPMENT COMMUNICATIONS and OPERATIONS

GEORGE NEWNES LIMITED



INVALUABLE TO ALL CIVIL AIR GUARDS AND ALL INTERESTED IN FLYING

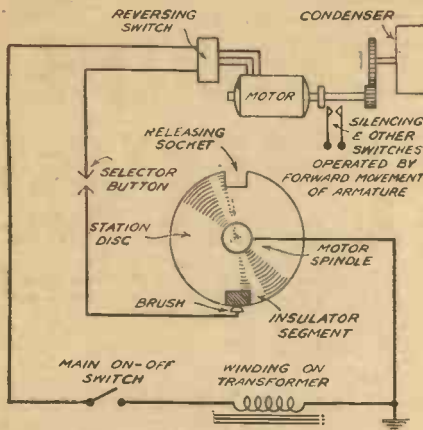

Fig. 9.—One of the American commercial motor-driven pre-selectors is operated as shown here. The disc is repeated for each station required.

first one on the English market to be fitted with a motor-driven tuning system. As many as eleven stations are obtainable with this system, in which the condenser is driven through a belt drive from a small motor situated beneath the chassis. The pressure on a button carries out several different actions—firstly, it switches off the visual tuning indicator; secondly, it mutes or silences the set; thirdly, it starts the electric motor which rotates the gang condenser; fourthly, it switches in the A.F.C. circuit; the movement of the ganged condenser turns also the tuning pointer, and when the correct position has been obtained the muting device is open-circuited, and the visual tuning indicator “comes to life.”

The Ekco control is effected in the following manner. At the back of the cabinet is a double semi-circular rail, adjacent to a slotted disc. At intervals around the rail, according to the stations selected, are small detachable contact clips, numbered to correspond with the buttons on the front of the cabinet. To adjust, say, the top button (No. 1) to London Regional, this button and the manual button are depressed together, and the set then tuned in the normal manner to that station. When correctly adjusted the clip marked 1 is lifted from the rail and replaced in the slot near the metal disc, and it is then moved slightly until a small pilot lamp goes out to indicate that the exact setting has been obtained. The remaining buttons are adjusted in exactly the same way, so that, if it is desired to change the setting given for any particular button, all that is necessary is to depress that button and the manual button (so that the tuning condenser may be turned in the ordinary way), locate any station not already automatically provided for and adjust the appropriate clip as just mentioned. Thus the user of the set may make the adjustments if desired, and it will not be necessary to call in a service man.

Obviously, with this system the critical adjustment necessary in a sharply-tuned superhet circuit may not be exactly found, and to compensate for this an A.F.C. or automatic-frequency control circuit is provided.

The motor movement is fairly rapid, the maximum movement of the tuning pointer from one end of the scale to the other taking about eight seconds. This means that to tune from the London National to the London Regional (or *vice versa*) takes approximately three seconds. It should also be noted that the pointer travels directly, backwards or forwards, to the

name of the station selected. In some of the American models the motor continues to travel in the direction in which it last moved, and should the required station be in the opposite direction the pointer continues until it comes to the end of its travel when the motor automatically reverses and the pointer travels back until it comes to the selected station.

**Other Systems**

In the Cossor receivers, which are operated by a dial as may be seen from Fig. 1, the movement of the dial turns the gang condenser, but when the finger is pushed into the hole it at the same time pushes in a button situated at the bottom of the hole. This brings into circuit a muting device and pushes forward a peg. As the dial is pulled round, the peg travels

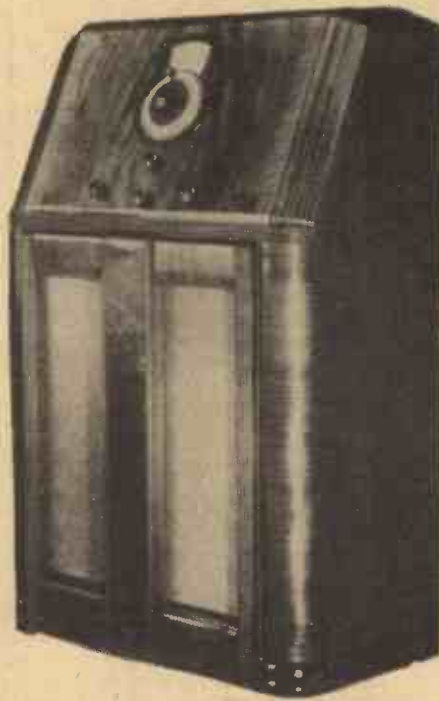

Fig. 10.—This is the Philco “Empire Nine” with automatic tuning.

in a slot until arrested at the end of the travel provided on that particular peg, and when this resistance is felt the finger is removed, opening the muting device and enabling the station to which the condenser has been pulled to be heard. In the Philco arrangement a somewhat similar device is employed, the movement of the dial turning the gang condenser, and at the completion of the movement a special electrical circuit known as an automatic frequency control circuit compensates for any slight error in the adjustment which has been obtained. In these two receivers, therefore, there are two additional features introduced and these are of great importance in automatic tuning devices. The pre-set switching device provides a jump from one station to another, but when the main tuning condenser is turned it will obviously have to pass over one or more stations, and it is necessary to mute the receiver to avoid the clash of sound which would be heard as the various stations were passed over. The Cossor is a very simple but effective device for carrying out the muting, but in certain motor-operated receivers more elaborate muting devices are employed.

It was mentioned in the opening paragraphs of this article that the switching-in of pre-set condensers is the simplest way of carrying out the idea of automatic tuning, and where a number of tuned circuits have to be adjusted (such as the aerial and oscillator coils in a superhet) it is only necessary to duplicate the condensers and to gang the switching mechanism. The arrangement is shown in Fig. 11, and it will be obvious that further condensers are just as easily included. Interaction between leads and circuits will, of course, have to be avoided, but this is not difficult. This adjustment, as previously mentioned, is adopted in the Decca receivers, and special steps have been taken to ensure that the adjustment will be entirely unaffected by temperature, climatic and similar changes. The pre-sets are, accordingly, of the ceramic type, one being included in the grid circuit and one in the oscillator circuit after the style of the circuit shown in Fig. 11.

**Arranging the Pre-sets**

It is obviously possible with a scheme of this nature to arrange the pre-sets in a convenient position so that they may be adjusted by the user to bring in the best-received stations in the locality in which the set is employed, and by providing special replaceable nameplates any range of stations may be automatically selected. A push-button unit, built on this arrangement could, of course, be fitted to any receiver, but at the moment no manufacturer has produced the separate unit, although we understand that one will be available in the near future. It will also be possible, by means of a unit of this type, to build a superhet-converter which could be added to any receiver and used as a remote tuning-control device and would greatly improve many existing receivers.

.....JUST PUBLISHED!.....

## PRACTICAL WIRELESS SERVICE MANUAL

By F. J. CANN

A Complete, Practical and Up-to-date Work on the Testing of all Types of Wireless Receivers. It contains 288 Pages and Over 220 Photographs, Diagrams and Plans.

From all Booksellers 5s. net or by post 5s. 6d., direct from the Publishers, George Newnes, Ltd. (Book Dept.), Tower House, Southampton Street, London, W.C.2.

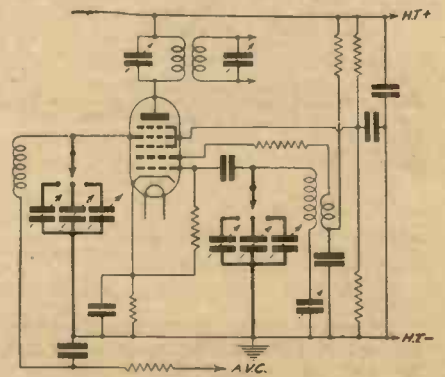

Fig. 11.—How simple superhets are automatically tuned on two circuits at once.

# Magical Productions

Some of the Methods by which Conjurers manage to Produce from a Box or Other Container far more Articles than it could apparently hold



Fig. 1.—A large folding cage. The bottom slides up to the top and the sides fold inwards.

By Norman Hunter  
 (The Well-known Conjurer of  
 "Maskelyne's Mysteries")  
 Further Articles on the Secrets of  
 Conjuring will appear Regularly  
 and Exclusively in this Journal

folded up the cage will collapse quite flat, but will open again by its own weight when picked up by the handle. A cage of this type is frequently built into a special tray fitted with a spring blind as shown in Fig. 5. The tray appears to be an ordinary tray, but at any moment a large cage may be produced upon it by covering it with a cloth. Under the cloth the spring blind is released and the cage lifted, when it remains solid and firm. It is usually found convenient to fasten the bottom of the cage permanently to the tray.

### A Collapsible Cage

The bottom having been slid up to the top, the four sides of the cage are now folded inwards, being hinged at the top as shown in Fig. 1. The complete cage is now only 1 inch thick. The act of picking it up by the handle on the top causes the cage to open automatically the sides swinging down and the bottom dropping into place by its own weight. When fully open the cage is quite solid, and may be stood on a table without giving any suggestion of its collapsible nature.

The cage illustrated folds quite flat and is intended for use with dummy birds made of wool. If live birds are to be used the top of the cage is made dome shaped so that when the cage is folded there remains a small space for the birds under the domed roof. See Fig. 3.

Another system of folding a bird cage is illustrated in Fig. 4. The cage shown here is smaller, but the principle is applicable, of course, to cages of any size. Two opposite sides of the cage are hinged across the centre to fold inwards. The other two sides are hinged to the top of the cage and fold up against the top. These sides being

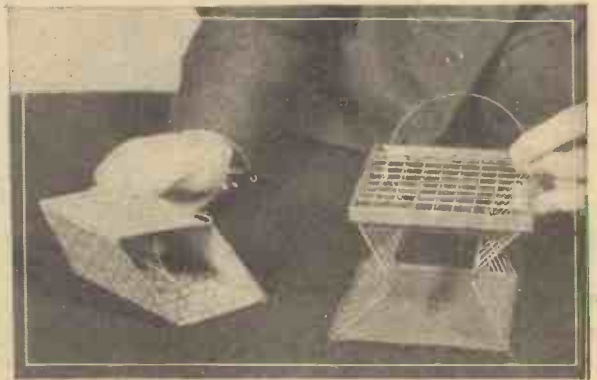

Fig. 4.—Another type of folding cage. The ends fold up against the top and the sides hinge inwards across the centre. The small folding box shown here can be made from playing cards.

### A Round Cage

This type of cage, like the other, can be made available for use with live birds by constructing the top either in a curve or with a slightly pointed top like the roof of a house. Such a cage, however, cannot be produced from a thin tray, but must be secured by other means, which I shall describe later in this article.

The principle of a sliding bottom and hinged sides can also be applied to a round

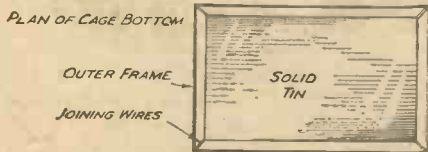
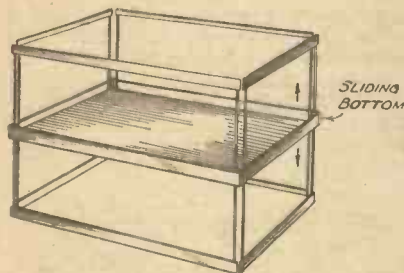

Fig. 2.—Details of the sliding bottom of the folding cage.

that bottom and outer frame may be slid up to the top of the cage as shown in Fig. 2. When allowed to drop into its normal position it is prevented from falling right out by the strips which connect the bars at the lower part of the cage sides.

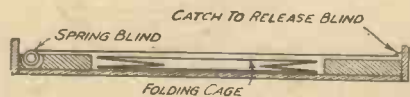

Fig. 5.—Section of tray with recess to take folding cage.

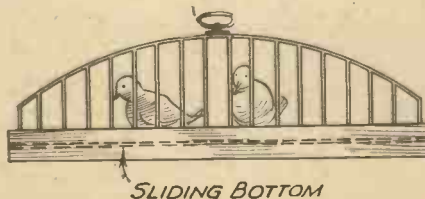

Fig. 3.—An end view of domed top to cage for use with live birds.

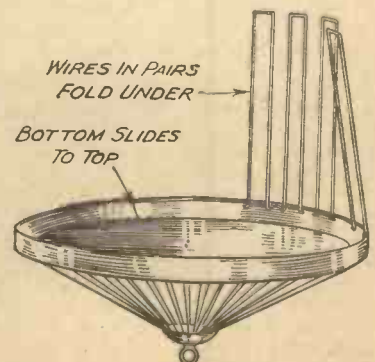

Fig. 6.—How a round cage is made to fold. Only a few wires are shown, for clearness.



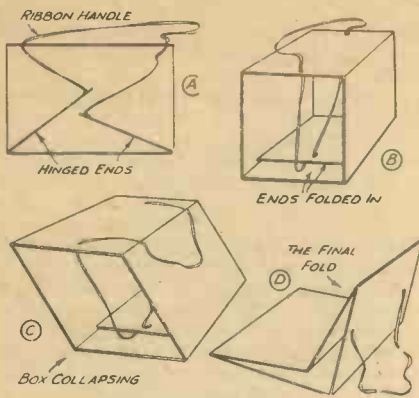

Fig. 7.—A folding box.

age. In this case the bottom slides up just as in Fig. 1 and each pair of wires is joined at the bottom to form a loop. These pairs of wires fold individually up to the top and so reduce the cage to a flat parcel. See Fig. 6.

The left-hand object in Fig. 4 is a small folding box made of cardboard. The construction is further explained in Fig. 7. A shows a side view of the box. The ends are hinged with cloth hinges to the bottom. A length of ribbon is passed through slits in the top and attached to the free ends of the hinged portions so that the act of pulling out the ribbon handle causes the folded down ends to rise into position. The ends having been folded down leaves the box as shown at B, which gives an end view. The four sides being hinged also with strips of cloth, the whole box can now be laid flat as shown at C. Sufficient play is allowed in hinging the sides so that the now flat box can be folded again as shown at D. The box is thus reduced to a flat packet the size of one of its sides. To open the box it is only necessary to pick up the ribbon handle and give it a shake.

**Simple Form of Production**

Boxes made like this are usually produced six or a dozen at a time and frequently ordinary playing cards are used for making

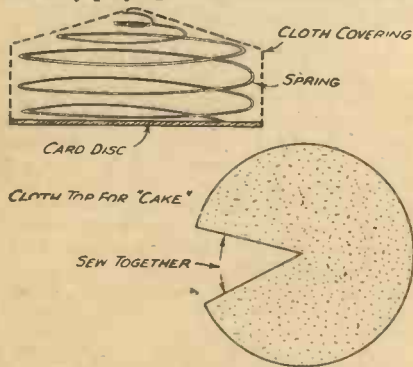

Fig. 9.—A spring "cake."

them. This also lends itself to a simple form of production, six boxes, folded together, having the general appearance of a pack of cards. The pack is placed in a hat and apparently changes to half a dozen fancy boxes. Similar boxes on a larger scale may be decorated in imitation of cigar or chocolate boxes while a very large box, made of sheet tin, could be painted to look like a travelling trunk. A box of this kind can, of course, also be produced from a tray with spring blind such as that described for a birdcage.

Now we come to the second group of articles, those made on spring foundations.

Fig. 8 shows a number of these. The large one is an imitation cake, made of cloth on a spring foundation as shown in Fig. 9. A disc of cardboard is cut and a large weak spiral spring is attached to one side of it. A strip of yellowish brown cloth is sewn round the side and another disc with a wedge-shaped piece cut out of it to enable it to be sewn into a slightly conical form, as shown at A, Fig. 9, is sewn on for the top. The complete article is then painted to give as good a representation of a cake as the skill of the maker allows.

Fig. 8.—Articles for magic production made on spring foundations. A spring cake is shown being collapsed, together with a spring ball. The carrot and the other balls are also on spring foundations.



The partly coloured balls shown in Fig. 8 are of cloth over a spring made in just the same way. Four sections of cloth are sewn to make the covering of the ball and the spherical shaped spring is inserted before finally sewing up the covering. A dozen of these spring balls may be packed together and tied with tape into a packet actually smaller than one ball will be when expanded. The balls are about the size of tennis balls as a general rule, but occasionally larger ones are used, measuring about 6 to 8 inches in diameter.

**Imitation Cabbage**

A large spring ball can also be made into an imitation cabbage. The ball is covered with pale green material and suitably painted, after which pieces of painted material are cut to the rough shape of

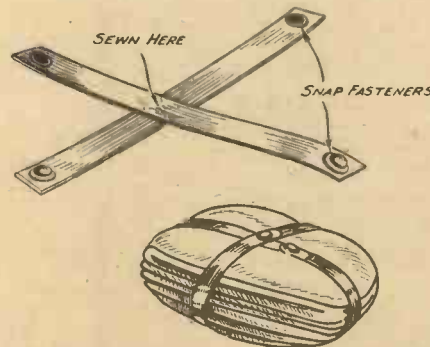

Fig. 10.—A tape harness for a load of spring articles.

cabbage leaves and sewn round the ball. Spring carrots always cause a lot of amusement when produced. One is shown in Fig. 8. These too are made by sewing up a long, pointed, shaped, cloth case round a spring of similar shape, painting the result with suitable colours and adding a tuft of green wool at the thick end. Some of the same shapes can be coloured differently and presented as parsnips.

Some means of controlling these spring articles is, of course, necessary in order that they shall remain compressed until required.

Tying with tape is a simple method, but not always convenient. A better way is to make a simple harness of wide tape as shown in Fig. 10. Two pieces of tape are sewn crosswise and a snap fastener is sewn to the ends. The spring articles being compressed are placed in the centre of the cross, the ends folded over and snapped together. To produce the articles it is only necessary to snick the fasteners undone and they will expand of their own accord.

Things which nest together to occupy the smallest possible space include such objects as metal goblets and imitation glass tumblers. Special goblets can be bought at the conjuring stores or the ordinary aluminium picnic goblets can be used. The tumblers are made of talc or some similar transparent

substance, cemented together. They may be made all plain or some in various colours by tinting them with transparent photo tints. There is a type of unbreakable goblet sold for picnic purposes quite cheaply, made of some talc-like substance which could be used.

**Imitation Cakes**

Fig. 11 shows a nest of imitation cakes which are very easy to make. Simply obtain a few shallow cake tins and paint the outsides to represent cakes with icing on them. Tin jelly moulds can be similarly treated, a nest of three occupying little more space than one; and, of course, the space inside the inner one can be filled with other articles.

One very effective production on the nesting principle is half a dozen alarm clocks, produced with their bells ringing furiously. The clocks are all dummies and may be made from small cake tins of the round shape with slightly tapering sides. These usually have loose bottoms which can be discarded and cardboard discs painted with clock faces substituted. The

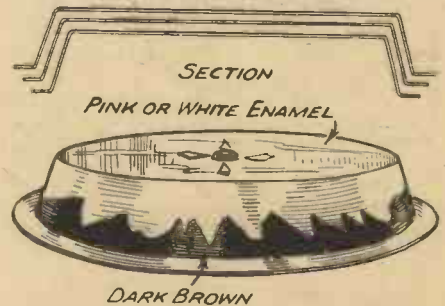

Fig. 11.—A nest of imitation iced cakes made from cake tins.

bells can be made from the very small tumbler-shaped tins soldered to strips of metal bent and attached to the dummy clocks as shown in Fig. 12. The six clocks will then nest with the dummy bells grouped all round the edge as in Fig. 13. As the clocks have no feet some provision must be made for them to be kept standing upright when they are put down. The simplest

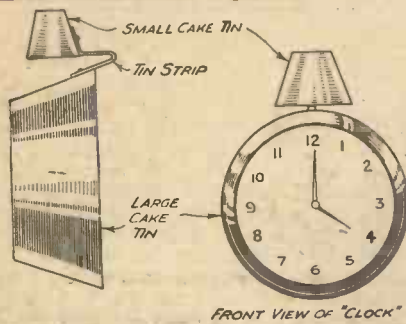

Fig. 12.—Alarm clocks made from cake tins.

method is to fasten small pieces of metal to a tray as shown in Fig. 14, under which the edges of the clocks may be pushed.

The ringing effect is produced by having an ordinary wind-up door bell screwed to the under side of the table with a lever to move across and depress the button. The bell is set ringing just before the first clock is produced and the same bell will be found quite effectively to represent the ringing of six clocks.

#### A Dummy Skull

Articles made hollow to contain other goods for production need very little explanation. A rather gruesome, but very startling production is that of a dummy skull, illustrated in Fig. 15. This is made of papier mâché and will accommodate a load of such things as spring balls. The balls are produced followed by the skull. Other presumably solid objects may also be constructed hollow to contain loads. A dummy clock, made from a wooden box, for instance, or a large hollow ball or Easter egg may be used. Such articles serve the double purpose of acting as a holder for the load and being of themselves effective things to produce.

The means of producing all these various articles from apparently empty receptacles have to some extent already been dealt with in this series. The various trick boxes and hats for instance provide suitable receptacles for some of the smaller things. When a very large production is required the usual plan is to start by producing a number of silk handkerchiefs or a quantity of paper

ribbon. The latter can be bought from conjuring shops all ready wound in coils, the coils being unwound from the centre in producing the ribbon. The ribbon or handkerchiefs are laid over the back of a chair or on a table while some more small things are produced, then the ribbon is picked up and the large articles produced from its midst.

One way of securing the large load is to suspend it from a push pin in the back of a

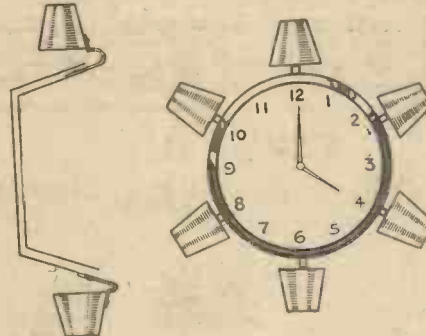

Fig. 13.—How the clocks nest together.

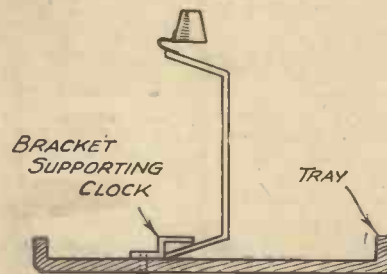

Fig. 14.—The clip on the tray supports the clock chair. A cloth thrown over the chair hides the load. The ribbon just produced is thrown over the back of the chair and when later it is picked up, the load is scooped up with it and developed through the mass of paper.

#### Producing a Flat Object

A simple way to produce a flat object such as a folding bird cage is to put it on the seat of a chair and drape a few silk

handkerchiefs negligently over it so as to hide it. Let your first production consist of a quantity of silk handkerchiefs and drop them on the chair as you develop them. Go on to produce some other small articles and the audience will forget about the few silks that were originally on the chair. The heap of silk can then be picked up and with it the folded cage which can be allowed to expand and be pulled out from the centre of the mass of silk. By this method a cage with domed top containing one or two live birds can be produced quite easily.

Another and quite subtle method of introducing a large load into a mass of paper ribbon is to have a box with the bottom moved up to within an inch or so of the top. The load is placed on a table and the box placed over it. Some excuse is given for the presence of the box by taking from it a pack of cards or some other article for a previous trick. When the paper ribbon is produced it is held in front of the box, the box is lifted to make room for the ribbon to be laid on the table, when of course it goes over the concealed load. The trick box is then put aside and in due course the load is developed from the ribbon.



Fig. 15.—A hollow imitation skull made of papier mâché to contain a load of small articles for production.

## SYNTHETIC DIAMONDS

### Ingenious Apparatus Used by Scientists in Producing Synthetic Stones

SCIENCE has long known that diamonds are merely a crystalline form of carbon, or, in other words, transparent carbon, and in every way analogous with burnt sugar, charcoal, or graphite. In fact, the only difference between the Koh-i-noor and coal or graphite is the mode of crystallisation.

For years authors have written stories about wonderful "recipes" for diamonds, while sober-minded scientists laboured to produce the gem synthetically or—in simpler language—by reproducing the conditions of nature and building up the gem from its native carbon. The first real step towards synthesis was taken a great many years ago when a diamond was burned by an electric spark in an atmosphere of oxygen and left a residue of plain coke, thus proving it to be pure carbon. Nearly forty years ago the French physicist, Moissan, produced synthetic diamonds of a sort and his efforts were merely to reproduce the conditions of a meteorite

which fell in Devil's Gulch, America, and which was found to contain a great number of very small diamonds.

Briefly, Moissan's method was to load a carbon crucible with pure iron and carbon obtained from sugar. This crucible was heated in an electric furnace and, at the tremendous temperature generated, a certain amount of carbon was dissolved into the liquid iron. The crucible, at the right moment, was dropped into a bath of molten lead, thus causing a far greater drop in temperature than that obtained by plunging a red-hot poker into ice-water.

The outer part of the iron solidified first, exerting tremendous pressure on the still liquid core, and this pressure forced some of the liquid carbon to crystallise, thus forming diamonds in the true sense of the word, though they were minute and badly coloured.

The method of obtaining the stones from the iron matrix was to dissolve the whole thing in strong acid.

#### An Improved Process

Within recent years, however, a research worker, Dr. L. H. Barnett, has improved on Moissan's process, and obtained diamonds of good colour, though still very small and costly, the actual cost being about £100 per carat. Dr. Barnett simply added silicon and phosphorus to the mixture in his first experiments. The silicon forced the precipitation of carbon and formed graphite, while the phosphorus prolonged the fluidity of the molten iron. In these experiments the molten mass was cooled slowly in steel shells.

The largest diamond produced by Dr. Barnett measured by weight 1/20th of a carat, and the cost was as mentioned above, but recent advices from Dr. Barnett hold our distinct hope of synthetic diamonds being available very soon in good size and at a cost of about £1 per carat.

Naturally, the production of synthetic (not artificial) diamonds would mean a tremendous drop in the value of the stones as gems, but the benefit to industry would be colossal. Drilling and tunnelling tools—high-speed bearings and wire drawing equipment would be revolutionised, as the diamond is the finest possible tool, albeit the most expensive, in these and kindred operations.

Get your Tools at

# GAMAGES



**BRITAIN'S KEENEST PRICES for HIGH-GRADE TOOLS**

## ELECTRIC MOTOR-DRIVEN JIG SAWS

Big, Powerful, Speedy

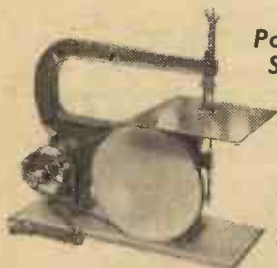

Cuts up to 3/4 in. plywood and to the centre of a 2 1/2 in. circle. Cutting table 8 in. square, combined belt pulley and sanding disc 8 in. diam. Overall length 18 in. Height to top of frame 12 1/2 in. Maximum width, 8 in.

Powerful Universal Motor. For A.C. or D.C. mains, 200/250 volts  
**57/6**  
Carriage, England or Wales, 2/-

## HANDY STEEL BOXES

Divided into compartments



Just the thing for keeping screws, bolts, etc. Size: 1 1/2 in. by 6 in. by 2 1/2 in., divided into nine compartments 3/4 in. by 2 in. by 2 in. Post 6d. Each

**3/6**



MICROMETER CALLIPER GAUGE

Reads from 0 to 1/4 in. by .001 in. with legibly engraved graduation on both the sleeve and thimble. Adjustable anvil for correcting the zero setting when necessary. Post 3d.

**5/6**

## ELECTRIC DRILLING MACHINES

In bench and floor types. The following is the main specification for both models. Three speeds, sensitive feed; depth of feed 3 in.; spindle graduated in 16ths; Stop collar for regulating depth, three jaw, self-centring chuck, 1/2 in. capacity. Centre of chuck to pillar 6 in. Oilite bronze bearings, diameter of pillar 1 1/2 in. Tilt-ing and swivelling table 8 in. by 8 in.

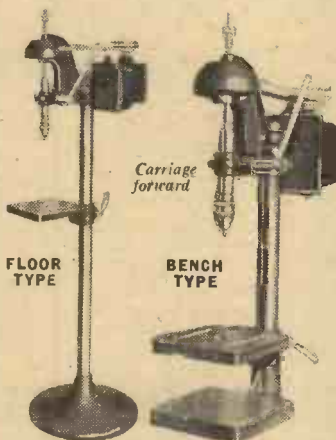

FLOOR TYPE

BENCH TYPE

Bench type (individual details): Maximum distance, chuck to table, 10 in. Height to top of frame, 30 in. Weight with 1/4 h.p. motor, 67 lb. Without motor, 45 lb.

With motor

**£8/7/6**

OR DELIVERED ON FIRST OF 12 MONTHLY PAYMENTS OF

**15/3**

Without motor, £5/12/6, or 12 Monthly Payments of 10/3. Floor type (individual details): Maximum distance, chuck to table, 33 in. Height to top of frame, 56 in. Weight with 1/4 h.p. motor, 80 lb. Without motor, 59 lb.

With Motor, £9/5/0, or Delivered on First of 12 Monthly Payments of 16/9. Without Motor, £6/10/0, or 12 Monthly Payments of 11/9.

## HEAVY DUTY AIR COMPRESSORS

First-class jobs at a price that cannot be repeated. 1 1/2 in. bore, 1 1/2 in. stroke. Splash lubricated, sealed crank case. Diameter of fly-wheel 9 in. Weight 34 lbs.

To-day's Value 6 gns.

**63/6**



Carriage Outside Our Extensive Delivery Area, 1/6 England or Wales.



## BENCH GRINDERS

Hand driven, fitted 4 by 3/4 in. wheel, and with tool rest. Well made throughout, and will give years of service.

**3/6**

Post 7d.

Send for copies of Gamages Tool Bargain Leaflets



## HEAVYWEIGHT BENCHES

A bench for which you would expect to pay at least 30/-. Well made and solidly constructed throughout. Measurements: Top 72 in. by 17 1/2 in. by 2 1/2 in. Legs 2 1/2 in. square. Height 34 in.

**21/6**

No Home Garage or Workshop complete without one.

Carriage Forward Outside Our Extensive Delivery Area.

## BOXES OF TWELVE ASSORTED FILES

The best and cheapest way to buy files. British made and of excellent quality. Wonderful value.

Sizes 4 to 8 in. **2/11**

Post 6d. Per box Also sizes 6 to 12" 4/6. Post 0d.



## The GAMAGE 3-inch, BACK GEARED, SCREWCUTTING, SLIDING, MILLING and SURFACING LATHE WITH COMPOUND SLIDE REST

Headstock and Bed are of ample proportions; with large diameter mandrel in long adjustable bearings. Quick Traverse Handle for Saddle Return. Saddle has machine cut slots. All gears are machine cut. Dimensions: Swing in gap, 8 in.; Swing over saddle 4 1/2 in.; Diameter of mandrel, 1/2 in.; Mandrel and tailstock barrel bored 3/4 in. clear; Centres, standard No. 1 Morse taper; Cross-slide traverse, 3 1/2 in.; Top-side traverse, 3 in.; Lead-screw, 1/2 in. diameter by 8 T.P.I.; Cone pulley, 3 1/2 in., 3 1/2 in., 2 1/2 in. by 1/2 in. width; Back-gear ratio, 6 to 1; Approximate weight 60 lbs. With Compound Slide Rest and Back Gear, 20 in. between Centres, including 6 in. Face Plate, 2 1/2 in. Driver Plate, Machined Chuck Plate, 10 Change Wheels and Double Clasp Nut.

**£6/7/6**

OR DELIVERED ON FIRST OF 12 MONTHLY PAYMENTS OF **11/6**

Also with single clasp nut £5/19/6, or 12 Monthly Payments of 10/9. Carriage Outside Our Extensive Delivery Area, England and Wales, 3/6



GUARANTEED TRUE to .001 in.

Send for fully Descriptive Leaflet

# CLIX

## TRIMMER CONDENSERS

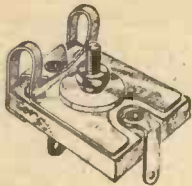

These are the latest addition to the Clix range of Frequentite (ceramic) components for Television and all Low-Loss High Efficiency Circuits.

List No.	Price
T C 1 3-30 mfd. (single) each	6d.
T C 2 4-50 mfd. (single) each	6d.
T C 3 3-30 mfd. (double) each	1/6

### CLIX ACORN VALVE-HOLDERS

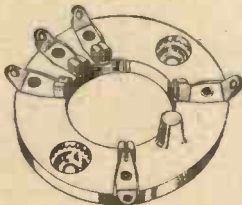

In addition to their low-loss characteristics the method of contacting the valve pins with nickel silver clip sockets makes for knife-edge binding.

English, 90 degrees, each 2/-  
American, 60 degrees, each 2/-



BRITISH MECHANICAL PRODUCTIONS LTD.

79a, Rochester Row, London, S.W.1.

Details of all Clix products are given in our 1938-39 folders "P.M."



To her husband said young Mrs. Vere,  
"Since you've done all our odd jobs this year,  
The money we've saved  
Buys the fur coat I craved,  
Shall I kiss you or FLUXITE,  
my dear?"

See that FLUXITE is always by you—in the house—garage—workshop—wherever speedy soldering is needed. Used for 30 years in government works and by leading engineers and manufacturers. Of Ironmongers—in tins,

4d., 8d., 1/4 and 2/8. Ask to see the FLUXITE SMALL-SPACE SOLDERING SET—compact but substantial—complete with full instructions, 7/6.

Write for Free Book on the ART OF "SOFT" SOLDERING and ask for Leaflet on CASE-HARDENING STEEL and TEMPERING TOOLS with FLUXITE.

TO CYCLISTS! Your wheels will NOT keep round and true unless the spokes are tied with fine wire at the crossings and SOLDERED. This makes a much stronger wheel. It's simple—with FLUXITE—but IMPORTANT.

## THE FLUXITE GUN

is always ready to put Fluxite on the soldering job instantly. A little pressure places the right quantity on the right spot and one charging lasts for ages. Price 1/6.



ALL MECHANICS WILL HAVE

# FLUXITE

IT SIMPLIFIES ALL SOLDERING

FLUXITE Ltd., Dept. P.M., Dragon Works, Bermondsey St., S.E.1

## RAILWAYS MODELS SHIPS

● WE ARE NOW IN OUR NEW SHOWROOMS and should be glad to see you or receive your enquiries by post.

● OUR NEW CATALOGUE IS NOW READY. By Post 6d.—send for your copy now.

● We have an increased staff of experts and many new lines in production.



10-11 NEW BURLINGTON ST.  
REGENT ST., LONDON, W.1  
Regent 5676

THE SPECIALISTS ANNOUNCE—

### "BROWN" ENGINES

Sole Agents British Isles.

Type "M" (Marine) ..	£4/15/-	Type "C" ..	£4/18/6
"B" ..	£5/17/6	"D" ..	£3/17/6

All models complete with propeller and flywheel.

### "CYCLONE" ENGINES

Model "F" £5/2/6 complete with propeller.

### SUPER "1938" SPITFIRE

Britain's "Baby" Engine. Colossal power. Platinum points. Easy starting. All-on weight, 7½ ozs. at £4/17/6 complete with propeller. AND ALL SUNDRIES. Send 3d. stamp for Price List.

MODEL AIRCRAFT STORES (B'NM'TH) Ltd.,  
127b, HANKINSON ROAD, BOURNEMOUTH

Telephone: 1922 Winton

## 25 inches of FLYING WONDER 2/6



### COMET'S unbeatable value

These amazing value kits have Comet's famous full-size easy-to-follow plan, balsa spars, printed sheet, flying prop, cement, thrust button, tissue, etc. Comet marvels have built-in flyability.

- HOWARD DGA-9
- LUSCOMBE
- AERONEER
- RYAN 30 in. wing 3/11 Complete kit
- STINSON
- REARWIN
- Complete kits, post free, 2/6 each
- AERONCA, 54 in. 7/6 wing Complete kit



SEND YOUR ORDER NOW TO

P.M. SWEETEN LTD.

BANK HEY STREET, BLACKPOOL

ABROAD—All kits are postage extra—allow 1/- on small kits and 2/- on large.

**BIG WINGSPANS.** Write for special leaflets giving illustrations of eight amazing value models.  
**PETROL KITS.** Comet Golden Eagle 19/6, and Comet Clipper 38/- in stock. Ask for leaflet.  
**CATALOGUE** of the finest flying scale model range in England sent for 3d. stamps. 54 finely illustrated pages of actual models; 36 different kits to choose from.

**GLOSTER GLADIATOR**  
Wingspan 18 in., length, 14 in. Super detailed model with large, clear easy-to-follow plan. Comet plans explain themselves! Shock absorbing undercarriage. Complete kit with everything needed, balsa, quick drying cement, dope, hand-carved hardwood flying prop, etc. Carriage 5/- paid  
Trade enquiries welcomed.



# A Rapid Calculator

By D. J. Williams, B.Sc.

With The Aid Of A Ruler Or Strip Of Celluloid, This Chart Constitutes A Device That Will Add Up For You

### The Principle Used

IF you draw three equal parallel lines at equal distances apart, graduate the two outside lines from 0 to 10 evenly, and the middle one from 0 to 20, you will find that a line joining any two graduations on the outside scales crosses the middle scale at the point representing the sum of the two outside values. With a ruler or a strip of celluloid this chart constitutes a device which will add up for you. But as you can undoubtedly manage to add up two figures in your head you will not think this device of very great value.

If you have studied and used "Logs", however, you will know that we can multiply numbers together by adding their "Logs" and finding the "Antilog." The slide rule does this for us mechanically. But a good slide rule is expensive and the making of an accurate one is beyond the scope of the average amateur.

Anyone who has the ability and patience to make a few accurate measurements on squared paper can, however, make a device which will multiply and divide to three figures. The three parallel lines of Figure 1 are graduated according to the "Logs" of numbers instead of according to the numbers, and the process of addition resolves itself into one of multiplication.

### How to Draw the Chart

Take a sheet of stout graph paper, 12 in. by 8 in., graduate in inches and tenths. Using a hard pencil (or better, a fine ruling pen and Indian ink), draw three

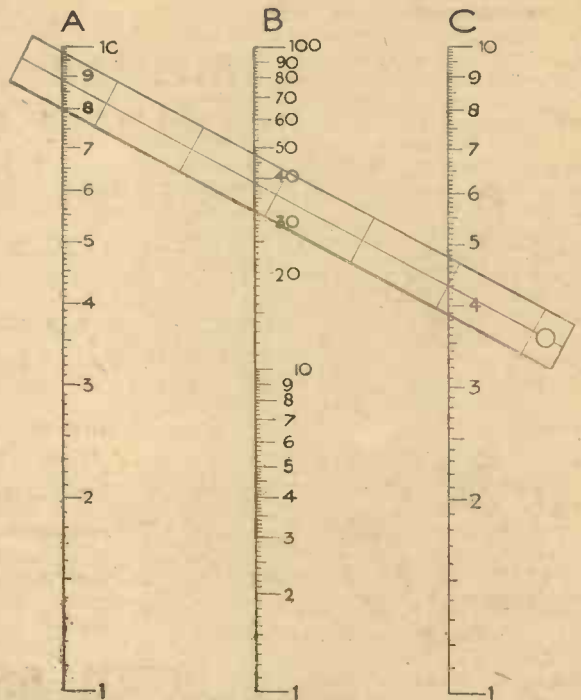

Fig. 1. Details of the Rapid Calculator

Graduations	Distance from unit mark in inches		Graduations	Distance from unit mark in inches	
	Outside Scales	Middle Scales		Outside Scales	Middle Scales
1.	0.00	0.00	5.6	7.48	3.74
1.1	.41	.21	5.7	7.56	
1.2	.79	.40	5.8	7.63	3.82
1.3	1.14	.57	5.9	7.71	
1.4	1.46	.73	6.0	7.78	3.89
1.5	1.76	.88	6.1	7.85	
1.6	2.04	1.02	6.2	7.92	3.96
1.7	2.30	1.15	6.3	7.99	
1.8	2.55	1.28	6.4	8.06	4.03
1.9	2.79	1.40	6.5	8.13	
2.0	3.01	1.50	6.6	8.20	4.10
2.1	3.22	1.61	6.7	8.26	
2.2	3.42	1.71	6.8	8.33	4.17
2.3	3.62	1.81	6.9	8.39	
2.4	3.80	1.90	7.0	8.45	4.23
2.5	3.98	1.99	7.1	8.51	
2.6	4.15	2.08	7.2	8.57	4.29
2.7	4.31	2.16	7.3	8.63	
2.8	4.47	2.24	7.4	8.69	4.35
2.9	4.62	2.31	7.5	8.75	
3.0	4.77	2.39	7.6	8.81	4.41
3.1	4.91	2.46	7.7	8.87	
3.2	5.05	2.53	7.8	8.92	4.47
3.3	5.19	2.60	7.9	8.98	
3.4	5.32	2.66	8.0	9.04	4.53
3.5	5.44	2.72	8.1	9.10	
3.6	5.56	2.78	8.2	9.15	4.58
3.7	5.68	2.84	8.3	9.20	
3.8	5.80	2.90	8.4	9.25	4.63
3.9	5.91	2.95	8.5	9.30	
4.0	6.02	3.01	8.6	9.35	4.68
4.1	6.13	3.06	8.7	9.40	
4.2	6.23	3.12	8.8	9.45	4.72
4.3	6.34	3.17	8.9	9.49	
4.4	6.44	3.22	9.0	9.54	4.77
4.5	6.53	3.27	9.1	9.59	
4.6	6.63	3.32	9.2	9.64	4.82
4.7	6.72	3.37	9.3	9.69	
4.8	6.81	3.41	9.4	9.73	4.87
4.9	6.90	3.46	9.5	9.78	
5.0	6.99	3.50	9.6	9.83	4.92
5.1	7.07		9.7	9.88	
5.2	7.16	3.58	9.8	9.92	4.96
5.3	7.24		9.9	9.96	
5.4	7.32	3.66	10	10.00	5.00
5.5	7.40				

parallel lines 10 in. long, spaced at equal intervals of 2 in. Starting with the lower ends as the unit graduations, graduate the lines from the figures in the table (see table on the left), measuring upwards. (N.B.—The measurements given for the middle scale for graduations 1 to 10 cover 5 in. from the lower end. These measurements must be repeated from 10 to 100.)

### The Straight Edge

The best form of straight edge is a strip of celluloid carrying a fine line. The strip should be cut to about 12 in. by 1 in. A straight line should be drawn down the centre by drawing a needle point along a steel rule, applying a gentle but steady pressure. The line should be filled with ink by rubbing with an inked rag, and polishing off the excess ink. Two or more cross lines, drawn exactly at right angles to this centre line, also prove useful when square roots are being determined.

### Using the Calculator

Labelling the lines A, B and C from left to right :

To multiply 8.9 by 4.3  
Join 8.9 on A to 4.3 on C and read the answer, 38.3 on B.

To divide 11.9 by 7.3  
Join 11.9 on B to 7.3 on A and read the answer, 1.63 on C.

To find Square Root of 13.  
Place the line horizontally through 13 on B, registering one of the cross lines with a vertical. Read the answer on A or C. (3.61).

To find the Square of 3.7.  
Join 3.7 on A to 3.7 on C and read the answer, 13.7 on B.

### WORKSHOP CALCULATIONS, TABLES AND FORMULAE

By F. J. CAMM.

216, or 2110 by Post from :—  
Geo. Newnes Ltd., Tower House,  
Southampton Street, Strand, W.C.2.

# NEW INVENTIONS

## For Human Giraffes

THE human form, as regards the shape of the shoulders, sometimes resembles a giraffe or a champagne bottle. Now, since square shoulders are by many folks considered to be desirable, it is the practice among tailors, in the case of the narrow and sloping, to build out and up the shoulders, to produce the appearance of broad physique. This effect is obtained by some kind of padding. The ideal fabric for the purpose necessarily must be light as regards weight.

I note that the United States Patent Office has granted a patent for a special kind of padding for ladies' and gentlemen's clothes. The principle of the invention is a number of tubes in layers. The tubing in question apparently is not pneumatic, although aerated garments might convert the Thin Man into a John Bull.

## A Good Tip

AN improved dumping vehicle has made its debut. It is a combination of chassis, spindles and pivots.

The modern dumping vehicle is a lineal descendant of the old-fashioned tip-cart, which deposited its load with a prodigious bump. The body of the cart was prevented from tipping at the wrong moment by means of a peg. Many years ago, an inventor conceived the idea of a tip-cart whose body could be lowered and raised mechanically by turning a handle. The object, presumably, was to avoid the aforementioned bump, which was apt to undermine the constitution of the cart. One purchaser of this patent cart found the mechanism somewhat heavy. He reduced it, but even then I think it probable that the carter preferred the original vehicle, which operated more quickly, and had no detachable handle liable to be lost.

Appropos of the tip-cart I find in a pigeon-hole of my memory, a record of a human load of workmen riding in a tip-cart to a void homeward plodding their weary way. The restraining peg, unfortunately, did not do its duty. The living load was precipitated on the highway—a tip which the horny hand did not appreciate.

## Over Her Shoulder

IN the last century, the hairpin was in great demand. The primitive pattern consisted of parallel lines which culminated in a curve. Eventually these lines, like the hair which they kept in order, were waved. When the hair of the ladies was abbreviated, being bobbed, shingled and bingled, I am told that the hairpin was less required. But now that the fair are going to greater lengths, as regards their locks, hairpins are again in demand.

To facilitate the toilet of the modern Venus there has recently been introduced a box for hairpins, which is so shaped that it fits the contour of the shoulder of the goddess. From her own point of view, one imagines that the toilet table would be the most convenient spot for the hairpin box. But in the event of there being a lady's maid in the boudoir or a coiffeur in the cubicle, who would work behind the subject of the toilet, the shoulder of the lady would unquestionably be a handy position for the box.

## Pneumatic Foot

SINCE the days when, as recorded in *Pickwick Papers*, a purveyor of cats' meat used to wear second-hand wooden

The following information is specially supplied to "Practical Mechanics," by Messrs. Hughes & Young (Est. 1829), Patent Agents, of 9 Warwick Court, High Holborn, London, W.C.1, who will be pleased to send readers, mentioning this paper, free of charge, a copy of their handbook, "How to Patent an Invention."

legs, the artificial limb has, figuratively and literally, made great strides. The resemblance to nature attained by the ingenious inventor and the skilful craftsman is very remarkable. It is true I have known a cat to detect the deception by preferring to rest on the limb of flesh in which he could dig his claws.

I understand that the cost of these artificial legs de luxe is considerably greater than that of the kind with which Captain Cuttle stumped along. But the price does not reach the altitude of that of the golden leg worn by Miss Kilmansegg, whose admirers, according to Thomas Hood, worshipped the Golden Calf.

The illusion of the artificial limb has been yet further heightened by the production of a pneumatic foot and ankle. There is a casing shaped to imitate a human foot, having heel, instep and toe portions and provided with a chamber containing an inflatable inner tube. The happy possessor of this effective substitute will walk on air.

## Spats with Zippers

SPATS were once the hallmark of the city magnate. To-day, though not obsolete, like mittens, their vogue has waned. However, there must be some demand for these ankle cosies in America, since an application for a new variety has been accepted by the United States Patent Office. The original type buttoned at the side of the foot. A slide fastener replaces the buttons in the latest brand, reinforced by a strap passing beneath the foot. If President Roosevelt affects what have been termed "mudguards," he will now be able to secure them with a zipp fastener.

## Erasing by Machinery

"TO err is human." The lack of infallibility on the part of the human family is shared by the typist. As a consequence, an incalculable amount of rubber is worn away in the process of effacing mistakes made on the typewriter. I trust that I shall not be considered unchivalrous in mentioning that the bulk of these errors are perpetrated by the fair sex. This is not due to the excessive fallibility of the ladies, but to the fact that the majority of the noble army of typists are of the feminine gender. That being so, it is appropriate that a lady should devise a typewriter erasing attachment, for which a patent has been granted in the United States.

The invention comprises an erasing wheel capable of vertical inclination and adapted to wear concavely on the curve of the typewriter cylinder. Means are provided for rotating this wheel, which can be swung to one side out of the way when not in use. And the vertical inclination of the axis of the wheel can be changed so that it may bear harder on one part of the wheel than on the other.

It remains to be proved whether the average stenographer—as the typist is termed in the country of the inventress—will prefer this mechanical eraser to her own elegantly manicured fingers, with which in the past she has gracefully rubbed along.

## Long Live Rubber!

RUBBER plays such an important part in the life of to-day that any method which gives it long life and efficiency is sure to receive a hearty welcome. There has been submitted to the British Patent Office a new process and composition for preserving the original quality of rubber goods. The aim of the inventor has been to provide a means of softening and enhancing the elasticity of the rubber in these articles. And it is contended that the ageing of the rubber is arrested and its serviceability is increased.

And what will produce these most desirable effects? I learn that the principal ingredients are glycerine and lemon juice. It suggests a lubricant for the lungs which the family chemist supplies for the bronchial tubes. According to the inventor's contention, it should benefit a great many other inner tubes.

## Detachable Sleeves

THE turning up of the sleeve of the coat and of the shirt has been a practice from time immemorial. It is now possible to have a garment with detachable sleeves. The sleeve fastener, consisting of a slide, when in locked condition, is hidden from view. The effect of removing one's sleeve on a hot day would be cooling. And one's arms would be free for work which sleeves might impede. And there would be no danger of the sleeve coming in contact with the butter!

## Artificial Branches

MY attention has been arrested by a tree-decorating device, for which a patent has been granted. This is an appliance for attaching loose branches to the trunk of a tree. It comprises a socket for receiving the inner end of the branch, means for clamping the branch in the socket and a tapered threaded shank on the inner end of the socket for insertion in the tree trunk. The idea is not grafting, but simply mechanical attachment. This may produce a semblance of nature, but it will be no more genuine than an orange tree which some time ago was visible in a London club. One does not expect to find the golden fruit flourishing in this climate. A close inspection of the tree revealed the fact that the oranges were tied on to the branches!

## The Passing of the Parasol

AN application has been made to the British Patent Office for a patent with reference to yet another invention relating to the umbrella. The deviser, in this instance, has arranged that the sleeve-like tube which moves up and down—known as the runner—shall, when the umbrella is closed, project beyond the ends of the ribs. This, the inventor contends, makes for an easier opening of the umbrella, and enables its frame, when closed, snugly to embrace the stick.

The specification states that the idea is equally applicable to sunshades. In the days of Queen Victoria, the fair were literally fair and an alabaster complexion was regarded as an attribute to beauty. Consequently, the parasol was very much in evidence. But the current damsel is a russet apple instead of a peach. The Lido, in her case, is a tannery. Therefore she has no use for a sunshade. However, this newly devised umbrella might have been of interest to Robinson Crusoe.

# THE MODERN MOTOR ENGINEER

In view of the many recent developments that have taken place in Motor Engineering, it has been considered necessary to bring out an entirely new and revised edition of "The Modern Motor Engineer" to meet the demands of the garage manager and mechanic for a practical up-to-date book of instruction on all phases of their work.

## BREAKDOWNS ON THE ROAD

A feature of special value is the section dealing with breakdowns on the road. Repairs are treated in great detail, and instruction is given in welding, brazing, sheet metal work, machinery and grinding. There is also a section on chassis frame straightening and repairs.

## THE SCOPE OF THE WORK

Among the many subjects which are dealt with in detail are: Garage Lay-out and Equipment—Dismantling, Tuning and Repairs of Engines—Clutches, Gear Boxes, Transmission, Spraying and Brakes—Modern Ignition Systems—Armature Winding and Repairs—Carburettors—Tyre Troubles—High-speed Oil Engines—How to cost Garage Jobs—Legal Requirements—etc., etc.

## ELECTRICAL DIAGRAMS

A volume entitled "Electrical Diagrams" is given free to all purchasers of this work. This volume, handsomely bound, contains about 70 electrical wiring diagrams, and electrical data of the most popular English and American Cars and commercial vehicles. Its value to motor engineers cannot be overstressed.

## THE ILLUSTRATIONS

The work is fully illustrated with 32 full-page plates and over 1,600 illustrations in the text, all of which have been chosen for their practical value.

## THE MOTOR ENGINEERS' CHART

Supplied free with this new edition is a specially prepared chart, which shows, by means of diagrams and tables, all the information regarding measurements, etc., which the engineer or mechanic is likely to require in his day-to-day work.

## A FREE BOOKLET

To the Caxton Publishing Co., Ltd.,  
119, Clun House, Surrey Street,  
London, W.C.2.

Please send me, free of charge, Booklet, describing "The Modern Motor Engineer."

Name.....  
Send this form in unsealed envelope  
(½d. stamp).

Address.....

O.14 .....

# MODERN ELECTRIC WIRING

The New and Revised Edition of "Modern Electric Wiring" is a practical guide to the wiring of Private Dwellings, Business Premises, Factories, and Public Buildings, for Lighting, Heating and Power, with chapters on Wireless Practice, Electric Motors, Talking Picture Equipment, and Neon Illumination.

The author has had a wide and varied experience in the practice of wiring, and is therefore able to describe in detail how every phase of the work should be carried out.

## THE SCOPE OF THE WORK

General Principles of Electrical Conductivity—Materials—Wire Gauges—Insulators, Insulation, and Resistances—Systems of Wiring—Safety Fuses—Illumination, Heaters, Cookers, Small Motors, Appliances—Wiring Layouts—Lighting, Heating, and Cooking—Temporary Wiring—Measuring Instruments, Meters, and Mains—Bells and Signals—Domestic Telephones—Testing—Wiring for Wireless Installations—Power Amplifiers, Public Speech and Talking Picture Equipment—The Workshop—Electric Motors and Generators—Principle of Neon Illumination—Specifications, etc.

## THE WORKSHOP

To the ambitious wireman, anxious to commence business, the chapter on the workshop will be full of interest because, apart from equipment and routine (with specimens of time and material sheets), the business side is also discussed and useful hints given as to carrying out work, stock-taking, calculating profits, etc.

## THE ILLUSTRATIONS

"Modern Electric Wiring" contains over 270 illustrations, the majority of which are wiring diagrams, specially designed to demonstrate practical working, and many of them suitable for use in actual practice.

## AN OPINION

Mr. G. B. BENNETT, Tudor Road, Leicester, writes:

"I am delighted with 'Modern Electric Wiring.' It treats a big subject in a manner remarkably easy to understand. It is the best book on Electric Wiring I have seen."

## A FREE BOOKLET

To the Caxton Publishing Co., Ltd.,  
119, Clun House, Surrey Street,  
London, W.C.2.

Please send me, free of charge, Illustrated Booklet describing "Modern Electric Wiring."

Name.....  
Send this form in unsealed envelope  
(½d. stamp).

Address.....

S.14 .....

# ENGINEERING WORKSHOP PRACTICE

This up-to-date book provides a complete practical course of instruction in every important branch of engineering workshop methods, materials, and equipment. It deals with the underlying principles, craftsmanship, machines, tools, measuring processes and machining methods of to-day, and it will prove indispensable to the engineer, draughtsman, mechanic, apprentice, and engineering student. Its scope extends from simple hand tools to the latest elaborate machines employed for mass-production purposes.

## DATA AND RECIPES

Apart from the mass of practical instructional and descriptive information given, there is a wealth of data, formulae, workshop recipes, hints and tips which render this book a valuable reference work.

## SOME OF THE SUBJECTS

Hand Tools, Measuring Methods, Verniers, Micrometers, Gauges, Optical Devices, Fluted and Twist Drills, Grinding Angles, Drilling Data, Drilling Machines, Electric Drills, Lathework, Machining of Metals and Synthetic Materials, Tungsten-carbide and Diamond Tools, Lapping, Honing, Cleaning, Polishing and Rust-protection of various metals. Grinding Operations and Machines, Milling Operations, Cutters and Machines, Planing, Shaping, Slotting and Broaching. Plate and Bar Machines. Gears and Gear Cutting Methods, Templates, Jigs and Fixtures. Overhauling and Adjusting Machines, Millwright Work, Welding, Brazing and Soldering Metals, Forging Work. Sheet Metal Work. Foundry Work. Patternmaking. Press Work. Engineering Steel and other Metals; their properties, Testing, Hardening, Tempering and Annealing. Engineers' Drawings. Workshop Calculations, Data, Hints and Recipes.

## THE ILLUSTRATIONS

The book is lavishly illustrated so that the explanations are rendered very clear with examples taken from actual works practice in many instances. There are 24 full-page plates and 877 illustrations in the text.

## ENGINEERING CHART

In order to make the work even more comprehensive, a chart, which can either be carried in the pocket, or hung upon the workshop wall, is supplied free to all purchasers. It contains many useful Tables of Screw Threads, Tapers, Angles, Drill Speeds and Sizes, etc.

## A FREE BOOKLET

To the Caxton Publishing Co., Ltd.,  
119, Clun House, Surrey Street,  
London, W.C.2.

Please send me, free of charge, Illustrated Booklet describing "Engineering Workshop Practice."

Name.....  
Send this form in unsealed envelope  
(½d. stamp).

Address.....

G.14 .....



*"Look Boys..*

**THIS PIFCO METER WILL TEST RADIO AND EVERYTHING ELECTRICAL"**

With this sensitive instrument you can make literally thousands of tests. You can find what has gone wrong with your radio, test electric train circuits, transformers, bells, motors, and carry out many interesting experiments as well.

**RANGES**

- 0.5 volts
- 0.20 volts
- 0.100 volts
- 0.400 volts
- 0.10 mA
- 0.50 mA
- 0.250 mA
- Resist. valve test.
- Plug-in test for valves.



**42/-**

Complete in velvet-lined case with testing leads.

**PIFCO RADIOMETER.**  
The only instrument of its kind in the world for making both A.C. and D.C. Tests.



**RANGES**  
0.6 volts. 0.240 volts. 0.30 mA. Filament and Resistance Test, and socket for plug-in test for valves. 8,000 ohms Resistance. Complete with two 15-inch flex cables. Fitted with PIFCO DRY CELL.

**12/6**

Your regular dealer can supply you, or write: **PIFCO LTD., WATLING STREET, MANCHESTER.** London Address: 58, City Road, E.C.1.

**PIFCO**

**ROTAMETERS and RADIOMETERS**  
**PIFCO ON THE SPOT WILL TRACE YOUR TROUBLES LIKE A SHOT**

**HOME STUDY FOR EXAMINATIONS**

University Correspondence College, founded 1887, prepares students for London University Matriculation, Intermediate, and Degree exams.; also for Oxford or Cambridge School Certificate, Civil Service, R.S.A., Book-keeping, etc. The College has a resident staff of Tutors, specialists in their subjects. Over 1,000 U.C.C. students pass London University examinations each year. 5,029 matriculated during the ten years 1928-1937.

**FREE GUIDES** to London University and other exams. (mention exam.) may be obtained post free from the Registrar.

**UNIVERSITY CORRESPONDENCE COLLEGE**  
62 Burlington House, Cambridge

**For Work after Dark**

Mechanics and owners of small workshops, lathe sheds, observatories, etc., should get the

**TILLEY LANTERN**



(Burns ordinary Paraffin)

Light of 300 c.p. for 6 hours for 1d. Its magnificent light enables work to continue after dark, either in or out of doors. Can be placed anywhere. Made in stout brass, and there are no parts which can rust, corrode, or get out of order. Burns steadily anywhere, unaffected by weather, however severe. Get rid of all antiquated devices and use this marvellously efficient All-British Tilley Storm Lantern. Price 36/-.

Remit 36/- or can be sent C.O.D. Post and Charges Paid.

**TILLEY LAMP CO. (Dept. P.M.), HENDON, N.W.4**



**ENGINEER'S Guide to Success**

This Great Guide shows how to study at home with The T.I.G.B. for a well-paid post. Contains the widest choice of engineering courses in the world—over 200—including MECHANICAL, CIVIL, ELECTRICAL, AUTOMOBILE, AERONAUTICAL, RADIO, TELEVISION, CHEMICAL, etc.—alone gives the Regulations for Qualifications such as A.M.I.Mech.E., A.M.Inst.C.E., A.M.I.E.E., C. & G., G.P.O., etc.—contains remarkable tributes from Engineering Institutions and eminent technical men to the successful tuition methods of The T.I.G.B.—and details latest successes of T.I.G.B. students in all fields. Training until successful guaranteed for the one fee. Write for Free copy TO-DAY.

**THE TECHNOLOGICAL INSTITUTE OF GREAT BRITAIN,**

218 Temple Bar House, London, E.C.4  
Founded 1917. 20,000 Successes.

*An Absorbing Hobby*

**BUILDING A STUART MODEL IS AN ENGROSSING PASTIME, AND THE RESULT A CONTINUOUS PLEASURE**



We illustrate:

- STUART NO. 10.
- High Speed Steam Engine.
- Bore 3/4".
- Stroke 3/4".

Each set is quite complete—drawings and instructions are included.

- If you have a lathe—  
The rough castings - - 8/6
- If not—  
Fully machined set - - 18/6
- Ditto, with all holes drilled and tapped - - 25/-

This and many other Stuart engines are fully described in the 72-page CATALOGUE No. 3, 6d. post free.

**STUART TURNER LTD. HENLEY - ON - THAMES**



building up with rings of plywood and a cotton or wire reel, the whole block cellulose painted and the base loaded. The tube D consists of two separate jackets with different solutions, and if tackled will be an ambitious effort indeed; but not impossible if one remembers to build in sections. It cannot be too highly stressed that to finish a successful piece of work, every effort should be made to plan it stage by stage; considering carefully the order of assembling; what tubes will be open for blowing purposes, and which joints and bulbs to do in a single operation. It may happen that an internal seal may

tubes should be capped to facilitate the connection of high tension leads. These caps are usually of brass, made from thin sheet. The sheet is cut into squares about  $\frac{3}{8}$  in. each way, and these are hammered into a hemispherical shape by using a ball bearing about  $\frac{1}{4}$  in. diameter, and a block of lead or type-metal. The rag is cut off with shears and the base filed flat. It is now polished and a convenient method is to mount a hand-brace in the vice with small piece of hard wood rod in the chuck. The cap should fit tightly over the rounded end, and with a piece of emery cloth applied

round the inside edge, pressed over this. It should set quite firmly. A good cement for this purpose is plaster of paris with a little seccotine. A special cap cement is made by heating red ochre or venetian red powder in a stove at 212 degrees F. or above and adding to beeswax and rosin already melted together. The proportions are: rosin  $2\frac{1}{2}$  oz., beeswax  $\frac{1}{2}$  oz., powder  $\frac{1}{2}$  oz.

If, during the exhaustion of a tube, one suspects a leak and evacuation does not seem to progress, it is easy to test the pump by sealing up the side tube from the pump head. Usually it will be found that the

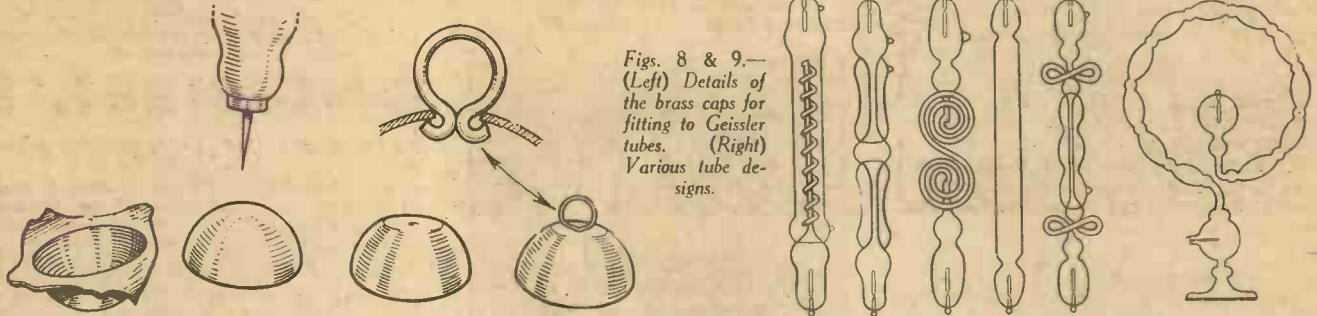

Figs. 8 & 9.— (Left) Details of the brass caps for fitting to Geissler tubes. (Right) Various tube designs.

be so placed as to be dangerous to attempt any near at hand work without a fracture occurring. Lastly, it may be necessary to strap complicated sections together with strips of wood and string to prevent distortion when joining up, as for instance the tube D.

**Brass Caps or Terminals**

To get a professional finish, Geissler

whilst turning the brace briskly, a good polish should result. The centre of the cap should now be punctured with an awl; this leaves a rag on the inside which holds the loop of wire or strip brass in position. Fig. 8 shows how these caps are made. For fixing, a pellet of tin or aluminium coil not too tightly compressed is pressed over the protruding wire on the Geissler tube and the cap, loaded with cement

leakage is from the tube, or from the join where it is sealed to the pump. If the latter case, and the trouble is a small crack, one cannot do better, short of re-heating, than paint the joint with strong shellac varnish. If the trouble is in the Geissler tube then this should be disconnected and repaired. Various other tubes with differing shapes are shown in Fig. 9.

# AN INGENIOUS SCANNER

## The Advantages of Mechanical Scanning

**A** VERY ingenious television scanner has been developed by the Fernseh Co., in Germany and was shown for the first time at the Berlin Radio Exhibition. It is a mechanical scanner employing the German standard of 441 lines interlaced and shows an extraordinary increase in efficiency when compared with the earlier forms of mechanical equipment. By means of a simple electrical changeover which can be effected instantaneously it is possible to use the machine alternately for film, lantern slide or actual person transmissions. This has been done by employing one single scanning disc which rotates at the very high speed of 10,500 revolutions per minute in a completely evacuated casing. The scanning apertures are arranged in two 7-fold spirals; one spiral being used for the scanning of films, while the other is the medium for scanning persons or lantern slides, as desired.

engineer in charge is in a position to change over from one transmission to another at any desired moment. This adaptability is useful for many purposes. For example, in the case of a lecture it is possible for the lecturer himself or films and lantern slides illustrating the talk to be transmitted without any delay except a straightforward electrical fade over.

**Individual Scanning**

The whole scheme is shown very clearly in the diagrammatic illustration of Fig 1, where the individual sections of the equipment and their function have been itemised. For individual scanning it will be seen that the light spot method has been resorted to and owing to the use of very high efficiency photo electric cells in conjunction with

secondary amplification it has been found possible to dispense with arc lamps for all three scanning devices, in spite of the high number of lines. In each case incandescent lamps have been employed, a scheme which is preferable because of the greater degree of reliability, coupled with the simplicity of operation. Mention should also be made of the lighting arrangement of the cabin for the scanning of persons. Up to the present it has been usual with light spot scanning to have the cabin always in darkness but with this equipment the small studio is illuminated during the fly-back or synchronising pulse period and is then darkened while the picture signal is being generated. The person seated in the studio therefore with this arrangement is quite capable of reading a manuscript, a factor of great importance with either lecturers or announcements. The demonstration of this apparatus shows quite definitely that for certain purposes mechanical scanning still has specific advantages and the resulting pictures are sharp and clear.

**882 Apertures**

The disc has as many as 882 very fine apertures of about .06 mm., together with 441 slots for the generation of the line synchronising pulses and another set of slots for the frame synchronising. The very high degree of accuracy necessary on account of the large number of apertures, and the use of interlaced scanning has been achieved by a specialised production method developed only after years of research work. The three scanning sets for film, persons and lantern slides are arranged in such a way that they can be operated and supervised at the same time. By using this arrangement the three transmissions are ready for operation at any moment and the

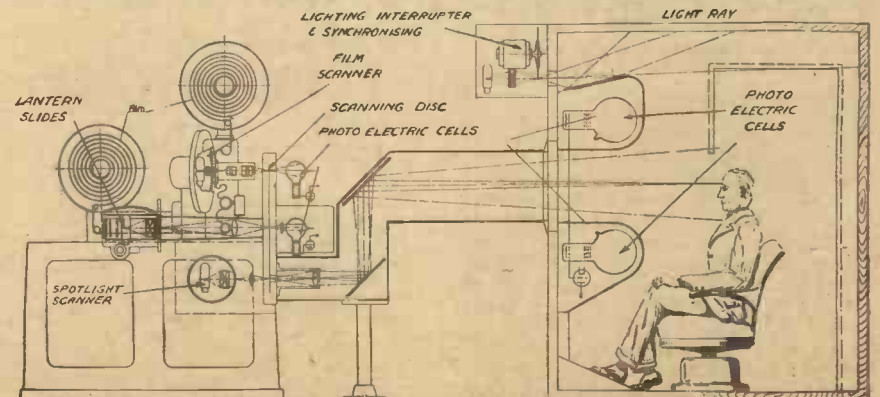

Fig. 1.—Schematic diagram of a universal mechanical television scanner

# STARGAZING FOR AMATEURS

A NEW SERIES

By N. de Nully  
A GUIDE FOR OCT.

THE Moon will be in apogee (251,350 miles) on the 2nd, in perigee (229,940 miles) on the 16th, and in apogee again (251,310 miles) on the 30th. When in perigee the Moon's distance from the Earth will be over 20,000 miles less than when in apogee. Consequently the nights of the 15th, 16th and 17th will, if clear, be very suitable for exploring under afternoon illumination the numerous formations lying along or near the terminator, when they will be at closer quarters than at any other period of the month. On those dates the Moon will rise between 10.0. p.m. and half an hour after midnight. The changed appearances of the "craters" lit up by the last rays of the setting Sun, compared with their more familiar aspects when thrown into sharp relief at the commencement of the lunar day, will be curiously different yet similar.

### The Planets

Mercury rises and sets with the Sun and will therefore not be seen. Mars is a "morning star" rising in the dawn about 4.0 a.m., but is no longer of much interest as its disc has shrunk to one-third the diameter it exhibited when in opposition in 1937, and the perception of detail is virtually impossible except in huge instruments. Mars and Neptune will be very close together on the morning of the 12th.

Venus will be at greatest brilliancy as an "evening star" on the 16th. Through a telescope it now presents a broad crescent, resembling the phase of the Moon two days or so before First Quarter. The accompanying drawing indicates the kind of faint diffused markings that many competent observers have consistently reported to have glimpsed from time to time; they may be extensive or in patches. These elusive shadings are considered to represent thinnings in the planet's cloudy atmosphere, rather than indistinct views of the actual surface. They are best discernible through an intervening pale neutral-tinted eyepiece cap, or a pair of ordinary sun spectacles such as are sometimes worn to diminish glare. The nature of the enveloping covering—or atmosphere—of Venus is not definitely known. Spectroscopic observations reveal the presence of considerable quantities of carbon di-oxide; but there are no signs of either oxygen or water vapour.

Jupiter rises in daylight at 4.15 p.m. and will be due south at 9.0 p.m., setting at midnight at the end of the month. The following interesting configurations of its four principal "moons" may be observed at 8.30. p.m. on the dates stated. On the 6th, 22nd, 28th and 29th there will be a transit in progress of one or the other of the four principal satellites; and at the same time on the 4th, 5th, 7th, 12th, 14th, 17th, 30th and 31st there will be temporarily only three of them visible, the missing one in each case being hidden in eclipse. The commencements and terminations of other eclipses that will take place before or soon after midnight this month may be watched on the undermentioned evenings. The times given are of disappearance, those in brackets being of reappearance. On the 4th, Sat : IV, 6.34 p.m. (11.15 p.m.). On the 7th, Sat : I, 6.30 p.m. (9.51 p.m.). On the 12th, Sat : II, 6.14 p.m. (11.23 p.m.). On the 14th, Sat : I, 8.20 p.m. (11.46 p.m.). On the 17th, Sat : III, 5.28 p.m. (8.59 p.m.). On the 50th, Sat : I, 6.31 p.m. (10.5 p.m.). With the exception of Sat : III, on the

17th, which will be obscured by and emerge from the great cone of shadow cast by Jupiter in space, all the other "moons" will be eclipsed by the disc of the planet itself and emerge from the shadow.



The Planet Venus, when at Greatest Brilliancy

Saturn will be "in opposition" and at its nearest to the Earth on the 8th, its distance being then reduced to 781,276,000 miles. Thereafter their separation will rapidly increase, but subsequently diminish again

until both are once more on the same side of the Sun in 1939. Saturn rises at 6.0 p.m. at the beginning and at 4.0 p.m. at the end of October, remaining above the horizon most of the night. The spectacle of the rather bulging yellowish ball, girdled by two wide somewhat inconspicuous belts and floating, as it were, poised in the centre of a unique system of thin flat flood-lit rings, is a beautiful sight in an astronomical telescope of four inches aperture and upwards: smaller instruments will, however, give quite good general views under favourable atmospheric conditions. Of the nine satellites only the largest, Titan, can be perceived with ordinary instruments. On rare occasions white spots appear on the cream-coloured exterior of the ball. These are ascribed to violent sub-surface eruptions of gaseous or liquid material welling up from the depths below. At first they are noticed as glistening patches of irregular shapes which soon expand and later on gradually elongate into narrow encircling bands. After a while they imperceptibly merge into their cloudy surroundings. The last of these mysterious outpourings was accidentally detected in 1933 by an amateur stargazer using a 12-inch reflector: but, once discovered, it was found to be discernible with lesser apertures. In addition to the outer ring A, and the brighter inner ring B, which are separated by a dark empty gap called Cassini's Division after the famous astronomer, there is the innermost gauzy Craze Ring. Though invisible (except in very large telescopes) against the black background of the space between Saturn and the illuminated rings, its existence is readily perceptible as a dark curved margin to the more compact

(Continued on page 48)

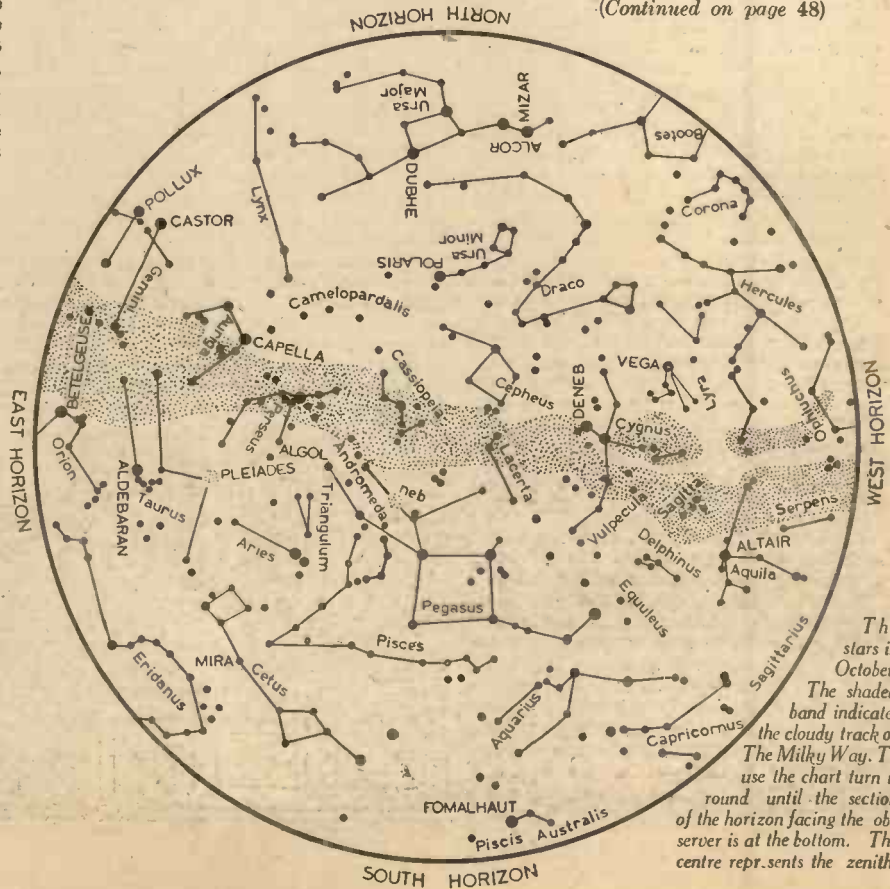

The stars in October. The shaded band indicates the cloudy track of the Milky Way. To use the chart turn it round until the section of the horizon facing the observer is at the bottom. The centre represents the zenith.

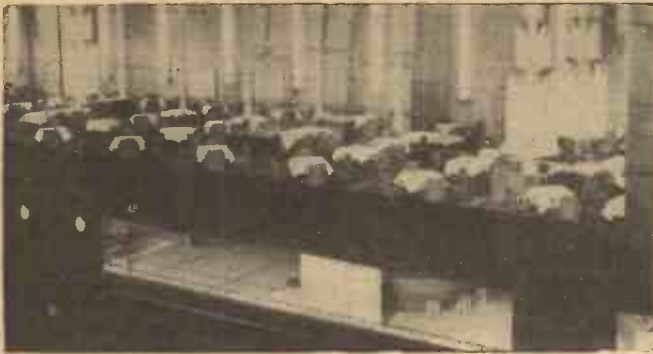

Close-up of the dining saloon of the "Normandie" scenic model.



Fitting up the small suites-de-luxe.

# INSIDE A MODERN LINER

Records, in Model form, of Ocean Travel

By W. J. BASSETT-LOWKE

EVER since we can remember, even in the sailing days, models have been made to keep a record of ocean history. It is a good thing, for the models in museums of some of the early ships are practically our only record—except for very rare drawings—of what vessels of that time were like.

The scale for such models has been generally  $\frac{1}{4}$  in. to the foot or one fortieth the actual size. Nowadays, with the giant ocean liners which sail the seven seas,  $\frac{1}{4}$  in. to the foot means that the models will be enormous—in the case of the *Queen Mary* and *Normandie* over 20 ft. long. If a model is made to  $\frac{1}{4}$  in. scale or one ninety-sixth actual size, the ship will appear to the public who are not versed in shipcraft as small, and will not allow for as much detail in finish.

The Paris Exhibition of 1937 saw the early development of a new idea in presenting the modern ocean giant to the public; that is, taking a section of the ship to a fairly large scale and also showing the interior of parts of the vessel. A part of the *Normandie* was modelled in this way by Messrs. Bassett-Lowke, Ltd., of Northampton, for the French Line and shown in the marine section of the exhibition, causing an enormous amount of interest in both model and ship. The dining saloon, swimming pool and some luxury suites were shown in the cut-away hull.

The first British shipping company to realise the possibilities and appeal of this new scenic model has been the Orient Line. The two new vessels of this line, *Orion* and *Orcades*, have given the lead to English

shipping in so much as their interior decoration is concerned. By appointing a distinguished expert, Mr. Brian O'Rorke, in charge of the whole of the ship's decoration scheme, the design has been kept uniform.

The Orient Line's model is of the *Orcades*, showing typical first-class accommodation on the ship, and the making of the model was entrusted to Messrs. Bassett-Lowke, who have endeavoured to produce with exactitude the details of a section amidships. The scale is  $\frac{3}{8}$  in. to the foot or one thirty-second real size. The model is 4 ft. high by 3 ft. wide and takes a section of the ship from funnel to waterline, showing the boat and sports deck, upper and lower promenade decks, cabins on the main deck and a portion of the magnificent dining saloon.

The first thing to strike your eye is the pleasing colour scheme of the model. Buff funnel with its naval type black cap—a singular feature of Orient Line ships, sparkling white upper work relieved by teak surround and doors, cream hull and green boot-topping and window-framing.

On the sports deck we find ship games of every kind, deck quoits, bull board, deck tennis and shuffleboard, etc., and the promenade decks are most carefully lined, and a feature to notice is the deck chairs of two types, which are to scale and most realistic. A peep on the upper promenade deck shows you a portion of the ballroom, and on the lower deck is a two-berth promenade deck cabin with bath.

On the main deck the ship's plating is cut away to reveal three different types of first-class accommodation—double cabin state-

room with bath, and single, and also one of the air-conditioned flats, with its own lavatory, bathroom, entrance hall, living-room and pantry. It has multi-coloured curtains and bedspread with capstans and other sea things depicted. On the wall of one of the rooms is a unique needlework picture.

The majority of the dining saloon is modelled, and gives the real atmosphere of this attractive and delightful room. There are approximately 150 chairs most exquisitely modelled, and the model makers have also reproduced Mr. Ceri Richards' "Conversation Piece" wall decoration. This work shows Neptune watching over the course of the ship. Neptune is in white wood beside a sea of ribbed steel, over which are floating skies of glass carved with the Zodiac signs. There is an astrolobe of silver metal, a sun, moon and mermaid, and the design is built on varying planes, with no positive colour except the different metals and their points of reflected light, and the varying tones of the glass.

To get the colours correctly and the little details, several visits to the ship were necessary and the constructional work was in the hands of Mr. R. Carroll. The work was supervised by Mr. P. Tranter and his sister, Miss Tranter, was responsible for the hand painting of the curtains, carpets and other fabrics used in connection with the furniture.

The model is at the present time in the Australian Government Pavilion of the Glasgow Empire Exhibition and at the close of the exhibition will probably be seen in the West End office of the Orient Line, London.



The funnel and deck details under construction.



Decorating the small cabin.

## STARGAZING FOR AMATEURS

(Continued from page 46)

structures where they cross in front of the ball. As all stargazers are aware, these curious appendages are composed of multitudes of what are believed to be the tiny fragments of one or more shattered satellites which somehow came within the disintegrating area of the powerful tidal forces of gravity exerted by the ponderous mass of the planet. This theory, at first deduced mathematically, was subsequently confirmed spectroscopically. Moreover, the obviously sparsely distributed particles constituting the Crape Ring seems to furnish visual corroboration of the granular character of all three especially as, when stars pass behind them, they are merely more or less dimmed and not entirely obliterated.

### Shooting Stars

There is a possibility that "shooting stars" associated with Comet Giacobini-Zinner may give a display on the nights of the 8th or 9th of this month though, unfortunately, the Moon will be almost full. The meteors of this stream unexpectedly provided an astonishing exhibition on the earlier date in 1933, but nothing has been seen of them since. The associated comet was discovered by Giacobini in 1900 and again independently by Zinner in 1913, hence the combined name. It has a calculated period of about 6½ years. After being missed in 1907 and 1920, the comet was picked up in 1926, in which year a good shower of meteors occurred followed by another in 1927. Since it has been inferred that a dense swarm precedes the nucleus of the comet, there is a very fair chance of at least a moderate shower this month, with a grander one next year when the comet is due to return again.

### The New Hammond Electric Clocks

**ELECTRICAL COMMODITIES, LTD.**, Spartan Works, Beresford Avenue, Webley, makers of Hammond clocks, provide a clock for every room in your house—at prices you can afford. In these new models, the natural beauty of rare and lovely woods, genuine onyx, mirror glass in attractive colours, metals, "Onex" in lovely pastel shades, and moulded materials combine to produce clocks that are objects of unusual beauty. You have your choice from a range which is delightful.

An outstanding feature of Hammond electric clocks is the electrically operated automatic calendar.



A Hammond Electric Calendar Clock.

This calendar clock mechanism is patented throughout the world and can, therefore, only be incorporated in movements manufactured by the Hammond Clock Company.

This "three-in-one" movement incorporates time, alarm, and automatic changer and, besides being particularly useful, these special features are novel and attractive.

The datal calendar movement is housed in nine different specially designed cases and every care has been taken to harmonise the metal work with the surround and the colour schemes are such that they will fit in with every decorative scheme.

Hammond clocks will operate on any voltage from 200 to 250 volts and a frequency of 50 cycles. A variation of voltage within limits will not affect their operation. A frequency variation, however, will make them gain or lose.

### 1938 Broadcast Catalogue

**T**HE home constructor will find plenty to interest him in the new 1938 Broadcast Catalogue just issued by the Dubilier Condenser Co. (1935), I.t.d., Ducon Works, Victoria Road, North Acton, London, W.3. Every type of fixed condenser used in radio construction is listed, together with appropriate tables showing working voltages, size, etc., of each type. Metallised resistances and volume controls are also shown, together with various types of motor radio suppressors, which satisfactorily cut out interference from electrically ignited internal combustion engines as used in motor-cars, motor-boats, and small electric lighting plants, etc. A resistance calculator is also printed at the back of the catalogue.

### ARTIFICIAL GEMS

For a considerable time now rubies and sapphires have been synthetically produced on a paying commercial scale, while emeralds have also been successfully produced, but not as a paying proposition. Everyone, of course, knows of the Japanese cultured pearl, but this gem is not in the same category—being a silicon product but of animal origin—if one may call an oyster an animal?

### Synthetic Rubies

The synthetic rubies are absolutely indistinguishable from genuine, as are also the sapphires, and the only certain test is the use of the Ultra Violet Ray, which shows variation in what lapidaries term the "cleavage lines."

Ruby is simply a variety of corundum or alumina, the shade of colour being due to greater or lesser percentages of chromic oxide, while sapphires are basically the same, the colour being due to the presence of magnetic oxide of iron. They are both easily and profitably produced by Prof. Verneuil's process of fusing the raw alumina in an oxy-hydrogen flame, the much-prized pigeon blood ruby colour being obtained by adding 2.5 per cent. of chromic oxide and the rare cornflower blue sapphire with 1.5 per cent. magnetic iron oxide.

At the present moment some 20 million carats are produced commercially per annum. It is only a matter of time before that Queen of Gems the diamond is available as readily.

Those of us who are so fortunate as to own diamonds, rubies, sapphires, or any of the precious stones in quantity need not,

however, worry, for there will always be a sharp "line of cleavage" between the natural and synthetic stones in point of value. This has been clearly seen in the case of pearls, as mentioned above, and will undoubtedly extend to the mineral gems also, for the development of Ultra Violet and Quartz Lamp tests will be a definite and expert guide to the relative values.

### The Opal

One thing is pretty certain, and that is that the synthetic production of diamonds will, without doubt, enhance the values of such gems as opal, catseye, etc. It is almost impossible for the opal, that wonderful stone which the old Greek writer likened to a "rainbow on a midnight sky," to be produced by laboratory methods. The opal is not, like the foregoing gems, crystalline, but is an amorphous form of hydrated silica containing quite an appreciable amount of water. It exists in many forms other than the gem, and one very curious type, known as hydrophane, is more porous than a sponge, indeed such is its affinity for water that if applied to the tongue, it will cling to that organ like a leech.

### A FIRM ATTACHMENT

**W**HEN linoleum is laid, an effective adhesive must be used in order to secure a happy alliance between the covering and the floor. An application has been accepted by the British Patent Office to protect a new adhesive for linoleum. The object of this device is to prevent moisture from penetrating into the floor and to furnish an adhesive which is permanent and unaffected by expansion and contraction caused by varying temperatures.

The adhesive in question is a highly viscous liquid or plastic mass, consisting of a resin of low softening point, for example, colophony, and a resin of relatively high softening point, such as copal, in alcoholic solution. In addition, there are alkali-resin soap and finely divided mineral substances.

One outstanding advantage which it is asserted this adhesive possesses is that the linoleum can be pressed on to the floor immediately after the application of the adhesive. And it is further stated that prolonged pressure is unnecessary.

This attachment between the linoleum and the floor should prove a union of compatibility.

### THE P.M. LIST OF BLUEPRINTS

F. J. CAMM'S  
PETROL-DRIVEN MODEL MONOPLANE  
7s. 6d. per set of four sheets, full-size.

The "PRACTICAL MECHANICS" £20 CAR  
(Designed by F. J. CAMM.)  
10s. 6d. per set of four sheets.

The "PRACTICAL MECHANICS"  
OUTBOARD SPEEDBOAT  
7s. 6d. per set of three sheets.

A MODEL AUTOGYRO  
Full-size blueprint, 1s.

SUPER-DURATION BIPLANE  
Full-size blueprint, 1s.

The  
P.M. "PETREL" MODEL MONOPLANE  
Complete set, 5s.

The 1-c.c. TWO-STROKE PETROL ENGINE  
Complete set, 5s.

The above blueprints are obtainable post free from  
Messrs. G. Newnes Ltd., Tower House, Strand, WC2

# ATOMIC MECHANICS

By R. L. MAUGHAN, M.Sc.

## Exploring the Structure and Internal Mechanics of the Atom

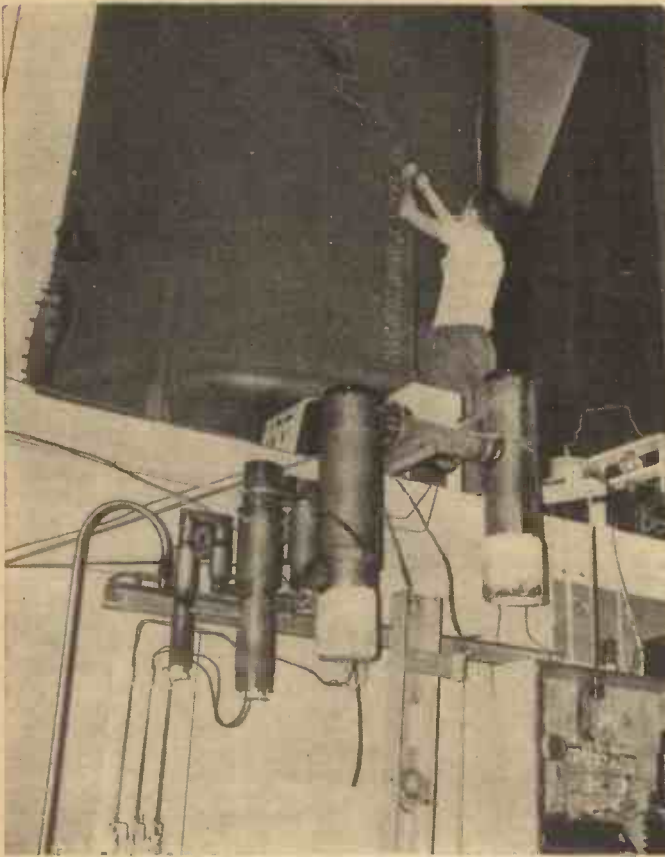

A two-million-volt machine for transmitting the elements. It was built under the direction of Dr. Lauritsen, who for some years has been engaged in measuring energies released when one element is changed into another element by the smashing of particles out of the hearts of the atoms, or nuclei.

magnetism and electricity were grouped together into the Electromagnetic theory of light, forming all told the two main classes Material Physics (heat, sound, mechanics), and Non-material or Ether Physics (light, magnetism, electricity).

### Process of Unification

The evolution of scientific theory seems to be a process of unification. It aims at an elucidation of the universe in terms of a minimum number of postulates and fundamentals. The achievement of nineteenth century classical theory was to reduce it to these two groups, material physics and ether physics. A link between the two was provided by the electron, which was recognised as being a fundamental particle of matter and electricity simultaneously. A further bond came in 1900 in the form of Planck's theory of all quantisation of radiation, and the subsequent quantisation of all forms of mechanical energy, whereby light and kindred forms of energy were shown to be discontinuous and atomic in nature just as matter is. Investigations into the existence of the ether and nature of quantisation led to a reassignment of the subjects in the above two groups to give the two main divisions of modern physics, Cosmic Physics and Atomic Physics.

### Two Theories

These two theories treat with the extreme ends of the scale of things in nature. Cosmic physics, which is based on Einstein's relativity theory, tends to ignore the detailed structure of matter and wanders to the outer edges of the universe in an attempt to regard it as a unified whole. Atomic physics on the other hand, is primarily concerned with the minute structure and mechanism of the interior of the individual atom, a region of space whose diameter is of the order of one hundred millionth of a centimetre.

Atomic physics had its beginnings in the last decade of the last century. The belief that matter is atomic in nature had been held for practically two thousand years, but nothing was known about the inside of an atom until the phenomenon of radioactivity was discovered and the conduction of electricity through gases at low pressure was investigated. In 1896 Becquerel discovered radioactivity in the element uranium. His line of research which led to it was inspired by the discovery of X-rays in the previous year by Röntgen, who had observed that these rays were emitted amongst other radiations from the glass walls of a discharge tube which were made to phosphoresce under the impact of the cathode rays inside the tube. Henri Becquerel suspected that a relation existed between X-rays and phosphorescence, and

atom and attempting to provide this theory was bequeathed to the twentieth century.

### Classical Physics

Nineteenth-century physical theory is usually described as "classical," suggesting that it is no longer accepted as current theory but is still of much historical importance. As a subject classical physics was divided into six more or less clear cut departments: Heat, Light, Sound, Magnetism, Electricity, and the Properties of Matter. In time, with the further development of the subject, these various departments became linked together, heat and mechanics were identified in terms of the kinetic theory by reason of the atomic nature of matter, sound was discussed in terms of oscillation mechanics, and light,

WHEREAS mechanics as a science has been recognised and used in some form or other for twenty centuries or more, the structure and mechanism of the atom is a branch of physics which was opened up only about forty years ago.

The application of the principles of mechanics, as they were then understood, to the atomic theory of matter reached a high degree of elegance in the late nineteenth century in the form of the Kinetic Theory of Gases. This theory, which is one of the most successful ever evolved in the development of scientific thought, seeks to account for the observed behaviour and properties of fluids, and, to a smaller extent, of solids, in terms of the motion of the atoms and molecules which constitute the substance. These small particles were regarded, as far as the kinetic theory was concerned, as being "fundamental" in the sense that they were small, round, completely elastic, and indivisible, and their movements under ordinary dynamical forces gave a completely satisfactory explanation of the majority of the properties of matter known at the time. No phenomena were known which suggested that atoms were not the hard, massy, indivisible spheres which the kinetic theory supposed them to be, until the closing years of the last century brought the discovery of radioactivity, and the phenomena of discharge of electricity through gases and radiation spectra.

These events brought with them the urgent need of a comprehensive atomic theory, and the problem of exploring the structure and internal mechanics of the

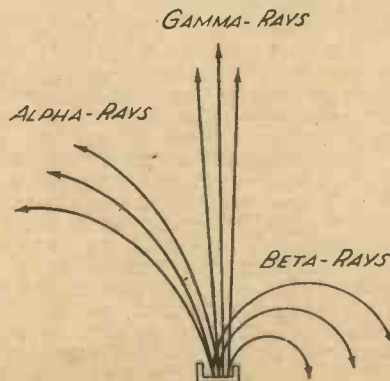

Fig. 1.—The magnetic field is directed at right angles to the plane of the diagram.

accordingly examined various phosphorescent materials for X-rays by first of all subjecting them to an intense light bath to render them phosphorescent, and then placing them on top of a photographic plate wrapped up in black paper. He found that a salt of uranium produced an effect on the plate in a way which had nothing to do with phosphorescence, and eventually saw that uranium was a natural source of a new and powerful radiation which he described by the word "radioactive."

### A Radioactive Element

A radioactive element is one whose atoms explode spontaneously with the emission of radiations, leaving atoms of a new element which are usually radioactive themselves. They disintegrate in their turn, forming new atoms and the process continues until stable non-radioactive atoms are formed. The emitted radiations are of three sorts, which are distinguished by the terms, alpha-, beta-, and gamma-rays, and a disintegrating atom can radiate one or more of these rays in the various stages of its radioactive decay. These rays can be recognised and distinguished by precise laboratory tests based on their varied abilities to penetrate thin sheets of metal, to render gases conductors of electricity, and undergo deflection in electrostatic and magnetic fields. The latter test is perhaps the most striking; in a magnetic field the gamma-rays remain undeflected while the alpha- and beta-rays are bent into curved paths turning away in opposite directions. (See Fig. 1.)

The fact that the gamma-rays were not influenced by magnetic or electric fields suggested that they were electromagnetic in nature, and a detailed examination of their properties, frequency, penetrating power, and spectral resolution when they are passed through the lattice structure of a crystal has shown that they are non-material vibrations in the form of ultra-violet light of particularly short wavelength, closely related to X-rays. The deflection of the alpha- and beta-radiations proved that they were small material particles projected out of the exploding atom with high velocity, and subsequent experiments have established the facts that an alpha-particle is a nucleus of a helium atom, and a beta-particle is a swift electron. One important contribution made by the study of radioactive phenomena is the theory of atomic structure therefore is that the atom is not the hard, round, indivisible object which it was conceived to be by the earlier scientists, but apparently contains alpha-particles, beta-particles, and a means of manufacturing gamma-rays. The existence of discrete particles within the atom implies some sort of arrangement or structure amongst them, and a system of forces to hold them together, the breakdown of which results in the radioactive decay of the atom.

### Disintegration

The theory of radioactive disintegration is founded on the single assumption that the number of atoms in a radio-element which are breaking up at any moment is always proportional to the number of atoms of that element which are left at that moment. The gradual decay of such a substance can therefore be represented by an exponential curve shown in Fig. 2, and a definite lifetime can always be associated with any radioactive element. It is found

to be more convenient practically to express this decay in half-life periods, and a great variety of these periods is proffered by different substances. Radium, for instance, has a half-life period of 1590 years, whereas thorium B<sub>1</sub> half expires in one thousand millionth of a second.

### Rates of Decay

In spite of a considerable variety in lifetimes, chemical properties, and emission rays, all radioactive elements have one particular property in common. Their rates of decay, and the energies of their emitted particles cannot be affected or altered in any way by any human agency. They remained unaltered by the application of extreme physical conditions, very high or very low temperatures, intense electric or magnetic fields, high mechanical pressure or complete evacuation, or by being compounded chemically with other elements.

From the discovery of radioactivity in 1896 until January 1934 it was considered that the promotion of radioactive change in substances as well as the control of the phenomenon, lay outside the powers of human experiment, and all radioactive

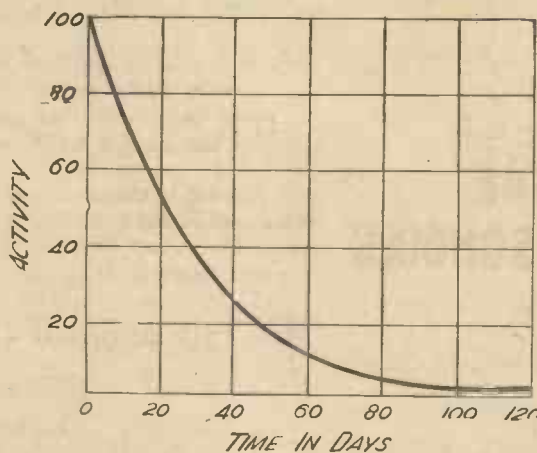

Fig. 2.—An exponential curve showing the disintegration of a radio-active substance.

materials used during that period were those which disintegrated naturally and had apparently been doing so, in accordance with their respective decay laws, for some time before their discovery. But in 1934 Mme. and M. Curie-Joliot succeeded in inducing the process of radioactive decay in several elements by artificial means. By directing the stream of alpha-particles ejected by radioactive polonium into the elements Boron, Magnesium and Aluminium they caused them to become unstable and to disintegrate in the characteristic manner of naturally radioactive elements.

### Sir J. J. Thomson

Research into the discharge of electricity through gases contained in glass tubes at very low pressures began its development a few years prior to Becquerel's discovery of radioactivity. Foremost amongst the pioneers in this branch of physics was Sir J. J. Thomson who clearly demonstrated that the electron, which had been recognised since the time of Faraday as a fundamental unit of electricity, was a particle of matter incorporated into the structure of all atoms. The glowing discharge between the electrodes in a tube of gas at low pressure was shown to be a high velocity stream of negatively charged particles torn out of the gas atoms and directed from cathode to anode by the high voltage applied across the tube. Thomson proved that identical negative particles were always obtained

from gases which were chemically different, from which it was concluded that these particles were "fundamental building bricks" common to the structure of all atoms. He did this by measuring the ratio of charge to mass for the cathode ray corpuscle in a discharge tube specially designed for the purpose, and at the close of a series of brilliant experiments which remain a landmark in the history of physics, announced in 1897 that this ratio (and hence the particle itself), was the same no matter which gas it came out of. This ratio value was furthermore seen to be the same as that for the fundamental unit of charge, the electrolytic monovalent ion, met with in the phenomenon of discharge of electricity through liquids, to which the name "electron" had been applied by Dr. Johnston Stoney in 1891. The cathode rays were thus proved to be a cascade of electrons.

### Discharge Tube

The Thomson discharge tube contains a plane metallic cathode fused into one end of the tube from which the electrons are propelled rectilinearly at high speed towards the anode. The anode, situated a few centimetres from the cathode, has a small circular aperture in its centre through which the rays pass as a solid cylindrical beam which is further pared down into a narrow flat ray by the slit in an auxiliary anode farther down the tube. This ray afterwards passes through a region of "crossed fields" (an electric field and a magnetic field acting across the ray so that at the point of intersection all three are mutually inclined at right angles) which tend to deflect it in opposite directions, the deviation being precisely measured on a phosphorescent screen divided into squares and mounted in the end of the tube. The screen glows with a sharp blue light at a point where the rays make impact, and by suitably controlling the field intensities the ray can be brought back to its undeviated position. A simple calculation then gives the ratio of the charge to the mass of the electron

### Accumulated Data

By 1911 sufficient data had been accumulated from radioactive and gas discharge research to enable the late Lord Rutherford, leading experimentalist in radioactive work, to propound his Nuclear theory of the Atom, which explains a structure made up of protons and electrons collected in a nucleus with a distribution of electrons in surrounding orbits. It was left to Niels Bohr to suggest two years later a definite arrangement of these extra-nuclear electrons which gave an interpretation of optical spectra on a quantum theory basis.

(To be continued)

### THE P.M. LIST OF BLUEPRINTS

- F. J. CAMM'S  
**PETROL-DRIVEN MODEL MONOPLANE**  
 7s. 6d. per set of four sheets, full-size.  
 The "PRACTICAL MECHANICS" £20 CAR  
 (Designed by F. J. CAMM.) 10s. 6d. per set of four sheets.  
 The "PRACTICAL MECHANICS"  
**OUTBOARD SPEEDBOAT**  
 7s. 6d. per set of three sheets.  
**A MODEL AUTOGYRO**  
 Full size blueprint, 1s.  
**SUPER-DURATION BIPLANE**  
 Full size blueprint, 1s.  
 The P.M. "PETREL" MODEL MONOPLANE  
 Complete set, 5s.  
 The 1-c.c. TWO STROKE PETROL ENGINE  
 Complete set, 5s.

The above blueprints are obtainable post free from Messrs. G. Newnes Ltd., Tower House, Strand, W.C.2.

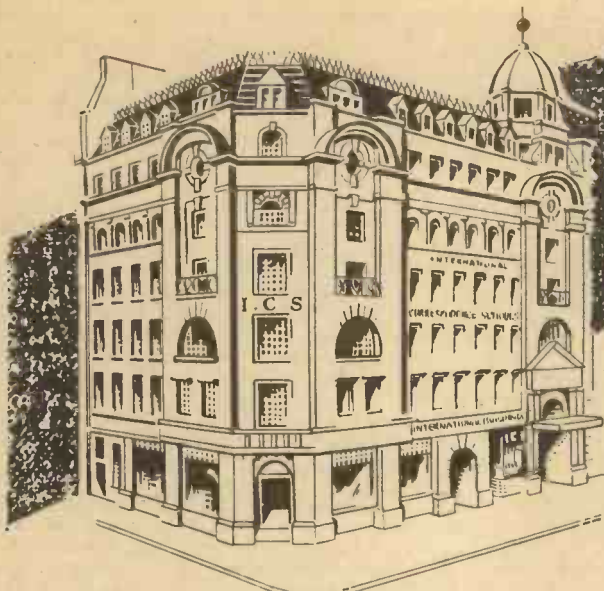

*Your Work -  
AND Your Pay*

The size of your salary is more or less in accordance with the measure of what you know and therefore can do. The more you know, the greater your pay.

Success—progress won by merit—depends on trained ability. Unless you have studied IN YOUR SPARE TIME, you have little chance of promotion, for knowledge that comes through everyday work is not enough.

You must know the principles underlying your work and be familiar with the many processes closely related to that work. *The one and only means of obtaining such knowledge is specialized study.*

No man need be without that extra efficiency which adds so much to his income, security, and happiness. He can acquire it on easy terms, by the simple I.C.S. method of teaching by post.

If you are in the early stages of your career and have not yet had a specialized training, you should start to get one without delay. Or perhaps you feel that your knowledge is a little out of date and ought to be modernized. In either case

**The International Correspondence Schools can help you.**

*Our expert advice on any matter concerning your work and your career is yours for the asking—free and without obligation. Let us send you a booklet dealing with the subject in which you are especially interested. It is packed with valuable information.*

The I.C.S. offer instruction in the subjects given below.

**Write for Special Booklet to-day or use the Coupon.**

This is  
**INTERNATIONAL BUILDINGS  
KINGSWAY, LONDON**  
Head Offices of the  
**INTERNATIONAL  
CORRESPONDENCE SCHOOLS**

It is the centre from which radiates technical, commercial, and professional instruction that has been of great benefit to tens of thousands of ambitious people.

The I.C.S. is the greatest as well as the largest institution in the Empire devoted to spare-time training. Its prestige is unequalled. Several State Departments have entered into working arrangements with the I.C.S. for the training of men.

More than 1,500 I.C.S. text-books, prepared at International Buildings, are marvels of clearness, accuracy, and practical helpfulness.

There are 80 Instructors at Kingsway, many of them Associates, Members, or Fellows of their respective technical or professional bodies. *All are specialists, and expert in giving the student individual attention throughout his Course of Study.*

Among the 400 I.C.S. Courses there is one that can qualify YOU for Promotion and better Pay.

**COUPON FOR FREE BOOKLET**

**INTERNATIONAL CORRESPONDENCE SCHOOLS, LTD.; (Dept. 95), International Buildings, Kingsway, London, W.C.2**

Please send me your booklet containing full particulars of the Course of Correspondence Training before which I have marked X. I assume no obligation.

- |                                                   |                                                    |                                                        |                                                       |
|---------------------------------------------------|----------------------------------------------------|--------------------------------------------------------|-------------------------------------------------------|
| <input type="checkbox"/> Accountancy              | <input type="checkbox"/> Diesel Engineering        | <input type="checkbox"/> Marine Engineering            | <input type="checkbox"/> Scientific Management        |
| <input type="checkbox"/> Advertising              | <input type="checkbox"/> Draughtsmanship           | <input type="checkbox"/> Mechanical Drawing            | <input type="checkbox"/> Short-Story Writing          |
| <input type="checkbox"/> Aeronautical Engineering | <input type="checkbox"/> Electrical Engineering    | <input type="checkbox"/> Mechanical Engineering        | <input type="checkbox"/> Steam Engineering            |
| <input type="checkbox"/> Air Conditioning         | <input type="checkbox"/> Engineering Shop Practice | <input type="checkbox"/> Mining Engineering            | <input type="checkbox"/> Surveying                    |
| <input type="checkbox"/> Architecture             | <input type="checkbox"/> Fire Engineering          | <input type="checkbox"/> Motor Engineering             | <input type="checkbox"/> Telephone and Telegraph Eng. |
| <input type="checkbox"/> Boiler Engineering       | <input type="checkbox"/> Garage Management         | <input type="checkbox"/> Pattern-making                | <input type="checkbox"/> Textiles                     |
| <input type="checkbox"/> Book-keeping             | <input type="checkbox"/> Gas-Power Engineering     | <input type="checkbox"/> Plumbing                      | <input type="checkbox"/> Welding, Gas and Electric    |
| <input type="checkbox"/> Building                 | <input type="checkbox"/> Heating and Ventilation   | <input type="checkbox"/> Radio Equipment and Servicing | <input type="checkbox"/> Wireless Engineering         |
| <input type="checkbox"/> Chemical Engineering     | <input type="checkbox"/> Hydro-Electric            | <input type="checkbox"/> Salesmanship                  | <input type="checkbox"/> Woodworking                  |
| <input type="checkbox"/> Civil Engineering        | <input type="checkbox"/> Journalism                | <input type="checkbox"/> Sanitary Engineering          | <input type="checkbox"/> Works Management             |

**EXAMINATIONS**

Technical, Professional, Matriculation, and Civil Service. State the one you wish to pass.....

NOTE.—If your subject is not on the above list, write it here.....

NAME..... AGE.....

ADDRESS .....



# A NIBBLING MACHINE

A Useful Device for Model Making and Small Engineering Work.

**T**HERE are a great many parts made of steel and iron plate in model and other small engineering work which require extensive drilling, sawing and filing to cut the inside to the desired shape, and a nibbling machine allows this to be done quickly and easily and will give openings with the edges truly square with the surface.

The principle of the "nibbler" is the reciprocating of a vertical pillar through a bearing in a horizontal iron plate. The pillar carries a small hardened steel cutter which projects about 3/16 in. (or less) and the work is held to the pillar which acts as a guide to the depth of cut. Since the tool is in the pillar, and there is no obstruction on the table, the cutter can deal with all shapes of cut inside a circle not less in diameter than the diameter of the pillar plus the amount the cutter projects from the outside surface of the pillar.

Such a cutter can cut mild steel if the cutter projects only 1/16 in. to 1/8 in. It can cut brass easily and also such materials as vulcanised fibre, papier mâché, etc. Fig. 2, shows a simple but very substantial "nibbler" suitable for general workshop use.

### The Table

The table A and guide boss B is in one casting of iron. In it is fitted the tool post C which carries in a transverse 1/4 in. hole, the tempered steel nibbling cutter D. This cutter is held down by a set screw E which should be case hardened. This screw is 3/8 in. Whitworth and has a square head. A small grub screw F, 5/16 in. in diameter, screws in the hole which carries the cutter and while backing up the cutter, also acts

as a very fine method of adjustment of the cutter outwards away from the pillar and to the work. The pillar is guided in the long bore which it fits snugly, a good sliding fit.

At the bottom it is reduced as shown, to 1/2 in. in diameter and threaded with a Whitworth thread, the bottom of the guide hole in the casting having a 1/2 in. hole to fit it. Inside the annular space thus provided is a compression helical spring G which keeps the pillar held upwards in the position shown.

### The Treadle

The upward stroke of the pillar is governed by the nut H which has a hard rubber washer J above it to act as a buffer and the nut is locked by a sleeve K which is flattened each side at the bottom and has a hole bored through it to take the hook L. This hook is the means by which the reciprocating pillar C is drawn down on the cutting stroke through the medium of an iron rod and a treadle. The arrangement of this treadle and its connection to the machine is shown at Fig. 1.

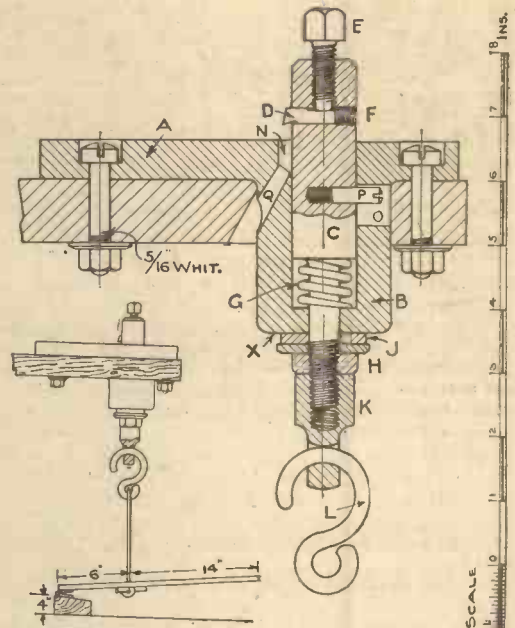

Figs. 1 and 2.—(Left) Details of the treadle and method of connection to the "nibbler" machine shown in section on the right.

held in the three jaw chuck and the flat surface of the table faced off, using the cross slide set dead square with the lathe mandrel. The edges of plate A need not be machined.

### Tipping the Pillar

The parallel hole to take the pillar C is then bored to the depth shown and finally the hole for the reduced end of the pillar to dimensions in Fig. 4. A slot 1/4 in. wide and to the length shown is cut at O (Fig. 2.). This takes a 1/4 in. cast steel pin P screwed in the pillar, the hole in the pillar being clear 1/4 in. for 3/8 in. and then tapped 1/4 Whitworth as in Fig. 2. This pin should stop the pillar at such a position that the bottom of the cutter is 1/4 in. above the surface of the table. The slot at N should be just wider than the cutter, the shape and dimensions of which are shown in Fig. 4 to twice the scale of the rest of the drawing.

To clear the smallest chips a hole Q is drilled at an angle, as in Figs. 2 and 4, and reamed out with a taper reamer so that the chips, pushed down by the cutter, will have clearance to fall away through the sawn slot in the bench to which the tool is fixed.

The pillar C is a straight forward piece of turning in Bessemer bar. The end is turned and threaded to 1/4 in. Whitworth. The hole at the top is 3/8 Whitworth. The cutter hole is 1/4 in. and at the back is threaded 5/16 in. for the hardened grub screw F.

An ordinary motor-cycle valve spring cut down and with ends flattened (by grinding, not heating), will probably be found suitable for the return spring G. The sleeve K is made of Bessemer bar flattened by sawing and filing, and should be long enough to allow of some adjustment, when necessary, of the cutter above the table if material more than 1/4 in. thick (such as brass plate) is to be worked upon. A 1/4 in. hole is bored through the flat and rounded each end, as shown, to conform with the curvature of the hook (see Fig. 2). The hook is made of 1/4 in. steel rod.

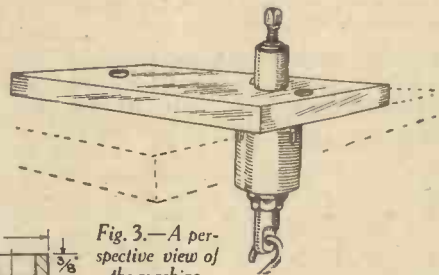

Fig. 3.—A perspective view of the machine.

It consists of an oak board 5 in. wide and 3/4 in. thick hinged, by an ordinary hinge shown, to a block of wood screwed to the floor under the bench to which the tool is bolted by the recessed bolts, shown in Fig. 2, with washers and nuts underneath the bench.

The table A is recessed at N to allow the cutter to pass the top surface of the table.

The downward stroke, after the cutter has nibbled the plate, is checked by spring G which raises the pillar C after each stroke and lifts the treadle by the wire rod which is anchored under a hole in the treadle by a cross pin shown in Fig. 1.

Fig. 4 shows the different parts dimensioned. The machining is simple. The only casting is the bed, made from a wooden pattern of the same shape and dimensions. The casting of this plate is chucked on the lathe face plate with the barrel part B outwards, and the latter is rough turned and the bottom face X is faced off. It is then reversed, the barrel part B being

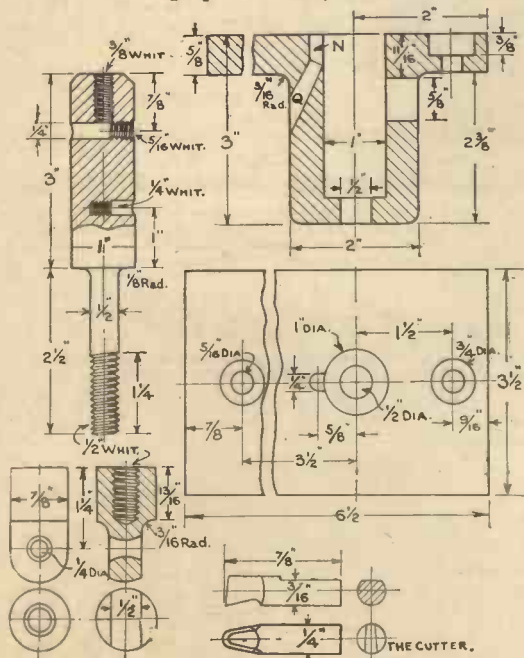

Fig. 4.—Construction details and measurements of the various parts.





# QUERIES and ENQUIRIES

A stamped addressed envelope, three penny stamps, and the query coupon from the current issue, which appears on page 668, must be enclosed with every letter containing a query. Every query and drawing which is sent must bear the name and address of the sender. Send your queries to the Editor, PRACTICAL MECHANICS, Geo. Newnes, Ltd., Tower House, Southampton Street, Strand, London, W.C.2.

## PRODUCING OXYGEN

"WOULD you kindly inform me of a method to produce small quantities of oxygen as cheaply as possible, and at a low temperature?"

"I was under the impression that applying heat to potassium chlorate ( $KClO_2$ ) plus manganese dioxide ( $MnO_2$ ) was one of the best methods, but I am now given to understand that there is a better method." (G. D., Gloucester).

THERE are a number of methods whereby fairly pure oxygen gas may be produced at normal temperatures. Either of the two undermentioned methods will, we think, be suitable for your requirements:—

(a) Mix equal volumes of hydrogen peroxide and dilute sulphuric acid. This mixture, when dropped on to a fairly strong solution of potassium permanganate, will evolve oxygen abundantly.

(b) By dropping water on dry sodium peroxide, six or seven grams of sodium peroxide will, in this manner, give rise to about a litre of oxygen.

## MAKING DOLLS' HEADS

"I UNDERSTAND that 'Otto Compound' is a mixture of paste, sawdust, paper pulp, etc., and can be used for the manufacture of dolls' heads from plaster casts. Could you supply me with a formula for wood pulp, to be used for the same purpose and used in plaster casts?" (J. B. H., Barrow-in-Furness.)

THE compound you name is a mixture in approximately equal parts of wood flour and paper "stuff" or pulp of fine grain and fairly high quality. It is stirred up with gelatine solution, glue or other binding agent previous to moulding.

In making up a preparation of the above nature, you cannot possibly make your own wood pulp. Dried paper "stuff" or pulp can be procured from Messrs. W. Grant & Co., 5 St. Andrew's Square, Edinburgh, or from East London Paper Stock Company, Love Lane, Shadwell, London, E.1.

Wood flour can be obtained from Kinghorn Mills, Ltd., 15 Arundel Street, London, W.C.2.

## CLEANING CLOTH

"I WISH to clean a number of articles made of gaberdine and tweed. Could you advise me of a suitable method to do this, and is naphtha used by firms that do this kind of work? If so, can you explain how?" (J. W., Yorks.)

WE are sorry that you did not inform us exactly what tweed and gaberdine articles you require to clean, since the exact method depends to some extent upon the nature of the fabric articles.

At one time naphtha was used extensively by dry-cleaning firms, but nowadays it is largely replaced by solvents such as carbon tetrachloride, trichlorethane, etc., which, unlike naphtha, are non-inflammable.

If your fabric articles are not big ones, we would advise you to mix chalk or fuller's earth with naphtha or carbon tetrachloride to the consistency of paint. Dab this mixture well on to the fabric, working it well into the fibres. Allow the solvent to evaporate in the open air, and then brush away the chalk or fuller's earth with a stiff brush. The fabric will now be found to be clean and grease-free.

If the cloth will not stand the brushing treatment or if it is too extensive in area for this type of treatment, your best plan is to wipe it down several times with a soft rag well saturated with one of the above solvents.

Remember, of course, if you work with naphtha, that it is highly inflammable and that it should preferably be used entirely out of doors.

Firms who undertake dry-cleaning usually totally immerse the garments in vats containing the solvent. The vat is then heated, after which the garment is removed, dried, pressed and finished.

## CEMENT FOR BALSA WOOD

"IN an attempt to make up a cement for balsa wood, I have used celluloid chip-pings dissolved in amyl acetate and acetone. I find this very slow drying, and should welcome any suggestions you can give me for making a quick-drying cement. Some of the commercial varieties I have purchased from model aeroplane stores are moderately firm after only a minute or so." (P. M., Sussex.)

FOR light cementing work, you will find collodion (which is a solution of gun cotton, cellulose nitrate or "pyroxyline" in a mixture of 2 parts ether and 1 part alcohol) an exceedingly quick-drying solution. Collodion can be obtained ready made from the usual chemical supply firms.

Alternatively, if you dissolve your celluloid chippings in a mixture of 2 parts acetone and 1 part ether, you will obtain a quick-drying cement, particularly when the joined parts are slightly warmed.

All the above liquids are exceedingly inflammable and, when working with them, due regard should be paid to this fact.

Celluloid dissolved in equal parts of acetone and methyl (not emyl) acetate forms a quick-drying cement, also.

## TEMPERATURE OF DEW POINT

"WHAT is the temperature of dew point? If a tank is exhausted of air, will the air in the tank become damp as the temperature falls?"

"How can the air be kept dry, without raising the temperature?" (H. J. S., Ifley).

THE dew point is the temperature at which the water vapour in the air is present in just sufficient amount to saturate

# Be rid of Fear, Inferiority Complex, Shyness, Mind-Wandering, Indecision, Self-Consciousness, TAKE UP PELMANISM

PELMANISM develops the qualities that make for success, such as:

- Courage
- Perseverance
- Self-Confidence
- Business Acumen
- Observation
- Reliability
- Cheerfulness
- Concentration
- Optimism
- Reliable Memory

Pelmanism eradicates the negative qualities that hold one back, such as:

- Timidity
- Unnecessary Fears
- Pessimism
- The Worry Habit
- Procrastination
- Indecision
- Forgetfulness
- Depression
- Shyness
- Inferiority Complex

Pelmanism is a sure way to success if you will give it your loyal effort, your honest endeavour, and a regular and definite amount of time until you have completed the Course. A sustained effort over a period of but a few weeks will yield you dividends that will last you your whole life through.

The Course is exceedingly simple and interesting. Satisfy yourself as to what Pelmanism can do for you. Write or call to-day for a free copy of

## "The Science of Success"

in the pages of which you will read the story of Pelmanism, and, more fascinating than fiction, the stories told by Pelmanists themselves of how their lives have been changed beyond their fondest hopes by Pelmanism stories of promotion, increased incomes, of greater enjoyment of life.

## Pelman Institute

(Established over 40 years)

130 Pelman House, Bloomsbury Street London, W.C.1

## MAKE YOUR APPLICATION TO-DAY

Send in the coupon below and we will send you, absolutely free, the 48-page book "The Science of Success." You owe it to yourself to find out more about this world-famous Course of Training.

To the PELMAN INSTITUTE, 130 Pelman House, Bloomsbury Street, London, W.C.1.

Please send me, gratis and post free, a copy of "The Science of Success."

NAME.....

ADDRESS.....

Occupation.....

All correspondence is confidential.

PELMAN (OVERSEAS) INSTITUTES: PARIS: 176 Boulevard Haussmann. NEW YORK: 271 North Avenue, New Rochelle. MELBOURNE: 306 Flinders Lane. DURBAN: Natal Bank Chambers (P.O. Box 1489). JOHANNESBURG: P. O. Box 4928. CALCUTTA: 102 Chive Street. DELHI: 10 Alipore Road. AMSTERDAM: Damrak 08. JAVA: Malabarweg, Malang.

## ELECTRADIX BARGAINS



**SOUND RECORDING**  
Electric FEIGH set has ball-bearing centre gear box and geared traverse rod. Set with Tracking Gear, Pick-up and Tone-arm fitted diamond, 37/6. Tracker gear only, less Pick-up and Tone-arm, is 21/6. Diamond Cutter Needles fit all pick-ups, 7/6. Blank Discs, 4/- dozen. Complete Acoustic Sets de Luxe, 50/-.

18/-; No. 2, 10/6; Junior Type, 5/6 each, complete.

**CRYSTAL SETS.**—No battery or valves wanted. Efficient for emergency, 7/6 each.

**TELEPHONES.**—For all purposes, Table or wall, house or office phones, from 10/-. Portable Emergency Telephones and Cable Headphones, Pocket type W.D. leather Headbands, 2/6 pr. Sullivan Radio Aluminium Headbands, 9 pr. 4,000 ohm 5/8W lightweight Headphones, 4/6 pr.

**LIGHT RAY CELLS. LEDIX CELLS** are light sensitive, with gold grids, moisture proof, 5/-. Mounted in Bakelite Case, 7/6.

**MICROPHONES.**—Reproduce your voice amplified from radio set to loudspeaker.  
**SOLO BUTTON MICROPHONES, 1/-**—A new practical Solo Microphone for broadcasting at home. It is a general purpose, robust mike, with solid bakelite body, black terminals, front metal grills. No. 11. New design finely finished, 5/6. No. 11A. Special, in solid brass body, unsequenced at the price on speech and music, 7/6. No. "NW" 11 Table Mike.—This is a splendid microphone for speech and music. The bakelite case, containing a 2 in. mike and transformer is on a bronze pedestal. Switch and plug sockets are fitted on the case. It stands unrivalled for quality and price, 15/-.



**AUTOMATIC SWITCHES.** 6 volt Relay, 5/-. Polarised, 6v. change-over 6/-. Transmitter Relays 7/6; ditto Sounder type 10/-. Cresol Relay, 6/-. Magnetic Key Relay 15/-. Time Switches, 1 amp. to 200 amps., cheap, 35 mm. CINE PROJECTOR on stand, Dallmeier lens, motor drive, lantern arc and spools, 27/10/-; Suitable for Talkies. Table Projectors for slides, 200v. 250 watt focus bulb, 25/-.

**LEDIX ELECTRIC PUMPS** for A.C. or D.C. mains. Centrifugal, all-bronze pump, 3 ft. lift, 120 gallons per hour. For 6 ft. fountain, etc. Price 67/6. Supplied in strong case for 5/- extra. Larger pumps quoted for.

**LEDIX AIR COMPRESSORS** for paint, set cleaning, inflation, etc. Foot-operated, 45/-; Electric No. 1 size, 25/15/-; No. 2, twin-cylinder, 27/10/-; A few S.M. plants, in good order, cheap.

**THE DIX-MIPANTA METER.** A.C. or D.C. Three ranges of volts, 7½, 150, 300 v., or used for milli-amps reads 12½ and 75 m.a. In black Bakelite case, 2½ in. x 2½ in., 19/6. Boigun Hidget Milliammeters, 8 m.a., 6/-. Sifam 1½ in., 10 m.a., 8/6.

**TWO CLEAR SCALES WITH MIRROR ARE ON THE DIX-ONEMETER.** The Dix-Onemeter with only 6 terminals, but 50 Ranges, is a valuable instrument for laboratory work. It is of portable size to go in the pocket, but big enough to cover the whole range of D.C. electrical measurements, 50 microamps. to 20 amps. and 20 millivolts to 2,000 volts. 55/- ONLY. Multiplicars from 6/6 each.



**39 MILLIAMMETERS.** 3/9 only for a new 8 m.a. meter for back of panel illuminated plain dial, 1 in. needle, back lamp and bracket. For D.C. anode current, 3/9.

**L.F. TRANSFORMERS.** Fine lot of Ferranti shrouded and B.T.H. Bakelite for coupling and outputs. Ferranti A.36, R.D.354, 3-1, etc., 5/6. B.T.H. 4-1 at 5/- each. Ferranti O.P.2, 3 & D, for output to speaker, 6/-. 46A Push Pull, 6/6. O.P.M. 3 ratio output, 6/6. Large, B.A.F. 100-watt amplifier output Transformers for 6 speakers, 52/6.

Transformers for working models, 200/250 A.C. to 10 volts 5 amps., 15/-.

**PARCELS** of experimental odd cells, magnets, wire, chokes, switches, terminals, etc., post free; 10 lbs., 7/-; 7 lbs., 5/-.

Our Sale List of 15 Foolscap pages has over 100 illustrations of Electrical and Radio Bargains not obtainable elsewhere. Free for stamped envelope.

## ELECTRADIX RADIOS

218, Upper Thames Street, London, E.C.4

Telephone: Central 4611

## BE A MAN!

**STRENGTHEN YOUR VITAL FORCES!**

Are you a victim of **Inferiority Complex, Self-Consciousness, Unreasonable Fears, Bad Concentration and Memory, Timidity, Lack of Self-Control, Weak Will, Bad Habits, Thinness, Flabbiness, Nervous Disorganisation, etc.**

To trace the cause, write for my free book—

**"DO YOU DESIRE HEALTH?"**

Sent POST FREE in plain envelope.

Also write to me fully in confidence for a **FREE and considered opinion of your case.**

Over 30 years' experience in the drugless Treatment of Nervous disorders and ill-health arising from weakening and health-destroying habits and a lack of manly self-control.

All replies and books sent in plain sealed envelopes.

**T. W. STANDWELL, Curative Physical Culture Consultant**  
Dept. P.M., 329, High Holborn, London, W.C.1

## USED MODEL TRAINS

PERFECT BARGAINS, EQUAL TO NEW. SEND 4½d. FOR OUR CATALOGUE AND SAVE MONEY **GEORGES', 11, FRIARS STREET, IPSWICH**

the latter. The dew point varies according to the barometric pressure of the atmosphere. It can be determined at any given moment by means of an instrument known as a hygrometer, a description of which you will find in any elementary textbook of physics.

We are afraid that you have become rather involved in your query concerning the exhausting of air from a tank. You ask if a tank is exhausted of air, will the air therein become damp. To which we can only reply by asking you how can the air in the tank possibly become damp if it has been removed from the tank?

We do not see the meaning of this query, but if moist air is removed from a tank, the moisture will be removed from the tank as well as the air, and as the pressure in the tank is lowered, any moisture particles adhering to the sides of the tank will at once vapourise and will also be removed in the exhausting process.

Air can be kept dry by exposing a confined volume of it to the action of certain chemicals such as concentrated sulphuric acid, fused calcium chloride, magnesium perchlorate ("anhydron") and phosphorus pentoxide, which have a very powerful affinity for water vapour and are capable of extracting it from air. Thus if we place a few pieces of fused calcium chloride in a flask and tightly cork the latter, the air within the flask will become almost perfectly moisture-free within a few hours. Such processes of moisture removal from air and various gases are frequently employed by scientists.

## SUGAR CRYSTALS

"CAN you tell me how to make large crystals of sugar?"

"I have been informed that there is a certain alloy of sulphur bronze and chromium which resembles gold. Is this correct, and does it resist acid tests?" (T. B., Cardiff.)

IT is really a very difficult task to obtain large crystals of common sugar. Your best plan is to recrystallise a small quantity of common sugar, and to select the driest and the most perfectly formed crystal which you can find.

Next, obtain a piece of cotton or a long hair and by means of a tiny speck of adhesive cement, attach the small "seed" crystal to the hair. Have ready a strong solution of common sugar, and immerse the "seed" crystal into it, suspending it about half way down the solution. Be careful not to disturb the solution for several days, nor, also, to allow its temperature to be changed. Gradually, if the conditions of solution strength are correct, the "seed" crystal will grow.

Common salt, alum, borax and many other common inorganic chemical substances can all be obtained in large crystals by the above method—much more easily, indeed, than common sugar can be.

We are afraid that your information is incorrect in respect of this query. No alloy containing sulphur would have the properties of gold. You are probably thinking of the various "Pinchbeck" metals which, resembling gold in outward appearance, are used for cheap jewellery. They contain approximately 88 per cent. of copper and 12 per cent. of zinc. In some modifications of these metals a little chromium has been introduced, but it seems to have no particular advantage apart from modifying the colour of the alloy.

## A CELLULOSE SOLUTION

"I HAVE occasion to coat many sheets of white cardboard with a tinted cellulose. The only solution I have been

able to obtain up to now which would do the job satisfactorily, is the liquid polish sold for ladies' manicure purposes.

"This costs 6d. for about an ounce bottle, and as I need quite a lot, it would be too costly to use. Could you please tell me how I could tint a solution of celluloid in amyl acetate to get the same effect?" (S. P., Yorkshire.)

YOUR best plan is to dissolve scrap celluloid in a mixture of acetone and amyl acetate. The proportions of these two solvents are more or less immaterial, but, as the amyl acetate content increases, the longer the celluloid film takes to harden and the more glossy it becomes.

Solution of the celluloid is effected by vigorous shaking for about half an hour. When fully dissolved, the celluloid solution can have up to twenty per cent. of toluene added to it, thus cheapening the cost of production. It is also advisable to add a few drops of castor oil to the solution to act as a plasticiser and to prevent the celluloid film from becoming too brittle.

A celluloid solution made as above may be coloured simply by adding to it the necessary quantity of a solution of a spirit-soluble dye in methylated spirit. The spirit solution of the dye should be a fairly concentrated one in order that the addition of a large amount of the methylated spirit to the celluloid solution will not be necessary.

All the necessary materials for your job may be obtained from Messrs. A. Boake, Roberts & Co., Ltd., Stratford, London, E.15. You can also purchase celluloid varnish ready made up from most large paint and varnish stores.

## FORCE OF GRAVITY

"CAN you give me any information regarding the force of gravity?" (J. M. A., Merthyr Tydfil.)

GRAVITY is, perhaps, the most mysterious influence in the whole of the universe, and very little is known about its nature and causation.

We define gravitation as the attraction which bodies exert upon one another, and the degree of this attraction is measured in accordance with Newton's great law which enunciates the fact that bodies attract each other with a force proportional to the product of their masses and inversely proportional to the square of the distance between them.

A bomb is liberated from an aeroplane. It falls under the influence of the earth's gravity. But it must also be remembered that, during its fall to the ground, the bomb is attracting the earth to it with a force which is continually increasing as it gets nearer and nearer to the ground. Theoretically speaking, the earth actually moves up a little to meet the bomb, but the measurement of such an infinitesimal movement on the part of the earth is beyond the limits of the most sensitive instrument.

Gravity operates throughout the universe. It is thought that, out in the depths of space, under unknown influences, it may be capable of some modification which we know not of.

On earth, however, gravity cannot be influenced in any way at all. In a vacuum, a feather and a lump of lead would both fall to the earth at the same rate, and there is no known process by which such a fall could be in any way modified or influenced.

It is also impossible to insulate gravity in the way that we can insulate heat and electricity. There is nothing which will absorb gravity. Mr. H. G. Wells, in his scientific romance, *The First Men in the*

# Feeling Cold?

Keep warm in workshop or home with a PORTABLE

## TILLEY RADIATOR



How miserable it is to feel cold. You cannot enjoy your leisure hours nor work with efficiency. With a Tilley Radiator, however, you can have pleasant warmth in your workshop and afterwards in any room in the house, because it is PORTABLE. Most attractive in appearance and requires no connections or fixing. Burns ordinary paraffin at the low cost of 1d. for 6 hours. Absolutely safe. No wick to adjust and causes neither smoke, smell nor mess. British throughout. Recommended price 37/6. Remit, or can be sent C.O.D., post and charges paid.

TILLEY LAMP CO. (Dept.P.M.), HENDON, N.W.4

## "DOUBLE O" MODEL RAILWAYS

The small gauge with the big appeal

A layout in "OO" takes only ONE QUARTER the space of the same design in "O" gauge. You can have a real Model Railway in a small room. We have the most extensive range of models and specialise in this gauge. Send 6d. in stamps for our new 1938-9 Catalogue. Ask for FREE SAMPLE of scale model Permanent Way.

**GEORGE E. MELLOR (DEPT. P.M.)**

5, Brewis Road, Rhos-on-Sea  
NORTH WALES



The Hallam "Nipper" Aero Petrol Engine

**MINIATURE PETROL ENGINES** . . . for Aero planes and Speed Boats. 1 c.c. 3 and 6. Easily made from our Castings, 12/6 per set. Complete Engines ready to run, £3 15.

SEND 3d. FOR PARTICULARS

**J. HALLAM & SON, Upton, Poole, Dorset**

## Worth Pounds to You! MONEY-MAKING MADE EASY

By  
L. Harvey Wood

A book containing scores of practical ideas of making money in your spare time. Available from all booksellers 2/6 net, or by post 2/10 from the publishers:

**C. ARTHUR PEARSON LTD.**  
(BOOK DEPT.)  
Tower House, Southampton Street,  
LONDON, W.C.2.

Moon, imagines a gravity-insulating substance which he calls "Caverite" and by means of which it became possible for his adventurers to undertake a voyage to the moon, but, although such a substance has long been a dream of scientists, its realisation is as far off as ever.

Gravity is not a form of etheric energy. It is not a wave motion. Neither is it a form of magnetism or electricity. Gravity, in fact, is a totally inexplicable force which matter exerts upon matter.

Just as the existence of the hypothetical Ether, the carrier of various radiations, is disputed by Albert Einstein and his co-workers in the "Relativity" theory, so, too, there are scientists who are inclined to believe that this mysterious force which we call gravity is, really, non-existent, also. Such theorists explain the phenomenon of gravitation by suggesting that it may be merely an illusion set up by the motion of bodies in space-time.

### GREASE-BANDING

"CAN you tell me how to make an adhesive known as 'grease-banding,' as I wish to mix a fairly large quantity, 7 lbs.?"

"I wish to line a shed roof, so as to insulate it against heat and cold. It is roofed with pantiles. I have filled the spaces between the rafters with shavings and wonder if you could suggest something cheaper than asbestos with which to cover it." (J. C., Surrey).

**GREASE-BANDING** compositions are not, strictly speaking, adhesives, for they do not dry and they have a relatively poor adhesive strength. They are, as you will be aware, merely permanently sticky preparations employed for the purpose of retaining destructive insects which are caught on them.

A good grease-banding preparation may be made up according to the following formula:—

Resin, 10 parts; linseed (or rapeseed) oil (raw), 5 parts; candle wax, 1/2 part; sugar or treacle, 1 part.

Melt the resin and wax in the oil, stirring the mixture well over a slow fire, and when it has cooled down, add the sugar or treacle. The cool mixture should be stored in jars or tins having closely-fitting lids.

For use, spread the mixture not too thickly over waterproof bands of paper or over some fabric material capable of being placed around the trunk of the tree.

It is not always good to use shavings as a heat insulator, especially on a roof, for under the influence of damp some shavings are likely to become mouldy and actually to heat up, thereby becoming liable to spontaneous ignition.

An air space is as good an insulator as any for ordinary purposes.

Tarred felt is a fairly effective heat and moisture insulating material for the purpose you require, and it is much cheaper than asbestos sheet. It may also be procured in several grades. Alternatively, you could use ordinary clean sacking, but before doing this the sacking should have been soaked for 24 hours in a strong solution of common alum in order to increase its moisture resistance, and to render it mould-proof.

### READ

**PRACTICAL & AMATEUR WIRELESS**  
3d. EVERY WEDNESDAY

**PRACTICAL MOTORIST**  
3d. EVERY FRIDAY

**THE CYCLIST**  
2d. EVERY WEDNESDAY

# SKYBIRDS

**World Famous Aeronautical Models**  
FIRST and BEST solid non-flying 1/72nd scale model Aircraft Construction with every accessory to make the complete hobby.

The World's 3 Fastest Fighters

"HURRICANE," "SPITFIRE" and "CURTISS"

Constructive Sets, price 2/6 each.

IF YOU ARE INTERESTED IN SMALL SCALE MODELS write for SKYBIRDS FREE LIST or for a copy of "AIR REVIEW" post free 7d.

The Official Organ of the SKYBIRD LEAGUE  
GREAT NEWS! SKYBIRDS ANNOUNCE  
**THE NEW No. 1 FLYING MODEL**



Amazing Climb and Height!  
A Strong Model with a contest performance!

Simple construction! A model which the beginner has been waiting for and the expert will want to fly. Average flight 60 seconds! Record flight to date 120 seconds!  
A BRITISH model for British weather. If unable to obtain from local agents, write:

"SKYBIRDS" (Desk P.M.)  
3 ALDERMANBURY AVENUE,  
LONDON, E.C.2

**THE STURDY MODEL**  
Span 30"  
Length 21 1/2"  
Power—14 ft. Rubber  
Weight 2 ozs.  
Price complete  
**6/6**



### PROTRUDING EARS

ORO, a simple modern method sets them in position immediately. Invisible—Comfortable—Harmless, used any time by adults and children. Endorsed by physicians and users as the best method for correcting this disfigurement. Write for free booklet and testimonials to—

M. TRILETY (R 158)  
45 Hatton Garden, London, E.C.1.

# FOYLES

**Booksellers To The World**  
Enrolments taken for the Scientific Book Club  
119-125 CHARING CROSS RD., LONDON, W.C.2  
Telephone: Gerrard 5660 (14 lines)

### WEBLEY AIR PISTOLS

Marvellously accurate for target practice.

No licence required to purchase or use at home  
Senior 45/., Mark 1 32/6  
Junior 21/., Webley Air Rifle 95/.  
Write for List. WEBLEY & SCOTT LTD.,  
106 WEAMAN STREET, BIRMINGHAM.



### INVENTORS

#### VALUABLE GUIDE

General Advice Free. POST FREE 6d.

**CHATWIN & CO.** Est. 1880  
Regd. Patent, Design and Trade Mark Agents for all countries.

253 (D) Gray's Inn Road, London, W.C.1.

**WE HAVE THEM** Why send to America for American Technical Society's Cyclopedias? Air Conditioning, Automobile Engineering, Diesel Engineering, Architecture, Carpentry, Building, Applied Electricity, etc. Descriptive booklets free.—Economy Educator Service, Glenside (En.), Plymouth.

# BUY, EXCHANGE OR SELL

## TOOLS

Special large purchase  $\frac{1}{8}$ " Split Circular Dies, guaranteed quality, usual price 10d. to 1/3 each. Sizes in stock,  $\frac{1}{8}$ ",  $\frac{3}{32}$ ",  $\frac{1}{16}$ ",  $\frac{3}{32}$ ",  $\frac{1}{4}$ ",  $\frac{5}{32}$ ",  $\frac{3}{16}$ ", Whit., B.S.F., also Brass Tube Thread, Cycle Thread, and Model Engineer 40 Thread; also in 0, 1, 2, 3, 4, 5, 6 B.A. Thread. Offered at the low price of 6d. each, 5/6 per doz. Also Taps to suit, guaranteed, 6d. to 10d. quality clearing at 3/- doz., 4d. each; all B.A. sizes and others to  $\frac{1}{4}$ " diam.; also  $\frac{3}{32}$ " and  $\frac{1}{16}$ ", 6d. each. Also best Adjustable Tap Wrenches to  $\frac{1}{4}$ ", 9d.; Die-Stocks, 9d.—Below.

12 only, Ball-Bearing Double-ended Grinding Heads to take  $\frac{3}{8}$ " bore wheels, practically new, 15/- each. Six only, Stands for same fitted with rise and fall slide suitable for converting to surface or special tool grinder, bargain 10/- each.—Below.

300 Sets 1" Circular Dies,  $\frac{1}{8}$ ",  $\frac{3}{16}$ ",  $\frac{1}{4}$ ",  $\frac{5}{16}$ ",  $\frac{3}{8}$ ",  $\frac{7}{16}$ ",  $\frac{1}{2}$ ", Whit., B.S.F., Brass Thread, also American S.A.E. Thread for Yankee Cars; clear at 2/9 set of Five; also best quality Taps to suit any above sets, 2/0 set of Five. Adjustable Tap Wrenches to  $\frac{1}{4}$ ", 1/9 each; 1" Die-Stocks, 1/9 each. Guaranteed.—Below.

3,000 High Speed Twist Drills,  $\frac{1}{32}$ " to  $\frac{3}{32}$ ", actual value from 6d. to 8d. each. Bargain 2/- doz.—Below.

Finest Quality Tool Steel, Round, Bright,  $\frac{1}{4}$ " to  $\frac{3}{4}$ " diam., 4 lb., 2/6; larger sizes, 8 lb., 4/-. Costs 2/- lb.—Below.

1/9 any lot. Wonderful Value.—Below.  
 One Gross Bright Steel Hex. Bolts with Nuts.  
 Dozen Assorted Files, 4" to 6".  
 Six Assorted Files, 6" to 12".  
 Three Assorted Files, 12" to 14".  
 Six Assorted Grinding Wheels, 2" to 2 $\frac{1}{2}$ " diam.  
 Dozen Twist Drills,  $\frac{1}{16}$ " to  $\frac{1}{8}$ " diam. Best quality Grinding Wheels, Carborundum, about 6" by 1" wide, 1" hole.  
 Three Hex. Die Nuts, Cycle Thread,  $\frac{3}{8}$ ",  $\frac{1}{2}$ ",  $\frac{5}{8}$ ".  
 Three Slitting Saws, 2 $\frac{1}{2}$ " diam.,  $\frac{3}{32}$ " to  $\frac{1}{4}$ " thick.

Four M.M. Dies,  $\frac{1}{8}$ " diam.  
 Dozen Assorted Taps.  
 $\frac{3}{4}$ " Square Tool Holder, with H.S. Tool.  
 2 Doz. Hack-saw Blades, 9", 10", or 12".  
 Two H.S. Tap Fluting Cutters,  $\frac{1}{4}$ " diam.—Below.  
 2/9 any lot.—Below.  
 0 to  $\frac{1}{2}$ " Drill Chuck, Morse Taper or half-inch Straight Shank.  
 Dozen Drills,  $\frac{1}{16}$ " to  $\frac{3}{16}$ ".  
 One each,  $\frac{1}{4}$ ",  $\frac{3}{8}$ ", 1" Whit. Taper Taps.  
 18 Assorted Flexible Shaft Grinding Wheels,  $\frac{1}{4}$ " to 1" diam.—Below.

4/- any lot.  
 16 Lengths Silver Steel,  $\frac{1}{16}$ " to  $\frac{3}{8}$ " Round.  
 Dozen Superfine Swiss Files.  
 2 Dozen Files, 4" to 10".  
 Taper, 2nd and Plug Taps, Whit.,  $\frac{3}{16}$ ",  $\frac{1}{4}$ ",  $\frac{5}{16}$ ", 8".  
 Set Hex. Die-Nuts,  $\frac{3}{8}$ ",  $\frac{1}{2}$ ",  $\frac{5}{8}$ ", 1", Whit. or B.S.F.  
 400 Dozen Tool-makers' Needle Files. An absolute necessity for small work. Clearing at 2/9 per dozen; assorted shapes.—Below.

600 Morse Taper Sleeves, 1-2, 1/6; 2-3, 1/10; 3-4, 2/6. Best quality, ground finish. British made.—Below.  
 1,000 Fine Emery Wheels, 2" to 4" diam.,  $\frac{1}{8}$ " hole,  $\frac{1}{4}$ " to  $\frac{1}{2}$ " thick, slightly used, but quite serviceable, 1/6 per dozen.—Below.

Super Quality High-Speed End Mills, Right hand, for use in Lathe. Straight Shank,  $\frac{1}{4}$ ", 2/-;  $\frac{3}{8}$ ", 2/0; actual value nearly treble. Also  $\frac{1}{2}$ ". Best Quality Carbon Steel, 1/9 each.—Below.

Genuine Carborundum Wheels, 9" diam., 1" hole, 1" wide, 5/-;  $\frac{1}{4}$ ", 6/6;  $\frac{1}{2}$ ", 7/0; 2", 10/- each; 7" diam.,  $\frac{1}{4}$ " hole,  $\frac{1}{4}$ " to  $\frac{3}{8}$ " wide, 2/6 each. All suitable for general tool use. Also Rough Wheels, 1 hole  $\frac{1}{4}$ " wide, 8", 3/6; 7", 3/-; 6", 2/3.—Below.

Please Note.—£1 orders and above only are post paid; small orders please allow for postage.—Steel Bars, carriage forward.—Below.

J. BURKE, 30 TRIPPET LANE, SHEFFIELD.

MYFORD LATHE SPECIALISTS. Cash or no deposit terms from 10/- monthly. Immediate deliveries anywhere. List free.—Nuttalls, 20, Albert Street, Mansfield.

BRAND NEW POWER TOOLS of quality. 10 in. Bandsaws, 54/-. Jigsaws, 22/6. Wood Planing Machines, 80/-. Bench Drills, 11/-. Circular Saws, from 25/-. 3 in. S.C. Toolroom Lathes, from £4 16s. New 1 in. Chromium Plated Micrometers, 12/6. Electric Drills, 32/6. Grinders, Spray Plants, Guns, Air Compressors, etc.—John P. Steel, Clyde St. Mills, Bingley.

## BECK'S CHEMISTRY

**BUILD UP A HOME LABORATORY WITH THE HELP OF OUR SPECIAL OFFER of 2/6 Sets of APPARATUS & CHEMICALS**

A CONVENIENT AND INTERESTING METHOD OF PURCHASING EQUIPMENT Write for free leaflet containing full particulars

**BECK** (Scientific Dept. A), 60, High St., Stoke Newington, London, N.16.  
 BOOKLET of Tested Experiments, 6d. Post Free



The 'ADEPT' LATHE  
 15/8 in. centres, 6in. between centres.  
 With compound slide-rest 22/-, or with hand-rest only, 13 9.  
 Screw Tall Stock, 5 6 extra Post 1/-.

THE SUPER 'ADEPT', 33/-.  
**F. W. PORTASS, Sellers Street, SHEFFIELD.**

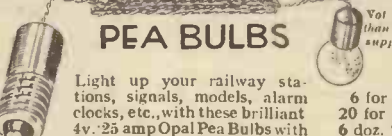

Light up your railway stations, signals, models, alarm clocks, etc., with these brilliant 4v. 25 amp Opal PEA Bulbs with M.E.S. fitting and 30 in. flex. Light from 4v. Pkt. battery or accumulator.

6 for 1/-  
 20 for 2/6  
 6 doz. 7/6  
 post free

H. FRANKS, DEPT. P, 81 NEW OXFORD ST., LONDON, W.C.1



My latest improved Model 25 corrects all ill-shaped noses quickly, painlessly, permanently and comfortably at home. It is the only nose-shaping appliance of precise adjustment and a safe and guaranteed patent device that will actually give you a perfect-looking nose. Write for free booklet and testimonials.

M. TRILETY, SPECIALIST (D.257).  
 45, MATTON GARDEN, LONDON, E. 1



Easily, Quickly, Enjoyably.  
 To learn to play really beautifully is not difficult—it is easy with proper teaching! Even if you start at middle age, not knowing a note, I CAN TEACH YOU to play so that your friends will want you always. I will send you by POST, Sun-clear Fascinating Lessons from ordinary musical notation, no freakish methods, enabling you to read and play at sight any standard musical composition. I have taught over 49,000 adult pupils during 34 years, and I CAN TEACH YOU, and I guarantee to please and even surprise you with your rapid progress. Send p.p.c. for a FREE BOOKLET, "Mind, Muscle and Keyboard," and form for free advice.  
 Say if Moderate, Elementary or Beginner.

Mr. H. Becker  
 (Dept. 5B),  
 69, Fleet St., E.C. 4



**PORTASS LATHES**  
**3" MOTOR DRIVEN MODELS**  
**B.G.S.C. LATHE**  
**£11. 15. 0**

USUAL PRICE £14.16.0.  
 $\frac{1}{2}$  B.T.H. motor with reduction gears, iron stand, flywheel belts. Terms. No interest charged. Stamp please. 3 1/2 in. lathes from £4.10.0.

**AMAZING OFFER**  
 USUAL PRICE £6.16.0.  
**£3.15.0** Mod. "S."

Crate 2/6. Takes 12 1/2 in. bet. cen. To take 18 in. extra 15/-. Compound Rest extra 15/6. Money returned if you are not delighted.

Packing 10/-  
**PORTASS LATHES, BUTTERMERE RD., SHEFFIELD**

## TOOLS—Continued

GRAYSON'S Glass-boring Outfits and Tube Cutters avoid risk.—Below.  
**DRILLS**, 1aps, Dies, riles, Chisels and Punches. Best quality at keenest prices.—Grayson & Company, 300 Campo Lane, Sheffield.

2/6 EACH LOT. 6 of any following: Milling Cutters, Reamers, Slitting Saws, Grinding Wheels, Taper Shank Drills. 5 lots post paid, 12/-.—BROOKS, Milton Street, Sheffield 3.

## WOODWORK

**CABINET HARDWOODS**, Oak, Mahogany, Ash, Whitewood, Plywoods. Lowest Prices. Send Cutting Lists.—Willred Parr & Co., March Works, Lancaster Road, Levtonstone, E.11.

## MODEL ENGINES

**AERO ENGINE SETS**.—Baby aero castings as low as 5/9. Tiptop  $\frac{1}{2}$  h.p. sets, water or air-cooled 9/9. Charging dynamos, ball-bearing enclosed, from 8 amps., 15/-. Boat propellers, tubes, fittings. Castings made in any metal. Instructive, interesting catalogue 3d. Write—Butler's, Profit-Sharing Works, Wade Street, Littleover, Derby.

## CANOEES

**BOAT AND CANOE**. Kits from 25/-. All types completed craft. Winter Reductions. List stamp. Trade.—Metacraft (P), Christchurch, Hants.

## MISCELLANEOUS

"**PHOTO-ENGRAVING**."—A practical Handbook with complete set of materials for engraving printing blocks, 4/6.—Industries, 2 Waldegrave Park, Twickenham.

A 20-TON STOCK of surplus Instruments, Magnet, Resistance, etc., Wire. Low prices.—London Electric Firm, Croydon.

**REFLECTING TELESCOPES**, 6 in., £8. Silvering; Author's Moon Map.—Wilkins, 127 Eversley Avenue, Barnehurst, London, S.E.

**FLYING FLEA** completed except covering main wing, with Douglas engine and airscrew. Offers or exchange light car.—Dodman, Beech Hill Garage, Wadhurst, Sussex.

**STAMMERING Cured**. Amazing Opportunity. Particulars Free.—M. Hellyer, 1 Glenside, Plymouth.

## CHARGE IT AT HOME

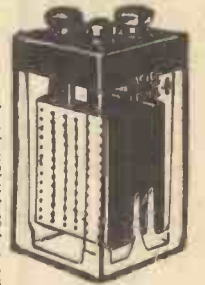

with a "SILEX" Battery Charger. Cheap to run. Model 252 runs 200 hours for 1 unit of electricity. Prices:  $\frac{1}{2}$  amp, 8/6; 1 amp, 12/6; 2 amps, 18/6; 3 amps, 25/-; post free.—Special Car Battery Models, 6 v. 25/-; 12 v. 30/-; Charging Rate, 2 amps. Commercial Charger, for 1 to 14, 2-v. cells, with ammeter, switches, etc., 50/-; others quoted for. H.T. Accumulator Charger, 150 v., 250 M/A, complete, 35/-. Combined H.T. Eliminator and  $\frac{1}{2}$ -amp. Charger, 25/-. All above complete in strong steel cases with metal rectifiers, robust mains transformers, mains flex, adaptor, and insulated output terminals; guaranteed 2 years. SEND 3d. for Real PHOTO, or have any unit on 7 days' FREE TRIAL. Please state Mains Voltage when ordering.

**BRIGHTON RADIO SERVICE**,  
 34 Middle Street, Brighton

**LUTON MINOR** with 35-h.p. LUTON ANZANI, Dual Ignition, Starter, £225. Materials, £10. Semi-manufactured, £75. Blue Prints & Instruction Book, £5.  
**LUTON AIRCRAFT LTD.**, Phoenix Works, Gerrards Cross.

## OUR ADVICE BUREAU COUPON

This coupon is available until October 31, 1938, and must be attached to all letters containing queries; together with 3 penny stamps. A stamped addressed envelope must also be enclosed.  
**PRACTICAL MECHANICS, OCT., 1938.**

# BUY, EXCHANGE OR SELL

Advertisements are accepted for these columns at 3d. per word (minimum 12 words at 3s.—advertisements of less than 12 words are charged at the minimum rate of 3s.) subject to a discount of 2½% for 6 consecutive monthly insertions or 5% for 12 consecutive monthly insertions. **TERMS:**—Cash with order. Cheques, Postal Orders, etc., should be made payable to George Newnes, Ltd. *The Proprietors reserve the right to refuse or withdraw advertisements at their discretion.* All advertisements must be received on or before the 5th of the month preceding date of publication and should be addressed to the Advertisement Manager, "Practical Mechanics," George Newnes Ltd., Tower House, Southampton Street, Strand, W.C.2.

## CINEMATOGRAPHY

**ART CINE FILMS.** Exclusive 9.5-mm. and 16-mm. Projectors from 35/-. Cine Cameras 75/-. Used Bargains. Part Exchanges. Catalogue Free.—P. M. Dane, 64 Stanley Street, Liverpool, 1.

**CINEMATOGRAPH FILMS.** Standard Size from 6d. 100 feet. Machines, Accessories. Sample Films 1/- and 2/6 post free. Catalogues free.—"Filmaries," 57 Lancaster Road, Levenshulme, E.11.

**MOVIES AT HOME.** How to make your own Cinema Projector. Particulars free.—Moviescope (N), Pear Tree Green, Doddinghurst, Essex.

## ELECTRICAL

**A.C. & D.C. MOTORS,** Dynamos, Converters, Transformers, Chargers, Supplies and Repairs.—Easco, 18pm, Brixton Road, S.W.9.

**½-h.p. A.C. MOTORS. REPUSION OR CAPACITOR,** All voltages, £2/2/6 each. D.C. £1/2/6.—Johnson Engineering, 86 Great Portland Street, W.1.

**SUPER A.C. MOTORS.** Brand New, 1/10 h.p., 30/-; ¼ h.p., 38/6; ½ h.p., 38/6; ¾ h.p., 55/-; larger sizes. Electric Tools, Machines, Pumps, Compressors, etc.—John P. Steel, Clyde Street Mills, Bingley.

## ENGINEERING

**A BALL-BEARING ANNOUNCEMENT.** Miniature Ball-Races, 1½ mm. to 30 mm. o/d. Sample of the smallest standard ball-race in the world, under 1/16 in. overall, 2/6 post free. Send 2d. stamp for lists. Dept. P., Miniature Bearings, Ltd., 3 Duke Street, St. James's, S.W.1.

## LITERATURE

**CALVERTS MECHANICS YEAR BOOK, 1938.** Over 190 pages. Illustrated Workshop Hints and Calculations. 8d. post free.—Endors & Co., Progress House, 75 Wood Street, Manchester, 3.

## METAL WORK

**MAKE METAL TOYS.** Easy, profitable with "Success" Moulds. List Free. Complete trial mould 1s. 6d.—Loe's, 1 Birkin Avenue, Nottingham.

## MICROSCOPY

**THE MICROSCOPE.** The British Journal of Microscopy and Photomicrography, 1s. monthly. All Newsagents, or 1s. 1d., post free, from The Microscope, 20/21 Took's Court, London, E.C.4.

**MICROSCOPIC OBJECTS**—unmounted, prepared. Assorted packet, 2/-.—Leng, 183 Manchester Drive, Leigh-on-Sea.

## JUBILEE WORM DRIVE HOSE CLIPS



The long-life clip with the ever-tight grip  
**The Best Known**  
For Radiator Joints, Air, Oil, and Water Hose Joints.

We guarantee a Tight Joint

Stocked by all Garages and Accessory Dealers.

L. ROBINSON & CO.  
25 London Chambers, GILLINGHAM, KENT.

## MICROSCOPY—Continued

**STUDENTS RESEARCH MICROSCOPE** £6. Prism glasses, telescopes, eyepieces and lenses.—Mackett & Co., Manufacturing Opticians, 51 Millers Road, Brighton.

## MODELS

**TABLE TOP PHOTOGRAPHIC MODELLING.** Make, use and supply the right material. 2/8 illustrated.—Architrave, 2 Jeffreys Place, London, N.W.1.

**SLIGHTLY USED TRIX TWIN RAILWAY GOODS** for disposal, list 14d. Georges', 11, Friars Street, Ipswich.

**STEEL TUBING,** Seamless, ¼" to 5¼", ½" to 1" thick. Please say lengths you cut to. Cotes, Church Walk, Brentford, Middlesex.

## MUSICAL INSTRUMENTS

**BAND GUIDE.** Hints on the Bugle, Drum, Flute, Staff Parade formation, etc. Free, post paid.—Potter's (Manufacturers), West Street, London, W.C.2.

## PATENTS

**REGINALD W. BARKER & CO.** (Established 1886), 56 Ludgate Hill, London, E.C.4.—Patent and Trade Mark Booklets Gratis.

## HAVE YOU A RED NOSE?

Send a stamp to pay postage, and you will learn how to rid yourself of such a terrible affliction free of charge

Address in confidence—

P. TEMPLE, Specialist  
"Palace House," 128 Shaftesbury Avenue, W.1  
(Est. 37 years.)

## NERVOUSNESS

Every nerve sufferer should send for my interesting book, which describes a simple, inexpensive home treatment for Self-consciousness, Blushing, Depression, Worry, Insomnia, Weak Nerves, Morbid Fears, and similar nervous disorders. This wonderful book will be sent in a plain sealed envelope to any sufferer without charge or obligation. Write **NOW** and learn how to conquer your nervousness before it conquers you!

HENRY J. RIVERS (Dept. 40 Lamb's Conduit St., LONDON, W.C.1)

## MAKE MORE MONEY

£3 to £6 weekly can be earned at home in a wonderful business of your own. No matter where you live you can commence to make money in your spare or whole time. No risk, canvassing or experience required. A wonderful opportunity for anyone wishing to add pounds to their income. Particulars, stamp.

BALLARD, York House, 12 Hamdrop Road, LONDON, S.E.25.

## PATENTS AND INVENTIONS

**HAVE YOU** a sound, practical invention for sale, patented or unpatented? If so, write Chartered Institute of American Inventors, Dept. 104, Washington, D.C., U.S.A.

## PHOTOGRAPHY

**"PANTOGRAPHS"** make large accurate drawings from small photographs, etc., easily. 1/-.—Cooke 10 Hawthorn Road, Levenshulme, Manchester.

**£500** worth, good, cheap Photo Materials, Films, Plates, Cards, Papers, Chemicals, Catalogue and 4 Samples free.—Hackett's Works, July Road, Liverpool 6.

**DON'T TAKE RISKS.** Good developers mean good results. Our reliable stock developers keep twelve months after mixing. Satisfaction certain to amateurs and professionals. Best developers ever put on the market. Makes two pints strong developer. 6d. each, 6 for 2/3, 12 for 4/-. Post free.—Hackett's Works July Road, Liverpool 6.

**PHOTOGRAPHIC MATERIALS.** Plates, Films, Mounts, Chemicals, etc. Interesting money-saving lists and samples free.—"Kimber's" 105 Queens Road, Brighton.

## SITUATIONS VACANT

**G.P.O. ENGINEERING DEPT.** (no experience required). Commencing £3/13/0 per week. Age 18-23. Excellent prospects. Free details of Entrance Exam. from B.I.E.T. (Dept. 579) 17-19 Stratford Place London, W.1.

**ENGINEERS.** Recent Government Action has resulted in thousands of outstanding opportunities now open to trained men. For full information write for our new handbook, "ENGINEERING OPPORTUNITIES." This 268-page guide shows how to secure A.M.I.Mech.E., A.M.I.E.E., A.M.I.A.E., A.M.I.W.T., etc., on "NO PASS—NO FEE" terms, and outlines 150 Courses in all branches of Civil Mech., Elec., Motor, Radio and Aero Engineering, Television, Building, Government employment, etc. This new handbook is invaluable to you. Send for a copy to-day. **THE BRITISH INSTITUTE OF ENGINEERING TECHNOLOGY,** 140 Shakespeare House, 17-19 Stratford Place, Oxford Street, W.1.

## WATCHMAKING

**WATCH & CLOCK REPAIRERS.** Send 3d. for complete list of material and tools. Blakiston & Co. Ainsdale, Southport.

## WIRELESS

**HEAR AMERICA, AUSTRALIA, JAPAN.** New Receivers with valves, from 19/6. Numerous testimonials. List free.—W. J. Buckle, 63 Avenue Approach, Bury St. Edmunds.

## 3/4 MYFORD 3/4

BEST VALUE—INEXPENSIVE



DESIGNED AND MANUFACTURED ON THE FINEST ENGINEERING PRINCIPLES.

Bench-Treadle-Motorised Lathes & Accessories. Send P.C. for free illustrated list (your tool merchants' address would be appreciated).

MYFORD ENG. Co., Ltd., Beeston, Nottm.

I Can Make  
**YOU** a New  
Man!



**CHARLES ATLAS**  
as he is to-day,  
Holder of the title  
"The World's Most  
Perfectly Developed  
Man."

**FREE**

-the **BOOK** that tells how

JUST jot down your name and address on the coupon below, post it to me—and I'll send you absolutely free of charge a copy of my big new book "Everlasting Health and Strength."

I've helped more than 40,000 other men, youngsters and oldsters, fat and skinny. Some were weak, run-down specimens that looked like scarecrows—before I showed them my **NO APPARATUS** way to add weight, get smooth, even layers of powerful muscle and the handsome, evenly balanced proportions that you see in my own photo.

**48-Page BOOK FREE**

Now I'll give YOU the **PROOF** in only 7 DAYS that I can turn you, too, into an "Atlas Champion"—make a **NEW MAN** of you—give you a handsome, **HUSKY BODY**, give you big, **POWERFUL MUSCLES**, put on **POUNDS** of firm flesh, or if you are fat pare you down to **FIGHTING TRIM**.

And with this **NEW FIGURE** I'll give you **NEW HEALTH**—the through-and-through health that rids you of constipation, pimples, bad breath and that half-alive, played-out feeling that does you out of the good times and good things of life.

Send **NOW** for a free copy of my new book containing scores of pictures of myself and others who have used my secret "**DYNAMIC TENSION**" method. Don't delay—post the coupon **NOW** for **YOUR** free copy of my new book. Address: **CHARLES ATLAS**, (Dept. 10/K), 2, Dean Street, London, W.1.

**CHARLES ATLAS** (DEPT. 10/K,) 2 Dean Street, London, W.1.

I want the proof that your system of Dynamic Tension will make me a New Man. Send me your book "Everlasting Health and Strength" **FREE** and details of your amazing 7-DAY TRIAL OFFER.

Name.....  
(Please print or write plainly)

Address.....

**YOUR OWN HOME CINE**

**FOR 3/1 A WEEK**

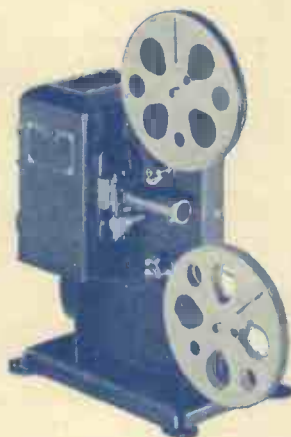

That's all it costs to buy this super 8-mm. projector on our 2-year terms. Good allowance on your used apparatus in part exchange.

**KODASCOPE 50.R**  
A popular home movie by the world's best-known makers.

Gives clear movies up to 40in. x 30in. in area. Motor driven and can be used in any electric light circuit.

Price **£13 13 0**

24 Monthly Payments of 12/3

Send for 320-page Handbook which tells you all about cinematography and illustrates all the best-known makes with full particulars, prices, etc., price 1/-.

**CITY SALE & EXCHANGE**  
(1929) LTD.

59/60 CHEAPSIDE, LONDON, E.C.2.

TELEPHONE: CITY 1124/5/6.

**THE CHEAPEST SUPER DETAIL PERMANENT WAY**



**PRICES. Standard Gauge "0" Parts**

- Steel Rail, sheradised, per yd. 2d., 1/8 doz. yds.
  - Brass Rail ... per yd. 4 1/4d., 4/3 doz. yds.
  - Cast Chairs, slide-on at ... per 100 1/2
  - Chairs for Wood Keys ... per 100 1/6
  - Wooden Keys ... per 100 6d.
  - Electric Raised Chair ... per 100 2/-
  - Fishplates ... per doz. 3d.
  - Sleepers, stained correct colour ... per 100 2/3
  - Battens, 1/2-in. x 1/2-in. section per yd. 2 1/4d., 2/3 doz. yds.
  - Pins, approx. 1,000 ... 6d. packet
  - Track Gauge, special, with elec. chair jig 9d. each
- All prices plus postage.

**Megow Balsa Flying Kits**



Kits for 12" wing span Flying Models of the AERONCA, BOEING P12E, CURTISS PURSUIT, HELL DIVER, LOCKHEED VEGA, MONOCOUCPE, PUSS MOTH, STINSON RELIANT, TAYLOR CUB, VULTEE VIA, WACO.

Price 10d. Postage 3d.

Kits for 24" wing span Flying Models of the STINSON RELIANT, WACO CUSTOM, MONOCOUCPE, CONSOLIDATED P/30, FAIRCHILD, HAWKER FIGHTER, CURTISS HAWK, RICHMAN & MERRILL'S VULTEE.

PRICE 2/- Postage 6d.

SEND FOR BOND'S GENERAL CATALOGUE, PRICE 6d.; THIS WILL INTEREST YOU AS ITS 200 PAGES LIST ALL THE GOODS WE STOCK

**BOND'S O' EUSTON ROAD LTD.**  
357, EUSTON ROAD, N.W.1

'Phone EUSton 5441-2

Established 1887



Published about the 30th of each month by **GEORGE NEWNES, LIMITED**, Tower House, Southampton Street, Strand, London, W.C.2, and Printed in England by **THE SUN ENGRAVING CO., LTD.**, London and Watford. Sole Agents for Australia and New Zealand—**Gordon & Gotch Ltd.** Sole Agents for South Africa—**Central News Agency Ltd.** Subscription Rates: Inland and Abroad, 7s. 6d. per annum; Canada, 7s. per annum. Registered at the G.P.O. for transmission by Canadian Magazine Post.