

IS PERPETUAL MOTION POSSIBLE?

NEWNES

PRACTICAL MECHANICS

NOVEMBER

6^D

LEARNING
TO GLIDE



WHAT IS LIGHTNING?, HOUSE WIRING SIMPLIFIED, HOW COINS ARE MADE, REWINDING ARMATURES, LATHE WORK, RADIO, MODELS, MONEY MAKING IDEAS, PATENT ADVICE, ETC.

OPEN LETTER TO PARENTS

Dear Sir or Madam,

When your children first arrived they brought with them a wonderful lot of sunshine.

Later you became proud of the intelligence they displayed, but still later, you became anxious as to what would become of them in the future. Perhaps you were anxious when you visualised them as grown men and women.

Even with plenty of money it is not always easy to select the right career, and a parent is sometimes inclined to ask advice of some relative, and in ninety-nine cases out of a hundred that relative knows nothing at all about the possibilities of employment.

Why not let me relieve you of some of your anxieties? In fact, why not let me be their Father?

We do not profess to act as an employment agency, but the nature of our business compels us to keep an eye upon the class of men and women that are wanted and who wants them.

There are some people who manufacture an article and put it on the market to sell. We do not do that; we work in exactly the opposite direction. We find out what employers want and we train our students to fill those jobs. We have to be experts in the matter of employment, progress and prosperity.

If you have any anxieties at all as to what your sons or daughters should be, write to me, or better still, let them write to me personally—Fatherly Advice Department—and tell me their likes and dislikes, and I will give sound practical advice as to the possibilities of a vocation and how to succeed in it.

Note address carefully:

F.A. Dept. 76, The Bennett College Ltd., Sheffield

Yours sincerely,



CAN YOU CHANGE MY EXPRESSION?

IF SO, YOU MAY BE THE ARTIST THAT COMMERCE IS WAITING FOR.

Just try it for yourself, trace or draw the outline and then put in the features.

Jim Duck

There are hundreds of openings in connection with Humorous Papers, Advertisement Drawing, Posters, Calendars, Catalogues, Textile Designs, Book Illustrations, etc.

60% of Commercial Art Work is done by "Free Lance Artists" who do their work at home and sell it to the highest bidders. Many Commercial Artists draw "retaining fees" from various sources, others prefer to work full-time employment or partnership arrangement. We teach you not only how to draw what is wanted, but how to make buyers want what you draw. Many of our students who originally took up Commercial Art as a hobby have since turned it into a full-time paying profession with studio and staff of assistant artists; there is no limit to the possibilities. Let us send full particulars for a FREE TRIAL and details of our course for your inspection. You will be under no obligation whatever.

Jim Duck Art Dept. 76.

YOUNG MEN

Young men physically fit and whose careers are not definitely fixed should join the Police Force. We have Special Courses for Entrance and Promotion.

1/- per week brings success.

Full particulars free.

Address: Police Dept. 76.

TO STUDENTS LIVING ABROAD

or on the high seas, a good supply of lessons is given, so that they may be done in their order, and despatched to us for examination and correction. They are then sent back with more work, and in this way a continuous stream of work is always in transit from the Student to us and from us to the Student.

LET ME BE YOUR FATHER

Unless you are in touch with all branches of industry, you cannot see the possibilities of employment, but with our gigantic organisation we are in touch with every sphere of activity, and we know that in many trades and professions there are more vacancies than there are trained men to fill them.



J.A. Bennett

We do not profess to act as an employment agency, but we certainly are in a position to give fatherly advice on all careers and the possibility of employment therein.

THE MOST SUCCESSFUL AND MOST PROGRESSIVE CORRESPONDENCE COLLEGE IN THE WORLD

We teach by Post in all parts of the world and specialise in all Examinations.

Accountancy Examinations
Advertising and Sales Management
A.M.I. Fire E. Exam.
Applied Mechanics
Army Certificates
Auctioneers and Estate Agents
Aviation Engineering
Banking
Boilers
Book-keeping, Accountancy & Modern Business Methods
B.Sc. (Eng.)
B.Sc. (Estate Management)
Building, Architecture and Clerk of Works
Civil Engineering
Civil Service
All Commercial Subjects
Commercial Art
Concrete and Structural Engineering
Draughtsmanship. All branches
Engineering. All branches, subjects & examinations
General Education
G.P.O. Engineering Dept.
Heating and Ventilating
Industrial Chemistry
Insurance
Mathematics

Matriculation
Metallurgy
Mining, all subjects
Mining, Electrical Engineering
Motor Engineering
Motor Trade
Municipal and County Engineers
Naval Architecture
Pattern Making
Police, Special Course
Preceptors, College of Pumps and Pumping Machinery
Radio Service Engineering
Road-Making & Maintenance
Salesmanship
Sanitation
Secretarial Exams.
Shipbuilding
Shorthand (Pitman's)
Structural Engineering
Surveying
Teachers of Handicrafts
Telephony and Telegraphy
Transport Inst. Exams.
Weights and Measures
Inspector
Welding
Wireless Telegraphy and Telephony
Works Managers

If you do not see your own requirements above, write to us on any subject.

IT COSTS NOTHING TO ENQUIRE.

Also ask for our New Book (FREE OF CHARGE), THE HUMAN MACHINE, Secrets of Success.

STUDY AT HOME

IN YOUR SPARE TIME



CAN HAVE A COLLEGE TRAINING IN ALMOST ANY CAREER FOR A FEW SHILLINGS MONTHLY.

MATRICULATION

There are many ways of commencing a career, but Matriculation is the jumping-off board for all the best ones.

CIVIL SERVICE

Suitable to both sexes. Ages 15½ to 24.

G.P.O. ENG. DEPT.

CUSTOMS AND EXCISE; INSP. OF TAXES, Etc.

NO EXPERIENCE REQUIRED. OPEN EXAMS.

We prepare candidates for all

INSTITUTE EXAMS.

TECHNICAL, INSURANCE, COMMERCIAL, GENERAL, POLICE, Etc., Etc.

ENGINEERS ALL BRANCHES

There are examinations which are open and suitable to you, others which are not. Get our advice before deciding.

The Commercial Side of

THE MOTOR TRADE

offers exceptional opportunities for young men of good education.

EVERY DEPARTMENT IS A COMPLETE COLLEGE.

EVERY STUDENT IS A CLASS TO HIMSELF.

DO NOT DELAY

There may be chances for you to-day for which you may be too late to-morrow. Every day counts in a man's career.

It is the personal touch which counts in Postal Tuition.

NOTE ADDRESS CAREFULLY:

Dept. 76, THE BENNETT COLLEGE LTD., SHEFFIELD



Practical Mechanics

VOL. II. No. 14
NOVEMBER
1934

Edited by **F.J. CAMM**

SUBSCRIPTION RATES :

Inland and Abroad, 7s. 6d. per annum
Canada - - - 7s. per annum

Editorial and Advertisement Offices : "Practical Mechanics," George Newnes Ltd., Southampton Street, Strand, W.C.2.
Registered at the G.P.O. for transmission by Canadian Magazine Post.

Notes, News and Views

New White Star Liner "Queen Mary"

THE launch of the new Cunard White Star liner *Queen Mary* was an outstanding event in the history of the British mercantile marine, and the following brief particulars of this huge vessel should prove interesting. The length overall is 1,018 ft., the beam 118 ft., and the depth from the keel to the top of the superstructure 135 ft. There are twelve decks altogether, and the length of the promenade deck is 750 ft. The propelling machinery will consist of four quadruple-screw Parsons type turbines, having a total output of about 200,000 h.p. There are two engine rooms and four boiler rooms accommodating twenty-four Yarrow oil-fired boilers, which will supply steam at a pressure of 400 lb. per square inch. For supplying electric current for operating the steering mechanism, electric lighting, and for other purposes, there are seven 220-volt turbo-generators having a total output of 9,100 kw., and in addition there are two oil-driven plants each having an output of 75 kw. Each of the four propellers is nearly 20 ft. in diameter and weighs 35 tons, the caps weighing nearly 1 ton each. The thickness of the steel plates of the shell is approximately 1 in., some of the plates being 30 ft. in length and weighing 3 tons. It is stated that the number of rivets used in the structure reaches the enormous figure of 10,000,000. When completed, the new liner will have accommodation for about 4,000 persons, including passengers, officers, and crew.

New Fire-resisting Paint

ACCORDING to a recent report a series of very successful tests of a new fire-resisting paint, known as Firesta, were recently carried out at the makers' works in Hull. The new paint, which is an under-coating, is claimed to hold any fire in check long enough for it to be dealt with by ordinary fire-extinguishing appliances. A box treated with Firesta withstood a heavy fire inside, whilst a plain wooden box of the same size burned to a cinder in a few minutes. Some large-scale models of ships' cabins were treated with the new paint and other models were left untreated. Fans sent the fire down the "corridor" of the ship, and the cabins painted with Firesta successfully resisted the fire, but in the untreated cabins the flames destroyed everything.

The First Oil-engined Zeppelin

THE first Zeppelin airship to be equipped with oil engines will probably be put into service shortly for regular voyages between Germany and South America.

The speed is estimated at 84 m.p.h., and the airship's capacity will be 6,700,000 cubic feet, comprising six separate cells. It is understood that helium will be used instead of hydrogen, and this fact, combined with

THE MONTH'S SCIENCE SIFTINGS

By the use of a double-coiled hair-like filament, which reduces the loss of heat, the manufacturers of Mazda lamps have increased the efficiency of their latest lamp by 20 per cent., as compared with the ordinary gas-filled lamp. The filament is wound in a close coil, and then wound again upon itself, without any contact between adjacent turns.

According to a recent report, cast aluminium can now be welded with a rod containing 95 per cent. aluminium and 5 per cent. silicon. The silicon is claimed to lower the congealing point of the molten metal.

A new process for converting Chelyabinsk coal into liquid fuel has been discovered in the laboratory of the U.S.S.R. Academy of Science. One ton of coal is stated to have yielded 300 litres of petrol and 280 kilos of lubricating oils.

During a test flight in his new Lockheed Altair racer, which has been entered in the Melbourne Centenary Air Race, Air-Commodore Sir Kingsford Smith recently landed at Sydney from Perth (Western Australia), having covered the 2,175 miles at the amazing average speed of 230 miles an hour.

At Montreal, four heavy oil engines, each of 600 h.p., are nearing completion, and will be put into service at the new municipal power station at St. Hyacinthe, Quebec. These engines, which are the largest yet constructed in Canada, have eight cylinders with a 12½-in. bore and 18-in. stroke.

Britain's latest destroyer, H.M.S. "Fury," which was recently launched at Cowes, is 326 ft. long, and has a beam of 33 ft. 3 in. Her main armament consists of four 4.7 guns, two sets of quadruple 21-in. torpedo tubes, and a number of small-calibre anti-aircraft automatic guns.

the employment of engines using heavy oil, reduces fire risk to a minimum. The length is 815 ft. and the diameter 135 ft., and the total power of the oil engines is about 4,400 B.H.P. Electric power will be utilised throughout, including that required for the kitchen, and special oil-engined

generators will be installed for this purpose. Accommodation for about fifty passengers will be provided.

An Ingenious Tile-making Plant

AN interesting tile-making plant capable of turning out 3,000 Brosely tiles an hour was exhibited by Pegson Ltd., of Leicester, at the recent Building Trades Exhibition at Olympia. Plastic concrete is fed into a hopper, formed and compressed into tiles, coloured to any desired shade, and delivered from the machine without the need of any supplementary process other than storing for a short time to allow maturing to take place.

Synthetic Radium

THE remarkable discovery of the long-sought formula for the production of artificial radium which was recently made by Madame Joliot (daughter of the late Madame Curie) and her husband brings new hope in the war on cancer. Thousands of patients in need of this precious substance will now be able to benefit by its curative properties, whereas hitherto, owing to its rarity and high cost, only a few hospitals possessed a tiny supply. With the artificial product, which is claimed to be just as effective, doctors and hospitals will be able to obtain as much as they require, and at a comparatively cheap price.

New Phototelegraphy System

AN important Imperial link between Australia and Great Britain has just been brought about by the inauguration of the most modern system of photo-telegraphy. Apparatus at the Central Telegraph Station of Cable and Wireless Ltd., is now available for public use for the transmission of pictures and other photo-telegraphic matter. The system used is the improved Marconi Facsimile, which gives a much better reproduction than the systems hitherto used. A picture measuring 9 x 9 in. occupies about half an hour in transmission and tests are stated to have been very satisfactory. This system of transmitting pictures over long distances is becoming extensively used by bankers, accountants and auditors, engineering contractors, and by newspapers. The charge for the service is 3s. 3d. per square centimetre of picture.

A Wireless Development

MR. F. J. Camm, the editor of PRACTICAL MECHANICS, has designed an entirely new receiver—a battery-operated superhet employing only three valves! It may be made for less than £5 and a free blue print is given in October 27th issue of *Practical Wireless*.

Learning to Glide.

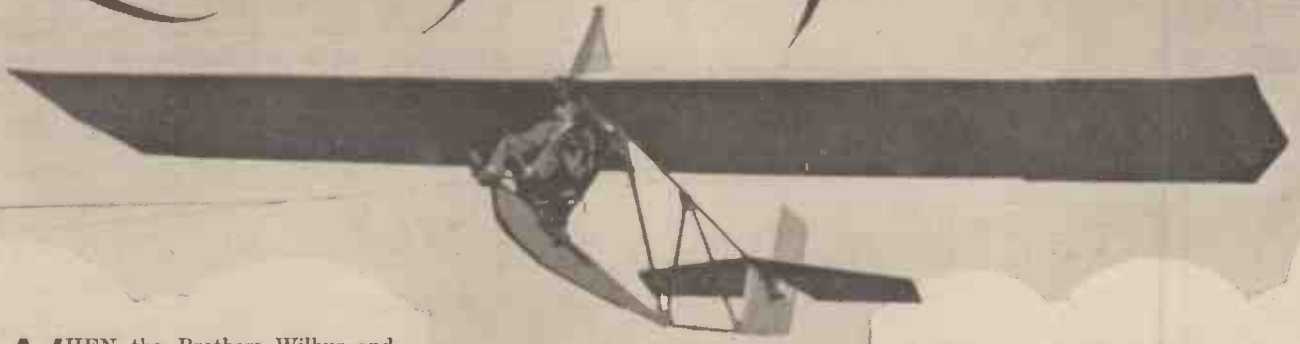

WHEN the Brothers Wilbur and Orville Wright made their original gliding experiments in America, which terminated in their record glide of a few minutes' duration, it was considered that this was the ultimate in motorless flight. Many experimenters, notably Otto Lillienthal and Percy Pilcher, had constructed gliders before them. Pilcher's experiments were made in a machine which he called the "Gull," at Wallace-town Farm, near Cardros, on the banks of the Clyde, in July, 1895. Notwithstanding extensive alterations to the structure, he was unable to achieve glides of more than a few yards in length. His greatest success seems to have been a glide of twenty seconds' duration at a height of only 12 ft. According to history, the earliest attempts were made by Roger Bacon, who, in the year 1250, is reputed to have made a soaring machine. It is more likely, however, that Bacon is confused with Oliver of Malmesbury, who undoubtedly did make such a machine, during the first flight in which he broke both his legs. In 1854 Captain Le Bris built a glider somewhat on the lines of an albatross, which is said to have ascended 300 ft. in the air and landed 600 yds. away. Later, Octave Chanute conducted some successful experiments with gliders; but Lillienthal, an engine builder of Berlin, who was killed whilst gliding, was undoubtedly what we may term the "father" of gliding.

Most of these early gliders were of the biplane class, and were so built for purposes of strength, the materials then available



A test flight in progress during a gliding contest held at the opening of a new glider aerodrome in Germany.

By F. J. CANN

being inferior to those which are in use to-day. The consequence was that gliding could often be done in winds which would be too light for the modern heavy monoplane glider. A greater advantage was that only two men were required as a launching team, and quite frequently the pilot was able to launch himself by running down a suitable hill when the direction of the wind was up the hill.

The Revival of Interest

The revival in interest in gliding dates from 1920, when some German students in the Rhone Valley succeeded in making some phenomenal glides of over an hour's duration. These flights received world-

wide publicity, and were responsible for an English leading daily paper offering a £1,000 prize for the longest glide. The gliding contests were held at Itford, and the English pilot, F. P. Raynham, succeeded on the very first day of the trials in remaining aloft for one hour fifty-seven minutes, and then made a voluntary landing in the presumption that no one could possibly beat that figure.

The Frenchman, Maneyrol, came over on the very last day of the tests and remained aloft for over three hours. This event succeeded in creating enormous interest in gliding in this country. It soon became generally known that gliders were cheap to construct, and that even if wrecked could be speedily and cheaply repaired.

The formation of the British Gliding Association marked a new era in gliding as a hobby, and gliding clubs were formed throughout the country.

The Fascination of Motorless Flight

The recent achievement of a British gliding pilot in making a cross country run on a glider as well as by looping the loop and performing other aerobatics in a glider, indicates the vast strides which have been made. Under suitable conditions it is possible to make considerable journeys overland by means of a glider, and to remain aloft for hours. There is a peculiar fascination in gliding. I can write with first-hand knowledge of it for, before the war, I designed, built and flew several full-sized gliders, one of which is illustrated below.

There is a remarkable "silence" when, seated in a glider, you attain an altitude of a few hundred feet. You miss, if you have ever been up in an aeroplane, the deafening noise of the engine, and experience an almost unbelievable sense of absolute safety. The comparatively slow speed of a glider enables you to correct any tendency to dive, stall or side slip, and there is a feeling that you are quite stationary above the remarkable mosaic and panorama of the countryside beneath.

Learning to Glide

Hundreds of people have dis-



A biplane glider with joy-stick control, sprung chassis, and inverted ailerons, designed and built by Mr. F. J. Cann.

covered how easy it is to learn to glide. It takes a very short time to do so, and it is not costly. In England there are no less than thirty-five gliding clubs scattered about the country, fifteen of which are affiliated with the British Gliding Association. The total membership of all clubs is about 2,500, and the cost of membership varies according to the club. Usually, however, the entrance fee is about £1 and the annual subscription £3.

All those readers who can possibly do so should witness one of the many gliding meetings being held in various parts of the country each week-end. Gliding may be sub-divided into elementary gliding and sailplaning. There is a distinct difference between these two things. In gliding, the machine is towed or catapulted into the air from the top of a hill, and the glider gradually comes to rest a few hundred yards further on; but in sailplaning, which requires a greater degree of skill, the pilot takes advantage of up-currents to gain altitude, and is able to keep aloft for considerable periods.

Building Your Own Glider

As stated earlier, it is not a costly matter to build a glider yourself. The parts will cost not more than £3 or £4, and the work is well within the ability of any amateur capable of making a few simple metal fittings and who is reasonably skilled in the use of woodworking tools. It will be necessary, of course, to have access to some suitable hill, and to obtain the assistance of two or three others to operate the tow-rope or the catapult. I suggest, however, that the reader will save a considerable amount of time and money if he joins a gliding club, for in the early stages of learning to glide, mild accidents to under-carriages and wing tips are frequent, and the lone hand would spend a considerable amount of time in repairing his machine, even if he is not discouraged from making further attempts.

The Gliding Clubs

The gliding clubs have a number of

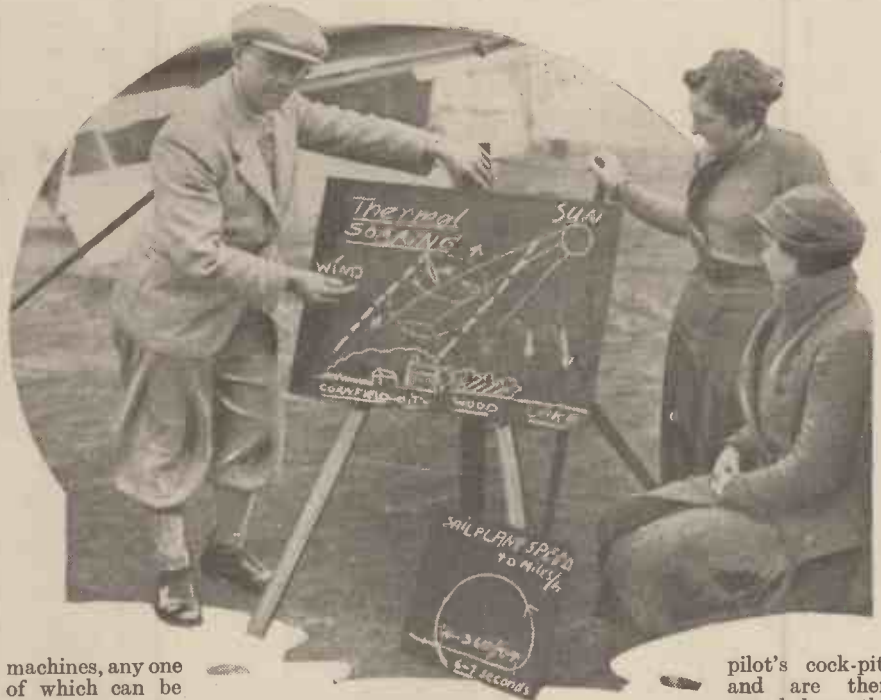

machines, any one of which can be brought into action should one become damaged. All clubs own gliders of two types—the primary, or beginner's type, and the sail-plane. The members are taught first to control the glider by means of short towed flights in a primary glider. As soon as he has learned to control the machine by means of the joy-stick he is permitted to make short "free" glides. This practice continues for some time until he passes over to the sail-plane.

Herr Wolf Hirth, who is one of the leaders of the gliding and soaring movement in America and Germany, lecturing to young gliding enthusiasts at Dunstable.

pilot's cock-pit, and are then towed down the hill by other members of the club by means of ropes attached

to the wing tips. As the glider gains speed you will gradually ascend to a height of about 40 ft, and by means of these ropes those towing are able to correct the mistakes which you will undoubtedly make. After a few of these towed flights you will rapidly get the "feel" of the machine and proceed to the "free" glide. After further experience you will be catapulted into the air.

The First Flights

As a new member of a gliding club, when your turn comes you take your seat in the

Catapulting

Catapulting is effected in the following way: A loop of fairly stout rubber cord is

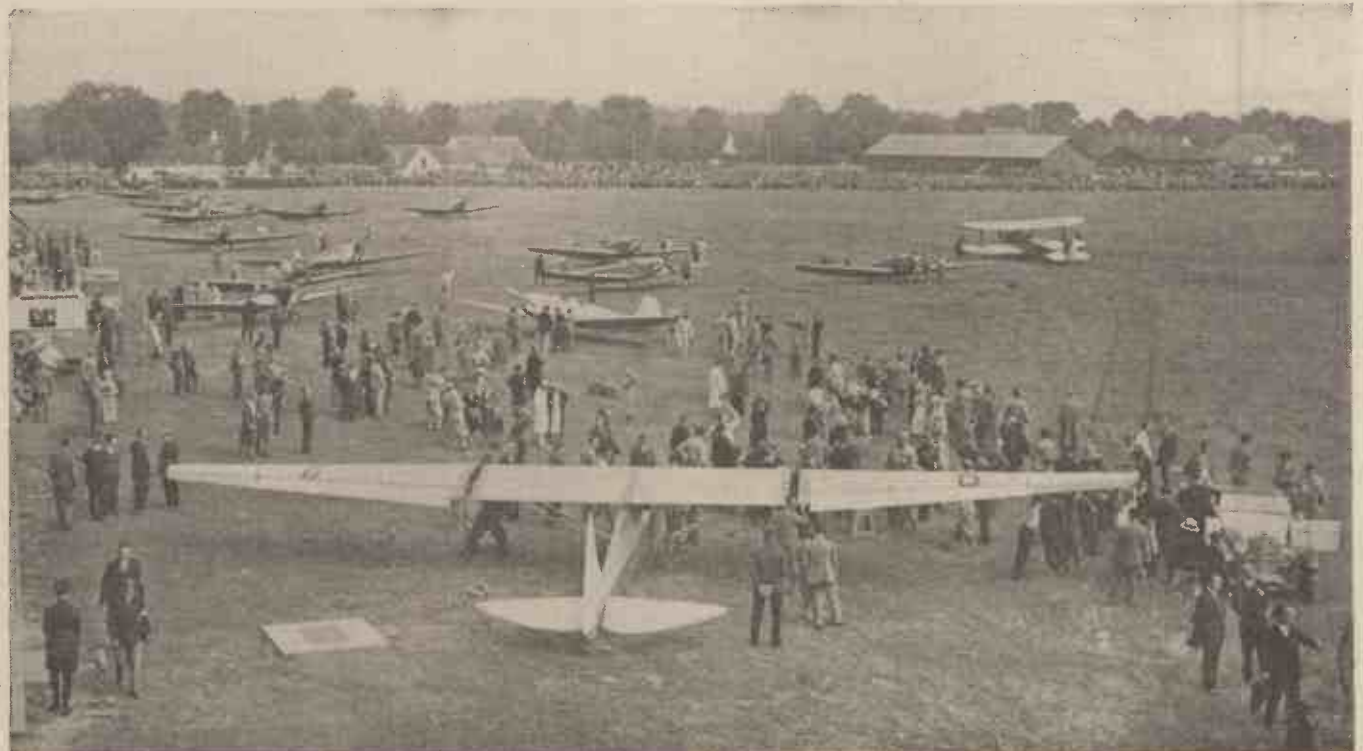

A fine view over an airfield during a gliding meeting at Augsburg. The glider shown in the foreground is that flown by Herr Kronfield.



A small glider demonstrating at Ivinghoe, Buckinghamshire.

attached to the nose of the glider, the ends of the rubber catapult being tethered to the ground. Several members then pull the glider backwards to stretch the rubber cord. Upon releasing the glider, the rubber cord propels the machine into the air, and you will then make glides of longer duration. It is very simple and quite safe, as is evident by the clean record of gliding.

Some clubs give their tuition by means of three grades of machines—primary, intermediate and sail-plane—and after tuition on the primary, you proceed to the sail-plane *via* the intermediate glider. Both the intermediate and the sail-planes are suitable for soaring.

Certificate of Airworthiness

If you elect to build the glider yourself, it is highly desirable that you should obtain a certificate of airworthiness for it. In order to obtain this you should apply to the Technical Committee of the British Gliding Association, 19 Berkeley Street, London, W.1. If the glider is of an approved type, two inspections are given by the Association. If the glider is of a new type of your own creation, drawings must be submitted, which the Technical Committee submit to stress calculations to make quite sure that it is strong enough to comply with gliding conditions. It is hence better to submit these drawings before building is commenced.

The Gliding Ground

Attention should be paid to the nature of the ground required for gliding. You will require a hill at least 150 ft. long and of reasonable altitude facing the prevailing wind. That is to say, the wind should be blowing up the hill. The minimum slope

for successful gliding is about 1 in 5, and the hill, needless to say, should be free from obstacles. A wind of at least fifteen miles an hour is necessary, although this will to a large extent depend on the loading per square foot employed on the glider and to the lift-drag ratio of the wing section employed. It is here necessary to explain a term used in gliding and aeronautics known as "lapse rate." Temperature normally falls in direct proportion to the height ascended. A high lapse rate is good for soaring, whereas an inversion of the lapse rate gives rise to a stable atmosphere, which is decidedly bad for soaring. An inversion of lapse rate occurs when the temperature rises with the height ascended—for example, as when fog is present.

Soaring

For thermal or cloud soaring, the greatest lift occurs particularly under recently formed cumulus clouds, and reaches a maximum intensity in thundery conditions. The following are the British gliding records:—

Height: G. M. Buxton, Sutton Bank, Yorks, 7,970 ft.

Distance: G. E. Collins at Sutton Bank, Yorks., 98½ miles.

Duration: J. Laver at Dunstable, Beds., 12 hours 21 min.

Licences

The British Gliding Association issues licences to glider pilots. For Certificate A it is necessary to travel thirty seconds in a straight line. For Certificate B it is necessary to glide for at least a minute, making two "S" turns, and also to make two flights of at least forty-five seconds each. For Certificate C it is necessary to make a soaring flight of at least five minutes at or above the starting point. An additional certificate, known as the "Silver C," which is only issued to those glider pilots who achieve a duration flight of at least five hours at a height of 3,500 ft. and a distance of 330 miles.

Up to the moment 350 A licences have been issued, 160 B licences, 85 C licences, but only 2 Silver C licences.

Gliding offers ample scope not only as a sport, but as a thrilling hobby to which is attached less danger than motor-cycling or boating.

Those readers who are sufficiently interested to wish to build a glider should make sure that they use the correct materials. The fuselage, the wing spars, and all ribs should be made from silver spruce. Skids and chassis members are best made from steel tubes or birch. Sixteen-gauge piano wire should be used for bracing, and a good brand of aero-cloth should be used for covering the surfaces. For primary gliders, Nainsook or Irish linen is suitable. After covering it should be doped with aeroplane proofing material, as it is essential that the wings should be airtight and waterproof. For primary gliders I recommend a loading of from 1 to 1½ lb. per square foot, and for soaring and sail-planes up to 2 lb. per square foot.

THE EVOLUTION OF THE AIR-LINER

BRITISH progress in the design and construction of passenger air-liners is illustrated, strikingly, by a comparison which is now possible between the latest craft of the "Diana" type and a machine such as the D.H. 18, one of the first aircraft to be built for regular air transport on the routes between London and the Continent.

Machines of the "Diana" type are to be used by Qantas Empire Airways, an associate Company of Imperial Airways, on the new Malaya-Australian extension of the Eastern Empire route, which is to be inaugurated in December.

The D.H. 18, which was put into service between London and Paris in 1922, was driven by a single 450-h.p. engine, and carried a paying load of 1,100 lb. at a maximum speed of 115 miles an hour, and at a cruising speed of 95 miles an hour.

In contrast to this, the modern "Diana" type of machine, which is driven by four engines developing a total of 800 h.p., carries a pay-load of 3,147 lb. at a maximum speed of 170 miles an hour, and a cruising speed of 145 miles an hour.

Actually, the increased reliability of the four engines in the "Diana" machines—any two of them maintaining the machine in flight when carrying a full load—together with the increase in cruising speed of 50 miles an hour, have been accompanied by an improved commercial performance which is represented by the fact that, whereas the pay-load per horse-power of the D.H. 18 was 2.4 lb., that of the "Diana" machines is 3.9 lb.

Constructional progress, in the twelve years from 1922 to 1934, is demonstrated by the fact that, whereas the D.H. 18, built to carry six passengers and a crew of two, weighed 7,200 lb., a machine of the "Diana" class, designed to carry ten passengers and a crew of two, does not weigh more than 6,351 lb., even when incorporating all the factors of structural security, which are an essential feature of British air design. This means that the factor of weight per horse-power has been reduced from 16 to 7.9 lb.

It is specially noteworthy, also, that these improvements in commercial performance have been accompanied by a remarkable all-round increase in the comfort of passengers, as is evidenced by modern luxury air saloons with their sumptuous fittings, full catering service, and noise reduction, even when flying at high speeds.

What is

ITS CAUSES—

FROM time immemorial lightning has aroused our fear and respect as one of the mighty—yet wayward—manifestations of the forces of nature. But it is only in comparatively recent times that it has been made the subject of serious scientific study.

The first definite clue to its nature was given by Benjamin Franklin in 1752. By flying a kite during a thunderstorm he showed clearly that the clouds were heavily stored with electricity. "When the rain," he says, "has wet the kite and twine, so that it can conduct the electric fire freely, you will find it stream out plentifully from the key (to which the twine was fastened) on the approach of your knuckle." From this he concluded that lightning was neither more nor less than a large-scale demonstration of the same energy which caused sparks to pass from a Leyden jar, or from a glass globe or tube that had been rubbed with silk, or from any of the other primitive electrical machines then known.

Our knowledge of atmospheric electricity remained more or less where Franklin left it, until Lord Kelvin—over a century later—took matters a stage further by showing that the whole of the atmosphere is permeated with electricity at all times, and not only during a thunderstorm.



A steady, direct-current lightning bolt of 7,000,000 volts, the most powerful man-made thunderbolt of its kind produced so far. This is the highest amount of direct current voltage ever seen by man, and the voltage is over seven times higher than the previous highest. This voltage will be used to bombard and split atoms. Here we show the 7,000,000 volts of light being flashed through the air during the first test.

An Interesting Experiment

By his classical water-dropping experiment he measured the "static" potential of the air at different levels, and so established the existence of a "potential gradient" from the ground upwards. This is always present, though it varies both in sign and strength from time to time.

Kelvin's water-dropper, which is still in use at Kew, consists of an elevated cistern from which water is allowed to fall drop by drop. If there is any initial difference in potential between the water in the insulated cistern and the surrounding air, an electric charge of opposite sign will be induced at the end of each drop. Since this charge is carried away by the drop as it falls, the rest of the water left in the cistern will gradually be charged up until it attains the same electric "level" as the surrounding air. As soon as this state of equilibrium is reached the potential of the water in the cistern is measured by an electrometer, and so indicates the atmospheric potential at that point.

Air is, of course, generally regarded as a non-conductor of electricity. If that is so, it is difficult at first sight to see how atmospheric electricity can move about from point to point. In short, even admitting the existence of a potential gradient, it is not clear how this gradient can change, nor how electric charges can accumulate at any one point more than another, and so form the beginnings of a lightning discharge.

(Left) This remarkable photo shows the breaking of 500,000 volts in a demonstration of high-frequency current from Tesla Coils. With a crashing sound, this electrical flame goes from the top of the instrument set on the floor and strikes the concrete ceiling overhead, and (right) A new experimental lightning-rod passes enough electricity in less than 1/100 of a second to lift St. Paul's Cathedral from its foundations. Two funnel-shaped flashes of fire are all that is left of 132,000,000 volt-amperes. This lightning-rod is designed to protect overhead transmission lines from the ravages of lightning, and is expected to save America millions of dollars a year.

Lightning?

—AND BEHAVIOUR

Ionisation

The answer is to be found in the process known as ionisation. The molecules of gas forming the air are built up of ions and electrons, which are normally bound to each other by chemical attraction. Owing to the action of ultra-violet rays from the sun, as well as the so-called "cosmic rays" and other forms of short-wave radiation, a certain number of the air molecules are split up into free ions and electrons, and these act as electricity carriers.

It is calculated that there are approximately 500 free ions and electrons in every cubic centimetre of air. This makes the air sufficiently conductive, for instance, to allow the charge of electricity on any insulated body to leak away in a comparatively short time when exposed to the open air. It is also sufficient to allow the electricity stored up in the atmosphere itself to move about from point to point instead of remaining equally distributed throughout.

Anyone who has ever heard bad "atmospherics" on a wireless set will readily agree that the electrical state of the atmosphere is anything but tranquil. Each "crash" and "growl" and "grinder" picked up by the aerial represents the rapid movement in bulk of electric charges. Some are merely the reflections of distant



thunderstorms, whilst others are the result of nearby "silent" discharges from a point of high to a point of low potential.

Wireless "static," in fact, gives us a picture of incessant electrical movement, resembling a storm at sea rather than a placid ocean.

An Explanation

The usual explanation of the manner in which the stage is first set for a thunderstorm is that the clouds "gather" a charge of electricity, which gradually increases until the pressure becomes so great as to break down the insulation of the air. The pent-up voltage then discharges as a flash of lightning either to earth or to a nearby cloud of lower potential.

This is all very well so far as it goes, but it rather leaves one in the dark as to the way in which the cloud actually acquires its excessive charge of electricity. According to Dr. G. C. Simpson, the charge is collected as the result of the action of an upward current of air upon a cloud of raindrops.

The moisture in the upper regions of the atmosphere first condenses into very small drops, which, when they grow to a certain size, begin to fall. If now they happen to meet a vertical current of air—travelling upwards at a speed of not less than 30 feet a second—the large drops are broken up into smaller ones. As this happens, the drops acquire a positive and the air a negative charge, in much the same way as a glass rod when rubbed by a piece of silk.

The broken-up drops are now too small to continue to fall under gravity, and so they are swept up again until the air reaches the top of its vertical sweep, where it "fans out" and starts to descend.

The small drops—once they have lost their upward movement—coalesce into larger ones, until they again reach a sufficient size to begin to fall under the force of gravity. Before long the falling drops are once more broken up by the rising column of air, and again acquire a further electric

(Right) This unusual photograph was obtained during a recent thunderstorm over New York, and the optical illusion that it presents would really lead one to believe that the bolt of lightning was really anchored to the lofty pinnacle of the new building shown, and (below) Vivid lightning over London.

charge. And so the process goes on, until the cloud

builds up a potential beyond the breaking strain of the surrounding air. Once the lightning discharge starts, free ions from the surrounding air crowd in upon the path of rupture and assist in breaking down the insulation of the air.

The average lightning flash discharges about 20 coulombs of electricity, over a length of 2 kilometres, under a potential

gradient of approximately 100,000 volts per metre.

Sometimes the flash does not occur simultaneously along the whole of its length, but "rockets" along from point to point, waiting until it can create fresh ionisation at each

of these points. If there is a considerable lag in the process of ionisation, the discharge takes the form of a floating "ball of fire," which appears to move along its path to earth.

Occasionally the field of force created by a thunder cloud will set up a brush discharge from some pointed body on the ground. This phenomenon is known as St. Elmo's fire.



THE chief aim of the mechanical engineer is to obtain the maximum of strength from the minimum of material. One of the most important principles employed is the Principle of Triangulation. Fig. 1 shows some pieces of wood loosely bolted together, and it is obvious from the illustration that the only one of the three

HOW ENGINEERS MAKE RIGID STRUCTURES

which possesses any rigidity is the middle one (supporting the weight), which is triangulated. Fig. 2 shows two pieces of wood, one on top of the other, the two constituting a beam, supported at the ends but not fixed. This beam carries at its centre a board on which are placed a collection of heavy weights. A thin cord goes from the top of the beam and is wound several times round a wooden pulley at the centre of the back of the graduated disc. When no weight is on the beam, the pointer is vertically upright. In Fig. 3 the pieces of wood constituting the beam have been separated and are now

connected by inclined pieces of wood bolted to them, in the form of triangles. In the first case the pointer has moved through at least four times the distance than that shown in Fig. 3. But the inclusive loads in Fig. 2 is 6 stone, whilst in Fig. 3 it is 10 stone.

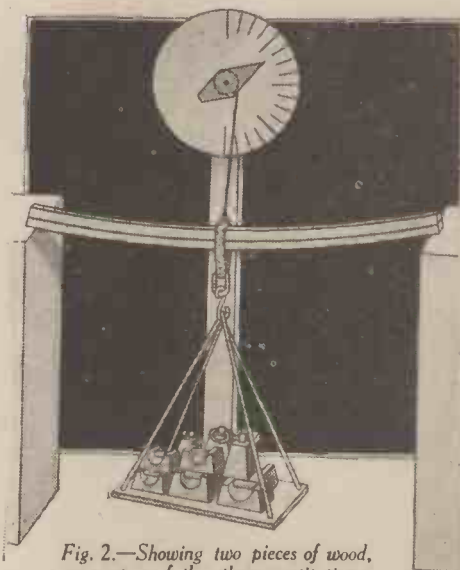

Fig. 2.—Showing two pieces of wood, one on top of the other, constituting a beam, supported at the ends but not fixed.

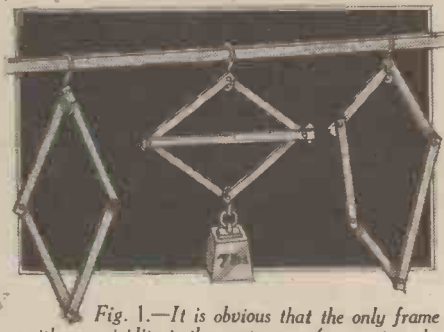

Fig. 1.—It is obvious that the only frame with any rigidity is the centre one (supporting the weight), which is triangulated.

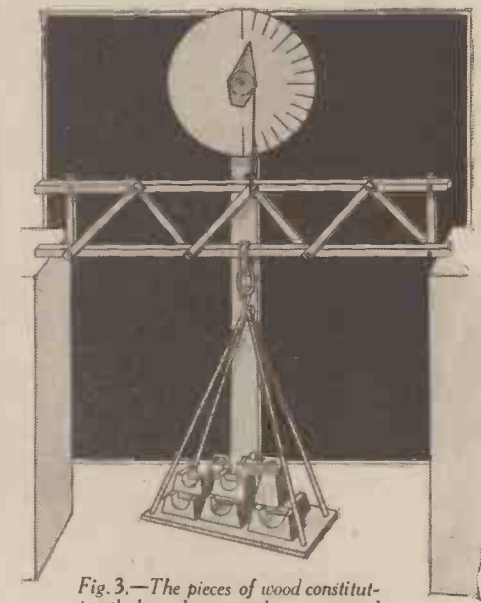

Fig. 3.—The pieces of wood constituting the beam have now been separated and connected by wooden struts as shown.

IS PERPETUAL MOTION POSSIBLE?



Fig. 3.—Details of the radiometer, which is considered to be the nearest approach to perpetual motion.

FOR centuries men have toiled to invent a machine which would go for ever. Now it can be definitely stated that perpetual motion is an impossibility and will never be an accomplished fact. It is only the untrained mind, the unmechanical mind, the mind knowing little about first principles, that would waste time, money or thought on the proposition. And yet every year the specifications at the Patent Office represent a bulky and tangible proof of the fact that perpetual motion is still thought to be possible.

One favourite device which took various forms was a wheel or mill on one side of which gravity apparently acted with greater force than on the other.

Fig. 1 illustrates such a mill. The power of the machine is obviously derived

from the energy stored up in each sphere or weight in falling from its highest to its lowest point, but in order to do this each weight has previously to be lifted from the bottom to the top. Thus the spheres consume just as much energy as they produce, and there is no energy left over for working the driving belt or for overcoming the friction of the machine. Therefore the machine cannot even turn round, let alone do any useful work. The idea is, of course, that

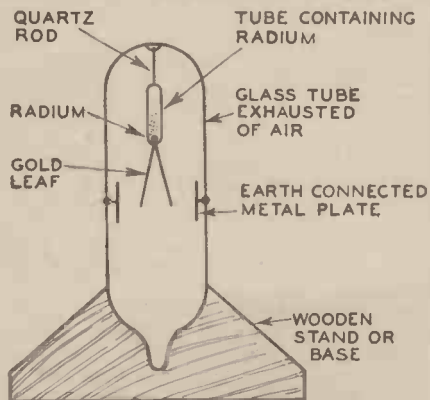

Fig. 4.—The construction of the radium clock.

the hinged levers have a greater turning movement on the right than when on the left. It will be seen that the weights are never at the full length of the arms until the unhinged part has passed the horizontal, because the weights cannot overbalance and straighten out the arms until this is so. Moreover, the hinged arms must always

Details of Ingenious Devices Intended to Work for Ever—but Which, of Course, Failed to do So

have a greater number of weights on the ascending side, as Fig. 1 clearly shows.

Hydrostatics

Another example of misplaced ingenuity comes from that branch of mechanics known as hydrostatics (Fig. 2). Imagine first of all that the small tank on the left is omitted. Obviously if the spheres in the water are hollow and light, they will tend to rise, since they each displace far more than their own weight of water. The problem is to get

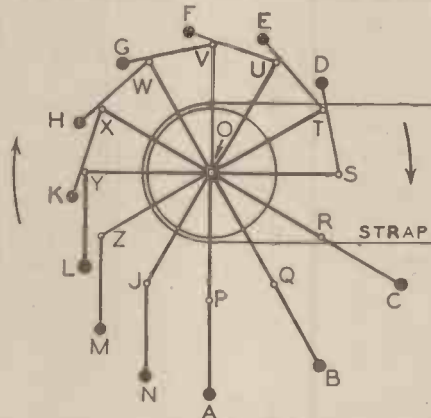

Fig. 1.—The automatic mill. A to N are equal heavy solid spheres or weights, on the ends of rods of equal length hinged at the points marked P to Z and also J.

them into the tank without letting the water run out, since there must obviously be a hole and slot for the spheres and arm to enter.

A Tank containing Mercury

Another inventor got over this difficulty by having a small tank (communicating with the higher and larger one on the left) containing mercury. This held the water in all right because mercury is more than thirteen times heavier than water. But just as much power would be required to drag the spheres downwards through this shallower depth of mercury as if the whole contrivance were immersed in water, when obviously no movement would take place. Supposing the original design had the water continually running out, compensated by water pouring into the top of the tank, would the machine work and would this be perpetual motion as intended by the inventor?

In another example the inventor caused water falling from a tank to work a water wheel which by suitable gearing worked a pump which in its turn pumped the water up again into the tank. Many other examples might be given. In some the fallacy is not always quite so easy to detect, but it is always there. It is one thing to construct a piece of mechanism which shall run for hundreds, or it may be thousands, of years, but it is quite another matter to get it to do any useful work. For no work can be done without an equivalent expenditure of energy.

The Radiometer

This device is often seen in chemists' or opticians' windows and is shown in Fig. 3. It usually consists of four very light vanes or arms; at the end of each is a light disc

painted a dull black on one side and silver on the other. These vanes and arms are carried on a light steel axis with hardened ends, and the glass bulb in which the whole is mounted has had the air pumped out so that there is no air resistance inside. When set in the sun the vanes rotate rapidly, not, as many people think, owing to the light rays from the sun (we have not yet managed to harness light successfully), but owing to the heat rays, for the blackened sides of the vanes absorb the heat far more rapidly than the silvered ones, which causes the pressure to vary on either side of the vanes.

An electric radiator (radiating heat) will work them quite well. If a vessel containing iodine is placed between the vanes and the source of heat, the device will still work quite well because the iodine only cuts off the light rays; but if an alum cell, which passes the light rays but cuts off the heat, is substituted for the iodine cell, it will quickly stop the vanes rotating. So long as heat rays fall upon it, it will continue rotating, but not without absorbing heat energy.

The Radium Clock

The Hon. Q. J. Strutt constructed what is popularly known as the radium clock, illustrated in Fig. 4. He enclosed a small quantity of radium (about the size of an apple pip) in a small glass tube, which was fastened to the top of another glass tube in which had been created a vacuum. From the lower end of the tube containing the

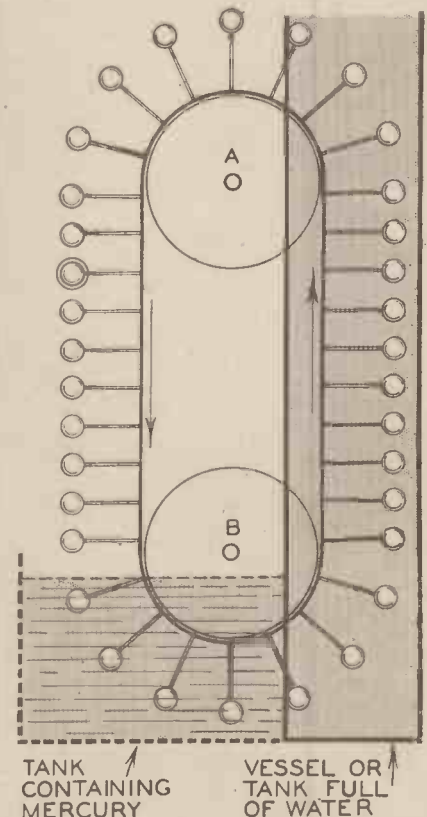

Fig. 2.—A and B are the centres of two freely turning wheels or flat pulleys, round which runs an endless belt from which spring a number of arms at right-angles carrying light hollow balls.

radium was suspended two strips of gold leaf, similar to an electroscope. Now the alpha rays of the radium caused an accumulation of positive electricity in the tube containing the radium, which by induction caused an accumulation of positive electricity in the leaves of the electroscope. As both leaves were similarly charged, they repelled one another, this continuing until they touched the earthed plates or foil

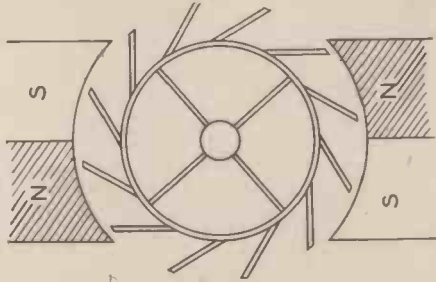

Fig. 6.—The magnetic wheel.

placed on or near the sides of the vacuum tube. The leaves were at once discharged and fell together again, and since radium works without a stop, this continues and can go on indefinitely so long as the vacuum and insulation is maintained. It is the nearest approach to perpetual motion as yet attained by man.

As the leaves can easily be made to perform a complete cycle every half minute, and the time of the cycle is independent of

all external conditions, it can serve as an exact measure of time; hence the name radium clock. With enough radium to work a machine on a large scale, there is very little doubt it could be made to record the time on a dial. It is not, of course, really perpetual motion, because disintegration of some kind must be going on, but this loss is so small it cannot at present be measured. It has been calculated that about half the radium would have disappeared in 1,000 years.

The H.P. of a Stone of Radium

The peculiar property of radium is its heat-producing power, each gram of radium emitting sufficient heat to melt its own weight of ice in one hour. On this fact the following calculation has been based, viz., that if a stone of radium could be obtained and all the energy given off as heat be used mechanically, then it would be sufficient to drive a 1-h.p. engine for some 50,000 years.

The Balls in the Wheel and the Magnet Wheel

An ingenious device is shown in Fig. 5, where a series of balls are shown in their relative positions in the spokes of a wheel, as if the latter were revolving, the spokes being so constructed that the balls run in a little track to prevent them falling out. Unfortunately, it was not successful. Fig. 6 recalls the old idea for perpetual motion known as the magnetic wheel. The specious claims of the inventor state that "a light

wheel is mounted on friction rollers, set with slips of iron at an angle round its periphery. The two magnets, N, which attract the rim of the wheel, will render one side lighter and the other heavier, thus imparting perpetual motion! To render the apparatus more powerful, the steel rims might be magnetised and fixed on the wheel

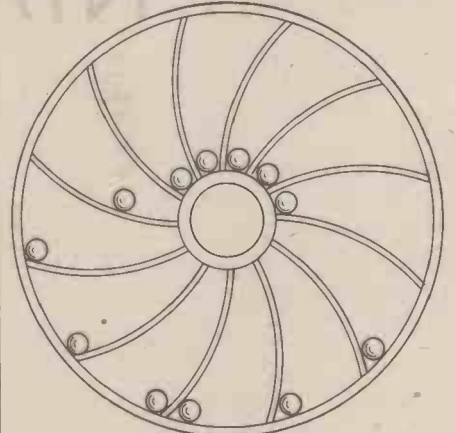

Fig. 5.—The wheel and balls.

with their north poles facing towards its centre. Two more magnets (shown shaded) must be added." Again the hopes of the inventor were dashed to the ground, for nothing short of some form of electric motor would induce it to work.

A TREASURE-LOCATING DEVICE

If you are thinking of taking a holiday on Cocos Island, or in the Land of the Incas, or at any other spot where vast treasure is reported to be securely hidden, here is your chance to locate it, and return to your native land rich beyond the dreams of avarice. The great idea comes from the land of the almighty dollar, and consists of

ADAPTING WIRELESS FOR LOCATING HIDDEN TREASURE

a portable wireless apparatus which will indicate the near presence of a secret hoard or, presumably, any other mineral deposit.

As will be seen from the illustration, the searcher after wealth trails a long pole, at either end of which is carried a type of portable set. The forward one is a transmitter, and is adjustable as to its angle with the receiver at the rear end of the pole. The transmitter consists of a one-valve Hartley oscillator, the radiating aerial being a "loop" or frame wound around the outside of the containing case. The receiver at the other end has a three-valve straight circuit, with tuned loop,

and a tuned coupling between the screened grid and detector valves. The latter is coupled by a transformer to a pentode output. A variable series resistor controls the H.T. supply to the screening grid as well as oscillation.

How it Operates

The theory of operation is simple. Radiation from the transmitter heterodynes the oscillations of the receiver, which is tuned to a wavelength slightly above or below that of the transmitter, so causing a whistle or beat note in the headphones. If the prospector walks over or near a metallic deposit, the deflection of the waves radiated, or the absorption of power by the metal, alters the note to a greater or less extent according to the magnitude and distance of the "find." The receiver may also be worked in a non-oscillating state, but adjusted to be "on the edge." In this condition any disturbance of the surrounding electrical or magnetic conditions causes oscillation and a consequent note in the 'phones. The wavelength used may be between 100 and 200 metres, that being the band allotted to geological survey in the U.S.A.

A very similar arrangement is, of course, employed in naval circles for the location of sunken craft and also, in a modified form, for the ascertaining of the depth of the ocean bed. In the latter case the radiations from the transmitter are directed downwards and a special type of directional aerial is employed. The radiations are reflected when they touch the ocean bed, and the direction of radiation is arranged so that the returning wave from the ocean bed strikes the ship. A receiver is placed in this position, and by working out the length of time for the wave to return, the depth can be ascertained.



A diagram illustrating the treasure-locator and its action.

A MOTOR-CAR IN MINIATURE

What at first sight appears to be little more than a toy
has practical possibilities

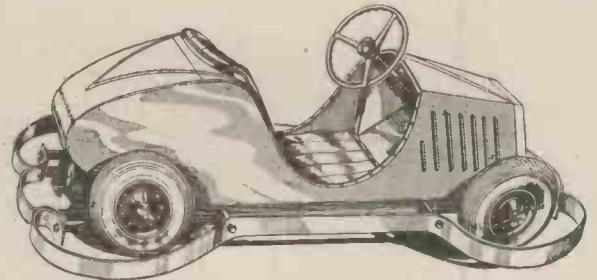

This sketch of the new midget car shows the business-like layout adopted.

NUMEROUS attempts have been made to produce miniature motor-cars capable of carrying one and in some cases two passengers, but they have almost invariably been the work of amateurs. A thoroughly practical vehicle, however, has recently been evolved and developed by a British concern. This new miniature motor-car can be handled by the most inexperienced driver, as the maximum speed attainable is about fifteen miles per hour, but extremely low build, coupled with fairly high engine revolutions, gives a greater impression of speed than is actually the case.

the speed of the vehicle without the need for a change in the gear ratio. Removing one's foot from the control closes the throttle and at the same time applies the brake.

A casing just behind the driver's seat can be removed quickly, and this discloses a 1 h.p. Villiers engine, having the crankshaft supported in ball bearings. Air cooling is effectively arranged by means of a vaned flywheel enclosed in an aluminium cowling. The engine is coupled to a clutch which comes into operation when the engine speed exceeds 800 r.p.m. An enclosed gear box

Aids to Publicity

The novelty of these vehicles and the widespread attention which they draw, inevitably make them extremely valuable for advertising purposes, and Mr. Shillan is arranging to supply them fitted with bodies which are almost exact reproductions in miniature of certain well-known larger cars. These reproductions of full-sized automobiles will be supplied to various motor agents at home and abroad as a valuable means of drawing attention to the particular make of car in which the agency is interested. The manufacturers of Frazer-Nash cars have already ordered fifty.

Apart from the possibility of advertising propaganda, there are openings for these tiny vehicles in private service. They are, for example, perfectly safe for children to drive, although in such hands they would need to be used on private roads. One can imagine that youthful owners would not be left in sole possession of the cars, and that adults might be tempted to find an excuse to borrow them! There is no reason why they should not experience such useful adaptations as having a large hopper body fitted, the resultant vehicle taking the place of a wheelbarrow in large gardens. The weight of the complete vehicle is so small—only just over 200 lb.—that the proportionately large tyres would leave no impression on a lawn. Owing to the low running costs and simplicity of handling, they should also find a market overseas. It is understood that the price for single vehicles will be £70. Petrol consumption works out as low as seventy miles per gallon.

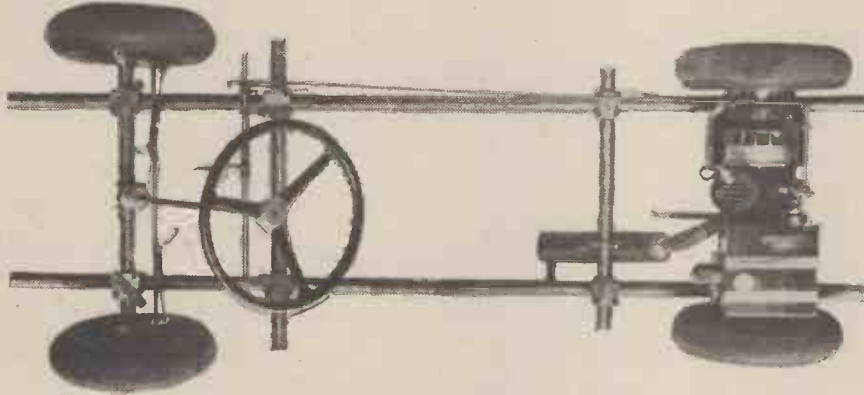

A plan view of the tubular steel chassis of the "Scoota-car."

Already production has commenced on quite a considerable scale. Mr. J. W. Shillan, Britannia House, Ampton Street, London, W.C.1, and his chief engineer, Mr. Charles Harrison, are responsible for the design and production of these miniature vehicles, which are known as "Rytecrafft Scoota-cars." Incidentally, Mr. Shillan has considerable practical experience of the motor-cycle market, and is the producer of the popular Britannia outboard and inboard motors for small marine craft, so that his knowledge in regard to small engines and various forms of transmission is extensive.

The chassis of the "Rytecrafft Scoota-car" is composed of two parallel tubular members. The rear wheels, together with the engine and transmission, which form a compact unit just behind the driving seat, may be removed in a few minutes. The steering is extremely light, flexible steel cables being used. These are spring-loaded, so that any slack is automatically absorbed. The front wheels are well cambered, and the centre of gravity of the car is so low that when running at full speed of twelve to fourteen miles an hour with the present gearing it is possible to pull the wheel hard over without capsizing the vehicle. Balloon tyres are fitted to wheels approximately 12 in. in diameter. A single pedal is the only speed control. Upon taking one's seat the brakes remain hard on until the pedal is depressed to the extent of about $\frac{1}{4}$ in. Further depression accelerates the engine, and the drive is then taken up sweetly. Still further movement of the pedal increases

is interposed before the final drive to the near-side rear wheel, the engine and transmission being in line between the rear wheels. A small cylindrical fuel tank is fitted sufficient to give nearly eight hours' running at full speed.



An idea of the size of the new miniature vehicles can be obtained from this photograph.

The Manufacture of Coins

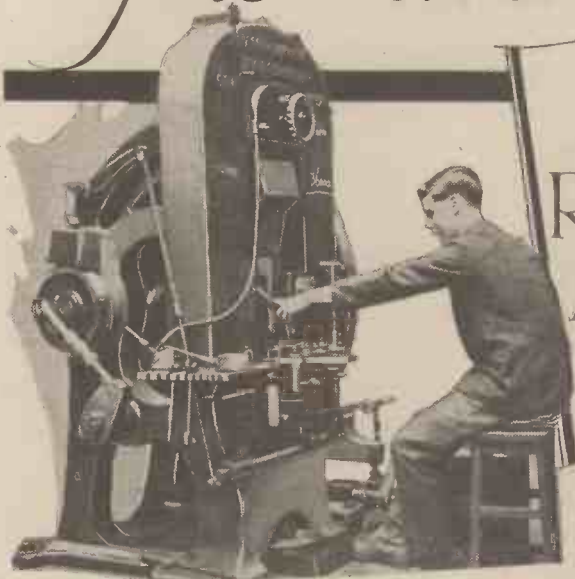

Stamping machine at work.

THE Royal Mint is in a peculiar position. It is supplied with more or less precious metals, and dealing in such huge quantities (it has struck as many as 300,000,000 coins in one year), fractional errors in any one of them must be kept so small as to be negligible. The jeweller, for instance, also working in precious metals, can cover himself by fixing a price for his finished product higher than is actually called for, and so guard against comparatively large inaccuracies that would otherwise tell against him, but not so the Mint. To make a "gain" would be as much a confession of inefficiency as to make a loss. Accordingly, at Tower Hill there exists an organisation that must be unique in the country for supplying the exact value of what it produces and neither a fraction more nor a fraction less.

A Visit
to the
**ROYAL
MINT**
By
Our Special
Representative

The Mint buys bullion in large quantities and proceeds to have that bullion assayed. It is inexpedient, owing to the extra cost, to buy silver that is 100 per cent. silver. Accordingly, a sample weighing, say, 1,000 oz. that contains 992 oz. of silver, is adequate for requirements, but it must, nevertheless, be known how much is silver and how little is dross. It is alloyed, but the assayer must be able to put his hand on so many ounces of alloy at any time and confidently assert that it contains so many ounces of pure silver. For the purpose of this article silver coinage is primarily considered, and unless otherwise stated the actual coin referred to is the Imperial half-crown.

The Foundry Furnaces

To see the first stage of actual manufacture we must visit the foundry. Here are

THE WORK OF THE MINT

Coins are produced by mass production methods to a supreme standard of accuracy.

the pre-heater furnaces and the working furnaces, crucibles which are each, roughly, a foot in diameter and 18 in. in depth. They are heated by gas from the city mains which is mingled with air under pressure and fed tangentially to each individual furnace, thus producing a whirling flame effect. The temperature of the pre-heater furnaces may be between 500° and 600° C., and that of the working furnaces about 1,000° C., according to the metal being worked. For Peruvian silver, for instance, which contains 10 per cent. nickel, the temperature will be 1,300° C. A dip of molten metal is then taken and a check made by an assayer, the bulk being poured into narrow cast-iron moulds which have been smeared with lard oil to make smooth-surfaced castings. These castings (in the case of metal intended for half-crowns) are 2½ in. wide by ¼ in. thick and 26 in. long, and the next step is to roll them to the appropriate thickness. Each bar is therefore passed a dozen times between the accurately ground rollers of a 15-in. mill, which is driven by a 100-h.p. motor with suitable reduction gear. This roughing down process renders the metal strips so hard that they must then be placed in a closed annealing furnace, in which oxidation is prevented by water sealing. They are then rolled in smaller mills six or eight times to bring them approximately to the required thickness for the coin blank.

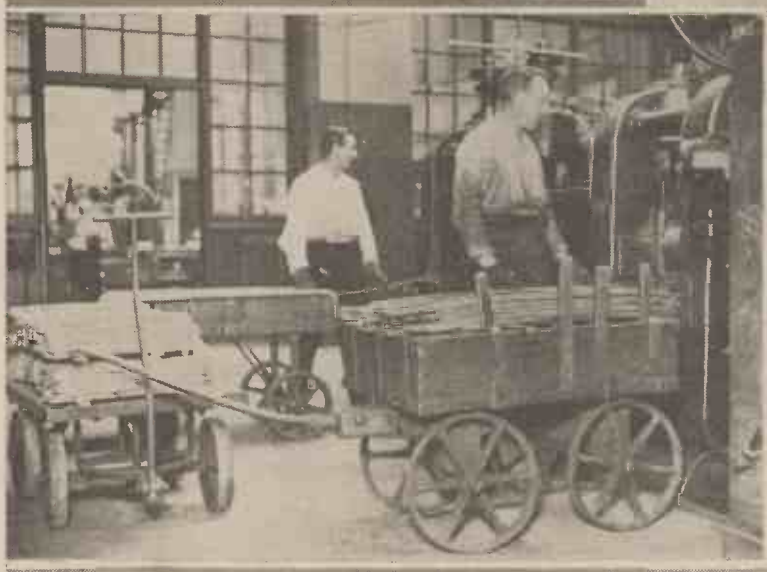

(Above) Taking a crucible of silver from the furnace.

(Left) Rolling silver bars to the correct thickness.

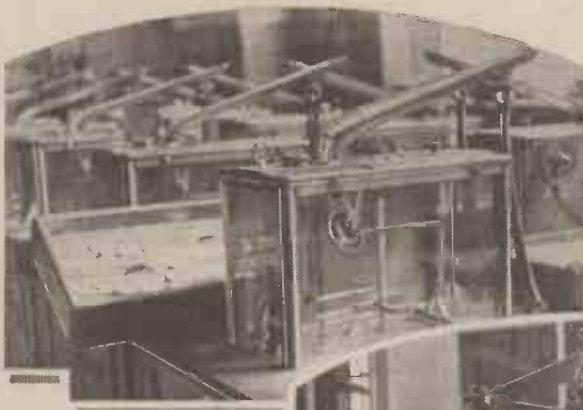

(Above) Weighing machine at work. (Right) Weighing new silver.



Compensating for Varied Thicknesses

Great care is taken in rolling the bars into strips, and the accuracy attained is in the region of one ten-thousandth of an inch. Even this accuracy is insufficient to ensure that each blank cut from the strip will fall within the legal limits for weight, and accordingly the strips are now tested for thickness with elaborate micrometers and divided into four categories which are respectively standard, two slightly lighter than standard and one slightly heavier than standard. Blank discs are now stamped out of the strips, having rather larger or smaller diameters according to the thickness of the strip to ensure the blank being of standard weight. Subsequent edge-rolling of the blanks themselves brings them to the exact diameter and at the same time produces the small edge which protects the face of the coin from excessive wear.

The Second Annealing

It is now necessary to soften the blanks ready for stamping, and they are accordingly passed through revolving horizontal open furnaces,

travelling the length of each furnace in a thread, in a manner not unlike water travelling along an Archimedean screw. In the course of this annealing process the blanks become heavily oxidised. They are therefore "blanched" in a mixture of bichromate of potash and sulphuric acid in revolving drums that are reminiscent of concrete mixers on a small scale, after

which they are thoroughly washed with hot water in similar revolving drums. The water and acid from these drums afterwards passes into a large sump to collect the small particles of settled silver that would otherwise be lost. This deposit is removed at intervals of two or three months and melted down for future use. The blanks pass to revolving drying machines in which streams of hot air remove the moisture. Any silver dust carried along by the air-flow is also recovered.

Stamping the Coins

A battery of forty-five stamping machines, each capable of dealing with about 100 blanks per minute, now complete the coins, the blanks for which are, of course, automatically fed. Dies top and bottom are pressed simultaneously to each blank. At the same time as the actual striking takes place the milling, if any, of each coin is impressed on it by the "flow" of the metal blank itself against a surrounding milled collar of hard steel. The coins are then tested for weight by automatic machines, which reject any that do not pass a rigorous standard, and finally they are tested for "ring." Undetected air bubbles in the original strip may result in a coin being "dumb," in which case it is passed back to be re-melted. Coins are fed one after another at the rate of 300 per minute per

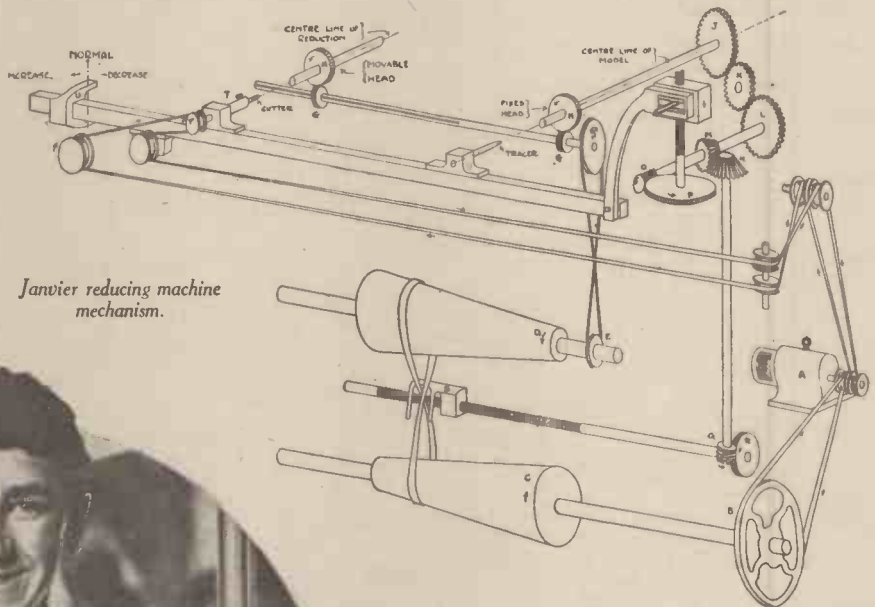

Janvier reducing machine mechanism.



A tray of silver coins made at the Mint.

operator so as to strike a steel slab in passing. Each should ring distinctly in doing so. The few that do not are rejected. The finished coins are then passed through machines that count them automatically at the rate of 1,500 per minute each in the case of half-crowns, and 2,500 each in the case of threepenny pieces, and are sealed in bags which are afterwards weighed as a final check.

The Reducing Machine

One of the most interesting departments in the Mint is that where the various dies are made with which to stamp the coins. The original design for the face of a coin takes the form of a plaster plaque of large diameter. From this a nickel electrotype full-scale model is made and is placed in what is known as the Janvier reducing machine. In effect this takes the form of a pantograph which works in three dimensions instead of two, thus being able to deal with subjects in relief.

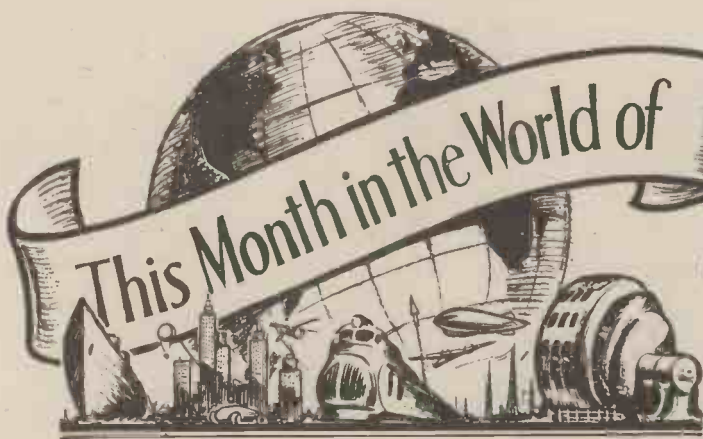

Science,

produced a shutterless motion - picture camera. The cell is incorporated in the camera

A NEW RAILWAY SLIP-COACH

An English railway invention which now has

AN ELECTRIC CYCLE

BELOW, we show a new type of cycle which is the invention of M. M. Fauque, a Parisien. Driven by electricity, it is entirely noiseless, and can attain an average speed of between eleven to twelve miles per hour. The photograph shows the inventor himself seated on the cycle.

A NEW DESIGN IN SPEEDBOATS

A radical departure in speedboat design, and expected to develop double the speed of present water craft of the same power, has been completed in America. The boat, powered with a standard outboard motor, is the first of its kind to be built upon the hydrofoil principle developed by Dr. O. G. Tietjens. This boat is expected to attain a speed of sixty miles per hour, and consists of a plane suspended underneath the boat, which cuts through the water as the boat gathers speed and reduces the fluid resistance to a minimum.

SIMPLIFYING PHOTOGRAPHY

A hitherto undiscovered use of the photo-electric cell has been devised by a Mexican inventor who has

and accurately gauges the amount of light passing through the lens and acting on the film. The actinic value of the light, translated into figures, may be easily read by the camera man on the dials shown in the photograph. From these figures the speed at which the film should be driven as well as the lens aperture to be used, are readily visible.

BOAT PROPULSION

The queer looking boat shown at the foot of this page is the latest invention of a Berlin engineer. The two arms shown projecting each side of the boat are worked by the hands and feet, which moves the arms backwards and forwards, similar to an oar, thus propelling the boat forward at a reasonable speed.

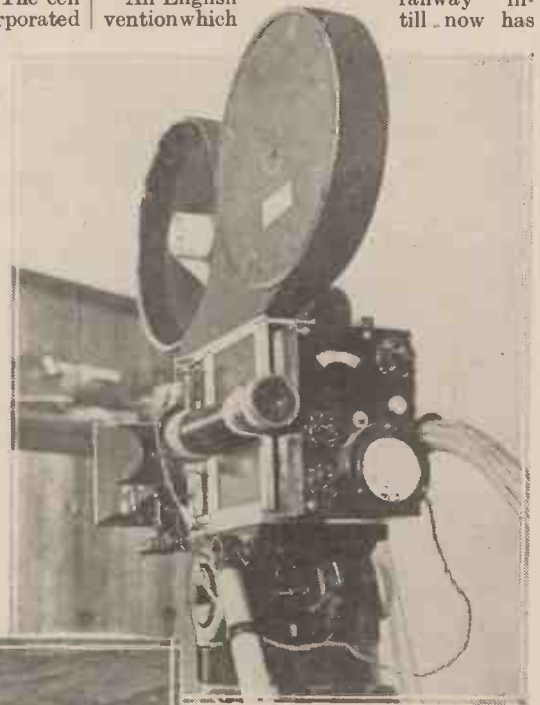

A hitherto undiscovered use for a photo-electric cell is incorporated in this shutterless motion-picture camera.



(Left) Showing M. Fauque mounted on an electric cycle of his own invention. (Above) A new type of speedboat, radical in design and expected to develop double the speed of present water craft of the same power. (Right) Using hand and footwork as an accelerating force for a boat. This device is the invention of a Berlin engineer.



Invention & Progress

been employed exclusively on the English railways, is beginning to find popularity on other railways throughout the world. We show in the photograph the slip-coach at work on the G.W.R. The guard's van is situated in the centre of the train, enabling the guard to operate the "slip." The guard is shown just after "slipping" a coach, and two seconds after this operation, the coaches are separated. The train runs without a locomotive.

A NEW SAFETY RAZOR SHARPENER

A new device for sharpening safety razor



An English railway invention is the slip coach here seen at work on the Great Western Railway.

blades is shown on this page. The blade is clipped to a cylinder which is set rotating by drawing the apparatus along a thread, thus the blade gains its former sharpness.

A FLYING TANK

Imagine an armoured tank, equipped with aeroplane wings, soaring over London and alighting in Hyde Park. As it comes to a stop, within a short distance, the wings fall off and the machine quickly attains a speed of seventy miles an hour over the ground. The caterpillar tracks are then removed from the tank whilst it is in motion, and it then travels at 100 miles an hour on rubber-tyred wheels. Such is the performance claimed of the tank shown at the top of this page.

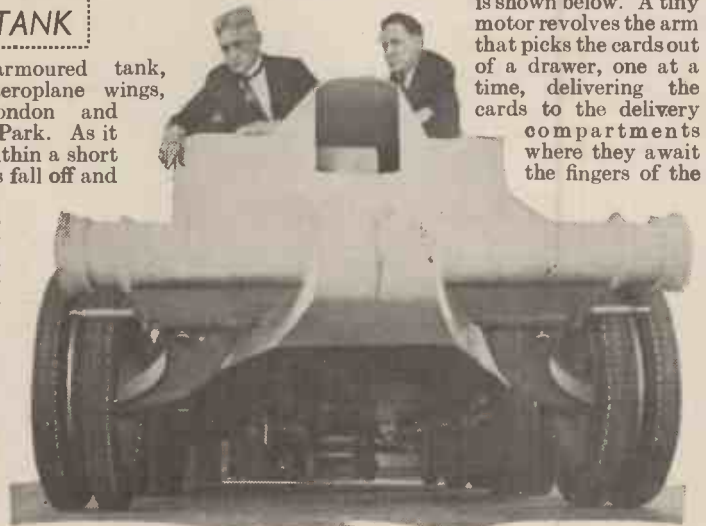

The flying tank shown above is the result of three years of experimenting by Mr. J. W. Christie.

FOR THE BRIDGE FAN

A new electric bridge table that shuffles and deals for the convenience of a card fan is shown below. A tiny motor revolves the arm that picks the cards out of a drawer, one at a time, delivering the cards to the delivery compartments where they await the fingers of the expectant players. It never deals and shuffles twice in the same manner. Card-sharping is impossible on this machine, and any kind of hand can happen, the same as in a conventional hand shuffle and deal. Not only does it ensure fair play, but also speed in dealing.

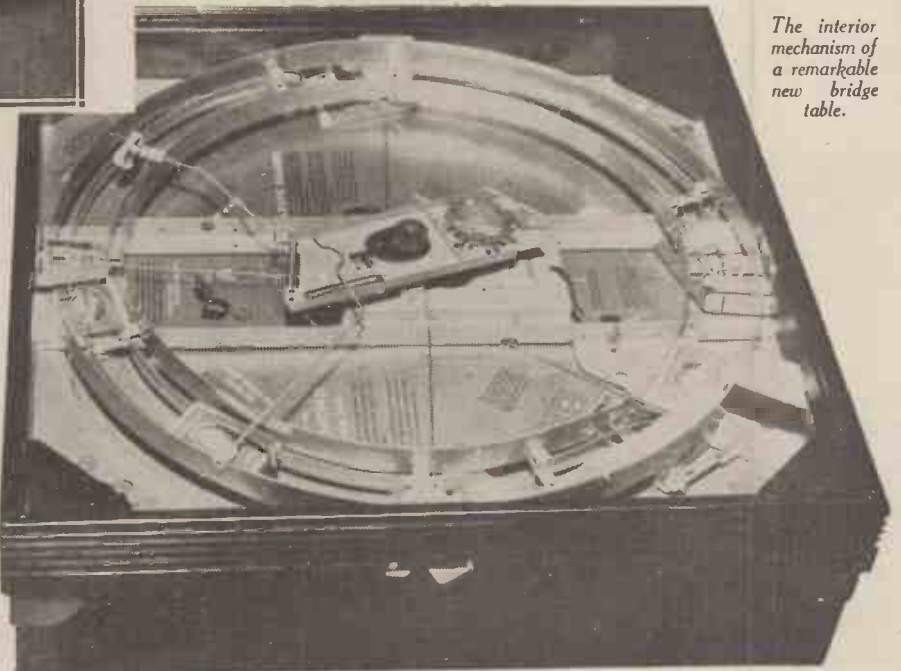

The interior mechanism of a remarkable new bridge table.



Showing a demonstration of the simplicity of the new safety razor sharpener.

WHAT ARE COSMIC RAYS?

THE old notion of the atom or electron as an irreducible unit is being replaced by the modern theory of "wave mechanics," which lays stress upon the importance of radiation as the ultimate basis of all things. We make our first contact with the material universe through the medium of light and sound waves, and as we push forward in the pursuit of knowledge find other forms of wave motion crowding into the story.

Amongst this "wilderness of waves" the so-called cosmic rays are unique in at least two respects. They are far higher in frequency and possess greater energy and more penetrating power than any other waves we know. What their ultimate significance may be—or what "news" they may one day give us of the interstellar regions from which they come—still remains to be seen. But of the vital part they play in the economy of the universe there can be no doubt.

We know that sound is produced by compression waves formed either in a solid, liquid, or gas, whilst light is supposed to be the result of transverse waves in an electromagnetic ether. Actually, we are not too sure about the "mechanism" of light, because we have not yet found any experimental proof of the existence of the ether. Neither are we certain that light is necessarily a wave motion. Under certain circumstances it seems as if it were carried by a stream of particles like tiny "bullets"—though at other times it is undoubtedly a radiated wave.

On the other hand, things which were once thought to be solid in their nature have recently been found to behave at times suspiciously like a train of waves. The electron, as already mentioned, is now interpreted as a form of radiation, and since electrons are in the "make-up" of every known substance it would seem that all matter will ultimately be resolved into waves.

Philosophic Doubts

If we assume that the ether actually exists—in spite of the "philosophic doubts" of modern science on this point—we know that the radiations which give rise to the sensation of light are exactly the same in kind and quality as wireless waves. There is no essential difference between the two, other than that of magnitude.

The 300-metre wave used for transmitting wireless signals travels through space at the same speed and in the same manner as a ray of light. But whilst the former is roughly one-sixth of a mile long, light waves are so minute that they crowd 10,000 "crests and troughs" in every inch of their travel. Microscopic as this may seem, the X-rays discovered by Dr. Rontgen are still smaller. They fit no less than 50 million to the inch, and so are able to force their way through substances which are opaque to ordinary light.

But finality seems to have been reached with the "Cosmic waves," which occupy less than the 100,000 millionth part of an inch.

Our first knowledge of Cosmic waves came from the diligent observation of a very simple occurrence. This is an old story in the annals of science, and is on all-fours with the discovery of Radium, and of the rare gases in the atmosphere.

Everyone is aware that a body charged with electricity will gradually lose its

MYSTERY MESSENGERS FROM SPACE

charge even when carefully insulated. The ordinary electroscope is a case in point. This instrument consists of a piece of gold-leaf hung over a bent wire, as shown in Fig. 1. A charge of electricity applied to the terminal is shared equally by the two leaves, and since both carry the same kind of charge they mutually repel each other and fly apart.

"COSMIC WAVES" OCCUPY A SPACE LESS THAN A 100,000 MILLIONTH PART OF AN INCH.

COSMIC RAYS HAVE BEEN FOUND TO PENETRATE TO A DEPTH OF OVER 50 FT. BELOW WATER.

WHERE THE COSMIC RAYS ACTUALLY COME FROM, OR HOW THEY ARE FORMED, STILL REMAINS A MATTER OF SPECULATION.

If the instrument is left to itself, the charge gradually escapes and the two leaves collapse. This could not, of course, happen if the air were a perfect conductor.

Ionising the Air

Now there are several known factors which tend to ionise the air, so as to make it slightly conductive. Light will do it, for instance, as well as a number of radioactive substances.

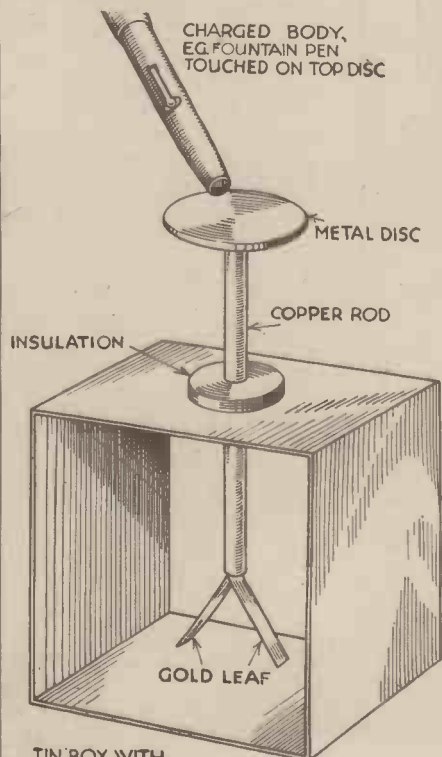

Fig. 1.—Details of the electroscope, which consists of a piece of gold leaf hung over a wire as shown.

Early in the present century Sir Ernest Rutherford noticed that the rate at which the leaves of an electroscope lost their charge was reduced when the instrument was placed inside a metal case. He was quick to see the significance of this, and found that even when the thickness of the case was increased so as to cut out all the known sources of ionisation, the charge still gradually leaked away. This could only be attributed to the action of some "electrifying" agent having very unusual powers of penetration.

Here was the first clue, which has since been followed up in every quarter of the globe—as well as in the sky above and in the waters beneath.

The Existence of Cosmic Rays

Needless to say, the evidence for the existence of cosmic rays does not rest on the electroscope experiment alone. They have been detected passing through a chamber surrounded by walls of lead more than 3 ft. thick. In addition, their effect has been observed as a visual "track" formed by the condensation of "droplets" in a gas-filled container or cloud chamber. Their occurrence in the chamber is curiously intermittent. A sudden appearance of tracks is followed by a quiet period, and then by a second "burst," and so on.

The tracks are caused by a chain of free electrons following the passage of the ray. In ordinary ionisation such a track can be bent to one side or other by the application of an external magnetic field. But with cosmic rays the deviation is so slight, even when using the most powerful fields, as to show that the rays must have immense energy and speed—amounting in fact to more than the equivalent of 15 million volts.

In order to discover their point of origin, intensity measurements have been taken at the top of the Alps, the Andes, and the Sierras, whilst test electroscopes have been sent up in balloons to a height of over twelve miles. The results show that, beyond a certain height, the rays definitely increase in intensity with elevation above the surface of the earth.

Other experiments have been made at the bottom of mines, and by submerging electroscopes in fresh-water lakes and in the sea. The strength of the rays naturally diminishes in this direction, though they were found to penetrate to a depth of over 50 ft. under water.

The Earth's Magnetic Field

Tests have also been made to find out what effect, if any, the earth's magnetic field has upon the distribution of the rays—assuming them to be electrified particles coming to us from beyond the stars. Here the results are not yet conclusive, though there is some evidence to show that they are deflected towards the Poles and away from the Equator.

Where the Cosmic rays actually come from, or how they are formed, still remains a matter of speculation. Professor Millikin believes they are due, not to the disintegration of matter, but to the production of new atoms in the depths of interstellar space.

We have grown accustomed to the notion that the Universe is gradually running-down. Here is the reverse of the picture—based on evidence which, although not fully confirmed, seems far too striking to be ignored.

Facts About Fireworks

By ALAN St. HILL BROCK



An exploding bombshell.

BELIEVE that a large proportion of those who have never visited a firework factory see in their mind's eye an imposing commercial building in which workmen are busily engaged in shovelling heaps of gunpowder, while others are engaged in filling the same substance into cardboard tubes, which, by some extraordinary process, subsequently produce effects as varying as those of a coloured light or a sky rocket.

Probably the first thing that strikes a visitor to a firework factory is space. Our own works cover an area of 207 acres, which is divided into two parts, namely the "explosives area" and the "non-explosives area." In the latter are situated the offices, laboratory, the saw-mill and wood-working departments, blacksmith's and fitter's shops, the Christmas cracker factory, printing works, the workrooms in which are rolled the paper tubes that later form the exterior of the fireworks themselves; also stores for paper, chemicals and other components.

Here, too, is the large building, resembling a Zeppelin shed, in which are drawn full-size on the floor the sections of the 600-ft. long Crystal Palace set pieces, and racks for the storage of the tons of woodwork used in carrying out each year nearly 500 public displays at home and overseas.

A line of red-painted stakes stretching right across the estate divides this portion of the factory from the explosives area, which contains the explosives working buildings, the drying rooms, the magazines, in which during the year the stock of "November the Fifth" fireworks is gradually accumulated, and the large packing shops in which thousands of packages of fireworks are completed in the two months preceding the national fireworks festival.



Making Armistice Day maroons.

Fire Precautions

The working buildings are sheds 20 x 16 ft., divided into two compartments, each with a door at either end. They are placed 12½ yards apart, the distance being fixed by the Explosives Act of 1875, under which Act fireworks are manufactured. Between each pair of buildings is a strongly constructed corrugated iron screen, the function of which is to prevent a fire or explosion in one building communicating with another. Without these screens the statutory distance would be 25 yards, so that without them the works would cover twice the area. That they achieve their aim is proved by the fact that we have never had a case of fire or explosion where more than one building has been involved.

Beyond the rows of working buildings, about a hundred in all, are the drying rooms and expense magazines, in which partly finished fireworks are either dried or stored pending further manipulation. These buildings are spaced at wider intervals, and farther apart still are the twenty-five large magazines. All are screened in the same way as are the working buildings, with the exception of the two stores for gunpowder, which are partially sunk in the ground with mounds of earth surrounding them.

The Schedule of Operations

Conspicuously displayed in each compartment of every

building in the explosives area is a schedule of the operations which may be carried out there, showing clearly the weight of composition or partly made or finished fireworks, also the number of persons permitted to be present. These amounts naturally vary according to the risk involved. For instance, when packing or labelling finished fireworks, six persons may be present and as much as 300 lb. of fireworks, whereas when composition is being mixed, only two workers are allowed and a total of 30 lb. of composition.

All workpeople wear fire-resisting clothing and leather boots over their ordinary shoes, made without nails; to avoid striking a spark if any grit should accidentally be present on the floor. For the same reason the floors are covered with thick lino secured by copper nails. No iron or steel tools are allowed in any of the buildings, and workpeople are forbidden to carry pocket knives, keys, steel hat-pins or hair-pins. It may be mentioned in this connection that the practice of hair-bobbing among female workers effected a considerable saving for the firm, as previously it was necessary to issue brass hair-pins for their use.

A Necessary Task

Each building has to be swept out morning and afternoon to prevent any accumulation of explosive material. It is a fact that many years ago we were fined because a visiting inspector found a cobweb in one of the buildings. Not, it is perhaps unnecessary to explain, that cobwebs in themselves are dangerous,

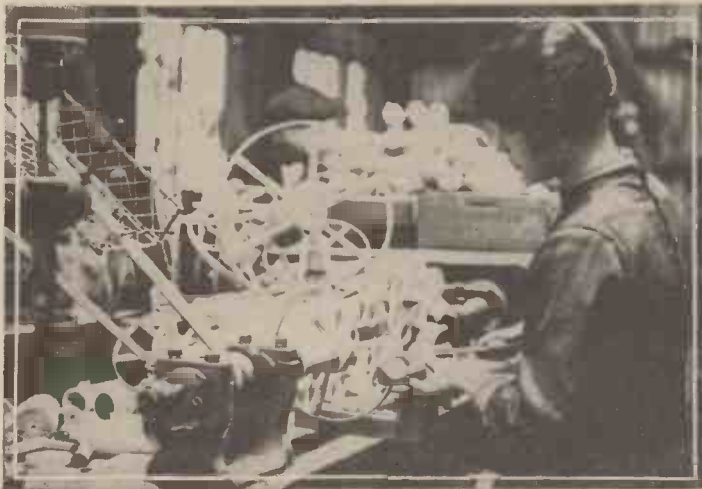

(Left) Turning the woodwork for the wheels, and (right) Assembling the cases for "joke bombs."

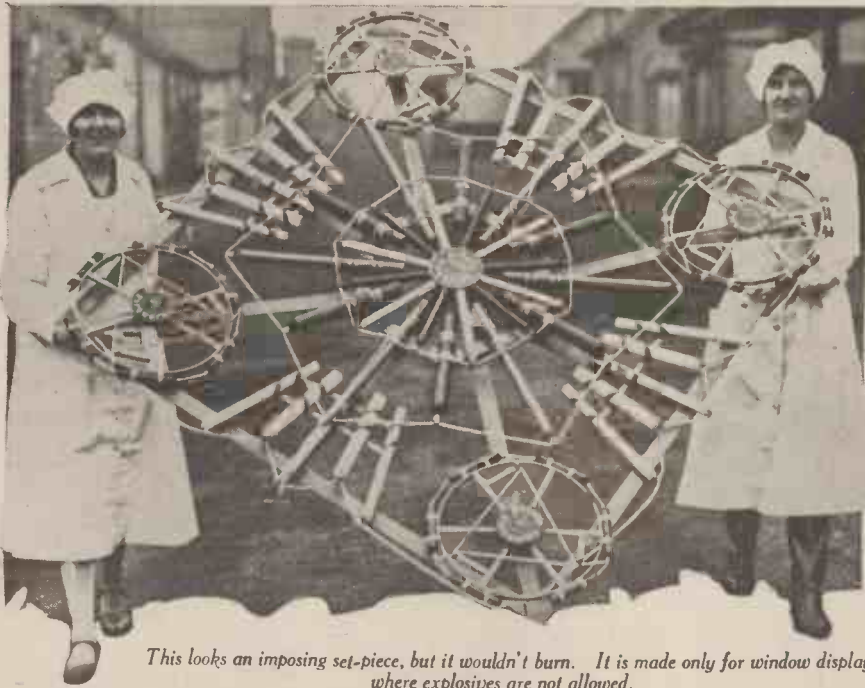

This looks an imposing set-piece, but it wouldn't burn. It is made only for window display, where explosives are not allowed.

but because its presence indicated that the sweeping had not been properly carried out.

These precautions may suggest to the layman that firework-making is a hazardous occupation, whereas it is on account of them and because of the fact that the works are situated in the open country, that it is as safe and as healthy almost as any in the country. This is borne out by the fact that until recently we had in our employ fourteen workers whose total service with the company totalled well over 700 years. Among them were those whose memories carried them back to the bad old days when the majority of small fireworks were made in the workers' own homes, being brought into the factory, where they were paid for at piecework rates. Then the whole family from father (possibly smoking) down to the youngest child would sit round the kitchen table manipulating compositions of so sensitive a nature that they would not be permitted to-day. It is perhaps hardly to be wondered at that even with the limited output of those days, accidents were much more frequent and generally of a more serious character than they are to-day, when each year we turn out something like 60 million fireworks at prices between a halfpenny and sixpence, to say nothing of the larger kinds and those required for the big displays.

INTERESTING MODEL LOCOMOTIVES

IN these days of super-construction, maximum loads and high speeds, the three locomotives recently introduced by Bassett-Lowke Ltd. should greatly appeal to the modern Gauge "O" Model Railway owner.

The first in the series is the German State Railways 4-6-2 type, modelling all the bold characteristics of this well-known locomotive, and finished in matt black with gold lining. The second, shown on the right, is an excellent representation of the American type locomotive used on the New York Central Railway—a 4-6-4 type with its unusual 6-wheeled bogie tender and specially designed cow-catcher. The third is a miniature of the French mountain-type locomotive 4-8-2, finished in French grey with black lines.



A model of the American type locomotive used on the New York Central Railway.

Each locomotive is fitted with cab and front headlights and an electrical connection for train lighting. In fact, each model is remarkably accurate and life-like, with a great amount of detail for a moderate price. The electric motor fitted is the most powerful constructed for model work of this kind, with tripolar armature, spur-gear drive, disc-type commutator, and adjustable

type carbon brushes, and is wound for 20 volts A.C. Reversing can be operated from cab or track, and any of the models will negotiate a standard curve of 6 ft. diameter. The prices range from £6 10s. to £8 8s.

THE MODERN "GRID" SYSTEM IN MINIATURE

THE photograph shows model electric pylons made by Bassett-Lowke Ltd., of Northampton. These intricate models are strongly made in special angle brass, and measure approximately 4 ft. 6 ins. high, on a 20-in. square base.

They are very realistic representations of the high electric pylons of the "grid" system used to carry millions of units of electricity all over the country to out-of-the-way places, where previously only oil was available. Each centralised power station is like the nucleus of a spider's web, sending out power through the air by means of cables supported on these pylons, and in this way covers a vast area hitherto without the amenities of electricity. The pylons themselves are constructed of fine strong steelwork, combining maximum strength with as light a framework as possible, and they are mounted on concrete bases. The electric cables are carried from one pylon to another on very carefully constructed insulators capable of withstanding enormous voltages. Very little current is lost in transmission from place to place because of the very high voltage of the alternating current, and at each destination the voltage is transformed to make the current suitable for use with every-day appliances.

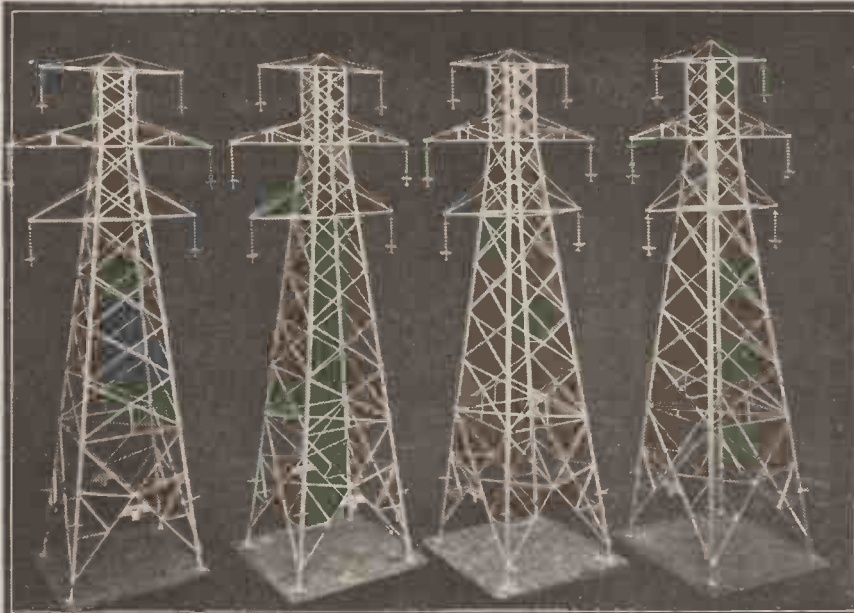

The modern "Grid" system in miniature.

SOLDERING SIMPLIFIED

SOLDERING is an easy process if one is skilled to the rules, but even so-called decent mechanics fail hopelessly on many soldering jobs. Cleanliness is the great thing, but not more important than a "hot" iron and the right "flux." It is natural that the parts to be united should be clean, and unreasonable to expect hot solder and flux to remove refractory



Fig. 1.—Chloride of zinc can be made by dissolving strips of zinc in hydrochloric acid. A porcelain vessel should, for preference, be used.

material whose melting point is above that of the iron or at once oxidises when heated.

Oxygen is the enemy of all forms of uniting metals, as nearly all metals absorb oxygen readily on the temperature being raised, and it is to protect the metals from being oxidised that fluxes are used. An excellent flux for one metal is not so effective on another, or for some reason cannot be used owing to after effects which cannot be eliminated. As an instance, acid fluxes must not be used on electrical connections. The electrical flow sets up some form of electrolysis definitely aided by the minute imprisoned particles of acid, which particles are never entirely removed, however efficient the washing of the part in question.

The Two Main Fluxes

Chloride of zinc and resin are the two main fluxes used on repairs. The former is a liquid and the latter is used powdered. The easiest way to make up chloride of zinc is to dissolve thin strips of zinc in commercial hydrochloric acid. Do this slowly in an open porcelain basin until the acid will no longer "act" on the zinc. When cool, the solution is ready for use, and it should not be adulterated with water. The action of this flux not only helps to clean the job, but the moment the hot iron touches it, it entirely covers the spot without further trouble. When cold, it rests on the surface in isolated globules, but the heating transforms it into a liquid coating, thus excluding oxygen from the air, that is unless the heat is too great and the flux is evaporated. As an iron too cold will not run the solder, so an iron too hot will counter the effect of the flux. A small iron over-heated will not, and cannot, take the place of a larger iron which, if anything, is on the cold side. This flux is used on all tinned goods and articles, such as petrol tanks, autovacs, lamp bodies and petrol pipes, which are "tinned" before soldering.

A Practical Article on the Elementary Principles of Soldering

Don't try to solder chromium plating, as it cannot be done. The chromium must be removed before the solder will take, whatever the flux. Aluminium is only successfully soldered by the professional, and then with special solder and flux. It is not easy, and is often unsatisfactory. An excellent preparation, based on zinc chloride, is a good soldering fluid. It is better and cleaner than the home-made product and equally as cheap in the long run.

Resin is a difficult flux at all times, therefore "Fluxite" (a paste) is far better for general use in every way, and is men-



Fig. 4.—When soldering two wires together, an efficient joint can be made by using sleeving over the two ends as shown.

tioned because it is based on resin and is ideal for all electrical joints.

POINTS TO REMEMBER

Make sure you are using the right flux for the job.

Chloride of zinc and resin are the two main fluxes.

Many failures are due to the iron cooling off before it can do any effective work.

Always keep the iron well "tinned."

When the Iron Cools

Many failures are due to the iron cooling off before it can do any effective work, the job carrying off the heat when the iron is applied. The larger the iron the better,

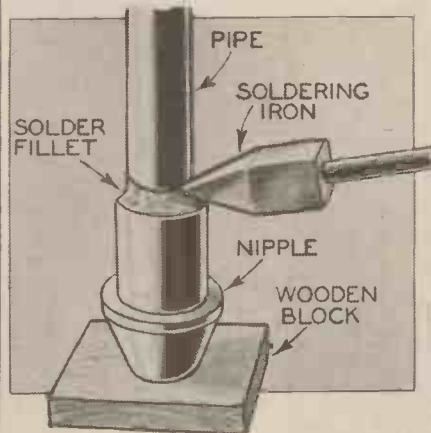

Fig. 2.—The correct method of soldering a nipple to a pipe.

as it must hold more heat, also repeated application of a small iron means that the applied heat is flowing away whilst the second heat is being added. Hold the iron still when once applied and watch the effect of the molten solder around it. The solder

cannot be rubbed in—it must flow of its own accord. Solder has little strength as a metal, therefore always remember it as the "glue" that holds the work together only. Piling it on the job in the hope that it will overcome the difficulty or your poor workmanship is no use and only failure will result.

Suppose a nipple is to be soldered on a copper pipe: first, the end of the pipe must be clean and really fit the nipple. The pipe should just slide into the nipple with slight pressure. Dip the end of the pipe into the liquid flux and apply some solder with the hot iron. It will now be "tinned" and will have cooled off somewhat. Again dip the end in the flux and tap on the nipple. This "tinned" end will act as a small iron and save the trouble of having to "tin" the small interior of the nipple. Hold the pipe vertically on a piece of wood with one hand and apply the iron with the other hand. As the iron has again been charged with solder, it flows from the iron on to the pipe, where it is already tinned, and so passes down between the nipple and pipe.

A Bad Joint

Should the pipe have been a bad fit in the nipple, the hot solder will not only have penetrated between the pipe and nipple, but up the inside of the pipe also, not being able to run out at the bottom on account of the wood acting as a washer. Should this happen, the pipe must be drilled and the shavings from the drill blown out. If too much solder is applied, it is possible to wipe it off before cooling, but it leads to "blobs," where they are not wanted, such as on the cone of the nipple, and perhaps a leaky union. With practice, the right quantity of solder can be gauged, and if not enough, the iron can, in this instance, be applied again the second time, such process doubly assuring a tight soldered joint.

A patch on a tank is also an excellent example of heat transmission by the soldering iron. As usual, clean the place on the tank thoroughly and "tin" the place to be operated upon about half an inch all round the patch to be applied. The patch should be tinned both sides, as the hot solder on the outside helps to convey the heat from the iron to the patch proper, and so to the solder under the patch. The hot iron, supplied with solder, should be slowly and systematically moved over the whole of the patch so that it sticks to the tank at every point, and towards the end the iron is applied to the edges, when, if there is still any air under the patch, it will be seen to bubble out through the molten solder.

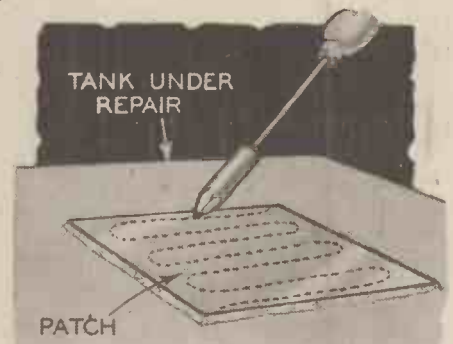

Fig. 3.—When patching a tank make sure that both sides of the patch are "tinned," thus ensuring an efficient job.

The iron should only be applied to the edges last of all, mainly to make a neat job and to prove the exclusion of all air. Again, the largest iron possible should be used, especially as it is not always possible to do the job with one application.

Electrical Repairs

In dealing with all electrical repairs, it is again pointed out that fluxite or resin must be used and it is preferable to keep a special iron for such repairs. An iron continuously dipped in the liquid flux is bound to impart some of the acid to the electrical joint, eventually leading to trouble. Smear a little Fluxite on the parts to be soldered, as too much is not only a waste but the surplus paste has a tendency to mess up the nearby insulation. Cleanliness here is a definite injunction, as the fluxite has no cleansing

powers like the fluid, and old wires that have become blackened through burned solder must be cleaned with fine emery cloth until they are bright. Dipping the wires in nitric acid is fatal for the same reason mentioned with the liquid flux.

A spliced joint is out of the question owing to the confines of the space allotted, also a sleeve-joint is far more efficient from an electrical point of view and occupies less space. Fig. 4 shows the sleeve, bored out so that the prepared wires just slide into the hole. The ends of the wires will be seen at the centre of the sleeve, where a slot has been filed so that the hot solder can be applied. Place a little Fluxite on the centre of the sleeve where the wires meet, and immediately the hot iron and solder is introduced, the Fluxite will run freely along the inside of the sleeve and between the stranded wires.

"Tinning" the Iron

To "tin" an iron with either acid or Fluxite, the bit should be cleaned up with a file until the copper is bright. Heat it on the gas-ring until the copper is about to change colour and rub with a stick of solder which has previously been dipped in the flux. Apply it quickly to all sides, afterwards wiping the solder over evenly with a piece of rag. The iron is now "tinned" and ready for use, but there is another method which is equally as good, and that is to have a small piece of tinned steel on the bench on which to rub the iron instead of wiping it with the rag. Both methods apply to both fluxes. When the iron is "tinned," it should still be carefully heated, as a "burned" iron ruins the tin on the surface, turning it into a very brittle dark mass that will neither convey heat nor hold the solder.

THE WINGLESS AUTOGIRO

One of the most advanced Flying Machines* in existence

THE first machine designed by Señor de la Cierva was built in Spain, but unfortunately it proved unsuccessful. He persevered with his invention, and after a number of failures, he produced a machine which flew with a measure of success. This machine incorporated the articulated wing or rotor blade, a hinge at the root of the blade allowing it to flap up and down slightly as it rotated. And now, at Hanworth a few weeks ago, Señor de la Cierva himself demonstrated his latest model, which is considered one of the greatest triumphs of aeronautical engineering of the decade. The machine has no fixed wings, no rudder, ailerons or elevator, but only a rotor which lifts it, and its aero-engine and air-screw which move it along. The pilot uses two controls only when in the air, one "hanging" stick and one engine throttle. With these, the aircraft can be taken off, climbed, turned, dived, glided and landed.

Moreover, it can be landed in a run less than its own length with engine either on or off; it can be taken off in about 20 yards, and can clear a barrier 6 ft. high in less than 50 yards. The machine is automatically stable, and its top speed seems to compare favourably with that of an ordinary aeroplane of equivalent power.

"Direct Control"

This machine is known as the "Direct Control" Autogiro, Type C30, and it is the outcome of Señor de la Cierva's thirteen years' work. It is a two-seater and is to be sold for less than £1,000, while a smaller single-seater is to be sold for a much lower price. He is also considering replacing the engine throttle lever with an accelerator pedal, in the manner of a

motor car. Then the pilot will merely have to steer the machine with his hands and accelerate and decelerate with his right foot. A tail wheel has taken the place of the tail skid, and this wheel is steerable from the pilot's cockpit. The foot brakes have been removed and substituted by hand-operated brakes, and these do not act independently as previously. As usual, a mechanical rotor starter is fitted to the three-bladed rotor system, the blades of which can easily be folded for hangarage. The letter references on the sectional diagram at the foot of this page are as follows: (1) Boss for mounting the dual-control lever. (2) Inverted joystick. (3) Petrol tap. (4) Longitudinal bias (adjustable at pilot's will). (5) Clutch for starting rotor when on the ground. (6) Rudder bar for steering tail wheel. (7) Throttle control. (8) Lateral bias (adjustable at pilot's will). (9) Wheel brake lever (ground control only). (10) Clutch and rotor brake lever (ground control only).



A photograph of the new wingless autogiro.

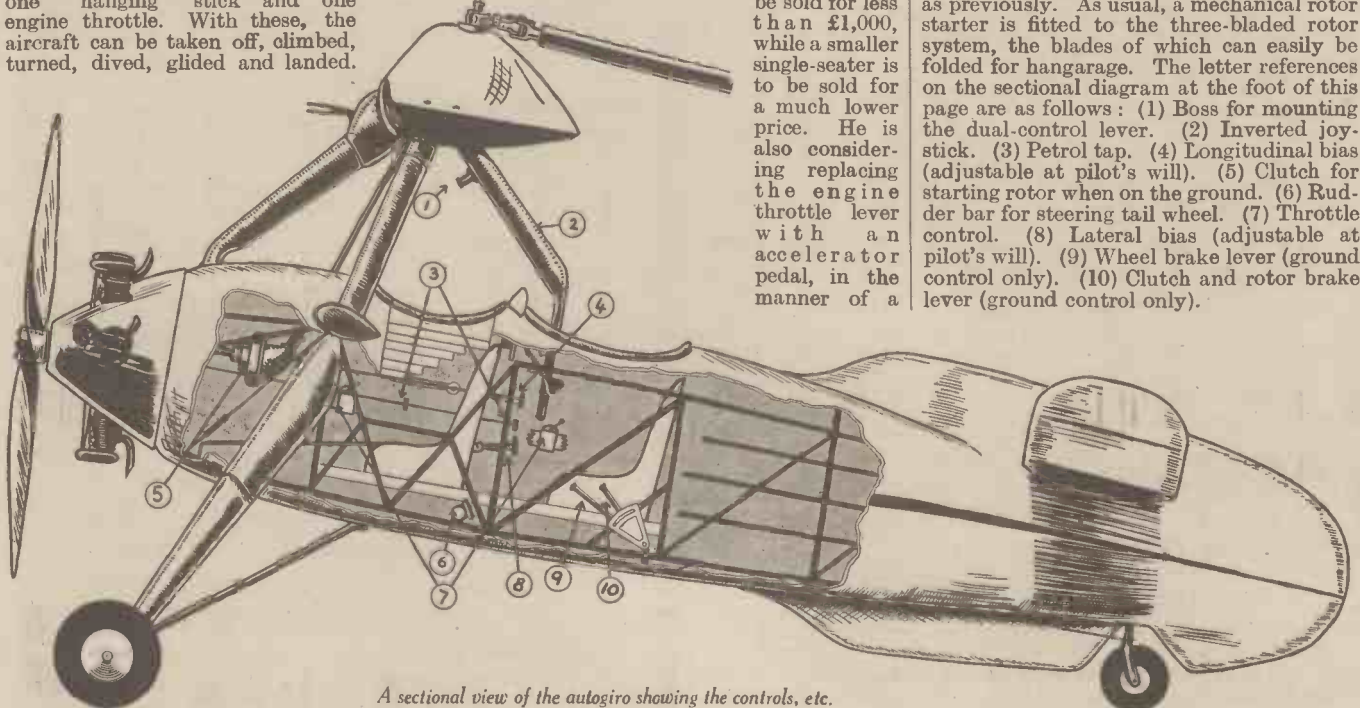

A sectional view of the autogiro showing the controls, etc.

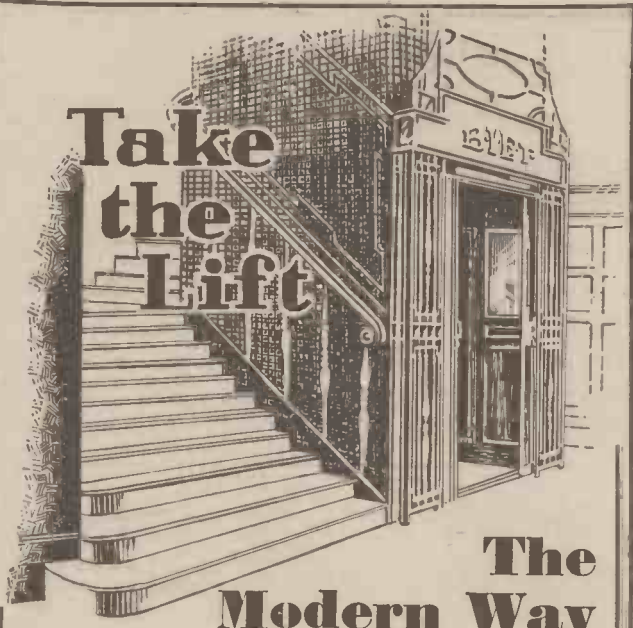

Take the Lift The Modern Way to Success

Instead of remaining in the crowd, struggling with others along the old zigzag paths, decide now to take the more modern, more certain, and *much quicker* way to the top.

If you are ambitious for something more than a "bread and butter" job send for a copy of our unique 256-page guide entitled

"Engineering Opportunities"

In this handbook Professor A. M. Low (*the eminent Engineer and Consultant*) shows clearly and definitely the most certain way to a well-paid post.

The book gives particulars of all leading Examinations, including

A.M.I.Mech.E., A.M.I.C.E., A.M.I.E.E., A.M.I.A.E., A.M.I.W.T., CITY AND GUILDS, G.P.O. (ENGINEERING DEPT.), etc.

and also outlines over a hundred Home-Study Courses in all branches of

CIVIL, MECH., ELEC., MOTOR, RADIO AND AERO ENGINEERING
WE GUARANTEE—"NO PASS—NO FEE"

Write, call or phone for your FREE COPY of this important handbook to-day. We promise that it will be a moment of your time well spent. *There is no cost or obligation.*

BRITISH INSTITUTE OF ENGINEERING TECHNOLOGY

410 Shakespeare House
29-31 Oxford Street, London, W.1

Telephone Nos.: GERRARD 3486; GERRARD 4625.

HERE IS THE WAY TO MAKE MONEY EASILY AND QUICKLY!

YOU can start making big money right away in your **SPARE TIME**, and eventually **BECOME YOUR OWN MASTER.** Get out of the rut and on the road to fortune, **NOW**, with the greatest guide to money-making ever published. Scores and scores of hitherto unexploited sources of profit-making, many requiring no capital. **MONEY** waiting to be picked up by **YOU!**

HENLEY'S 20th CENTURY BOOK OF

10,000 MONEY-MAKING FORMULAS, PROCESSES AND TRADE SECRETS

(Complete in one large Volume)

If you do not wish to start a business, why not make this book, of 10,000 formulas, your hobby? You can save pounds by making things for your own use instead of paying high shop prices—think of the enjoyment you will derive from making thousands of different articles—and imagine the peace of mind you will experience when you realise that **SHOULD ANYTHING HAPPEN TO YOUR SOURCE OF INCOME, YOU COULD IMMEDIATELY TURN YOUR KNOWLEDGE TO MONEY-MAKING ACCOUNT.**

The cost of manufacturing most things is only a fraction of the retail selling price. Articles displayed in a Shop are not always made in a big Factory—many are produced without any more expensive equipment than that usually found in the ordinary kitchen.

↓ *This Coupon may well mean the turning point in your life, and the foundation stone of your future prosperity* ↓

FILL IN (and Post) this COUPON NOW
To The Scientific & Commercial Publishing Co. (Dept. P.M.3),
Artillery House, Westminster, London, S.W.1.

Please send **FREE** Descriptive Particulars of your Book of **10,000 MONEY-MAKING FORMULAS, PROCESSES AND TRADE SECRETS** (complete in one large volume).

It is understood that this coupon places me under no obligation whatsoever and that I do not wish a Traveller to call.

Name.....

Address.....

If this coupon is sent, *without any other written matter*, and placed in unsealed envelope, halfpenny stamp only is required.
Please use **BLOCK CAPITALS.**

P.M.3

CHEMISTRY AT HOME

Hours of interest for Boys with Lott's Chemistry Sets

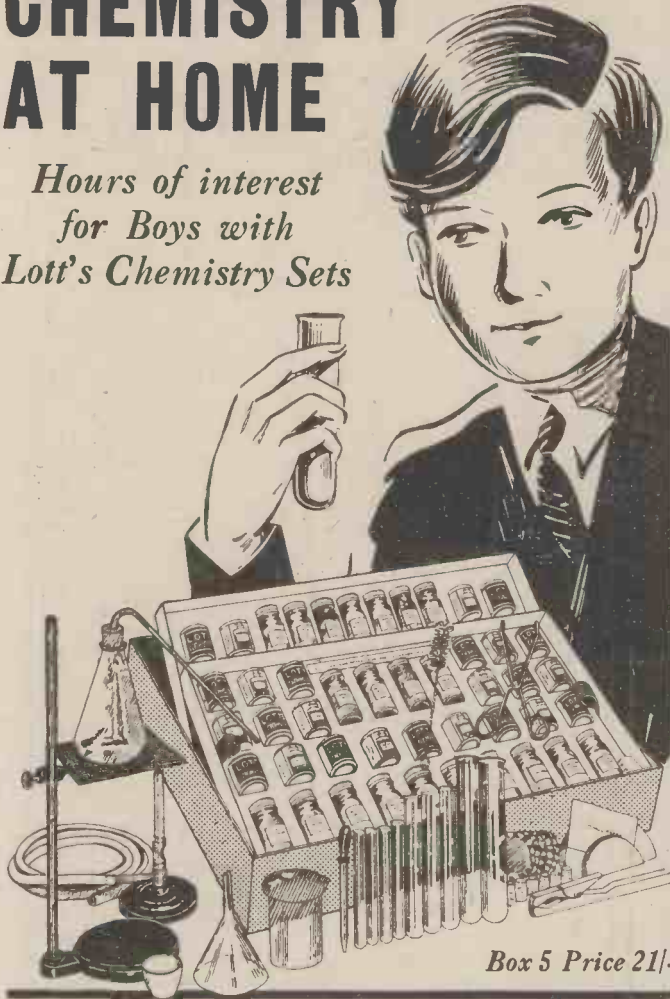

Box 5 Price 21/-

Every Boy will appreciate a Lott's Chemistry set for Christmas! Each set is a miniature "Lab." in itself. Here are the subjects of a few of the fascinating experiments that can be carried out: Colour changes in liquids, secret inks, crystal formations, evolution of gases, fire-proofing, oxidization, dyeing, bleaching and coloured fire.

Lott's Chemistry Sets contain chemicals and apparatus, including flasks, test-tubes, crucibles, Bunsen burner, etc. Full instructions and explanations (by a Doctor of Science) of the processes and reactions are given.

Complete Sets at 2/-, 3/6, 6/-, 10/6, 15/6, and 21/-.
Larger Students' Cabinets at 31/6, 42/-, 73/6, and 105/-.
Spare Supplies of all Chemicals and apparatus can be obtained.

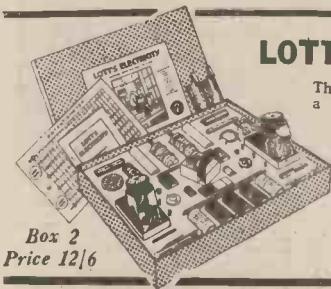

Box 2 Price 12/6

LOTT'S ELECTRICITY SETS

These sets provide the equipment for performing a really remarkable range of experiments in magnetism, static and current electricity.

Working models and instruments such as the following can be made: buzzer, relay, electrically operated railway signal, traffic signal, gold-leaf electroscope, electric motor, etc., etc.

Sets at - - - - 6/-, 12/6, 21/-

LOTT'S CHEMISTRY AND ELECTRICITY SETS

Obtainable at all leading Toy Dealers and Stores

WRITE FOR FREE ILLUSTRATED LISTS OF ALL LOTT'S PRODUCTS
Dept. N.1., LOTT'S BRICKS LTD., WATFORD, HERTS

BUILD IT WITH A "GOLD-MINE" GUARANTEED KIT

THE "DROITWICH SPECIAL" Exact to Specified Values!
"GOLD-MINE" RADIO The sign of VALUE HIGH ABOVE THE PRICE 100% RESULTS 27/6 50% SAVING

- Every Kit made up of brand new goods and of exact values as specified. You are ensured of 100% results with this latest set, but at a price which constitutes a real bargain.
- Kit "A." Full set of components, with chassis and all sundries... 27/6
- Kit "B." As Kit "A." with the addition of set of valves: types as specified... 42/6
- Kit "C." As Kit "B." with the addition of console cabinet and Ormond permanent magnet speaker... 67/6
- Kit "D." As Kit "C." with complete set of batteries... 79/6

The "GOLD-MINE" STORES
"The Radio Market-Place of the World"

3d. STAMP SECURES RADIO'S GREATEST INVESTMENT.

Enclose also 3d. stamps for the November "RADIO GOLD-MINE" the most comprehensive and most attractive catalogue of surplus radio goods in the world. Literally packed with hundreds of brand new surplus lines offered at the lowest liquidation prices ever. Illustrated and produced in two colours—it's yours for 3d. stamps by return. Send to-day.

LONDON EAST CENTRAL TRADING CO. (Dept. R.99)
33 BARTHOLOMEW CLOSE
LONDON, E.C.1
Telephone: National 7473



Television is the coming boom in wireless—it will bring even greater prosperity to the industry and create many more opportunities for a career. Men who foresaw the broadcasting boom made good—be trained and prepared for this television boom which must follow as surely as night follows day.

At the WIRELESS COLLEGE students receive training in all the latest developments in all branches of the Wireless profession. Marine, Aircraft, Manufacturing, Designing, Experimenting, Sales and Service, etc. College on sea front. Write for free prospectus.

STUDENTS ACCEPTED AS BOARDERS. TRAINING FEE CAN BE PAID AFTER APPOINTMENT SECURED

The WIRELESS COLLEGE COLWYN BAY N. WALES

ECONOMIC ELECTRIC CO. TWICKENHAM, LONDON, S.W.

E.E.C. RACING BOAT MOTORS



There is no better motor on the market. High efficiency, low consumption, high speed.

Prices: 15/-, 17/6, 21/-, 25/- Post 9d.

CONVERT YOUR BOAT TO ELECTRIC DRIVE. Specially Designed Boat Accumulators.

4 volt 5 amp., 6/6. 6 amp., 7/6. 10 amp., 10/- Post 9d.

Dry Battery Motors, 9/6, 13/6. Take 3 amp. only. Post 6d.

MICROPHONES



Highly Sensitive Super Type. Equal to those selling at three times the price. 3/6, post 3d. Button Pattern, 3/- and 1/-. Acts in any position. Send for our 72 pp. Illustrated pocket list of motors, telephones, instrument and resistance wires, dynamos and parts, miniature fittings, etc., 2d., post free.

The "UNICORN" Electric Drill IS INDISPENSABLE TO ALL MECHANICS

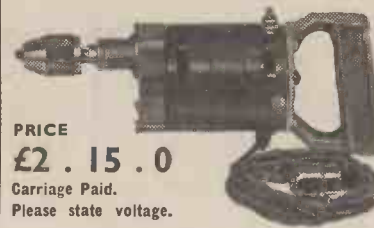

Efficient, a model of accuracy and workmanship, and trouble-free qualities are the features of this drill. Its equipment comprises a powerful A.C. or D.C. Motor, voltages 100/120, 200/230, 230/250, with Armature Shaft in ground alloy steel. Hobbled gears in metal housing. Hoffman ball thrust. Keyless chuck, 1/2-in. capacity. Aluminium die cast handle. Current consumption 175 watts, using 1/2-in. drill on mild steel. 8 ft. Cab tyre flex with earth wire. Weight 5 lbs.

PRICE £2. 15. 0

Carriage Paid. Please state voltage.

These drills are British Made and are designed for drilling up to 1/2-in. diameter and are guaranteed under these conditions for six months and are now in constant use in many factories. Send for illustrated leaflet to:—

GORONA ENGINEERING CO., Leighton Place, Kentish Town, N.W.5
Tele.: GULLIVER 3739

ALL RADIO
QUESTIONS
ANSWERED
FREE.

The PRACTICAL MECHANICS

Every Question
must be accom-
panied by the
Coupon on
page iii of Cover

Wireless Experimenter

THIS month's set should have a special appeal to readers, as it has been designed on strictly economical lines. Every unnecessary component has rigorously been obviated, and nothing except real essentials has been retained. This does not mean that those valuable refinements which are so popular on present-day sets have been



A rear view of the set, showing the neat layout on top.

omitted, for the set has every feature which is generally wanted by the average listener. It is remarkably neat and compact in design, as can be seen from the photographs, and is quite a straightforward job to assemble.

The Coils

A feature of the set is in the coils employed, which have recently been developed by British Television Supplies. The coils are of the air-core type, and, whilst employing a standard arrangement for the medium waves, have been designed on rather unorthodox lines as far as the long waves are concerned. In addition to the provision of a small series condenser, a separate aerial coupling coil is employed on the long waves. No switching is required to bring this coil into use, as it is permanently joined to the aerial terminal. The actual arrangement of the windings, the value of the coupling condenser, and the number of turns in the primary coil have all been carefully worked out so that, on medium waves, the coil gives a performance fully up to the requirements of a modern wireless receiver, namely, good signal

—THE DROITWICH SPECIAL—
A low-priced set with a high standard of performance.

strength and good selectivity. On the long waves, however, the effect of the coupling coil is found to be such that the Droitwich transmitter may be confined to a narrow band without any loss of signal strength.

The Circuit

It will be seen from the accompanying circuit diagram that the arrangement is on popular and well-tried lines. A plain screen-grid valve with tuned grid coupling feeds into a leaky grid detector, this in turn being fed to a high efficiency output pentode through a "straight" L.F. transformer. To avoid instability, motor-boating, or other similar troubles, the anode circuit of the detector is effectively decoupled by means of a 25,000-ohm resistance and a 1-mfd. fixed condenser.

Special importance is attached to the Droitwich coils specified, and which have previously been referred to. It will be seen that the first one is so connected that three different degrees of selectivity are obtainable: by connecting the aerial to terminal A, least selectivity and maximum efficiency is obtained; by connecting to tapping on the medium wave winding, increased medium-wave selectivity is secured; or by connecting the aerial to one terminal of the reaction winding, still further increased selectivity is obtained on both wave bands. This use of the reaction winding is somewhat unconventional, but has proved to be extremely effective in difficult situations, or when a long aerial is employed. Still further selectivity can be obtained by connecting the lead from the coupling condenser attached to the anode of the S.G. valve from terminal A on the first coil to the tapping on the medium-wave winding.

Mounting the Components

It will be seen from the drawings and photographs that the coils are mounted one above and the other below the baseboard. The reason for this is that the metallised surface of the chassis acts as an effective screen, and further, the fact that the coil axes are at right-angles to each other prevents all possibility of inter-action between them. It will be seen from this that an appreciable saving in cost is affected, as the ordinary unshielded coils can be used, and prove equally effective

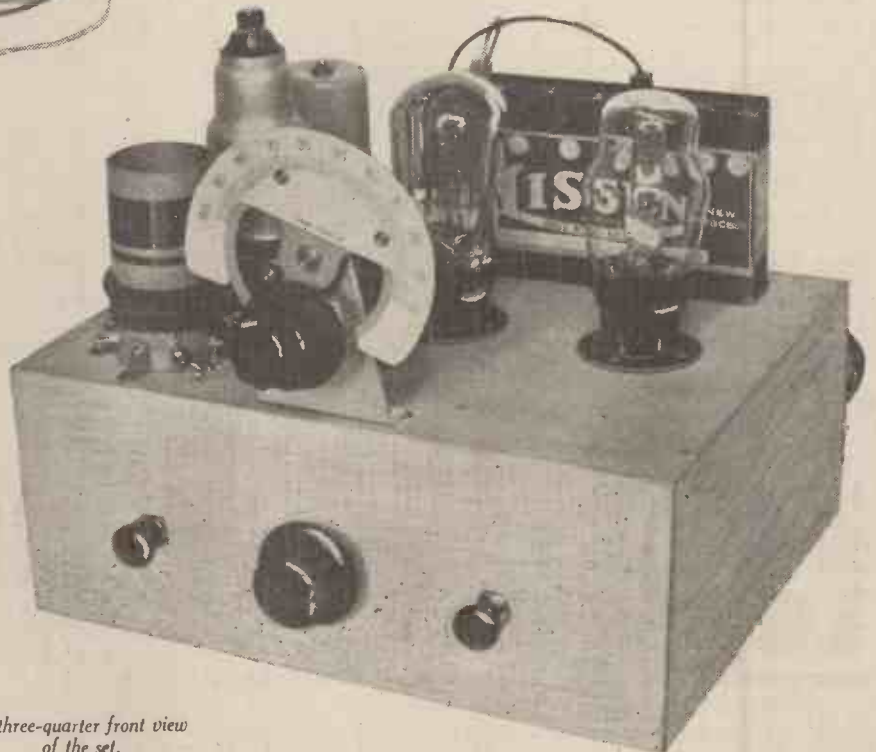

A three-quarter front view of the set.

LIST OF COMPONENTS

- One Metaplex Chassis, 10 × 8 in., with 3 1/4-in. Runners.
- Three Clix Valveholders—two 4-pin and one 5-pin.
- Two B.T.S. "Droitwich Coils."
- One B.R.G. .0005 mfd. 2-gang Bakelite Dielectric Condenser.
- One B.R.G. 3-point "Push Pull."
- One B.R.G. 2-point "Push Pull."
- One "Goltone" Screened H.F. Choke.
- One "Goltone" Super H.F. Choke.
- One T.M.C. .1 mfd. Tubular Condenser.
- One T.M.C. Tubular Condenser, .0003 mfd.
- Two T.M.C. Tubular (.0002 mfd.) Condensers.
- One T.M.C. 1 mfd. Fixed Transformer, Type 25.
- One pair G.B. Clips, Peto-Scott.
- One B.R.G. .0003 mfd. Reaction Condenser.
- One Dubilier 25,000-ohm Fixed Resistance.
- One Dubilier 2-ohm Grid Leak.
- One 100 m.a. Microfuse.
- One B.R.G. 5 : 1 L.F. Transformer.
- One Belling-Lee 5-way Battery Cord.
- Two Belling-Lee Terminal-socket-strips, one A. and E. and L.S.
- Two Wander Plugs, G.B.+ and G.B.- Clix.
- Three Hivac Valves, S.G. 210, D210, Y220.
- One Amplion "Lion" Loud Speaker. Batteries and Accumulator.

as the shielded type of coil in the usual disposition on the baseboard, namely, side by side. There are only four controls on the front of the set, these being the wave-change switch, the reaction condenser, the tuning control, and the on-off switch. When mounting the latter, care should be taken to insulate it from the chassis by scraping away the metallised surface underneath the locking nut.

Simple Construction

It need scarcely be stressed that the constructional work is extremely straightforward, and has been planned out to assist the amateur who does not possess any workshop facilities. Nevertheless, the finished set presents a very workmanlike appearance. The parts have been placed so that there is very little waste space, and yet there is ample room for making the necessary connections and carrying out the wiring in a minimum of time. Those who prefer soldered joints can, of course, use them, but there is no necessity for this, because all the components are provided with terminals of a suitable size. The first thing to do is to drill the metallised chassis

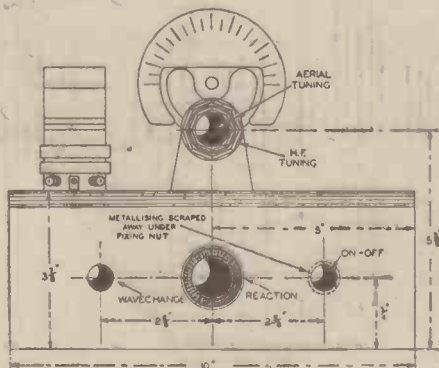

and measurements for the front of the set.

THE ABOVE AND BELOW CHASSIS WIRING PLAN OF THE DROITWICH SPECIAL.

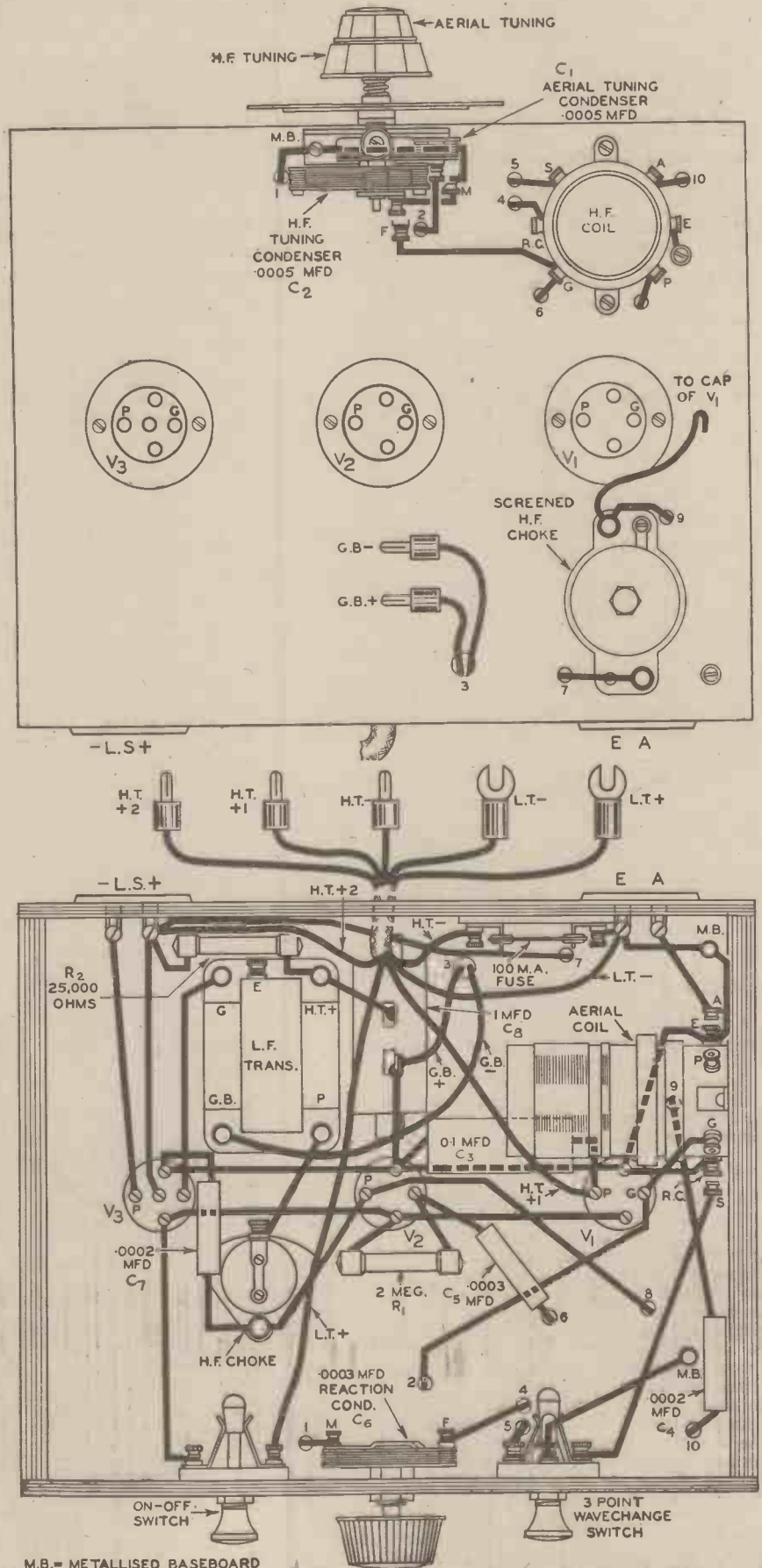



BRITAIN'S LEADING SPEAKER MANUFACTURERS

BRITAIN'S LEADING RADIO SUPPLIERS



Co-operate in this Amazing

SPEAKER OFFER



W. B. STENTORIAN BABY (On left) With matching Transformer, suitable Power, Pentode, Class "B" or Q.P.P. Yours for 2/6; balance in 9 monthly payments of 2/6. Cash or C.O.D. Carriage Paid, £1/2/6.



YOURS FOR 2/6 DOWN

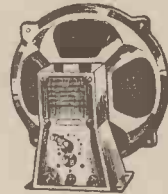

W.B. STENTORIAN STANDARD (On left) For Power, Pentode and Class "B". Yours for 2/6; balance in 11 monthly payments of 3/-. Cash or C.O.D. Carriage Paid, £1/12/6.

W.B. STENTORIAN SENIOR (Above) For Power, Pentode, and Class "B". Yours for 2/6; balance in 11 monthly payments of 4/-. Cash or C.O.D. Carriage Paid, £2/2/0.

SEND FOR SPEAKER LISTS.

PETO-SCOTT

EVERYTHING RADIO - CASH C.O.D. or EASY TERMS

SEND US YOUR ENQUIRIES FOR EVERYTHING RADIO... Miscellaneous Components, Parts, Kits, Finished Receivers or Accessories for Cash or C.O.D. or H.P. on our system of Easy Payments. Send us a list of your wants. We will quote you by return. C.O.D. orders value over 10/- sent carriage and post charges paid (GREAT BRITAIN ONLY). Hire Purchase Terms are NOT available to Irish and Overseas customers.

DROITWICH SPECIAL

These are the Parts the Author Used

KIT "A" CASH OR C.O.D. £2:11:6

- | | | | |
|--|---|----|----|
| 1 Peto-Scott Metaplex Chassis, 10" x 8" with 3" runners... | £ | s. | d. |
| 1 Pair Peto-Scott G.B. Clips | 0 | 0 | 2 |
| 2 B.T.S. "Droitwich" Coils | 0 | 7 | 0 |
| 1 B.R.G. 3-point Push-Pull Switch | 0 | 1 | 3 |
| 1 B.R.G. 2-point Push-Pull Switch | 0 | 1 | 0 |
| 1 B.R.G. 2-gang Solid Dielectric Condenser, type 68A | 0 | 8 | 6 |
| 1 B.R.G. .0003 mfd. Reaction Condenser | 0 | 2 | 6 |
| 1 B.R.G. 5:1 L.F. Transformer (Minor) | 0 | 4 | 6 |
| 1 100 m/a Microfuse | 0 | 1 | 0 |
| 1 T.M.C. 1 mfd. Fixed Condenser, type 25 | 0 | 2 | 3 |
| 3 T.M.C. Tubular Condensers, 1, .0003, .0002 mfd. | 0 | 2 | 3 |
| 2 Dubilier Fixed Resistances, 25,000 ohms, and 2 meg. | 0 | 2 | 0 |
| 3 Clix Valve Holders, (2) 4-pin and (1) 5-pin | 0 | 2 | 1 |
| 1 Goltone Screened H.F. Choke, S.H.F. | 0 | 4 | 0 |
| 1 Goltone Super H.F. Choke | 0 | 4 | 6 |
| 1 Belling-Lee 5-way Battery Cord | 0 | 2 | 0 |
| 2 Belling-Lee Terminal Socket Strips; (1) A. and E. and (1) L.S. | 0 | 1 | 6 |
| 2 Clix Wander Plugs, marked G.B. x and G.B. - | 0 | 0 | 3 |
| Wire, Screws and Flex | 0 | 2 | 0 |

AUTHOR'S kit of first specified parts including Peto-Scott ready-drilled Metaplex Chassis and B.T.S. Droitwich coils; less valves, cabinet and speaker. Balance in 8 monthly payments of 6/6. Yours for **5/-**

KIT "B." As for Kit "A" but including set of specified valves, less cabinet and speaker. Cash or C.O.D. Carriage Paid, £3/10/3 or 12 monthly payments of 7/-.
KIT "C." As for Kit "A" but including set of valves and Peto-Scott Droitwich Special Consolette Cabinet, less Speaker. Cash or C.O.D. Carriage Paid, £4/10/9 or 12 monthly payments of 8/9.

If Specified Amplion Speaker is required with any of the above Kits, add £1/12/6 to Cash or C.O.D. prices, or 3/- to deposit and each monthly payment.

● SPECIFIED DROITWICH COILS ●
B.T.S. DROITWICH COILS
BAND CONTROL

Receive Radio-Paris without interference from Droitwich with these amazing new coils. This high degree of selectivity results from the NEW WAVE WINDING, now offered the Home Constructor for the first time. Interchangeable for aerial or anode circuits.
 1 pair B.T.S. Droitwich Band Control Coils 7/- Part post and packing 6d. extra.

PETO-SCOTT CO. LTD.

77 (Pr. M.1) CITY RD., LONDON, E.C.1. Telephone: Clerkenwell 9406/7. West End Showrooms: 62 (Pr. M.1) High Holborn, London, W.C.1 Telephone: Holborn 3248.

Buy by Post - its Quicker - CASH - C.O.D. - EASIWAY

HIVAC

THE SCIENTIFIC VALVE

BRITISH MADE

MAINS AND BATTERY VALVES

PUT NEW LIFE INTO YOUR RECEIVER BY REPLACING ALL TIRED VALVES WITH THEIR HIVAC EQUIVALENT.

Hivac equivalents for other well-known makes are clearly set out in the 1935 Hivac Valve Guide "M" sent free on request.

BATTERY TYPES FROM **3/9** MAINS TYPES FROM **9/6**

These are the valves specified for the "DROITWICH SPECIAL"

SG 215...10/6. D 210...3/9. Y 220...10/6.

Obtainable from all Curry's branches and high-class dealers.

HIGH VACUUM VALVE CO., LTD., 113-117 Farringdon Road, London, E.C.1.

Telephones: Clerkenwell 7587 & 8064.

CLIX

Whatever the form of contact required, Clix are the first to produce an efficient component. An example of this was shown in the CLIX AERIAL-EARTH MASTER PLUG dealt with in the October issue (see page 27).

Clix perfect contact components have been specified for every one of the receivers designed by the Editor and Technical Staff of this popular journal.

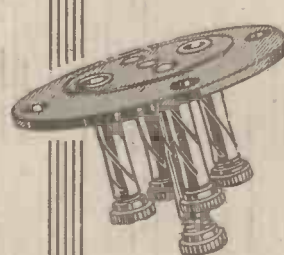

Clix specified for the "DROITWICH SPECIAL"

Clix Chassis Mounting Valveholders. Standard Type. 5-pln 9d. 4-pin 8d.

Clix "Master" Wander Plugs G.B. and H.T. 1 1/2d. each.



FREE: CLIX FOLDER "M." SEND FOR A COPY NOW

LECTRO LINX LIMITED

79a Rochester Row, London, S.W.1

WIRELESS NOTES

New Times for Television Broadcasts

THE alteration in the time of the television transmissions, which now take place on Wednesdays at 11 p.m. to 11.45 p.m., and on Saturday afternoons from 4.30 to 5.15, has created renewed interest in this latest branch of radio. It gives the experimenter a chance to carry out experiments on a Saturday afternoon and to have his visor in good working order in time for the transmissions on Wednesday nights. The extra quarter of an hour in the length of the transmissions is a move in the right direction, and indicates that television, far from being a scientific phantasy, is at long last coming into its own.

Television Developments Abroad

In France and Italy, special commissions have been appointed by the respective governments to advise as to the possibility

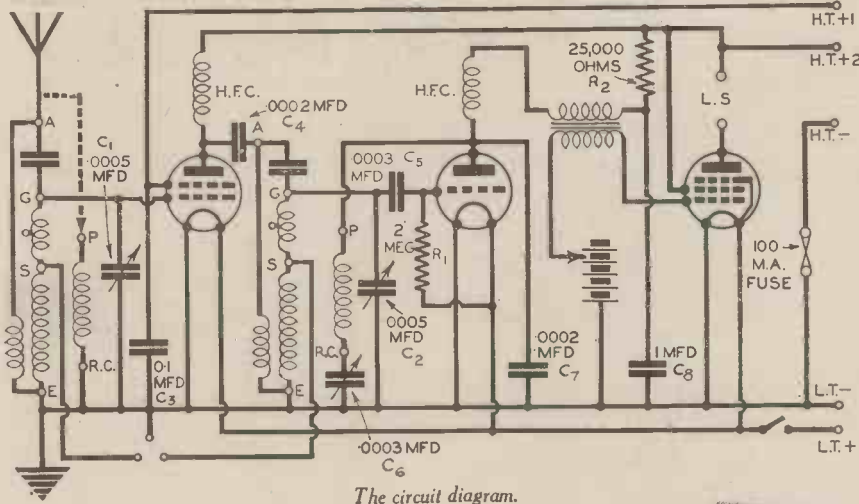

with three holes for the valveholders, the holes being 1 in. in diameter. When these have been made, the valveholders can be mounted in position by passing four 3/8-in. screws through the holes in each. The method of dealing with the other components calls for no special mention, since they are simply attached to the chassis by means of 1/4-in. screws.

Battery Connections

Most of the wiring is carried out by means of insulated connecting wire, but the leads to the batteries and loud-speaker unit consist of flex. The H.T. and L.T. leads are combined in a five-way battery cord, but separate lengths of rubber-covered flex are employed for the G.B. connections and loud-speaker leads. All these flexible-lead connections can be made by looping the ends of the wire and gripping the loops under the terminal nuts, or they can be soldered if desired.

Testing Out

Connect up the batteries, speaker, aerial and earth in

readiness for giving the set its preliminary trial. Of the H.T. positive leads, marked 1 and 2, the first is for the screening grid of the first valve, and should be plugged into the 60-volt socket, and the other feeds the anodes of the three valves and goes into the 120-volt socket. The bias voltage should be about 4 1/2 volts. After making these connections the receiver is ready for use, and can be tuned in the conventional manner.

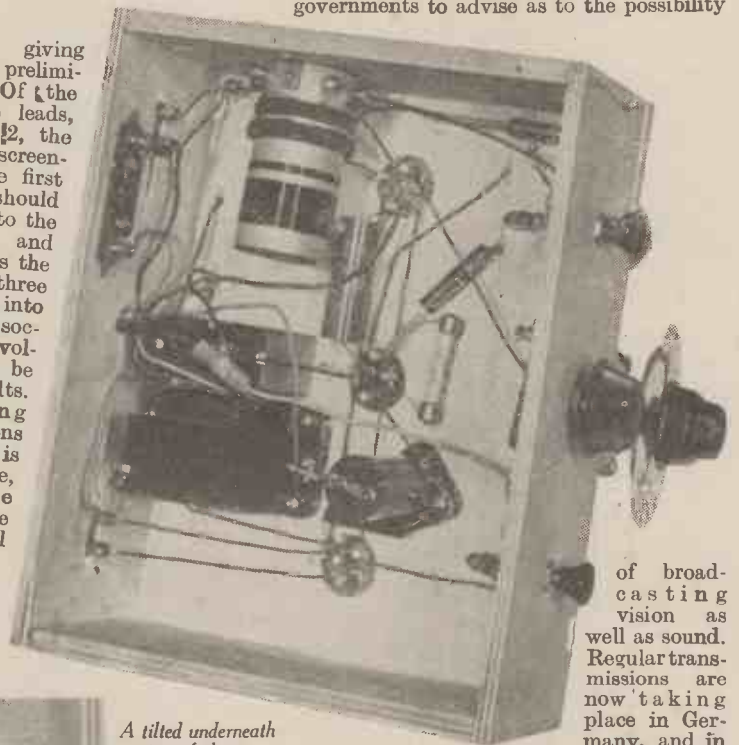

A tilted underneath view of the set.

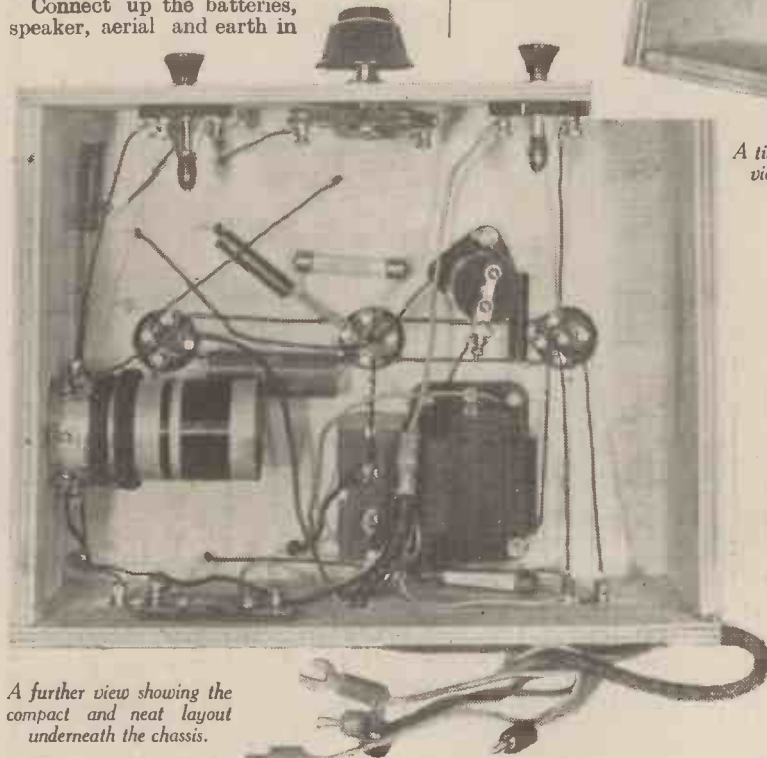

A further view showing the compact and neat layout underneath the chassis.

of broadcasting vision as well as sound. Regular transmissions are now taking place in Germany, and in America there

are several privately owned stations broadcasting vision programmes. In this country, experimenters keenly await the findings of the Advisory Committee appointed by the Postmaster-General. The time cannot be far distant when we have complete home radio entertainment in the form of sound and vision programmes.

Newnes' Television and Short Wave Handbook

Those readers interested in television and short wave reception should avail themselves of a special Presentation Offer of the above volume which is being made by our companion journal, "Practical Wireless" (3d. every Wednesday). This volume deals in an interesting and popular way with all of the varied aspects of these two subjects. The text is illuminated by hundreds of easily understood diagrams and photographs. Full details are available from the Editor, PRACTICAL MECHANICS, George Newnes Ltd., 8/11 Southampton Street, Strand, London, W.C.2. The work is a companion volume to "Everyman's Wireless Book," "The Wireless Constructors' Encyclopædia," and the "Encyclopædia of Popular Mechanics."

Tradition



The Technical Press agrees with us in our statement that the Amplion 1935 "Lion" Speakers faithfully uphold our reputation for producing speakers that give life-like reproduction, fine tonal balance, sensitivity and the ability to handle heavy input without the slightest distortion.

"Popular Wireless" says:—

"To-day, Amplion moving coil loudspeakers are continuing to enjoy tremendous popularity, proof—if proof is wanted—that the old-time traditions associated with this famous name have been well maintained." . . . The Amplion "Lion" Speaker, a high-class permanent magnet moving coil instrument, is an outstanding example.

The "Droitwich Special"

Because "Lion" loudspeakers can be correctly matched to every class of output, they are suitable for use with any receiver and have been specified for the "Droitwich Special."

UNIVERSAL TRANSFORMER, 1 to 20 AND 2,000 to 40,000 OHMS.

PROVISION FOR VOLUME OR TONE CONTROL AND USE OF ADDITIONAL SPEAKER.

"Lion" 7" cone, 47/6.
"Lion Super" 10" cone, 55/-.

AMPLION SPEAKER, RECEIVER, AND COMPONENT LISTS, FREE.

47/6
(7" CONE)

AMPLION

LION LOUDSPEAKERS

AMPLION (1932) LTD.

82-84 Rosoman Street, London, E.C.1.

"DROITWICH SPECIAL"

This Modern Receiver DEMANDS FIRST-CLASS COMPONENTS

INSIST ON "GOLTONE"
H.F. CHOKES—AS
USED BY DESIGNER



CONSTRUCTORS! Follow the choice of the designer, and use "GOLTONE" H.F. CHOKES to be certain of maximum performance from your "Droitwich Special."

"GOLTONE"
SCREENED H.F. CHOKE
Type S.H.F.

As used in the original receiver.
Highly efficient, Robust Mechanical Construction.
Inductance 250,000 mics. approx.
D.C. Resistance 500 ohms. Current (maximum) 50 m/a approx.
Grey enamelled metal screening cover.
No. R3/S.H.F. - Price 4/- each.

"GOLTONE"
SUPER H.F. CHOKE
(Also specified)

Inductance 350,000 mics.
D.C. Resistance 700 ohms.
Self-capacity 4 to 5 mmfda.
Current (max.) 50 m/a approx.
No. R4/492.
Price 4/6 each.

Obtainable from first-class radio stores—refuse substitutes, if any difficulty write direct

ON REQUEST.
1934/35.
FREE 60-page Radio Catalogue, giving range of "Goltone" components suitable for the "Droitwich Special."

Ward & Goldstone
PENDLETON MANCHESTER LTD.

I Use Them at Work & at Home



RAWLPLUGS
WALL PLUGS

Rawlplugs enable anyone to make firm fixtures in brick, concrete, stone, tile, plaster, etc. The old method of using unsightly nails or ugly wood plugs is never satisfactory, because they always work loose. The Rawlplug method is far neater, stronger and firmer, and no damage is done to walls or decorations. Complete Outfits 1/6, 3/6 and 5/6.

Rawlplug DUROFIX

The Heat & Waterproof Adhesive

Rawlplug Durofix is the most effective of all adhesives by reason of its great strength. It will withstand boiling water or the heat of an oven. Durofix is the ideal adhesive for Sportsmen, because once dry it will not become tacky again. Sold in big orange tubes, 1/- . Smaller size, 6d.



B. 108 The Rawlplug Co. Ltd., Cromwell Road, London, S.W.7

Add more realism to your models

DETAILS and results are the main things that count with the men and boys of to-day—even with their hobbies and playthings. That is where the BASSETT-LOWKE model scores, with its impressive background and foundation of 30 years' experience and skill in the art of modelling to scale. For realism, accuracy of detail, efficiency of performance and value for money the BASSETT-LOWKE model—locomotive, engine or ship—is unsurpassed.

WHICH IS YOUR HOBBY? Look below and see just a few of the scores of fine models and fittings made by this world-famous firm. Choose your favourite this Christmas and make it a BASSETT-LOWKE.



L.M.S. ROYAL SCOT & L.N.E.R. FLYING SCOTSMAN
Undoubtedly the two most popular Gauge "0" Expresses BASSETT-LOWKE have yet produced. Models of "class," true in external detail to their prototypes. Engines of power and speed 1 "Royal Scot," clockwork and electric, d.c., 75/-; electric, a.c., 75/6. "Flying Scotsman," 84/- and 91/-.



TANK LOCOMOTIVE No. 5374.

A new addition to the BASSETT-LOWKE range. Undoubtedly the most handsome Gauge "0" Tank Engine on the market. A powerful hauler, with a fine turn of speed. Clockwork £2.2.0; electric, a.c. and d.c., £2.5.0.



"ENTERPRISE"

Introduced recently as an experiment this Gauge "0" Steam Locomotive has drawn a remarkable number of testimonials from purchasers. It is absolutely foolproof—an ideal first steam-model for a boy to have. Under test hauled five long bogie coaches for 50 minutes non-stop, covering 11 miles, 50/-.

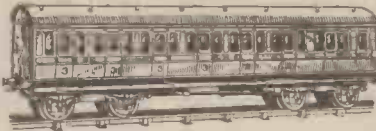

PASSENGER COACH

One of BASSETT-LOWKE'S inexpensive range of Gauge "0" model Coaches, which can be obtained in L.M.S., L.N.E.R., G.W.R., and S.R. colours. Oval-headed buffers and scale corridor connections. 14/6 each. L.M.S. Postal Sorting Van, an accurate model for picking up and delivering mails, 30/-.

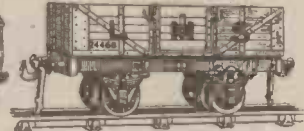

GOODS WAGON

A typical example of a Gauge "0" BASSETT-LOWKE Wagon. The complete range is described in section A.17 (price 6d.), Goods Wagon, Open and Covered, Private Owners, Petrol, Cattle, Milk and Oil Tank Wagons, Refrigerator, Goods, etc. Model illustrated, 2/9.

Scale Model Railways

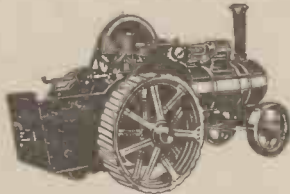

TRACTION ENGINE

Make this fine Burrell type 1-in. scale Single Cylinder Traction Engine from castings, parts and drawings supplied by BASSETT-LOWKE. Or buy the finished model. Price £13 16s. complete. A princely gift for the model enthusiast.

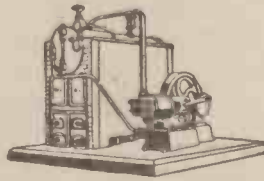

"TANGYE" ENGINE AND BOILER SET

A useful Steam Plant. There is not more substantial steam engine and boiler obtainable at the price. Set No. 1, consisting of No. 1 Babcock boiler and No. 1 Engine, having a 3/4 x 4 in. cylinder. £4 15s. Set No. 2 of No. 2 Babcock boiler and No. 2 Engine, having 1 x 1 in. cylinder. £7 12s. 6d. Other sizes obtainable.



BOILER FITTINGS

The BASSETT-LOWKE B.12 List (price 6d.), contained a most comprehensive and interesting selection of Scale Model Boiler Fittings which are useful for any type of Model or Small Power Boiler. Fittings include Water Gauge, Cocks of all types, Wheel and Needle Valves, etc., Whistles, Lubricators, Pumps, Injectors, and every accessory necessary to the model engine and boiler enthusiast.

Scale Model Engines



CABIN MOTOR BOAT "MARGARET ROSE,"

Clockwork or Electric, £3 17s. 6d.



TROTMAN ANCHOR.
8d. each.



CABLE.
Cheap quality from 8d.
Best quality from 1/-.

Ships Catalogue
S.12. 6d.

"AZALEA" Super Steam Yacht. £8 10s.



SKYLIGHT.
1 1/2" long. 1/-.



DECK BUCKET
3d. each.



REMOLD PROPELLER.
2" dia. Left-hand blade. 1/6 each.



Scale Model Ships

Write to Northampton to-day and give this well-known British firm the opportunity of supplying your model wants this year. There are experts at Manchester and Holborn Branches and at Northampton ready to give you advice and every attention. Don't hesitate to call! Make it a BASSETT-LOWKE. Then you'll have the "real" thing in miniature—a model to be depended upon, something you can really be proud of.

Although they have two branches and a number of agents, BASSETT-LOWKE send most of their models by mail order. Therefore, send for their catalogues, choose your favourite model, and it will be despatched to you, spick and span, straight from the makers at Northampton.

BASSETT-LOWKE'S POPULAR CATALOGUES: Scale Model Railways A.12, Scale Model Engines B.12, and Scale Model Ships S.12. Price 6d. each section (post free). Also splendid new free booklet of railways and ship models, and free high-class toy folder.

LONDON BRANCH: 112 HIGH HOLBORN, W.C.1

MANCHESTER: 28 CORPORATION ST.

BASSETT-LOWKE LTD NORTHAMPTON
MAKERS OF ENGINEERING MODELS

Fig. 21.—
The G.W.R.
engine "The
Great Bear"
having the
Pacific or
4-6-0 wheel
arrangement.

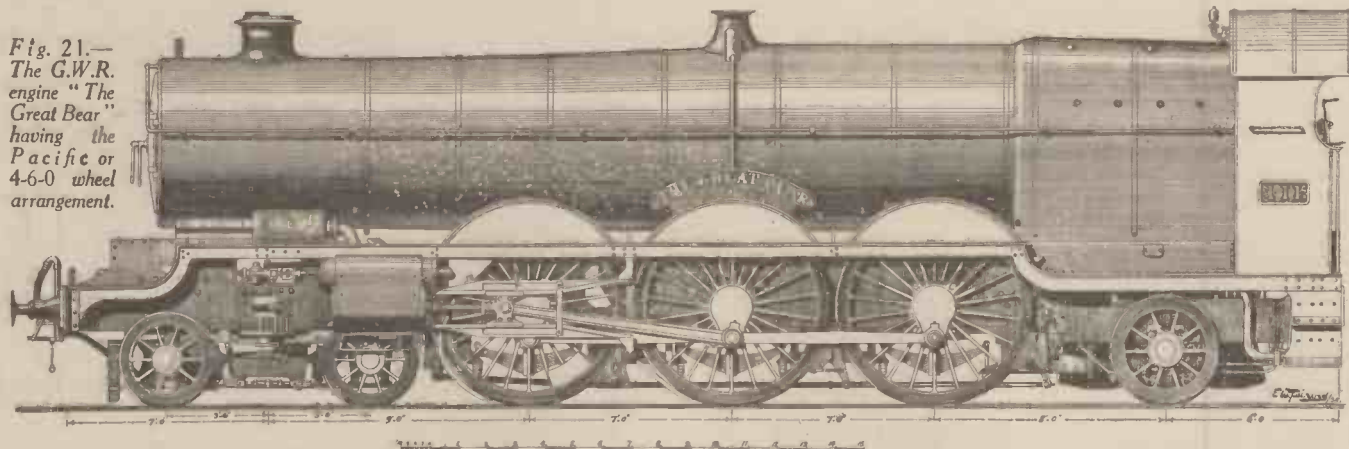

MODELLING HISTORIC LOCOMOTIVES

SPACE considerations prevent more than a passing reference to the rapid increase in size between the years 1900 and 1908. The *Atlantic*, or 4-4-2 wheel arrangement, came into great favour, the Great Northern being the first with it, followed by the Lancashire and Yorkshire; the Great Central, the North Eastern, the Great Western and the North British all built the type. At the same time many of the lines were also running the 4-6-0 type, one or two, including the Caledonian Railway, with inside cylinders. Examples are far too numerous to enable me to give drawings, and so I will revert to the Great Western and pass on to the year 1908.

G.W.R. "The Great Bear"

In this year Mr. Churchward designed and built an engine of a type entirely new to this country, No. 111, named *The Great Bear*, having the *Pacific*, or 4-6-2, wheel arrangement. A side elevation drawing of this enormous engine is given in Fig. 21.

She weighed, in working order without the tender, which, by the way, ran upon two 4-wheeled bogies, the unprecedented weight of 96 tons, and had a total length, measured over the frames, of 44 ft. The six coupled driving wheels were 6 ft. 8½ in. diameter, bogie wheels 3 ft. 2 in. and trailing wheels 3 ft. 8 in. There were four cylinders, measuring 15 × 26 in. The boiler, as will be seen, had a barrel, which was partly parallel and partly coned; the maximum diameter was 6 ft., tapering to 5 ft. 6 in. The centre line was pitched 9 ft. above the rails. The heating surface of firebox and tubes was 2,855.81 sq. ft., and to this may be added the area of the superheaters—

By E. W. TWINING

The concluding article of this interesting series.

545 sq. ft., making a total of 3,400.81 sq. ft. The firebox was of the wide Belpaire pattern, and had a grate area of 41.79 sq. ft. The working pressure was 225 lb. per square inch. During its career this locomotive was improved from time to time by small additions, one of which was the provision of the top water-feed.

Although the engine was, up to a point, successful, the traffic demands of the time do not appear to have warranted a repetition of the type. I believe I am correct in saying that trouble was experienced with the long wheel-base on certain curves, and so after running for some years the engine was rebuilt without the trailing wheels, with a standard boiler, and was converted to the new *Castle* class, named *Viscount Churchill*, and retained its original number: 111.

My own view of the matter is that, like many other splendid locomotives, it was before its time, and that had the trailing wheels been placed in a radial truck instead of radial axle boxes, the necessity for converting the engine may not have arisen. Then again there is the fact that a boiler so large as this should have been capable of supplying steam to cylinders much bigger than 15 in. After all, four 15-in. cylinders are only equal to two 21½-in., and Dean's 7 ft. 8 in. singles, when they first came out, had 20-in. cylinders. However, we may rest assured that the locomotive engineers

of the Great Western know what they are about, and if Mr. Collett sees fit not to repeat Mr. Churchward's experiment of 1908, he has, no doubt, very good reasons for avoiding the *Pacific* type.

In order to bring this series of articles to a close, I must pass over the period of nineteen years of development on the Great Western Railway which intervened between the construction of *The Great Bear* and the appearance of the fine four-cylinder *King George V.*, the latest class of express passenger locomotive, which Mr. Collett put upon the road in 1927.

The G.W.R. Castle Class

During those nineteen years many fine classes of engines were turned out at Swindon, the most noteworthy perhaps being the famous *Castle* class, which invariably is employed to haul the train known as the *Cheltenham Flyer*: the fastest train in the world on daily scheduled time, the weight of which sometimes amounts to as much as 340 tons without including the engine and tender. The first of the class turned out was named *Caerphilly Castle* and made its appearance in 1923.

The *Caerphilly Castle* and all its later sister engines have 6 ft. 8½ in. six-coupled wheels, 3 ft. 2 in. bogie wheels and four cylinders each 16 × 26 in. The boiler pressure is 225 lb. per square inch and tractive effort, at 85 per cent. boiler pressure, is 31,625 lb.

King George V.

The engines of the *King* class, of which the subject of my drawing (Fig. 22) was the precursor, are all named after English

Fig. 22.—
G.W.R. 4-6-0
Type "King
George V."
1927.

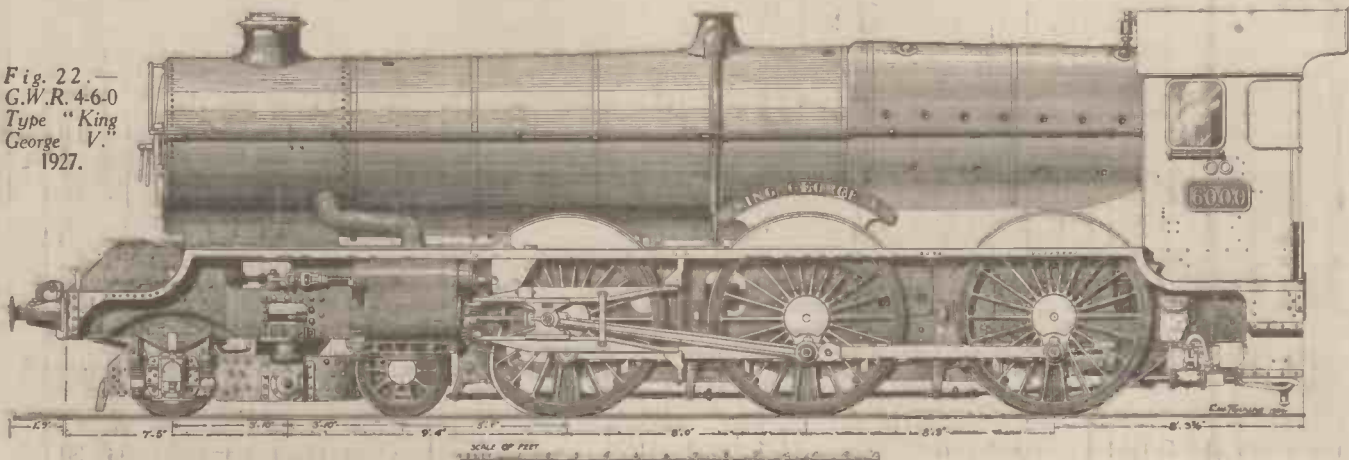

monarchs, such names being given in chronological order backwards as the engines were turned out of the shops; thus the name of the reigning sovereign was taken first.

The four cylinders, each 16½ in. diameter by 28 in. stroke, drive the two front coupled axles; two cylinders are inside driving the leading coupled axle, which is cranked, and two outside driving the centre pair of coupled wheels. The four valves are operated by two sets of inside Walschaerts' gear, the expansion links being driven by eccentrics on the leading axle. Connection is made between the inside and outside valve spindles on each side of the engine by rocking levers; thus one valve gear serves for both cylinders on either side.

The driving wheels are 6 ft. 6 in. diameter or 2½ in. smaller than all previous G.W.R. four-cylinder express engines. The bogie wheels are 3 ft. diameter.

The boiler carries a working pressure of 250 lb. per square inch, the highest em-

horizontally as indicated by the shading in Fig. 22.

It is a generally recognised fact that certain locomotive designers in the past were artists in metal. Amongst the many may be mentioned Mr. McConnell of the London and North Western Railway, Mr. Stroudley of the London, Brighton and South Coast, Benjamin Connor of the Caledonian, Mr. Wainwright of the South Eastern and Chatham and Mr. Patrick Stirling of the Great Northern Railway. But I share the opinion of many other people that the greatest of them all was Mr. Samuel W. Johnson of the Midland.

Midland Railway Bogie Singles

On this line, during the whole of Mr. Johnson's régime, up to 1887 no other than coupled engines were turned out at Derby, but in that year Mr. Johnson designed and constructed a number of bogie singles having driving wheels 7 ft. 4 in. diameter. These were followed two years later, in 1889, by a further lot, somewhat larger and with

other parts, including the base of the chimney or smokebox. The chimney shaft was, curiously enough, painted white.

The *Planet* (Fig. 8) and the *Patentee* (Fig. 9), since they were both Liverpool and Manchester locomotives, would doubtless be painted in the same style; it is certain, in fact, that the *Planet* was.

Gooch's *Great Western* (Fig. 11) and all his succeeding engines were painted as the *North Star*, except that the boilers were, definitely, green.

In connection with the *Lord of the Isles* (Fig. 12) I would like to give an interesting fact which I do not think has previously been recorded. When this engine was shown at the 1851 Exhibition she had an all-iron chimney and small sandboxes over the leading wheels, but a photograph taken in 1856 shows a copper top and large sandboxes against the driving wheels as well as the smaller, original ones. Then in a still later photograph the small boxes are missing. Now Gooch's four coupled class, of which I gave *Ivanhoe* (Fig. 15) of 1855, had iron chimneys, so it is clear that the copper chimney cap was first introduced

Fig. 23.—Johnson's 7 ft. 6 in. single Midland Railway Engine, built 1889.

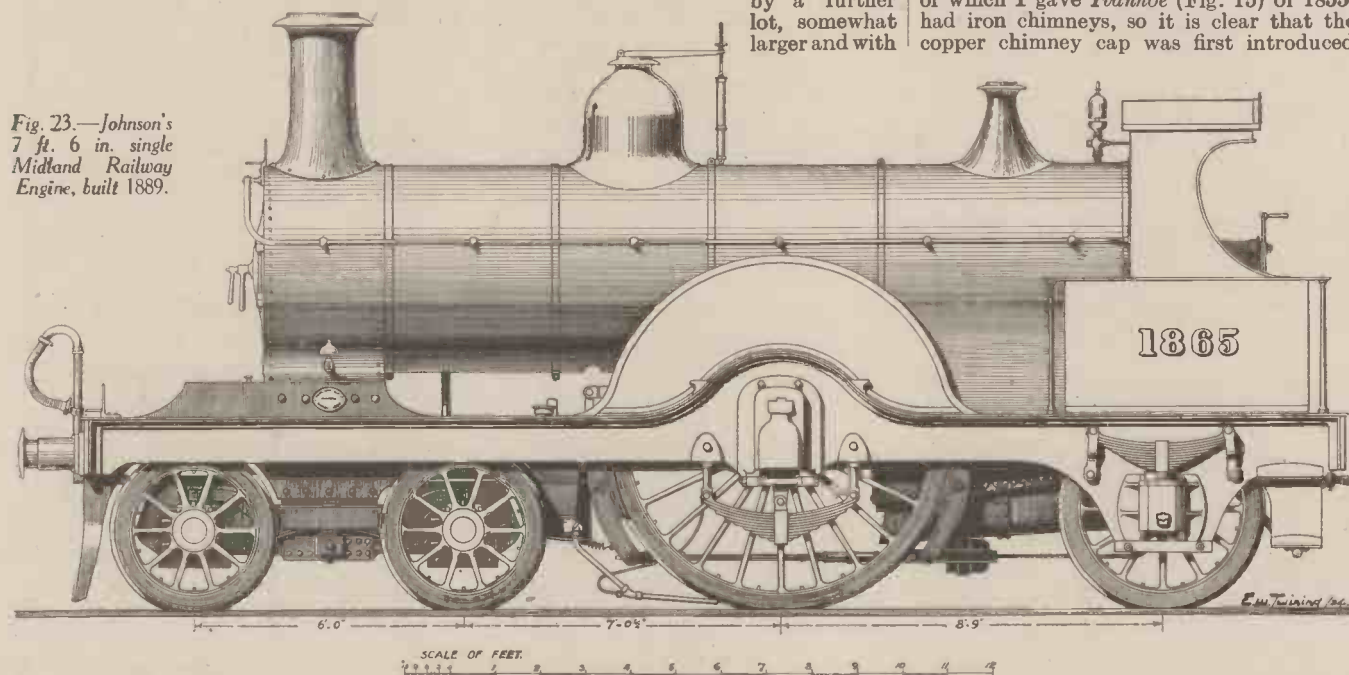

ployed in a standard type of locomotive boiler in this country. This pressure, coupled with the cylinder dimensions and driving wheel diameter, results in giving to the engines the highest tractive effort of any engines in Great Britain, viz., 40,300 lb. It has only just been exceeded by Mr. Gresley's L. & N.E.R. new 2-8-2 engine *Cock o' the North* with 43,460 lb., the coupled wheels in this case being only 6 ft. 2 in. diameter. The L. & N.E.R. *Pacifics* have only 36,465 lb. and the L.M.S. *Royal Scot* class 33,150 lb.

The boilers of the G.W.R. *King* class are, of course, tapered, the diameter at the firebox being 6 ft. and at the smokebox tube plate 5 ft. 6½ in. The firebox is 11 ft. 6 in. long and the grate area 34.3 sq. ft. The total weight of the engine only in working order is 89 tons and with the tender 135 tons 14 cwt.

A unique feature in the bogie is the provision of outside axle boxes to the leading wheels and inside to the rear. This is done to give the necessary clearance on each side and below the large inside cylinders which are situated over the front axle. The outside cylinders, of course, prevented the possibility of carrying the frames back to the outside of the rear wheels. The plate frames are therefore cranked

7 ft. 6 in. drivers. The cylinders were 18½ × 26 in. One of these larger engines is shown in Fig. 23.

The whole engine has been designed as a complete unit and nothing appears to be stuck on as an afterthought. Yet, at the same time it was a magnificent engineering job. The engines of this class, and succeeding ones with larger wheels up to 7 ft. 9 in. diameter, hauled their trains over the heavy gradients of the line with ease and remarkable economy of fuel, the coal consumption being from 20 to 23 lb. per mile; much less than one half of that burned by a big modern engine. The re-introduction of the single-wheeler was largely brought about by the invention of the steam sanding gear for the prevention of slipping.

Colours of Old Locomotives

Nothing is known of the paint work, if any, of the locomotives of pre-*Rocket* days. Quite possibly they were not painted at all. So we must commence with Robert Stephenson's successful machine. Fortunately the painting of all the competing engines has been recorded and amongst the records is a statement that the *Rocket's* principal colour was yellow. The boiler lagging and wheels were finished in this, all framing and

either late in 1855 or early in 1856.

The *Lord of the Isles* had all the splashers, the safety-valve casing, the large rounded corners front and back of firebox and the boiler lagging bands of polished brass.

Ivanhoe had the same brass-work on the firebox, the lagging bands were painted iron, but the whole length of the beaded angle below the footplating, which formed the faces of the splashers, was of bright brass.

The Bristol and Exeter engines were, until after the double bogie single tanks (Fig. 14) appeared, painted dark green, picked out with black. This colour was used on wheels and boiler and probably frames as well, but in the 'sixties the green was dropped and they were painted black all over without any relief whatever.

No. 157 (Fig. 16) had the driving splashers and the safety-valve casing only of brass. The chimney top was of copper. Until some time after they came out, these engines and all other locomotive stock of the G.W.R. were picked out in black, fine-lined yellow, but the tenders and tanks were elaborately panelled with brilliant grass green bands, fine-lined on the upper edge with yellow and on the under edge with black. The first change took place in the early 'eighties, when Mr. Dean altered the colour of the wheels and splashers.

FOR THE STUDENT WHO WILL HAVE THE BEST

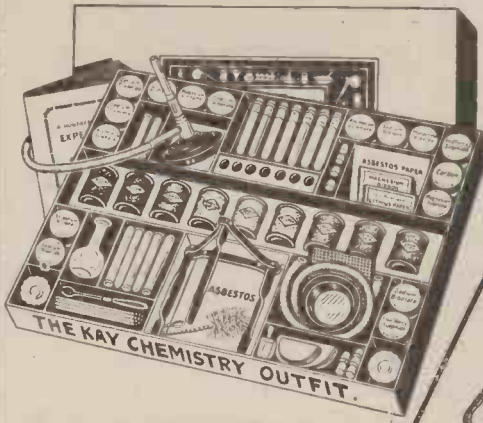

Here is a complete laboratory for the student, containing 34 different Chemicals, Bunsen Burner, Rubber Tubing, Tripod and Gauze, Flask, Test-Tubes, Glass Tubing, Filters, Test-Tube Brush, Asbestos Paper and Millboard, Trays, Scoop, Test-Tube Holder, Corks and a splendid book full of Instructions and experiments.

10/6 each

Other splendid outfits, each complete with Bunsen Burner, a good supply of chemicals and apparatus, and a book of experiments and instructions, at 2/6, 3/6, 5/-, 7/6, 15/-, 21/-, 35/-, 63/- and 105/- each.



KAY TELEPHONES

A pair of marvellous House Telephones—full-sized, one-piece Instruments, each 8½ in. long—easy to instal—automatic calling—perfect reception—works off ordinary pocket-lamp batteries! Each set complete with two Instruments, 30 feet of twin wire, and full instructions. 25/- set

Also other wonderful Telephone Sets at 10/6, 15/6 and 21/- set.

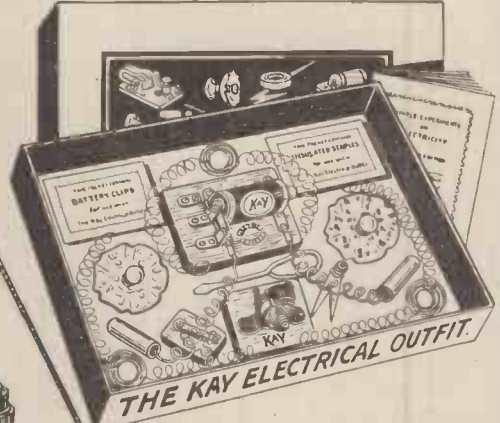

Here is a complete electrical workshop, containing a wonderful Electric Induction Coil, a Triple-coil Electric Motor, 2 Bulb Holders, 2 Fancy Shades, 2 Bulbs, Turn-screw, Battery Tester, Switch, 3 Coils of Wire, Battery Clips, Insulated Staples, and a splendid book full of instructions and experiments.

10/6 each

Other complete outfits at 2/-, 3/6, 5/6, 7/6, 12/6, 15/-, 21/-, 30/- and 50/- each, the larger ones including Dynamotors, Tapper Sets, Telephones, in addition to Electric Bells, Induction Coils, Motors and Lighting Equipment, etc.

Obtainable from all leading Stores, Toyshops, and Sports Shops. If you have any difficulty, please send direct to the manufacturers :

KAY (Sports and Games) LTD., Dept. P.M., PEMBROKE WORKS, LONDON, N.10

Send for FREE Illustrated Catalogue

E. GRAY & SON Ltd.

18-20 CLERKENWELL RD., LONDON, E.C.1

BENCH DRILLING MACHINES.

¾ Capacity Chuck. Guaranteed British Manufacture. Height, 20". Automatic and Adjustable Feed. Cut Gears. Steel Spindle. 3-Jaw Self-centring Chuck. 14/- Weight, 14 lbs. Carriage paid.

SPECIAL OFFER!

SETS TWIST DRILLS.

Set 1-60, 8/6. Set of 29 Drills, 9/3. From ⅛ to ½ inch, by 1/64ths. Complete on stand. Post 9d. extra.

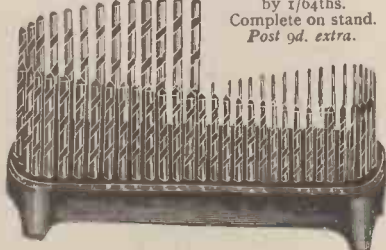
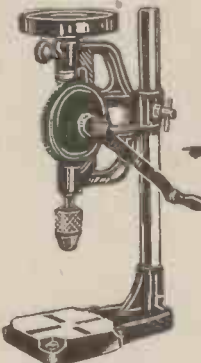

THE IDEAL BELLOWS AND BLOW-PIPE FOR GAS.

The most perfect Bellows, giving a steady and perfectly controlled blast, with a sufficient volume for all the ordinary bench purposes.

The important feature of these Bellows and Blowpipe is that they can be used with the greatest comfort while seated; and the flame can be directed to any point, leaving the hand of the operator free to manipulate his work. Bellows, Rubber Balloon, with Net and Tubing complete, without Blowpipe, large size 17/- each. Extra Rubber Pipe and Nets 4/6 each.

NICKEL PLATED ON BRASS.

Fitted with Bypass. This Blowpipe gives a very fine Jet, also can be adjusted to give a larger flame, 5/6 each.

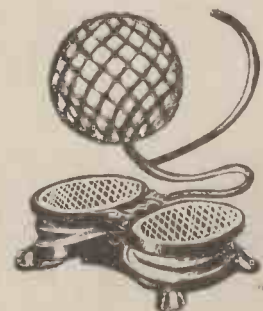

CATALOGUES ON ISSUE POST FREE :

PE	Price List for Petrol Engines ..	3d.
MM	" " for all Materials ..	3d.
SM	" " for all Model Ship Fittings ..	3d.
BT	" " for Bench Tools and Lathes ..	6d.

A HOME CINE

can be yours for only

15'9 DOWN

PATHSCOPE HOME MOVIE

(as illustrated), embodies in miniature, with the greatest simplicity, yet with the maximum of working efficiency, all the principles of professional motion-picture projectors. A perfectly clear, brilliant, flickerless picture, 3 ft. by 2 ft. 6 in. is shown at 10 ft. from the screen.

£6/15/0 9 monthly payments of 15/9

**DON'T MISS THIS
'BEST OF ALL'
WINTER HOBBIES**

Every model in stock. Generous exchanges.
CATALOGUES FREE AND POST FREE.



CITY SALE & EXCHANGE

(1929) LTD.

59 CHEAPSIDE, LONDON, E.C.2

WIRING THE HOUSE FOR ALL ELECTRIC POWER

A few years ago the wiring of the house for electric lighting was standardised by builders as an added attraction for sales, but in the present day, with the advent of the grid system of electric supply, this standard has been changed to power, and we find that houses are now wired for power at the time of building.

distribution equipment must be capable of carrying this current, and further, all main switches should be of the Ironclad type.

A list is shown below that will apply to all installations.

- LIST OF MATERIALS**

 - Mains Switch and Fuses, Ironclad Type.
 - Combined Plug Switch.
 - Wooden Mounting Blocks.
 - Cooker, Fires, Water Heater.
 - Ironclad Switch.
 - Lamp Holder, Batten Mounting Type.
 - Ironclad Switch.
 - Lamp Holder, Mounting Type.
 - Mounting Boards, Wood.
 - Distribution Box, Ironclad Type.

Wiring

Twin cable will be used throughout, with the exception of the cable from the water-heater control switch to the actual heater, and this must be triple cable to allow for heat changing which will be explained later.

Commence by wiring the main switch to the distribution box, taking a piece of

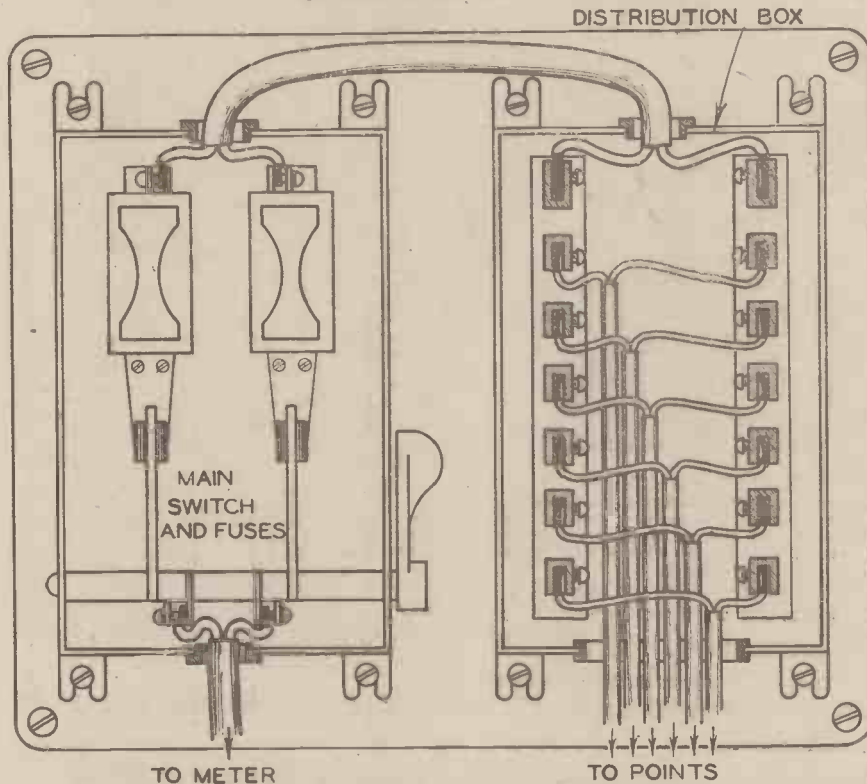

Fig. 1.—The distribution board, showing the connections to the main switch fuses and output terminal connectors.

VERY many people have, no doubt, considered the change to all-electric power, but upon obtaining an estimate for the wiring have been compelled to lay the matter aside or abandon it owing to cost. Any house with supply to hand may be brought up to the minute and in line with the latest labour-saving houses, at reasonable cost, if the person concerned is prepared to do the wiring for himself, and this may be done with safety if a careful study of this article be made and the instructions followed.

Finding the Current

Wattage divided by voltage will give the amperes passing in any circuit, whatever it may be, and by way of an example let us take the case of an electric cooker rated by the makers at 5 units (B.O.T. unit = 1,000 watts), and we will assume that the local supply is 200 volts, therefore

$$\frac{\text{watts}}{\text{volts}} = \frac{5,000}{200} = 25 \text{ amperes.}$$

A wire or cable table has been supplied showing the wire required for different

Room.	Points.	Apparatus.	Wattage.
Reception	1	Fire	2,000
Dining	1	"	2,000
Bedroom	1	"	1,000
"	2	Fire and water heater	4,000
Kitchen	1	Cooker	3,000
	6		12,000

current values, and this table will cover anything likely to be used in the ordinary household. In selecting the cable, when the current does not work out exactly to one or the other cables mentioned, always use the next size above and not below the current to be passed. The type of cable most suitable for amateur use is the tough rubber-covered kind.

The best way in which to tackle the question of installation is to wire an imaginary house. This will give an idea of the method of finding the materials needed, etc., but of course each individual will make his own list according to the particular house and the wiring to be done.

We now know that our total current will be 12,000 watts, and, assuming a supply voltage of 250 watts, by using the method given previously the total current flowing, if all apparatus be in use at one time, will be 48 amperes; it must therefore follow that the main switch and

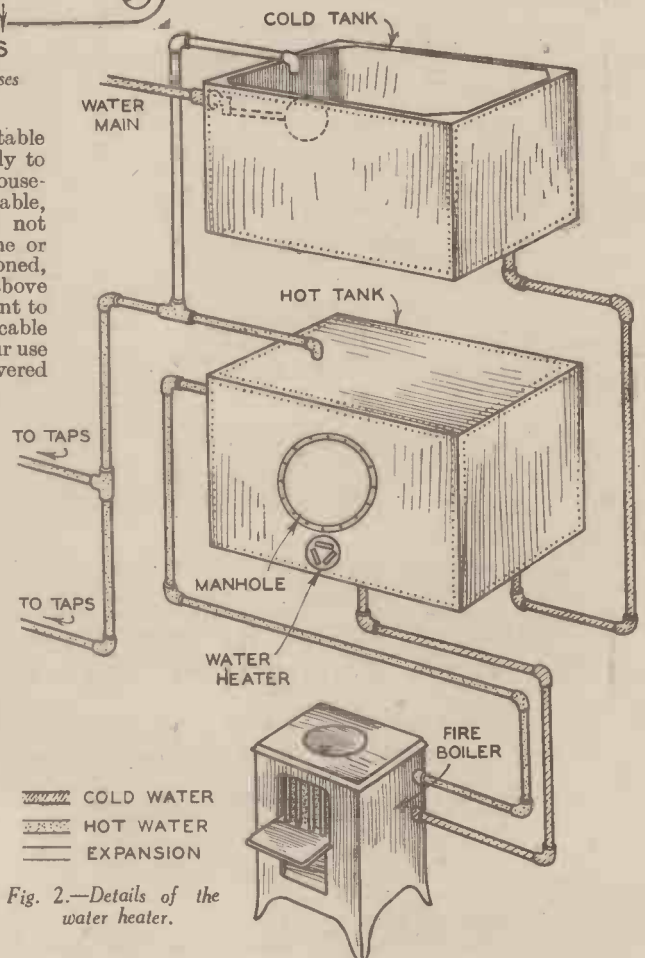

Fig. 2.—Details of the water heater.

MAKE EXTRA MONEY IN YOUR SPARE TIME!



**Finest
Sheffield
Tools**

ONLY are included in the New and Improved G.T.L. Tool Chest, making it better value than ever.

All Best British

With the New and IMPROVED **G.T.L.** TOOL CHEST AND HOME REPAIRING OUTFIT

YOUR spare time—during the present long winter evenings can be turned to good account if you've a G.T.L. Tool Chest and Home Repairing Outfit. With it you can make a thousand-and-one useful articles for your home and garden. And it opens up a new and inexpensive way of adding to the comfort, convenience, and amenities of your property, while saving you literally pounds a year in repairs for which you would otherwise have to pay. Incidentally, it also affords a new, pleasurable way of adding to your income by making articles to sell. So that—with a G.T.L. Tool Chest—instead of spending money in your leisure hours, you will be making it, saving it, and enjoying it!

NO EXPERIENCE NEEDED

A valuable FREE BOOK OF INSTRUCTION, containing over 200 working illustrations, is included in the G.T.L. Tool Chest. If you have never handled a tool, you CAN be sure of immediate success because this book tells you what to make and shows you step-by-step how to make it.

FREE
To Readers of
**PRACTICAL
MECHANICS**

A Beautiful 16-page BROCHURE describing the G.T.L. GUARANTEED TOOL CHEST and Home Repairing Outfit in detail, and telling how you can save and make money—as tens of thousands of others are already doing.

The New and Improved G.T.L. Tool Chest

The new G.T.L. Chest for 1934-35 has been vastly improved by the inclusion of additional Tools and improvements to existing ones. Now there are over fifty high-quality articles, all the finest Sheffield Tools, neatly fitted in steel clips, and they come to you direct from the manufacturers after being carefully tested. Everything for every purpose is here, and the G.T.L. Tool Chest stands alone in its quality, completeness, and arrangement. Remember, this is the original and only G.T.L. Guaranteed Tool Chest.

A FEW SHILLINGS BRINGS YOU THE G.T.L. TOOL CHEST AT ONCE ON 7 DAYS APPROVAL

A first payment of a few shillings and the G.T.L. Tool Chest is sent at once to your home. CARRIAGE PAID and packing free. The balance can be paid by small monthly sums to suit your pocket; meanwhile the G.T.L. Tool Chest is making money for you.

COUPON

TO GUARANTEED TOOLS (1933) LTD.
12-13 Chiswell St., Finsbury, London, E.C.1

Name.....

Address.....

Please send me by return, free of all cost and obligation, your beautifully illustrated booklet of the G.T.L. Guaranteed Tool Chest and Home Repairing Outfit, together with particulars of price, and how I can obtain it at once for a small first payment

(PLEASE WRITE CLEARLY. 1d. stamp is sufficient if in an unsealed envelope.)

PM/2/34

NEW ADANA HIGH-SPEED AUTOMATIC PRINTING MACHINE



PRINT XMAS CARDS & MAKE MONEY

There are only a few weeks left to Xmas, and during this time there will be a colossal demand for printed Xmas Cards. We supply cards in a variety of attractive designs at very low prices all ready for you just to print names and addresses to sell to your friends and neighbours. This opportunity of making money MUST NOT be missed—the time is limited—the profit enormous.

CASH or EASY TERMS

A Real Automatic Machine in every detail. Accurate Metal Diecastings (having a tensile strength of over 20 tons) from costly moulds have made it possible to market this fine piece of machinery at this remarkably low price. Nothing has been spared to produce a smooth-running, high-class, fast Printing Machine. The result is wonderful. No words can explain what fine adjustments can easily be made to produce a perfect print, and which, once set, is permanently maintained throughout the job, as the impression is entirely mechanical.

1,000 COPIES PER HOUR

A thousand copies per hour are easily obtainable. Any size of paper, card, or made-up cartons, etc., can be printed. It is, therefore, possible to do an unlimited number of jobs that are in everyday use. The inking mechanism is all that can be desired. Standard printer's type and blocks of all descriptions can be used as well as line, colour, register and half-tone work. Adjustable lay gauge is provided to do away with the necessity of gauge pins.

FREE with Every Machine 100-Page Book "85 Ways of Making Money with a Printing Machine."

In order to celebrate the success of the Adana Printing Machine and to provide the utmost assistance to all purchasers, it has been decided to present FREE OF CHARGE a copy of a 2/6 Book, "85 Ways of Making Money with a Printing Machine," by the well-known expert, Mr. C. A. H. Aspinall. With this book, containing over a hundred pages and fully illustrated, the owner of the small ADANA printing outfit has the key to "The Road of Success."

MONEY-MAKING POSSIBILITIES WITH THIS MACHINE ARE GREATER THAN EVER

Write at once for full illustrated Particulars and Samples of Work.

D. A. ADANA (Dept. P.M.9) 17/18 CHURCH STREET, TWICKENHAM
 London Depot: 1 Ludgate House, Fleet Street, E.C.4. Manchester: 60 Oldham Street

SIX GOOD LINES

AMAGINE TRANSFORMERS for all Cine Projectors (A.C. only). Pathe Home Movie - 25/- Pathescope 200b - 35/- Pallard Bolex, C, D, DA or PA - 35/- Pallard-Bolex G916 50/- Bell Howell 750 watt 80/-	AMAGINE TITLE BOARDS Four line with 180 letters and figures 7/6 Six line with 360 large and small letters - 12/6	AMAGINE-ADHESIVE TAPE (Transparent or Black) for 16 mm. wipe-offs, repairs, editing, etc. 5/- per 33 ft. roll with instructions. Bakelite Container and Roller 2/6
--	---	--

MASTRAL FILM CEMENT for all 16 mm. and 9.5 mm. films with brush and stopper - 1/3	MASTRAL CLEANING FLUID for films, lenses, etc., quick-drying - 1/6	MASTRAL FILM BLACK for fades and blacking-out, dense black, quick-drying - 1/-
---	--	--

ALL PRICES SUBJECT

AMATEUR CINE SERVICE
52 WIDMORE ROAD, BROMLEY, KENT. LTD.
RAVENSBORNE 1926.

MARINE STEAM ENGINES

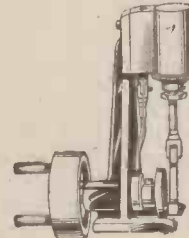

DOUBLE-ACTING PISTON VALVE
1" Bore. 3/8" Stroke.
7/6 Postage 4d.

PROPELLERS



OSCILLATING ENGINES
From 3/-

1 1/2" 8d.
2" 9d.
SHAFTS. Complete with stern tube.
Rigid .. 7" .. 11d.
Flex .. 9 3/4" .. 1/-
Post 2d.

Boilers. Steam Fittings. Accumulators.
Write for Catalogue, 2d.

F. YATES & SON LTD.,
144 Church Street, Kensington, London, W.8.

MICROSCOPES FOR ALL

SPECIAL OFFER OF 1,700 BRAND NEW STUDENTS' PORTABLE MICROSCOPES, as illustrated.

Each model has inclinable body, swing mirror, stage clips, and is nicely finished in Black Crystalline Enamel and bright Nickel Plating.

SHARP DEFINITION IS OBTAINABLE AND GOOD WORK CAN BE DONE

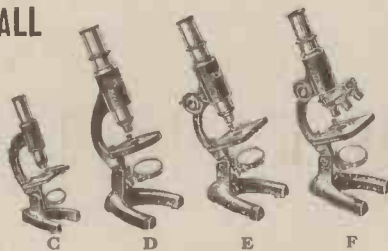

Model G. Height 5 1/2 in., sliding focus, magnification 25x linear. Price 5/-	Model D. Height 7 in., sliding focus, circular stage magnification 50x linear. Price 9/6	Model E. Height 7 in., rack and pinion focusing, magnification 50x linear, square stage. Price 12/6	Model F. Height 7 in., rack and pinion focusing, triple nose-piece, 3 lenses, magnifications 25x, 50x, 100x, in wood case, with set of Dissecting Instruments. Price 30/-
---	--	---	---

IMMEDIATE DELIVERY FROM STOCK. Post Free in Great Britain.
BROADHURST, CLARKSON & CO. 63 FARRINGTON ROAD, LONDON, E.C.1

TRADE **Grelco** MARK

MOTORS!!

In addition to our listed stock of first-class Motors we have a limited number of 1/50 h.p. B.T.H. Motors to offer Practical Mechanics readers.

SILENT RUNNING.

1/50 h.p., 2,000 r.p.m., 100-250 v., Universal A.C. or D.C. Special End Bearing enables Motor to be run either vertically or horizontally. Large Flat Pulley fitted to Spindle. Motor complete with resistance; both absolutely new, 30/- Carriage free U.K.
 Have you our latest Catalogue, 3d. post free?



"Supreme" 4 v. or 20 v. 9/6



"De-Luxe" 4-6 v. 9/6

GRAFTON ELECTRIC CO., 54 Grafton St., Tottenham Court Rd., London, W.1.

the heavy cable (in our case for 48 amperes, the wire table gives 19/052 twin) and attaching one end to the switch above the fuses; this will be at the top, and the other end to the main terminals on the distribution box. To the terminals at the bottom of the switch another piece of the same size cable is attached and one end left hanging for connection to the meter by the supply company.

All wiring from now on should be either under the floor boards where possible or concealed in corners. The usual position to mount plug switches is on the skirting board, and for a fire, near the fireplace. Run a length of suitable cable (7/044 twin) from the distributor box under the floor to the desired place—Fig. 1 will make it clear how the two wires are connected to the box, and explanation is only needed as to the plug connection.

Bring the cable at the plug end up through the floor boards and cut off, leaving enough spare to pass through the block and the back of the plug fitting. Next place the plug on the block and mark the holes with a small bradawl, being four holes in all, two for the fixing screws and two for the cable to pass through.

Cable Capacity List.		
Strands.	Size of wire.	Current capacity.
7	.044	15 amperes.
7	.064	25 "
19	.044	35 "
19	.052	60 "

An electric cooker for all ordinary purposes of explanation is the same as a fire, with the exception that the element cannot be seen and also by arrangement of switching the amount of heat can be regulated. As it is impossible to see whether the cooker is on or off, some means of visual indication is usually supplied, and this takes the form of a small lamp placed in parallel with the main switch controlling the whole of the cooker elements, so that when the main switch is on the lamp remains lighted, thus indicating that current is passing, and this, by the way, will apply to all apparatus where the elements are not seen. Heat control of all this type of apparatus is carried out by dividing the heater element into halves and using a parallel series method of switching.

Run a length of cable from the distribution box to the cooker control panel on the wall of the kitchen (in all cases the connections to the distribution point are the same for all points), and attach the other end of the twin cable to the bottom end of the cooker main switch. From the top end of the switch will be two sets of wiring; one pair of wires to the batten type lamp holder and the other pair to the terminals on the cooker. Examination of the outside frame will reveal an earthing terminal, and to this a piece of cable must be attached and taken to earth.

The Water Heater

For wiring purposes we deal with one particular type of heater manufactured by Messrs. Belling & Co., the reason being that all immersion type heaters vary somewhat, and all the heaters manufactured by this firm have the same connections whatever the wattage.

It is usual to use this kind of heater in conjunction with the existing hot-water installation, but a complete installation of electric heaters may be used, and the diagram (Fig. 2) applies to both complete and assisted systems. The assisted system is dealt with first, as this will be the

same as the new hot-water installation, with the exception that a plumber must be called in to fit the piping.

The hot-water supply tank is as a rule fitted in the airing cupboard either in the back bedroom or other convenient upstairs part of the house; it is necessary that before any fitting can be done the tank should be emptied.

Most tanks will have a round plate on one side secured either by means of bolts or a dog, and this plate must be removed to allow access to the inside of the tank. Next a hole 1 1/8 in. diameter will be needed in one side of the tank as near to the bottom as possible.

Should the tank be one of the few that are without a manhole, a special flange for outside fitting can be purchased, and the hole is then cut to suit the flange.

Remove the lock nut on the heater and push the end into the tank, but before pushing right home slide the lock nut over the end again ready for screwing into position. Before the lock nut is drawn up, steam-tight packing must be put round the inside and outside joints of the tank, and for this red lead and asbestos string will make a very good joint. To refill and test the joints turn on the main water supply and attach to a convenient cold tap a short length of hose, the other end of which must be attached to the nearest hot-water tap. Turn on both hot and cold taps, thus allowing the high-pressure cold water to drive out the air in the tank, and if all is in order the air and water will be heard rushing out of the cold tank through the pipe that usually supplies water to the hot tank. Do not attempt to go further until you are assured that the hot tank is full.

Looking at the projecting end of the heater, it will be seen that three terminals

are fitted, and these are for varying the heat. The switch at the other end will also have corresponding terminals, and for the three point connections triple cable must be used. The current for the heater will be 12 amperes, therefore triple 7/044 will be needed. The different cables will be marked in colours, so that they cannot be confused when making connections at different ends of the circuit. In the drawing of connections for the water heater, the cables have been marked, but whatever the actual colours provided, like colours are connected to the points. Connection from the distribution box to the main switch for the heater will be by twin cable, in exactly the same way as for the cooker, and the pilot lamp is also wired in exactly the same manner. The switch used for the heater control is of the non-reciprocating type, and it is usual when more than one pilot lamp is in use to arrange to have them different colours to prevent confusion over the two circuits.

When considering the size of heater to purchase, the capacity of the tank in gallons may be found in the following manner:—

Rectangular tank

$$\frac{\text{Height} \times \text{width} \times \text{depth}}{276} = \text{gallons.}$$

Cylindrical tank

$$\frac{\text{Dia.} \times \text{dia.} \times .78 \times \text{depth}}{276} = \text{gallons.}$$

The time taken to heat a tank to any given temperature may be found by the following:—

$$\frac{\text{Gallons} \times \text{temperature}}{\text{Wattage of heater} \times 5.7} = \text{time in mins.}$$

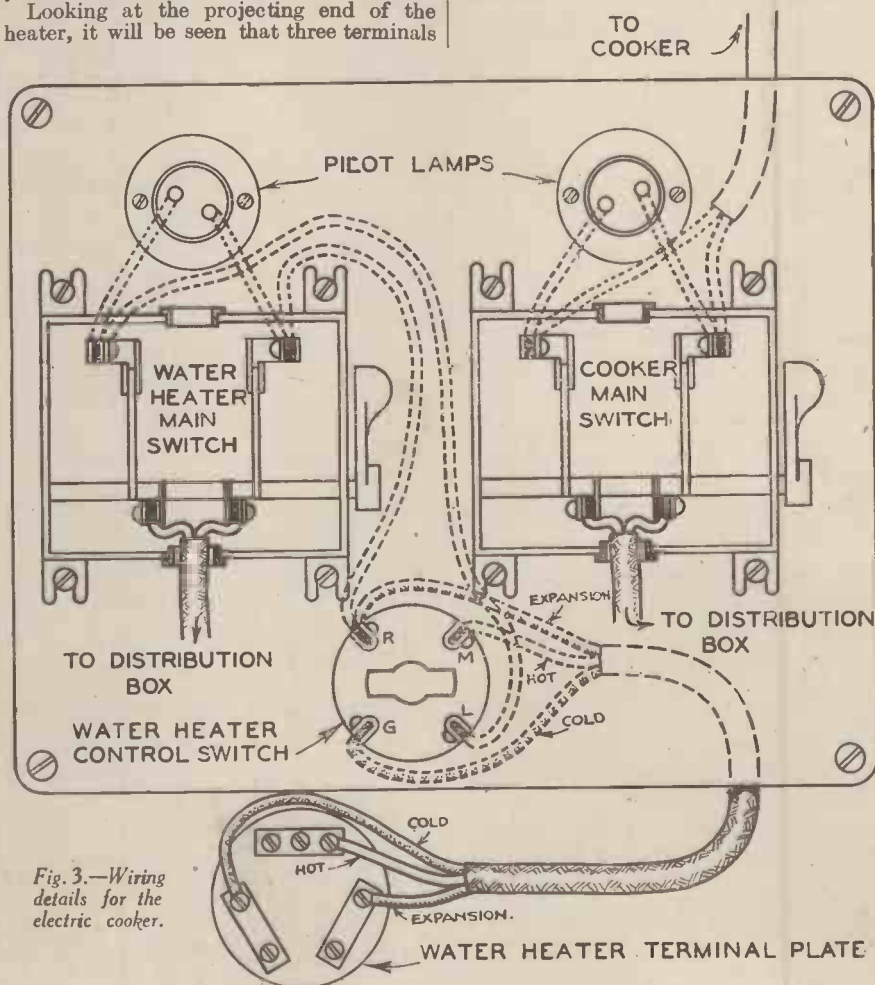

Fig. 3.—Wiring details for the electric cooker.



Fig. 1.—The parts to start upon. The body casting first, the rear cover casting second, main bearing housing casting third, and the cylinder-head casting fourth.

THE "Atom Minor" is an engine of the two-stroke type having a bore of 1 in. diameter and a stroke of $1\frac{1}{2}$ in. For those who have the facilities, complete sets of parts are available requiring, at the most, light machining operations to finish them. These parts are boxed and include the necessary castings, sufficient material of the correct section to make the small parts, all the screws and bolts and certain finished parts such as piston rings, ball races and sparking plug. Heavy machining has been rendered unnecessary by supplying such parts as the steel crankshaft in a roughed-out condition. The machining and building of this engine will in itself provide an interesting pastime, and this, coupled with the fact that when completed the engine is one that performs in an efficient manner, makes it one that is really worth while.

General Design

As previously stated, the engine is a two-stroke. A considerable saving in weight is effected by making the whole of the castings in aluminium alloy. The main or body casting forms the crankcase and cylinder casing complete with cooling fins. A channel is cored out in the wall of the cylinder casing leading from the crankcase. The cast-iron cylinder liner is finished machined with the exception of the inlet, transfer and exhaust parts, which require cutting. When the liner is assembled into the cylinder casing, the transfer-port lines up with the end of the cored channel. This arrangement solves in a simple manner the problem of

The crankshaft is of the single bearing overhung type and is machined from the solid, complete with crankpin and balance weight. This is mounted on two substantial ball races, which are housed in a casting bolted directly on to the end of the crankcase. A contact breaker is attached to the housing, and it is operated by a short tappet rod, the

of the bush is coned out and is attached to the shaft adjustably by means of a split coned nut. This is necessary for timing purposes. At the rear end the crankcase is sealed by a bossed cover plate which projects into the crankcase in order to reduce the compression space to the proper proportions. Two rings are fitted to the piston and the connecting rod is made from duralumin, machined from solid bar. The cylinder head and the parts mentioned complete the engine, with the exception of small parts such as bushes and pins.

Material and castings are also included for making the carburettor, which is one of the floatless type, and the details concerning this will be dealt with in turn.



Fig. 2.—Examine the blue-print carefully.

Machining the Castings

Commence by machining the castings forming the body, rear cover, main bearing housing and cylinder head. These parts are shown in the rough state lying apart in Fig. 1. Before starting the turning operations carefully examine the blue-print, Fig. 2, in order that the important dimensions, so far as they affect the fit-

ting together of the parts may be properly understood. It will be noticed that certain portions of the castings are machined to register into the body casting, and unless these registers fit accurately some difficulty will be found in making and maintaining proper joints between the parts.

Turning the Body

The actual turning of the body casting

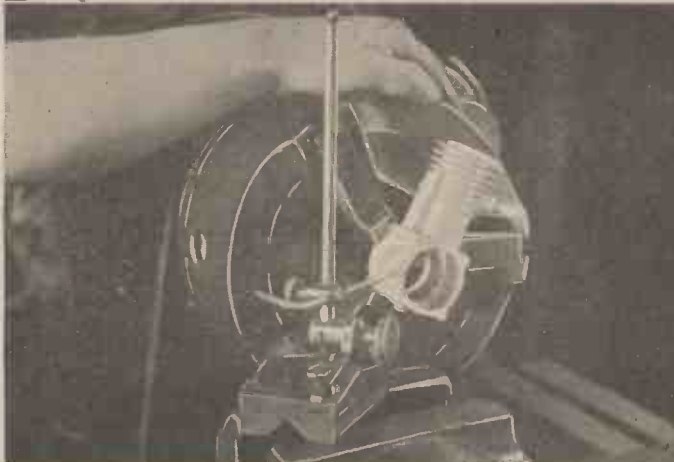

Fig. 3.—Setting up the body casting for the first operation (Part No. 1).

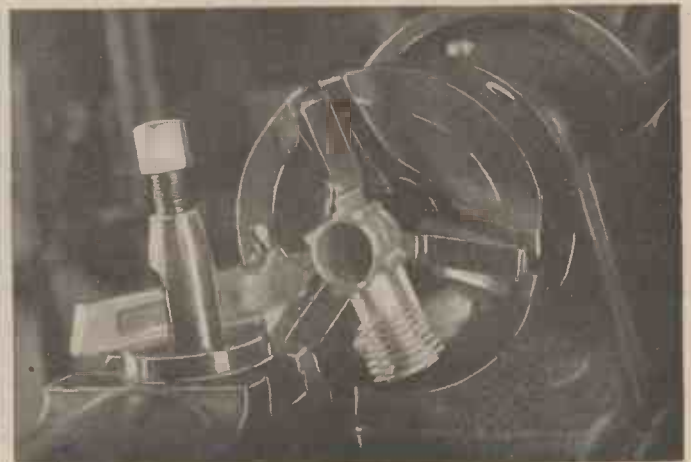

Fig. 4.—Machining the crankcase face.

MODEL TWO— ENGINE

By W. H. DELLER

aeroplanes the "Atom Minor" petrol engine is, by the of model boats or, for that matter, of any model calling but powerful unit.

consists of boring and facing both sides of the crankcase and boring and facing the cylinder casing or jacket. It will be noticed that on one side of the crankcase there is cast an extra ring of metal for chucking. Catch the casting by this portion in the 3-jaw chuck, setting the bolt bosses flush with the face of the jaws. True the casting up on the face with a scribing block or scriber held in the tool as in Fig. 3, noticing at the same time that the outside of the casting runs true. Grip the casting firmly but not so hard as to spring it, or distortion will result when the work is released after machining. For this reason it will be best to use the "ring jaws" when a "Cushman" type chuck is used. This will allow the jaws to make contact with a larger area on the outside of the casting and therefore less pressure will be required to hold the casting properly.

Face the front of the casting slightly below the surface of the cylinder jacket, as in Fig. 4. The finished surface should be smooth and flat. This is best accomplished by leaving it as finished by the tool. Stone the slightly rounded nosed tool before taking the finishing cut with a fine feed, and a little paraffin as a lubricant will assist in obtaining a good finish.

The next step is to bore the hole right through to $1\frac{1}{8}$ in. diameter, as in Fig. 5. Here again a good finish is essential, as a close fit between this hole and the parts fitting into it will help to a very great extent

in making tight joints. It is also advisable to bore the diameter as close as possible to the dimension given, there being only $\frac{1}{4}$ in. clearance all round between the sides of this hole and the outside of the crank web. This portion now requires facing down on the opposite side to within $1\frac{1}{4}$ in. of the first machined face. The faces when finished should be exactly parallel, and although the chuck jaws can be expanded into the finished bore it will be safer to turn a hard-

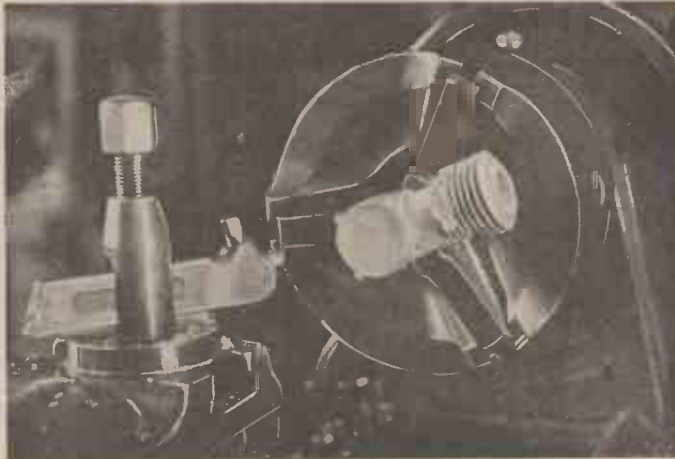

Fig. 6.—The crankcase mounted on a turned peg for finishing second crankcase face.

wood or metal peg upon which to hold the casting, as in Fig. 6. By adopting this method the faces must come out parallel, also the risk of distortion will be eliminated. If a metal plug is made, see that it is smoothly finished and that the crankcase is only a good "push-fit" on to it. To finish the face to size it is necessary to go slightly

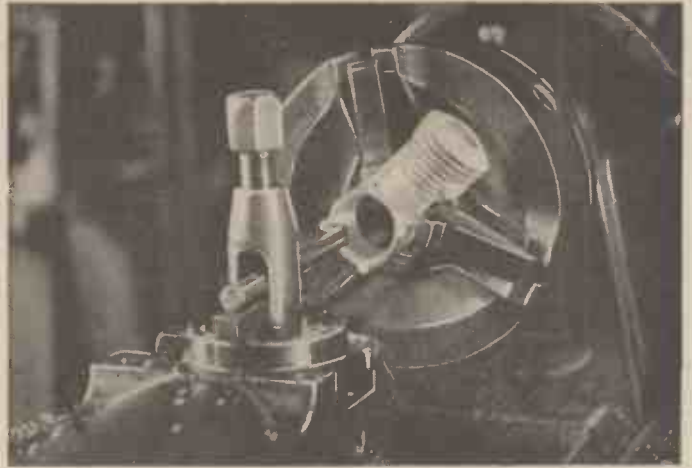

Fig. 5.—Boring the crankcase.

below the wall of the cylinder casing on this side also, as in Fig. 7.

Before removing the partly machined casting from the peg the carburettor flange seating can also be faced. To bore the cylinder casing for the liner the casting will have to be mounted on an angle bracket, and, therefore, while the chuck is still on the rear cover and bearing housing can be dealt with.

The Rear Cover

The rear cover, part No. 2, is chucked as shown in Fig. 8, and a light facing cut taken over the front face. Bore out the recess to $1\frac{1}{8}$ in. diameter for a depth of $\frac{1}{2}$ in. These sizes are not important, but should be worked to as closely as possible. The pitch circle diameter of 2 in. for the bolt holes may also be lightly scribed on the lugs with a point of a fine screw-cutting tool before removal from the chuck. To finish the casting on the reverse side, the chuck jaws can be expanded into the recess, or the peg, if one has been turned, can be reduced in diameter, but first file a flat along the top of the peg to allow the air to escape before pushing the casting on to it.

Turn the top of the casting to $1\frac{1}{8}$ in. diameter, leaving the lugs $\frac{1}{2}$ in. in thickness. Turn the $\frac{1}{8}$ -in. diameter boss and face back to the sizes given. The important diameter is the $1\frac{1}{8}$ in. one. This must be made so that it is a good "push-fit" into the bore of the crankcase. See also that the corner is machined out square and clean to allow the faces to pull down close when bolted up.

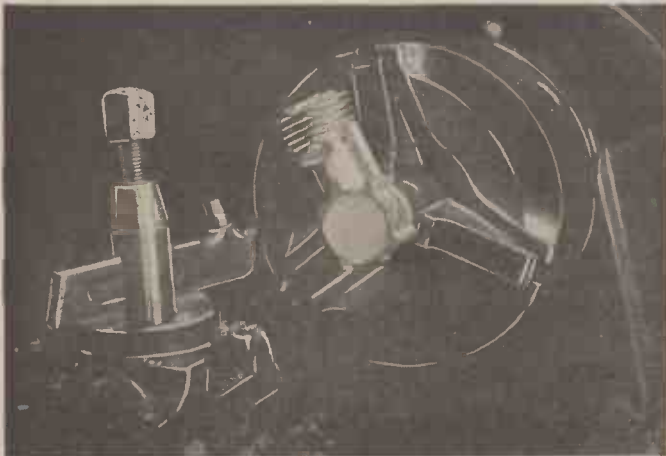

Fig. 7.—The second face finished parallel to the first one. Note that the machining cuts slightly into the cylinder wall on both sides.



Fig. 8.—Facing and skimming out the inside of the rear cover (Part No. 2).

Boring and turning the Bearing Housing

Next bore and turn the main bearing housing, part No. 3. This part is also cast with an extension on one end for chucking. This is held and trued up against the nose of the tool, as shown in Fig. 9. Make sure before starting that the casting is firmly held in the chuck. Rough face the front and bore out the cored hole right through

the part at this stage. Note the ball-race fitted as a plug gauge lying against the tool-post. The casting is now faced back at the opposite end to a length of $1\frac{1}{2}$ in. overall.

Finishing the Cylinder Casing

Having arrived at this stage, the cylinder casing may be finished to receive the liner.

enters. The job is shown in Fig. 12 at this stage. Do not attempt to force the liner in yet, as there is further work required on both the casting and the liner before this is done.

It must be remembered that once the liner is in place in the cylinder it cannot be removed, so do not be tempted to try it in the cylinder. The ports which ensure the

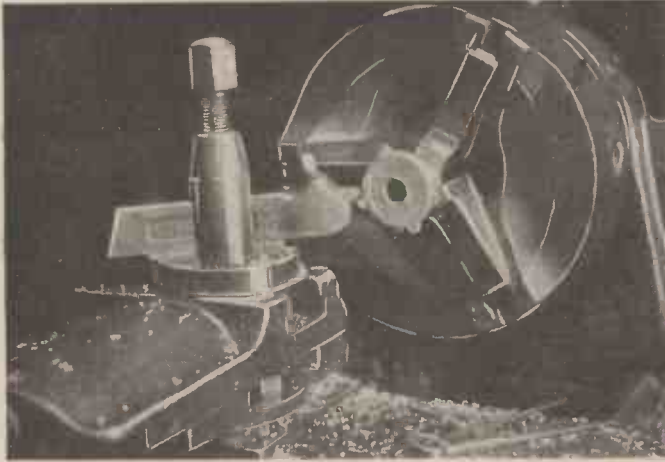

Fig. 9.—Setting up the main bearing housing (Part No. 3).



Fig. 10.—The finished main bearing housing bored and turned at one end. Note the ball race fitted with a temporary handle, lying against the tool post, for use as a plug gauge.

to $\frac{1}{8}$ in. diameter. If a reamer of this size is available it may be conveniently employed for finishing, as the bore of the hole must be smooth, otherwise a small flat can be stoned on the nose of the tool before taking the final cut.

Now turn the register to $1\frac{1}{8}$ in. diameter to fit into the crankcase exactly the same as the rear cover, turning back to leave the lugs $\frac{1}{2}$ in. in thickness. The corner again needs to be sharp and the face finished square with the turning. Before boring the holes to receive the ball-races, temporary handles fitted to the races to enable them to be used as plug-gauges will greatly facilitate the process. An easy way to do this is to pass a suitable cheese-head screw through each race, with a washer under the head if

Fig. 11 shows the set-up. Set the top face of the angle-plate exactly $\frac{1}{8}$ in. below the centre of the face plate. Use a large substantial flat washer under the head of the holding-down nut to prevent damaging the machined face of the crankcase. Before bolting the casting down, scribe a line accurately above the fins at a distance up from the centre of the $1\frac{1}{8}$ -in. diameter bored hole of $3\frac{1}{2}$ in. or alternatively $2\frac{1}{2}$ in. from the top of the hole. This will give an indication of the amount to be faced off, it being impossible to make such a measurement once the casting is fixed to the angle plate.

Carefully true up the casting, so that it runs true all along (this is important on account of the cored slots in the bore) and

transfer of the gas to the crankcase at the appropriate moment, and the escape of the exhaust gas, as well as the inlet of petrol-and-air mixture from the carburetter, have yet to be cut. These need to be very care-

READY SHORTLY!

POWER-DRIVEN MODEL AIRCRAFT

By F. J. CAMM

1/-, or 1/2 by post from Geo. Newnes, Ltd.
8-11 Southampton Street, Strand, W.C.2

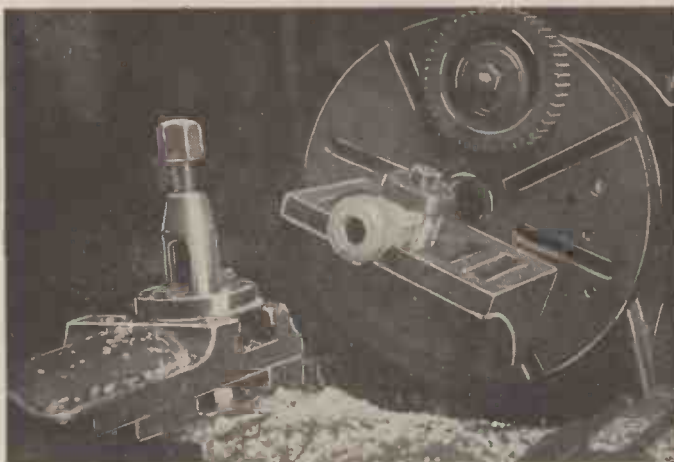

Fig. 11.—The set-up for boring the body to receive the cylinder liner.

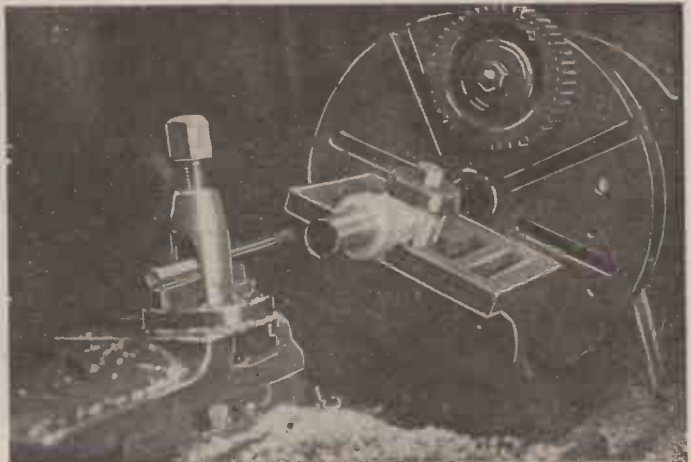

Fig. 12.—The body bored and faced with the liner entered.

necessary, and to secure the race with a nut. Bore the hole for the smallest race $\frac{1}{8}$ in. in diameter exactly 1 in. deep from the front face after it has been machined, the hole finishing with a square shoulder. The ball-race must be a tight "push-fit" in the bore of the hole. Counter-bore the front of this hole for a depth of $\frac{1}{2}$ in. to receive the $\frac{1}{8}$ -in. diameter race. Fig. 10 shows

attach a balance weight to the face plate. Bore a smooth hole with a diameter of 1 in. right through into the crankcase to correspond with the hole in the liner. Face off the front to the line made thereon and rebore, to a depth $2\frac{1}{8}$ in. from this face. See that this hole is clean, and finish at the bottom with a square corner, the size being such that the liner just

fully marked off, and instructions regarding this will be given next month. In the meantime, study the blue print and fix in your mind the positions of the various ports. The carburetter, transfer and exhaust ports are disposed at 90 degrees to one another and in a certain order. It is quite easy to spoil the liner by cutting the ports in the wrong positions.

RE-WINDING AN ARMATURE

THE successful re-winding of an armature depends on an even distribution of the turns.

The amount of wire in each slot should be exactly the same, so that an even current is produced and a perfectly even mechanical balance is obtained. The armature dealt with in this article has twelve slots and twelve segments as shown in Fig. 1. First make a wooden stand from three pieces of wood (Fig. 2) on which to mount the armature. See that it revolves freely.

The inside dimensions of the stand can be obtained by measuring the distance

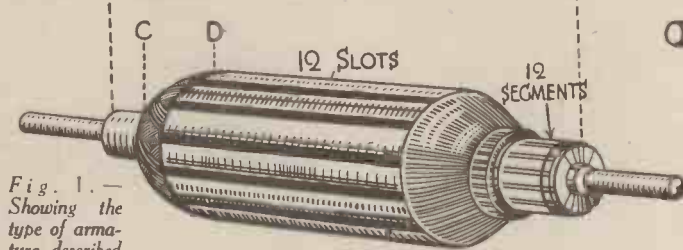

Fig. 1.—Showing the type of armature described in the text. As will be seen, it has twelve slots and twelve segments.

armature (see Fig. 1); the distance between C and D is the back-end of the winding. Count the slots and segments, and note where the top coil starts and finishes, which will give the coil span. The span of the armature described is 1 and 6—that is, it starts in No. 1 slot and finishes in No. 6.

Dismantling the Old Windings

Remove the top coil at the back of the armature and count the number of wires in the coil. Dismantle the old wire, insulation and remove the stray wires attached to the commutator. Run a three-cornered file along the mica which separates the copper bars on the commutator, and then cut a small nick on the riser of each commutator bar in readiness to receive the new wires when the armature is wound. Test the commutator with a lamp in series, both for short circuits and also leakage to the spindle.

The Winding Process

Insulate the spindle between the commutator and laminations and also the spindle at the back of the armature ($\frac{1}{2}$ in. more than the back end of the winding) as shown in Fig. 1, C and D. Empire cloth should be used for the insulation, but paper is sufficient where the voltage is not more

SIMPLIFYING A DIFFICULT JOB

than 50 volts. The papers for the slots should be cut so that they overlap about $\frac{1}{8}$ in. at the ends of the armature, leaving about $\frac{1}{2}$ in. to spare at the top of the slot. To commence re-winding make a knot in the wire, allowing about 2 in. for connections to the commutator. This is placed in slot No. 2, with the knot at the back end of

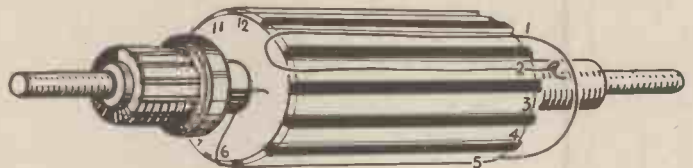

Fig. 3.—The commencement of the re-winding process.

the slot as shown in Fig. 3. Thread the wire into slot No. 1 and wind in a clockwise direction to slot No. 6.

Keep a gentle strain on the wire as you are winding, and when twenty-five turns are wound on, twist the starting and finishing ends together and cut. Push the twisted

IN BRIEF

TEST EACH COIL FOR SHORT-CIRCUITS AFTER RE-WINDING
KEEP A GENTLE STRAIN ON THE WIRE WHEN WINDING THE COILS

ends into slot No. 2 so that they are out of the way, place papers in slots Nos. 12 and 5 and wind another twenty-five turns.

The winding sequence will then be: 1-6; 12-5; 11-4; 10-3; 9-2; 8-1; 7-12; 6-11; 5-10; 4-9; 3-8; and finally 2-7. Carefully pack the wires and insulating papers into the slots with a flat piece of fibre sheet, and slide a small piece of thin fibre sheet into each slot, so as to prevent the coils from throwing out when revolving.

These coils will now have to be tested to make sure that there are no short circuits between them.

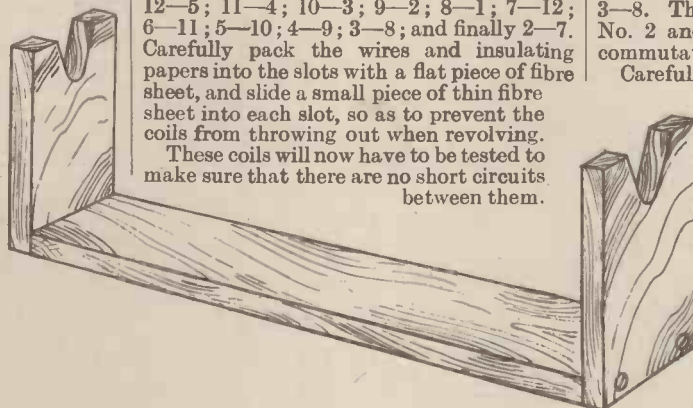

Fig. 2.—(Left) Details of the wooden stand on which the armature is mounted ready for re-winding.

Lift the twelve twisted ends and bare them for about $\frac{1}{2}$ in. Arrange these ends so that they are clear of the armature, join them together with a very fine fuse wire (see Fig. 4) and test each coil by cutting the fuse wire and placing a lamp in series.

Short Circuits

Assuming that the first coil is corrected, cut the second and test, and so on all round the armature.

Should your lamp light whilst making this

test, then the coil which is being tested is making electrical contact with another coil. This will have to be located before the work can proceed.

The commutation point must now be found. The field coils and brush boxes on most small motors are generally fixed.

In the case of the motor, which generally is being re-wound, the brush boxes are at right angles to the field coils (see Fig. 5). Therefore, find two of the coils on the armature which are not cutting lines of force and place the ends of these coils on to the commutator bars, which are under the brushes, as shown in Fig. 6. In this case, coils 1-6 and 7-12 are not cutting lines of force and therefore the ends of these coils are brought under the brushes.

Finishing the Re-winding

Take the knotted end of coil 1-6 and bend it back out of the way; then twist the finishing end of coil 1-6 to the knotted end of coil 2-7. Clean the ends and place them on to segment No. 1 and the finishing end of coil 2-7 to the starting end of coil 3-8. They are then placed on to segment No. 2 and so on round the coils until the commutator is filled.

Carefully solder up and turn the commutator on a lathe. It is then dipped in baking varnish or shellac and baked in an oven until the varnish is hard. Clean the surplus varnish from the armature and test. The armature should now revolve.

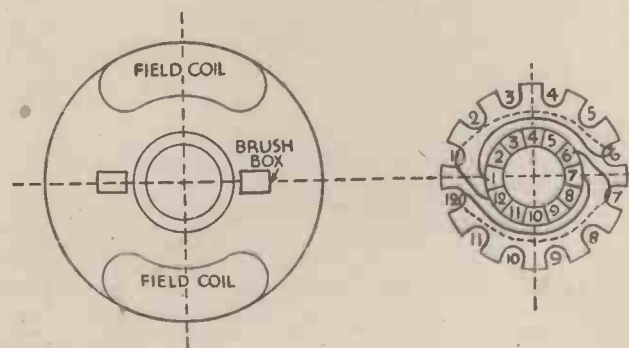

Figs. 5 and 6.—(Left) The diagrammatic arrangement of the brush boxes and field coils, and (right) how to test each coil separately.

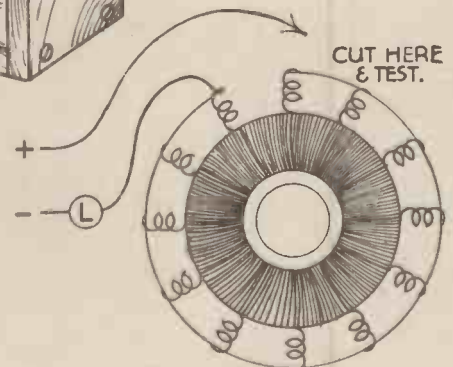

MODERN METHODS OF ILLUMINATION

THERE are few better manifestations of the progress made in electric lighting than that given by the Lighting Service Bureau at Savoy Hill. Here are set forth in a contemporary setting demonstrations of the part played by lighting in every sphere of present-day activity. But though the demonstrations are all of them interesting, and many of them spectacular, the chief impression that one takes away

Dealing with the improved methods used in the illumination of houses, theatres, shops, etc.

ten different ways of lighting the studio, each one a practical system that can be applied in shops, houses, theatres, etc.



The up-to-date method of illuminating an aircraft factory.

after a visit there is one of patient, never-ceasing research and investigation being carried on by the lighting firms so that they may achieve still further improvements in their lamps and in the uses to which they are put.

It is just this constant research which marks off the manufacturers who maintain the Bureau from other purely "commercial" lamp-manufacturing enterprises. These firms, of which there are six, namely, Cosmos, Cryselco, Ediswan, Mazda, Osram and Siemens, spend between them huge sums every year on research and testing. Each firm, moreover, makes its lamps to the same rigid and exacting specification, so that each one of these six brands reaches a uniform standard of excellence. Every lamp turned out by these firms is just as good as the pooling of their resources and skill can make it.

The Architectural Lighting Room

In this room experiments are carried out by designers and architects with the various lighting systems, and there are no less than

DO YOU KNOW THAT—

The pupil of the eye becomes small with age—consequently elderly people need more light.

Sewing is generally much harder on the eyes than reading—therefore much more light is needed.

It takes three times as much light to read a newspaper with the same ease as it does a well-printed book.

Reading with the page brilliantly illuminated and the rest of the room comparatively dark often causes unnecessary eyestrain and fatigue. Let some light go to the ceiling.

Light acts as "magnifier" of small details. An object must be twice as large to be visible under 1 foot-candle as it would have to be under 300 foot-candles.

From the ceiling a suspended trough provides indirect illumination from 1,200 watts. The illumination, 3 ft. from

the ground, is 20 foot-candles. In a second system the illumination is obtained from four lighting features positioned on the sides of the recessed ceiling. Vertical coves on the fittings conceal the lamps and light up the main vertical curved faces of the fitting. Yet another means of lighting the room is provided by a cornice arranged at the head of a succession of vertical planes projecting from the surface of the wall.

Bracket Reflectors

A green semi-translucent medium round the rim of a reflector adds a touch of colour while screening direct view of the lamp. Other systems include lighting from horizontal bands, luminous panels, architectural lamps and an illuminated chain frieze. The above demonstrations show how light can be used as an important element in architectural design and show new principles in lighting which, with a little imagination, can be applied universally. Over half a million homes in Great Britain are re-lighted annually due to electricity being installed and to redecoration made possible by the flexibility of modern electric lighting systems. Coloured lamps behind the window pelmet will flood the curtains when switched on at night, and greatly add to the general appearance of a room. An alcove in the wall may be flooded with softly coloured light by means of lamps fixed behind a panel of obscured glass. Mantelpieces can be fitted with glass tops illuminated from below, thus lighting objects placed on the glass shelf. Local lighting for bookshelves, china cabinets and pictures helps to give a room an air of distinction.

Unsuspected beauty can be revealed in the smallest garden by the use of a few simple flood lights concealed at convenient points or by coloured lamps. Illuminated fittings can also be treated in the same way. The effect obtained by flood lighting can be gathered by a glance at the two photographs shown below. The new architectural lamps can now be obtained in a large variety of lengths and colours, and are particularly useful from a decorative point of view as they reveal the beauty often obscured by shadows.



These two photographs show the clever effect obtained by placing a number of 60-watt bulbs at various points of a garden. The illumination of the garden costs 5d. an hour.



The LATEST Novelties

The address of the makers of any device described below will be sent on application to the Editor, PRACTICAL MECHANICS 8-11, Southampton St., Strand, W.C. 2. Quote number at end of paragraph.

A New Two-Reflector Lamp

THE electric lamp shown on this page, whilst incorporating a number of novel features, is also fitted with two reflectors which provide two light sources: one a sharp, penetrating spot beam of 800 ft., the other a brilliant broad, spread light. Both lights operate from a simple double-action switch, and by pushing the switch to the right you obtain the spot beam, and to the left the broad, spread light. This lamp will give forty-five hours of continuous light, but used intermittently for portable lantern purposes, it has a life of 80 to 100 hours at a battery cost of less than $\frac{1}{2}$ d. per hour. It operates from a 6-volt lantern battery, and as can be seen from the illustration, it is fitted with an adjustable handle. It sells at 17s. 6d., complete with batteries. [86.]

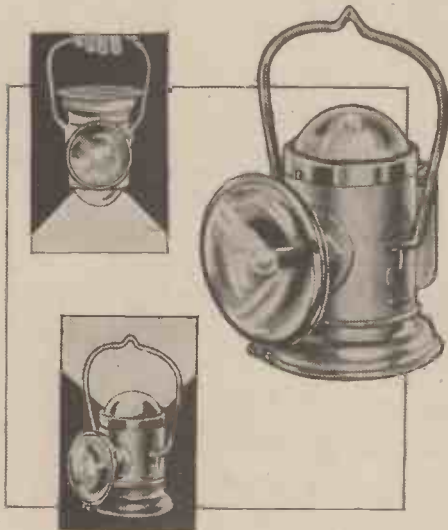

Details of the two-reflector lamp.

New Clix Plug Adapter

MAINS apparatus is generally fitted with a mains connecting plug, which may take the form of either a two-pin plug or a bayonet-socket plug, and as the average home is usually fitted with both power sockets and lamp holders, it sometimes becomes convenient if the apparatus can be inserted into either type of connection at will. There are already on the market some interesting types of adapter which permit of apparatus to be used with both types of socket, and illustrated on this page is shown a new form of adapter now on the market. It is moulded in bakelite of substantial thickness and consists of a hollow "cowl" through which the connecting flex is passed, to which is fitted an internal thread. Screwing into this section is another moulded portion, which has two pins on one end and an ordinary lamp socket on the other, the mains leads being joined to small terminals situated in the centre of this part of the complete adapter. It will thus be

seen that the two portions may be screwed together to enable either end to project, whilst the attachment of the lead to the reversible portion prevents this from being lost. It costs 1s. 3d., postage extra. [87.]



A universal two-way plug adapter.

A Detachable Table for a Car

THE drawing below shows a neat and convenient little table which can readily be fixed to the side of the car. The table itself has a pivot which fits on to the small bracket screwed to the car body. The table itself can be obtained in a variety of finishes, including black, mahogany and mottled. The bracket is chromium-plated, and is attached by means of two wood screws. It costs 2s. 6d., plus postage. [88.]

A Novel Door Silencer

THE simple fitting shown herewith is intended to prevent door-rattling, which often proves annoying to the householder.

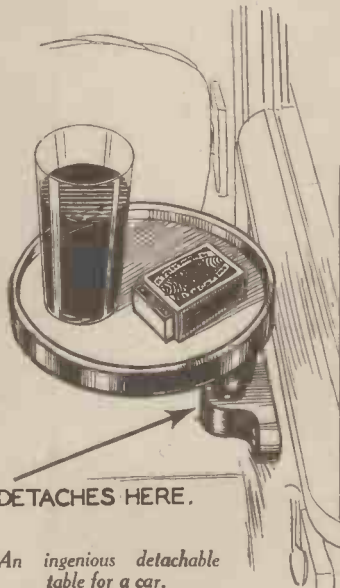

DETACHES HERE.

An ingenious detachable table for a car.

INFERIORITY COMPLEX GONE FOR EVER

"CAN'T HAS SLIPPED OUT OF MY VOCABULARY,"—WRITES A STUDENT OF PELMANISM

"That great handicap, Inferiorty Complex, has gone for ever. 'Can't' has just slipped out of my vocabulary. The Course has broadened my mind more than five years of life could have done. I have been able to distinguish the hollow things of life and—pushing them into the background—have discovered what a really wonderful world this is."

(Pelman Student: E.36063)

This remarkable letter, received at the Pelman Institute, will carry a message of hope to thousands of readers who are cursed with Diffidence, Shyness, Timidity, Self-Depreciation, Lack of Self-Confidence, Lack of Social Courage, Fear of Failure, Fear of the Future, Fear of Taking Responsibility, Fear of doing something unusual or out of the way. "The Inferiorty Complex" is one of the greatest handicaps that can burden any man or woman to-day.

Fears Banished and Self-Confidence Developed

Pelmanism cures mental defects. Here are a few reports taken at random from the tens of thousands of similar statements:—

- "Cured Fear."—"Pelmanism has cured the fear of self and of failure to keep pace with my colleagues." Pelman Student (T.37110)
- "Strengthened my Will."—"It has given me a more cheerful outlook, strengthened my Will and helped me to overcome a timid disposition." Pelman Student (M.34208)
- "Inferiorty Complex is Dead."—"I have rid myself of all fears of the future." Pelman Student (T.36007)
- The inferiorty complex is dead." Pelman Student (L.34224)
- "Given me Self-Confidence."—"It has given me Will-Power and Self-Confidence and trained my Imagination." Pelman Student (F.36143)
- "Personality has Developed."—"I have lost nervous fears. I am more self-confident. My personality has developed, and I have gained a lot in knowledge." Pelman Student (T.36007)

Pelmanism is taught through the post and is practised by the student in his or her own time and place. It is fully described in a book entitled "The Science of Success." We shall be glad to send you a copy of "The Science of Success," 48 pages, post free.

Address: The Secretary,

The Pelman Institute
130 PELMAN HOUSE, BLOOMSBURY ST.,
LONDON, W.C.1.]

Pelman (Overseas) Institutes: Paris, 80 Boulevard Haussmann. NEW YORK, 277 North Avenue, New Rochelle. MELBOURNE, 396 Flinders Lane. DURBAN, Natal Bank Chambers. DELHI, 10 Alipore Road. CALCUTTA, 102 Clive Street. AMSTERDAM, Leliegracht 30 JAVA, Kromhoutweg 8, Bandung.

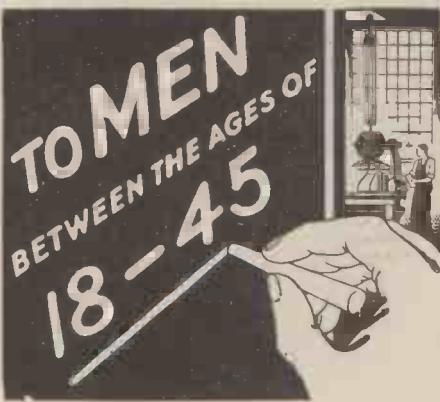

Things are happening to-day which vitally affect you!

If you are about 18, perhaps you are getting settled in your chosen work and already feeling the strain of competition for a better position. If you are in the 40's, your family responsibilities are near the peak, the necessity for money is tense—and younger men are challenging your job. And men of the ages between 18 and 45 face similar problems, in one form or another.

The most valuable employment security to-day is the security a man creates for himself—in himself! Through training, he is able to adapt himself to new conditions, to utilise experience without being handicapped by habit! He masters jobs and makes new jobs. He meets emergencies—and is not overwhelmed by them. And this is an age of emergencies.

For 43 years the International Correspondence Schools have helped thoughtful and ambitious men to acquire the training they need. To-day with this need more urgent than ever, this world-famous institution offers greater opportunities than ever. Why not permit us to show you the way to greater security and larger earnings? Our expert advice is free. Write to-day.

COUPON FOR FREE BOOKLET...

INTERNATIONAL CORRESPONDENCE SCHOOLS, LTD.,
Dept. 95, International Buildings, Kingsway, London, W.C.2

Please send me your booklet containing full particulars of the Course of Correspondence Training before which I have marked X. I assume no obligation.

- | | |
|---|--|
| <input type="checkbox"/> Accountancy | <input type="checkbox"/> Marine Engineering |
| <input type="checkbox"/> Advertising | <input type="checkbox"/> Mechanical Engineering |
| <input type="checkbox"/> Aeronautical Engineering | <input type="checkbox"/> Mining Engineering |
| <input type="checkbox"/> Architecture | <input type="checkbox"/> Motor Engineering |
| <input type="checkbox"/> Bookkeeping | <input type="checkbox"/> Plumbing |
| <input type="checkbox"/> Building | <input type="checkbox"/> Radio |
| <input type="checkbox"/> Chemical Engineering | <input type="checkbox"/> Railway Equipment and Running |
| <input type="checkbox"/> Civil Engineering | <input type="checkbox"/> Salesmanship |
| <input type="checkbox"/> Draftsmanship | <input type="checkbox"/> Steam Engineering |
| <input type="checkbox"/> Electrical Engineering | <input type="checkbox"/> Textiles |
| <input type="checkbox"/> Engineering Design | <input type="checkbox"/> Woodworking |

Examinations, state which.....

The I.C.S. teach wherever the post reaches, and have a wide variety of courses of Study. If, therefore, your subject is not in the above list, write it here.

.....
Name..... Age.....
Address.....

The silencer consists of a small rubber buffer moulded from high-grade rubber, and it is simply fitted between the door and the door pillar by means of a single screw as shown. These devices may also be used as pneumatic cabinet feet for wireless sets, "golf tees," etc., and they are also very useful for preventing doors slamming. They are priced at 3d. each. [89.]

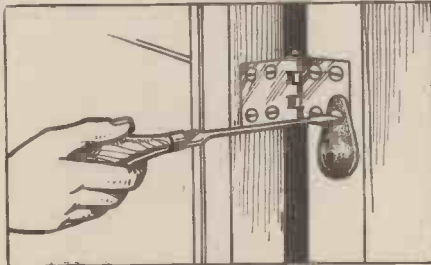

The method of fixing the door silencer to a door.

A Combined Ash Tray and Cigarette Holder

THE average smoker if careless flicks the ash from his cigarette on to the floor or in the fireplace; in fact anywhere but in an ash tray. If you are one of the many offenders, a combined ash-tray and cigarette holder which is now on the market should certainly appeal to you. It will be found ideal for smokers whilst reading or relaxing. The tray will catch the ash, irrespective of the position of the holder, its upright position being maintained by gravity, and it will be found almost impossible to upset. The "Relax," as it is called, is both light and strong, and is provided with a small stand. The tray is of polished aluminium and the support and stand stainless steel. The mouthpiece is made in black, blue, red and amber, and the cigarette holder complete costs 1s. 9d. post free. [90.]

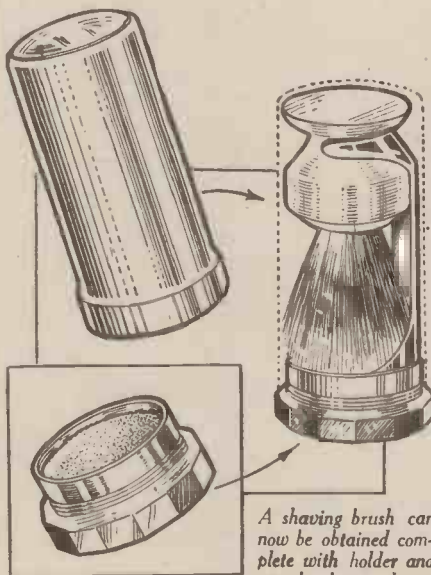

A shaving brush can now be obtained complete with holder and absorbent pad.

A Simple Shaving-Brush Stand

IT is now possible to obtain a shaving brush complete with stand similar to that shown in the sketch. The brush is sold in an attractive bakelite case, into which the stand is screwed. Fitted in the cap of the stand is an absorbent pad which prevents any leakage of moisture. It costs 3s. 6d. [91.]

1935 EDDYSTONE SHORT WAVE MANUAL



Fully illustrated with constructional details for building Battery and Mains S.W. Receivers, 6v. S.W. Super-het with A.V.C. All Wave Wavemeter, 5-metre Receiver Simple 5-metre Transmitter, Crossfeeder Aerial System, Battery and Mains S.W. Converters, Amateur Bands Receiver, 100 watt Transmitter Eliminators, etc

COMPILED BY THE LEADING SHORT WAVE SPECIALISTS

PRICE 1/6

Obtainable from your radio dealer, W. H. Smith, or in case of difficulty, direct from STRATTON & CO. LTD. (Dept. 25), Broomsgrove Street, Birmingham. London Service Dept. — Webb's, 14 Soho Street, W.1

WHY BE THIN?

BUILD UP YOUR BODY AGAINST ILLNESS AND DISEASE. DON'T HIDE YOUR BONES UNDER AN OVERCOAT!

Thousands have put on weight and muscular tissue with the aid of

VITAEPON (THE ENEMY OF) THINNESS

A customer writes:—"After my illness I gained 15 lb. in weight, and my nerves improved tremendously as the result of a six weeks' course of Vitaepon."

Vitaepon is not a drug—simply take two tablets with the morning and evening meal.

Obtainable only from:—

WESTGOTT & CO. (Dept. P.), 37 Albemarle Street, Piccadilly, London, W.1.

For Week's Trial Supply send P.O. for 3/- or 15/- for full six weeks' course. Abroad by registered post, 3/6 and 16/-, post free. Sent in plain covers.

A new book, entitled "Thinness: Its Cause and Cure" sent free with every six weeks' course.



THIS COMBINED ASH-TRAY AND CIGARETTE HOLDER will be found ideal for smokers while reading or relaxing. The tray will catch ash irrespective of the position of the holder, its upright position being maintained by gravity, and it will be found almost impossible to upset. The "RELAX" is both light and strong, and is provided with a small stand as shown. The tray is polished aluminium and the support and stand stainless steel. The mouthpiece is made in Black, Blue, Red and Amber.

Sole Manufacturers: **BRYANT BROS.,** PRICE 1/9
Perseverance Works, 2a Brighton Road, LONDON, E.6 Post Free



BE A MAN

I positively GUARANTEE to give you Robust Health, Doubled Strength and 10-25" more muscle in 30 days or return your money in full. The famous STEBBING 4-in-1 Course consists of four great courses in one, yet costs only 5/- post free. It has been proved (1) The most effective HEALTH and ENERGY System ever devised; (2) It quickly builds NORMAL WEIGHT and VIRILE MANHOOD; (3) It develops a Strong Will, rigid SELF-CONTROL; and (4) It includes an amazing SUCCESS and PERSONAL MAGNETISM Course. Complete Course, 5/-

No extras, no appliances to Pupil S. Davey (London) purchase.

Further details sent privately, under plain, sealed cover. **LIONEL STEBBING, STEBBING INSTITUTE,** Dept. C.P., 28 Dean Road, London, N.W.2.

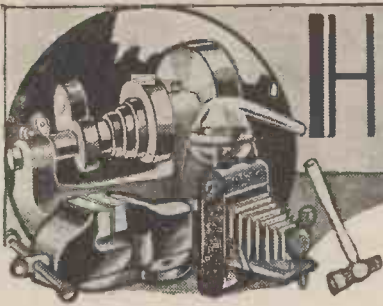

Hints about Hobbies

THAT HINT OF YOURS
 Every reader of PRACTICAL MECHANICS must have originated some little dodge which would be of interest to other readers. Why not pass it on to us? For every item published on this page we will pay 5s. Address your envelope to "Hint," PRACTICAL MECHANICS, George Newnes Ltd., 8-11 Southampton Street, W.C. Put your name and address on every item. Please note that every hint sent in must be original. No other correspondence whatever should be included.

A Novel Grease-gun

THIS little grease-gun is made from the barrel of a discarded propelling pencil, and will have numerous uses in the home workshop. It is extremely handy for greasing small machinery, and for use in awkward places.

Any standard pencil will do—metal or vulcanite—and from this the mechanism is removed, leaving the plain barrel. The plunger is a short length of stout wire or

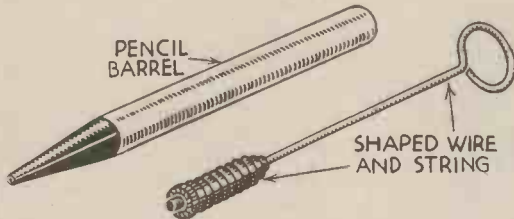

Details of the grease-gun made from an ordinary propelling pencil.

cycle-spoke, suitably looped at one end and with a soft string wound around the other. The wire is nicked to prevent the string slipping. It should nicely fit in the barrel.

To use, place a small quantity of grease in the barrel, insert the plunger, then push as required.—F. G. (Salop).

Your Watch as a Compass

IF you have a watch with the correct time, place it on your hand with the hour hand pointing towards the sun. Half-way between this and twelve o'clock draw an imaginary radius; this will be pointing due south, and will thus provide a simple substitute for a compass.

An Electric Gas Lighter

OBTAIN a discarded element from an electric iron (repair it if broken), attach a pair of flexible leads and immerse in a jar of water. One lead is plugged into the line side of a plug (A.C. only), the other being attached to a piece of $\frac{1}{8}$ in. brass rod set in an old file handle. Turn on the gas and draw the brass across the burner. On

breaking contact a "hefty" flash will ignite the gas. This idea will save a lot of matches. Be careful not to touch the line lead when turning on the gas, or you will get a powerful shock.—H. F. (Parkside).

[We think this method is accompanied by considerable danger, and should be adopted only by skilled electricians.—ED.]

Protecting Chisel Handles

WHEN subjected to the constant blow of mallet or hammer, the ends of gouge and chisel-handles either splinter or split.

This annoyance can be prevented by sawing off the rounded end of the handle, and nailing on to the surface two circular pieces of shoe leather, as shown.

The leather protectors can be fitted to new or damaged handles. In the latter case it is only necessary to remove the damaged part where the split ends, fix the discs, and further splitting is prevented.—F. J. (Ellesmere).

Loosening Tight Nuts

THERE are several methods available for loosening tight nuts, the most effective being to squirt paraffin over the nut and apply heat from

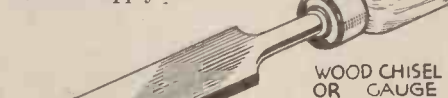

Protecting the handle of a chisel from hammer blows by means of a leather cap fitted as shown.

a candle. When hot, the nut will yield to the application of a spanner. If the nut is so situated that heat cannot be applied without spoiling adjacent parts, try lightly

tapping each of the six faces of the nut with a hammer. This should result in the nut spinning off. If these methods fail, saw through the nut and open the sawcut with a cold-chisel and hammer. It may then easily be unscrewed in the ordinary way.

A Handy Light

WHEN making a repair to a car, etc., at night, a light that can be placed near the work is useful. Obtain an old upholstered chair spring, a large lamp bulb, and a large lamp socket. The lamp is put in the spring, contact end first, at one end, and at the other the socket is engaged with it in the usual manner (see sketch).

An Electric Water Boiler

STRIP about half the winding of a discarded element from an electric iron. Wind it on a piece of asbestos and fix with

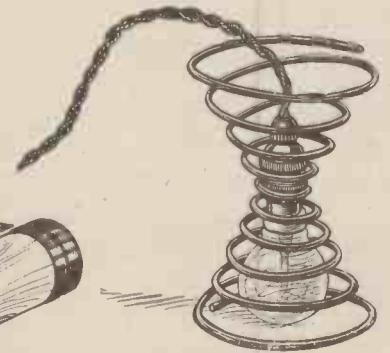

This is the simple and easily-made inspection lamp described in the text.

cement. Attach a pair of 14 S.W.G. copper wires to the ends of the element with brass screws and nuts. Solder twin flex to the other ends of the copper. Immerse in water in an earthenware vessel and plug into the A.C. mains. This will boil a quart of water in under four minutes.

I have been using the above idea for about two years and find it excellent. Never switch on the current unless the element is completely covered, otherwise you will burn it out.—H. F. (South Australia). [See note above.—ED.]

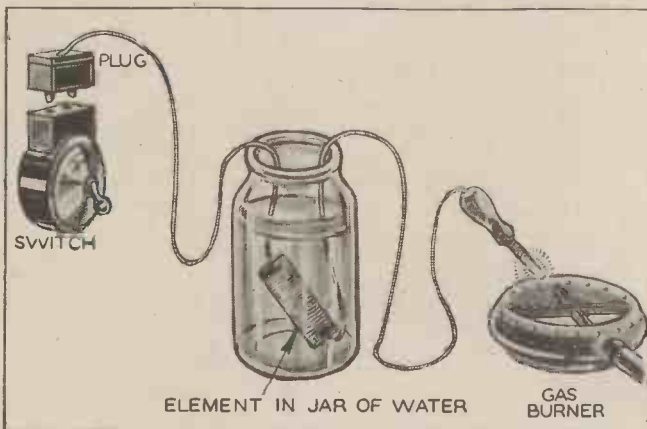

(Left) An electric gas lighter, showing the method of connecting up the element, which is placed in a jar of water, and (right), Another use for a discarded electric-iron element. The sketch shows a simple water boiler.

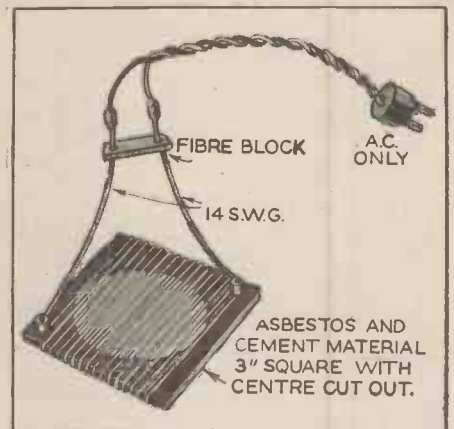

USE "WILCO" MOTORS
IDEAL FOR MODEL DRIVING, ETC.



This fine 2-6 volt motor is very speedy and powerful, will work off batteries or accumulators.

If you use our Transformer you can work it off the Electric Light at practically no cost and at the same time you will have the speed control arm which will give you perfect control over your PRICE models. We are small Motor and Dynamo specialists and stock all kinds from 2/6 each to large Mains Motors at 24.

7/9
Post 6d.

"WILCO" ELECTRIC GRINDER

There are many uses for a motor-driven Grinder. Price both in the home and workshop, sharpening knives, scissors, drills, chisels, etc. Will work off 27/6 any electric light socket. A.C. only. 200/250 volts. Each. Supplied with a fine and coarse grinding wheel.

Send for Electrical Catalogue, 4d. Post Free.

L. WILKINSON, 8 City Road, London, E.C.

FACTS ABOUT THE STARS

STARS, like all physical things, have lives and develop along certain lines. Some are in their youth, others are ascending to the zenith of their brilliance, some of them have reached the maxima of their brilliancy, and some hurrying to extinction. The distances of the stars from the earth are computed on the basis of the sun's distance from the earth in our

conjectures of the stars are based upon what is known of these. Though they look like faint specks in the sky, they must be at least equal in luminosity to the sun. At the same distance from the earth the sun would appear like a star.

It is easy to be deceived by the apparent magnitude of the stars, because irradiation makes all bright objects look larger. The filament of an electric lamp, no thicker than a human hair, seems to swell up when the current makes it luminous, but looked up through tinted glass, to take off the glare, it is seen at its proper size.



The Great Nebula in the constellation Andromeda. (From a photograph by Professors Ritchey and Pease, taken with a reflecting telescope of 24 inches aperture at Yerkes Observatory, U.S.A. Exposure four hours.)

New Stars

It should be stated that new stars are not new stars at all, but old ones suddenly glaring forth. All the stars are moving at a velocity of many miles a second, and speed means heat.

There is a gradual ascent of temperature in the star. A red star is either a new or a dying star, a blue one is in the prime of its existence.

Recently Professor Turner gave practical details of methods of photographing the stars.

There are many groups of stars flying along like a flock of birds; but, like birds, they eventually come back.

In the last twenty years a fact has been established that meteors travel outwards and inwards. This proves that the system governing the motion of the stars differs from that of our solar system. If the star system is similar to our solar system we should, ere this, have been able to recognise its sun, and we should have observed any star bigger than the rest. It would be

INEXPENSIVE CHEMISTRY EQUIPMENT

APPARATUS & CHEMICALS FOR STUDENTS' LABORATORIES

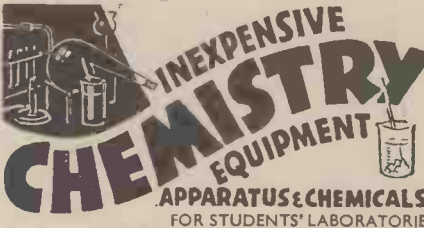

Complete range of CHEMICALS in Bottles from 3d. each. Extensive selection of APPARATUS, including Beakers, Flasks, Graduated Ware, Condensers, Retorts, Balances, etc.

Also MINERALS and TEXT BOOKS.

SPECIAL PARCEL OF APPARATUS
Containing: 1 Flask, flat bottom 150 c.c., 1 Beaker, spouted 100 c.c., 3 Test Tubes 4 in. x 1/2 in., 1 Thistle Funnel 20 cm., 3 ft. Glass Tubing, 1 Rubber Cork 2 Holes, 4 ins. Rubber Connection Tubing, 1 Glass Stirring Rod. **2/6** Post Free.

BECK (Scientific) 60 HIGH STREET, (Dept. A.) STOKES NEWINGTON, N.16.
WRITE FOR CATALOGUE—FREE.

YOURS for 3/- DEPOSIT

£7.70 VALUE for 65/-

Built like a Piano with the Power of an Organ. ILLUSTRATED LIST POST FREE.



A remarkable opportunity to obtain a Real Piano Accordion at a greatly reduced price. Triple chord piano action, 14-fold bellows, 21 piano keys and 8 basses. Black polished. Complete with shoulder strap. Send only 3/- deposit. Balance 5/- monthly until 65/- is paid.

J. A. DAVIS & CO. Dep. P.M. 36
94-104 DENMARK HILL, LONDON, S.E. 5.

solar system, which is about 90,000,000 miles, a distance known as the "astronomer's yard measure." The bulk of the sun is a million times the size of the earth, but Mars is the only planetary body resembling the earth.

There are serious difficulties in the way of recognising the presence of any beings similar to our own on Mars, according to a recent investigation of Dr. Fison. Saturn has too high a temperature for anything we know as life to exist upon it. Betelgeuse is distant nearly 10 million times the distance from the earth to the sun, which gives some idea of the illimitable extent of the heavens, and yet the speed of light is such that it could travel eight times round the world in a second. Travelling at the same speed, a ray of light from Betelgeuse would take 160 years to reach the earth. From the nearest star, Alpha Centauri, light takes four and a half years to reach the earth, and from the Pole Star fifty-four years.



Star Cluster in the constellation Cassiopeia. (From a photograph by Dr I. Roberts, Crowborough, taken with a reflecting telescope of 20 inches aperture. Exposure ninety minutes.)

All the Stars are Suns

It is difficult to imagine human beings living upon them, but it is interesting to speculate as to whether they may be centres of planets revolving round a distant star, on which it is possible there may be beings as intelligent as the inhabitants of this earth. If these supposititious beings were equipped with super-telescopes, and they were now directed towards the earth, they would see things that happened years ago, such as the Battle of Waterloo.

Beyond these are still more-distant stars beyond the limit of calculation. We know the distances of nearly 2,000 stars, and our

impossible to account for two streams of stars if the star system was identical to our solar system. There is at least a thousand million stars in our cluster whose course is controlled by a movement common to all the stars. They are all attracting or pulling against each other by the law of gravity.

DON'T BE BULLIED



Learn to fear no man. The BEST self-defence ever invented, namely, JUIJESU. Easy to learn. Send 2 penny stamps for SPLENDID ILLUSTRATED LESSONS. Photo Plates of Japanese Champions and particulars, or P.O. 1/- FOR A PORTION of my course. You will be more than delighted.

Send NOW to Dept. "P." Blenheim House, Bedford Lane, Feltham, Middlesex.

FEAR NO MAN



A Review of the Latest Devices for the Amateur Mechanic. The Address of the Makers of the Items mentioned can be had on application to the Editor. Please quote the number at the end of the paragraph.

A Portable Hand Shearing Machine.

THE portable hand shearing machine shown below is specially designed for the home mechanic, and will cut sheets of metal of any size in any way, either straight or curved lines. It always leaves a clean edge without fash or burr and is easily re-sharpened. As will be seen from the sketch, it is clamped to the bench by means of a thumbscrew and is operated by a hand lever. It costs 25s. [90.]

A Magazine Hack-Saw Frame

THIS latest improvement in metal-sawing equipment has a number of special features incorporated in its design. The position and shape of the unbreakable metal handle gives the operator comfortable control with one hand when the frame is used on jobbing work where a vice is not available. Five spare blades in assorted pitches are carried in the nickel-plated bow which forms the magazine, and the non-detachable tension pieces allow instantaneous swivelling of the blade for cutting at right-angles. The provision of the long rear tension piece and the use of "Eclipse Flex" blades, which are unbreakable, ensure protection for the operator's hand. It is sold complete with six 10-in. blades at the low price of 5s. [91.]

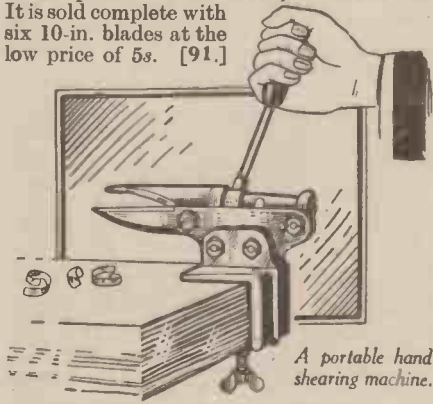

A portable hand shearing machine.

Rubber Tool Grips

ONE of the most important aspects of the Rawlplug method of fixing is the drilling of holes to take the plugs. These holes must be accurate, or the job is not satisfactory. The Rawlplug tool ensures this accuracy, and is, therefore, indispensable when making a Rawlplug fixture. In order to make the use of these tools still easier, this firm have introduced a rubber tool grip. These grips fit tightly over the holders and provide a firm, comfortable grip and protection for the fingers. They absorb the shock of the hammer blows, and this prevents the hand from becoming tired. The grips are made in two sizes, red to fit holders Nos. 3, 6 and 8, and grey to fit Nos. 10, 12, 14, 16 and 18. The price of both sizes is 1s. [92.]

The "Fluxite" Gun

AS most readers know, "Fluxite" is the paste flux that enables a soldering job to be carried out quickly and effectively. A big disadvantage, however, was the method one had to adopt when applying the flux

to a job, which was generally carried out by means of a matchstick, etc. This drawback has been overcome, however, by means of the gun shown at the foot of the middle column. All that is required is to fill the nozzle portion and half fill the cup. When the two parts are placed together and pressed, the paste is projected on to the desired spot. It costs 1s. 6d. [93.]

A Combination Depth Gauge

A GAUGE designed to meet the demand for modern shop practice as regards gear-cutting, etc., is now on the market.

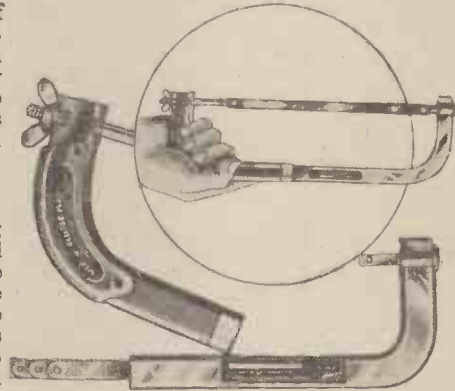

The latest improvement in metal-sawing equipment is the frame shown above.

By means of a sliding bar, accurately graduated to the whole depth of the gear tooth, the same is transferred to a gear blank, thus giving the operator definite sight measurements for machining. The tip distance of bevel gear wheels can also be readily measured to a very accurate dimension, thus doing away with a large quantity of plate gauges usually required. The gauge will also be found of value for scribing or measuring gauges similar to those used for making form tools, etc., and form tools of the flat variety can be measured direct. Adjustment is made by a sliding piece and fine pitch adjusting nut. It costs 50s. [94.]

A New Screwdriver

THERE are a considerable number of ingenious screwdrivers now on the market, most of which have been reviewed in these pages. We deal with yet another this month, which is known as the "Scrutite." It is a screwdriver of extra robustness and rigidity, and is fitted with a square blade which runs the whole length



The "Fluxite" gun, which simplifies the method of applying the paste.

THE GLUE THAT GRIPS

Use

Ste-Fix

A PURE VEGETABLE GLUE

ODOURLESS COLOURLESS

For Joinery, Fretwork, Leather, Model-making, Repairing Pottery, Glass-ware etc. and for all purposes where a really powerful adhesive is required.

In Tubes 2d., 6d. and 9d.

Made by the Proprietors of

STEPHENS' INKS,

57 Aldersgate Street, E.C.1.

ALWAYS READY FOR USE



GUARANTEED 7 YEARS AGAINST BREAKAGES

Made by the suppliers to IMPERIAL AIRWAYS & AIR MINISTRY CONTRACTORS.

The Ideal watch for hard wear, it can be worn without fear of damage whilst at work, or when camping or swimming! Impervious to any climate. Floating non-magnetic jewelled movement, shock, vibration, dust and sand proof.

Each watch time tested under water. Chromium patent gland case, 24 hr. dial, leather strap. Cash price 59/6, chromium adjustable bracelet 5/- extra, luminous dial 2/6 extra.

THE ORIGINAL **Aeroplane**

SPECIALLY BUILT FOR USE UNDER ALL CONDITIONS

Send your order to-day, or write for FREE Catalogue of 75 models from 25/-.

G. & M. LANE & CO. Ltd.,

Dept. P.M.2, 24-26 Ludgate Hill, London, E.C.4.

BELLING-LEE components are specified for every home constructor receiver
SEND FOR FREE CATALOGUE



UNIFORMITY

The perfect uniformity of movement in a well-trained chorus is not as easy to achieve as it looks. It calls for experience, endless practice and endless patience. So it is with T.M.C.-HYDRA condensers. Patient and careful checking is carried out at every stage in their manufacture. Stringent tests are applied to ensure uniform accuracy within the narrowest of limits. And so you know that every T.M.C.-HYDRA condenser you buy is absolutely reliable.

T.M.C.
BRITISH MADE
HYDRA
CONDENSERS

The special method of sealing T.M.C.-HYDRA condensers definitely prevents the penetration of moisture and so preserves the high electrical properties of the condensers. T.M.C.-HYDRA condensers of all types are sold by your radio dealer, but if you have any difficulty in obtaining supplies, write to the Sole Distributors:

T.M.C.-HARWELL (SALES) LTD
Britannia House, 233 Shaftesbury Avenue
London, W.C.2. (A few doors from New Oxford St.)
Telephone: Temple Bar 0055 (3 lines)

Made by TELEPHONE MANUFACTURING Co.Ltd.

of the handle. The blade projects $5\frac{1}{2}$ in. from the handle and is $\frac{1}{8}$ in. square. It sells at 2s. 6d. [95.]

An Improved Spanner

THE handle mechanism of the spanner shown is mounted in a ball race, which eliminates friction and enables the spanner to obtain an efficient grip of the nut. It has an adjustable handle mounted on the end of the spanner, which not only provides ease of accessibility but, in addition, is sufficiently large to enable a full hand-grip. This ensures ease of adjustment and a very powerful grip for the jaw members. The body, which is of hydraulic-drawn steel, is in one piece and virtually unbreakable. It is extended up behind the adjustable jaw, giving maximum support against spring.

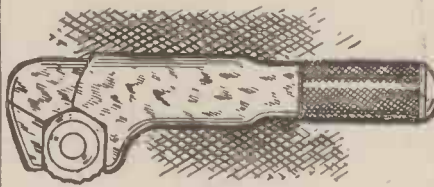

An improved design in spanners.

The spanner is sold in three sizes as follow : 9 in., which takes $\frac{3}{8}$ in. Whit., 8s. 6d. ; 6 in., which takes $\frac{1}{2}$ in. Whit., 5s. 6d. ; and $3\frac{1}{2}$ in., which takes $\frac{1}{4}$ in. Whit., 3s. 6d. [96.]

For Cleaning the Commutator

A CONVENIENT and very efficient little tool for re-servicing the commutator segments of a dynamo or similar electric machine is shown in the illustration below.



Dynamo commutators can rapidly and safely be cleaned and ground with this handy Rumbaken tool.

The tool is double-ended, having a coarse aloxite stone at one end for smoothing the segments when they have become pitted or badly worn and a fine burnisher at the other end. This compact device rapidly removes both copper and mica separators and can be used while the machine is running at normal or slow speed. The stone and burnisher are replaceable so that new ones may be fitted if and when necessary, although the originals will last for a considerable time. The price is 4s. 9d. [97.]

DEEPEES LIMITED 35 BEAK STREET, REGENT STREET, LONDON, W.1
PHONE : 2560 GERRARD.
MANUFACTURERS OF AND DEALERS IN ALL SCIENTIFIC INSTRUMENTS

10-in. Ebonite Plate Wimshurst Machine, nickelled fittings. Every possible refinement.
£3 . 10 . 0. Carriage extra.

SOME KNOW US. SOME DON'T. CALL AND MAKE OUR ACQUAINTANCE. YOU WILL BE SURPRISED AT OUR UNIQUE STOCK.
AT HOME 9 to 7. 1 o'clock SATURDAYS.

ELECTRADIX BARGAINS

METERS, we stock all ranges. Special charging CZ 3-0-3 amps. 5/-. Pole Testers 2/6, 0-20 volts 5/-, 0-50 volts 5/-, 0-100 volts 5/6, 0-200 volts 6/-, all A.C. or D.C. MIPANTA A.C. Test Meter, 300 v., 150 v., $7\frac{1}{2}$ v., 3 Scales 19/6. Moving-Coil 1st grade meter movements for own tester 5/-. VEEDER Turn Counters for coil winding 1/3. Useful Parcels Electrical and Radio oddments 7 lbs. 5/-, 20 lbs. 7/-, post free.
Morse Silent Chains, new, 29 ins. long, with large and small sprockets and Chain Cases, $\frac{1}{2}$ H.P. rating, for motor drive, 35/-, quarter price. 10 Skew drive Gear Boxes for Cinema, $\frac{1}{2}$ to $\frac{1}{4}$ H.P., 10/-. Rubber Diaphragms, 18 ins. dia., 1/16 in. thick, new, 2/6.

HOME BROADCASTER. Why not send for our Bargain Sale List, "P.M." post free, and you will save money? Fun with your home radio.

MICROPHONES. A New Practical Home Mike for Wireless Broadcasting at Home. A solo mike for hand or stand in fine bakelite case with back terminals, front metal grille. New and finely finished, 5/6. Type No. "P.M." 11 Table with high ratio transformer, all bakelite case, 15/-. Ring Pedestal Mikes 18/6; Lecture Mikes 63/-; Unit for Detectaphones 3/-; DEAF AIDS. For those hard of hearing, the lowest-priced aid is our Hear Easy Pocket Set at 18/6, complete. We are also able to offer Brown's Aids to the Very Deaf at a greatly reduced price. These comprise his Aural Box or the Ossiphone for the totally deaf.

Selenium Cells in Bakelite case 7/6, super model, tubular, 10/-. Radiovisor 17/6, Photocells glass bulb for Talkies 15/-, 3 guinea Ray Kits, secret Burglar Detectors, 36/-.

TRU-VIEW CAMERASCOPES, BROWN'S, double lens, folding. Listed 7/6, sale 2/-. Telescopes, 9-mile distance, Naval Gun Sighting, internal focus ring 24 in. long, weight 6 lbs., short and long range. Cost £25. Sale 15/- and 17/6.

Officers' Spotting Telescopes, 17 x 1 1/2 in., 25/-. Prisms and Lenses, all sizes from 1/-, Projectors from 3/6, Navy Telescopes 17/6. Morse Signal keys 4/6, Sounders 5/-, Headphones 2/6 pair, Bells, British, 2/-, Mains Transformers 3/6, 1 mfd. Condensers 4d.

Mains Transformers, for Bells, Models, Lamps, etc., 3-5-8 volts, 230 volts, double 3/6, 110 volts single 2/6. DYNAMOS. 16 volts, 10 amps., shunt wound, ball bearing, encl. dustproof machines, 25/-. Full auto Switchboard with meter 22/6. 220-volt Motors 17/6. Motors, Dynamos, Telephone parcels. Post 6d.

PARCELS of experimental odd coils, magnets, wire chokes, condensers, switches, terminals, etc., post free. 10 lbs., 7/-; 7 lbs., 5/-; 1,000 other Bargains in New Sale List "N."

ELECTRADIX RADIOS
218 Upper Thames Street, London, E.C.1
Telephone: Central 4611.

PACKED WITH INFORMATION
the latest FERRANTI literature for the experimenter!

- Wa 560. New complete Valve Catalogue.
- Wf 522. New list, Mains Components.
- Wa 561. New list, Potentiometers.
- Wg 550. New Speaker List.
- R.2. New complete Catalogue of Components.
- Wi 526. New Catalogue, Radio Meters.



FERRANTI Ltd.
HOLLINWOOD
LANCASHIRE

Any of these publications will be sent on receipt of 13d. stamp, or all of them on receipt of 3d. stamp to Dept. P.M.



The Beginners Book of Stamp Collecting

BY STANLEY PHILLIPS. 2s. 6d. net. 223 pages. 16 full-page stamp plates. Published by Messrs. Sampson, Low, Marston & Co. Ltd., 100 Southwark Street, London. The secret of enjoyable stamp collecting is to find out which side of it appeals to you and take up that side. The new, up-to-date stamp collecting can be something very different from the mere accumulation of stamps. Think for a moment of the different ways in which you can look at a stamp. You can think of its purpose of franking a letter, perhaps only from one street to the next, or may be from a busy city to a tropical jungle. If the stamp comes from abroad you may be curious to know something about the place it comes from and why it was issued in the particular form in which you see it. This volume deals with the stories told by stamps—tales of explorers, spies, aviators, and men famous in literature, music and art. It explains the hidden meaning of stamp designs, shows you interesting details you might never notice for yourself; in a word, it makes stamps live and tell

their stories in the most entertaining fashion.

Air History in Stamps

By STANLEY PHILLIPS. 58 pp. 116 illustrations. 1s. net. (Stanley Gibbons, Ltd., 391 Strand, London, W.C.2.) Any history of aviation is interesting, but there is a particular fascination in the one just published by Messrs. Stanley Gibbons Ltd., for it deals with the subject as it is illustrated on postage stamps.

Starting from the days of Icarus and Mercury, the story introduces us to such pioneers as Leonardo da Vinci, the Wright Brothers, Professor Charles, the early balloonist, Santos Dumont, Blériot, Lilienthal and Count von Zeppelin, and in many cases, not only the men but their balloons, airships and aeroplanes are shown on the stamps illustrated.

We fly with Santos Dumont round the Eiffel Tower, and land with him outside his hotel in the streets of Paris; accompany the *Graf Zeppelin* on her trip to the Pole, and ascend with Piccard and the ill-fated Russians into the stratosphere. If we prefer heavier-than-air machines, here is the story of the early experiments, the great Trans-Atlantic flights, and the historic world flights of Pinedo, Kingsford Smith, Balbo and his men, and many other heroes of the air.

Nor are the modern machines neglected, for many of these are shown on the stamps illustrated, including a number of air liners and some of the latest fighting types.

AN INTERESTING PROCESS IN MINIATURE

HERE is a novel model of a milk pasteurising plant, built by Bassett-Lowke Ltd., of Northampton, for the United Dairies. It is approximately

evaporator are very realistically modelled and also the brine tank in the centre. The cone-like heat exchanger heats the milk, and with the help of the ammonia destroys the harmful bacteria in the milk, and the pasteurised liquid is cooled and conveyed by stainless steel piping into the great glass-lined railway tank.

This process is made clearer in miniature

A fine scale model of a steamer made by Bassett-Lowke Ltd.

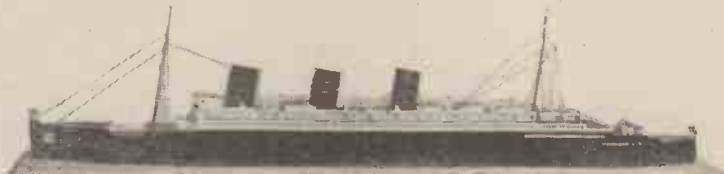

5 ft. 10 in. x 2 ft. 6 in. and shows clearly the whole process of purifying the milk.

The milk is brought in churns from the different arms and poured into the stainless steel tipping tank, and is drawn by the centrifugal pump in the spiral heat exchanger and milk purifier. The motor compressor, the ammonia condenser and

and the model has already excited interest in dairy processes. It is made to a scale of 1/4 in. to the foot and this scale gives opportunity for a fair amount of interesting detail to be shown. The plant itself is finished in green and white enamel, with white tiled walls and two types of tiled floors, one in red and the other in black and white.



There was a young plumber of Ayr
When needed he always got there!
And the reason is plain—
Much time he did gain—
He used FLUXITE for every repair!

See that FLUXITE is always by you—in the house—garage—workshop—anywhere where simple speedy soldering is needed. Of all Ironmongers—in tins 4d., 8d., 1/4 and 2/8.

Ask to see the Fluxite Pocket Soldering Set—complete with full instructions 7/6. Ask also for Leaflet on Case Hardening and Hardening Tools with Fluxite.

THE FLUXITE GUN

is a handy and economical tool that enables you to put the Fluxite exactly where you want it on the soldering job. Also used to project grease into bearings, etc.—like a miniature grease gun. Just fill the nozzle portion—half fill the cap—put together and press as required. PRICE 1/6



ALL MECHANICS WILL HAVE

FLUXITE

IT SIMPLIFIES ALL SOLDERING

FLUXITE LTD. (Dept. P.M.), DRAGON WORKS BERMONDSEY STREET, S.E.1



8/6 POST 6/-

The most amazing offer ever made to popularise this fine organ-toned instrument. Full scale of piano keys with a syncopating bass notes. Producing clear, mellow music as easily as a 20 gn. model. Strong bellows. Well finished. Highly nickel plated metal parts. Ivory finished piano keys. With leatherette hand & shoulder straps at a price to advertise our name all over the world. 8/6. Post, etc., 6d. Money back if not satisfied. AIRCRAFT PRODUCTS, LTD., (Dept. Z.P.M.1), 89 New Oxford St., London, W.C.1. Opposite Graves.

Engineers' Guide

containing the widest choice of engineering courses in the world

Study at home with The T.I.G.B. for a well-paid post. Become an A.M.I.C.E., A.M.I.Mech.E., A.M.I.E.E., etc. Training until Successful is guaranteed. WRITE NOW for Free Guide stating branch, post or qualification that interests you, to THE TECHNOLOGICAL INSTITUTE OF GREAT BRITAIN, 123 Temple Bar House, London, E.C.4. (Founded 1817, 19,000 Successes.)



To Success



A model of a milk pasteurising plant.

REPLIES TO QUERIES & ENQUIRIES

If a postal reply is desired, a stamped addressed envelope must be enclosed. Every query and drawing which is sent must bear the name and address of the sender and be accompanied by the coupon appearing on page III of cover. Send your queries to the Editor, PRACTICAL MECHANICS, Geo. Newnes Ltd., 8-11 Southampton Street, Strand, London, W.C.2.

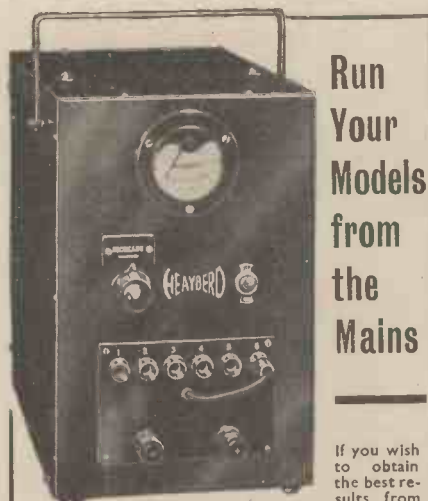

Run Your Models from the Mains

If you wish to obtain the best results from your working models, run them from the mains. Heayberd have introduced two new Rectifier Units for Model Railway Working. Fitted with Rubber Feet, ensuring perfect safety.

Model T.V.5. Output 12 volts at 1 to 5 amps. Tappings: 6, 8, 10 and 12 volts.

PRICE £5 17 6

Nett.

Model 22c. Output 15 volts at 5 to 3 amps. Fitted with Special Forward and Reverse Switch, and Centre Zero Ammeter.

PRICE £5 17 6

Nett.

POST NOW

(Fill in coupon for full descriptive leaflet.)

Mr.

P.M.

F. C. HEAYBERD & CO.
10 FINSBURY STREET, LONDON, E.C.2.

BE TALL

Your Height increased in 14 days or money back. The amazing Stebbing System soon brings 3-5 inches

increase and new energy. The first, original, and the one GENUINE GUARANTEED Height Increase System. Recommended by Health and Efficiency. Complete Course, 5/-, or Booklet free, privately,

STEBBING SYSTEM, Dept. M.P., 28 Dean Rd., London N.W.1.

The WEBLEY SERVICE AIR RIFLE, Mk. II.

No Licence required to purchase

WRITE FOR DESCRIPTIVE FOLDER

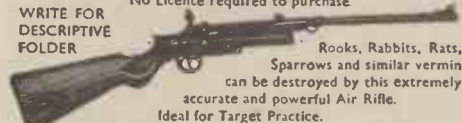

Rooks, Rabbits, Rats, Sparrows and similar vermin can be destroyed by this extremely accurate and powerful Air Rifle. Ideal for Target Practice.

Calibre 22 or 177 With Leaf-sight and Peepsight.

WEBLEY & SCOTT, Ltd. 108 Weaman St., BIRMINGHAM 4

Baker's SOLDERING FLUXES

Sold in 6d. and 1/- tins at all Cycle Accessory Dealers, Tool Shops, Ironmongers, etc.

Write for your free copy "Joining of Metals" to

SIR W. M. BURNETT & CO. LTD. (CHEMICALS) LTD.
GREAT WEST ROAD, Uxbridge, MIDDLESEX
TELEPHONE: HOUNSLOW 0476

MAGNETO QUERY

"I have just bought a Bosch Magneto and would like to convert it into a hand generator or anything in the electrical line." (J. M. W., Aberdeen.)

You will find a use for your Magneto fully described in "Simple Electrical Apparatus," obtainable from the publishers, Geo. Newnes Ltd., 8-11 Southampton Street, Strand, W.C.2, at 1s. 2d. post paid.

GRAMOPHONE RECORDS QUERY

"Can you tell me whether there is any restriction on the sale of second-hand gramophone records of any kind? Also is it permissible to play them with the shop door open?" (J. B., Belfast.)

We do not think there is any restriction on the sale of second-hand gramophone records providing they are sold as second-hand records. It is not permissible to play them with the shop door open as this would constitute a form of public entertainment and would infringe the rules of the Performing Rights Society.

"COLD LIGHT"

"After perusing your article on 'Cold Light' I would appreciate some further information on the following aspects of this interesting subject.

"Is it possible to make a fluorescent screen sensitive to infra-red rays, if so, what material should be used?

"Is it correct that both infra-red and ultra-violet rays are absorbed by glass lens throughout their respective ranges, if so, could a lens be manufactured from quartz glass, which I understand transmits both these rays fairly freely?

"Is it possible to heterodyne one colour frequency with another, and if so, what law governs the computation of the resultant frequency? And how would this third frequency compare with the originals for intensity?

"Assuming that infra-red rays travel in a direct line (due to their greater penetrating power), is there a definite angle of refraction for the ultra-violet band? If not, is there any means of calculating this angle or is it governed by the transmitting medium? As I am desirous of generating both infra-red and ultra-violet rays, what means could you recommend for this purpose within reach of an amateur workshop such as mine?" (J. N., Gt. Crosby.)

As fluorescence essentially involves a conversion of the incident light into a luminous effect of lower wavelength, it is clearly impossible to produce a screen which will transform infra-red light directly into visible light, since this would mean converting a long wave into a shorter one.

There is, however, an indirect method of making infra-red light visible by using a sensitive cell consisting of caesium deposited upon a salt or oxide of the same metal, so thin as to be transparent. The cell gives off electrons corresponding in intensity to the graduations of the infra-red image projected upon it. By using a sufficiently high plate potential, the emitted electrons are drawn off in a straight line, and if the plate is covered with a coating of zinc silicate the impact of the electrons produces a fluorescent replica of the infra-red image.

Unfortunately, we can only refer very briefly to some of your other queries. It is not possible, so far as we know, to heterodyne different colours in order to produce a beat frequency; nor is there any known substance which would detect such beat frequencies.

Ultra-violet rays are given off from any arc lamp. By placing a screen of ebonite before the same lamp, all rays other than the infra-red are filtered out.

ADAPTING A CAMERA

"I am adapting a folding camera for enlarging and require the following information.

"I want to know if there is any formula or rule to find the distance required between

"(a) The light (electric) and the condenser;

"(b) The two halves of the condenser;

"(c) The condenser and the negative."

(F. P., Beds.)

It is necessary to know the focal length of the condensing lens. This may be determined by holding the condenser in the sun's rays and focussing the sun's image as small as possible; the distance from the condenser to the spot of light represents the focal length.

(a) This should be approximately twice the focal length as determined by the above means;

(b) This is not important, but keep the two glasses as close together as possible without touching;

(c) The distance from the condenser to the projection lens should be approximately equal to (a), and the negative should be arranged at the proper focal distance from the projection lens.

OXYGEN FROM THE AIR

"I should be greatly obliged if you would advise me on the following:—

"(1) What is the best and simplest method of obtaining oxygen from the air?

"(2) Is a spirit vaporised and compressed with oxygen more combustible than a spirit vaporised and compressed with air?" (A. W., Sheffield.)

(1) Brin's Process. Barium oxide is heated to a temperature of 500° in atmospheric air. It rapidly acquires oxygen, becoming converted into barium peroxide. On raising the temperature still further to 1,000°, this extra oxygen is liberated and the oxide remains. When it has cooled down to 500° the peroxide again forms and the process is repeated. In actual practice it is found more economical to keep the oxide at a temperature of about 700° and to pump air under pressure over it. The oxygen combines with the barium oxide and the nitrogen passes over and is released. The process is then reversed, the pressure over the barium peroxide being reduced when the oxygen is released, drawn off and collected.

(2) Air is liquefied and the nitrogen allowed to evaporate. Almost pure oxygen remains, and as this evaporates it is collected and pumped into steel cylinders.

Spirit vaporised and compressed with oxygen is more explosive than spirit vaporised and compressed with air.

Money Making IDEAS

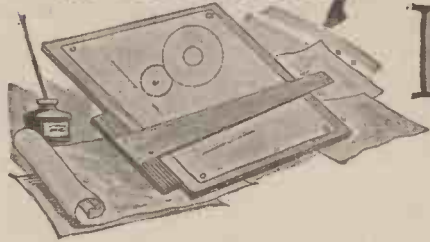

SUGGESTED BY OUR READERS

AN IMPROVED SMOOTHING IRON

"I would like your opinion of my invention, which is an idea for an improved iron. The handle of the iron will never get hot, nor will the heat from the iron itself be able to 'travel' and burn the user's fingers." (T. H., Leeds.)

The improved smoothing and pressing iron is ingenious and forms fit subject-matter for Letters Patent. So far as is known from personal knowledge the idea is novel, but a search amongst prior Patent Specifications would be necessary to establish the fact. The only smoothing iron known to the writer in which the heated portion was made and heated separately from the handle is the old-fashioned box iron in which a cast-iron element was removably enclosed in a box-like casing, the lower surface of which formed the operative surface of the iron. The larger end of the hollow casing was closed by a vertically sliding door to allow for the introduction and removal of the cast-iron element.

The proposed construction should have advantages over such known constructions and appears to be particularly useful for domestic use and in which gas is employed for heating and cooking purposes. The inventor is advised to protect his invention by filing an Application for Patent with a Provisional Specification, which will give him about twelve months' protection at the least cost, in which to ascertain if the invention is likely to be commercially successful or to obtain financial assistance in marketing the invention.

A SIGNALLING DEVICE FOR THE MOTORIST

"Could you advise me as to the best method of developing a Provisional Specification, as my agents are unable to instruct me from a financial or manufacturing point of view?"

"Does the granting of protection show the idea to be a commercial proposition?"

"Is it worth while having extra outside assistance re development and sketches, etc.?"

"My idea is described in the specification as 'Switch for Automobile Direction Signalling Devices,' and intends to automatically cancel indicators when the signalled turn is being undertaken by a small projection on the underside of the steering wheel base, and so avoiding further distraction of driver."

"If you are of the opinion that my idea is marketable as it stands, perhaps you will be good enough to give me a list of firms who would be likely to be interested, and information as to the amount of detail to forward when canvassing." (J. C., Newcastle-on-Tyne.)

The acceptance of an application for Patent with a Provisional Specification does not show that the invention is either novel or a workable or commercial proposi-

tion. The protection afforded by "Provisional Protection" is that any use or publication of the invention during the period of provisional protection has no prejudicial effect on a Patent subsequently granted for the same invention. The official search for novelty of an invention is only made after a Complete Specification has been filed, and even when the Complete Specification has been accepted the Patent Office does not guarantee the validity of the Patent subsequently granted, nor is the acceptance of the Complete Specification proof that the invention is either a workable or commercial proposition.

It is not considered necessary to incur further expense in having the invention further developed or put into a practical form, as this would be undertaken by the firm who became interested in the invention. It should be sufficient to forward a copy of the Provisional Specification, together with sketches, to the firm who would be willing to look into the invention. It is suggested that one or more of the following firms, if approached, would be likely to consider the invention: Messrs. Brown Bros. Ltd., 22 Gt. Eastern Street, London, E.C.2; Messrs. Benton and Stone Ltd., 108 Great Portland Street, London, W.1; Messrs. A. H. Hunt Ltd., Tunstall Road, Croydon.

A WALLPAPER CUTTER

"I have thought of an idea for a cutter which will take the edge off wallpaper by simply being run along the table."

"I would like your advice regarding the novelty and commercial value of this idea." (J. H., Leeds.)

The proposed device for cutting off the margins of wallpapers is fit subject-matter for protection by Letters Patent. The particular device is thought to be novel, but the broad idea of a device for trimming wallpapers is not new. There are several machines on the market for a like purpose, one of which employs a pair of circular cutters or knives and is probably a less expensive construction than the one proposed. The inventor is advised to make enquiries in the trade as to existing machines for the purpose before taking any steps to protect his invention.

A THIEF-PROOF HASP

"I would like your advice on a thief-proof hasp for sheds, boxes and cupboards, etc."

"The idea of the hasp is that it covers the screws while locked, thus preventing the fixing screws from being removed. A petty pilferer will hesitate before using brute force." (E. R., Sussex.)

The improved hasp should prove effective, but it is not thought to be novel. The inventor is advised to have a search made through prior Patent Specifications dealing with the subject before incurring any expense in protecting the invention, as it is confidently believed that such a search will disclose one or more Patent Specifications covering the idea.

MAXALDING

IS HIGHLY PRAISED BY
REX FERRUS,
SOUTH AFRICA'S HERCULES
AND FOREMOST TRAINER



REX FERRUS, whose photograph appears herewith, wrote in August, 1934:—

"I gained a lot since I took up your course. I increased my weight by 16 lb."

Photograph guaranteed untouched and testimonial unsolicited under forfeit of £50 to this paper.

MAXALDING HAS PUBLISHED MORE EVIDENCE IN PROOF OF ITS SUPERIORITY OVER ANY OTHER METHOD, OVER THE LAST 25 YEARS, THAN ALL OTHER METHODS COMBINED.

Investigate Maxalding by Letter or Coupon. If the Coupon is used *Please delete the unnecessary items* and post it together with the following particulars to Mr. Saldo: Name, Address, Age and Occupation. No obligation involved.

COUPON

1. I suffer from and desire to be cured of Constipation, Indigestion, Biliousness, Nervous Debility, Lung Weakness, Liver Sluggishness, Fatigue, Stomach Weakness, Lumbago, Obesity, Susceptibility to Colds, Lack of Self-Confidence, Dizziness when Stooping, Lack of Physical Development.
2. I desire to secure great nervous energy.
3. I desire to secure great speed and endurance.
4. I desire to secure great strength and heavy muscular development.

NAME.....

ADDRESS.....

.....

Occupation..... Age.....

Postage or reply coupon for 3 ounces appreciated.

MAXALDING (Dept. 852),
14 Cursitor St., London, E.C.4

BAND GUIDE
 Giving hints on the Bugle, Drum and Flute, also Parade Formations, use of Parade Cane, Staff, etc., free and post paid.

Makers:
POTTER'S
 36/38, West Street,
 Charing Cross Road,
LONDON,
 W.C.2

PATENTS, TRADE MARKS AND DESIGNS
"ADVICE HANDBOOK" AND CONSULTATIONS FREE!

KINGS PATENT AGENCY LTD.
 Director: B. T. King, O.T.M.S., Reg. Pat. Agent G.B., U.S.A. & Can.
 146a Queen Victoria St., LONDON, E.C.4
 and 67 Chancery Lane (near Patent Office), W.C.2.
 49 Years' Experience. TELEPHONE: CITY 6181.

PRACTICAL HINTS ON PATENTING
 and the development of inventions.
 Sent free on application.

THE IMPERIAL PATENT SERVICE
 First Avenue House, High Holborn, W.C.1.
 Principal: M. E. J. GHEURY DE BRAY, F.P.S.
 Preliminary Consultation Free. Telephone: Holborn 9191.
 Telegrams: Imperatrix, London.

PATENTS, DESIGNS AND TRADE MARKS
 A VALUABLE GUIDE ON INTERNATIONAL PROTECTION OF INVENTIONS.
 100 Pages - - Post Free, 6d.
The TECHNICAL ADVERTISING AGENCY
 253 (D) Gray's Inn Road, London, W.C.1

FROST & CO.
 70 Old Compton St., London, W.1
 Engineers, Tool and Model Makers.
 Models of all descriptions.
 Inventors, Scale and Advertising.
 Patterns, Castings, or Finished Parts, Small Stampings and Press Tools.
 Experimental and Repetition Work

YOU CAN USE YOUR SPARE TIME
 to start a MAIL ORDER BUSINESS

that quickly brings you a full-time income. Few pounds capital only needed; no samples or "outfits" to buy. No rent, rates, or canvassing. New method makes success certain. Send to-day for free Booklet.

BUSINESS SERVICE INSTITUTE, Dept. 440A,
 6 CARMELITE STREET, LONDON, E.C.4

NERVOUSNESS
 Every sufferer from "nerves" should read my interesting book describing an inexpensive treatment for Weak Nerves, Depression, Morbid Fears, Insomnia, Self-Consciousness, Blushing and similar nervous disorders; sent privately free of charge.

HENRY J. RIVERS (Dept. K.D.3),
 40 Lamb's Conduit Street, London, W.C.1

MICROFU GOLD FILM FUSES
 20 Stock Ratings. Type F.2 suitable for Battery sets, 150 M/A blows at 200 M/A Resistance 74 ohms. Voltage 280 Volts D.C.
 Type F.2, suitable for Mains sets, 500 M/A blows at 1 amp. resistance 14 ohms. 280 Volts D.C. Now available, 2 mA. 4/-. 1 mA. 4/6.
HOLDERS 6d.
MICROFUSES LTD., 36 Clerkenwell Rd.
 London, E.C.1. Phone: OLE 4049.

HAVE YOU A RED NOSE?
 Send a stamp to pay postage, and you will learn how to rid yourself of such a terrible affliction free of charge.
 Address in confidence—
P. TEMPLE, Specialist,
 "Palace House," 128 Shaftesbury Avenue, W.1
 (Est. over 25 years.)



BRIEF ITEMS AND TOPICAL THOUGHTS CONCERNING MANUFACTURERS AND THEIR PRODUCTS

A Conversion Table for 00 Gauge 4 m/m.
 THE table reproduced below, which is half actual size, has been prepared by Hambling's, 26 Charing Cross Road, W.C.2, for the convenience of their customers in giving the direct conversion of standard heights, lengths, etc., in feet to millimeters, for the 4 m/m. scale. Thus if you wish to construct a building 20 ft. high, you will see that the model has to be 80 m/m. high, or again, if you wish to construct a van that you know from data already published is 15 ft. long, your model is then 60 m/m. long. Certain standard heights are given on the right which are useful for users of Merco track, measurements being taken from the top of the running rail.

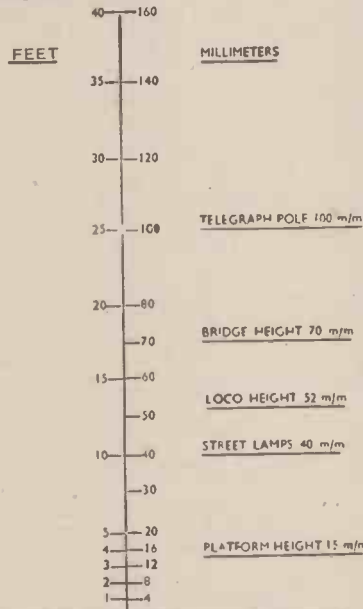

A Powerful Adhesive for Handicraftsmen
 MOST of our readers who use a glue for model-making, fretwork, joinery or home cabinet work, will be interested to learn about Ste-fix. This is a pure vegetable glue which is now extensively used by manufacturers of toys, fancy goods, etc. It is always ready for immediate use (no heating being necessary), and is quite clean and colourless. One other important feature is that Ste-fix is odourless. This glue is a product of the proprietors of the well-known Stephens' Inks, and can be confidently recommended for all purposes where a reliable and really powerful adhesive is required. Despite its special qualities, Ste-fix is quite inexpensive. It is sold in 2d., 6d. and 9d. tubes, which are on sale at most stationers.

A Chemistry "Lab." at Home
 HAVE you ever experienced the thrill of analysing a substance, of preparing chemicals with peculiar-looking apparatus, of making gases and testing their properties, or of doing any of the hundreds of things that can be done in a chemistry laboratory?
 The amount of entertainment to be got from a bunsen burner, a few chemicals and a couple of test tubes only, is amazing.
 Then again, the whole atmosphere of a laboratory is fascinating. When you start using such things as crucibles, retorts, flasks, condensers, or any of the dozens of other pieces of apparatus used for distilling, igniting, boiling, filtering, and other processes, you will become so absorbed in the mysteries of chemistry that you will forget the world outside your own room.
 Yes, it is very easy to fit up a "lab." in your own home and carry out your own researches in your own way. And it is by no means expensive.
 If you are searching for a hobby that is different or are studying chemistry at school, you really must possess a copy of a beautifully illustrated catalogue which has just been published, containing full details of practically all the equipment for a chemistry laboratory—apparatus, chemicals, a special section on minerals, and text-books. Just drop a card to Messrs. A. N. Beck & Sons, 60 High Street, Stoke Newington, London, N.16, mentioning PRACTICAL MECHANICS, and a copy will be sent to you by return of post, free of charge.



GOOD IDEAS—
 are often rejected because of unconvincing drawings!
 Let us prepare attractive illustrations which will convey your idea quickly and clearly to Manufacturers, Editors, Agents, etc.
 We specialise in Patent Office and Technical drawings of all descriptions.
 Write or phone us at
HIGH HOLBORN HOUSE,
HIGH HOLBORN, W.C.1.
 Hol. 8638

BE TALLER!!
RESULTS SPEAK FOR THEMSELVES
 Pupil, age 19, gains 5 ins. in 6 wks.
 " " 21, " 5 ins. in 5 mths.
 " " 20, " 3 1/2 ins. in 16 dys.
 " " 30, " 2 ins. in 4 wks.
 " " 40, " 1 1/2 ins. in 6 wks.
 Increased my own height to 6' 3".
ROSS SYSTEM
 Testimonials from all over the world NEVER FAILS
 Fee: £22s. complete. Convincing Testimony 2/6d. stamp. Mailed privately.
L. MALCOLM ROSS, Height Specialist,
 → Scarborough, England. (P.O. Box 15.)

CLASSIFIED ADVERTISEMENTS
 Private or trade announcements can be inserted in this column at the price of THREEPENCE per word PREPAID.
 All communications should be addressed to THE ADVERTISING MANAGER, PRACTICAL MECHANICS, 8/11 SOUTHAMPTON ST., STRAND, LONDON, W.C.2.

SPARE-TIME SALESMAN wanted. Experience unnecessary. 20/- weekly easily earned.—Apply "Salesman," Richfords Ltd., Snow Hill, London.

MAKE LEAD TOYS! Easy, profitable, with "SUCCESS" Moulds. List Free.—LEE'S, BENTINCK ROAD, NOTTINGHAM.

FRETWORKERS! "Bigvalu" parcel of Jigsaw Pictures, Calendar Pads, etc., 1/3.—LEE'S, BENTINCK ROAD, NOTTINGHAM.

SUPER A.C. MOTORS. 1/2, 1/3 and 1 h.p. 35/- to 70/-.—A. Musham, 397 Killinghall Road, Bradford.

CINEMATOGRAPH FILMS.—Standard size from 6d. 100 feet. Machines, Accessories. Sample Films, 1/- and 2/6 post free. Catalogues free.—"Filmeries," 57 Lancaster Road, Leytonstone, E.11.

TO BECOME A Sanitary Inspector, Weights-Measures Inspector, Woodwork or Metalwork Teacher, School Attendance Officer, etc., write, Chambers College, 385, High Holborn. W.C.1.

MAKING REAL MUSIC IS EASY—if you have the right instruments! Write for our illustrated lists of genuine professional Saxophones, Accordions and Guitars—as used by bandsmen, entertainers, broadcasters.—Messys Ltd. (P.M.) 18-20 Manchester Street, Liverpool.

THE ONLY BOOK of its kind. Compiled by an acknowledged expert, this volume forms a complete guide, in alphabetical order, to the construction, operation, repair, and principles of every type of wireless receiver, with a special section on television, and complete instructions on the making of various wireless components. 392 pages, 490 illustrations. "The Wireless Constructor's Encyclopedia." By F. J. Camm (Editor of "Practical Wireless"). Obtainable at all Booksellers, 5/-, or by post 5/4 from George Newnes Ltd., 8-11 Southampton Street, Strand, London, W.C.2.

FULLY ILLUSTRATED throughout. Mr. Ralph Stranger, who is a master of lucidity, has produced in this book a valuable and fully explained synopsis of technical terms that everybody can understand. "Dictionary of Wireless Terms," by Ralph Stranger. Obtainable at all Booksellers, 2/6, or by post 2/9 from George Newnes Ltd., 8-11 Southampton Street, Strand, London, W.C.2.

"FIFTY TESTED Wireless Circuits." By F. J. Camm (Editor of "Practical Wireless"). This handbook contains every modern circuit, complete with instructions for assembling, component values, and notes on operation. On sale at Booksellers, 2/6, or by post 2/9 from George Newnes Ltd., 8-11 Southampton Street, Strand, London, W.C.2.



"IDEAL-LATHES" 3 in. S.C. LATHES from £4.
3½ in. S.C.B.G. from £7/18/6. LISTS, Stamp please.
J. WILLIMOTT & SON, Neville's Factory, Chilwell, Notts.

MODEL AIRCRAFT MATERIALS
SEND 1d. STAMP for lists of
KITS, BLUE PRINTS, Balsa WOOD, etc.
'CONDOR' KITS AND MATERIALS EVERYTHING FOR THE AERO MODELLIST
NORTHERN MODEL AIRCRAFT CO.,
11a HIGH ST., MANCHESTER, 4
(Hours: Mon.—Fri. 9.30—6.30. Sat. 9.30—2.0)

MAKE YOUR OWN LEAD SOLDIERS

Cowboys, Indians, Animals, Zulus, Model Farmyard Sets, Rodeo, etc. Our CASTING MOULDS make thousands from any scrap lead WITHOUT PREVIOUS EXPERIENCE. Send stamp to-day for NEW Illustrated Catalogue. **J. TOYMOULDS,** 7 Jamaica Row, Birmingham. Mention "Practical Mechanics."



Send to FOYLES FOR BOOKS!

New and second-hand books on every subject. Over two million volumes in stock. Catalogues free on mentioning your interests.
119-125 Charing Cross Road, London, W.C.2
Telephone—Gerrard 5660 (seven lines).

FREE SERVICE FOR READERS

READERS requiring information concerning goods or services advertised in **PRACTICAL MECHANICS** should give names of Advertisers from whom particulars are desired. Any number of names may be included and we will obtain for you catalogues, lists, and any other information you may be wanting. THERE IS NO CHARGE FOR THIS SERVICE.

Readers desiring particulars from a number of Advertisers will, by this method, save time and postage. Half-penny stamp only is required if your envelope is left unsealed. If any Advertiser stipulates that stamps or postal orders are necessary before samples or catalogues are sent, please enclose the necessary amount with your instructions. You are cordially invited to make full use of this service.

Post to
ADVERT. SERVICE DEPT.,
PRACTICAL MECHANICS,
8-11 SOUTHAMPTON STREET,
STRAND, W.C.2

Please obtain and send to me particulars from the Advertisers in your November issue whose names I give on the list attached.

Advertiser.	Page No.	Information Required.
Attach sheet of paper, with particulars, and your name and address (written in BLOCK letters), with date.		

SPECIAL OFFER

of Battery chargers, complete in neat metal cases, Westinghouse Rectifiers; charge at 1 amp., ready to plug-in to A.C. Mains 200-250 v., 10/8 post free. Satisfaction guaranteed or money back. Reduced prices of Tantalum Kits: "A" charges at 1 amp., now only 5/10 post free; "B" charges at 1 amp., now only 7/6 post free. Tantalum 1/3. Mod 1 "E" a Real charger, charges 2-, 4- and 6-v. cells at 2 amps., or 6 2-v. cells at 1 amp., 21/- . A massive job that stands up to its work. Please state mains voltage when ordering.

FROST RADIO CO., 21 Red Lion Street, E.C.1

MICROPHONES

BY WESTERN ELECTRIC CO.
HANGING TYPE 3/- . HAND TYPE 3/6.
TRANSFORMERS 3/6.
BEAUTIFUL QUALITY—SPLENDID VALUE
(Carr. Paid)
Write for UTILITY SALES CO.,
Complete Lists. 27a SALE ST., PADDINGTON.

ART

MAKE MONEY IF YOU SKETCH or wish to write Showcards, Posters, Fashion Drawings or Tickets, etc., in your own time. Earn from 5/- to 10/- an hour.

Write for our free booklet. It will interest you. All kinds of drawings bought. Secretary,

ART STUDIOS, 12 & 13 HENRIETTA STREET, STRAND, W.C.2. Est. 1900

FREE ADVICE BUREAU COUPON

This coupon is available until November 30th, 1934, and must be attached to an letters containing queries.

PRACTICAL MECHANICS, NOVEMBER, 1934

Tools for the Home Mechanic

Hobbies Ltd. supply all kinds of tools and materials for the amateur craftsman. They are reliable, serviceable and reasonable. Wood, tools, fret machines, lathes, fancy fittings, hinges, transfers, all obtainable at low prices. Free lists on request if you mention your needs.

FRETSAWS for Wood or Metal

Strong British-made blade of superior quality steel, 4 1/2 in., 6 in. and 9 in. a dozen, in a variety of grades. Also special wide blades for thicker work, or fine tooth blades for metal work.

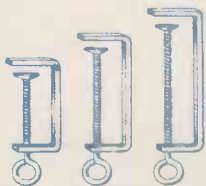

LIGHT CRAMPS
2 in. 4d.; 2½ in. 5d.;
3½ in. 6d.; 4½ in. 8d.
Postage extra.

MITRE CUTTING TOOLS

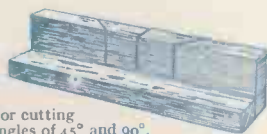

For cutting angles of 45° and 90°. Made in hardwood. Price 9d. (postage 6d.)

SINGLE-HANDED DRIVER



A screwdriver for small screws. With swivel head for use in one hand only. Ideal for model making and small work. Price 8d. (post 1½d.)

SMALL NAILS AND SCREWS

In brass or iron from ¼ in. to 3 in. Special thin shanks. Strong and well-cut Nails 3d. a box, Screws 1½d. doz. (iron) and 2½d. doz. (brass), postage extra.

SMALL HAMMERS, 4d.



AMATEUR'S BENCH VICE



Easily fixed to the kitchen table with screws provided. An essential tool to the handyman. Wonderful value. 12 in. Vice, 2/3; 15 in. Vice, 3/3. Postage 9d. extra.

The HOBBIES HANDBOOK

A book of 268 pages packed with articles on how to make and how to do. A free Toy Fort design and others worth 2/-. Over 500 things to make. Price 6d. at newsagents or post free 9d. from Hobbies as below.



You can get them from
HOBBIES

Obtainable from Hobbies Branches in London, Glasgow, Manchester, Birmingham, Leeds, Sheffield, Southampton, Brighton, or by post from Hobbies Ltd., Dept. 70, Dereham, Norfolk.

NEWNES

TO BE COMPLETED IN ABOUT 32 WEEKLY PARTS

CHEMISTRY IN COMMERCE

ADVISORY EDITOR :

M. D. CURWEN, B.Sc., A.I.C.

TO BE COMPLETED IN ABOUT 32 WEEKLY PARTS

NEWNES

CHEMISTRY IN COMMERCE

SHOWS HOW CHEMICAL PRINCIPLES ARE APPLIED IN PRACTICE

PRICE 1/-

WHY YOU SHOULD BUY IT

If you could spend several weeks visiting the works of some of our largest manufacturers, being shown round by the chemist responsible for the manufacturing operations, would you not glean an immense amount of really useful and interesting information?

This in effect is what the publication of this wonderful work now makes available to you, at a very small cost. Every alert man will appreciate the value of this authoritative survey of modern industrial processes, from the manufacture of chocolate to the production of chemicals.

Ask your newsagent to show you a copy of Part I to-day.

HOW THE WORK HAS BEEN WRITTEN AND ILLUSTRATED

THE WRITERS

We enlisted the co-operation of some of the leading manufacturers concerned in the industry mentioned. We were fortunate in securing their permission for their chemists to contribute the articles dealing respectively with their own industries.

Thus we have been enabled to bring within a manageable space an immense amount of essential data relating to chemistry, as applied to modern industry.

To the young chemist this comprehensive survey will provide an education in itself. To the business man it offers a reliable source of reference on those industries upon which the commercial prosperity of this country is based.

THE PLAN

The general plan of each series of articles is as follows:

First a brief outline of the manufacturing processes involved, and, secondly, details as to the routine control tests and analyses as actually carried out in the works laboratory.

THE ILLUSTRATIONS

We were also fortunate in obtaining permission for our photographers to visit each works laboratory, to take a series of pictures showing the exact methods and the sequence of operations as practised in the works laboratory, whilst each test was being carried out.

A FINE OPPORTUNITY FOR YOUNG MEN

The young man who has already decided upon the chemical profession for his career will need no persuasion to purchase this work. Whatever his academic training, he will appreciate the practical treatment given and he will see from the articles exactly how works chemists are dealing with practical problems in industry to-day.

Young men engaged in any of the industries below, though not directly on the chemical side, will also find the work well worth purchasing.

Clearly written text and action photographs taken in the works and works laboratories of some of our largest manufacturers convey a vast amount of information unobtainable from any other source. This work will form a most useful reference book for years to come. Order your copies to-day.

WHICH OF THESE INDUSTRIES INTEREST YOU?

Below is a list of industries dealt with in this work.

- | | |
|---------------------------------|-------------------------------|
| Gas Manufacture | Paints, Varnishes and Enamels |
| Coke and By-products | Glass Manufacture |
| Water Works Practice | Metallurgy |
| Manufacture of Heavy Chemicals | Electro Deposition |
| Bleaching and Dyeing | Petroleum Refining |
| Milk Distribution | Perfumes and Essences |
| Sugar Refining | Medicinal Chemicals and Drugs |
| Brewing and Distillery | Photographic Materials |
| Food Preserving | Paper Making |
| The Meat Industry | Ink Manufacture |
| Baking and Confectionery | India Rubber |
| Cocoa and Chocolate Manufacture | Flour Milling |
| Margarine Manufacture | Laundry Work |
| Glue Manufacture | Leather Industry |

BUY A COPY OF PART I TO-DAY, 1/-

Obtainable from all Newsagents and Bookstalls, or 1s. 2d., post free, from

GEORGE NEWNES LTD., 8-11 SOUTHAMPTON STREET, STRAND, LONDON, W.C.2