

**PRACTICAL**

June 1991 • £1.50

# ELECTRONICS

SCIENCE AND TECHNOLOGY

**£2000  
to be  
won!**  
Turn to page 30  
for details

## Light Speed

Fibre optic  
communications

## Phantom Phone

Build a trick  
cordless wonder

## Data Sheet

Hitachi H8/300

## How It Works

The Dot Matrix  
Printer

## CAD Review

A hard look at  
Seetrax Ranger

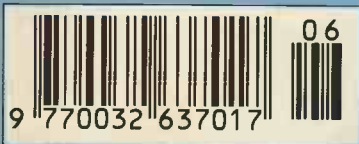
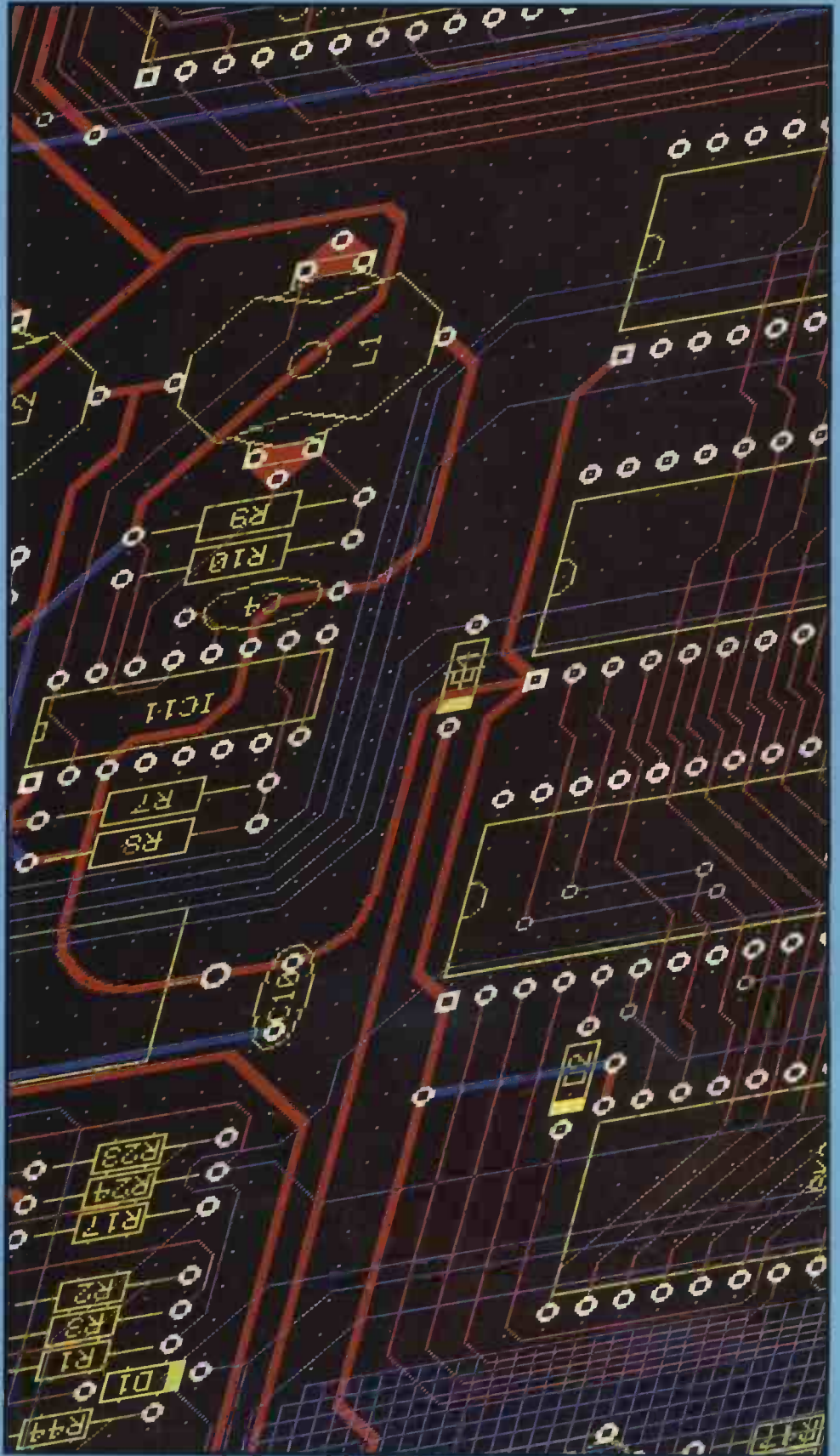

# Finally... an exceptional PCB and Schematic CAD system for every electronics engineer!

**B**oardMaker 1 is a powerful software tool which provides a convenient and professional method of drawing your schematics and designing your printed circuit boards, in one remarkably easy to use package. Engineers worldwide have discovered that it provides an unparalleled price performance advantage over other PC-based systems.

BoardMaker 1 is exceptionally easy to use - its sensible user interface allows you to use the cursor keys, mouse or direct keyboard commands to start designing a PCB or schematic within about half an hour of opening the box.

## HIGHLIGHTS

### Hardware:

- IBM PC, XT, AT or 100% compatible.
- MSDOS 3.x.
- 640K bytes system memory.
- HGA, CGA, MCGA, EGA or VGA display.
- Microsoft or compatible mouse recommended.

### Capabilities :

- Integrated PCB and schematic editor.
- 8 tracking layers, 2 silk screen layers.
- Maximum board or schematic size - 17 x 17 inches.
- 2000 components per layout. Symbols can be moved, rotated, repeated and mirrored.
- User definable symbol and macro library facilities including a symbol library editor.
- Graphical library browse facility.
- Design rule checking (DRC)- checks the clearances between items on the board.
- Real-time DRC display - when placing tracks you can see a continuous graphical display of the design rules set.
- Placement grid - Separate visible and snap grid - 7 placement grids in the range 2 thou to 0.1 inch.
- Auto via - vias are automatically placed when you switch layers - layer pairs can be assigned by the user.
- Blocks - groups of tracks, pads, symbols and text can be block manipulated using repeat, move, rotate and mirroring commands. Connectivity can be maintained if required.
- SMD - full surface mount components and facilities are catered for, including the use of the same SMD library symbols on both sides of the board.
- Circles - Arcs and circles up to the maximum board size can be drawn. These can be used to generate rounded track corners.
- Ground plane support - areas of copper can be filled to provide a ground plane or large copper area. This will automatically flow around any existing tracks and pads respecting design rules.

### Output drivers :

- Dot matrix printer.
- Compensated laser printer.
- PostScript output.
- Penplotter driver (HPGL or DMPL).
- Photoplot (Gerber) output.
- NC (ASCII Excellon) drill output.

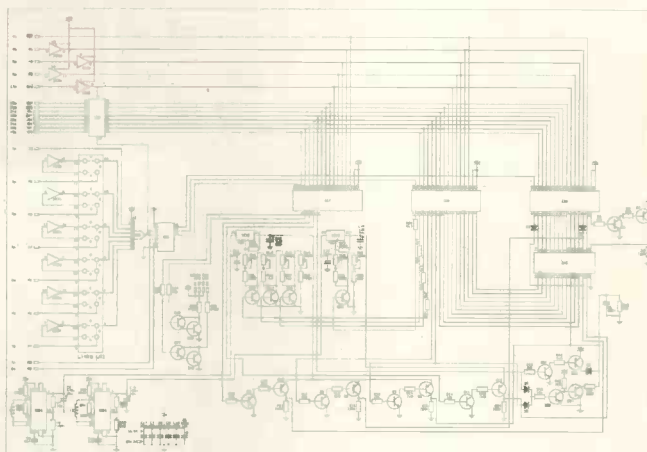

Produce clear, professional schematics for inclusion in your technical documentation.

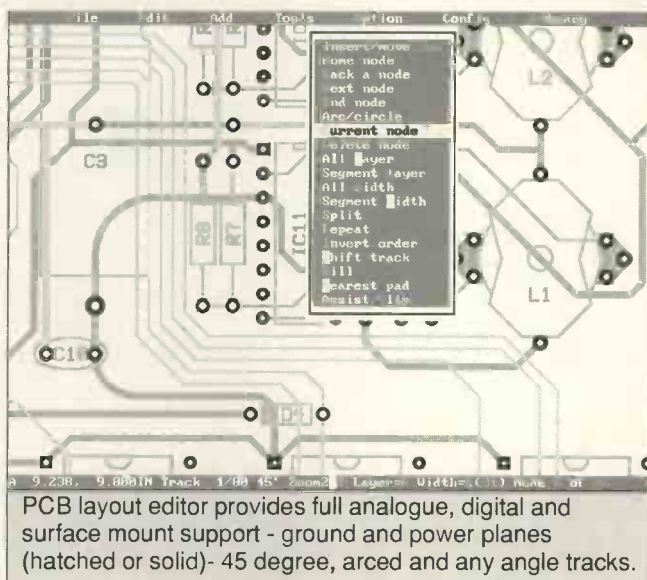

PCB layout editor provides full analogue, digital and surface mount support - ground and power planes (hatched or solid) - 45 degree, arced and any angle tracks.

**£95**

Despite its quality and performance, BoardMaker 1 only costs £95.00 + £5.00pp + VAT. Combine this with the 100% buy back discount if you upgrade to BoardMaker 2 or BoardRouter and your investment in Tsien products is assured.

**Don't take our word for it. Call us today for a FREE demonstration disk and judge for yourself.**



**tsien**

**Tsien (UK) Limited**  
 Cambridge Research Laboratories  
 181A Huntingdon Road  
 Cambridge CB3 0DJ  
 Tel 0223 277777  
 Fax 0223 277747

All trade marks acknowledged

## This month...

The secret of modern life is good communications, and as our transport system becomes overloaded, the need for electronic communications to replace it grows. Optical links offer a way to increase vastly the clarity and speed of data transfer.

Television will probably be part of the revolution, but how has the basic technology been built up and where is it leading? Talking of basic technology, the dot matrix printer has been around for a long time. This month's How It Works takes one apart and examines the basic operation.

A component found in all electronics hardware, both old and new, is the diode. Our regular Practical Components feature takes a closer look. At the other end of the scale, the new Hitachi microcontroller is an 8-bit wonder that points the way to a future where even the simplest electronic device will have a degree of intelligence.

*Kenn Garroch, Editor*

## Next month...

**PRACTICAL ELECTRONICS**  
SCIENCE AND TECHNOLOGY

July 1991 • £1.50

**A Global Village**  
Satellites come down to Earth

**Neural Networks**  
Electronics with intelligence

**Low Herz Metering**  
Simple designs for beginners

**Practical Components**  
Transistors with everything

**Data Sheet**  
Remote Control Chips

Plus the latest in Consumer Electronics

Satellite communications technology has created the global village, we are told. How much electromagnetic traffic is routed through orbital systems, and what are the limits of the technique?

## Build It

- Phantom Phone**.....15  
*Confuse everyone with this cell-phone trick device, and learn how to create simple sound effects into the bargain.*
- PE Chronos**.....37  
*The second part of our Universal Counter Timer project.*
- Ultra-Vision** .....46  
*See how the world looks in ultrasound with this PC based scanner.*

## Features

- Optical Fibre Technology** .....10  
*Once optical fibres replace conventional phone lines, optronics may replace electronics.*
- A Short History of TV** .....21  
*Find out why it has taken 70 years to get satellite communications into our homes. Will there ever be a world standard?*
- Seetrax Review** .....26  
*Computer Aided Design at your fingertips.*
- How It Works**.....44  
*The Dot Matrix Printer is still the basic system for hard copy output from most small computers.*

## Regulars

- Wavelength**.....5  
*Read what you think of PE.*
- Innovations**.....6  
*The latest chips, meters, computers, catalogues and events plus the usual roundup of international electronics news.*
- Data Sheet** .....31  
*Full specifications and diagrams of the new Hitachi H8/300 super powered microcontroller.*
- Practical Components**.....34  
*The diodes comes in many forms even though it is the simplest member of the semiconductor family.*
- Techniques** .....58  
*This month a rain detector and an explanation of guitar pickups.*
- Book Reviews** .....61  
*Reference material reviewed.*
- Barry Fox** .....63  
*Looking through expert eyes, Barry views the electronics industry.*

Editor: Kenn Garroch Technical Editor: Andrew Armstrong Technical Illustrator: Derek Gooding Advertisement Manager David Bonner Production Manager: Richard Milner Production Assistant: Michael Sullivan Office Manager: Laura Esterman Office Secretary: Wendy Rhodes Publisher: Angelo Zgorelec • **Practical Electronics** Intra House 193 Uxbridge Road London W12 9RA Tel: 081-743 8888 Fax: 081-743 3062 Telecom Gold: 87: SQQ567 • **Advertisements** The Publishers of PE take reasonable precautions to ensure that advertisements published in the magazine are genuine, but cannot take any responsibility in respect of statements or claims made by advertisers. The Publishers also cannot accept any liability in respect of goods not being delivered or not working properly. • © Intra Press 1991. Copyright in all drawings, photographs and articles published in PRACTICAL ELECTRONICS is fully protected, and reproduction or imitations in whole or in part are expressly forbidden. All reasonable precautions are taken by PRACTICAL ELECTRONICS to ensure that the advice and data given to readers is reliable. We cannot, however, guarantee it, and we cannot accept legal responsibility for it. Prices quoted are those current as we go to press. All material is accepted for publication on the express understanding that the contributor has the authority to permit us to do so. • Practical Electronics is typeset at Intra Press on Macintosh computers using Quark Xpress. Reproduction by Tetracolour Ltd. Printing by Andover Press, St Ives plc. Distribution by Seymour Press • ISSN 0032-6372 •



# Happy Memories

## Memories

4116	150ns (Pulls)	1.00
4164	100ns	1.35
41256	120ns	1.40
41256	100ns	1.55
41256	80ns	1.65
41464	80ns	4.45
411000	80ns	4.45
1Meg x 9 SIMM	80ns	37.50
1 Meg x 8 SIPP	80ns	39.50
6264	100ns LP	2.45
62256	100ns LP	3.45
2764	250ns	1.85
27128	250ns	2.25
27256	250ns	2.45
27C256	250ns	2.45
27512	250ns	3.45
27C512	250ns	3.75

## Motherboards

80286 12MHz	EMS on board,	Up to 4Mb RAM	£79
80286 16MHz	"	"	£95
80286 20MHz	"	"	£112
80386SX 16MHz	"	Up to 8Mb RAM	£255
80386SX 20MHz	"	Up to 20Mb RAM	£290
80386DX 25MHz	"	Up to 16Mb RAM	£390
80386DX 33MHz 32K Cache	"	"	£675

## Diskdrives

5.25" 1.2Mb Floppy	£47	3.25" 1.4Mb Floppy	£44
40Mb 28Ms IDE 3.25"	£140	80Mb 19Ms IDE 3.5"	£265
106Mb 19Ms IDE 3.5"	£325	177Mb 15Ms IDE 3.5"	£475
IDE Controller for 16 bit bus. 2 x FDD & 2 x HDD			£12
Ditto with Serial, Parallel and games ports on board	£29		

## Video

VGA card, 8 bit 256K RAM, up to 800 x 600 resolution	£37.50
VGA card, 16 bit 512K RAM, up to 1024 x 768	£69
VGA card, 16 bit 1MEG RAM, 1024 x 768 in 256 colours	£85
VGA colour monitor, up to 1024 x 768 14"	

## Miscellaneous

120Mb internal tape streamer (uses floppy controller)	£215
102 Key Keyboards with tactile clicking keys	£35

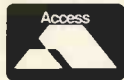

Carriage on Motherboards, Floppy drives & Keyboards £5, Video & Controller cards £3, Hard disks & monitors £10, IC's free if over £15 nett, otherwise add 50p. VAT to be added to the total. Full list of other ICs and computer parts on request. Send orders to: HAPPY MEMORIES, FREEPOST, HEREFORDSHIRE HR5 3BR TEL: (054 422) 618 FAX: (054 422) 628

## EPROM PROGRAMMERS

MODEL 200 - £295 (other models from £195)

- Includes MSDOS driver software, serial cable, comprehensive manual, 32 pin ZIF socket and universal object file editor/converter.
- Programs virtually all EPROM devices currently available including micro-controllers (nearly 600!).
- Emulation capability with our E512 or the Greenwich Instrument emulators.
- Easy to set up - *not* a plug in board.
- 12 Month Guarantee. Money back if not completely satisfied.
- Designed, manufactured and supported in the UK.



### Z8 ADAPTER FOR MODEL 200

- Programs Zilog and SGS parts
  - All Security Functions Programmable £75
- Increasingly popular 8 bit microcomputer available in CMOS versions.

### PIC 16C5x ADAPTER FOR MODEL 200

- Available for DIL or SOIC parts
  - Manufacturer approved algorithms From £75
- The 16C54/7 is a range of low cost, low power, high speed microcontrollers ideally suited to low or high volume developments

### 8 PIN SERIAL EPROM ADAPTER FOR MODEL 200

- Reads & programs over 50 devices
  - 1°C (M8571, X2402), 9306, 2506 etc. £95
- As used for security devices in many car radios, mobile radios, cellular phones & security systems.

- Adapters available also include
- 8748/41 family £75
  - 8751 family £75
  - 40 pin EPROMs up to 4 Mbit £75
  - 63701/5 from £75
  - 32 pin PLCC EPROMs £85
  - 647180 £125
- Other families in development - please enquire.

We also sell Bipolar and Gang Programmers, EPROM Emulators and Erasers and a universal cross-assembler for IBM PCs and compatibles.

Write or phone today for Free Information Pack  
Tel: (0666) 825146 Fax: (0666) 825147



MQP ELECTRONICS, PARK ROAD CENTRE, MALMESBURY, WILTSHIRE, SN16 0BX UK

Scandinavian customers please contact:  
Digitron A/S, Alesund, Norway  
Phone 071-45 890 Fax 071-45 453

German customers please contact:  
Synatron, Grasbrunn B. München, Germany  
Phone 089/4602071 Fax 089/4605661



## MICROPROCESSOR CONTROL AND DATA LOGGING APPLICATIONS



**HARDWARE**

'Off the Shelf' or custom made. A simple interfacing circuit or a full microprocessor system.



**SOFTWARE**

High and/or low level language programs to your specification supplied on disc or EPROM.



**MECHANICAL**

Sensors, positional slides, brackets, linkages etc. supplied or designed and manufactured.

Whether your application is control of a model railway or data acquisition on a factory production line, we can help by working with you to provide any or all of the above requirements needed to produce successful completion of your project. Hobby or industry, one off or batch work, we would be pleased to discuss your requirements.

### Just some of our stock items include:

PCW Parallel I/O Interface - 32 I/O Lines	£65.75
PCW 8 ch. AtoO (use with above interface)	£46.95
Z80A Single Board Micro Controller Special Offer	£69.95
PC/XT/AT 48 line Digital I/O + 3 counters	£80.50
PC/XT/AT 12 bit 16 ch AtoD, 1 ch DtoA	£133.36
PC/XT/AT 8 bit card - AtoD/DtoA/DIO/counters	£225.00
RS232/PCW printer/PC printer cables all	£10.28
Speech Synthesiser (use with CENTRONICS port)	£49.95
4 Colour Printer/Plotter (Use with CENTRONICS port)	£89.95
Computer to 8 off 10A DPCCO Relay Interface	£125.00



Prices include VAT and P&P  
OEM, trade and overseas enquiries welcome



**SM ENGINEERING**  
Telephone 0323-766262

'St Georges'  
Lion Hill, Stone Cross, Pevensey  
East Sussex BN24 5ED

# Wavelengths

If you have any comments, suggestions, subjects you think should be aired, write to PE

## QWERTY

I am writing to say how much I enjoyed Barry Fox' rant about portable computers. I have had my Psion Organiser for a year or so now and have found that it fulfils most of functions I need, clock, calendar, address book, but, unfortunately, not notebook. The trouble lies with the layout of the keyboard which is set out alphabetically. Having been a two fingered typist for a number of years I now find that I am hunting around like a beginner for the keys – can I make a public appeal for a qwerty version? The only realistic way to get notes into the machine is via a serial link to my PC which works well. Keep up the good work Barry Fox, your comments on the electronics industry are invaluable.

Alan Leigh  
London SW4

## Metal IC

I am a fourth year student of Fair Oak School in Rugeley and I wish to make a metal detector for industrial purposes.

I understand that there was one article on metal detectors using digital circuit ICs in one of your Practical Electronics magazines.

Would it be possible to provide me with information and circuit diagrams for a simple metal detector which could be made in the laboratory?

Shailen Bhatia  
Rugeley  
Staffs.

*Just this once we can reveal that there was a project in the October 1988 issue of PE. Anyone else who wants to know what was in PE over the years can now buy the complete PE back issues indices. Part 1 goes from issue 1, 1964 to 1973, part 2 from 1974 to 1983 and part 3 from 1984 to 1991. There are available at £2.00 each directly from PE. Constructors should note that trying to construct a project that*

*appeared more than three years ago can lead to problems getting hold of components.*

## In The Clear

I am writing with reference to your editorial and excellent review of Easy-PC in the December 1990 issue.

I subsequently made a telephone tour of the office equipment wholesalers and retailers in the area and eventually found one person who had heard of such a product but informed me that it had been discontinued.

Would you please be kind enough to give me the names of the makers of transparentisers and, if possible, the names and phone numbers of anyone who sells the product in 1991.

P A Waspe  
Cambridge

*There have been a number of requests for this product which is actually called Iso Draught Transparentiser and the only source we know of is:*

Cannon & Wrinn  
68 High St.  
Chislehurst  
Kent  
Tel. 081 467 0935

## Help

We were greatly helped by your magazine which had great influence on the foundation of our Young Scientists Club where we mostly try to repair and make all sorts of electrical appliances.

Here we currently have a severe shortage of kits like soldering irons, components etc. We are appealing to you if you could help us in any way to improve our club, either by telling us where we can buy (at discount) or donate some. Your co-operation would be greatly appreciated by all the club members. The components in the country are expensive which

hinders the enthusiasm of our practical electronics members.

Please help our club to grow and to associate with other clubs if possible. We look forward to hearing from you.

Rogers Ojesi  
Chairman  
Young Scientists Club  
Churchill Boys High School  
P O Box 8112  
Causeway  
Harare  
Zimbabwe

*Anyone who thinks they can help should get in touch at the above address.*

## Portable DAT Exists

I read with interest your articles about digital compact cassette and how it stands to take the market from under DATs not so firmly planted feet. One aspect of the matter seems to be whether DAT could be made portable or not. Your article mentioned that Philips were of the opinion that this would not be possible. However, a recent copy of CD Review had, you guessed it, a portable CD player under test. It seems that Philips may have been presuming too much or purposefully talking the opposition down. In the final outcome the specification of DAT appears to be much higher and what's more, it exists. Who's seen a DCC machine apart from a few journalists who made it to CES and who has heard one and compared it to the superb quality of DAT.

Philips are currently going through great ructions and its ability to produce a new product that requires as much backup as DCC must be in question. Unless, of course, a mysterious new backer such as Matsushita comes in to help out.

W Simmonds  
Portsmouth  
Hants

## Chip Count

Zilog has just launched its new Z86C06 micro-controller unit (MCU) which features a full Z8 and a serial peripheral interface (SPI) as used in the automotive industry and other consumer applications. A special feature of the device means that the Z8 can be connected to a common bus along with other modules. It can then remain in sleep mode until woken up by another device sending the correct address. Since the chip is fabricated using low power CMOS technology complete systems are readily run on battery power.

Also on the chip are two analogue comparators to allow implementation of a simple ADC, 124 bytes of RAM, a low electromagnetic interference (EMI) option for noise sensitive applications and two programmable counter timers with 6-bit prescaler. It operates from 3V to 5.5V over a wide -40°C to +105°C temperature range at three clock speeds, 4, 8 and 12MHz and is housed in a small 18-pin DIP package.

To help with the implementation of Z8 systems, Zilog has released Icebox, a set of in circuit emulators (ICE). These come in two formats, the high speed real time S series running at up to 20MHz and featuring a WIMP (Windows Icons Mouse Pointer) front end and full symbolic assembler/disassembler for IBM PC/XT/AT/386 systems. The cost effective C series communicates with the ICE via a serial cable and offers a cheaper emulation solution.

# Mini LCD

**L**CD modules are becoming smaller and smaller. The new TRMOD-34 from Trident Microsystems offers two lines of 16 five by seven dot matrix characters, each measuring 4.9x2.1mm.

The display area itself is 45x14mm and the whole module just 74x30x8mm. Billed as ideal for handheld instruments where space is at a premium, it is available from Trident on 0737 765900.



For more information contact Zilog at 210E Hacienda Ave. Campbell CA USA. □

**T**he first samples of a 16Mbit memory device were produced recently by Siemens. Boasting 33 million components on a chip measuring 142mm<sup>2</sup> it is said to be capable of storing the equivalent of 1000 typed A4 pages (2Mbytes). Following two years of research that came up with the 1Mbit and 4Mbit DRAMs, the 16Mbit DRAM should go into production in the near future – the next, a 64Mbyte chip designed in conjunction with IBM, should be available in the mid 1990s. □

# The Real Thing

**I**t may seem like a rather odd thing to manufacture, but OK Industries make dummy surface mount components. Physically identical to the real thing but at a fraction of the price all sorts of device packages are available. Actually aimed at pre-production trial systems

the chips save wasting money on test systems. The next time a manufacturer displays its new pre-production gizmo at a show, take a careful look at the chips, they may not be real. For more information contact OK Industries on 0703 619841.

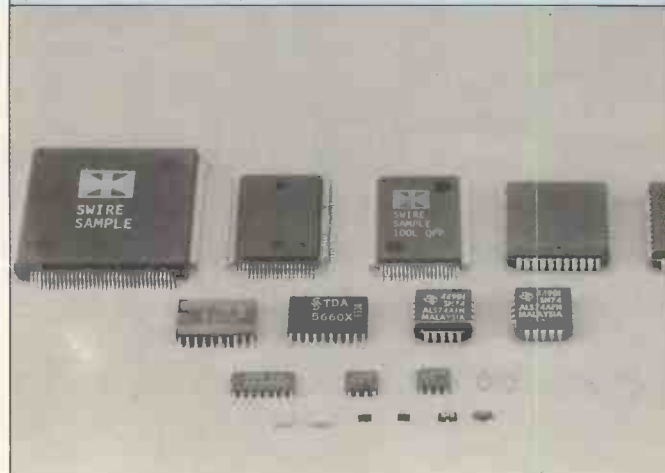

**T**he PCM67 is a dual 18-bit audio DAC (Digital to Analogue Convertor) featuring low cost, small size and a single +5V operation. Designed for use in digital audio applications, the chip provides high quality with better than 108dB dynamic range and a high signal to noise ratio (SNR). For more info. contact Burr Brown, PO Box 11400, Tucson, AZ, USA. □

**C**ompatible with the 80287 -6/-8/-10, 80C287 -12/-16/-20 and the 80287XL/XLT (it plugs straight into waiting sockets), the new universal maths co-processor from Ambar Cascom plugs directly into most PCs to help increase speed in applications that require lots of mathematical processing – such as spreadsheets. The 82S87 is a CMOS chip and a reduced power feature allows it to consume just

# High Speed PC

500 $\mu$ W – for use in laptop systems.

Also from Ambar Cascom is a new 16-bit DAC offering increased accuracy via laser trimmed thin film resistors, and very high speed – the settling time is just 150ns. The output voltage can be in a preselected range of +10 to 0, +5 to -5 and +2.5 to -2.5 volts. The HDAC52160 operates from a +15V supply for the analogue side and +5V for the digital. All logic levels are TTL and 5 volt CMOS compatible. Contact Ambar Cascom on 0296 434141. □

## General

Using micro-machining, microscopic silicon bridges, beams and pressure diaphragms can be used to build ultra sensitive sensors and optical switches. For use in medical applications, telecommunications and research, the new technique is capable of creating structures smaller than the width of a human hair. Contact Battelle, 505 King Avenue, Columbus Ohio, USA. □

The BOS 900 enclosure from Bopla is aimed at hand-held equipment constructors. The upper section is built to take a display of 16 characters by four lines there is also room for a membrane keypad around one millimeter thick.

Variations on the design offer a built-in battery compartment, carrying strap and battery charger stand. Finished in textured light grey the unit provides extra grip for outdoor applications. Contact Bopla on 0296 399999. □

Turning an 80286 based IBM AT compatible computer into a faster 80386SX has usually meant junking the machine and getting a new one. The Microway accelerator card Fastcache-SX Plus features a 16MHz 80386SX micro-processor, 32kbytes of high speed cache memory (expandable to 64k) and a socket for an optional 80387SX floating point co-processor. Both 16- and 32-bit applications such as Lotus 1-2-3 and Autocad can be run without modification with speed increases of up to 10 times that of a normal 6MHz IBM AT and 0.85 times that of a 16MHz 80386. What makes the Fastcache different from other similar cards is that performance is improved by placing data in a write buffer before passing it to system memory during write operations. This allows the processor to execute code from the cache while the last write to system memory is taking place. Contact Microway (Europe) Ltd., 32 High Street, Kingston-upon-Thames, Surrey, KT1 1HL, Tel. 081 541 5466.

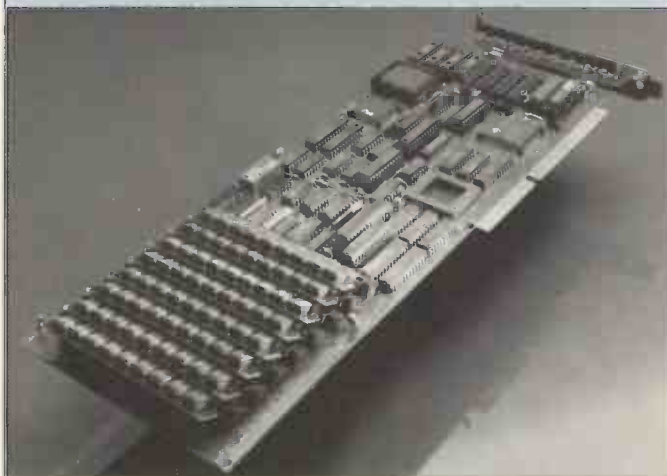

There are applications where equipment needs to be so robust it will withstand even the roughest treatment. A F Bulgin has announced its latest addition to its range of vandal resistant push switches. The MP0034 comes either in stainless steel or brass and requires a hole of only 18.9mm diameter. It uses a momentary action single-pole change-over microswitch and is ideal for exterior mounted security locks. Contact A F Bulgin & Co. on 081 594 5588. □

## Computers

Laser printers are finally reaching affordable prices if the new Mannesman Tally and Apple machines are anything to go by. The first is a new four page per minute machine currently priced at £949 with an expected high-street price of £699. The MT904 has HP laserjet IIP emulation with 14 built-in fonts, a 512kbyte memory and a footprint of 36.5cmx40.5cm.

The other new laser printer is from Apple – not generally known for being cheap. The Personal

Laserwriter LS is priced at £825 and is fully compatible with Apple Mac systems running system 6.0.7 with 1Mbyte of RAM and a hard disk. For more information dial 100 and ask for freephone Apple. Mannesman Tally can be contacted on 0734 788711. □

## Instruments



With a basic accuracy of 0.2%, inductance ranges of 190 $\mu$ H to 1900H, resistance ranges from 1900m $\Omega$  to 19M $\Omega$  and capacitance ranges from 190pF to 19mF, the LCR 815 from Flight Electronics offers high accuracy and selectable test frequencies. Other features are auto-ranging and auto parallel and series circuit mode selection. Costing £595 it is available from Flight Electronics Tel. 0703 229041. □



The Precision Thermometer from Electronic Temperature Instruments Ltd. gives readings to 1/10th degree over a range of -99.9 to 199.9°C. The display automatically

shows a minus sign for sub-zero temperatures and has a low battery warning. The temperature probe uses platinum resistance sensors to give very high accuracy and stability. The thermometer should prove useful in a variety of applications. Costing £75 it is available from ETI on 0903 202151. □

### Catalogues

A new catalogue from STC Instrument Services contains a comprehensive range of instruments and power supplied from over 70 leading manufacturers. It features all of the latest additions to STC's range including Seawards high-performance electrical and telecommunications equipment and the ABI series of in-circuit chip testers. The catalogue is available free of charge from STC Instrument Services, Edinburgh Way, Harlow, Essex CM20 2DF, Tel. 0279 641641. □

Circle recently launched a new catalogue specifically covering the Toko range of coils, filters and inductors as well as communications ICs. In addition to listing the products, the catalogue provides applications information which should prove useful to design engineers. □

Anyone interested in renting test and measurement equipment will be interested in the IR Group's latest catalogue. Products covered are analysers, component testers, computers development systems, industrial test equipment, meters, counters, oscilloscopes, peripherals, power

## Colour Carry Out

The Toshiba T3200 SXC is one of the first high quality colour portable PCs to become available. Using thin-film-transistor (TFT) LCD display technology the screen gives 256 colours out of a palette of 185193 - VGA with 640x480 pixels. The main system is 80386SX bases running at 20MHz with 1Mbytes of RAM as standard (expandable up to 13Mbytes) a 120Mbyte hard disk, high density floppy, 92 key keyboard

plus three expansion slots - either ISA and 8-bit half size or 16-bit Toshiba and a Toshiba internal modem. Interfaces are also available for 2 serial ports, an extra floppy disk drive and a VGA analogue CRT (Cathode Ray Tube). Weighing in at 7.9kg and measuring 283x217x25mm the only major drawback is the cost - a cool £6695. Toshiba are on 0932 841600.



Making equipment talk back has now been made easier with J P Design's Vocom. This consists of a module called Backchat which can either play back a passage of speech recorded on EPROM or record speech on RAM using delta recording to give up to 20 seconds of

sound time. Also available is a development unit which sports an integral EPROM programmer so that speech can be pre-recorded and then copied for multiple Backchat modules. Contact J P Designs, The Old School, Prickwillow, Ely, Cambs.



supplies, pro-programmers, recorders, signal sources, telecom-munications and data-communications testers and TV test equipment. For more information contact IR Group, Dorcan House, Meadfield Road, Langley, Slough, SL3 8AL Tel. 0753 580000. □

Anyone who has tried to get hold of technical manuals for obscure or out of date electronic equipment might like to try Mauritron Technical Services, 8 Cherry Tree Road, Chinnor, Oxon, OX9 4QY, Tel. 0844 51694. The company specialises in supplying workshop manuals for almost any type of equipment, no matter what it is, when it was made or what its age. Over 100,000 different makes and model are covered and an additional search and trace service is available for anything that is especially hard to find. A catalogue listing the manuals in stock is available in either hard-copy (A4) form for £10 or on IBM PC compatible floppy disk for £3 (5.25 inch) or £3.50 (3.5 inch). □

### Events

Though not directly connected with electronics, The Triumph Of The Embryo lecture at the Royal Society on 23rd May at 5.30pm may be of interest to readers. The lecture, given by Professor Lewis Wolpert, will discuss the development of genetic programming and cell interaction as well as patterning processes and mechanisms. For information contact The Royal Society, 6 Carlton House Terrace, London, SW1 5AG, Tel. 071 839 5561 ext 219/247. □



# Interak 1 BUILD YOUR OWN COMPUTER

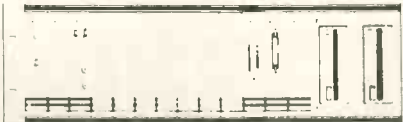

INTERAK can be commenced with the minimum of outlay. Bare boards from £10.95, beg borrow or steal the components, or buy from us - all parts available separately. No special or custom chips (ie PALs, ULAs, ASICs etc) used - no secrets.

Go as fast or as slowly as your funds and enthusiasm permit.

Made for those who must know what goes inside. Full circuit diagrams and descriptions are provided. And honestly can you really use a computer effectively if you don't know what's inside and nobody will tell you?

Solid engineering construction - something to be proud of. 19" 3U rack mounting plug in circuit boards and modular construction keeps obsolescence at bay.

Flourishing Independent Users Group and newsletter. Hundreds of programs on disk at little or no cost from the Users Group.

Program in machine code (Assembler), Basic, C, Fort, etc Database, Word Processing, Scientific applications.

Cassette tape operation or disk (up to 4 drives, 1 Megabyte 3.5" available from us, but you can add 3" 5.25" 8" if you want). Disk operating system CP/M Plus.

64K RAM Z80 based at present with potential for expansion to a 16 Megabytes address space and Zilog's latest Z80280 in the future.

Needs no specialised knowledge to construct, and we will happily get you out of a jam if you get into one.

Availability of personal and individual after sales service, impossible to obtain from large companies who are only after your money.

Security of supply - from Greenbank Electronics, established in 1970.

**Greenbank**

For more details write or phone us:

**Greenbank Electronics, Dept PE06 460 New Chester Road, Rock Ferry, Birkenhead, Merseyside. L42 2AE. Tel: 051-645 3391**

## UPGRADE OR BUILD YOUR OWN IBM COMPATIBLE



### MOTHERBOARDS

CPU	RAM	L/SPEED	PRICE
286-12	Ok	16Mhz	£105
286-12	1Mb	16Mhz	£165
386-SX	Ok	19Mhz	£285
386-25	Ok	33Mhz	£485
386-33	64k cache	54Mhz	£850

### GRAPHIC CARDS

VGA	256k	16 BIT	£75
SUPER VGA	512K	16BIT	£95

### ADD-IN CARDS

Floppy Hard Disc Controller I/O Card for XT/AT	£59
	£28

### BOOKS

Build your own 80286 IBM Comp-Pilgrim	£16.30
PC Upgrade Book Smith	£11.85

### KEYBOARDS

	(ENHANCED 102 KEY)	PRICE
IBM + COMPATIBLE		£35
AMSTRAD 1640/1512		£59
PS2 + COMPAQ		£75

### FLOPPY DRIVES

360k	5.25	£55
1.2M	5.25	£59
720k	3.5	£55
1.44	3.5	£59

### HARD DISC DRIVES

ST 225 20Mb 68MS 5.25"	Half Height	£145
ST 251 40Mb 28MS 5.25"	Half Height	£240
IDE hard disc 40Mb 28MS 3.5"	Half Height	£219
Dual Drive Cable Set		£10

### MANY OTHER PERIPHERALS AVAILABLE

**PANRIX  
ELECTRONICS**

93 KENTMERE APPROACH,  
LEEDS LS14 1JW.  
Tel: 0532 650214  
Fax: 0532 300 488



Whether your requirement for surveillance equipment is amateur, professional or you are just fascinated by this unique area of electronics SUMA DESIGNS has a kit to fit the bill. We have been designing electronic surveillance equipment for over 12 years and you can be sure that all of our kits are very well tried, tested and proven and come complete with full instructions, circuit diagrams, assembly details and all high quality components including fibreglass PCB. Unless otherwise stated all transmitters are tuneable and can be received on an ordinary VHF FM radio.

**UTX Ultra-miniature Room Transmitter.** Smallest room transmitter kit in the world! Incredible 10mm x 20mm including mic. 3-12V operation. 500m range.....£15.95

**MTX Micro-miniature Room Transmitter.** Best-selling micro-miniature room transmitter. Just 17mm x 17mm including mic. 3-12V operation. 1000m range.....£12.95

**STX High Performance Room Transmitter.** High performance transmitter with a buffered output stage for greater stability and range. 22mm x 22mm including mic. 6-12V operation, 1500m range.....£14.95

**VT500 High-Power Room Transmitter.** Powerful 250mW output providing excellent range and performance. Size 20mm x 40mm. 9-12V operation. 3000m range.....£15.95

**VXT Voice Activated Room Transmitter.** Triggers only when sounds are detected. Very low standby current, variable sensitivity and delay with led indicator. Size 20mm x 67mm, 9V operation, 1000m range.....£18.95

**QTX180 Crystal Controlled Room Transmitter.** Narrow band FM transmitter for the ultimate in privacy. Operates on 180 MHz and requires the use of a scanner receiver or our QRX180 kit (see catalogue). Size 20mm x 67mm. 9V operation. 1000m range.....£39.95

**SCRX Subcarrier Scrambled Room Transmitter.** Scrambled output from this transmitter cannot be monitored without the SCDM decoder connected to receiver. Size 20mm x 67mm, 9V operation, 1000m range.....£21.95

**SCDM Subcarrier Decoder Unit for SCRX.** Connects to receiver earphone socket and provides decoded audio output to headphones. Size 32mm x 70mm. 9-12V operation.....£21.95

**HVX400 Mains Powered Room Transmitter.** Connects directly to 240V AC supply for long term monitoring. Size 30mm x 35mm. 500m range.....£18.95

**ATR2 Micro Size Telephone Recording Interface.** Connects between telephone line (anywhere) and cassette recorder, variable automatically as phone is used. All conversations recorded. Size 16mm x 32mm. Powered from line.....£12.95

**UTLX Ultra-Miniature Telephone Transmitter.** Smallest telephone transmitter kit available. Incredible size of 10mm x 20mm! Connects to line (anywhere) and switches on and off with phone use. All conversation transmitted. Powered from line. 500m range.....£14.95

**TLX700 Micro-Miniature Telephone Transmitter.** Best-selling telephone transmitter. Being 20mm x 20mm it is easier to assemble than UTLX. Connects to line (anywhere) and switches on and off with phone use. All conversations transmitted. Powered from line. 1000m range.....£12.95

**STLX High-Performance Telephone Transmitter.** High power transmitter with buffered output stage providing excellent stability and performance. Connects to line (anywhere) and switches on and off with phone use. All conversations transmitted. Powered from line. 1500m range.....£15.95

**TKX900 Signalling/Tracking Transmitter.** Transmits a continuous stream of audio pulses with variable tone and rate. Ideal for signalling or tracking purposes. High power output giving range up to 3000m. Size 25mm x 63mm. 9V operation.....£21.95

**CD600 Professional Bug Detector/Locator.** Multicolour readout of signal strength with variable rate bleeper and variable sensitivity used to detect and locate hidden transmitters. Switch to AUDIO CONFIRM mode to distinguish between localised bug transmission and normal legitimate signals such as pagers, cellular, taxis etc. Size 70mm x 100mm. 9V operation.....£49.95

### ★★★ SPECIAL ★★★

**DLTX/DLRX Radio Control Switch.** Remote control anything around your home or garden, outside lights, alarms, paging system etc. System consists of a small VHF transmitter with digital encoder and receiver unit with decoder and relay output, momentary or alternate, 8-way dip switches on both boards set your unique security code. TX size 45mm x 45mm, RX size 35mm x 90mm. Both 9V operation. Range up to 200m. Complete System (2 kits).....£49.95  
Individual Transmitter DLTX.....£18.95  
Individual Receiver DLRX.....£36.95

A build-up service is available on all our kits if required.

UK customers please send cheques, POs or registered cash. Please add £1.50 per order for P&P. Goods despatched ASAP allowing for cheque clearance. Overseas customers send sterling bank draft and add £5.00 per order for shipment. Credit card orders welcomed on 0827 714476.

OUR LATEST CATALOGUE CONTAINING MANY MORE NEW SURVEILLANCE KITS NOW AVAILABLE. SEND TWO 22P STAMPS OR OVERSEAS SEND TWO IRCs.

## SUMA DESIGNS

The Workshops  
95 Main Road, Baxterley,  
Nr. Atherstone, Warwickshire CV9 2LE



Tel: 0827 714476

# Getting The Message Across

*Optical fibre transmissions will leap forward when new switching and modulation techniques develop. Mike Sanders sums up the position.*

Signal transmission through hair-thin filaments of glass (optical fibres) is an infant technology. Twenty years is a long time once development is accelerating, but not so long to get a brand-new technology off the ground. We will see many more developments in the next 20 years.

Current optical fibre transmission systems do signal processing electrically before using the optical signal (from a continuous laser source) as a carrier. Future systems will amplify optical signals directly, switching by extracting the required pulses without demodulating. Very fast optical switching will be used in telephone exchanges as well as computers.

Pockels and Kerr cells and acousto-optic modulators can be used to interrupt the lasing process to produce short, high energy pulses. These devices could be used as modulators or even optical

switches. They have many applications, so we will look at the general principles first.

## Faster Than Light

Some materials exhibit a feature called bi-refringence – they possess two different indices for perpendicular components of light. This can be used to separate rays that are elliptically or circularly polarised (Fig.1).

The Nicole prism for instance uses a material called calcite, in which a ray parallel to the optical axis travels faster than a ray perpendicular to it, so that two polarised beams can be separated.

A number of crystals and liquids show a bi-refringent effect when a high-voltage external electric field is applied, either linearly (the Pockels effect) or quadratically (the Kerr effect). The difference in refractive index depends on the voltage. The optical axis can be

switched rapidly, in a few nanoseconds. The Kerr effect requires stronger fields, and is strongest in liquids with anisotropic molecules, such as nitrobenzene. The Pockels effect only occurs in crystals which lack a centre of inversion, such as potassium dihydrogen phosphate and lithium niobate, where it dominates the Kerr effect.

## Bending The Beams

An acousto-optic modulator can be used for deflecting a beam, as well as for frequency and amplitude modulation. A transparent block such as quartz is used (Fig.2). A piezo-electric transducer is attached to this and acoustic waves induced in the block by applying, for instance, one volt at 50 MHz.

The transducer vibrates sending acoustic waves through the block. A laser beam is then aimed at the block at an angle shallow compared to the acoustic wavefront in the block (Fig.2). This causes light reflected from the wavefront to interfere constructively, if the following relationship holds:

$$m\lambda_o = 2\lambda_a \sin\theta$$

where  $m$  takes on the values 1,2,3 etc.

$\lambda_o$  is the optical wavelength  
 $\lambda_a$  is the acoustic wavelength in the quartz block.

With careful design, only the first order mode is induced where  $m = 1$ . By varying the voltage applied, the diffracted laser beam can be varied in amplitude from zero to maximum, so modulating the optical beam.

Fig. 1. Polarised rays.

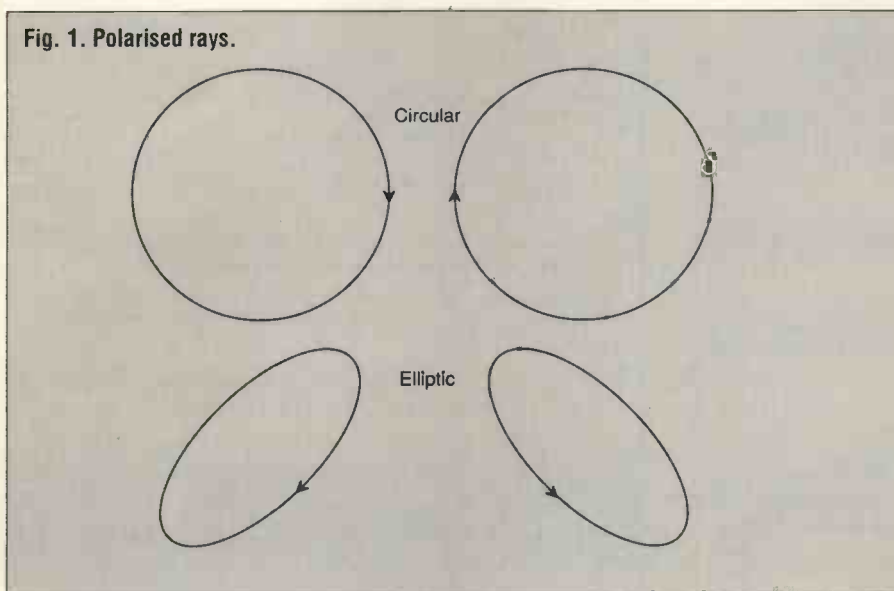
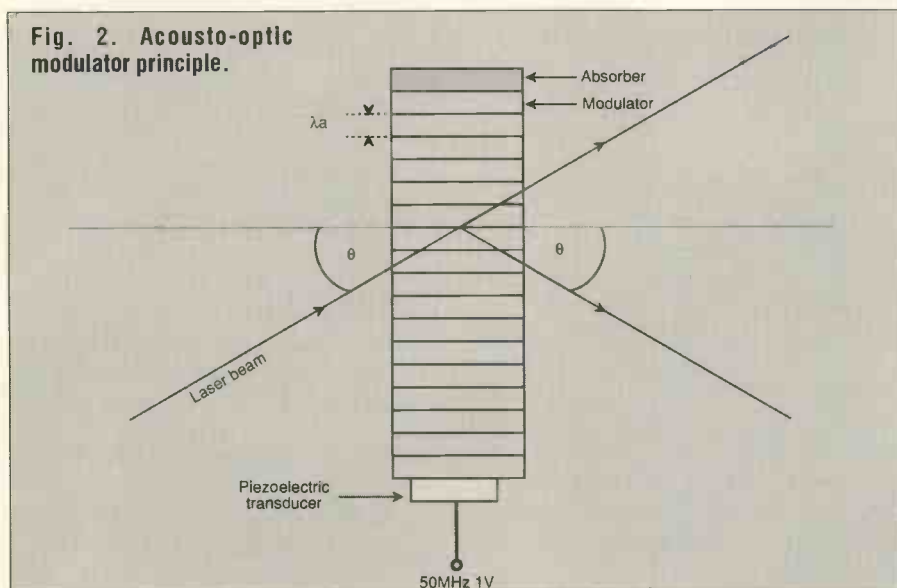

Fig. 2. Acousto-optic modulator principle.



## Seeing Through Crystal

One type of commercial modulator uses a lithium niobate (LiNbO<sub>3</sub>) chip to which the modulating voltage is applied (Fig.3). This produces an electrical field across the waveguide, changing the refractive index of the crystal and modulating the optical signal.

Operation at several gigahertz is possible if the electrodes are designed as transmission lines, so that the electrical control signals and optical wave propagate down the crystal together. To reduce interaction between the optical signal and the metal electrodes, a silicon dioxide layer is deposited on the surface of the crystal. This helps reduce the insertion loss. Light is launched into the modulator from an optical fibre connected to a highly polished waveguide in the crystal.

The waveguide is constructed in the surface of the crystal by selective diffusion of titanium. This raises the refractive index in the region. Conventional wet etching or an advanced gaseous reactive ion technique can be used. The electrodes, aluminium tracks 5µm thick, are formed in the same way.

The chip is sometimes hermetically sealed in a submodule, in which case it is soldered to the base, and electrical as well as optical subassemblies are welded with a high power laser. The hermetic submodule can be in a separate box for temperature control.

A typical modulator requires about 7 volts for a 180 degree phase

shift and modulation speeds of up to 4GHz have been achieved. Another type, the Mach-Zehnder modulator, consists basically of two phase modulators fed via a Y waveguide structure (Fig.4).

Applying a control voltage to the electrodes changes the phase of the two optical signals relative to each other, and they are then combined via the second Y branch. If the two signals are 180 degrees out of phase, the interference is destructive and no signal emerges at the output. If the signals are in phase, the interference is constructive and the output signal is of maximum intensity.

Obviously, such devices can be developed as modulators and optical switches as well as optical frequency translators, polarisation controllers and optical filters.

## Ons And Offs

The basic type of optical switch consists of two single mode waveguides (Fig.5). The waveguides cross each other at an angle of less than five degrees and

electrodes are placed across the point. The refractive index in this region is twice that of the waveguide, causing both the fundamental and first order mode to propagate. When a voltage is applied to the electrodes, light at the input is stopped from reaching the output; when it is removed, light reaches the output. A typical application would be switching broadband television.

A slightly different type of switch is the directional coupler (Fig.6). Two waveguides approach each other and run parallel for a short distance, where the fields couple and interact. As with the basic switch, the input light appears at the output only when the control voltage is absent.

These switches use the Pockels electro-optic effect when the voltage is applied. Lithium niobate is the usual material, and the waveguide uses thermally diffused titanium. When a voltage is applied, lithium niobate shows large proportional change in refractive index compared to other materials.

The speed of these switches is not limited by the Pockels effect but by the capacitance of the electrodes. The switching speed can be increased by altering the wavelength structure as for travelling wave operation, and speeds of higher than 5Gbits/s have been reported.

An 8 x 8 optical switch matrix has been manufactured on a single lithium niobate crystal. Each of the cross points is a directional coupler requiring a control voltage of 30V.

Holographic techniques can also yield higher switching capacities. Research continues into optical beam steering using holographic diffraction gratings in bismuth silicon oxide (BSO) crystals. Large arrays of 1000 x 1000 appear possible with switching speeds in

Fig. 3. Lithium niobate modulator.

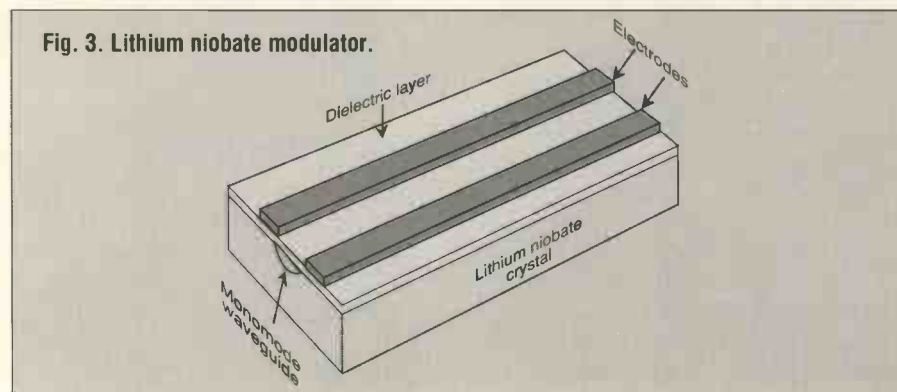

Fig. 4. Mach-Zehnder modulator.

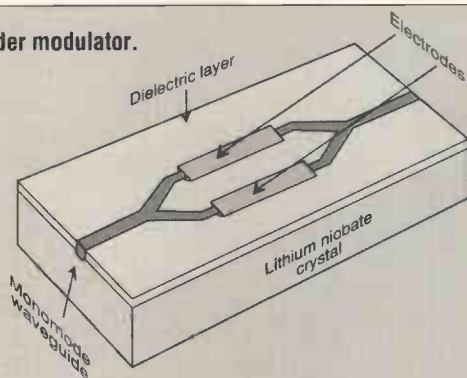

Fig. 5. Simple optical switch.

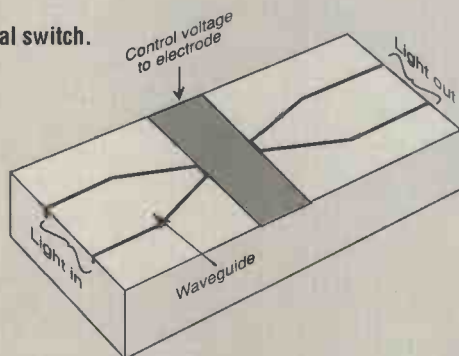
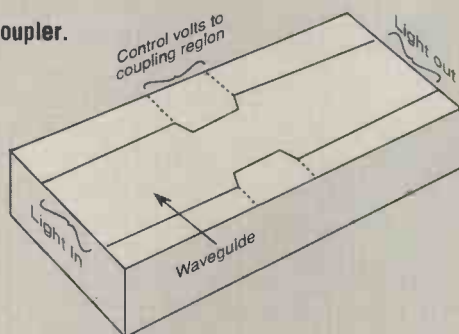

Fig. 6. Directional coupler.



the milli-second region.

Since lithium requires a high switching voltage, there is interest in devices made from gallium arsenide and indium phosphide. However, lithium niobate gives better matching into single mode fibres.

Liquid crystal can be switched in the same way. A matrix of 4 x 4 has been demonstrated which would be useful in optical fibre computer networks. Optical switching in computers would allow higher speeds of operation, parallel connections and a greater number of interconnections. The first optical computers will be expensive and probably belong to defence and research establishments, but they should get cheaper as the technology establishes itself.

The basic building block for the optical computer will be an optical bistable switch, the equivalent of today's electrical bistable switch.

When the light incident on an optical switch exceeds the threshold intensity, the switch passes it. If it is below the threshold, the switch stops it. The switch uses the hysteresis loop of Fig.7, where a small change in input results in a large change in output - reminiscent of the hysteresis loop of magnetic core switches in old computers.

Various other devices are under investigation, including the self electro-optic effect device (SEED). A 6 x 6 array of switches has been built, based on gallium arsenide.

## Optical Amplifiers

Optical amplifiers are being researched not only to replace regenerators but also to act as pre-amplifiers before the light detector.

One type of amplifier uses an optical fibre doped with the chemical erbium during

manufacture. Lasers housed in the amplifiers pump energy into the erbium, and the energy is transferred to the signal to amplify it. Amplifiers operating around the 1500 nm window with a 35nm bandwidth have been produced. Fig.8 shows a typical response.

## One For All

Wave division multiplex is where different wavelengths are combined and transmitted down a single fibre. The low loss window is from 1500nm to 1700nm. If the linewidth of the laser could be made narrow enough, a thousand wavelengths could in theory fit into the window. However, even if this were possible, in practice it would be necessary to multiplex the wavelengths, and demultiplex them at the receive end.

Physically these multiplexers and demultiplexers would be too large, as they employ diffraction gratings (Fig.9). Practical devices for multiplexing and demultiplexing about 20 channels have been devised.

In between this present practical limit and the theoretical limit of about 1000 channels, perhaps 200 channels would be practical if spaced one nanometer apart between 1500nm and 1700nm.

Modulating carriers separated by 1nm gives a bit rate of  $10^9$  bit/s. Present systems transmit 140Mbit/s, 180 Mbit/s and 565Mbit/s and are nowhere near the maximum capacity.

Two methods of wave division multiplex are possible, the diplex (Fig.10) and the duplex (Fig.11). In the diplex mode all the transmit wavelengths are multiplexed onto one fibre and all the receive wavelengths onto another. In the duplex mode all wavelengths are multiplexed onto just one fibre.

Another approach to coupling light from one fibre to another is with D fibres (Fig.12). Here the core is close to the surface, since this is like conventional fibre with half the cladding removed. Fibres are coupled by placing one across the other (Fig.13). For light to couple from one core to the other the flat part must be held in a reference plane. At the moment this is done by holding them in a substrate about 3cm x 1cm. The fibre is embedded in a polymer pressing

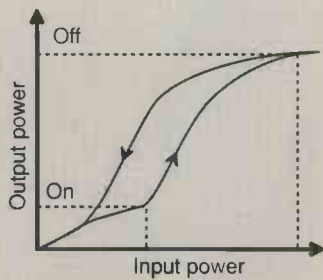

Fig. 7. Hysteresis loop.

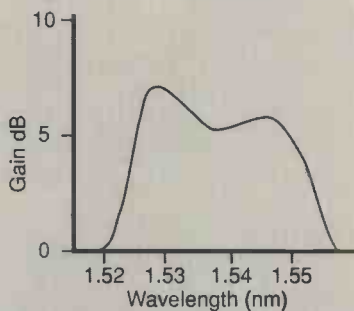

Fig. 8. Response of an optical amplifier.

against a flat surface. A flatness of better than  $5\mu\text{m}$  is achieved over a distance of 1cm.

Strictly this technique is not wave division multiplex, but the principle is much the same: a portion of the light energy is coupled from one fibre to another. Such devices can be used in switches, power splitters and filters.

## Fibres In Action

The biggest area of application is telecommunications but there are others.

In medicine, the fibre can be inserted into parts of the body such as the stomach or lungs to examine them. The fibre is thin enough to avoid too much irritation. Two fibres are usually used, one for transmitting light and the other for receiving images. The same two-fibre method can be used industrially to examine areas of machinery too dense for the insertion of mirrors.

Modern hydrophones (instruments for listening in water) use optical fibres to pick up vibrations, as do flow meters. The vibration of the fibre is proportional to the rate of flow of the liquid. This only requires a single fibre. Another single-strand application is measuring the transparency of liquids.

Optical fibre transmission of

telephony or data is extremely useful in areas where there is high electrical noise, such as factories.

Since optical fibres are safe to use near electric wires, they can measure high currents without breaking into the circuit or risking a short circuit with metal leads. The fibre is wrapped around the bus bar whose current is to be measured, and the rotation of the plane of polarisation of the light is then proportional to the length of path through the field and the strength of the field. This is Faraday's principle.

## Submarine Cables

No more analogue coaxial submarine cables are planned, and there is talk of withdrawing them from service, even though some were designed to last until after the year 2000.

On the other hand many new optical cables have been introduced in the last couple of years, each competing with its predecessor in length, bit rate or distance between repeaters.

The first optical fibre field trial in the UK took place between Hitchin and Stevenage, a distance of 9km. The system carried 140Mbit/s and used regenerators at 3km intervals. The whole cable was less than 7mm in diameter and carried three optical fibres, four copper wires for supplying dc to the generators and a steel cable in the centre for strength.

Optical submarine cables have improved in both bit rate and distance between regenerators in a few years.

The world's first international optical submarine cable was the 122km UK-Belgium 5, installed in 1985, costing £7.25 million. It has three pairs of fibres, each carrying 280Mbit/s. The wavelength of

operation is  $1.3\mu\text{m}$  and the regenerators are spaced at 30km.

The Transatlantic number 8 (TAT8) cable was installed in 1988 at a cost of £250 million. With figures like that it is obvious that optical fibres are big business, but this is the tip of the iceberg. Millions go into landlines linking cable landing points to telephone exchanges. TAT8 is 6600km long with three fibre pairs, each carrying 280Mbit/s, and 50km regenerator spacing. It runs from the USA and splits at a branching unit to the UK and France.

The Transatlantic number 9 (TAT9) cable is due in 1991 at a cost of around £250 million and will land in five countries: Canada, USA, UK, France and Spain. Unlike the passive branching units of TAT8, there will be two submerged active multiplexing units, as shown in Fig.14.

The system will operate at  $1.55\mu\text{m}$  and because of the low loss at this wavelength compared to  $1.3\mu\text{m}$ , the regenerator spacing will be 100km, double that of TAT8. TAT9 will carry 15,000 circuits and up to 75,000 circuits with circuit multiplication.

The UK-Denmark 4 entered service in 1988 at a cost of £24 million and able to carry 8000 circuits. It has two fibre pairs operating at 280Mbit/s over each pair, and 11 regenerators over a distance of 635km.

Closer to home there have been abundant opportunities for short unrepeaters links to the Isle of Man, the Isle of Wight and the Channel Islands. These short links have become longer as the technology has improved.

The world's first undersea single mode fibre cable was to the Isle of Wight in 1985. Costing £600,000, it ran 23km from Portsmouth to Ryde.

The next was to the Isle of Man

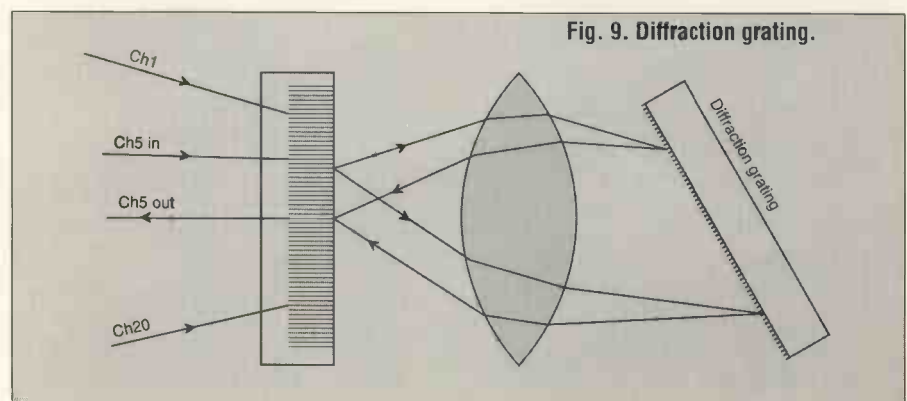

Fig. 9. Diffraction grating.

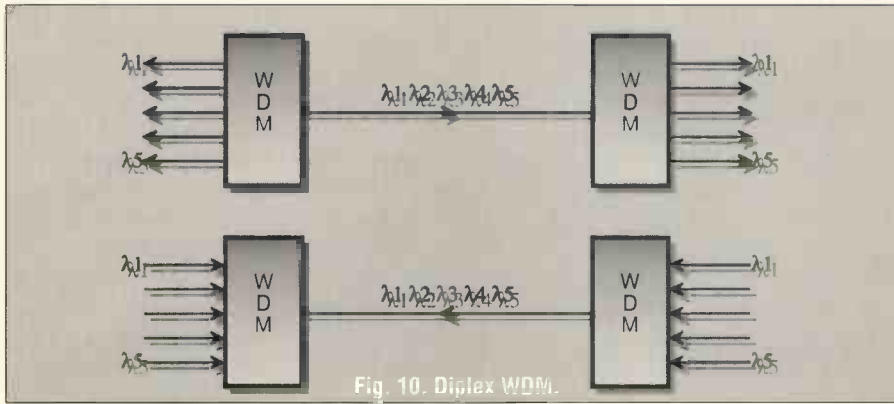

Fig. 10. Diplex WDM.

in 1987 costing £6 million. Unrepeated over 90km with a bit rate of 140Mbit/s, it has six pairs of fibres operating at 1550nm. Next to break the unrepeated distance record. with the same spec as its predecessor, was the 124km UK-Channel Islands number 7 costing £9M.

### The Future Of Fibre

Future cable systems will focus their interest on the 2.4µm window where losses are even smaller. These will use materials other than silica, such as zirconium tetrafluoride and beryllium fluoride. Although practical results have not improved on 1dB per kilometre, the theoretical limit is about 0.01dB/km at 2.5µm for zirconium tetrafluoride and 0.005dB/km at 2.1µm for beryllium fluoride.

The newer materials are less robust than silica and absorb water, so they will probably need silica cladding.

Development of a fifth generation of optical fibre systems would mean a corresponding development of very pure, stable and powerful single frequency

lasers. This would allow coherent systems where light waves are heterodyned in the same way as radio waves, combining the light wave carrying the signal with an intermediate frequency. Heterodyning would increase the sensitivity of optical systems by at least an order of magnitude.

### Analogue Systems

We saw above how optical fibre has been used to transmit digital signals with higher and higher bit rates, and finally in analogue mode to amplify the light and even extract desired signals without conventional demultiplexing.

Even now, optical fibres are used to carry analogue signals, but at much lower bandwidths. For instance, a single television signal of 6MHz bandwidth is carried on one fibre, when theoretically a single fibre should be capable of carrying many tv links. Such links are used within studios as well as between, say, a studio and a satellite earth station.

When the optical fibre is used in this way the signal needs to be applied to the straight part of the laser characteristics so that it is

amplified in the same way as in an analogue amplifier (Fig.15).

The transmitter would look something like Fig.16, with a biasing and matching network and a temperature controller. The receiver on the other end of the optical fibre uses a photodiode with appropriate bias circuitry, as in Fig.17.

### Up The Ladder

The advantages of optical fibre over copper cable include wide bandwidth and immunity to electrical noise. Most fibre is monomode these days. Developing fibre systems is now economically as well as technologically

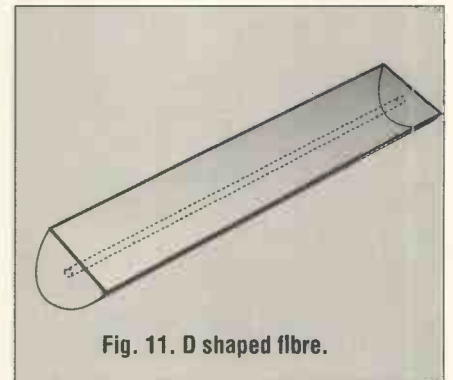

Fig. 11. D shaped fibre.

important, particularly modulators, optical switches and wave division multiplexers.

Optical submarine cables are advancing: early cables used regenerator spacing of 30-50km and a wavelength of 1.3µm while current systems achieve 60-100km and 1.5µm.

Future fibre systems will seek to climb the wavelength spectrum and exploit the 2.4µm window. We are set to go high on light. ■

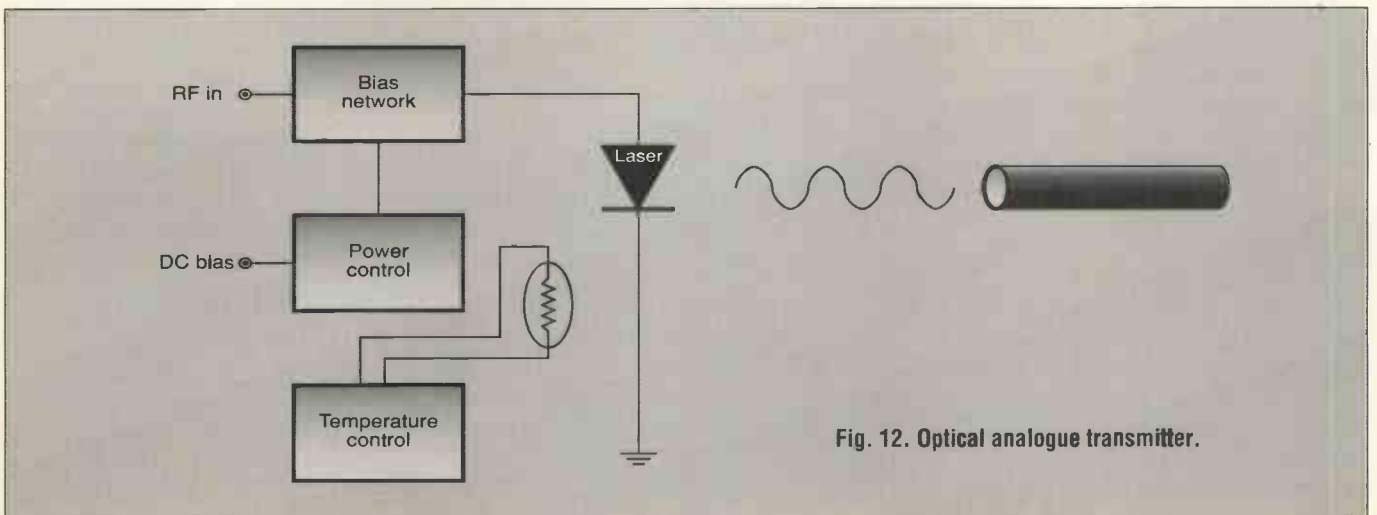

Fig. 12. Optical analogue transmitter.

**OMP POWER AMPLIFIER MODULES-TURNABLES-DIMMERS-LOUDSPEAKERS-19 INCH STEREO RACK AMPLIFIERS**

**OMP POWER AMPLIFIER MODULES**

Supplied ready built and tested.

**OMP POWER AMPLIFIER MODULES** Now enjoy a world-wide reputation for quality, reliability and performance at a realistic price. Four models available to suit the needs of the professional and hobby market - i.e. Industry, Leisure, Instrumental and Hi-Fi etc. When comparing prices, NOTE all models include Toroidal power supply, Integral heat sink, Glass fibre P.C.B. and Drive circuits to power compatible Vu meter. Open and short circuit proof.

**THOUSANDS OF MODULES PURCHASED BY PROFESSIONAL USERS**



**OMP100 Mk 11 Bi-Polar Output power 110 watts R.M.S. into 4 ohms. Frequency Response 15Hz - 30KHz - 3dB. T.H.D. 0.01%, S.N.R. -118dB. Sens. for Max. output 500mV at 10K, Size 355 x 115x65mm. PRICE £33.99 + £3.00 P&P.**

**NEW SERIES II MOS-FET MODULES**

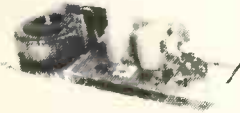

**OMP/MF 100 Mos-Fet Output power 110 watts R.M.S. into 4 ohms. Frequency Response 1Hz - 100KHz - 3dB. Damping Factor >300. Slew Rate 45V uS. T.H.D. Typical 0.002%. Input Sensitivity 500mV, S.N.R. -125dB. Size 300 x 123 x 60mm. PRICE £39.99 + £3.00 P&P.**



**OMP/MF200 Mos-Fet Output power 200 watts R.M.S. into 4 ohms. Frequency Response 1Hz - 100KHz - 3dB. Damping Factor >300. Slew Rate 50V uS. T.H.D. Typical 0.001%. Input Sensitivity 500mV, S.N.R. -130dB. Size 300 x 155 x 100mm. PRICE £62.99 + £3.50 P&P.**



**OMP/MF300 Mos-Fet Output power 300 watts R.M.S. into 4 ohms. Frequency Response 1Hz - 100KHz - 3dB. Damping Factor >300. Slew Rate 60V uS. T.H.D. Typical 0.0008%. Input Sensitivity 500mV, S.N.R. -130dB. Size 300 x 175 x 100mm. PRICE £79.99 + £4.50 P&P.**

NOTE - MOS-FET MODULES ARE AVAILABLE IN TWO VERSIONS STANDARD INPUT SENS 500mV BAND WIDTH 100KHZ P.E.C. (PROFESSIONAL EQUIPMENT COMPATIBLE) INPUT SENS 775mV BAND WIDTH 50KHZ ORDER STANDARD OR P.E.C.



**Vu METER** Compatible with our four amplifiers detailed above. A very accurate visual display employing 11 L.E.D. diodes (7 green, 4 red) plus an additional on off indicator. Sophisticated logic control circuits for very fast rise and decay times. Tough moulded plastic case, with tinted acrylic front. Size 84 x 27 x 45mm. PRICE £8.50 + 50p P&P.

**LOUDSPEAKERS**



**LARGE SELECTION OF SPECIALIST LOUDSPEAKERS AVAILABLE, INCLUDING CABINET FITTINGS, SPEAKER GRILLES, CROSS-OVERS AND HIGH POWER, HIGH FREQUENCY BULLETS AND HORNS, LARGE S.A.E. (30p STAMPED) FOR COMPLETE LIST.**

**McKENZIE:- INSTRUMENTS, P.A., DISCO, ETC.**

- ALL MCKENZIE UNITS 8 OHMS IMPEDANCE**
- 8" 100 WATT C8100GPM GEN. PURPOSE. LEAD GUITAR. EXCELLENT MID. DISCO. RES. FREQ. 80Hz FREQ. RESP. TO 14KHz SENS. 99dB. PRICE £28.59 + £2.00 P&P.
  - 10" 100 WATT C10100GP GUITAR, VOICE, ORGAN, KEYBOARD, DISCO, EXCELLENT MID. RES. FREQ. 70Hz FREQ. RESP. TO 6KHz SENS. 100dB. PRICE £34.70 + £2.50 P&P.
  - 10" 200 WATT C10200GP GUITAR, KEYBOARD, DISCO. EXCELLENT HIGH POWER MID. RES. FREQ. 45Hz FREQ. RESP. TO 7KHz SENS. 100dB. PRICE £47.48 + £2.50 P&P.
  - 12" 100 WATT C12100CP HIGH POWER GEN. PURPOSE. LEAD GUITAR, DISCO. RES. FREQ. 45Hz FREQ. RESP. TO 7KHz SENS. 98dB. PRICE £36.66 + £3.50 P&P.
  - 12" 100 WATT C12100TC TWIN CONE) HIGH POWER WIDE RESPONSE. P.A., VOICE, DISCO. RES. FREQ. 45Hz FREQ. RESP. TO 14KHz SENS. 100dB. PRICE £37.63 + £3.50 P&P.
  - 12" 200 WATT C12200B HIGH POWER BASS, KEYBOARDS, DISCO, P.A. RES. FREQ. 40Hz FREQ. RESP. TO 7KHz SENS. 100dB. PRICE £64.17 + £3.50 P&P.
  - 12" 300 WATT C12300GP HIGH POWER BASS LEAD GUITAR, KEYBOARDS, DISCO, ETC. RES. FREQ. 45Hz FREQ. RESP. TO 5KHz SENS. 100dB. PRICE £85.79 + £3.50 P&P.
  - 15" 100 WATT C15100BS BASS GUITAR, LOW FREQUENCY. P.A., DISCO. RES. FREQ. 40Hz FREQ. RESP. TO 5KHz SENS. 98dB. PRICE £53.70 + £4.00 P&P.
  - 15" 200 WATT C15200BS VERY HIGH POWER BASS. RES. FREQ. 40Hz FREQ. RESP. TO 4KHz SENS. 99dB. PRICE £73.26 + £4.00 P&P.
  - 15" 250 WATT C15250BS VERY HIGH POWER BASS. RES. FREQ. 40Hz FREQ. RESP. TO 4KHz SENS. 99dB. PRICE £80.53 + £4.50 P&P.
  - 15" 400 WATT C15400BS VERY HIGH POWER, LOW FREQUENCY BASS. RES. FREQ. 40Hz FREQ. RESP. TO 4KHz SENS. 102dB. PRICE £94.12 + £4.50 P&P.
  - 18" 400 WATT C18400BS EXTREMELY HIGH POWER, LOW FREQUENCY BASS. RES. FREQ. 27Hz FREQ. RESP. TO 3KHz SENS. 99dB. PRICE £167.85 + £5.00 P&P.

**EARBENDERS:- HI-FI, STUDIO, IN-CAR, ETC.**

- ALL EARBENDER UNITS 8 OHMS EXCEPT EB8-50 DUAL 4 AND 8 OHM. BASS, SINGLE CONE, HIGH COMPLIANCE, ROLLED FOAM SURROUND**
- 8" 50 WATT EB8-50 DUAL IMPEDANCE. TAPPED 4 & 8 OHM BASS. HI-FI, IN-CAR. RES. FREQ. 40Hz FREQ. RESP. TO 7KHz SENS. 97dB. PRICE £8.90 + £2.00 P&P.
  - 10" 50 WATT EB10-50 DUAL IMPEDANCE. TAPPED 4 & 8 OHM BASS. HI-FI, IN-CAR. RES. FREQ. 40Hz FREQ. RESP. TO 5KHz SENS. 99dB. PRICE £12.00 + £2.50 P&P.
  - 10" 100 WATT EB10-100 BASS, HI-FI, STUDIO. RES. FREQ. 35Hz FREQ. RESP. TO 3KHz SENS. 96dB. PRICE £27.50 + £3.50 P&P.
  - 12" 60 WATT EB12-60 BASS, HI-FI, STUDIO. RES. FREQ. 28Hz FREQ. RESP. TO 3KHz SENS. 92dB. PRICE £21.00 + £3.00 P&P.
  - 12" 100 WATT EB12-100 BASS, STUDIO, HI-FI, EXCELLENT DISCO. RES. FREQ. 26Hz FREQ. RESP. TO 3KHz SENS. 93dB. PRICE £32.00 + £3.50 P&P.
  - FULL RANGE TWIN CONE, HIGH COMPLIANCE, ROLLED SURROUND**
  - 5 1/2" 60 WATT EB5-60TC (TWIN CONE) HI-FI, MULTI-ARRAY DISCO ETC. RES. FREQ. 63Hz FREQ. RESP. TO 20KHz SENS. 92dB. PRICE £9.99 + £1.50 P&P.
  - 6 1/2" 60 WATT EB6-60TC (TWIN CONE) HI-FI, MULTI-ARRAY DISCO ETC. RES. FREQ. 38Hz FREQ. RESP. TO 20KHz SENS. 94dB. PRICE £10.99 + £1.50 P&P.
  - 8" 60 WATT EB8-60TC (TWIN CONE) HI-FI, MULTI-ARRAY DISCO ETC. RES. FREQ. 40Hz FREQ. RESP. TO 18KHz SENS. 89dB. PRICE £12.99 + £1.50 P&P.
  - 10" 60 WATT EB10-60TC (TWIN CONE) HI-FI, MULTI-ARRAY DISCO ETC. RES. FREQ. 35Hz FREQ. RESP. TO 12KHz SENS. 86dB. PRICE £16.49 + £2.00 P&P.

**TRANSMITTER HOBBY KITS**

PROVEN TRANSMITTER DESIGNS INCLUDING GLASS FIBRE PRINTED CIRCUIT BOARD AND HIGH QUALITY COMPONENTS COMPLETE WITH CIRCUIT AND INSTRUCTIONS

3W FM TRANSMITTER 90-108MHz. VARICAP CONTROLLED PROFESSIONAL PERFORMANCE. RANGE UP TO 3 MILES. SIZE 38 x 123mm. SUPPLY 12V IN 0.5AMP. PRICE £14.49 + £1.00 P&P

FM MICRO TRANSMITTER (BUZ) 100-108MHz. VARICAP TUNED COMPLETE WITH VERY SENS FET MIC RANGE 100-300m. SIZE 36 x 46mm. SUPPLY 9V BATT. PRICE £8.62 + £1.00 P&P



3 watt FM Transmitter



POSTAL CHARGES PER ORDER £1.00 MINIMUM. OFFICIAL ORDERS WELCOME FROM SCHOOLS, COLLEGES, GOVT. BODIES, ETC. PRICES INCLUSIVE OF V.A.T. SALES COUNTER. VISA ACCESS ACCEPTED BY POST, PHONE OR FAX.



\* PRICES INCLUDE V.A.T. \* PROMPT DELIVERIES \* FRIENDLY SERVICE \* LARGE S.A.E., 30p STAMPED FOR CURRENT LIST.

**OMP VARISPEED TURNTABLE CHASSIS**

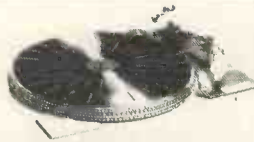

- \* MANUAL ARM
- \* STEEL CHASSIS
- \* ELECTRONIC SPEED CONTROL 33 & 45
- \* VARI PITCH CONTROL
- \* HIGH TORQUE SERVO DRIVEN DC MOTOR
- \* TRANSIT SCREWS
- \* 12 DIE CAST PLATTER
- \* NEON STROBE
- \* CALIBRATED BAL WEIGHT
- \* REMOVABLE HEAD SHELL
- \* CARTRIDGE FIXINGS
- \* CUE LEVER
- \* POWER 220 240V 50/60Hz
- \* 390 x 305mm
- \* SUPPLIED WITH MOUNTING CUT-OUT TEMPLATE

PRICE £59.99 + £3.50 P&P.

**OPTIONAL MAGNETIC CARTRIDGES**

STANTON AL500  
PRICE £16.99 + 50p P&P

GOLDRING G850  
PRICE £6.99 + 50p P&P

**OMP MOS-FET POWER AMPLIFIERS, HIGH POWER, TWO CHANNEL 19 INCH RACK**

**THOUSANDS PURCHASED BY PROFESSIONAL USERS**



**NEW MXF SERIES OF POWER AMPLIFIERS**  
THREE MODELS:- MXF200 (100w + 100w)  
MXF400 (200w + 200w) MXF600 (300w + 300w)

All power ratings R.M.S. into 4 ohms.

**FEATURES:** \* Independent power supplies with two Toroidal Transformers \* Twin L.E.D. Vu meters \* Rotary indexed level controls \* Illuminated on off switch \* XLR connectors \* Standard 775mV inputs \* Open and short circuit proof \* Latest Mos-Fets for stress free power delivery into virtually any load \* High slew rate \* Very low distortion \* Aluminium cases \* MXF600 Fan Cooled with D.C. Loudspeaker and Thermal Protection

USED THE WORLD OVER IN CLUBS, PUBS, CINEMAS, DISCOS ETC.

- SIZES:- MXF 200 W19 x H3 1/2" (2U) x D11  
MXF 400 W19 x H5 1/2" (3U) x D12  
MXF 600 W19 x H5 1/2" (3U) x D13

MXF200 £171.35  
MXF400 £228.85  
MXF600 £322.00  
SECURICOR DELIVERY £12.00 EACH



**OMP LINNET LOUDSPEAKERS**

THE VERY BEST IN QUALITY AND VALUE



MADE ESPECIALLY TO SUIT TODAY'S NEED FOR COMPACTNESS WITH HIGH OUTPUT SOUND LEVELS. FINISHED IN HARDWEARING BLACK VYNIDE WITH PROTECTIVE CORNERS GRILLE AND CARRYING HANDLE. INCORPORATES 12" DRIVER PLUS HIGH FREQ. HORN FOR FULL FREQ. RANGE 45Hz-20KHz BOTH MODELS 8 OHM. SIZE H18" x W15" x D12"

CHOICE OF TWO MODELS

POWER RATINGS QUOTED IN WATTS RMS FOR EACH CABINET

OMP 12-100 (100W 100dB) PRICE £159.99 PER PAIR  
OMP 12-200 (200W 102dB) PRICE £209.99 PER PAIR

SECURICOR DEL:- £12.00 PER PAIR

**PIEZO ELECTRIC TWEETERS-MOTOROLA**

PIEZO ELECTRIC TWEETERS - MOTOROLA

Join the Piezo revolution. The low dynamic mass (no voice coil) of a Piezo tweeter produces an improved transient response with a lower distortion level than ordinary dynamic tweeters. As a crossover is not required these units can be added to existing speaker systems of up to 100 watts (more if 2 put in series) FREE EXPLANATORY LEAFLETS SUPPLIED WITH EACH TWEETER.

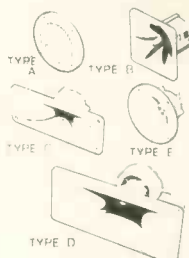

\* TYPE 'A' (KSN2036A) 3" round with protective wire mesh, ideal for bookshelf and medium sized Hi-Fi speakers. Price £4.90 each + 50p P&P

\* TYPE 'B' (KSN1005a) 3 1/2" super horn. For general purpose speakers, disco and P.A. systems etc. Price £5.00 each + 50p P&P

\* TYPE 'C' (KSN6016A) 2" x 5" wide dispersion horn. For quality Hi-Fi systems and quality discos etc. Price £6.99 each + 50p P&P

\* TYPE 'D' (KSN1025A) 2" x 6" wide dispersion horn. Upper frequency response retained extending down to mid range (2KHz). Suitable for high quality Hi-Fi systems and quality discos. Price £9.99 each + 50p P&P

\* TYPE 'E' (KSN1038A) 3 1/4" horn tweeter with attractive silver finish trim. Suitable for Hi-Fi monitor systems etc. Price £5.99 each + 50p P&P

\* LEVEL CONTROL Combines on a recessed mounting plate, level control and cabinet input jack socket. 85x85mm. Price £3.99 + 50p P&P

**STEREO DISCO MIXER**

STEREO DISCO MIXER with 2 x 5 band L & R graphic equalisers and twin 10 segment L.E.D. Vu Meters. Many outstanding features 5 inputs with individual faders providing a useful combination of the following:-  
3 Turntables (Mag). 3 Mics. 4 Line including CD plus Mic with talk over switch Headphone Monitor. Pan Pot L & R. Master Output controls. Output 775mV. Size 360x280x90mm. Supply 220-240v.  
Price £134.99 - £4.00 P&P



**B. K. ELECTRONICS** Dept PE  
UNIT 5, COMET WAY, SOUTHEND-ON-SEA, ESSEX. SS2 6TR  
TEL: 0702-527572 FAX: 0702-420243

# Is Anybody There?

*A C Denison's Phantom Phone could drive you and your friends crazy. After all, who can ignore a ringing telephone?*

I am sure that the vast majority of electronics enthusiasts will certainly own a sizeable conglomeration of the most wonderful odds and ends, tucked carefully away in every conceivable corner of the home just waiting for that rainy day that somehow never seems to come. Every now and then a tidy up is in order, if only to muse for a while over the priceless cache. It was on one such occasion that I came upon a broken, one piece telephone, long since discarded and completely forgotten about. Being blessed with a shade of inspiration and a suitably strange sense of humour, it wasn't long before the innards were plucked out and replaced with a slightly different circuit. The end product is the

Phantom Phone, guaranteed to drive all but the most saintly to the brink of despair.

When the instrument is placed on a hard, flat surface, the hookswitch will initiate a timing cycle of around two minutes, after which it will start to ring, sounding just like the real thing. When a suitable victim tries to answer the incoming call, the ringer will stop the instant the phone is picked up, but of course, there is no-one on the other end of the line because there is no line. Strangely enough, some victims of this harmless prank never seem to notice the total absence of side tone or even the fact there is no line cord. They simply replace the phone with a puzzled expression only to be caught again

two minutes later. Depending on the patience of the hapless victim, the process can continue ad infinitum.

## Ring A Ding Ding

The earliest method of one telephone set attracting the attention of another was for the caller to literally shout down the handset, Hello or Ahoy. Understandably, this unlikely arrangement soon gave way to a more convenient and practical way of signalling, the Telephone Ringer. Patented in 1878 by Thomas Watson, (Alexander Graham Bell's assistant), the electromagnetic bell is rugged, reliable and loud enough to be heard for some appreciable

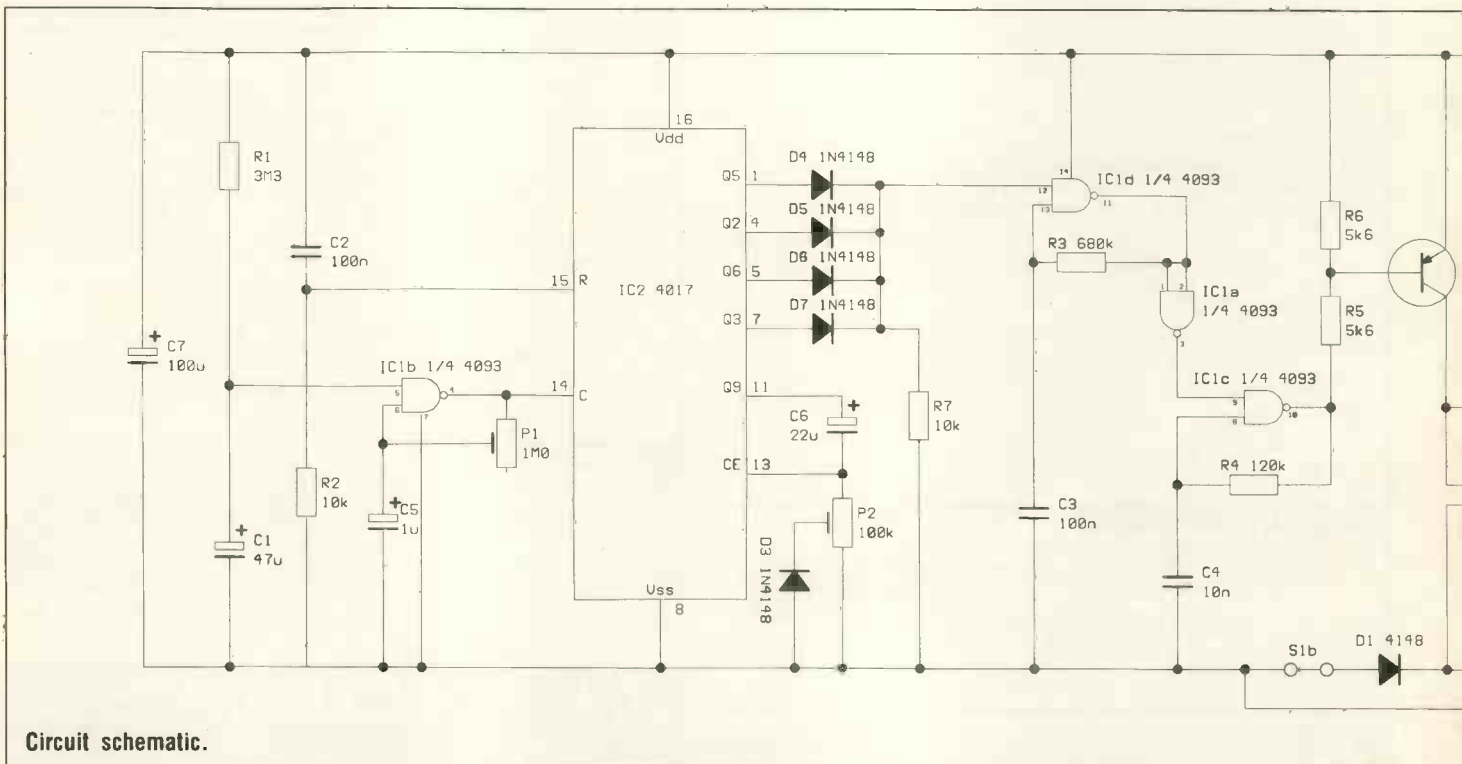

Circuit schematic.



distance, an important consideration in days when one telephone per household seemed to be the accepted standard. The resonant qualities of the bell type ringer created a sense of urgency to spur the subscriber into answering the incoming call without undue delay, a desirable aspect from the Telephone Company's point of view as ringing ties up essential equipment and makes no profit.

It would seem clear that the telephone bell was a major step forward from the original method of shouting at the handset but an underlying snag was to emerge as the telephone network gained momentum. In an office environment for example, where a large number of phones were in use, it was no easy task to distinguish which phone was ringing when they all sounded very much alike. It was apparent that some form of individuality was essential if the world was to remain sane, and so it is reasonable to expect some considerable development to have taken place in this particular problem area, which has indeed been the case. Although the telecommunications system has remained with relatively few changes in its basic concept for a hundred years or more, the ringer has emerged today as a remarkably versatile part of telephone equipment.

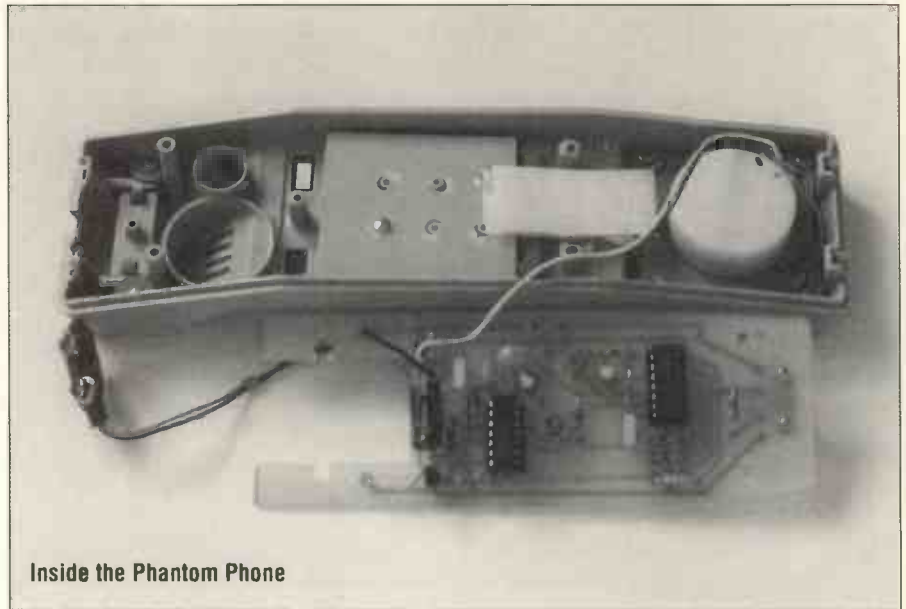

Inside the Phantom Phone

Surprisingly, the humble bell is still very much in evidence today and cannot be denied its place when a more resounding quality of sound is required. However, electronic ringing circuitry clearly dominates the field with modern preferences for lighter, more compact equipment in keeping with up to date domestic and business environments. It is a relatively simple matter to implement a low cost electronic ringer using just one transistor, a piezo electric transducer and a few passive components. However, advances in integrated ringer technology provide ICs which contain virtually all the necessary elements for a complete ringer circuit and can offer other features as well. The ringing pitch can normally be made infinitely variable so that one telephone can be easily identified from a number of others when a call is incoming. Other useful options include multitone ringers, to positively identify a special line and an integral control which will increase the ringer volume if a call remains unanswered for more than a few minutes.

Although electronic circuitry can provide the audible higher frequency sound of the ringer, the incoming AC signal, typically 75V at around 25Hz will usually control the low frequency component, giving the characteristic warble effect commonly recognised as the modern telephone sound. This low frequency component is the one aspect of electronic ring generation that cannot normally be altered.

## Circuit Description

The electronic telephone ringer in its basic form consists of an oscillator set to run within the easily heard AF (audio frequency) speechband – around 600Hz. This is gated and modulated by an incoming low frequency AC ringing signal in the region of 25Hz to produce a Trimphone type sound, characteristic of most modern telephones. The Phantom Phone has been designed to simulate this sound closely without need of an incoming signal. The circuit blocks required to achieve this are a main oscillator to provide the basic tone, a modulation oscillator to simulate the AC ringing waveform and the timing circuitry to mimic the well known double ring and pause of the standard UK ring signal. After the phone is picked up, S1b switches a low resistance across the circuit. Without this connection the ringer will fail to cut out crisply on switchoff. The frequency of the main oscillator is not critical, so can vary to some extent without undue problems, but component tolerances may cause the timing to be incorrect with a resultant loss of realism. Two presets are provided to allow adjustments to be made. P1 sets the overall timing while P2 adjusts the pause between rings.

The timing control is the main area which may require some explanation and reference to the timing diagram will simplify things. The 4017BE is a sequential decade counter whose outputs switch high, in order, from Q0 to Q9, Q0 being

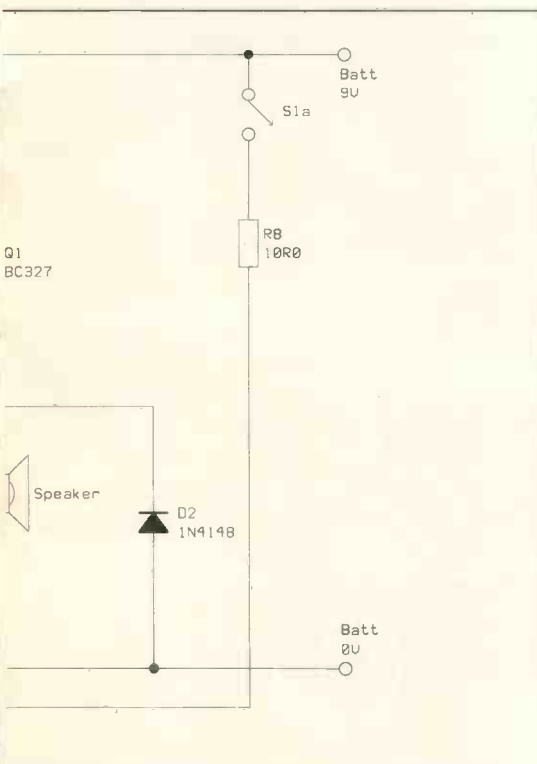

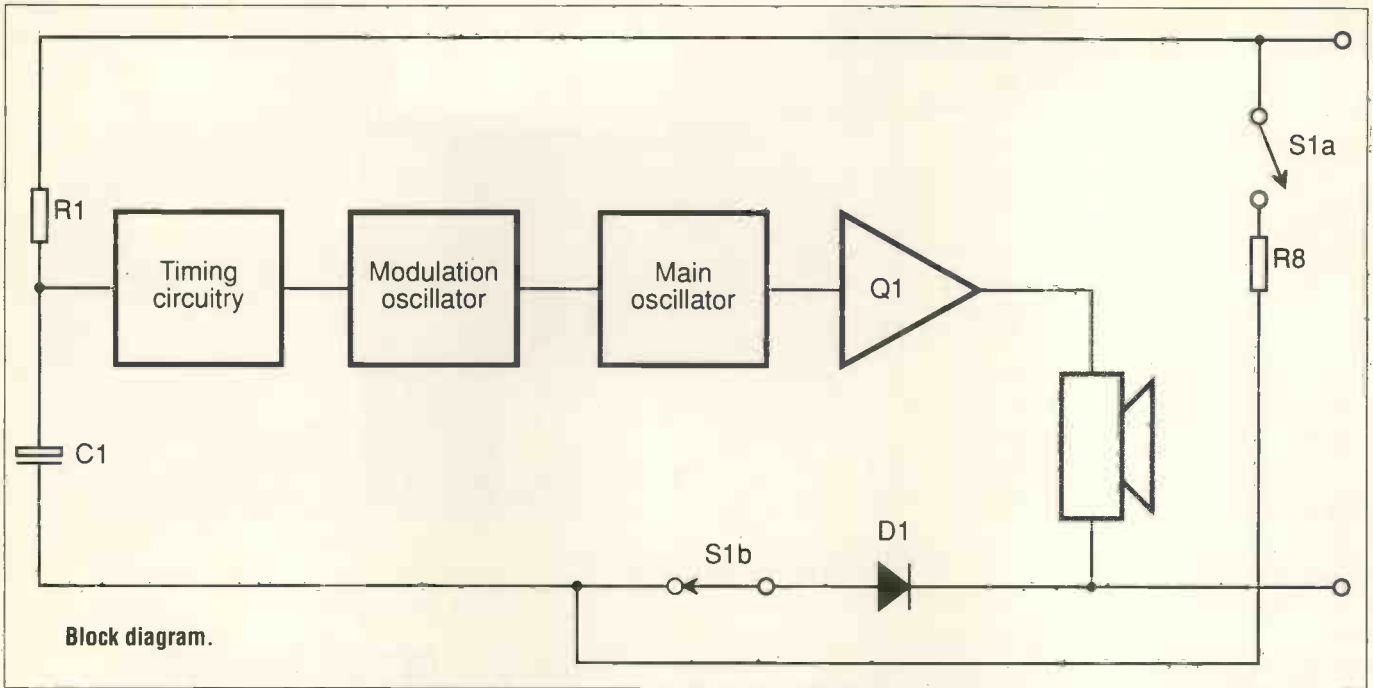

Block diagram.

the reset condition whenever the reset input is at logic 1. Since ten separate clock periods are represented by the counter, by ORing the outputs, any time period or combinations thereof can be obtained.

In the circuit, four outputs have been diode ORed to realise two separate rings with the remaining six outputs left unconnected – creating a pause period between rings. One drawback of this system is that the time duration required is longer than can be obtained in just six clock periods. When any output of the 4017 is connected to the clock inhibit input (CE), the counter will latch when this output goes high. To achieve an extension of the available pause time, one output has been linked to the clock inhibit input via an RC network which inhibits response to further clock

pulses until the capacitor charge voltage at the inhibit input has decayed below the input threshold, around 2V. D3 clips the negative spike at pin 13, when the counter restarts. At switch-on, a momentary high at the reset input, derived from R2-C2, resets the timer to Q0, ensuring silence until the switch-on hold-off time is complete. Commercial telephone ringers usually employ a piezo-electric device to create sound but in this application this proved somewhat feeble in both volume and resonant quality, therefore the earpiece was tried instead with excellent results. The impedance of the earpiece used in the prototype was rather more than 100Ω, so the common emitter BC 327 is quite capable of handling the drive current and produces a respectably high volume with a truly authentic ringer sound.

When the circuit is energised by an on-hook condition, the clock will be disabled until the voltage across C1 rises to about 70% of the supply, approximately two minutes. The counter will then be clocked round, producing gating signals for the slow oscillator, (IC1d), which in the turn gates the main oscillator, (IC1c), via inverter, (IC1a).

Tone bursts simulating a typical telephone ringer are then buffered by Q1 to drive the output transducer. When the instrument is picked up in response to the phantom caller, S1 will change over, instantly removing the supply and discharging the circuit to produce a crisp cut-off, as would be expected from a real telephone. Replacing the phone will re-start the process from square one.

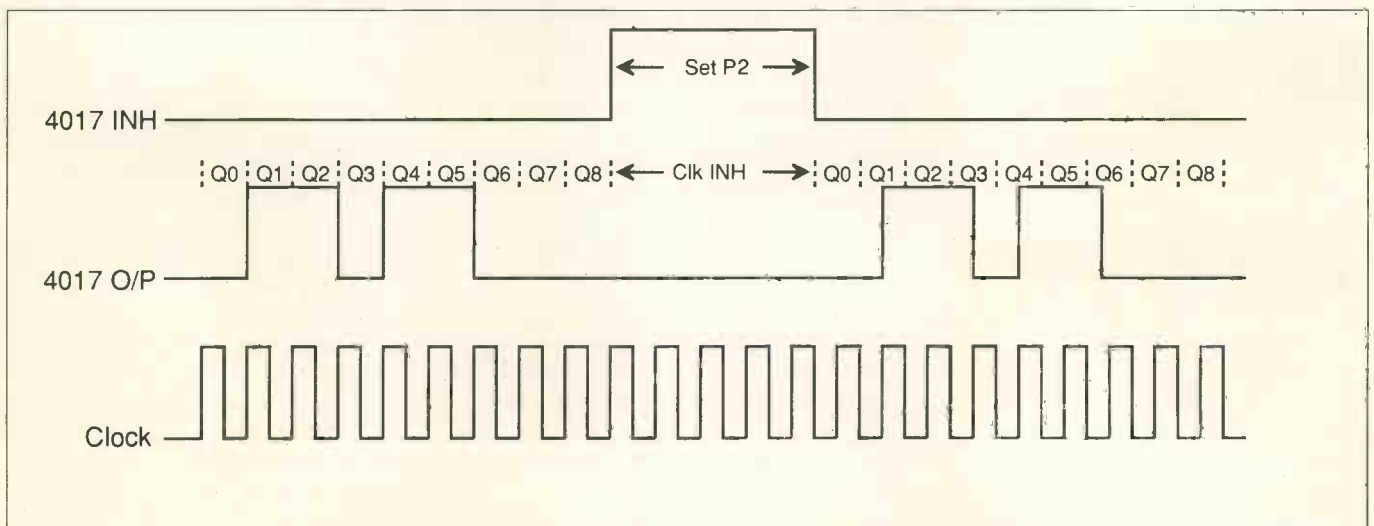

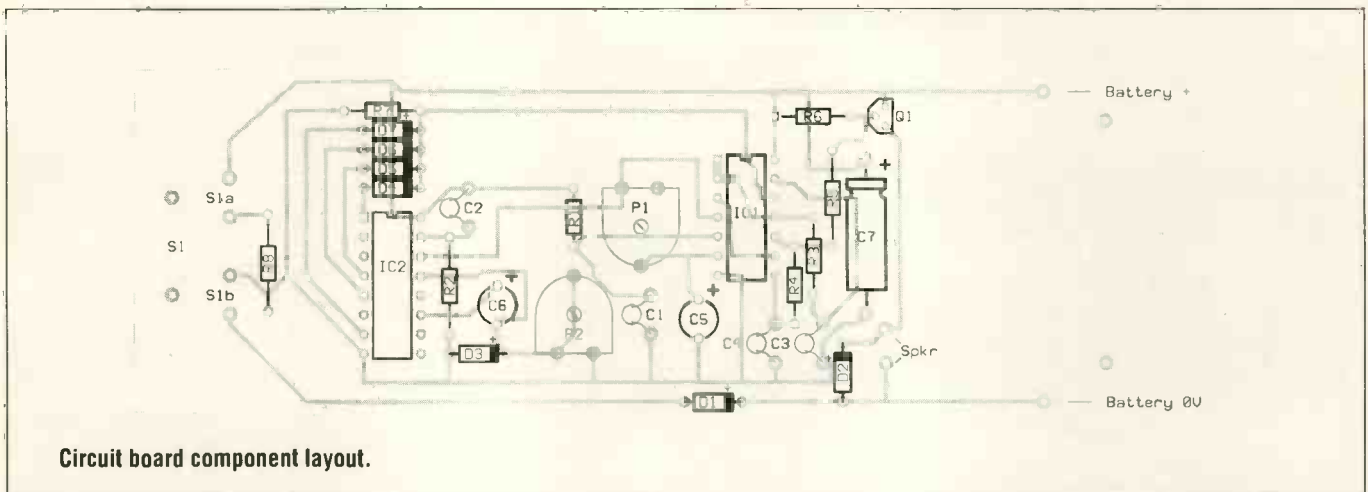

## Construction Details

Several prototypes of the Phantom Phone were constructed with no appreciable problems being encountered; a few points are worthy of note however. The PCB was designed after considering the general dimensions of several different telephone housings, so should present no difficulties, although it was found that mounting screwholes needed some adjustments to correctly align the hookswitch. Some degree of weakness, due to the odd shape of the board, necessitates the use of glass but not SRBP which is liable to crack at the base of the two tongues during filing etc. The compact dimensions of this type of phone housing provides little headroom so components should be as small as possible, subminiature electrolytics and low profile IC sockets being ideal. When the phone is initially dismantled, some obstruction may be found in the rear moulding, used to hold the original piezo device but if this looks like causing a problem it can easily be trimmed out with sidecutters. The double pole hook switch should be retained for use in the new circuit, checking the

mounting holes against the PCB layout.

When the PCB has been etched and trimmed, ensure that all mounting holes are in line and a PP3 battery slips easily between the two protrusions each side of the square cutout, as filing a completed board is awkward and may damage components. Construction can now begin with the usual format of resistors first, although it can sometimes be an advantage to fit the IC sockets at an early stage to assist in the less obvious location of other components. The last component to be fitted should be the hookswitch as this tends to make the board rather clumsy if fitted too early in construction. Some means of securing the battery clip leads should be included to avoid stress on the soldered ends or an eventual breakage may occur with subsequent failure of the equipment. On completion, the trackside should be thoroughly cleaned with a PCB cleaner to remove all flux deposits, paying particular attention to the area around the tantalum bead capacitor. Any leakage across the pads at this point could prevent the capacitor from charging with the

result that the circuit will never start up.

## Testing

Before commencing any tests it is a wise precaution to check the polarity of all electrolytics and diodes, small errors will always occur from time to time but need cause no undue problems if a simple check is made before power-up. The resistance can now be evaluated across the supply rails, this should be about 10R0, rising to a high value when the hookswitch is depressed.

Assuming all is well, both presets should now be centred and one last check made to ensure both ICs are fitted the right way round before fitting the completed board into its housing and connecting the earpiece to facilitate further tests. When testing any unknown circuit, it is desirable, although not entirely necessary, to supply power from a fully protected PSU as some types of battery can cause a problem should things go wrong. The most likely cause of failure in the Phantom Phone circuit is with the switch-on delay. The charging current for the tant is extremely

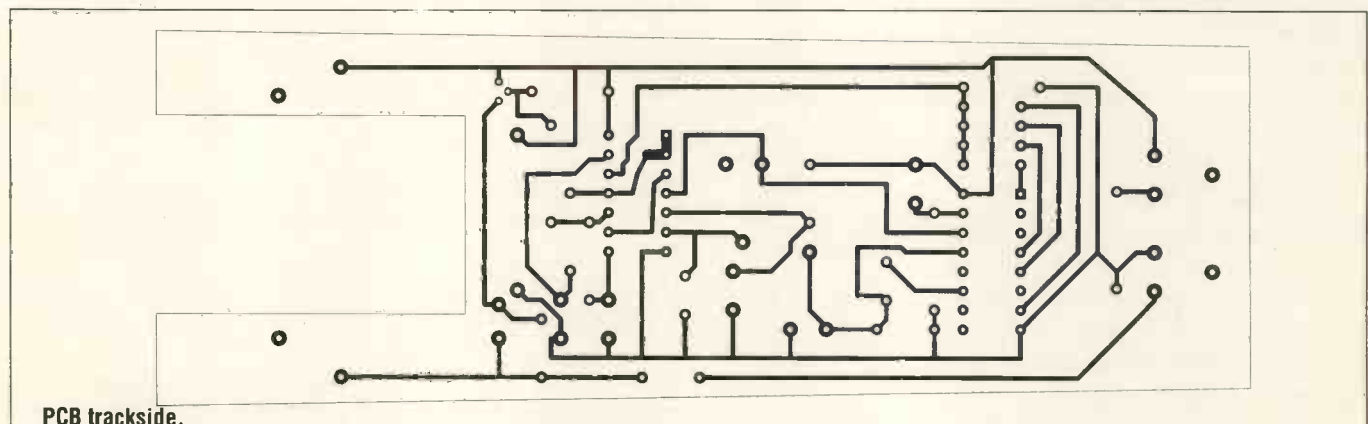

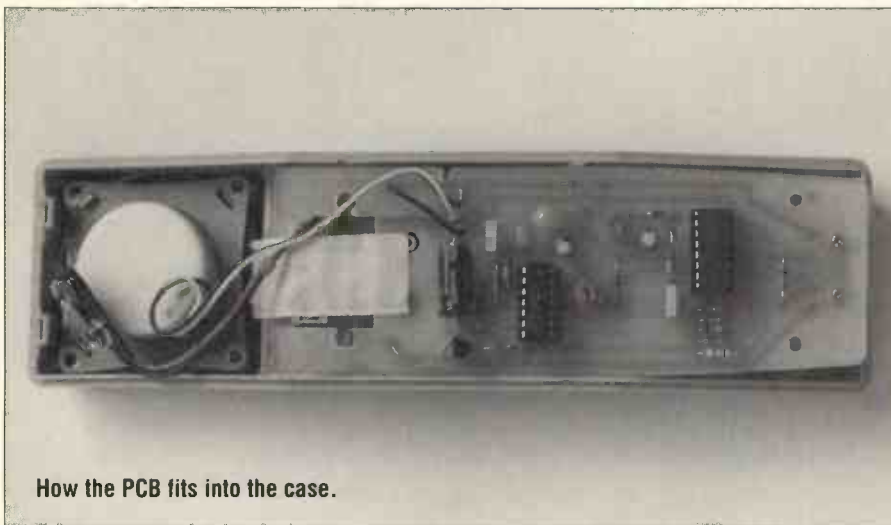

How the PCB fits into the case.

small, so any contamination on either side of the PCB, in the area of the tant, or even a rather leaky tant can prevent the clock enable threshold voltage from being reached. This results in a circuit that can never start up. Draining away vital current with a meter clipped across the tant is another cause of failure so should be avoided in preference for blind patience. The prototype took about two minutes

to begin its ringing sequence which is typical for the RC values used so it would be an error condition if this time is exceeded by more than around 50%.

Hopefully all will be well and the two presets can be carefully trimmed to produce the most authentic sound. All that now remains is to secure the PP3 battery in place and complete assembly of the unit. ■

## Components

### Resistors

R1	3M3
R2, R7	10K
R3	680K 1%
R4	120K 1%
R5, R6	5K6
R8	10R0

### Potentiometers

P1	1M0	Miniature
P2	100K	Miniature

### Capacitors

C1	47µF	16V/Tantalum Bead
C2, C3	100nF	Poly Box
C4	10nF	Poly Box
C5	1µF	16V/Submin Radial
C6	22µF	16V/Submin Radial
C7	100µF	16V/Min Axial

### Semiconductors

D1 to D7	1N4148
Q1	BC327
IC1	4093BE
IC2	4017BE
SK1	14 Pin DIL Low Profile
SK2	16 Pin DIL Low Profile

### Miscellaneous

PP3 Battery Clip
Glass PCB
Hookswitch

## Subscribe to Practical Electronics

Set your sights on technology with

- ⊕ Great Projects – like the PC EEPROM Programmer, or the Box that Bites portable burglar alarm
- ⊕ Innovations – the latest chips and gadgets, and a world electronics round-up
- ⊕ How It Works – explodes important electronic hardware
- ⊕ Data Sheet – full pin-outs and technical stats on a major chip
- ⊕ Techniques – expert answers to your technical problems

To order a 12-month subscription and get a free gift, fill in and return this form (or a photocopy) to:

**Practical Electronics Subscriptions**  
**Intra House**  
**193 Uxbridge Road**  
**London W12 9RA**

### UK Readers

One Year Subscription at £18.....  
 BAEC/Educational Rate £16.20.....

### Overseas Readers

Surface Mail at £22.....  
 BAEC/Educational Concession Rate £19.80.....  
 Air Mail at £39.....  
 BAEC/Educational Concession Rate.....  
 I enclose proof of BAEC membership.....  
 I enclose proof of Educational status (e.g. Headed paper)

I wish to start/renew my subscription from the .....issue.  
 As my free gift I would like to receive (tick one)  
 The Practical Electronics Binder.....  
 The Transistor Equivalents Guide.....

Please send my monthly copy of PE to:

Name.....  
 Address.....  
 Town.....  
 Post Code.....

I enclose a cheque/postal order for.....  
 Or: Please charge my VISA/MasterCard  
 Number.....  
 Expiry date.....  
 Signature (for credit card orders).....

(N.B. Cheques/Postal Orders or Banker's Drafts must be made out in £ Sterling, payable to Intra Press.)

# The History Of Television

*Only 55 years ago, the idea of films and news being shown in every house in the country would have seemed pure fantasy. Ian Poole tells of how it became fact.*

Television is accepted as part of everyday life and most people have at least one set in the house. Many of the programs we see are also becoming part of family life. Neighbours, The Bill and many others are all very popular and are watched by millions of people. However, it is only just over fifty years since the first television programs were broadcast. Television technology has progressed rapidly since this time and few people would have predicted the popularity which it now enjoys.

## In The Beginning

Shortly after Alexander Graham Bell invented the telephone people started to wonder if it was possible to send pictures over wires. Soon science fiction authors started to

write stories which included the potential uses for this proposed invention. However, it was too early to make any real developments even though the first step had already been taken.

The first breakthrough was the discovery that that light falling on the chemical element selenium made its resistance change. This allowed light to control the amount of current flowing in a circuit.

The next major step occurred just before the turn of the century, when in 1897 a German scientist named Braun developed the basic cathode ray tube (CRT). Braun's CRT was taken further by a Russian named Rosing who in 1907 managed to display the crude outline of a number of shapes, although the means of generating the signals to feed to the tube was purely mechanical.

Following on from the invention of the CRT, an Englishman named A A Campbell Swinton suggested that it could be used as a television receiver with a similar device used as a transmitter. He freely admitted that the technology did not exist to implement his ideas, however, they formed the basis of the electronic systems which were to follow many years later.

In 1920 a Russian emigre named Zworykin working in America started to develop a photoelectric TV camera tube. He progressed quite rapidly and by 1923 had developed the idea sufficiently to take out a patent. However it took him until 1928 to produce a working item which he called an iconoscope. This development was vital and paved the way for the all electronic television system.

## TV Comes To Life

Whilst the development of the iconoscope was taking place in America a Scot named John Logie Baird was making tremendous progress towards a mechanical television system.

Although the system was very crude by today's standards Baird managed to produce his first TV picture in October 1925. It was of an office boy who could just be recognised on the small screen of the receiver. Definition was poor because the system only had eight lines. However, this was soon increased to 30 lines with Baird making the best use of any publicity he could get, often reaching the news headlines.

Baird was also working towards a transmitter. February 1928 saw this accomplished with a test



Early TV exhibit, Museum Of the Moving Image.

transmission that was reported on the front pages of a number of newspapers. Later he even made some transatlantic transmissions which were also widely reported.

Despite his initial success Baird found it difficult to gain any cooperation from the BBC, who held the monopoly on broadcasting at the time, however with Baird's skilful manipulation of the media, the BBC eventually agreed to make some test transmissions. On 30th September 1929 transmissions started on the medium wave.

Unlike today's television signals, which have to be transmitted in the UHF portion of the spectrum because of the large amount of bandwidth required, these early transmissions could be accommodated on a medium wave transmitter because they only consisted of 30 lines with a frame being repeated at twelve and a half times a second. These transmissions did not represent any milestone in terms of technical development but they did achieve their aim of winning a lot of publicity, even if they were only watched by a few people.

With the advent of TV transmissions, other companies started to develop their own systems. The most notable was EMI who soon had an all electronic scanning system running. The camera tube was called an Emitron

and was similar to the iconoscope developed by Zworykin - the receiver used a CRT.

As development progressed EMI quickly realised that the definition of the system could be increased. This meant that higher bandwidths would be needed and they did not have the expertise to design transmitters. As a result the Marconi company, which had a wealth of experience in transmitter design, was invited to join the venture.

A government inquiry was set up in 1934 to look into the future of television broadcasting and decided that a service should be set up and run by the BBC. It also recommended that the service should have at least 240 lines, which happened to be the limit for the Baird system at the time.

The two competing systems for the BBC's service were from Baird

and Marconi-EMI which was an all electronic system with 405 lines. To decide between them, both systems were used for a trial period on alternate weeks. Transmissions started on 2nd November 1936 from Alexandra Palace in North London and constituted the world's first regular high definition TV channel.

The tests conclusively proved that the Baird mechanical system could not compete with an all electronic system and after only three months it was abandoned.

At this stage TV developed quite slowly and by mid 1939 only 18,000 sets had been sold. One reason for this was that they were expensive, costing about the same as a new car at around £100 each.

In 1939 the Second World War broke out and, for fear that enemy bombers would use the transmitters for guidance, the service was closed down. However the transmitters

### TV Cameras

The early TV cameras were based on the Nipkow disc which consisted of a rotating wheel with a spiral of holes on it. As the disc turned, the image would be scanned as a series of rows and the strength of the light coming through the holes sensed with a photo-detector and turned into an electrical signal to be viewed with a TV monitor.

Most modern professional television cameras rely on vacuum

tubes on one end of which is a photosensitive surface. The picture is focussed on this and charges are stored up in relation to the amount of brightness of the various portions of the image. A scanning beam then discharges the target in a predetermined sequence to produce an analogue voltage which can be transmitted to TV sets.

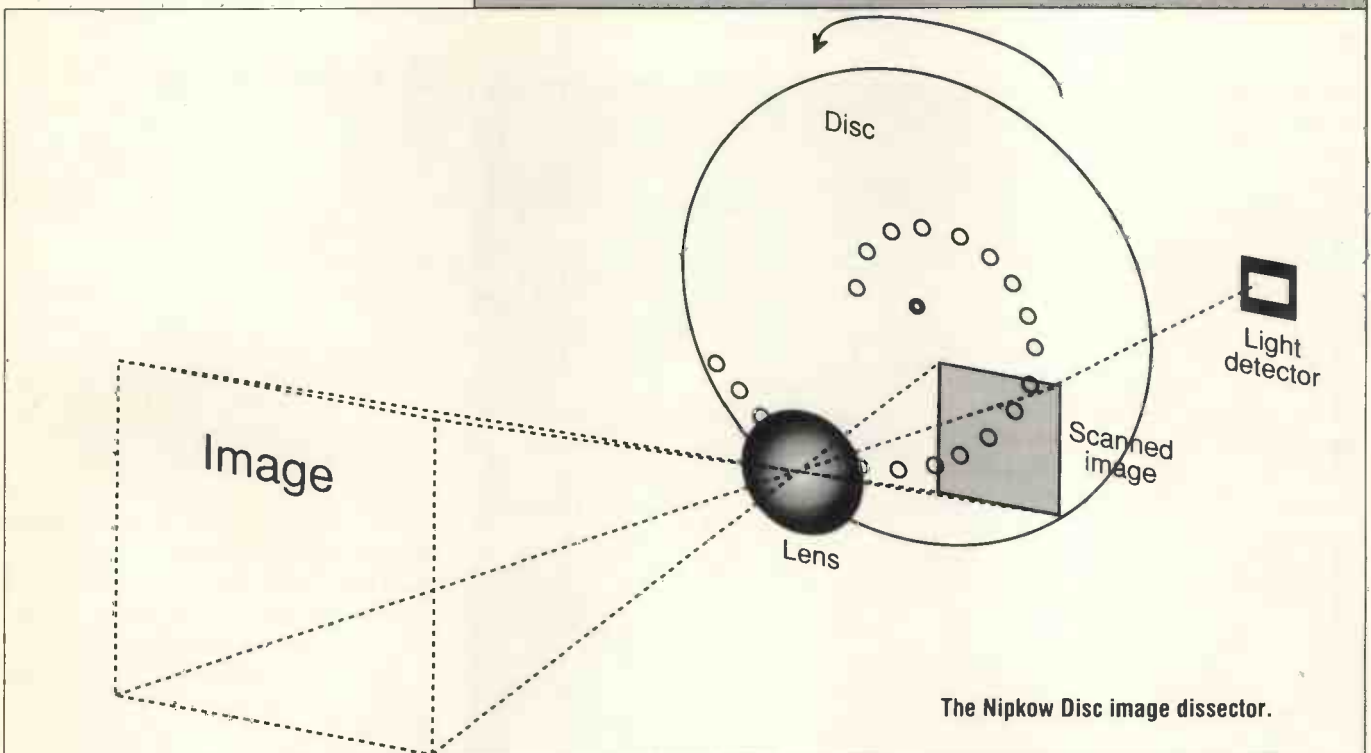

The Nipkow Disc image dissector.



The future of TV, a portable colour LCD.

were activated a few times during the next few years to jam German navigational signals which happened to use the old television frequencies.

Despite the fact that British television transmissions had stopped, other countries opened their own services. America launched its first in 1941 and in 1942 the Nazis started a service in Paris. However the war served to advance television technology because CRTs were also used for radar and a lot of effort was invested in improving them.

## After the War

At the end of the War, television transmissions were not resumed. In 1945 a committee was set up to review how the service should restart. It decided that the BBC should continue along the same lines as it had before the War and less than a year later on 7th June 1946, television transmissions recommenced. Initially there were only a few viewers because the only sets in existence were those from before the War.

Fortunately demand for sets soon started to increase as the country started to recover from the war. People also began to realise the importance of TV as a medium for entertainment and news coverage. This was demonstrated particularly well in 1953 when the coronation of Queen Elizabeth II was televised. A huge outside broadcast operation was mounted showing every part of the event and it was an enormous

success. More than 20 million people tuned in and, apart from the mass appeal, it was a tremendous technical achievement since no event had been given this level of coverage before.

## The Coming Of Ads

With the success of the televising of the coronation more people started to buy television sets. In turn this started to increase pressure on the government to provide a second channel. Ideas of having a commercial channel funded by advertising created concerns about standards. Many people doubted whether it would ever be viable. The debate was ended on 22nd September 1955 when Independent Television was launched.

At first the viewing figures were fairly low. The main reason was that the BBC broadcast on a frequency band between 41 and 68MHz, whereas ITV was allocated those between 174 and 216MHz. To overcome the fact that existing televisions could not receive the new channel, converter units were sold. These consisted of an amplifier and mixer to convert the ITV signal down to a frequency which could be received by existing sets. However, new sets soon appeared that were able to receive all the TV channels.

In addition to the new channel other improvements were being made. Many of these gave better service with fewer breakdowns. Others allowed the programme producers more flexibility. One

notable milestone occurred after the satellite Telstar was launched. On 11th July 1962 television engineers managed to transmit live television signals across the Atlantic. These pictures were watched by millions and represented a huge achievement for the engineers involved.

## Bigger And Better

Whilst the 405 line high definition standard was adequate for television of the 1940s and 1950s, it soon became apparent that higher quality was needed. America had gone for 525 lines which gave a noticeable improvement over the British television transmissions. In order to meet the growing demand for better definition the BBC launched a new service in the UHF part of the spectrum. BBC 2 was opened on 20th April 1964 and was initially broadcast from the Crystal Palace transmitter, although the service was soon extended to other sites. BBC 1 and ITV were also transferred to UHF about two years later.

## Television History

1924	Baird transmits his first 8 line picture.
1928	First 30 line pictures transmitted.
1929	BBC starts experimental TV transmissions from a medium wave transmitter using the Baird system.
1936	Baird and Marconi-EMI commence high definition transmissions from Alexandra Palace on alternate weeks.
1938	Soviet TV opens.
1941	TV transmissions start in the USA.
1955	A second TV channel (ITV) opens in the UK.
1964	BBC 2 opens with 625 line transmissions from Crystal Palace.
1967	BBC starts Europe's first regular colour service.
1969	BBC 1 and ITV start colour transmissions.
1982	Channel 4 starts as a new national commercial service.
1987	Satellite TV.
1990	BSB TV

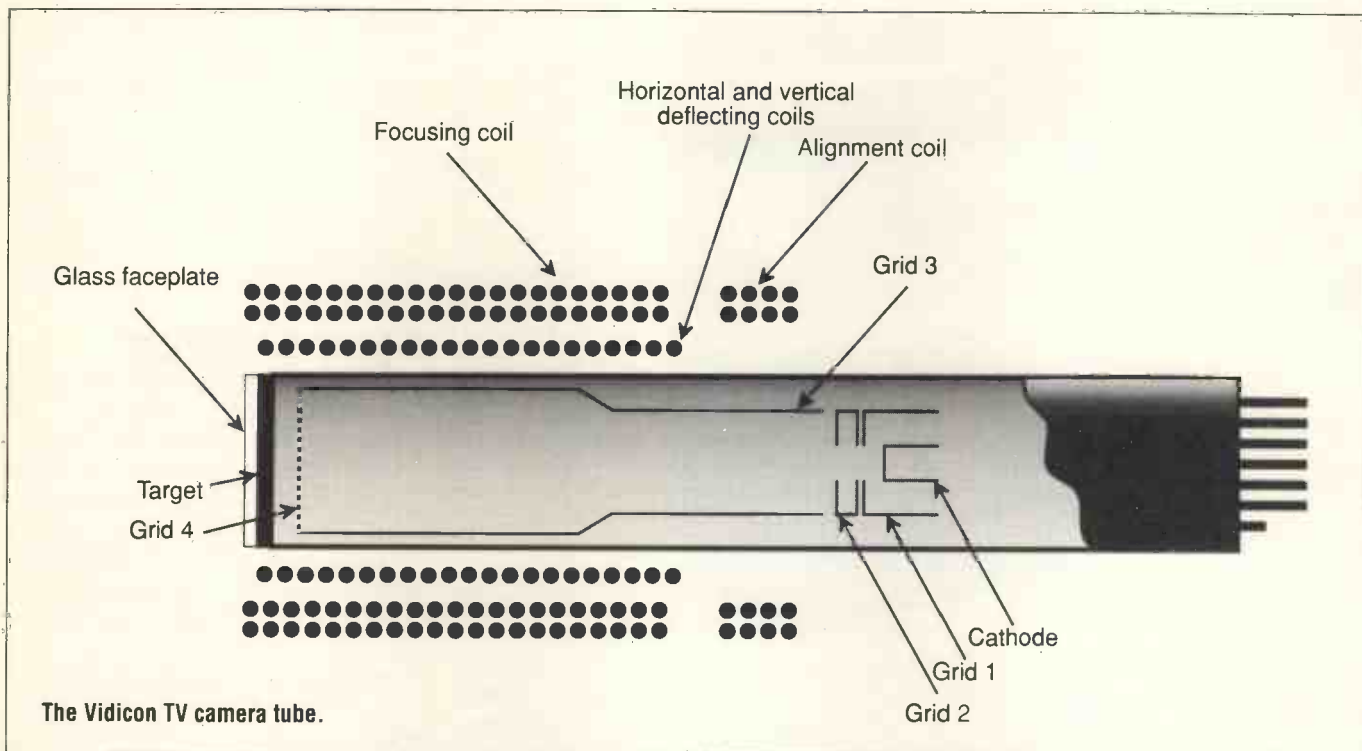

## Colour TV In 1928

The new high definition service offered more than just a better black and white picture. It was envisaged from the outset that it would be possible to use it for colour. On 1st July 1967 the BBC launched Europe's first regular colour service representing the culmination of many years of work beginning in the earliest days of television.

It is surprising to note that colour television had been demonstrated by Baird in 1928 using his mechanical television system. He did this by synchronously rotating blue green and red filters in front of the camera and receiver. However it was not easy to use and it required many more pictures to be transmitted.

With the demise of his mechanical system, Baird still pursued his investigations into television. He devised a colour system for the electronic system using two images with filters to combine them optically. RCA (Radio Corporation of America) devised a similar system using three filters to give full colour. Unfortunately, both of these schemes had severe limitations and neither came to fruition.

Real progress was made when RCA invented the shadowmask CRT. It was first demonstrated in 1950 but was very expensive to make and the idea of colour lay

dormant for several years. In 1953 the American National Television Standards Committee (NTSC, also known as Never Twice the Same Colour) adopted a system for colour transmissions. It was based on the fact that a colour picture contains both luminance (light or brightness) and the colour. These two signals were encoded separately before transmission and had the advantage that monochrome receivers could still be used. However, it did have some disadvantages, the main one being that slight changes in the phase of the signal gave rise to colour changes. Further work was carried out in Europe to improve the system. The French came up with the SECAM system which was adopted in France, the USSR and Eastern Europe. In Germany Telefunken devised PAL which was adopted in the rest of Western Europe.

## Sky's The Limit

Television technology is still advancing and the idea of direct broadcasting from a satellite is an indication of this. In addition there are the new picture transmission standards. The Independent Broadcasting Authority has put forward a new system named MAC (Multiplexed Analogue Components) and the Japanese are trying to establish a new 1125 lines, 30 frames per second, high

definition standard (HDTV). The battles for supremacy of these systems are still being fought and only time will tell which system will be accepted. ■

## TV Camera History

- 1929 RCA invented the Iconoscope.
- 1936 EMI designed the Super Emitron which was more sensitive.
- 1939 RCA came back with the Orthicon tube, an improved version of the Iconoscope.
- 1946 RCA invented the Image Orthicon which improved resolution.
- 1949 RCA improved its design again with the Image Isocon which had much better low light capability.
- 1950 RCA Vidicon was the first small size tube with improved resolution but susceptible to damage by high light levels.
- 1964 Philips introduced the Plumbicon which used a target of Lead Oxide.
- 1966 Bell Labs designed the Silicon Vidicon which used a silicon diode array as its target.
- 1972 Toshiba came up with the Chalnicon which had a target of cadmium selenide based on the now standard Vidicon format.



# On The Right Tracks

*Seetrax brings automation to PCB design with its computer aided engineering software packages Ranger 1 and Ranger 2. Kenn Garroch probes into the details.*

For a number of years now, computers have been used to help with the design of electronic circuitry from chips to printed circuit boards. The ability to produce and edit graphical objects and automatically assign information to them means that the computer can keep track of component connections, pin names and numbers and even be used to design the tracks on a PCB. A whole host of possibilities, not available to the manual designer make board design, editing and even testing a quick, clean and easy process.

Seetrax Ranger 1 and 2 are two computer aided engineering systems written to help design PCB. The first is the cheaper product at £200 and provides a relatively inexpensive way to "get into" CAD

with a sophisticated system that provides all the facilities needed to produce artwork for printed circuit boards. For more complex projects, Ranger 2 provides a host of extra facilities although at £999 it is a lot more expensive.

## Computer power

Ranger 1 requires an IBM PC XT or compatible machine with 640k of RAM, a 20M hard disk, EGA or VGA, parallel and serial ports and DOS version 2.0 or later. The drawback here is the EGA or VGA screen required since many low end PC XTs and ATs are usually supplied with CGA or Hercules video drivers, neither of which will work. However, most modern graphics software looks a lot better on EGA or VGA so it is generally

worth spending the extra £350 or so on a VGA card and monitor (the card itself should only be about £75 if an analogue RGB monitor is available) to gain the extra quality.

Installation is simply a matter of putting the disk in the drive and typing A:INSTALL. The program takes care of the work of setting up directories and decompressing the files. It can take quite a while since there are a good 1.5 megabytes of data to be extracted from the 720k 5.25" disk supplied. The only information required from the user is what type of display is to be used – EGA (640x350), VGA (640x480), high resolution VGA (800x600) or Video 7 high res (800x600) – and what type of input device is required – mouse, digitiser or cursor keys. Once these have been set up, the system is ready to go.

## The Main Menu

On start-up the user is presented with a main menu which allows an existing job to be loaded or new job to be started.

After starting a new job and giving it a title, the main functional menu is put up allowing a number of options from designing the schematic to routing the board to be selected. One of the nice things about Ranger is its ability to perform schematic capture. This allows the connections set up in the circuit diagram to be used in the PCB layout without any further modification – the connectivity is maintained throughout the design process.

The first step in producing a PCB is to define the schematic. Selecting this option from the menu presents the design screen. Up the

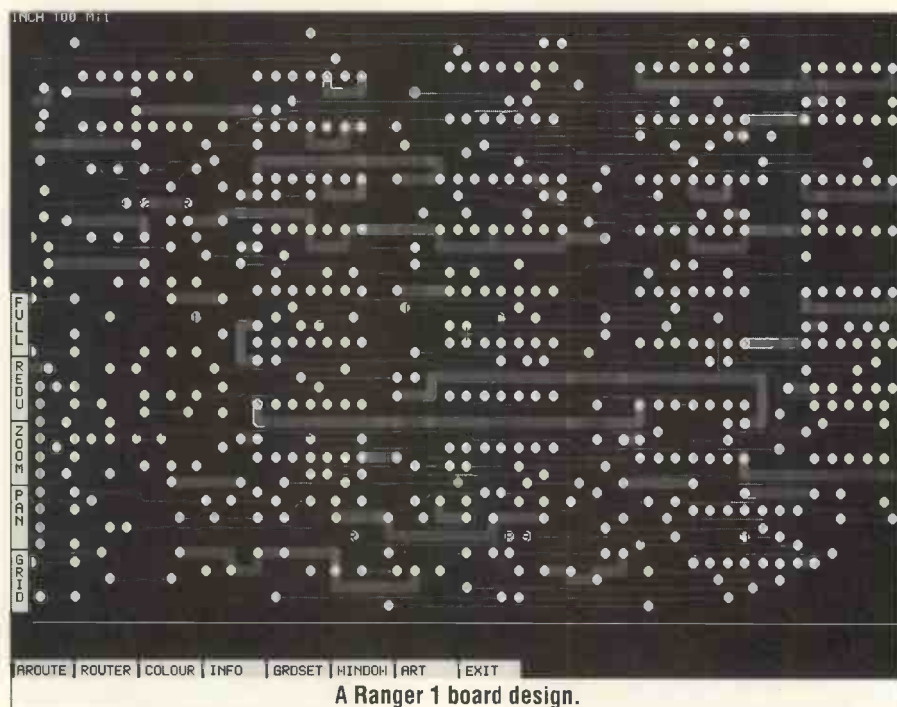

## Specifications

### Ranger 1

#### Schematic design software:

Macro capability  
 Auto net list generation  
 Auto allocation of part names and pin numbers  
 A maximum of:  
 eight interconnected drawing sheets per design  
 five drawing sheet sizes from A1 to A5  
 600 symbols per library volume  
 100 library volumes  
 256 pins per symbol  
 3500 interconnections per sheet

#### PCB design software

Component footprint library  
 Footprint designer  
 One thousandth of an inch resolution  
 Automatic net connection, clearance checking and comparison of artwork against netlist  
 A maximum of:  
 8000 component pins per design  
 1400 components per design  
 16 layers  
 256 pins per component  
 32"x32" board area

### Autorouting software - extra

Power, memory and orthogonal routing strategies  
 Input from ASCII and Futurenet

### General

Output for:  
 nine and 24 pin dot matrix printers  
 Hewlet Packard Ink and Desk Jet printers and pen plotters  
 Houston Instruments pen plotters  
 Gerber photoplotters  
 NC drilling and routing machines  
 Support for Microsoft Mouse or Summagraphics Digitisers

### Ranger 2

as Ranger 1 except:

#### PCB software:

Maximum of:  
 16000 component pins per design  
 Graphical board shape designer  
 32"x32" board area  
 Auto copper fill generation, signal highlight, power plane generation

### General

Outputs for PSpice simulator  
 Compatible with Ranger 1 designs.

example the 7400 series or various transistors, from which the components could be selected by pointing and clicking. As each was selected, it was added to the current list or tray, displayed on the right hand side of the screen. If other devices are needed as the design progresses, they can be added to the tray at any time.

Having selected the components they can be put onto the schematic with the symbol place menu option. Clicking on a component name selects it and placing the cursor at the schematic position and clicking again positions it. Other menu options allow the positions to be changed around to obtain the optimum layout.

Connecting the components up is performed with the wires/connect option and is simply a matter of clicking on one component pin and moving the cursor to produce the require wiring layout, with clicks at each bend and eventually on the destination connection. The system automatically inserts blobs at wiring junctions eliminating extra symbols and missing connections. Internally, the system forms a network of connections which will be used in future by the board routing and checking software.

As well as helping with the blobs, connections and positioning, the software also lends a hand with component numbering and signal naming. Any wire can be given a signal name which will be retained

left hand side of the screen in a vertical menu are the display controls. Most behave as expected although the way in which they are activated is a little unusual. Unlike many pointer driven systems, a menu option is not selected by pointing at it and clicking a button - either on the mouse, pen or keyboard. Instead the pointer is moved onto the option causing it to change colour (to green) and then off again with another change of colour (red) which causes it to activate. Some functions take effect straight away, for example moving on and off the grid menu item causes the grid to toggle on and off. Other functions require a button click as well.

Across the bottom of the screen is a horizontal menu which is used for the main design work such as placing components and wiring them together. What appears on this depends on which function is selected.

Before starting a design the components to be used are defined. Selecting the tray option gives access to 100 library volumes. In practice only a few of these are used, the rest being available for new component definitions as they

are set up - with up to 500 per volume there is plenty of space. Unfortunately it was necessary to refer to manual to determine the contents of the volumes, some sort of titling system as well as or instead of numbering would have helped a lot. Opening a volume revealed the device numbers, for

**Selecting components from a tray in Ranger 2.**

	7400	7401	7402	7403	7404	7405	7406	
PAGE	7407	7408	7409	7410	74100	7411	7412	IN4001
	7413	7414	7415	7416	7417	7420	7421	CAP410
TBOX	7422	7423	7425	7426	7427	7428	7430	BPTDGE0
	7432	7433	7437	7438	7439	7440	7442	PL10-01
FULL	7443	7444	7445	7446	7447	7448	7449	BZ4000
	7450	7451	7452	7453	7454	7455	7460	7499
REDU	7461	7462	7463	7464	7465	7470	7471	PT010
	7472	7473	7474	7475	7476	7478	7480	74245
ZOOM	7481	7482	7483	7484	7485	7486	7487	PB_25W
	7490	7491	7492	7493	7494	7495	7496	741
PAN	7497	7498	7499	74H54	74LS54	7495	7496	VPES-
GRID								TESTIN
								CAP400E
TRAY								*TEMP
SYMBOL								*ABLANK
HIRES								
ALLOC								
SIGNAN								
NONELE								
WINDOW								
GRDSET								
SETUP								
EXIT								
	LIBADD	COLADD	MACADD	NEXT	BACK	DELETE	SORT	

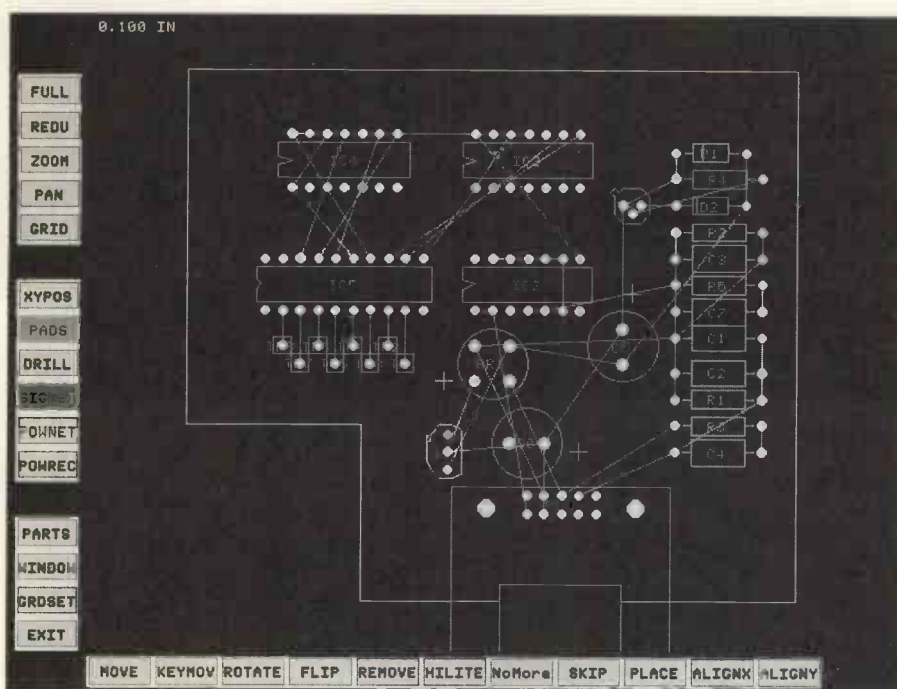

A Ranger 2 network ready for autorouting.

even if the wire is moved. The component designators and pin numbers operate in a similar way. When using a chip which has, for example, four NAND gates or four opamps, each will automatically be annotated with the correct number and pin connections. Components such as resistors and capacitors can have values assigned which they then retain throughout the design process. These features are very useful and save a great deal of time and effort as well as making sure that the system knows which connections go where for routing and testing.

## In The Lists

Once the circuit schematic is complete and all of the components have been given names, values and numbers, any extra text and graphics can be added and the circuit compiled to produce parts and wiring lists. These can be viewed and, if necessary, edited in text form. The format appears to be a standard ASCII file so importing and exporting wiring and component lists from and to other systems is a possibility. The next step in creating a board is to define which layers are to be used for what. Up to 16 of these can be set up although normally only one plus a silk screen (the component outlines and text) or two (top and bottom) plus two silk screens would be used. Multiple layer boards

require sophisticated production techniques which are beyond the capabilities of most of us. Also selected at this point are the drill, pad and track sizes.

## On The Boards

Defining the shape of the board proved to be a little more difficult than designing the schematic. The system asks for the coordinates of each corner of the board to be entered in a table. For simple square boards, this was not too difficult but more complex shapes would have to be drawn on paper, the coordinates figured out, and then entered into the system. Ranger 2 gets around all this messing about by using a graphical system where the shape of the board can be drawn directly onto the screen.

Moving to and from the various menus at this stage of the design showed up a minor inconsistency in the user interface. Some of the menus were exited with the escape key while others used the pointer to move to an exit option. Reading the screen commands solved the problem but quickly popping in and out of menus was not as easy as it could have been.

Placing the components on the board was very easy. The graphics screen was almost identical to that used for the schematic design except that different commands were available in the horizontal menu. The parts were automatically

selected by the system for placement. For example, the after placing IC1, R1 will be selected as the next component followed by R2 and so on. Parts can be rotated through 90° and flipped from one side of the board to the other. A little care has to be taken when placing the components so that routing can be done in a sensible way otherwise the board will turn out to be more complicated than necessary, possibly requiring wire links.

Before routing the board, the pads and tracks must be digitised to give them their correct sizes. This is simply a matter of selecting the correct menu options and takes very little time and effort.

## Rules of Thumb

The basic Ranger 1 system only has a manual routing system which is operated from the artwork editor. The method is to select each connection and define the tracks in a similar way to the original schematic connections except, of course, they are not allowed to cross on the same side of the board. Full point editing facilities are available as well as layer swapping. Once they have been defined a series of design rule checks can be made. The first makes sure that all track bend angles conform to 0°, 90° or 45°. Others can be used but the gap check won't work with them so it is best to stick with the predefined angles, it also looks neater. If any errors are found they will be highlighted so that they can be corrected. The next check is the amount of clearance between tracks and pads. Again, any errors are highlighted for editing. The final check is for connectivity and uses the original schematic network design to make sure that the circuit is set up in the same way.

## Automation

For an extra £100 Ranger 1 can be upgraded to use an autorouter. This takes the schematic output and automatically lays out the tracks on the PCB. There are a number of things to consider before deciding whether autorouting is a good idea. First of all, autorouted boards must have at least two sides. This is a side effect of the way in which the software works. To make the layout

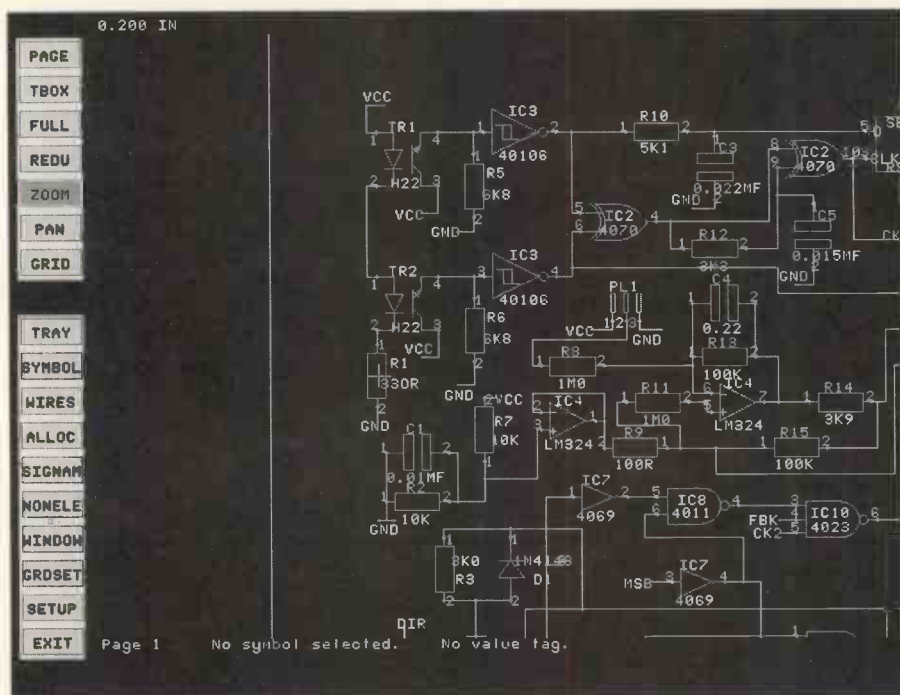

The Ranger 2 schematic editor

within reach of the modest computing power available, one side of the board is given the vertical tracks and the other the horizontal. This makes the task of routing the circuit relatively easy. Similar software to route a single sided board would require a lot more memory than 640k plus a good deal more processing speed if the job were to be finished in a reasonable time – basically due to the amount of looking ahead and re-routing needed. A double sided system solves all of these problems.

Anyone who has had experience with manual routing will probably find that for simple boards, the autorouter doesn't do a particularly good job and hence doesn't save a great deal of time. It also can't guarantee to make all of the connections and whole chunks have to be manually ripped out and relayed. On the other hand, an autorouter can improve on manual jobs in complex circuits and provide a good starting point for manual

jobs. It all comes down to whether paying out an extra £100 is better than doing the job by hand – bear in mind that the computerised method of manual track laying is a great deal faster and easier than using a pencil and paper, especially on multi-layer boards. The autorouting software supplied for Ranger 1 is reasonably efficient, especially when run on a 16MHz AT computer.

## Ranger 2

The next step up from Ranger 1 is Ranger 2. Comparing the specifications of the two systems makes it seem as though there is not a great difference. However, for the extra £800 or so there has to be something.

The first noticeable difference can be seen when installing the software. There is a lot more to it with larger libraries and additional functions. The computer requirements are pretty much the same with support for additional video display cards (mainly EIZO 1024x768 and Metheus 1024x768) but a mouse or pen and graphics tablet are a must. The system can be operated from the cursor keys but it is so slow that it is virtually unusable – the cursor crawls across the screen as the system seems to ignore most of the keypresses.

Starting up and operating Ranger 2 is very similar to Ranger 1. The next obvious difference comes when artwork screens are

displayed. This gave the impression of being higher quality and offered a few more facilities. For example, when placing components the outline of the device moves with the cursor until placed. As mentioned earlier, board profiles can be designed graphically rather than with the manual numeric system used in Ranger 1.

An autorouter is supplied as standard and additional PCB design facilities include copper fill to create large areas of copper. Overall, it has a much more professional feel than Ranger 1 and has a number of high-tech add-ons available. The Trax router package provides true copper sharing and via hole minimisation as well as auto placement, Gerber input (output is standard) and AutoCAD input and output.

For most small users, Seetrex Ranger 1 provides sophisticated system at an affordable price. It is better than EasyPC or Tsien's Boardmaker since it provides a lot more automation and takes the design all the way from schematic to PCB – other packages require separate designs for both, that is, no schematic capture. It is more expensive but the ability to draw in the circuit diagram and quickly turn it into a board design easily makes up for this.

Ranger 2 is, perhaps overpriced since Ranger 1 with the autorouter added will do almost as good a job. If Seetrex reduced the price to around the £500 mark it would provide a more realistic upgrade path for users of Ranger 1. ■

## Prices

Ranger 1 £200 (ex VAT)  
 Autorouter £100 (ex VAT)  
 Ranger 2 £999 (ex VAT)  
 Ranger 2 auto utilities (Trax router) £750 (ex VAT)  
 Bartells 100% rip up and retry (286 or 386) £2000 (ex VAT)  
 Available from  
 Seetrex Hinton Daubnay House  
 Hinton Daubnay  
 Lovedean  
 Portsmouth  
 Hants  
 PO8 0SG  
 Tel 0705 591037  
 Fax 0705 599036



Ranger 1 screen colour selection.

Yes, it's true! The new  
**LOW COST RANGER**  
 from SEETRA offers you

**SCHEMATIC - PCB DESIGN - AUTOROUTING**  
 at prices you won't believe

For £200.00 you get  
**SCHEMATIC CAPTURE and PCB LAYOUT**

featuring

- Auto Net-List Generation • Net-List Import • Manual Routing
- Full Design Rule Checking • Gerber • HDG • Dot Matrix

For £100.00 you get

**AUTOROUTING**

Power • Memory • Signal



Call now for a free Demo Disk

Seetra Limited • Hinton Daubney House • Broadway Lane  
 Lovedean, Hampshire • PO9 0SG • Tel: (0705) 591037 • Fax: (0705) 599016

# LYS Electronic Components

& Innovative Electronic Development Company

## LOWEST PRICES ANYWHERE!

### MANUFACTURERS OF

Printed Circuit Boards, Alarm systems - Burglar, fire and smoke

### STOCKISTS OF

Computer Hobby Kits Used Test Equipment

### COMPUTER AND ELECTRONIC REPAIR SPECIALISTS

LYS ELECTRONICS COMPONENTS specialise in all types of electronics components. An established company, LYS ELECTRONIC COMPONENTS have successfully emerged from the eighties and are rising to the challenge of the nineties. With branches in London and North Wales they have recently expanded to the south coast with the opening of their permanent unit on the ground floor of CHARLOTTE'S SUPERSTORE, Charlotte Street, Portsmouth, in order to target the domestic as well as the commercial user. So whatever business you are in, if you need electronic components we are the people to deal with.

WE GUARANTEE OUR PRICES ARE THE LOWEST IN THE SOUTH

Lower Floor  
 Charlotte Superstore  
 Charlotte Street  
 Portsmouth  
**TEL: (0705) 386550**

### SAMPLE PRICES OF OUR EXTENSIVE STOCKS

555 TIMER	5 for £1.00	741 opamp	5 for .90
7805 +V REG	40	7905 -V REG	.35
7812 +V REG	40	7912 -V REG	.35
LM317 ADJ REG	50	LM337 ADJ REG	.50
ZENER DIODES 400mW ALL AT .05 EACH			
HORIZ/VERT CARBON PRESETS .12 EACH			
1 4W 5% CARBON RESISTORS 0.1 each (100)	60 (1000) £5.50 any mix		
1 2W 5% CARBON RESISTORS 0.2 each (100)	90 (1000) £7.50 ANY MIX		
5mm RED LED .08 GREEN .08 YELLOW .09			
DIL SOCKETS L PROFILE 8 pin .03 14 pin .05 16 pin .06 18 pin .07 20 pin .08			
DIL SWITCHES 2 way .40 4 way .60 10 way .90			
LM3914 BARGRAPH DRIVER £3.40			
R.F. COAX (ANTI MICROPHONIC) 75 OHM ORANGE OUTER SHEATH (NORM £3.00 MTR) ONLY .90 MTR 100MTR £60.00			
DIGITAL FREQUENCY METER KIT 2 RANGES 0-30MHZ 25-1000MHZ			
COMPLETE INC 3 PCBs (EXC METALWORK) £83.60 ANALOGIC PROBE KIT (EXC CASE) £9.60			
WE HAVE ONE OF THE LARGEST RANGES OF USED TEST EQUIPMENT INC: SCOPES, ANALYSERS, MULTIMETERS, SIGNAL GENERATORS, AF BRIDGES ETC. ALL BY LEADING MANUFACTURERS. EG: PHILIPS PM3217 50MHz SCOPE £300			

Components for Success

## "BOFFINS SPECIAL" - UNIQUE OFFER

Surplus Precision Medical Unit, internally in excellent condition. Designed primarily to eject a precise controllable amount of fluid from a medical syringe (latter not supplied). Contains the following removeable components: Dual Micro Processor Boards and EPROMs.

Escap Precision 12V. DC. Motor with 300:1 Gear Box, and optical encoder coupled to a precision threaded drive mechanism. Mains supply with 12x1.5V. Ni-Cad AA cells back-up. LCD Digital read-out 17mm high with legends. Audible warning.

These are sold for the dismantling of the exceptional quality components. Regret no Circuits available.

Ridiculously low price: £16.00 + £4.00 p&p (£23.00 incl VAT).

Service Trading Co.

57 Bridgman Road, London W4 5BB

Tel: 081 995 1560

## MAKE YOUR INTERESTS PAY!

Over the past 100 years more than 9 million students throughout the world have found it worth their while! An ICS home-study course can help you get a better job, make more money and have more fun out of life! ICS has over 90 years experience in home-study courses and is the largest correspondence school in the world. You learn at your own pace, when and where you want under the guidance of expert 'personal' tutors. Find out how we can help YOU. Post or phone today for your **FREE INFORMATION PACK** on the course of your choice. (Tick one box only!)

Electronics	<input type="checkbox"/>	TV, Video & Hi-Fi Servicing	<input type="checkbox"/>
Basic Electronic Engineering (City & Guilds)	<input type="checkbox"/>	Refrigeration & Air Conditioning	<input type="checkbox"/>
Electrical Engineering	<input type="checkbox"/>	Car Mechanics	<input type="checkbox"/>
Electrical Contracting/Installation	<input type="checkbox"/>	Computer Programming	<input type="checkbox"/>
GCSE/GCE/SCE over 40 examination subjects to choose from			

Name \_\_\_\_\_ Address \_\_\_\_\_



International Correspondence Schools, Dept. ED061, 312/314 High Street, Sutton, Surrey SM1 1PR.  
 Telephone: 081-643 9568 or 041-221 2926 (24 hours)

# Practical Electronics is giving away up to £2,000 Pounds to its readers!

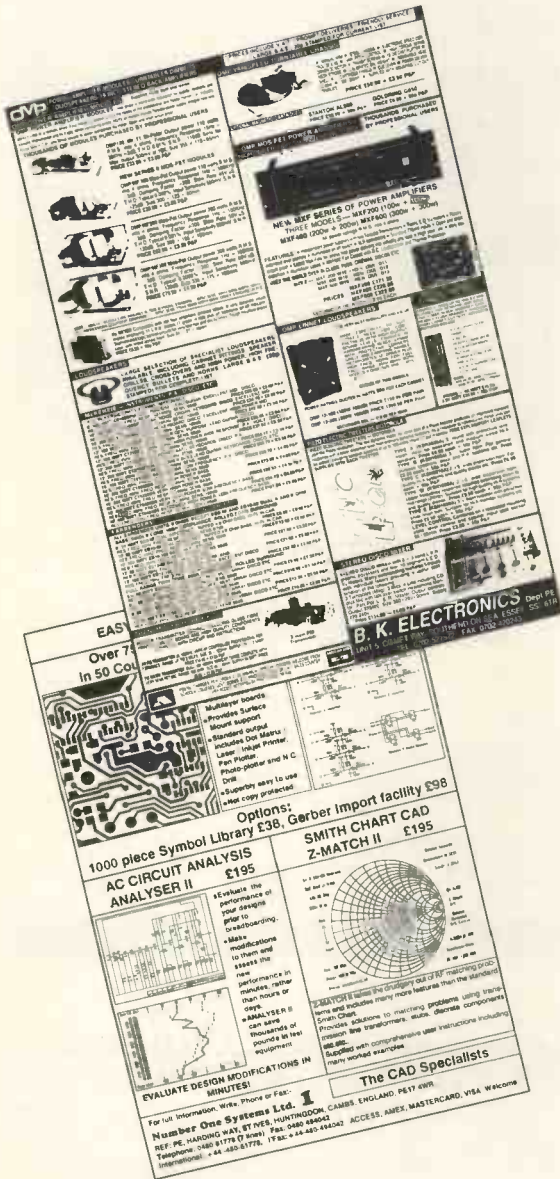

Refit your workshop this summer. PE might pay for it.

We're offering to refund 10 readers of Practical Electronics up to £200.00 for purchases made from advertisers in this issue (including all products from our advertisers' catalogues like Maplin, Greenweld etc.)

The rules are simple:  
Buy any product from any advertiser and we will refund you all or part of the cost, up to a maximum value of £150, or £200 if you are a subscriber.

All you have to do is complete and cut out the coupon below and send it to us with proof of purchase. Then if you are one of the lucky readers drawn out of the bag, we will refund your money.

**Needless to say, this is one offer you really can't afford to refuse!**



Send to: PE Reader Loyalty Bonus, June 1991  
Intra Press, 193 Uxbridge Road, London W12 9RA

I purchased ..... price.....  
as advertised by.....  
Name .....  
Address.....  
Town..... Postcode.....  
I am a Subscriber  Complete and return this coupon by June 30th. The winners will be announced in the September issue of PE.

# Data Sheet:

# The 8255 PPI

*This chip gets used in a great many PE articles and is one of the most efficient ways of interfacing to Intel microprocessors such as the Z80 and 80x86 series.*

The 8255 PPI is a widely used interface chip that provides a number of sophisticated features. Originally designed to be used with Intel architecture systems, the processor side of the interface is quite straightforward requiring only two address selects, read, write controls, a chip select, an eight-bit data bus and the system reset signal. In practice, it can be used with other microprocessor systems, for example, 6502, 68000, all that is needed is a little extra logic to provide the read and write signals.

From the microprocessor's point of view, the 8255 has three readable and four writable registers, selected by A0 and A1 (table 1). The three I/O ports can be read and written, the fourth write only register is the control byte. This can operate in two main ways, either as a mode and port operation control, or as a bit set and clear control. Both of these are summarised in Fig. 2 with bit seven switching between them.

In bit control mode (bit seven of the control byte cleared to zero), bits 1, 2 and 3 select one of the bits of port C which is to be set or cleared. Bit 0 of the control byte selects which way the bit is to be

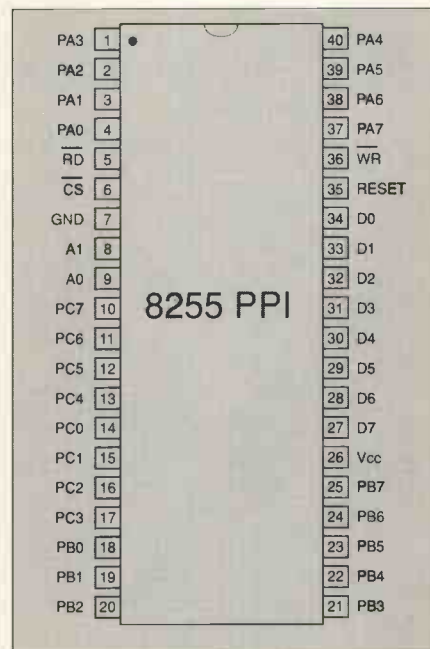

changed. For example, a control byte of 15 will set bit seven on port C, a control byte value of 14 will clear it.

With control byte bit seven set, the 8255 has three operating modes and, depending on which is used, the three eight-bit ports provide different forms of I/O and handshaking. In mode 0, all the pins on each of the ports can be set to be either input or output. For

example, port A could supply eight input lines, port B eight output lines and port C can be split into four outputs and four inputs. No handshaking is available and a read or write from the appropriate internal registers transfers the data to and from the microprocessor (table 1).

Mode 1 allows strobed I/O to take place. Ports A and B still operate as eight-bit ports but port C now supplies some handshake lines. The block diagram in Fig. 2 shows that the internal control of the 8255 is split into two groups. This allows split modes to be set up so that one group can be in mode 0 and the other in mode 1. With group A in mode 1 and port A set to input, port C provides the strobe, input buffer full and interrupt handshake lines on bits 3, 4 and 5 of port C. Bits 6 and 7 can still be used for normal I/O under control of bit 3 of the control byte. More details are given in table 2 which also describes the various pin functions. Similar handshake facilities are available for port B and for when either ports are in their output states.

Mode 2 is only available to group A and ports A and the upper five bits of C. It provides a bidirectional bus with tri-state on port A. This can be used to operate with other devices on a common bus structure, similar to that used in microprocessor systems. The five control lines provide all of the handshaking functions necessary to talk to other bus users and tri-state the bus. Also available is an interrupt request output and internal enable flip-flop controlled by the acknowledge and output buffer full signals.

A1	A0	RD	WR	CS	Input operation (read)	Table 1. selecting the registers.
0	0	0	1	0	Port A → data bus	
0	1	0	1	0	Port B → data bus	
1	0	0	1	0	Port C → data bus	
<b>Output operation (write)</b>						
0	0	1	0	0	Data bus → port A	
0	1	1	0	0	Data bus → port B	
1	0	1	0	0	data bus → port C	
1	1	1	0	0	data bus → control byte	
<b>Disable function</b>						
X	X	X	X	1	Data bus → high impedance	
1	1	0	1	0	Not allowed	
X	X	1	1	0	Data bus → high impedance	

## 8255 Pin functions

- | Pins | Name            | Function   |
|------|-----------------|--|
| 1-4  | PA3-PA0         | Port A low nibble - can be all in or all out in modes 0, and 1 and bi-directional in mode 2. Mode 0 has no handshaking, modes 1 and 2 use lines on port C for handshake.   |
| 5    | $\overline{RD}$ | Read input This is connected to the CPU RD line and is used by the microprocessor to read data from the 8255.  |
| 6    | $\overline{CS}$ | Chip select When this is high the data bus, D0-D7, goes high impedance allowing other devices to use it. Sending this signal low 'selects' the 8255 allowing it to communicate with the CPU.   |
| 7    | Gnd             | Ground Connected to 0V.  |
| 8-9  | A0-A1           | Port select lines - when used in conjunction with $\overline{WR}$ and $\overline{RD}$ , these lines select the ports or control register.  |
| 10   | PC7             | Port C bit 7 - in mode 0 this forms part of the upper nibble of port C and along with PC6-PC4 can be either input or output. In mode 1, where port A is defined as output, and in mode 2, it is used as the OBF (Output Buffer Full) signal. This goes low when the CPU has finished writing data to port A. When port A is defined as input in mode 1, PC7 can be defined as input or output in conjunction with PC6. |
| 11   | PC6             | Port C bit 6 - for mode 0 operation see pin 10. In mode 1 when port A is defined as output, and in mode 2, it is used as the ACK input. Sending this low signifies that a peripheral has read the data on port A. When port A is defined as input in mode 1, PC6 can be defined as input or output in conjunction with PC7.  |
| 12   | PC5             | Port C bit 5 - for mode 0 operation see pin 10. In mode 1  |

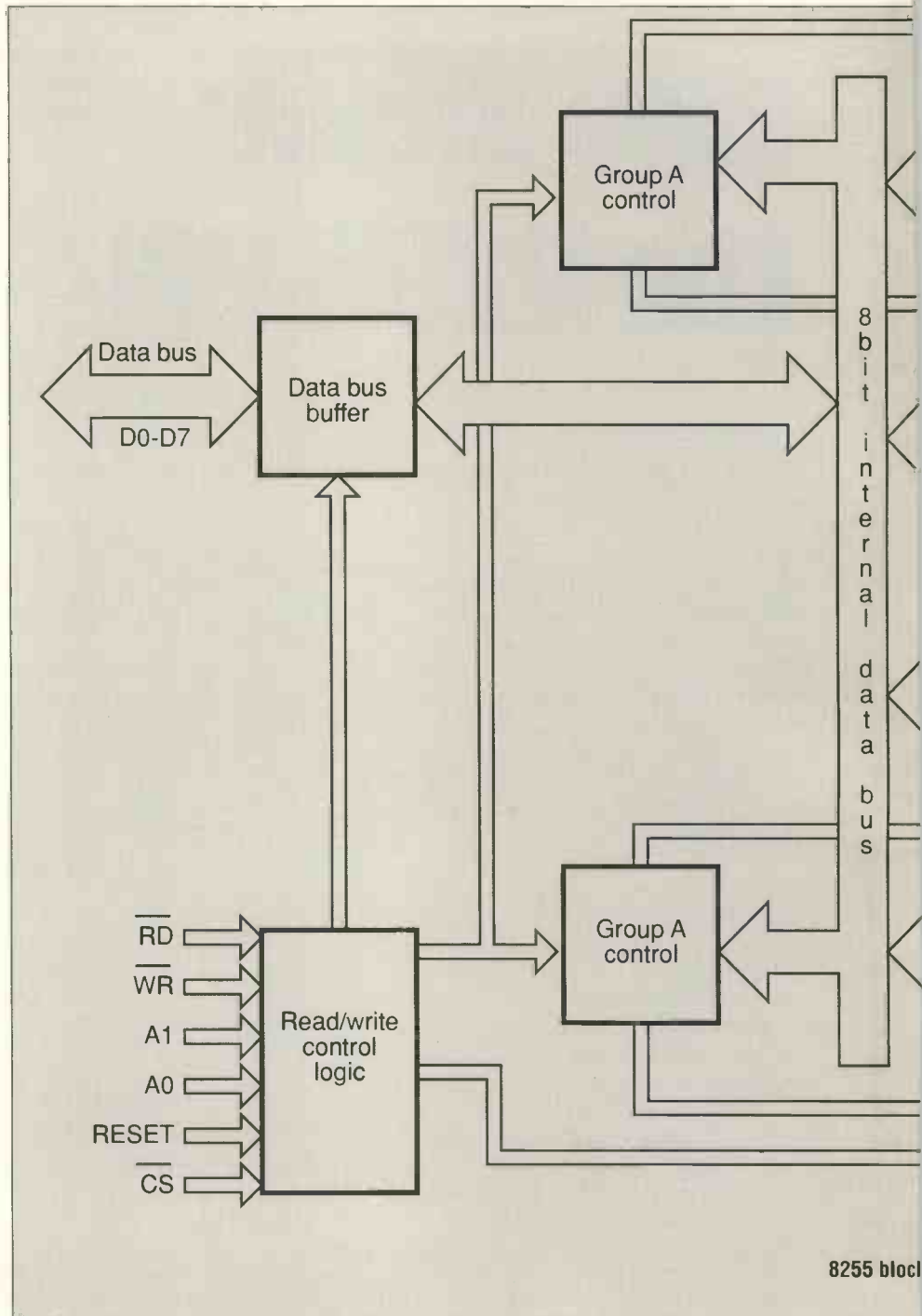

- when port A is defined as input, and in mode 2, it is used as the IBF output. This is sent low when data from port A has been read into the input latch. It is set when  $\overline{STB}$  goes low and cleared by the rising edge of  $\overline{RD}$ . When port A is defined as output in mode 1, PC5 can be defined as input or output in conjunction with PC4.
- 13 PC4 Port C bit 4 - for mode 0 operation see pin 10. In mode 1 when port A is defined as input, and in mode 2, it is used as the  $\overline{STB}$  input. Sending this low latches data into port A.
- 14 PC0 Port C bit 0 - in mode 0 this forms part of the lower nibble of port C and along with PC1-PC3 can be used for input or output. In mode 1 it becomes  $\overline{INTRB}$  or interrupt request B. This is set when ACK, OBF and  $\overline{INTR}$  are high and is cleared by the falling edge of  $\overline{WR}$ . It can be used to generate an interrupt signal for the CPU when data has been accepted by a peripheral. In mode 2 PC0
- When port A is defined as output in mode 1, PC4 can be defined as input or output in conjunction with PC5.



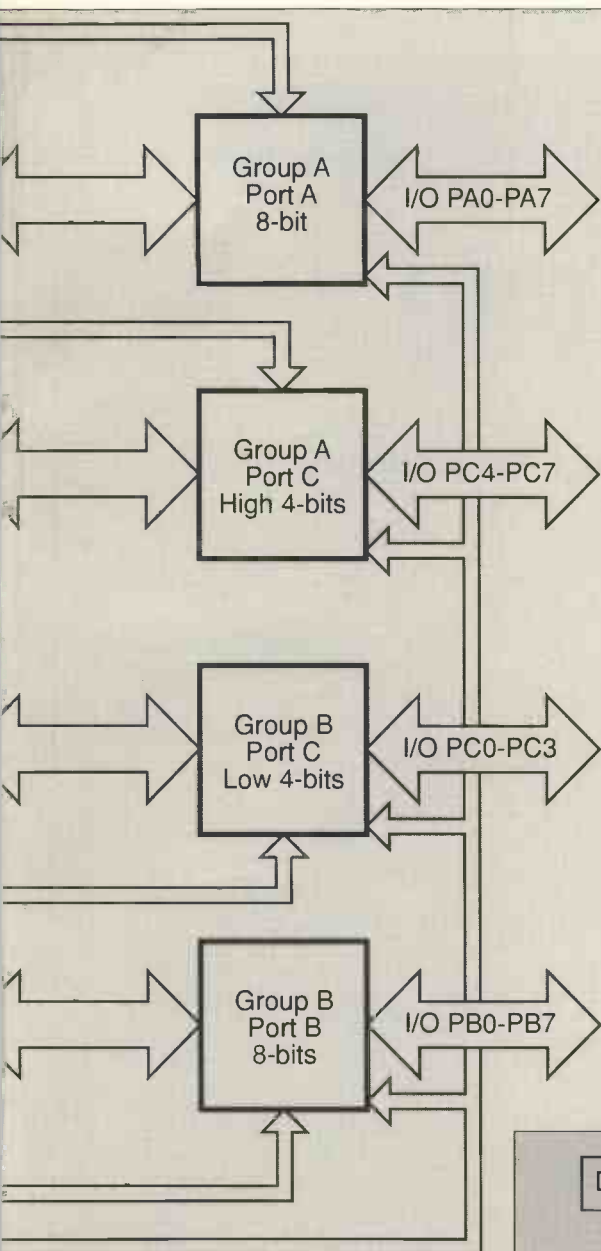

- 17 PC3 Port C bit 3 – for mode 0 operation see pin 14. In modes 1 and 2 it operates in the same way as PC0 except for port A (that is, it becomes INTRA).
- 18-25 PB0-PB7 Port B – in mode 0 the whole port can be either input or output. As with port A, mode 0 provides no handshake lines, whereas mode 1 does. Port B has no mode 2 operation though it can be in modes 0 or 1 when port A is in mode 2.
- 26 Vcc Supply voltage – +5V.
- 27-34 D7-D0 Data bus – used for bidirectional communication with the CPU and connects directly to the its data bus.
- 35 RESET A high on this line clears the control register returning the 8255 to mode 0 and all the ports to input.
- 36 WR Write input This is connected to the CPU WR line and is used by the microprocessor to write data to the 8255.
- 37-40 PA7-PA4 Port A high nibble – see pins 1 to 4. ■

diagram.

can be used for input or output in conjunction with PC1 and PC2.

- 15 PC1 Port C bit 1 – for mode 0 operation see pin 14. In mode 1 it operates in the same way as PC5 except for port B. In mode 2 it can be used for I/O along with PC0 and PC2.
- 16 PC2 Port C bit 2 – for mode 0 operation see pin 14. In mode 1 it operates in the same way as PC4 except for port B. In mode 2 it can be used for I/O along with PC0 and PC1.

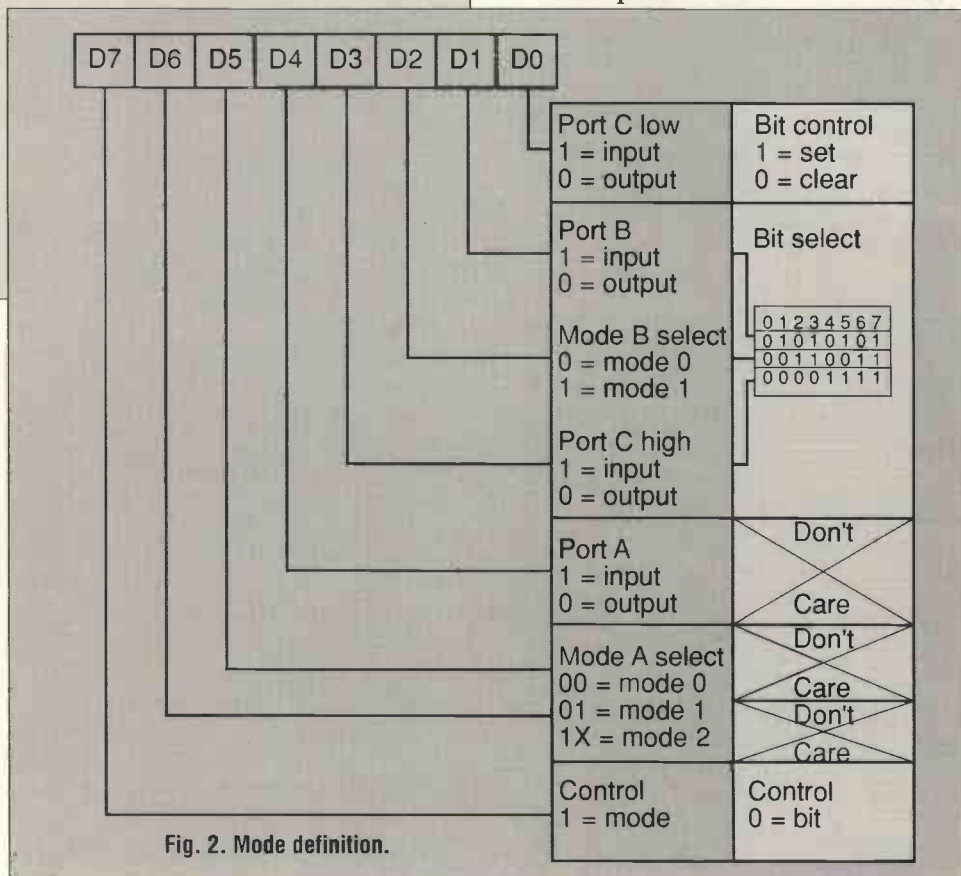

Fig. 2. Mode definition.

# Practical Components: The Junction Diode

*An understanding of the p-n junction is basic to understanding other semiconductor devices, as explained by Steve Knight B.Sc.*

The modern p-n junction diode had its origins in the early days of radio when the point-contact *cat's whisker* detector was found in every crystal receiver. During the Second World War, the development of radar meant the use of shorter and shorter wavelengths and a reduction in the physical size of equipment. At microwave frequencies, the limitations of conventional valves led to the re-adoption of the point-contact rectifier using a silicon crystal for the high frequency stage of the receiver. Production of these detectors was a hit and miss affair, requiring great skill and patience to turn out a good specimen.

A great deal of work, therefore, was done on gaining a theoretical understanding of the crystal-wire interface, and it was this work that provided a foundation for the subsequent development of the solid state diode and the transistor in the late 1940s.

## Go With The Flow

The smallest particle of any substance that retains the characteristics of the substance is a molecule. Each molecule is built up from a number of chemical elements and the smallest particle of each element is an atom. Atoms are made up of a positively charged

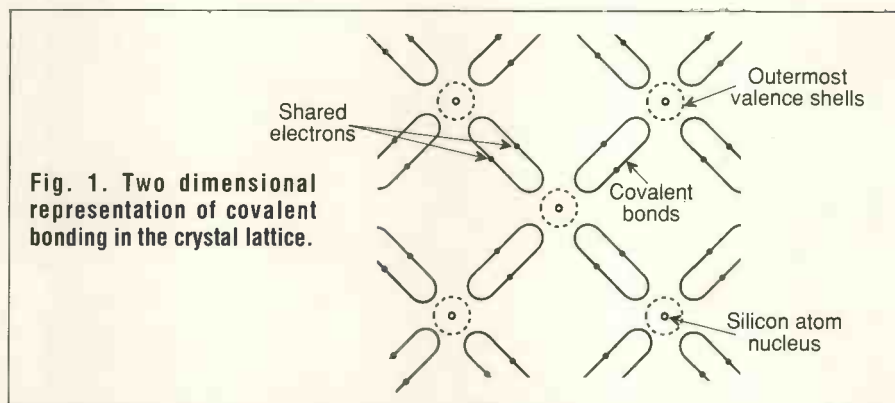

core or nucleus about which one or more negatively charged particles called electrons rotate in orbital rings or shells. These electrons are held in their orbits by the attracting force of the nucleus; in normal circumstances the sum of the negative charges carried by the electrons is balanced by the positive charge carried by the nucleus, so the entire atom is electrically neutral.

The electrons making up the outermost of the orbital shells are called valence electrons and these are least tightly bound to the nucleus. In metals like silver and copper, the valence electrons can easily break free from their parent atoms and drift about within the atomic structure. When a voltage is applied across the metal, these free electrons move towards the positive pole of the supply and become

current carriers. All metals have an abundance of mobile carriers and are described as good conductors.

In substances such as glass, mica, most plastics, the valence electrons are too tightly bound to their parent atoms to break free, so no current carriers are available in these materials, which are called insulators.

## Semiconductors

The distinction between conductors and insulators is not always precise. Some materials are neither good conductors nor good insulators: these are called semiconductors and form the basic component of all solid state electronics.

Semiconductors, particularly germanium and silicon, are crystalline substances in which the atoms are held together in a stable geometrical arrangement known as a crystal lattice. Both germanium and silicon have four valence electrons and the crystal structure is maintained by a bonding arrangement in which each atom shares its valence electrons with those of neighbouring atoms. A representation of covalent bonding, as it is called, is shown in Fig.1.

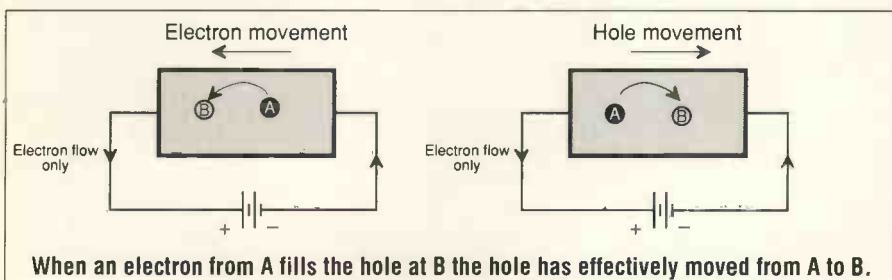

Each of the inter-atomic bonds is a shared valence electron.

In a perfect crystal at low temperatures there will be no free electrons and therefore no charge carriers – the crystal behaves as an insulator. As temperature rises, the thermal energy given to the crystal breaks some of the covalent bonds and electrons are released. At room temperature, therefore, germanium and silicon crystals behave as conductors, though very poor ones. This weak thermally generated conductivity is called intrinsic conductivity.

Electrons, however, are not the only charge carriers available in semiconductor materials. Wherever an electron breaks free, a space or hole is left in the crystal lattice and, since this hole has been created by the defection of a negative charge, the hole behaves as a positive charge. Fig.2 shows the concept of the hole as a carrier; when an electron moves from a point A into a hole at point B, the hole appears to have moved from B to A. The overall process can be viewed as electrons moving from the positive towards the negative pole within the crystal (and in the external wires) and holes moving in the opposite direction. There is no particle called a *hole* it is simply the absence of an electron, but it can nevertheless be treated as a carrier.

## Impurity Atoms

As intrinsic conductivity is dependent upon temperature, the manufacture of usable semiconductor material requires the control of the conduction characteristics so that either electrons or holes become the dominant, or majority, charge carriers. This is accomplished by the addition of an impurity into the basic material.

Certain other elements such as aluminium, indium, boron and phosphorus have atoms which can *fit* into the crystal lattice of germanium or silicon without upsetting the pattern. If these added atoms have a different number of valence electrons from those of the semiconductor material, the conductivity is enormously increased and is virtually independent of temperature.

The germanium or silicon material is first purified to a very

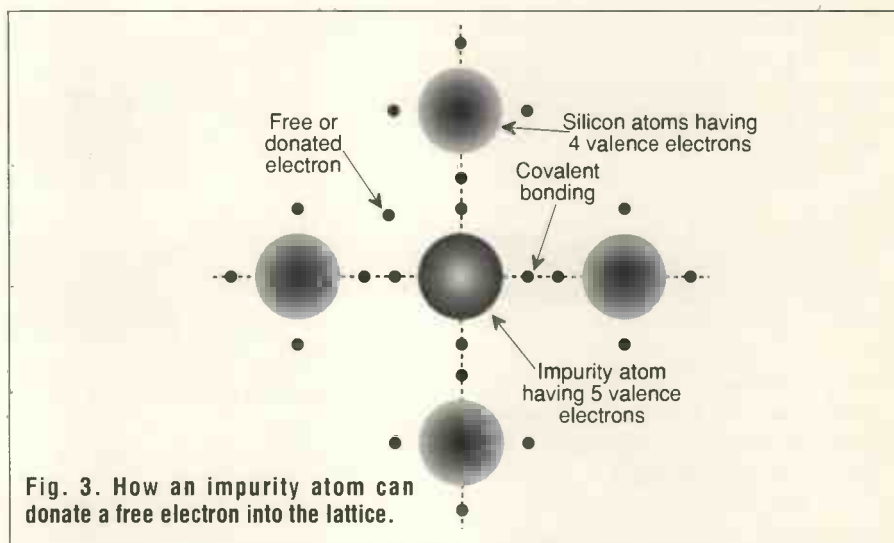

Fig. 3. How an impurity atom can donate a free electron into the lattice.

high degree. While it is molten, impurity atoms are added by introducing a controlled quantity of the appropriate element into the melt. When the material cools, the crystal formation is re-established, but containing atoms from the impurity additive. Fig.3 shows the situation when the impurity atoms have five valence electrons. Four of these go into covalent bonding with adjacent atoms, but the fifth is left unattached to wander about the lattice, acting as a charge carrier. Such an impurity is called a donor, as it donates free electrons to the material; the semiconductor then becomes N (or negative) type and electrons are the majority carriers.

Fig.4 shows the effect of impurity atoms with only three valence electrons. Three covalent bonds with neighbouring atoms are occupied, and a hole accordingly *appears* at what would have been the fourth bond. This material is P (positive) type and the holes are the majority carriers. These impurity atoms are known as acceptors, as

they can accept a wandering electron.

Both N and P type crystals are electrically neutral; for each charge carrier resulting from an impurity, there is also an impurity atom carrying an opposite charge, so balance is maintained.

## The P-N Junction

When a single crystal is formed in such a way that part of it is N type material and part P type, the junction between these regions has remarkable properties which make it the foundation of both diode and transistor action.

To understand what happens, suppose we start off with two separate pieces of material of opposite types (Fig. 5a). Only the majority carriers are shown. Imagine the two pieces brought together to form a continuous lattice structure: this is how the junction will be.

Electrons and holes are naturally attracted to each other; initially,

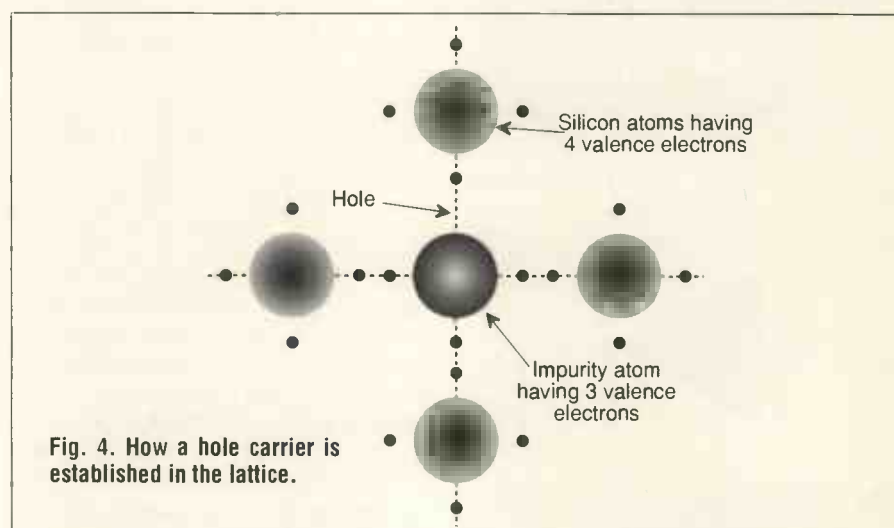

Fig. 4. How a hole carrier is established in the lattice.

there is a movement of electrons from the N to the P region and therefore an (apparent) movement of holes in the other direction, from P to N (Fig.5b).

Although it might seem that this migration will continue until all the electrons and holes have neutralised each other out of existence, this does not happen. When a small percentage of the electrons has crossed the junction and recombined with holes going the other way – a process known as diffusion – the migration stops. The situation is then as shown in Fig.6. While the diffusion continues, electrons assemble in the P material close to the junction, and holes assemble in the N material. This build-up of charges is sufficient to block any further migration.

What we have then in effect is a thin layer of material with no mobile charges, on either side of which are layers of free positive and negative charges. There is therefore a potential difference acting across the junction (just as there is across the dielectric of a charged capacitor). The magnitude of this voltage is a function of the carrier densities and the semiconductor material and is about 0.3V for germanium and 0.7V for silicon. It can be represented as an imaginary battery connected across the junction as shown in Fig. 6. This voltage is described as the *potential barrier* and the area around the junction which is free of charge carriers is called the *depletion layer*.

### Biasing The Junction

When the junction is subjected to an externally applied DC bias voltage, the result depends upon whether the voltage aids or opposes the potential barrier. When the P region is made positive, it is clear that the barrier is being opposed; holes are repelled by the positive field and

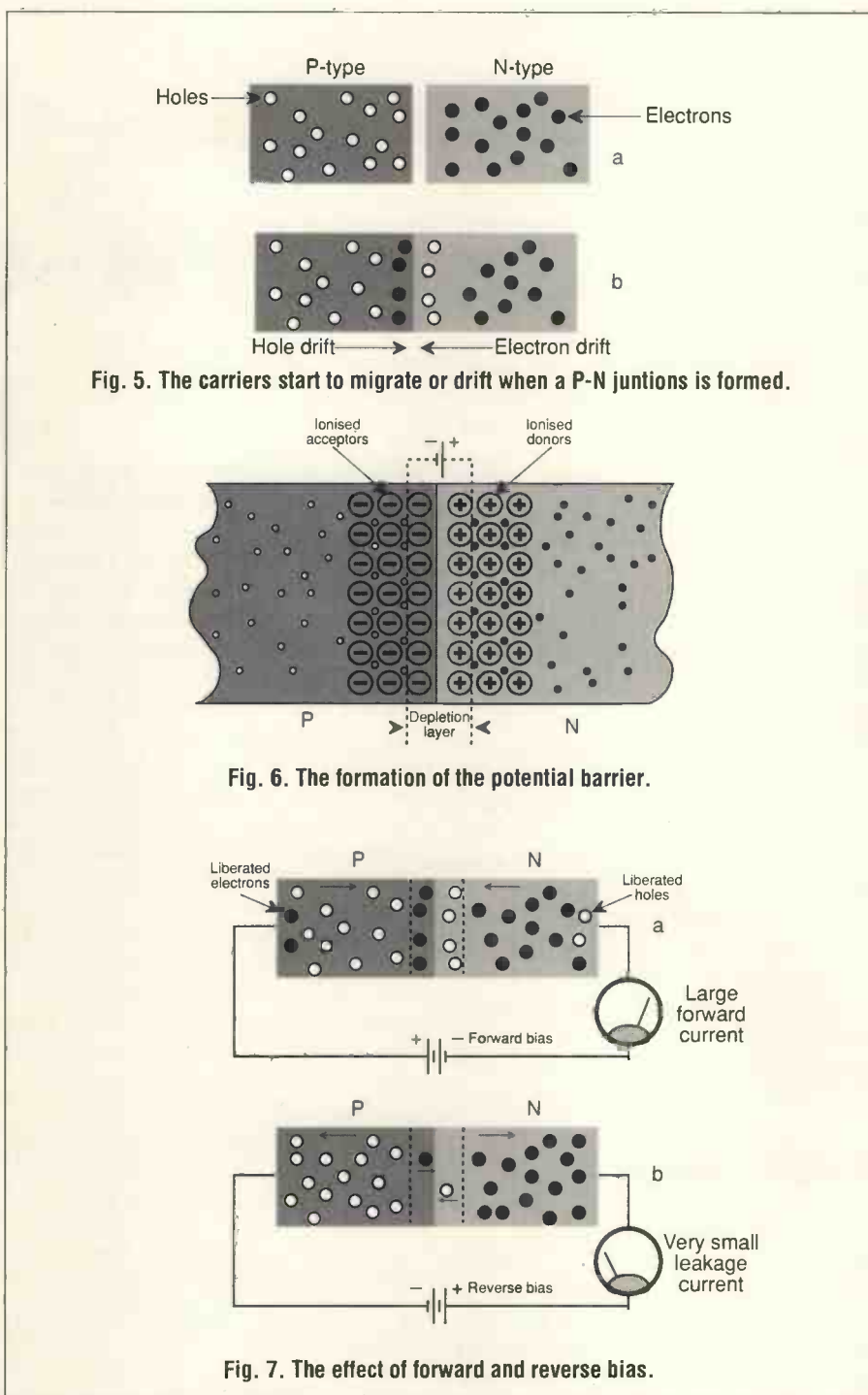

electrons by the negative field. Both holes and electrons are urged in the direction of the arrows in Fig.7(a), that is, towards the P-N junction where they recombine. A high current consequently flows around the circuit as long as this forward bias is applied.

When the P region is made negative, as in Fig.7(b), the potential barrier is being assisted; holes are attracted by the negative field and electrons by the positive field. Each type of carrier is pulled away from the other in the direction of the arrows and there can be no significant recombination, so the

depletion layer is widened and the current flow is very small. A few nanoamps flows due to the relatively small number of minority carriers crossing the junction with this bias. These carriers create what is known as the reverse leakage current.

The P-N junction diode is a rectifier because it only passes current in one direction. Fig.8 is the diode symbol. The arrow points in the direction of conventional current flow, which is taken to be from positive to negative. The cathode is usually marked on the diode case.

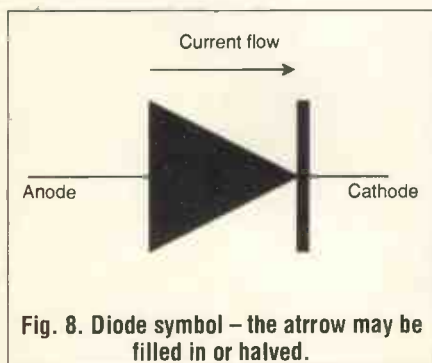

Fig. 8. Diode symbol – the arrow may be filled in or halved.



**HIGH POWER AMPLIFIER** For your car, it has 150 watts output. Frequency response 20HZ to 20 KHZ and a signal to noise ratio better than 60db. Has built in short circuit protection and adjustable input level to suit your existing car stereo, so needs no pre-amp. Works into speakers ref 30P7 described below. A real bargain at only £57.00 Order ref 57P1.

**HIGH POWER CAR SPEAKERS.** Stereo pair output 100w each. 40hm impedance and consisting of 6 1/2" woofer 2" mid range and 1" tweeter. Ideal to work with the amplifier described above. Price per pair £30.00 Order ref 30P7.

**PERSONAL STEREOS** Customer returns but complete with a pair of stereo headphones very good value at £3.00 ref 3P83.  
**2KV 500 WATT TRANSFORMERS** Suitable for high voltage experiments or as a spare for a microwave oven etc. 250v AC input. £10.00 ref 10P93

**MICROWAVE CONTROL PANEL** Mains operated, with touch switches. Complete with 4 digit display, digital clock, and 2 relay outputs one for power and one for pulsed power (programmable). Ideal for all sorts of precision timer applications etc. £6.00 ref 6P18  
**FIBRE OPTIC CABLE.** Stranded optical fibres sheathed in black PVC. Five metre length £7.00 ref 7P29

**12V SOLAR CELL** 200mA output ideal for trickle charging etc. 300mm square. Our price £15.00 ref 15P42

**PASSIVE INFRA-RED MOTION SENSOR.** Complete with daylight sensor, adjustable lights on timer (8 secs -15 mins), 50' range with a 90 deg coverage. Manual override facility. Complete with wall brackets, bulb holders etc. Brand new and guaranteed. £25.00 ref 25P24.



**PACK OF TWO PAR38 BULBS** for above unit £12.00 ref 12P43

**VIDEO SENDER UNIT** Transmit both audio and video signals from either a video camera, video recorder or computer to any standard TV set within a 100' range! (tune TV to a spare channel). 12v DC op. £15.00 ref 15P39



**Suitable mains adaptor** £5.00 ref 5P191

**FM TRANSMITTER** housed in a standard working 13A adapter (bug is mains driven). £26.00 ref 26P2

**MINIATURE RADIO TRANSCEIVERS** A pair of walkie talkies with a range of up to 2 kilometres. Units measure 22x52x155mm. Complete with cases. £30.00 ref 30P12

**FM CORDLESS MICROPHONE.** Small hand held unit with a 500' range! 2 transmit power levels reqs PP3 battery. Tuneable to any FM receiver. Our price £15 ref 15P42A



**10 BAND COMMUNICATIONS RECEIVER.** 7 short bands, FM, AM and LW DX local swing, tuning 'eye' mains or battery. Complete with shoulder strap and mains lead **NOW ONLY £19.00!! REF 19P14.**



**WHISPER 2000 LISTENING AID.** Enables you to hear sounds that would otherwise be inaudible! Complete with headphones. Cased. £5.00 ref 5P179.

**CAR STEREO AND FM RADIO.** Low cost stereo system giving 5 watts per channel. Signal to noise ratio better than 45db, wow and flutter less than .35%. Neg earth. £25.00 ref 25P21.

**LOW COST WALKIE TALKIES.** Pair of battery operated units with a range of about 150'. Our price £8.00 a pair ref 8P50



**7 CHANNEL GRAPHIC EQUALIZER** plus a 60 watt power amp! 20-21KHZ 4-8R 12-14v DC negative earth. Cased. £25 ref 25P14.

**NICAD BATTERIES.** Brand new top quality. 4 x AA's £4.00 ref 4P44, 2 x C's £4.00 ref 4P73, 4 x D's £9.00 ref 9P12, 1 x PP3 £6.00 ref 6P35

**TOWERS INTERNATIONAL TRANSISTOR SELECTOR GUIDE.** The ultimate equivalents book. Latest edition £20.00 ref 20P32.

**CABLE TIES.** 142mm x 3.2mm white nylon pack of 100 £3.00 ref 3P104. Bumper pack of 1,000 ties £14.00

## VIDEO AND AUDIO MONITORING SYSTEM



**£99.00**

Brand new units consisting of a camera, 14cm monitor, 70 metres of cable, AC adapter, mounting bracket and owners manual. 240v AC or 12v DC operation complete with built in 2 way intercom. £99.00 ref 99P2.

**1991 CATALOGUE AVAILABLE NOW IF YOU DO NOT HAVE A COPY PLEASE REQUEST ONE WHEN ORDERING OR SEND US A 6"x9" SAE FOR A FREE COPY.**

**GEIGER COUNTER KIT.** Complete with tube, PCB and all components to build a battery operated geiger counter. £39.00 ref 39P1

**FM BUG KIT.** New design with PCB embedded coil. Transmits to any FM radio. 9v battery req'd. £5.00 ref 5P158

**FM BUG** Built and tested superior 9v operation £14.00 ref 14P3

**COMPUSITE VIDEO KITS.** These convert composite video into separate H sync, V sync and video. 12v DC. £8.00 ref 8P39.

**SINCLAIR C5 MOTORS** 12v 29A (full load) 3300 rpm 6"x4" 1/4" O/P shaft. New. £20.00 ref 20P22

**As above but with fitted 4 to 1 inline reduction box (800rpm) and toothed nylon belt drive cog £40.00 ref 40P8.**

**SINCLAIR C5 WHEELS** 13" or 16" dia including treaded tyre and inner tube. Wheels are black, spoked one piece poly carbonate. 13" wheel £6.00 ref 6P20, 16" wheel £6.00 ref 6P21.

**ELECTRONIC SPEED CONTROL KIT** for c5 motor. PCB and all components to build a speed controller (0-95% of speed). Uses pulse width modulation. £17.00 ref



17P3.  
**SOLAR POWERED NICAD CHARGER** Charges 4 AA nicads in 8 hours. Brand new and cased £6.00 ref 6P3.

**MOSFETS FOR POWER AMPLIFIERS ETC.** 100 watt mosfet pair 2SJ99 and 2SK343 £4.00 a pair with pin out info ref 4P51. Also available is a 2SK413 and a 2SK118 at £4.00 ref 4P42.

**10 MEMORY PUSH BUTTON TELEPHONES.** These are 'customer returns' so they may need slight attention. BT approved. £6.00 each ref 6P16 or 2 for £10.00 ref 10P77.

**12 VOLT BRUSHLESS FAN** 1/2" square brand new ideal for boat, car, caravan etc. £5.00 ref 5P206.

**ACORN DATA RECORDER ALF503** Made for BBC computer but suitable for others. Includes mains adapter, leads and book. £15.00 ref 15P43

**VIDEO TAPES.** Three hour superior quality tapes made under licence from the famous JVC company. Pack of 10 tapes £20.00 ref 20P20.

**ELECTRONIC SPACESHIP.** Sound and impact controlled, responds to claps and shouts and reverses when it hits anything. Kit with complete assembly instructions £10.00 ref 10P81.



**PHILIPS LASER. 2MW HELIUM NEON LASER TUBE.** BRAND NEW FULL SPEC £40.00 REF 40P10. MAINS POWER SUPPLY KIT £20.00 REF 20P33 READY BUILT AND TESTED LASER IN ONE CASE £75.00 REF 75P4.

**SOLDER 22SWG** resin cored solder on a 1/2kg reel. Top quality. £4.00 a reel ref 4P70.

**600 WATT HEATERS** Ideal for air or liquid, will not corrode, lasts for years. coil type construction 3"x2" mounted on a 4" dia metal plate for easy fixing. £3.00 ea ref 3P78 or 4 for £10.00 ref 10P76.

**TIME AND TEMPERATURE MODULE** A clock, digital thermometer (Celsius and Fahrenheit (0-160 deg F) programmable too hot and too cold alarms. Runs for at least a year on one AA battery. £9.00 ref 9P5

Remote temperature probe for above unit £3.00 ref 3P60.

**GEARBOX KITS** Ideal for models etc. Contains 18 gears (2 of each size) 4x50mm axles and a powerful 9-12v motor. All the gears etc are push fit. £3.00 for complete kit ref 3P93.

**ELECTRONIC TICKET MACHINES** These units contain a magnetic card reader, two matrix printers, motors, sensors and loads of electronic components etc. (12"x12"x7") Good value at £12.00 ref 12P28.

**JOYSTICKS.** Brand new with 2 fire buttons and suction feet these units can be modified for most computers by changing the connector etc. Price is 2 for £5.00 ref 5P174.

**GAS POWERED SOLDERING IRON AND BLOW TORCH** Top quality tool with interchangeable heads and metal body. Fully adjustable, runs on lighter gas. £10.00 ref 10P130

**SMOKE ALARMS** Ionization type 5 year warranty complete with battery only £5.00 ref 5P206

**ANSWER MACHINES** BT approved remote message playback, integral push button phone, power supply and tape. Exceptional value at £45.00 ref 45P2

**CAR IONIZER KIT** Improve the air in your car! clears smoke and helps to reduce fatigue. Case required. £12.00 ref 12P8.

**6V 10AH LEAD ACID** sealed battery by yusha ec equipment but in excellent condition now only 2 for £10.00 ref 10P95.

**12 TO 220V INVERTER KITS** as supplied it will handle up to about 15w at 220v but with a larger transformer it will handle 80watts. Basic kit £12.00 ref 12P17. Larger transformer £12.00 ref 12P41.

**VERO EASI WIRE PROTOTYPING SYSTEM** Ideal for designing projects on etc. Complete with tools, wire and reusable board. Our price £6.00 ref 6P33.

**MICROWAVE TURNABLE MOTORS.** Ideal for window displays etc. £5.00 ref 5P165

**STC SWITCHED MODE POWER SUPPLY** 220v or 110v input giving 5v at 2A, +24v at 0.25A, +12v at 0.15A and +90v at 0.4A £6.00 ref 6P59

**TELEPHONE AUTODIALLERS.** These units, when triggered will automatically dial any telephone number. Originally made for alarm panels. BT approved. £12.00 ref 12P23 (please state telephone no req'd).

**25 WATT STEREO AMPLIFIER.** STK043. With the addition of a handful of components you can build a 25 watt amplifier. £4.00 ref 4P69 (Circuit dia Included).

**LINEAR POWER SUPPLY** Brand new 220v input +5 at 3A, +12 at 1A, -12 at 1A. Short circuit protected. £12.00 ref 12P21.

**MAINS FANS** Snail type construction. Approx 4"x5" mounted on a metal plate for easy fixing. New £5.00 5P166.

**POWERFUL IONIZER KIT.** Generates 10 times more ions than commercial units! Complete kit including case £18.00 ref 18P2.

**MINI RADIO MODULE** Only 2" square with ferrite aerial and tuner. Superhet. Req's PP3 battery. £1.00 ref BD716.

**HIGH RESOLUTION MONITOR.** 9" black and white Phillips tube in chassis made for OPD computer but may be suitable for others. £20.00 ref 20P26

**BARGAIN NICADS** AAA SIZE 200MAH 1.2V PACK OF 10 £4.00 REF 4P92, PACK OF 100 £30.00 REF 30P16

**CB CONVERTORS.** Converts a car radio into an AM CB receiver. Cased with circuit diagram. £4.00 ref 4P48.

**FLOPPY DISCS.** Pack of 15 3 1/2" DSDD £10.00 ref 10P88. Pack of 10 5 1/4" DSDD £5.00 ref 5P168.

**SONIC CONTROLLED MOTOR** One click to start, two click to reverse direction, 3 click to stop! £3.00 each ref 3P137.

**FRESNEL MAGNIFYING LENS** 83 x 52mm £1.00 ref BD827.

**BULL ELECTRICAL**  
250 PORTLAND ROAD HOVE SUSSEX  
BN3 5QT TELEPHONE 0273 203500  
MAIL ORDER TERMS: CASH PO OR CHEQUE  
WITH ORDER PLUS £2.50 POST PLUS VAT.  
PLEASE ALLOW 10-14 DAYS FOR DELIVERY  
FAX 0273 23077



**LCD DISPLAY.** 4 1/2 digits supplied with connection data £3.00 ref 3P77 or 5 for £10.00 ref 10P78.

**ALARM TRANSMITTERS.** No data available but nicely made complex transmitters 9v operation. £4.00 each ref 4P81.

**100M REEL OF WHITE BELL WIRE** Fine 8 pattern ideal for intercoms, door bells etc £3.00 a reel ref 3P107.

**TRANSMITTER RECEIVER SYSTEM** Originally made for nurse call systems they consist of a pendant style transmitter and a receiver with telescopic aerial 12v. 80 different channels. £12.00 ref 12P26

**CLAP LIGHT.** This device turns on a lamp at a finger 'snap' etc. nicely cased with built in battery operated light. Ideal bedside light etc. £4.00 each ref 4P82

**ELECTRONIC DIPSTICK KIT.** Contains all you need to build an electronic device to give a 10 level liquid indicator. £5.00 (ex case) ref 5P194.

**UNIVERSAL BATTERY CHARGER.** Takes AA's, C's, D's and PP3 nicads. Holds up to 5 batteries at once. New and cased, mains operated. £6.00 ref 6P36

**ONE THOUSAND CABLE TIES** 175mm x 2.4mm white nylon cable ties only £5.00 ref 5P181.

**PC MODEMS** 1200/75 baud modems designed to plug into a PC complete with manual but no software £18.00 ref 18P12

**ASTEC SWITCHED MODE POWER SUPPLY** 80mm x 165mm (PCB size) gives +5 at 3.75A, +12 at 1.5A, -12 at 0.4A. Brand new £12.00 ref 12P39

**VENTILATED CASE FOR ABOVE PSU** with IEC filtered socket and power switch. £5.00 ref 5P190.

**IN CAR POWER SUPPLY.** Plugs into cigar socket and gives 3.4, 5.6, 7.5, 9, and 12v outputs at 800mA. Complete with universal spider plug. £5.00 ref 5P167.

**CUSTOMER RETURNED** switched mode power supplies. Mixed type, good for spares or repair. £2.00 each ref 2P292.

**DRILL OPERATED PUMP.** Fits any drill and is self priming. £3.00 ref 3P140.

**PERSONAL ATTACK ALARM.** Complete with built in torch and vanity mirror. Pocket sized, req's 3 AA batteries. £3.00 ref 3P135

**POWERFUL SOLAR CELL 1AMP .45 VOLTS** only £5.00 ref 5P192 (other sizes available in catalogue)

**SOLAR PROJECT KIT.** Consists of a solar cell, special DC motor, plastic fan and turntables etc plus a 20 page book on solar energy! Price is £8.00 ref 8P51.

**RESISTOR PACK.** 10 x 50 values (500 resistors) all 1/4 watt 2% metal film. £5.00 ref 5P170.

**CAPACITOR PACK 1.** 100 assorted non electrolytic capacitors £2.00 ref 2P286.

**CAPACITOR PACK 2.** 40 assorted electrolytic capacitors £2.00 ref 2P287.

**QUICK CUPPA?** 12v immersion heater with lead and cigar lighter plug £3.00 ref 3P92

**LED PACK.** 50 red leds, 50 green leds and 50 yellow leds all 5mm £8.00 ref 8P52

**FERRARI TESTAROSSA.** A true 2 channel radio controlled car with forward, reverse, 2 gears plus turbo. Working headlights. £22.00 ref 22P6.

**ULTRASONIC WIRELESS ALARM SYSTEM** wo units, one a sensor which plugs into a 13A socket in the area you wish to protect. The other, a central alarm unit plugs into any other socket elsewhere in the building. When the sensor is triggered (by body movement etc) the alarm sounds. Adjustable sensitivity. Price per pair £20.00 ref 20P34. Additional sensors (max 5 per alarm unit) £11.00 ref 11P6.

**TOP QUALITY MICROPHONE.** Unidirectional electret condenser mic 600 ohm sensitivity 16-18khz built in chime complete with magnetic microphone stand and mic clip. £12.00 ref 12P42.

**WASHING MACHINE PUMP.** Mains operated new pump. Not self priming. £5.00 ref 5P18

**IBM PRINTER LEAD.** (D25 to centronics plug) 2 metre parallel. £5.00 ref 5P186.

**COPPER CLAD STRIP BOARD** 17" x 4" of .1" pitch 'vero' board. £4.00 a sheet ref 4P62 or 2 sheets for £7.00 ref 7P22.

**STRIP BOARD CUTTING TOOL** £2.00 ref 2P352.

3 1/2" disc drive. 720K capacity made by NEC £60.00 ref 60P2

**TV LOUDSPEAKERS.** 5 watt magnetically screened 4 ohm 55 x 125mm. £3.00 a pair ref 3P109.

**TV LOUDSPEAKERS.** 3 watt 8 ohm magnetically screened 70 x 50mm £3.00 a pair ref 3P108

**BBC TRACKBALLS** Once again in stock only £4.00 ref 4P96

**CROSS OVER NETWORKS** 8 ohm 3 way Japanese made units. Excellent units available at only £2.00 for a pair ref 2P363

**SPEAKER GRILLS** set of 3 matching grills of different diameters. 2 packs for £2.00 (6 grills) ref 2P364

**50 METRES OF MAINS CABLE** £3.00 2 core black precut in convenient 2 m lengths. Ideal for repairs and projects. ref 3P91

**4 CORE SCREENED AUDIO CABLE** 24 METRES £2.00. Precut into convenient 1.2 m lengths. Ref 2P365

**TWEETERS** 2 1/4" DIA 8 ohm mounted on a smart metal plate for easy fixing £2.00 ref 2P366

**COMPUTER MICE** Originally made for Future PCs but can be adapted for other machines. Swiss made £8.00 ref 8P57. Atan ST conversion kit £2.00 ref 2P362



# PE Chronos: Getting Into Condition

Anthony Smith describes the ICM7226A ic and the input conditioning circuits in part two of his universal counter and timer.

Last month's article looked at the basic specification of Chronos. This month we discuss the "central processor" and the necessary input signal conditioning.

The design uses the Intersil ICM7226A universal counter and LED display driver. This chip is the heart of the Chronos, so we must be familiar with it.

The 7226A is 40-pin DIL CMOS chip, so antistatic precautions must be taken. It needs a single +5V supply. With the addition of a 10MHz crystal, eight LED displays, a few switches, and a handful of discrete components, and the 7226A is the basis of a complete counter timer system, functioning as a frequency counter, period counter, frequency ratio counter, time interval counter, or totalising counter.

Fig.1 shows a typical arrangement. If you'd like to test the 7226A yourself, this circuit can be built exactly as shown – the only additional requirement is a +5V DC supply.

## Multiplexed Operation

The LED drive outputs of the 7226A are multiplexed – the only way to

drive seven displays using a 40-pin chip.

Fig. 2 shows the principles. Inside each of the eight displays are eight LEDs (including the decimal point). The anodes of all eight LEDs are connected to a common anode terminal. The cathodes, however, are brought out at separate terminals connected to the segment outputs of the 7226A, a,b,c,d,e,f,g, and dp (Disp.8 identifies each segment).

In each digit, if the common anode is connected to a positive supply, current can be drawn from any combination of cathodes to light LEDs. For example, if current is drawn from segments a,b and c, these will light up to form a figure 5. Removing power from the common anode will switch off all segments.

In the multiplexed display, the corresponding (a,b,c,etc.) cathodes of each display are connected together, but the common anodes for each display are separate. Each anode is energised in turn, while current is drawn from the appropriate cathodes to show the figure required at each digit. This process runs quickly at 500Hz, so that eye sees all the digits illuminated together.

The current through the LEDs is limited by the 7226A chip, so current limiting resistors are not needed. Segments are typically pulsed at 35mA for 12.2% of the time, averaging to a reasonable brightness. There is a 6µs blanking period between each digit to allow the cathode drives to settle to the next required state, avoiding ghosting on the displays.

Multiplexing has a drawback: because each digit is lit one time in eight, display brightness is lost. I use high efficiency displays – more expensive, but worthwhile, especially if the Chronos is to be used in high ambient lighting.

Note that the 7226A can only be connected to common anode displays, common cathode types must not be used. (Intersil make a 7226B, for common cathode displays, but the Chronos can only use the 7226A.) The decimal point of display 8 is not connected, but replaced with an overflow LED, which lights if the measurement exceeds the display capacity.

The 7226A uses its digit driver outputs in the selection of function, range and control modes, and for external decimal point selection if required. Any one of five digit drivers can be connected to the

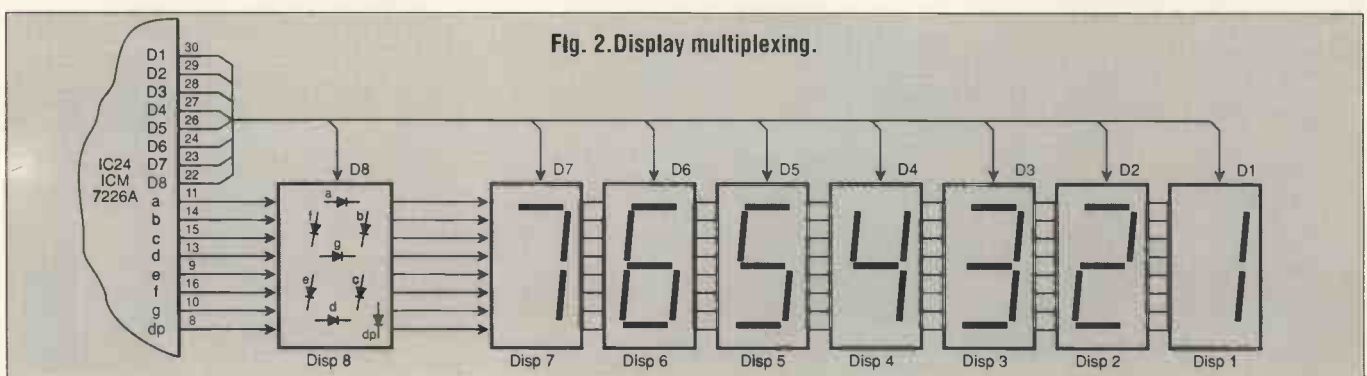



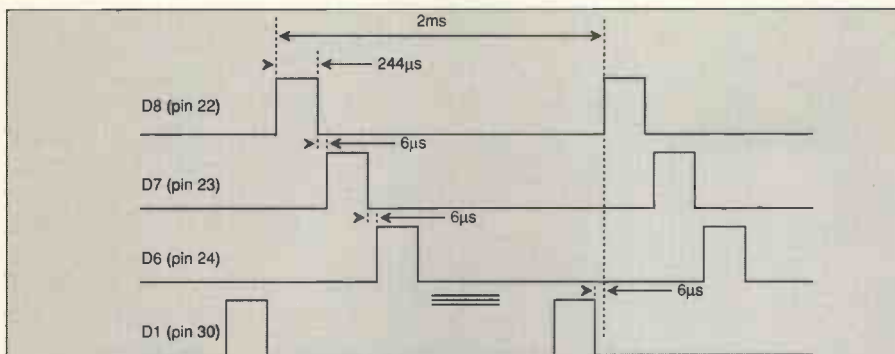

Fig. 3. ICM 7226A multiplexing signals.

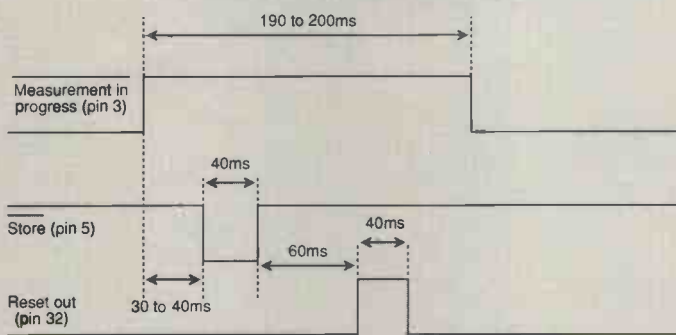

Fig. 4. ICM7226A outputs for interface control.

and needs an external 10MHz quartz crystal for precise frequency control (Fig.1). This provides the frequency standard for all measurements, and the basis for the timing signals used by the processing and multiplexing circuits.

The 7226A can also use an external (to itself) oscillator connected to pins 33 and 35, which overrides its own oscillator when digit driver D1 is connected to the CONTROL input. The Chronos uses this arrangement, for two reasons. Firstly, the oscillator can then drive the rest of the Chronos' timing and processing circuits, as well as the 7226A. Secondly, if required, any ultra-precise 10MHz oscillator (such as an atomic standard) can be connected to the Chronos.

### More Inputs

As well as signal inputs A and B, the 7226A has RESET and HOLD inputs at pins 19 and 39.

RESET resets the main counter within the 7226A, stops any

measurement in progress, and returns the display to zero. The 7226A will remain reset for as long as pin 19 is held low.

HOLD stops the measurement in progress and holds the reading at the last complete measurement.

When HOLD is released, the 7226A begins a new measurement from scratch, unless the units counter is selected, in which case it continues to count during HOLD, even though the display is frozen. When HOLD is released, the display returns to the current value of the count, rather than the held value.

RESET and HOLD can also be activated from front-panel BNC connectors, or by digital signals from the external bus.

### More Outputs

The 7226A has several other outputs which can enhance the basic counter timer system. MEASUREMENT IN PROGRESS (pin 3), STORE (pin 5), and RESET OUT (pin 32) are mainly for

external interfacing - their relationships are shown in Fig.4.

After a measurement, the signal at pin 3 goes high for around 200ms. This pause allows the last reading to be read or stored by an external system.

The STORE output allows, for example, the falling or rising edge of STORE to latch the reading into a suitable memory device. RESET OUT can be used to clear any external latches before the next measurement. (The RESET OUT signal is driven high whenever RESET is activated.) MEASUREMENT IN PROGRESS and STORE can also drive a gate indicator, and implement one shot measurements.

The 7226A outputs data through four BCD (binary coded decimal) outputs at pin 18 (BCD 1), pin 17 (BCD 2), pin 6 (BCD 4) and pin 7 (BCD 8). The BCD representation of each digit appears at these pins when the corresponding digit driver is high.

### Time Interval Priming

In time interval mode, measurement takes place as usual, with input A going low at the start of the interval and input B going low to terminate the interval. When a single time interval is measured, the 7226A must be primed first, by generating a high to low transition at input A and then at input B. The 7226A is then ready to measure the single interval. After the measurement, the inputs must be primed again before another interval can be timed. Fig.5 illustrates typical waveforms.

With repetitive time intervals, the transitions forming every alternate interval automatically provide the priming edges.

With single intervals, priming the timer is a little more troublesome. We could send transitions directly to inputs A and B from an external source, but that would be slow for a large number of singles.

The Chronos has an internal priming circuit linked to the RESET circuit such that a single press of the reset button (or external reset) clears the 7226A for the next measurement and primes it as well - there is no need for priming transitions at the UCT inputs. Priming operates when voltage

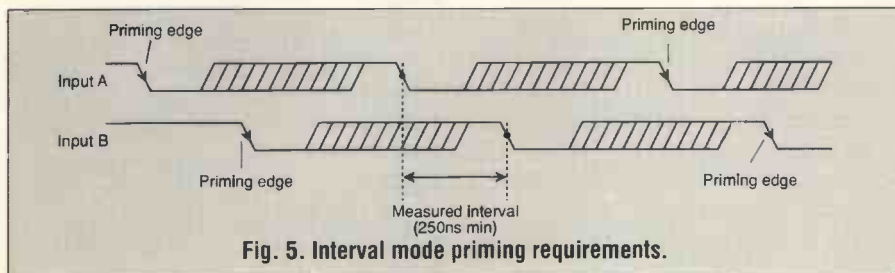
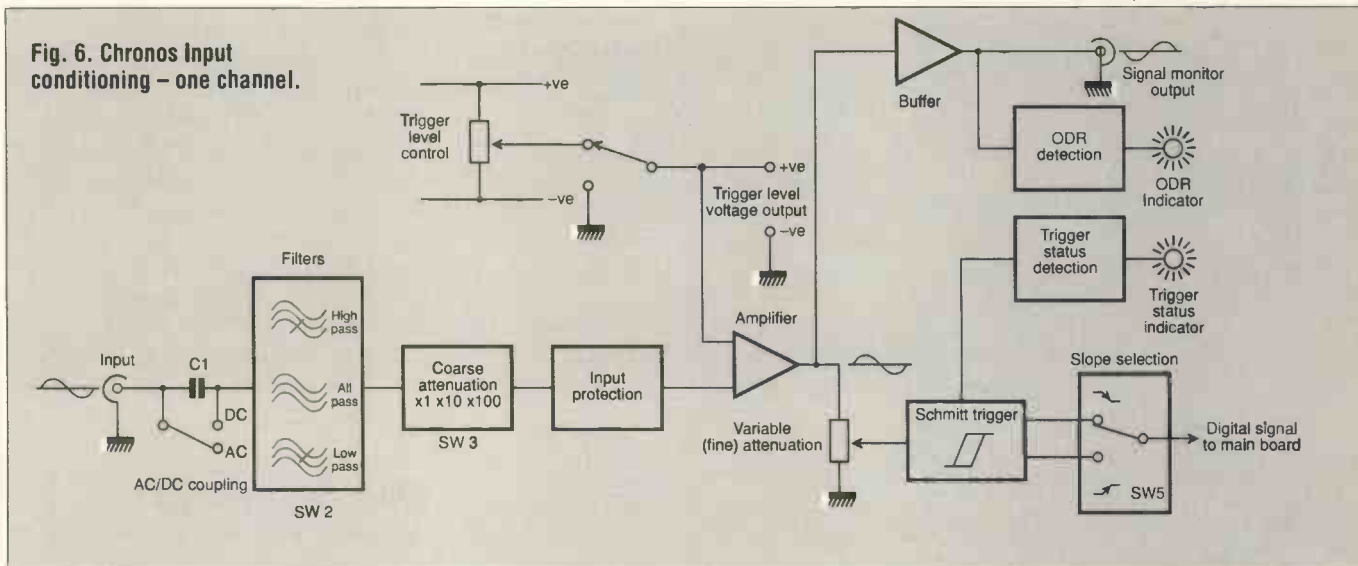

Fig. 5. Interval mode priming requirements.



Fig. 6. Chronos Input conditioning - one channel.



levels are present at inputs A and B, irrespective of those levels.

## To Slow Or To Fast

The 7226A has some limitations. For example, there is no function to read the pulse width of the input signal directly. Frequency measurements are limited to frequencies around 10MHz, and timing measurements to a maximum of ten seconds.

The Chronos tackles these shortcomings with extra circuitry. The Chronos can measure frequencies well in excess of 100MHz, and can make timing measurements - including pulse widths - lasting more than 27 hours. It also has a stopwatch function, a trigger delay facility, a one shot mode, and A gated via B operation.

Finally, the FUNCTION, RANGE, DP SELECT and CONTROL switches in Fig.1 are mechanical. The Chronos does all this electronically, removing the threat of interference, and reducing wiring, as well as allowing system control through an external bus.

## Signal Conditioning

To work properly, the 7226A should only be called upon to measure clean rectangular waveforms at logic levels. Signal excursions outside the power supply rails will damage the inputs of the 7226A. This poses no problems measuring 5V digital logic signals, but most signals to be measured will need to be conditioned by interface circuitry before being measured.

Fig.8 shows one input circuit (channels A and B are identical). The input signal is AC or DC coupled via S1. With S1 closed, C1 is short-circuited, and the signal goes directly to the filters. With S1 open, the signal is DC coupled via C1, removing any DC component. AC coupling is needed to measure an AC signal riding on a high DC level.

Consider, for example, a 2V RMS sinewave centred on a +10V DC level. DC coupled, the +10V level would force the sinewave outside the dynamic range of the input (Chronos inputs have a dynamic range of  $\pm 5V$ ). AC coupled the sinewave at the amplifier input will swing symmetrically about 0V, with no triggering problems.

The maximum DC voltage which can safely be removed depends on the input protection circuit and the voltage rating of C1. The Chronos' nominal maximum value is around 300V, although slightly greater voltages can be handled with the correct rating for C1.

AC coupling can attenuate and/or distort very low frequency sinusoids and low frequency squarewaves.

## Cleaning Up

The Chronos input channels have high pass and low pass filters switched via three-position S2. In the all-pass position, all signals go to the amplifier unattenuated.

The high pass filter attenuates frequencies below 1kHz at a rate of 20dB per decade. The low pass filter

attenuates signals above 50kHz at the same rate (Fig.7).

The filter break frequencies of 1kHz and 50kHz should meet most common filter needs. The low pass band embraces the audio frequency range: on audio signals where HF noise is a problem, the low pass filter will remove it.

The high pass filter is primarily designed to stop 50Hz mains interference distorting higher-frequency signals. In some cases, the amplitude of the interference is much greater than the HF signal being measured.

Note that the filters are designed for sinusoidal inputs. They can be used on rectangular digital signals with care. Rectangular signals contain a theoretically infinite range of frequency components, and attenuating some components could cause severe pulse distortion.

## The Dynamic Range

For proper measurements, signal amplitude should be sufficient to provide a logic level at the input of the 7226A, but not so large as to overload the input amplifier. The difference between these two levels is called the dynamic range.

Dynamic range is usually dictated by the output voltage swing of the amplifier. The Chronos amplifier output can swing to  $\pm 5V$  before saturating so it needs input signals which do not force the output beyond  $\pm 5V$ . Larger signals will cause distortion. In many cases output signal distortion causes gross inaccuracy.

In the Chronos, the amplifier gain is precisely set at 20dB, a

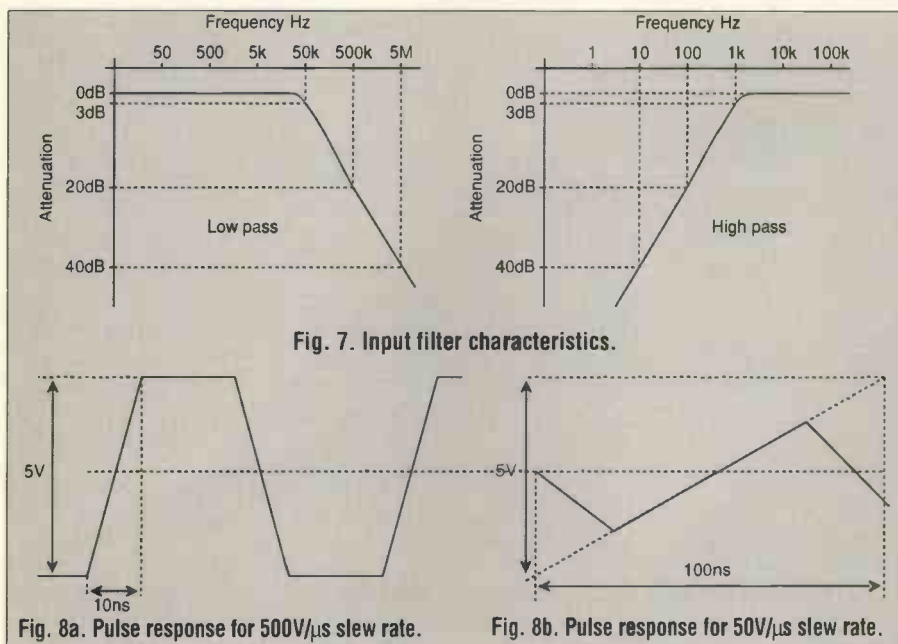

Fig. 7. Input filter characteristics.

Fig. 8a. Pulse response for 500V/ $\mu$ s slew rate.

Fig. 8b. Pulse response for 50V/ $\mu$ s slew rate.

voltage gain of ten, so an input signal swing of  $\pm 500\text{mV}$  causes an output swing of  $\pm 5\text{V}$ . An amplifier input signal greater than  $\pm 500\text{mV}$  cannot be directly tolerated without distortion.

If, for instance, we wish to measure a 5V TTL signal, we must bring it within the amplifier's range at the input. If we attenuate 5V by a factor of 10, the input will see 500mV, and the amplifier will not saturate.

S3 selects attenuation. x1 is zero attenuation – the signal goes direct to the amplifier. This corresponds to a dynamic range of  $\pm 500\text{mV}$ .

x10 attenuation cuts the input signal by a factor of ten, giving a dynamic range of  $\pm 5\text{V}$ . x100 attenuation gives a dynamic range of  $\pm 50\text{V}$ , accommodating any signal from -50V to +50V.

The attenuators are precision potential dividers, frequency compensated by shunt capacitors. Without frequency compensation, the input capacitance of the amplifier, though small, would cause unwanted attenuation and distortion of high frequency signals, particularly pulse-type waveforms.

## Protection Racket

Input attenuators do NOT protect against high voltage inputs. A counter needs overload protection independent of the attenuator setting. Immediately before the Chronos' amplifier is a voltage clamp circuit protecting everything following from overload voltages as

high as 250V RMS at 50Hz (350V peak), for any attenuator setting, and for either AC or DC coupling.

## The Amplifier

With the exception of the Schmitt trigger, the amplifier is probably the most important part of the input circuit, and has five specific needs:

1. Very high input impedance: ie input resistance  $> 1\text{M}$  and input capacitance  $< 10\text{pF}$ .
2. Wide bandwidth
3. High slew rate
4. Nullable input offset voltage
5. Low input offset voltage drift

There are others: very low input bias current; large output voltage swing; good large signal frequency response; good pulse response – to give a few examples. Any old op-amp will not do. The Chronos uses a high performance hybrid device, the LH0032.

High input impedance is essential. Good quality UCTs have an input impedance of 1M in parallel with a typical shunt capacitance of around 30pF. This is similar to most oscilloscopes. Less will cause overloading of the signal source, unwanted signal

attenuation and distortion.

Everything before the amplifier (filters, attenuators, protection circuit) has been designed for an impedance of 1M/30pF. It follows that an amplifier with a lower impedance will excessively load all the earlier circuits, and ruin the impedance specification. The LH0032 has a fet input stage giving an input resistance of 1012, or 1 million, million ohms. The input capacitance is almost ideal, typically 5pF.

## Wide Bandwidth

Inputs A and B are specified to measure frequencies from DC to 10MHz. The amplifier's open loop gain must be at least 20dB greater. The LH0032 meets this easily, with an open loop gain of around 30dB even at 10MHz.

The amplifier also needs excellent pulse response to handle the fast rise times of many digital signals. The LH0032's 500V/ $\mu$ s typical slew rate can handle 5V digital signals with rise times up to 10ns. Fig.8a shows the typical 10MHz, 5V pulse response; Fig.8b shows the effect on the same signal if the slew rate were only 50V/ $\mu$ s, or 5V per 100ns.

For input impedance, bandwidth and pulse response, the amplifier requirements are similar to an oscilloscope. For a scope, however, input offset voltage and drift do not pose problems, since they show up only as vertical trace movements.

For the UCT, input offset voltage is troublesome, because it can cause incorrect triggering. From another point of view, with no signal at the amplifier input, the output should be zero. However there is always a small offset voltage even in the best amplifiers. This upsets the circuit's quiescent conditions: at best, it constitutes an unwanted bias in the trigger point; at worst, it may cause complete mistripping of the Schmitt trigger. The situation is worsened by any drift in the offset

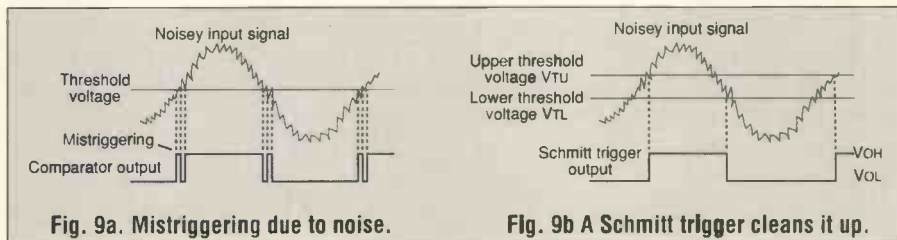

Fig. 9a. Mistripping due to noise.

Fig. 9b. A Schmitt trigger cleans it up.

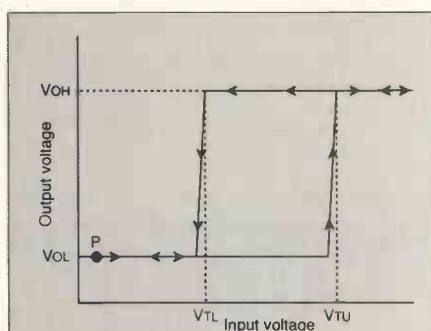

Fig. 10. Schmitt trigger hysteresis.

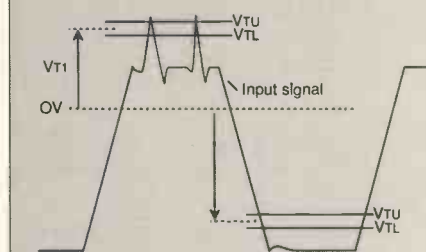

Fig. 11. Trigger level variation.

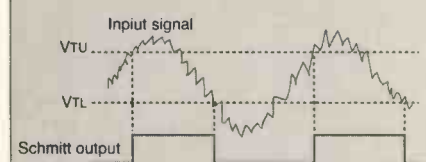

Fig. 12. The use of variable attenuation.

voltage with time, or temperature change.

Fortunately, the input offset voltage of the LH0032 is small, typically 2mV, and an offset null trimmer can cancel it. Long term drift or temperature fluctuation (typically  $25\mu\text{V}/^\circ\text{C}$ ) may necessitate occasional readjustment of the offset null, so the trimmer is accessible from the front panel.

## Essential Hysteresis

The amplifier output is passed via a variable attenuator to the Schmitt trigger which converts the signal to a rectangular digital signal for processing by the main circuits and, finally, by the 7226A. But the Schmitt trigger's main purpose is to remove noise.

Signals (even filtered) contain a certain amount of noise which would cause mistrigging if the signal were fed to a simple comparator (Fig.9a). The Schmitt trigger removes the effects of noise so that only the signal causes triggering (Fig.9b).

The Schmitt trigger is a comparator with hysteresis: the threshold voltage is determined by

the signal increasing or decreasing.

The Schmitt's input-output characteristic is shown in Fig.10. If the input voltage increases from point P the output is initially at a low voltage, VOL. When the input voltage reaches the upper threshold voltage VTU, the output rapidly changes state and assumes a high level voltage, VOH. Any further increase has no effect.

If the input voltage now falls below VTU, the output voltage does not immediately fall back to VOL. The input must reduce to the lower threshold voltage VTL, before the output changes state, rapidly falling to VOL. The same process can be seen in the input signal in Fig.9b.

The difference between the higher and lower threshold voltages is called the hysteresis voltage  $V_H$  ( $V_{TU} - V_{TL} = V_H$ ). Only signals larger than the hysteresis voltage (or trigger window) cause the Schmitt to trigger - smaller signals, particularly noise, have no effect.

In the Chronos, the trigger window is centred about 0V and is 200mV wide:  $V_{TU} = +100\text{mV}$ , and  $V_{TL} = -100\text{mV}$  (nominal values). Any signal at the amplifier input greater than 20mV peak-peak will trigger the Schmitt (the amplifier has a gain of ten, so an input of 20mV produces an output of 200mV). Consequently, the input sensitivity is 20mV peak-peak, or 7mV RMS.

The Schmitt trigger has complementary outputs: S5 can be used to select measurement beginning on the rising or falling edge of the input signal (positive or negative slope).

## Trigger Variation

Although VTU and VTL are fixed relative to ground, there are many cases - mainly timing measurements - where we need to shift the trigger window to some positive or negative voltage. In Fig.11, with the trigger level set to a positive voltage VT1, the Schmitt will be triggered by the two spikes, allowing us to measure, say, the time between them. Setting the trigger level to a negative voltage VT2 would allow us to measure the average pulse width of the negative portion of the signal.

This offset is achieved by the trigger level control (Fig.6) which adds a positive or negative voltage

to the output signal: shifting the signal negative moves the trigger window positive, and vice-versa.

To set the trigger level as precisely as possible, the offset voltage appears at the trigger level output terminals which can be connected to a digital voltmeter.

S4 sets the trigger level offset so that the trigger window is symmetrical about 0V - the usual setting for frequency measurement.

The trigger level can be varied from -5V to +5V; this corresponds to -500mV to +500mV with x1 attenuation, and -50V to +50V with x 100 attenuation.

## Variable Attenuation

There is a variable attenuator at the amplifier output. It does not affect dynamic range, which is fixed by the switched attenuator setting. The fine attenuator selects optimum measurement conditions for very noisy signals, allowing signal amplitude at the Schmitt input to be reduced until only the extremes of the signal cause triggering. Signals buried in noise can be measured this way (Fig.12).

## Monitoring

The amplifier output is connected to a front-panel BNC connector, via a unity-gain buffer, so the signal can be monitored on an oscilloscope without loading the amplifier. This output allows direct observation of the input signal after it has been AC or DC coupled, filtered, attenuated and amplified.

The outside dynamic range (ODR) circuit is connected to the buffer output. This circuit monitors the amplifier output: when signal and trigger level combine to push the output beyond +5V, an indicator lights, warning the user to select a higher attenuation or more suitable trigger voltage.

The trigger status circuit monitors the Schmitt trigger output and the state of the digital outputs, and indicates whether the signal is large enough for correct triggering. If all is well the trigger status indicator flashes. If the trigger level is so high that the amplifier output signal is entirely above the trigger window, the indicator stays on; if the trigger level forces the signal entirely below the trigger window, the indicator stays off. ■

# How It Works...

## The Dot Matrix Printer

*Despite the recent emergence of exotic bubble jets and desktop lasers, the humble dot matrix printer is likely to remain an industry standard for years.*

One of the most reliable technologies in the computer industry is the dot matrix printer. Although it is now being replaced by higher quality machines, it is still in use in millions of offices and homes, churning its way through tons of paper every day.

### The Matrix

At the heart of the machine is the print head. This has a line of needles mounted vertically behind the printer ribbon (Fig. 1). Each can be fired at the ribbon by activating a small solenoid and by using a vertical pattern of these in a set of horizontal columns, a character pattern can be traced out (Fig.2). Older printers used eight or nine

pins and the characters were based on an 8x8 dot matrix pattern – hence the name given to the printer.

Control of the print head is usually from a built-in microprocessor which takes the information from the interface and converts it into the necessary control signals for the print head pins. Stepper motors are used to move the print head across the paper and control the paper feed mechanism. The amount of intelligence available to the printer depends on the capabilities of the microprocessor. Many early machines simply took the data from the computer and translated it directly into simple print operations. However, more advanced features soon became available with graphics, alternative

character sets, printer emulation and bidirectional printing quite common.

As the technology developed and eight and nine pin printers became faster and more reliable, the 24 pin entered the market – instead of eight or nine pins, 24 are used. Offering greatly improved resolution, the printer could almost compete with the emerging laser technology and was certainly good enough to fool most eyes.

Printers are normally judged by their printing speed. Quoted in characters per second (cps) this is a misleading figure since it depends very much on the type of output being generated. Near letter quality (NLQ) produces a result that is almost indistinguishable from typewritten text but is achieved by printing each character twice. After the first imprint, the print head is moved very slightly, to blur out the matrix image with the second print. This slows down the printer dramatically, the price of high quality output.

### Interfaces

Connecting up to a computer is usually by means of either a parallel Centronics or a serial RS232 interface. The first transfers data in a parallel format and is generally easy to hook up and get working. Serial systems, on the other hand, can cause a lot of problems usually due to the lack of standardisation of connectors.

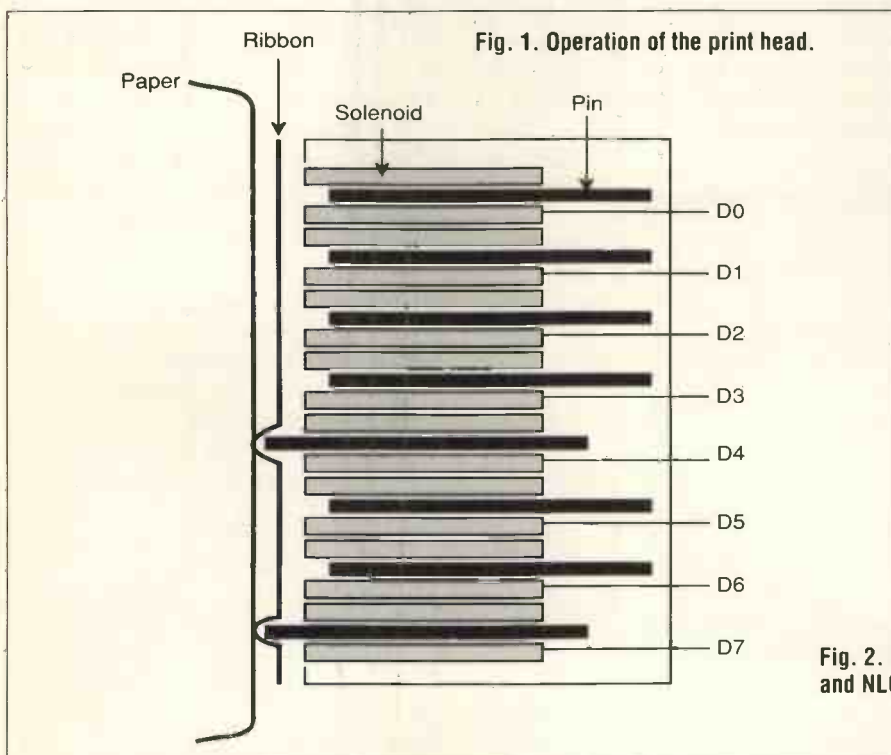
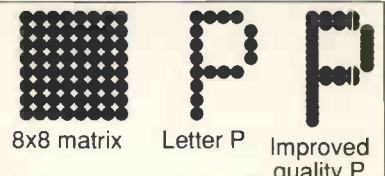

Fig. 2. Matrices and NLQ.



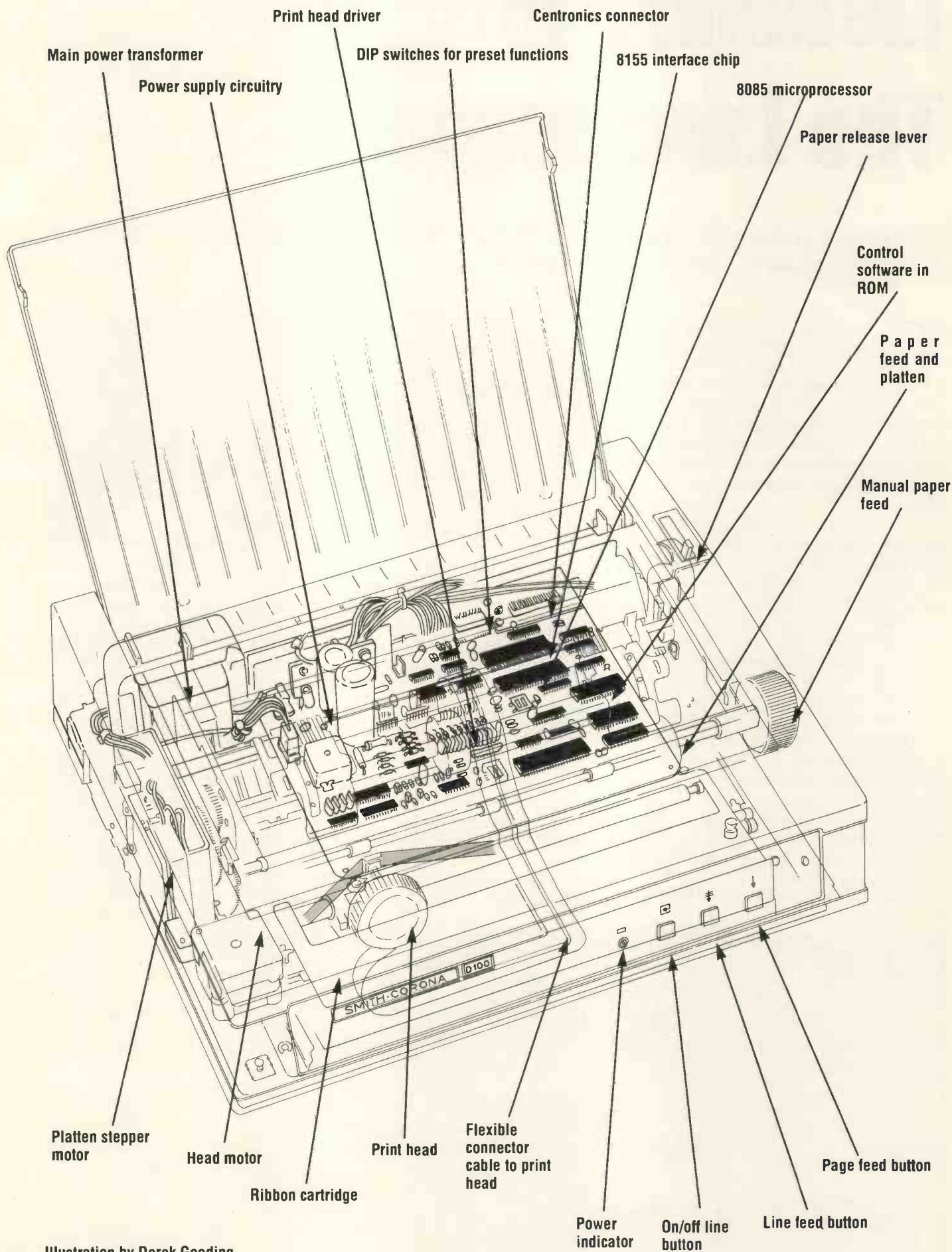

Illustration by Derek Gooding

# Listening To The Landscape

*John Becker's ultrasonic scanner and PC interface provide a way of allowing your computer to see without any expensive video equipment.*

This month's project embraces electronics, computing and robotics. It is a rotating ultrasonic scanner for use with any remote controlled model vehicle and a PC-compatible computer. The scanner is mounted on the model and sends echo data back to the computer for processing and display.

Written in Basic, the software can be extended to selectively enhance the data, enabling, for example, differentiation between target densities as well as distances. It could also be used as a subroutine within an existing model control program to allow interactive feedback. The 'Robot Car' articles of PE April-June 90 will be of interest in this respect.

The project is in three sections. A data converter and decoding interface plugs into the computer's expansion port socket. An ultrasonic signal generator and receiving amplifier is on a second board, intended for mounting inside the model. The scan controlling hardware is on a third board.

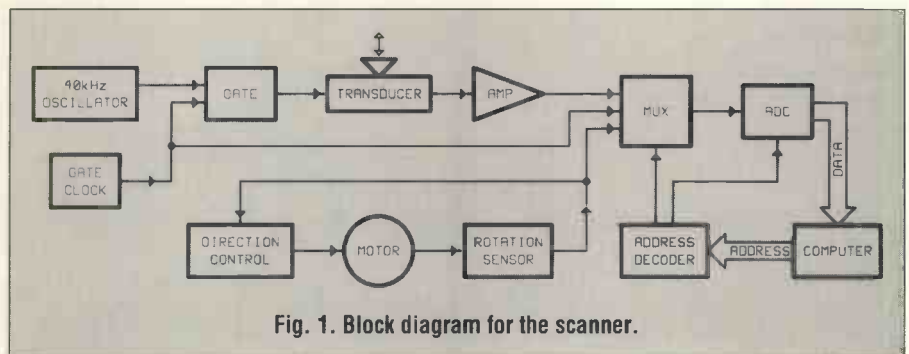

Other motors may be substituted for the type shown. There is a choice of using one or two ultrasonic transducers.

Fig.1 shows the block diagram for the complete project.

## TRANSDUCERS

Conventionally, most ultrasonic transceivers use two transducers, one for transmitting, the other for receiving. The transmitting and receiving transducers for such units are usually manufactured to different specifications. Those designed as transmitters have a low impedance to allow a greater power

output, whereas the receivers generally have a high impedance. However, there are situations in which either type may be used interchangeably. In some pulsed echo units it is possible, therefore, to use a single transducer as both transmitter and receiver. Many depth sounders, for instance, use only one transducer.

A small drawback of using a single transducer is that the minimum echo detection limit is lengthened due to the "ringing" time of the transducer following the end of the transmission pulse. This can be as long as three milliseconds. In air, at sea level and at 0°C, sound travels at 1120 feet per second, and so three milliseconds represents a distance of around three feet (an echo target distance of 1.5 feet). A compromise between power output and input sensitivity must also be accepted in single transducer units. However, even when using two transducers there can still be sympathetic ringing of the receiver if its circuit is in proximity to the transmitter.

In the situations where the prototype of this project was used, a single transducer was found to be satisfactory. It worked equally well with either transmitting or

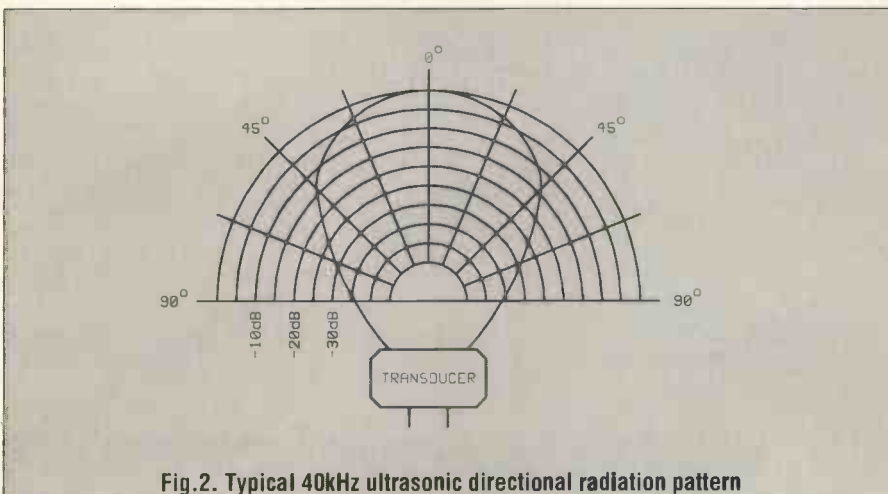

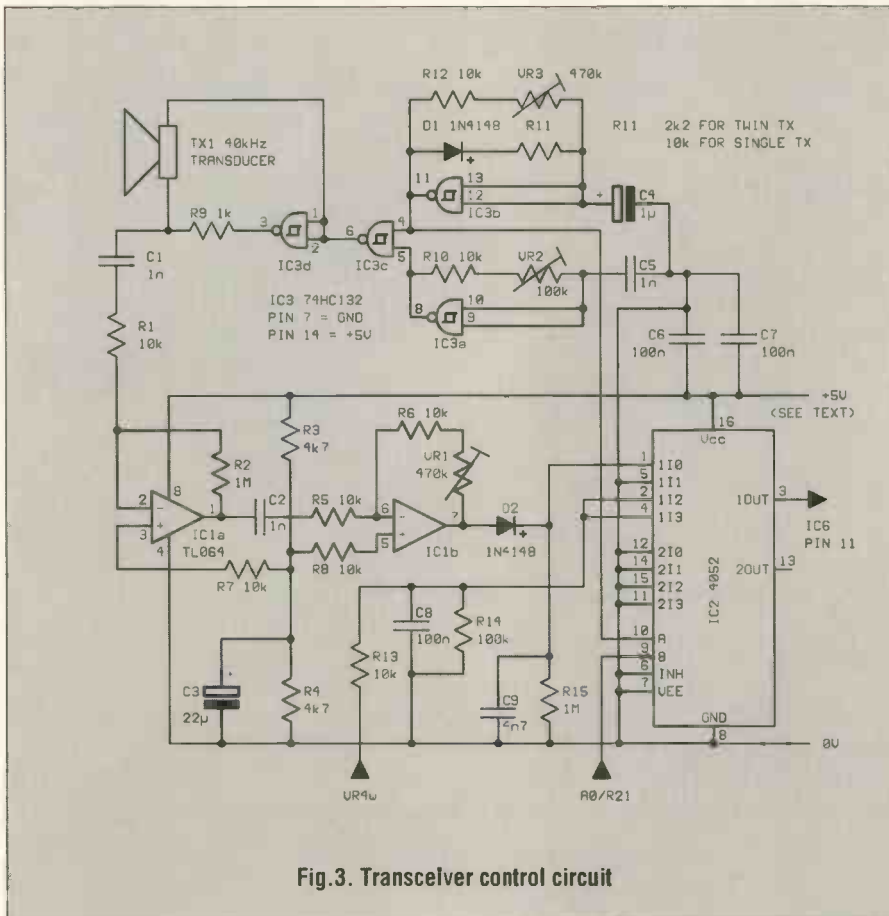

Fig. 3. Transceiver control circuit

receiving devices as the transducer. The circuit has been designed, though, to allow constructors the choice of twin transducers if preferred.

Ultrasonic transducers tuned to a variety of frequencies from 25kHz to over 455kHz are manufactured, though those most widely available to the hobbyist constructor are the 40kHz variety. The project has been designed around 40kHz transducers, though it may be used with those tuned to 25kHz by retuning the pulse generator circuit.

The 40kHz variety have a slightly narrower beam width, typically between 20° and 30°. Fig.2 shows the directional radiation pattern for the readily available transducer types RS307-351 and RS307-367. Receiver and transmitter respectively, both have a nominal directional angle of 30°.

## TRANSCEIVER

The circuit for the single transducer ultrasonic signal transmitter and receiver is shown in Fig.3. Fig.4 shows the minor change required for dual transducer operation.

A constant 40kHz signal is generated around IC3a. C5 sets the

basic oscillation rate and VR2 allows for precise tuning to match the transducer. Typically, as shown in Fig.5, a 40kHz transducer will have an optimum output resonant peak frequency lying between 39kHz and 41kHz. In receiving mode, the transducer will respond to any frequency from about 36kHz to in excess of 50kHz. Only the transmitting circuit of this design needs tuning.

A second oscillator around IC3b generates the transmission gating pulse. It is a slow speed oscillator having a wide mark-space ratio. C4 and VR3 control the basic period between pulses. For the major part of each period, the output of IC3b is low. It is triggered high only for the duration set by the feedback path across D1 and R11. Note that the value for R11 is higher for a single transducer unit in order to optimise the power output.

The signals from IC3a and IC3b are gated via IC3c. Operating in push-pull configuration, the transducer is driven by the anti-phase outputs of IC3c and IC3d. In twin transducer mode, the transmitter receives the full power from IC3c and IC3d. For single transducer use, R9 has to be

inserted to allow the echo pulse to generate a signal across the transducer without IC3d affecting it significantly.

The received echo pulse is taken via C1 to the dual amplifier stage around IC1a and IC1b. The overall gain is variable by adjustment of VR1. Following IC1b is an envelope detection circuit consisting of D2, C9 and R15. This converts the AC output signal into a DC voltage suitable for subsequent analogue to digital conversion prior to being read by the computer.

IC2 is connected as a triple-choice analogue signal multiplexer. Normally, the envelope voltage passes through IC2 from input pin 1 to output pin 3. The other two paths route synchronisation data to the computer. The path choice is controlled by the logic levels on IC2 pins 9 and 10. In transmission mode, and with pin 9 low, the gating pulse oscillator IC3b sets pin 10 high, thus routing the 0V level on pin 5 to the output. When the gating pulse ends, pin 10 goes low, allowing the envelope voltage to pass through.

Since the unit repeatedly scans its surroundings, it is also necessary to know the direction in which the beam is pointing. As will be seen, the rotation angle is signified by an equivalent voltage level. This level is routed to IC2 pins 2 and 4. Irrespective of the state of the gate pulse on pin 10, when pin 9 is taken high, the rotation voltage via one or other of these pins will be routed through to output pin 3.

## COMPUTER INTERFACE

From IC2 pin 3, the selected analogue signal is routed to the analogue to digital converter (ADC), shown as IC6 in Fig.6. The

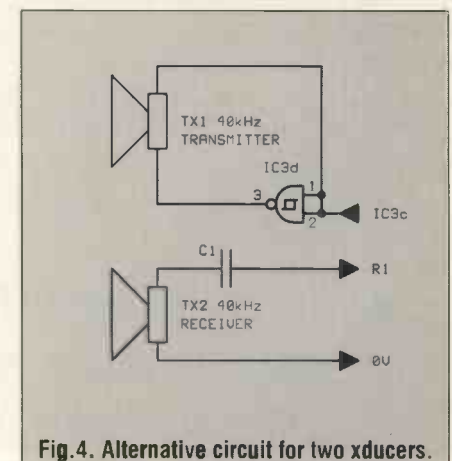

Fig. 4. Alternative circuit for two xducers.

# Rewarding Loyalty

You can be a winner with our Reader Loyalty Bonus.

## This month's top ten readers:

**A. Kahn** of Bolton has £150.00 of the money spent with Maplin Electronic Components refunded.

**A. Jones** of Colwyn Bay who bought £152.00 worth of goods from Greenweld.

**W. Henderson** of Norwich receives £101.22 for buying goods from Hobbykit.

**N. Burrows** of Oldham has the £75.00 spent with Maplin refunded.

**S. K. Goodson** of Ashton in Makerfield traded with Tandy and has £60.00 refunded.

**B. R. Johnson** of Bristol gets back the £57.50 he spent with Bull Electrical.

**L. Silverstein** of Southampton claims his £45.00 which he spent with J. J. Components.

**A. Hewitt** of Watford secures his £31.20 for purchasing goods from Suma Designs.

**A. Morell** from Winchester is reimbursed £27.52 for trading with Maplin Electronics.

**P. Marsden** of Liverpool has £15.00 repaid for his purchase from Keytronics

**See page 30 for entry details!**

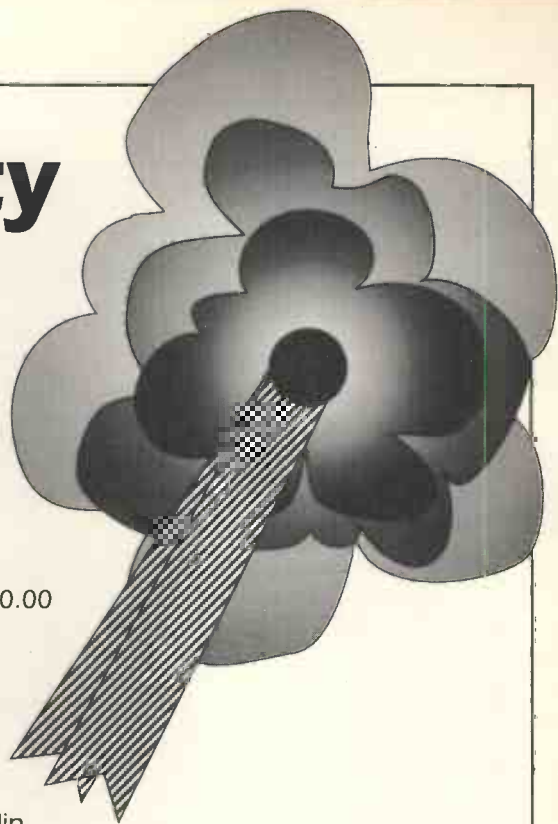

## WANT TO LEARN ABOUT COMPUTING? WANT TO TRY INTERFACING?

This is the computer for you:

- Enhanced Microsoft BASIC
- 80 character 8 line LCD display (480\*64 dots)
- Two RS232 ports
- Microcassette data/programme storage
- Battery backed
- 15K available for BASIC or machine code programmes
- Full bus interfacing possible, input/output board available to connect your computer to the outside world
- In-house programming advice included for first 3 months
- Full technical manuals and specification available
- 30 day money-back guarantee.

At £175+VAT (the screen and keyboard alone are worth more than that), including £100 off if you order before 7th June, this could be the cheapest interfacing computer you're ever likely to find.

## E.P. Electronics

35 Mall Road, London, W6 9DG

Tel: 081 748 0052 Fax: 081 741 1135

## The **ONE STOP** Component Shop



▶ **Massive Stocks**

▶ **Old & New Technology**

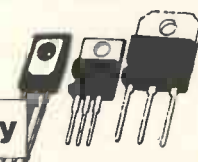

▶ **Latest Japanese  
Semi-conductors  
& Transistors  
Available**

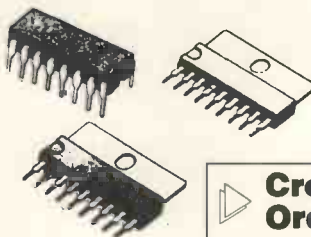

▶ **Credit Card Telephone  
Orders a Speciality**

**CRICKLEWOOD  
ELECTRONICS**

Tel: 081 4520161 & 081 4500995

40 Cricklewood Broadway, London NW2 3ET

Fax: 081 2081441 - Telex: 914977 CRICKEL G





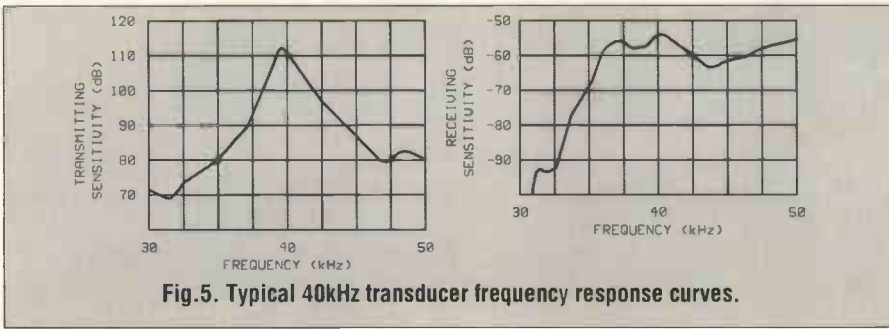

Fig.5. Typical 40kHz transducer frequency response curves.

ADC chip chosen is the popular 15MHz 6-bit flash converter CA3306. In many computer interface situations, this type of ADC is far preferable to the successive approximation varieties. The latter, although inexpensively offering at least 8-bit conversions, require a chain of clock pulses for each conversion. The CA3306 device basically needs only one conversion pulse. However, the converted data is only transferred to the output register on receipt of the next conversion pulse. This fact has significance when sampling multiplexed sources, such as those used here. In this instance, though, software takes care of the situation.

Although specified as a 6-bit device, the CA3306 has an overflow (OFL) output, effectively adding a seventh bit. The chip also has two reference level inputs, high and low. The levels are set by R16 and R17 to approximately 4.0V and 1.0V respectively. This range covers the likely maximum to minimum swings from the envelope detector and rotation sensor. Swings above the maximum are signified and read by the computer on the OFL output. For synchronisation purposes, the gate control generator when pulsed high causes a 0V level to be fed to the ADC. Since this is below the 1V lower reference level, the ADC is assured of producing a zero output. The software looks for this level as its base plotting reference.

Triggering of the ADC's conversion is performed by a software routine reading from a specific computer input address.

### ADDRESS DECODING

Any of a PC-compatible's three or more expansion sockets can be used to hold the unit's interface board. 32 unique addresses are available on the computer for accessing the expansion sockets, from hex \$0300

to \$031F. Decoding of the computer address lines is performed by IC4 and IC5. In the configuration shown in Fig.6, the ADC is triggered by reading from either address \$0300 or \$0301. Address line A0 controls the multiplexer IC2 via its pin 9. Reading from address \$0300 routes the envelope detector to the ADC. Rotary position levels are routed by reading from address \$0301. Any other address call will be ignored by the ADC.

The circuit may, however, be simply modified to respond to any other pair of addresses up to \$031E/F by changing the relevant Y output connections from IC4 and IC5. This allows the unit to be used in parallel with other interface boards without address conflicts occurring.

### SCANNING

The scanning action is self-activated and needs no computer prompting. There are numerous ways in which the scanning action could be performed. Mechanically, the easiest would be to fix the ultrasonic transducer to a

perpetually rotating motor. Regrettably, this method does not allow for easy transfer of the transmission and echo pulses. The use of wires is obviously unacceptable since they would quickly wrap around the motor. Contact brushes carrying the signals between fixed and rotating parts could be used, but they are not readily available to hobbyist constructors.

The solution used here is to scan back and forth across a wide angle, reversing the motor direction at the end of each swing. This simply entails switching the motor wiring polarity, although it does result in additional control circuitry, and an increase in current consumption.

A 6V DC motor and 640:1 reduction gear box were chosen to drive the scan. This combination resulted in a scan rate of about five seconds. A faster rate could be achieved by selecting a gear box with a narrower ratio. Alternatively, although no advice is offered on this, a stepping motor could be used under direct computer control via other decoded addresses.

Switching of the motor wiring polarity is achieved by using a relay, as shown in Fig.7.

Via a pulley wheel and drive band, the gear box is connected to the shaft of a potentiometer, VR4. Wired across the power line, the pot rotates and the voltage on its wiper changes proportionately, triggering the comparator IC8 when its low or high threshold levels are crossed. IC8 is wired for full positive

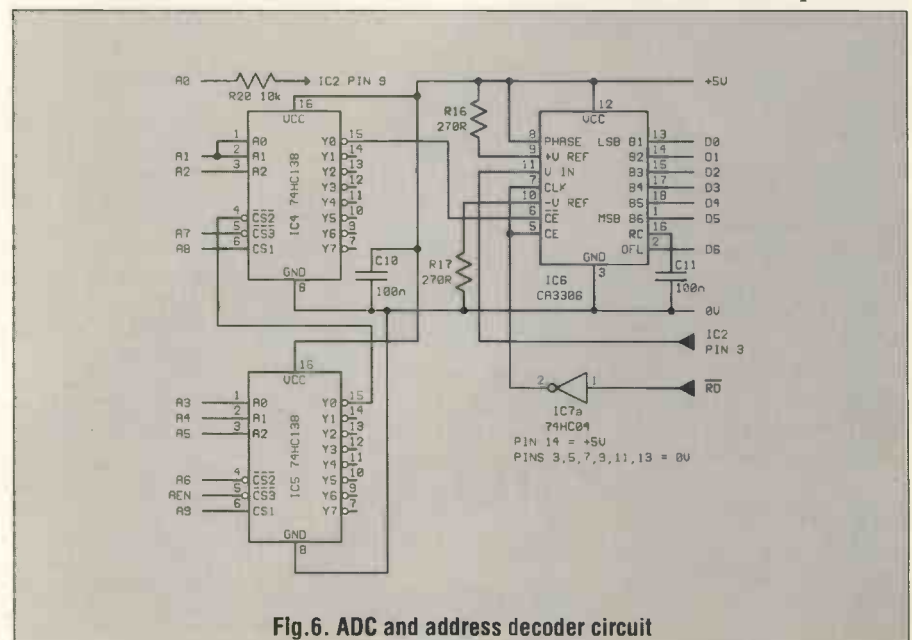

Fig.6. ADC and address decoder circuit

# PCBs for PE Projects

*Practical Electronics' circuit boards make assembly much simpler. All our PCBs are fully drilled and roller tinned – just slot in and solder the components as shown in the project*

## Mail Order

Select the boards you want and send your order to:  
PE PCB Service, Practical Electronics, Intra House, 193  
Uxbridge Road, London W12 9RA  
Prices include VAT, postage and packing. Add £2 per board for overseas airmail.

Cheques should be made payable to Intra Press (payments by Access and Visa also accepted). Quote the issue, project name and PCB code number. Print your name and address in black capitals. Please do not send any other correspondence with your order.

## Phone Order

Use your Access or Visa card and phone 081 743 8888.

Although many boards are held in stock, occasionally they must be re-ordered before despatch, so please allow 28 days for delivery.

Older circuit boards may have been deleted from the catalogue. Please check the latest issue of Practical Electronics before ordering.

Photocopies of the original project text are available for £1.50 each (£2 overseas).

We do not carry components. Refer to our advertising pages for suppliers.

### DEC 89

VIDEO AGC STABILISER	199	£6.65
MINI METRONOME	201	£6.05

### JAN 90

BARGRAPH TACHOMETER	202	£6.05
EEPROM PROGRAMMER (KEYBOARD VER)	203	£14.85

### APR 90

PC/INTERFACE	209	£6.05
--------------	-----	-------

### MAY 90

EPROM POLY-PROG (MAIN PCB)	210	£8.70
----------------------------	-----	-------

### JUNE 90

EPROM POLY-PROG (TOP PCB)	211	£7.70
MESSAGE MAKER	212	£9.70
BAUD RATE CONVERTER	213	£5.00
INTERMITTENT WIPER	214	£4.00
CIRCUIT BREAKER	215	£5.00

### JULY 90

MORSE DECODER	216	£9.70
---------------	-----	-------

### AUG 90

VOLTAGE PROBE	218	£5.95
AF OCTAVE MEASURER:		
FILTER DRIVE	219	£6.75
ANALOGUE FILTER	220	£7.50

### SEP 90

AF OCTAVE MEASURER		
AMPLIFIER	221	£7.50
SWITCHED FILTER	222	£7.50

SWITCHED FILTER DRIVE	223	£7.50
TELE-SCOPE – MAIN PCB	224	£11.75
<b>OCT 90</b>		
TELE-SCOPE – SIGNAL PCB	225	£5.00
TV INTERFACE	226	£5.00
CHIPTESTER	227	£11.75
<b>NOV 90</b>		
BIKE COMPUTER		
– MAINPCB	228	£9.70
– POWER SAVER	229	£5.00
<b>DEC 90</b>		
8748 PROGRAMMING ADAPTOR	230A/B	£6.65
<b>FEB 91</b>		
FROST ALARM	233	£5.65
DIGITAL COMPASS	234A/B/C	£16.85
SERIAL MULTIPLEXER	235	£6.65

### OTHER BOARDS AVAILABLE IN SMALL NUMBERS

175, 178

181, 183

194, 197

204, 206, 208

THESE BOARDS ARE NOT BEING REPRINTED

## Advertisers' Index

ADM .....	55
AGS .....	55
BK Electronics .....	15
Cambridge Computer Sci .....	55
Coles Harding .....	55
Cooke International .....	54
CR Supply .....	55
Cricklewood .....	48
Electronics Shop .....	54
EP Electronics .....	48
Fraser .....	54
Greenbank .....	9
Happy Memories .....	4
HST .....	55
ICS .....	29
J&N Bull Electrical .....	37
JPG Electronics .....	55
Kew Bridge Steam Museum .....	56
Laser Alarms .....	56
London Elec. College .....	54
Lys Electronics .....	29
Maplin .....	OBC
Marapet .....	55
Mauritron .....	56
NR Bardwell .....	55
Number One Systems .....	IBC
Omni Electronics .....	54
Panrix .....	9
Radio & Telecom School .....	54
Seetrax .....	29
Service Trading Co. ....	29
SM Engineering .....	4
Suma Designs .....	9
Tsien .....	IFC

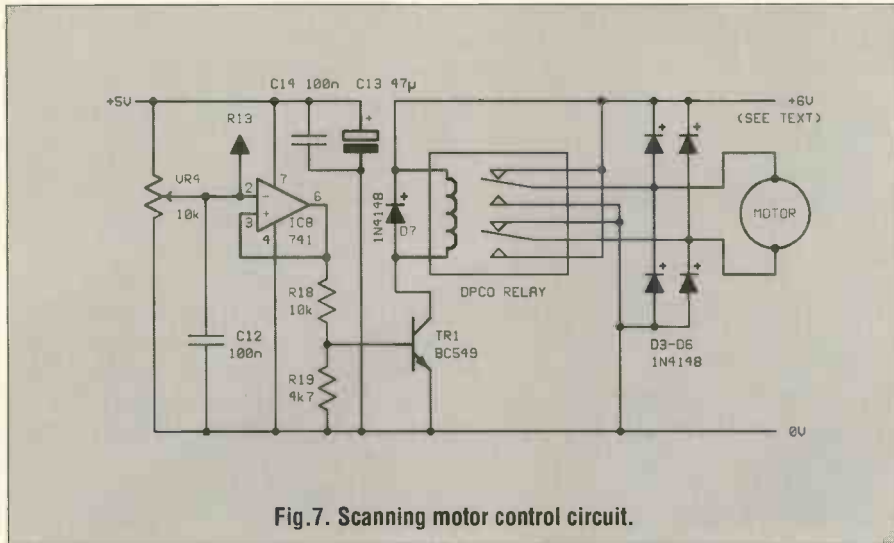

Fig.7. Scanning motor control circuit.

feedback, thus setting its own trip thresholds. Its output drives TR1 via R18/R19 causing the relay to be turned on and off, so reversing the motor connections. D3-D7 suppress any inductively produced voltage transients caused by switching the relay and motor coils.

VR4's wiper voltage is also fed via R13 to the ADC. Sampled at regular intervals, it provides the computer with rotation reference data. C8 smooths the voltage while R14 drops the maximum level to within the ADC's acceptable range.

### POWER SUPPLY

The address and ADC board is powered directly by the computer's own 5V power supply. The analogue signal board also runs from 5V and, with many computers, might also be powered from their 5V supply line. It was found, however, that when the unit was used with an Amstrad 1640, adequate protection against interference noise was hard to achieve. Consequently, a separate 5V PSU was used. Another possibility that could be explored is to use the computer's 12V power line, reducing the voltage to 5V via a 78L05 regulator.

In view of their potentially heavy current consumption it is preferable that the relay and motor should be powered by a separate 5V or 6V power supply. This will also help to avoid adverse reactions from the analogue signal processing circuit. The amplifier stage in particular will be sensitive to noisy power lines.

Long-life batteries may be used to power both external boards.

### ASSEMBLY

Component and track layout details for the three PCBs are shown in Figs.8-10.

With the double-sided interface board, pins should be inserted through the inter-side connection holes, soldering them on both sides. The two wire links shown are the connections required to configure the address decoding for \$0300/0301. Access holes have been provided to allow the linking to be set for other addresses as discussed above.

An ordinary low-cost carbon rotary pot was used for VR4, though a cermet type can be substituted if more precise tracking resolution is required.

Fig.10 also shows the gearbox to pot coupling details. Other pulley sizes may be used instead to change the ratio.

The transducer should be fixed to the pot pulley wheel using a

metal-to-metal adhesive. If two transducers are used, the case of the transmitter must be insulated from contact with other conducting surfaces since it is actively connected to one of the 40kHz push-pull outputs.

### SOFTWARE

Fig.11 gives the software listing used with prototype. It provides the basic signal sampling and screen plotting commands. GW-Basic is the dialect used, though the instructions can be readily translated to suit other dialects, providing they allow access to the expansion socket bus lines.

GW-Basic allows screen plotting to be carried out in a selection of four colours. Other dialects may allow simultaneous use of more colours from a broader palette. The unit can also be used with monochrome screens, omitting the colour commands.

The listing is intended as a simple framework within which further processing commands can be built. Other than memory size, there is no limit to the number of extra lines which may be added.

Two display techniques are written into the listing. The first plots the echo data in different colours radiating out from a focus at the bottom of the screen. The colours relate to the intensity of the signals received and are plotted across the screen at time related intervals. The plot angle is determined in relation to the voltage on VR4's wiper.

The routine first repeatedly

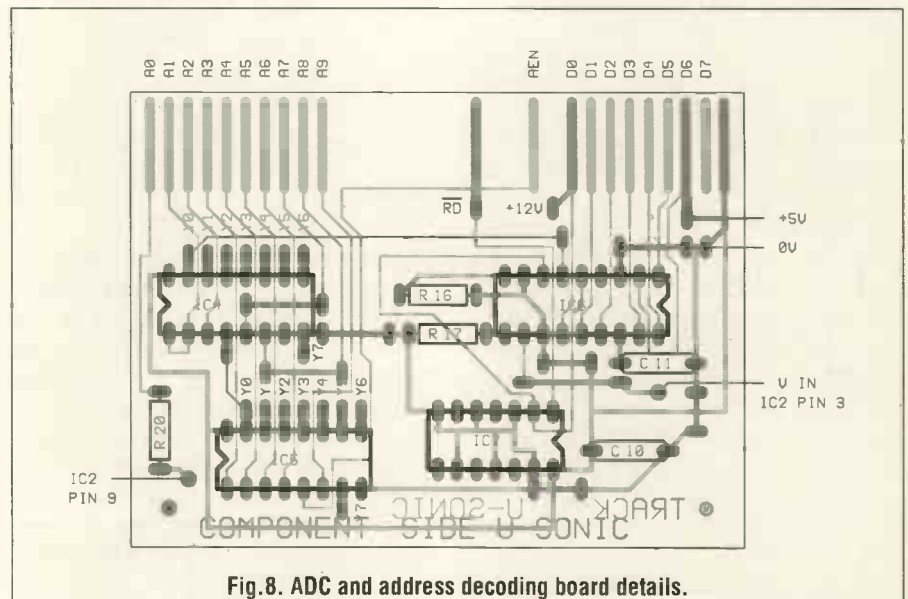

Fig.8. ADC and address decoding board details.

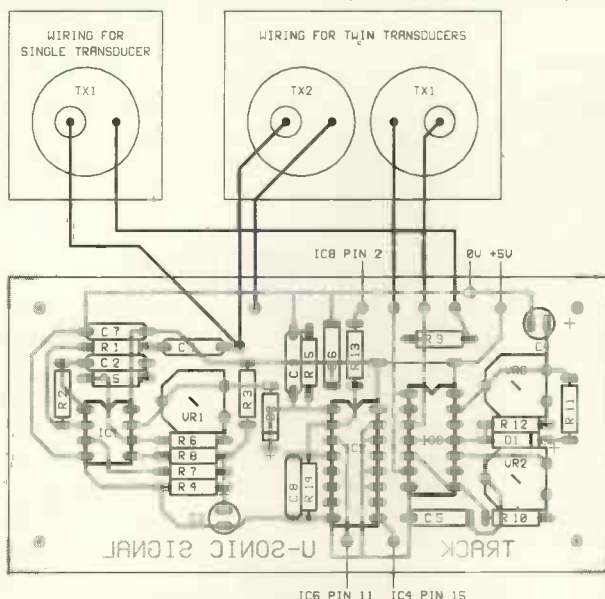

Fig.9. Transceiver control board.

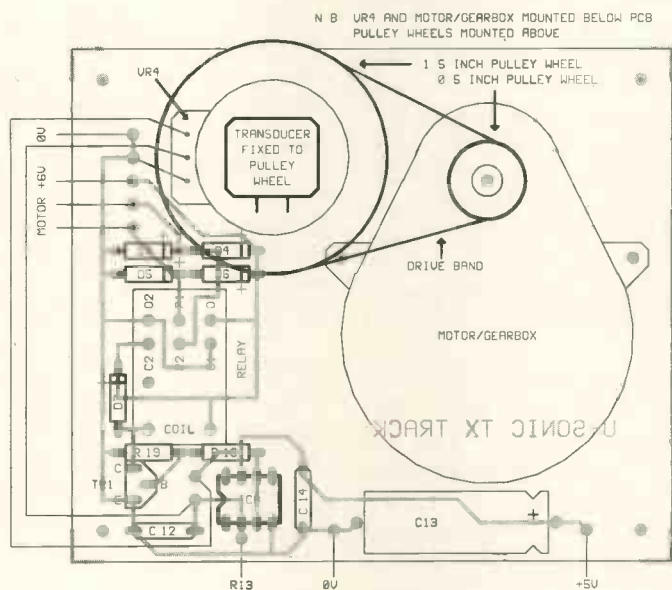

Fig.10. Motor control board.

samples the ADC until a zero output is detected. This corresponds to the onset of the ultrasonic transmission pulse and provides an initial sync point.

Next, to maximise the data sampling resolution, the ADC is read 25 times via address decimal 768 (hex \$0300) and the data stored in array variable A(B). With the Amstrad 1640 this proved to be the optimum number of samples that could be taken in Basic during each pulsed transmission period. Other machines and other Basic dialects may offer increased sampling rates, in which case the loop length can be extended. Re-writing the routine in machine code will also increase the sampling rate.

Following the looped input,

address 769 is read twice. This action sets IC2 to route the data from VR4 to the ADC. On the first reading, the data is digitally converted. Then, as discussed above, on the second reading the result is transferred to ADC's output registers from where it is input for use as variable M.

The value of each echo sample is now plotted across the screen from the focal point at an angle set by M. The division routine shows a simple example of one way in which the plotting colour can be related to amplitude. Each sample is plotted at regular intervals and so the positional colour changes are related to time and to the equivalent distance of the target detected. More sophisticated analysis

routines may be written into the program.

As repeated batches of samples are plotted radially, the screen builds up a representational display of reflective targets within the scanner's arc. Data from subsequent scans over-writes previous screen plots on the same angle.

The second display routine in the listing is mainly of use when setting up the unit. It repeatedly samples the ADC and displays the data in oscilloscope fashion as waveforms across the screen. It also allows echo data amplitudes in specific situations to be examined prior to inserting additional plot command lines in the main routine.

## SETTING UP

The only alignment required is the adjustment of the three presets on the analogue board. This should be done in conjunction with the computer.

First, plug the ADC interface board into the computer with the other boards unconnected. Switch on and check that the computer responds as normal. Should it fail to do so, immediately switch off and check the accuracy of the board's assembly.

Next, make the connections between the interface and analogue boards, but leave the motor board unconnected. Wire up the transducer as shown in Fig.9 and point it across a room scattered with a few solid objects of reasonable size. Load the software and run the scope-display routine.

Set VR3 for maximum resistance to produce the slowest transmission rate. Next tune the 40kHz oscillator by adjusting VR2 until the screen shows that the best echo response is occurring. VR1 may then be adjusted until a reasonable amplitude is obtained. Large objects as distant as 20 to 25 feet should be discernable as peaks on the screen trace. The negative-going transmission sync points should also be apparent.

Now run the main routine and adjust VR3 until the transmission rate allows 25 samplings to cover one period. If the computer is capable of a faster sampling rate, the software loop length and the transmission rate can be altered accordingly.

When satisfied, connect the

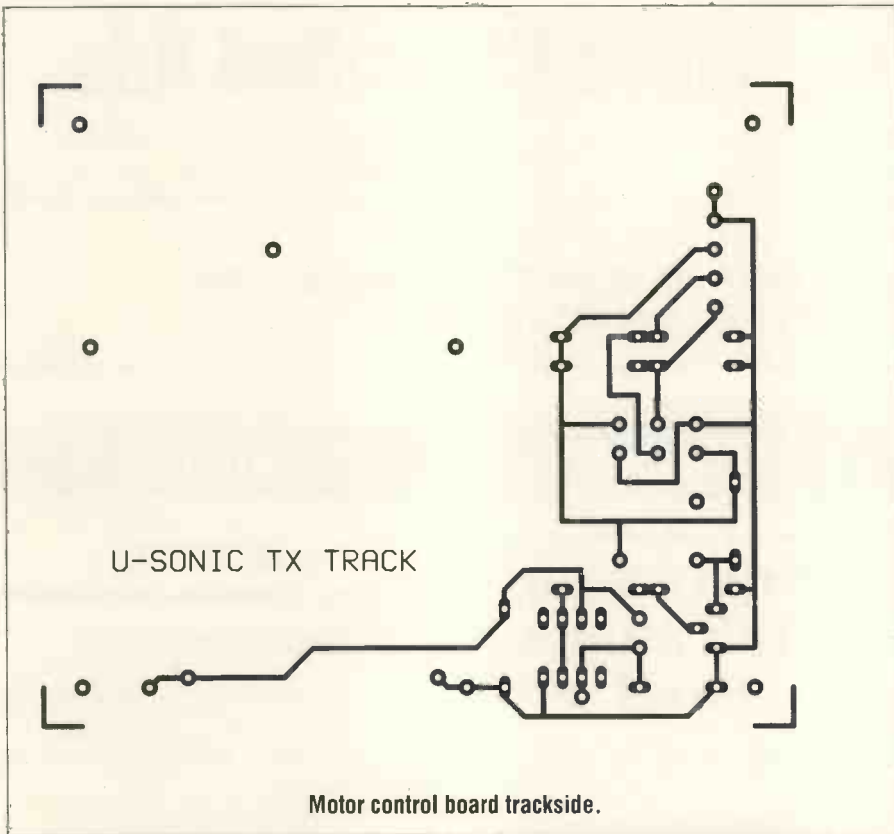

motor board and mount the transducer in place. The correct motor polarity should be established experimentally. Power up the complete system and run the main routine. The transducer will scan across its arc and a corresponding map of what it detects will be displayed on screen.

### FURTHER DEVELOPMENT

An interesting possibility that can be explored is that of focussing the transducer(s) to cover a narrower angle. Microphones of the 'rifle' type achieve their acute directional sensitivity by using a tube in front of the transducer. Experiments with ordinary copper plumbing pipes show that a similar technique can

be used with ultrasonic transducers. Interested readers could experiment with transducers taped to pipes of different lengths to achieve optimum directionality. Two points to watch out for are whether the pipes adversely produce additional echoes by 'ringing', and whether air pressure within long pipes has an attenuating effect during transmission.

The other three boards can be found on page 61. ■

### COMPONENTS

#### RESISTORS

- R1, R5-R8, R10, R12, R13, R18, R20 10k
- R2, R15 1M
- R3, R4, R19 4k7
- R9 1k
- R11 2k2 or 10k (see text)
- R14 100k
- R16, R17 270R

All 0.25W 5% carbon film or better

#### POTENTIOMETERS

- VR1, VR3 470k min horiz preset
- VR2 100k min horiz preset
- VR4 10k lin mono rotary

#### CAPACITORS

- C1, C2, C5 1n polystyrene
- C3 22µ 16V electrolytic
- C4 1µ 16V electrolytic
- C6-C8, C10-C12, C14 100n polyester
- C9 4n7 polystyrene
- C13 470µ 10V electrolytic

#### SEMICONDUCTORS

- D1-D7 1N4148
- TR1 BC549
- IC1 TL064
- IC2 4052
- IC3 74HC132
- IC4, IC5 74HC138
- IC6 CA3306
- IC7 74HC04
- IC8 741

#### DIL IC SOCKETS

- 2x8-pin, 2x14-pin, 3x16-pin, 1x18-pin

#### MISCELLANEOUS

- 40kHz transducer (see text)
- 6V DC motor and gear box (see text)
- 6V DPCO relay
- Pulley wheels and drive belt to suit
- Printed circuit boards

#### CONSTRUCTORS NOTE

The Author's components were all purchased from RS/Electromail, except for the pulleys which came from Henry's Radio. Motors and gear boxes are also sold by Magenta.

### SOFTWARE LISTING

```

10 REM ULTRASONIC RADAR 26MAR91
20 SCREEN 0:COLOR 4,5:SCREEN 1:COLOR 0,1
30 VIEW (1,1)-(300,198),0,3:DIM A(2000)
40 REM GOTO 140
50 REM ARC PLOT
60 IF (INP(768) AND 63)<>0 THEN 60
70 FOR B=1 TO 25:A(B)=INP(768):NEXT
80 M=INP(769):M=(INP(769) AND 127)-32:IF M>32 THEN M=32
90 M=M*3:PSET (150,170),1:K=10:P=0:DRAW "TA=M;COU6"
100 FOR A=1 TO 25:E=(A(A) AND 127)-25:F=INT(E/6):IF F<0
THEN F=0
110 IF F=P THEN K=K+5:GOTO 130
120 DRAW "TA=M;C=P;U=K;":K=5:P=F
130 NEXT:DRAW "TA=M;C=P;U=K;":GOTO 60
140 REM SCOPE PLOT
150 F=1:D=10:C=32:CLS
160 FOR B=1 TO 256*4:A(B)=INP(768):NEXT
170 FOR B=1 TO 300 STEP 20:LINE (B,1)-(B,3),1:NEXT
180 FOR H=1 TO 4:J=0
190 FOR B=1 TO 256:E=A(B) AND 63
200 IF (A(B) AND 64)=64 THEN F=F+1:IF F>3 THEN F=1
210 J=J+2:E=63-E
220 LINE (J-2),D+C)-(J,D+E),F:C=E
230 NEXT:D=D+42:NEXT:GOTO 150
    
```

# Practical Electronics Classified Ads

Reach thousands of serious electronic and computer enthusiasts – advertise in PE Classified pages:  
 Rates 20p (plus 4p VAT) per word or £8.50 (plus £1.49 VAT) per column cm. All classified advertisements must be pre-paid. Send your copy, with remittance payable to Intra Press, (Payment by Visa or Access accepted – ads may be phoned in) to:

**Practical Electronics, Intra House, 193 Uxbridge Road, London W12 9RA.  
 Tel: 081-743-8888. Fax: 081-743-3062**

## Education

### FULL-TIME TRAINING COURSES

#### 2 YEAR BTEC NATIONAL DIPLOMA

Electronics and  
Communications  
Engineering

(TV, Computers, Programming, IT)

#### 1 YEAR

#### BTEC NATIONAL CERTIFICATE

##### 1. Electronic Equipment Servicing

(TV, Video, CCTV)

##### 2. Computing Technology

(Microprocessors, DataComms, Interfacing)

##### 3. Information Technology

(Telecomms, Satellite TV, Networks)

##### 4. Software Engineering

(Assembler, BASIC, Pascal, CAD/CAM)

★ Those eligible can apply for E.T. grant support ★

★ An equal opportunities programme ★

#### COURSES COMMENCE

Monday 16th September

### LONDON ELECTRONICS COLLEGE

Dept: AA, 20 Penywern Road,  
London SW5 9SU. Tel: 071-373 8721

## Retailers

### Project your retail image here!

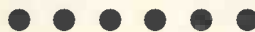

Phone David Bonner  
for details on  
081-743-8888

## Retailers

### MANCHESTER

#### THE ELECTRONICS SHOP

We stock a large range of electronic components, test equipment, telephone accessories, computer accessories, microphones, speakers, discolorighting, mixers, meters, stylus, so call in and have a look around.

29 Hanging Ditch, Manchester M4 3ES  
Telephone: 061-834-1185  
Fax: 061-833-2969

### SOUTHSEA

#### ELECTRONIC COMPONENTS

EVERYTHING FOR YOUR NEXT PROJECT  
THE BIGGEST DISPLAY IN THE SOUTH IS AT

#### FRASER ELECTRONICS

42 ELM GROVE ★ SOUTHSEA ★ HANTS  
Telephone: 0705-815584

### SOUTH COAST

#### Cooke International

"We stock used scopes, signal generators, power supplies, power meters, DVMS, oscillators, attenuators, test equipment. Much more available, visit our s/room and bargain store.  
Prices from £5 upwards!"

Contact: Cooke International, Unit Four,  
Fordingbridge Site, Main Road, Barnham, Bognor Regis, West Sussex PO22 0EB. Tel: 0243 545111  
Fax: 0243 542457

"Open: Mon – Fri 9am – 5pm or phone"

### EDINBURGH

#### OMNI ELECTRONICS

stock a wide range of electronic components at  
174 Dalkeith Road  
Edinburgh EH16 5DX  
Tel: 031 667 2611

Open Mon-Fri 9am-6pm  
Sat. 9am-5am

NEW CATALOGUE OUT NOW  
Price is just £1.50  
Contact Omni Electronics  
now for details

### LONDON N WEST

#### CRICKLEWOOD ELECTRONICS

One of the largest ranges of components in the UK!

40 Cricklewood Broadway,

LONDON NW2 3ET

Tel: 081-450 0995/452 0161

### Start training now for the following courses.

- Telecomms Tech C&G 271
- Radio Amateur Licence C&G
- Microprocessor
- Introduction to Television

Send for our brochure - without obligation or telephone us on 06267 79398 (Ref: PE6/91)  
Name.....

Radio & Telecommunications  
Correspondence School,  
12 Moor View Drive, Teignmouth,  
Devon TQ14 9UN

**Support your local electronics specialist**

## Surplus

### SURPLUS/REDUNDANT ELECTRONICS COMPONENTS WANTED

ICs - Tuners - Transistors - Valves - Diodes etc - any quantity considered - immediate payment.

ADM ELECTRONICS SUPPLIES

Tel 0827 873311

Fax: 0827 874835

### TURN YOUR SURPLUS

ICS transistors etc into cash, immediate settlement. WE welcome the opportunity to quote for complete factory clearance.

Contact:

COLES-HARDING & CO.,

103 South Brink, Wisbech, Cambs.

ESTABLISHED 15 YEARS

Tel: 0945 584188 - Fax: 0945 588844

## Components

### CAMBRIDGE COMPUTER SCIENCE LIMITED

5.25" Disk Drives, 80TK, DSDD .....	£34.00 each
5.25" Disks - DSDD, 48bit, boxes of 10 .....	£3.00/box
40W PSU SV 2.75A, 12V 1.5A, -12V 0.4A, cased with on/off switch .....	£10.00 each
Apocot Disk Drive PSU .....	£10.00 each
Bare switch mode PSU SV 2.5A, 12V 2A -12V 0.1A .....	£7.00 each
5V @ 6A PSU .....	£4.95 each
5V @ 10A PSU .....	£6.40 each
68000 CPUs (The first order get 10MHz chips) .....	£3.50 each
8086 CPU chips .....	£2.00 each
Z80A CPU, CTC PIO £1.20 each; DMA £2.00 .....	£4.50 all 4
27128 EPROMS (Ex equipment) .....	£1.20 each or £5.00/5
27128 EPROMS .....	£2.50 each
27C256-25 EPROMS .....	£3.50 each
256KByte DRAM Modules, removed from equipment .....	£6.00 each
512K 2KByte SRAM .....	£1.10 each
6264-12 8KByte SRAM .....	£3.80 each
62256-10 32KByte SRAM .....	£5.00 each
65256 32KByte RAMs .....	£4.00 each
Smoke detectors, small size .....	£7.00 each
Smoke detectors, large with escape light and pause feature .....	£13.00 each

Prices include postage. Add 50p (plus VAT) to orders below £5.00  
 All items new unless stated. Add 17.5% VAT to all prices.  
 Send an SAE for our latest list or for more info.  
 Dept PE, 374 Milton Road, Cambridge, CB4 1SU  
 Tel: 0223 424802 or 0861 430486 (Please note mail order only)

### CATALOGUE £1.00 + 25P&P

Resistor Pack 85 different E12 values + zero ohm link total content		
1000 resistors .....	£8.95	
LEDs 3mm or 5mm red/green .....	6p each. Yellow 11p each,	
Cable ties 1p each £5.95/1,000 £49.50 per 10,000		
Stepping motor 4 phase 12V 7.5 step 50 ohms .....	£8.95	
SAAI027 stepping motor driver chip .....	£3.95	
FM Transmitter kit good quality sound .....	£8.60	
High quality photo resist copper clad epoxy glass boards		
Dimensions	single sided	double sided
3x4 inches	£ 0.95	£1.07
4x8 inches	£ 2.40	£2.68
6x12 inches	£ 5.37	-
12x12 inches	£10.66	-

### Special Offers

Computer Grade Capacitors with screw terminals 38000µf 20V .....	£2.50
8700µf 10V £1.95, 68000µf 15V £2.95, 10000µf 16V .....	£1.50
7 segment Common anode led display 12mm .....	£0.45
LM2931ATS.0 Low drop out 5V regulator T0220 package .....	£0.85
BS250 P channel MOSFET £0.45, BC559 transistor .....	£3.95 per 100
74LS05 hex inverter £10.00 per 100, used 8748 Microcontroller .....	£3.50
Stereo LW/MW/FM Tuner pre-amp assembly complete with volume/tone controls and tuning scale Brand new in maker's carton. £6.95, faulty £3.50	
Circuit etc. for above £0.50.	
Hour counter (used) 7 digit mains 240V AC 50Hz .....	£1.45
LCD display 16 digit 7x5 dots dot matrix .....	£2.50
Qwerty keyboard 58 key good quality switches new .....	£5.00
Qwerty keyboard with serial output, no data .....	£5.00

Wide range of CMOS TTL 74HC 74F Linear transistors kits capacitors, resistors tools etc always in stock.  
 Please add 95p towards P&P - VAT Included

JPG Electronics 276 - 278 Chatsworth Road  
 Chesterfield S40 2BH

Access/Visa orders (0246) 211202. Callers welcome

## Components

### High Stability Resistors

Carbon Film Resistors 0.56R to 10M E24 series 1/4W - 1p  
 100 off per value - 75p. 1000 off in even hundreds per value - £5.00  
 Metal Film 1/4W 10R0 to 1M0 E12 series 5% - 2p. 1% E24 series - 3p  
 Mixed metal/carbon film 1/2W E24 series 1R0 to 10M0 - 1 1/2p  
 Mixed metal/carbon film 1W 4R7 to 10M0 E12 series - 5p  
 BC107/8/9 - 12p. BC182, BC183, BC184, BC212 & L versions - 10p  
 BFY50.51 & 52 - 20p. 2N3055 - 50p. TIP31A, 32A - 25p. TIP, 41,42 - 40p

### Tantalum bead electrolytics subminiature (Mids/Volts)

0-1/35, 0.22/35, 0.47/35, 1.0/35, 2.2/35, 3.3/16, 3.3/20, 4.7/16 - 14p. 3.3/35, 4.7/25, 4.7/35 - 15p. 6.8/16, 6.8/35 - 16p. 10/16, 20/25 - 20p. 10/35, 22/16, 33/10, 47/10 - 30p. 100/6 - 30p. 100/16 - 50p. 220/6 - 60p

### Aluminium Electrolytics (Mids/Volts)

1/50, 2/50, 4.7/50, 10/16, 10/25, 10/50 - 5p. 22/16, 22/25, 22/50, 47/16, 47/25, 47/50 - 6p. 100/16, 100/25 - 7p. 100/50 - 12p. 220/16 - 8p. 220/25, 220/50 - 10p. 470/16, 470/25 - 11p. 1000/16 - 15p. 1000/25 - 18p. 2200/25 - 22p

### Miniature Polyester Capacitors 250V Wkg. Vertical Mounting

01, 015, 022, 033, 047, 068 - 4p. 0.1 - 5p. 0.15, 0.22 - 5p

### Mylar Capacitors 100V Wkg. Vertical Mounting E12 Series

1000p to 8200p - 3p. 0.01 to 0.66 - 4p. 0.1 - 5p. 0.15, 0.22 - 5p

### Subm. Ceramic Plate 100V Wkg. E12 Series Vertical Mounting

2%. IP8 to 47P - 3p. 56P to 330P - 4p. 10% 390P to 4700P - 4p

### Plat/disc ceramic 50V. Wkg. Vertical Mount. E12 series 1P0 to 1000P & E6 series 1500P to 47000P - 2p. 0.1 - 3p

### Polystyrene Capacitors 63V Wkg. E12 Series Axial Mounting

10P to 820P - 4p. 1000P to 10,000 - 5p. 12,000P - 6p.

### Diodes

Zener diodes E24 series 3V3 to 33V 400mW - 8p. 1 watt - 12p. 1N4148 - 2p. 1N4001 - 3p. 1N4002 - 3.5p. 1N4007 - 5p. 1N5404 - 14p. OA91 - 8p. AA143 - 10p. W005 - 20p. W01 - 25p. BYX10 - 5p.  
 L.E.D.s Red, Green & Yellow 3mm & 5mm - 10p 8mm - 35p  
 20mm fuses 0.15A to 10A quick blow - 5p. 0.1A to 5A Anti Surge - 8p  
 High Speed dnits 0.8mm, 1.0mm, 1.3mm, 1.5mm, 2mm - 30p  
 "Explo" "Reliant" drilling machines 12V d.c. with improved 3-jaw chuck - £7.00  
 Nicads AA - 30p. HP11 - £2. HP2 - £2.20. PP3 - £5 Universal chargers for all above batteries - £6.50

Glass reed switches with single pole make contacts - 8p. Magnets - 12p. 0.1" stripboard 2.5" X 1" 9 rows 27 holes - 20p. 3.75" X 2.5" 24 rows 37 holes - 60p. Insensers list price £16.95 7 year guarantee - £12.00. Jack plugs 2.5mm & 3.5mm - 10p. Sockets panel mfg - 10p  
 All prices VAT inclusive. Postage 30P (free over £5).

THE C.R. SUPPLY CO.  
 127 Chesterfield Road,  
 Sheffield S8 0RN.  
 Tel: 0742 557771

IS YOUR ADVERTISEMENT  
 A TIGHT SQUEEZE?

STRETCH  
 OUT!

IN THE  
 DISPLAY  
 PAGES OF PE!

PHONE DAVID BONNER FOR  
 DETAILS ON 081-743-8888

### Manufacturers Original Spares

For Amstrad, Atari, Commodore, Epsom and Sinclair computers.		
Many TV, VCR & Audio Parts also available - Send S.A.E. or Phone 0452 26883 for a 'Price and Availability' on your requirements		
Atari	C025915 'GLUE' Chip (ST)	£24.31
Commodore	906114 'PLA' Chip (C64/C)	£6.73
ditto	901255 'CHAR ROM Chip (C64/C)	£6.37
ditto	8565 'VIC' Chip (C64/C)	£23.48
ditto	8580RS 'SID' Chip (C64/C)	£13.98
Spectrum	40056 'ULA' Chip (128Kx2)	£16.99
ditto	40054 'ROM' Chip (+2)	£17.75
Sinclair	ZX802 'ULA' Chip (QL)	£10.75
Membranes: QL £7.95. Spec. 48K £4.50. +128K £7.90		
Amstrad	Original Service Manual (CPC464 + Monitors)	£8.49
ditto	Original Service Manual (PCW8526/8512)	£13.59
Chips: PE6A1A-£32.72. TEA2000-£3.69. AY38912-£5.74.		
Sanyo/Fisher VCR Belt Kit VTC6500/VBS3500		£2.49

The above is just a very small sample of our stock. For a Catalogue please send 50p CHQ./Stamps/dx/IRC's etc. Please add 95p (UK) P & P to above orders.

MARAPET (PEE) 1 Hornbeam Mews, Gloucester GL2 0UE  
 MAIL ORDER ONLY TEL: 0452 26883

PE Classified Works!

## Components

### N.R. BARDWELL

200 - Signal diodes .....	1.00
80 - 4U7 16V radial electrolytics small size .....	1.00
75 - 4U7 63V radial electrolytics small size .....	1.00
50 - 10UF 50V radial electrolytics small size .....	1.00
80 - 22UF 25V radial electrolytics small size .....	1.00
60 - 33UF 16V radial electrolytics small size .....	1.00
50 - 47UF 50V radial electrolytics small size .....	1.00
60 - 470UF 10V radial electrolytics small size .....	1.00
50 - 100K sub-min horizontal presets .....	1.00
20 - 1" glass reed switches .....	1.00
25 - Assorted high brightness leds .....	1.00
12 - Assorted seven segment displays .....	1.00
10 - 4P3W MBB min rotary switches .....	1.00
30 - Assorted dill sockets up to 40 pin .....	1.00
30 - Assorted socket/conn's/edge-dill-etc .....	1.00
20 - Min SP/CO slide switches .....	1.00
20 - Magnetic ear clips + lead & plug .....	1.00
1 - Pettier effect heat pump .....	1.95
1 - 10 watt stereo amplifier, 4 control + data .....	2.95

Prices include VAT, postage £1.00. Many more lines in stock.  
 Lists - stamp.

288 Abbeydale Road, Sheffield S7 1FL

## HST For All Your Components

Large stocks of Resistors, Diodes, Transistors, Capacitors, Semiconductors, Connectors, LEDs and Crystals plus many more. Available at Discount Prices. Send for your FREE price list.

Sample Prices:

Resistor 1/4W 5% .....	0.50/100
1N4148 .....	0.65/100
741 Op. Amp. ....	0.14 ea.
74LS00 .....	0.09 ea.
4001 CMOS .....	0.11 ea.
555 Timer .....	0.11 ea.
2764 - 250ns .....	1.55 ea.
4164 - 150ns (64Kx1) .....	0.75 ea.
LEDs 5mm R/G/Y .....	0.07 ea.
25W Plug Submin. D .....	0.27 ea.

Prices Exclude VAT at 17.5%  
 Postage £1.00  
 Official orders welcome

HST Ltd. 2a Prospect Road,  
 Carlton, Nottingham NG4 1LA  
 Telephone (0602) 587225  
 Fax (0602) 484530

### N.R. Bardwell Ltd. (PE)

Over one million capacitors for sale in small quantities at prices which are much less than manufacturers 10,000 off prices. Also many, many other types of components at silly prices. Stamp for lists.

288 Abbeydale Road, Sheffield S7 1FL  
 Phone 0742 552886 Fax 0742 500689

Large selection of interesting components at very competitive prices. Large S.A.E. for lists to AGS Electronics, Unit 2, Haxter Close, Bellver Ind. Estate, Plymouth, Devon PL6 7DD. Tel: 0752-767738.

EPROMS £1 each. Type 27256 150ns. Programming voltage 12.5V. Used once but erased and with no bent pins. Tel: (081) 842 3862

## Surveillance

### SPY BOOKS

Interested in espionage, counter-surveillance, personal freedom or investigation? Do you seek information that some people feel should remain secret or unpublished? Send S.A.E. PO Box 2072, London NW10 0NZ.

Surveillance devices, lasers, Tesla coils, scramblers, ultrasonic and many more, over 150 designs. Send SAE to: Plancentre, Old Wharf, Dynock Road, Ledbury HR8 2HS for free list.

NEW VHF MICROTRANSMITTER KIT, tuneable 80-135 MHz, 500 metre range, sensitive electret microphone, high quality PCB. SPECIAL OFFER complete kit ONLY £5.95, assembled and ready to use £9.95 post free. Access orders telephone 021 411 1821. Cheques/ P.O.'s to: Quantek Electronics Ltd, (Dept P.E.), 45a Station Road, Northfield, Birmingham, B31 3TE

Kits, Plans, Assembled Units, Surveillance Microtransmitters, Phone Recording Switches, Trackers, Defence /Protection Circuits, Plus much more. Send 2 x 22p stamps for lists, or tel. 05436 76477 24hrs. Everything for the budding 007. ACE(PE). 53 Woodland Way, Burntwood, Staffs. WS7 8UP.

Suma Designs sell top quality surveillance equipment. See our display ad on page 9

## Surveillance

### PROFESSIONAL INTRUDER ALARM EQUIPMENT

One x 1 Coded Keypad Microprocessor Control Panel, One Rechargeable Battery, Two x 12mts Passive Infra Red Detectors, One self Actuating Siren Bell Box and flashing Strobe Light, Four Magnetic Door Contacts, two Panic Buttons, 100 mts Cable and one box of Cable Clips.

Only £189.00 + VAT Inclusive of delivery. Allow 28 days for delivery.

Please make cheques payable to:

**Laser Alarms Limited,  
Laser House,  
Newton Avenue,**

## Miscellaneous

**Modernising your workshop?  
Sell your old equipment  
through PE Classifieds pages.**

Oscilloscope double beam 10MHz. Portable (telequipment) £120, AVO 8 Mk5 cased £100, both excellent, geiger counter £50. Wanted: Transistorized 20-60 MHz oscilloscope not working/"cheap!" 0803-882572.

Make your visit to London enjoyable!  
Stay at the family run

**MARANTON HOUSE HOTEL**  
14 Barkston Garden,  
LONDON SW5 Tel: 071 373 5782  
(Underground: Earl's Court)

## Miscellaneous

### FOR SALE

Practical Electronics in Binders volumes one (1965) to ten (1974) and later loose copies. Offers for lot (0905) 54318.

### SERVICE MANUALS

Available for most equipment. TVs, Videos, Test, Amateur Radio etc. Write or phone for quote. **Mauritron (PE), 8 Cherry Tree Road, Chinnor, Oxon OX9 4QY**  
Tel: (0844) 51694. Fax: (0844) 52554

### School Visits

**Steam Technology 1820-1910**  
See the World's Largest

School Day Steamings  
22nd May and 6th Nov 1991

**Working Beam Engine**  
**Kew Bridge Steam Museum**  
**Green Dragon Lane**  
**Brentford TW8 0EN**  
**Technology Tours throughout**

**Missing that vital PE back issue?**

**Don't despair!**

Reprints of articles and software listings are available for £2 from the editorial address. We cannot accept credit card orders below £5 value.

# CLASSIFIED COUPON

									£3.36
									£5.04
									£6.72
									£8.40
									£10.08
									£11.76

Rates are 20p per word plus 4p VAT (lineage, for semi-display advertisements contact our Ad. Dept.). All classified advertisements must be pre-paid. Please send your copy with the remittance (payable to Intra Press or payments by Visa or Access accepted) to: Practical Electronics Classified Dept., Intra House, 193 Uxbridge Road, London W12 9RA. Tel: 081-743 8888, Fax: 081-743 3062



# Techniques

*Some people want to keep their work dry, and others want to keep it damp. Andrew Armstrong advises.*

**I** am an amateur orchid grower. One of my biggest problems is maintaining adequate levels of humidity. Recently I read about ultrasonic humidifiers, or nebulisers, and I discovered that the basic principle of these machines is a device that will produce sound energy at high frequencies (1-3MHz). These waves, applied to a reservoir of water, disrupt the molecular attraction, and the water molecules escape the effects of surface tension to rise from the water at high velocity as a fog. This can then be dispersed with the aid of a fan.

I would like to build these for my three large greenhouses, each of which would require two devices. To buy them would cost a lot of money. Could you tell me where I could purchase a device to produce the high frequency sound, to build into such a system?

I would also like to know where I can buy an electronic humidistat in kit form, or some other form that could be built at home.

John Beal  
Tyne & Wear

The subject of humidification is more complicated than it at first appears. There are two main methods by which the humidity of an environment is increased: by boiling water to produce steam, or by vaporising water using ultrasonics. This latter, of course, consumes much less electricity per unit of water vaporised. However, this is not the whole story.

## Latent Heat

When water changes from a liquid to a vapour, it requires an amount of heat known as the latent heat of change of state. It is this heat which is being supplied by the gas ring when a pan of water is boiling. A lot less gas is used in raising the water to boiling point, than in turning it into a vapour. Were this not so, pans would boil dry very rapidly indeed.

When water vapour is produced by ultrasonic means, the latent heat of change of state is absorbed from the atmosphere. Operating an ultrasonic humidifier in a normal environment, produces a very cold mist, and cools down the surrounding area. In a situation where the environment needs to be maintained at a certain temperature, extra heating equal to the latent heat of change of state of the water must then be supplied. This means that in some cases just as much electricity can be required (assuming electrical heating is used) when using an ultrasonic humidifier as when using a steam humidifier.

Ultrasonic humidification also has a little-known shortcoming: if the water used is not distilled or de-ionised, the dissolved solid content of the water is emitted into the atmosphere with the tiny water droplets forming the mist. The mist droplets vaporise to form invisible water vapour, leaving behind a sub-micron dust in the atmosphere. Long-term inhalation of this dust causes various lung diseases of a type which, if incurred at work in a

dusty environment, could be classified as industrial diseases. Whether this would be harmful to orchids or not, I do not know, but the question should be asked.

Industrial ultrasonic humidifiers generally incorporate water de-ionised in their feed pipes, but the small domestic units which are now on sale, very often have no such provision. Occasional use of these items with tapwater may not be harmful, but long-term, consistent use might carry the risk of illness.

## Relative Humidity

The amount of water vapour which the air can hold depends upon the temperature of the air, being higher if the air is warmer. A given partial pressure of water vapour might give 50% relative humidity (rh) outdoors, while giving only 35% in a heated building. The laws of physics state that, gases behave, to a large extent, as if other gases were not present, so that a higher partial pressure of water vapour inside a building (necessary to increase the relative humidity) tends to find its way out of the building via the

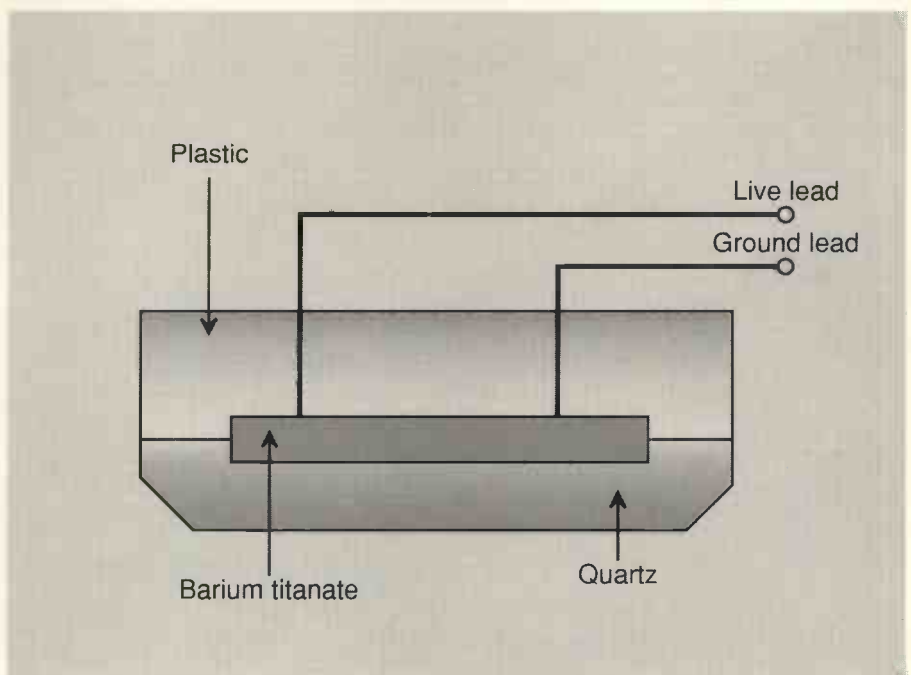

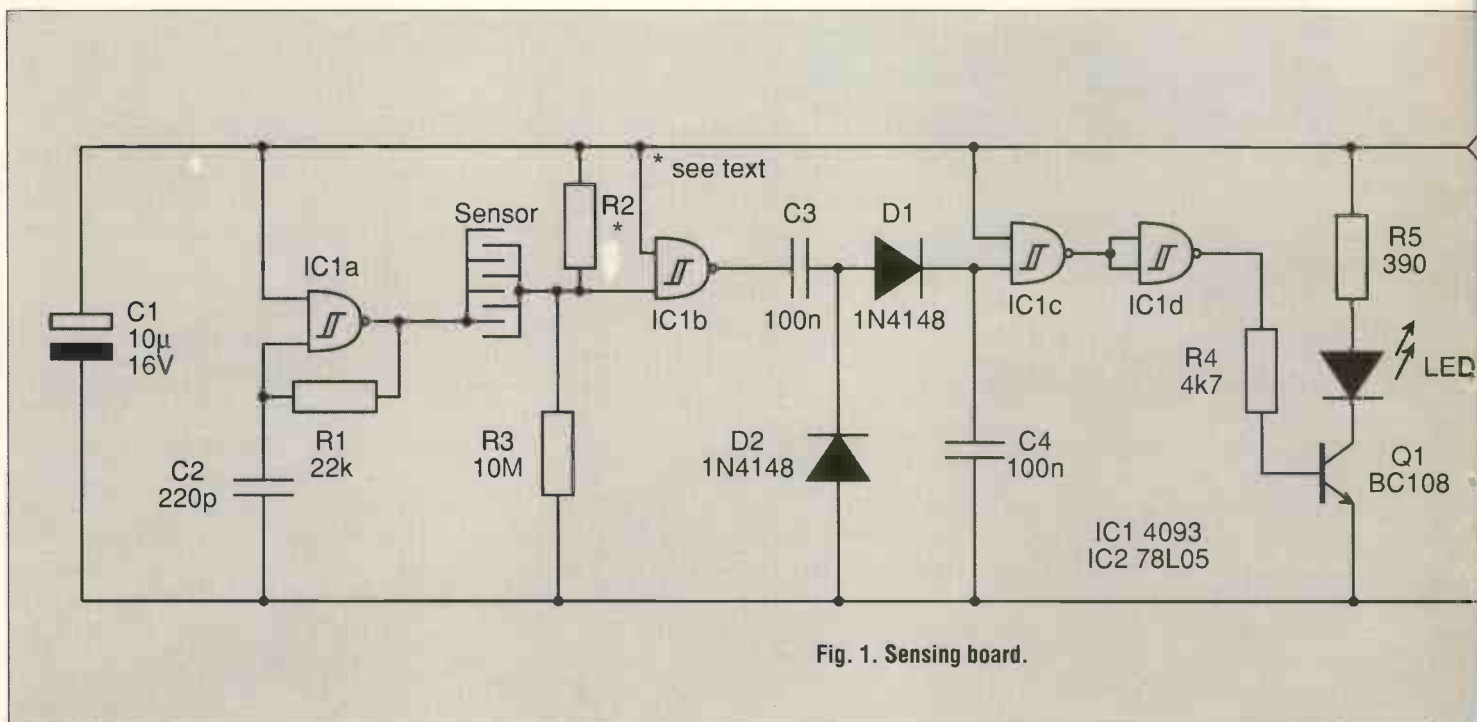

Fig. 1. Sensing board.

ventilation. Who said environmental control was simple?

There is a further complication to maintaining the required environmental conditions. Changing the humidity almost inevitably alters the temperature, and a change in the temperature alters the relative humidity, so that if too close a control is attempted, or if the positioning of a humidistat or thermostat is not carefully considered, the control system can "hunt", effectively making an environmental oscillator.

Despite all these problems, it is possible to achieve reasonably well-controlled temperature and humidity. Humidity can be controlled either by a simple humidistat, which turns on the humidifier when the humidity is too low and turns it off when it is high enough, or by a proportional controller which varies the water vapour output according to how much below the required level the humidity is. Simple humidistats can be made using a hair, which stretches as the humidity gets higher, and which operates a mechanical switch.

Electronic humidity controllers can also be made. These normally use a sensing element whose capacitance varies with humidity. Very briefly, the way in which they work is by adsorption of water vapour (water molecules binding to a surface layer) onto a polymer. Sensing elements are available at

various prices and accuracies. Philips components make a reliable low-cost sensor (part no. 2322-691-90001, stocked by Farnell Components at a current catalogue price of £7.67 plus VAT. There may be a minimum order charge and/or carriage charge. Farnell's telephone number is 0532 636311.).

Next month we will look at the circuit of an electronic humidistat using this sensor. In the meantime I want to do some research into an alternative means of humidification.

**I**want to make a rain detector. My current situation is that just as our washing is "ironing dry", it rains and creates more work for the XYL. A rain detector would seem to ease this problem.

Sydney Davis G3KVR  
Somerset

I don't have a rain detector circuit on file, but I have adapted a design I used for another purpose to provide what should be a very dependable rain detector.

The most obvious way to detect rain would be to use a device which applies a voltage to any rain which falls on it, and measures the resulting current. Any significant current flow could be used to trigger an alarm. A suitable detector could be made, for example, by wiring together alternate tracks of a piece of stripboard. Raindrops

falling between the strips would conduct and trigger the alarm.

This method will work, but suffers from the problem that oxides (and other compounds) of copper will form, and will soon short out the detector. It would require regular cleaning.

## Capacitive Detection

The design here uses an AC signal and a capacitive sensor which should be much more resistant to contamination. An interdigital sensing element is used, very much like the idea of the resistive sensor. The difference is that the rain does not come into contact with the copper.

The capacitance between track edges in the sensor is very low, but a raindrop straddling two adjacent tracks has a capacitance to each one, and couples a signal through. Sufficient extra capacitance will couple through a big enough signal to be detected.

A suitable design is shown in Figs. 1 and 2. The main part of the electronics must be close to the sensor, so it is designed to connect to an alarm/power supply unit by means of a reversible two wire connection. This permits the rain detector head to be positioned some distance from the alarm if necessary, with no worry about connection polarity.

IC1a forms an oscillator with a frequency set by R1 and C2. The

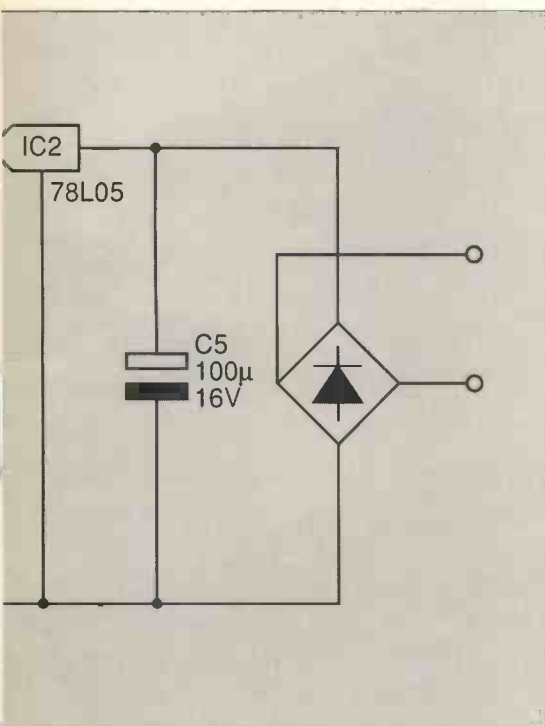

squarewave output from this feeds one side of the sensor.

The other side of the sensor is connected to a Schmitt trigger, which is biased partway between the supply rails to increase its sensitivity. The value of R2 sets the sensitivity, with 10M giving greatest sensitivity and lower values giving decreased sensitivity.

When sufficient signal is coupled to IC1b to make its output switch, the charge pump formed by C3, D1, and D2 charges C4 to a sufficient voltage to switch IC1c to logic 0, which in turn puts IC1d to logic 1, switching on Q1.

This illuminates the LED, and more than doubles the current

consumption of the entire unit. It is this increase in current consumption which triggers the alarm.

Fig. 2 shows the power supply/alarm unit. All the load current of the sensing head, which will be between 3mA and 6mA in the absence of rain, passes through R6. The voltage drop across this load resistor is thus always insufficient to switch on Q2 in the absence of rain.

When rain is detected, an extra approximately 7mA flows, bringing the total current to between 10mA and 13mA. This switches on Q2 and sounds the alarm.

## Construction

The LED serves as a setting-up aid, so that the sensing head can be tested, and the value of R2 chosen, by using a 9V battery connected across the bridge terminals to power the unit.

C7 reduces the likelihood of RF from the amateur radio transmitter triggering the alarm falsely. If a long wire is used between alarm unit and sensing head, a capacitor may also be required across the bridge input terminals.

The sensing element itself may be made from a square of stripboard, approximately three inches on a side, with alternate strips linked. The track side should be sealed from the elements.

One way to do this would be to make a shallow mould and encapsulate the sensor in clear-cast or fibreglass resin. The cover should

be as thin as possible, consistent with covering the tracks with a smooth layer. If the covering is too thick, the sensitivity will be inadequate, so abrasive paper or a file should be used to reduce it if it is thicker than about 2mm.

Ideally the result should be a sensor with a smooth surface which can be cleaned of contamination when necessary by wiping with a cloth.

## Caveat

All these circuit elements work, but the last time I used this type of sensor it was part of a touch switch. In this design a double sided PCB was used, with the interdigital pattern etched on one side, and a rectangle of copper on the other. The copper rectangle had sufficient capacitance to switch the following. When the rectangle of copper was touched, the signal was much attenuated by stray capacitance to ground, and the following stage ceased switching.

I have not carried out experiments to discover how low a value of coupling capacitance will work, but it is clear that one raindrop will not be enough. The precise quantity of rain required to trigger the alarm must be determined by experiment (and the precise needs of the laundry superintendent, who may not wish to be called outside for a few drops), and if the sensitivity is inadequate, a new and larger sensor, of the same type, may be needed. ■

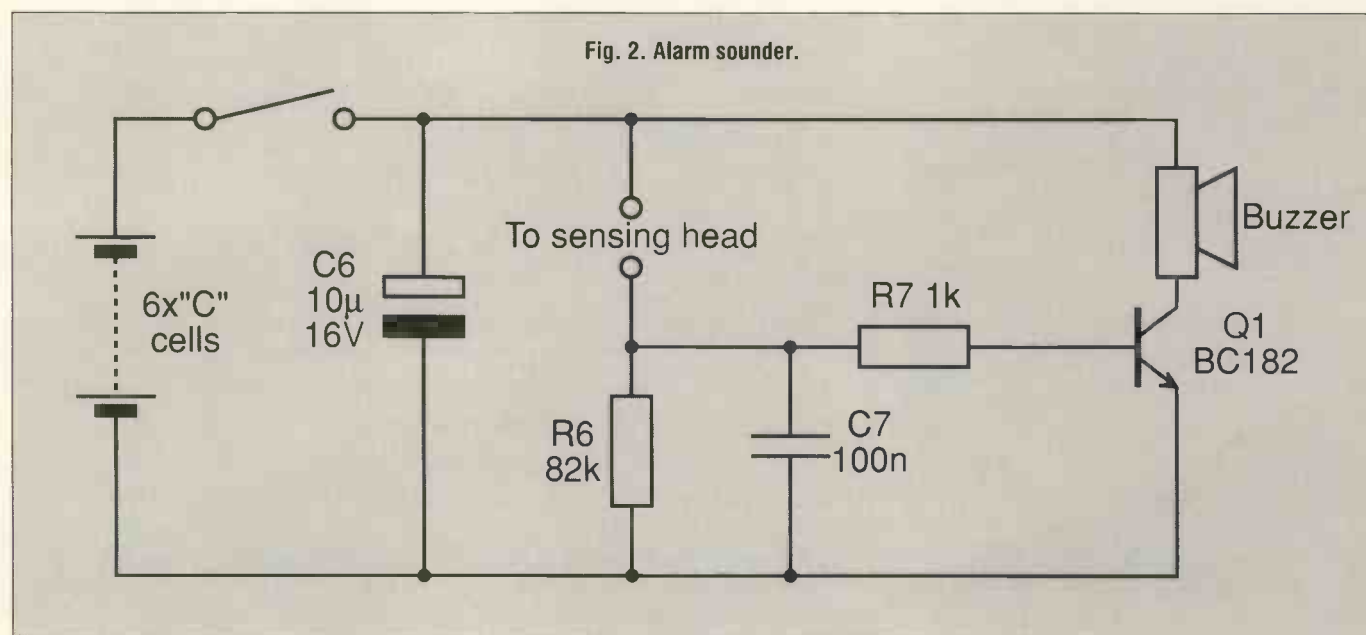

# PRACTICAL ELECTRONICS

SCIENCE AND TECHNOLOGY

*What has changed over the past 25 years of PE? We open up the tomes and take a look.*

## June 1966

The editorial in this month's issue considered the possibilities of automating the London Underground. Radical new ideas, such as automatic barriers at entrances and exits, magnetic strips in the tickets that could be interrogated by computers to ensure validity and operation of whole stations by one person using visual and audio surveillance equipment, were suggested. Anyone who has been on the Tube recently will have noticed that all of these things have come to pass, although the use of only one person to run a station is usually due to staff shortages.

Among the projects in this issue was a machine to play the game of NIM – not using computer techniques but with a set of four multi-pole switches – not an electronic component in sight, not even a resistor. Other topics of interest were the beginning of a series on logic gates – using discrete components – and a feature on radio controlled models.

## 1976

This was the year that VAT on most electronics goods was cut to 12.5% in the April budget and PE announced the winners in its invention competition. Top of the heap winning £250 was a high intensity beacon which used a Xenon flash bulb to provide a simple yet portable warning light. Second prize (£100) went to a portable heart starter – presumably a primitive defibrillator. The third prize (£50) idea was for an Alpha Beta particle detector, while a number of runners up offered anything from insect killers and gas detectors (explosive?) to animal goads. Projects this issue were a rally mileometer, an audio millivoltmeter, and a proportional radio control.

## 1981

Whatever happened to wire wrapping? Back in 81, a whole feature was dedicated to the ins and outs of this arcane technique. The editorial examined how Japan was looking to the future in electronics technology and making plans to be ahead of everyone else – something that seems to have worked.

## 1986

An article on neural networks gave an insight into something that is still at the forefront of electronics technology. The editorial had a good rant about the British education system – another topic still popular today. ■

## PE Book Bargains

*The following titles are being deleted from the PE Book Service. We have small stocks left which are available at a discount price on a first-come first served basis. Please phone 081 743 8888 and check availability before ordering. Prices include VAT and postage.*

Code	Title	List Price	PE Price
PC101	Electronics Build & Learn	£5.95	£4.76
PC103	Practical Midi Handbook	£5.95	£4.76
BM	The Design of Electronic Hardware	£6.95	£5.56
NT10	Newness Electronics Pocket Book	£9.95	£7.96
NT13	Newness Computer Engineers Pocket Book	£9.95	£7.96
NT3	Oscilloscopes	£12.95	£10.36
BP 44	IC 555 Projects	£2.95	£2.36
BP 56	Electronic Security Devices	£2.50	£2.00
BP 74	Electronic Music Projects	£2.50	£2.00
BP 76	Power Supply Projects	£2.50	£2.00
BP 80	Popular Electronic Circuits Book1	£2.95	£2.36
BP 88	How to Use Op-Amps	£2.95	£2.36
BP 108	International Diode Equivalents Guide	£2.95	£2.36
BP 111	Audio (Elements of Electronics - Book 6)	£3.95	£3.16
BP 117	Practical Electronics Building Blocks Book 1	£1.95	£1.56
BP 118	Practical Electronics Building Blocks Book 2	£1.95	£1.56
BP 121	How to Design and Make Your Own PCB's	£2.50	£2.00
BP 144	Further Practical Electronics Calculations	£2.50	£2.00
BP 162	How to Get Your Computer Program Running	£2.50	£2.00
BP 171	Easy Add-on Projects for Amstrad CPC 464, 664, 6128 and MSX Computers	£2.95	£2.36
BP 173	Computer Music Projects	£2.95	£2.36
BP 174	More Advanced Electronic Music Projects	£2.95	£2.36
BP 177	An Introduction to Computer Communications	£2.95	£2.36
BP 179	Electronic Circuits for the Computer Control of Robots	£2.95	£2.36
BP 180	Electronic Circuits for the Computer Control of Model Railways	£2.95	£2.36
BP 182	MIDI Projects	£2.95	£2.36
BP 183	An Introduction to CP/M	£2.95	£2.36
BP 189	Using Your Amstrad CPC Disc Drives	£2.95	£2.36
BP 190	More Advanced Electronic Security Projects	£2.95	£2.36
BP 192	More Advanced Power Supply Projects	£2.95	£2.36
BP 195	An Introduction to Satellite TV	£5.95	£4.76
BP 227	Beginners Guide to Building Electronic Projects	£1.95	£1.56
BP 233	Electronic Hobbyists Handbook	£4.95	£3.96
BP 239	Getting the Most From Your Multimeter	£2.95	£2.36
BP 290	Introduction to Amateur Comm Satellites	£3.95	£3.16

# Ultra-scanner PCBs

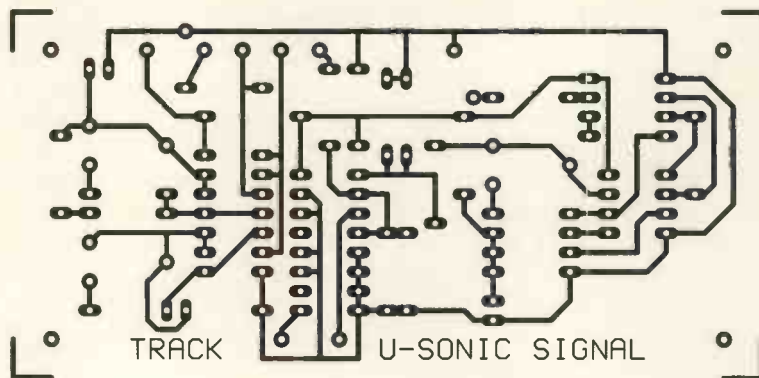
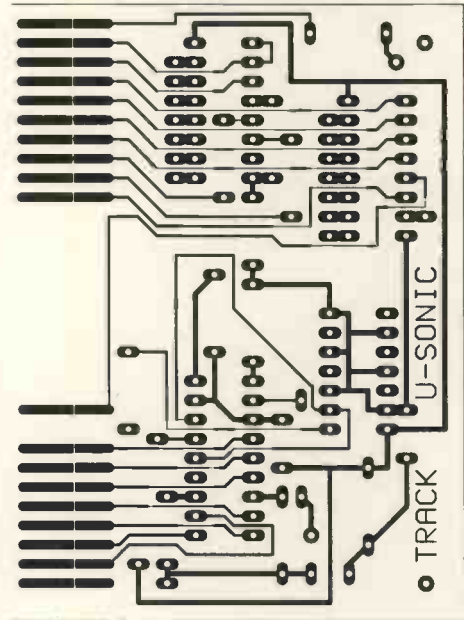
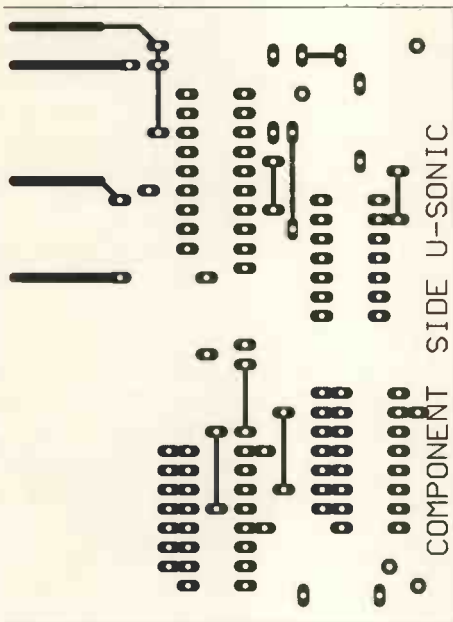

Top right, ADC and address coding board top side, top left, the same but showing the component side. Bottom is the motor control board trackside – see page 46 for more details.

# Consensus Of Opinion

*Barry Fox examines the methods behind the making of the census commercial. Six weeks in the making, was it worth the money?*

Personally I think it is monstrous that the government should have squandered our money on TV commercials encouraging Britons to fill in their census forms. It was a legal obligation to do so anyway. But be that as it may, there was some interesting technology behind the commercial, which looks likely to win prizes and be shown in the future as an example of what computer graphics can do. It also shows how videotaped interviews can now be edited, just like audio tapes, to make people appear to say and do what they never said or did.

## Baby Talk

The census commercials, broadcast in April, show a six month old baby, talking. Most viewers will immediately have realised that the baby's voice had been dubbed. But only a very few viewers will have wondered how the baby's lip movements can so exactly match the sound of someone else's words. The 30 second sequence took 6 weeks of hard work with a computer to doctor and the result was so successful that the trickery passed largely unnoticed.

The soundtrack, which has the baby talking about her future, was recorded by an eight year old girl reading a script. The girl's lips were filmed in close-up at the same time. Separately, the producers auditioned 140 babies and picked six month old Jade. They then pointed a 35mm movie film camera at her and left it running for most of a day to capture all her moods and movements.

Next a cartoon animator at London TV production company Rushes made a paper tracing from every one of the 25 pictures per second that made up the 30 second film of the lip movements. Refining these tracings, the animator then

**P**eople appear to say and do what they never said or did.

built up a 30 second animated sequence of line drawings representing lip movements to match the spoken words. This sequence was then recorded as digital code on a magnetic disk, of the Winchester type used by computers to store text.

## Lip Service

The images were then transferred to a Silicon Graphics Unix workstation, running a software program called Alias written by Alias Research of Toronto. Alias uses line drawings to

build a moving 3-dimensional model. For the Census commercial it used the line outline of the lips and their surrounding muscles to make models. These models, known as wire frames, look like the designs displayed on screen by a Computer Aided Design system.

The computer operator then perfected the shape of the wire frame models by "painting" extra detail on the computer screen with a computer mouse. The result was a 30 second animated wire frame sequence, depicting in 3-D the shape of human lips mouthing the scripted text in perfect synchronism with the recorded sound.

## Alternative Reality

The final step was to blend the original film of the baby's face with the wire frame model. This is done by "texture mapping" using the digital special effects equipment called Paintbox and Harry made by the British company Quantel. The colour and texture of the baby's lips and skin are added to the wire frame, like paint from an electronic palette. The wire frame disappears to leave an apparently real video recording of the baby's lips mouthing the spoken words.

The result is a motion sequence in which the main part of the baby's face remains exactly as filmed, but the mouth and lips appear to open and close as if forming the speech heard on the soundtrack. The processing took Rushes' computer scientist Ellen Poon six weeks, working six days a week for twelve hours a day, to make the seams invisible. ■

# EASY-PC, SCHEMATIC and PCB CAD

Over 7500 Installations  
in 50 Countries Worldwide!

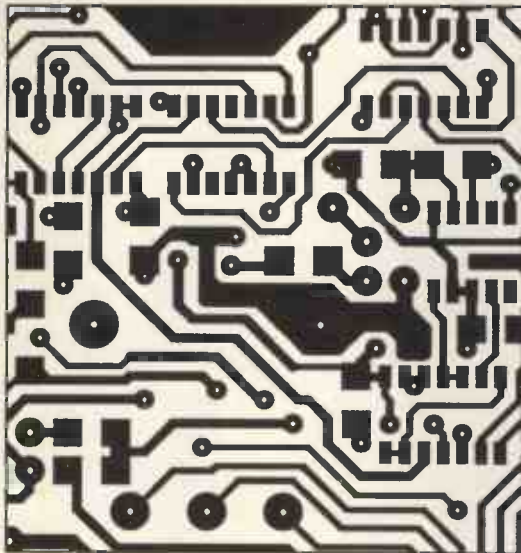

- Runs on:- PC/XT/AT/ 286/ 386/486 Herc, CGA, EGA, VGA.
- Design:-Single sided, Double sided and Multilayer boards.
- Provides Surface Mount support.
- Standard output includes Dot Matrix / Laser / Inkjet Printer, Pen Plotter, Photo-plotter and N.C. Drill.
- Superbly easy to use.
- Not copy protected.

**Still Only £98.00!**  
Plus P&P+VAT

**BRITISH DESIGN AWARD 1989**

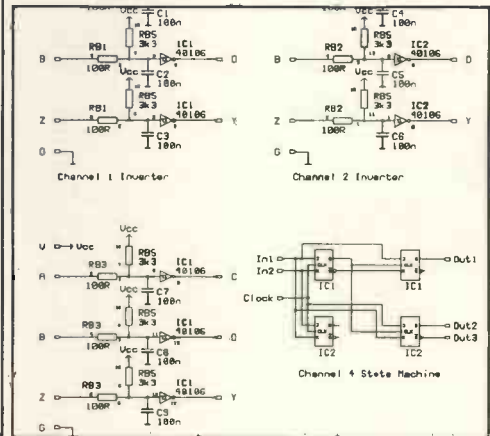

## Options:

1000 piece Symbol Library £38, Gerber Import facility £98

### AC CIRCUIT ANALYSIS ANALYSER II £195

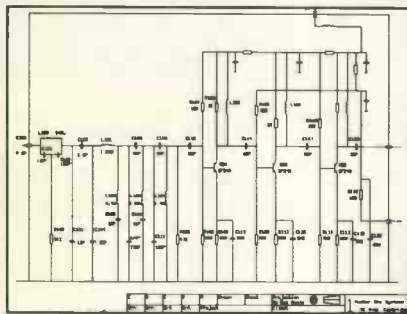

- Evaluate the performance of your designs prior to breadboarding.
- Make modifications to them and assess the new performance in minutes, rather than hours or days.
- ANALYSER II can save thousands of pounds in test equipment

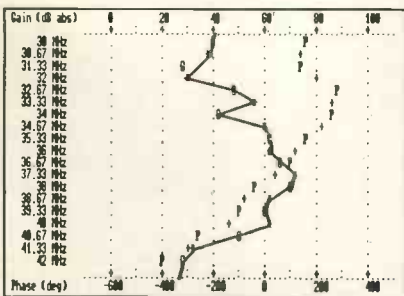

**EVALUATE DESIGN MODIFICATIONS IN MINUTES!**

### SMITH CHART CAD Z-MATCH II £195

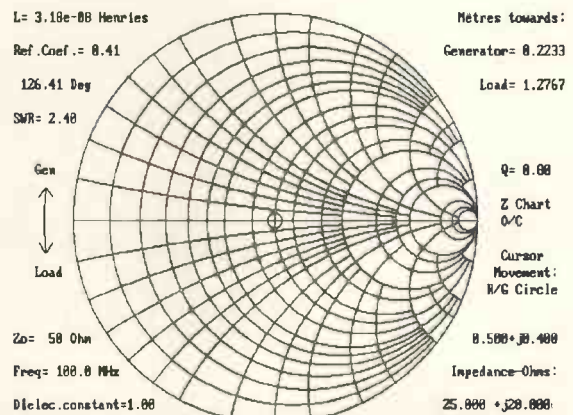

Z-MATCH II takes the drudgery out of RF matching problems and includes many more features than the standard Smith Chart. Provides solutions to matching problems using transmission line transformers, stubs, discrete components etc.etc.. Supplied with comprehensive user instructions including many worked examples.

For full information, Write, Phone or Fax:-

**Number One Systems Ltd. I**

REF: PE, HARDING WAY, ST.IVES, HUNTINGDON, CAMBS, ENGLAND, PE17 4WR.

Telephone: 0480 61778 (7 lines) Fax: 0480 494042

International: + 44 -480-61778, I'Fax: + 44-480-494042 ACCESS, AMEX, MASTERCARD, VISA Welcome.

**The CAD Specialists**

# NICAM

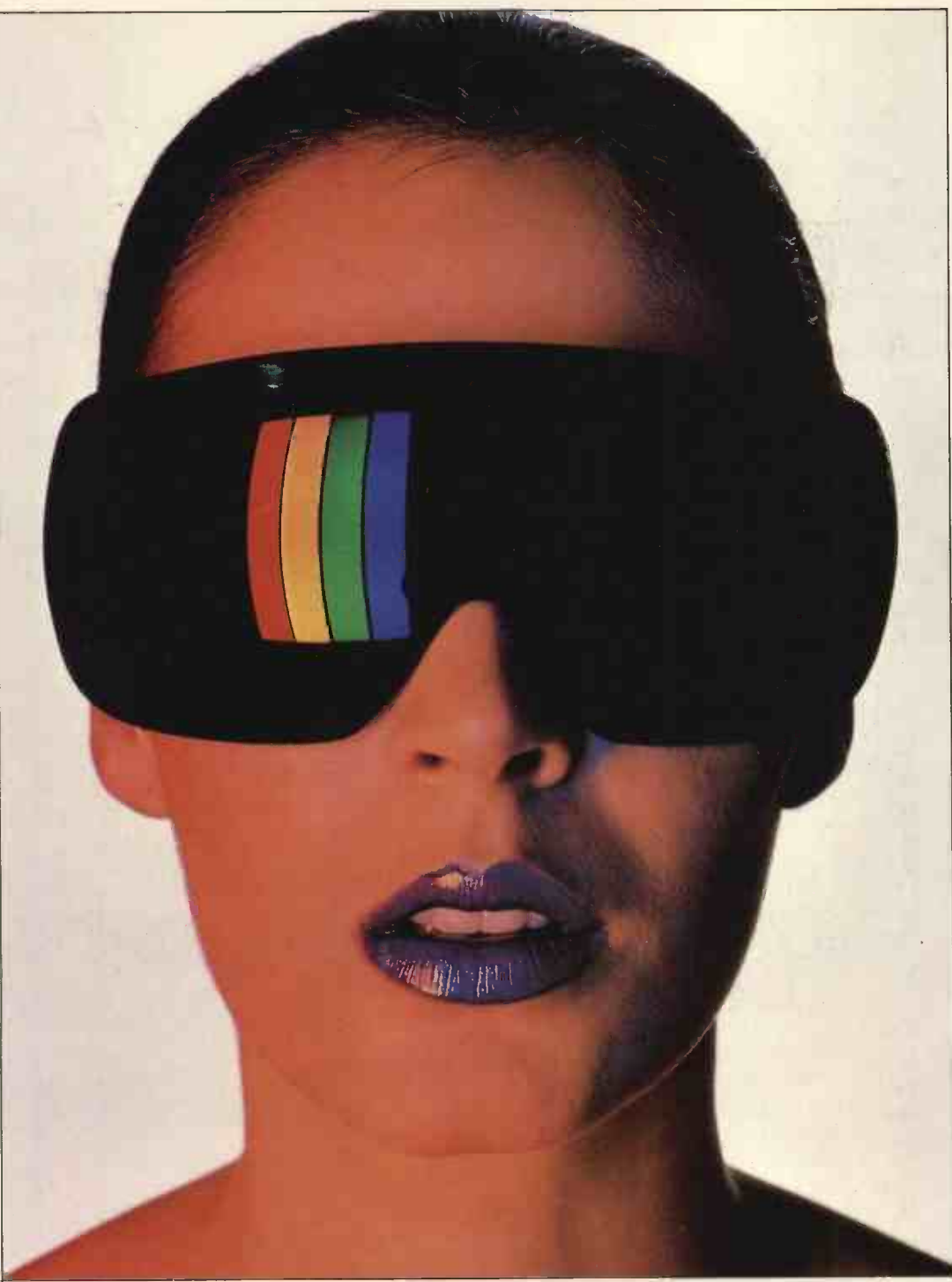

## ...set your sights on a better sound!

**E**xperience a new sensation. An experience that opens up a whole new spectrum of sound.

Put yourself on stage at the Albert Hall, surrounded by a great orchestra. Imagine the sound you will hear, every nuance, every note; or travel up the Nile with an intrepid explorer, a journey not only full of breathtaking beauty and colour, but rich in the sounds of another continent; or capture the hidden gasps of 100,000 hardened fans at Wembley for the F. A. Cup Final, when the ball skims the crossbar with the last kick of the match; follow with your ears as well as your eyes, dodging the bullets, as your favourite hero battles out of yet another tight corner, it's just like being in a cinema!

Nicam hi-fi stereo will turn your living-room into a living room of

sound! You don't settle for second best with television picture quality, why settle for second best in television sound quality? Nicam sound is the new high quality digital stereo sound system, pioneered by BBC, ITV and TV/video manufacturers. In fact so good is Nicam it is comparable to the superb sound reproduction of the compact disc, when played through your existing hi-fi arrangement. If your television hasn't got a built-in Nicam decoder, you will need the Maplin Nicam Tuner System. Ultimately almost all of your favourite programmes will be broadcast in superb hi-fi quality stereo-sound. Without a Maplin Nicam Tuner you won't be able to capture every sound to its full.

Nicam hi-fi stereo. Catch your breath, open your eyes, and pin back your ears! It's what your hi-fi system was made for... It's what your ears are made for!

### DIGITAL STEREO TV SOUND FROM YOUR HI-FI

The complete kit contains all the components required to build the unit. However you will also need: a power supply, 12V at 600mA regulated e.g. YZ21X at £9.95; a co-ax lead adaptor e.g. FS23A at £1.20; a co-ax lead to connect to your TV or video; RW36P 2m long at £1.36, JW39N 5m long at £1.98, or JW40T 10m long at £2.95; a phono lead to connect to your hi-fi e.g. RW50E at £1.06 or a SCART/Peritel lead JW36P at £5.95. An infra-red remote control kit is also available LP20W at £29.95. Complete kit LP19V only £149.95 incl. VAT + £1 mail-order handling charge.

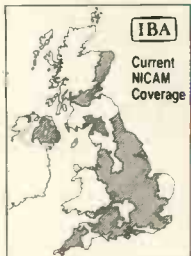

## Maplin ELECTRONICS

### CREDIT CARD HOTLINE 0702 554161

For a friendly welcome and the very best of service why not visit our shops in Birmingham, Brighton, Bristol, Leeds, London (Edgware and Hammersmith), Manchester, Newcastle-upon-Tyne, Nottingham, Reading, Southampton and Southend-on-Sea.  
Subject to availability. Prices subject to change.

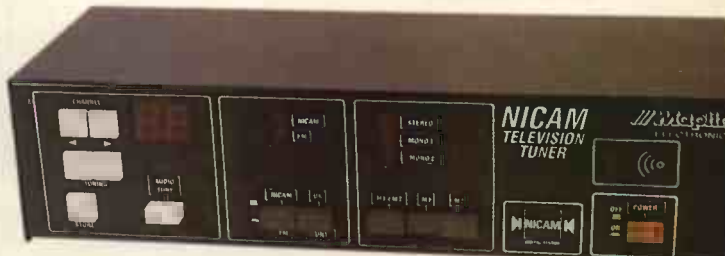

Digital stereo sound companion for your TV set.