

Free Poster

March 1991 • £1.50

# PRACTICAL ELECTRONICS

SCIENCE AND TECHNOLOGY

**£2000**  
to be  
won!  
Turn to page 36  
for details

## Build It! MIDI Analyser

*Troubleshoot your  
synthesiser*

## Signal Generator

*Essential test equipment*

## Car Parking Monitor

*Ultrasonic ranging*

**Also:**

The History of ICs

What is Ham Radio?

BoardMaker CAD review



9 770032 637017



# Tandy®

## THE PLACE FOR PARTS

Here at Tandy we stock a large selection of parts for the hobbyist and professional alike. Whether you are repairing a computer or building your first electronic project your needs can be catered for all under the same roof.

Tandy has a range of lamps and assemblies; ICs, diodes, regulators, displays, transistors, relays, enclosures, power connectors, in fact anything and everything you could ever need for repairs and projects.

Our range of adapters and connectors is second to none, and our after sales service is something in which you can trust.

So, whether you are building an alarm system, repairing a radio or just wiring a plug, Tandy is the place for parts!

### TEMPERATURE INDICATOR



£14.95

Use "as-is", or add simple circuits to control an LED, fan, heater, buzzer. -40 to +50°C, -40 to +122°F range. Requires "AA" battery. With probe cord, data.

277-123 ..... £14.95

### COUNTING MODULE

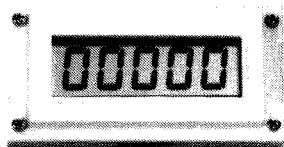

£12.95

Counts up to 99,999. Advanced by external switch closure or digital circuit. Count rate up to 7 Hz. 12.7mm LCD display. Requires "AA" battery.

277-302 ..... £12.95

### MECHANICAL COUNTER

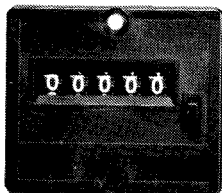

£10.99

Extra rugged device with many uses. Advances one count with a 12 VDC pulse. Manual pushbutton reset. With leads and data.

277-222 ..... £10.99

### MINI AUDIO AMPLIFIER

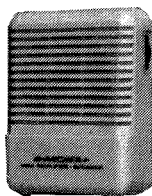

£9.99

High gain IC design, use as a test bench amplifier. Ideal for computer voice/music synthesis. On/off volume control. 3.5mm earphone and input sockets. Requires 9v battery. 277-1008 ..... £9.99

### COMPUTER JOYSTICKS

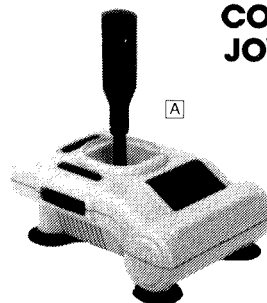

£16.95

£7.99

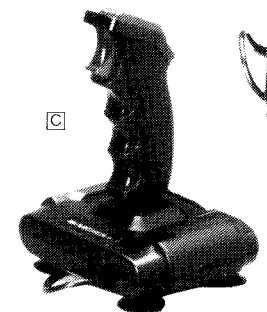
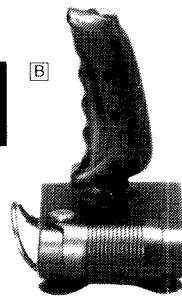

£9.99

### DIGITAL LOGIC PROBE

£15.95



Colour-coded LEDs indicate high, low or pulsed logic states (up to 10 MHz). Simultaneous tone output frees your eyes for fast testing. Switches for pulse or normal modes. Input: 100K ohms. Minimum detectable pulse width: 50 ns. Operates from 4 to 15 VDC. Instructions included. With 91.4cm leads. 22-303 ..... £15.95

**A** Joystick For Tandy/IBM. Features smooth-tracking stick and high-speed auto-firing. With 15 and 5-PIN connections. 270-9207 ... £16.95

**B** Jet Fighter Style Competition Joystick. Features two "fire" buttons plus auto-fire control. 270-1701 ..... £7.99

**C** Super-Deluxe Competition Joystick. Features large contoured handle and two firing buttons. 270-1703 ..... £9.99

Tandy

# PRACTICAL ELECTRONICS

SCIENCE AND TECHNOLOGY

Editor: Kenn Garroch

Projects Editor: John Becker

Sub-Editor: Helen Armstrong

Technical Illustrator: Derek Gooding

Group Advertisement Manager: Jacqueline Barlow

Advertisement Executive: David Bonner

Production Editor: Richard Milner

Office Manager: Wendy Cooper

Office Secretary: Wendy Rhodes

Publisher: Angelo Zgorelec

## Practical Electronics

### Intra House

193 Uxbridge Road

London W12 9RA

Tel: 081-743 8888

Fax: 081-743 3062

Telecom Gold: 87: SQQ567

### Enquiries

All editorial correspondence should be addressed to the editor and any letters requiring a reply should be accompanied by a stamped addressed envelope, or equivalent payment.

We regret that technical enquiries cannot be answered over the phone.

### Advertisements

The Publishers of PE take reasonable precautions to ensure that advertisements published in the magazine are genuine, but cannot take any responsibility in respect of statements or claims made by advertisers. The Publishers also cannot accept any liability in respect of goods not being delivered or not working properly.

### Subscriptions

Annual subscription rates are £18.00 for the U.K. or £22.00 overseas (Air mail £39.00). Please send sterling cheques or banker's drafts payable to Intra Press. Payment by Visa or Access also accepted. Practical Electronics, Subscription Dept., P.O. Box 500, Leicester LE99 0AA. Telephone: 0858 410510 (ask for Practical Electronics Subscriptions).

### Back Issues

We still have a limited number of the back issues from the last three years available (Certain issues from earlier years are also available, but check before ordering). Price £1.75 - overseas £2.25 (inclusive of postage). Orders should be sent to our editorial address.

© Intra Press 1991. Copyright in all drawings, photographs and articles published in PRACTICAL ELECTRONICS is fully protected, and reproduction or imitations in whole or in part are expressly forbidden. All reasonable precautions are taken by PRACTICAL ELECTRONICS to ensure that the advice and data given to readers is reliable. We cannot, however, guarantee it, and we cannot accept legal responsibility for it. Prices quoted are those current as we go to press. All material is accepted for publication on the express understanding that the contributor has the authority to permit us to do so.

ISSN 0032-6372

# March 1991

Volume ~~26~~ #3  
27 3

## Projects

MIDI Analyser.....	10
<i>R.A. Penfold</i>	
Computerised Signal Generator.....	20
<i>John Becker</i>	
A Car Positioning Aid.....	27
<i>Owen Bishop</i>	

## Features

Converting Ideas Into Cash.....	17
<i>Barbara Cookson</i>	
Basic Electronics Part 15.....	35
<i>Owen Bishop</i>	
Amateur Radio.....	45
<i>Ian Poole</i>	
The IC Story.....	51
<i>Ian Poole</i>	
CAD Review.....	58
<i>Kenn Garroch</i>	

## Regulars

Innovations	
<i>A look at the latest chips and gadgets.....</i>	5
Techniques	
<i>Andrew Armstrong answers your questions.....</i>	8
Data Sheet	
<i>The workings of the 6402 UART.....</i>	32
Barry Fox	
<i>Squeezing four new TV stations onto channel 5.....</i>	62

## Editorial

This month PE has both a new look and some new regular sections. Innovations replaces the news pages and Data Sheet provides an area to have an in depth look at both new and commonly used integrated circuits. With the end of Basic Electronics, the introduction of the Techniques section will allow readers to tap the brain of an electronics expert.

*Kenn Garroch, Editor*

## COMPUTER ICs

80C31 MICRO	£2
P8749H MICRO	£5
BBC MICRO PARTS	
SN76489AN	£3
VIDEO ULA 201647	£10 ea 10+ £8
6845 CRT	£5
6522 PIA	£3
DM88L120	£4.50
AY3-1015D UART	£2.50
8086 processor ex-equipment	£2
USED 41256-15	£1.50
USED 4164-15 ex-equipment	£1
9 x 41256-15 SIMM MODULE NEW	£10
8 x 4164 SIP MODULE NEW	£8
HD 146818 CLOCK IC	£2
2864 EEPROM	£3
27128A 250nS EPROM USED	£2 NEW £2.30
FLOPPY DISC CONTROLLER CHIPS 1772	£16 ea
68000-3 PROCESSOR NEW	£5
HD63484-8	£5
ALL USED EPROMS ERASED AND BLANK CHECKED CAN BE PROGRAMMED IF DESIRED.	
2716-45 USED	£2 100/£1
2732-45 USED	£2 100/£1
2764-30 USED	£2 100/£1.60
27C256-30 USED	£2
27C512 USED (ALSO 27512)	£3.00
1702 EPROM EX EQPT	£5
2114 EX EQPT 60p 4116 EX EQPT	70p
6264-128K static ram	£3.00
62256-12 32K static Ram	£7.00
2532 EPROM USED	£2
4416 RAM	£3.00
USED 4416-15 RAM	£2
USED 41464-15	£5

## REGULATORS

LM317T PLASTIC TO220 variable	£1
LM317 METAL	£2.20
7812 METAL 12V 1A	£1
7805/12/15/24V plastic	35p 100 + 20p 1000 + 15p
7905/12/15/24V plastic	35p 100 + 20p 1000 + 15p
CA3085 T099 variable reg	2/£1
LM338 5A VARIABLE	£5

## CRYSTAL OSCILLATOR

1.8342 £1 each 1M, 1.8432M, 4M, 16M	£1.50 each
-------------------------------------	------------

## CRYSTALS

2.7 MHz±2.000 MHz±4.9152MHz±20MHz±49.504MHz±2, 8M, 16.588M	£1 each
--	---------

## TRANSISTORS

BC107, BCY70 PREFORMED LEADS full spec	£1 £4/100 £30/1000
BC557, BC548B, BC238C, BC308B	30/£1 £3.50/100

## POWER TRANSISTORS

N POWER FET IRF531	3/£1
P POWER FET IRF531	2/£1
2SC1520 sim BF259	3/£1 100/£22
TIP141/2 £1 ea TIP112/125/42B	2/£1
TIP35B TIP35C	£1.50
SE9301 100V 10A DARL. SIM TIP121	2/£1
2N3055 EX EQPT TESTED	4/£1
PLASTIC 3055 OR 2955 equiv 50p	100/£35
2N3773 NPN 25A 160V £1.80	10/£16

## QUARTZ HALOGEN LAMPS

A1/216 24V 15W WATTS	£2.25
H1 12V 50W (CAR SPOT)	£1.50
14 WAY ZIF SKT	£1
TEXT/OOL single in line 32 way. Can be ganged (coupling supplied) for use with any dual in line devices.	2/£2
28 WAY TEXT/OOL ZIF SOCKET EX NEW EQUIPMENT	£2.50

## CAPACITORS COMPUTER GRADE

3300uF 350V SIC SAFCO FELSIC 037	£6(£1.50)
2200uF 180V SIC SAFCO FELSIC C038	£4(£1.20)
24,000uF 50V	£3 (1.30)

## TURNS COUNTING DIALS

10 turn dial 21 mm dia. fits 3mm spindle	£2
10 turn digital dial (3 digits) for 3mm or 6mm shaft	£3.50
10 turn clock face dial for 6mm spindle	£4

## MISCELLANEOUS

MAINS ADAPTOR 9V DC 200mA	£1.25
SLOPING FRONT PLASTIC CASE 225 x 215 x 76mm	£3.30
76mm WITH ALL FRONT PANEL 200 x 130mm	£3.30
HUMIDITY SWITCH ADJUSTABLE	£2
WIRE ENDED FUSES 0.25A	30/£1
NEW ULTRASONIC TRANSDUCERS 40kHz	£2/pair
12 CORE CABLE 7.02mm OVERALL SCREEN	70p/METRE
OP AMP LM101CLN	£2.90
BNC 50 OHM SCREENED CHASSIS SOCKET	3/£1
BNC TO CROC CLIPS LEAD 1 metre	£1
LEMAG EARTH LEAKAGE TRIP 35A 30mA trip	£9.00
AMERICAN CHASSIS 2/3 pin SOCKET	2/£1
USED 3 1/2" FLOPPY DISCS D/S 720K	50p 10/£4
TO-220 HEAT SINK sim RS 403-182	10/£2.50
SMALL MICROWAVE DIODES AEI DC1028A	2/£1

## D.I.L. SWITCHES 10 WAY £1 8 WAY 80p 4/5/6 WAY ... 80p

180 volt 1 watt ZENERS also 12v & 75v	20/£1
VN10LM 60v 1/2A 50hm TO-92 mosfet	4/£1 100/£20
MIN GLASS NEONS	10/£1
MINIATURE CO-AX FREE PLUG RS 456-071	2/£1
MINIATURE CO-AX FREE SKT. RS 456-273	2/£1.50
DIL REED RELAY 2 POLE n/o CONTACTS	£1
PCB WITH 2N2646 UNIJUNCTION with 12v 4 POLE RELAY	£1
400m 0.5w thick film resistors (yes four hundred megohms)	4/£1
STRAIN GAUGES 40 ohm Foil type polyester backed balco grid alloy	£1.50 ea 10+ £1
ELECTRET MICROPHONE INSERT	£0.90
Linear Hall effect IC Micro Switch no 613 SS4 sim RS 304-267	£2.50 100+ £1.50
HALL EFFECT IC UGS3040 + MAGNET	£1
OSCILLOSCOPE PROBE SWITCHED X1 X10	£10
CHEAP PHONO PLUGS	100/£2 1000/£18
1 pole 12 way rotary switch	4/£1
AUDIO ICS LM380 LM386	£1 ea LM324
555 TIMER 5/£1 741 OP AMP	5/£1
ZN414 AM RADIO CHIP	80p
COAX PLUGS nice ones	4/£1
COAX BACK TO BACK JOINERS	3/£1
4 x 4 MEMBRANE KEYBOARD	£1.50
15.000uF 40V	£2.50 (£1.25)
INDUCTOR 20uH 1.5A	5/£1
1.25" PANEL FUSEHOLDERS	3/£1
CHROMED STEEL HINGES 14.5 x 1" OPEN	£1 each
12v 1.2w small wire ended lamps fit AUDI VW TR7 SAAB VOLVO	10/£1
12V MES LAMPS	10/£1
STEREO CASSETTE HEAD	£2
MONO CASS. HEAD £1 ERASE HEAD	50p
THERMAL CUT OUTS 50 77 85 120°C	£1 ea
THERMAL FUSE 121°C 240V 15A 220°C	5/£1
TRANSISTOR MOUNTING PADS TO-5/TO-18	£3/1000
TO-3 TRANSISTOR COVERS	10/£1
STICK ON CABINET FEET	30/£1
PCB PINS FIT 0.1" VERO	200/£1
TO-220 micas + bushes	10/50p 100/£2
TO-3 micas + bushes	15/£1
PTFE min screened cable	10m/£1
Large heat shrink sleeving pack	£2
CERAMIC FILTERS 6M/9M/10.7M	50p 100/£20
1EC chassis plug rfi filter 10A	£3
Potentiometers short spindles values 2k5 10k 25k 1m	5/£1
2M5 lin	4/£1
500k lin 500k log	4/£1
40KHz ULTRASONIC TRANSDUCERS EX-EQPT NO DATA	
OMRON 12V G2V DIL RELAY 2 POLE CHANGEOVER	2/£1
SCART CONNECTOR	5/£1
BZV48C12 WIRE ENDED 12V 7WATT ZENER 17K STOCK	£1
3M/SCOTCHFLEX 50 WAY ROUND JACKETED FLAT CABLE 3659/50 (50 WAY IDC RIBBON WITH FOIL AND BRAID SCREENS, ROUND SECTION WITH BLACK PVC OUTER) £1.METRE, 100' REEL	£65
FANS 240V 120mm	£6 (1.50)
(OTHER VOLTAGE/SIZES USUALLY AVAILABLE)	
MOULDED INDUCTOR 470UH SIZE OF 1W RES	8/£1

## DIODES AND RECTIFIERS

1N4148	100/£1.50
1N4004/SD4 1A 300V	100/£3
1N5401 3A 100V	10/£1
BA158 1A 400V fast recovery	100/£3
BA159 1A 1000V fast recovery	100/£4
120V 35A STUD	65p
BY127 1200V 1.2A	10/£1
BY254 800V 3A	8/£1
BY255 1300V 3A	6/£1
6A 100V SIMILAR MR751	4/£1
1A 800V BRIDGE RECTIFIER	4/£1
4A 100V BRIDGE	3/£1
6A 100V BRIDGE	2/£1
8A 200V BRIDGE	2/£1.35
10A 200V BRIDGE	£1.50
25A 200V BRIDGE	10/£18
25A 400V BRIDGE	10/£22

## SCRs

PULSE TRANSFORMERS 1:1 + 1	£1.25
2P4M EQUIV C106D	3/£1
MCR72-6 10A 600V SCR	£1
35A 800V STUD SCR	£2
TICV106D 800mA 400V SCR	3/£1 100/£15
MEU21 PROG. UNIJUNCTION	3/£1

## TRIACS

BT 137-600 8A TO-220	2/£1
BT138-600 12A TO-220	70p
MEU21 PROG. UNIJUNCTION	3/£1
NEC TRIAC AC08F 8A 600V TO220	5/£2 100/£30
TXAL225 8A 400V 5mA GATE 2/	£1 100/£35
3TA08-400 8A 400V 5mA GATE ISOL TAB	£1
CA3059 0 VOLTAGE SWITCH	£1 each

## DIACS 4/£1

## CONNECTORS

D25 IDC SOCKET FUJITSU	£2
34 way card edge IDC CONNECTOR (disk drive type)	£1.25
CENTRONICS 36 WAY IDC PLUG	£2.50
CENTRONICS 36 WAY IDC SKT	£4.00
BBC TO CENTRONICS PRINTER LEAD 1.5M	£3.00
CENTRONICS 36 WAY PLUG SOLDER TYPE	£4
USED CENTRONICS 36W PLUG+SKT	£3

## USED D CONNECTORS price per pair

D9 60p, D15 £1.50, D25 £2, D37 £2, D50 £3.50 covers 50p ea.	
---	--

## WIRE WOUND RESISTORS

W21 or sim 2.5W 10 of one value	£1
R10 OR15 OR22 2R0 4R7 5R0 5R6 8R2 10R 12R 15R 18R 20R 22R 27R 33R 47R 56R 62R 91R 120R 180R 390R 430R 470R 680R 820R 910R 1K15 1K2 1K5 1K8 2K4 2K7 3K3 3K0 5K0	4 FOR £1
W22 or sim 6W 7 OF ONE VALUE	£1
R47 R62 1R0 1R5 1R8 3R3 6R8 9R1 12R 20R 24R 27R 33R 51R 56R 62R 68R 100R 120R 180R 220R 390R 560R 620R 910R 1K0 1K2 1K5 1K8 2K2 2K7 3K3 3K9 4K7 8K2 10k 15K 16K 20K	
W23 or sim 9W 6 of one value	£1
R22 R47 1R0 1R1 56R 62R 100R 120R 180R 220R 300R 390R 680R 1K0 1K5 5K1 10K	
W24 or sim 12W 4 OF ONE VALUE	£1
R50 2R0 9R1 18R 22R 27R 56R 68R 75R 82R 100R 150R 180R 200R 220R 270R 400R 620R 1K0 6K8 8K2 10K 15K	

## PHOTO DEVICES

SLOTTED OPTO-SWITCH OPCOA OPB815	£1.30
2N5777	50p
TIL81 PHOTO TRANSISTOR	£1
TIL38 INFRA RED LED	5/£1
4N25, OP12252 OPTO ISOLATOR	50p
PHOTO DIODE 50p	6/£2
MEL12 (PHOTO DARLINGTON BASE n/c)	50p
4 DIGIT LED 7 SEG. DL4770	£1
LEDs RED 3 or 5mm 12/£1	100/£50
LEDs GREEN OR YELLOW 10/£1	100/£50
LEDs ASSORTED RD/GN/YW + INFRA/RED	200/£5
FLASHING RED OR GREEN LED 5mm 50p	100/£40
HI BRIGHTNESS LEDS COX24 RED	5/£1

## STC NTC BEAD THERMISTORS

G22 220R, G13 1K, G23 2K, G24 20K, G54 50K, G25 200K, RES @ 20°C DIRECTLY HEATED TYPE	£1 ea
F8225W NTC BEAD INSIDE END OF 1" GLASS PROBE @ 20°C 200R	£1 ea
A13 DIRECTLY HEATED BEAD THERMISTOR 1k res. Ideal for audio Wien Bridge Oscillator	£2 ea

## CERMET MULTI TURN PRESETS 3/4"

10R 20R 100R 200R 250R 500R 2K 2K2 2K5 5K 10K 47K 50K 100K 200K 500K 2M2	50p each
---	----------

## IC SOCKETS

6 pin 15/£1 8 pin 12/£1 14/16 pin 10/£1 18/20 pin 7/£1, 22/24/28 pin 4/£1 40 pin 30p	
---	--

## SOLID STATE RELAYS

40A 250V AC SOLID STATE RELAYS	£18
--------------------------------	-----

## POLYESTER/POLYCARB CAPS

100n, 220n, 63v 5mm	20/£1 100/£3
1n/3n/5n/6n/8n/2/10n 1% 63v 10mm	100/£6
10n/15n/22n/33n/47n/68n 10mm rad	100/£3.50
100n 250v radial 10mm	100/£3
100n 600v sprague axial 10/£1	100/£6 (£1)
2u2 160v RAD 22mm, 2u2 100v RAD 15mm	100/£10
10n/33n/47n 250v ac x rated 15mm	10/£1
470n 250v ac x rated rad	4/£1
1U 600V MIXED DIELECTRIC	50p ea.
1u0 100v RAD 15mm, 1u0 22mm RAD	£8/100
2U2 250V PNT CAPS. STOCK 6K	£20/100

## RF BITS

MINIATURE CO-AX 50Q URM95	100m/£12
TRIMMER CAPS ALL	4/50p
SMALL 5pl 2 pin mounting 5mm centres	
SMALL MULLARD 2 to 22pF	4/50p
SMALL MULLARD 5 to 50pF	4/50p
larger type grey 2 to 25pF black 15 to 90pF	
TRANSISTORS 2N4427	60p
FEED THRU CERAMIC CAPS 1000pF	10/£1
MICROWAVE X BAND GUNN OSCILLATOR 9 TO 11GHz EX- EQUIPMENT (DOPPLER SHIFT MICROWAVE MODULE)	£9.50

## MINIATURE RELAYS Suitable for RF

5 volt coil 1 pole changeover	£1
5 volt coil 2 pole changeover	£1
12 volt coil 1 pole changeover	£1

## MONOLITHIC CERAMIC CAPACITORS

10n 50v 2.5mm	100/£4.50
100n 50v 2.5mm or 5mm	100/£6
100n ax short leads	100/£3
100n ax long leads	100/£6
100n 50v dl package 0.3" rad	£10/100

## STEPPER MOTORS

7.5 DEGREES PER STEP 2 12 volt windings	£4
---	----

# KEYTRONICS

TEL. 0279-505543

FAX. 0279-757656

P O BOX 634

BISHOPS STORTFORD

HERTFORDSHIRE CM23 2RX

## MAIL ORDER ONLY

MIN CASH ORDER £3.00 OFFICIAL ORDERS WELCOME  
UNIVERSITIES COLLEGES SCHOOLS GOVT. DEPARTMENTS

MIN. ACCOUNT ORDER £10.00

P&P AS SHOWN IN BRACKETS (HEAVY) ITEMS

65p OTHERWISE (LIGHT) ITEMS

ADD 15% VAT TO TOTAL

ELECTRONIC COMPONENTS

BOUGHT FOR CASH



# Innovations

*A look at what's new in the world of electronics, science and technology.*

Philips Components recently announced a selection of new chips and modules. The QUART (Quad Universal Asynchronous Receiver Transmitter) SCC2694 features a specialised interrupt system that reduces the host processor workload. Five types of interrupt are accepted, receiver and transmitter FIFO (First In First Out) bytes, break detection and the change of state on two pins for each UART. The operating speed of each transmitter and receiver can be selected independently from one of 18 fixed baud rates. To minimise the amount of overrun and reduce the interrupt overhead, each receiver is buffered with eight character FIFOs and one shift register. There is also a power-down mode which stops the internal oscillators and stores the register contents.

The 27C010 and 27C240 add two new EPROMs to Philips' range of memories, providing one and four megabytes respectively. The first is set out as 131072 (128k) words of 8 bits and the second as 262144 (256k) words of 16 bits. Other features are CMOS circuitry for low power and good immunity to noise – power consumption is only 100µA in standby mode. Access times are 200ns and 150ns for the two versions offered.

To increase its range of LCD modules, Philips has announced three new devices. The LBN441R-30 provides four lines of 40 characters with the other two having 2 lines of 16 characters. The difference between them is that one (LBN211F-90) uses supertwist whereas the other (LTN211F-90) uses twisted nematic technology. All three modules incorporate their own control and drive circuitry.

To get things moving a little faster, a 30MHz version of the 80C51 microcontroller has been introduced. The PCB80C51BH-5-30 executes 60% of its instructions in 0.4µs with the rest at 0.8µs. Running at full speed the chip consumes 44mA at 5.5V supply voltage and 10.8mA and 50µA in power down and idle modes respectively. With two 16-bit timer/counters and various bit manipulation and BCD handling instructions, the 80C51 provides high performance at low cost.

For those who don't want to go to the trouble of programming the thing in

assembler, Philips can provide PL/M-51 and C language compilers.



The new Xicor X88C64 is a sophisticated EEPROM (Electrically Erasable Programmable Read Only Memory). It features a multiplexed address and data bus designed to interface directly to microcontrollers without the need for address latching and extra decoding logic. The advanced dual plane architecture sets out memory as two independent 4K x 8 memory areas. This allows non-volatile write operations to happen within one of the 4k blocks while simultaneously reading from the other 4k block. In addition there is a block protect option for individual 1k blocks which allows layers of security to be assigned to various sections of the memory. In the field, parameters can be pre-set in a protected portion of the memory and accessed only by service personnel.

The X88C64 gives 8k bytes of 5 volt EEPROM (or E<sup>2</sup>PROM) that can be used either for program or data storage in systems based around the 80XX or 68XX architectures – also known as Harvard and Von Neumann respectively. Available in a 24-pin DIP, more information can be obtained from Micro Call, 17 Thame Park Road, Thame, Oxon, OX9 3XD, Tel. 0844 261939.

**X88C64 EEPROM Operational Schematic. A12 selects between the memory blocks allowing reads and writes to take place at the same time.**

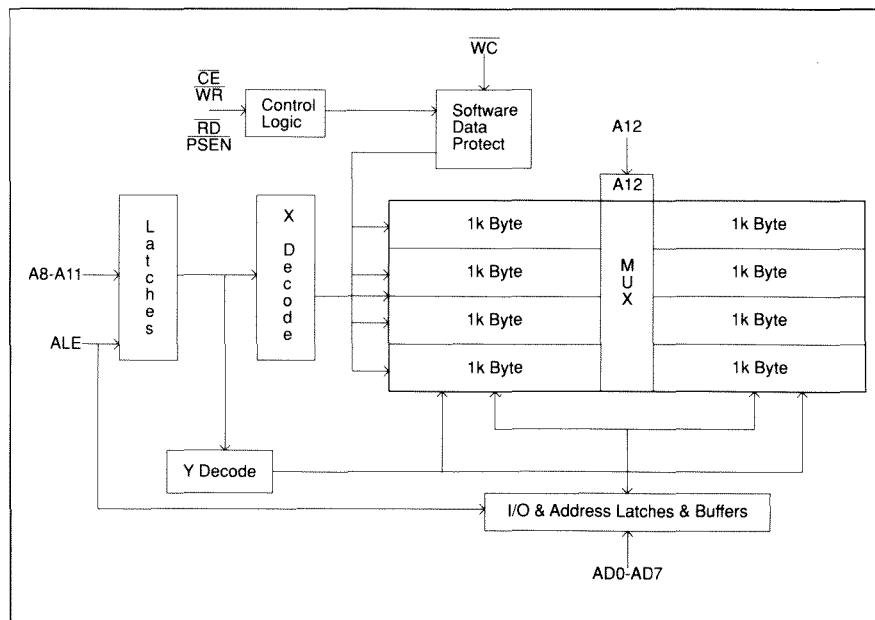

# Rewarding Loyalty

**You're on a winner with our Reader Loyalty Bonus.**

## The top ten readers:

**D. Brook** of London has £118.16 refunded for trading with Number One Systems.

**I. Radcliffe** of Isle of Man receives £90.95 for buying goods from Greenweld Electronics.

**D. Gladding** of Manchester who bought £52.20 worth of goods from Greenweld Electronics.

**D. E. Cossen** of Bristol has the £45.54 he spent with Cirkit refunded.

**I. J. McNair** of Crewe traded with B. K. Electronics and has £39.99 refunded.

**P. Eldridge** of Dunstable gets back the £35.88 spent with Greenweld.

**R. McConnell** of Ratherland claims his £27.08 which he spent with Light Soldering Iron Developements.

**D. Crome** of Kent secures his £20.50 for purchasing goods from J. N. Bull Electrical.

**J Kirby** from London is reimbursed £19.95 for trading with T. K. Electronics.

**A. G. Clark** of Cheltenham has £12.50 repaid for his purchase from J. N. Bull Electrical.

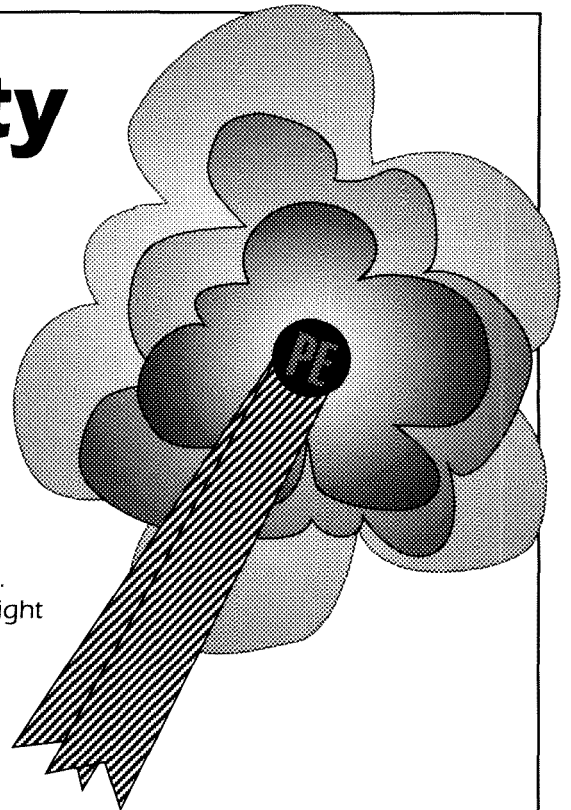

**See page 36 for more details!**

**FREE**

**CRICKLEWOOD  
ELECTRONICS**

**90'S DECADE COMPONENT CATALOGUE**

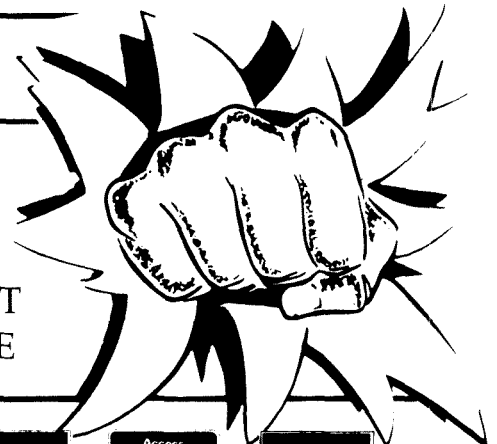

- ONE OF THE LARGEST RANGES OF COMPONENTS IN THE UK
- FAST AND EFFICIENT SAME DAY PERSONAL SERVICE
- VERY COMPETITIVE PRICE; QUANTITY DISCOUNTS AVAILABLE
- DISCOUNT VOUCHERS INCLUDED
- NO MINIMUM ORDER

CRICKLEWOOD SUPPLY MOST OF THE COMPONENTS FOR P.E. PROJECTS. 13,000 STOCKLINES (MANY UNOBTAINABLE ELSEWHERE) PLEASE PHONE US FOR YOUR SPECIFIC NEEDS.

FILL IN THE COUPON AND POST IT TO RECEIVE YOUR FREE CRICKLEWOOD ELECTRONICS CATALOGUE AND VOUCHERS WHICH YOU CAN USE AGAINST YOUR NEXT PURCHASE.

**Cricklewood Electronics Ltd**  
**40 CRICKLEWOOD BROADWAY, LONDON, NW2 3ET**  
**Tel: 081-450 0995/452 0161**  
**Fax: 081-208 1441 Telex: 914977**

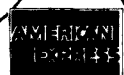

TELEPHONE ORDERS OUR SPECIALITY

**CRICKLEWOOD ELECTRONICS  
COMPONENTS CATALOGUES**

PLEASE SEND.....COPIES OF THE  
FREE CRICKLEWOOD ELECTRONICS  
CATALOGUE TO:

NAME .....

ADDRESS .....

.....

.....

.....

Remittance enclosed £.....



Anyone building battery powered systems may be interested in the Maxim MAX406 precision operational amplifier (op amp). The device is specially designed for use in low power applications and can operate from single supplies ranging from 2.4V to 10V or from dual supplies up to +5V. It requires only a 1.2µA supply current enabling battery powered circuits to operate more than 15 times longer than those using other op amps. Able to source 2mA from a 9V supply, the MAX406 output voltage can swing from rail to rail (plus supply to minus supply) when the input voltage range extends down the negative supply rail.

When the chip is set for unity gain, the gain bandwidth product is typically 8kHz and the slew rate is 5V/ms. In its other operating mode, the MAX406 is stable with gains of two or more and the gain bandwidth product is typically 40kHz and slew rate of 20V/ms.

For more information contact Kudos Thame, 55 Suttons Park, London Road, Reading, Berks, RG6 1AZ, Tel. 0734 351010



For those with a critical ear, Furukawa has introduced a new range of speaker cables featuring grain free, oxygen free, single crystal, 99.9999% pure copper conductors. The new process, known as Procc, ensures that there are no grain boundaries in the signal direction so that resistance is lowered. Normally, inclusions of hydrogen and oxygen create barriers to current flow and increase the resistance of the cable.

Known as the Evencap range, the cables are made up from strands of Procc conductor protected by polypropylene insulation. In the larger cables a non-magnetic cord is placed down the centre in order to reduce constant variations of electrostatic capacitance at the conductor's centre. This provides good overall linearity and clarity at low frequencies.

Prices start at £4.50 per metre for the FS2T14 with improved quality in the FS2T30F at £12 per metre and the even larger FS2T55F at £22.50 per metre.

For more information contact Quantum Audio Ltd, 22-26 Nelson Street, Kilmarnock, KA1 1BA - 0563 71122.



Burr-Brown recently announced the launch of its new 12-bit digital to analog converter (DAC), the DAC667. It includes a 10V reference, double buffered latch, microcomputer

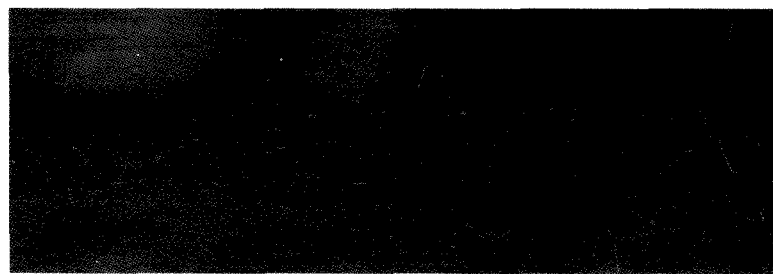
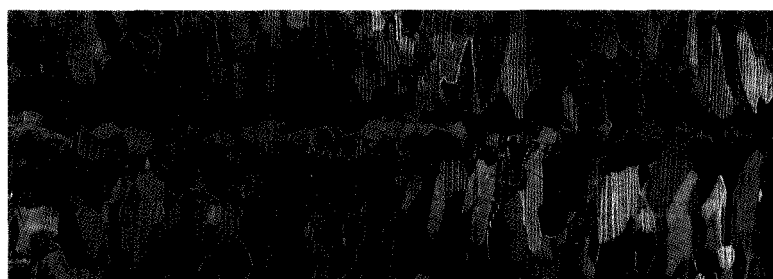

The upper photo shows the copper crystals produced by a conventional process. The difference can clearly be seen when they are lined up with the new process.

interface and voltage output amplifier. The latter is able to swing ±10V on a ±12V supply. Offered as a direct replacement to the AD667, the device requires lower power and lower prices.

To assist interfacing to a variety of computer architectures, the DAC667's double buffered system is made up from four individually addressable latches. The first three of these each take four bits to be loaded into the main 12-bit latch when ready. This allows the device to be connected to four-eight-12-or 16-bit microprocessor buses. It also makes sure that no incorrect analogue voltages appear at the output due to unsynchronised bits.

On the output side, internal scaling resistors may be connected to produce bipolar output voltage ranges of ±10V, ±5V and ±2.5V or unipolar ranges of 0 to +5V and 0 to +10V.

For more information contact Burr-Brown, PO Box 11400, Tucson, AZ, USA.



Operation and pin outs for the DAC667. The three 4-bit latches feed into the main 12 bit latch to allow interfacing to 4, 8, 12 and 16 bit data buses.

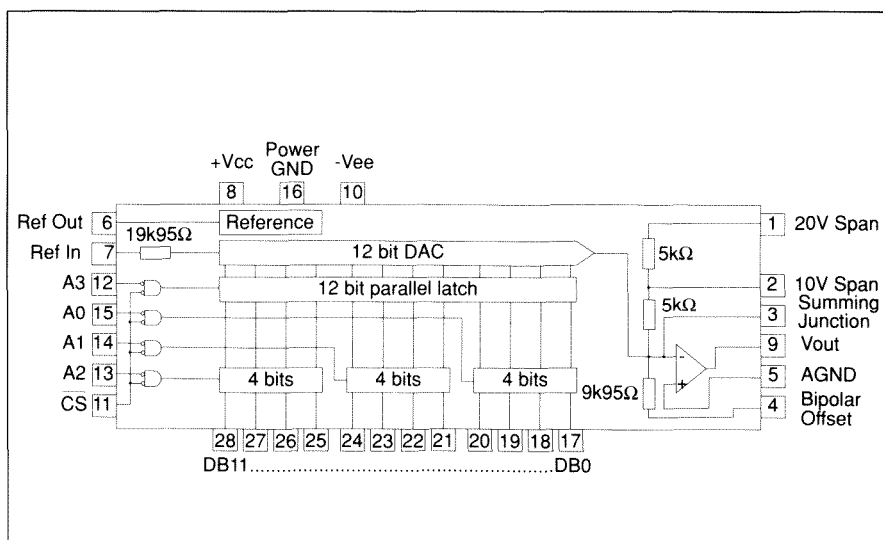

# Techniques

Andrew Armstrong begins a new series of questions, answers and technical tips.

This is the first of a new series in which readers' questions will be answered and unusual technical tips presented. To start the ball rolling, here is a design for a simple ADC (Analogue to Digital Converter) for use where a dedicated ADC chip is not justified. In this example it is used in conjunction with a BCD to 7-segment display driver as a simple level indicator displaying readings of 0 to 9. However, it should find many other applications.

The analogue voltage is converted to a four-bit digital signal, so it digitises to 16 levels, counting zero. It uses only ordinary 2% resistors, one LM339 quad comparator, and one CMOS inverting buffer, so it is a little cheaper than a normal ADC chip.

The circuit is shown in Fig. 1. The complexity increases from left to right. The first comparator, IC1a, has its reference voltage set to half the total reference by R1 and R2, so that it switches when the analogue voltage crosses half the reference

voltage. It is clear to see that this does what the most significant bit should do.

The second comparator's comparison voltage is partly dependent upon the state of the first comparator. When the input voltage is below 50%, the output from the first comparator is at logic 1, and the output from the inverting buffer, IC2a, is at logic 0. This sets the comparison voltage to a quarter of the reference voltage, as is shown by the following reasoning: the network comprising R5, R6 and R7 may be re-drawn as shown in Fig. 2. The resistance  $R_a$  is the value of R5 and R7 in parallel, and the voltage  $V_1$  is the voltage that would appear on the junction of R5 and R7 if nothing else were connected. This is a completely exact-equivalent circuit, and it shows a potential divider dividing half  $V_{ref}$  down by a half, to a quarter  $V_{ref}$ .

The second comparator switches from 1 to 0 as the input voltage rises past a quarter of the reference voltage, but switches back to 1 when the first comparator switches at half of the reference voltage. This is exactly the function required of the second-most significant bit.

This reasoning extends to the third and fourth comparators, though by the fourth comparator it is less clear to see what is happening. The ideal resistor values would be in the ratio 1:2:4:8,

but to digitise to 16 levels the values shown here are good enough.

With care, this technique could be expanded to five or six bits, but inaccuracies caused by the CMOS buffers not quite reaching its supply rails, and by the hysteresis applied to the comparators, would make it increasingly difficult to maintain monotonicity (meaning that, as the analogue input voltage is increased from zero to  $V_{ref}$ , all the digital codes occur in the correct order).

The CMOS buffer must be powered by the reference supply, which may be in the range 3 volts to 12 volts, while the comparator should be powered from a supply at least 3 volts higher than that of the reference.

## Undistorted,

Do you know of any type of design suitable for controlling volume in response to a control voltage without causing distortion?

J R Gibbs  
Swindon

There is more than one approach to this problem. A possible answer would be to use a proper analogue multiplier, which tends to give much less distortion than low-cost gain control ICs. Unfortunately, analogue multipliers good enough

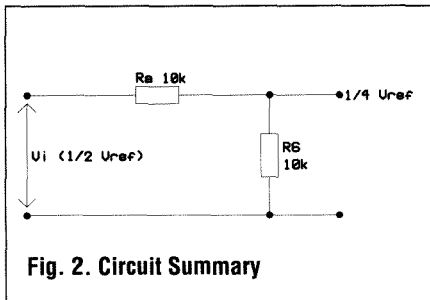

Fig. 2. Circuit Summary

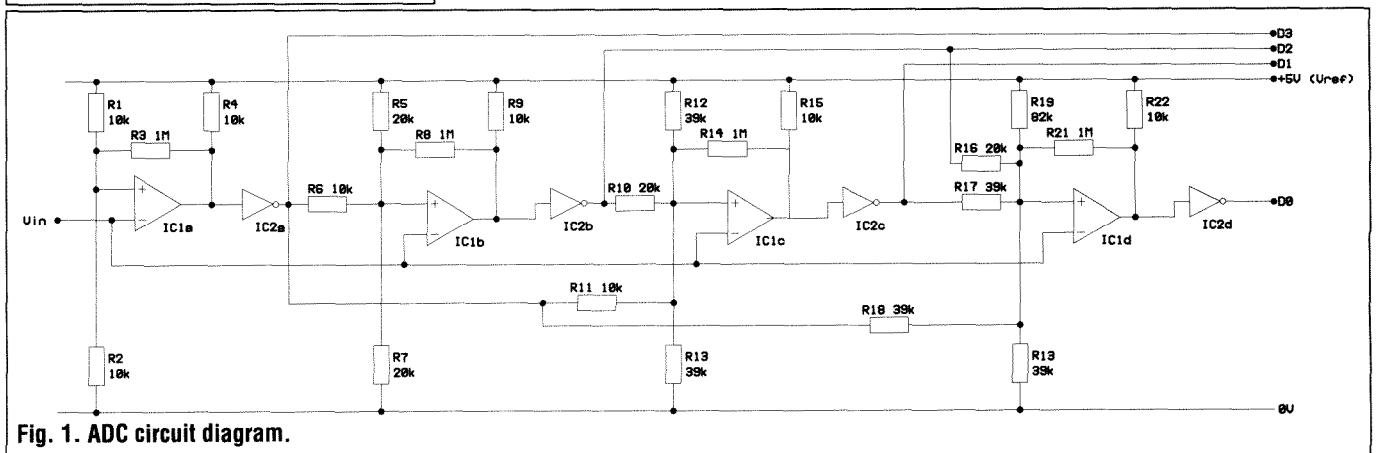

Fig. 1. ADC circuit diagram.



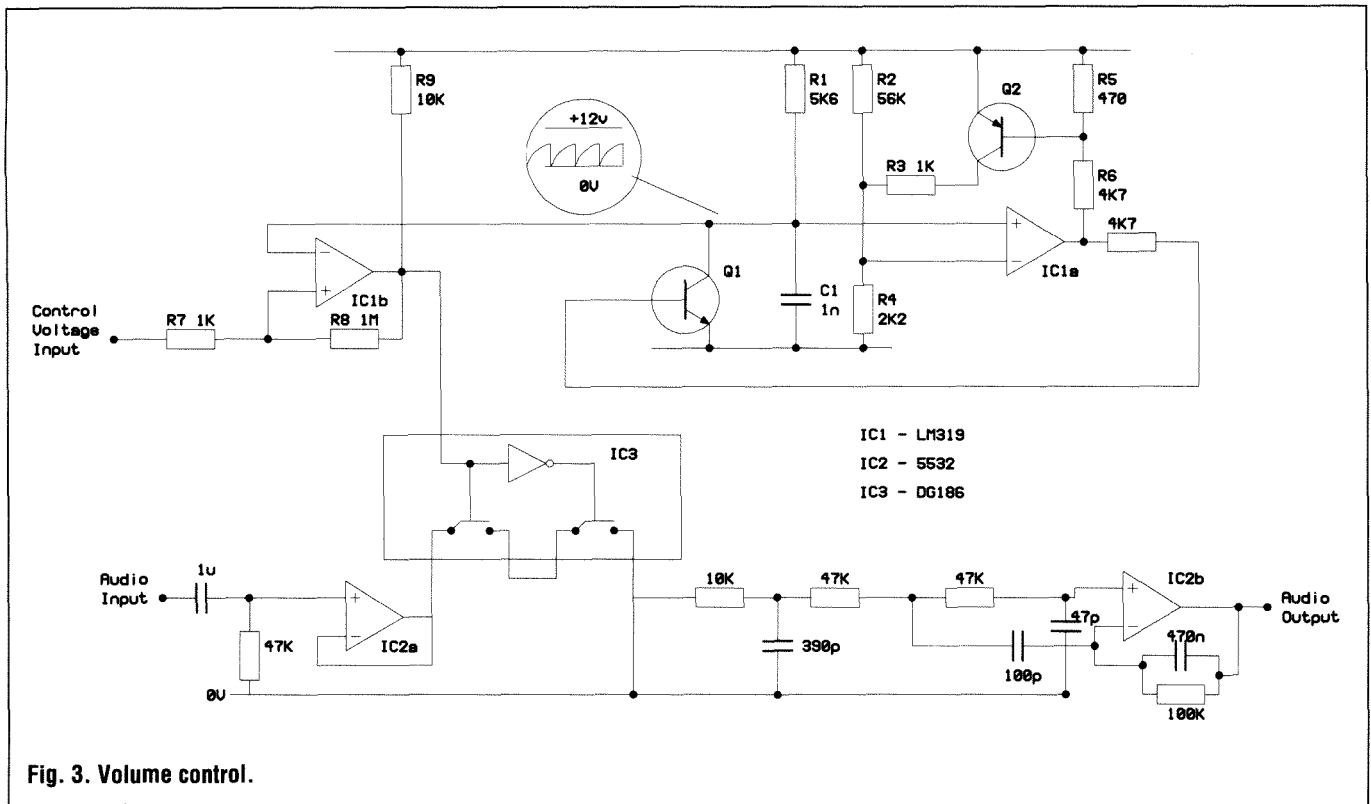

Fig. 3. Volume control.

to be worth considering for the purpose are very costly.

The circuit I have chosen does not rely on any analogue characteristic to control the gain, so distortion that would normally arise due to analogue non-linearities is largely eliminated.

The design employs a fast analogue switch to switch the output rapidly between signal input and ground. The output is filtered to average the signal voltage, and the switching frequency is well outside the audio range. The net effect is that the output signal consists of the input signal multiplied by the mark:space ratio of the switching.

The circuit can be divided into two main parts. There is the variable mark:space waveform generator, which generates a sawtooth waveform and compares this with the control voltage to generate the switching waveform, and the audio chain consisting of input buffer, switch and filter.

The sawtooth generator works by charging and discharging a capacitor between two well-defined voltages. The capacitor is charged via a resistor rather than, as might have seemed possible, a constant current source, so that the waveform will be exponential in shape. This means that the mark:space ratio of the switching

responds approximately as would a logarithmic potentiometer to a linear variation of control voltage, just the volume control law that one needs.

While the capacitor is charging towards the threshold voltage, the output of IC1a is at 0V and transistor Q2 is switched on while Q1 is switched off. This sets the switching threshold at approximately 8.25V. As soon as the capacitor voltage crosses this threshold, IC1a switches so that Q2 switches off and Q1 switches on. C1 rapidly discharges via Q1, until its voltage falls below the voltage set by the potential divider formed by R4 and R2, approximately 450 mV. The output of IC1a switches back to 0V and the process repeats itself. IC1b compares the sawtooth waveform with the control voltage input to provide the switching signal for the analogue switch ic. Note that IC1 is a fast comparator, and that slower devices are unlikely to work properly in this circuit.

The sawtooth generator operates at a frequency of approximately 150kHz. This may be calculated as follows: the capacitor charges to 69% of the power supply voltage each cycle, and because the discharge is very rapid, it is the charging time which largely determines the frequency. Starting with the standard capacitor

charging equation:

$$V = 1 - \exp(-t/T)$$

where  $V$  is the instantaneous voltage at time  $t$ , and  $T$  is the time constant of the resistor and capacitor, we can arrive at the equation:

$$t/T = -\ln(1-V)$$

Using the value of  $V$  above, 0.69, we find that the charging time is 1.17 times the RC time constant.

The analogue switch ic is chosen primarily for its ability to switch rapidly. The DG186 can switch in 150ns, and has the added advantage of a nominal 15 ohms on-resistance. The on-resistance matters, because it can be affected by the instantaneous value of the signal voltage, and thus cause non-linearity. If the on-resistance is insignificant compared with the load resistance on the output of the analogue switch, then small changes in this resistance will add an insignificant amount of distortion to the signal.

The audio input buffer uses a standard low noise, low distortion opamp, the 5532. The other half of this opamp is used for the filter on the output. The second-order active filter on the output (with a turnover frequency of 49kHz) is preceded by a passive RC filter, at a frequency of 40kHz so as to avoid placing too much demand upon the slew rate of the opamp. ■

# You *Can* Stop The Music

*Robert Penfold's in-line MIDI Analyser allows rapid analysis of many common electronic music faults.*

There can be no doubt that the MIDI (Musical Instrument Digital Interface) standard has revolutionised musical electronics. Modern digital electronics provided us with instruments of great power and versatility. MIDI provides the means of connecting them all together, with or without a computer controller, into an integrated system in which one instrument can act as a 'master player' for a number of others, and the control codes can be stored on disk for use later if desired.

Although MIDI is an extremely good system which has been able to accommodate a wide range of electronic musical instruments and recording equipment, it is not totally without problems. One of these is simply that, in order to make the system sufficiently versatile to be really useful, it has become somewhat complex and daunting in appearance. Even so, it is not too difficult to grasp a basic understanding of the MIDI codes and facilities that are available, but a little concentrated study is required.

What is probably a more major problem is that MIDI is often implemented on individual instruments in a rather convoluted fashion. Modern instruments, and those a few years old, come to that, achieve compactness and low cost by using a minimum of controls. The familiar push-button switches and multi-digit led or lcd displays usually enable any desired parameter to be adjusted and displayed, but it can be slow and cumbersome finding the right combination of key presses to reach the desired function.

## Grabbing a byte

For some instruments it is possible, at extra cost, to use an external controller to simplify adjustments and reduce the risk of errors when setting up. For most of us, though, it is a matter of muddling through with the front panel controls until we become familiar with the instrument. This can take time, and can naturally bring problems when something in the system fails to work. Is the problem due to a faulty lead, is the controller set up sending the wrong data, or is the receiving device set up wrongly?

Without the aid of test equipment it can be very difficult to track down the problem quickly. In fact, without some means of checking the MIDI data being transmitted it can sometimes begin to seem impossible to locate the problem at all.

There are various types of MIDI tester, ranging from simple units that merely indicate whether or not there is a signal at the end of the cable, through to complex computer-based systems which can store and display large amounts of data. The most popular MIDI testers fall somewhere between these two extremes, and one popular type which works quite well has a simple decoder and led display which shows the types of message being received (note on, note off, system exclusive, and so on), plus the channel number. Although a unit of this type is very useful for much testing, it sometimes fails to provide sufficient detail. For instance, it will not usually give any indication of such things as note values and velocity values.

This led to the development of the MIDI analyser featured in this article, which is quite straightforward and inexpensive to build, but provides reasonably detailed information on the received MIDI signals. In essence it is very simple, as it merely grabs a MIDI byte and displays the binary pattern on a row of eight leds. The prototype simply displayed the first byte received after switch-on, or after the reset button had been activated. This was useful, but would only show the header byte of a MIDI message. The header reveals the message type and the channel number, but does not give any idea as to what follows in the data bytes.

The final unit as described here has the additional feature of a counter so that anything from the first byte received through to the ninth byte received can be displayed. This is much more versatile, and by selecting the second or third bytes, and then playing a note on the instrument, the note or velocity values (respectively) will be displayed. If a note is played and immediately released, a six-byte sequence should be produced by the instrument. The fourth byte will be the note-off message, while the fifth and sixth ones will again be the note and velocity values. These can all be checked using this MIDI analyser.

You are not restricted to testing note-on and note-off messages. With a velocity sensitive keyboard you could check that it is functioning properly by holding down a note. The first three bytes will then be the note-on message, and the fourth byte will be the velocity message header byte. The fifth byte will be the data byte for

this message. The unit will obviously respond to program-change messages, or any other MIDI messages produced by changing controls on a MIDI device. Always read the first byte to check the message type and channel, and the second and third bytes (where appropriate) to check the data values. By using this method to check message types, channel numbers, and data values, you can take most of the guesswork out of MIDI system troubleshooting. You will know whether data is reaching its intended destination and, in most cases, exactly what data is being sent. This makes it obvious whether the problem is due to wrong data, a faulty cable, or the receiving device being incorrectly set up (or faulty).

Of course, unlike a complex computer-based analyser, you can not use the unit to read a number of bytes at once. To check (say) a pair of three-byte messages you must repeat the message six times, checking a different byte each time the message is transmitted. This is obviously less convenient, but greatly simplifies the unit and makes it relatively cheap.

## The system

The block diagram (Fig.1) shows the general make-up of the MIDI analyser. It is built around a UART (universal asynchronous receiver/transmitter). A MIDI signal is a form of serial signal, and is in many respects the same as a conventional RS232C type. It uses a word format of one start bit, eight data bits, one stop bit, and no parity. This can be handled by virtually all serial devices, and is probably the most common word

format these days. MIDI differs from the RS232C standard in that it has the non-standard and relatively high baud rate of 31250 baud (or 31.25k baud if you prefer). Although higher than the maximum RS232C standard of 19200 baud, it is still within the capabilities of most serial interface chips. Another way in which MIDI deviates from the RS232C standard is that it does not use signal levels of (nominally) plus and minus 12 volts. Instead, it uses a current loop system with opto-isolated inputs and a loop current of 5mA.

The unit therefore has an opto-isolator at the input. This drives the serial input of the UART, and also drives an output socket, or THRU socket, as it is called in the MIDI standard. This enables the unit to be connected in-line, so that the data can be checked, but still fed through to the appropriate receiving device. The basic clock signal is generated by a 4MHz crystal-controlled oscillator. The UART requires a clock frequency that is sixteen times the required baud rate, which in this case works out at 500kHz ( $31.25 \times 16 = 500$ ). The 4MHz signal is therefore fed through a three-stage binary counter in order to give a divide-by-eight action and the required 500kHz clock signal. Note that in this application the transmitter section of the UART is not required, and is just ignored.

The UART decodes the serial input signal, and as soon as each byte has been received and decoded, the appropriate binary pattern is placed on the eight parallel outputs. This data is fed to an eight bit latch which in turn drives the led display. A pulse must be fed to the clock input of the latch in order to latch the appropriate

byte of data. There is a status flag output on the UART which goes high when a fresh byte of data has been received and decoded, plus an input which is taken low in order to reset this flag. An inverter connected between these two terminals results in the data received flag resetting itself almost instantly every time it is set, generating a brief pulse in the process. This pulse is fed to a divide-by-N counter which can be set to count from one to nine pulses, and then inhibit itself. When the appropriate number of pulses have been counted it activates a monostable which generates a short pulse that stores the current byte of data in the latch.

Once the counter has deactivated itself, further bytes of MIDI data will have no effect on the main circuit, and the display is "frozen". However, data will still flow through to the output socket. Operating the reset button resets the counter and the latch, switching off all the leds in the display. The Nth byte of data received thereafter will then be latched onto the display again.

## Circuit operation

Fig.2 shows the full circuit diagram of the MIDI analyser project. The UART (IC3) is an AY-3-1015D. The industry standard 6402 type is also suitable (but generally a bit more expensive). IC3 can handle any standard word format, and it is programmed for the required format via pins 34 to 39. In this case they are simply hard-wired for the required format of eight data bits, one stop bit, and no parity.

TR1 generates the 4MHz clock signal, and operates in a standard

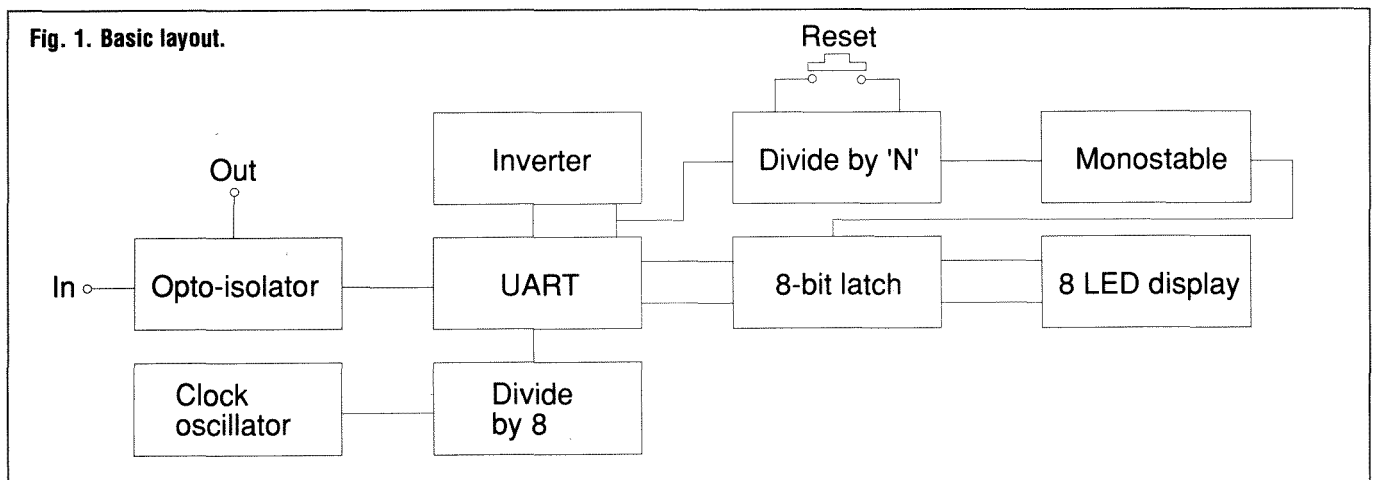
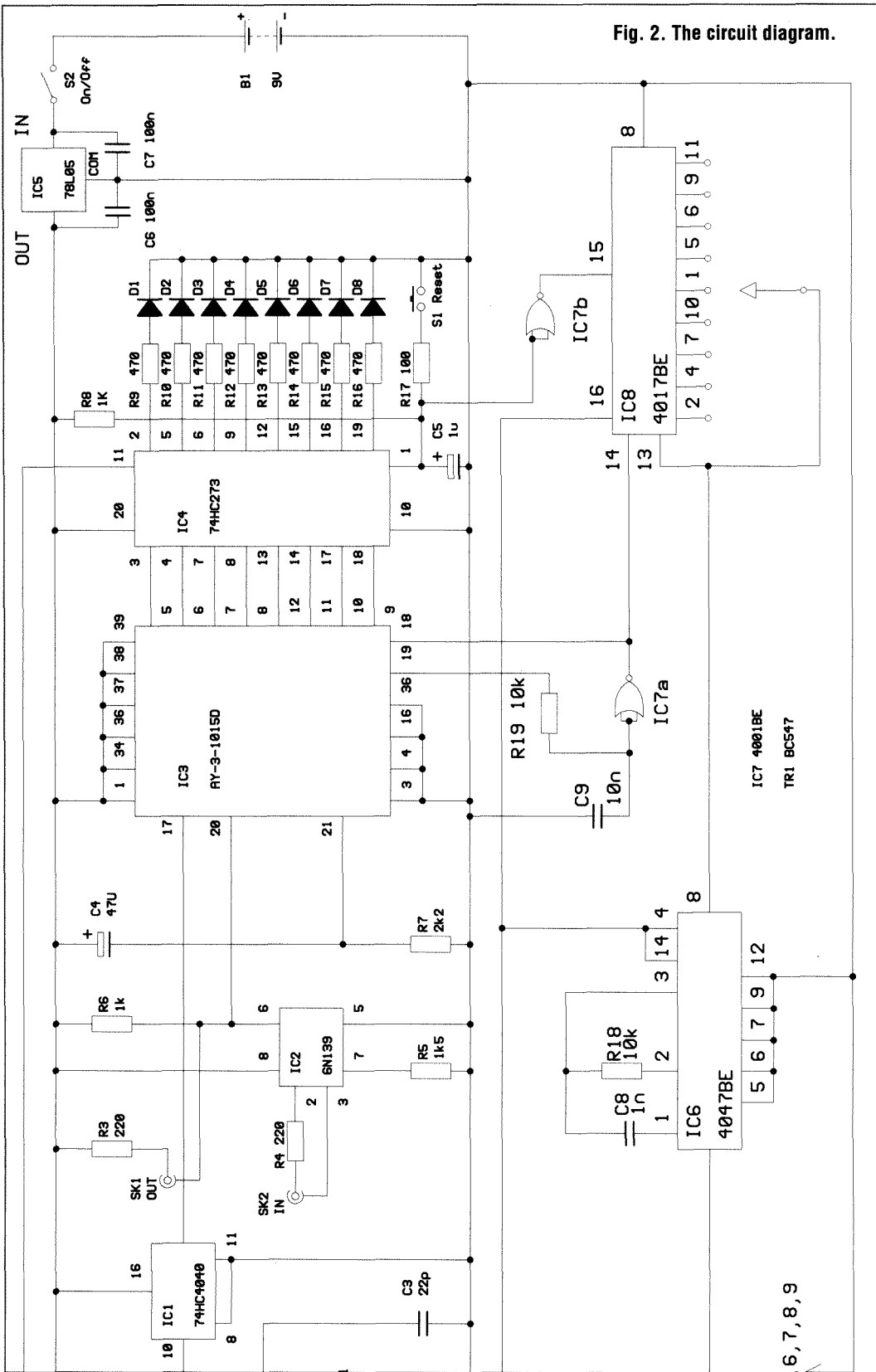



Fig. 2. The circuit diagram.



configuration. IC1 is a 12-stage binary divider, but in this circuit only the first three stages are used, giving the required divide-by-eight action. Note that IC1 must be the 74HC version of the 4040 counter in order to guarantee that it will be fast enough to cope with a 4MHz input using a 5 volt supply.

Opto-isolation is provided by IC2. This is a high quality device which on has a photo-diode driving an emitter follower on the receiving side, and a common emitter switch at the output. This gives the combination of high efficiency and high operating speed that is demanded by MIDI applications. Its

efficiency is easily high enough to permit it to drive both IC3 and output socket SK1.

IC7a is a two input NOR gate, but in this circuit it is simply wired as an inverter. This is used to reset the data-received flag, with C9 and R19 providing a short delay so as to lengthen the pulses generated. This ensures that IC7a will drive the counter circuit (IC8) reliably. The latter is a CMOS 4017BE one of ten decoder. This has ten outputs (0 to 9) which go high in sequence for one clock cycle each. At switch-on the counter is reset to zero by the pulse produced by R8 and C5. This pulse is a negative type which is designed to reset the latch (IC4), but an inversion through IC7b gives a positive pulse which resets IC8. Operating S1 permits the latch and counter to be manually reset.

IC8 has an 'inhibit' input that blocks the clock signal if it is taken high. S3 is used to connect this input to one of the decoded outputs. If, for example, output 2 is used, this will go high after two clock cycles, and block the counter. The clock cycles are derived from the data-ready flag of IC3, and the counter will therefore block itself when the second byte of MIDI data is received. The selected output, as it goes high, triggers IC6, which is a 4 0 4 7 B E astable/monostable, used here in the positive edge-triggered monostable mode. Its not-Q output produces a negative pulse that is used to latch the current byte of MIDI data into IC4. This device is actually an octal D-type flipflop, but it works as an eight bit data latch if the latching pulse is fed to its clock



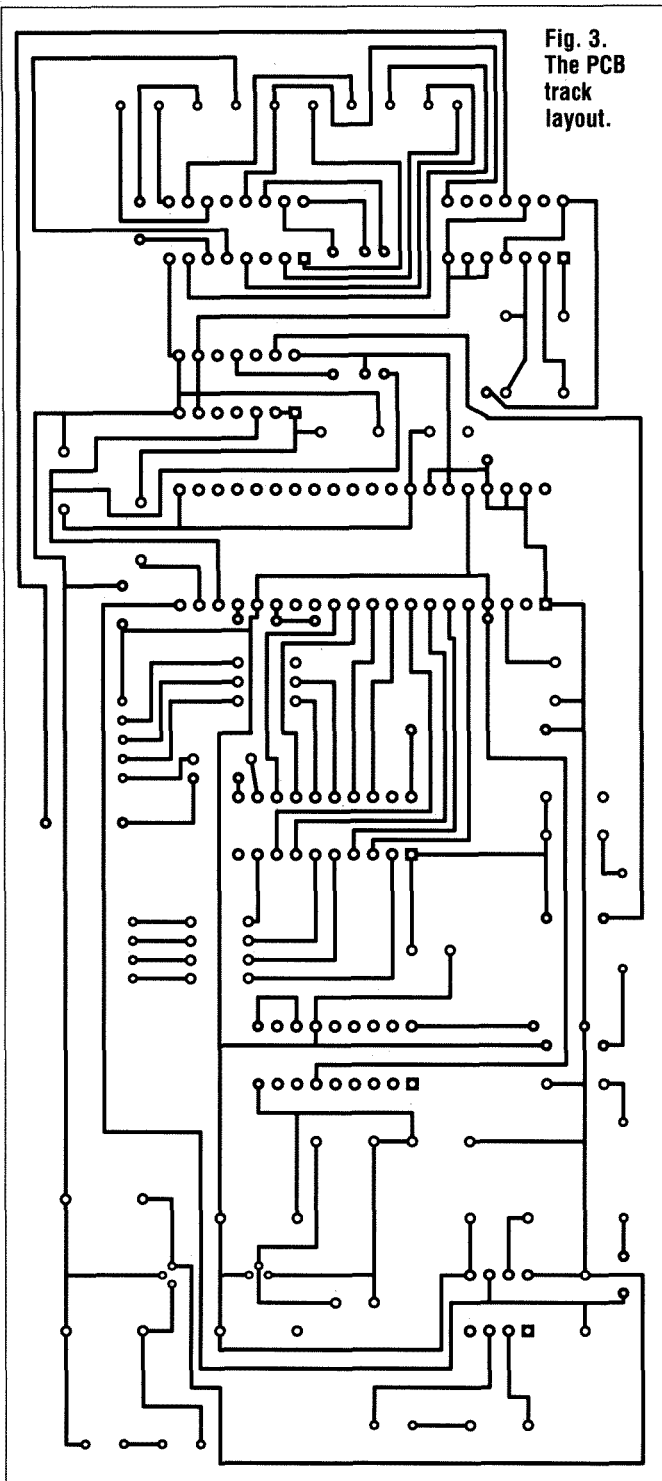

Fig. 3. The PCB track layout.

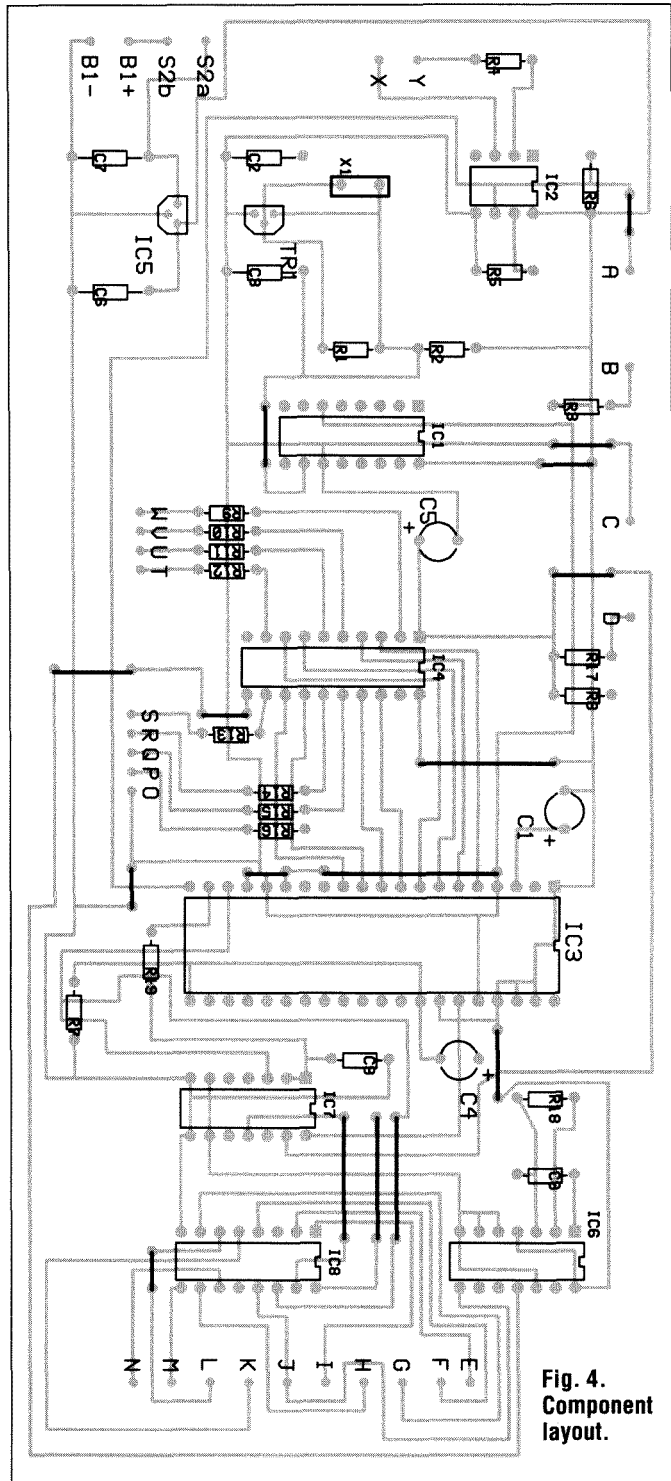

Fig. 4. Component layout.

input. The eight outputs of IC4 drive individual panel leds via current limiting resistors R9 to R15. The HC version of the 74273 has been specified for IC4 since, with the intermittent operation involved in this application, it gives a much lower current consumption. However, the ordinary 74LS273 seems to work perfectly well.

Although IC8 is a one of ten decoder, only bytes one to nine (not ten) can be latched into IC4. This is simply because output 0 of IC8 goes

high at reset, making it unusable. Using it would simply block the operation of the unit.

Power is obtained from a 9 volt battery, but IC5 is used to give a 5 volt stabilised supply from this. The current consumption of the circuit is approximately 7mA under standby conditions, but the led currents must be added to this once a byte of data has been latched into the unit. The led current is about 6mA per device, giving a total current consumption of over 50mA

with all eight leds switched on. The unit could be powered from a high power PP3-size battery, but if it is likely to receive a lot of use a higher capacity type, such as six HP7 cells in a holder, would be a better choice.

Note that IC7 is a CMOS quad two-input NOR gate, but in this circuit only two sections of the device are actually used. The inputs of the other two gates are connected to the negative supply rail to prevent spurious operation and



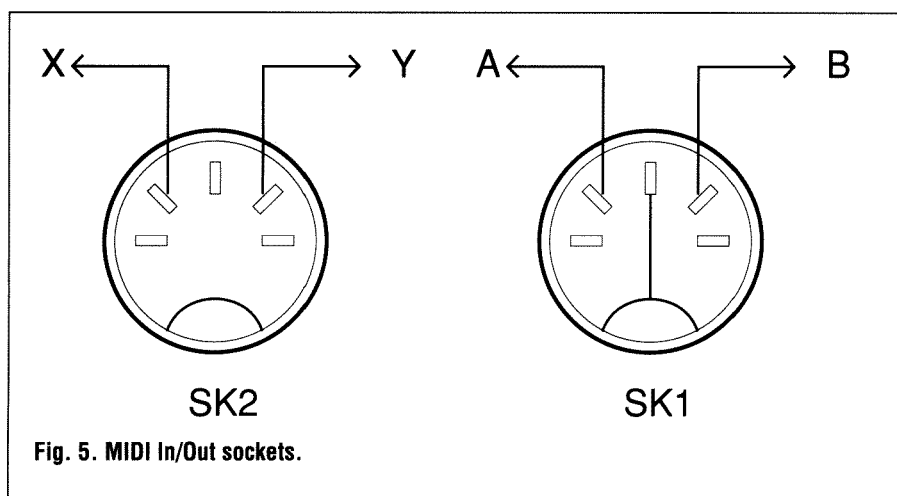

Fig. 5. MIDI In/Out sockets.

possible damage due to static charges. Apart from this these two gates are just ignored.

## Construction

Details of the printed circuit board are provided in Fig. 3. Construction of the board is largely straightforward, but bear in mind that, with the exception of optoisolator IC2, all the diode integrated circuits are static-sensitive types. The usual anti-static handling precautions should therefore be observed when dealing with these devices. Although IC2 is not a mos device, it is not particularly cheap, and I would recommend that a holder should be used for this component as well.

There are several link wires, and these can be made from about 22 swg tinned copper wire. Alternatively, trimmings from resistor and capacitor leadout wires may well suffice. For crystal X1 to fit onto the board properly it must be a miniature wire-ended (HC-49/U or similar) type. Most 4MHz crystals currently available would seem to be of this type. The capacitors must also be miniature printed circuit mounting types if

they are to fit into the layout properly (7.5mm lead spacing types in the case of polyester components). Fit single-sided pins to the board at the points where the connections to the off-board components will be made.

An instrument case measuring about 200x130x50mm makes an excellent housing for this project. The exact layout of the unit is not critical, but try to use a sensible layout that avoids too many long wires. It might be difficult to find sufficient front panel space to accommodate the eight display leds comfortably in a single row. To avoid cramming the leds very close together I opted for the alternative of using two rows of four leds. As many MIDI bytes are effectively two four-bit messages, this gives what is in many ways an equally clear display.

The wiring is fairly simple and is detailed in Fig. 6. You will probably not be able to obtain a nine-way switch for use in the S3 position, but twelve-way rotary types with an adjustable end stop are readily available. It has been assumed in Fig. 4 that S3 is a switch of this type. To conform strictly to the MIDI standard the middle pin of SK1

should be connected to the chassis of the MIDI analyser (which helps to minimise the radiation of radio frequency interference from a cable connected to the THRU socket). Most DIN sockets have a chassis tag, or this connection can be made via a soldertag fitted to the case.

## Getting it across

When initially testing the unit it is advisable to feed it from the OUT socket of a synthesiser or other MIDI keyboard instrument. The unit has standard (for MIDI) five-way 180 degree DIN connectors, and so it can be wired into the system using ordinary MIDI leads. Set the instrument so that it is not sending any MIDI data such as active sensing of MIDI clock signals (most instruments will by default fail to send any messages such as these). At switch-on all eight leds should fail to light up. Switch off at once and recheck all the wiring if any of the leds should switch on.

Set S3 to the 1 position, and then play any note on the instrument. The unit should then display the header byte, which for all MIDI channel messages is split into two nibbles (the upper and lower sets of four bits). The most significant nibble shows the message type, while the least significant one shows the channel number. The binary code for a note-on message is 1001, and this should be shown on the four left hand leds. The channel number is the appropriate binary value, but there is a minor complication here in that the convention is for MIDI channels to be numbered from 1 to 16. The binary value in the least significant nibble is, of course, in the range 0 (0000 in binary) to 15 (1111 in binary). Therefore, the value displayed will be one less than the MIDI channel number used. Table 1 shows the binary pattern for each MIDI channel number.

As an example, if channel 4 is used, the full binary number on the eight leds will be 10010011 (with leds being switched on for a 1, and off for a 0).

If you reset the unit by pressing S1, set S3 to the 2 position, and then

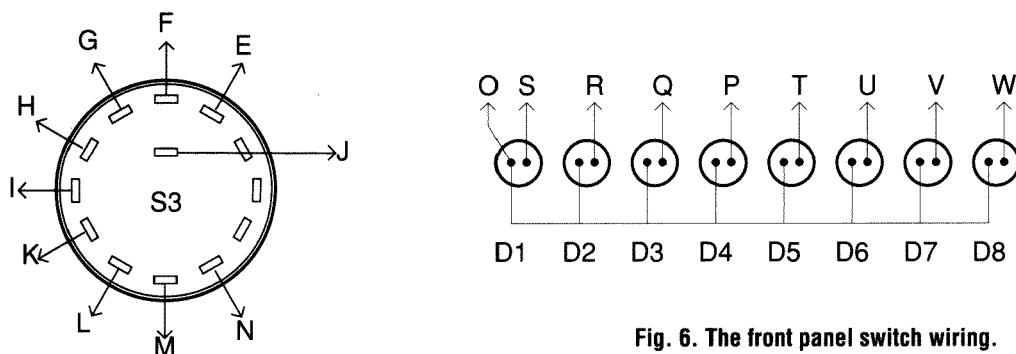

Fig. 6. The front panel switch wiring.

**Table 1**

Binary code    MIDI channel number

0000	1
0001	2
0010	3
0011	4
0100	5
0101	6
0110	7
0111	8
1000	9
1001	10
1010	11
1011	12
1100	13
1101	14
1110	15
1111	16

play another note. The note value should be displayed. Data values will, of course, be shown on the display as seven-bit binary patterns (the most significant bit is always set to 0 for data bytes), rather than as decimal numbers from 0 to 127. It is not too difficult to do a quick conversion where necessary, but in most cases you can simply test data bytes under different conditions to check that the data is changing in basically the right way. With note values, for instance, try checking a low note first, and then a high one. This should give an obvious

Most sig. nibble	Message type	Data bytes
1000	note-off	2
1001	note-on	2
1010	poly key pressure	2
1011	control change	2
1100	program change	1
1101	channel key pressure	1
1110	pitch wheel change	2

**COMPONENTS**

**RESISTORS**

R1	470k
R2,R6,R8	1k (3 off)
R3,R4	220R (2 off)
R5	1kS
R7	2k2
R9 - R16	470 (8 off)
R17	100
R18,R19	10k (2 off)

**CAPACITORS**

C1	100µ 10V radial elect
C2,C3	22p ceramic plate (2 off)
C4	47µ 10V radial elect
C5	1µ 63V radial elect
C6,C7	100n ceramic (2 off)
C8	1n polyester
C91	0n polyester

**SEMICONDUCTORS**

IC1	74HC4040
IC2	6N139 opto-isolator
IC3	AY-3-1015D (or 6402)
IC4	74HC273
IC5	µA78L05
IC6	4047BE
IC7	4001BE

IC8	4017BE
TR1	BC547
D1 - D8	Panel LED (8 off)

**MISCELLANEOUS**

B1	6 x HP7 size cells in plastic holder
S1	Push to make - release to break
S2	s.p.s.t. sub-min toggle
S3	12 way 1 pole with adjustable end-stop
SK1,SK	25 way (180 degree) DIN socket (2 off)
X1	4MHz miniature wire-ended crystal

Case about 200 x 130 x 150mm  
control knob  
battery connector  
DIL IC holders; 8 pin, 14 pin (2 off), 16 pin (2 off) 20 pin, and 40 pin  
printed circuit board  
wire, solder, pins, fixings, and so on.

increase in the binary value displayed. A similar approach could be used when testing the third byte in a note-on message, which is the velocity value. Playing a note gently should give a low value, playing one hard should give a high value. Often when checking systems using this unit you will only be interested in the basic note-on and note-off messages, or

in the channel number contained in the least significant nibble of a message. However, you may occasionally need to identify other channel message types, in which case Table 2 should help

If 1111 is the most significant nibble of the header byte, then the message is a system type such as a system exclusive message, or a MIDI clock type. In this case, the least significant nibble does not indicate the channel number, but instead shows the type of message (such as 0000 for a system exclusive type). ■

★ Make sure of your copy of Practical Electronics every month.

★ Place a regular order with your local newsagent, who will be glad to reserve PE for you.

★ To make his life easier, fill in this form with your requirements.

Please reserve/deliver me a copy of Practical Electronics magazine every month until further notice.

Name .....

Address .....

Post Code .....

Signature .....

Practical Electronics is published by Intra Press on the first Thursday of the month preceding the cover date and is distributed by Seymour Press.

# Converting Ideas Into Cash

*Ever thought of patenting your invention? Barbara Cookson explains how it is done and points out the pitfalls.*

Many people toy with the idea of converting an electronics project into a business proposition. A clever design for a new electronic gadget looks good but how is it possible to get it manufactured by an existing company, and wouldn't the idea be stolen? Such paranoia means that many good ideas never see the light of day commercially and their inventors never see any profit. There is not much satisfaction in saying to your grandchildren, "Of course, I thought of personal phones or 3D TV before they did but I was afraid to make a go of it".

## Protection

The solution, of course, is to have to foresight to obtain a patent at an early stage before anyone else thinks of the idea. An example is Mr. Hyatt who has, after many years, convinced the US Patent Office to issue him a patent for a microprocessor chip and is now hoping to collect from the US manufacturers. Although he may not have contributed one jot to the development of the PC, he is still entitled under US law to royalty on all US sales. Most inventors who fail to exploit an idea themselves are not so fortunate in finding that an independent third party does so within the life of their patent. Of course to operate in this way in the UK would probably require a prohibitive outlay in legal fees on the part of the person applying for the patent. In the US it is lawful for such cases to be taken on by a law firm on the basis that they share in any money recovered.

The patent is the key to protecting an idea while an attempt

is being made to convert it into cash. The idea of the patent system is that in exchange for a description of the new idea and how it may be put to work in an industrial setting, you are given the right to prevent any other person using it as specified in the country where the patent has been granted. Getting a patent will not of itself make any money. It will, however, give a new business venture using the idea some shelter from competition as it grows.

## Secrecy

The golden rule, if you are going to profit from an idea, is to keep quiet about it until you are ready to go public. On the other hand, you are going to have to talk to someone; you may need advice on components, help from the company that makes the prototype for you, testing by an independent organisation. You will certainly

want to try out your idea on a friend or colleague in case there is some fatal flaw you have missed. All of these disclosures can be made in confidence. It is not strictly necessary for a confidentiality agreement to be signed. What is important is that the person you are talking to should realise they are not meant to go tell the whole world. If you are talking to a lawyer, patent agent or accountant, all of this probably goes without saying. For anybody in the commercial world, it is better to have something in writing. It doesn't have to be anything complicated, a simple letter will do. All it needs to say is that the information being discussed is to be kept confidential and not to be used for any purpose other than negotiations with you. Some companies will send a standard letter saying they don't receive

**Spot the number of trademarks and patents in the case.**

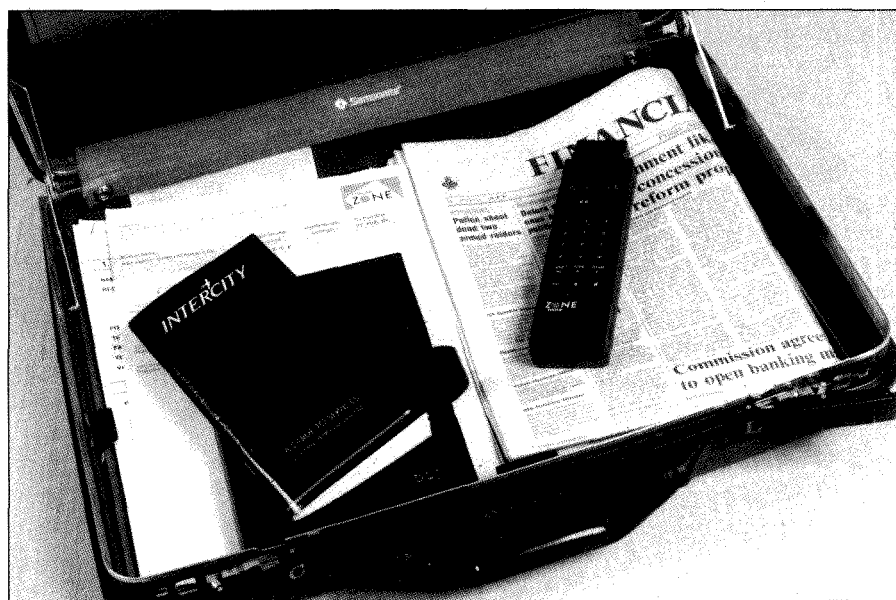



disclosures in confidence. The best course of action in this case is to say sorry and goodbye. There is a good chance they will call you back and agree to confidentiality anyway.

## Start the clock

Once the patent application has been filed at the UK Patent Office you have established your priority date and in theory can talk freely about the invention without risking your right to patent it in almost every country of the world. Unfortunately, there are two problems.

First, inventions have a habit of developing – the process of discussion, testing and prototyping means that the final version may bear scarcely any relation to the original paper proposal.

Second, once you have established your priority date the clock starts to run – and it runs alarmingly fast. Within twelve months you have to decide on a definition of your invention for the 'claim' and, what is worse, decide whether to protect it in the UK only, or fork out for protection on a grander scale – which means big money. So, by the first anniversary of the priority date you need to be in a position to know whether your idea is a commercial starter or not. You will also need some financial support at this stage as well.

All this leads to the necessity for a plan. This should be done at an early stage and frequently reviewed and revised. Some ideas flounder at a pretty early stage for example, the realisation that only gold has the right properties for the critical component of the invention, it becomes clear that it can never be made at an economic price.

## Presentation

Even a company which claims to be receptive to outside ideas is inundated by what it believes to be unworkable ideas from cranks. The best thing to do is to distinguish yourself right from the start with an impressive presentation. You may still find yourself being shown the door but do not lose heart. There are many successful ideas that have had the same thing happen. Ron Hickman, inventor of the highly successful Workmate, had to get his workbench manufactured and start

selling it before Black & Decker realised it had turned away a winner and had the good sense to change its mind.

Since so much depends on your ability to present your idea that it is worth considering the best way to go about it. You will be talking to people who may wish to take a licence, put capital into the business or just lend you money. You will need to be armed with well developed ideas and some sort of working model or prototype. It is all too easy for someone listening for the first time to say that the idea simply can't work.

Ideally you should also have done at the very least some serious thinking about the uses and market for the resulting product. This is important in deciding which companies to approach and whether your idea fits into their product range.

It is also worth giving some thought to the technical problems your invention solves. It helps your patent agent sell the invention to the Patent Office and get grant of a patent, and it helps you sell the idea to the world. If there is nothing wrong with what is already on offer, why should anybody part with more money for something new?

## On your own

If you are going to start your own business, the big question is: are you enthusiastic enough about the idea to get someone to provide the starting capital? One place to start is with your bank manager (start here for practice but don't expect to succeed) or a provider to seedcorn or venture capital. Obviously you will be using some of your own money, but beware of using all of it and certainly don't start by mortgaging your home, especially if you haven't asked your wife or husband first.

A better place to start is with a company you already run since it provides a vehicle which can be used to develop and promote the new idea. The Japanese company Sony was started back in 1946 in the most hostile commercial climate imaginable provided by a defeated, war-torn and occupied country – even England in the recession of 1991 cannot be as bad as that.

Sony's first innovative product

was a tape recorder. Before that it hand-made and sold low-technology heating pads in order to provide early cash flow.

## Finding the right advice

If you have ever watched *Tomorrow's World*, you will know they sponsor, together with the Engineering Council, an innovation prize for new businesses that are turning ideas into cash – The Prince of Wales Award for Innovation and Production. Fourteen local enterprise agencies have set up a network to give entrants advice and are able to put people into contact with other specialised advisors and investors.

There is also help available from a local enterprise agency, small firms centre or business centre. Get in touch with the regional offices of the DTI and the Department of Employment. The largest local library is probably an excellent starting point.

There is also help available from various types from a solicitor, accountant or patent agent – at a price. Ask the Chartered Institute of Patent Agents (071-405 9450) for their regional list of patent agents. When you are paying for advice, look for someone who knows their stuff and is enthusiastic about your business idea.

## You gotta have faith

Remember that you need masses of enthusiasm. If you lack faith in your own invention then you can hardly expect anyone else to believe in it either. All businesses started at some time with some first business project. No business can be started without some initial birth pangs. Was it easy for any high tech business or indeed any business to start up? Usually any business that is successful will have started a few years ago but it takes a few years to become a big name in British business. ■

Barbara Cookson has extensive experience in patents having spent 10 years in private law practice in the UK. She currently works with the law firm Titmuss Sainer & Webb in the City of London. She is a chartered patent agent, a European Patent Attorney and a member of the Institute of Electrical Engineers.

**OMP POWER AMPLIFIER MODULES-TURNABLES-DIMMERS-LOUDSPEAKERS-19 INCH STEREO RACK AMPLIFIERS**

**OMP POWER AMPLIFIER MODULES**

Supplied ready built and tested.

**OMP POWER AMPLIFIER MODULES** Now enjoy a world-wide reputation for quality, reliability and performance at a realistic price. Four models available to suit the needs of the professional and hobby market i.e. Industry Leisure Instrumental and Hi-Fi etc. When comparing prices, NOTE all models include Toroidal power supply, Integral heat sink Glass fibre P.C.B. and Drive circuits to power compatible Vu meter. Open and short circuit proof

**THOUSANDS OF MODULES PURCHASED BY PROFESSIONAL USERS**

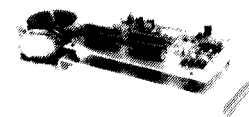

**OMP100 Mk 11 Bi-Polar** Output power 110 watts R.M.S. into 4 ohms. Frequency Response 15Hz - 30KHz - 3dB. T.H.D. 0.01%. S.N.R. -118dB. Sens. for Max. output 500mV at 10K. Size 355 x 115 x 65mm. **PRICE £33.99 + £3.00 P&P.**

**NEW SERIES II MOS-FET MODULES**

**OMP/MF 100 Mos-Fet** Output power 110 watts R.M.S. into 4 ohms. Frequency Response 1Hz - 100KHz - 3dB. Damping Factor. >300. Slew Rate 45V uS. T.H.D. Typical 0.002%. Input Sensitivity 500mV. S.N.R. -125dB. Size 300 x 123 x 60mm. **PRICE £39.99 + £3.00 P&P.**

**OMP/MF200 Mos-Fet** Output power 200 watts R.M.S. into 4 ohms. Frequency Response 1Hz - 100KHz - 3dB. Damping Factor >300. Slew Rate 50V uS. T.H.D. Typical 0.001%. Input Sensitivity 500mV. S.N.R. -130dB. Size 300 x 155 x 100mm. **PRICE £62.99 + £3.50 P&P.**

**OMP/MF300 Mos-Fet** Output power 300 watts R.M.S. into 4 ohms. Frequency Response 1Hz - 100KHz - 3dB. Damping Factor >300. Slew Rate 60V uS. T.H.D. Typical 0.0008%. Input Sensitivity 500mV. S.N.R. -130dB. Size 330 x 175 x 100mm. **PRICE £79.99 + £4.50 P&P.**

NOTE - MOS-FET MODULES ARE AVAILABLE IN TWO VERSIONS STANDARD INPUT SENS. 500mV BAND WIDTH 100KHz. PEC. PROFESSIONAL EQUIPMENT COMPATIBLE. INPUT SENS. 775mV BAND WIDTH 50KHz. ORDER STANDARD OR PEC.

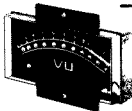

**Vu METER** Compatible with our four amplifiers detailed above. A very accurate visual display employing 11 L.E.D. diodes (7 green, 4 red) plus an additional on/off indicator. Sophisticated logic control circuits for very fast rise and decay times. Tough moulded plastic case, with tinted acrylic front. Size 84 x 27 x 45mm. **PRICE £8.50 + 50p P&P.**

**LOUDSPEAKERS**



**LARGE SELECTION OF SPECIALIST LOUDSPEAKERS AVAILABLE, INCLUDING CABINET FITTINGS, SPEAKER GRILLES, CROSS-OVERS AND HIGH POWER, HIGH FREQUENCY BULLETS AND HORNS, LARGE S.A.E. (30p STAMPED) FOR COMPLETE LIST.**

**McKENZIE:- INSTRUMENTS, P.A., DISCO, ETC.**

**ALL MCKENZIE UNITS 8 OHMS IMPEDENCE**

- 8" 100 WATT C8100GPM GEN PURPOSE LEAD GUITAR, EXCELLENT MID DISCO. RES. FREQ. 80Hz FREQ. RESP. TO 14KHz SENS. 99dB. **PRICE £28.59 + £2.00 P&P.**
- 10" 100 WATT C10100GP GUITAR VOICE ORGAN, KEYBOARD, DISCO, EXCELLENT MID. RES. FREQ. 70Hz FREQ. RESP. TO 6KHz SENS. 100dB. **PRICE £34.70 + £2.50 P&P.**
- 10" 200 WATT C10200GP GUITAR, KEYBOARD, DISCO, EXCELLENT HIGH POWER MID. RES. FREQ. 45Hz FREQ. RESP. TO 7KHz SENS. 103dB. **PRICE £47.48 + £2.50 P&P.**
- 12" 100 WATT C12100GP HIGH POWER GEN. PURPOSE, LEAD GUITAR, DISCO. RES. FREQ. 45Hz FREQ. RESP. TO 7KHz SENS. 98dB. **PRICE £36.66 + £3.50 P&P.**
- 12" 200 WATT C12200B HIGH POWER BASS, KEYBOARDS, DISCO, P.A. RES. FREQ. 40Hz FREQ. RESP. TO 7KHz SENS. 100dB. **PRICE £37.63 + £3.50 P&P.**
- 12" 300 WATT C12300GP HIGH POWER BASS LEAD GUITAR, KEYBOARDS, DISCO, ETC. RES. FREQ. 45Hz FREQ. RESP. TO 5KHz SENS. 100dB. **PRICE £64.17 + £3.50 P&P.**
- 15" 100 WATT C15100BS BASS GUITAR, LOW FREQUENCY, P.A., DISCO. RES. FREQ. 40Hz FREQ. RESP. TO 5KHz SENS. 98dB. **PRICE £85.79 + £3.50 P&P.**
- 15" 200 WATT C15200BS VERY HIGH POWER BASS. RES. FREQ. 40Hz FREQ. RESP. TO 4KHz SENS. 99dB. **PRICE £53.70 + £4.00 P&P.**
- 15" 250 WATT C15250BS VERY HIGH POWER BASS. RES. FREQ. 40Hz FREQ. RESP. TO 4KHz SENS. 99dB. **PRICE £73.26 + £4.00 P&P.**
- 15" 400 WATT C15400BS VERY HIGH POWER, LOW FREQUENCY BASS. RES. FREQ. 40Hz FREQ. RESP. TO 4KHz SENS. 102dB. **PRICE £80.53 + £4.50 P&P.**
- 18" 400 WATT C18404BS EXTREMELY HIGH POWER, LOW FREQUENCY BASS. RES. FREQ. 27Hz FREQ. RESP. TO 3KHz SENS. 99dB. **PRICE £94.12 + £4.50 P&P.**
- 18" 400 WATT C18404BS EXTREMELY HIGH POWER, LOW FREQUENCY BASS. RES. FREQ. 27Hz FREQ. RESP. TO 3KHz SENS. 99dB. **PRICE £167.85 + £5.00 P&P.**

**EARBENDERS:- HI-FI, STUDIO, IN-CAR, ETC.**

- ALL EARBENDER UNITS 8 OHMS EXCEPT EB8-50 AND EB10-50 DUAL 4 AND 8 OHM. BASS, SINGLE CONE, HIGH COMPLIANCE, ROLLED FOAM SURROUND
- 8" 50 WATT EB8-50 DUAL IMPEDENCE, TAPPED 4 8 OHM BASS, HI-FI, IN-CAR. RES. FREQ. 40Hz FREQ. RESP. TO 7KHz SENS. 97dB. **PRICE £8.90 + £2.00 P&P.**
- 10" 50 WATT EB10-50 DUAL IMPEDENCE, TAPPED 4 8 OHM BASS, HI-FI, IN-CAR. RES. FREQ. 40Hz FREQ. RESP. TO 5KHz SENS. 99dB. **PRICE £12.00 + £2.50 P&P.**
- 10" 100 WATT EB10-100 BASS, HI-FI, STUDIO. RES. FREQ. 35Hz FREQ. RESP. TO 3KHz SENS. 96dB. **PRICE £27.50 + £3.50 P&P.**
- 12" 60 WATT EB12-60 BASS, HI-FI, STUDIO. RES. FREQ. 28Hz FREQ. RESP. TO 3KHz SENS. 92dB. **PRICE £21.00 + £3.00 P&P.**
- 12" 100 WATT EB12-100 BASS, STUDIO, HI-FI, EXCELLENT DISCO. RES. FREQ. 26Hz FREQ. RESP. TO 3KHz SENS. 93dB. **PRICE £32.00 + £3.50 P&P.**
- FULL RANGE TWIN CONE, HIGH COMPLIANCE, ROLLED SURROUND**
- 5 1/2" 60 WATT EB5-60TC (TWIN CONE) HI-FI, MULTI-ARRAY DISCO ETC. RES. FREQ. 63Hz FREQ. RESP. TO 20KHz SENS. 92dB. **PRICE £9.99 + £1.50 P&P.**
- 6 1/2" 60 WATT EB6-60TC (TWIN CONE) HI-FI, MULTI-ARRAY DISCO ETC. RES. FREQ. 38Hz FREQ. RESP. TO 20KHz SENS. 94dB. **PRICE £19.99 + £1.50 P&P.**
- 8" 60 WATT EB8-60TC (TWIN CONE) HI-FI, MULTI-ARRAY DISCO ETC. RES. FREQ. 40Hz FREQ. RESP. TO 18KHz SENS. 89dB. **PRICE £12.99 + £1.50 P&P.**
- 10" 60 WATT EB10-60TC (TWIN CONE) HI-FI, MULTI-ARRAY DISCO ETC. RES. FREQ. 35Hz FREQ. RESP. TO 12KHz SENS. 86dB. **PRICE £16.49 + £2.00 P&P.**

**TRANSMITTER HOBBY KITS**

PROVEN TRANSMITTER DESIGNS INCLUDING GLASS FIBRE PRINTED CIRCUIT BOARD AND HIGH QUALITY COMPONENTS COMPLETE WITH CIRCUIT AND INSTRUCTIONS

- 3W FM TRANSMITTER 80-108MHz. VARICAP CONTROLLED PROFESSIONAL PERFORMANCE. RANGE UP TO 3 MILES. SIZE 38 x 123mm. SUPPLY 12V @ 0.5AMP. **PRICE £14.49 + £1.00 P&P.**
- FM MICRO TRANSMITTER (BUG) 100-108MHz VARICAP TUNED COMPLETE WITH VERY SENS FET MIC. RANGE 100-300m. SIZE 56 x 46mm. SUPPLY 9V BATT. PRICE **£8.62 + £1.00 P&P.**



3 watt FM Transmitter

\* PRICES INCLUDE V.A.T. \* PROMPT DELIVERIES \* FRIENDLY SERVICE \* LARGE S.A.E., 30p STAMPED FOR CURRENT LIST.

**OMP VARISPEED TURNTABLE CHASSIS:**



- \* MANUAL ARM
- \* STEEL CHASSIS
- \* ELECTRONIC SPEED CONTROL 33 & 45
- \* VARI PITCH CONTROL
- \* HIGH TORQUE SERVO DRIVEN DC MOTOR
- \* TRANSIT SCREWS
- \* 12 DIE CAST PLATTER
- \* NEON STROBE
- \* CALIBRATED BAL WEIGHT
- \* REMOVABLE HEAD SHELL
- \* CARTRIDGE FIXINGS
- \* CUE LEVER
- \* POWER 220 240V 50 60Hz
- \* 390 x 305mm
- \* SUPPLIED WITH MOUNTING CUT-OUT TEMPLATE

**PRICE £59.99 + £3.50 P&P.**

**OPTIONAL MAGNETIC CARTRIDGES**

**STANTON AL500**  
PRICE £16.99 + 50p P&P

**GOLDRING G850**  
PRICE £6.99 + 50p P&P

**OMP MOS-FET POWER AMPLIFIERS, HIGH POWER, TWO CHANNEL 19 INCH RACK**

**THOUSANDS PURCHASED BY PROFESSIONAL USERS**

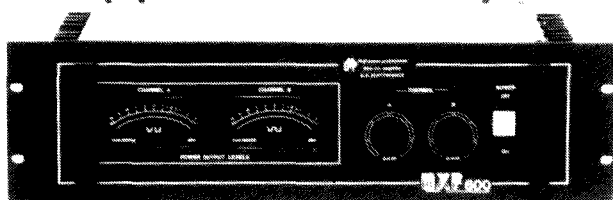

**NEW MXF SERIES OF POWER AMPLIFIERS**  
THREE MODELS:- **MXF200** (100w + 100w)  
**MXF400** (200w + 200w) **MXF600** (300w + 300w)

All power ratings R.M.S. into 4 ohms

**FEATURES:** \* Independent power supplies with two Toroidal Transformers \* Twin L.E.D. Vu meters \* Potentiometer level controls \* Illuminated on/off switch \* XLR connectors \* Standard 775mV inputs \* Open and short circuit proof \* Latest Mos-Fets for stress free power delivery into virtually any load \* High slew rate \* Very low distortion \* Aluminium cases \* MXF600 Fan Cooled with D.C. Loudspeaker and Thermal Protection

**USED THE WORLD OVER IN CLUBS, PUBS, CINEMAS, DISCOS ETC.**

- SIZES:- **MXF 200 W19** - H3 1/2 (2U) - D11
- MXF 400 W19** - H5 1/4 (3U) - D12
- MXF 600 W19** - H5 1/4 (3U) - D13

**PRICES: MXF200 £171.35**  
**MXF400 £228.85**  
**MXF600 £322.00**

SECURICOR DELIVERY £12.00 EACH

**OMP LINNET LOUDSPEAKERS**

THE VERY BEST IN QUALITY AND VALUE

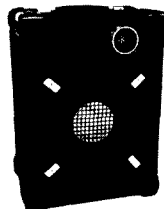

MADE ESPECIALLY TO SUIT TODAY'S NEED FOR COMPACTNESS WITH HIGH OUTPUT SOUND LEVELS. FINISHED IN HARDWEARING BLACK VYNIDE WITH PROTECTIVE CORNERS GRILLE AND CARRYING HANDLE INCORPORATES 12 DRIVER PLUS HIGH FREQ. HORN FOR FULL FREQ. RANGE 45Hz 20KHz BOTH MODELS 8 OHM SIZE H18 - W15 - D12

CHOICE OF TWO MODELS

POWER RATINGS QUOTED IN WATTS RMS FOR EACH CABINET

- OMP 12-100 (100W 100dB) PRICE £159.99 PER PAIR
- OMP 12-200 (200W 102dB) PRICE £209.99 PER PAIR

SECURICOR DEL:- £12.00 PER PAIR

**OMP SLIDE DIMMER 1K WATT & 2.5K WATT**

CONTROLS LOADS UP TO 1KW & 2.5KW SUITABLE FOR RESISTIVE AND INDUCTIVE LOADS BLACK ANODISED CASE READY TO FIT MOUNTED THROUGH PANEL CABINET CUT OUTS. ADVANCED FEATURES INCLUDE:

- \* FULL 65mm SLIDE (TRAVEL)
- \* NEON MONITOR INDICATOR
- \* FLASH OVERRIDE BUTTON
- \* HIGH & LOW LEVEL PRESETS
- \* FULLY SUPPRESSED TO BS 800

SIZES:- 1KW H128 - W40 - D59mm  
2.5KW H128 - W76 - D59mm

PRICES:- 1K WATT £15.99  
2.5K WATT £24.99 + 60p P&P

**PIEZO ELECTRIC TWEETERS-MOTOROLA**

**PIEZO ELECTRIC TWEETERS - MOTOROLA**

Join the Piezo revolution. The low dynamic mass (no voice coil) of a Piezo tweeter produces an improved transient response with a lower distortion level than ordinary dynamic tweeters. As a crossover is not required these units can be added to existing speaker systems of up to 100 watts (more if 2 put in series). **FREE EXPLANATORY LEAFLETS SUPPLIED WITH EACH TWEETER.**

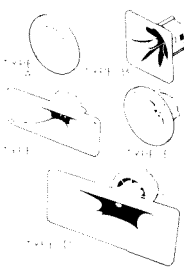

- TYPE 'A'** (KSN2036A) 3" round with protective wire mesh. Ideal for bookshelf and medium sized Hi-Fi speakers. **Price £4.90 each + 50p P&P.**
- TYPE 'B'** (KSN1005A) 3" - super horn. For general purpose speakers, disco and P.A. systems etc. **Price £5.00 each + 50p P&P.**
- TYPE 'C'** (KSN016A) 2" - 5" wide dispersion horn. For quality Hi-Fi systems and quality discos etc. **Price £6.99 each + 50p P&P.**
- TYPE 'D'** (KSN1025A) 2" - 6" wide dispersion horn. Upper frequency response retained extending down to mid range (2KHz). Suitable for high quality Hi-Fi systems and quality discos. **Price £9.99 each + 50p P&P.**
- TYPE 'E'** (KSN1038A) 3" - horn tweeter with attractive silver finish trim. Suitable for Hi-Fi monitor systems etc. **Price £5.99 each + 50p P&P.**
- LEVEL CONTROL** Combines on a recessed mounting plate, level control and cabinet input jack socket 85 x 85mm. **Price £3.99 + 50p P&P.**

**STEREO DISCO MIXER**

**STEREO DISCO MIXER** with 2 x 5 band L & R graphic equalisers and twin 10 segment L.E.D. Vu Meters. **Many outstanding features** 5 inputs with individual faders providing a useful combination of the following:-  
3 Turntables (Magi) 3 Mics. 4 Line including CD plus Mic with talk over switch Headphone Monitor, Pan Pot L & R Master Output controls, Output 775mV. Size 360 x 280 x 90mm Supply 220-240V  
**Price £134.99 - £4.00 P&P**

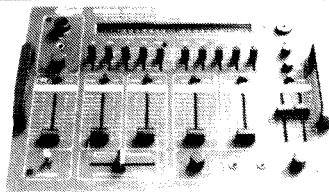

**B. K. ELECTRONICS** Dept PE  
UNIT 5, COMET WAY, SOUTHEND-ON-SEA, ESSEX, SS2 6TR  
TEL: 0702-527572 FAX: 0702-420243

# Frequency Master

*How can you construct a digitally controlled signal generator? John Becker examines some of the options and presents a solution that includes a dual frequency counter.*

This project uses the VCO section of a 4046 phase locked loop (PLL) whose output frequency is monitored by computer. Using simple feedback techniques, the accuracy of the signal can be improved tremendously. All that's needed is to calculate the voltage required by the VCO to achieve a particular frequency, then to set that voltage via a DAC. This allows precise selection of any frequency between 1Hz and 1MHz. In addition, the design can be used as a dual frequency counter, simultaneously monitoring the internal signal and an external source.

Any computer with an eight bit parallel independent input/output port can be used to control the system. The desired frequency is entered on the keyboard and the monitored results displayed on the computer's screen. The unit is controlled by a Basic program but greater speed could be achieved by writing the program in machine code.

## Block Diagram

The block diagram in Fig. 1 shows the main sections of the design. A mixture of parallel and serial data is used to control the various parameters. The VCO receives tuning data from two DAC chips each of which is controlled by serial-to-parallel data latches. A multiplexed 5-decade BCD (binary coded decimal) counter counts the VCO output frequency. The duration for this is set by the controller to 0.1 seconds. At the end of this period the controller steps the counter through its multiplexed stages, reading the final total. If the

correct frequency has not been set, fresh data is sent to the VCO tuners and the process repeated up to a maximum of 16 times.

The VCO has a frequency range of slightly more than one decade, from a little below 100kHz to a bit above 1MHz. A second multiplexed 5-decade counter is clocked by the VCO. Any of the counter's internal decade ranges can be selected as the output by suitable triggering from the controller giving the range of 1Hz to 99.999kHz. An additional multiplexer can switch between the counter output and that coming directly from the VCO. In the latter mode, frequencies from 100kHz to 999.999kHz are available.

Obviously, to achieve a range of 1Hz to 1MHz in 1Hz steps, one million separate control codes need to be generated, requiring a binary data length of 20 bits ( $2^{20} = 1048576$ ). Running variations on the

formula it turned out that 16 bits could control the VCO with a very acceptable of level of accuracy (typically to within about 0.001% of the aimed-for frequency). By using two 8-bit DACs this degree of control was easier and cheaper to achieve than using two 10-bit devices. However, simulating temperature change effects on frequency, it became obvious that the VCO output could not be guaranteed simply by calculated control codes. It would be better if the frequency were set by a sample-and-correct technique. This approach is used in the controlling software.

A signal source selector allows for monitoring an external frequency as well as the internal VCO. Once the VCO has been set, the controlling program repeatedly switches the frequency counter between internal and external

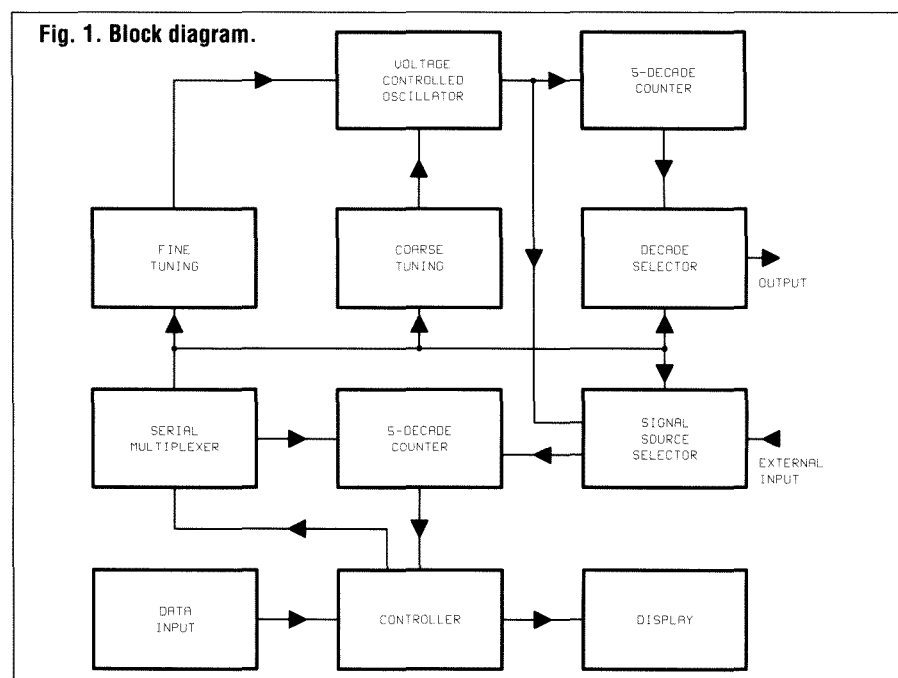

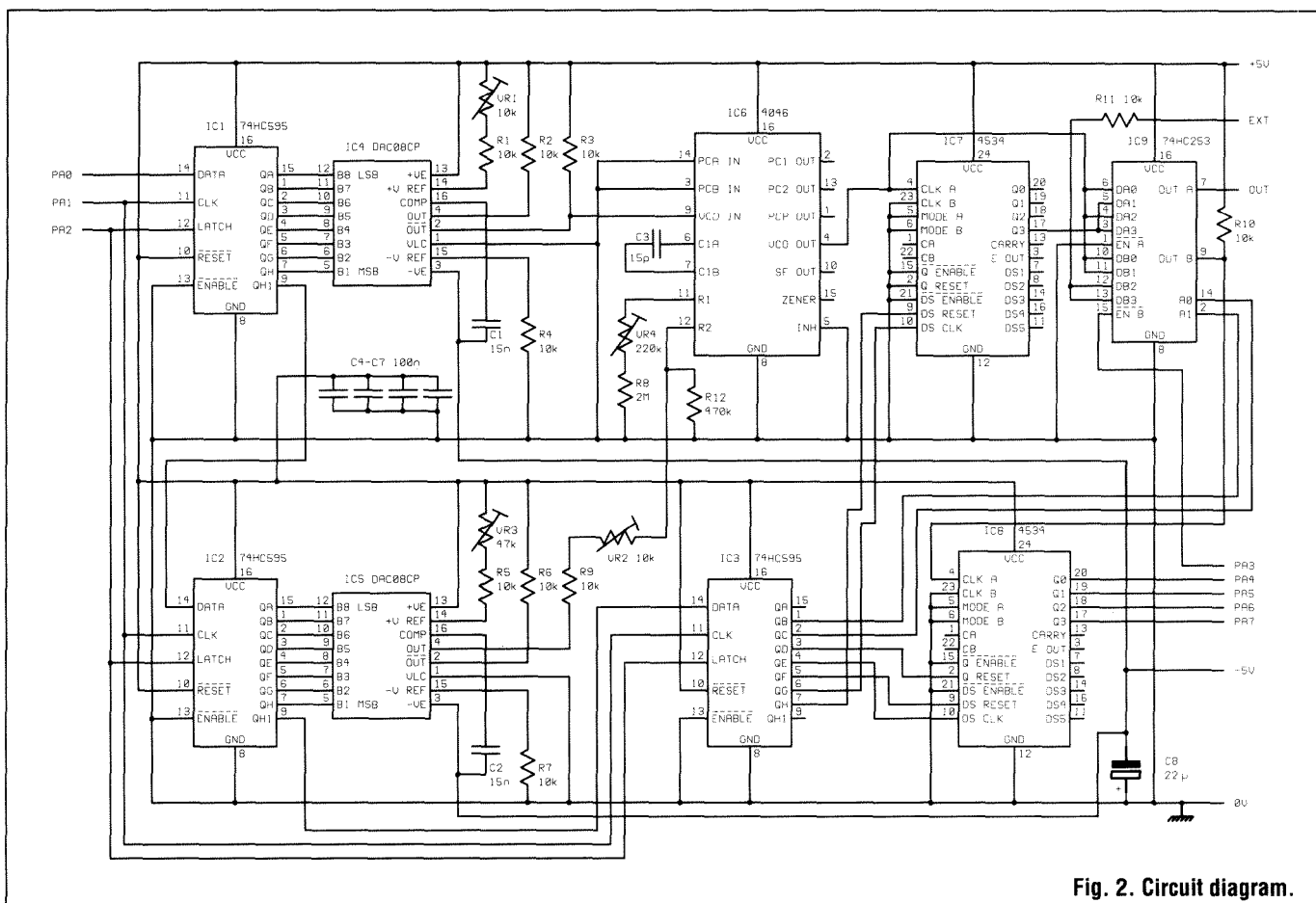

Fig. 2. Circuit diagram.

sources, displaying both results on the monitor. The VCO and its output multiplexer remain unaffected by the routing of the frequency counter.

### VCO Control

Fig. 2 shows the circuit diagram for the VCO, decade counters and control devices. IC6 is the 4046 phase locked loop (PLL) chip containing the VCO. Its phase locking functions are not used. The basic frequency range is preset by C3 together with the effective currents seen by pins 11 and 12. Coarse frequency tuning is carried out by changing the current from pin 12. Fine tuning is achieved by varying the voltage on pin 9.

Both controls are derived from the DAC chips IC4 and IC5, which are controlled by the serial to parallel latching shift registers IC1 and IC2.

Only three computer output lines are needed for this part of the circuit. Each DAC produces an output voltage/current in response to an 8-bit data code presented on its inputs. The codes are sent as two consecutive blocks of 8-bit serial

data clocked into IC1 and then IC2. Each of the 16 bits is separately presented to the data input pin 14 of IC1 via line PA0. Line PA1 is then clocked up and down, shifting the PA0 data into IC1. Simultaneously, the data on each internal stage of IC1 is shifted on by one place, the final bit appearing at its QH1 output. Data on this pin is presented to the data input of IC2. Since PA1 synchronously clocks both IC1 and IC2, data flows through IC1 into IC2. When all bits have been clocked in, the data is latched into the shift register outputs by a single pulse on line PA2. The outputs now retain their data until the latch is again clocked following receipt of the next serial data block.

### Digital to Analogue

Fig. 3 shows the block diagram for the DAC0800. Note that +V REF and -V REF do not require voltages. It is the current flowing at these reference points that is important. Usually it is necessary to have a resistor in series with the reference inputs to control the current (there are instances, though, when the -V

REF input may be tied to ground). The reference current may then be varied by changing the voltage, or by varying the resistance.

Although some DACs produce a voltage directly at their outputs, the DAC0800 produces an output current which is converted into an equivalent voltage by tying the outputs to the power line via resistors. By varying the output resistance value the overall output voltage swing range can be changed.

In this circuit the DAC outputs have been tied to the +5V line via fixed resistors. Range control is carried out by changing the current flowing into the +V REF inputs, as set by VR1 and VR3 respectively.

The twin outputs of each DAC are complementary; when the current on one rises, the current on the other falls. The VCO produces an increase in frequency when the voltage on its pin 9 rises. Conversely, its pin 12 input requires a voltage decrease to produce a rise in frequency. For programming convenience, the inverting output (pin 2) of IC4 controls VCO pin 9, whereas the non-inverting output (pin 4) of IC5



## Computer simulation.

Before building a project it can be a good idea to test the concept to prove that it works. Since data sheets for integrated circuits give all of operational details including formulae, one way of simulating the circuitry is to use a computer program. This allows various parameters to be tested and changed before any hardware is put together.

In the case of the Frequency Master, a simple program was written in Basic using the 4046 VCO frequency control formula. This was used to give a plot of frequency against various different voltages using pre-defined resistance and capacitance inputs.

The 4046 VCO has a linear voltage controlled input, two inter-related resistor inputs and a capacitor input. The output frequency is also related to the power-line voltage. Referring to Fig. 3, the frequency calculation formula is:

$$f = \frac{K \left\{ \frac{VCO_{in}-1.65}{R1} + \frac{VDD-1.65}{R2} \right\}}{(C1+32)(VDD+1.6)} \quad \text{MHz at } 21^{\circ}\text{C}$$

where:

VDD in VDC; 5.0VDC  $\leq$  VDD  $\leq$  15Vdc

VCOin in VDC; 1.65VDC  $\leq$  VCOin  $\leq$  (VDD - 1.35VDC)

R1 and R2 in Meg $\Omega$ ; R1  $\geq$  0.005M, R2  $\leq$  10M

C1 in pF; C1  $\geq$  50pF

K = 0.95 @ VDD = 5VDC; 0.95 @ VDD = 10VDC; 1.08 @ VDD = 15VDC

The following Basic program illustrates the formula re-interpreted to suit a computer. The values of R1, R2 and C1 are fixed while the VCO control voltage is incremented in steps of 0.1V across the range 1.7V to 5V. Other values may be substituted. The readout displays the voltage, frequency in Hz, and the difference between the current and previous frequency calculations.

```
100 VDD=5:R1=0.01:R2=2:C1=100
110 FOR VCO=1.7 TO 5 STEP 0.1
120 X=((VCO-1.65)/R1)+((VDD-1.35)/R2):X=X*0.95
130 Y=(C1+32)*(VDD+1.6)
140 F=X/Y:F=F*1000000:PRINT VCO;F;F-Z:Z=F:NEXT
```

controls VCO pin 12.

These DACs require a  $\pm$ VE power supply and there is not a pin specifically allocated for ground. In most instances, the VLC pin is tied to ground.

## VCO Control

One way of changing the frequency of the VCO is to alter the resistance value between pin 12 and ground – this changes the current flowing from pin 12. A similar result occurs when changing the voltage to which a fixed resistor is connected, the current flow decreasing with an increase in tail voltage. Hence a higher voltage will result in a lower frequency. VR2 was included to provide for an initial presetting of the resistance value. In practice changing VR3 provides sufficient control. R12 limits the maximum effective resistance at pin 12.

The current flowing from VCO pin 11 also determines the output frequency and affects the frequency range controlled by the voltage on pin 9. Although the formula is complex, as a rule of thumb the higher the resistance the smaller the range. Correction of the range was allowed for by inclusion of VR4, but it was found to be only marginally beneficial in view of the control offered by VR1.

The VCO feeds its output to IC7, which acts as a frequency divider, and to the dual stage 4-way multiplexing chip IC9.

## Output Divider

IC7 is a multiplexed 5-stage decade counter with BCD outputs and three clock inputs. The signal to be counted is taken to input CLK A and divided internally by a series of five decade counters, any of whose contents may be routed to the BCD outputs. Routing is determined by a second internal counter triggered via the DS CLK input. The signal and DS (digit select) counters may be reset and their outputs enabled/disabled via the control inputs shown in the circuit diagram.

The third clock input, CLK B, is not used.

IC7 is used to divide the VCO frequency by one of five factors of ten, taking the output from Q3. With the DS counter clocked to DS1, the Q3 output frequency is the input frequency divided by ten. Clocking to DS5 divides the frequency by 10000. The output is a pulsed waveform in which the pulse is high for one tenth of the count (up for the duration of one input pulse to the stage selected, down for the next nine).

The output may be taken from any of the other Q0-Q2 outputs, wiring additional leads to the relevant pins. With DS1 active, Q0 divides by two and Q1 divides by four, in both instances producing a square wave output. Q2 divides by five, but with an uneven pulse

spacing. Similar ratios occur for other DS settings.

Although the unit cannot directly monitor the Q0-Q2 outputs, they can be fed to the external signal input of the frequency counter via an appropriate switch.

## Multiplexer

Either the Q3 or the original VCO output may be switched through the multiplexer IC9 (Fig. 7 clarifies the chip's function). Either the VCO signal or an external signal can be routed to the frequency counter. This consists of another 5-decade counter, IC8, which is reset and enabled under computer control. First the counter is reset, then the frequency to be counted is gated through IC9 for precisely one tenth of a second under control of the PA3 line. At the end of the period, the gate is closed and a control pulse resets the DS counter. The DS clock is then triggered five times, presenting in turn each of the internal decade counters to the outputs. They are read by the computer on lines PA4-PA7. The computer then performs its calculations, repeating the VCO resetting if necessary. Once the VCO has been satisfactorily set the computer goes into monitor mode, repeatedly reading the frequency counter and displaying the results on screen.

Counter resetting, DS clocking and signal sourcing via IC9 is

controlled by serial data codes clocked into IC3. This has its data input in series with the IC1/IC2 chain and is clocked and latched synchronously with them. Each fresh data code is thus sent as part of a 24-bit serial block, with latching occurring after the 24th bit. This makes the Basic program a little slow but can be improved by using machine code.

### Basic Software

The Basic program in Fig. 5 was written in a version of Microsoft Basic and variations of it can be used with any computer which understands Basic and has an 8-bit parallel input/output port.

Apart from a few minor dialect changes in the code, the principal changes that may have to be made are to the three port register addresses and the frequency counter pulse duration control factor. In line 110, DRT holds the Data Direction Register address, IN holds the input register address, and OUT holds the output register address - note that other dialects of Basic use these names as commands so changes may be necessary. Check your manual for the addresses of the ports and substitute them, in decimal, for the numbers in the program.

Also in line 110 is variable Y which is set to 36. This is used to set the timing loop duration in line 360. The value should be adjusted so that the loop duration allows a positive pulse of 0.1 secs (or as near as possible) to be generated on output line PA3. (Some computers may designate their i/o port lines differently - PA3 here indicates the line which controls Bit 3. Similarly, PA0 is Bit 0 and PA7 is Bit 7.)

Depending on the the computer in use, lines 350 and 370 may not be applicable. They are used to control a system interrupt routine which takes care of internal housekeeping. Since these interruptions can affect the predictable timing of the pulse control loop, it is disabled. Some computers have a specific Basic command which will perform this action. With the 6502, four machine code commands are used: SEI, RTS and CLI, RTS, meaning turn maskable interrupts off, Return and turn them on again, Return. The respective codes are 120, 96, 88 and 96. The first two are used

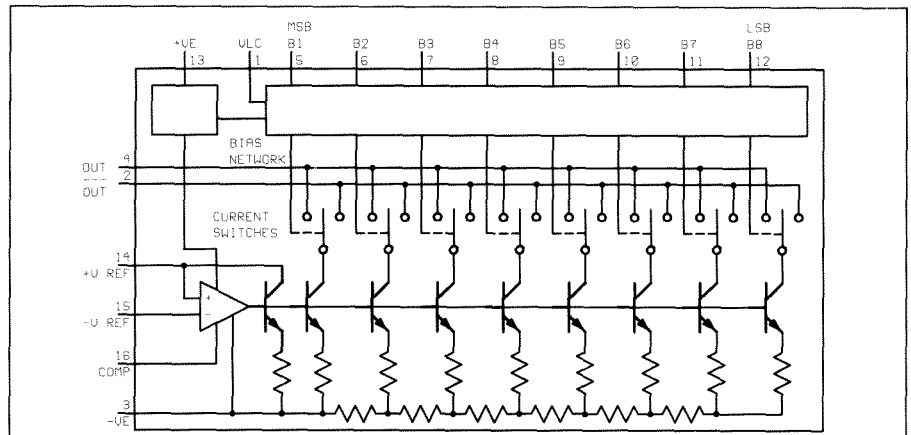

Fig. 3. The operation of the DAC0800

immediately prior to the loop, the second two immediately after it. The codes are poked into two memory locations known to be unused on the machine and then called at the appropriate time.

If interrupts cannot be disabled then lines 350 and 370 should be omitted. Frequency monitoring precision will be lost, but otherwise the program will run as intended.

### Binary Chop

The program first of all requests the frequency number to be set. The program sets IC7 and IC9 to the correct decade output, then goes into its search and set routine.

Using the binary chop search algorithm an item in an ordered list can be found in a binary-related number of steps. With a sorted list of 256 items, this technique takes only eight steps to find the desired item. With a million items in the list it takes only 20 steps. This technique is used to set the VCO to the closest frequency required within 16 steps, monitoring the output frequency at each step and correcting accordingly.

When setting the VCO, the value in S(X) is sent to the DAC controllers. The resulting output frequency, V, is monitored and compared against the desired frequency, N. If there are not the same, S(X) is increased or decreased to as necessary and the VCO is set with the new value. If, within the maximum eight steps, V doesn't equal N, the VCO is set as near as possible. For convenience, the routine is run twice, first for the coarse control DAC, then for fine control.

### Decimal To Binary

In the search routine S(X) is a decimal number. It has to be sent to the shift registers as binary bits. The routine in lines 510 and 520 performs the conversion.

The important routine that sends data to the shift registers is in lines 300-320. The two-dimensional variables R(1,D), R(2,D) and R(3,D) hold the individual binary bits in order of registers 1 to 3 (variable D indicates the bit location between 0 and 7). Lines 530-600 are for information only.

The speed at which the Basic

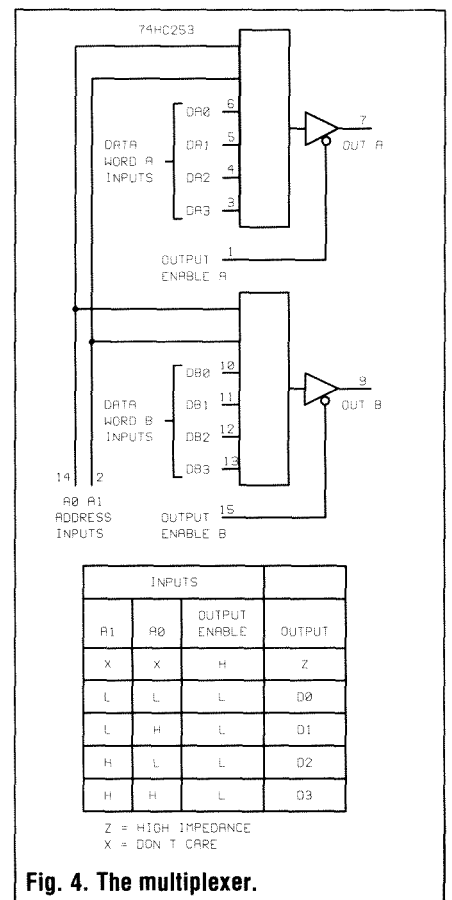

Fig. 4. The multiplexer.

program sets the VCO may be increased by reducing the search routine to eight steps instead of 16. The search will be less precise, but in many instances the frequency established during the coarse setting may well be satisfactory. To shorten the search replace the statement FOR X = 2 TO 1 STEP-1 with X = 2 in line 170, then delete the NEXT statement in line 180.

Once the search and set has been completed the program goes into frequency monitor mode in the

perpetual loop of line 200. To enter another frequency number, stop the program and re-run it.

## Assembly and checking

If the unit is to be used with a computer that provides a  $\pm 5V$  power supply, the PCB in Fig. 9 is the only one needed. Sockets should be used for all ICs. Note that two of the wire links go under IC7.

Check the soldered joints with a magnifying glass and connect up to

the computer, referring to the manual for the port connection details and a suitable socket.

Set all four presets to minimum resistance and run the program to check its effective control of the circuit. An oscilloscope can be used to monitor the VCO output at pin 4 and IC9 at pin 7 (test points are included on the PCB).

VR1 and VR3 are the only presets that may need to be adjusted. To do this the DAC chips IC4 and IC5 must be set to their

```

100 REM BASIC PROGRAM FOR FREQ GEN.COUNT (FB34)
110 DRT=59459:IN=59457:OUT=59471:GATE=8:POKE DRT,15:Y=36:REM SEE TEXT
120 DIM R(3,8),S(2),F(20)
130 INPUT"NUMBER":J:R(1,7)=1:R(2,7)=1:G=0:N=INT(N):N=J
140 IF N<10 OR N>999999 THEN PRINT:GOTO130
150 DP=1:U=5:R(3,2)=1:IF N>99999 THEN N=INT(N/10):U=0:R(3,2)=0:DP=10:GOTO170
160 IF N<10000 THEN N=N*10:U=U-1:DP=DP/10:GOTO160
170 GOSUB 460:X=1:GOSUB 510:FOR X=2 TO 1 STEP -1:K=999999:GOSUB 210:S(X)=M
180 PRINT "REGISTER":X;"SET AT":M:GOSUB 510:NEXT X:GOSUB 460
190 REM CONTINUE MONITORING
200 X=2:GOSUB 290:GOSUB 340:GOSUB 390:GOTO 200
205 REM BINARY CHOP SEARCH
210 L=1:H=255
220 S(X)=INT((H+L)/2):GOSUB 510:GOSUB 290:GOSUB 340:GOSUB 390
230 IF V<9000 THEN 220
240 IF V=N THEN 280
250 IF N<V THEN H=S(X)-1:GOTO 270
260 L=S(X)+1
270 IF L<H THEN 220
280 RETURN
290 REM SEND
300 FOR C=3 TO 1 STEP -1:FOR D=7 TO 0 STEP -1
310 A=R(C,D)+2+GATE:POKE OUT,A:POKE OUT, A AND 9:NEXT D:NEXT C
320 POKE OUT,4+GATE:POKE OUT,GATE:RETURN
330 REM TIMING
340 PRINT "REG"X:S(X),:R(3,3)=1:GOSUB 290:R(3,3)=0:GOSUB 290:REM RESET COUNTER
350 POKE 0,120:POKE 1,96:SYS 0:REM INTS OFF - SEE TEXT ABOUT THIS LINE
360 POKE OUT,GATE:POKE OUT,0:FOR A=1 TO Y:NEXT A:POKE OUT,GATE:REM 82
370 POKE 0,88:POKE 1,96:SYS 0:REM INTS ON - SEE TEXT ABOUT THIS LINE
380 RETURN
390 REM INPUT
400 R(3,5)=1:GOSUB 290:R(3,5)=0:GOSUB 290:REM RESET COUNT STAGES
410 V=0:FOR CLK=4 TO 0 STEP -1
420 R(3,4)=1:GOSUB 290:R(3,4)=0:GOSUB 290:REM CLOCK COUNTER OUTPUT
430 F=PEEK(IN) AND 240:F=(F/16)*(10^CLK):V=V+F:NEXT V:PRINT "FREQ":V*DP
440 G=G+1:F(G)=V:P=ABS(N-V):IF P<K THEN K=P:M=S(X)
450 RETURN
460 REM RESET AND CLOCK SIGNAL COUNTER
470 PRINT "SET OUTPUT"
480 R(3,6)=0:R(3,7)=1:GOSUB 290:R(3,7)=0:IF U=0 THEN RETURN
490 FOR CLK=1 TO U:R(3,6)=1:GOSUB 290:R(3,6)=0:GOSUB 290:NEXT CLK:RETURN
500 REM DECIMAL TO BINARY CONVERT
510 D=S(X):FOR T=7 TO 0 STEP -1:A=2^T:B=0:IF (D/A)>=1 THEN D=D-A:B=1
520 R(X,T)=B:NEXT T:RETURN
530 REM REG 3 ALLOCATIONS
540 REM 0    NIL    QA
550 REM 1-2  IC9 A0/1    QB/QC
560 REM 3    RESET COUNTER    QD
570 REM 4    CLOCK COUNT DS    QE
580 REM 5    RESET COUNT DS    QF
590 REM 6    CLOCK SIG DS    QG
600 REM 7    RESET SIG DS    QH

```

Fig. 4. Basic program to run the frequency master.

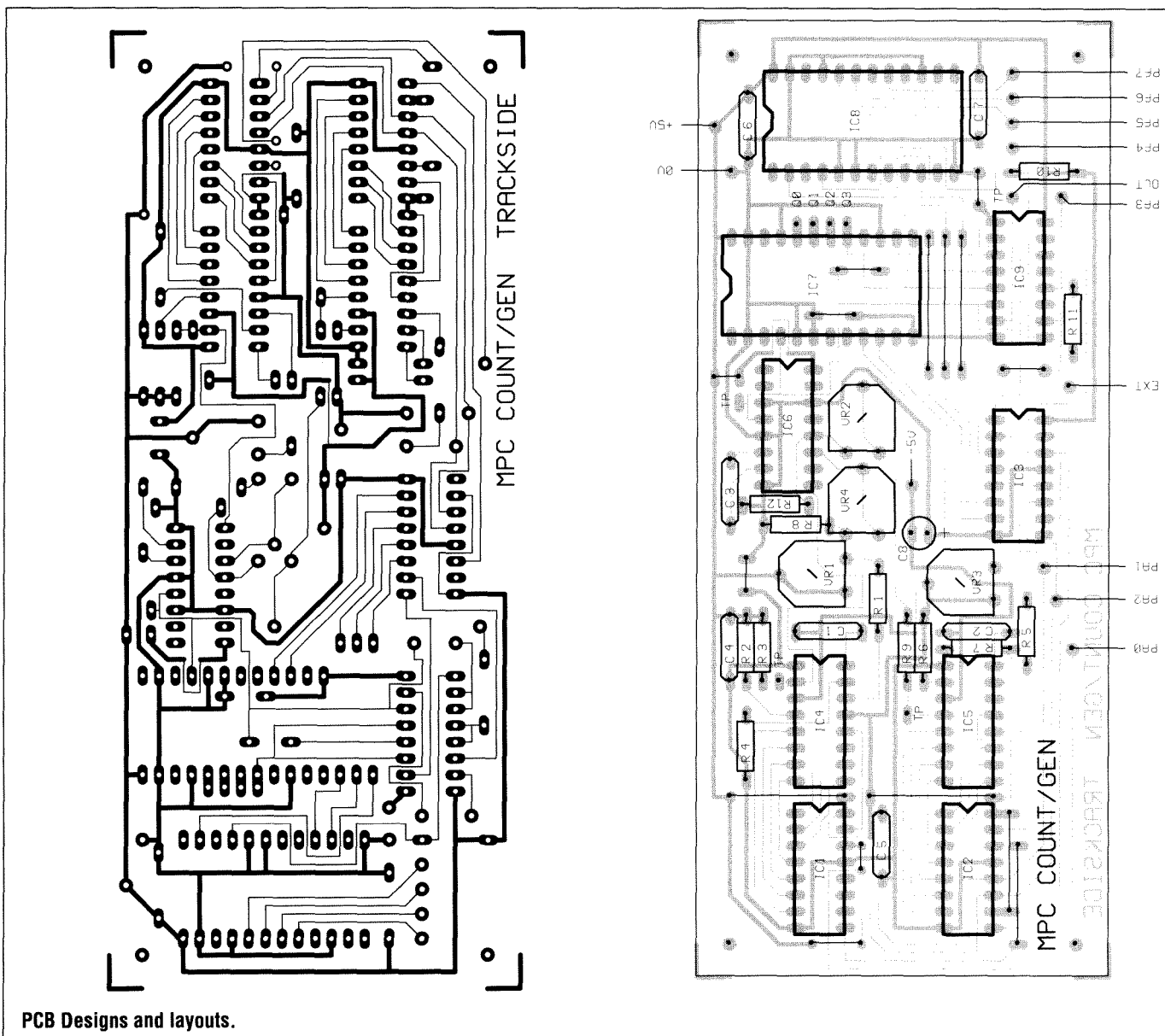

PCB Designs and layouts.

extreme limits, via IC1 and IC2, with codes 0 and 255. Insert the following line into the program:

```
125 S(1)=0:S(2)=255:FOR
X=1 TO 2:GOSUB510:NEXT:
GOTO 200
```

Run the program, then monitor the voltage on IC4 pin 2. Adjust VR1 until a voltage of about 1.7V is obtained. Now monitor IC5 pin 4 and adjust VR3 until the voltage reads roughly 0V. No further adjustment is necessary when running from Basic. Now delete line 125.

The setting of timing factor Y in the program may be adjusted by trial and error, or in conjunction with an oscilloscope or another frequency counter.

In the Basic program as listed, no provision has been made for

monitoring an external frequency. However, this can be done by setting IC9 to gate an external signal into IC8 by setting register 3 bit 1 high, so setting IC9 pin 2 (address A1) high. If only external monitoring is needed put back line 125 and amend its end to read:

```
R(3,1)=1:GOTO 200
```

Alternatively, a toggling between internal and external is a matter of amending the end of line 200 to read:

```
R(3,1)=(R(3,1)+1) AND 1
:GOTO 200
```

This alternately sets R(3,1) high or low each time round the monitor loop while retaining the frequency search and set facility. ■

**Components**

<b>Resistors</b>	
R1-R7, R9-R11	10k
R8	2M
R1	2470k
all 0.25W 5% carbon or better	
<b>Capacitors</b>	
C1, C2	15n polyester
C3	15p polystyrene
C4-C7	100n polyester
C8	22u 10V electrolytic
<b>Potentiometers</b>	
VR1-VR	210k horiz skel preset
VR3	47k horiz skel preset
VR4	220k horiz skel preset
<b>Semiconductors</b>	
IC1-IC3	74HC595
IC4, IC5	DAC08CP or DAC0800
IC6	4046
IC7, IC8	4534
IC9	74HC253
<b>Miscellaneous</b>	
Printed circuit board, PCB supports, 16-pin DIL IC sockets, 24-pin dil IC sockets.	



# Practical Electronics Subscriptions

Book your place in the technological future with a subscription to Practical Electronics. Our combination of in-depth features, innovation updates and electronic projects you can build yourself is available in regular monthly doses for only £18 a year. Subscribe or renew now and get a free gift, either a 12-issue binder or the 300-page International Transistor Equivalents Guide. Concessionary rate (-10%) available to students and teachers upon proof of status.

Fill in and return this form (or a photocopy) to:

**Practical Electronics Subscriptions  
Intra House  
193 Uxbridge Road  
London W12 9RA**

## UK Readers

One Year Subscription at £18.....

BAEC/Educational Rate £16.20.....

## Overseas Readers

Surface Mail at £22.....

BAEC/Educational Concession Rate £19.80.....

Air Mail at £39.....

BAEC/Educational Concession Rate.....

I enclose proof of BAEC membership.....

I enclose proof of Educational status (e.g. Headed paper).....

I wish to start/renew my subscription from the ..... issue.

As my free gift I would like to receive (tick one)

The Practical Electronics Binder.....

The Transistor Equivalents Guide.....

Please send my monthly copy of PE to:

Name.....

Address.....

Town.....

Post Code.....

I enclose a cheque/postal order for.....

Or: Please charge my VISA/MasterCard

Number.....

Expiry date.....

Signature (for credit card orders).....

(N.B. Cheques/Postal Orders or Banker's Drafts must be made out in £ Sterling, payable to Intra Press.)

## Interak 1 SINGLE BOARD COMPUTER

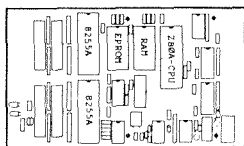

"SBC-1"

A computer doesn't *have* to look like you'd expect a computer to look. It doesn't have to *have* a keyboard and a screen and floppy disks and so on.

The SBC-1 has the bare minimum of chips a Z80 computer can have and still be a computer: A 4 MHz Z80-CPU chip, an EPROM chip (up to 32K), a static RAM chip (up to 32K) and a pair of 8255A I/O (input output) chips giving 48 individual lines to wobble up and down. There are one or two additional "glue" chips included, but these are simple "74LS" or "HC" parts.

A star feature is that no special or custom chips (ie PALs, ULAs, ASICs etc) are used — and thus there are no secrets. The Z80A is the fastest and best established of all the 8-bit microprocessors — possibly the cheapest too!

Although no serial interface is included, it is easy for a Z80A to wobble one bit up or down at the appropriate rate — the cost is a few pence worth of code in the program: why buy hardware when software will do?

Applications already identified include: Magnetic Card reader, mini printer interface, printer buffer, push button keypad, LCD alphanumeric panel interface, 40-zone security interface for auto sending of security alarms, code converter (eg IBM PC keyboard codes to regular ASCII), real time clock (with plug in module), automatic horticultural irrigation controller.

By disabling the on-board Z80A-CPU this card will plug into our Interak 1 CP/M Plus disk-based development system, so if you don't fancy hand-assembling Z80 machine code you don't have to!

The idea is (if you are a manufacturer) you buy just one development system and then turn out the cheap SBC-1 systems by the hundred. If you are really lazy we can write the program for you and assemble the SBC-1 cards so you can get on with manufacturing your product, leaving all your control problems to us.

**Greenbank**

For more details write or phone us:

Greenbank Electronics, Dept PE03 460 New Chester Road, Rock Ferry, Birkenhead, Merseyside. L42 2AE. Tel: 051-645 3391.

## WE HAVE THE WIDEST CHOICE OF USED OSCILLOSCOPES IN THE COUNTRY

TEKTRONIX 2445 Four Trace 150MHz Dual TB	£1200
TEKTRONIX 2245A Four Trace 100MHz Dual TB	£1000
TEKTRONIX 2235 Dual Trace 100MHz Delay Sweep	£650
TEKTRONIX 2215 Dual Trace 60MHz Delay Sweep	£450
TEKTRONIX 475 Dual Trace 200MHz Delay Sweep	£550
TEKTRONIX 465 Dual Trace 100MHz Delay Sweep	£450
H.P. 1722B Dual Trace 275MHz Delay Sweep 5 Function LED Display for Real Time Measurement	£750
H.P. 1740A Dual Trace 100MHz Delay Sweep Trig	£350
PHILIPS PM3217 Dual Trace 50MHz Delay Sweep	£400
TELEQUIPMENT D775 Dual Trace 50MHz Delay Sweep	£250
GOULD OS3000 Dual Trace 40MHz Delay Sweep TV Trig	£250
GOULD OS1100 Dual Trace 30MHz TV Trig	£180
GOULD OS3000 Dual Trace 20MHz	£250
GOULD OS250B Dual Trace 15MHz TV Trig	£160
COSSOR CDU150 Dual Trace 35MHz Delay Sweep from £100 - £150	£150
S.E. LABS SM111 Dual Trace 18MHz	£130
TEKTRONIX 2210 Digital Storage Dual Trace 50MHz (20MS/s Sampling Rate) As New	£1150
GOULD 4025 Digital Storage Dual Trace 20MHz	£750
GOULD OS4020 Digital Storage Dual Trace 10MHz	£450
GOULD OS4000 Digital Storage Dual Trace 10MHz	£300
THIS IS JUST A SAMPLE - MANY OTHERS AVAILABLE	
H.P. 8112A Programmable Pulse Generator 50MHz	£1500
BRADLEY Oscilloscope Calibrator 192 with Cal Cert.	£800
DATRON 1061 Auto Cal OMM. True RMS etc	£650
SOLARTRON 7075 DVM up to 7+1/2 digit. AC/RMS/DC/OHM	£700
R&S SW084 (Sweep Gen with display) 0.1-1000MHz	£750
MARCONI TF2008 AM/FM 10KHz-510MHz Sig Gen	£450
MARCONI TF2015 AM/FM 10-520MHz Sig Gen with TF2171	£250
MARCONI TF2015 with Synchroniser TF2171	£250
V TF2016 AM/FM 10KHz-120MHz Sig Gen with TF2173	£350
MARCONI TF2356/2357 Level Osc/Meter 20MHz, the pair	£950
H.P. 8623C Sweeper Multi Meter (Plug-ins available)	£1000
LEADER LV55851A Vectorscope	£400
TEKTRONIX 491 SPEC ANALYSER 1.5-12.4GHz from £1000-£1400	
SYSTRON DONNER 1702 Sig Gen 100Hz-1GHz	£950
POLARAD Sig Gen 1105B 0.8-2.4GHz	£500
POLARAD Sig Gen 1106B 1.8-4.4GHz	£500
POLARAD Sig Gen 1207A 3.7-8.4GHz	£500
POLARAD Sig Gen 1207A with 1500 Freq Doubler	£750
POLARAD Sig Gen 1208A 6.95-11GHz	£500
POLARAD Sig Gen 1280A with 1510 Freq Doubler	£750
TEKTRONIX TM504 with PG50E/SG503/TG501	£2250
RACAL STORE 14DS 14 Channel Magnetic Tape Recorder	£2000
RACAL 9081 Synthesised Sig Gen 5-520MHz	£650
RACAL 9009 Mod Meter 10MHz-1.5GHz	£350
RACAL 9301 RMS Voltmeter 10KHz-1.5GHz	£250
TIME 2004 DC Voltage Standard 0.005%	£450
SOLARTRON 7150 Digital Multimeter 6+1/2 digit	£300
AVO Valve Characteristic Meter VCM163	from £250-£350
FERROGRAPH RTS2 Recorder Test Set	from £200
THURLBY PL320MD Twice 30V 2A Quad Mod. Digital	£200

TELEQUIPMENT CT71 Curve Tracer	£250
MARCONI TF2700 Universal LCR Bridge Battery from	£125
MARCONI TF2337A Automatic Distortion Meter 400Hz/1KHz	£100
MARCONI MOD Meters TF2300, TF2300B, TF2303 from	£100
MARCONI TF2603 RF Millivoltmeter 50KHz-1.5GHz	£75
MARCONI TF2430 Digital Freq Counter 10Hz-80MHz	£60
MARCONI TF1152/1 RF Power Meter 500MHz 10/25W 50ohm	£25
MARCONI TF893A AF Power Meter 20Hz-35KHz 20mW-10W	£20
RACAL 9915 Freq Counter 10-520MHz Crystal Oven	£150
FARNELL PSU K301100 0-30V 0-100A	£750
UNINTERRUPTED Power Supply type RBS-AC. 500VA	£150

**AVO 8- MULTIMETERS**  
GOOD WORKING ORDER - PHYSICALLY NOT BRILLIANT  
SUPPLIED WITH BATTERIES & LEADS ONLY £30  
ALL OTHER MODELS AVAILABLE

LEADER LMV186A Two Ch MVmeter 5Hz-500KHz/1mV-300V	£100
KIKUSUI AVM23 AC Voltmeter Dual Ch 10Hz-500KHz	£75
Solartron 7045 Multimeter 4-1/2 digit 30 ranges Auto-Man	£95
FARNELL Pulse Gen System 1Hz-10MHz Single/Double	£40
LOGIC PROBE type 33000A TTL/CMOS (P&P £3)	£10
Large range of BENCH POWER SUPPLIES available from	£40
X-Y PLOTTERS Various Models	from £25-£400

**SOME BRUEL - KJOER EQUIPMENT ALWAYS AVAILABLE.**  
PLEASE ENQUIRE.

LEVELL TM3B AC Millivoltmeter 1Hz-3MHz, 5uV-500V	£80
LEVELL TM3A AC Millivoltmeter 1Hz-3MHz 5uV-500V	£40
LEVELL Oscillator TG152 1.3Hz-300KHz Sine Sq	from £55
LEVELL Oscillator TG150M 1.3Hz-150KHz Sine Wave	£20
LEVELL Decade Osc TF68A 0.2Hz-1.2MHz Low dist.	from £35

## NEW EQUIPMENT

HAMEG OSCILLOSCOPE HM11005 Triple Face 100MHz Delay Timebase	£792
HAMEG OSCILLOSCOPE HM604 Dual Trace 60MHz Delay Sweep	£610
HAMEG OSCILLOSCOPE HM203 7 Dual Trace 20MHz Component Tester	£338
HAMEG OSCILLOSCOPE HM205 3 Dual Trace 20MHz Digital Storage	£610
All other models available - all oscilloscopes supplied with 2 probes	
BLACK STAR EQUIPMENT (P&P all units £5)	
APOLLO 10 100MHz Ratio Period Time Interval etc	£222
APOLLO 100 100MHz (As above with more functions)	£295
METEOR 100 FREQUENCY COUNTER 100MHz	£109
METEOR 600 FREQUENCY COUNTER 600MHz	£135
METEOR 1000 FREQUENCY COUNTER 1GHz	£178
JUPITOR 500 FUNCTION GEN 0.1Hz-500KHz Sine Sq In	£110
ORION COLOUR BAR GENERATOR PAL TV Video	£209
All other Black Star Equipment available	
HUNG CHANG DMM 7030 3 digit Hand held 28 ranges including 10 amp ACDC 0.1% ACC (P&P) £4	£39.50
As above DMM60100 25%	£33.50
Carrying cases for above	£3.00 ea
OSCILLOSCOPE PROBES Switched X1X10 (P&P) £11	

This is a very small sample of stock. SAE or telephone for LIST of OVER 700 ITEMS. Please check availability before ordering. CARRIAGE all units £16. VAT to be added to total of goods and carriage.



## STEWART OF READING

110 WYKHAM ROAD, READING, BERKS RG6 1PL

Tel: 0734 68041

Fax: 0734 351696

Callers welcome 9am to 5.30pm MON-FRI (UNTIL 8pm THURS)



# A Car Positioning Aid

*Owen Bishop's electronic gadget is intended to help you park your car without the risk of scratching the body-work.*

Most private garages and parking areas are cramped and putting the car away can be a nerve-wracking matter. Often there is some inconveniently sited low wall or stout branch that is out of sight of anyone sitting in the driving seat. It's much easier if there is a second person to help the driver steer a safe course, but so often the driver is unassisted at such a critical moment.

## Ultrasonic Ranging

The device works on the principle of an ultrasonic range-finder. The sensor is located at the rear of the garage and is low down so that its beam strikes the bumper and is reflected. It measures the time taken for a pulse of ultra-sound to travel to the bumper and back again. This gives a measure of the distance  $d$ . A display continuously indicates the distance between the bumper and the back wall of the garage. The display is mounted on the side wall of the garage where it may conveniently be viewed by the driver.

Obviously this device is not restricted to locating cars; it has many other applications as a proximity meter.

## Circuit Design

The main features of the aid are shown in Fig. 1. The clock oscillates at 80kHz, a frequency which is divided by 2 and by 32 to give two frequencies, 40kHz and 2.5kHz. The first signal is fed to a pair of drivers which make the ultrasonic transmitter transducer oscillate strongly at its resonant frequency. The reason for generating 80kHz

and then dividing it by 2 is that the original 80kHz waveform is asymmetrical, but the divided waveform is symmetrical – its mark/space ratio is 1 – and thus suited for driving the transducer. The drivers receive an enabling input from a counter so that a tone-burst of ultra-sound lasting 0.4ms is generated every 3.2ms.

The ultra-sound reflected from any object in its path is detected by the receiver transducer. This generates an alternating voltage which is conditioned and amplified by three operational amplifiers. The amplified signal from the final stage is rectified and smoothed. It goes high (as the beginning of the reflected tone-burst arrives) every 3.2ms. Ultra-sound that is being reflected back from the point on the object nearest to the transducers has travelled a distance of  $2d$ .

The remainder of the system consists of the logic needed to

register the return of successive tone-bursts. This is controlled by a counter which has eight output terminals, numbered 0 to 7. These outputs are normally at logic low but, as the counter is incremented, they go high one at a time. The counter is driven by the 2.5kHz signal so each output is high for 0.4ms and the complete cycle takes 3.2ms.

The sequence of operation at each stage of counting is:

- 0 clear the shift register
- 1 enable the transmitter
- 2-6 shift the registers as the retiring tone-burst is received
- 7 transfer the data in the registers to the latches

Although the shift register used has six registers, only the first four are used in this circuit. The shifting of the registers allows the output of the rectifier to be sampled at

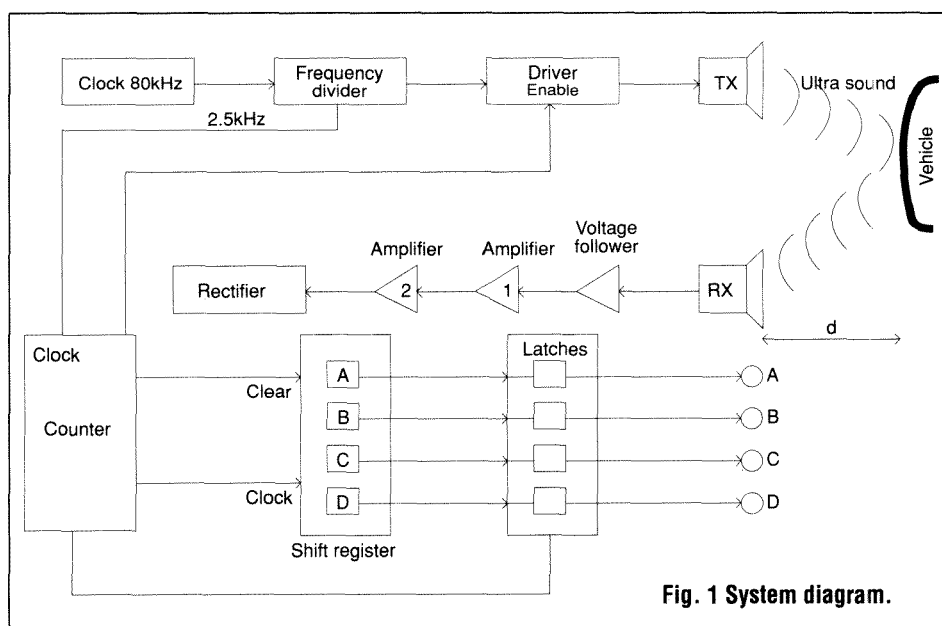

Fig. 1 System diagram.

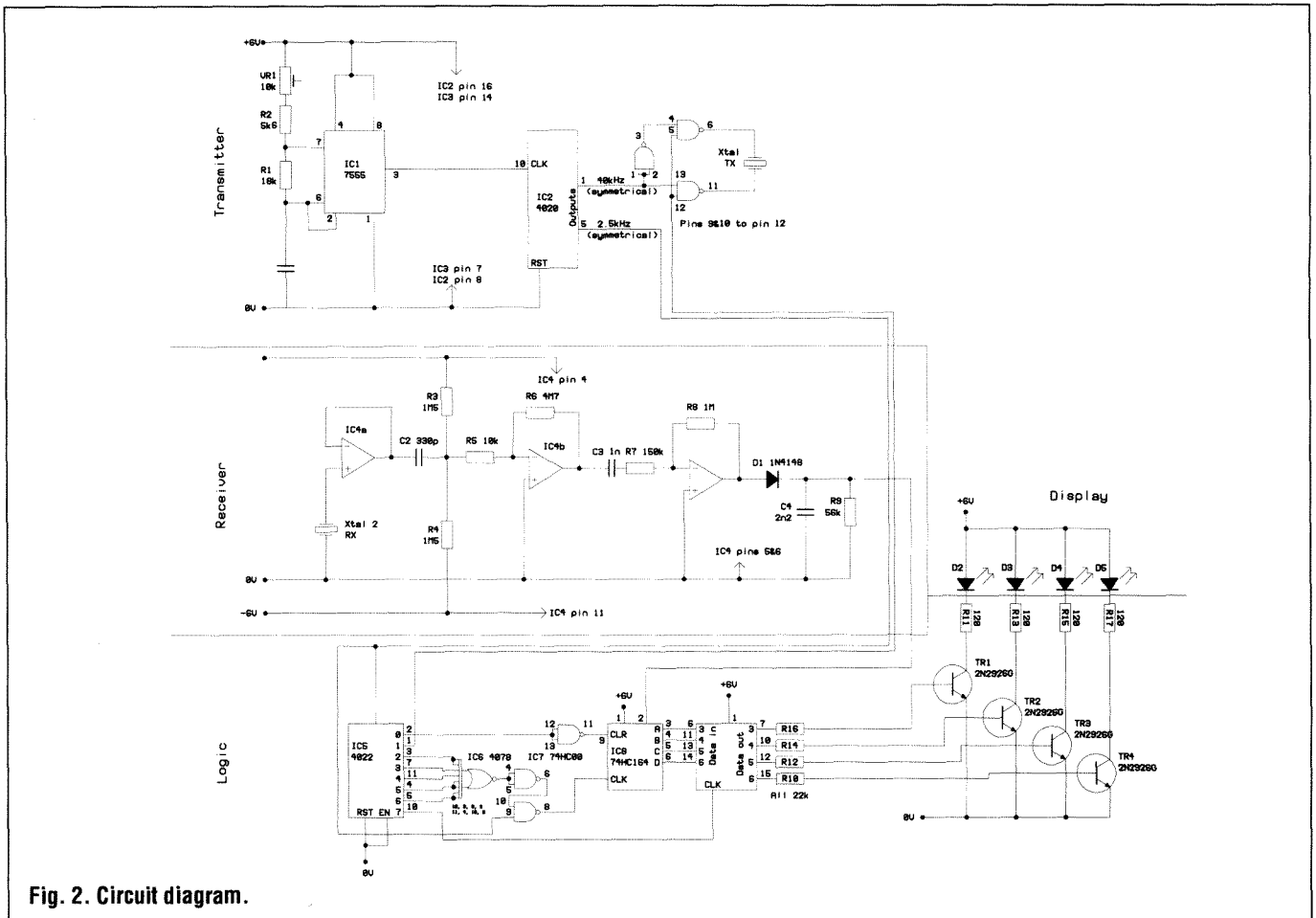

Fig. 2. Circuit diagram.

intervals of 0.4ms and later to store and view the data obtained.

As the car approaches the sensor unit, first lamp A lights up, followed by lamps B, C and finally D. Once a lamp is lit it stays lit. When the car is within 30cm of the sensors the LEDs light in strict sequence without flickering.

### Circuit Details

The clock (IC1, Fig. 2) is an astable multivibrator based on the well-known 555 timer IC in its CMOS version, the 7555. The variable resistor VR1 allows the frequency to be set to 80kHz. IC2, a 14-stage ripple counter/divider, divides the frequency by two and by 32. The 40kHz symmetrical waveform from stage 1 of the divider is fed directly to a NAND gate. It is also inverted and fed to a second NAND gate. The other input of these two gates is controlled by the level from the sequential counter (IC5, see later). When this is high the 40kHz signal passes through the gates and their outputs switch rapidly from high/low to low/high, applying an alternating voltage to the transducer crystal XTAL1. This

causes it to emit ultra-sound. When the level from IC5 is low, the 40kHz signal does not pass through the gates and no ultra-sound is produced. Thus the level from IC5 is used to produce short tone-bursts of ultra-sound.

The ultra-sound detected by the receiver crystal XTAL2 causes an alternating sine-wave voltage to appear across its terminals. The three amplifiers which follow are all contained in IC4. The first amplifier is used as a voltage follower. Its output goes to C2 which, in conjunction with R3 and R4, acts as a high-pass filter. This removes any low-frequency component of the signal, such as arises from picking up the mains frequency from nearby cables. IC4b is a high-gain inverting amplifier, with gain of 470. Its output swings strongly, almost to the positive and negative supply voltages, when ultra-sound is being received. IC4c gives a further stage of amplification, becoming saturated on each voltage swing, so that its output is virtually a square wave at 40kHz, alternating between +6V and -6V.

The rectifying action of D1, C4

and R9 is as follows. On the positive half of each cycle, current flows through D1 and charges C4. The current leaks away continuously through R9, but the values of C4 and R9 are chosen so that the voltage on C4 is well over +3V whenever a signal is being received. This is equivalent to logical high. When there is no signal the voltage across C4 drops rapidly to zero, giving a logical low output.

The heart of the logic circuit is the counter IC5, driven by the 2.5kHz signal from IC2. The action of this counter has already been explained in outline. Output 0 is inverted by a NAND gate and goes to the CLEAR input of the shift register IC8. As 0 goes high at the beginning of the counter's cycle, the output of the NAND gates goes low resetting the registers. Output 1 then goes high, enabling the two NAND gates that drive XTAL1. This produces the 0.4ms tone-burst.

Outputs 2 to 6 go to a NOR gate, the output of which is low when any one of the outputs 2 to 6 is high. This output is inverted by a NAND gate, so that pin 6 of IC7 is high during the whole of stages 2 to 6 of

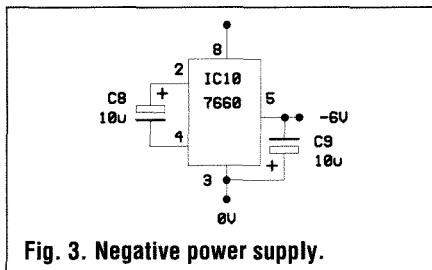

Fig. 3. Negative power supply.

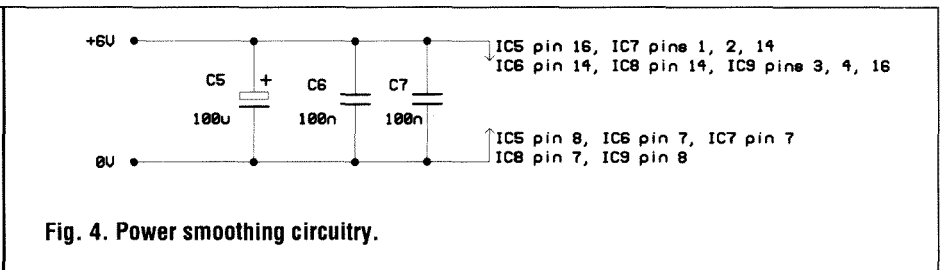

Fig. 4. Power smoothing circuitry.

the counting. This controls the 2kHz signal passing through the third gate of IC7 to the CLOCK input of IC8. The result is that the register is clocked on 5 times at 0.4ms intervals during stages 2 to 6 (figure 3). Output 7 of the counter goes to the clock input of the latches IC9. As this output rises from low to high, data present in the shift registers is transferred into the latches. It is held there until the next time output 7 goes high, when it is replaced by the new data then in the registers. The outputs of the registers are fed to transistors, which are used to switch LED indicators on or off. A high output from a latch turns on the corresponding transistor and makes the LED light. The LEDs and their series resistors could be replaced by filament lamps of 6V rating and taking up to 100mA, or by miniature relays which could be used to switch mains-voltage lamps.

Fig. 3 also shows the sub-circuit, a 7760 voltage converter, used to obtain the -6V supply for IC4. Note the polarity of C9. So that the ICs can function properly it is important to smooth out surges and voltage spikes on the supply lines caused by switching in other parts of the circuit. The 100µF capacitor across the supply lines where they enter the logic board and the two 100nF capacitors placed on either side of the diode-switching transistors help to achieve this – see Fig. 4.

### Construction

The sensor circuits are built on three boards, the transmitter, receiver and logic boards. These may be built and tested one at a time.

The transmitter board is arranged so that the ultra-sound is directed through a hole in the side of the case.

Ultra-sonic transducers are usually sold in pairs and although they may look alike they are electronically different. They can be identified by a serial number, or by a colour code as specified in the manufacturer's or retailer's catalogue.

The transducer is fixed to the board by adhesive or a small lump of Blu Tack. Short wires are wrapped around and soldered to the terminals of the transducer, passed through the holes at F31 and 31 and soldered there.

The transducer on the receiver board is connected to the circuit by a short length of screened cable. Usually one of the terminal pins is directly connected to its metal case. This terminal should be soldered to the screen of the cable, the other end of the screen being twisted and passed through hole K29. The core of the cable connects the other – insulated – terminal pin to G29.

The display normally requires a

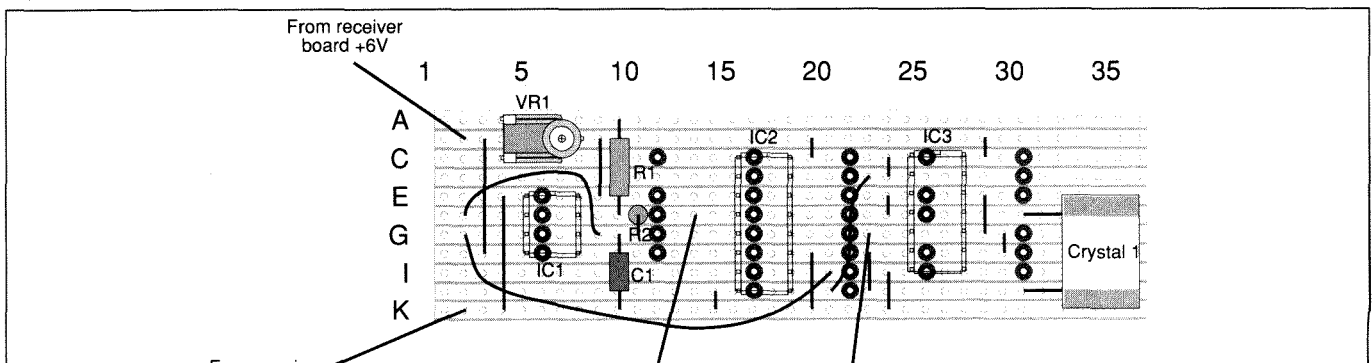

Fig. 5. Transmitter board.

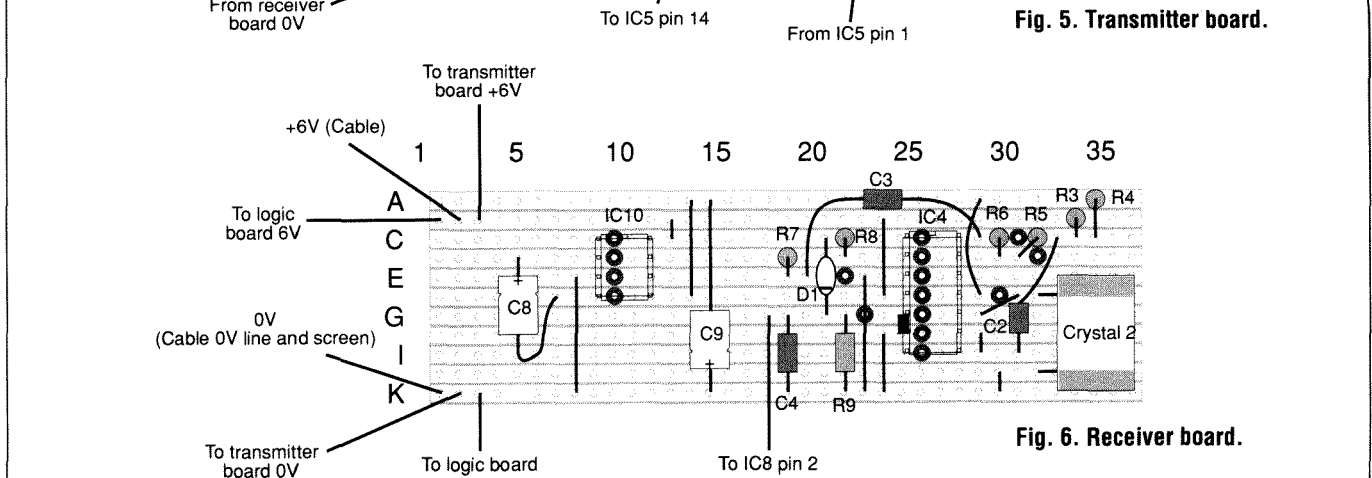

Fig. 6. Receiver board.



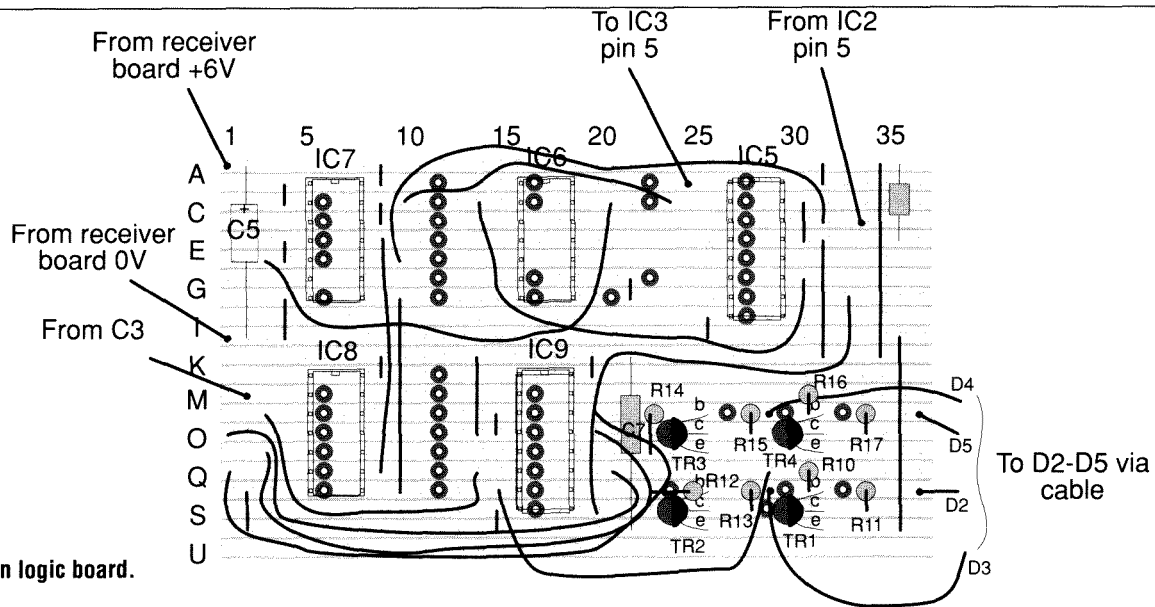

Fig. 7. Main logic board.

separate box, on the lid of which are mounted the 4 display LEDs, a power-switch and an LED (D6) to indicate that the power is on – see figure 9. Suitable colours for the LEDs are yellow for D2-D4, indicating Caution, red for D5, indicating Stop and green for D6. The latter LED needs a resistor – R18 – in series to limit the current. The screening – if any – of the cable is connected to the 0V rail of the receiver board.

The circuit requires only 20mA when quiescent (including the power-on LED), and an additional 20mA for each display LED illuminated. A battery holder containing 4 type cells is sufficient to provide the power, and there is plenty of room for such a battery in the display box.

### Setting Up

The circuit needs no setting up in the electronic sense, but the positioning of the sensor and display boxes need to be considered

carefully. It is best to mount them temporarily until the final positions have been decided. Operating it at a lower level leads to complications as wheels, hub-caps, and wings pass in front of the transducers.

The display is mounted wherever the driver finds it convenient. This could be centrally above the garage door, or on the wall close to the final position of the driver's window. ■

### Components

#### Resistors

(carbon 0.25W, 5% or metal film 0.6W, 1%)

R1	5k6
R10,R12,R14,R16	22k
R2	18k
R11,R13,R15,R17	120
R3,R4	1M5
R18	180
R5	10k
R6	4M7
R7	150k
R8	1M
R9	56k
VR1	10k miniature horizontal preset

#### Capacitors

C1,C2	330p polystyrene
C3	1n polystyrene
C4	2n2 polystyrene
C5	100µ electrolytic
C6,C7	100n polyester

#### Semiconductors

D1 1N4148 silicon signal diode  
D2-D5 LEDs, high intensity, 5mm diameter (3 off yellow, 1 off red) and plastic mounts (optionally bezel-mounted)

D6 LED, 3mm diameter, green, and plastic mount

TR1-TR4 2N2926G (green spot) NPN transistor

#### Integrated circuits

IC1	7555 CMOS timer
IC2	4020BE CMOS 14-stage ripple counter/divider
IC3,IC7	74HC00 CMOS quadruple 2-input NAND gate (2 off)
IC4	TL064C quadruple low-power operational amplifier
IC5	4022BE CMOS 8-stage counter with 1-of-8 outputs
IC6	4078BE CMOS 8-input NOR gate
IC8	74HC164 CMOS 8-bit shift reg
IC9	74HC174 CMOS Hex D-type latch
IC10	7660 voltage converter

#### Miscellaneous

XTAL1,XTAL2 ultrasonic transducers (transmitter and receiver pair, 40kHz)

S1 single-pole single throw-toggle switch

stripboard 11 strips by 37 holes (2 off) and 20 strips by 36 holes, cut from two sheets 95mm x 63mm (Vero 10346);  
1mm terminal pins (29 off)  
8-pin d.i.l. sockets (2 off)  
14-pin d.i.l. sockets (5 off)  
16-pin d.i.l. sockets (3 off)

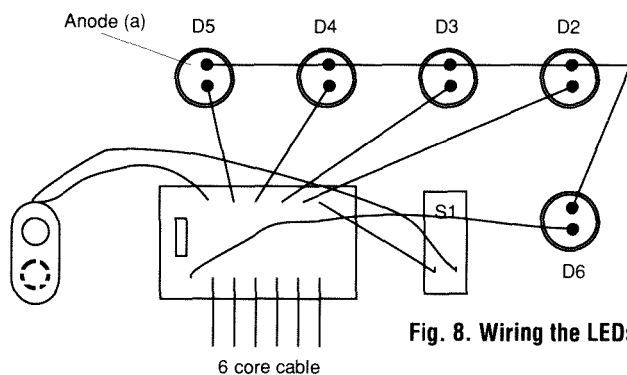

Fig. 8. Wiring the LEDs.

# PCBs for PE Projects

*Practical Electronics' circuit boards make assembly much simpler. All our PCBs are fully drilled and roller tinned – just slot in and solder the components are shown in the project.*

## Mail Order

Select the boards you want and send your order to:

**PE PCB Service, Practical Electronics, 193 Uxbridge Road, London W12 9RA**

Prices include VAT, postage and packing. Add £2 per board for overseas airmail.

Cheques should be made payable to Intra Press (payments by Access and Visa also accepted). Quote the issue, project name and PCB code number. Print your name and address in block capitals. Please do not send any other correspondence with your order.

## Phone Order

Use your Access or Visa card and phone 081 743 8888.

Although many boards are held in stock, occasionally they must be re-ordered before despatch, so please allow 28 days for delivery.

Older circuit boards may have been deleted from the catalogue. Please check the latest issue of Practical Electronics before ordering.

Photocopies of the original project text are available for £1.50 each (£2 overseas).

We do not carry components. Refer to our advertising pages for suppliers.

<b>MAR 88</b>			
APPLIANCE TIMER	166A/B	£9.38	
<b>APR 88</b>			
LIGHT METAL EFFECTS	169	£7.10	
<b>JUNE 88</b>			
AMSTRAD ROM EXPANSION	173	£12.60	
MAINS MODEM	174	£4.90	
<b>AUG 88</b>			
SPEAKING CLOCK	176	£16.75	
<b>SEPT 88</b>			
BBC MULTIPLEXER	177	£4.50	
<b>OCT 88</b>			
METAL DETECTOR	178	£6.50	
<b>DEC 88</b>			
PANNING MIXER	181	£7.80	
<b>MAR 89</b>			
CAMERA SHUTTER TIMER	187	£9.95	
<b>APR 89</b>			
PC MULTIPOINT	188A/B	£20.55	
<b>MAY 89</b>			
KIRLIAN CAMERA	189A/C	£10.50	
<b>JUNE 89</b>			
DELUXE METRONOME	198	£10.95	
<b>JULY 89</b>			
PROJECTOR SYNCHRONISER	190A	£9.50	
<b>SEP 89</b>			
FREQUENCY COUNTER-GENERATOR	194A/B	£12.50	
<b>OCT 89</b>			
HOME SECURITY CONTROLLER	196A/C	£19.50	

<b>DEC 89</b>			
VIDEO AGC STABILISER	199	£6.50	
ECHO STATION	200A/B	£11.50	
MINI METRONOME	201	£5.90	
<b>JAN 90</b>			
BARGRAPH TACHOMETER	202	£5.90	
EEPROM PROGRAMMER (KEYBOARD VER)	203	£14.50	
<b>FEB 90</b>			
EEPROM PROGRAMMER (SWITCH VERSION)	204	£4.90	
MODEM	205	£11.50	
MOCK STEREO	206	£4.90	
<b>MAR 90</b>			
RADIO CLOCK (TUNER AND PULSE)	207	£6.50	
<b>APR 90</b>			
RADIO CLOCK (DISPLAY DECODER)	208	£13.50	
PC/INTERFACE	209	£5.90	
<b>MAY 90</b>			
EPROM POLY-PROG (MAIN PCB)	210	£8.50	
<b>JUNE 90</b>			
EPROM POLY-PROG (TOP PCB)	211	£7.50	
MESSAGE MAKER	212	£9.50	
BAUD RATE CONVERTER	213	£4.90	
INTERMITTENT WIPER	214	£3.90	
CIRCUIT BREAKER	215	£4.90	
<b>JULY 90</b>			
MORSE DECODER	216	£9.50	
<b>AUG 90</b>			
SCOPE EXPANDER	217	£9.50	
VOLTAGE PROBE	218	£5.80	
AF OCTAVE MEASURER:			
FILTER DRIVE	219	£6.60	
ANALOGUE FILTER	220	£7.35	
<b>SEP 90</b>			
AF OCTAVE MEASURER			
AMPLIFIER	221	£7.35	
SWITCHED FILTER	222	£7.35	
SWITCHED FILTER DRIVE	223	£7.35	
TELE-SCOPE – MAIN PCB	224	£11.50	
<b>OCT 90</b>			
TELE-SCOPE – SIGNAL PCB	225	£4.90	
TV INTERFACE	226	£4.90	
CHIPTESTER	227	£11.50	
<b>NOV 90</b>			
BIKE COMPUTER – MAIN PCB	228	£9.50	
– POWER SAVER	229	£4.90	
<b>DEC 90</b>			
8748 PROGRAMMING ADAPTOR	230a/b	£6.50	
<b>JAN 91</b>			
CAR ALARM	231a-c	£13.50	
LCD REV COUNTER	232	£6.50	

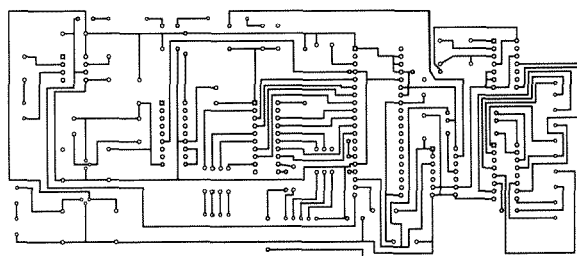

# The 6402 UART

The first in the Data Sheet series looks at the industry standard Universal Asynchronous Receiver Transmitter serial communications chip.

Serial communications systems provide a useful way of sending data from one device to another over a single wire. Because most data is held and processed in parallel form there is a need for a standard way to translate the data from parallel to serial and vice versa. The 6402 UART (Universal Asynchronous Transmitter Receiver) does this job very neatly and is flexible enough to allow a number different of parallel and serial formats. The connections for the standard 40 pin package and a functional diagram plus various tables should prove useful to anyone wanting to design a system using this device.

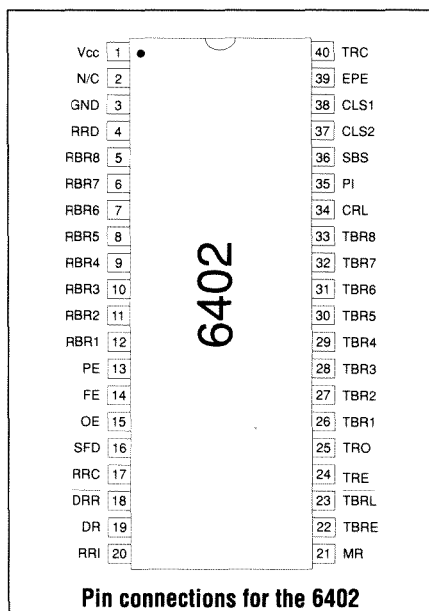

buffer register is empty and available for new data. The data from the transmitter register is clocked onto TRO at 1/16th of the clock frequency supplied to TRC.

Point 3 sees another load of data latched into the transmitter buffer register. However, the move to the transmitter register is delayed until the previous transmission is complete. At point 4 the data is automatically transferred to the transmitter register since it is now empty – as signified by TRE's brief pulse – and transmission of this character gets underway.

## Receiver Operation

Data is received into the chip via the RRI input. When no data is coming in, the RRI should be set high. The data is clocked into the chip at 1/16th of the rate defined by RRC using the timing diagram in Fig. 2.

## Transmitter Operation.

The transmitter section of the 6402 takes parallel data adds start, stop and parity where necessary and sends it in serial form through the TRO pin.

The timing of the transmitter operation is shown in Fig. 1. At point 1, data is loaded from the inputs TBR1-8 into the transmitter buffer register. The TBRL input is set low to accomplish this. If character word lengths less than 8 bits are being used only the least

significant are used. For example, a five bit character would use bits TBR1 to TBR5 leaving TBR6 to TBR8 unused.

At point 2 the rising edge of TBRL clears the TBRE output and by 1 clock cycle later, the data to be transmitted is transferred to the transmitter register causing the TRE flag to be cleared and transmission to start. TBRE will then be set high again since the transmitter

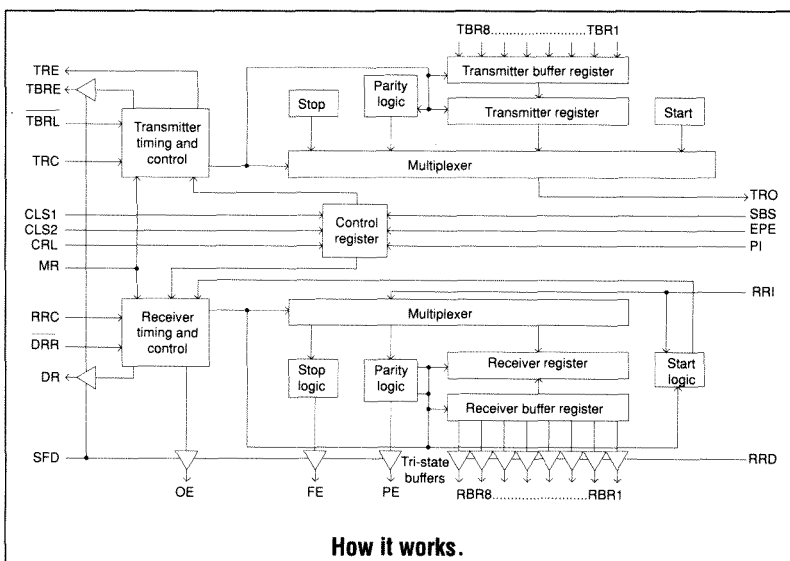

Control word	CLS2	CLS1	P1	EPE	SBS	Bits	Parity	Stop
0	0	0	0	0	0	5	Odd	1
0	0	0	0	1	1	5	Odd	1.5
0	0	0	1	0	0	5	Even	1
0	0	0	1	1	1	5	Even	1.5
0	0	1	X	0	0	5	None	1
0	0	1	X	1	1	5	None	1.5
0	1	0	0	0	0	6	Odd	1
0	1	0	0	1	1	6	Odd	2
0	1	0	1	0	0	6	Even	1
0	1	0	1	1	1	6	Even	2
0	1	1	X	0	0	6	None	1
0	1	1	X	1	1	6	None	2
1	0	0	0	0	0	7	Odd	1
1	0	0	0	1	1	7	Odd	2
1	0	0	1	0	0	7	Even	1
1	0	0	1	1	1	7	Even	2
1	0	1	X	0	0	7	None	1
1	0	1	X	1	1	7	None	2
1	1	0	0	0	0	8	Odd	1
1	1	0	0	1	1	8	Odd	2
1	1	0	1	0	0	8	Even	1
1	1	0	1	1	1	8	Even	2
1	1	1	X	0	0	8	None	1
1	1	1	X	1	1	8	None	2

The control word is clocked in under CRL.

Pin Dire  
1 In  
2 Non  
3 In  
4 In  
5 Out  
6 Out  
7 Out  
8 Out  
9 Out  
10 Out  
11 Out  
12 Out  
13 Out  
14 Out  
15 Out  
16 In  
17 In  
18 In  
19 Out  
20 In  
21 In  
22 Out  
A (DR  
Rece  
then  
gets  
from  
recei  
length  
their  
stage  
error  
has  
befo  
clear  
check  
a pa  
the P

Pin	Symbol	Description	Pin	Symbol	Description
Vcc	+Ve power supply				
N/C	Not connected				
GND	Ground (0V)		23	In(*)	TBRL
RDR	Receiver Register disable. A high level forces the receiver holding register outputs RBR1-RBR8 to high impedance.				
RBR8	Receiver Buffer Register bit 8. Holds the received data byte bit 8 – data formats of less than eight bits are justified towards bit 1.		24	Out	TRE
RBR7	Receiver Buffer Register bit 7.				
RBR6	Receiver Buffer Register bit 6.		25	Out	TRO
RBR5	Receiver Buffer Register bit 5.				
RBR4	Receiver Buffer Register bit 4.		26	In	TBR1
RBR3	Receiver Buffer Register bit 3.				
RBR2	Receiver Buffer Register bit 2.				
RBR1	Receiver Buffer Register bit 1.				
PE	Parity Error. Goes high when the received parity doesn't match that set by the control bits. It remains active until parity matches on a succeeding character. When parity is none, it is low.		27	In	TBR2
FE	Frame Error. Goes high if the first stop bit of the received is wrong. It stays active until the next valid character's stop bit is received.		28	In	TBR3
OE	Overrun Error. Goes high if the data received flag is not cleared before the last character was transferred to the receiver buffer. It is cleared at the next character's stop bit if Data Received Reset is sent low.		29	In	TBR4
SFD	Status Flags Disable. Set high forces the outputs PE, FE, OE, DR and TBRE to high impedance.		30	In	TBR5
RRC	Receiver Register Clock. Timing at 16 times the receiver data rate.		31	In	TBR6
DDR(*)	Data Received Request. Set low clears the data received output (DR) to low.		32	In	TBR7
DR	Data Received. Goes high when a character has been received and is available in the RBR.		33	In	TBR8
RRI	Receiver Register Input. Serial data supplied to here is clocked into the receiver register.		34	In	CRL
MR	Master Reset. Set high clears PE, FE, OE, DR, TRE and TBRE and sends TRO high. Less than 18 clocks after MR goes low, TRE goes high. MR doesn't clear the RBR but should be used at power up.		35	In	PI
TBRE	Transmitter Buffer Register Empty. Goes high when data is transferred to the transmitter register for serial transmission. The transmitter buffer is then ready for new data.		36	In	SBS
			37	In	CLS2
			38	In	CLS1
			39	In	EPE
			40	In	TRC

when data is transferred to the transmitter register for serial transmission. The transmitter buffer is then ready for new data.

Transmitter Buffer Register Load. Set low transfers data from the data inputs TBR1-8 to the TBR.

Transition from low to high requests data transfer to the transmitter register. If this is busy then transfer is automatically delayed until it is ready.

Transmitter Register Empty. Goes high when a character has been transmitted including the stop bits.

Transmitter Register Output. Start, character, parity and stop bits emerge here in serial form.

Transmitter Buffer Register bit 1. Data is transferred from here to the TBR where it is moved to the TB and shifted out serially via TRO.

Character lengths up to eight bits can be input on TBR1-8. If the character length is less than eight bits then bits 8, 7 and 6 may be ignored.

Transmitter Buffer Register bit 2.

Transmitter Buffer Register bit 3.

Transmitter Buffer Register bit 4.

Transmitter Buffer Register bit 5.

Transmitter Buffer Register bit 6.

Transmitter Buffer Register bit 7.

Transmitter Buffer Register bit 8.

Control Register Load. Set high transfers data to the control register from CLS2, CLS1, PI, EPE and SBS.

Parity Inhibit. Set high stops parity checking and generation in conjunction with CRL.

Stop Bit Select. Set high defines 1.5 stop bits for 5 bit characters and 2 stop bits for other lengths. Used in conjunction with CRL.

Character Length Select 2. In conjunction with CLS2, CLS1, both low selects 5-bits. CLS2 low, CLS1 high, 6-bits, CLS2 high, CLS1 low, 7-bits and both high, 8-bits. Used in conjunction with CRL.

Character Length Select 1. See CLS2. Used in conjunction with CRL.

Even parity Enable. With PI low, a high level on EPE selects even parity and low, odd. Used in conjunction with CRL.

Transmitter Register Clock. Timing at 16 times the transmitter data rate.

point 1 the Data Received Reset is set low to clear the Data received output to low. The chip is able to receive data and when it stop bit it transfers the character to the receiver register. Character of less than eight bits will have unused bits set to zero. At this a check is made for an overrun which happens when a character been received

be asserted if this occurs. At point 3, half a clock cycle later, DR is sent high and the frame error is checked for. If the stop bit was incorrect then the FE pin goes high. Having received the character and signaled its arrival on DR, the chip goes back to monitoring the RRI for the next start bit.

**Absolute maximum ratings.**

Operating temperature	-40°C to +85°C
Storage temperature	-65°C to +150°C
Operating voltage	+4V to +7V
Supply voltage	+8V
Voltage on any input or output pin	-0.3 to Vcc+0.3V

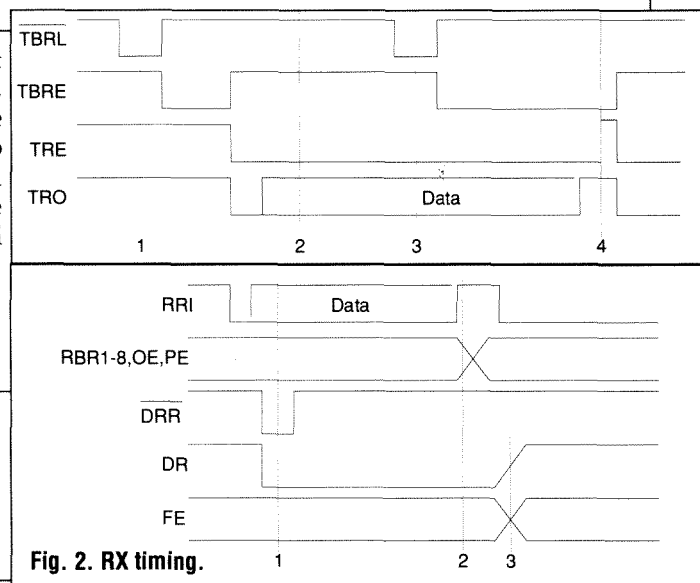

Fig. 2. RX timing.



**REAL POWER AMPLIFIER** For your car, it has 150 watts output. Frequency response 20HZ to 20 KHZ and a signal to noise ratio better than 60db. Has built in short circuit protection and adjustable input level to suit your existing car stereo, so needs no pre-amp. Works into speakers ref 30P7 described below. A real bargain at only £57.00 Order ref 57P1.

**REAL POWER CAR SPEAKERS.** Stereo pair output 100w each. 4ohm impedance and consisting of 6 1/2" woofer 2" mid range and 1" tweeter. Ideal to work with the amplifier described above. Price per pair £30.00 Order ref 30P7.

**PERSONAL STEREO** Customer returns but complete with a pair of stereo headphones very good value at £3.00 ref 3P83. We also have customer returned units with a built in FM radio at £6.00 ref 6P34

**2KV 500 WATT TRANSFORMERS.** Suitable for high voltage experiments or as a spare for a microwave oven etc. 250v AC input. £10.00 ref 10P93

**MICROWAVE CONTROL PANEL.** Mains operated, with touch switches. Complete with 4 digit display, digital clock, and 2 relay outputs one for power and one for pulsed power (programmable). Ideal for all sorts of precision timer applications etc. £6.00 ref 6P18

**FIBRE OPTIC CABLE.** Stranded optical fibres sheathed in black PVC. Five metre length £7.00 ref 7P29

**12V SOLAR CELL.** 200mA output ideal for trickle charging etc. 300 mm square. Our price £15.00 ref 15P42

**PASSIVE INFRA-RED MOTION SENSOR.** Complete with daylight sensor, adjustable lights on timer (8 secs -15 mins), 50' range with a 90 deg coverage. Manual override facility. Complete with wall brackets, bulb holders etc. Brand new and guaranteed. £25.00 ref 25P24. Pack of two PAR38 bulbs for above unit £12.00 ref 12P43

**VIDEO SENDER UNIT.** Transmit both audio and video signals from either a video camera, video recorder or computer to any standard TV set within a 100' range (tune TV to a spare channel). 12V DC op. £15.00 ref 15P39 Suitable mains adaptor £5.00 ref 5P191

**FM TRANSMITTER** housed in a standard working 13A adaptor (bug is mains driven). £18.00 ref 18P10

**MINIATURE RADIO TRANSCEIVERS.** A pair of walkie talkies with a range of up to 2 kilometres. Units measure 22x52x155mm. Complete with cases. £30.00 ref 30P12

**FM CORDLESS MICROPHONE.** Small hand held unit with a 500' range! 2 transmit power levels reqs PP3 battery. Tuneable to any FM receiver. Our price £15 ref 15P42

**10 BAND COMMUNICATIONS RECEIVER.** 7 short bands, FM, AM and LW DX/local switch, tuning 'eye' mains or battery. Complete with shoulder strap and mains lead. £34.00 ref 34P1

**WHISPER 2000 LISTENING AID.** Enables you to hear sounds that would otherwise be inaudible! Complete with headphones. Cased. £5.00 ref 5P179

**CAR STEREO AND FM RADIO.** Low cost stereo system giving 5 watts per channel. Signal to noise ratio better than 45db, wow and flutter less than .35%. Neg earth. £25.00 ref 25P21.

**LOW COST WALKIE TALKIES.** Pair of battery operated units with a range of about 150'. Our price £8.00 a pair ref 8P50

**7 CHANNEL GRAPHIC EQUALIZER** plus a 60 watt power amp! 20-21KHZ 4-8R 12-14V DC negative earth. Cased. £25 ref 25P14

**NICAD BATTERIES.** Brand new top quality. 4 x AA's £4.00 ref 4P44. 2 x C's £4.00 ref 4P73, 4 x D's £9.00 ref 9P12, 1 x PP3 £6.00 ref 6P35

**TOWERS INTERNATIONAL TRANSISTOR SELECTOR GUIDE.** The ultimate equivalents book. Latest edition £20.00 ref 20P32

**CABLE TIES.** 142mm x 3.2mm white nylon pack of 100 £3.00 ref 3P104. Bumper pack of 1,000 ties £14.00



## BUILD AN IBM COMPATIBLE PC!

AT 12 meg turbo 286 mother board.	£115.00	pc1
1 meg memory for above board.	£55.00	pc2
4 meg memory for above board.	£214.00	pc3
AT keyboard	£49.00	pc4
AT power supply and pc case (complete)	£115.00	pc5
AT controller card with 2 x serial, 1 x parallel Floppy and hard controller + mono Display driver.	£74.00	pc6
1.2 meg 3 1/2" disc drive.	£74.00	pc7
1.44 meg 5 1/4" drive.	£66.00	pc8
Amber monitor 12".	£99.00	pc9
40 meg hard disc.	£270.00	pc10
100 meg hard disc.	£595.00	pc11

minimum system consisting of mother board, 1 meg of memory, case, power supply, 1.44 meg floppy, interfaces, and monitor is £525.00 inc VAT (single drive mono 286) pc12  
£795.00 inc VAT (40 meg + floppy + mono 286) pc13

**1991 CATALOGUE AVAILABLE NOW IF YOU DO NOT HAVE A COPY PLEASE REQUEST ONE WHEN ORDERING OR SEND US A 6"x9" SAE FOR A FREE COPY.**

**GEIGER COUNTER KIT.** Complete with tube, PCB and all components to build a battery operated geiger counter. £39.00 ref 39P1

**FM BUG KIT.** New design with PCB embedded coil. Transmits to any FM radio. 9v battery req'd. £5.00 ref 5P158

**TV SOUND DECODER.** Nicely cased unit, mains powered 8 channel will drive a small speaker directly or could be fed into Hi Fi etc. Our price £12.00 ref 12P22

**COMPOSITE VIDEO KITS.** These convert composite video into separate H sync, V sync and video. 12v DC. £8.00 ref 8P39

**SINCLAIR C5 MOTORS.** 12v 29A (full load) 3300 rpm 6"x4" 1/4" Q/P shaft. New. £20.00 ref 20P22

As above but with fitted 4 to 1 inline reduction box (800rpm) and toothed nylon belt drive cog £40.00 ref 40P8.

**SINCLAIR C5 WHEELS** 13" or 16" dia including treaded tyre and

inner tube. Wheels are black, spoked one piece poly carbonate. 13" wheel £6.00 ref 6P20, 16" wheel £6.00 ref 6P21.

**ELECTRONIC SPEED CONTROL KIT** for c5 motor. PCB and all components to build a speed controller (0-95% of speed). Uses pulse width modulation. £17.00 ref 17P3

**SOLAR POWERED NICAD CHARGER.** Charges 4 AA nicads in 8 hours. Brand new and cased £6.00 ref 6P3

**MOSFETS FOR POWER AMPLIFIERS ETC.** 100 watt mosfet pair 2S499 and 2SK443 £4.00 a pair with pin out info ref 4P51. Also available is a 2SK413 and a 2SJ118 at £4.00 ref 4P42.

**10 MEMORY PUSH BUTTON TELEPHONES.** These are 'customer returns' so they may need slight attention. BT approved. £6.00 each ref 6P16 or 2 for £10.00 ref 10P77.

**12 VOLT BRUSHLESS FAN** 4 1/2" square brand new ideal for boat, car, caravan etc. £8.00 each ref 8P26

**acorn data recorder ALF503.** Made for BBC computer but suitable for others. Includes mains adapter, leads and book. £15.00 ref 15P43

**VIDEO TAPES.** Three hour superior quality tapes made under licence from the famous JVC company. Pack of 10 tapes £20.00 ref 20P20

**ELECTRONIC SPACESHIP.** Sound and impact controlled, responds to claps and shouts and reverses when it hits anything. Kit with complete assembly instructions £10.00 ref 10P81.



**PHILIPS LASER. 2MW HELIUM NEON LASER TUBE. BRAND NEW FULL SPEC £40.00 REF 40P10. MAINS POWER SUPPLY KIT £20.00 REF 20P33 READY BUILT AND TESTED LASER IN ONE CASE £75.00 REF 75P4.**

**SWITCHED MODE POWER SUPPLY** (Boshert) +5 at 15A, +12 at 3A, -12 at 2A, +24 at 2A. 220 or 110v input. Brand new £20.00 ref 20P30

**SOLDER 22SWG** resin cored solder on a 1/2kg reel. Top quality. £4.00 a reel ref 4P70

**600 WATT HEATERS.** Ideal for air or liquid, will not corrode, lasts for years. coil type construction 3"x2" mounted on a 4" dia metal plate for easy fixing. £3.00 ea ref 3P78 or 4 for £10.00 ref 10P76

**TIME AND TEMPERATURE MODULE.** A clock, digital thermometer (Celsius and Fahrenheit (0-160 deg F) programmable too hot and too cold alarms. Runs for at least a year on one AA battery. £9.00 ref 9P5

**Remote temperature probe** for above unit £3.00 ref 3P60

**GEARBOX KITS.** Ideal for models etc. Contains 18 gears (2 of each size) 4x50mm axles and a powerful 9-12v motor. All the gears etc are push fit. £3.00 for complete kit ref 3P93

**ELECTRONIC TICKET MACHINES.** These units contain a magnetic card reader, two matrix printers, motors, sensors and loads of electronic components etc. (12"x12"x7") Good value at £12.00 ref 12P28

**JOYSTICKS.** Brand new with 2 fire buttons and suction feet these units can be modified for most computers by changing the connector etc. Price is 2 for £5.00 ref 5P174

**QUALITY PANEL METERS.** 50uA movement with 3 different scales that can be brought into view with a lever! £3.00 each ref 3P81

**CAR IONIZER KIT.** Improve the air in your car! cleans smoke and helps to reduce fatigue. Case required. £12.00 ref 12P8

**METAL DETECTOR.** Fun light weight device for buried treasure! 33" long with tune and fine tune controls. £10.00 ref 10P101

**6V 10AH LEAD ACID** sealed battery by yuasha ex equipment but in excellent condition now only 2 for £10.00 ref 10P95

**12 TO 220V INVERTER KIT.** As supplied it will handle up to about 15 w at 220v but with a larger transformer it will handle 100 watts. Basic kit £12.00 ref 12P17. Larger transformer £12.00 ref 12P41.

**VERO EASI WIRE PROTOTYPING SYSTEM.** Ideal for designing projects on etc. Complete with tools, wire and reusable board. Our price £6.00 ref 6P33

**MICROWAVE TURNABLE MOTORS.** Complete with weight sensing electronics that would have varied the cooking time. Ideal for window displays etc. £5.00 ref 5P165

**STC SWITCHED MODE POWER SUPPLY.** 220v or 110v input giving 5v at 2A, +24v at 0.25A, +12v at 0.15A and +90v at 0.4A £12.00 ref 12P27

**CAMERA FLASH UNITS.** Require a 3V DC supply to flash. £2.00 each ref 2P38 or 6 for £10.00 ref 10P101 (ideal multi-flash photography)

**TELEPHONE AUTODIALERS.** These units, when triggered will automatically dial any telephone number. Originally made for alarm panels. BT approved. £12.00 ref 12P23 (please state telephone no req'd)

**25 WATT STEREO AMPLIFIER** ic. STK043. With the addition of a handful of components you can build a 25 watt amplifier. £4.00 ref 4P69 (Circuit dia included)

**MINIATURE DOT MATRIX PRINTER** assembly 24 column 5v (similar to RS type). £10.00 each ref 10P92

**LINEAR POWER SUPPLY.** Brand new 220v input +5 at 3A, +12 at 1A, -12 at 1A. Short circuit protected. £12.00 ref 12P21.

**MAINS FANS.** Small type construction. Approx 4"x5" mounted on a metal plate for easy fixing. New £5.00 5P166

**POWERFUL IONIZER KIT.** Generates 10 times more ions than commercial units! Complete kit including case £18.00 ref 18P2

**MINI RADIO MODULE.** Only 2" square with ferrite aerial and tuner.

Superhet. Req's PP3 battery. £1.00 ref BD716

**HIGH RESOLUTION MONITOR.** 9" black and white Phillips tube in chassis made for OPD computer but may be suitable for others. £20.00 ref 20P26

**SURFACE MOUNT KIT.** Makes a high gain snooping amplifier on a PCB less than an inch square! £7.00 ref 7P15

**SURFACE MOUNT SOLDER.** In easy to use tube. Ideal for above project £12.00 ref 12P18

**CB CONVERTORS.** Converts a car radio into an AM CB receiver. Cased with circuit diagram. £4.00 ref 4P48

**FLOPPY DISCS.** Pack of 15 3 1/2" DSDD £10.00 ref 10P88. Pack of 10 5 1/4" DSDD £5.00 ref 5P168

**SONIC CONTROLLED MOTOR.** One click to start, two click to reverse direction, 3 click to stop! £3.00 each ref 3P137

**FRESNEL MAGNIFYING LENS.** 83 x 52mm £1.00 ref BD827. lcd display. 4 1/2 digits supplied with connection data £3.00 ref 3P77 or 5 for £10.00 ref 10P78

**TRANSMITTER AND RECEIVER.** These units were designed for nurse call systems and transmit any one of 16 different codes. The transmitter is cased and designed to hang round the neck. £12.00 a pair ref 12P26

**ALARM TRANSMITTERS.** No data available but nicely made complex transmitters 9v operation. £4.00 each ref 4P81

**100M REEL OF WHITE BELL WIRE.** figure 8 pattern ideal for intercoms, door bells etc £3.00 a reel ref 3P107

**ULTRASONIC LIGHT.** This battery operated unit is ideal for the shed etc as it detects movement and turns a light on for a preset time. (light included). Could be used as a sensor in an alarm system. £14.00 each ref 14P8

**CLAP LIGHT.** This device turns on a lamp at a finger 'snap' etc. £4.00 each ref 4P82

**ELECTRONIC DIPSTICK KIT.** Contains all you need to build an electronic device to give a 10 level liquid indicator. £5.00 (ex case) ref 5P194

**UNIVERSAL BATTERY CHARGER.** Takes AA's, C's, D's and PP3 nicads. Holds up to 5 batteries at once. New and cased, mains operated. £6.00 ref 6P36

**ONE THOUSAND CABLE TIES!** 75mm x 2.4mm white nylon cable ties only £5.00 ref 5P181

**HI-FI SPEAKER.** Full range 131mm diameter 8 ohm 60 watt 63-20 khz excellent reproduction. £12.00 ref 12P33

**ASTEC SWITCHED MODE POWER SUPPLY.** 80mm x 165mm (PCB size) gives +5 at 3.75A, +12 at 1.5A, -12 at 0.4A. Brand new £12.00 ref 12P39

**VENTILATED CASE FOR ABOVE PSU** with IEC filtered socket and power switch. £5.00 ref 5P190

**IN CAR POWER SUPPLY.** Plugs into cigar socket and gives 3.4, 6.7, 5.9, and 12v outputs at 800mA. Complete with universal spider plug. £5.00 ref 5P167

**CUSTOMER RETURNED** switched mode power supplies. Mixed type, good for spares or repair. £2.00 each ref 2P292

**DRILL OPERATED PUMP.** Fits any drill and is self priming. £3.00 ref 3P140

**PERSONAL ATTACK ALARM.** Complete with built in torch and vision mirror. Pocket sized, req's 3 AA batteries. £3.00 ref 3P135

**POWERFUL SOLAR CELL 1AMP .45 VOLT!** only £5.00 ref 5P192 (other sizes available in catalogue)

**SOLAR PROJECT KIT.** Consists of a solar cell, special DC motor, plastic fan and turntables etc plus a 20 page book on solar energy! Price is £8.00 ref 8P51

**RESISTOR PACK.** 10 x 50 values (500 resistors) all 1/4 watt 2% metal film. £5.00 ref 5P170

**CAPACITOR PACK 1.** 100 assorted non electrolytic capacitors £2.00 ref 2P286

**CAPACITOR PACK 2.** 40 assorted electrolytic capacitors £2.00 ref 2P287

**QUICK CUPPA?** 12v immersion heater with lead and cigar lighter plug £3.00 ref 3P92

**LED PACK .** 50 red leds, 50 green leds and 50 yellow leds all 5mm £8.00 ref 8P52

**12" HIGH RESOLUTION MONITOR. AMBER SCREEN BEAUTIFULLY CASED NEEDS 12V AT 1A TTL INPUT (SEP SYNC). £22.00 REF 22P2.**

**RADIO CONTROLLED CAR.** Single channel R/c buggy with forward reverse and turn controls, off road tyres and suspension. £12.00 ref 12P40

**FERRARI TESTAROSSA.** A true 2 channel radio controlled car with forward, reverse, 2 gears plus turbo. Working headlights. £22.00 ref 22P6

**SUPER FAST NICAD CHARGER.** Charges 4 AA nicad's in less than 2 hours! Plugs into standard 13A socket. Complete with 4 AA nicad batteries £16.00 ref 16P8

**ULTRASONIC WIRELESS ALARM SYSTEM.** Two units, one a sensor which plugs into a 13A socket in the area you wish to protect. The other, a central alarm unit plugs into any other socket elsewhere in the building. When the sensor is triggered (by body movement etc) the alarm sounds. Adjustable sensitivity. Price per pair £20.00 ref 20P34. Additional sensors (max 5 per alarm unit) £11.00 ref 11P6

**TOP QUALITY MICROPHONE.** Unidirectional electret condenser mic 600 ohm sensitivity 16-18khz built in chrome complete with magnetic microphone stand and mic clip. £12.00 ref 12P42

**WASHING MACHINE PUMP.** Mains operated new pump. Not self priming £5.00 ref 5P18

**IBM PRINTER LEAD.** (D25 to centronics plug) 2 metre parallel. £5.00 ref 5P186

**QUICK FIX MAINS CONNECTOR.** Ideal for the fast connection of mains equipment. Neon indicator and colour coded connectors. £7.00 ref 7P18

**COPPER CLAD STRIP BOARD.** 17" x 4" of 1" pitch 'vero' board. £4.00 a sheet ref 4P62 or 2 sheets for £7.00 ref 7P22

**STRIP BOARD CUTTING TOOL.** £2.00 ref 2P352  
3 1/2" disc drive. 720K capacity made by NEC £60.00 ref 60P2  
**TV LOUDSPEAKERS.** 5 watt magnetically screened 4 ohm 55 x 125mm. £3.00 a pair ref 3P109  
**TV LOUDSPEAKERS.** 3 watt 8 ohm magnetically screened 70 x 50mm. £3.00 a pair ref 3P108  
**TOROIDAL TRANSFORMER.** 24v 5A encapsulated 4" dia £5.00 ref 5P34

BULL ELECTRICAL

250 PORTLAND ROAD HOVE

SUSSEX BN3 5QT DEPT PE

TELEPHONE 0273 203500

MAIL ORDER TERMS: CASH PO OR CHEQUE

WITH ORDER PLUS £2.50 POST

FAX 0273 23077

# Basic Electronics

The final part of Owen Bishop's introductory series looks at oscillators and electromagnetic radiation, and describes how to build a simple radio receiver.

To conclude this series we look at one of the earliest and still one of the major applications of electronics - radio communication. Before we do this, we need to pick up one of the topics mentioned last month and consider it in more detail.

## LC tuned circuit

Looking at Fig. 1, suppose that it starts off with the capacitor fully charged, as in (1). At this instant no current is flowing in the circuit, so there is no magnetic field in the inductor. This has negligible resistance and the capacitor discharges through it causing a magnetic field to appear in the inductor coil (b). The capacitor eventually becomes fully discharged (c) and at this point the current should cease to flow and the magnetic field collapse. But, an inductor generates a back EMF to maintain any current through it which continues to flow in the same direction as before. This charges the capacitor but in the opposite direction. The capacitor eventually becomes fully charged again as the current dies away (d). This state lasts only an instant since the whole process repeats from (a) but with the current flowing in the opposite direction. The frequency at which this changeover or oscillation takes place is given by:

$$f = 1/(2\pi\sqrt{LC})$$

These oscillations can continue for quite a long time since the only loss is due to the resistance of the circuit converting some of the energy to heat. By topping up the capacitor at precisely timed

intervals it will oscillate indefinitely. The situation is similar to pushing someone on a swing. If the swing is pushed regularly at the wrong moment, it will slow down. However, if it is pushed at the right time it will keep on swinging and even get higher.

In a Colpitts oscillator, energy is supplied to the LC circuit by using a transistor to produce an alternating voltage across it. This is kept in phase with the oscillations in the circuit by tapping off a signal from the capacitor and feeding it back to the transistor. In another type of oscillator, the Hartley oscillator, the signal is tapped off from the inductor coil and used in a similar way.

## EM radiation

Listed in order of increasing wavelength, electromagnetic (EM) radiation starts with gamma rays (10-12pm where the p starts for pico or  $10^{-12}$ ), X-rays, ultraviolet, visible light, infra-red, microwaves and radio waves (about 1cm up to 1km or more).

Like all forms of EM radiation, radio waves spread out from their source in all directions and, potentially, can travel indefinitely into space. However, they can be absorbed, reflected or refracted and are affected by EM and gravitational fields.

EM radiation is a combination of two oscillating forces, one electrical and the other magnetic, vibrating at right angles to each other and at right angles to the direction in which the waves are travelling.

Any electrical event that produces rapid changes of electron velocity can be a source of radio waves. A natural example is a lightning strike, and an artificial example is the spark produced when a switch is opened. Either of these events causes a surge of electromagnetic radiation, which spreads out from the source and is detectable by a radio receiving circuit. Some of the earliest radio transmitters relied on the production of sparks to generate the signal.

In the aerial or antenna of a modern radio transmitter, electrons

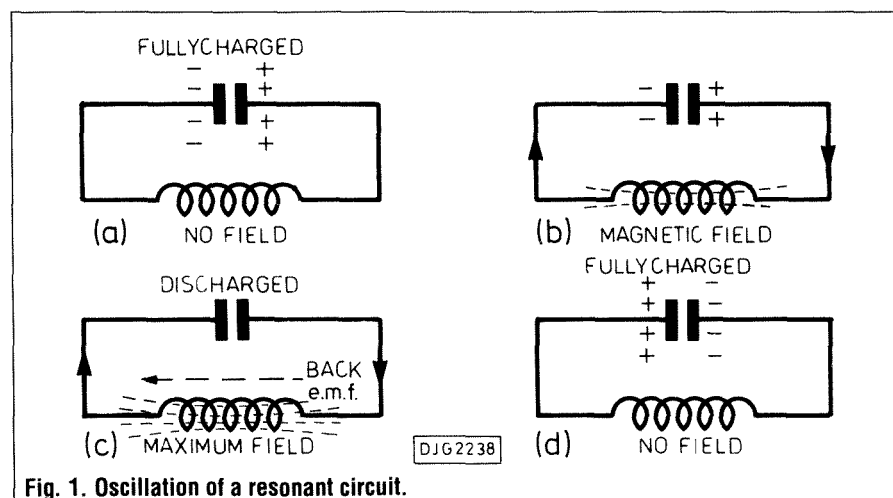

# Practical Electronics is giving away up to £2,000 to its readers!

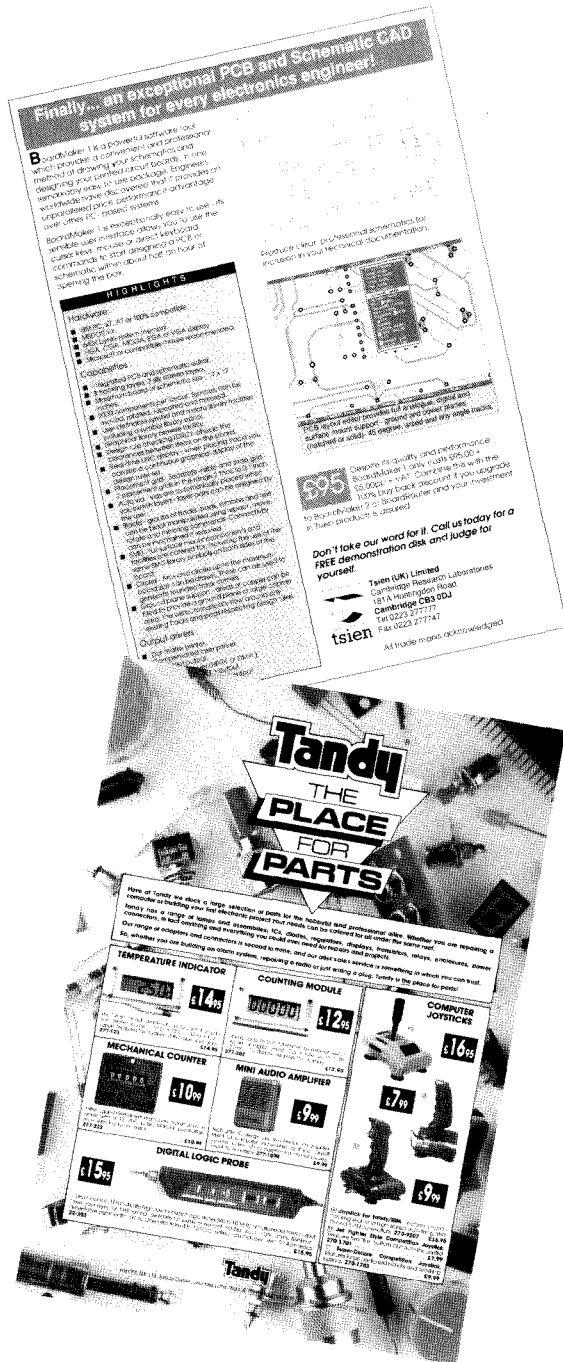

## March Madness!

The cash bonanza continues.  
Don't miss out – enter now and  
win up to £200 pounds.

We're offering to refund 10 readers of  
Practical Electronics up to £200.00 for  
purchases made from advertisers in this  
issue of PE.

The rules are simple:  
Buy any product from any advertiser and we will  
refund you all or part of the cost, up to a maximum  
value of £150, or £200 if you are a subscriber.

All you have to do is complete and cut the coupon  
below and send it to us. Then if you are one of the  
lucky readers drawn out of the bag on April the  
5th, we will refund your money upon proof of  
purchase.

Needless to say, this is one offer you  
really can't afford to refuse!

**Buy any product  
from any of our  
advertisers!**

Send to: PE Reader Loyalty Bonus, March 1990,  
Intra Press, 193 Uxbridge Road, London W12 9RA

I purchased ..... price .....  
as advertised by .....  
Name: .....  
Address: .....  
Town: ..... Postcode: .....

I AM A SUBSCRIBER

Complete and return this coupon as soon as possible. The winners will be  
announced in the June issue of PE, published on the first Thursday in May.

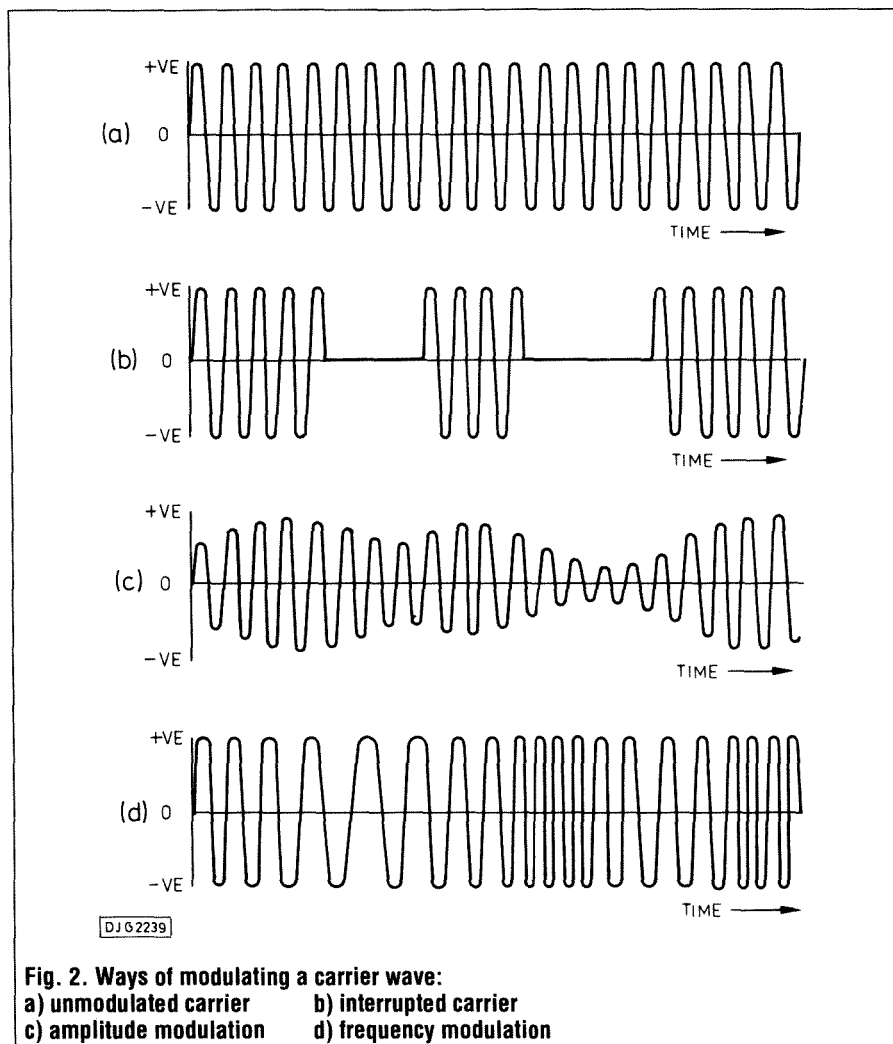

are accelerated to and fro by an alternating electric field. The energy for this field comes from the transmitter circuit. The oscillations of the electrons generate electric and magnetic forces (i.e. radio waves) which spread out from the antenna.

## Modulation

The oscillator of a radio transmitter produces a sine wave of constant amplitude and frequency (Fig. 2a) – known as a carrier wave, since it is used to carry information. Putting information onto this carrier is known as modulation and the simplest way of doing this is to turn it on and off repeatedly. This produces an interrupted carrier wave (Fig. 2b) which can be used to transmit a code, such as the Morse.

A more sophisticated method is amplitude modulation (AM), as shown in Fig. 2c. Fig. 3 shows how the information to be transmitted (speech, music) is picked up by a microphone, amplified by an audio frequency (AF) amplifier and fed to

a circuit called a modulator which superimposes the audio signal onto the carrier. Fig. 4a shows the original carrier wave and Fig. 4b shows the audio signal. In the modulated carrier wave of Fig. 4c, the frequency of the wave is that of the carrier, but the amplitude varies according to the audio signal. Since

the frequency of the carrier is so much higher than that of the audio signal, the amplitude of the carrier follows the shape of the audio signal almost exactly.

Another way of adding signal information to the carrier is frequency modulation (FM), as shown in Fig. 2d. This requires a different type of modulator circuit to slightly increase or decrease the carrier frequency according to the audio signal. A third method of modulation is phase modulation (PM), in which the phase of the carrier is varied according to the audio signal.

## Transmitters

The carrier wave of a transmitter is produced by a radio-frequency (RF) oscillator (Fig. 3) which may be based on a LC circuit (Colpitts or Hartley). Unfortunately, these circuits have frequency stability problems under a range of operating conditions. One solution is to use a piezo-electric crystal in the circuit. Now, the capacitor and inductor pair form an oscillating circuit with the latter being part of a RF transformer allowing the oscillating signal to appear on the coil feeding the aerial. The oscillations are maintained by the fluctuating collector potential of the transistor. This also causes the crystal to vibrate at its natural frequency, which is close to that of the tuned circuit. The vibrations of the crystal act as feedback, varying the base current to the transistor and hence the collector current and potential. Whereas the tuned circuit

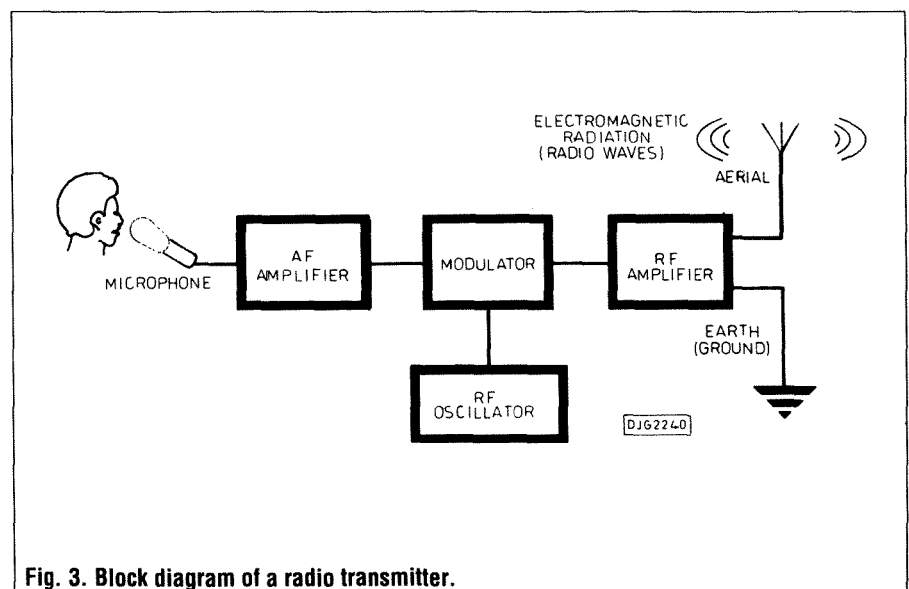

# Finally... an exceptional PCB and Schematic CAD system for every electronics engineer!

**B**oardMaker 1 is a powerful software tool which provides a convenient and professional method of drawing your schematics and designing your printed circuit boards, in one remarkably easy to use package. Engineers worldwide have discovered that it provides an unparalleled price performance advantage over other PC-based systems.

BoardMaker 1 is exceptionally easy to use - its sensible user interface allows you to use the cursor keys, mouse or direct keyboard commands to start designing a PCB or schematic within about half an hour of opening the box.

## HIGHLIGHTS

### Hardware:

- IBM PC, XT, AT or 100% compatible.
- MSDOS 3.x.
- 640K bytes system memory.
- HGA, CGA, MCGA, EGA or VGA display.
- Microsoft or compatible mouse recommended.

### Capabilities:

- Integrated PCB and schematic editor.
- 8 tracking layers, 2 silk screen layers.
- Maximum board or schematic size - 17 x 17 inches.
- 2000 components per layout. Symbols can be moved, rotated, repeated and mirrored.
- User definable symbol and macro library facilities including a symbol library editor.
- Graphical library browse facility.
- Design rule checking (DRC) - checks the clearances between items on the board.
- Real-time DRC display - when placing tracks you can see a continuous graphical display of the design rules set.
- Placement grid - Separate visible and snap grid - 7 placement grids in the range 2 thou to 0.1 inch.
- Auto via - vias are automatically placed when you switch layers - layer pairs can be assigned by the user.
- Blocks - groups of tracks, pads, symbols and text can be block manipulated using repeat, move, rotate and mirroring commands. Connectivity can be maintained if required.
- SMD - full surface mount components and facilities are catered for, including the use of the same SMD library symbols on both sides of the board.
- Circles - Arcs and circles up to the maximum board size can be drawn. These can be used to generate rounded track corners.
- Ground plane support - areas of copper can be filled to provide a ground plane or large copper area. This will automatically flow around any existing tracks and pads respecting design rules.

### Output drivers:

- Dot matrix printer.
- Compensated laser printer.
- PostScript output.
- Penplotter driver (HPGL or DMPL).
- Photoplot (Gerber) output.
- NC (ASCII Excellon) drill output.

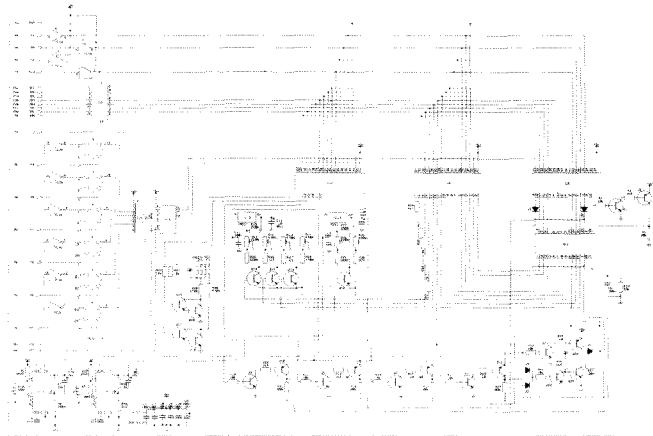

Produce clear, professional schematics for inclusion in your technical documentation.

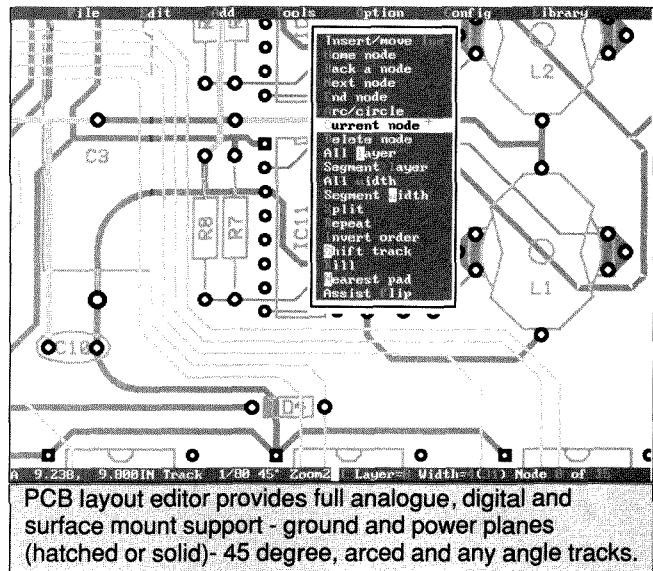

PCB layout editor provides full analogue, digital and surface mount support - ground and power planes (hatched or solid) - 45 degree, arced and any angle tracks.

**£95**

Despite its quality and performance, BoardMaker 1 only costs £95.00 + £5.00pp + VAT. Combine this with the 100% buy back discount if you upgrade to BoardMaker 2 or BoardRouter and your investment in Tsien products is assured.

**Don't take our word for it. Call us today for a FREE demonstration disk and judge for yourself.**

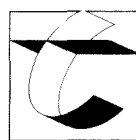

**tsien**

**Tsien (UK) Limited**  
 Cambridge Research Laboratories  
 181A Huntingdon Road  
**Cambridge CB3 0DJ**  
 Tel 0223 277777  
 Fax 0223 277747

All trade marks acknowledged



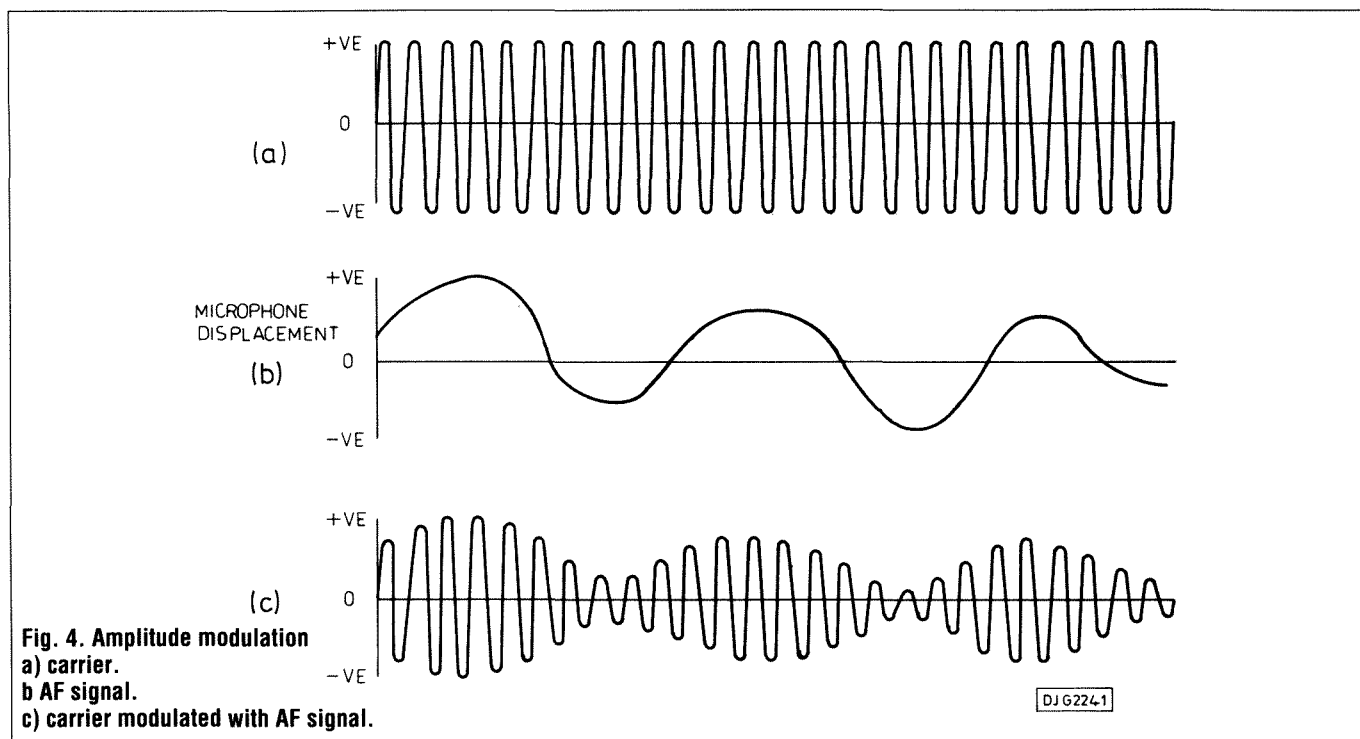

Fig. 4. Amplitude modulation  
 a) carrier.  
 b) AF signal.  
 c) carrier modulated with AF signal.

is able to resonate to a range of frequencies around its theoretical resonant frequency, the crystal oscillates at a frequency that is determined by its physical dimensions.

Crystals are made to exacting standards and a typical radio oscillator crystal is precise to 30 parts per million (ppm), and varies by only 50 ppm over the normal range of operating temperatures.

## Radio transmission

In Fig. 3 the carrier wave is fed directly to the aerial but, in most transmitters, there is an RF amplifier to increase the power before it is sent to the aerial. This consists of a simple metal rod or, for transmitters in the medium-wave and long-wave bands, it may be a wire or array of wires suspended above ground on tall masts. EM radiation spreads out in all directions which gives wide distribution of the signal but is wasteful of energy. By suitable design of the array it is possible to concentrate the radiation and increase the transmission range in one particular direction. In the UHF bands the aerial is much shorter and is often mounted at the focal point of a parabolic metal or wire-mesh reflector. Such as dish not only has the advantage of maximising transmission range but gives a certain amount of privacy to

transmissions.

## Reception

The first requirement in a radio receiver is an aerial to intercept the radio waves. In the early days of radio, the aerial was a wire several metres long, suspended as high as possible above the ground (Fig. 5), known as a 'long wire' aerial. Its ends were attached to insulators so that there was no direct conduction of the signal to the ground. Radio waves passing through such an aerial exert forces on the electrons in the wire, resulting in an alternating current.

A simple 'long-wire' wire aerial is intended to receive a wide range of wavelengths. The exact length of the wire itself is immaterial, the general rule being that the longer the wire, the stronger the reception. Aerials for UHF and VHF are generally designed to receive only a limited range of frequencies. The length of the receiving element is important. In a commonly-

used type of aerial, the dipole, the total length of the aerial is half the radio wavelength (Fig. 6). At the centre of the aerial the fluctuations in current produced by the radio wave are at a maximum, while fluctuations in voltage are at a minimum. The aerial is split at this point and connections made to the receiver. A simple dipole may be combined in the aerial array with one or more metal rods which act as reflectors and directors (Fig. 7). These not only enhance the strength of the reception but give the array directional sensitivity. It can be 'aimed' at the transmitter, receiving signals from it strongly, yet ignoring signals from other transmitters not in line with the

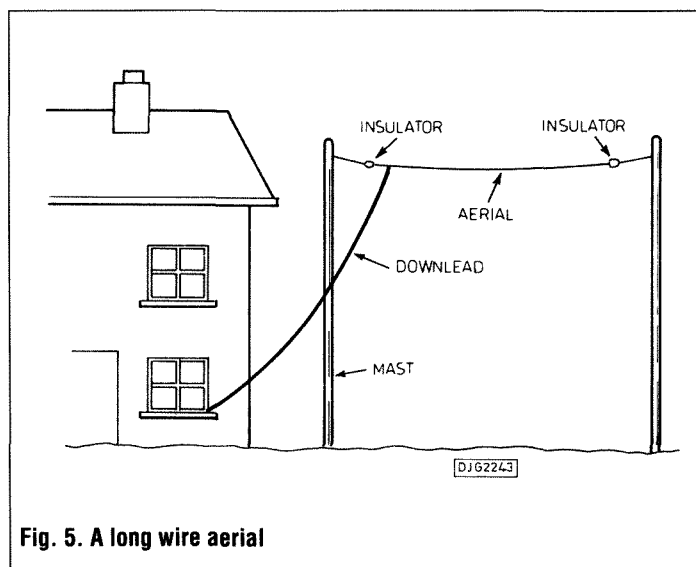

Fig. 5. A long wire aerial

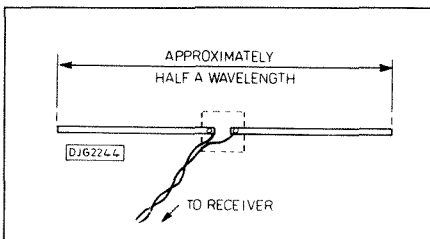

Fig. 6. A dipole aerial.

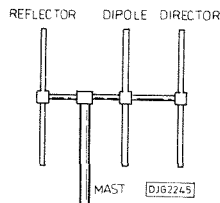

Fig. 7. A 2-Element receiving mast.

array.

With present-day radio receivers in the medium and long wave bands, a rod of material, known as ferrite, is normally used. This is a composite material with a high magnetic permeability – if the rod is placed in a magnetic field, the magnetic lines of force tend to bunch together and pass through the rod, rather than pass by on either side of it. When radio waves arrive, their magnetic component is concentrated by the rod to produce a strong alternating magnetic field within it. For maximum effect the rod is placed so it is perpendicular to the arriving wave, making it directional. The rod has one or more coils wound round it and, as the field in the rod alternates in response to the radio waves, an alternating current is induced in the coil. The coil is connected as the inductor in an LC tuned circuit (Fig. 1) and as there is usually more than one coil, each can be used for receiving different wavebands.

### AM receiving circuits

The simplest type of AM receiver is illustrated in Fig. 8. There is very little in this receiver, apart from the tuned circuit consisting of the inductor L1 and the variable capacitor VC1 – to allow the circuit to be tuned to different radio frequencies. This type of receiver is known as a tuned radio frequency receiver. The inductor consists of about 85 turns of enamelled copper

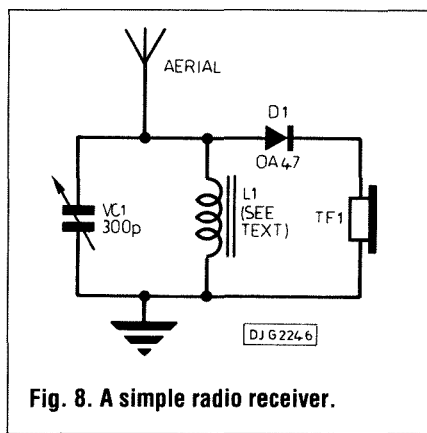

Fig. 8. A simple radio receiver.

wire wound on a ferrite rod. Although the rod is acting as an aerial, as described above, it doesn't supply enough power and a 'long wire' aerial must also be attached to one side of the tuned circuit, the

the signal appears across the combined high impedances of the inductor and capacitor connected in parallel. It can not pass to Earth and is available to pass to the next stage of the receiver circuit.

The next step in reception is rectification or detection which, in the circuit of Fig. 8, is performed by the diode D1. This takes the place of the crystal of the early crystal sets where the diode consisted of a fine wire, the 'cat's whisker', touching against a crystal of galena, a mineral consisting mainly of lead sulphide. The diode in Fig. 8 conducts only during the positive-going half of the waveform, producing the rectified signal shown in Fig. 9b. This is still an RF signal but the carrier part is no

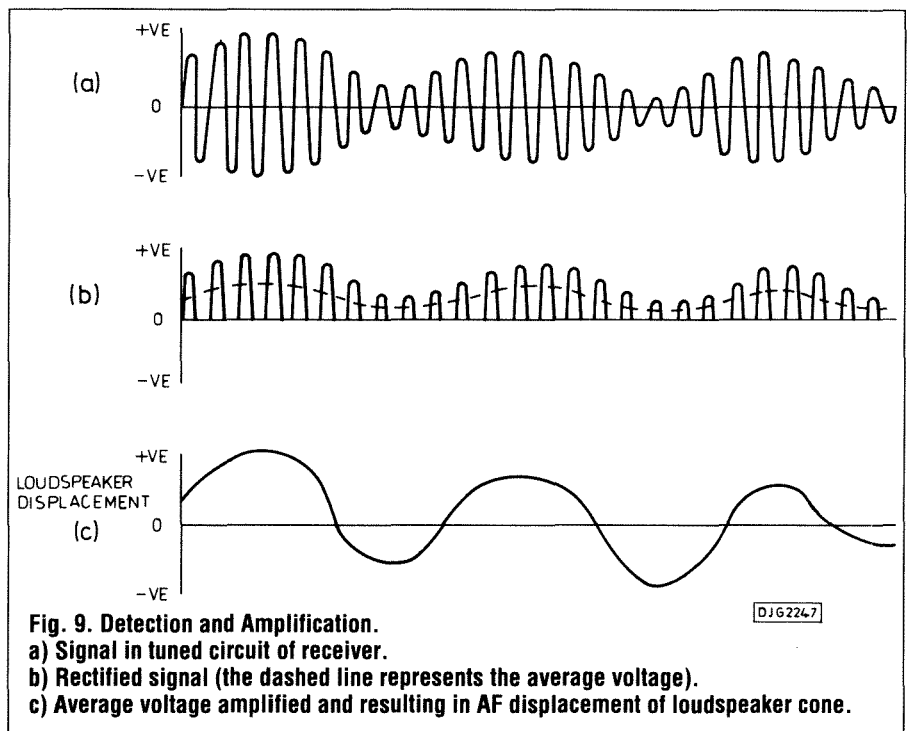

Fig. 9. Detection and Amplification.  
 a) Signal in tuned circuit of receiver.  
 b) Rectified signal (the dashed line represents the average voltage).  
 c) Average voltage amplified and resulting in AF displacement of loudspeaker cone.

other side being connected to Earth.

Fig. 9 shows what happens when this circuit is receiving an AM radio signal. If the circuit is tuned to the correct frequency, it resonates and the signal appearing across it is as shown in Fig. 9a. This is a replica of the transmitted signal with an amplitude of a few millivolts. The action of the tuned circuit can also be explained by considering it to be a band-pass filter. At frequencies lower than the tuned frequency, the signal passes to Earth through the inductor. At frequencies higher than the tuned frequency, the signal passes to Earth through the capacitor. At the tuned frequency

longer required and is removed by means of a low-pass filter. In practice, there is no need to use a resistor and capacitor specially for this. The resistance of the diode and the capacitance of the earphone TF1 together do the job. The signal that passes through this filter is the average voltage, shown in Fig. 9b by a dashed line. This is an AF signal, a replica of the original audio signal (Fig. 4b), and can be heard in the earphone.

### Investigation 1

*Radio receiver with amplification*  
 This circuit (Fig. 11) has tuning and detection stages and an amplifier.

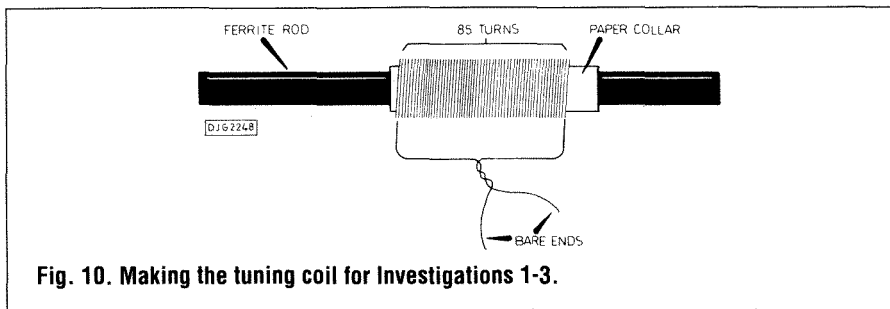

Fig. 10. Making the tuning coil for Investigations 1-3.

Assemble the circuit as in Fig. 13. The circuit diagram shows a loud-speaker. This is of the high-resistance ( $64\Omega$ ) type, not one of the low-resistance types ( $4\Omega$ ,  $8\Omega$ , or  $12\Omega$ ) more commonly used in audio circuits. With a really powerful transmitter near by, it is possible to obtain enough power to operate the speaker, but you may have to place your ear close to hear clearly. Alternatively, use a crystal earphone.

## Selectivity

You will probably have noticed that, unless you have only one strong transmitter in your neighbourhood, it is not easy to tune the receiver so as to receive only one station at a time. This is because the tuned circuit is capable of resonating to a greater or lesser extent over a fairly wide range of frequencies. It is not selective. The situation becomes worse at night

when the strengthening of the ionosphere helps bring in more and more distant stations. Selectivity may be improved in a number of ways, all of which result in more complicated circuits which can not easily be assembled on a breadboard. Fortunately there are several ICs available which include almost complete radio circuits on a single chip. One of these is the ZN414, which contains 4 radio-frequency amplifiers and a transistorised detection stage. As a result of the RF amplifiers a 'long wire' aerial is not required. The ZN414 is used in this month's module.

## The superhet

The superheterodyne receiver employs a commonly used technique for improving the selectivity of AM reception. Its circuitry is shown in Fig. 12 and is more complicated than that of any

of the receivers described in this article,

The superhet depends on the phenomenon known as beats. When two waves of similar form and amplitude but slightly different frequencies are combined, the resultant shows regular changes of amplitude, or beats. This effect can be noticed if two people whistle the same note and then one changes slightly. The combined tones produce a throbbing effect whose frequency depends on the notes and their

differences. Fig. 13 illustrates this. A shows a wave at 200Hz (20 waves in 0.1s) and B a similar wave, but at 202Hz. C we shows both these waves drawn in thin lines and the sum of A and B is drawn in a thick line. Its amplitude varies or beats with a frequency of 2Hz. The rule is that, if we combine two waves of frequency  $f_1$  and  $f_2$ , the beat frequency is the absolute value of the difference between them.

The superhet receiver uses an RF oscillator, operating at an intermediate frequency (IF). When the receiver is tuned to a particular station, the IF oscillator is tuned to a frequency that differs by a fixed amount from the station frequency. Usually this is 455kHz above the station frequency and is mixed with the signal from the aerial in a mixer circuit. The result is a new RF signal which beats at a frequency equal to the difference between the station and IF frequencies, that is, at 455kHz. The amplitude modulation of the station signal is superimposed on this, just as it was on the original transmitted signal. The point about this process is that whatever the station frequency a modulated 455kHz signal is always produced. This is then amplified with a narrow band-pass filter to ensure that only a signal at exactly 455kHz is passed which means that the receiver is very selective. Stations on nearby wavelengths produce an IF other than 455kHz and so do not pass through the filter. There is also the advantage that, since the amplifiers and subsequent stages of the receiver always have to operate at 455kHz, they can be designed to give their best performance at this frequency.

## Module of the month

### Single-chip AM receiver

This radio (Fig. 14) relies on the LC circuit as the tuning element. The output from this goes to the IC, which has a high-impedance input stage, and is amplified by four RF amplifiers before reaching the transistor based detector. The output pin of the IC (pin 1) is also the pin through which it is powered. Power is supplied by a constant-voltage generator circuit, based on TR1, from the R3/R4 network.

There is feedback from the output of the IC to this network

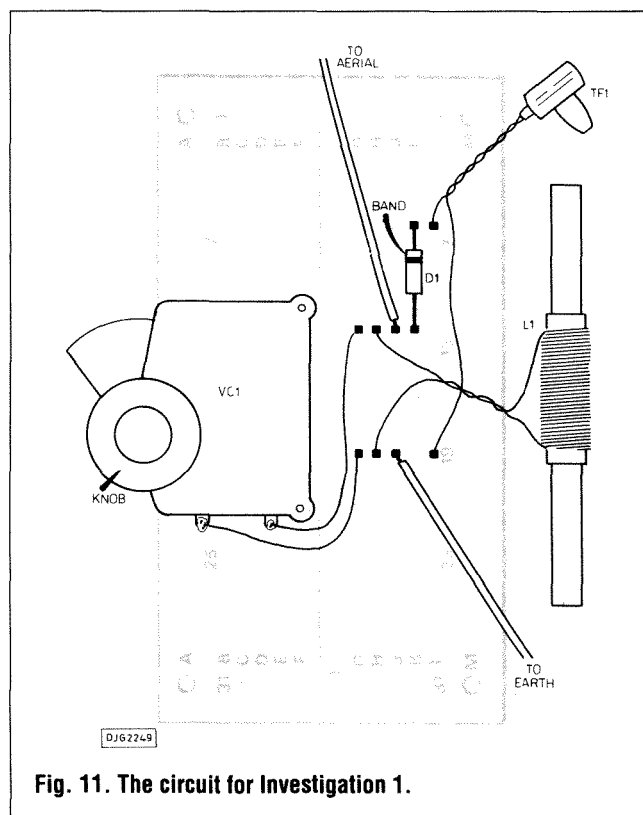

Fig. 11. The circuit for Investigation 1.

## UPGRADE OR BUILD YOUR OWN IBM COMPATIBLE



### MOTHERBOARDS

CPU	RAM	L/SPEED	PRICE
286-12	0k	16Mhz	£105
286-12	1Mb	16Mhz	£165
386 SX	0k	19Mhz	£285
386-25	0k	33Mhz	£485
386-33	64k cache	54Mhz	£850

### KEYBOARDS

	(ENHANCED 102 KEY)	PRICE
IBM + COMPATIBLE		£35
AMSTRAD 1640/1512		£59
PS2 + COMPAQ		£75

### GRAPHIC CARDS

VGA	256k	16 BIT	PRICE
SUPER VGA	512K	16BIT	£95

### ADD-IN CARDS

Floppy Hard Disc Controller	£59
I/O Card for XT/AT	£28

### BOOKS

Build your own 80286 IBM Comp-Plgrim	£16.30
PC Upgrade Book Smith	£11.85

### MANY OTHER PERIPHERALS AVAILABLE

**PANRIX ELECTRONICS**

93 KENTMERE APPROACH,  
LEEDS LS14 1JW.  
Tel: 0532 650214  
Fax: 0532 300 488



### VARIABLE VOLTAGE TRANSFORMERS

INPUT 220/240V AC 50/60 OUTPUT 0-260V	Price	P&P
0.5KVA 2.5 amp max	£29.00	£3.75 (£37.65 inc VAT)
1KVA 5 amp max	£37.40	£4.25 (£41.90 inc VAT)
2KVA 10 amp max	£54.00	£5.48 (£68.40 inc VAT)
3KVA 15 amp max	£71.50	£6.24 (£89.40 inc VAT)
5KVA 25 amp max	£126.50	(Carriage on request)

### VOLTAGE CHANGING TRANSFORMER

1250 Watt Auto. Tapped 0-90V, 100, 110, 115, 120, twice to obtain voltages between 90 and 240V. Fitted in heavy duty louvered metal case. Fused input. Price incl VAT & p&p £39.50

**COMPREHENSIVE RANGE OF TRANSFORMERS-LT ISOLATION & AUTO 110-240V** Auto transfer either cased with American socket and mains lead or open frame type. Available for immediate delivery.

### ULTRA VIOLET BLACK LIGHT FLUORESCENT TUBES

4ft 40 watt £10.44 (£12.00 inc VAT) <b>Callers only</b>
2h 20 watt £7.44 + £1.25 p&p (£9.99 inc VAT)
13m 10 watt £5.80 + 75p p&p (£6.38 inc VAT)
12m 8 watt £4.80 + 75p p&p (£5.38 inc VAT)
9in 6 watt £3.95 + 50p p&p (£5.12 inc VAT)
6in 4 watt £3.95 + 50p p&p (£5.12 inc VAT)

**230V AC BALLAST KIT** for either 6in, 9in or 12in tubes £5.50 + 55p p&p (£6.96 inc VAT). For 13in tubes £6.00 + 75p p&p (£7.75 inc VAT)

### 400 WATT UV LAMP

Only £34.00 + £2.50 p&p (£41.98 inc VAT). **175 WATT SELF BALLASTED BLACK LIGHT MERCURY BULBS** Available with BC or ES fitting. Price incl VAT & p&p £19.84.

### 12 VOLT BILGE PUMPS

Buy direct from the importers  
**500 GPH 15ft head 3 amp**  
£176.00  
**1750 GPH 15ft head 9 amp**  
£20.18 + £2.00 p&p (£25.50 inc VAT)

### EPROM ERASURE KIT

Build your own EPROM ERASURE for a fraction of the price of a made-up unit kit of parts less case includes 12in 8 watt 2537 Angstrom Tube Ballast unit pair of bi-pin leads neon indicator on/off switch safety microswitch and circuit £14.00 + £2.00 p&p (£18.40 inc VAT)

### SUPER HY-LIGHT STROBE KIT

Designed for Disco, Theatrical users etc. Approx 16 joules. Adjustable speed £48.00 + £2.00 p&p (£57.50 inc VAT)

**Case and reflector** £22.00 + £2.00 p&p (£27.60 inc VAT). SAE for further details including Hy-Light and Industrial Strobe Kits.

### WIDE RANGE OF XENON FLASHTUBES

Write/Phone your enquiries  
**EXTENSIVE RANGE OF DIFFERENT TYPES OF GEARED MOTORS AVAILABLE FROM STOCK**

### WASHING MACHINE WATER PUMP

Brand new 240V AC fan cooled can be used for a variety of purposes. Inlets 1 1/2 ins. Outlet 1 inch. Price including p&p and VAT - £10.95 or 2 for £20 including p&p and VAT.

### 12V DC 20 RPM REVERSIBLE MOTOR

Swiss precision built. Ideal for robotics. Size: length inc shaft 90mm. Diameter front fixing 38mm square. Currently advertised by well known supplier at £27.00 plus p&p & VAT. **Our Price £14.95 inc. p&p & VAT**

### GIANT BLOWER EXTRACTOR UNIT

Twin output centrifugal blower 1 HP 240V AC motor, output approx 3800 c.f.m. Size: Length 100cm; Height 27cm; Depth 28cm; Fixing plate 106 x 33cm. Price £125 + VAT. Ex warehouse.

### TORIN CENTRIFUGAL BLOWER

230V ac - 2.800 RPM (1.9 amp), 130mm diameter impeller outlet 63 x 37mm overall size 195 x 160 x 150mm long. Price £17.50 + £2.50 p&p (£23 inc VAT)

### SHADED POLE GEAR MOTORS

In the following sizes:  
9 RPM 12 RPM 80 RPM 160 RPM 110V AC or 240V AC with capacitors (supplied). Price incl VAT & p&p £12.65

### GEARED MOTORS

71 RPM 20lb inch torque reversible 115V AC input including capacitor and transformer for 240V AC operation. Price incl VAT & p&p £23.00.

### SOLID STATE EHT UNIT

Input 230 240V AC. Output approx 15KV. Producing 10mm spark. Built in 10 sec timer. Easily modified for 20 sec, 35 sec to continuous. Designed for boiler ignition. Dozens of uses in the field of physics and electronics - eg supplying neon or argon tubes etc. Price less case £8.50 + £1.00 p&p (£10.93 inc VAT) NMS.

### HEAVY DUTY MOTOR

Crouzet 115V/230V AC heavy duty 1RPM motor Anticlockwise type 82/015. Size 68mm diameter x 55mm long. Shaft 6mm diameter x 20mm long. Price inc. VAT & p&p £18.40

### RHEOSTAT

50W 2 ohm 5 amp ceramic power rheostat. Price inc. VAT & p&p £10.35

### MICROSWITCH

Pye 15 amp changeover lever microswitch, type S171 Brand new. Price £5 for £6.90 inc. VAT & p&p. NMS - NEW MANUF. SURPLUS R&T - RECONDITIONED AND TESTED



Whether your requirement for surveillance equipment is amateur, professional or you are just fascinated by this unique area of electronics SUMA DESIGNS has a kit to fit the bill. We have been designing electronic surveillance equipment for over 12 years and you can be sure that all of our kits are very well tried, tested and proven and come complete with full instructions, circuit diagrams, assembly details and all high quality components including fibreglass PCB. Unless otherwise stated all transmitters are tuneable and can be received on an ordinary VHF FM radio.

**UTX Ultra-miniature Room Transmitter.** Smallest room transmitter kit in the world! Incredible 10mm x 20mm including mic. 3-12V operation. 500m range.....£15.95

**MTX Micro-miniature Room Transmitter.** Best-selling micro-miniature room transmitter. Just 17mm x 17mm including mic. 3-12V operation. 1000m range.....£12.95

**STX High Performance Room Transmitter.** High performance transmitter with a buffered output stage for greater stability and range. 22mm x 22mm including mic. 6-12V operation, 1500m range.....£14.95

**VT500 High-Power Room Transmitter.** Powerful 250mW output providing excellent range and performance. Size 20mm x 40mm. 9-12V operation. 3000m range.....£15.95

**VXT Voice Activated Room Transmitter.** Triggers only when sounds are detected. Very low standby current, variable sensitivity and delay with led indicator. Size 20mm x 67mm, 9V operation, 1000m range.....£18.95

**QTX180 Crystal Controlled Room Transmitter.** Narrow band FM transmitter for the ultimate in privacy. Operates on 180 MHz and requires the use of a scanner receiver or our QRX180 kit (see catalogue). Size 20mm x 67mm. 9V operation. 1000m range.....£39.95

**SCRX Subcarrier Scrambled Room Transmitter.** Scrambled output from this transmitter cannot be monitored without the SCDM decoder connected to receiver. Size 20mm x 67mm, 9V operation, 1000m range.....£21.95

**SCDM Subcarrier Decoder Unit for SCRX.** Connects to receiver earphone socket and provides decoded audio output to headphones. Size 32mm x 70mm. 9-12V operation.....£21.95

**HVX400 Mains Powered Room Transmitter.** Connects directly to 240V AC supply for long term monitoring. Size 30mm x 35mm. 500m range.....£18.95

**ATR2 Micro Size Telephone Recording Interface.** Connects between telephone line (anywhere) and cassette recorder. Switches tape automatically as phone is used. All conversations recorded. Size 16mm x 32mm. Powered from line.....£12.95

**UTLX Ultra-Miniature Telephone Transmitter.** Smallest telephone transmitter kit available. Incredible size of 10mm x 20mm! Connects to line (anywhere) and switches on and off with phone use. All conversation transmitted. Powered from line. 500m range.....£14.95

**TLX700 Micro-Miniature Telephone Transmitter.** Best-selling telephone transmitter. Being 20mm x 20mm it is easier to assemble than UTLX. Connects to line (anywhere) and switches on and off with phone use. All conversations transmitted. Powered from line. 1000m range.....£12.95

**STLX High-Performance Telephone Transmitter.** High power transmitter with buffered output stage providing excellent stability and performance. Connects to line (anywhere) and switches on and off with phone use. All conversations transmitted. Powered from line. 1500m range.....£15.95

**TKX900 Signalling/Tracking Transmitter.** Transmits a continuous stream of audio pulses with variable tone and rate. Ideal for signalling or tracking purposes. High power output giving range up to 3000m. Size 25mm x 63mm. 9V operation.....£21.95

**CD600 Professional Bug Detector/Locator.** Multicolour readout of signal strength with variable rate bleeper and variable sensitivity used to detect and locate hidden transmitters. Switch to AUDIO CONFIRM mode to distinguish between localised bug transmission and normal legitimate signals such as pagers, cellular, taxis etc. Size 70mm x 100mm. 9V operation.....£49.95

### ★★★ SPECIAL ★★★

**DLTX/DLTX Radio Control Switch.** Remote control anything around your home or garden, outside lights, alarms, paging system etc. System consists of a small VHF transmitter with digital encoder and receiver unit with decoder and relay output, momentary or alternate, 8-way di/d switches on both boards set your unique security code. TX size 45mm x 45mm, RX size 35mm x 90mm. Both 9V operation. Range up to 200m. Complete System (2 kits).....£49.95  
Individual Transmitter DLTX.....£18.95  
Individual Receiver DLRX.....£36.95

A build-up service is available on all our kits if required.

UK customers please send cheques, POs or registered cash. Please add £1.50 per order for P&P. Goods despatched ASAP allowing for cheque clearance. Overseas customers send sterling bank draft and add £5.00 per order for shipment. Credit card orders welcomed on 0827 714476.

OUR LATEST CATALOGUE CONTAINING MANY MORE NEW SURVEILLANCE KITS NOW AVAILABLE. SEND TWO 22P STAMPS OR OVERSEAS SEND TWO IRC'S.

## SUMA DESIGNS

The Workshops

95 Main Road, Baxterley,

Nr. Atherstone, Warwickshire CV9 2LE



Tel: 0827 714476

other battery voltages in the range 3V to 12V.

Since this module includes one stage of amplification it can be used on its own, with earphones, as a self-contained radio receiver. It requires no aerial or earth.

Details for winding the coil are given in Fig. 11. All connections should be kept as short as possible. In particular C3 must be soldered as

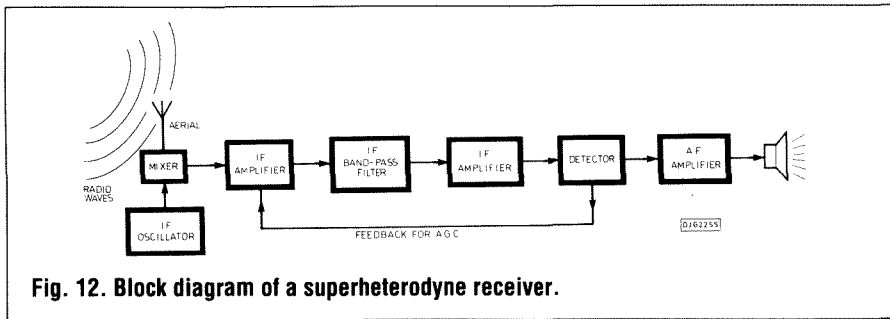

Fig. 12. Block diagram of a superheterodyne receiver.

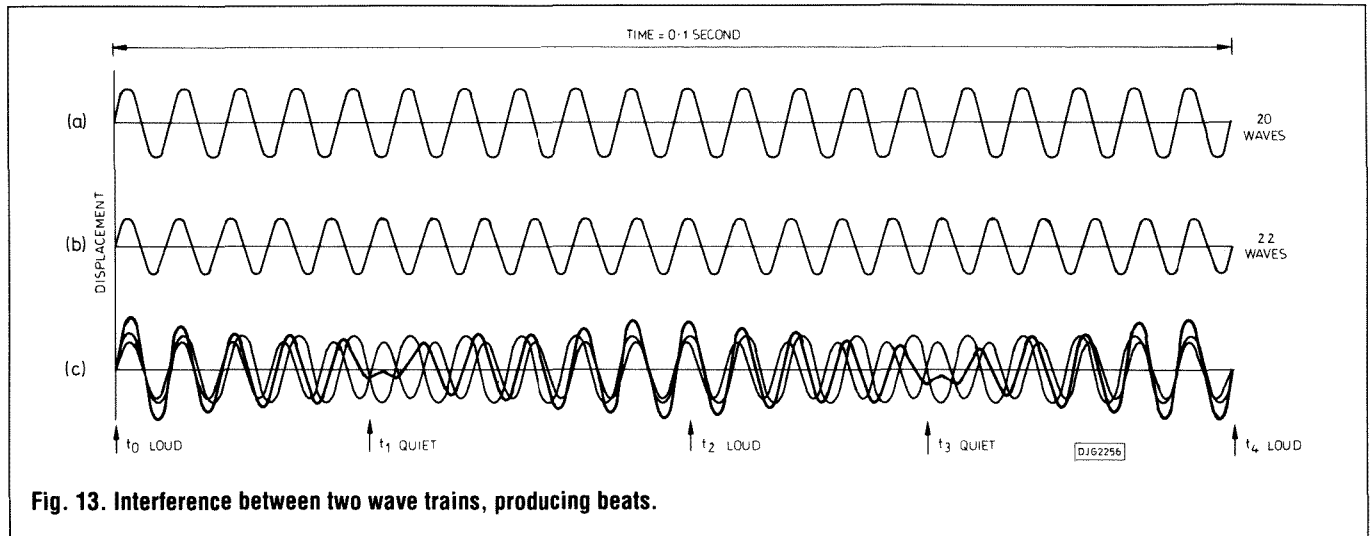

Fig. 13. Interference between two wave trains, producing beats.

which gives what is referred to as automatic gain control. Gain is decreased for strong stations and increased for weak stations. This has the effect of compensating for fading which may occur under poor reception conditions. It also has the effect that signals from strong local stations are not amplified as much as those from weaker stations. They are less likely to swamp the signals from weaker stations operating on nearby wavelengths. This helps to improve the apparent selectivity of the receiver, though this is not a true improvement of selectivity as such. As before the circuit can be

built on stripboard.

The quality of reception depends very much on the voltage supplied to the IC which must be in the range 1.2V to 1.6V. The voltage can be altered by substituting resistors of different values for R1 and R2. With low voltage, the sensitivity of the receiver is reduced. This also introduces the problem that electrical interference from other sources, such as thunderstorms, becomes more noticeable. With high voltage strong stations may swamp the circuit. The resistors may also be changed to allow the receiver to operate on

close as possible to pin 3 of IC1. Connect the tuning capacitor VC1 so that its fixed plates are wired to the junction of R4 and C2, and its movable plates to pin 2 of IC1. The circuit should be housed in a small plastic enclosure. Mount VC1 on the lid or front panel and fix the aerial rod and coil to the inside of the box. Any loudspeaker mounted on the box should be positioned as far away as possible from the aerial rod. The relevant component values are given in Fig. 14 and the circuit can be constructed on a piece of stripboard – as in the previous modules in this series.

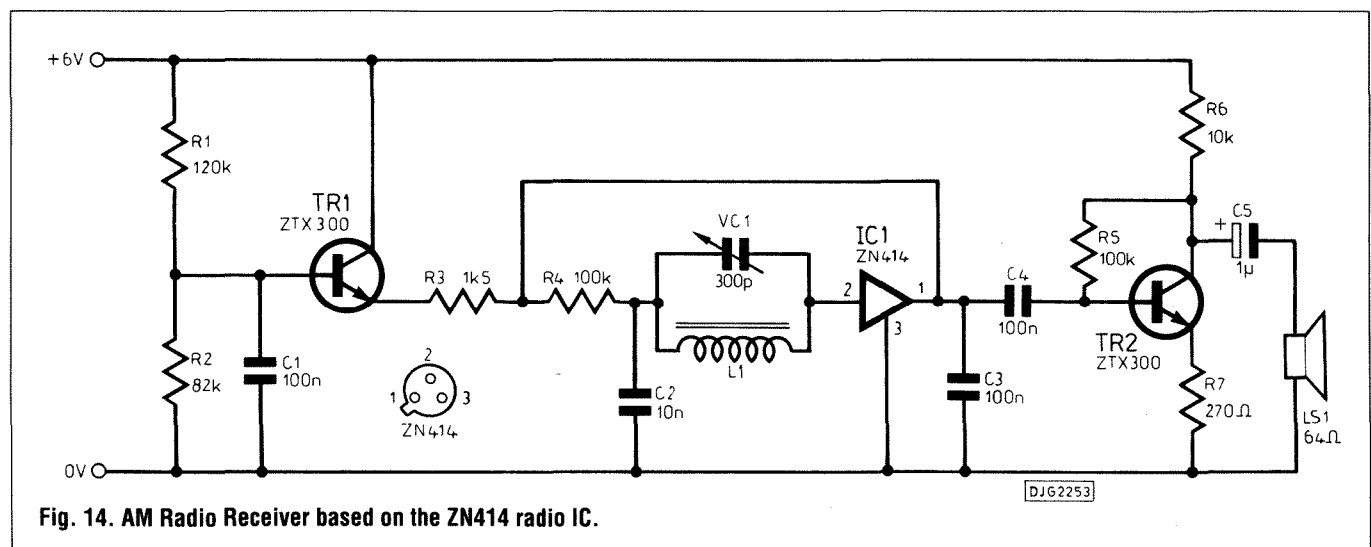

Fig. 14. AM Radio Receiver based on the ZN414 radio IC.



## NEW LOW PRICES ON MICRO PANELS!!

**Z4209** Panel 360 x 210mm covered in high quality chips: 8085AHC, 8255, 8257, 8251A x 2, 8253-5, 8275, 8202A, 2732, 2716 all in sockets; 18 x 4116-2 + other mainly LS chips + min switches, LED's, oscillator, large tants, 3 x 50 way double sided edge connectors. Amazing value at only ..... **£9.95**

**Z4210** Panel 260 x 210 which could plug into the above board. Lots of memory on this one: 36 x 4116-20. Also 8085AC, 8202 & 2716 in sockets + 55 other mainly LS chips, DIL switch, large tants etc. .... **£6.95**

**Z4223** 80186 Panel. 346 x 280mm 'Benchmark 186' panel packed with high class chips. Just look at what you get!! 80186 16 bit 8MHz microprocessor; 16 x 4164-12 RAMs; 2 x 6116-3; 2 x 2732 EPROMs; 2 x 8255A-5; 8259A-C-2; 68455P; 146818P; 7201C all in sockets. Over 80 LS chips, 4 xtals, back up battery, 2 x 25 way 'D' sockets etc, etc!! Total chip value alone must exceed £150 and remember all the large chips are in sockets. .... **£25.00**

**Z4356** Microprocessor panel 310 x 85mm with 2 x 8035 8 bit CPU (64 bytes RAM) in sockets, 2 x 2716 EPROM 5 x P8243 I/O expanders, also 18 other chips, 2 x 6MHz xtals etc. .... **£3.00**

## 4 WAVEBAND RADIO

**Z8891** Superb 4 waveband radio by Ross, model RR5. Covers FM 88-108MHz, MW 518-1610kHz, LW 150-275 kHz, SW 5.7-18.1 MHz (16.5-52.6m). Nicely styled case measuring 210 x 145 x 70mm with clear scale markings. Telescopic aerial, headphone socket. Volume, tone and tuning controls. ON/OFF switch and waveband selector switch and AFC switch. Mains/battery. (Takes 4 x C cells). Originally retailed at £19.95. .... **£14.95**

## COMPONENT PACKS

**LOTS MORE IN OUR CATALOGUE! K531 Precision Resistor Pack** - High quality, close tolerance R's with an extremely varied selection of values mostly 1/2W and 1/4W; tolerances from 0.1% to % - ideal for meters, test gear etc. .... **250/£3.00**; 1,000/£10.00

**K538 Diode Pack** - untested small signal diodes like IN4148 etc, at a price never before seen!! .... **£2.50**

**K537 IC Pack** - a mix of linear and logic chips, from 6 to 40 pin. All are new and marked, but some may not be full spec. .... **£6.75**

**K539 LED Pack**. Not only round but many shaped LEDs in this pack in red, yellow, green, orange and clear. Fantastic mix of new full spec devices. .... **100/£5.95**; 250/£11.75

**K575 Plastic Power Pack**. Mainly TO126 and TO220 transistors, SCRs, Triacs etc. All new full spec marked devices offering fantastic value. Lots of TIP and BD types. .... **50/£7.50**

**K581 Copper clad board pack**. We have now obtained further supplies of offcuts, all reasonable sizes. May include single and double sided, SRBP and glass fibre. Pack of approx 200 sq ins. .... **£2.00**

**K582 Polystyrene Caps**. An amazing range of values from a few pF to 0.01. Tolerances 1-20%. Voltages to 500V. Pack of 200. .... **£4.00**

**K580 Metal Oxide resistors**, TR4 0.25W by Electrofil. Wide range of values, mostly 5%, few closer tolerances. Super value pack of 200. .... **£2.00**

**K587** A selection of toggle switches, mainly from page 122 of our 1990 Catalogue. Includes single pole to 4 pole sub min, and min. Pack of 50, £30.00 at catalogue prices. .... **£14.95**

## MOTOR + GEAR PACK

**K579**. This pack contains 10 assorted battery powered motors (mostly 3V) + 90 gears etc; 16-60mm dia + worms and shafts. Amazing value. .... **Only £7.95**

## INDICATOR PACK

**K700** Big variety of neons in this pack! Round, square and oblong, clip and screw fix. Red, Green, Amber and Clear. Tag & wire-ended. All are 110V, but suitable resistors for use on mains are included. Really great value for money! .... **20/£2.50**

## 1991 CATALOGUE

**YOU GET A GREAT DEAL MORE WHEN YOU DEAL WITH GREENWELD!!**

**The 1991 Greenweld Catalogue is out NOW!**

- ★ Many substantial reductions
- ★ Quantity pricing for bulk buyers
- ★ 132 pages of value-packed goods
- ★ Next 6 updates plus lists included in price
- ★ Easy to use order form
- ★ 1st class reply paid envelope
- ★ Our famous Bargain List

Price to include Catalogue, current bargain list and next 6 lists. All supplied with reply paid envelope **£2.50** (UK & BFPO) **£5.00** Overseas.

## SWITCH MODE POWER SUPPLIES

Over the years, we've had many different switch mode power supplies, but this latest unit is without doubt one of the finest we've ever seen! Made by Astec, it is a totally enclosed steel cased unit measuring 175 x 136 x 65mm, which has incorporated in it a switched and fused IEC mains inlet. Inside, the PCB is 160 x 80mm with output pins fitted on one end. A connector to these pins to extend the outputs to the exterior of the case is provided.

Specification:  
Model Number: **BM41012**  
Input: 115/230V, 50/60Hz  
Outputs: +5V 3.75A  
+12V 1.5A  
-12V 0.4A  
Total Wattage: 65W  
Price **£14.95**; **100 + 11.21**

We've also discovered a small quantity of an Astec model offered previously. Regrettably we've had to increase the price, but they still represent outstanding value for money. Enclosed in a steel case 203 x 112 x 60mm is a PCB 197 x 106mm. Input and Outputs are via pins on the PCB.

Specification:  
Model Number: **AC9231**  
Input: 115/230V, 50/60Hz  
Outputs: +12V 2.5A  
+5V 6A  
12V 0.5A (+ or -)  
5V 0.5A (+ or -)  
Total Wattage 50W  
Price **£17.95**; **100 + 13.46**

We still have good supplies of yet another Astec model. This one is partially cased, the overall size being 160 x 104 x 45mm. The PCB measures 160 x 100mm. Input and Outputs are on flying leads, all colour coded. There is also an additional IEC socket to extend mains to another unit.

Specification:  
Model Number: **AA12531**  
Input: 115/230V, 50/60Hz  
Outputs: +5V 5A  
+12V 0.15A  
Total Wattage 50W  
Price **£6.95**; **100 + 5.21**

Also still available: An Astec 'bare board' model. The PCB is standard Eurocard size, 160 x 100mm. Input and Outputs are on right angle PCB pins. This is a very compact model offering excellent value for money.

Specification:  
Model Number: **ACB151-01**  
Input: 115/230V, 50/60Hz  
Outputs: +5V 2.5A  
+12V 2A  
-12V 0.1A  
Total Wattage 40W  
Price **£12.95**; **100 + 8.91**

**Z8887** Made by STC, this 160 x 100mm PCB is attached to an aluminium chassis 165 x 102 x 65mm and has a single 5V 6A output. Supplied with connection details, we can offer these at fraction of their normal cost!  
Prices ..... **£5.95**; 10 + £4.95; 100 + £3.95

## VISTEL II VISUAL TELEPHONE

Total communication for deaf people - this brilliant piece of equipment has a full QWERTY keyboard and 40 character screen. Text editor, 9,500 character memory, Auto answer, Auto dial, Calculator, Printer interface, RS232 (V24/28) serial interface. Modem support V21/23/25. These are new and boxed but because the makers are bankrupt, there's no guarantee. Originally sold for over £500. A comprehensive 143 page instruction manual is provided. (Manual only - send £12, £10 refunded on return).

Our special price ..... **£150.00**

## BBC SOFTWARE

**Special Price to schools for Classroom Pack!**

For BBC 'B' Computer; full colour leaflets on request.

**Z4326** Music Master recorder tutoring system. Was £52.78

Our price ..... **£14.95**

**Z4328** Mupados Recorder Tutor with stereo cassette containing 52 tunes and handbook. Originally £30.94

Our price ..... **£7.95**

Micro Maestro turns computer screen into a music stand! Supplied with audio cassette. Original price £17.25

**Z4332** Keyboard ..... **£4.95**

**Z4333** Concert pitch ..... **£4.95**

**Z4334** B<sup>D</sup> ..... **£4.95**

## BREADBOARDS

**FREE**, if requested, with every breadboard sold this month! K574 wire link pack with about 250 links for use with breadboard or PCB's!

**G708** Protobloc 1 - 400 tiepoints, Size 80 x 60mm. Takes up to 3 16 pin chips. .... **£2.50**

**G711** Protobloc 2 has a total 840 tie points. Will accommodate up to 7 16 pin devices. Size 172 x 64mm ..... **£3.95**

**G712** As above, but mounted onto a rigid base plate complete with 3 4mm terminals for power connections. A mounting bracket which clips into the base is also provided to accept a variety of components including switches and potentiometers, etc. .... **£6.95**

**G724** 2 of type G711 mounted onto a rigid baseplate with 3 coloured terminals for power connections. Overall size 225 x 150mm ..... **£13.95**

**G736** 3 of type G711 and an additional strip of 100 tie points mounted onto a rigid base plate with 4 coloured terminals. Overall size 242 x 195mm. .... **£19.95**

All prices include VAT (except bulk components); P&P **£2.00** per order. Min Credit Card £5. No CWO min. Official orders from Education welcome; min invoice charge £10.00. Payment is accepted by cheque, postal order, cash, including foreign currency bank notes, book tokens, Access, Visa, Connect. Our stores have enormous stocks of components and our trade counter is open from 9-5.30 from Mon-Sat. Come and see us!

Tel: (0703) 236363

Fax: (0703) 236307

## GLUE GUNS

**87-0400 Hot melt glue gun.** Electronically controlled heating element which melts the long stick of glue when inserted. Trigger feed. Mains operated. Normally sells for £8.60.

Our price ..... **£4.95**

Glue sticks - pack of 10 ..... **£1.00**

## NI-CAD BATTERIES

Regular stocks: AAA **£1.20**; AA 99p; C **£2.20**; D **£2.30**; PP3 **£3.95**

**Z4150** Ex mobile radio battery. 58 x 63 x 33mm case (sometimes damaged) contains 8 x AA size rechargeable Nicads. These can be removed by breaking the case open. Each cell rated 1.2V 600mA.

Price ..... **£3.00**

**Z4149** As above but 84 x 66 x 33mm. There are again 8 cells but they are longer than AA size, being 73mm long. Each cell rated 1.2V 900mA.

Price ..... **£4.50**

**Half AA Nicads available in 3 styles. Each cell rate 1.2 V 0.25Ah. Normal charge 25mA for 16hr.**

**Z1809** Cell with wires attached at both ends. .... **£1.00**

**Z1810** Cell enclosed in black heatshrink with wires attached at both ends. .... **£1.00**

**Z1811** Pack of 4 cells, enclosed in black heatshrink with wires attached at both ends. .... **£3.95**

**Z1830** Saft 40 RF310 back up Nicad battery PC mounting on 70 x 22.5mm centres. Rated 3.6V. 10mAh (20mA). Overall size 76 x 28 x 8mm. .... **£2.00**

**Z1829** Nicad 25mm dia x 34mm long rated 9.6V 500mA. PC mounting tags. .... **£2.00**

**Z1719** Back-up battery 4.8V 110mA PCB mounting. 23.5mm dia x 16.5mm made by Emmerich. Normally £3.76. .... **£1.50**

**Z1720** Lithium Manganese coin cell. Extremely thin, just 1.6mm x 20mm dia model 2016. Normally £1.67. .... **70p**

**Z1406** PC mounting deac 6V 100mA. Rating made by Memec 30 x 15 x 27mm. List £4.65. .... **£1.50**

Price ..... **£1.50**

## TAPE DECKS

**Z8885** Telephone answering machine believed to have been used as an alarm system. Steel chassis 245 x 220 x 35mm contains PCB 228 x 145mm and an 8-track cassette unit. The output from the tape head is fed into an MC3301 quad op-amp. The PCB also has 10 CMOS gates, 3 relays, isolator transformer, several transistors, R's, C's, etc. 12-way connector for BT line, 12V supply etc also plug and socket arrangement for Auto/Manual and Bell delay. .... **£10.00**

**Z4307** 8-track cassette mechanism. Sturdy steel chassis 132 x 126 x 50mm. Contains 12V motor, solenoid, tape head and mechanical bits to change track. .... **£2.50**

**Z4274** Micro cassette mechanism 100 x 74 x 35mm as used in dictaphones/answerphones etc. Complete with head, optical sensing and hall effect switch, solenoid and motor. .... **£2.00**

Price ..... **£2.00**

## BULK COMPONENTS (All + VAT IN THIS SECTION)

**Our 16 page Bulk Buyers List is out now - send for your copy.**

**Z4353** 6 way DIN lead to open end ..... **100 + 0.104**  
1k + 0.07  
280 CPU's by Zilog ..... **100 + 0.35**  
2.2µF 25V Tants ..... **100 + 0.04**  
1k + 0.025  
5V 5A TO3 Regulator ..... **100 + 2.00**  
12V 5A TO3 Regulator ..... **100 + 2.00**  
HM6116LP-4 RAM ..... **100 + 0.60**  
200V 25A Bridge Rectifier ..... **100 + 0.75**  
TIPP31 ..... **100 + 0.07**  
1k + 0.04  
TIPP32 ..... **100 + 0.07**  
1k + 0.04

10,000µF 40V cans ..... **100 + 1.50**

4,700µF 63V cans ..... **100 + 1.30**

BDW93 Darlington ..... **100 + 0.20**

BDW94 Darlington ..... **100 + 0.20**



**27C PARK ROAD, SOUTHAMPTON, SO1 3TB**

# Amateur Radio Explained

*Ian Poole, aka G3YWX, reveals what Q codes mean, what King Hussein and Rajiv Gandhi have in common and why radio waves bounce around the world.*

For most people amateur radio conjures up images of Tony Hancock in his brilliant comedy *The Radio Ham* – someone with hundreds of pounds worth of equipment talking to people in Japan about the weather, playing chess with people in Birmingham and trying unsuccessfully to help people sinking in the middle of the Atlantic.

Amateur radio is far from this. It covers a wide range of interests from the technical to plain relaxation. Some people enjoy the fascination of listening or talking to stations on the other side of the world. They may choose to take up the challenge of contacting as many countries as possible. There are many interesting places where people have set up stations. Often people based in remote scientific stations will have an amateur station so that they can spend some of their spare time talking to people around the world. Some well known statesmen and heads of government like King Hussein of Jordan and Rajiv Gandhi hold amateur licences and it is occasionally possible to talk to them.

Another aspect of the hobby is the challenge of construction, especially when the project can be tested on the air with the possibility of a long distance contact.

Many other people enjoy relaxing and chatting over the air to friends across town, or possibly using their equipment in the car to make a long journey more interesting. It is even possible to help the community by participating in one of the emergency groups which are set up all over the country to help in the

event of disaster. These groups are widely used to set up emergency communications quickly and help relay important messages. Recently they have come into action on a number of occasions – two examples were the air crash at Lockerbie and the storms of early 1990.

In fact, whatever one's interest in electronics and radio there is always something in amateur radio to keep a healthy interest. This is proved by the ever-increasing numbers of radio amateurs and listeners all over the world.

## How It Started

Amateur radio can trace its origins to the very beginnings of radio. At the end of the nineteenth century people like Hertz, Marconi and many others began to experiment with wireless, as it was called then. At this time there were no regulations, and as the implications of radio began to be realised the government decided a form of licence was needed. This was first issued in 1905 as a licence for experimentation and it continued in this form until the outbreak of the First World War, when amateur operation was banned and all equipment impounded.

No further activity took place until 1921 when a new form of licence was issued. It became necessary to pass a theory examination and a Morse test as well as outlining a set of experiments before a licence would be granted.

At this time radio was still in its infancy. Amateur experimenters were only allowed to use the short wave bands, which were thought to be of little use, as the long wave

bands were reserved for long distance communications. However, in late 1923 amateurs proved the worth of the short waves when they conducted the first transatlantic contacts.

Many other improvements were taking place. Transmitters and receivers were being improved all the time as was knowledge about propagation and the ionosphere. Much of this knowledge was contributed by radio amateurs. Unfortunately all of this came to an end in 1939 when the Second World War broke out and all amateur operation ceased.

After the cessation of hostilities new licences were not issued until 1946. Gone was the need to define a set of experiments before a licence would be issued as were many of the other petty restrictions. Now it was only necessary to pass the theory examination and a Morse test.

In the years that followed licence conditions were improved to enable amateurs to do considerably more. Television transmissions were permitted and so was mobile operation from cars. Later on a Class B licence was introduced, which originally allowed operation on frequencies above 430 MHz but now permits operation on amateur bands above 30 MHz. Recent modifications to the licence have allowed low powered remote control of equipment, digital repeater facilities and so forth. This enables the amateur licence to keep pace with technology.

Today a licence is still needed to transmit. The theory examination called the Radio Amateur's Examination, or RAE for short, is

## Radio Basics

There are two main ways of transmitting information via radio waves, amplitude modulation (AM) and frequency modulation (FM). Both take audio signals and impose them on a radio frequency 'carrier', the wavelength of which is anywhere from 160m to 3cm. The important point is that the frequency of this carrier is generally higher than the frequency of the audio signals being imposed upon it. Audio frequencies range from 20Hz to 20kHz and radio frequencies start at around 1MHz and go upwards.

AM uses the audio signal (Fig. 1a) to vary the amplitude or volume of the carrier to produce the signals shown in Fig. 1b. This consists of the carrier frequency itself and two copies of the audio signal either side of it, the whole thing being moved up to centre on the carrier frequency. The 'spread' of the signal in frequency terms is now quite wide and contains redundant information – a copy of the audio signal and the carrier. Both of these can be filtered out, making more efficient use of the radio spectrum, to give a single sideband (SSB) signal as shown in Fig. 1c. At the receiver a beat frequency oscillator (BFO) is used to reproduce the original signal so that it can be demodulated in the usual way – basically a matter of amplifying and rectifying the radio signal.

Frequency modulation varies the frequency of the carrier in time with the audio signal being transmitted. This produces quite a wide bandwidth but has the advantage of being almost immune to changes in volume such as noise. Because of the wider bandwidth required, FM transmitters are operated at frequencies in the VHF (Very High Frequency from 30MHz to 300MHz) and UHF (Ultra High Frequency from 300MHz to 3000MHz) bands. Unfortunately these have the disadvantage that signals cannot be transmitted over the horizon since they are not normally reflected by the ionosphere, apart from under unusual weather conditions or by special techniques such as meteor scatter.

As a meteor hits the Earth's atmosphere, it is travelling so fast that it leaves behind a trail of ionised gas. This temporary ionised layer or area is reflective to high frequency signals and allows occasional communication over distances as large as 2000km. The trails can be found at around 100km up in the atmosphere and occur at fairly predictable times. The optimum time for a connection is early in the morning since at this time the Earth is moving towards orbital meteors rather than away from them. There is also a set distribution of meteors around the sun which creates a peak around July. This and other new areas allows amateur radio enthusiasts to keep up with and sometimes lead the field in communications technology.

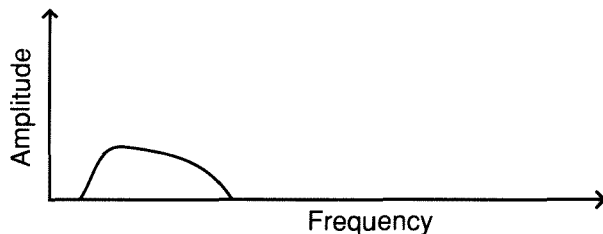

Fig. 1a. Spectrum of an audio signal.

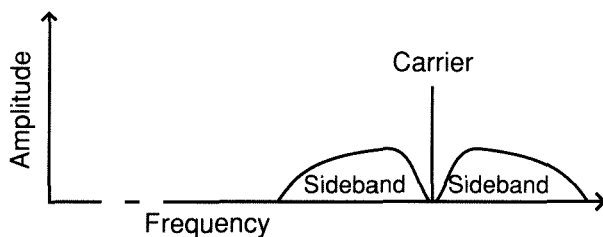

Fig. 1b. Spectrum of an amplitude modulated signal.

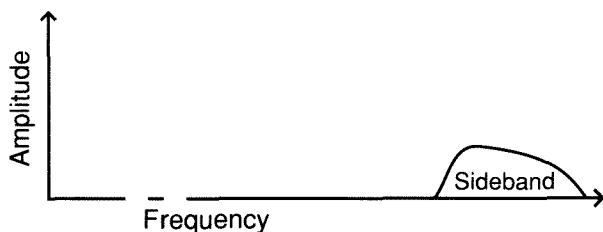

Fig. 1c. Spectrum of a single sideband signal (upper sideband).

contacts. Frequency modulation is the favourite for VHF and UHF local and mobile contacts. It has the advantage that signal variations can be all but removed if the signal is above a minimum strength. This makes it particularly suitable for mobile applications where signal strengths will vary as the car moves along.

Though most transmissions are voice, Morse code is still very popular because it can be understood at very low signal strengths. This can enable a contact to be made where no other method could get through.

## Amateur Bands

Amateurs are not allowed to transmit just anywhere in the frequency spectrum, they can only use the bands which are allocated to them. Fortunately there are a lot dotted over most of the spectrum – see figure 2. The lowest frequency band, 160 Metres, stretches from 1.81 MHz to 2.0 MHz. It is just above the top end of the Medium Wave band and many transistor radios can be adjusted to cover it without much difficulty. Other bands such as the 40 and 20 Metre bands are often covered by radios with a short wave band. There is also a good selection of bands in the VHF and UHF portion of the spectrum, for example the Six Metre band, which has recently been released for amateur use, covers 50 to 52 MHz – this is where some of the old VHF BBC 405 line

required for both the Class A and B licences. The syllabus covers a lot of basic theory likely to be used in the course of running an amateur station. It also includes questions about the licensing conditions. The Morse test needed for the Class A licence requires the candidate to be able to send and receive at a speed of 12 words a minute. Both examinations require a little study and preparation but most

applicants are able to pass them relatively easily.

## Amateur Transmissions

Amateur licences permit a wide variety of different types or modes of transmission. Amplitude modulation (AM) is not used very often because it is not as efficient as many of the other modes. Single sideband, or SSB for short, is the favourite mode for long distance

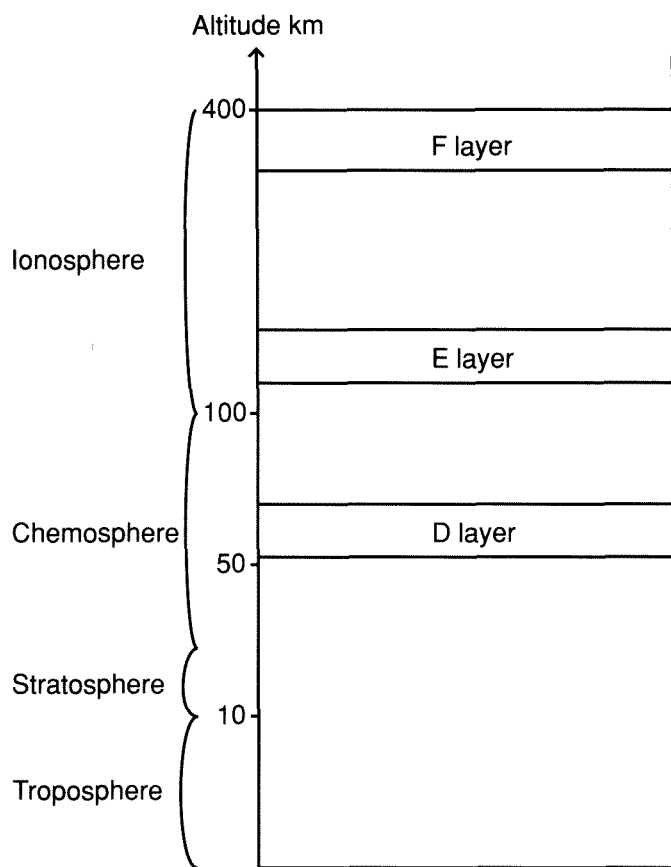

Fig. 3. Layers in the atmosphere.

transmissions used to be.

Further up in frequency there are several more bands. These are not as popular as some of the lower frequency ones but with technology advancing more people are beginning to use them. They also provide new challenges for radio

Frequency limits (MHz)

1.81	.....	2
3.5	.....	3.8
7	.....	7.1
10.1	.....	10.15
14	.....	14.35
18.068	.....	18.168
21	.....	21.45
24.89	.....	24.99
28	.....	29.7
50	.....	52.0
70	.....	70.5
144	.....	146
430	.....	440
1240	.....	1325
2310	.....	2450
3400	.....	3475
5650	.....	5680
5755	.....	5765
5820	.....	5850

Fig. 2. UK amateur bands.

amateurs as very little commercial equipment is available.

**Propagation**

The wide variety of bands available allows radio amateurs to take advantage of the characteristics of different frequencies. Some bands support long distance contacts whilst others give good reliable communications with less interference over short distances. The way in which signals propagate changes from day to day and over the course of a day. Many people find the study of propagation very interesting. Accordingly a little understanding of the basic concepts will help any short wave listener or licensed amateur to know the best times and frequency bands to contact a particular area.

There are two main areas which affect the propagation of radio signals. The first is the ionosphere. This is a region of the atmosphere about 100 to 400 km above the earth's surface. In it there are different ionised layers – see figure 3. The lowest of these, the D

layer, is only present during the day and tends to absorb low frequency signals. This is why at night it is possible to hear signals from much further afield. As the frequency rises the signal will pass through the D layer and come to the E layer. This will reflect the signals so that they are bounced back to Earth – see figure 4. As the signal frequency increases still further the effect of the E layer is reduced so that the signals will eventually pass through and reach the F layer. This is quite changeable. During the day it splits into two layers, called the F1 and F2 but at night they combine. Signals reaching them will be bent back to earth, but as the frequency increases they will pass through to reach the next layer or travel out into space. Generally the maximum frequencies which are reflected by the ionosphere are very roughly confined to the HF portion of the spectrum i.e. frequencies below about 30 MHz. These reflections enable signals on the short waves to travel vast distances. However they cannot fully explain how signals manage to travel from one side of the earth to the other. This happens because a signal can be reflected several times off the ionosphere and ground.

The second area affecting the propagation of radio signals is the troposphere. The frequencies which it affects are up into the VHF and UHF portion of the spectrum. Changes in the refractive index of the air cause the signals to curve round the earth's surface, extending the coverage. This often happens when areas of high pressure are over the country, although other weather conditions can be the cause. Whilst radio amateurs make the most of it and enjoy the long distance contacts which can be made, it can be an inconvenience to TV watchers because of interference from stations outside the normal range.

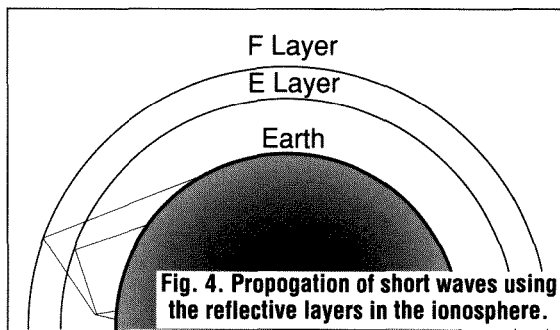

Fig. 4. Propagation of short waves using the reflective layers in the ionosphere.

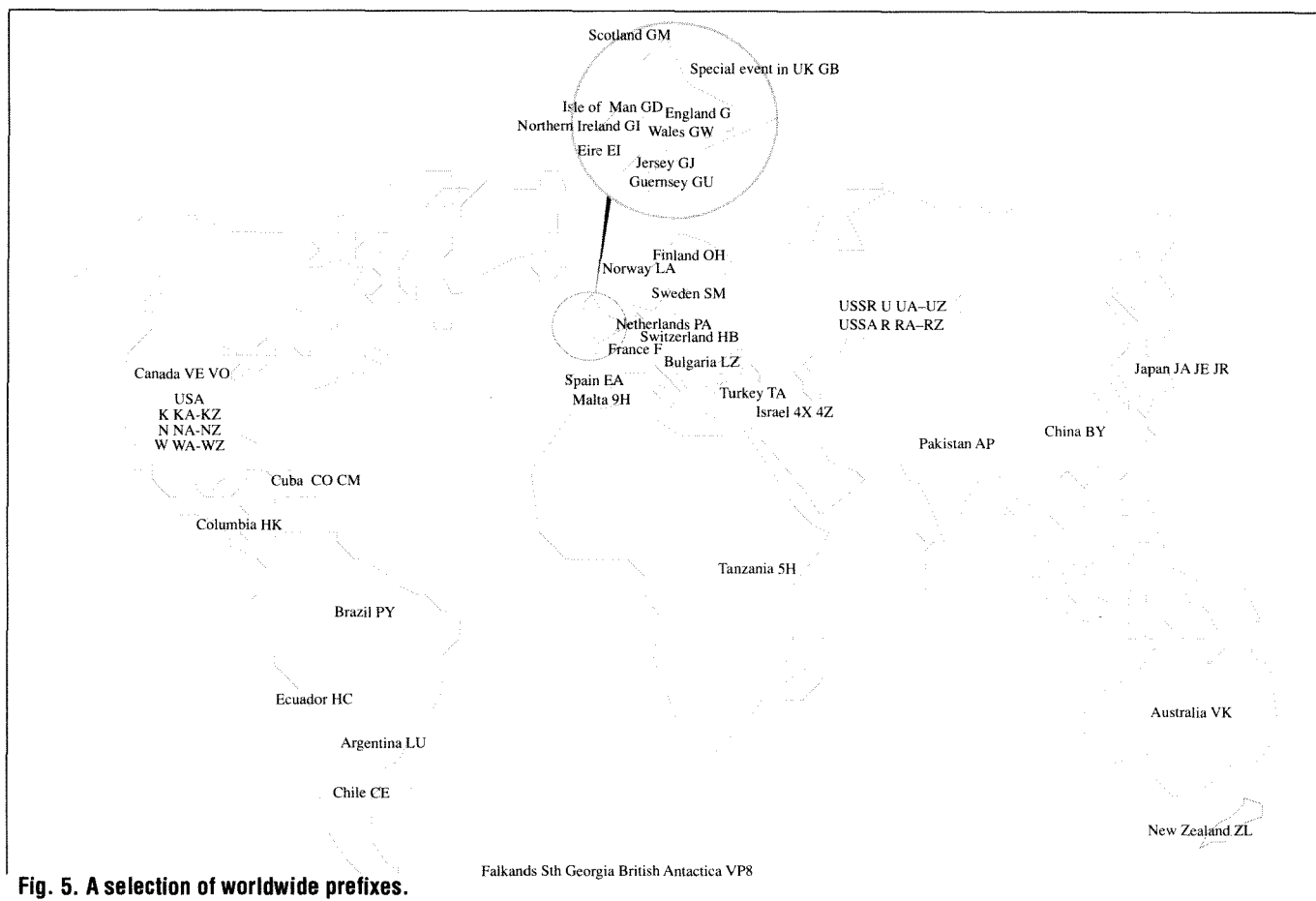

Fig. 5. A selection of worldwide prefixes.

## Callsigns

Listening on the amateur bands it is possible to hear stations from all over the world. Each station is given its own particular callsign when the licence is issued. From this it is possible to determine which country it comes from and sometimes a specific area within the country as well.

As an example, take the callsign G3YWX. It consists of two parts: the prefix up to and including the last number (in this case G3) and the

serial letters. By comparing the prefix with a list such as the abbreviated one in figure 6 it is possible to locate the station. G3 means the station is located in England.

## Jargon

There is a lot of other jargon associated with the amateur radio. Fortunately much of it can be learnt quite easily. It has come about for a number of reasons. One is that in the early days words had to be abbreviated to be sent by Morse code without taking too long. Many of these abbreviations have been carried over into the general 'ham' vocabulary. Another reason for their widespread use is the international nature of the hobby. As many people cannot speak English fluently the use of abbreviations as a sort of code can help.

Some are quite obvious, for example TVI is short for television interference, but others, like 73, are not. It is said that this particular one originated from the days of the old railway telegraph operators when they used to send two dashes six dots and two dashes as a form of greeting before a message. Over the

years this became corrupted to 73.

Other codes are used. One is the RST code. This is used when giving signal reports and it is very useful because it helps give a standard by which several reports can be compared. The basic system is shown in Fig. 7 and consists of a number for the readability, strength and tone. When using speech only the readability and strength sections are used, tone is used for Morse.

Another well known code is the Q code used in professional communications. Some of the codes have been adopted for amateur use. Although they are defined, as shown in Fig. 8, in a question and answer form, in speech their basic meaning is often carried over. For example one may talk of having a instead of a contact or a QRP transmitter instead of a low power transmitter.

## QSL Cards

Another Q code which has been adopted in a special way is QSL. Generally it means "Do you acknowledge receipt?" or "I acknowledge receipt", however amateurs have taken to sending postcards to confirm a contact. These cards are, not surprisingly,

BFO	Beat frequency oscillator
CW	Continuous wave (used to denote a Morse signal)
DX	Long Distance
FB	Fine Business
HI	Laughter
Mod	Modulation
PA	Power Amplifier
SWL	Short Wave Listener
TVI	Television Interference
WX	Weather
XTAL	Crystal
XYL	Wife
YL	Young Lady
73	Best Regards
88	Love and Kisses

Fig. 6. Common abbreviations.



**Readability, Strength and Tone****Readability**

- R1 Unreadable
- 2 Barely readable
- 3 Readable with difficulty
- 4 Readable with little difficulty
- 5 Perfectly readable

**Strength**

- S1 Barely detectable
- 2 Very weak signals
- 3 Weak signals
- 4 Fair signals
- 5 Fairly good signals
- 6 Good signals
- 7 Moderately strong signals
- 8 Strong signals
- 9 Very strong signals

**Tone**

- T1 Extremely rough note
- 2 Very rough note
- 3 Rough note
- 4 Fairly rough note
- 5 Note modulated with strong ripple
- 6 Modulated note
- 7 Near DC note but with smooth ripple
- 8 Near DC note but with trace of ripple
- 9 Pure DC notes

**Fig. 7. RST code.**

called QSL cards. Although not every contact deserves a card, it is nice to have one for an interesting contact or a new country.

Listeners can also send cards to give reception reports in the hope of receiving a card back. When doing this it should be remembered that many amateur stations receive a lot of these cards which are usually of little use. Any reports sent should give some useful information. Also return postage should be included. If the station is abroad this can be done using an International Reply Coupon (IRC).

As one may imagine sending plenty of cards to all the corners of the world can be expensive. In order to reduce the cost most of the national radio societies like our Radio Society of Great Britain (RSGB) operate what is called a QSL Bureau available to listeners and licensed members alike. The system operates by sending cards in bulk. The station owner will send his cards to the bureau in batches of ten, twenty or more. The RSGB

collects cards from all over the UK and sends them to other countries in bulk or to members in batches. This obviously takes more time, but it saves a tremendous amount in postage!

Collecting cards can be fascinating, almost a hobby in its own right. Some of the cards are very bright and colourful, others even have photographs on them. In fact people often use them to put up around the wall in the radio room as a form of decoration, showing the variety of countries and places which have been contacted or heard.

**Equipment**

For those interested in listening in, the choice of equipment is very important, and there is a wide variety of receivers on the market these days. Domestic portable receivers which cover the short wave bands are not really suitable because most amateur transmissions use either SSB or Morse which require the receiver to have a BFO (Beat Frequency Oscillator). The cheapest form of receiver is one of the 'World Band' types which are becoming more popular these days. They generally cover frequencies from the long wave band right up to 30 MHz and the broadcast FM band. Those which could be used for amateur radio listening have a frequency synthesiser with keypad frequency entry to enable accurate location of frequencies and the normal tuning knob for scanning around the bands. They also possess the essential BFO.

The cost of these receivers varies quite widely. The most expensive can cost several hundred pounds but at the bottom of the market there are a number at around £90 which can be found in high street electrical stores.

The next step up is a proper communications receiver. These are generally larger and have a better performance. They are more expensive, but the extra investment may be worth while if anything more than casual listening is envisaged.

**Clubs and Societies**

To anyone starting out in a hobby it is helpful to be able to get advice from people who have some experience. Amateur radio is no

different and fortunately there are plenty of clubs and societies all over the country. They will be only too pleased to welcome a new member

**QRM** Is there any (man made) interference?  
There is (man made) interference.

**QRN** Is there any atmospheric noise?  
There is atmospheric noise.

**QRO** Shall I increase power?  
Increase power.

**QRP** Shall I decrease power?  
Decrease power.

**QRT** Shall I stop sending?  
Stop sending.

**QRU** Do you have any messages for me?  
I have no messages for you.

**QRV** Are you ready to receive?  
I am ready to receive.

**QRZ** Who is calling me?  
You are being called by.....

**QSL** Can you acknowledge receipt?  
I can acknowledge receipt.

**QSP** Can you relay a message?  
I can relay a message.

**QSY** Shall I change to another frequency?  
Change to another frequency.

**QTH** What is your location?  
My location is .....

**Fig. 8. Q codes.**

and offer advice.

There is also the Radio Society of Great Britain. This organisation publishes a monthly magazine, Radio Communication, full of articles and news about amateur radio. It also runs a QSL bureau, organises contests, negotiates with the licensing authorities to obtain better conditions and performs a whole host of other functions. For further information the address is RSGB, Lambda House, Cranborne Road, Potters Bar, Herts. EN6 3JE.■



NATIONAL  
COLLEGE OF  
TECHNOLOGY

## Packaged Short Courses

The National College of Technology (NCT Ltd) offers a range of packaged short courses in analogue electronics, digital electronics & fibres, optoelectronics & programmable logic controllers for study at home or at work. The advantages are that you may,

- commence at any time
- work at your own pace
- have a tutor (optional)

and there is no travelling involved. BTEC certificates are available subject to the conditions of the award. These highly popular packed courses contain workbooks, a cassette tape, circuit board and components necessary to provide both theoretical and practical training.

Whether you are a newcomer to electronics or have some experience and simply need updating, there is probably a packaged short course ready for you. Write or telephone for details, quoting Practical Electronics, to:

**NCT Ltd, Bicester Hall**  
5 London Road, Bicester  
Oxon OX6 7BU  
or telephone (0296) 613067 Ext. 202

# HENRY'S ELECTRONICS DISTRIBUTORS

QUANTITIES FROM STOCK

ALL PRICES  
INCLUDE VAT

ASK ABOUT OUR LOW LOW QUANTITY PRICES!

### FANS

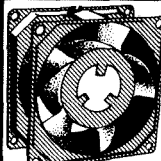

Axial Fans in stock  
220/240V A/C  
110/120V A/C, 12 volt  
and 24 volt.  
Various sizes.

### SWITCH MODE POWER SUPPLIES

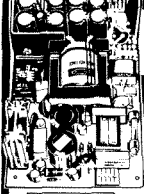

TWO MODELS  
AVAILABLE IN  
QUANTITY -  
FROM STOCK

#### TYPE 1 OPEN CHASSIS TYPE

Output + 5 volt 8 amp,  
+ 12 volt 0.5 amp,  
- 12 volt 0.3 amp.  
230-250 V A/C Input  
Size 7.7 x 4.2 x 1.9 ins

BRAND NEW £5.95 EX-UNITS £2.95

### TIMERS & RELAYS

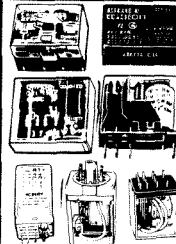

All types of Relays.  
Low Voltage, 110/240V  
A/C DIL, OCTAL,  
PLUG IN, PCB Ecc  
Also 110 and 240 V A/C  
timers.

### MOTORS

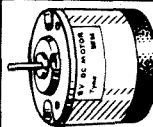

Low voltage DC, 3 volt,  
6 volt, 9 volt and 12 volt  
stocked

#### TYPE 2 ▶ ASTECC ENCLOSED METAL BOX

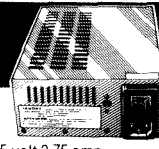

Three pin  
mains socket  
input, on/off  
switch. Output + 5 volt 3.75 amp,  
+ 12 volt 1.5 amp, - 12 volt 0.4 amp.  
115-230 V A/C Input Size 7.0 x 5.3 x 2.5 ins

BRAND NEW £12.95  
Post, Packing and Insurance  
£2.05 for 1 or 2

### TEST INSTRUMENTS

UK's largest in-stock  
range. Also components  
and Semi-conductors.  
Security and Audio/PA

**HENRY'S AUDIO ELECTRONICS**  
404 Edgware Road, London W2 1ED. Tel: 071-723 1008

- Open 6 days a week for callers and Telephone orders
- Trade/Export supplied
- Quantity Enquiries Tel: 071-258 1831
- FAX: 071-724 0322

CALL IN OR  
SEND FOR  
CATALOGUES  
Send A4 SAE  
(UK Stamp £1.10)  
Mark Ref. SWP  
FREE to callers,  
Trade/Industry  
and Education



## AG E & G ELECTRONICS

ELECTRONIC COMPONENTS MAIL ORDER COMPANY.

1990 COMPONENTS CATALOGUE  
IS AVAILABLE NOW.

**FREE** entry to win an ultraviolet exposure Unit Value £ 200.

Have you send for your copy yet ?

Electronic Components  
at the right prices.

- FAST SERVICE
- LOW PRICES
- LARGE DISCOUNTS

Competition ends  
31 Dec 1990.

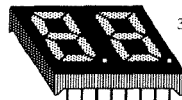
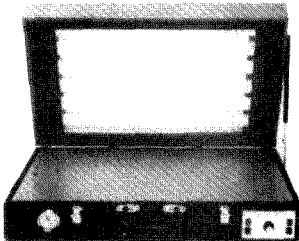

0.5" ORANGE DUAL LED DISPLAY  
Value £ 2.00 absolutely free !!!

Simply complete and return the order form below and we will send your free gift.

PLEASE SEND A COPY OF THE A & G ELECTRONICS CATALOGUE  
AT £1.00 ( REFUNDABLE WITH MY FIRST ORDER ) AND MY FREE  
GIFT TO:  
NAME .....

ADDRESS .....

I HAVE ENCLOSED £ .... Tick box to enter the competition.

A & G ELECTRONICS LTD.  
Free Post ,100 Park Avenue ,  
London E 6 2BR. (No Stamp Required)  
TEL : 081-552 2386 Fax : 081 - 519 3419.

## What's so Special about

**PAGE 37?**



It's one of many showing how  
wide and varied are the  
ranges of COMPONENTS,  
PRODUCTS and MATERIALS  
to be found in our 1991  
Catalogue.

It is well presented, illustrated  
and easy to look up.  
88 pages and cover, A4 size

### WE ARE SPECIALIST SUPPLIERS FOR SIEMENS FINE QUALITY COMPONENTS

Please send £1.50 (Cash/PO/Cheque/stamps)  
for your 1991 EV Catalogue (Postage paid). We  
give you refund vouchers for £1.50 usable  
towards your next order value £5.00 or more.

MAKE  
YOURS A  
**FREE**  
COPY



Britain's preferred mail-order  
suppliers backed by 25 years  
continuous experience and as up to  
date as tomorrow's world.

Catalogue orders to:

### ELECTROVALUE LTD

28c St. Judes Rd, Englefield Green, Egham, Surrey TW20 0HB  
Phone Egham (0784) 433603 :: Fax: (0784) 435216

# The Integrated Circuit Story

*It is an undisputed fact that the silicon chip has come to dominate the electronics scene. Where and when was the concept invented? Ian Poole reports.*

If it were not for the invention of the integrated circuit (IC) most of today's electronics could not be made in a cost-effective or practicable way. Computers would be large and very costly, and the personal computer would only be a dream. Many other everyday pieces of electronic equipment would be different too. Car electronics, clocks and even the humble transistor radio would not have the number of facilities we have come to expect. Yet, in spite of its dominance, the integrated circuit had very humble beginnings. In fact the scientists at Bell Laboratories, where the transistor was invented, did not believe they were possible.

## Immaculate Conception

It was not long after 1947, when the transistor was invented, before people started to wonder if several transistors could all be put onto the same piece of silicon. One of the reasons for this was that equipment was becoming increasingly complicated.

The first investigation into methods of overcoming the problems of size and reliability was based around thermionic valve technology. In the early 1950s the US Government was looking at ways of improving circuit assembly. It funded a project, known as Tinkertoy, to investigate the possibility of screen printing components onto a ceramic base. As transistors were still very much in their infancy at the time, conventional valves formed the mainstay of the project.

As the project got underway, a number of other ideas were slowly being developed. For example, as

early as 1952 Dr G. Drummer from the Royal Radar Establishment (RRE) in Britain proposed that it might be possible to build a circuit as a solid block without any interconnecting wires. Unfortunately he did not suggest any practical ways in which the idea might be realised. Meanwhile, in the US, the Radio Corporation of America (RCA) was investigating methods for making a phase shift oscillator on a single piece of silicon. However, the project was somewhat before its time because the technology did not exist to enable any real progress to be made.

The next milestone occurred in Britain when the RRE placed a contract with Plessey to investigate the feasibility of making an integrated circuit. Unfortunately, before any progress was made, Texas Instruments announced its first IC.

## Tinkertoy Transistors

By 1957 the US Government was trying to update Tinkertoy to use transistors. The work was shared between a number of contractors causing different companies to work separately along similar lines.

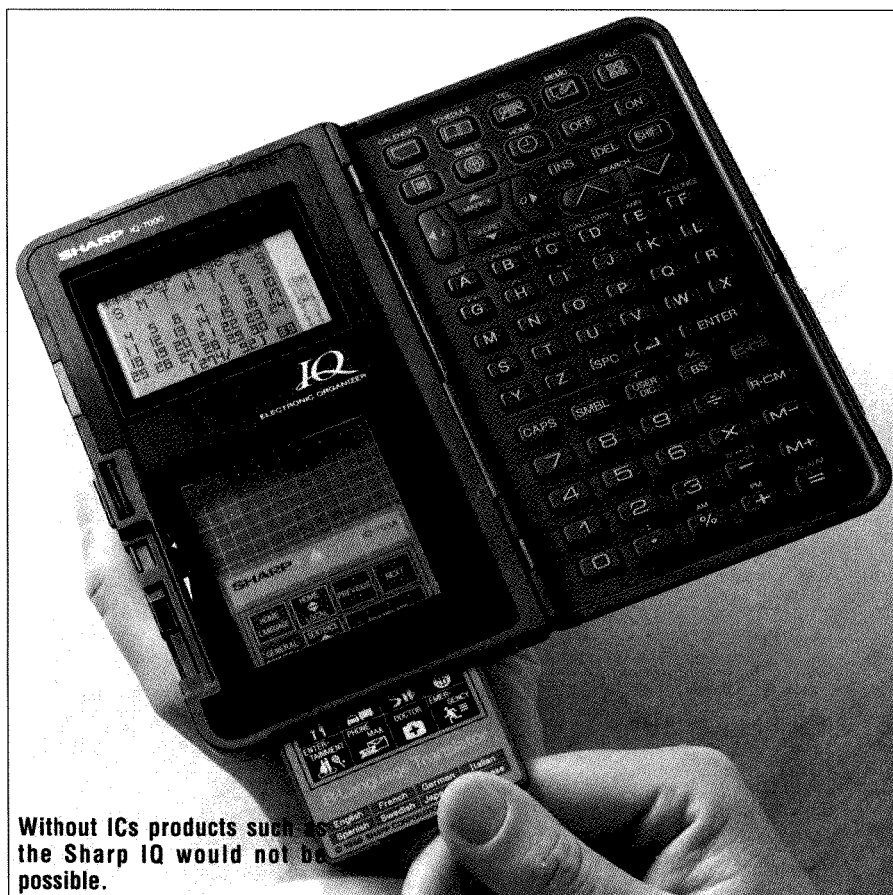

Without ICs products such as the Sharp IQ would not be possible.

## The first years of the IC.

The first main use of semiconductors was in rectifiers – devices for converting the positive and negative voltages of alternating current into positive voltages only. Later they were used in early radio sets where a wire, known as a 'cats whisker', touched to a crystal of Lead Sulphide or Silicon formed part of the tuning circuit.

- 1948 The Germanium transistor was discovered by John Bardeen and Walter Bratain working at Bell Telephone Laboratories.
- 1949 William Shockley outlined some of the basic theories behind semiconductors and invented the junction transistor.
- 1956 Bardeen, Bratain and Shockley were awarded the Nobel prize for their work in developing the transistor. Shockley also started the Shockley Transistor Corporation, one of the first Silicon Valley firms. Eight engineers eventually left to form Fairchild and later two of these, Robert Noyce and Gordon Moore, founded Intel (and became millionaires in the process).
- 1958 Jack Kilby, working for Texas Instruments, fabricated the first integrated circuit which was used in a calculator replacing a number of discrete components.
- 1964 The number of components per IC rose to around 10.
- 1969 M E Huff Jr. working for Intel, designed the first microprocessor, the 4004. National Semiconductor and Rockwell also also entered the field. However, Texas Instruments, Motorola and Fairchild continued to manufacture high power semiconductors and ICs for calculators thinking that microprocessors were not very important.
- 1970 The average number of components per chip rose to around 1000.
- 1972 Intel launched the 8008 microprocessor as an upgrade to the 4004.
- 1973 Intel launched the 8080, one of the most widely used microprocessors ever, running 20 times faster than the now outdated 4004.
- 1975 Motorola entered the market with the 6800 and General Instruments and Texas also entered the fray – Texas began second sourcing the 8080 ensuring its availability and establishing it as the front runner.
- 1976 The number of components per chip jumped over the 32000 mark and the age of the Integrated Circuit had begun.

A year after the start of the project, a bright young engineer named Jack Kilby joined one of the companies in the project, Texas Instruments. He had a number of ideas of his own which he wanted to follow through. Normally this wouldn't have been possible but, having very little leave entitlement, he offered to work through the annual holiday shutdown. In two weeks he was able to make tremendous progress.

Kilby set about making three phase shift oscillators on a germanium substrate. The first of these was made to work on 12th September 1958. Soon afterwards he made a batch of multivibrators. The dawn of the integrated circuit age had arrived.

As with so many other inventions, when the technology is ripe the idea is discovered by several people at the same time. Robert Noyce of Fairchild (who died only recently) reasoned that instead of making a large number of transistors on a single piece of silicon, cutting them up into single devices, packaging them into their cans and then reassembling them, the stages of splitting and reassembling could be done away with. By following this reasoning through Noyce developed the ideas which form the foundation of modern IC manufacturing. Kilby and Noyce are now jointly credited with the invention of the IC.

## Space Race Technology

The integrated circuit was not an instant success and it was 1961 before any ICs were available commercially. Even then they were used by very few people.

Only two companies manufactured ICs, Texas with its 51family and Fairchild with the Micrologic series. ICs were very expensive because they used new technology and demand was not large enough to bring prices down. However, the impetus needed to get the new technology off the ground did not take long to arrive. In May 1961 President John F Kennedy said it was the intention of the US government to have a man walk on the moon before the decade was out.

With NASA now in the market for new technology which was both small and powerful, ICs were in

great demand and prices started to fall. The range of ICs began to expand as more money was put into research.

## ICs Hot Up

Although virtually all the initial development work had been done in the States other countries soon started producing their own ICs. Europe saw many large companies enter the field; Mullard, Philips, Ferranti and Plessey were but a few. Japan started to look at the idea very seriously as well. The Nippon Electric Company (NEC) in particular was close on the heels of the Americans.

Reliability and yield were steadily increased by manufacturing process improvements, and more and more components were put onto each chip. The problem to crop up was that of heat

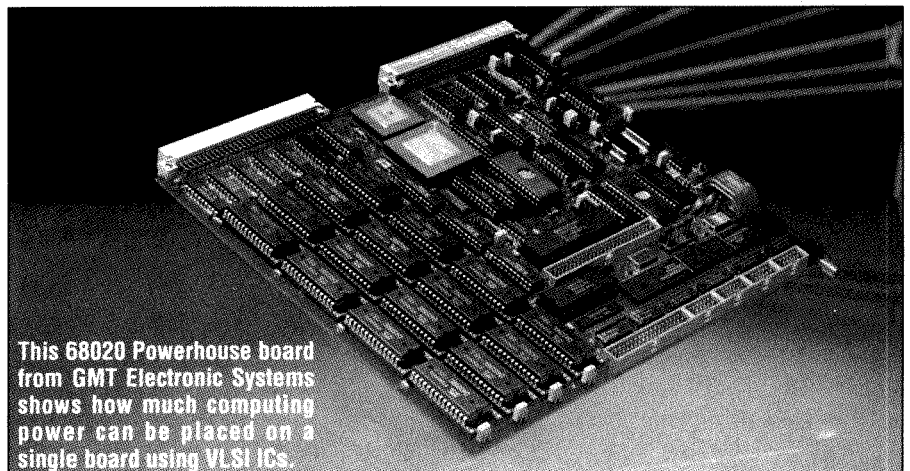

This 68020 Powerhouse board from GMT Electronic Systems shows how much computing power can be placed on a single board using VLSI ICs.

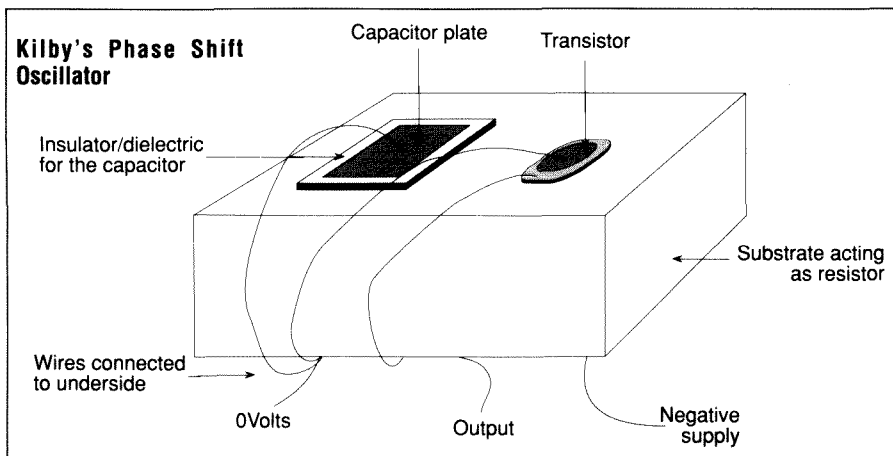

dissipation. Even the small amount of heat generated by a tiny IC had to be removed from the chip. Efficient methods of removing heat had to be found or, better still, less heat had to be generated.

The answer came in the form of a new transistor technology. FETs (Field Effect Transistors) had only just been brought onto the market and IC designers jumped at the opportunity of being able to use the new MOS (Metal On Silicon) technology. They saw the possibility of reducing heating by many orders of magnitude and, at a stroke, the scale of integration rose yet again.

In 1966 Texas Instruments was the first company to introduce a MOS device – a binary to decimal converter. Many other devices followed and ICs were now in a position to gain even more prominence in electronics.

With MOS technology the possibility of Very Large Scale Integration (VLSI) was in sight. The first step along this path was taken by Fairchild. In 1967 a device with over a thousand transistors appeared – a RAM chip intended for use in computers. Unfortunately it was still more expensive than the magnetic core memory in use at the time and was not marketed. Even so it showed what could be done and was a step toward the future.

### New on the Scene

It was about this time that Noyce and one of his colleagues left Fairchild to found Intel. Progress in this new company was swift. In less than a year it had designed, tested and started to manufacture a bipolar static RAM. Having done this it started to develop other memory devices.

### The Microprocessor

In the early 1970s electronic calculators came onto the market. Even though they contained ICs which had a high level of integration, these calculators still contained a relatively large number of chips. Seeing the requirement for a more general set of ICs, Noyce and his team set about designing devices which would reduce the chip count and, as a bonus, could be used in other applications. They came up with four ICs; the 4004 processor, a ROM, a RAM and a chip to control input and output functions.

Intel was not sure about marketing this set of chips because it was primarily a memory company. Even though the idea was new it went ahead hoping it might increase memory sales. The 4004 was reasonably successful, though the microprocessor boom was yet to start. The next device from Intel was the 8008, but users found it had several shortcomings. Some redesign was undertaken and it was relaunched as the 8080. This soon received its seal of approval when the Digital Equipment

Corporation decided to use it in their PDP range of computers.

Intel was not the only manufacturer producing microprocessors. Motorola was close on its heels with the launch of its 6800. This also proved to be successful and fierce competition broke out between the two companies. Following on from the original 8-bit devices some 16-bit processors were designed. Intel launched its 8086 in 1986 and Motorola followed a year later in 1987 with the 68000. Intel managed to score a coup when their device was chosen for use in the IBM PC leading to the 80286, and eventually the 32-bit 80386.

### Microwave ICs

Whilst microprocessor technology forms a very large part of today's IC manufacture it is by no means the only development. Many other types of IC are being manufactured. It is only necessary to look at satellite TV to see ICs being used at frequencies of thousands of Megahertz for amplifiers and signal processing. This has only been made possible by a considerable amount of research into new materials and new methods of manufacture.

Monolithic microwave ICs made from gallium arsenide are breaking all the speed records.

### Thirty Years On

It is about 30 years now since the first ICs were produced. In this time they have developed from an idea which many people thought would never be viable to become the central element in today's electronics industry. ■

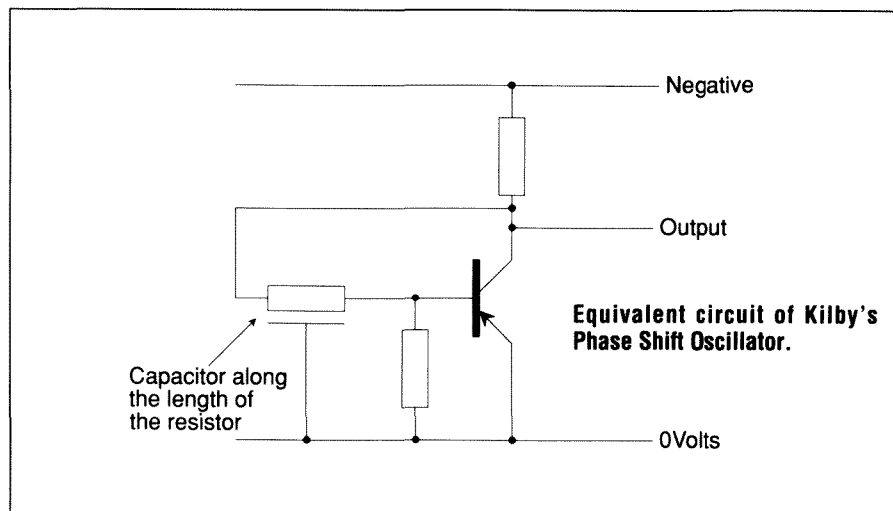



# Practical Electronics Classified Ads

Reach thousands of serious electronic and computer enthusiasts – advertise in PE Classified pages:  
 Rates 20p (plus 3p VAT) per word or £8.50 (plus £1.28 VAT) per column cm. All classified advertisements must be pre-paid. Send your copy, with remittance payable to Intra Press, (Payment by Visa or Access accepted – ads may be phoned in) to:

**Practical Electronics, Intra House, 193 Uxbridge Road, London W12 9RA.  
 Tel: 081-743-8888. Fax: 081-743-3062**

## Education

### FULL-TIME TRAINING COURSES

#### 2 YEAR BTEC NATIONAL DIPLOMA

Electronics and Communications Engineering

(TV, Computers, Programming, IT)

#### 1 YEAR

#### BTEC NATIONAL CERTIFICATE

##### 1. Electronic Equipment Servicing

(TV, Video, CCTV)

##### 2. Computing Technology

(Microprocessors, DataComms, Interfacing)

##### 3. Information Technology

(Telecomms, Satellite TV, Networks)

##### 4. Software Engineering

(Assembler, BASIC, Pascal, CAD/CAM)

★ Those eligible can apply for E.T. grant support ★

★ An equal opportunities programme ★

#### COURSES COMMENCE

Monday 22nd April 1991

### LONDON ELECTRONICS COLLEGE

Dept: AA, 20 Penywern Road,  
 London SW5 9SU. Tel: 071-373 8721

### Start training now for the following courses.

- Telecomms Tech C&G 271
- Radio Amateur Licence C&G
- Microprocessor
- Introduction to Television

Send for our brochure - without obligation or telephone us on 06267 79398 (Ref: PE3/91)  
 Name.....

Radio & Telecommunications Correspondence School,  
 12 Moor View Drive, Teignmouth,  
 Devon TQ14 9UN

## Retailers

### EDINBURGH

#### OMNI

stock a wide range of electronic components at  
**174 Dalkeith Road  
 Edinburgh EH16 5DX**

**Tel: 031 667 2611**

Open Mon-Fri 9am-6pm

Sat. 9am-5am

NEW CATALOGUE OUT NOW

Price is just £1.50

Contact Omni Electronics now for details

### LONDON N WEST

### CRICKLEWOOD ELECTRONICS

*One of the largest ranges of components in the UK!*

**40 Cricklewood Broadway,  
 LONDON NW2 3ET**

**Tel: 081-450 0995/452 0161**

## Project your retail image here!



Phone David Bonner for details on  
**081-743-8888**

## LONDON

### HENRY'S

ELECTRONICS DISTRIBUTORS

*Please see our display advertisement in this issue for more details!*

## LONDON WEST

### Large Selection of Kits & Other Goodies

from

TK Electronics,  
 13 Boston Road,  
 LONDON W7 3SJ  
 Tel: 081-567-8910

## MANCHESTER

### THE ELECTRONICS SHOP

We stock a large range of electronic components, test equipment, telephone accessories, computer accessories, microphones, speakers, discolorighting, mixers, meters, stylus, so call in and have a look around.

**29 Hanging Ditch, Manchester M4 3ES**  
 Telephone: 061-834 -1185  
 Fax: 061-833-2969

## SOUTHSEA

### ELECTRONIC COMPONENTS

EVERYTHING FOR YOUR NEXT PROJECT  
 THE BIGGEST DISPLAY IN THE SOUTH IS AT

### FRASER ELECTRONICS

42 ELM GROVE ★ SOUTHSEA ★ HANTS  
 Telephone: 0705-815584

Barclaycard

Access

## Components

### CAMBRIDGE COMPUTER SCIENCE LIMITED

3.5" 720K Diskette Drives. NEW in Stock ..... £39.00 each  
 10MByte Winchester, used, 3 months Wty ..... £42.00 each  
 5.25" Disk Drives, 80 Tk. DSDD ..... £34.00 each  
 5.25" Disks, DSDD, 48tp boxes of 10 ..... £3.00/box  
 40W PSU 5V 3.75A, 12V 1.5A-12V 0.4A cased with on/off switch ..... £10.00 each  
 Base switch mode PSU 5V 25A, 12V 2A-12V 0.1 A ..... £7.00 each  
 Gould PSU 0-30V @ 5A Limited quantity only at ..... £45.00 each  
 Single Data lead (BBC Micro to Disk Drive) ..... £2.00 each  
 Dual Data lead (BBC Micro to 2 Disk Drives) ..... £4.00 each  
 Power lead (BBC Micro to Disk Drive) ..... £2.00 each  
 Dual power lead (BBC Micro to 2 Disk Drives) ..... £4.00 each  
 2764 EPROMS (Ex-equipment) ..... £1.00 each  
 27128 EPROMS (Ex-equipment) ..... £1.20 each or £5.00/5  
 256K Byte DRAM Modules, removed from equipment ..... £6.00 each  
 6264-12 8K Byte SRAM ..... £3.80 each  
 62256-10 32KByte SRAM ..... £5.00 each  
 65256 32K Byte rams ..... £4.00 each  
 8K Byte NV ram chips £3.00 each ..... £10.00 each  
 CPU cards (Newbrain) Z80 CPU, 3 EPROMS & 60 + mostly 74LS ICs £2.00 each  
 LCD graphics module 240 by 64 pixel with driver chips ..... £13.00 each  
 Keyboard, 100 keys on board LCD & micro if ..... £8.00 each

Prices include postage. Add 50p (plus VAT) to orders below £5.00  
 All items new unless stated. Add 15% VAT to all prices.  
 Send an SAE for our latest list or for more info.  
 Dept PE, 374 Milton Road, Cambridge, CB4 1BU  
 Tel: 0223 424602 or 0861 430486 (Please note mail order only)

### Manufacturers Original Spares

Available for many makes of TV, Video & audio Equipment. Also Sinclair, Amstrad, Commodore & Atari Computers. Write (Encl. SAE please) or Phone for a 'Price and Availability' on your requirements.

**Sinclair ULA's:** 6C001E - £15.99 LA15 - £12.63  
 7C001/40056 - £16.99 PCF 1206P/40058 - £7.89  
**Membranes:** QL - £7.95 Spec. 48K - £4.50 +128K - £7.90  
**Atari (ST):** Glue - £24.31 PC900 - £3.07 CNY65 - £4.34  
**Amstrad PEGA1A (PC1640)** - £32.72 IC Protector N50 - £1.02  
**Commodore IC's:** 6569 - £23.99 6581 - £15.99  
 8565 - £23.48 8580 - £13.98 8701 - £6.90

**VCR Belt kits:** Sanyo 5150 - £1.25 Hitachi VT7000 - £1.48  
**THIS IS JUST THE TIP OF THE ICEBERG!** We are holding many other items: Manuals, Tools, Telephone Accs., Computer Chips/Accs., Connectors, etc. For our **New Catalogue** please send 50p CHQ./Stamps/3x1RC's etc. Please add 95p (UK) P & P to above orders.

**MARAPET (PEC) 1 Hornbeam Mews, Gloucester GL2 0UE**  
**MAIL ORDER ONLY TEL: 0452 26883**

Large selection of interesting components at very competitive prices. Large S.A.E. for lists to AGS Electronics, Unit 2, Haxter Close, Bellver Ind. Estate, Plymouth, Devon PL6 7DD. Tel: 0752-767738.

### PE Classified Works!

#### CATALOGUE £1.00 + 25P&P

Resistor Pack 85 different E12 values + zero ohm link total content  
 1000 resistors ..... £8.95  
 LEDs 3mm or 5mm red/green ..... 6p each. Yellow 11p each.  
 Cable ties 1p each £5.95/1,000 £49.50 per 10,000  
 Stepping motor 4 phase 12V 7.5' step 50 ohms ..... £8.95  
 SAA1027 stepping motor driver chip ..... £3.95  
 FM Transmitter kit good quality sound ..... £8.60  
 High quality photo resist copper clad epoxy glass boards  
 Dimensions single sided double sided  
 3x4 inches £ 0.95 £1.07  
 4x8 inches £ 2.40 £2.68  
 6x12 inches £ 5.37 -  
 12x12 inches £10.66 -

#### Special Offers

Computer Grade Capacitors with screw terminals 38000µf 20V.... £2.50  
 8700µf 10V £1.95, 68000µf 15V £2.95, 10000µf 16V..... £1.50  
 7 segment Common anode led display 12mm ..... £0.45  
 LM2931A75.0 Low drop out 5V regulator T0220 package ..... £0.85  
 BS250 P channel MOSFET £0.45, BC559 transistor ..... £3.95 per 100  
 74LS05 hex inverter £10.00 per 100, used 8748 Microcontroller ..... £3.50  
 Stereo LW/MW/FM Tuner pre-amp assembly complete with volume/tone controls and tuning scale Brand new in maker's carton. £6.95, faulty £3.50  
 Circuit etc. for above £0.50.  
 Hour counter (used) 7 digit mains 240V AC 50Hz ..... £1.45  
 LCD display 16 digit 7x5 dots dot matrix ..... £2.50  
 Qwerty keyboard 58 key good quality switches new ..... £5.00  
 Qwerty keyboard with serial output, no data ..... £5.00

Wide range of CMOS TTL 74HC 74F Linear transistors kits capacitors, resistors tools etc always in stock.  
 Please add 95p towards P&P - VAT included

**JPG Electronics 276 - 278 Chatsworth Road**  
**Chesterfield S40 2BH**  
 Access/Visa orders (0246) 211202. Callers welcome

## Components

**Carbon Film Resistors 1/4W E24 series 0.51R to 10MΩ - 1p**  
 100 op per value - 75p 1000 off in even hundreds per value - £7

**Metal Film 1/4W 10R0 to 1MΩ 5% E12 series - 2p 1% E24 series - 3p**  
 1/2Watt metal/carbon film E24 series 1R0 to 10MΩ - 1 1/2p  
 1 Watt metal/carbon film E12 series 4R7 to 10MΩ - 5p  
 BC107/8/9 - 12p BC547/8/9 - 8p BC182L 184L - 10p  
 BFY50/51/52 - 20p 2N3055 - 50p TIP31A.32A - 25p TIP. 41.42 - 40p

**Tantalum bead subminiature electrolytics (Mids/Volts)**  
 0.125 0.22/35 0.47/35 3.3/16 14p 4.7/35 15p  
 2.2/35 4.7/25 10/5 - 15p 4.7/35 6/8/16 16p 109/16 22/16 - 20p 22/16 -  
 20p 33/10 - 30p 47/10 - 35p 100/6 - 40p

**Aluminium Electrolytics (Mids/Volts)**  
 1/50 2.2/50 4.7/25 4.7/50 10/16 10/25 10/50 5p 22/16 22/25 6p 22/50  
 47/16 47/25 47/50 6p 100/16 100/25 7p 100/50 12p 100/100 14p 220/16 - 8p  
 220/25 220/50 10p 470/16 470/25 11p 1000/25 18p 1000/35 220/25 - 22p  
 4700/25 - 70p

**Miniature Polyester Capacitors 250V Wkg. Vertical Mounting**  
 01. 015. 022. 033. 047. 068 - 4p 0.1 - 5p 0.15. 22 - 6p 0.47 - 8p

**Mylar Capacitors 100V Wkg. Vertical Mounting E12 Series**  
 1000p to 8200p - 3p 01 to 068 - 4p 0.1 - 5p 0.15. 0.22 - 6p

**Subminiature Ceramic Plate 100V Wkg. E12 Series Vertical Mounting**  
 2% IPS to 47P - 3p 56P to 330P - 4p 10% 390P to 4700P - 4p

**Ceramic plate/disc E6 Series 50V 22P to .047 - 2p**

**Polystyrene Capacitors 63V Wkg. E12 Series Axial Mounting**  
 10P to 820P - 3p 1000P to 10,000 - 4p 12,000P - 5p 1N4148 - 2p 1N4002 - 4p  
 1N5404 - 14p W01 bridge - 25p 0A91 - 6p AA143 - 8p W005 - 20p 1N4006 - 6p

Zener diodes E24 series 3V3 to 33V 400mW - 8p 1 watt - 12p  
 L.E D's Red, Green & Yellow 3mm & 5mm - 10p 8mm - 36p  
 20mm fuse 0.1A to 5A quick blow - 5p Anti Surge - 8p  
 High Speed drills 0.8mm, 1.0mm, 1.3mm, 1.5mm, 2mm - 30p  
 Expo Reliant drilling machines 12Vd.c. with improved 3-jaw chuck £7.00  
 Nicads AA - 80p HP11 - £2 PP3 - £4.20 Universta Chargers - £6.50  
 Glass reed switches single pole make contacts - 8p Magnets - 12p

VAT inclusive Return postage 28P (free over £5). Lists free.

**THE C.R. SUPPLY CO.**  
**127 Chesterfield Road,**  
**Sheffield S8 0RN.**  
**Tel: 557771**

IS YOUR ADVERTISEMENT  
 A TIGHT SQUEEZE?  
**STRETCH  
 OUT!**

IN THE  
**DISPLAY  
 PAGES OF PE!**

PHONE DAVID BONNER FOR  
 DETAILS ON 081-743-8888

## Surveillance

### Simpson's Manufacturing

Manufacturers of chips  
 and security products

Rocket Trading Centre  
 Broadgreen  
 Liverpool L14 3NZ  
**051 220 9328**

### SPY BOOKS

Interested in espionage, counter-surveillance, personal freedom or investigation? Do you seek information that some people feel should remain secret or unpublished? Send S.A.E. PO Box 2072, London NW10 0NZ.

Surveillance devices, lasers, Tesla coils, scramblers, ultrasonic and many more, over 150 designs. Send SAE to: Plancentre, Old Wharf, Dynock Road, Ledbury HR8 2HS for free list.

**NEW VHF MICROTRANSMITTER KIT,** tuneable 80-135 MHz, 500 metre range, sensitive electret microphone, high quality PCB. **SPECIAL OFFER** complete kit ONLY £5.95, assembled and ready to use £9.95 post free. Access orders telephone 021 411 1821. Cheques/ P.O.'s to: Quantek Electronics Ltd, (Dept P.E.), 45a Station Road, Northfield, Birmingham, B31 3TE

**Circuit Diagram + Instructions for a 25 Watt FM Broadcast Transmitter** Cheques/POs £3.50 to AM Enterprises 44 Altyre Way Beckenham, Kent BR3 3HA

THE AFFORDABLE COMMUNITY BROADCAST MIXING DESK  
 ELEGANT IN STYLE SOUND AND QUALITY  
 THE NO SQUARE BOX LOOK

EVERY PART OF THIS FULLY MODULAR MIXER AVAILABLE SEPARATELY IN KIT FORM OR TESTED SUB UNITS FOR DESIGNER CONSTRUCTOR CLIENT DESKS

- ◆ Uncluttered Operational Area
- ◆ Presenter Designed Layout
- ◆ Full Remote Control Facilities
- ◆ The Low Profile User Friendly

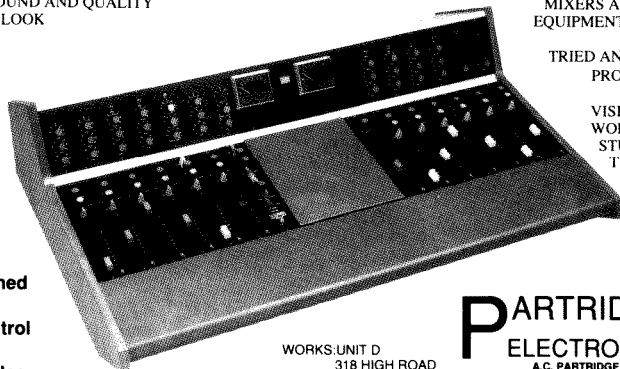

MANUFACTURERS OF MIXERS AND AUDIO EQUIPMENT SINCE 1951

TRIED AND PROVED PRODUCTS

VISIT OUR WORKING STUDIO AND TEST DRIVE THIS DESK  
 PHONE: 0268 793256

**PARTRIDGE  
 ELECTRONICS**  
 A.C. PARTRIDGE LTD.

WORKS: UNIT D  
 318 HIGH ROAD  
 BENFLEET  
 ESSEX SS7 5HB  
 PHONE: 0268 793381 FAX: 0268 565759



# PRACTICAL ELECTRONICS

SCIENCE AND TECHNOLOGY

*We chart the changing face of electronics with a look at the past 25 years of PE.*

## March 1966

**P**riced at 2/-6d, the March 1966 PE was a special issue featuring printed circuit boards and how to make them. Of the seven constructional projects, the most novel modulated an RF carrier with the output from a guitar allowing it to be played back through an AM radio. In the editorial, mention was made of how pay TV had just started in Westminster and Southwark in London. This allowed viewers to pay cash in advance for each program they watched and was considered quite a novel idea if unlikely to get very far.

## 1976

The constructional projects this month 15 years ago were a synchronome (an electronic metronome), a car/caravan clock, a peak level indicator and a total harmonic distortion filter allowing measurement of THD from 100Hz to 1kHz. The Industry Notebook column mentioned that the European Space Agency (ESA) was performing feasibility studies on direct colour TV reception from satellites – something now taken for granted. A PE kit report examined the Sinclair Black Watch. At £14.95 this was a build it yourself digital wristwatch which gave hours and minutes or minutes and seconds in red numerals on its black display. These days the technology is so cheap that better watches than this are given away with petrol.

## 1981

In 1981, PE looked at the Cegmon machine code monitor for the UK101 computer, one of the very first kit computers available to hobbyists. An interesting topic in the patents review section concerned that holy grail of electronics, 3DTV. The first patent, filed by the Marconi Company, used a camera with two lenses and cross polarised LCD filters. The second, by one William Etra of Oakland, California, described a system to process normal 2D images to 3D using colour fringing. For all of this activity, even in the 90's no one has yet produced a commercial system though patents are still filed quite frequently.

## 1986

Barry Fox's Leading Edge described how the now famous Cable News Network (CNN) reached Britain via satellite links. However, not too many people were receiving it as the government was only just getting around to licensing satellite dishes – a complete home system cost in the region of £2000. Projects included a Spectrum hardware restart, clock timer, fibre optic link and Amstrad I/O.

## PROGRAMMABLE ELECTRONIC LOCK KIT

**NEW**

Keys could be a thing of the past with this new high security lock. Secure doors to sheds, garages, even your home or prevent the unauthorised use of computers, burglar alarms or cars. One 4-digit sequence will open the lock while incorrect entries will sound an alarm. The number of incorrect entries allowed before the alarm is triggered is selected by you. Further entries will be ignored for a time also set by you. Only the correct sequence will open the lock and switch off the alarm. The sequence may easily be changed by entering a special number and code on the supplied keyboard. Kit includes: keyboard, alarm buzzer, high quality PCB and all electronic components. Supply: 5-15V d.c. Will drive our Latch Mechanism (701 150 @ £16.50) or relay directly.

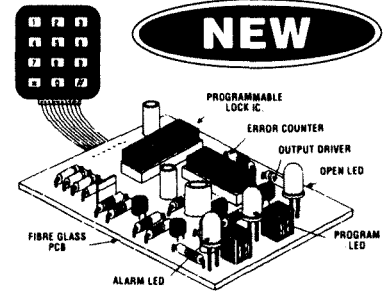

**XK131 ..... £19.95**

## DISCO LIGHTING KITS



DL8000K 8-way sequencer kit with built-in opto-isolated sound to light input. Only requires a box and control knob to complete. **£39.95**  
 DL1000K 4-way chaser features bi-directional sequence and dimming 1kW per channel. **£23.95**  
 XK139 Uni-directional version of the above. Zero switching to reduce interference. **£12.95**  
 DLA/1 (for DL & DLZ1000K) Optional opto input allowing audio 'beat' /light response. **95p**  
 DL3000K 3-channel sound to light kit, zero voltage switching, automatic level control and built-in mic. 1kW per channel. **£19.55**

## POWER STROBE KIT

Produces an intense light pulse at a variable frequency of 1 to 15Hz. Includes high quality PCB, components, connectors, 5Ws strobe tube and assembly instructions. Supply: 240V ac. Size 80x50x45.  
**XK124 STROBOSCOPE KIT... £17.25**

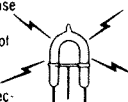

## REMOTE CONTROL DIMMER KIT

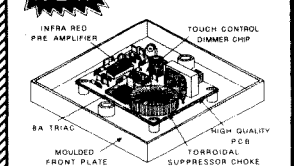

Imagine controlling the brightness of your lights or switching them on or off from the comfort of your armchair! This kit contains all the components from front panel to the last screw to enable you to do just that and fit the shallowest wall boxes. Max power 300W (not fluorescents). **£19.95**  
**XK132.....£19.95**

## IR TRANSMITTER KIT

Designed for use with the XK132 and comes complete with a pre drilled box. A PP3 9 volt battery is required.  
**MK8.....£4.95**



**XK136 TOUCH DIMMER KIT..... £12.95**

## VERSATILE REMOTE CONTROL SYSTEM

These kits can switch up to 16 pieces of equipment on and off or control 18 functions depending on the keyboard selected for the MK18 transmitter. MK12 receiver has 16 logic outputs and operates from 12 to 24V dc. or 240V ac. via the transformer supplied. The MK18 requires a 9V battery and keyboard. Great for controlling lights, TVs, garage doors etc.  
**MK12 IR Receiver.....£19.55**  
**MK18 Transmitter.....£8.95**  
**MK8 4-Way Keyboard.....£2.75**  
**MK10 16-Way Keyboard.....£7.95**  
**801 133 Box for transmitter.....£2.95**

## VOICE RECORD/PLAYBACK KIT

This simple to construct and even simpler to operate kit will record and playback short messages or tunes. It has many uses – seatbelt or lights reminder in the car, welcome messages to visitors at home or at work, warning messages in factories and public places, in fact anywhere where a spoken message is announced and which needs to be changed from time to time. Also suitable for toys – why not convert your daughter's £8 doll to an £80 talking doll!!  
 Size ..... 76 x 60 x 15mm  
 Message time ..... 1 – 5 secs normal speed, 2 – 10 secs slow speed  
**XK129 ..... £25.95**

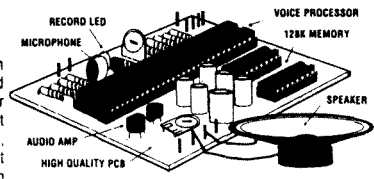

**TR ELECTRONICS**  
 13 BOSTON RD. LONDON W7 3SJ  
 TEL: 01-567 8910.  
 FAX: 01-566 1916

ORDERING INFORMATION:  
 All prices include VAT. Free P & P on orders over £60 (UK only), otherwise add £1.15. Overseas P & P: Europe £3.50, Elsewhere £10. Send cheque/PO/Visa/Access No. with order. Giro No. 529314002  
**LOCAL AUTHORITY AND EXPORT ORDERS WELCOME**  
**GOODS BY RETURN SUBJECT TO AVAILABILITY**

# Computer Aided Design

*Kenn Garroch looks at designing PCBs on an IBM compatible computer using the CAD packages BoardMaker 1 and 2.*

With IBM PC type computers becoming so cheap – a PC XT now costs as little as £500 – many people will at last find it worthwhile to buy one for word processing, small databases, perhaps spreadsheets and a little programming. Anyone who is interested in electronics and wants to design printed circuits boards (PCBs) will find another use for their PC: computer aided design (CAD).

There are a number of PCB CAD packages available for PCs covering a whole range of capabilities. Board Maker from Tsien (pronounced 'syen') is a middle of the range package that comes in two forms. Version one provides the basic facilities for designing circuit schematics and PCBs using libraries of standard components. Version two expands on this to provide a number of extra utilities as well as an autorouter. This takes a basic design and automatically routes the PCB tracks from component to component, saving a lot of time and effort.

## Getting started

Installing Board maker is pretty much the same for both versions and the package should work on any PC that is 100% IBM compatible – in other words virtually all PCs. Board Maker comes in two versions, and for both setting up is simply a matter of putting the relevant floppy disk into the drive, and typing INSTALL at the prompt. Since it is more expensive version two comes with a dongle. This is a piece of hardware used to protect the software from being copied. In practice, the

software can be duplicated very easily, simply by copying the disks with the DOS diskcopy command – which should be done anyway in case something happens to the originals. As there is only one dongle and making another would prove difficult, the software can only be used on one machine at a time, effectively copy protecting it.

Although the package can be installed on a dual floppy disk machine, the best performance is gained by installing it on a hard disk. This is automatically done by a program which sets up all of the files, directories and programs as needed. The next step is to type BM at the prompt to start the program up giving access to the PCB, schematic and library editors.

Board Maker can be operated in three main ways, using the arrow keys (or numeric keypad) to move the cursor around the screen and return to pull down menus, or with a two button mouse to control the cursor and menus. Alternatively, most of the commands have keyboard shortcuts, especially for

those which are most frequently used.

The quality of the display depends on the type of display hardware available on the PC. Most systems will support CGA (Colour Graphics Adapter) or EGA (Enhanced Graphics Adapter) though the best results can be seen with a VGA (Versatile Graphics Adapter). Version one of Board maker only supports these three. Version two can also cope with Hercules and MCGA (Multi Colour Graphics Adapter) though the former does have trouble with one of the printout selection screens. By making judicious use of the zoom and pan facilities, even the simplest system provides a reasonable display.

## Menus

The three sections or operating modes in Board Maker, PCB, Schematic and library editors, operate in more or less the same way. There are eight menus, File, Edit, Add, Tools, Option, Config,

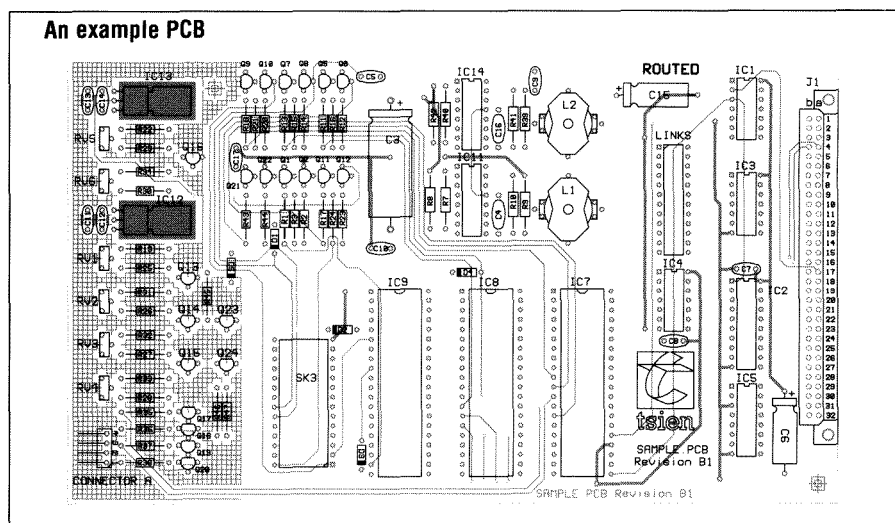



Net(version 2 only) and Library. The last two cannot be seen on some of the display adapters but are available on the file menu as well as via a keyboard shortcut. Depending upon the operating mode, the selections available from the menus vary. For example, in PCB editing mode, it is possible to select the library menu and activate all of the functions. However, those that are not applicable give an error message. It would have been better simply to put unavailable options in dimmed text or even remove them from the menus altogether. Other menus, mainly the Options menu, change their contents depending upon the type of operation in progress.

Loading, saving, exiting and so on are available from the File menu. The Edit menu allows the four main graphics operations, track, pad, text and symbol to be altered and the Add menu is used to place new ones. Again, depending on the operating mode, other items will be added to these menus – nets in PCB mode, designators and references in library mode. There was a little confusion here in that PCB library mode added Nets to the menu and then gave an error when it was used – Tsien should look at rationalising its menu system to resolve such conflicts.

The Tools menu gives a selection of useful gadgets from block selection, zoom and highlighting, to changing the cursor type, turning the grid on and off and changing the units – inches to millimetres. Most of the selections also have keyboard short cuts and, in general, they are fairly mnemonic – Z for zoom, G for grid size and so on. Most of the tools are of the on/off type and it would have been better to separate them from those which actually provide a function such as block and zoom.

The content of the Option menu depends entirely upon the

operating mode. It provides an area for extra commands. Normally it reads 'No mode selected' but as soon as, say 'add track', is invoked, it changes to provide a plethora of additional actions such as circles and arcs, shift, kill, repeat and layer control (only applicable in PCB editing). Using the Option menu in this way makes the package easy to get to grips with since basic board layouts and schematics can be done without having to use Options at all. As the user gets more familiar with the environment, all of the additional facilities become available at the drop of a menu. On the other hand, having the contents of a menu change depending on what is happening can be confusing, especially when the changes are inconsistent.

Setting up operating parameters such as track widths, pad and hole sizes, which layers should be used and the like is the job of the Config menu. In practice this is not really a menu but a setup page. When selected, the computer screen changes to text mode and reveals the current state of the settings. Once any of these have been set or altered, they can be saved in a file so that they automatically load the next time Board Maker is started up.

The final two menus are Library and Net. The first provides the user with a way to view the various component libraries. This can be done either by looking at the component names, or the actual symbols. The second menu, is not available in version one since it doesn't support Nets. However, in version two it provides facilities to hide, show, edit, import and export nets and, if the autorouter is present, run it. All of these menus can be accessed by holding down the control key and pressing the initial letter of the menu causing it to appear. This does have the effect of moving the cursor up to the

menu itself since it used to make a selection. Unfortunately, it isn't returned to its original position when the menu item is selected. When using Board Maker with the cursor keys only, this is very annoying since it means that the cursor has to be tracked all the way back to its previous position, usually far from the menu – with a mouse this is not a problem and using the keyboard short cuts also sorts it out.

## Designing Schematics

Board Maker's simplest use is in designing schematic electronics circuit diagrams. The component libraries supply many of the standard outlines such as ICs, transistors, resistors, capacitors, and so on. The computer's function keys are used for all of the basic add and edit commands. Once they are known, setting out a design is quick and easy.

The normal way to set out a schematic is to put down symbols and connect them together with tracks. The width of the tracks are set to the minimum – see examples – and using the grid, lines can be kept to neat and tidy right angles. Joins between links are defined by pads whose holes are set to the smallest possible. As well as tracks, pads and symbols, text can be added to the diagram. Each letter is actually made up from a small piece of track and there are eight possible sizes. However, there doesn't seem to be any way of adding new characters or changing the character set.

Once sections of the circuit have been set up, they can be moved or copied in sections using the block command. This also provides the ability to copy and mirror areas and even fill them – for example where a ground plane is needed. Unfortunately there is no facility to export or import blocks to and from

### Examples of BoardMaster text.

Practical Electronics  
Practical Electronics  
Practical Electronics  
Practical Electronics  
Practical Electronics  
Practical Electronics

disk. The edit functions also provide similar facilities for individual symbols, tracks, text and pads. With a track that consists of multiple points or nodes, the edit function allows the user to move from point to point and move or delete each one without interfering with the rest.

## Designing PCBs

PCBs are set out in much the same way as schematics. The symbol library is different in that it now holds component outlines and pin positions to scale. In addition, up to eight copper layers plus upper and lower silk screen can be set up to give 10 layers altogether. Depending on the graphics screen type being used, each of these will be designated with a different colour or grey shade. The Config menu also allows these colours to be changed and turned off so that specific layers can be examined without the others interfering. Unfortunately, there is no relationship between schematics and PCBs. A schematic file cannot be loaded into the PCB designer and converted into a PCB layout.

To make the design and implementation of PCBs even easier, Board Maker version two supports nets. These are used to define portions of the circuit that are connected together and allow design rules and auto-routing to be implemented. Nets also make keeping track of the various components and connection on a

board very easy. Since each electrical circuit or net can be given a name and each of its connections to a component can also be named – for example the ground net may connect with IC1 or even 7400 pin 7 – a circuit can be traced through by referring to actual device or component names and connections. Setting up a net is simply a matter of joining all of the components which connect to it together in a 'rat's nest' – just a set of point to point line connections

## Design rule checking

When designing a circuit board, an important consideration is how close tracks and holes are allowed to be. If, as in most cases, the board is to be soldered up by hand, then it is best not to make the tracks too close together. The design rule check (DRC) allows the tolerances for track to track, track to pad and pad to pad to be set. If, when laying out the board, a rule is violated, the DRC puts up an alert and the problem can be solved there and then. Since it relies on nets for its operation, DRC is only available in Board Maker version two.

Kenn - The main differences between the packages upgrade paths prices and details at work.

## Autorouting

An add on available to version 2 is the autorouter. This takes a set of pre-defined nets and converts them into tracks. It automatically routes

the tracks around the board from component to component. This may sound good but it does have a few drawbacks. Firstly, it can be a little slow, secondly it can't do single sided boards and thirdly, it relies somewhat on the components being set out in a reasonable way. According to the author, single sided boards would take longer to lay out with an autorouter than they could be done manually. Because it is necessary to look ahead a large number of tracks, the microprocessors used in PC XT's and even AT's are nowhere near fast enough.

## Improvements

Board Maker 1 is a pretty good buy. It takes all of the hard work out of PCB design and layout. Output is available in a number of formats, from drilling machines and encapsulated postscript to dot matrix. Version 2 while more expensive provides a few nice add ons such as networks and DRC that help with more complex boards. There are a few improvements that could be made to the system. It would be nice to be able to go from a schematic to a PCB design and then autoroute it – it would also be nice to be able to autoroute single sided boards but this probably won't be available for some time. On the more realistic side, a facility to be able to go into the library editors from the main design systems instead of having to return to the main menu every time. There is also an amazing amount of inconsistency in the user interface, especially the menus. For repetitive operation, some sort of macro definer would be a boon and the ability to define a new character set would be great.

At £95 Board Maker 1 is one of the best schematic and PCB design systems I have seen on the PC – most of the circuit diagrams and PCBs in the magazine were produced using it and until something better turns up, they will probably continue to be.

Tsien UK 0223 277777  
Cambridge Research Labs  
181A Huntingdon Road  
Cambridge CB3 0DJ  
BoarMaker 1 £95 ex VAT  
BoardMaker 2 ££295 ex VAT  
BoardMaker 2 with autorouter  
£495 ex VAT

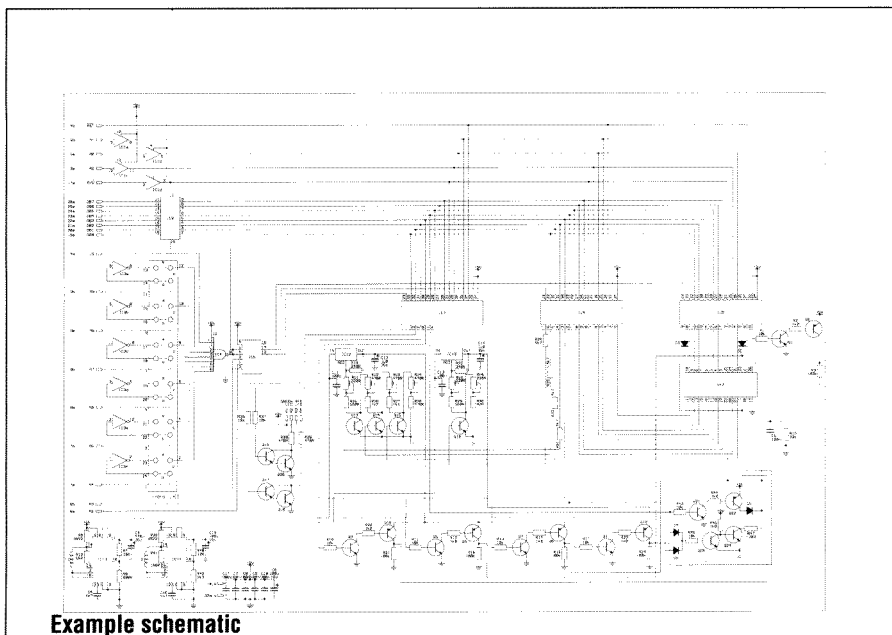

Example schematic

### LYS ELECTRONICS COMPONENTS

We have the largest range inc. surface mount devices. The best stock & lowest prices in the south.

Goods sent return of post.

Sample of our prices

555 timer at .22, 741 op.am. .20, 4013B .17, 4020B .28

8 pin DIL SKT .06 4 pin DIL SCK .08

2 way DIL switch .06 8 way DIL sw .06

10 way DIL switch .95

surface mount CA3130M 1.80

surface mount resistors .035

1/4 watt high stab carbon resistors 5% - .7 per hundred.

85 pref. values of above (1000 resistors) 7.30

LM337 50p

All prices incl. VAT & postage

Send for catalogue enclosing 60p P & P. 0705-386550

10 Westbrook Road, Portchester, Hants. PO16 9NS

### N.R. BARDWELL LTD (P.E)

200 - Signal diodes 1N4148	£1.00
100 - Zener Diode BYZ88 6V8	£1.00
75 - Electrolytics Radial 4U7 63V	£1.00
80 - Electrolytics Radial 47U 50V	£1.00
80 - Monolithic caps. Radial 100nf 63V	£1.00
10 - Monolithic caps. Radial 470nf 100V	£1.00
75 - Rectifier diodes 1N4001	£1.00
25 - Assorted high brightness LEDs	£1.00
12 - Assorted seven segment displays	£1.00
10 - 4p 3w MBB Min. Rotary Switches	£1.00
30 - Assorted DIL sockets up to 40 pin	£1.00
30 - Assorted sockets/Conns/DIL-EDGE-SIL-etc	£1.00
30 - Transistors BC478	£1.00
30 - Transistors BC182	£1.00
20 - Min SP/CO Slide switches	£1.00
20 - Magnetic ear pins + lead and plug	£1.00
30 - Assorted IFT transformers	£1.95
1 - Peltier effect heat pump	£2.95
1 - 10 watt Stereo Amplifier 4 controls + data	£2.95

Prices include VAT. Postage £1.00. All items new. Many more lines in stock. Lists - stamp. Shop open Mon-Sat 9.30 - 5.30.

388 ABBEYDALE ROAD, SHEFFIELD S7 1FL. Tel (0742) 552886. FAX (0742) 500689.

# TUTORKIT MICROELECTRONICS TUTORS

Logic Tutors  
OP Amp Tutors  
I.C. Patchboards  
GCSE Units  
Computer Interfaces

Prices from



Including instruction manual and patch leads

\*used by hundreds of schools in U.K. and overseas.

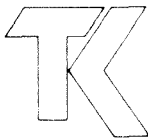
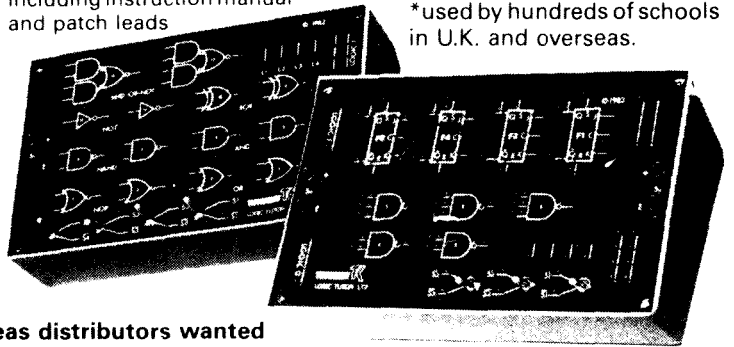

TUTORKIT PRODUCTS  
(Div of Limrose Electronics Ltd)  
Llay Industrial Estate  
Wrexham, Clwyd, U.K.  
LL12 0TU. Tel 0978 852285 Fax 0978 855556

Overseas distributors wanted

## ADVERTISERS INDEX

A+G Electronics.....50	London Electronics Coll.....54
ADM Electronics.....56	Lys Electronics.....61
BK Electronics.....19	Maplin.....OBC
Blue Rose Electronics.....56	Marapet.....55
Cambridge Computer Sci.....55	National College of Tech.....50
Colebourn Electronics.....56	NR Bardwell.....61
Coles Harding.....56	Number One Systems.....IBC
CR Supply Co.....55	Omni Electronics.....54
Cricklewood.....6	Panrix Electronics.....42
Electrovalue.....50	Partridge Electronics.....56
Fraser Electronics.....54	Phonosonics.....56
Greenbank Electronics.....26	Radio & Telecom Corr. Sch....54
Greenweld.....44	Seetrax.....13
Happy Memories.....61	Service Trading.....42
Henry's Audio Electronics.....50	Simpson Manufacturing.....55
J&N Bull Electrical.....34	Stewart of Reading.....26
JJ Components.....13	Suma Designs.....42
JPG Electronics.....55	Tandy.....IFC
Kew Bridge Steam Mus.....56	The Electronics Shop.....54
Keytronics.....4	TK Electronics.....57
Limrose.....61	Tsien (UK).....38



## Happy Memories

4164	180ns	64K x 1	1.45	2718	450ns	5 volt	2.45
41256	80ns	256K x 1	1.65	2532	450ns	Only pulls	3.50
41256	180ns	256K x 1	1.55	2732	450ns		2.15
41464	80ns	64K x 4	2.25	2764	250ns		1.85
44256	80ns	256K x 4	4.95	27128	250ns		2.25
411000	80ns	1 Meg x 1	4.45	27256	250ns		2.45
6116	150ns	Low power	1.45	27C256	250ns		2.45
6264	120ns	Low power	2.45	27512	250ns		3.45
62256	180ns	Low power	3.95	27C812	250ns		3.75
SIMMS	80ns	1 Meg x 9	37.50	SIPPS	80ns	1 Meg x 9	39.50

Please call for prices of other chips, same chips but different speeds, quantity discounts etc. Second-hand (Pulled) chips available for many of the above devices at substantially lower cost. Call for availability and price of these and other items. Full list available upon request.

Low profile IC sockets:	Pins	8	14	16	18	20	24	28	40
	Pence	5	9	10	11	12	15	17	24

Floppy disk drives 5.25" 1.2Mb or 3.5" 1.44Mb 45.00  
Motherboards: 80286-12 79.00 80286-16 EMS 119.00  
80386-SX 269.00 80386-25 479.00  
Keyboards XT/AT 102 Key 39.50 3.00 Post on these items.  
Full range of I/O cards, Hard disks etc: List available.  
Please add 50p post & packing to orders under £15. VAT to be added to total.  
Credit card orders by phone or mail welcome. Plc, Government & Educational orders welcome for minimum invoice value of £15 net.

Happy Memories (PE), FREEPOST,  
Kington, Herefordshire, HR5 3BR  
Tel: (054 422) 618 Sales, 628 Fax



(No stamp needed unless first-class required)

# Barry Fox

*The big switch to digital audio began ten years ago and it is now a worldwide standard. When will TV and Video go the same route?*

All domestic video and TV is analogue. So-called 'digital' TV sets and video recorders convert the analogue signal into digital code for some processing stages. This makes the circuits easier to integrate and widens the choice of special effects.

Professionals now use digital video recorders, which record digital code instead of analogue waveforms onto tape. Domestic digital video recorders are expected over the next few years. But before that we are likely to see digital TV transmissions. The advantage is that by converting a TV signal into code before transmission, and drastically compressing the code, it is possible to broadcast several programmes in the frequency spectrum needed for a single analogue transmission, or transmit a high definition signal in the bandwidth allocated for conventional programmes.

When you convert a signal into digital code, the bandwidth or space needed needed to record or transmit it with error correction increases by a factor of around 50:1. But the potential for digital compression is so vast that, with modern processing techniques, the loss can be turned into a gain. The digital version of the signal takes up less space than the original. Also, whereas an analogue signal suffers visibly (or audibly) from noise and interference, a digital signal remains immune as long as the decoder is able to distinguish between wanted and unwanted bits of information.

In the UK work on digital TV is under way at laboratories now owned by National Telecommunications Ltd, formerly the IBA Engineering Division.

NTL has a research contract to try and double the number of television stations available. Mike Windram, Head of NTL's Experimental and Development Department, says that results are "very encouraging".

Currently Britain's terrestrial TV transmissions use 44 of the 48 frequencies in the UHF band to provide four services (BBC1, BBC2, ITV and Channel 4). The plan to provide a fifth service relies on releasing two frequencies currently used by domestic video, satellite and games equipment, but is foundering because the service will reach only 70% of the population and cause interference to the equipment. Whoever wins the franchise will have to pay for retuning of all affected domestic equipment, which could cost hundreds of millions.

NTL's engineers believe that by using digital coding techniques, they can slot in another four nationwide services without causing any interference.

TV transmitters must be a long way apart if they use the same frequency, otherwise viewers suffer interference. For each transmitter site there are many 'taboo' channels which cannot be used because they cause interference.

NTL's system is called SPECTRE (Special Purpose Extra Channels for Terrestrial Radiocommunication Enhancements) and converts TV pictures into compressed digital code before transmission. The code is then broadcast from the same transmitters as the PAL analogue broadcasts, but at much lower signal strength and on taboo frequencies.

Because the signals are weak they do not interfere with distant transmitters. Because they are digital they can still give clear pictures on any set equipped with a decoder. NTL's computer model suggests that each transmitter site could use at least four taboo frequencies without causing interference. Viewers will be able to receive the new signals with existing TV roof aerials. The system would be ideal for subscription or pay-per-view TV services, where a decoder is needed anyway.

The difficult part is to squeeze enough bits per second into Britain's standard TV channels, which are 8MHz wide. NTL's starting brief was that there must be no loss of quality compared with analogue transmissions.

When a PAL TV signal is directly converted into digital code the resultant data stream runs at 216 Mbit/s. Clearly there is no hope of transmitting this in an 8 MHz channel without compression.

The system used is called DCT, Discrete Cosine Transform, with motion compensation, temporal interpolation and predictive coding. To cut a long, complicated story short, the DCT encoder breaks each picture down into blocks, compares them in successive pictures and records how they differ. The less change there is, the larger the blocks can be, with less code needed to describe them.

The encoder also describes and predicts how block patterns move from picture to picture. Imagine an actor moving across the screen. His shape is coded once, but then only the position on screen which he occupies is coded, along with any change of shape caused by changing perspective.

The system interleaves full reference or key frame pictures with partially coded pictures which contain only updating information. The ratio of key frames to updating frames can be fixed or vary with the programme material. The digital code adapts itself to the amount of information to be recorded, with the size of the coding steps changing according to the picture.

Using these techniques NTL has achieved a compression factor of 18:1. With digital stereo sound, and error correction, this gives a total data rate of 13.5 Mbit/s. By using multi-level phase shift keying to modulate the transmitted carrier with the code, NTL can fit it all into one 8MHz channel. On Air tests are expected to begin in 1992. ■

# EASY-PC, PCB and SCHEMATIC CAD

For Super Schematics....

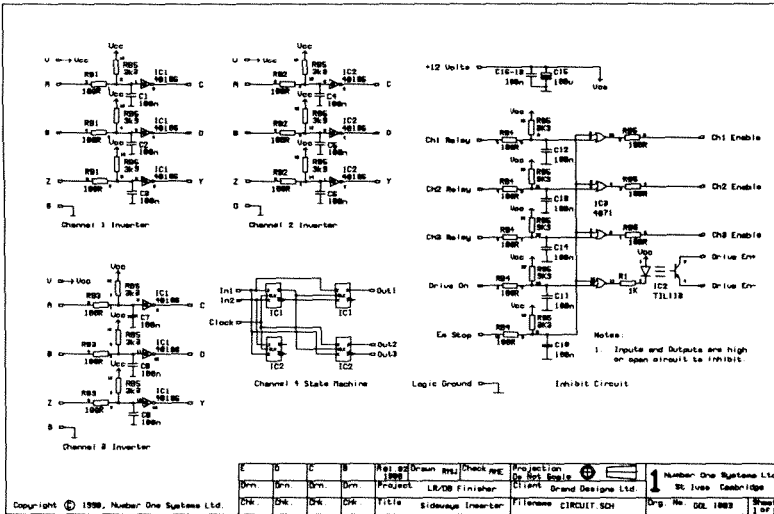

**Only  
£98!!**  
Plus P&P + VAT

**BRITISH  
DESIGN  
AWARD  
1989**

- **Runs on:-**  
PC/XT/AT/386/486  
with CGA EGA VGA.
- **Design:-**  
Single sided, Double  
sided and Multilayer  
boards.
- **Provides Surface  
Mount support.**
- **Standard output  
includes Dot Matrix  
printer, Laser Printer,  
Pen Plotter,  
Photo-plotter and N.C.  
Drill.**
- **Superbly EASY to use.**
- **Unlimited Hotline  
support.**
- **Not copy protected.**

.....and Perfect PCB's

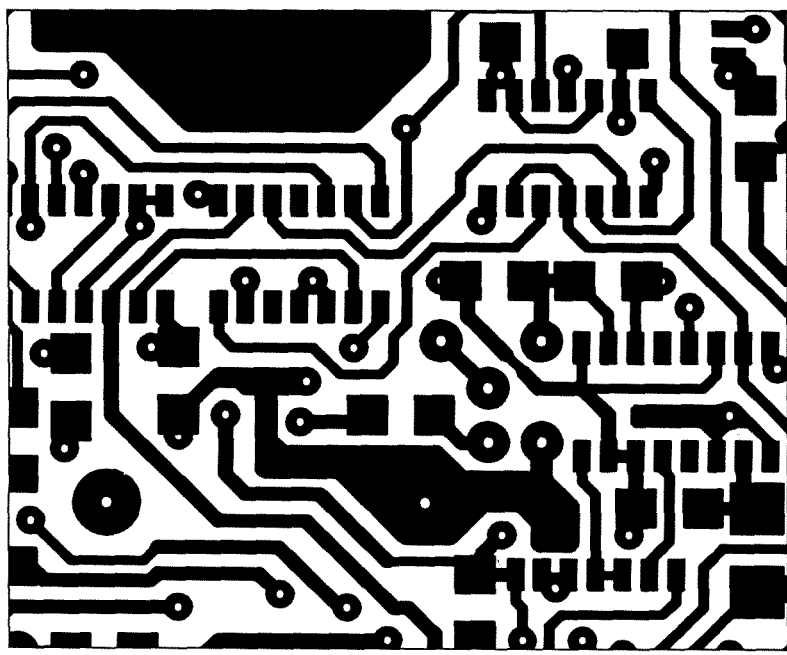

Use Award Winning EASY-PC

- **Over 6000  
installations in  
over 50 Countries  
worldwide.**
- **Over 500  
installations in  
Universities,  
Colleges** (NOV 90)

**NEW VERSION - LASER PRINTER SUPPORT!**

Write, Phone or Fax for full details:-

**Number One Systems Ltd.**  
REF: PE, HARDING WAY, ST.IVES, HUNTINGDON, CAMBS, ENGLAND, PE17 4WR.  
Telephone: 0480 61778 (7 lines) Fax: 0480 494042  
International: + 44 480 61778 / 494042

**The CAD Specialists**

ACCESS, AMEX, MASTERCARD, VISA Welcome.





# NICAM!

## ...set your sights on a better sound!

**E**xperience a new sensation. An experience that opens up a whole new spectrum of sound.

Put yourself on stage at the Albert Hall, surrounded by a great orchestra. Imagine the sound you will hear, every nuance, every note; or travel up the Nile with an intrepid explorer, a journey not only full of breathtaking beauty and colour, but rich in the sounds of another continent; or capture the hidden gasps of 100,000 hardened fans at Wembley for the F.A. Cup Final, when the ball skims the crossbar with the last kick of the match; follow with your ears as well as your eyes, dodging the bullets, as your favourite hero battles out of yet another tight corner, it's just like being in a cinema!

Nicam hi-fi stereo will turn your living-room into a living room of

sound! You don't settle for second best with television picture quality, why settle for second best in television sound quality? Nicam sound is the new high quality digital stereo sound system, pioneered by BBC, ITV and TV/video manufacturers. In fact so good is Nicam it is comparable to the superb sound reproduction of the compact disc, when played through your existing hi-fi arrangement. If your television hasn't got a built-in Nicam decoder, you will need the Maplin Nicam Tuner System. Ultimately almost all of your favourite programmes will be broadcast in superb hi-fi quality stereo-sound. Without a Maplin Nicam Tuner you won't be able to capture every sound to its full.

Nicam hi-fi stereo. Catch your breath, open your eyes, and pin back your ears! It's what your hi-fi system was made for... It's what your ears are made for!

### DIGITAL STEREO TV SOUND FROM YOUR HI-FI

The complete kit contains all the components required to build the unit. However you will also need: a power supply, 12V at 600mA regulated e.g. YZ21X at £8.95; a co-ax Y adaptor e.g. FS23A at £1.20; a co-ax lead to connect to your TV or video; RW36P 2m long at £1.28, JW39N 5m long at £1.98, or JW40T 10m long at £2.95; a phono lead to connect to your hi-fi e.g. RW50E at 98p or a SCART/Peritel lead JW36P at £4.95. An infra-red remote control kit is also available LP20W at £29.95.

**Complete kit LP19V only £139.95 incl. VAT + £1 mail-order handling charge.**



**Maplin ELECTRONICS**

**CREDIT CARD HOTLINE  
0702 554161**

For a friendly welcome and the very best of service why not visit our shops in Birmingham, Brighton, Bristol, Leeds, London (Edgware and Hammersmith), Manchester, Newcastle-upon-Tyne, Nottingham, Reading, Southampton and Southend-on-Sea.

Subject to availability. Prices subject to change.

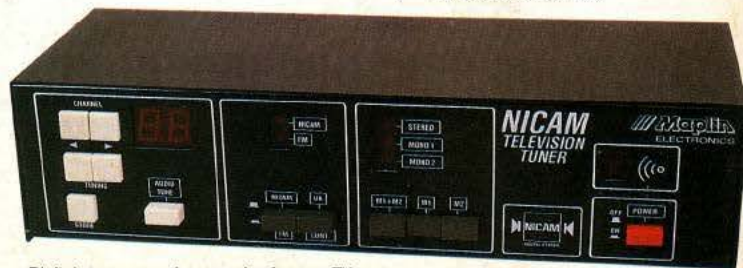

Digital stereo sound companion for your TV set.



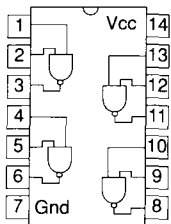

Quad 2 i/p  
NAND  
00 03oc 26oc  
37b 38boc  
1000b 1003b

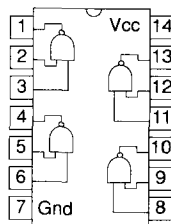

Quad 2 i/p  
NAND  
01oc

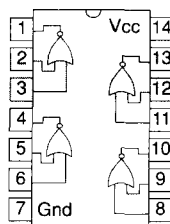

Quad 2 i/p  
NOR  
02 28b 33boc  
1002

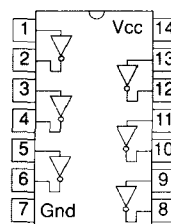

Hex inverter  
04 05oc  
06ochv  
16ochv 1004b  
1005b

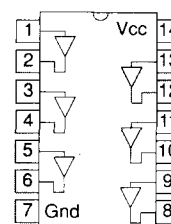

Hex buffer  
07ochv  
17ochv

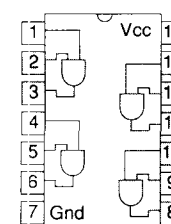

Quad 2 i/p  
AND  
08 09oc 1008b

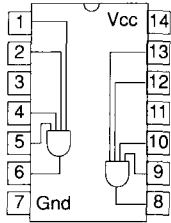

Dual 4 i/p  
AND  
21

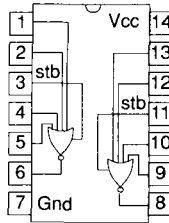

Dual 4 i/p  
strobed NOR  
23 25

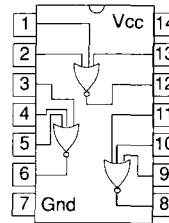

Triple 3 i/p  
NOR  
27

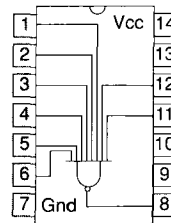

Single 8 i/p  
NAND  
30

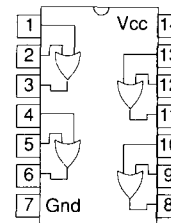

Quad 2 i/p OR  
32 1032b

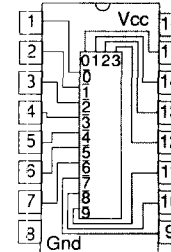

BCD to  
decimal  
decoder  
42

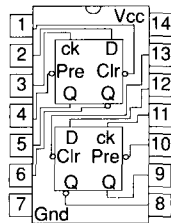

Dual D-type  
bistable  
74

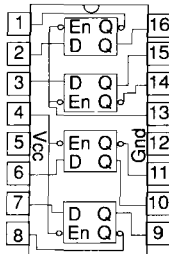

Quad bistable  
latch  
75

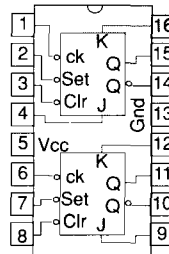

Dual JK  
bistable  
76

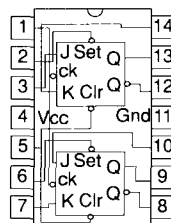

Dual JK  
bistable  
78

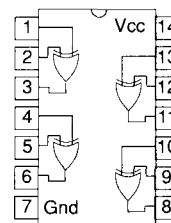

Quad 2 i/p  
exclusive OR  
86

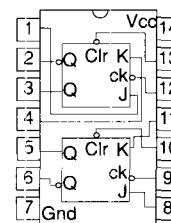

Dual JK  
bistable  
107

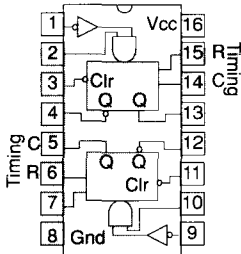

Dual Re-triggerable  
monostable  
123

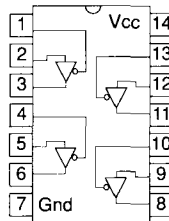

Quad tri-state  
buffer with invert  
controls  
125

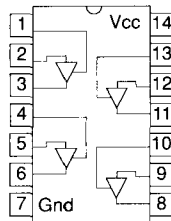

Quad tri-state  
buffer  
126

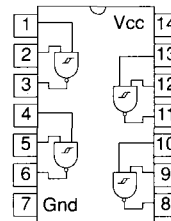

Quad 2 i/p  
Schottky NAND  
132

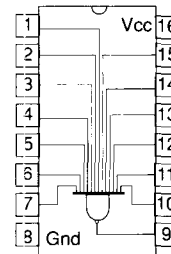

Single 13  
input NAND  
133

## Logic Gates

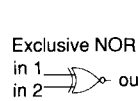
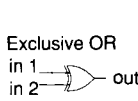
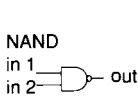
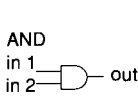
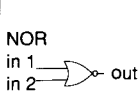
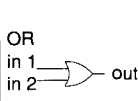
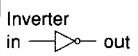
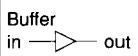

## TTL Types

Standard transistor transistor logic (TTL) is built using bipolar technology which is based on NPN junctions. This gives high speed but consumes quite a lot of power. The time taken for the signal to traverse a gate, the gate delay, is normally around 15ns. The supply current per gate is 4mA but other types of fabrication improve on this considerably.

Low power TTL, denoted by an L in the device number (74L), operate at much lower power than standard TTL. Unfortunately, the gate delays are longer. The typical gate delay is 90ns with a power consumption of 0.5mA.

Schottky TTL is another improvement on the original design that gives much higher speed. Gate delays are in the region of 7ns but power consumption increases accordingly to 6mA

per gate. Schottky TTL can operate at switching 125MHz. Devices using this technology have numbers - 74S.

To get around the high power consumption problem standard Schottky a low power version is available. Delays for this type of chip are 15ns but the power consumption is reduced to 0.4mA. Low power Schottky has device numbers. Another improvement is the Schottky (74AS) which runs approximately twice as fast with half the power consumption.

For applications that require very fast switching (74HS) can be used. Gate delays are typically 7ns with a power consumption 5mA per gate.

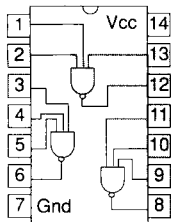

**Triple 3 i/p NAND**  
10 12oc  
1010b

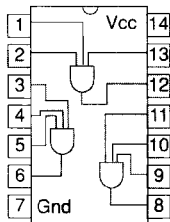

**Triple 3 i/p AND**  
11 15oc 1011b

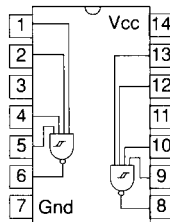

**Dual 4 i/p Schottky NAND**  
13

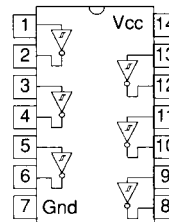

**Hex Schottky inverter**  
14

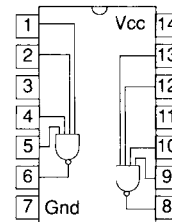

**Dual 4 i/p NAND**  
20 22oc 40b  
140 1020b

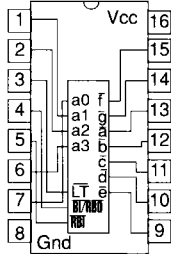

**BCD to 7 segment decoder**  
47ochv 48

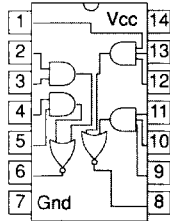

**Dual AND OR Invert**  
50 51

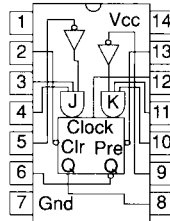

**Single JK bistable with inv i/p**  
70

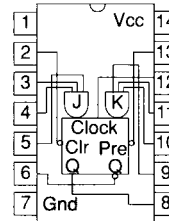

**Single JK bistable**  
72

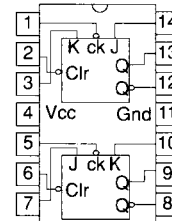

**Dual JK bistable**  
73

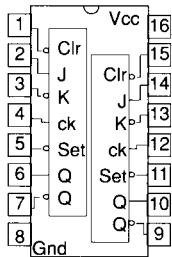

**Dual JK bistable**  
109

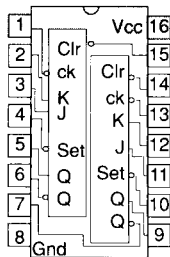

**Dual JK bistable**  
112

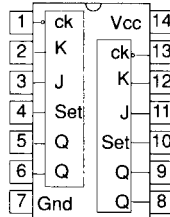

**Dual JK bistable**  
113

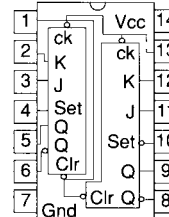

**Dual JK bistable**  
114

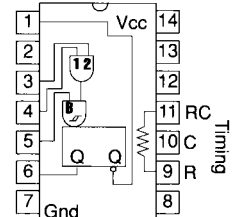

**Monostable**  
121

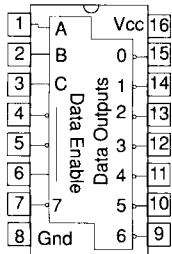

**3 to 8 line decoder**  
137

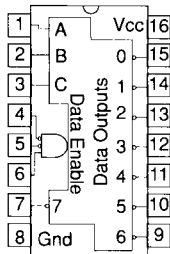

**3 to 8 line decoder**  
138

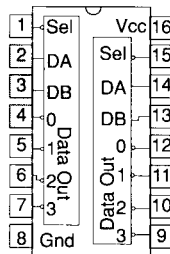

**Dual 2 to 4 line decoder**  
139

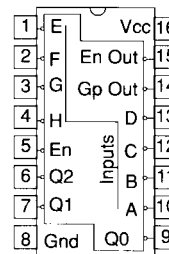

**8 to 3 line octal encoder**  
148

**PRACTICAL ELECTRONICS**  
SCIENCE AND TECHNOLOGY

**Key**  
oc Open Collector  
b Buffered  
hv High Voltage

**TTL Specifications**

The fan out or number of inputs that can be driven from an output is 10. The power supply must remain within 5% of 5V. Decoupling capacitors of about 0.1µF should be placed across the supply lines for every four to five chips.

**Standard TTL**

Supply Voltage 4.75V to 5.25V

Input

low +0.8V max, -1.6mA  
high +2.0V min, 10µA

Output

low +0.4V max, 16mA  
high +2.4V min, -400µA

**Low power**

Supply voltage 4.75V to 5.25V

Input

low +0.7V max, -0.18mA  
high +2.0V min, 10µA

Output

low +0.3V max, 2mA  
high +2.4V min, -100µA

**Schottky**

Supply voltage 4.75V to 5.25V

Input

low +0.8V max, -2mA  
high +2.0V min, 50µA

Output

low +0.5V max, 20mA  
high +3.4V min, -1mA

**Low power Schottky**

Supply voltage 4.75V to 5.25V

Input

low +0.8V max, -0.4mA  
high +2.0V min, 40µA

Output

low +0.5V max, 8mA  
high +2.45V min, -400µA

**High speed**

Supply voltage 4.74V to 5.25V

Input

low +0.8V max, -2mA  
high +2.0V min, 50µA

Output

low +0.4V max, 20mA  
high +2.4V min, -500µA

g speeds up to an S in their

blems of lable. Gate power per gate is 1 LS in the advanced ce as fast but

ng, high speed 6ns and power