

Australia \$2 New Zealand \$2.25 Malaysia \$5.25

PRACTICAL

JANUARY 1986 · £1.25

ELECTRONICS

ROBOTICS · MICROS · ELECTRONICS · INTERFACING

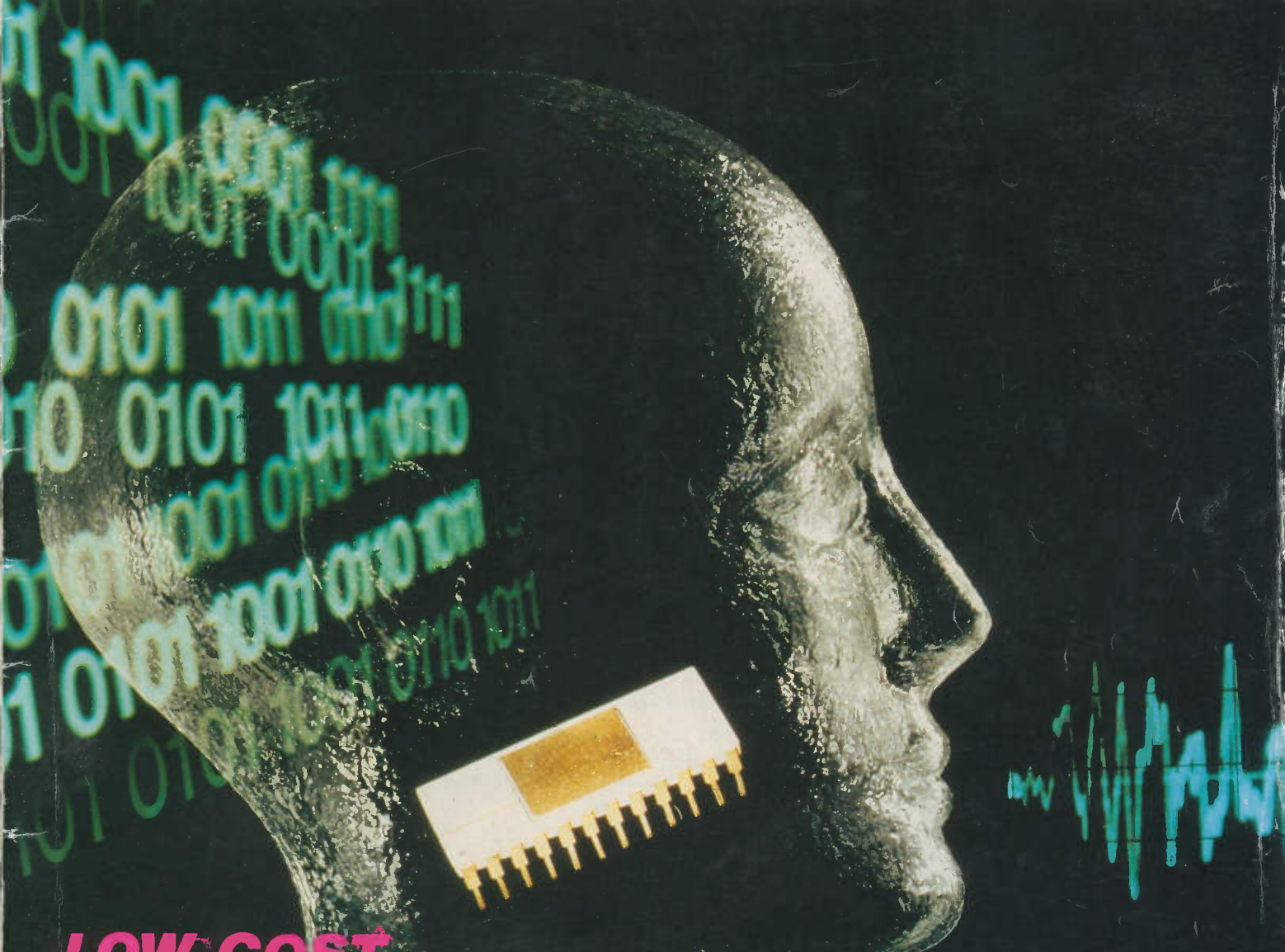

LOW COST...

Spectrum

SPEECH SYNTHESISER

& 8 BIT I/O PORT

MODULAR MIXER

Microelectronics Education Programme

ROBOTICS

Powertran's "Hebot II" and "MicroGrasp" kits offer unrivalled value for money to



colleges, schools and individual enthusiasts.

Put the kit together, plug into your micro and off you go!

Hebot II can perform a bewildering variety of actions under the control of a simple BASIC program. Features include independent control of two wheels, flashing "eyes" two-tone hooter and a retractable pen.

Complete kit **£39.95 + VAT**
Universal computer interface board kit **£5.50 + VAT**

MicroGrasp is a fully programmable electric robot arm with closed loop feedback for positive positioning. The robot can be driven from virtually all micros.

Robot kit with power supply **£150 + VAT**

Universal interface board kit **£42 + VAT**

Powertran kits are complete down to the last nut and bolt, with easy-to-follow assembly instructions.

COMPUTING

Cortex II. 16 Bit. 16 Colour. Cortex II offers the speed and power of true 16-bit processing at the same price that you might pay for some of the 8-bit games machines on the market.

The standard kit has interfaces for TV, cassette and RS232 - others are available as optional extras. Add disc drives, printer and a monitor for a fully-fledged business system. Price:

£199 + VAT



TOP KITS FROM

POWERTRAN

CYBERNETICS LIMITED

MUSIC

Powertran's range of quality audio products offers top quality at low, low prices. All the products are finished in rugged metal cabinets suitable for 19" rack mounting or as free standing units.



Headphone Amp
2 x 3 sets of stereo phones from either one or two inputs. **£20 + VAT** (metalwork and PCB's only)

Synth Mix
Stereo keyboard mixer with 3 aux sends on each of its 6 inputs. **£30 + VAT** (metalwork and PCB's only)

MPA 200 100 watt mixer-amplifier. Complete kit **£40 + VAT**
SP2 200 2-channel 100 watt amplifier. Complete kit **£50 + VAT**
Chromatheque 5000 5-channel light show controller. Complete kit **£40 + VAT**
Digital Delay Line Studio quality effects - up to 1.6s delay **£95 + VAT**
Patchbay 16 pairs of jacks - for studio or stage. **£20 + VAT**

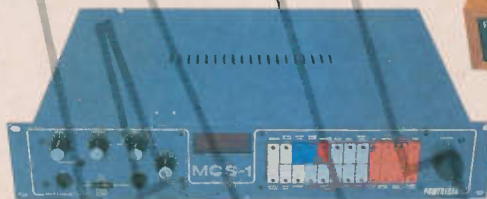

MCS-1 MIDI-controlled sampling unit - doubles as a high quality effects unit. Complete kit **£290 + VAT**

HOME SECURITY



Our Doppler Radar Alarm can detect intruders early enough (and loud enough) to offer your home real protection. Standard kit including two transmitters **£70 + VAT**
Pair of extra transmitters **£23 + VAT**
Special offer: extended kit including four transmitters **£84 + VAT**

Send for demonstration tape to sample some of the sounds available **£2.50 + VAT**

To Powertran Cybernetics Limited, Park Road, Crowborough, Sussex

Please send me the following kits _____
I enclose Cheque/Postal Order, value £ _____ (Don't forget to add V.A.T.)
Name _____ Address _____

Please allow 21 days for delivery. Offers subject to availability. Prices apply to UK only, are exclusive of V.A.T. and correct at time of going to press. Overseas customers - please contact our Export Department

Access/Visa cardholders - save time - order by phone: 08926 64222



We have moved!

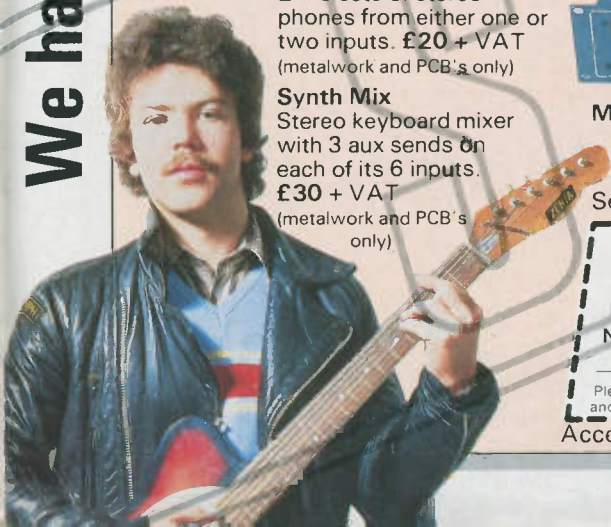

FRONT COVER

A representation of speech synthesis. Photograph by courtesy of Mullard.



PROJECTS

- | | | | |
|---|----|--|----|
| <p>SPECTRUM SPEECH SYNTHESISER & 8-BIT I/O PORT by G. Hodgson Give your computer "Freedom of Speech" and more besides!</p> | 10 | <p>EXPERIMENTING WITH ROBOTS by Sam Withey Part Five: safe d.c. or bi-polar motor interface, using opto-isolators</p> | 42 |
| <p>MODULAR MIXER by John M. H. Becker Comprehensive music mixer with lots of options</p> | 20 | <p>MICRO-SCOPE by John M. H. Becker Part Two: Make an "oscilloscope" out of a micro</p> | 50 |
| <p>DRILL SPEED CONTROLLER by William Woodard Clever control console for low voltage-current drills</p> | 32 | | |

INTEREST

- | | | | |
|---|----|--|----|
| <p>EDITORIAL MEP, DES and all that; Good Government!</p> | 7 | <p>ROBOTICS REVIEW by Nigel Clark A regular look at robotics and cybernetics</p> | 30 |
| <p>NEWS AND MARKET PLACE CD with a difference; boy lost in time; Robots for all in 30 years; Countdown</p> | 8 | <p>KIT REVIEW by Steve Taylor Circuit Fixed and Swept Frequency Signal Generator</p> | 34 |
| <p>MICROELECTRONICS EDUCATION PROGRAMME by Graham Bevis & Michael Page Part One: The what, why and how of MEP</p> | 14 | <p>SPACEWATCH by Dr Patrick Moore OBE Space Explorers; The Sky This Month</p> | 40 |
| <p>READOUT Readers' comment and views</p> | 18 | <p>BAZAAR Readers' buy and sell spot</p> | 41 |
| <p>SPECIAL OFER Lascar DP2020 Digital Multimeter</p> | 25 | <p>BBC MICRO FORUM by D. Whitfield MA MSc CEng RS423 serial data port interface</p> | 45 |
| <p>INTRODUCTION TO MICROPROCESSOR SYSTEMS by Michael Tooley BA and David Whitfield MA MSc CEng MIEE Part Four: Interrupt processing and peripheral control</p> | 26 | <p>INDUSTRY NOTEBOOK by Nexus What's happening inside industry</p> | 48 |
| | | <p>PRINTED CIRCUIT BOARD SERVICE</p> | 52 |
| | | <p>BOOK REVIEWS A selection of recent releases</p> | 52 |

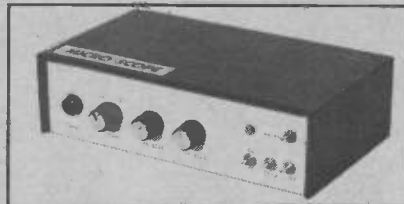
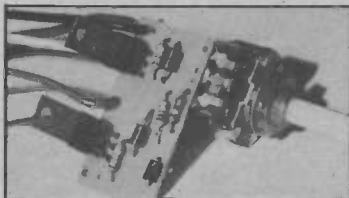

OUR FEBRUARY 1986 ISSUE WILL BE ON SALE FRIDAY, JANUARY 3rd, 1986 (see page 39)

© IPC Magazines Limited 1986. Copyright in all drawings, photographs and articles published in PRACTICAL ELECTRONICS is fully protected, and reproduction or imitations in whole or part are expressly forbidden. All reasonable precautions are taken by PRACTICAL ELECTRONICS to ensure that the advice and data given to readers are reliable. We cannot, however, guarantee it, and we cannot accept legal responsibility for it. Prices quoted are those current as we go to press.

WATFORD ELECTRONICS

250, HIGH STREET, WATFORD WD1 2AN, HERTS.
MAIL ORDER & RETAIL SHOP

Tel. (0923) 37774. Telex: 8956095 WATFORD
ORDERS NORMALLY DESPATCHED BY RETURN OF POST

All Devices Brand New & Fully guaranteed. SEND Cheques, P.O.s & Bank Draft or ACCESS/Master Charge & VISA card number with order. Government & Educational Establishments' OFFICIAL orders accepted. P & P add £1 to all Cash orders. Overseas orders, postage charged at cost AIR/SURFACE. PRICES SUBJECT TO CHANGE WITHOUT NOTICE AND AVAILABLE ON REQUEST.

VAT Export orders NO VAT. UK customers please add 15% VAT to the total cost incl. p&P. We stock thousands more items, it pays to visit us. Nearest Underground/British Rail station: Watford High Street. FREE car parking for customers. Open: Monday to Saturday, 9.00 am to 6.00 pm.

POLYESTER RADIAL LEAD CAPACITORS: 250V: 10n, 20n, 15n, 22n, 27n 6p; 33n, 47n, 68n, 100n 8p; 150n, 220n 10p; 330n, 470n 15p; 680n 19p; 1u 23p; 1u 23p; 4u 24p.

ELECTROLYTIC CAPACITORS (Values in µF): 500V: 10µF 52p; 47 78p; 63V: 0.47, 1.0, 1.5, 2.2, 3.3, 6.3p; 47 9p; 10 10p; 15 12p; 22 13p; 33 15p; 47 12p; 68 16p; 100 19p; 220 26p; 1000 70p; 2200 95p; 50V: 6.3, 20p; 100 17p; 220 24p; 40V: 6.8 15p; 22 25p; 33 20p; 47 32p; 100 40p; 2200 90p; 25V: 4.7, 1.0, 2.2, 47 9p; 100 17p; 220 24p; 40V: 6.8 15p; 22 25p; 33 20p; 47 32p; 100 40p; 2200 90p; 15V: 1.0, 2.2, 4.7, 10, 22, 47 10p; 100 20p; 220 24p; 40V: 6.8 15p; 22 25p; 33 20p; 47 32p; 100 40p; 2200 90p; 5V: 0.22, 0.47, 1.0, 2.2, 4.7, 10, 22, 47 10p; 100 20p; 220 24p; 40V: 6.8 15p; 22 25p; 33 20p; 47 32p; 100 40p; 2200 90p.

TAG-TYPE: 64V: 4700 245p; 3300 145p; 2200 120p; 50V: 3300 155p; 2200 95p; 40V: 4700 160p; 2200 70p; 3300 85p; 4000 4700 75p; 1000 2050; 15000 2700; 16V: 2200 200p; 25V: 4700 95p; 10000 320p; 15000 345p.

TANTALUM BEAD CAPACITORS: 35V: 0.1u, 0.22, 0.33 15p; 0.47, 0.68, 1.0, 1.5 16p; 2.2, 3.3 18p; 4.7, 6.8 22p; 10 20p; 15, 22, 3.3, 16p; 47, 6.8, 10 18p; 15 36p; 22 36p; 33, 47 50p; 100 95p; 220 100p; 10V: 15, 22 28p; 33, 47 50p; 100 75p.

SILVER MICA (pF): 10, 12, 18, 22, 27, 33, 39, 47, 56, 68, 75, 82, 95, 100, 120, 150, 180 15p; 220, 250, 270, 330, 360, 390, 470, 600, 800 & 820pF 21p; 1000, 1200, 1800 30p each; 3300, 4700 60p each.

SIEMENS multilayer miniature capacitors: 250V: 1nF, 1n5, 2n2, 3n3, 4n7, 6n8, 8n2, 10n, 15n, 22n 7p; 18n, 27n, 33n, 47n 8p; 39n, 56n, 68n 9p, 100nF 11p; 100V: 100n, 120n, 150n 11p; 220n 13p; 330n 18p; 470n 23p; 680n 30p; 1M 34p; 2M 50p.

GERMIC CAPACITORS: 50V Range: 1pF to 6800pF 4p; 10nF, 15n, 33n, 47n 6p; 100nF/20V 7p; 220nF/6V 8p.

POLYSTYRENE Caps: 10pF to 1nF 8p; 1n5 to 12nF 10p.

RESISTORS S.I.L. Package: 7 Commed, 100Ω, 470Ω, 680Ω, 1K, 2K2, 4K7, 10K, 47K, 100K 12p; 8 Commed: (9 pins) 150Ω, 180Ω, 270Ω, 330Ω, 330Ω, 1K, 2K2, 4K7, 10K, 22K, 47K, 100K 20p.

| LINEAR IC's | | | COMPUTER IC's | | |
|-------------|-----|---------|---------------|-----|----------|
| SP8823 | 425 | SP256AL | 8250 | 950 | UPD7002 |
| 555 CMOS | 80 | TA7120 | 8251 | 325 | UPD7007 |
| 702 | 50 | TA7130 | 8253 | 350 | WD1691 |
| 709C 8 pin | 35 | TA7204 | 8255 | 380 | WD1770 |
| 710 | 50 | TA7205 | 8256A | £15 | WD2143 |
| 741 | 16 | TA7232 | 8257A | 400 | Z80CPU4M |
| 747C 14 pin | 60 | TA7310 | 8257B | 300 | Z80CPU4M |
| 748C 8 pin | 35 | TA7311 | 8258 | 300 | Z80ACTC |
| 753 8 pin | 185 | TA7312 | 8259 | £6 | Z80E |
| 810 | 160 | TA7313 | 8260 | 400 | Z80DART |
| 9400CJ | 375 | TA7314 | 8261 | 450 | Z80DART |
| ADC0808 | £10 | TA7315 | 8262 | 450 | Z80DART |
| AY-11320 | 225 | TA7316 | 8263 | 450 | Z80DART |
| AY-15050 | 95 | TA7317 | 8264 | 450 | Z80DART |
| AY-16270 | 210 | TA7318 | 8265 | 450 | Z80DART |
| AY-3-120 | 720 | TA7319 | 8266 | 450 | Z80DART |
| AY-3-810 | 390 | TA7320 | 8267 | 450 | Z80DART |
| AY-3-812 | 430 | TA7321 | 8268 | 450 | Z80DART |
| AY-5-1317A | 630 | TA7322 | 8269 | 450 | Z80DART |
| AY-5-500 | 650 | TA7323 | 8270 | 450 | Z80DART |
| AY-5-8100 | 650 | TA7324 | 8271 | 450 | Z80DART |
| CA3011 | 130 | TA7325 | 8272 | 450 | Z80DART |
| CA3012 | 175 | TA7326 | 8273 | 450 | Z80DART |
| CA3014 | 275 | TA7327 | 8274 | 450 | Z80DART |
| CA3018 | 86 | TA7328 | 8275 | 450 | Z80DART |
| CA3019 | 86 | TA7329 | 8276 | 450 | Z80DART |
| CA3020 | 210 | TA7330 | 8277 | 450 | Z80DART |
| CA3023 | 210 | TA7331 | 8278 | 450 | Z80DART |
| CA3028A | 110 | TA7332 | 8279 | 450 | Z80DART |
| CA3035 | 255 | TA7333 | 8280 | 450 | Z80DART |
| CA3036 | 270 | TA7334 | 8281 | 450 | Z80DART |
| CA3043 | 275 | TA7335 | 8282 | 450 | Z80DART |
| CA3046 | 65 | TA7336 | 8283 | 450 | Z80DART |
| CA3059 | 325 | TA7337 | 8284 | 450 | Z80DART |
| CA3075 | 215 | TA7338 | 8285 | 450 | Z80DART |
| CA3080E | 65 | TA7339 | 8286 | 450 | Z80DART |
| CA3081 | 190 | TA7340 | 8287 | 450 | Z80DART |
| CA3085 | 160 | TA7341 | 8288 | 450 | Z80DART |
| CA3086 | 60 | TA7342 | 8289 | 450 | Z80DART |
| CA3090AQ | 250 | TA7343 | 8290 | 450 | Z80DART |
| CA3123 | 165 | TA7344 | 8291 | 450 | Z80DART |
| CA3130 | 85 | TA7345 | 8292 | 450 | Z80DART |
| CA3140 | 85 | TA7346 | 8293 | 450 | Z80DART |
| CA3160 | 95 | TA7347 | 8294 | 450 | Z80DART |
| CA3161E | 180 | TA7348 | 8295 | 450 | Z80DART |
| CA3162 | 540 | TA7349 | 8296 | 450 | Z80DART |
| CA3189 | 280 | TA7350 | 8297 | 450 | Z80DART |
| CA3240 | 100 | TA7351 | 8298 | 450 | Z80DART |
| HAI 356 | 175 | TA7352 | 8299 | 450 | Z80DART |
| HAI 388 | 235 | TA7353 | 8300 | 450 | Z80DART |
| ICL7106 | 675 | TA7354 | 8301 | 450 | Z80DART |
| ICL7107 | 675 | TA7355 | 8302 | 450 | Z80DART |
| ICL7161 | 95 | TA7356 | 8303 | 450 | Z80DART |
| ICL7680 | 250 | TA7357 | 8304 | 450 | Z80DART |
| ICL8038CC | 300 | TA7358 | 8305 | 450 | Z80DART |
| ICL8211 | 225 | TA7359 | 8306 | 450 | Z80DART |
| ICM7217A | 111 | TA7360 | 8307 | 450 | Z80DART |
| ICM7224 | 785 | TA7361 | 8308 | 450 | Z80DART |
| ICM7240 | 300 | TA7362 | 8309 | 450 | Z80DART |
| ICM7556 | 80 | TA7363 | 8310 | 450 | Z80DART |
| ICM7556 | 140 | TA7364 | 8311 | 450 | Z80DART |
| LA3350 | 250 | TA7365 | 8312 | 450 | Z80DART |
| LA4031P | 340 | TA7366 | 8313 | 450 | Z80DART |
| LA4032 | 295 | TA7367 | 8314 | 450 | Z80DART |
| LA4400 | 350 | TA7368 | 8315 | 450 | Z80DART |
| LA4422 | 320 | TA7369 | 8316 | 450 | Z80DART |
| LC7120 | 300 | TA7370 | 8317 | 450 | Z80DART |
| LC7130 | 300 | TA7371 | 8318 | 450 | Z80DART |
| LC7137 | 350 | TA7372 | 8319 | 450 | Z80DART |
| LF347 | 120 | TA7373 | 8320 | 450 | Z80DART |
| LF351 | 40 | TA7374 | 8321 | 450 | Z80DART |
| LF353 | 75 | TA7375 | 8322 | 450 | Z80DART |
| LF355 | 90 | TA7376 | 8323 | 450 | Z80DART |
| LF356 | 90 | TA7377 | 8324 | 450 | Z80DART |
| LF357 | 100 | TA7378 | 8325 | 450 | Z80DART |
| LF398 | 495 | TA7379 | 8326 | 450 | Z80DART |
| LM10 | 325 | TA7380 | 8327 | 450 | Z80DART |
| LM103 | 300 | TA7381 | 8328 | 450 | Z80DART |
| LM308 | 75 | TA7382 | 8329 | 450 | Z80DART |
| LM311 | 45 | TA7383 | 8330 | 450 | Z80DART |
| LM318 | 135 | TA7384 | 8331 | 450 | Z80DART |
| LM319 | 180 | TA7385 | 8332 | 450 | Z80DART |
| LM324 | 125 | TA7386 | 8333 | 450 | Z80DART |
| LM332Z | 130 | TA7387 | 8334 | 450 | Z80DART |
| LM335Z | 130 | TA7388 | 8335 | 450 | Z80DART |
| LM337 | 250 | TA7389 | 8336 | 450 | Z80DART |
| LM339 | 40 | TA7390 | 8337 | 450 | Z80DART |
| LM348 | 60 | TA7391 | 8338 | 450 | Z80DART |

TRANSISTORS

| | | | | | | | | | | | |
|---------|-----|----------|-----|----------|-----|-------|-----|-------------|-----|--------|----|
| AC1267 | 30 | BC237/8 | 10 | BF417/9 | 25 | TP25A | 32 | 2N706A | 25 | 2N5457 | 30 |
| AC1278 | 35 | BC307B | 15 | BFR801 | 25 | TP29C | 38 | 2N708 | 25 | 2N5459 | 30 |
| AC141/2 | 35 | BC308B | 15 | BF424 | 105 | TP30A | 35 | 2N914/5 | 32 | 2N5485 | 36 |
| AC176 | 25 | BC327/8 | 12 | BF429/84 | 28 | TP30C | 35 | 2N918 | 40 | 2N5486 | 36 |
| AC187/8 | 25 | BC337/8 | 12 | BF435 | 35 | TP31A | 38 | 2N930 | 40 | 2N5487 | 36 |
| AD126 | 120 | BC441 | 34 | BF435 | 35 | TP31C | 45 | 2N1312/2 | 40 | 2N5488 | 36 |
| AD142 | 120 | BC461 | 34 | BF525 | 35 | TP32A | 45 | 2N1303/4/5 | 40 | 2N5489 | 36 |
| AD149 | 79 | BC477/8 | 22 | BF555 | 35 | TP32C | 45 | 2N1307 | 45 | 2N5490 | 36 |
| AD161/2 | 42 | BC516/7 | 30 | BFY56 | 35 | TP33A | 70 | 2N1613/30 | 25 | 2N5491 | 36 |
| AC119 | 95 | BC530B | 15 | BFY64 | 35 | TP33B | 75 | 2N1617/18 | 160 | 2N5492 | 36 |
| AC176 | 60 | BC549C | 12 | BFY90 | 35 | TP34A | 85 | 2N1620 | 325 | 2N5493 | 36 |
| AF139 | 40 | BC556/7 | 15 | BFY90 | 35 | TP34B | 105 | 2N1622A/20A | 250 | 2N5494 | 36 |
| AF239 | 55 | BC558/9 | 15 | BFY90 | 35 | TP35A | 120 | 2N1629A | 25 | 2N5495 | 36 |
| BC107/8 | 12 | BCV41/42 | 30 | BFY90 | 35 | TP35B | 130 | 2N2388A | 18 | 2N5496 | 36 |
| BC107B | 14 | BCV70 | 18 | BFY90 | 35 | TP35C | 130 | 2N2389 | 80 | 2N5497 | 36 |
| BC108 | 14 | BCV71 | 20 | BFY90 | 35 | TP36 | 140 | 2N2390 | 140 | 2N5498 | 36 |
| BC108B | 14 | BCV72 | 18 | BFY90 | 35 | TP37 | 150 | 2N2391 | 250 | 2N5499 | 36 |
| BC109 | 12 | BCV78 | 30 | BFY90 | 35 | TP38 | 160 | 2N2392 | 250 | 2N5500 | 36 |
| BC109B | 14 | BD131/2 | 55 | BFY90 | 35 | TP39 | 170 | 2N2393 | 250 | 2N5501 | 36 |
| BC109C | 14 | BD133 | 55 | BFY90 | 35 | TP40 | 170 | 2N2394 | 250 | 2N5502 | 36 |
| BC114/5 | 25 | BD135 | 45 | BFY90 | 35 | TP41 | 170 | 2N2395 | 250 | 2N5503 | 36 |
| BC117/8 | 25 | BD136/7 | 35 | BFY90 | 35 | TP42 | 170 | 2N2396 | 250 | 2N5504 | 36 |
| BC119 | 35 | BD139/3 | 30 | BFY90 | 35 | TP43 | 170 | 2N2397 | 250 | 2N5505 | 36 |
| BC142/3 | 28 | BD158 | 68 | BFY90 | 35 | TP44 | 170 | 2N2398 | 250 | 2N5506 | 36 |
| BC147/8 | 12 | BD245 | 65 | BFY90 | 35 | TP45 | 170 | 2N2399 | 250 | 2N5507 | 36 |
| BC147B | 15 | BD434 | 70 | BFY90 | 35 | TP46 | 170 | 2N2400 | 250 | 2N5508 | 36 |
| BC148 | 12 | BD695A | 150 | BFY90 | 35 | TP47 | 170 | 2N2401 | 250 | 2N5509 | 36 |
| BC149C | 15 | BF115 | 45 | BFY90 | 35 | TP48 | 170 | 2N2402 | 250 | 2N5510 | 36 |
| BC153/4 | 30 | BF154/8 | 30 | BFY90 | 35 | TP49 | 170 | 2N2403 | 250 | 2N5511 | 36 |
| BC157/8 | 14 | BF167 | 35 | BFY90 | 35 | TP50 | 170 | 2N2404 | 250 | 2N5512 | 36 |
| BC167A | 14 | BF177 | 35 | BFY90 | 35 | TP | | | | | |

Table of electronic components including Speakers, Diodes, Bridge Rectifiers, Zeners, Varicaps, Triacs, SCR's, and Diacs with specifications and prices.

Table of OPTO ELECTRONICS components including LEDs, ALUM. BOXES, LCD DISPLAYS, DALO ETCH RESIST, COPPER CLAD BOARDS, VERO BOARDS, VERO WIRING, and VERO TOOLS with specifications and prices.

Table of VOLTAGE REGULATORS, SWITCHES, PUSH BUTTON, ROTARY, AMPHENOL CONNECTORS, ASTEC UHF MODULATORS, and BNTX Soldering Irons with specifications and prices.

Table of DIL SOCKETS, ZIF SOCKET, DIL PLUGS, RIBBON CABLE, 'D' CONNECTORS, MALE, FEMALE, COVER, EDGE CONNECTORS, and SIL Sockets with specifications and prices.

SPECTRUM 32K UPGRADE advertisement featuring text: 'Upgrade your 16K Spectrum to full 48K with our RAM Upgrade Kit. Very simple to fit. Fitting instructions supplied. ONLY £18'

Table of IDC CONNECTORS (Speed block type) showing Pin, Male, Female, and Card-Edge connector specifications.

SPECIAL OFFER table listing various component deals such as 2764-250ns, 6116LP-150ms, and 6264LP-150ms with their respective prices.

Table of TRANSFORMERS with specifications for various voltage ratings like 3-0-3V, 6-0-6V, 9-0-9V, etc., and their prices.

COMPUTER CORNER advertisement listing various printers (EPSON, KAGAX, BROTHER, Centronics), monitors (KAGA, ZENITH, MICROVITEC), and other computer accessories with prices.

BT TELEPHONE CONNECTOR advertisement listing various connector models like LJ1 1/4A Mini Line Master and LJ1 1/2A Mini Line Extension with prices.

DISC ALBUMS advertisement: 'Attractively finished in beige leather-vinyl, these conveniently store up to 20 discs. Each disc can easily be seen through the clear view pockets. ONLY £4.25'

5 1/4" Disc Drive HEAD CLEANING KIT £8 advertisement.

BBC MICRO WORD PROCESSING PACKAGE advertisement: 'A complete word processing package (which can be heavily modified to your requirements, maintaining large discout). We supply everything you need to get a BBC Micro running as a word-processor. Please call in for a demonstration.'

Example Package: BBC Micro, with DFS Interface, Wordwise, Twin 400K EPSON Disc Drives, 12" High-res green monitor, Brother HR15 Daisywheel printer, Beebcalk & Database software on Disc, 10 3M Discs, 500 sheets of paper, 4 way mains trailing socket, manuals and all cables. Only: £999

Table of CRYSTALS listing various frequencies from 32-768kHz to 14.765MHz with prices.

BBC MICROCOMPUTER advertisement: 'SPECIAL OFFER THIS MONTH ONLY £299'. Lists various peripherals like Disc Drives, Disc Doves, Cassette Recorder & Cassettes, Monitors, Connectors, etc. Includes CS100, CS200, CS400S, CD400, CD800S models and their prices.

WATFORD ELECTRONICS advertisement: 'Tel. (0923) 40588 Telex. 8956095'. Located at the bottom right of the page.

CROFTON PM101

ONLY £82.80



This 9 inch metal cased, monochrome monitor offers you the chance to obtain a high quality product at a budget price!

SPECIAL OFFERS

MONITOR KITS Brand new professional 12 inch. P31 anti-glare panel tube with T.T.L. 12v pcb. Easy to convert to composite. ONLY £30. ZX81 Full sized keyboard in metal case £13.80. COMPUTER DESKS £20.

Be sure to request our free catalogue describing our range of T.V. cameras, fixed and zoom lenses, sequential switchers, special and general monitors (colour and b/w including the PHILIPS 7502, PHILIPS 7522 and PHILIPS 2007 plus the full IKEGAMI range), video digitisers, light pens, eprom erasers etc.

THE VIDEO SPECIALISTS

Crofton

CCTV CAMERAS

ONLY £78.20

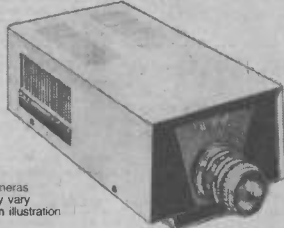

Cameras may vary from illustration

Though not new, these cameras have been completely refurbished to a high standard in our own workshops and come complete with a standard lens, ready to work. Short mains lead version requiring case respray available from £66.70. Weatherproof housings, motorised pan & tilts etc. available at extra cost.

THE CROFTON SPECIAL CCTV OFFER

The Crofton special CCTV package and the door entry system described by P.E. in the September 1985 issue are available at the following prices SPECIAL CCTV PACKAGE £193.00 DOOR ENTRY SYSTEM £103.45

NOTE: We can also offer a multiscan system enabling the outputs from 4 cameras to be displayed simultaneously or individually on a single screen.

THE NOVELX 1414

ONLY £185.15



This superb metal cased 14 inch RGB/ COMPOSITE COMPUTER COLOUR MONITOR is unbelievable value at this price!

ELECTRONIC KEY FOB

Quickly locate mislaid keys. Fob emits a shrill tone in response to your whistle! ONLY £7.95

ALL OUR PRICES INCLUDE VAT, CARRIAGE & INSURANCE AND CAN ONLY BE HELD AS LONG AS STOCKS LAST!

PHONE YOUR ORDER NOW!

MOST MAJOR CREDIT CARDS ACCEPTED OFFICIAL ORDERS FROM APPROVED INDUSTRIAL OR EDUCATIONAL ESTABLISHMENTS WELCOME.

Delivery within 28 days

CROFTON ELECTRONICS

01-891 1923

35 GROSVENOR ROAD, TWICKENHAM, MIDDLESEX TW1 4AD SALES & SERVICE: P.O. BOX 6, KINGTON HR5 3SX. LYONSHALL 557

Master Electronics - Microprocessors - Now! The Practical Way!

- Electronics - Microprocessors - Computer Technology is the career and hobby of the future. We can train you at home in a simple, practical and interesting way.
● Recognise and handle all current electronic components and 'chips'.
● Carry out full programme of experimental work on electronic computer circuits including modern digital technology.
● Build an oscilloscope and master circuit diagram.
● Testing and servicing radio - T.V. - hi-fi and all types of electronic/computer/industrial equipment.



New Job? New Career? New Hobby? SEND THIS COUPON NOW

Form with fields for NAME, ADDRESS, P.O., and checkboxes for ELECTRONICS, MICROPROCESSORS, RADIO AMATEUR LICENCE, CITY & GUILDS EXAMS, and Other Subjects.

Large table listing electronic components with columns for CMOSS, VALVES, LINEAR IC'S, and VOLTAGE REGULATORS, including part numbers and prices.

GRANDATA LTD. 9 & 12 THE BROADWAY, PRESTON ROAD WEMBLEY, MIDDLESEX, ENGLAND

Full kits include pcb's, hardware, cases (unless stated otherwise), IC sockets, wire, nuts & bolts. Article reprints extra 70p each.

| | |
|---|--------|
| HIGH PERFORMANCE STEPPING MOTOR DRIVER Dec 85 | £20.98 |
| EXTRAS: Transformer £5.98, Case £2.95, BBC lead & plug £1.98, Motor-1035 £14.50 | |
| COMMODORE USER PORT EXPANDER Nov 85 | £10.91 |
| MODEL RAILWAY TRACK CONTROL Nov 85 | £41.04 |
| 'SQUINT' ROBOT EYES Nov 85 | £8.68 |
| TOUCH CONTROL PSU Oct 85 | £28.38 |
| MODULATED SYNDRUM Oct 85 | £26.58 |
| GENERAL PURPOSE ROBOT INTERFACE, fully populated board Sept/Oct 85 | £74.99 |
| RS232 to CENTRONICS CONVERTER Sept 85 | £44.95 |
| CAR BOOT ALARM Sept 85 | £11.72 |

| | |
|--|--------|
| COMPUTER ENVELOPE SHAPER Aug 85 | £22.19 |
| VOLTMETER MEMORY ADAPTOR July 85 | £10.98 |
| STYLUS KEYBOARD FOR COM 64 Jun 85 | £9.55 |
| SYNTHESIZER INTERFACE FOR COM 64 Jun 85 | £15.69 |
| AMSTRAD SYNTHESIZER INTERFACE May 85 | £25.38 |
| CYLINDER THERMOSTAT May 85 | £21.77 |
| BBC POWER CONTROL INTERFACE Apr 85 | £20.99 |
| GUITAR ACTIVE TONE CONTROL less case Sept 83 | £11.97 |
| PROGRAM CONDITIONER June 83 | £18.67 |
| AUTO TEST SET May 83 | £34.62 |
| WIPER DELAY Apr 83 less relay | £8.24 |
| BATTERY TESTER Apr 83 | £13.25 |

EDUCATIONAL SETS

FUN WITH ELECTRONICS

Enjoyable introduction to electronics. Full of very clear full colour pictures and easy to follow text. Ideal for all beginners — children and adults. Only basic tools needed. 64 full colour pages cover all aspects — soldering — fault finding — components (identification and how they work). Also full details of how to build 6 projects — burglar alarm, radio, games, etc. Requires soldering — 4 pages clearly show you how. COMPONENTS SUPPLIED ALLOW ALL PROJECTS TO BE BUILT AND KEPT. Supplied less batteries & cases. FUN WITH ELECTRONICS, COMPONENT PACK £16.98 BOOK EXTRA £1.75. Book available separately.



ADVENTURES WITH ELECTRONICS

An easy to follow book suitable for all ages. Ideal for beginners. No soldering, uses an S-Dec Breadboard. Gives clear instructions with lots of pictures. 16 projects — including three radios, siren, metronome, organ, intercom, timer, etc. Helps you learn about electronic components and how circuits work. Component pack includes an S-Dec breadboard and all the components for the projects. Adventures with Electronics £3.58. Component pack £20.98 less battery.

GENERAL PURPOSE ROBOT INTERFACE

As featured in Sept/Oct/Nov issues 'EXPERIMENTING WITH ROBOTS' Feature. Full kit includes Double Sided PCB, Terminal Pins, IC Sockets, DIL Switches, and ALL ICs. Transistors, Capacitors etc. To build a FULLY POPULATED Board. Provides 4 servo channels and one Gripper Channel. Full kit (requires 5V, +9, and -9V supplies) less case. £74.99.

LOGIC TUTOR

A specifically designed test bed for the practical side of the 8 part educational series 'Introduction to Digital Electronics' Practical Electronics Oct 83 — May 84. Full kit includes screen printed pcb, power supply, connector strips and turned pin sockets (less case).

£34.98

REPRINTS EXTRA 70p EACH

COMPUTER ACCESSORIES

BBC TRACKBALL CONTROLLER. 2" ball. 2 fire buttons. Analogue input port connector. Includes simple software listing for fresh and drawing. Simply incorporates into your programs. £17.98. BBC Digital Joystick. 2 fire buttons. D plug connects to analogue input. £9.59.

HIGH PERFORMANCE STEPPING MOTOR DRIVER

As featured in this issue
Kit including PCB, I.C. & All Parts £20.98
Transformer 30V 18VA £5.98 extra
Case (houses PCB only) £2.95 extra
Lead & Connector for BBC Computer £1.98
Motor — ID35 £14.50
TEA1012 also available separately £6.88. Data £1.00

STEPPER MOTOR

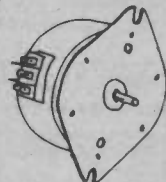

BBC TO ID35 STEPPER MOTOR INTERFACE KIT £13.99
PCB, driver IC, components, connectors and leads included. Demonstration software, listings, circuit diagram, pcb layout and construction details given. Requires unregulated 12Vdc power supply.
INTERFACE KIT (ref PE) £13.99.
OPTIONAL POWER SUPPLY PARTS £4.67.
ID35 STEPPER MOTOR 48 Steps. 12V £14.50.



DC MOTOR SETS

MOTOR — GEARBOX ASSEMBLIES 1.5V-4.5V. Miniature precision made. Complete with quality electric motors. Variable reduction ratios. Long 3mm dia output shafts.
Small unit — type MGS (3-2200rpm) £3.49
Large unit — type MGL (2-1150rpm) £3.98

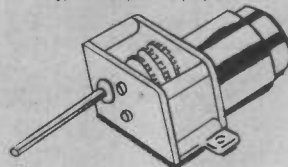

PULLEY WHEELS — metal 3mm bore
10mm dia 85p
20mm dia 98p
30mm £1.21
METAL COLLAR with screw — 3mm bore 24p
FLEXIBLE SPRING COUPLING 3mm. L31mm 68p
FLEXIBLE METAL COUPLING 3mm £2.98
FISCHERTECHNIK DC MOTOR SETS
SMALL TYPE 187 £9.85
LARGE TYPE 185 £9.90
DC MOTOR 1.5V-4.5V RPM 4,400-8,700
Shaft dia 2mm L 10mm. Body 29x38mm
DC MOTOR TYPE — DC28 £1.98
FLEXIBLE STEEL SPRING DRIVING BELT 47p
12" long. Joins to itself or 2 or more can be joined where long lengths are needed.

BBC — DC MOTOR CONTROLLER

FISCHERTECHNIK MOTOR CONTROL SYSTEM FOR THE BBC COMPUTER (BUILT) £46.55 (PE)
A high precision DC motor driver and BBC B computer interface system. Supplied complete with applications software cassette.
Ready to run control system supplied complete with mains lead, ribbon cable and user port connector, and terminal posts and plugs for the motor connection. Also included are the software cassette of 3 programs and instructions. The software is easily transferable to disc.
Recommended motor is the Fischertechnik type 185 as used in the u-12 motor and gear set.
Motor (185) available separately £9.90.

fischertechnik

We offer a range of the superb Fischertechnik sets. These cover robotics, electronics, electromechanics, motors and gears, and basic construction. Robotics kit build 11 different working models including a robot arm, graphics board, sorting system etc. Note that not all the models can be built at the same time. Simple to assemble. Easily combined with all other Fischertechnik kits. Top quality. Includes 2 motors, an electromagnet, lamps, potentiometers, switches etc.
ROBOTICS Kit (554) PE £64.99
Construction/base kit (ut1) £37.50
Motors and Gears (ut2) £42.70
Use ut2 to motorise ut1 £73.20
Electromechanics (ut3) £93.90
Electronics (ut4)

BBC — ROBOTICS INTERFACE

A READY TO USE INTERFACE for the BBC computer and the Fischertechnik Computing and Robotics Kit (554). Allows the BBC computer to operate all 11 of the standard models which can be built from the Fischertechnik Robotics kit.
The interface features forward — reverse and on/off control of four DC motors; on/off control output for driving an electromagnet or similar device; and eight switch inputs for reading microswitches or other binary inputs.
Two independent analogue input channels are provided for position sensing.
Supplied complete with connectors and leads the interface requires a power source of 9-12 volts at 1A.
Detailed programming information is supplied with the interface. A software disc with a comprehensive set of programs is also included.
FISCHERTECHNIK ROBOTICS — BBC COMPUTER INTERFACE (BUILT) (PE) £69.95

CATALOGUE

Brief details of each kit, book contents, and illustrations and descriptions of our range of tools and components are all included.
Robotics and Computing section included.
Our advert shows just a selection of our products.
Up to date price list enclosed. Official orders welcome.
Catalogue & Price List — Send £1 in stamps etc or add £1 to your order.
Price list only 9x4 SAE.
Catalogue free to schools/colleges requested on official letterhead.

HOW TO ORDER

MAGENTA ELECTRONICS LTD.
PE3, 135 HUNTER ST.,
BURTON-ON-TRENT
STAFFS, DE14 2ST.
MAIL ORDER ONLY.
0283 65435, Mon-Fri 9-5.
ADD 60P P&P TO ALL ORDERS.
PRICES INCLUDE VAT.
SAE ALL ENQUIRIES.
OFFICIAL ORDERS WELCOME.

OUR PRICES INCLUDE VAT

Access/Barclaycard (Visa) by phone or post.
24 hr Answerphone for credit card orders.



OVERSEAS: Payment must be sterling.
IRISH REPUBLIC and BFPO: UK PRICES.
EUROPE: UK PRICES plus 10%.
ELSEWHERE: write for quote.



TOOLS

| | |
|--|--------|
| Antex X5 soldering iron 25W 240V £7.25, 12V £7.45, 24V £7.65, 110/115V £7.35 | |
| Antex Model C soldering iron 240V | £8.98 |
| Heat sink tweezers | 45p |
| Solder handy size 5 | £1.39 |
| Solder carton | £2.50 |
| Solder reel size 10 | £4.67 |
| Low cost pliers | £1.98 |
| Low cost cutters | £1.99 |
| Bent nose pliers | £1.89 |
| Mini drill 12V (MD1) | £8.38 |
| Multimeter Type 1 1000Opv | £6.98 |
| Multimeter Type 2 20,000Opv | £17.98 |
| Multimeter Type 3 30,000Opv (taut baud) | £27.98 |
| Multimeter Type 4 10M digital | £39.98 |
| Desolder pump | £5.48 |
| Signal injector | £2.98 |
| Circuit tester | 78p |
| Helping Hands jig & magnifier | £7.98 |
| Miniature vice (plastic) | £1.85 |



BOOKS

| | |
|---|-------|
| A Practical Introduction to Microprocessors. Penfold | £2.10 |
| Basic Electronics. Holder & Stoughton | £8.98 |
| Beginners Guide to Building Electronic Projects. Penfold | £2.25 |
| BBC Micro. Usborne First Guide to | 2.26 |
| DIY Robotics & Sensors Billingsley. BBC | £7.95 |
| Commodore 64 | £7.99 |
| Elementary Electronics. Sladdin | £5.98 |
| Experiments with Your Computer (Science) | £2.43 |
| Science How to Design & Make Your Own PCBs. BP121 | £2.15 |
| How to Get Your Electronics Projects Working. BP110 | £2.15 |
| How to Make Computer Controlled Robots. Potter | £3.20 |
| How to Make Computer Model Controllers. Potter | £3.19 |
| Inside the Chip. Usborne | £2.19 |
| Interfacing to Microprocessors & Microcomputers | £6.50 |
| Machine Code for Beginners. Usborne | £2.45 |
| Making Music on the BBC Computer. Waugh | £6.45 |
| Micro Interfacing Circuits Book 1 | £2.45 |
| Microprocessors for Hobbyists. Coles | £4.98 |
| Practical Computer Experiments. Parr | £1.95 |
| Practical Things to do With a Microcomputer. Usborne | £2.19 |
| Programming for Education on the BBC Computer. Scriven/Hall | £6.45 |
| Questions & Answers — Electronics. Hickman | £3.45 |
| Understanding the Micro. Usborne | £1.85 |
| Usborne Introduction to Electronics | £2.45 |

BBC HEART RATE

BBC Heart Rate Monitor—
Ready Built £35.99

Practise relaxation or monitor fitness with this plug in heart rate monitor. Connects directly to the BBC computer. Programs give continuous heart rate displays, bar charts, graphs etc. Supplied with sensor, software & instructions—ready to plug in and use.

Tandy[®] MICRONTA[®] Quality Test Equipment



£69⁹⁵

Autoranging. "Beep" continuity, range-hold to override autoranging, "diode check" function and zero adjust. Measures to 1000 volts DC, 500 volts AC. Resistance to 2 megohms. Requires 2 "AA" batteries
22-193 £69.95

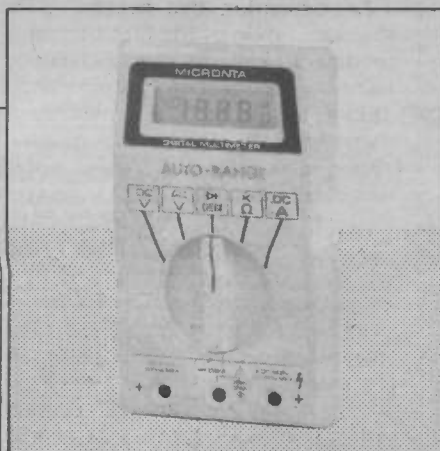

£34⁹⁵

Autoranging. Select the function and it does the rest. Measure to 1000 volts DC in 5 ranges, 500 volts in 4 ranges. Accurate from 45-10 kHz. Resistance to 2 megohms in 5 ranges. $4\frac{7}{8} \times 2\frac{13}{16} \times 1\frac{1}{8}$ " Requires 2 "AA" batteries.
22-188 £34.95



£22⁹⁵

25 Ranges, 20,000 Ohms Per Volt. Has 4" colour-coded mirrored scale and defetted hinge. Measures to 1200 volts DC, 1200 volts AC, DC to 300 mA. Resistance to 2 megohms dB. -20 to +, 5 ranges. Accuracy: $\pm 3\%$ DC, $\pm 4\%$ AC. 22-211 £22.95



£9⁹⁵

Transistor Checker. Makes Go/No-Go tests on small signal and power types. Indicates relative current gain. $2\frac{3}{4} \times 4\frac{3}{8} \times 1\frac{3}{16}$. Requires "AA" battery.
22-025 £9.95

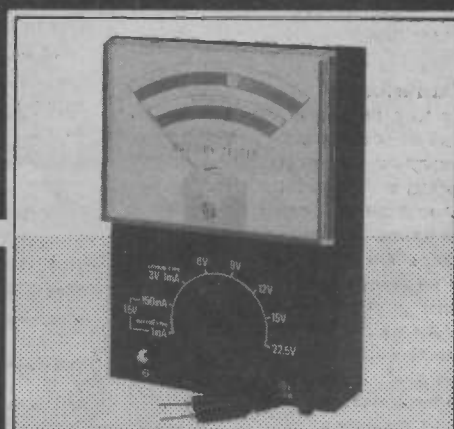

£7⁹⁵

8-Range Battery Tester. Tests almost any type of electronic, flashlight or button battery - including carbon-zinc, alkaline, mercury, silver oxide, nickel-cadmium and lithium batteries 22-031 £7.95



TAKE A LOOK AT TANDY, TODAY

Visit your local store or dealer and see these and many more bargains.
We service what we sell - over 2,600 exclusive lines!

Tandy[®]

OVER 9,000 STORES & DEALERSHIPS WORLDWIDE



Known As Radio Shack In The U.S.A.
Prices may vary at Dealers
Offers subject to availability

Editor Mike Kenward

Secretary Pauline Mitchell

Assistant Editor/Production
David Barrington

Assistant Editor/Technical
Richard Barron

Technical Editor Mike Abbott

Projects Editor David Brunskill

Technical Sub Editor/News
Brian Butler

Art Editor Keith Woodruff

Technical Illustrator
Isabelle Greenaway

Editorial Tel: Poole (0202) 671191

Advertisement Manager
David Tilleard 01-261 6676

Secretary
Christine Pocknell 01-261 6676

Ad. Make-up/Copy
Brian Lamb 01-261 6601

Classified Ads.
Mandy Morton 01-261 5846

Queries and letters concerning advertisements to:
Practical Electronics Advertisements,
King's Reach Tower,
Stamford Street, London SE1 9LS
Telex: 915748 MAGDIV-G

Letters and Queries

We are unable to offer any advice on the use or purchase of commercial equipment or the incorporation or modification of designs published in PE. All letters requiring a reply should be accompanied by a stamped addressed envelope, or addressed envelope and international reply coupons, and each letter should relate to **one published project only. We are unable to answer letters relating to articles more than five years old.**

Components are usually available from advertisers; where we anticipate difficulties a source will be suggested.

Old Projects

We advise readers to check that all parts are still available before commencing any project in a back-dated issue, as we cannot guarantee the indefinite availability of components used. **We are unable to answer letters relating to articles more than five years old.**

Technical and editorial queries and letters to:
Practical Electronics Editorial,
Westover House,
West Quay Road, Poole,
Dorset BH15 1JG

Phone:
Editorial Poole (0202) 671191

We regret that lengthy technical enquiries cannot be answered over the telephone.

MEP, DES AND ALL THAT

BACK to my theme of electronics in education this month, with the publication of the first part of a feature looking at the Microelectronics Education Programme and, at last, a reply to earlier published items from the Department of Education and Science. While much has been done with MEP it seems that just as things were all going in the right direction, Government funding has been slashed. It appears that while Mrs. Thatcher and fellows are saying how important they feel education is, they are not prepared to invest in it in a realistic way; witness the teachers' dispute which continues to drag on at the time of writing.

A further letter on this subject, and just about the only one we have received from a student, appears in this issue and underlines the problem as I see it; while much has been achieved by people like Graham Bevis from the funding provided, this work has still not resulted in significant change in many of the classrooms.

What is more worrying is that nothing new will get on the curriculum without the funds to pay for the equipment and information required and without the salaries to attract suitably skilled teachers—although letters to PE do show there are still some very dedicated teaching staff around. So while the Government smugly says that it only undertook to get the whole thing off the ground and now it has

done that it is up to the Local Education Authorities to progress things further, it fails to acknowledge that the work of MEP is not yet complete and that the funding is insufficient for all the LEA's to progress in a proper manner. When many parents are already assisting in the purchase of school essentials what hope is there of schools buying relatively expensive electronics boards?

GOOD GOVERNMENT!

The new Microelectronics Support Unit should be operational by April 1st—perhaps the date will be appropriate since as far as we can see little has been done to achieve a set up yet. Chris Patten takes pains to explain what the Government has said in White Papers and undertaken to do. He also points out what MEP and other schemes have cost, how the teachers have/will be trained etc., and how many students "will study some elements of the new technology" this year. What worries me is that while it all looks good from the Government's point of view, reaction from teachers and students shows that there is a very long way to go before they all see some of the material MEP has produced. With the close of MEP are we not failing to stoke the boiler just as the train is pulling away?

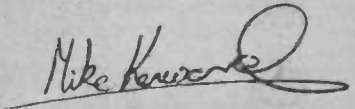

BACK NUMBERS, BINDERS & SUBSCRIPTIONS



Copies of most of our recent issues are available from: Post Sales Department (Practical Electronics), IPC Magazines Ltd., Lavington House, 25 Lavington Street, London SE1 0PF, at £1.25 each including inland or overseas p&p. When ordering please state title, month and/or issue required.

Binders for PE are available from the same address as back numbers at £5.50 each to UK or overseas addresses, including postage, packing and VAT.



Subscriptions

Copies of Practical Electronics are available by post, inland for £14, overseas for £16 per 12 issues, from: Practical Electronics, Subscriptions Department, IPC Magazines Ltd., Oakfield House, 35 Perry Mount Road, Haywards Heath, West Sussex RH16 3DH. Tel. 0444 459188. Cheques, postal orders and international money orders should be made payable to Practical Electronics. Payment for subscriptions can also be made using a credit card.

Items mentioned are available through normal retail outlets, unless otherwise specified. Prices correct at time of going to press.

CD WITH A DIFFERENCE

At the Philips headquarters in Holland, engineers have developed an amazingly comprehensive compact disc-based car navigation system. One disc can easily store all the road and street map information for the whole of the UK. Thanks to voice synthesised instructions, the driver has no need for conventional maps—just enter start-point and destination, the only other input required by the tripper could be en-route places of interest, or perhaps the most scenic route.

If the driver makes a mistake, Philips CARIN (Car Information System) will automatically find the best diversion to get back on the right road. When traffic information becomes available via digital RDS Radio Data System, CARIN will also be able to automatically allow for hold-ups and adverse weather conditions, modifying the route to allow these obstacles to be avoided.

Navigation is automatic when the car starts moving, and current prototypes monitor the car's position using 'dead reckoning' with inputs from sensors on the wheels and an electronic compass. The onboard computer can correct for errors by comparing sensor information with the digital road map loaded from the CD.

Geographical co-ordinates of every road are encoded onto the discs in two ways—either by plotting information from accurate road maps, or actual digitised inertial information, gleaned from physically driving the routes.

During the trip, the computer samples the encoded information and compares it to the vehicle's speed and direction. The optional extra monitor shown in the photograph displays the local map, and an illuminated 'blip' shows the position of the



vehicle. The screen is only operable when motionless, in any case the voice synthesis tells you all you need to know. The 'player' will also take music CD's with a voice override facility for directional information.

In the longer term, satellite navigation may be incorporated, with the help of the American NAVSTAR Global Positioning System (GPS) which will be completed at the end of 1988 with 18 satellites.

Eventually it is hoped to incorporate CARIN into a car's dashboard where further sensors could provide oil, fuel and brake monitoring etc. The system is already available for between £1,800 and £1,900.

ROBOTS FOR ALL IN 30 YEARS

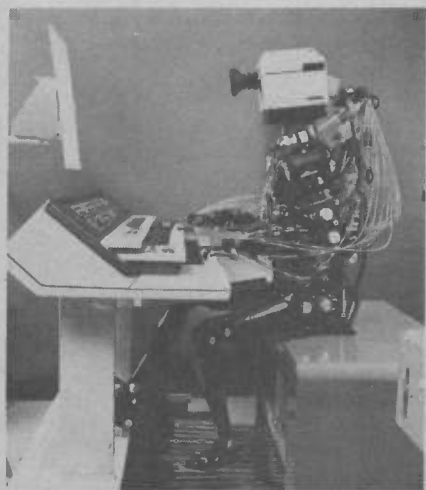

Information and photograph kindly supplied by New Scientist magazine.

At the recent Expo '85 exhibition at Tsukuba in Japan, visitors were privy to an impressive piece of robotics engineering. Wabot-2 the organ playing robot was the submission of Professor Ichiro Kato and his students from the Waseda University. The professor and his 50 disciples spent three years developing the musical automation which has 25 axes of movement, and can read a sheet of music with its c.c.d./camera eye in 15 seconds.

In the past, Kato has apparently been subjected to a certain amount of scepticism from his counterparts in industry, regarding his "misguided" in-depth efforts to humanise robots, they now tend to take him more seriously. Furthermore Kato firmly believes that within 30 years every home will have its own personal robot, with an ability to adapt to the environment and cope with abstract thought. Wabot-2 already does this—it can accompany a singer and, if necessary, change key mid-song to suit the singer's voice.

BOY LOST IN TIME

In 1802 the industrial exploitation of children brought about the passing of the first law in this country to regulate the conditions governing child labour. This law prohibited the employment of children under nine years old. The under fourteens were not allowed to work at night and furthermore their maximum daytime hours were restricted to 12. This law designed for 'pauper' children (those dependent upon charity) was extended to include all children in 1819.

It is reassuring to know that this marked the beginning of the end for the commercial child abuser, it did didn't it?

In the Health and Safety Executive's most recent report on Manufacturing and Service Industries, the following skeleton was liberated from the closet of a Cumbrian electronics company.

The case was brought to light when a visiting Fire Prevention Officer made a disturbing discovery in a room measuring fractionally more than nine feet by five feet. Therein he found, "a boy who was working near a heated diesel tank giving off copious fumes. The boy was drilling holes in printed circuit boards. The firm had given him a plastic tube to breathe through—one end in his mouth and the other end poking through an open window". The company has now "made safe" the tank and installed proper ventilation.

JUST TESTING

A new Universal Test Socket just introduced by Aries Electronics, is designed to accept all devices from 6 to 40 pins on 0-3, 0-4 or 0-6 inch centres. The socket has a plastic housing and the contact design has a normally closed arrangement which provides a consistent Normal force which prevents deformation (from oversized leads).

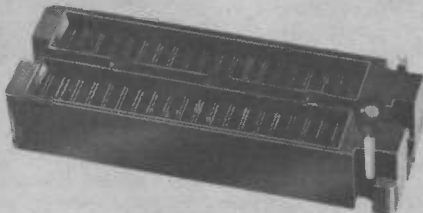

These test sockets accept leads from 0-015 through to 0-045 inches wide and mount onto p.c.b.s with either 0-3 or 0-6 inch centres. Contact materials are beryllium copper, available with gold or tin plating.

Typical prices for the tin plated types are 24 pin—£4.95; 28 pin—£5.80 and 40 pin—£7.25. These prices include VAT and p&p. From Aries Electronics (Europe), Alfred House, 127 Oatlands Drive, Weybridge, Surrey KT13 9LB (0932 57377).

MARKET PLACE

Mentor lead by nose

The Mentor desk-top micro hydraulic robot has been modified so that it can now lift a weight of up to 1kg, instead of its previous capacity of 300gms.

The software has also been extended, and amongst the improvements "lead by the nose" programming is now included in the free package of programs. As well as interfaces to BBC, Commodore and Apple computers, an interface with software for the IBM PC is also now available.

Mentor is a compact, electronically powered desk-top robot giving 6 axes of movement all simultaneously servo-controlled. It has been specially designed to give smooth controlled performance coupled with a high degree of built-in toughness, a combination ideal for use in educational establishments. Prices start at £495. Brochure, specification and full price list from, Cybernetic Applications, West Portway Industrial Estate, Andover SP10 3PE. (0264 50093).

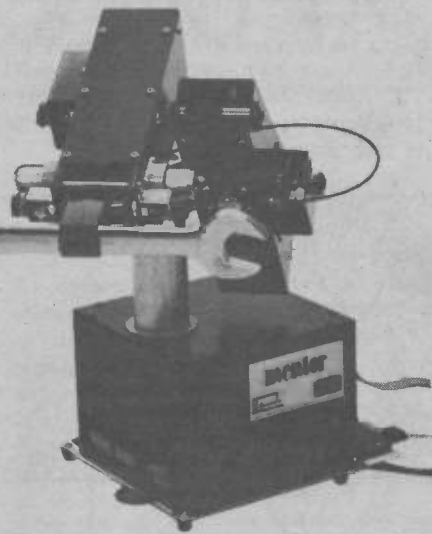

Briefly...

A new company has been launched, which readers may like to make a note of. Universal Semiconductor Devices can supply most 'ordinary' discrete semiconductors in addition to the following: High power/High frequency transistors; V.h.f./u.h.f.—f.e.t.s; Power Darlingtons; Germanium transistors n.p.n./p.n.p.; Unijunctions etc.—and many devices which may be "difficult to find elsewhere". Good prices and delivery are promised. For 75 pence (inc. p & p) a catalogue can be obtained from Universal Semiconductor Devices, 17 Granville Court, Granville Road, Hornsey, London N4 4EP. (01-348 9420).

The TTL Data book (Volume 3) has been published in a European edition, covering bipolar programmable logic and memory devices. Texas Instruments have used the usual format with three main sections: field-programmable logic, PROMs and RAMs, and memory based code converters. The book costs £8 (inc VAT and p & p) and is available from Texas Instruments Ltd., PO Box 50, Market Harborough, Leicestershire.

USEFUL WINTER CAR KITS

A trio of electronic kits for cars has been announced by Electronic and Computer Workshop Ltd.

The wiper delay unit kit (K2599) provides a three-step intermittent wiper timer, selected using a rotary switch. It employs a relay inserted into the car wiper control circuit. Comprehensive instructions show how the units can be fitted into virtually any existing wiper system.

Kit no. K2598 builds a 10-30 watt, mono or stereo power amplifier, designed to operate from a car's 12 volt supply. Fully compatible with the standard car radio/cassette player voltage levels (DIN45500), it has thermal/short-circuit protection.

The benefits of easy starting, efficient fuel

burning and very even firing provided by transistorised ignition can be achieved with kit no. K2543. Supplied with a large heat-sink for cool operation, the unit employs high voltage power Darlington transistors to produce a highly reliable performance. The wiper controller (K2599) costs £12.82, the 10-30 watt amplifier (K2598) costs £16.94 and the transistorised ignition kit (K2543) costs £12.48. All prices include VAT and p & p. The kits contain all the necessary components, a p.c.b., and step by step instructions, including application notes. From Electronic and Computer Workshop Ltd., 171 Broomfield Road, Chelmsford, Essex CM1 1RY. (0245 262149).

Record tokens are being given away by Sony. The £1 tokens will be exchanged for the correct number of vouchers collected from promotional packaging on audio and video tapes. Look out for them in the shops, the offer ends March 31, 1986.

A Stevenage based company, Direct Computers, has been hauled over the coals by the Advertising Standards Authority. The admonishment came after an advertising campaign which claimed that a VDU screen attachment "Somashield" would eradicate "99 per cent of harmful X-ray and ultraviolet radiation". An anonymous complainant's view that there was no evidence to prove that VDUs radiate harmfully was upheld by the ASA.

Countdown . . .

Please check dates before setting out, as we cannot guarantee the accuracy of the information presented below. Note: some exhibitions may be trade only. If you are organising any electrical/electronics, radio or scientific event, big or small, we shall be glad to include it here. Address details to Brain Butler.

Second Amstrad User Show Jan. 10-12. Novotel, Hammersmith. A
Which Computer Show Jan. 14-17. NEC, Birmingham. B
Hi-Tech And Computers in Education Jan. 22-25. Barbican Centre. C
Vidiotex User Show Jan. 29-31. Barbican Centre. D
Electronics in Oil and Gas Feb. 4-6. Barbican Centre. B
Sound Eighty Six Feb. 18-20. Novotel, Hammersmith. F
Electrex '86 Feb. 24-28. NEC, Birmingham. G

Scottish Electronics Technology Show Feb. 25-27. Exbn. Centre, Glasgow. B
Business Telecom '86 Mar. 4-6. Barbican Centre. I
Instrumentation '86 Mar. 5/6. Crest Hotel, Bristol. J
Electro-Optics/Laser International Mar. 18-20. Metropole, Brighton. B
CAD '86 Apr. 8-10. Metropole, Brighton. L
Internepcon Production Show Apr. 8-10. NEC, Birmingham. B
British Electronics Week Apr. 29-May 1. Olympia. N

A Database ☎ 061-480 0171.
B Cahners ☎ 01-891 5051.
C BEEA & Computer Marketplace ☎ 01-930 1612.
D Emap International ☎ 01-837 3699.
F ASCE Ltd. ☎ 06286 67633.
G Electrex Ltd. ☎ 0483 222888.
J Trident Int. Ex. Ltd. ☎ 0822 4671.
L Butterworth Scientific Ltd. ☎ 0483 31261.
N Evan Steadman ☎ 0799 26699.

Spectrum Speech Synthesiser & 8 Bit I/O Port

G.Hodgson

Get your Spectrum/ZX81 thinking out loud for around £18

THERE have recently been a few designs published utilising the SPO256AL2 speech processor manufactured by *General Instruments*. However, this circuit, as well as incorporating an SPO256AL2, contains a Z80A PIO of which one port, port A, is dedicated to the speech i.c. and the other port, port B, is taken to a 15-pin "D" socket and so can be used as a programmable, bidirectional 8-bit I/O port.

The circuit has a very low component count using only two i.c.s, a regulator plus some other discreet components. The whole unit can be made for less than £18.

THE SPO256AL2 AND Z80A PIO

The SPO256AL2 is one of a family of speech processors produced by GI. It contains a clock circuit, micro-controller, 16K ROM, and digital on-chip filter making it a compact unit. The ROM contains the data required to produce 59 different sounds, or allophones, plus five pauses of different lengths. The required allophone is selected by placing a 6-bit address on A0 to A5 and then taking ALD, allophone load, low when the data is latched into the i.c.

The Z80A PIO contains two bidirectional 8-bit ports, each of which is individually programmable. The i.c. is selected by taking pin 4, chip enable (CE), low and then the relevant port register is selected using pins 5 and 6, C/D and B/A respectively, thus each port is latched. The i.c. has four operating modes for each port and port B is capable of driving Darlington transistors (1.5mA at 1.5V).



CIRCUIT DESCRIPTION

No discrete logic is required for address decoding since the PIO's internal logic will detect when it has been selected. Address line A7 is used for device selection and must be taken low for the PIO to be selected. A5 is connected to B/A and A6 to C/D. Thus A5 and A6 are used for register selection:

| A5 | A6 | A7 | Port | | FUNCTION |
|-------|-------|------|---------|-----|-----------|
| (B/A) | (C/D) | (CE) | decimal | hex | |
| 0 | 0 | 0 | 31 | 1F | A Data |
| 0 | 1 | 0 | 95 | 5F | A Control |
| 1 | 0 | 0 | 63 | 3F | B Data |
| 1 | 1 | 0 | 127 | 7F | B Control |

Table 1. The PIO addressing details showing register/port allocations

A0 to A4 must always be high since these lines are used to select Sinclair peripherals; a logic low on one of these lines will select a certain peripheral and, if that peripheral is attached, this would lead to two peripherals trying to use the system bus simultaneously.

M1, IORQ and RD are used by the PIO to detect instruction type. INT is the interrupt output from the PIO; an interrupt is generated by certain conditions on either port A or port B, more later. M1 and IORQ are used to detect whether an interrupt has been acknowledged since they will both go low to indicate an interrupt acknowledge. CLK is the standard Z80 single-phase clock taken from the host computer. Pins 22 and 24, IEO and IEI respectively, are used for "daisy-chaining" Z80 peripherals. In this circuit the PIO is configured as having highest priority since its IEI pin is taken to +5V via R1. When the PIO, IC1, is having an interrupt serviced, its IEO pin will go low preventing any lower priority device from generating an interrupt. Port B, consisting of B0 to B7, BSTB, BRDY, is taken to SK2, a 15-pin female D-type socket. In this circuit ASTB and ARDY are not used since Port A is operated in Mode 3 only.

A0 to A5, READY and ALD from IC2 are taken to A0 to A7 on IC1 and so complete control over IC2 is exercised by port A, IC1. The two reset lines of IC2, pins 2 and 25, are taken to the Z80's RESET line and so IC2 is reset whenever the host computer is reset. PB1 is provided to generate a reset pulse whenever it is pressed since both the ZX81 and ZX Spectrum lack a reset button. IC2's internal clock is used in conjunction with X1, a 2.4576MHz crystal, to provide the clock frequency for IC2. Varying this frequency, by inserting a different crystal in the range 1MHz-3.5MHz, will alter the speed of the speech. The output from IC2, pin 24, consists of a pulse-width modulated signal which is then passed through a 5.3kHz low-pass filter formed by R2, R3 and C5, C6. This filter converts the signal into an analogue one.

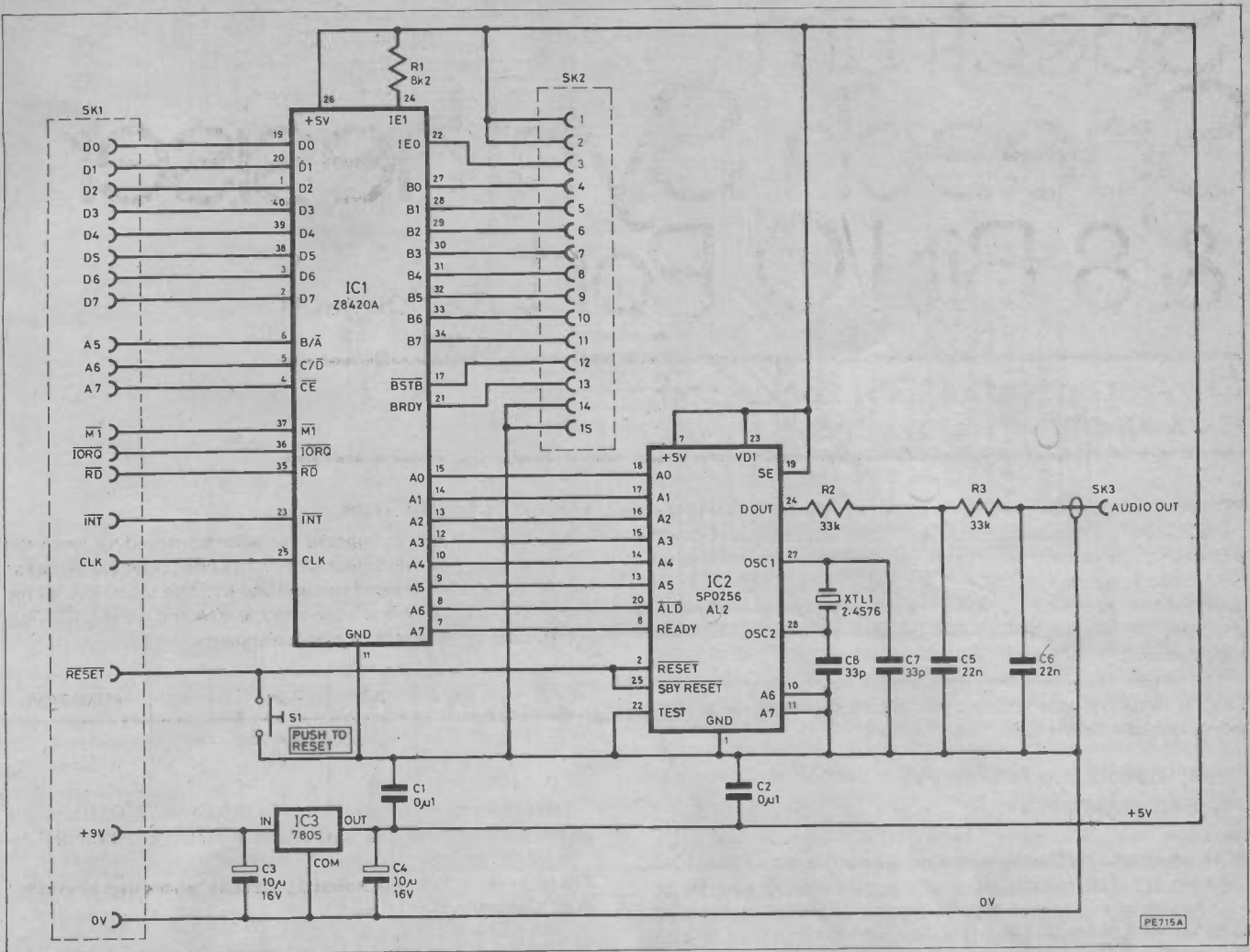

Fig. 1. Complete circuit diagram of the Spectrum, Speech Synthesiser and I/O Port

Further loading of the 7805 in either the ZX81 or ZX Spectrum is not advised and so the 9V output from the power supply is fed into a 7805 regulator, IC3, in this circuit to provide power for the circuit.

C1 should be mounted as close as possible to IC1 and C2 should be mounted as close as possible to IC2 as these are decoupling capacitors, across the supply rails. SK1 is a 2 by 23-way 0.1 inch pitch edge connector.

CONNECTIONS USED

Reset connections are different for each computer and a small wire link or switch should be incorporated to get around this problem. All other connections are the same.

PROGRAMMING

Although IC1 can have each port programmed in four different modes, it has been found that mode 3 (control mode) is the most useful and, indeed, the easiest and so I shall just describe this mode. The port strobe and ready lines (ASTB BSTB ARDY BRDY) are internally inhibited in this mode but BSTB and BRDY have been made available for those who have a knowledge of modes 0, 1 and 2. The Zilog publication Z80 PIO Technical Manual describes fully the PIO and how to program it, for those who are interested.

In mode 3, each bit can be individually defined as either input or output. For interrupt control in this mode, the CPU interrupt mode must be mode 2, i.e. a machine code IM2 instruction should be executed followed by an EI instruction to enable the interrupts. If interrupts are not to be used then programming of the PIO can be accomplished quite easily.

COMPONENTS . . .

Resistors

| | |
|-----------------------|-------------|
| R1 | 8k2 |
| R2,R3 | 33k (2 off) |
| All resistors 1/4W 5% | |

Capacitors

| | |
|-------|------------------------------|
| C1,C2 | 100n disc ceramic (2 off) |
| C3,C4 | 10µ 16V electrolytic (2 off) |
| C5,C6 | 22n polyester (2 off) |
| C7,C8 | 33p ceramic (2 off) |

Semiconductors

| | |
|-----|-------------------|
| IC1 | Z8420A (Z80A PIO) |
| IC2 | SPO256AL2 |
| IC3 | 7805 |

Miscellaneous

| | |
|--|---------------------------------|
| X1 | 2.4576MHz crystal |
| S1 | push-to-make switch |
| SK1 | 2 by 23-way 0.1" edge connector |
| SK2 | 15-pin female D-type socket |
| SK3 | Phono socket |
| Printed circuit board PE-023 available from the PE PCB Service; suitable heatsink for IC3. | |

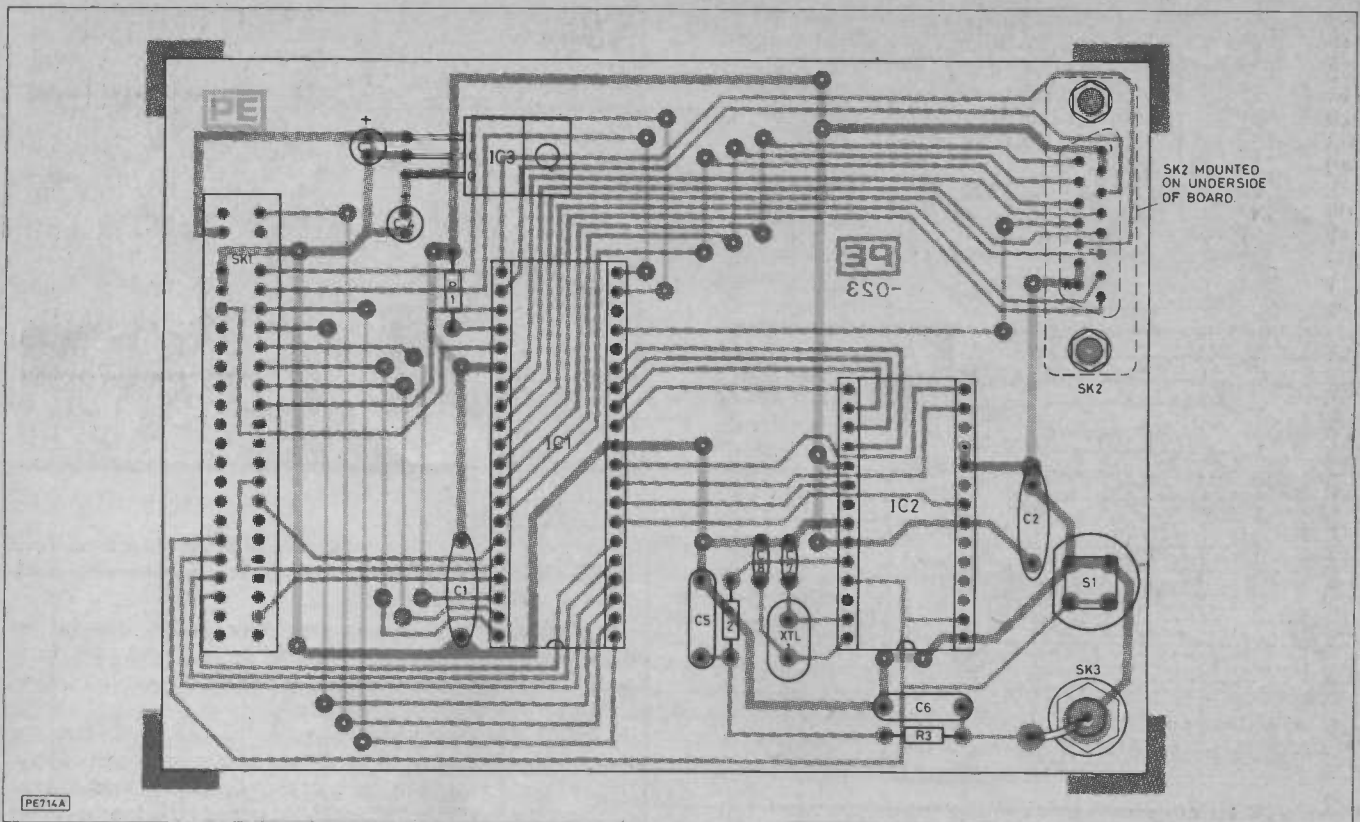

Fig. 2. P.c.b. design and layout

PIO PROGRAMMING

Port A

OUT 95, 255 Selects mode 3 for port A
 OUT 95, x x defines input and output bits: 0 sets bit to output, 1 sets bit to input, e.g. 255 would set all bits to input

Port B

OUT 127, 255 Selects mode 3 for port B
 OUT 127, x x defines input and output bits:
 0 sets bit to output, 1 sets bit to input; e.g.
 77 = D7 D6 D5 D4 D3 D2 D1 D0
 O/P 1/P O/P O/P 1/P 1/P O/P 1/P
 0 1 0 0 1 1 0 1

As interrupt mode 2 is rather hard to implement on a ZX81 or ZX Spectrum it is not practicable to use PIO interrupts. Nevertheless, it can be done and that is why the PIO INT line is connected.

Programming the SPO256AL2 is very straightforward. When READY is high the i.c. will accept an allophone and so to send an allophone to the SPO256AL2 a suitable program can easily be constructed.

SOFTWARE

This is a small sample of software for driving the SPO256AL2; and is of a skeletal nature. The programs may be expanded, of course.

ZX SPECTRUM

```
LD A,255
OUT (95), A          Port A mode 3
LD A, 128
OUT (95), A          A0 to A6 output, A7 input
IN A, (31) (LP1)
BIT 7, A
JR Z, (LP1)
LD A, (23728)
RES 6,A
OUT (31), A
SET 6,A
OUT (31), A
RET
```

Is READY high?
 Jump back if READY low
 Fetch allophone code
 ALD must be low
 Send allophone
 Take ALD back high again
 Back to BASIC

The allophone to be sent should be POKEd into 23728 which is an unused location in the system variables.

A BASIC program to poke the machine code into RAM is:

```
10 clear n (decide on a value for RAMTOP)
20 FOR a=n+1 TO n+26
30 READ b: POKE a,b: NEXT a
40 DATA 62, 255, 211, 95, 62, 128, 211, 95, 219, 31, 203,
127, 40, -6, 58, 176, 92, 203, 183, 211, 31, 203, 247,
211, 31, 201.
```

An allophone can then be sent using:

```
POKE 23728,x
RANDOMIZE USR (n+1)
```

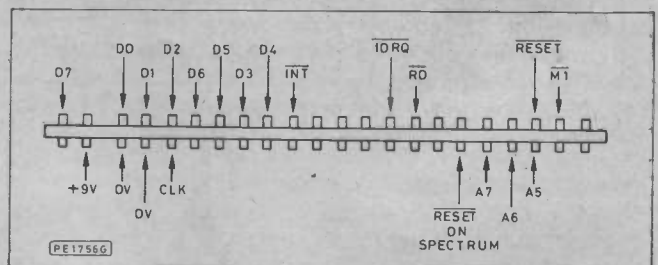

Fig. 3. The Spectrum and ZX81 edge connector

ZX81

The machine code program is the same for the ZX81 as that for the ZX Spectrum; however, location 16507 is used to hold the allophone code. Again this is an unused location in the system variables. Thus the instruction LD A, (23728) becomes LD A, (16507) [5812364].

The basic program is different since READ? DATA and CLEARn are not available on the ZX81:

```
10 REM XXXXXXXXXXXXXXXXXXXXXXXXXXXXXXXXXXXXXXXX
(26 X's)
20 FOR A = 16514 TO 16539
30 INPUT B
40 POKE A, B
50 NEXT A
```

The above program should be RUN and the following 26 bytes entered.

62 255
 211 95
 62 128
 211 95
 219 31
 203 127
 40 250
 58 123
 203 183
 211 31
 203 247
 211 31
 201

When this data has been entered, lines 20-50 may be deleted but line 10 must be kept since it is used to hold the machine code. Note also that line 10 must be the first line in ANY program.

64 An allophone can then be sent using:
 POKE 16507, x
 RAND USR 16514

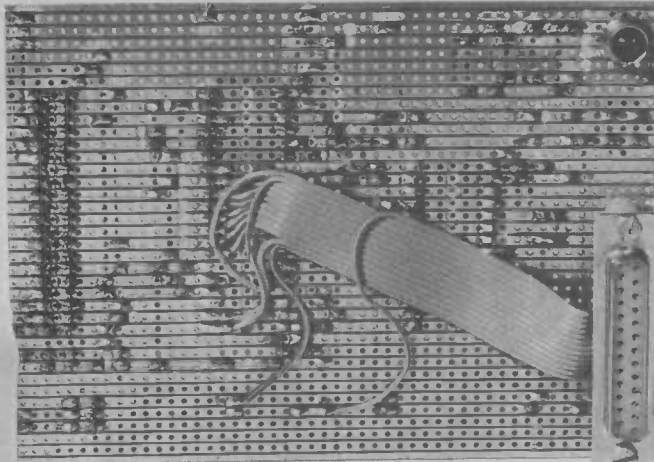

Photos illustrating both sides of the prototype model of the Spectrum Speech Synthesiser and 8-bit I/O Port. The prototype was built on Veroboard but the construction is similar to the p.c.b. design

CONSTRUCTION

The prototype model of the Spectrum Speech Synthesiser and I/O Port was built on a small Veroboard as shown in the

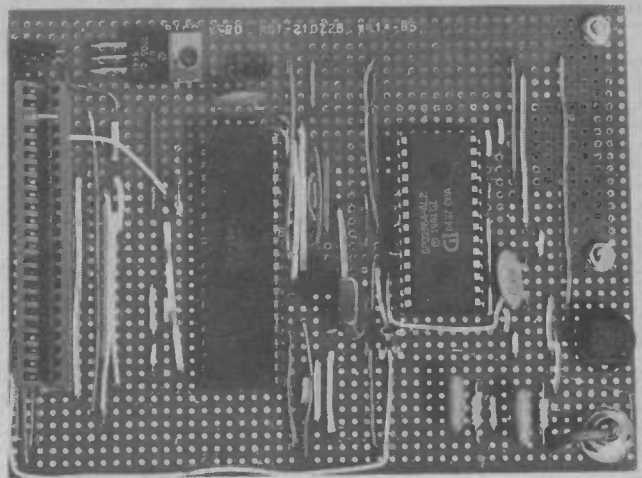

photographs. Because we think that this project will be very popular, we have designed a suitable p.c.b. of similar size to the prototype which is shown in Fig. 2.

Construction should start by assembling the components on the p.c.b. in the normal way, resistors and capacitors first. Next, the i.c. sockets and the regulator should be mounted, together with the switch and the crystal.

Provision has been made on the p.c.b. for the D-type connector to be mounted directly on to the p.c.b. or wired accordingly. When all the components have been mounted, all solder joints and connections should be carefully checked for solder splashes and dry joints. Finally, the two d.i.l. i.c.s should be fitted in their sockets making sure they are the right way round.

The project should be carefully connected to the computer edge connector (Fig. 3) and the Speech Synth And I/O Port may be used as described previously. You will probably find that further development of the computer software will enable better results. ★

THREE INTO ONE WILL GO— WITH THE GROTECH 3132

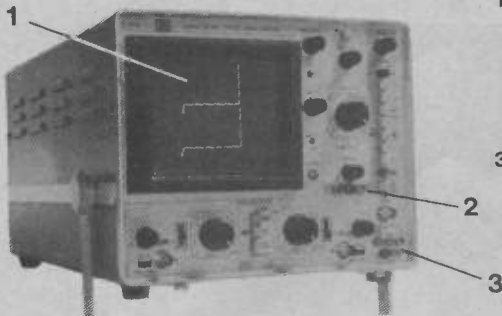

- 1 **SCOPE:**
 DC — 20MHz Bandwidth
 2mV/div Sensitivity
 40ns — 0.2s/div Sweep
 14 Trigger Functions
 Including active TV trigger on line & frame.
- 3 **Triple Output DC Source**
 +5V (1A); —ve grounded
 ±12V (200mA) Common Floating

- 2 **Active Component Comparator**
 (for checking Transistors, diodes and I.C.'s etc)
 Test Voltage: 8.6Vrms (28mA)

All for the price of a scope at
£295*

*Excluding Delivery and VAT)
 Correct at time of going to press

Crotech Instruments Limited

2 Stephenson Road, St. Ives, Huntingdon, Cambs. PE17 4WJ
 Telephone: (0480) 301818



Also available from Audio Electronics & Henry's

MACCON SYSTEMS

48k PRINTER BUFFER

Do you have to sit around waiting for the printer to finish before you can use the computer. Overcome this with Maccon's printer buffer, it will hold about 14 pages of text (A4) and load it in a few seconds, leaving the computer free for you.

Centronics type available, made and tested £120.00
 Kit (case not included) £ 90.00
 P.C.B. & parts list £ 14.75

All prices include VAT and Carriage—Please allow 14 days delivery.

Details from:

MACCON SYSTEMS

5 Cambridge Terrace, Scarborough YO11 2LQ. Tel: (0723) 365927

MAKE YOUR INTERESTS PAY!

More than 8 million students throughout the world have found it worth their while! An ICS home-study course can help you get a better job, make more money and have more fun out of life! ICS has over 90 years experience in home-study courses and is the largest correspondence school in the world. You learn at your own pace, when and where you want under the guidance of expert 'personal' tutors. Find out how we can help YOU. Post or phone today for your FREE information pack on the course of your choice (tick one box only).

| | | | |
|--|--------------------------|--|--------------------------|
| Electronics | <input type="checkbox"/> | Radio, Audio and TV Servicing | <input type="checkbox"/> |
| Basic Electronic Engineering (City & Guilds) | <input type="checkbox"/> | Radio Amateur Licence Exam (City & Guilds) | <input type="checkbox"/> |
| Electrical Engineering | <input type="checkbox"/> | Car Mechanics | <input type="checkbox"/> |
| Electrical Contracting/Installation | <input type="checkbox"/> | Computer Programming | <input type="checkbox"/> |
| GCE over 40 'O' and 'A' level subjects | | <input type="checkbox"/> | |

ICS

Name _____ P. Code _____
 Address _____
 International Correspondence Schools Dept EDS16, 312/314 High St., Sutton, Surrey SM1 1PR. Tel: 01-643 9568 or 041-221 2826 (24hrs).



Microelectronics Education Programme

Part 1 Graham Bevis & Michael Page

THE National Electronics Council is a prestigious body representing many interests—government, the armed forces, the electronics industry and consumers—each year it publishes a Review of developments and activities taking place. In the foreword to this year's Review the Prime Minister writes:

"The world of electronics and information technology is always exciting and always changing. Microprocessors, computer-aided design and manufacture, robotics, and the prospect of a "fifth generation" of computers, all these developments present our country with a challenging opportunity.

If we seize it, we can compete in the markets of the world, including the market here in Britain, create new jobs and increase our prosperity. If we fail, Britain can only slip back.

The skills required are many and various. Conceiving new products and bringing them to the market; designing new equipment at the forefront of development; manufacturing it efficiently and economically. New technology, though, is not just for specialists—people at all levels in industry and commerce need to appreciate what it can do, and acquire the facility to use it. So we need to make sure that young people in particular get the education and training in new technology that they need. Government, the education service, industry and commerce all have a part to play.

The opportunities for making a career in electronics and information technology are there. I hope that increasing numbers of young people will think seriously about making the most of them, for Britain's benefit as well as their own."

That statement is a reflection of the view which determined the nature and direction of the work of the Electronics and Control Technology (ECT) domain within the Microelectronics Education Programme (MEP).

Funded by the central education departments of England, Wales and Northern Ireland, MEP was set up in 1980, initially for four years but later extended until March 1986 when it will cease to exist. MEP's place will be taken by a small scale operation, termed the Microelectronics Support Unit, whose nature and scale has yet to be defined.

GENERAL AIM

The Programme's general aim has been to help educators become better able to prepare children for life in a society in which devices and systems based on microelectronics are becoming commonplace and pervasive. In this context it is perhaps worth noting that it says microelectronics and not microcomputers.

That statement formed a very satisfactory unifying concept for all the varied activities involved. They ranged from introducing ways of using the new technology to improve general teaching procedures to teaching about microelectronics itself in the many technology courses which are now part of the curriculum of an expanding number of schools and colleges.

The work of MEP and ECT has implications for the general curriculum of all and has produced developments in schools which have a significant bearing on the issue of skilled manpower shortfall at every level of IT activity in commerce and industry.

At the beginning of MEP relatively few pupils studied electronics or electronic systems as part of an examination course. Even fewer were fortunate enough to experience a practical course at an awareness level as part of their basic education. Since MEP began

various reports—Finniston, Alvey, and the Butcher/Baker inquiry into the problem of engineering and technology skills shortages have provided a very profitable background to the debate about education and new technologies. We now, at least, have some widely recognised questions that educators have to consider:

- What is the knowledge of technology that all pupils should acquire?
- What are the skills and attitudes required for young people to develop into confident and competent adults in a world dominated by new technology?
- How do we encourage more young people to look to future careers in engineering, commerce and industry?

THE PROGRAMME'S WORK

MEP has been facing many of these questions right from the start of its work. But it is in the nature of a dynamic situation, like that of which microtechnology is a part, that answers formulate themselves and evolve continuously as experience grows.

MEP was fortunate in being faced with an education system which was already recognising the new demands being placed on it and was prepared for change. Some individuals and schools were adopting locally defined solutions, borne out of particular interest or expertise.

However, there were—and still are—some significant difficulties.



The current curriculum is overfull so how can new ideas and topics be introduced? By the introduction of new subjects into the curriculum or by the insertion of appropriate elements into existing provision?

And what about the teachers? How do you enable a teaching profession which is largely devoid of any pre-service training in aspects of an information based society to equip itself to meet the new demands being placed on it? What new skills and knowledge should all teachers develop? How will they achieve this? What new skills and knowledge should specialist teachers develop? How?

The Programme has tried to cover most of these issues. It has undertaken both Curriculum Development (CD) activity and In-Service Training (INSET) work associated with aspects of micro-technology throughout the 5-18 age range.

As well as the ECT work which is the main subject we're looking at in this article, you might be interested to know that other domains exist to consider the computer as a tool for learning, for computer studies, for communication and information systems, and for special education (that is for those with particular needs through mental or physical disability).

Clearly, the nature of the provision is varied. Work for and with teachers of primary children will be very different to that required for teachers of sixth form pre-university students of technology. The output of the Programme has been quite remarkable.

There are now more than 2000 items available for teacher or classroom use and these include software, devices, video tapes, case studies, and so on. Every maintained school in the three countries where MEP works has been sent the Programme's catalogue (July 1984) and supplement (October 1985) through the Local Education Authority (LEA) mailing system.

| | |
|-------|--------------------------------------|
| MEP | Microelectronics Education Programme |
| ECT | Electronics and Control Technology |
| CD | Curriculum Development |
| INSET | In-Service Training of teachers |
| LEA | Local Education Authority |
| MFA | Microelectronics For All |
| CDT | Craft Design and Technology |

Abbreviations used in this article

THE ELECTRONICS AND CONTROL TECHNOLOGY DOMAIN

In 1980 ECT began as a "cinderella" in the MEP operation. Its purpose and potential contribution was little understood by educational administrators, both inside the schools themselves or in the power houses of the LEAs and the Department of Education and Science. How often have we heard the statement (it is not an argument) "we do not need to enable our children to understand anything about microelectronics technology anymore than we need to teach them about the intricate principles and operations of the internal combustion engine".

It took some time, following the many educational conferences, set up both nationally and regionally by MEP, and with not a little input from industrialists worried about IT skills shortfalls, to begin to establish an appreciation that:

(a) Microelectronics is increasingly pervasive in its influence on the world of work, leisure, education, the daily organisation of our individual lives and the way in which society is organised and controlled. Therefore, in a democratic society, all citizens should be well enough educated about the nature and capabilities of this new technology in order to be able to intelligently influence its adoption, application and development.

(b) A practical study of microelectronics has a very great deal to offer the basic educational process at all levels of ability and age. The subject is highly motivating because it is obviously relevant. It readily lends itself to a student-centred practical approach, which enables personal development in a wide range of skills, aptitudes and attitudes—particularly those of communication skills within working groups. It develops the ability to think logically, to learn and to apply knowledge to the solution of practical problems, to choose and implement a solution, to evaluate it and, if necessary, improve this solution in the light of experience.



A PROSPEROUS NATION

Couple these arguments with the absolutely clear fact that, if we are to survive as a reasonably successful and prosperous nation, we must be able to identify and stimulate those special pupils who have imaginative and creative talents, and to encourage them to become the engineers and technicians of a successful manufacturing-based economy, then you have no choice but to accept the fact that some practical experiences of microelectronics should be part of the curriculum of all pupils from 5-16 years.

These experiences should enable the development of an awareness of the processes, applications and potential of IT systems and should develop skills appropriate to life in general and to future employment, especially for those inclined to pursue technologically related careers.

SEEING THE LIGHT

The problems of initial perception, described above, meant that at the beginning of MEP the ECT domain was established with the purpose of providing INSET only for the specific courses which included electronics or microelectronics. At this time appropriate examination courses at 16+ and 18+ could be identified as control technology, modular technology, electronics, electronic systems, and in a small measure, some courses in physics.

However, for the more specialist courses, the number of candidates were few and so the INSET requirement in any MEP region (a grouping of nine or 10 LEAs) was limited. Given this situation, together with the fact that the teachers requiring training generally had limited knowledge and experience in this field and that they were so thin on the ground that they could only be allowed out of the school for short periods, then the only INSET model possible was one of small modules of individualised practical learning activity.

This helps to accommodate the above parameters and the fact that teachers, like pupils, learn at distinctly different rates and therefore cannot be satisfactorily "class taught".

Quite soon after beginning this programme of INSET, it was clear that with all the attendant problems described above plus the fact that very little curriculum development had been done in the ECT field, the task of the intending ECT teacher was well nigh impossible. It was also clear that many teachers felt it was far more

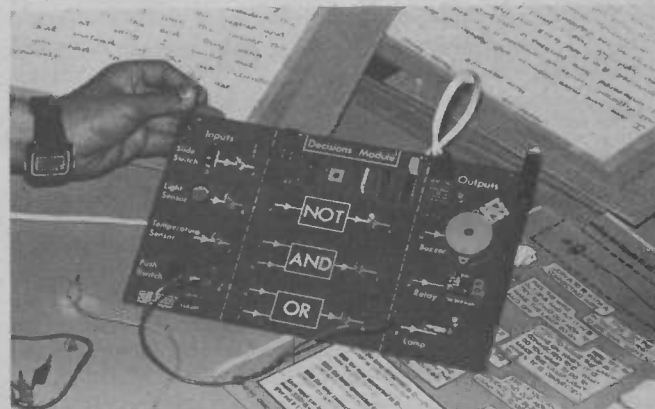

important to provide all pupils with some experience and knowledge of IT systems than to provide a specialist technical education for a few.

Out of the feedback from teachers on courses, the MEP ECT coordinators perceived a need to develop a highly supportive, practical course as an introduction to IT systems. This has now evolved as the MEP Microelectronics For All (MFA) scheme, and is described later.

Although the need was perceived, at that time there were no centres available to ECT for curriculum development activity. There were two models by which small scale curriculum developments were occurring. One, by commissioning the entrepreneurial teachers who had "done their own thing" to describe and document their work so it could be used by others. The other route was to use the MEP regional structure, which had a general responsibility for CD, to coordinate a specific development.

It fell to the MEP Greater Manchester and Lancashire Region to develop MFA. It was in this MEP Region that there was just the right blend of aspirations and experience of a significant group of teachers who had already tried an MFA approach for themselves. This, together with a sympathetic steering group of LEA advisers and an ECT coordinator with his base in the supportive and appropriately expert University of Salford, was the recipe for the production of a very innovative resource.

WHAT MFA IS ALL ABOUT

The MEP/MFA course has been designed as a low cost practical course which introduces the principles underlying information technology and demonstrates the action of basic simple IT Systems, illustrated below.

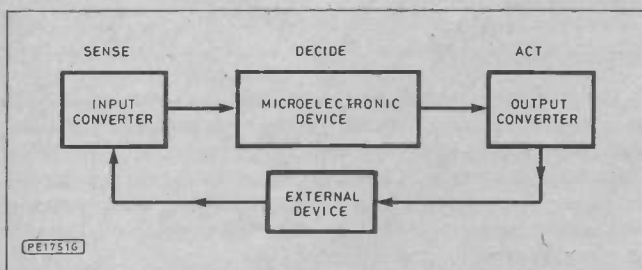

There are three basic MFA modules and these can be connected together to form a flexible demonstration system. All the modules are arranged so that information enters the system on the left hand side.

On the decisions module there are four two-state input devices. The light sensor indicates whether it is dark or light. The temperature sensor detects a rise above ambient temperature. A slide switch and push switch provide the other two information inputs. If the light sensor output is connected to the buzzer it sounds until the sensor detects darkness and causes it to be turned off.

With this module pupils first explore the interaction of input sensors and output devices before discovering ways of using more than one piece of information to control output devices. They are then in a position to be able to use their new found knowledge and solve simple problems given to them or conceived by themselves.

They can then, with the other two basic modules, progress through a similar structured exploration of the processes of counting and remembering, leading to work on simple stored sequence control systems. This leads directly to work with a microcomputer as the "control element" in an IT system. For this work there is an interface designed to lead directly from the initial MFA experience. As well as enabling the micro to be part of an electronic system, there is integrated software which further illustrates the IT systems being demonstrated.

APPRECIATION AND APPLICATION

Having developed an appreciation of the principles, structure and operating processes of IT systems, the pupils are then encouraged to turn their thoughts to the applications of IT. These include those around them in their everyday environment, and those not generally seen but important in their effects. From this the pupils begin to develop the all-important appreciation of just what

it is that silicon chip systems can do and, equally importantly, what they cannot do.

MEP is currently working with the BBC to produce three TV programmes aimed at addressing these questions by observation of real-world systems at work. Furthermore, a joint initiative by the BBC and MEP is facilitating the production of learning materials for older readers. This will provide the details of particular IT systems and describe the effects of the system on the work of people employed, either in the job situation itself or the nature of the product (in the broadest sense) produced by the employee.

WHAT'S NEXT MISS?

Having experienced MFA, many pupils wish to study the subject further, either for interest and enjoyment or because they have decided to pursue a career in the IT industry. For these pupils there needs to be a more extensive microelectronics curriculum. Therefore, the MEP/ECT domain has been engaged in developing very specific, highly-supportive learning packages for some of the many specialist areas of the subject which require it.

As a result of the success of the convincing MFA scheme and the need for a much wider range of activity, two national development centres were established, at Salford and in Sunderland, in September 1984. This is somewhat late in terms of the lifetime of MEP, but with the benefit of the background of four years' debate about, and developing experience of, the needs of the microelectronics curriculum and its associated INSET needs.

The Salford Electronics Education Development Unit, based at Salford University, was established to continue the development of the Microelectronics For All scheme, in terms of both hardware and pupil materials. It is enabling the MFA approach to be used at examination level in Craft Design And Technology (CDT) and science courses. Furthermore materials are being produced that are appropriate to sixth form general studies courses. The work of the Salford Unit is complemented by the very strong and productive links of the Greater Manchester and Lancashire MEP Region and the many practising teachers experienced in microelectronics education in that area.

Further north, the Sunderland Evaluation and Development Centre has been established partly to continue the very valuable and necessary work in the evaluation of hardware and curriculum packages and the resulting provision of advice and information to teachers of microelectronics. It is also involved with the development of highly innovative teaching materials in terms of their content, concept and place in the curriculum.

Projects complete or in hand include the "Analogue Sensor System", "Communications For All", and the "Compleat Meteorologist". The Centre benefits from being placed within the grounds of Southmoor School, Sunderland, and enjoying the support of the far-sighted and well resourced "Microelectronics Development Programme" of the Sunderland education authority. The MEP Centre shares premises and staff with the LEA's own Microelectronics Centre.

APPROPRIATE INSET

Many factors have encouraged schools and colleges to offer specialist courses at 16+ and 18+ in electronics or microelectronics or technology. Most of these courses are defined by new syllabuses, largely unsupported by an appropriate curriculum, or even advice on how best to teach the syllabus to meet the requirements of the examination at the end of the course.





The many teachers charged with responsibility for these courses find themselves in the position of having to define their own approaches and strategies when their own knowledge and experience in these subject areas is often at the stage of early development.

Frequently the practical scheme of work, which is the main part of the teacher's INSET experience, is equally applicable to the learning situation for the student at school. For both the teacher and the pupil there is the need to learn about the theory and concepts of the subject and to learn about the practical issues relating to its implementation. In any case electronics is a practical discipline and the best way to learn, as in many subject areas, is by practical experimentation designed in the first instance to illustrate principles and ideas and then to lead on to investigative problem solving activities.

GETTING THERE

Against a background of having begun the INSET programme in the MEP Regions with mostly introductory courses, the work has now moved on to the development of highly-detailed distance-learning packages which are tailored to particular hardware and approaches. The student's guide contains details of the theory and concepts to be explained by following practical exercises. Thus the study rate is self determined and allows for variation in previous experience and rate of learning. It also enables teachers to develop their knowledge in the subject at a rate and time convenient to them. The package course also serves as an encyclopaedic "aide memoire" which can be returned to as a refresher when the need arises.

Some of the hardware and practical exercises provided for the teachers will be appropriate for their pupils, depending on the level of study. There is a wide range of course topics for which development work on distance learning packages is in progress or planned. Many others will be needed as the level and extent of microelectronics technology courses in schools expands.

Clearly, great demands are being made on the teachers and, perhaps, the pupils. But the reported experience from teachers and pupils in this field is all the same, one of considerable enjoyment, satisfaction and interest in this work. The motivation is unquestionable. It is after all motivation which determines achievement in all learning, even more so than intelligence itself.

NEXT MONTH: Graham Bevis and Michael Page will be looking in more detail at the Microelectronics For All material and describing what may be happening when the government money for MEP runs out at the end of March and the new Microelectronics Support Unit hopes to start work. We also hope, in future issues, to be carrying some constructional projects that are supported by sound curriculum needs and teacher training materials.

If you would like an information folder which contains full details of the MEP/ECT domain and its teacher-training materials, then send a large (C4) self-addressed envelope stamped with 45p-worth of stamps PLUS 50p in unattached stamps, to Mrs Beth Bevis, Ronsella, Lordswood, Highbridge, Eastleigh, Hants SO5 7HR. It would be helpful, if you are a teacher, to say in which LEA you teach.

D.E.S. REPLIES

The Minister for Education and Science has now replied to our September Editorial which included the paragraph below:

While in no way wishing to get involved in politics, it is all too easy to blame the teachers when a continuing lack of investment in training, staffing and facilities, at Government level, is not allowing education in the UK to keep up with progress and the new demands of industry. Education which has, for many years, had a worldwide reputation for excellence. Perhaps the state schools should follow the lead given by the independent Schools Microelectronics Centre? Copies of this and other leaders and of the letters we have received have been forwarded to the Department of Education in the hope of a reply—Ed.

In your editorial in the September edition, you reported that you had sent a copy to the Department asking for a response. I am now replying.

In our White Paper "Better Schools", published last March, we said that, "The Government believes that all pupils should follow a broad, balanced and suitably differentiated curriculum until age 16; that such a programme should contain a strong element which relates to the technological aspects of working life". We amplified this in our Science Policy Statement for the 5-16 age group also published in March. The Government's position is therefore quite clear and we have sought to provide a stimulus to educational establishments through a substantial number of initiatives.

The Microelectronics Education Programme, established in 1980, aims to help schools to prepare children for life in an increasingly technological society through the development of software and devices, the provision of teacher training courses and an information network covering the country. Some £23m will have been spent on this Programme by its close in March 1986. The Programme is to be succeeded by a Microelectronics Support Unit which will provide further help, mainly through training and trainers, and providing a central information source. The Micros in Schools schemes, started at the same time, have been successful in ensuring that there is a microcomputer in every school. The 5,000 secondary schools now have an average of 12 micros per school; the 20,000 primary schools now have on average 2 micros per school.

The Technical and Vocational Education Initiative aims to stimulate the provision of practical and applicable elements within the curriculum for 14-18 year olds through pilot projects mounted by the LEAs but funded by Government. Almost £250m is being spent on the Initiative over a 9 year period.

An Educational Support Grant Scheme aims to encourage the use of information technology in non-advanced further education especially for those not specialising in IT subjects. The Government is spending £9m on this scheme in 1985/86, and a further £6m in 1986/87 with continuing substantial sums through to 1990. We have recently announced another project to facilitate the purchase of software by schools.

Finally, the British Schools Technology initiative aims to bring practical technology into all CDT courses and, by the end of the academic year 1986, will have conducted in-service training courses for some 10,000 teachers. The local authorities themselves, who are responsible for the details of the curriculum within the schools, have added much to these sums.

The position now is that more than half of secondary schools mount courses on information technology for their pupils. Topics associated with new technology are to be found in many examination syllabuses—computer studies, robotics, electronics, computer graphics—at 16, 17 and 18 years. Over 130,000 students will study some elements of the new technology to public examination level in school this year.

Of course, there is still a long way to go to introduce technology thoroughly into the education system and we cannot be complacent. But both in its public statements and its various initiatives, the Government is providing the clearest of leads on the way forward.

CHRIS PATTEN

Thank you for your response. I feel it is worth pointing out that total Government spending on education is around £10,000 million a year, so the £5 million (approx) a year for MEP spending can be put in perspective—Ed.

Readout...

Twenty Years of Stagnation in the U.K.

Sir—Your correspondents' letters in *Readout* in your September issue have covered this matter as far as schools are concerned fairly well. As a 73-year-old hobbyist of only 3 years at electronics, I am concerned, from my experience, at what more can be done to help ex-students who wish to extend their knowledge of electronics. For example take the case of an unemployed person who has passed O-level Physics and thinks that with further knowledge of electronics he might get a job as an electronics engineer or a teacher.

Having had my interest in the subject excited by my grandson's Electroni-Kit, I found a copy of *Everyday Electronics* for Nov. 1982 in a local stationers. (This shop no longer stocks this magazine. Special orders only.)

I realised that *Teach-In '82* could help me, obtained the October '82 issue for the start of the series and put in an order for *E.E. W.H. Smith* can now order *P.E.* for me as well, but few stationers in provincial towns stock these magazines i.e. it is not easy to buy purely electronic know how in magazine form from the shelves in the first instance. The same applies to books. I found one book (no choice) on electronics in a large book shop near here, and that was first printed in 1972 with little revision since the advent of transistors and i.c.s.

I obtained an Electroni-Kit and followed up an advert: for The British Amateur Electronics Club. They were most helpful and for 6 months I corresponded with another member who taught me a lot. I discovered one small electronics component shop in Salisbury which stocks Babani Books. Then I was able to buy these books off the shelf, after looking at their contents which no resumé in a catalogue can really tell you. The local bookshop took three months to obtain two Babani books for me.

My point is that in the provinces it is very difficult to buy books or magazines about electronics and enough to discourage any ex-student seeking further education. Public libraries hold a few volumes.

How many courses on electronics are run for evening classes during the winter? *P.E.* advertises two correspondence courses and one college. How can you "spread the Gospel"? I think in a way that too much has been said about computers too soon, because a market was there for a new sort of toy for children. You can buy numerous computer magazines, but do they teach you electronics—computers, radio, TV, discos and they use them like cars which you can drive without knowing what a sparking plug is.

I suppose it boils down to education but it is young persons with some knowledge of the subject you want to capitalise on now to produce teachers of future students.

Dr. R. G. Ticehurst,
Gillingham,
Dorset.

Lack of Guidance

Sir—Further to your July '85 editorial I would like to add my own comment to the shortfall of potential engineers in this country. I myself am currently studying on the 2nd year of a two-year OND in Technology (Engineering) at Cornwall College.

On leaving school I was somewhat surprised to learn that of the 100 or so students capable of going on to a technical further education, only 25 did so, the remainder going for arts-based courses or none at all. When asked why, many came up with such comments as "not my scene" or "too much like hard work" or even "girls can't do physics"(!).

Perhaps this is as a result of parental "guidance" or more likely a complete lack of understanding and information on the subject of Engineering in general. Thinking back to my time at school only just over a year ago, the careers service seemed positively biased against Engineering—there was simply no information on such subjects.

Your comment in the July '85 edition that "*PE* could be said to be doing more for industry than our educational system" is perhaps a little far-fetched. However, if one were to enquire at any secondary school in the area I think that they would be hard pushed to supply any textbook containing much more than simple Ohms law except perhaps the few magazines such as *PE* left after government cuts.

From what I can recall of my time at school, the interest was most definitely there in the students but a lack of resources and free staff time prevented anything more than letting us use the very limited computing facilities for perhaps one lunchtime a week. This was the closest I came to doing anything more than Ohms law at any time during my compulsory schooling.

I feel sorry for the large number of students staying on at school for "A" levels in technical subjects when just a few miles down the road there is a fully equipped Further Education College which has a severe lack of good student material although it has some of the best resources in the county.

The principal source of the problem as I see it is in two main areas. Firstly in the lack of guidance and information given to pupils in schools, especially concerning "options" and choices for further education. Second, the sooner a common core curriculum is introduced for both sexes and all ranges and abilities the better. It cannot be right that by the time a person has reached the age of 14 or so a large range of careers and jobs are already unobtainable.

As to your comment in the September '85 Editorial that "not one student has written" to you I would hazard to suggest that the present feeling of apathy in students today is due, in part at least, to the feeling of being unable to exert any influence in any particular direction and being a very small cog in a very large educational system.

Richard Freeborn,
Truro, Cornwall.



Congratulations

Sir—Congratulations on *Practical Electronics*' 21st anniversary! I appreciate all the enthusiastic help and support you and Fred Bennett (*PE*'s founding Editor) have given the British Amateur Electronics Club, since we started in 1966, in your leading magazine for electronics enthusiasts.

It was Fred, of course, who first realised that amateur electronics needed its own magazine, and both you and he have kept abreast of the times, and always given your readers what they wanted, even before they knew what it was themselves! Naturally, electronics comes first with me, but I have a BBC computer, and find your articles on it very helpful, so thanks and congratulations on knowing what I want!

With best wishes, and I am looking forward to *Practical Electronics*' 25th anniversary, not to mention *Everyday Electronics*' 21st!

Cyril Bogod,
British Amateur Electronics Club.

NEW
LOGIC KLIP
A versatile logic testing device at a budget price just **£58.75** INC VAT POST AND PACKING

- Attractive pocket-size unit provides clear and simple "hands-free" operation.
- Simultaneously monitors the interaction of up to 16 points or nodes via numbered LEDs.
- Simple connection using standard 4-point I.C. clip supplied or a combination of clips, interfaces, grabbers and probes supplied as optional extras.
- Power supply taken from test circuit, either TTL (operating voltage +5V) or CMOS (4.5-18V).
- Logic state at test point indicated by:
Logic 1 (high) LED on
Logic 0 (low) LED off
- Display face of unit can be temporarily marked, using a chinagraph pen, to describe circuit layout or I.C. pin-outs.
- Separate overlay supplied with unit for marking alternative layouts. Additional overlays available to build-up library.
- Uses include: Development, testing, maintenance, training.

JOHNSONS (LEIGH) LIMITED
100/102 Glendale Gardens, Leigh-on-Sea, Essex S9 2AY
Tel: 0702 710990/713734. Access facilities

THREE ACES FROM ALCON!

TESTER 20 A♣



20kΩ/V a.c. & d.c.
DIODE & FUSE PROTECTION
39 RANGES
 Accuracy: d.c. ranges and Ω 2% a.c. 3% (of f.s.d.)
 39 ranges: d.c. V 100mV, 1.0V, 3.0V, 10V, 30V, 100V, 300V, 1000V;
 d.c. I 50μA, 100μA, 300μA, 1.0mA, 3mA, 10mA, 30mA,
 100mA, 1A, 10A,
 a.c. V 10, 30V, 100V, 300V, 1000V; a.c. I 3mA, 10mA, 30mA,
 100mA, 1.0A, 10A,
 Ω 0-5.0kΩ, 0-50kΩ, 0-500kΩ, 5MΩ, 50MΩ.
 dB from -10 to +61 in 5 ranges.
 Dimensions: 105 x 130 x 40mm.

ONLY £29.75

MINI 20 A♥

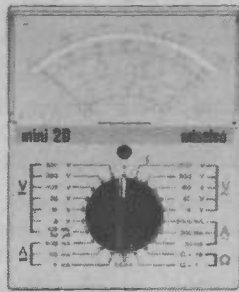

20kΩ/V d.c. & 4kΩ/V a.c.
28 RANGES WITH PROTECTIVE FUSE
 Accuracy: 2% d.c. and resistance, 3% a.c.
 28 ranges: d.c. V 100mV, 3V, 10V, 30V, 100V, 300V,
 600V, d.c. I 50μA, 600μA, 6mA, 60mA, 600mA,
 a.c. V 15V, 50V, 150V, 500V, 1500V; a.c. I 30mA,
 300mA, 3.0A, Ohms 0-2kΩ, 0-2MΩ,
 dB from -10 to +62 in 6 ranges.
 Dimensions: 105 x 130 x 40mm.

ONLY £21.60

SUPER 50 A♠

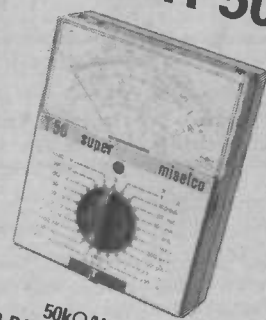

50kΩ/V a.c. & d.c.
39 RANGES - INDESTRUCTIBLE
 automatically protected on all ranges but 3A
 Accuracy: d.c. ranges and Ω 2% a.c. 3% (of f.s.d.)
 39 ranges: d.c. V 150mV, 1.0V, 3.0V, 10V, 30V, 100V,
 300V, 1000V, d.c. I 20μA, 100μA, 300μA, 1.0mA,
 3mA, 10mA, 30mA, 100mA, 1A, 3A, a.c. V 10, 30V,
 100V, 300V, 1000V; a.c. I 3mA, 10mA, 30mA,
 100mA, 1.0A, 3.0A,
 Ω 0-5.0kΩ, 0-50kΩ, 0-500kΩ, 5MΩ, 50MΩ,
 dB from -10 to +61 in 5 ranges.
 Dimensions: 105 x 130 x 40mm.

ONLY £36.30

3 HIGH QUALITY TEST INSTRUMENTS AT SUPERDEAL PRICES

EACH INSTRUMENT HAS A CLEAR MIRRORED SCALE AND COMES COMPLETE WITH A ROBUST CARRYING CASE, LEADS & INSTRUCTIONS.
 PRICES Our prices include VAT and postage and goods are normally despatched by return.
 Please write or telephone for details of these and the many other instruments in the Alcon range, including multimeters, components measuring, automotive and electronic instruments.

ALCON Instruments Ltd.

19 MULBERRY WALK · LONDON SW3 6DZ · TEL: 01-352 1897 · TELEX: 918867

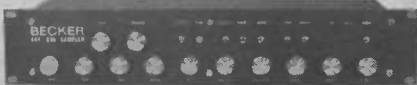

EFFECTS, DISPLAY AND TEST KITS



AUTOWAH
 Auto, manual & note triggered Wah-Wah, switchable. Set 140 £24.36

BASS BOOST
 With variable depth & range. Set 138B £13.62

BLOW BOX
 Voice operated filter & amplifier for fascinating effects with voice & music. Set 214 £29.33

CHORUS-FLANGER (PE JAN 84)
 Mono-Stereo. Superb dual mode music enhancement. Set 235 £59.99

COMPANDER
 Mono-Stereo. Compression, expansion, switchable. Set 238 £22.99

CYBERVOX (EE APR 85)
 Amazing robot type voice unit, with ring modulator & reverb. Set 228 £44.76

DISCO LIGHT CONTROL (PE NOV 85)
 3 Chan sound to light, with chasers, auto level & computer interface (BBC, C64, PET, etc.). Program incl. Set 245F £52.50
 3 Chan sound to light only. Set 245S £42.00

ECHO-REVERB (PE SEP 84)
 Mono-Stereo. 200MS echo (extendable), lengthy reverb, switchable multitracking. Set 218 £57.66

ENVELOPE SHAPER
 Note triggered ADSR, with VCA. Set 174 £25.20

EQUALISER
 3 channels. Variable low pass, high pass, band pass and notch filtering. Set 217 £25.33

FADER
 Voice controlled automatic music fader. Variable rate and sensitivity controls. Set 167 £22.22

FLANGER
 Variable rate & depth plus phasing controls. Set 153 £28.45

FREQUENCY DOUBLER
 Guitar octave raiser & tone changer. Set 98 £15.30

FUZZ
 Smooth distortion, retains attack and decay character. Set 209F £19.58

GUITAR EFFECTS
 8 variable tremolo and Wah-Wah effects. Set 196 £23.56

GUITAR SUSTAIN
 Extends note decay time, with noise gate. Set 222 £25.31

GUITAR TO SYNTH
 Interface for guitar control of synth, with voltage & trigger outputs. Set 173 £41.41

HAND CLAPPER
 Auto & manual variable clapping effects. Set 197 £26.69

HEADPHONE AMP
 For headphones and speakers from 8 ohms, 2 watts. Mono set 156M £18.07
 Stereo set 156S £26.65

LINKAFEX CHORUS
 Foot pedal. Variable rate & depth, 160Ms to 4 secs. Set 204 £42.96

LINKAFLEX DELAY
 Foot pedal. Echo & reverb 10Ms to 450Ms. Set 206 £42.09

LINKAFLEX EQUALISER
 Foot pedal. Switchable filtering - low pass, high pass, bandpass, notch. Set 216 £25.43

LINKAFLEX FLANGER
 Foot pedal. Variable rate & depth, 160Ms to 4 secs. Set 207 £34.92

LINKAFLEX FUZZ
 Foot pedal. Smooth variable distortion. Set 209L £23.24

LINKAFLEX MODULO
 Foot pedal. 8 switchable tremolo and Wah-Wah effects. Set 211 £25.41

LINKAFLEX PHASER
 Foot pedal. Variable rate & depth, 100Ms to 20 secs. Set 205 £34.38

LINKAFLEX SUSTAIN
 Foot pedal. Variable note die-away extender. Set 223 £26.47

METRONOME
 Variable rate & accented beat. Set 143 £21.35

MICRO-SCOPE (PE DEC 85)
 Turns a computer (PET, C64, BBC, etc) into an oscilloscope. Program incl. Mains powered. Set 247 £44.50

MIXER - 4 CHAN MONO (PE JAN 86)
 Separate input gains, levels, pans, filters, twin outputs, voltage controlled. Set 229M £49.95

MIXER - 4 CHAN STEREO (PE JAN 86)
 Separate input gains, levels, pans, filters, echo send, PFL, voltage controlled. Set 229S £89.95

MOCK STEREO
 Splits mono signal into stereo simulation. Set 213 £24.37

NOISE GATE & VCA (PE MAY 85)
 Mono-Stereo. Automatic noise reduction. Set 227 £26.61

PHASER (PE OCT 84)
 Phasing enhanced with modulated filtering. Set 226 £42.36

PRE-AMP
 Variable level & gain, switchable bass & treble filter. Set 144 £14.93

REVERB (STEREO)
 Lengthy reverb with stereo signal. Variable level & depth. Set 203 £36.54

REVERB - MONO (EE OCT 85)
 Superb lengthy reverb unit. Variable depth & level. Set 232 £27.35

RHYTHM GENERATOR
 9 instruments controlled by pre-programmed chip. 12 basic rhythms, superimposable with 4056 switch combinations. Set 240 £59.99

RHYTHM GENERATOR
 Computer driven (BBC, PET, C64, etc) 9 different drum instruments. programs available. Set 185 £34.64

RING MODULATOR (PE NOV 84)
 Fabulous effects generation, with ALC & multiwaveform VCO. Set 231 £45.58

SAMPLER & 64K DDL (PE JUN 85)
 Digital 64K memory. Up to 65 secs delay, echo, reverb, re-pitch, multi & reverse track, loop, etc. Micro interface (BBC, C64, PET, etc). Mains powered. Programs available. Rack case. Set 234R £245.00

SAMPLER - MINI (PE JUN 85)
 Short version of 64K ODL less memory. Micro controlled (PET, C64, BBC, etc) looping, pitch changing, multitracking, reverse tracking, echo, reverb etc. Mains powered. Programs available. Set 246 £95.00

SIGNAL GEN & F-V (PE JAN 85)
 Test gear. Multiwaveform VCO, freq. to voltage converter, sweep gen. Set 233 £46.96

STORM EFFECTS
 Auto & manual wind, rain, surf effects. Set 154 £23.60

TOM-TOM SYNTH
 Sound triggered multivariable drum effects. Set 130 £19.37

TREBLE BOOST
 With variable depth & range. Set 438T £13.62

TREMOLO
 Variable depth & rate modulation. Set 136 £15.62

VOCODAVOX
 Modular vocoder, 7 chans., extendable. Set 152 £79.95

VODALEK
 Simple robot type voice modulator. Set 155 £18.31

VOICE-OP-SWITCH
 Voice level controls 1 amp DPDT relay. Variable sensitivity & pause controls. Set 123 £20.41

Published Kits. PE = Practical Electronics; EE = Everyday Electronics. Designer John M.H. Becker.
 Boxes - DDL sampler - 19 inch steel rack mounting. Linkaflex units - Robust diecast. Other units black steel & aluminium. All kits include PCBs, parts, instructions, boxes, wire, solder.
 Further details are in catalogue of over 70 kits - Send 9"x4" SAE. (For overseas enquiries a catalogue send £1.00 or 5 IRCs.)
 MAIL ORDER: Payment CWO, cheq, PO, Access, Visa. Insurance cover 50p per £50.
 Details correct at press. E&OE
 Add 15% VAT. Add P&P £1.50 each kit. (Overseas rates in catalogue.)

**PHONOSONICS, DEPT PE61, 8 FINUCANE DRIVE, ORPINGTON, KENT BR5 4ED.
 TEL: ORPINGTON 37821 (STD 0689, LONDON 66).**

Modular Mixer

Part 1

John M.H. Becker

Clever connections allow countless combinations of mono or stereo signal controllers—selective filtering and panning facilities

THE design described here consists of a modular mixer permitting a wide variety of channel combinations to be assembled, and in which the majority of the signal paths are voltage controlled. As an example, two complete 4-input combinations for producing both mono and stereo mixers are described in

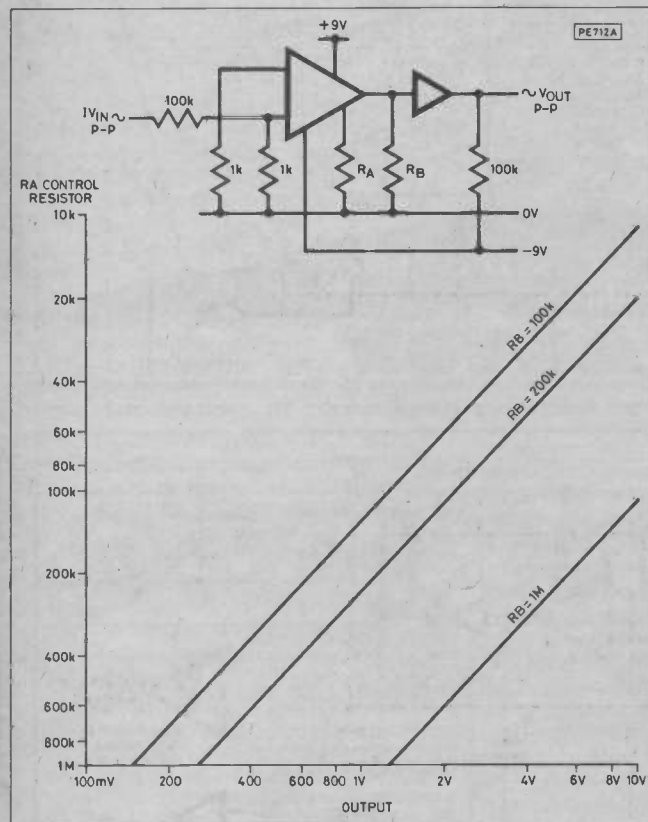

Fig. 1. Gain test—circuit and graph

detail. Each example provides variable control of the input gains and levels, selective filtering of the composite mix, and final output level control. The stereo mixer additionally provides echo send and prefade outputs, plus facilities for panning the inputs between the output channels. Other combinations can be readily assembled.

VOLTAGE CONTROL

The purpose of using voltage control is to minimise the number of signal routing leads normally associated with multi-control units. This not only reduces the number of wires, but also reduces the possibility of interaction.

With the exception of the filter mode selection all signals are controlled indirectly throughout the units. To achieve this the main chip used is the highly versatile transconductance amplifier (TCA), type 13600, available in several manufacturing prefixes such as LM and XR. This can be used in many configurations where voltage or current control of signal strengths is required.

In this circuit it is used as a VCA for amplitude control, and as a VCF for frequency response control. The chip consists of two programmable TCA's, and two uncommitted high impedance

buffers. A low level signal may be applied to either the inverting, or non-inverting inputs, and the signal strength present at the output is then related to the amount of current seen at the control node, and the value of the load resistor.

Fig. 1 graphically shows the results achieved on testing individual 13600s when varying the load and current control resistors. In practise a compromise has to be made between the ratio of high gain via the load resistor, to an increase in noise levels, and the ratio of the high gain via the control node and an increase in current consumption. On test, with R_B at 100k, this varied from 0.5mA with R_A at 1M, to 5.9mA with R_A at 10k. The noise levels were too low to significantly take readings.

Unlike an ordinary op-amp such as the types 072, 082 etc, the 13600 is happier processing low level signals, and it is usually desirable to provide attenuation immediately prior to the input. Naturally, exceeding the optimum signal level will produce overloading, though the effect of this results in a less pronounced change to a waveform than that associated with normal clipping. Photos 1 to 3 show an input signal in the upper trace and show a normal clipped output overload found with op-amps like the 082, 324, 741 etc. Photo 2 shows the effect of overloading the input of the 13600.

Although distortion still takes place it appears and sounds less harsh than that of a clipped waveform. The 13600 includes a distortion linearising input for higher level signals, but the use of this was not considered necessary in these units under the conditions normally expected. In the circuit to be described, IC2 is content to receive an output from IC1 of 2V before overloading occurs. The high impedance buffers enable the gain to be unaffected by subsequent loads being driven.

INPUT STAGES

Two options of variable gain input stages are shown in Fig. 2a and Fig. 2b. In each the phase polarity is maintained by using the non-inverting input ports, and the gain is dependent upon the ratio of the feedback resistance to the resistance on the inverting input ports. In Fig. 2a this is constantly variable by VR1, whereas in Fig. 2b the gain range is switch selected between high and low. In both the gain spread is about from X1 to X50.



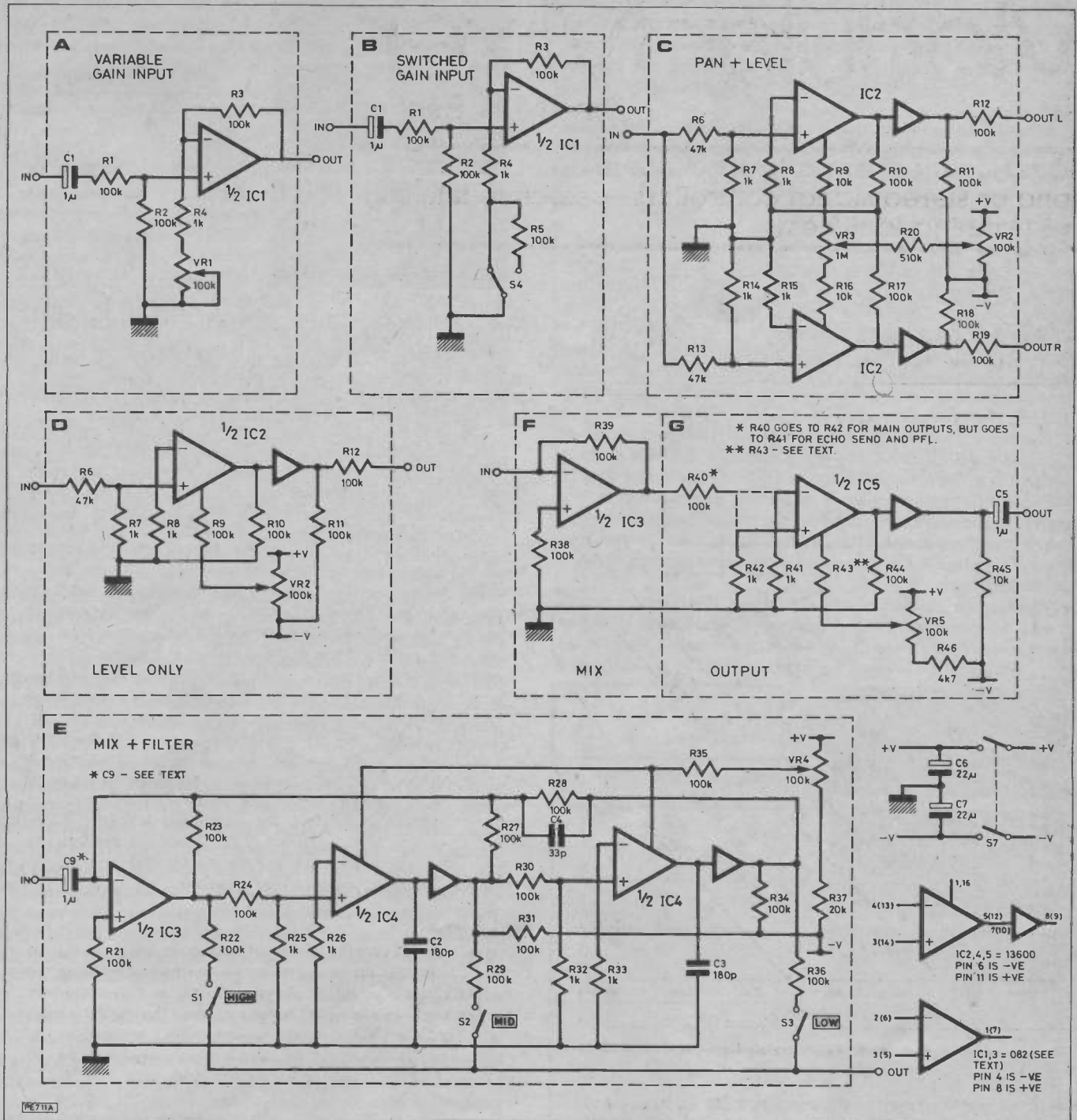

Fig. 2. The basic circuits of the Modular Mixer

The circuit of Fig. 2b is more suited to conditions where gain change versatility is less important, or when front panel space is insufficient to allow extra pots to be mounted. The i.c. used is a normal BIFET dual op-amp, and may be any of the 062, 072, 082 series, available with various prefixes such as TL and RS. The 082 is the standard version, 072 is low noise, and 062 a low power consumption version.

LEVEL CONTROL

The basic level control VCA consists of one half of the 13600, that is, one TCA and one buffer. Phase polarity is again maintained and the output level is fully controllable from nil to maximum by VR2. The amplitude level is dependent upon the voltage present at the wiper of VR2, which modifies the current through the resistor in series with the control port. Fig. 2d shows the circuit for a normal level control without panning facilities.



Photo 1

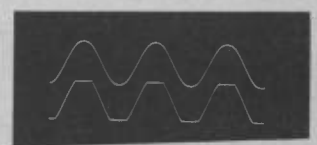

Photo 3

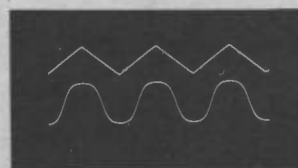

Photo 2

Photos 1-3 show the appearance of input overload distortion.
1. Triangle clipping.
2. Using the 13600 (note smoothness).
3. Sinewave clipping.

Fig. 2c shows two level controls coupled in such a way that the control voltage can be swung between the two by VR3, so that when one is up the other is down, and in the midway position equal emphasis is given to both outputs. Each output can be taken to a dedicated busline so that the signal can be routed to the desired left or right channels. In this configuration, a channel separation of around -40dB is maintained at either full left or full right swing.

At full swing the output level is approximately twice the original input level, and at the midway position is around three quarters of the original. In the circuit of Fig. 2d, the maximum output level is around three times the original.

VOLTAGE CONTROLLED FILTER

One of the many advantages of the 13600 is that it can readily be used as a VCF with only minor changes to the VCA circuit mode. The circuit in Fig. 2e is similar to the one used in the author's *PE Filter-Shift Phaser* in the October 1984 issue. In that instance only band pass filtering was required, but here the full facilities of low pass, band pass, high pass and notch filtering are needed. These four functions provide a wider variety of frequency modification than a normal tone control, especially in conjunction with the response control provided.

The circuit consists of the inverting mixer stage around half of IC3, and the full 13600. The signal from any previous stage is brought in to the mixer stage and to the first TCA. In response to the signal C2 then charges or discharges at a rate set by the current present on the first control node thus mopping up some of the higher frequencies. The charge is buffered by the high impedance stage IC4b, from whence part is fed back via R27 and controls the gain.

Without the addition of the next stage, the resultant output from IC4b would thus be a low pass signal, with the cut-off region set by the charge rate of C2. However, the resultant signal is fed on to the next TCA where C3 charges and discharges at the rate

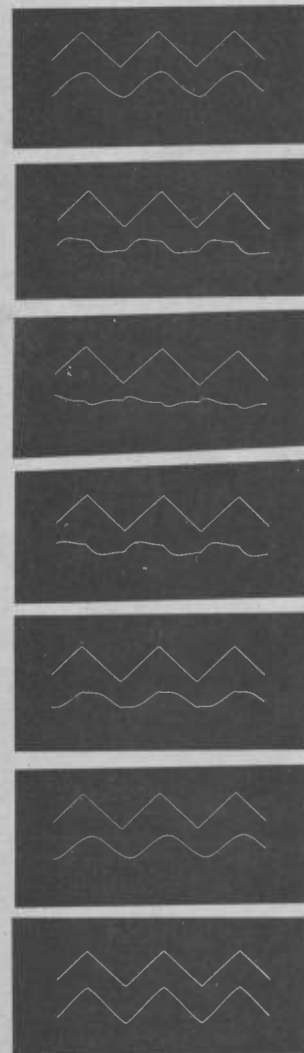

Typical effects of filtering triangle waveform

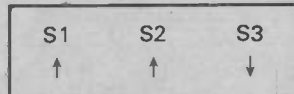

Photo 4

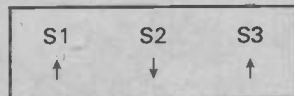

Photo 5

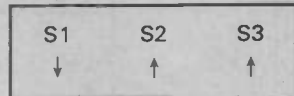

Photo 6

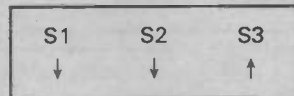

Photo 7

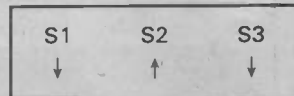

Photo 8

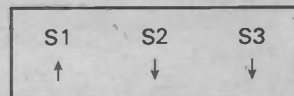

Photo 9

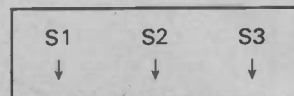

Photo 10

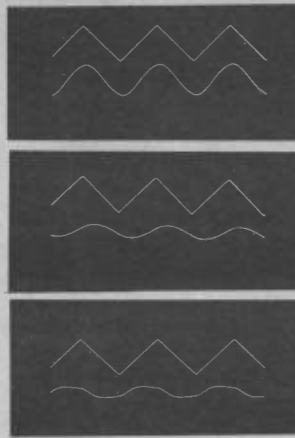

Photo 11. Bandpass

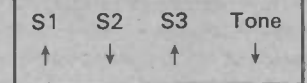

Photo 12. Below bandpass

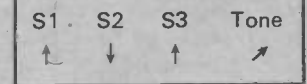
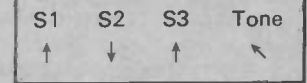

Photo 13. Above bandpass



set by the current on the second control node, so eliminating more of the higher frequency content. Buffered by IC4d, selective feedback of this part of the signal is also made. The effect is then that IC4d and IC3 respectively produce low and high pass outputs, where only frequencies below and above the set points are passed through unattenuated.

The output at IC4b thus becomes the band pass output consisting of those frequencies between the high and low pass ranges. The gain, and so the tightness of the band pass width, is determined by the feedback value of R27, which in this case is set for unity. In some other circuits it is possible to make this feedback resistance a variable panel control in order to vary tightness of the filtering, though this facility is not offered in the circuits shown.

The frequency regions at which the cut off points occur is variable by changing the amount of current flowing at the two control nodes, as set by the voltage on the wiper of VR4 in conjunction with the value of R35. R37 raises the threshold level controlling the minimum frequency response. Switches S1 to S3 allow any combination of the frequency pass outputs to be selected. On its own, each switch passes only the frequencies within the relevant band.

With all of them on, a basically uncorrected signal is produced by adding all three parts back together. With S1 off, treble-cut is given, and the output level is the same as that from the preceding stage. With S3 off, bass-cut results. With all three off, nothing results! However, with only S2 off, notch filtering occurs, allowing only frequencies to either side of the set region to pass through. This permits selective attenuation of the mid range.

VR4 is used to set the desired frequency range for any of the combinations, though of course it will have no apparent effect when all three switches are on together. By judicious use of the filter controls, tone control of the output signal is achieved, and its characteristics modified.

Photo 4 to Photo 10 shows the effect of various switched filter settings upon a single frequency. Note in particular how a sharp waveform is modified to become a more mellow sounding tone by smoothing off the edges. Photo 11 to Photo 13 shows the effect of the tone control upon a band pass region. Photos 14 and 15 show the clarity of the overall signal response as low as 10Hz, and as high as 30KHz.

OUTPUT MIX & LEVEL CONTROL

This is a multipurpose circuit that can be used to mix signals from any stage, and to allow control of the final output level. Half of IC3 is used as the mixer and inverts the phase. It is followed by a VCA stage similar to that in Fig. 2d, and VR5 varies the current through R43, and thus the output level with a maximum gain of 3. R46 raises the initial current to a minimum threshold point.

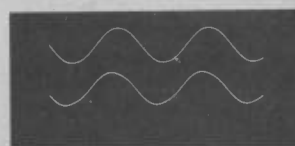

Photo 14. 10Hz

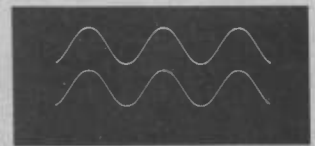

Photo 15. 30kHz

VC4 Mixer waveform retention

The final output can be fed to any other equipment, such as main or monitor amplifiers, or echo and other effects units. A choice of signal phase polarity setting is allowed for by being able to take the output from IC3 to either the inverting or non-inverting inputs of the VCA. The phase of the signals from the circuits shown in Fig. 2a to Fig. 2d is the same as that which they receive, whereas the output from the filter is inverted. In order to retain the original phase, R40 should be connected to R41, and thus the inverting input of IC5, for outputs directly from any of the circuits shown in Fig. 2a to Fig. 2d prior to the filter in Fig. 2e. When the output follows the inverted signal from the filter, R40 is connected to R42, and thus to the non-inverting input of IC5. In many instances failure to observe phase polarity may not be noticeable, though in other cases it could result in signal reduction caused by two antiphase signals cancelling each other.

CIRCUIT COMBINATIONS

From the above, it will be seen that a wide variety of circuit configurations can be put together to produce a mixer with as many input, output and filter networks as required. Practical examples of two such combinations are described in detail below, but other combinations, such as more inputs into the shown outputs, or into additional outputs, can be used.

Each input channel can also be given its own separate filter circuit immediately after either the gain or level control stages, though when following the input gain stage, C9 should be replaced by a 100k resistor.

POWER SUPPLY

The modules are extremely versatile and economical on the voltages and currents required. The voltage range can be any between +5V/0V/-5V and +15V/0V/-15V, enabling them to be powered either by two 9V batteries, or stabilised power supplies within the above ranges. Using 082s the four input stereo unit draws about 25mA from a +9V/-9V supply. The mono unit draws about 15mA. Virtually all of this is taken by the 082s at around 4mA to 5mA apiece, using 062s the consumption per p.c.b. will only be microamps.

All measurements quoted were taken using a +9V/0V/-9V supply and may vary with other supplies, and also in accordance with normal component tolerances. Where relevant, they are all peak to peak.

PRINTED CIRCUIT BOARDS

Examination of the circuits using the 13600 reveals that there are many similarities between each of them, and with only minor changes one circuit can be transformed into another. The same

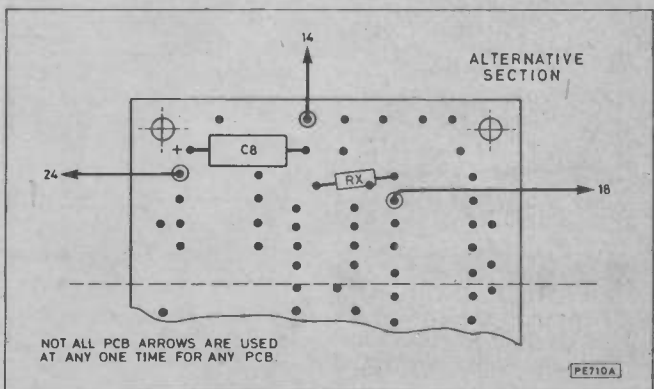
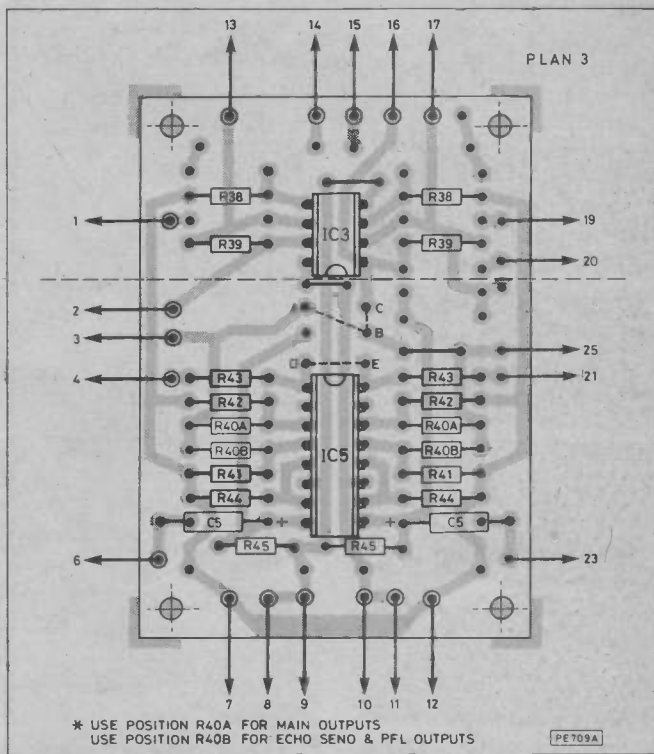
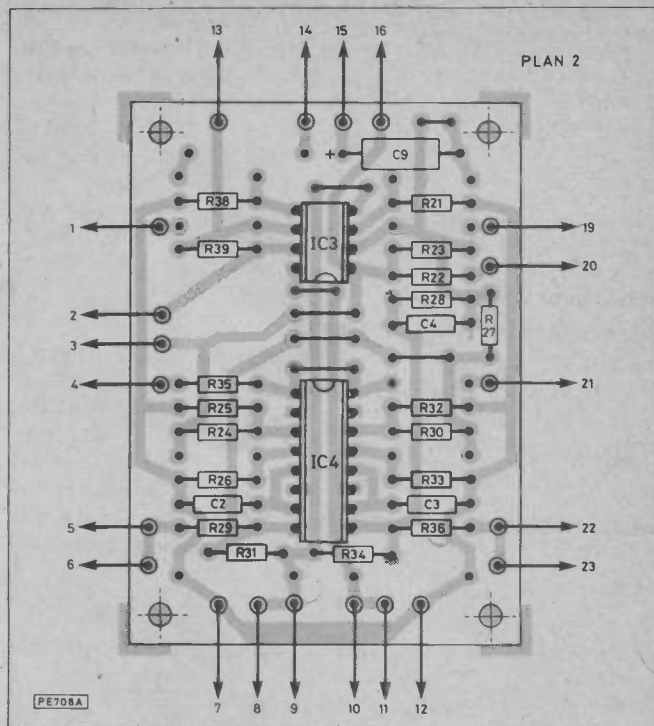
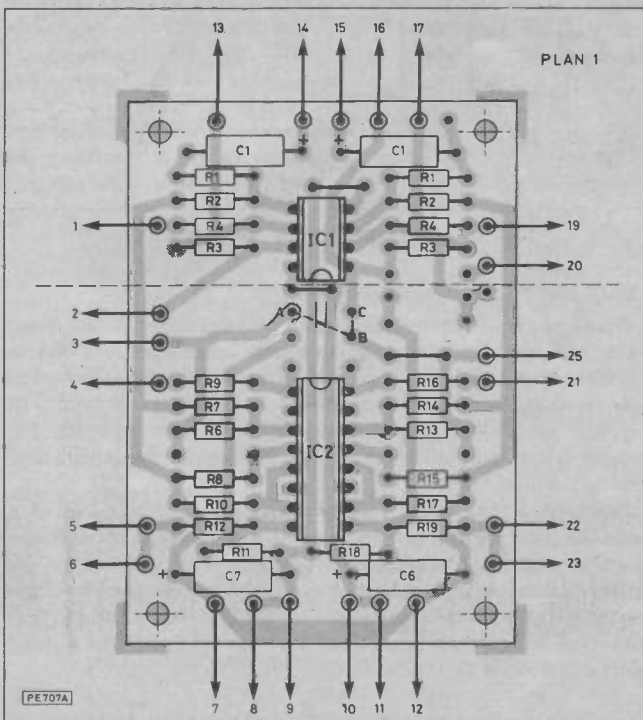

Fig. 3, P.c.b. plan layouts—Note: not all p.c.b. arrows are used at any one time

COMPONENTS . . .

VC4-1 MONO MIXER (4 CHANNELS)

Resistors

| | |
|---|---------------|
| R1-R3, R5, R9-R12, R21-R24, R27-R31, R34-R39, R38-R40, R44 | 100k (52 off) |
| R4, R7, R8, R25, R26, R32, R33, R41, R42 | 1k (20 off) |
| R6, R43 (see text) | 47k (5 off) |
| R37 | 20k |
| R43 (see text) | 390k |
| R45 | 10k (2 off) |
| R46 | 4k7 |

All resistors $\frac{1}{4}$ W 5%

Capacitors

| | |
|--------|-----------------------------------|
| C1, C5 | 1 μ 63V electrolytic (6 off) |
| C2, C3 | 180p polystyrene (2 off) |
| C4 | 33p polystyrene |
| C6, C7 | 22 μ 16V electrolytic (2 off) |

Potentiometers

| | |
|---------------|--------------------------|
| VR2, VR4, VR5 | 100k mono rotary (6 off) |
|---------------|--------------------------|

Semiconductors

| | |
|---------------|--------------------------|
| IC1, IC3 | TL082 (3 off) (see text) |
| IC2, IC4, IC5 | LM13600 (4 off) |

Switches

| | |
|-------|----------------------|
| S1-S4 | min s.p.d.t. (7 off) |
| S7 | min d.p.d.t. |

Miscellaneous

P.c.b. clips (16 off); knobs (6 off); p.c.b. (4 off); 8-pin i.c. socket (3 off); 16-pin i.c. socket (4 off); mono jack socket (6 off); box 230mm x 130mm x 55mm; feet (4 off)

VC4-2 STEREO MIXER (4 CHANNELS)

Resistors

| | |
|--|---------------|
| R1-R3, R10-R12, R17-R19, R21-R24, R27-R31, R34-R36, R38-R40, R44, R47, R48 | 100k (83 off) |
| R4, R7, R8, R14, R15, R25, R26, R32, R33, R41, R42 | 1k (36 off) |
| R6, R13, R43 | 47k (11 off) |
| R9, R16, R45 | 10k (12 off) |
| R20 | 510k (4 off) |
| R37 | 20k |
| R46 | 4k7 (3 off) |

All resistors $\frac{1}{4}$ W 5%

Capacitors

| | |
|------------|-----------------------------------|
| C1, C5, C8 | 1 μ 63V electrolytic (9 off) |
| C2, C3 | 180p polystyrene (4 off) |
| C4 | 33p polystyrene (2 off) |
| C6, C7 | 22 μ 16V electrolytic (2 off) |

Potentiometers

| | |
|--------------------|---------------------------|
| VR1, VR2, VR4, VR5 | 100k mono rotary (12 off) |
| VR3 | 1M mono rotary (4 off) |

Semiconductors

| | |
|---------------|--------------------------|
| IC1, IC3 | TL082 (5 off) (see text) |
| IC2, IC4, IC5 | LM13600 (8 off) |

Switches

| | |
|---------------|-----------------------|
| S1-S3, S5, S7 | min. d.p.d.t. (8 off) |
| S6 | min. s.p.d.t. (4 off) |

Miscellaneous

P.c.b. clips (32 off); knobs (16 off); p.c.b. (8 off); 8-pin i.c. socket (5 off); 16-pin i.c. socket (8 off); mono jack socket (5 off); stereo jack socket (2 off); box 280mm x 195mm x 90mm; feet (4 off).

Constructors' Note: A full kit of parts or combinations of this project are available from: **Becker Phonosonics, 8 Finucane Drive, Orpington, Kent, BR5 4ED. ☎ 0689 37821.**

applies to the op-amp stages around the 082 i.c.s. These similarities enable a general purpose p.c.b. to be used that caters for all the combinations of components within the various circuit configurations. This p.c.b. holds one 082 i.c. and one 13600.

The positioning of the components and their values determines the function that a particular board will perform. It will also be seen that by using a spare section of one i.c. on one board, a link can be made across to another board reducing the total i.c. count and minimising cost. In Fig. 3 the main p.c.b. variations are shown. Plan 1 consists of two stages for either input gain circuits (Fig. 2a or Fig. 2b), and two stages for either one pan and level control (Fig. 2c), or two separate level controls (Fig. 2d). Plan 2 consists of an entire VCF circuit, and a spare mixer stage (Fig. 2f). Plan 3 consists of two output stages (Fig. 2g), and two mixer stages (Fig. 2f). In some cases only the lower section of Plan 1 and 3 needs to be used, leaving the upper section empty. This enables miscellaneous components such as C8 from an echo return input, or one of the level biasing resistors R37 or R46 (Rx) to be mounted there.

From the p.c.b. block diagrams for the two practical examples, it will be seen which configuration plans are needed to construct mixer variations other than those shown in detail. The interwiring of such alternative combinations can also be seen from the wiring charts of the main examples:

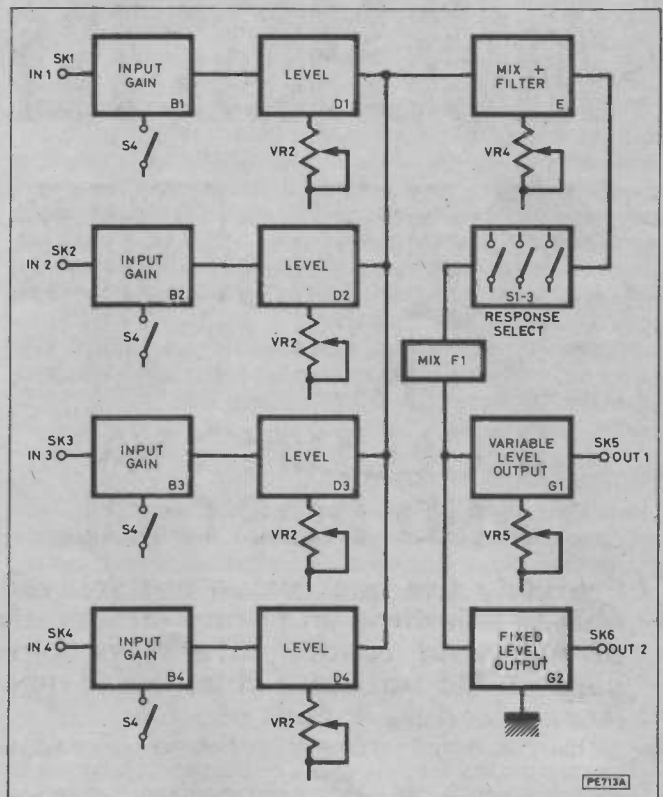

Fig. 4. Block diagram of the VC4-1

FOUR INPUT MONO MIXER

Fig. 4 shows the block diagram for constructing a four input mixer with switched gain, separate level controls, and a master filter, feeding to two outputs, one at a fixed output level, the other fully variable. The individual circuit blocks used are four circuits of Fig. 2b, using switchable gain settings, four circuits of Fig. 2d, providing individual level control, one filter stage, one mixer stage and two output stages.

Front panel space of the box used prevents the use of a separate level control for the second output stage (though one could be mounted on the back). This output is more suited for use with a monitor, and produces a maximum output level of 1V when being fed by one channel, with the output of IC1 at 1V and VR2 at maximum. Otherwise, apart from the level difference the second output delivers a signal identical to that from the first.

Next Month: 4-Input Stereo Mixer, more constructional details and final checking and testing procedures.

SPECIAL OFFER

LASCAR DP2020 DIGITAL MULTIMETER

£19.95

INCLUDING VAT AND POSTAGE

Probably the best value meter available at this time and undoubtedly one of the best reader offers we have carried. Do not miss this, order now. Access orders accepted.

This l.c.d. digital multimeter has been designed with an inclined display for ease of use on the bench. It comes with an instruction leaflet (with circuit diagram), test probes, battery and a year's guarantee against faulty components or workmanship. Housed in a tough black plastic case the meter has the following specification:

Input impedance 10M Ω on all voltage ranges.

D.C. Voltage 2V to 500V in four ranges at 0.6% \pm 1 digit.

A.C. Voltage 2V to 500V in four ranges at 1% \pm 2 digits (45 to 500Hz).

D.C. Current 2mA to 2A in four ranges at 0.75% \pm 1 digit (2.5% \pm 2 digits at 2A).

A.C. Current 2mA to 2A in four ranges at 0.75% \pm 1 digit (3% \pm 2 digits at 2A).

Resistance 2k Ω to 2M Ω in four ranges at 0.75% \pm 1 digit.

Diode check, polarity indication, over range indication, low battery indication, automatic decimal point display, overload protection, 2000 hours battery life (typical with alkaline battery). Size 164 x 75 x 24mm, weight 200g (including battery).

UK readers please allow 7 days for delivery. All overseas orders will be sent airmail.
Offer closes Monday March 31, 1986.



Make cheques payable to LASCAR ELECTRONICS LTD. and post to PE DIGITAL METER OFFER, LASCAR ELECTRONICS LTD., Module House, Whiteparish, Salisbury, Wiltshire, SP5 2SJ. Tel. 079 48 567.

PE DIGITAL MULTIMETER OFFER

Quantity

Please supply DP2020 meters.

Total value £.....

Access No.

Signature

I enclose cheque/PO No.

Name.....

Address

Please allow 7 days for delivery

OFFER CLOSES Monday March 31, 1986

Name.....

Address

Post to: PE DIGITAL MULTIMETER OFFER, LASCAR ELECTRONICS LTD., Module House, Whiteparish, Salisbury, Wiltshire, SP5 2SJ.

Please complete both parts of the coupon in BLOCK CAPITALS

Introduction to MICRO SYSTEMS

MICHAEL TOOLEY BA DAVID WHITFIELD MA MSc CEng MIEE PART 4

LAST MONTH, in Part 3 of this series, the business of getting a microprocessor system up and running was considered in some detail. Having got the basic system going, the way in which the micro communicates with the outside world needs to be examined. First, however, an overview of the start-up procedure.

START UP OVERVIEW

Having looked at each of the stages in starting up a micro system, it is useful to review the overall process to see how the various pieces fit together. One of the best ways of doing this is to follow the CPU's actions after a power-up reset. This is most easily illustrated by watching the progress through the address map of the system. In effect, this is the same as watching the value of the program counter (PC). Two snapshots of the memory map for the example system introduced in Part One are shown in Fig. 4.1 and Fig. 4.2.

The action after switch-on is shown in Fig. 4.1, where the CPU accesses the start address for the reset routine by putting values of FFFE and FFFF on the address bus, and then jumps to the address contained in these two locations. As mentioned, the ROM is located at address C000 to C3FF, but the partial address decoding causes FFFE/FFFF to access C3FE/C3FF, respectively. In the snapshot, we assume that the reset routine starts at C000. The first action in

this routine is shown as setting up the stack pointer to locate the stack at the top of the RAM (007F). The CPU then steps through the routine to configure the peripherals (PIA and ACIA). At the end of this routine, interrupts are enabled, and the CPU starts executing the main loop of the program.

A general view of the type of main loop to be found in such a system is shown in Fig. 4.2. This is typically an outer loop which repeats as the CPU goes through a sequence of looking at the inputs from the outside world, and taking any necessary action by setting outputs. At the point indicated, the program has branched two-deep into subroutines, and the stack shows that the two return addresses have been automatically pushed onto the stack.

At one point during the second subroutine, a third subroutine call was made, but since then a return (RTS) has been executed. The return address for this third-level subroutine is still on the stack (a pop does not delete anything from the stack), but the SP indicates that it occupies the next free locations on the stack, and hence will be over-written by any subsequent stack push, e.g. the PSHA instruction about to be executed to temporarily save accumulator A's contents on the stack.

This brief overview of the workings of a micro system from start-up will, it is hoped, help to consolidate the earlier discussions. To look at some practical applications, however, we will need to look at how the micro relates to the outside world through its peripherals.

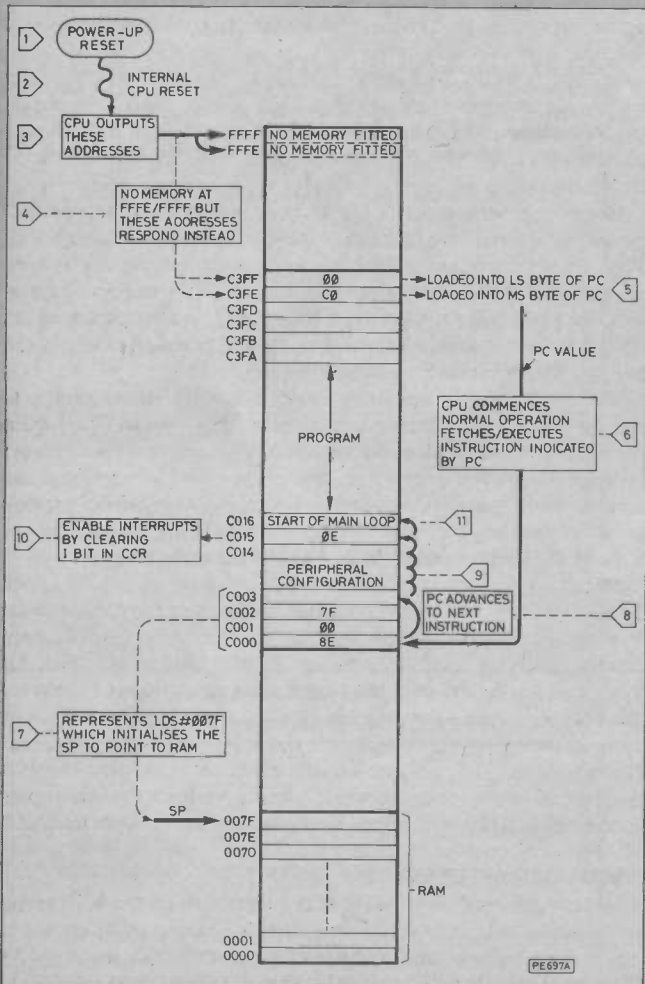

Fig. 4.1. CPU action after switch-on. The reset routine start address is located at addresses C3FE and C3FF

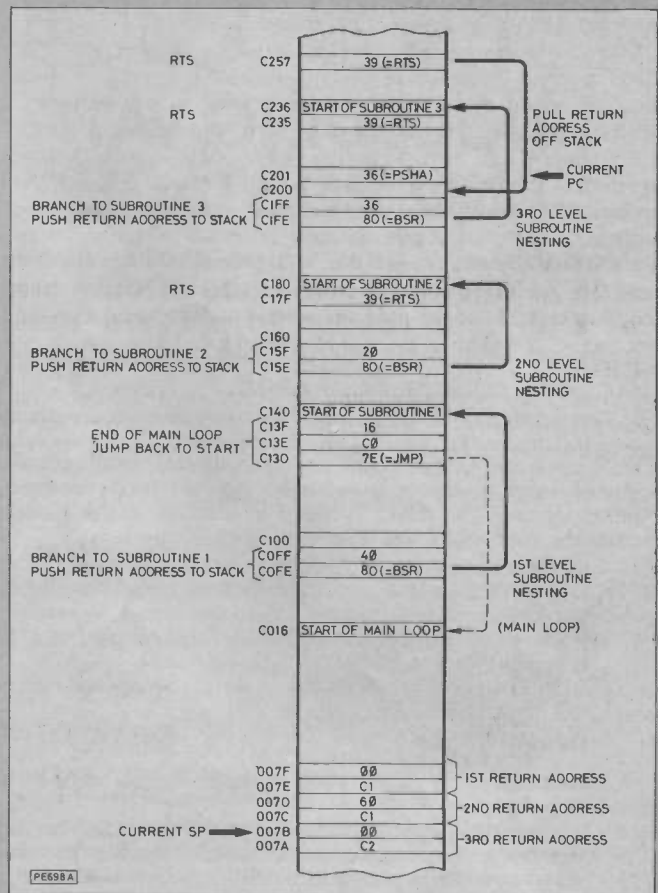

Fig. 4.2. Diagrammatic representation of a microprocessor system's actions, some time after start-up. Two subroutines have been partly-executed, and the program is currently completing subroutine number two, having executed the whole of subroutine three

INTERRUPT-DRIVEN SYSTEMS

Interrupt-driven systems represent an important category of systems in the field of control applications. However, understanding the workings of interrupts involves a significant change to the way in which we think of the working of such a system. Do not despair, therefore, if what follows seems a little difficult to follow at first; all should become clear in due course.

To date, we have thought of the CPU as being at the heart of the system, working its way logically through the control program. At each point in the program (particularly at the decision branches), it is possible to predict the system's subsequent behaviour simply by looking at the preceding sequence of instructions and the values of data in the various locations. Some of these locations may well form part of peripheral controllers, rather than be data stored in RAM, but it is still true that these locations will only be examined at the instigation of the control program. If the programmer chooses not to look at a particular memory location or peripheral register, then there is (as yet!) no other way to gain the attention of the CPU. Thus the CPU traces a continuous thread through the control program.

The introduction of interrupts to the scene, however, means that we also need to take account of the behaviour of the outside world when trying to determine the way in which a system will behave. No longer are the sequence of instructions in the program and the value of data the only factors affecting the system's behaviour at any instant. In addition, we must also consider the occurrence, or otherwise, of any external events which could give rise to an interrupt.

INTERRUPT PROCESSING

When an interrupt signal is recognised by the CPU, it causes the processor to stop what it is currently doing (usually at the end of the current instruction), and save its current status on the stack. The CPU then jumps to a special routine (known as an interrupt handler) which handles the necessary processing for the interrupt. The exact details of this processing will depend on the nature of the interrupt, and on the design of the system.

When the processing in the interrupt handler is finished, the CPU status prior to the interrupt is restored, and processing resumes from the point at which it was interrupted. The interrupted processing will thus proceed, unaware of the interruption.

The effect of an interrupt can thus be thought of as being similar to inserting a temporary subroutine call into the normal flow of the program. The previously continuous thread of the control program has been interrupted to perform some other task, one which does not necessarily bear any relation to the processing in hand at that time. The position of this notional subroutine call is determined only by the value of the program counter at the instant that the interrupt occurs. This effect is illustrated in Fig. 4.3.

But why, you may well be asking by now, should we want to use an interrupt—surely a subroutine call is just as good? The short answer is that interrupts allow us to design a more flexible system, and to make much better use of the available processing power of

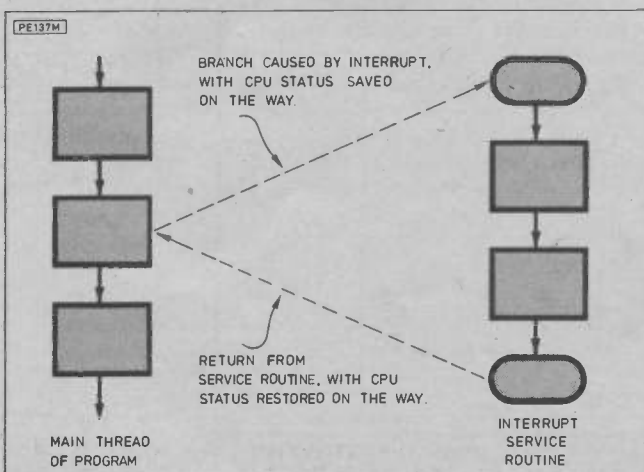

Fig. 4.3. Interrupt handling: the main program is suspended while the interrupt service routine is processed

the micro. Interrupts allow the system to spend time examining and controlling input or output events *only* when they occur, allowing the rest of the micro's time to be devoted to other useful tasks.

The alternative to using interrupts involves the control program checking for the occurrence of an event at regular intervals. The interval between this checking (or *polling* as it is often called) needs to be at a minimum of half the time within which a response is required from the system. Thus, if an event occurs once a second, it is necessary to check at least every 500ms if we are to make sure that an event will not be missed.

However, if the event in question only occurs infrequently, but in bursts, this can easily result in quite a significant amount of wasted processing. It also means that the design of such a system becomes rather more complicated than would be the case if some other method could be found to attract the CPU's attention to the occurrence of an event.

INTERRUPT vs. POLLED

At this point, it is becoming clear that a brief practical examination of the use of interrupts is necessary in order to clarify their potential usefulness. We will take as an example, therefore, a 6800-based system designed to control a cash register.

It is not uncommon for such machines to keep a track of the date and time for printing on the sales receipts. However, to save on hardware (in what is a highly competitive market), a complete calendar and clock in hardware is not usually included in the system. Instead, a very basic source of clock "ticks" is provided. This is typically a one-tick-every-second square wave derived from a crystal oscillator and a divider chain, with the remaining functions performed in software.

If interrupts are not used, the cash register program will need to keep looking at the clock input to see if it has "ticked" since it was last checked. If it has, then the software clock (which is used by the other parts of the program) will need to be updated; otherwise no action need be taken. The problem which quickly becomes apparent with this approach is that the control program *as a whole* needs to be designed to keep looking at the clock input, no matter which branch or loop it is currently executing. This clearly makes the whole process rather inelegant to say the least, and results in a control program which is very complicated and/or inefficient to implement.

However, if we use a clock interrupt as an alternative approach, it is possible to produce a much more elegant and efficient design. The first step is to arrange for the clock to cause an interrupt every time it ticks. The exact arrangement will depend on the configuration of processor and peripheral devices being used; the discussion of the 6821 PIA device a little later will examine a practical example of a suitable arrangement for a 6800 system.

The next step is to provide an interrupt handler whose job it is to handle the clock interrupts whenever they occur. The main processing of this service routine will be to check that the interrupt is indeed from the clock. If so, the routine will acknowledge the interrupt and update the software clock kept in a pre-determined group of memory locations. The final step will then be to restore the state of the CPU registers, and return to the main program.

With this type of approach, there is no need to poll the clock input, and no requirement for the remainder of the control program to worry about servicing the clock. All that has to be done is for the interrupt service routine to be set up at initialisation, with the appropriate start value for the clock's current setting in the selected memory locations. The main program can then simply use the clock time whenever required, and need never be aware of the interrupt being serviced. The only noticeable effect to an outside observer will be that whenever an interrupt is being serviced, the interrupted section of program will appear to run rather slower than normal.

6800 USER INTERRUPTS

A description of the working of the interrupts on the 6800 serves to round off our necessarily brief look at interrupts. There are in effect three types of hardware interrupt on the 6800: Reset (RES), Non-Maskable Interrupt (NMI), and Interrupt Request (IRQ). Most of our previous discussion, however, relates to only one of these types, the user interrupt (IRQ). For completeness, we should

mention that there is also a software interrupt (SWI), which is initiated by executing an SWI instruction; this is provided for applications which are rather beyond the scope of this series.

All of the hardware interrupts in the 6800 are activated by a logic 0 level on the appropriate CPU pin. The various interrupts are listed above in decreasing order of precedence, e.g. the reset interrupt takes precedence over the other two. The RES interrupt was dealt with last month in some detail, and while it is not a true interrupt in the sense that we have been using, many of its characteristics are the same. The other two interrupts behave in essentially similar ways, the only real difference between them being that the programmer cannot choose to ignore (*mask out*) an NMI, whereas this can be done for an IRQ.

The 6800 system is designed to look for the start address of the various interrupt service routines at defined locations in the highest memory addresses (between FFF8 and FFFF). The fixed arrangement of memory and start addresses assumed by the CPU is shown in Fig. 4.4. Thus, following the detection of a logic 0 level on the IRQ input, the CPU completes the execution of the current instruction, and then tests the interrupt mask (the I bit in the Condition Codes Register (CCR)). If the mask bit is set to logic 1, the interrupt is ignored, and the program continues execution. If the mask bit is clear, the interrupt sequence proper then begins.

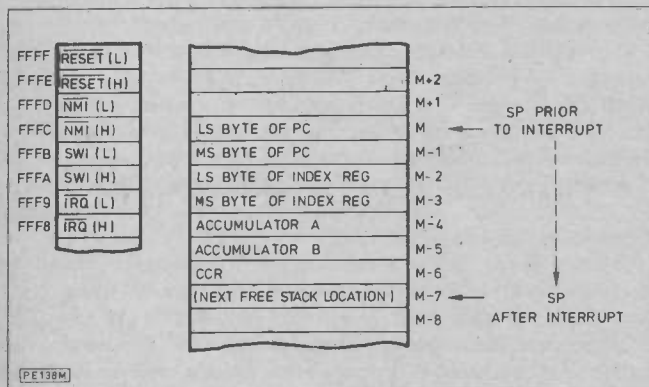

Fig. 4.4. Left, location of interrupt service routine addresses. Above, stack contents after an interrupt

The CPU status is first pushed onto the stack. This uses 7 bytes to save the contents of the Program Counter (PC), the Index Register (IR), the two accumulators (A and B), and the CCR, as shown in Fig. 4.4. The next step is to set the interrupt mask, thereby preventing any subsequent interrupts from interrupting the service routine currently in progress. The CPU then fetches the start address for the IRQ interrupt service routine from locations FFF8 and FFF9, and processing continues from the address indicated. This technique of getting the start address from locations permanently assigned by the CPU is known as *vectoring*, and is widely used by micros.

In some cases, it may be desirable to clear the interrupt mask at some point in the service routine (using a CLI instruction). This will allow further interrupts to be recognised during the processing of the first, thereby allowing a system to be implemented which can handle multiple interrupts. The saving of CPU status at each interrupt means that the interrupts will be stacked (a process known as *nesting*) up to a limit determined only by the amount of stack space available. All of the nested interrupts in such a scheme will eventually be serviced on a last-come-first-served basis.

On the other hand, if a CLI is not executed during the service routine, interrupts will not be nested, and each interrupt will be

processed to completion before the next is recognised.

At some point during the interrupt service routine, and *before* interrupts are re-enabled during the routine if this is required, the interrupt request must be reset at source. Otherwise the same event will cause a further interrupt to be recognised for the same event. Thus, in our example, the interrupt could be caused by a rising clock edge setting the output of a flip-flop to a logic 0. This output would be connected to the CPU's user interrupt pin. Remembering that the CPU recognises a logic level (not edge), it is clear that this flip-flop must be reset (output to a high) by the service routine before interrupts are enabled if repeated false interrupts are to be ignored.

At the end of the service routine, an RTI instruction must be executed. This pops the register contents from the stack, thereby restoring the state of the CPU prior to the interrupt. Processing then resumes from the point at which it was interrupted.

In a system where there is only one peripheral capable of generating an interrupt, the source of any interrupt is known, and servicing can begin immediately. However, although the 6800 has only one interrupt line for user interrupts, many systems will have more than one possible source of interrupt. Not only does the CPU then have to be able to decide on which device requires service when an interrupt does occur, but it must also be able to handle the situation whereby more than one device is requesting service at the same time.

In this introductory series, we can do little more than introduce the concept of organising interrupts in order of importance (priority) so that the most important is dealt with first. Suffice to say, however, that many systems make use of special purpose peripheral chips as well as software to handle interrupting devices to any level of sophistication. In any circumstances however, the objective remains the "simple" one of getting each interrupt serviced correctly, preferably in order of their importance.

6821 PERIPHERAL INTERFACE ADAPTOR

The 6821 Peripheral Interface Adaptor (PIA) is one of the range of support chips which provides a very flexible means for interfacing parallel peripheral equipment to a 6800-based system. The peripheral side of the interface provides two parallel 8-bit buses and four control/interrupt lines. The pin connections are shown in Fig. 4.5, while Fig. 4.6 shows the internal architecture.

The 16 data lines, PA0 to PA7 and PB0 to PB7, can each be configured separately as either an input or an output, all under program control. This allows any combination of input and output lines to be established. The four control/interrupt lines (CA1/2 and CB1/2) may be configured to act in one of several modes for handshaking with peripheral equipment. This includes using them for generating interrupts to the CPU.

Internally, the 6821 contains two very similar but independent sections ("A" and "B"). Each section comprises an output register, a control register, and a data direction register. Data is transferred from the CPU via the data bus buffers and bus input register to the output registers (and hence to the outside world) during a CPU write operation. Where a particular PIA data line has been programmed as an output, data will be then transferred to this line from the corresponding data bus line. Where a particular line has been programmed as an input, a CPU read operation will cause data to be transferred to the data bus, and hence to the CPU.

The data direction registers allow each data line to be separately configured as either an input or an output. The control registers allow the CPU to establish and control the operating modes of the peripheral control lines (CA1/2 and CB1/2). In addition, they provide flags to indicate when an interrupt has occurred.

A basic programming model for the 6821 is shown in Fig. 4.7, and

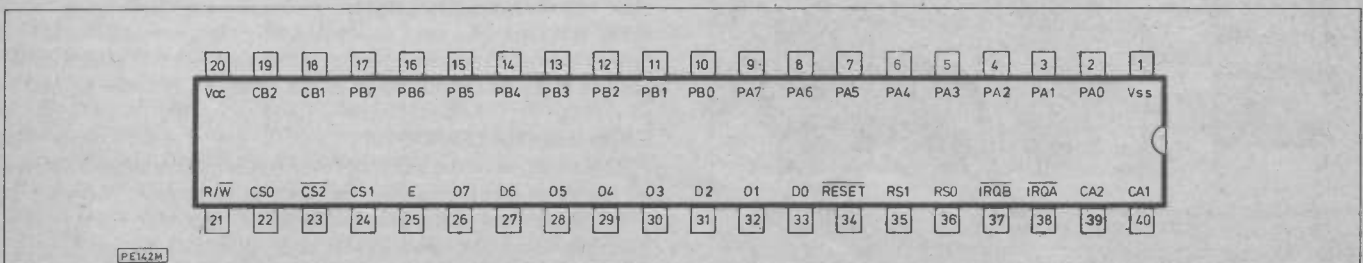

Fig. 4.5. Pinout for the 6821 Peripheral Interface Adaptor

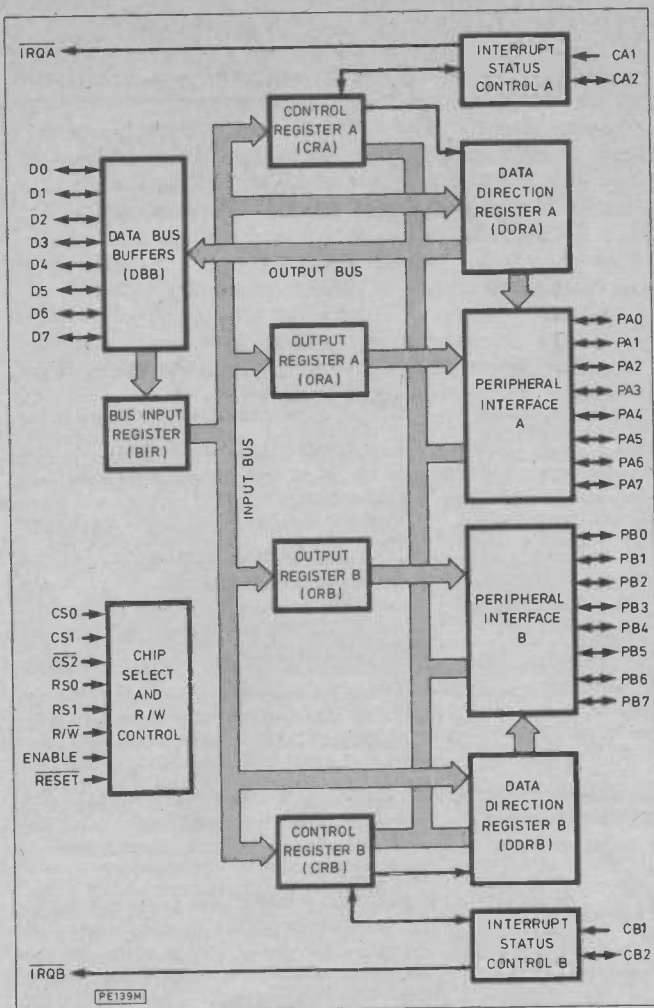
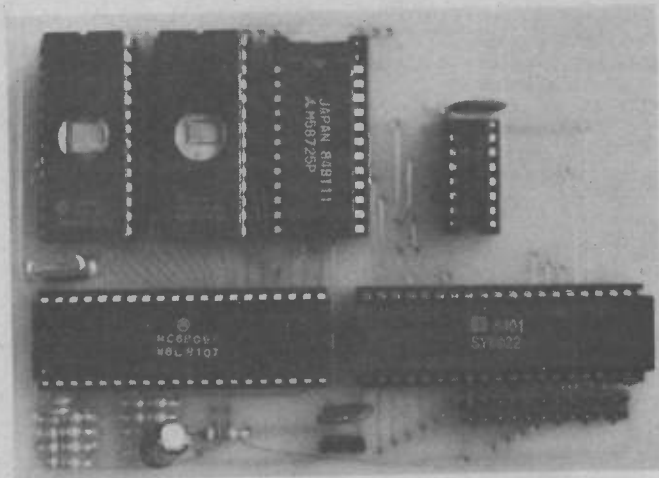

Fig. 4.6. Internal architecture of the 6821 PIA. This chip provides two 8-bit I/O buses

this identifies the various registers available to the programmer. The three registers in each half of the PIA make use of only two memory addresses. One of these two addresses is reserved for the control register. The register indicated by the second address of each pair is determined by the setting of bit 2 in the corresponding control register; 0=data direction register, 1=output register. In the data direction register a bit is set to a 0 to make the corresponding line behave as an input, and to a 1 for it to behave as an output. All 8 lines are configured at the same time for input/output, by the CPU writing a one-byte value to the corresponding address, remembering to first set bit 2 of the control register to a 0.



A microcontroller board containing 2K of RAM, 32K of EPROM, and a 6522 Versatile Interface Adaptor. The CPU is a 6809, an enhanced version of the 6800 containing on-chip clock circuitry, pseudo 16-bit architecture, and more than 100 instructions in its basic repertoire

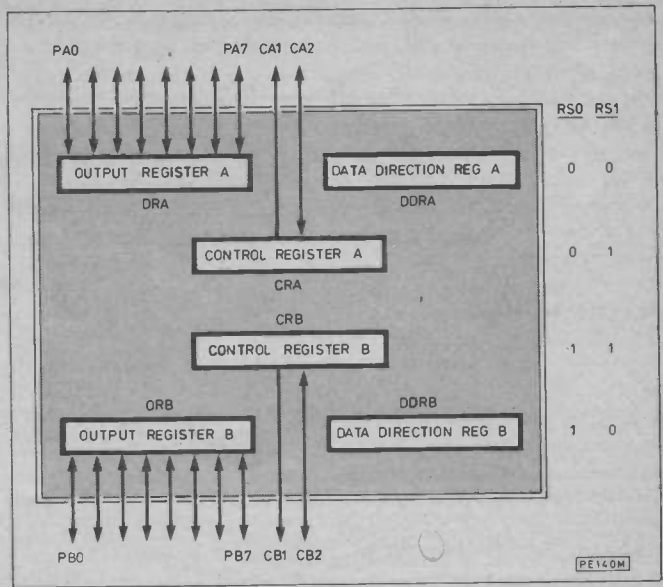

Fig. 4.7. Programming model for the 6821 PIA

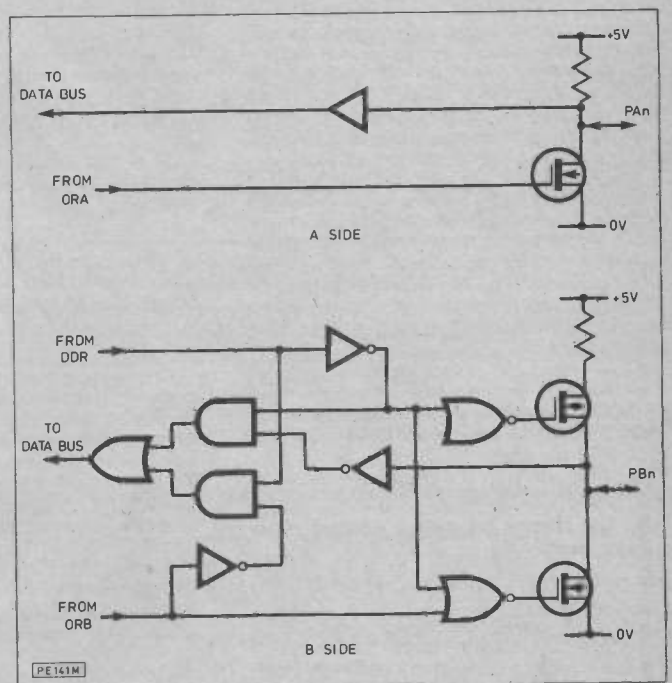

Fig. 4.8. Data transfer via the PIA, "A" and "B" sides

Both "A" and "B" sides will drive two TTL loads on each data line being used as an output. One of the only differences between the "A" and "B" sides of the PIA concerns the data input characteristics. The output stages for "A" and "B" sides are shown in Fig. 4.8. The circuitry on the "B" side adopts a tri-state (high impedance) condition on input, whereas the "A" side inputs are taken high by internal pull-up resistors. "A" side signal sources therefore require an impedance to 0V of 1k or less to assume the low state. The logic 0/1 levels are <1.4V/>1.6V for "A" and <0.7V/>3.0V for "B". The "A" and "B" sides are otherwise identical.

The PIA is configured to respond as a particular set of four addresses by driving the select inputs from a suitable address decoding arrangement. Thus, whenever an address in the correct range is output by the CPU, the PIA is enabled. The other inputs from the control bus to the PIA ensure that the correct bus phases are used. Thus, for example, a PIA could be configured to be enabled whenever an address in the range 1000 to 101F is output on the address bus. The lowest two address lines will then usually be used to drive the PIA's register select inputs (RS0 and RS1) directly. The correspondence between these select lines and the PIA registers is included in Fig. 4.7. In our example the PIA registers would then typically be accessed by the program as addresses 1000 to 1003. **NEXT MONTH:** Setting up the PIA, generating a clock interrupt, and an introduction to the 6502.

Robotics Review *Nigel Clark*

ONE of the pioneering names in personal robotics in Britain has disappeared almost completely from the market. **Powertran Cybernetics**, has moved from its long standing home in Andover, Hampshire, to Crowborough in Sussex alongside its parent company **Feedback Instruments** and at the same time most of Powertran's robots have been merged with those of Feedback.

The Genesis and Micrograsp names will disappear but the machines will continue in different guises sold by Feedback as will the recently-launched Ivax Scara robot. That will leave Powertran with Hebot II, the computer-controlled turtle-like mobile as its only stake in the robot market, alongside its other interests including musical equipment and home security devices.

The Genesis P101 and the bigger P102 were the first small robots to be powered hydraulically. A five axis standard arm it could lift 2.5kg and had its own controller based on a 6802 processor. The P101 had 2K of memory allowing eight sequences of 32 moves each to be stored with the P102 being able to store eight sequences of 64 moves.

They were sold as kits at prices of about £1,400 for the smaller machine and £1,800 for the larger. Feedback sold the machines made up as the HRA 933 and HRA 934 for about £2,700.

... a flurry of sales about two years ago ...

Mr Jack Hale, managing director of Feedback, said that for some time sales of the kits direct to consumers had only been a small part of Powertran's output. There had been a flurry of sales about two years ago when colleges preferred to buy at the lower prices but since then most of the kits had been going to Feedback in this country and the States to be made up and sold as complete systems.

"We thought it would be better to put the whole production under one roof where we could produce complete robots for only a little more than the cost of the kits and sell them under the Feedback name along with our other educational products which would allow us to provide the full back-up service which our customers require," Hale said.

They have dispensed with the smaller machine and will only be selling the HRA 934.

The cheaper, mechanical arm, Micrograsp, which has four axes is powered by servos with potentiometers and costs about £400, will be substantially upgraded.

"The original machine was designed down to a price which resulted in a number of features we did not like, such as the gripper and the power system," Hale said. He added that in all there would be between 40 and 50 changes resulting in a machine costing about £1,000 and having a much longer life than the original Micrograsp.

After all the changes Feedback would have a broad range of arms with the Pedro Scara arm at the top of the range, costing about £5,500, followed by the IVAX, the Genesis/HRA and the upgraded Micrograsp. Powertran will continue to sell the Micrograsp kits until present stocks run out.

The expected launch of two more imported toys by CGL of Essex has been postponed until next year. It had been intended to put Charles and Armstrong 800 on sale during the summer but the company decided to wait so that it could unveil them to the retail trade at the toy fairs in the first few months of 1986 in order to catch the Christmas market next year.

The rest of us will be able to catch glimpses of them at the computer shows during the year.

... infra-red controlled from a hand-held keyboard ...

Charles is a more complex version of the popular George Compurobot, a battery-powered mobile which can be programmed to carry out a number of moves using the membrane keyboard on its top. To give it added interest it has a siren and flashing lights. Charles has the extra facility of being infra-red controlled from a hand-held keyboard.

Armstrong 800 is a conventional arm with gripper which can be programmed and is infra-red controlled.

CGL says that no prices have been fixed as the import price is set in dollars so the UK retail price depends on the level of the exchange rate. However, they are both simple devices, in robot terms, and are likely to be in the range of £50 to £100.

At the same time as arms are having their capabilities expanded by the creation around them of work cells of varying complexity, turtles are being enhanced by the provision of increasing amounts of software. When most were launched they came with sufficient software to allow them to be controlled by a micro, usually using some form of Logo and little else.

Clwyd Technic's Trekker was the first machine to give equal importance to the software and was packaged from the start with a wide range of programs and documentation.

Valiant Designs, builder of the Valiant Turtle, is now developing a series of microworlds which can be explored using the turtle, nicknamed Myrtle.

... a big help to the many people who buy a turtle ...

At the moment there are two on which most of the development work has been completed, provisionally titled **Treasure Map** and **Time Machine**. Although written in the form of games they are intended to be educational. **Treasure Map** involves following a set of map instructions and **Time Machine** is concerned with learning geometry by meeting its creators.

In addition Valiant is considering a general package of about 50 ideas for uses of the turtle. That would be a big help to the many people who buy a turtle or arm because it is the latest in modern technological aids but then find they do not know what to do with them.

There are further developments for the Zero II, the turtle-like mobile from **IGR**, launched at the beginning of the year at less than £100. Interfaces are now available for the Atari 800 and Research Machines as well as the original BBC B, Spectrum and C64. And versions are being developed for the Apple and IBM PC in response to interest in the versatile device from the States.

Robin Bradbeer of IGR said that as expected when it was launched a number of third party companies have shown an interest in developing software and hardware to be added to it. IGR is also looking for people to produce the bump sensors and hole sensors which are in prototype but are not being produced in numbers because of lack of time.

Finally for the DIY enthusiasts there is a book, published by **Beaver Books**, entitled **Make And Program Your Own Robot** (£2.95). Written by Michael Clark (no relation) it details seven projects for building your own devices from Lego. It is available through **Commotion** of Enfield.

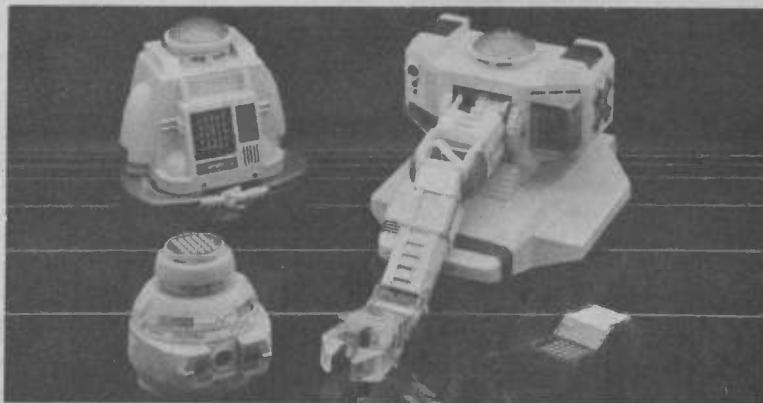

George, Charles and Armstrong 800

ROBOTS for EDUCATION TRAINING and INDUSTRY

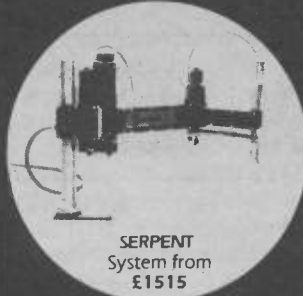

SERPENT System from £1515



MENTOR System from £495



Hydraulic using water!

NEPTUNE System from £2195



Hydraulic using water!

NAIAD System from £765

SERPENT I/II 5 axes 12 bit control system 2kg capacity 400/650mm reach.

MENTOR DC servo desktop robot, 8 bit control system, 1kg capacity, 420 reach.

NEPTUNE I/II 6/7 axes 8/12 bit control system 2.5kg capacity, 1120mm reach.

NAIAD 6 axis, 8 bit control system, 500gm capacity, 500mm reach.

Robots programmed from keyboard or hand-held simulator (model robot).

Robots may also be taught by 'lead by the nose' method.

Extensive software is supplied free with each robot.

Leads available for connection to BBC, ZX Spectrum, Apple IIe, Commodore 64, VIC 20 and IBM PC.

Most other micros are also easily usable with these robots.

Robots available as kits or ready built.

FMS (Flexible Manufacturing System) work cell additions also available.

Please phone for brochure: 0264 50093.

West Portway Industrial Estate, Andover SP10 3PE.

A private and independent company giving prompt, personal service.



DIGITAL LCD

MULTIMETER
RELIABLE STABLE ACCURATE
RUGGED & EASY TO HANDLE
● 3½ DIGIT DISPLAY ● 13 RANGE
● FULL AUTOPOLARITY ● OVERANGE INDICATION ● OVERLOAD PROTECTION ON ALL RANGES
● TEST LEADS, BATTERY, SPARE FUSE, INST MANUAL ● DC-1000V
● DCmA-200 ● ACV-500V ● 1Ω-2MΩ



£29.95

MINI DRILL CONTROL UNIT

FOR ARTICLE IN THIS ISSUE OF P.E. COMPLETE PLUS BLOCKS, SOCKETS AND FUSEHOLDER. (Without Transformer) £5.50

TUNGSTEN CARBIDE DRILL BITS

1mm. Ideal for glass fibre PCBs. (1/8" shank) £1.20 each 5 for £5 or pk of 10 £8.95.

MINI-DRILL LARGER TYPE 9-16V 18000 rpm 70W chuck 3.5mm £16.50.

FLEXIBLE DRIVE for Mini Drills. 55cm long complete with chuck & 3 precision collets up to 2.5mm dia £5.95.



PCB KIT £5.95. 4 pieces copper clad, circuit etchant, 2 pens, 5 different sheets transfers, plastic tray & instructions.

Book by R. A. Penfold 'How to Design & Make Your Own PCB's' £1.95.

COPPER CLAD S/S 4 pieces (total 100 sq ins) £1. CIRCUIT ETCHANT dilutes to 500mls £1.20. ETCH RESIST PENS Fine tip 75p ea or 2 £1.20. CHARTPAK etch res. transfers fine & thick lines circles & dil pads 39p per sheet or 6 sheets £2.

RESISTOR FILES - box of 73 pks of 10 ea 5% 1/4W carbon film. Continuous E12 range 10Ω-10MΩ £8.50.

400 mixed value RESISTORS mainly 1/4 & 1/2 £1.

CARBON POTS mixed values some miniature some standard size 15 for £1.50.

TRANSISTORS 2N3773 £2.50* ea.

DC MOTORS

TINY virtually inertia-less motor, i.e. no iron in rotor. 1.5-3V 15mm dia x 30mm + shaft 6x1.6mm. With governor - can be bypassed £2.00. NOMINAL 12V motor works down to 1V ex-unused equip. VCR transport mech. 33mm dia. 30mm o/a + shaft 12x2mm a bargain at 75p ea or 3 for £1.75. MINI TOY motors 1-3V 19x16x9mm 50p ea or 5 for £2.

UNIVERSAL NI-CAD CHARGER



With battery test facility and LED indicators. For PP3, AA, C & D cells. £5.99

NI-CAD RECHARGEABLE CELLS

AA - HP7 500mA Hr. Pack of 4 £1.50 or 4 pks for only £5.00. (Ex-equip. tested & guaranteed.)

AA/HP7 NICA0 CHARGER incl above pk of cells + holder £4.99.

BUTTON BATTERIES

1.5V for watches, calculators, cameras, Electronic games, GPO beepers & Hearing Aids. 4 types any mix £1.50. AG13 11.58x5.4mm, AG10 11.58x3mm, AG12 11.58x4.2mm, AG3 7.87x3.6mm or any 8 for £2.50.

SOLOERING IRONS

MAXICRFT 90034 10W/12V AC/DC. Specifically designed for fine circuit work (Oct EE) £3.75.

SRB Type-1 16/18W BREWSTER S/Iron 240V (featured in Oct EE). We have found this to be the most reliable iron of its type on the market £6.38 spare bits 97p.

SEALED LEAD/ACID RECHARGEABLE

battery 6V 2.6Ah 132x60x32mm. Brand new stock fully guaranteed £9.95 (rec retail £17).



Complete with charging instructions.

Goods sent by return post - please add 80p p&p to total order Shop open daily 10-5.30 or send s.a.e. for stock list.

CROYDON DISCOUNT ELECTRONICS

38 Lower Addiscombe Road, Croydon CR0 6AA. Tel. 01-688 2950

TECHNICIAN ENGINEERS

COMMUNICATIONS AND ELECTRONICS

A Planned Career in Technology in the Cotswolds
Salaries up to £13,745*

- VACANCIES at both **TECHNICIAN ENGINEER** and **ENGINEERING TECHNICIAN** level.
- **CHALLENGING WORK** in the development and support of highly sophisticated communications and computer systems.
- **OPPORTUNITIES** for gaining experience in a wide variety of technical roles.
- **EXTENSIVE ENGINEERING FACILITIES**

- **CAREER PLANNING** aided by regular assessments of performance.
- **ADVANCEMENT** opportunities on the basis of proven ability.
- **OVERSEAS** service (voluntary).
- **FLEXIBLE** working hours with up to six weeks leave.
- **RELOCATION EXPENSES** in most cases.

Applicants for the higher grade of **TECHNICAL ENGINEER** should normally possess a BTEC Higher National Certificate/Diploma in electronics or other relevant subject; or a City and Guilds Full Technological Certificate, or an equivalent qualification. An aggregate of at least 8 years relevant training and

experience is required. Registration as a Technician Engineer (T.Eng) would be an advantage. **Salary Scale: £11,413-£13,746*** Applicants with BTEC ONC or equivalent and at least 4 years relevant training and experience are eligible for posts at the **ENGINEERING TECHNICIAN** level for which a structured training programme is provided. **Salary Scale: £8,149-£10,685*** **INTERESTED?** Then for either post send for full details and application form to the address below, quoting Ref: T/6523/85

*Salaries quoted include special pay additions.



THE RECRUITMENT OFFICE, GCHQ, ROOM A/1108
OAKLEY, PRIORS ROAD, CHELTENHAM, GLOS GL52 5AJ
OR TELEPHONE (0242) 32912/3

Drill Control Unit

William Woodard

Clever control circuitry takes the drudgery out of drilling, providing high torque and high current

MANY readers will have small low voltage drills for making printed circuit boards using drill bits as small as 0.6mm up to 1.0mm in diameter and driven by mains power supply units giving between 12V and 18V output. Most of these small drills give about one thousand revolutions per minute per volt and whilst the top speed is necessary for the smaller bits some speed control is desirable for drilling larger holes. P.s.u.s suitable for the smaller drill with speed control have been around for some time supplying about 2A for normal running and up to 4A to safely deal with extra current taken when the motor stalls.

Model makers are the largest group using these drills and often adapt them for other purposes. Many modellers make up a mini workshop with electric tools such as circular saw tables, jig saws, sanders and lathes as well as mini drill stands.

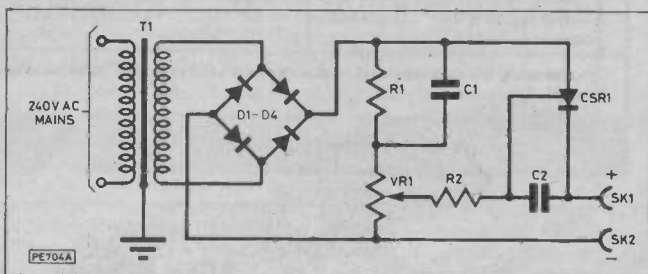

Fig. 1. Conventional control circuit

These tools require a bigger motor to cope with the more ambitious projects and this requires a more powerful p.s.u. Many of these tools have motors rated at 100W, not far short of one eighth horse power, requiring 8A when fully loaded and something in excess of this when the motor is stalled.

The speed control project described here has been well tested in practical use running circular saws etc., and is capable of supplying a 100W motor, maintaining full torque at low speeds. It seems quite happy to stand the excess current of a stalled motor whilst a fuse is making up its mind to blow. It's quite simple to build and does not cost an arm and a leg!

CONVENTIONAL CIRCUITS

As a matter of interest an earlier conventional circuit is shown in Fig. 1. It is quite adequate for the smaller drills and units employing this circuit can be obtained cheaply on the surplus market. At high currents the most highly stressed components

are the rectifiers because they have a low thermal inertia and the current through a stalled motor can be many times the average current. They can be called upon to dissipate as much as 12W when used with the larger drills and this makes them hot and bothered.

IMPROVED PERFORMANCE

So what is required from a p.s.u. for improved performance? Economy and simplicity in design, and reliability as in all designs, should be taken for granted although very often they are not. Also:

- Full torque available at all speeds.
- A large speed range.
- The ability to accept overloads.
- Maximum efficiency.

An improved circuit is shown in Fig. 2, and it is seen that it employs two thyristors, and the power rectifiers have been dispensed with. Thyristors being larger than diodes have a greater thermal capacity and the type used can handle an average current of 4A and a higher peak current with a square inch or so of heat sink. Comparing the two circuits the overall heating has been reduced by 60 per cent and the thyristor loading is now shared between the two components.

A small disadvantage is the need for a centre tapped transformer in that the regulation is not as good as a bridge circuit with a single winding transformer. But, there is a trade off in that there is only one volt lost in the rectification circuit instead of three volts as in the bridge plus thyristor arrangement. Perhaps worse is that centre tapped transformers cost a little more. (A good engineer must be very cost conscious!) The two diodes included in the circuit carry only small currents but 1A diodes are specified to take care of any current spikes.

Because of the intermittent nature of the load it is not necessary to have a continuously rated transformer. For a duty factor of 40 per cent averaged over say 15 minutes (that is the tool being used at full power for 40 per cent of the time) a transformer rated at 4A is suitable for most applications. This is born out in practice.

Most of the drills are given a rating of 12V for some 12,000 to 15,000 r.p.m. but it's usual to provide a transformer with secondary windings giving 15V. This will give a maximum no-load voltage a little higher than 12V across the motor terminals with the control turned to maximum, but with the control turned down the speeds and voltages will be approximately proportional to the angle through which the control is turned.

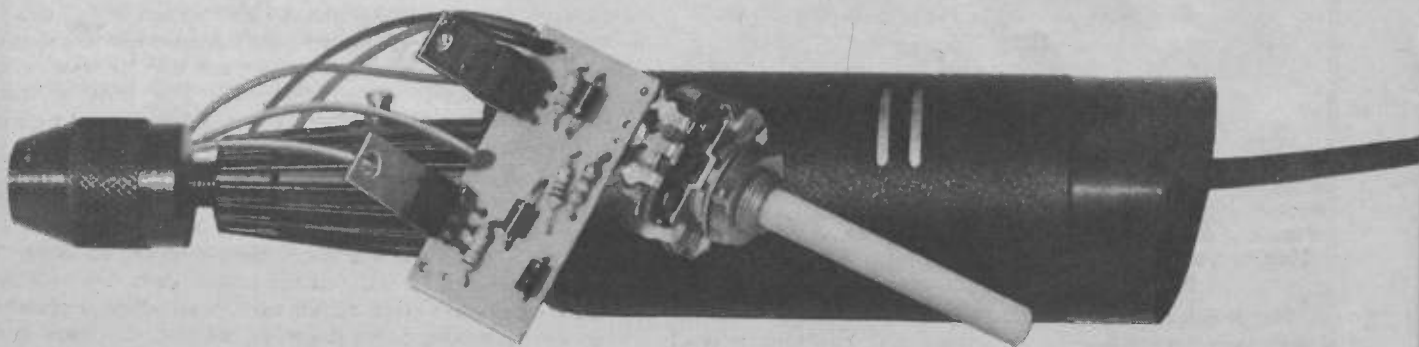

CIRCUIT OPERATION

Looking at Fig. 2, and following the circuit from the transformer it appears as a standard bi-phase rectifier except that the rectifiers are thyristors. To put these into conduction a positive potential on the gates relative to the cathode is required and this provided by the resistors R1 and R2.

A potential divider is formed by the resistor chain VR1, R3 and either R1 or R2 depending on which diode is conducting. This controls the voltage on the gates during the positive half of the cycle on the anode and therefore the degree of conduction of the thyristor.

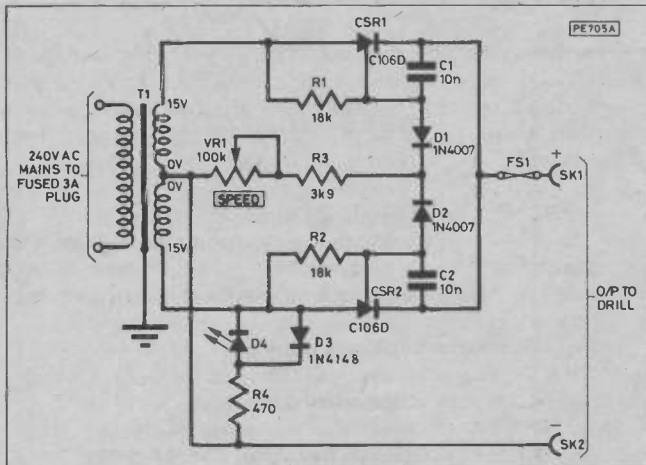

Fig. 2. Complete circuit diagram of the Drill Control Unit

The diode connected across the l.e.d. is there to limit the negative voltage that would otherwise impair its operation since it is fed from the a.c. line. A signal diode is adequate because the current is limited to 20mA by R4.

Depending on the setting of VR1 the thyristors conduct for a number of cycles and then stop conducting until the speed drops enough to start again. This mode of operation has the great advantage of not producing interference pulses on the mains as would be the case if thyristors were used to vary the conduction angle by chopping each half wave. It saves the cost of interference suppressors and simplifies the circuit.

A minor disadvantage is that irregular running occurs at very low speeds when the motor is running free. This is minimised by pre-setting the minimum speed to about 300 r.p.m. by including R3 in the control circuit. This still allows a useable speed range of 40 to 1 or more.

The authors own set up consists of a mini-drill with drill stand and a mini circular saw table. With these tools, some etch resist transfers, pens and etchant solution, it is very simple to make small p.c.b.s—rather more convenient than strip board.

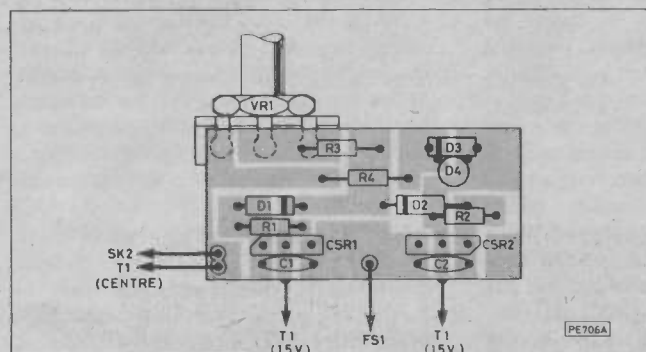

Fig. 3. P.c.b. design and component layout of the Drill Control Unit

This project has centred on the use of the circuit for the control of low voltage motors but the same arrangement can be used without much modification for voltages up to 50V, providing a

COMPONENTS . . .

Resistors

| | |
|----------------------------------|-------------|
| R1,R2 | 18k (2 off) |
| R3 | 3k9 |
| R4 | 470 |
| All resistors $\frac{1}{2}$ W 5% | |

Capacitors

| | |
|-------|--------------------------|
| C1,C2 | 10n 100V ceramic (2 off) |
|-------|--------------------------|

Potentiometer

| | |
|-----|-------------|
| VR1 | 100k 1W log |
|-----|-------------|

Semiconductors

| | |
|-----------|---------------|
| D1,D2 | 1N4007 |
| D3 | 1N4148 |
| D4 | 0.2" l.e.d. |
| CSR1,CSR2 | C106D (2 off) |

Miscellaneous

T1 15-0-15V secondary, 1A continuous rating for small drills up to 40W, 4A rating for drills up to 100W; p.c.b.; wire; cable; solder; sockets; fuse, etc.

Constructors' note: A full kit of parts for the Drill Control Unit is available from: **Croydon Discount Electronics, 38 Lower Adiscombe Rd., Croydon, Surrey CR0 6AA. ☎ 01-688 2950.**

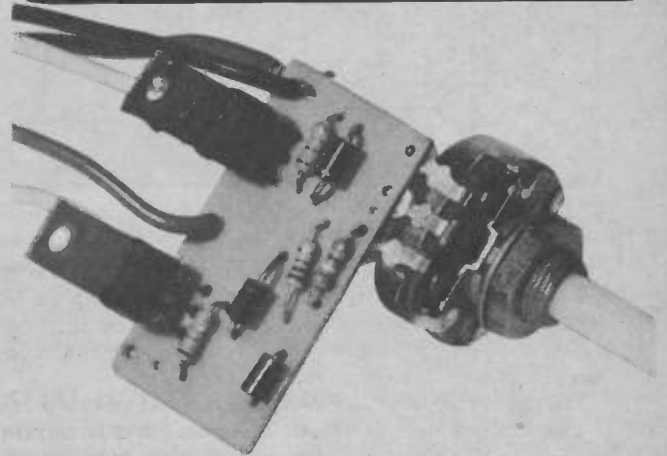

centre tapped transformer is available. The resistors R1 and R2 should be upgraded to $\frac{1}{2}$ W, the capacitors changed to a higher working voltage and the resistor in series with the l.e.d. changed to a suitable value.

CONSTRUCTION

It may be convenient to mount the p.c.b. shown in Fig. 3, on the potentiometer; it is small enough to do this and the layout has been designed with this in mind, otherwise the potentiometer can be wired.

For convenience the resistors and diodes are the first to be inserted into the board which is then inverted on to a piece of sponge for soldering. This prevents the components falling out again. The l.e.d. and the thyristors can then be inserted and soldered in place. Don't forget to check for dry joints and solder bridging the tracks and make sure that the diodes and thyristors are inserted the right way round.

Since the circuit is called upon to carry high peak currents the wiring from the transformer and to the drill should be reasonably heavy to minimise volt drop. Wires of 0.75sq.mm (6A) will be adequate. When everything has been checked, the p.c.b. and transformer may be mounted in a suitable case. The case used, depends on the type of transformer chosen which is dependent on the load likely to be driven by the unit. If a large load is envisaged, larger heatsinks will be required for the thyristors. ★

FIXED AND SWEPT FREQUENCY SIGNAL GENERATOR

KIT REVIEW

STEVE TAYLOR*

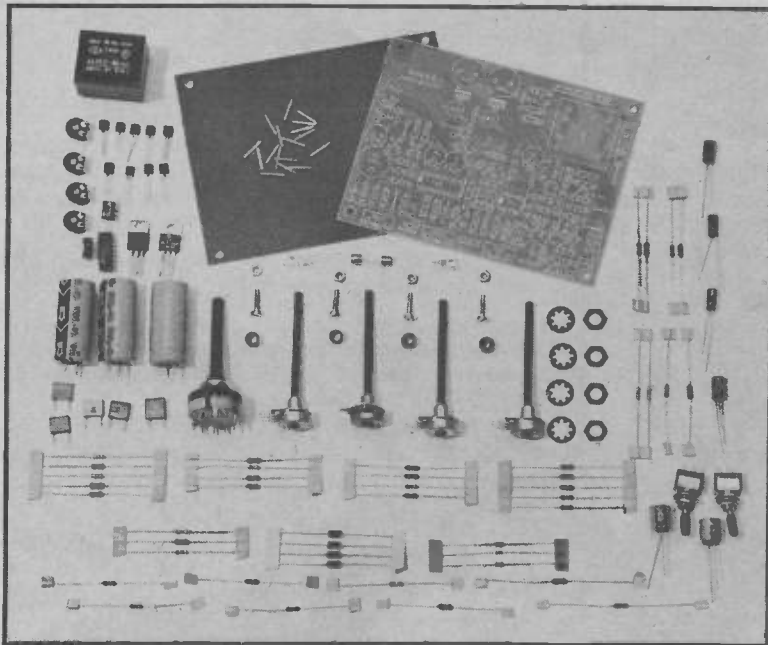

SPECIFICATION

Frequency Range: 1Hz to 600kHz in intermediate ranges
Frequency Ratio: 1:100
Waveforms: Sinusoidal, Triangular, Square
Output voltages: Sine/Triangular variable (1V r.m.s. max)
Square wave 12V
Saw tooth voltage: 5V p-p
Distortion: 0.5% (max)
Rise time: square wave—100ns
Sweep frequency: 0.1Hz–100Hz
Sweep ratio: 0–1:1000
Sweep drive: linear, logarithmic, manual
Synch. pulse voltage: 5V p-p (TTL)
Dimensions: 130mm x 100mm
Supply voltage: 240V 50Hz

MICROPROCESSORS, robotics, radio, model control, audio, video... each an aspect of "electronics", and each with its own distinct types of circuitry and hardware. However, everyone actively involved with the nuts and bolts of electronics will quickly find that after the soldering iron, multi-range meter and a simple oscilloscope, they need some other test equipment.

Nothing too sophisticated you understand, perhaps just (open your wallet) £500 worth of audio distortion analyser? £2,000 worth of digital logic analyser? Or can we stretch to just £12,000 worth of r.f. spectrum analyser? Well, before mortgaging the BMX or the BMW, why not try some d.i.y.?

Now available, for the "small" electronics workshop, for schools and colleges, for the hobbyist and all who suffer budget restrictions, is a range of test gear kits which can be used individually or can be combined for more complex tests and measurements, at prices ranging from £6 to £60.

A VERSATILE SIGNAL SOURCE

The Swept-Frequency Generator kit (see circuit in Fig. 1) was chosen for this review because the finished item is so versatile and useful as a source of square, sine, sawtooth and triangular waveforms of adjustable height and frequency. Furthermore it can be made to sweep repeatedly through a wide range of frequencies up to 1MHz. And, with its variable internal sweep function, which

can either apply sync. pulses to, or be synchronised from, external equipment, the generator can be coupled to a single beam 'scope to form a basic, but useful whole-spectrum display of frequency responses.

TYPICAL APPLICATIONS

1. Digital. For microprocessor and digital work the square wave and sync. outputs are a convenient source of variable frequency clocking signals or, by synchronising the module to an external clock, adjustable-period delay signals can be obtained.

As a source of fast rise-time sync. or clocking signals it is best to buffer the output to match it to the external circuitry, particularly for driving five volt TTL. A suitable buffer circuit is shown in Fig. 2.

2. Waveform Synthesis. For the music synthesiser buffs, the ramp, square and sine outputs can be used for tone creation and envelope shaping. The sawtooth and square outputs are low impedance drives, which are ground-referenced and can be used directly to drive most external circuits. For minimum distortion, the sine/triangular output should be treated as a one kilohm source and to avoid loading effects it may need buffering in a simple emitter follower stage as shown in Fig. 3.

Tremolo and reverse (downward) sweep effects can be applied directly to the "Lin 2" pin on the board, with the log/lin switch in the centre position. The rotary range-

change switch supplied with the kit has a spare switch action which, as shown in Fig. 4, can be used to automatically connect the "Lin 2" pin to external equipment when the switch is in the centre (fixed frequency) position.

3. Radio and Telecomms. The r.f. and communications applications include checking channel bandwidth and dynamic range, c.w., RTTY and modem filter response measurements, audio FSK generation and variable-width r.f. "comb marker" generation.

Speech processing and compression circuits can be checked using the fixed frequency sinewave output and the "Level" control. The overall channel bandwidth can be found by monitoring the channel output while applying a "log" swept sinewave to the input, using Range 2 (10Hz–10kHz). A similar technique is used to check audio filter responses.

Care should be taken with active filters, or where there are "gain blocks", to avoid exceeding the dynamic range, or hitting the supply rails. As a general rule tests should be made with as low a signal level as practical. Even entirely "passive" LC filters can suffer from saturation effects! As shown in Fig. 5 (and described below), with careful use of a 'scope to monitor the output level, it is possible to display the swept frequency response in a form such that the 3dB points can be determined by noting the frequency

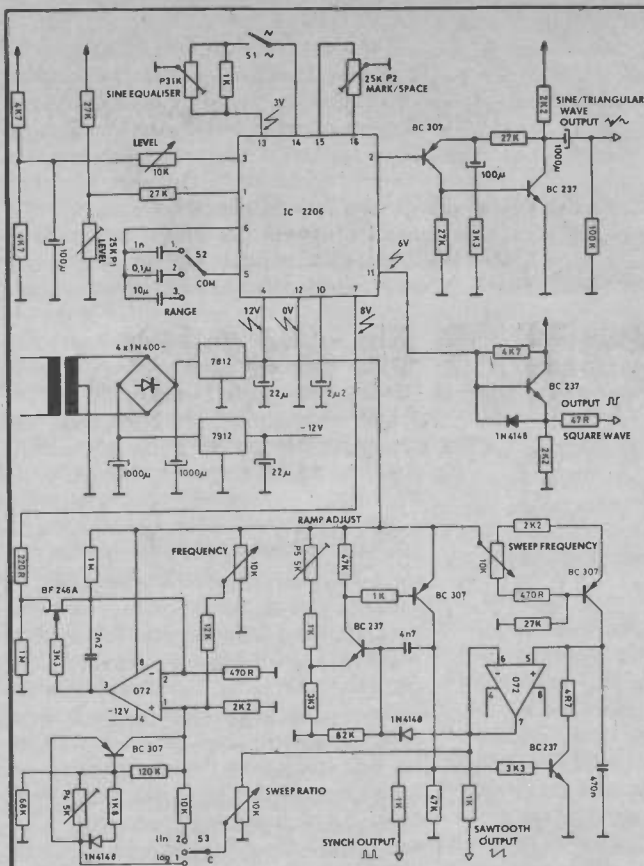

Fig. 1. Circuit diagram of the kit as shown in the instruction leaflet

Fig. 4 (right). Additional switch function giving access to the VCO control circuit

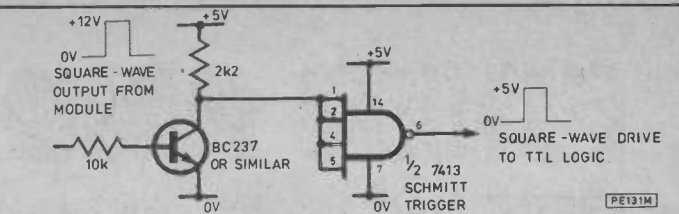

Fig. 2. Buffer circuit to drive 5V TTL from the generator's 12V square-wave output

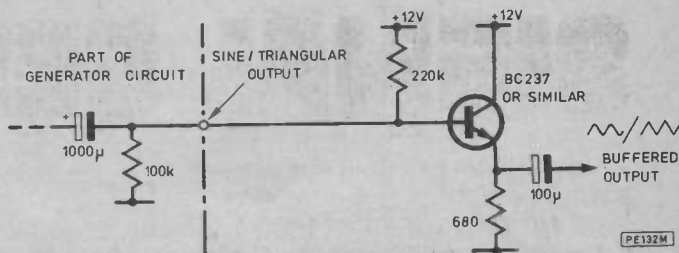
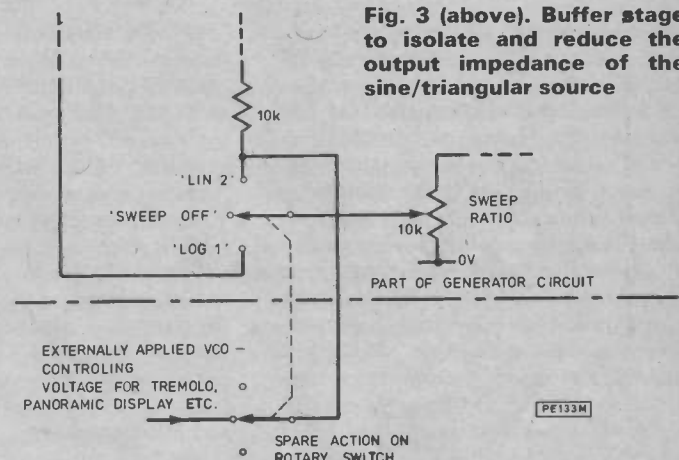

Fig. 3 (above). Buffer stage to isolate and reduce the output impedance of the sine/triangular source



at which the peak-to-peak voltage falls to 71 per cent of its mid-band (or maximum) level. The X (horizontal) axis of the scope which is normally calibrated in "time" can be re-calibrated in "frequency". Fig. 6 shows a practical example of a frequency/voltage plot relating the generator output frequency to the "Lin 2" pin voltage.

The set-up shown in Fig. 5 is easy to calibrate, requires no sophisticated test gear and is surprisingly effective. Being a continuous panoramic display it can be left scanning to show immediately the results of cut-and-try circuit engineering, tone control adjustments or filter component changes.

For modem, AMTOR, RTTY and other frequency/shift (FSK) experimental work, apply a low level square wave to the "Lin 2" pin on the board, and adjust both the "Frequency" setting pot and the amplitude of the applied square-wave. A typical relationship between the output frequency and the voltage at "Lin 2" pin is shown in Fig. 5. Due to component variations between modules these curves should be used as a guide only.

If you are experimenting with modems or speech networks remember that it is both dangerous and illegal to connect this, or any non-approved apparatus (including test equipment) to BT telephone lines. Offenders can be detected with inevitable disconnection of service. Re-connection cannot

Fig. 5. Swept frequency generator used as the basis for a simple panoramic display. The oscilloscope display is first calibrated to show "frequency" along the X-axis

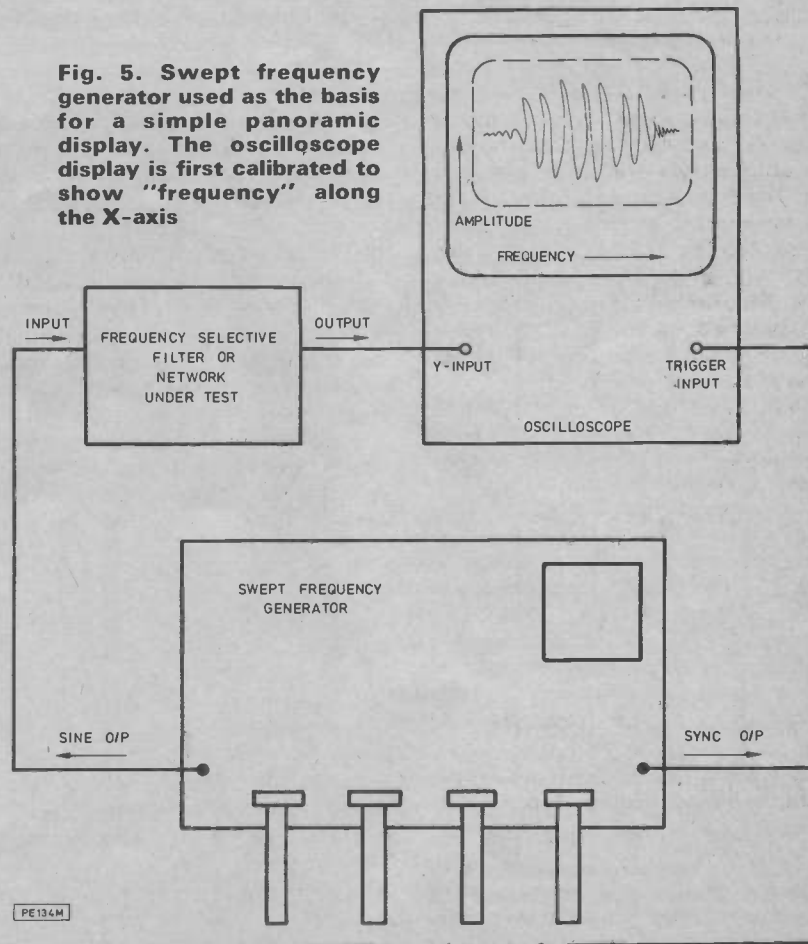

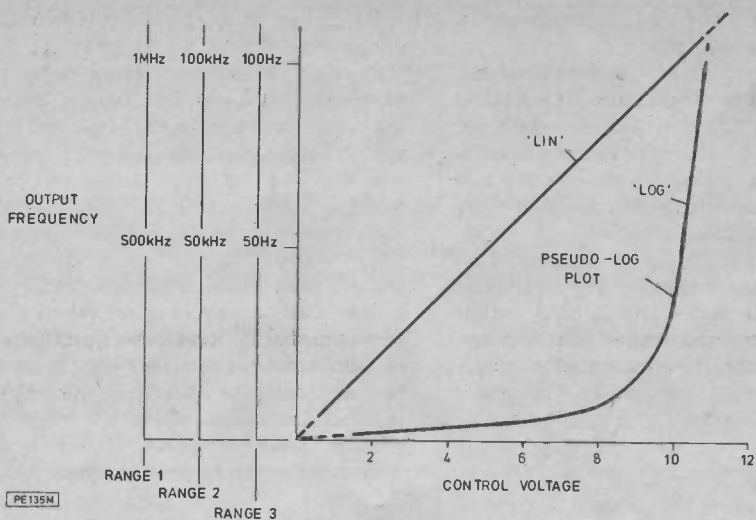

Fig. 6. Typical output frequency for each range, versus "lin" and "log" input control voltages

then be guaranteed simply by paying the court fine and offering to pay the BT connection charge.

4. Video. Video experimenters will find their own mind-blowing uses for the ramping and square-wave switching waveforms. The sweep function can be synchronised to external timebases, or line or frame sync pulses, by setting back the "sweep Frequency" pot so that the module's own sweep repetition rate is slightly less than the external rate. Then by applying a positive-going sync pulse to the "sync. output" pin, triggering will occur at the input rising edge.

5. Audio. Audio enthusiasts will find the fixed and sweeping facilities invaluable for checking the ultimate frequency and phase responses, throughout the audio and super-sonic ranges, of amplifiers, filters, graphic equalisers etc. As shown in Fig. 7, fixed frequency square-wave testing of amplifiers gives an immediate indication of the frequency response by the degree of "overshoot" or of "droop". The effect of introducing, or changing the setting of, bass and treble controls can be seen immediately, and the centre point (i.e. no cut, no boost) can be identified by noting the setting where the output wave form is truly rectangular and undistorted.

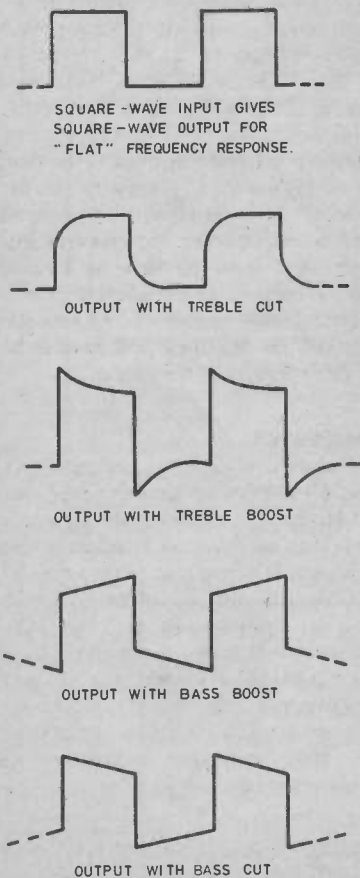

Fig. 7. Use of square-wave signal to indicate frequency response of amplifiers, tone control circuits, graphic equalisers, etc.

CONSTRUCTION

The well presented and carefully packed kit comes complete with all the components, hardware, assembly instructions and simple setting-up procedure to produce the fully working, mains powered module. There is even a plastic base plate to protect unwary fingers from the on-board 240V. For the complete novice, there is a sheet showing illustrations of all the components, each one identified by name, by picture and by symbol. From a reproduction of the top legend we learn that "Wobbelhub" and "Wobbelfrequenz" in "foreign" mean "Sweep Ratio" and "Sweep Frequency".

The more experienced constructor will appreciate the quality of the kit with its clear top legend and solder-resisted p.c.b. This makes the assembly very straightforward, with all the components of Fig. 1 mounted on a single 130mm x 100mm p.c.b. However, a few words of caution.

Check that each component is correctly positioned and oriented in the board before wielding the soldering iron. Mistakes can be corrected afterwards, but probably at the expense of the p.c.b. track, or the component itself. Finally check the finished assembly and solder-work before switching on! Active devices can be swiftly and silently destroyed if incorrectly connected. Likewise for electrolytic capacitors... except that they tend to be noisy and spectacular!

Above all, remember that there is full mains voltage on the p.c.b. tracks under the transformer and the mains input fuse. Although there is a protective plastic cover, the experienced constructor will already have covered the live tracks with insulating

Photograph of the complete kit showing all components supplied

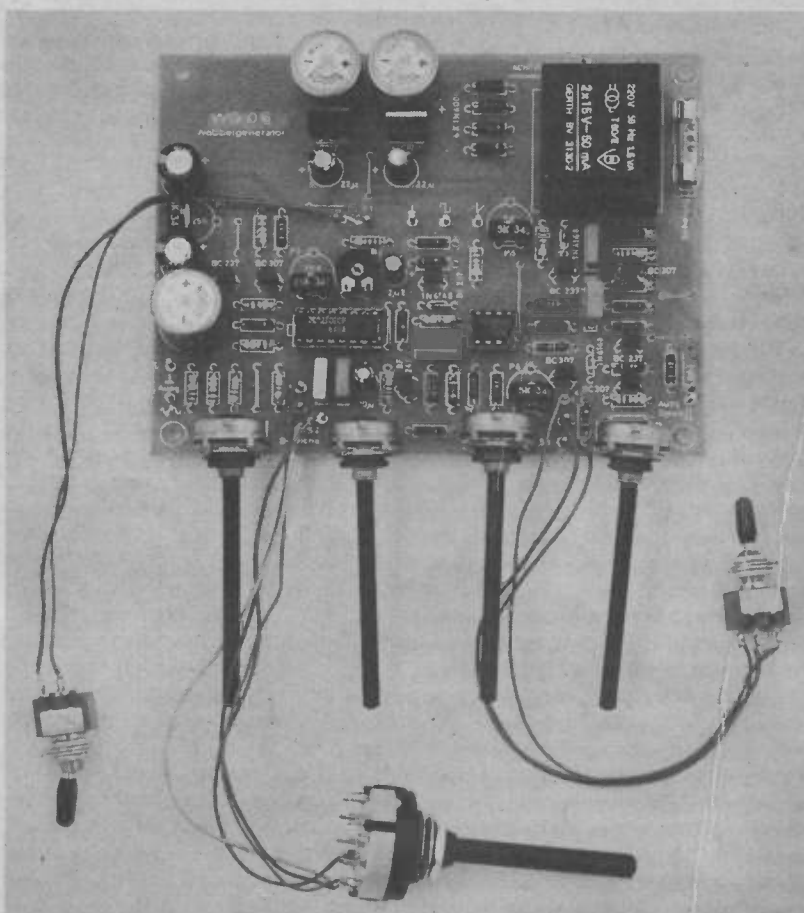

tape. The less experienced constructor should learn to do likewise!

The finished module will look like that shown in the illustration, with four on-board pots and, on flying leads, one rotary switch and two toggle switches. After setting up, the module can be housed in a case (the DX1 or AE1 cases from Cirkit are ideal), or it can be included in a larger composite piece of test equipment which might include an accurate digital frequency meter.

OPERATION

Referring to Fig. 1, at the heart of the circuit is a waveform generator based on the XR2206. This i.c. has two frequency adjustable outputs. One gives a sine or triangular waveform (switch selectable via S1), the other gives a square waveform. The sine/triangle waveform is also adjustable for level. Both outputs are buffered to give a low impedance, and in the case of the sine/triangular output, an a.c.-coupled output. The three position rotary switch selects the required frequency range:

- Range 1 1kHz to 750kHz
- Range 2 10Hz to 10kHz
- Range 3 0.67Hz to 125Hz

The circuitry around pins 5, 6 and 7 of the TL072 dual op-amp produces a sync. pulse for external use and a sawtooth waveform which, after conditioning in the log/lin circuitry around pins 1, 2 and 3, is applied to pin 7 of the XR2206 to produce an "upward" swing in the output frequency. Toggle switch S3 selects the log. or lin. sweep function. The centre (off) position disables the sweep function, so that the output frequency remains constant. The four pots control:

1. "Level", the output signal level.
2. "Frequency", the output frequency, or in the case of sweep operation, the starting frequency.
3. "Sweep Ratio", the span of the increasing frequency sweep.
4. "Sweep Frequency", the repetition rate of the sweep.

SETTING UP

The setting-up procedure involves adjusting presets P1 to P5 as follows:

A. Sine Wave Purity. With "sine wave" selected (using S1), the sweep switched off (S3 in its middle position) and the "Frequency" pot set to give a tone of about 1kHz (the second B above middle C on the parlour piano), adjust P2 and P3 for minimum distortion of the output waveform. The distortion can be checked in several ways, e.g.:

1. Display the waveform on a 'scope and adjust for "best shape", using your own judgement or by comparing the shape with that derived from another oscillator. This method has given results of 0.75 per cent distortion.
2. Monitor the output on a pair of headphones (do not load the module's output with anything less than two kilohms). Adjust for "purest tone" with the minimum of high frequency components. The purest tone will sound the smoothest and softest.

With care, this method has given results of 0.72 per cent distortion.

3. Using a Harmonic Distortion Analyser, simply tweak for a minimum. This method has given a figure of 0.6 per cent t.h.d. distortion (-43dB) on the lowest frequency range, which is approaching the best which can be achieved (0.5 per cent) with the sine shaper techniques employed.

For audio distortion measurements an input signal from a source with better than 0.01 per cent t.h.d. would be ideal, but for work on filter responses and most commercial (or amateur) communication equipment a level of 0.5 per cent to 0.7 per cent is useful.

B. Output Level. With the "level" pot at maximum (fully clockwise) adjust P1 to give an output of one volt r.m.s. at about 50 or 100Hz on a decent multimeter, or, at say 1kHz, 2.8V peak to peak on the 'scope.

C. Sawtooth Waveform. Adjust P5 for the most accurate sawtooth output. This is not a critical adjustment and the preset can be left at minimum resistance, i.e. at 100 per cent of full travel, to give the widest frequency sweep. Purists can adjust the preset for a maximally straight ramp on the sawtooth waveform.

D. Logarithmic Sweep. The logarithmic law is based on a combined "softened" diode and transistor forward current transfer law. It is only an approximation to a true log law, but the simple circuit used here has the advantage that both log. and lin. laws can be adjusted to cover the same overall frequency range. Preset P4 should be set so that with the frequency control set to a minimum the frequency sweep covers the same span as for the linear sweep. This can be done by going through the setting-up sequence detailed in "Panoramic Display" below.

With these setting-up procedures completed the module is ready for use as a piece of test gear.

PANORAMIC DISPLAY

To use the unit to give a simple panoramic display, the variation of generator output frequency with sweep voltage is determined by grounding the base of Q9 and then, by the use of the "Sweep Ratio" pot., setting the voltage at the "Lin 2" pin at a number of points between 0V and +12V. At each point the frequency can be measured, using the 'scope (frequency is the inverse of the period of one cycle), or more accurately with a suitable frequency meter.

Then, with the 'scope triggered from the module's sync. output and displaying across the screen one full sawtooth waveform from the "LIN 2" pin (not from the sawtooth output pin), the 'scope X axis (horizontal) can be calibrated or marked in voltage, by reading off the trace against the normal vertical (Y) voltage axis. (Note: on some 'scopes it will be possible to set the X-axis scale most conveniently to one volt/centimetre). This calibration can then be converted to "instantaneous output frequency" by reference to the frequency/voltage relationship recorded above, which, being similar to Fig. 6 will give a calibration close to

10Hz/cm for Range 3 (or 100Hz/cm for Range 2, or 1kHz/cm for Range 1).

Finally, with the set-up shown in Fig. 5, the output from the network, or filter, under test can be displayed on the 'scope and the point by point variation in overall amplitude can then be seen across the full frequency span.

With this display the qualitative effects on the "shape" of the response curve, of changes made in the circuit or network, or in individual component values, can now be seen immediately. Reasonable quantitative measurements can be made (with the accuracy determined principally by the limitations of the 'scope display) with more accurate, single frequency measurements undertaken when the response shape is as required.

If necessary, the starting and finishing frequencies for the scan can be altered by adjusting the "Frequency" pot and P5, the "Ramp Adjust" preset.

Because the vertical axis of the display is linear, rather than logarithmic, the dynamic range will be somewhat limited for showing ultimate out-of-band filter responses, although careful and cunning use of the 'scope's "Y" input range switch will usefully expand the vertical scale to show the more attenuated parts of the response.

Also since the control-voltage/output-frequency relationship is linear (as shown by Fig. 6), then a logarithmic frequency sweep along the X-axis can be achieved by applying a logarithmic voltage sweep to the "Lin 1" pin.

It is of course possible to calibrate the X-axis using the on-board log-response circuit via the "Log 1" pin on the module, instead of the "Lin 2" pin, in the above calibration procedure. This will give a non-linear, pseudo-logarithmic horizontal frequency calibration which could be more useful than the linear calibration. To show the classic "text book" filter response shape around the 3dB points however, requires true log-log axes. And it would then be nice to display the response as a single line, in true panoramic display manner... All interesting possibilities, but these will have to be left to the ingenuity of the reader.

KIT SUPPLIER

The complete kit at £41 (catalogue stock number 41-01400), the recommended case at £7.50 (type AE1, catalogue stock number 21-06241) or the low-cost alternative case at £5.30 (type DX1, catalogue stock number 21-06010), available by credit card telephone order, or by mail order, from Cirkit, Park Lane, Broxbourne, Herts EN10 7NQ. Tel. (0992) 444111. All prices plus VAT and 60p postage per order (for UK orders—overseas readers contact Cirkit for postage charges etc.), knobs and sockets are not included in the kit.

*Steve Taylor B.Sc AMIEE, Innovatech Ltd., Wickhambrook, Newmarket, Suffolk, CB8 8XZ. Design and development consulting engineer for all branches of electronics.

Make it with Cirkit

Swept frequency generator

As featured in this issue of Practical Electronics. A versatile and interesting piece of test equipment for testing amplifiers, digital and switching circuits. Supplied as a kit of parts with PCB, all components, pots and mains transformer.

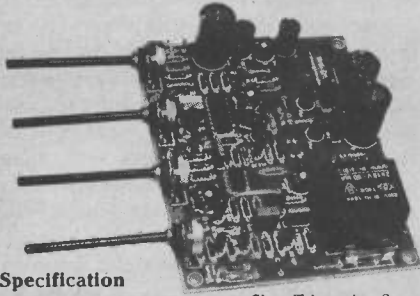

Specification

| | |
|--------------------------|--------------------------|
| Wave forms: | Sine, Triangular, Square |
| Frequency range: | 1Hz to 600kHz |
| Output voltages: | Variable -1V rms Max |
| Sine/Triangular | 12V |
| Square | 0.5% (max) |
| Distortion: | 100nS |
| Rise Time - square wave: | 0.1Hz-100Hz |
| Sweep frequency: | 1:1000 |
| Sweep ratio: | 130x100mm |
| Dimensions: | 240V 50Hz |
| Supply voltage: | |

Stock no. 41-01400 Price **£41.50**

Heart rate monitor

Effective ECG monitor gives audible and visual indication of heart rate. Supplied with programs to display waveform on the BBC.

Stock no. 41-02400 Price **£15.00**

VHF Weather satellite Rx

136-138MHz VHF receiver for orbiting weather satellites. Low noise front-end, PLL detector, audio amp, 6 channel. With Xtal for 137.50MHz.

Stock no. 40-02300 **£42.52**

Rewbichron II

Highly accurate time keeper, decodes and displays MSF transmission. 12 or 24 hour LED display.

Stock no. 41-00506 Price **£32.49**

MSF Receiver

60kHz MSF receiver. For use with Rewbichron II or other decoder circuits.

Stock no. 40-06002 Price **£10.51**

These are just a few of over 120 kits we hold in Stock.

Bumper new edition of the Cirkit Catalogue out now, containing 128 pages packed full of electronic components and accessories. Available from your local newsagents or by post from us. The Catalogue includes:

BATTERIES · BOOKS · CABLE
CALCULATORS · CAPACITORS
COMPUTER ADD-ONS · PRINTERS
CONNECTORS · CRYSTALS · FILTERS
BOXES · KNOBS · AEROSOLS
HEATSINKS · INDUCTORS
KITS AND MODULES · METERS
PCB MATERIALS · RELAYS
RESISTORS · SEMICONDUCTORS
MEMORIES · MICROPROCESSORS
LEDs · LOUDSPEAKERS · SWITCHES
TEST EQUIPMENT
SOLDERING IRONS · TOOLS
TRANSFORMERS

PE12

Please add 15% VAT to all advertised prices and 60p post and packaging. Orders despatched same day. Please call in to one of our shops or send for our catalogue to see the complete range of kits and components.

Cirkit Distribution

Park Lane, Broxbourne, Herts, EN10 7NQ Telephone (0992) 444111 Telex 22478

200 North Service Road,
BRENTWOOD
Essex CM14 4SG

53 Burrfields Road
PORTSMOUTH
Hampshire PO3 5EB

Park Lane
BROXBOURNE
Herts EN10 7NQ

NEW AUTUMN '85
CATALOGUE
OUT NOW
£1.15

Universal Semiconductor Devices Ltd.

17 GRANVILLE COURT, GRANVILLE ROAD,
HORNSEY, LONDON N4 4EP, ENGLAND.
TEL. 01-348 9420/9425 * TLX. 25157 usdco g



WE OFFER ONE OF THE LARGEST RANGES OF SEMICONDUCTORS AT HIGHLY ECONOMICAL PRICES. THE FOLLOWING SEMICONDUCTOR TYPES ARE AVAILABLE FROM STOCK. IF WE DON'T STOCK WHAT YOU NEED THEN WE CAN GET IT FAST FROM OUR FACILITIES IN WEST GERMANY AND USA UPON REQUEST.

TRANSISTORS - BIPOLARS - GERMANIUM AND SILICON
SMALL SIGNAL
POWER
DARLINGTONS - ALL SHAPES AND SIZES
VHF/UHF DEVICES - ALL SHAPES AND SIZES



FETS - POWER MOSFETS
UNIUNCTIONS

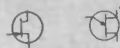

DIODES - GERMANIUM AND SILICON
RECTIFIERS AND BRIDGES
OPTO-ELECTRONIC DEVICES
LEDS OF ALL SHAPES AND SIZES



THYRISTORS AND TRIACS - ALL



SHAPES
SIZES
RATINGS

INTEGRATED CIRCUITS:

CONSUMER - DIGITAL/ANALOGUE
MICROPROCESSORS AND PERIPHERALS
IC SOCKETS



JAPANESE COMPONENTS - VAST RANGE OF DISCRETES AND CONSUMER IC's.

MAIL ORDER CUSTOMERS: PLEASE SEND FOR OUR COMPREHENSIVE PRICE LIST, ENCLOSED 75 PENCE IN STAMPS, CHEQUE OR POSTAL ORDER. THIS SUM IS REFUNDABLE WITH A FIRST ORDER VALUE OF £5.00 OR MORE.

CATALOGUE SENT FREE OF CHARGE, WHEN REQUESTED ON OFFICIAL LETTERHEAD (WITHOUT REFUND), TO OEM'S, SCHOOLS, COLLEGES, UNIVERSITIES, GOVERNMENT INSTITUTIONS, COMPUTER FIRMS, ELECTRONIC REPAIR FIRMS AND DISTRIBUTORS.

SPECIAL DISCOUNTS AND PAYMENT TERMS ARE AVAILABLE TO ABOVE INSTITUTIONS.

PLEASE ENQUIRE FOR QUANTITY DISCOUNTS.

WE WELCOME TELEPHONE AND TELEX ENQUIRIES!

P.E. CAR COMPUTER



This splendid instrument is still available from PIMAC

- ☆ **ECONOMY** - save petrol by improving your driving technique and improving the tuning of your car.
- ☆ **PERFORMANCE** - dynamic checks on timing to improve performance and economy.
- ☆ **SECURITY** - protect your car by disabling the ignition. Enter a personal listed combination to restart.
- ☆ **ATTRACTIVE** - easy to fit, easy to operate - comes complete with all parts needed. Full instructions provided.
- ☆ **READOUTS** - Imperial or metric read outs as desired.

PE CAR COMPUTER

£97.75

Easy-to-assemble kit of parts

£86.25

IGNITION CUT-OUT

£9.78

Send SAE for list of separately available parts.

P.E. ICE WARNING & LIGHTS LEFT ON ALARM KIT

(PE March '83)

DON'T BE CAUGHT UNAWARES BY ICE ON THE ROAD OR RETURN TO FIND A FLAT BATTERY!

An Ideal Christmas Gift at £9.75

All prices include VAT and post and package.
GOODS BY RETURN

PIMAC SYSTEMS LTD.

20 Bloomfield Road, Moseley, Birmingham B13 9BY.
Tel: 021-449 0384

all in your

FEBRUARY

issue!



BURGLAR ALARM

A professional quality alarm system at an affordable price. The basic system caters for magnetic latches, pressure pads and passive infra-red detectors. A "panic" switch is permanently active, even when the main system is switched off.

Simple to construct and install, but exceptionally difficult for a burglar to defeat.

LOGIC PROBE

Solve all your logic problems with this TTL and CMOS compatible test aid—includes advanced features such as pulse catch and waveform indicator.

Microelectronics Education Programme Part 2

We shall be looking at the Microelectronics For All material and describing what may be happening when the Government money runs out at the end of March and the new Microelectronics Support Unit hopes to start work.

PRACTICAL

ELECTRONICS

ROBOTICS · MICROS · ELECTRONICS · INTERFACING

FEBRUARY 1986 ISSUE ON SALE FRIDAY, JANUARY 3



SPACE EXPLORERS

The international Comet Explorer, *ICE*, reached its target—Comet Giacobini-Zinner—on 11 September last and has been very successful. It entered the tail 4,890

miles behind the nucleus and rushed through the tail at 45,000 miles per hour. The lack of damage due to tiny meteoritic particles and “dust” was pleasingly reassuring—an omen for Giotto?—and the tail was somewhat broader than had been expected. The magnetic environment was exactly as predicted.

Though the Americans will remain disconsolate about the cancellation of their Halley probe they will at least gain some satisfaction from *ICE* particularly if they manage to recover it in July 2012—as seems possible and which will, if achieved, be a notable “first”.

The Russians too have had successes with their *Vega* probes which by-passed Venus en-route to Halley's Comet and dropped probes into the atmosphere of that forbidding planet. On 11 June *Vega 1* dropped a capsule which divided in two; a “lander” which came down north of Aphrodite Terra (one of Venus's two major uplands) and a balloon, which was carried 6,000 miles from the night to the day side and was wafted up and down by winds of several feet per second.

When *Vega 2* dropped its capsule on 15 June the lander came down in Aphrodite Land and identified a rock called anorthosite-troctolite, which on Earth is rare but is abundant on both the Moon and Mars. The interesting point is that the Earth samples are much younger than the lunar or Martian ones. What age are those of Venus? As yet we do not know.

ASTRONOMICAL DECISION

Financial restrictions are having their effect upon astronomy and all associated sciences—that is to say, those which cannot be taxed and which cannot be used to kill people.

The latest casualty is the great 100-inch Hooker reflector at Mount Wilson in California. It came into operation in 1917, and for more than thirty years it was not only the largest and most powerful telescope in the world, but was in a class of its own. With it, in 1923, Edwin Hubble made the observations of short-period variable stars which proved that the so-called “starry nebulae” were independent galaxies, far beyond our own Milky Way system.

THE SKY THIS MONTH

This year ends with a moderate display of planets. Venus is still a morning object though by now it does not rise very long before the Sun and it is so nearly “full” that small telescopes will be hard pressed to show its phase.

On 4 December Venus is less than 2 degrees south of Mercury, which is above the first magnitude and may be visible with the naked eye. Jupiter is a brilliant evening object, in Capricornus, but it is inconveniently low as seen from Britain, and by the end of December its angular distance from the Sun is only 40 degrees.

Saturn is badly placed though by late December it has emerged into the morning dawn and on the 17th it will be close to Mercury. Mars passes from Virgo into Libra—early in the month it is near Spica—but even at the end of the year its magnitude is no brighter than 1.7 so that it can easily be mistaken for a red star.

Uranus is badly placed for observation but interest in it is mounting as Voyager 2 draws in towards it. I will have more to say about it next month!

Two meteor showers occur this month. The Geminids, with a ZHR or Zenithal, Hourly Rate of almost 60 are active between December 7 and 15 with their maximum on the 14th; the Ursids extend between 17 and 24 December, peaking on the 22nd with a ZHR of about 12.

To refresh your memory, the ZHR is the number of shower meteors which would be expected to be seen by an experienced observer under ideal conditions, with the radiant at the zenith. As these conditions are never attained the actual observed shower rate is always rather lower than the theoretical ZHR.

The Ursids are associated with the famous periodical comet P/Tuttle. The Geminids have no known parent comet. The orbit is much the same as that of the remarkable “sun-grazing” asteroid Phaethon discovered by the Infra-Red Astronomical Satellite in 1983 and there have been suggestions that Phaethon is in fact a dead comet.

Personally I am very dubious, if only because spectroscopic observations indicate that Phaethon is rocky rather than icy, but it is certainly strange that there is no known “Geminid comet”. Of course this situation is not unique. Neither is there a known parent comet for the Quadrantid meteors which can be very spectacular for a few hours around 3 January; sometimes the ZHR can exceed 100.

HALLEY'S COMET

However, the main attention this month must be on Halley's Comet. In fact, the period from December through to mid-January represents the only real chance of seeing the comet from Britain with the naked eye.

This is one time when even the most enthusiastic lunar observer (such as myself) is not pleased to see the Moon in the sky; and unfortunately the Moon is full on 27 December, so that during the last week of the month it will tend to drown the comet.

It is always dangerous to make exact predictions about comets (remember Kohoutek!) and the magnitudes given in the following table may be very much on the optimistic side but at least the positions are correct. It is seen that by the end of December the comet is still more than 50 degrees away from the Sun.

| Date | R.A. | | Dec. | Magnitude | Solar elongation degrees |
|---------|------|-----|----------|-----------|--------------------------|
| | h | m | | | |
| Dec. 1 | 1 | 5.3 | N. 13 39 | 5.7 | 132 |
| Dec. 11 | 23 | 40 | 05 59 | 5.6 | 99 |
| Dec. 21 | 22 | 48 | 00 51 | 5.6 | 75 |
| Dec. 31 | 22 | 17 | S. 02 19 | 5.4 | 57 |

This is clearly the right time to take photographs of the comet. Various detailed publications have been produced* but it is true that fairly elementary equipment can be used to take reasonable pictures—and the next opportunity will not come for more than seventy years.

Early observations, carried out by astronomers at the observatory on Tenerife, have shown that the comet's coma is larger than expected—in early October it was 9 minutes of arc across instead of only 1.2 minutes of arc, as had been predicted. If this is an indication of what is to come, then Halley may well be more of a spectacle than has been feared.

During December the track carries the comet through Pisces into Aquarius and by the end of the month it will be close to the star Gamma Aquarii; the distance from Earth will then be over 80,000,000 miles. Even when the comet is at its nearest to us, in early April 1986, it will not come much within 40,000,000 miles, as against less than 15,000,000 miles at the last return—1910.

*Such as *The Return of Halley's Comet*, by Patrick Moore and John Mason published by Patrick Stephens Ltd. (paperback).

Mount Wilson has other instruments too: for instance the 60-inch reflector, which was the first of the "modern-type" great reflectors, and two major solar towers, as well as the horizontal Snow solar telescope. Now it has been decided to cut off all their funds and to close the observatory down. The official reason is that the seeing conditions there have deteriorated markedly because of the spread of Los Angeles. This is true enough; but there is still a tremendous amount of important work for the telescopes to do.

It is wrong to believe that the annual cost is great by national standards. If compared with (say) the cost of a nuclear submarine,

or even a helicopter, it is absolutely negligible. The loss to astronomy is great—and there are many who look back to the 100-inch with feelings of real affection.

Can we hope for a change of heart? Various ideas are under consideration but at the moment it cannot be claimed that the outlook is very bright. So for the moment, at least, the great telescope has come to the end of its career. On 25 June it was turned to the sky for perhaps the last time and now the observatory is boarded up with cobwebs gathering inside the dome.

Surely there is something wrong with the modern world!

SUNSPOTS

During much of 1985 the Sun has been comparatively inactive and there have been many "spotless" days. However, calculations by D. R. Whitehouse indicate that we are not yet really close to actual minimum which he times for the early spring of 1988. This will mean that maximum will occur in the autumn of 1991.

These forecasts are necessarily uncertain by a month or two either way but they are not likely to be very wide of the mark so that through 1986 and 1987 we cannot expect major groups with their associated phenomena such as aurorae.

FREE! READERS' ADVERTISEMENT SERVICE

PE BAZAAR

RULES Maximum of 16 words plus address and/or phone no. Private advertisers only (trade or business ads. can be placed in our classified columns). Items related to electronics only. No computer software. PE cannot accept responsibility for the accuracy of ads. or for any transaction arising between readers as a result of a free ad. We reserve the right to refuse advertisements. Each ad. must be accompanied by a **cut-out valid** "date corner". Ads. will not appear (or be returned) if these rules are broken.

For sale 50 pounds weight old electronics magazines £10. Wanted plug-in tele-text unit. J. Fulton, Derrynaseer, Dromore, Co. Tyrone BT78 3BE.

Radio Constructor From No. 1. Practical Wireless 1951-71. Television 1972-75. W. World 1940 to date. 74 Ellesfield Drive, Ferndown, Dorset.

Floppy discs (8in.) new in library cases. 10-DS/DD £15, 10-DS/SS £10 inc. N. L. Smith, 31 Meadow Avenue, Wetley Rocks, Stoke-on-Trent, Staffs. ST9 0BD. Tel: Wetley Rocks (0782) 550684.

Printer Heathkit H14. W/serial interface. Used 20 hrs. Price? Any reasonable offers. S. Rudmark, Kvalsv. 10, S-14600 Tullinge, Sweden.

Jason FMTI tuner high performance self-powered shelf case; valve enthusiasts; gram valve amp. also. Offers? E. G. Middleton, 30 Zodiac Court, 165 London Road, Croydon CRO 2RJ. Tel: 686 2031.

Wanted power supply for Oric. Also any information on Oric Atmos. Ian Shanks, 13 Payne Road, Wootton, Beds. MK43 9JL.

Swap Tamron 80-210, 35-70mm lenses, Olympus 28mm lens. Want scope, digital multimeter, plotter, etc. W.H.Y. Mel Saunders, 7 Drumcliff Road, Thurnby Lodge, Leicester LE5 2LH.

Philips games computers for spares—keyboard, micros, SMPS u.h.f. modulator. Several faulty. £12 each. Perfect £25. Tel: Reading (0734) 581549 evenings please.

Wanted 'Television' magazines 1979 onwards. Tel: 01-451 3093.

Wanted Elmac 4810 oscilloscope power transformer, or damaged unit for spares. Tel: Dean 34432.

Microtan 65 cased, keyboard Tanex, basic, Tambug, x-Bug, space invaders. Offers. Mr. Stauber. Tel: 01-398 6022.

Pye vanguard crystals 70-26MHz TXRX £10 C.W. key £4 144MHz antenna. VGC. Never used £4. Mr. R. A. Pearson, 573 Pentregiehin Road, Ravenhill, Swansea SA5 5ET. Tel: 0792 582941.

Wanted good condition oscilloscope in Hull area. Apply: Mr. Ron Salmon, 119 Witham, Hull. Tel: 23597.

PE April 72-May 74. Sept. 74-March 76. Television July 75-May 77. WW March 74-March 75, Feb. 79-Aug. 82. Some missing. Some ETIs. Mr. King. Tel: 0277 363856.

Radio Communication journals RSGB 1979-Sept. 1985. Less one in 1981. £15. F. E. Godward, 40 Beaufort St., Southend-on-Sea. Tel: 68254.

Hewlett Packard 180A/AR dual trace oscilloscope and probes, 3 operators and service manuals. Needs attention. Offers. L. T. Cowell, 69 Crewe Road, Haslington, Crewe CW1 1QX. Tel: 0270 581157.

Clef string synthesiser £85. Electronic piano £85. Gicrotan Tanex. Needs attention £50. All ono. Tel: Knowle 78488.

Wanted CCTV camera in working order, with manual if possible. Tel: Portsmouth (0705) 812226.

Wanted first, second, third, fourth book of OHIO Scientific. Jan Ockier, Mgr. Christiaensstraat, 16, 8880-Tielt, Belgium.

Guitar and 45 watt amp £190 or willing to exchange for stacking Hi-Fi system. Tel: 01-328 7615 evenings.

Wanted student requires reasonably priced oscilloscope. Christian Montanero, Cathedral Court, University of Surrey, Guildford, Surrey GU2 5XH.

Brand new components 1000 assorted i.c.s, transistors, diodes, capacitors, resistors, etc. Sent for £7.50 post free. K. Bailey, 40 Seymour Close, Selly Park, Birmingham B29 7JD.

Clearing Workshop scope, Marconi bridge, counter, Windsor meter, transistor checker, etc. £150 ono the lot. Might separate. P. S. Adey, 39 Oxford Road, London SW15. Tel: 01-785 2990.

Wanted manual and circuit diagram for Exidy Sorcerer computer. I. Jones, 71 Craigmount View, Corstorphine, Edinburgh EH12 8XX. Tel: 031-339 6345.

For sale PE, PW, R&EC, EE, H-F, Elektor. SAE for lists. Must sell—space needed. Mr. M. Doncaster, 465 Blackstock Road, Rollestone, Sheffield, S. Yorks. S14 1LB.

Two hi-fi woofers and two hi-fi tweeters with crossover components. One woofer slightly damaged. £15 + p&p. J. C. D. Darwent, 36 Westfield Road, Dronfield, Sheffield S18 6YE. Tel: 413667.

Wanted Watford Electronics WE ROM for Acorn Atom or any information on WE ROM. Tel: 041-946 4967.

Wanted circuit diagram to convert domestic TV into a good oscilloscope which plugs into aerial socket. Mr. D. Harries, 17 Eccleshall Avenue, Oxley, Wolverhampton

Please publish the following small ad. FREE in the next available issue. I am not a dealer in electronics or associated equipment. I have read the rules. I enclose a **cut-out valid** date corner.

Signature Date

Please read the **RULES** then write your advertisement here—one word to each box. Add your name, address and/or phone no. **COUPON VALID FOR POSTING BEFORE 3 JANUARY, 1986** (One month later for overseas readers.)

SEND TO: PE BAZAAR, PRACTICAL ELECTRONICS, WEST-OVER HOUSE, WEST QUAY ROAD, POOLE, DORSET BE15 1JG.

BLOCK CAPITALS PLEASE

| | | |
|-----------------|--|--|
| | | |
| | | |
| | | |
| | | |
| | | |
| Name & Address: | | |
| | | |
| | | |
| | | |
| | | |

For readers who don't want to damage the issue send a photostat or a copy of the coupon (filled in of course) with a **cut-out valid** "date corner"

Experimenting With ROBOTS

Sam Withey Part 5

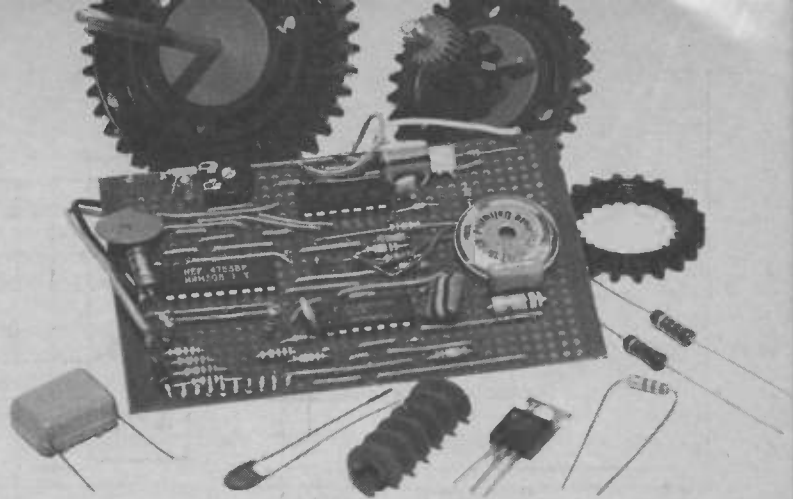

WITH a growing interest in robotics amongst home computer users and schools there is an increasing need for simple, safe, reliable, motor controllers. Whilst stepper, or stepping motors are essential for accuracy in line plotting and automatic control modes, the fundamental practice in keyboard controlled applications can be achieved though the use of simple low voltage, permanent magnet, d.c. motors of the kind used in toys and models.

The interface described here is not only suitable for driving these motors in forward and reverse directions, but is also a standard interface for controlling bi-polar stepper motors.

The next generation of electronics and computing will make extensive use of optical transmission systems due to their high degree of reliability, speed and comparative low cost. This is effectively an extension of opto-isolator techniques, the simple infra-red l.e.d. being replaced by the laser and the plastic casing replaced by a fibre-optic coupling. Because of their proven reliability and in keeping with the earlier recommendation that the host computer should be optically isolated from any external electrical devices, this interface uses opto-isolators on the computer output and inport ports, but provision is made for disabling the outputs by bringing the normally logic '1' state to ground potential in applications where purely mechanical micro switches are used as limit switches.

CIRCUIT DESCRIPTION

The principal components of the interface consist of two p.n.p. and two n.p.n. transistors arranged as an "H" bridge (Fig. 2). The interface is capable of driving two small d.c. motors or one bi-polar stepper motor in c.w. or c.c.w. direction, the direction being determined by the logic signals present at the base of transistors TR1 to TR4 and TR5 to TR8. The direction of rotation of a d.c. motor is changed by reversing the polarity of the electrical field and transistors TR1 and TR4 can be represented by switches S1 to S4 in the schematic in Fig. 1.

It can be seen that current can only flow through the motor coils when switches S1 and S2 are both closed, or it will flow in the opposite direction when switches S3 and S4 are both closed. Any other arrangement would bring about a short circuit between the +ve and -ve lines.

The n.p.n. transistors TR1 and TR3 (TIP35) conduct when a logic '1' is placed on their base pins, whilst the p.n.p. transistors, TR4 and TR2 (TIP36) conduct when a logic '0' is placed on their bases. As the bases of TR1/TR4 and TR3/TR2 are coupled

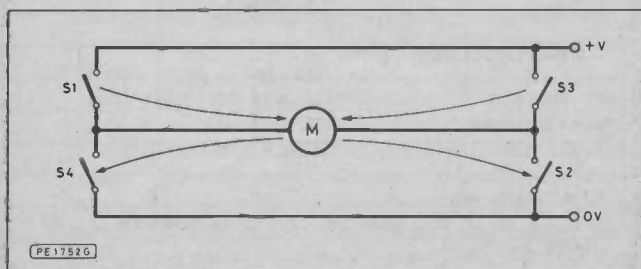

Fig. 1. Straightforward switch equivalent of the motor driver

together, only one transistor of each pair can be turned on at any time no matter what logic state exists at their common base junction. The commoned emitters of TR1/TR4 and TR3/TR2 are connected across the commutator of the motor M1. The table indicates the performance of the motor in accordance with the truth table of the logic state on the bases of the transistor pairs.

| Base Logic | TR1/TR4 | Base Logic | TR3/TR2 | Motor direction |
|------------|---------|------------|---------|-----------------|
| 0 | On/Off | 0 | On/Off | Stop |
| 0 | On/Off | 1 | Off/On | Forward |
| 1 | Off/On | 0 | On/Off | Reverse |
| 1 | Off/On | 1 | Off/On | Stop |

It can be seen that the transistor switches respond in the same manner as the mechanical switches, i.e. TR1/TR2 ON causes the motor to rotate in one direction, whilst TR3/TR4 ON causes the motor to rotate in the opposite direction. However, due to the use of n.p.n. and p.n.p. transistors in series, the possibility of a short circuit is removed. Transistors TR5/TR6 and TR7/TR8 behave in the same manner.

Whilst transistor types TIP35/36 are used here, providing up to 1A, types TIP31/32 can be used if up to 3A is required. In the same way, more powerful transistors can be used externally, but the protection diodes should be upgraded to a suitable value.

Diodes 1 to 4 and 5 to 8 protect the transistors from damage by back e.m.f. generated by the motor coils in the short period when the motors stop rotating.

OPTO ISOLATORS

The transistors of the opto isolators are held high at logic '1' by a resistor between their collectors and supply. With D0 to D3 set as outputs the transistors cannot be turned on. By bringing the cathodes of their l.e.d.s low relative to anode either by placing a logic '0' on the respective data line, or with a micro switch, pulling the data line low, the l.e.d.s is turned on. This turns on the transistor, bringing its collector low. This changes the logic state at the bases of the coupled motor driver transistors.

Where electrical signals provide inputs D4 to D7 are set as inputs and held high by a resistor (the author used 1M to limit current drain on computer supply) until a signal on the l.e.d. of the opto isolator turns the associated transistor on, bringing its collector low to logic '0' providing an active input.

NOTE: In applications, where limit switches are used to turn off a motor, care must be taken to ensure that the switch is connected to the data line normally set at logic '1' to run the motor.

CONNECTION TO THE COMPUTER

Quad-opto-isolators are used to protect the computer I/O port from accidental short circuit at the motor drivers. Should initial experiments only concern the driving of a single d.c. motor and dual opto-isolators be available, these may be inserted at pin 1 of the sockets. Also, two dual opto-isolators are pin compatible with the quad pack and can generally be mounted in the same socket in tandem.

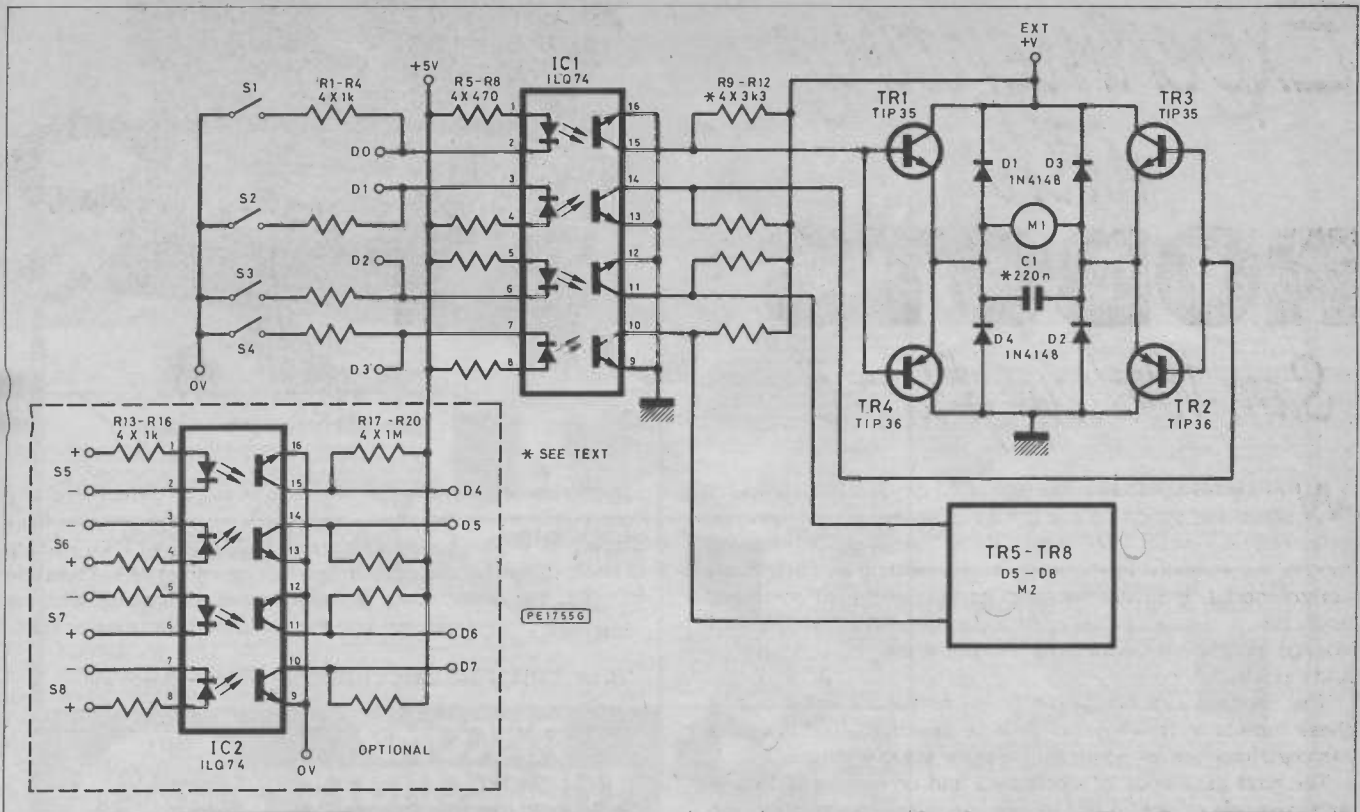

Fig. 2. Circuit diagram

ground the signals numbered S1 to S4) and bits 4 to 7 set as inputs. There is nothing to prevent the user reversing the order of these functions to facilitate the wiring to individual computers. The opto-isolated input switch pins are numbered S5 to S8. In order to keep the size of the board down to a minimum size most of the resistors are mounted vertically.

CONSTRUCTION

All components are mounted on a p.c.b. as shown in Fig. 3. It is suggested that 16-pin d.i.l. sockets be used for the opto-isolators. Ensure that the i.c.s are inserted the correct way around (Pin 1 is indicated by an indenture. Also, there is usually a half circle or slot cut out of the plastic case between pin 1 and pin 16). After ensuring that the diodes are correctly polarised, cathode distinguished by black or broad yellow band, the greatest care must be taken that n.p.n. transistors are inserted in position for TR1, TR2, TR5 and TR6 and p.n.p. transistors for TR3, TR4, TR7 and TR8. These all face in the same direction and care should be taken that the first one to be inserted is the right way round.

COMPONENTS . . .

- Resistors**
 - R1-R4, R13-R16 1k (8 off)
 - R5-R8 470 (4 off)
 - R9-R12 3k3 (4 off)
 - R17-R20 1M (4 off)
- Capacitors**
 - C1 220n (see text)
- Semiconductors**
 - D1-D4 1N4148 (4 off)
 - TR1, TR3 TIP35 (2 off)
 - TR2, TR4 TIP36 (2 off)
 - IC1, IC2 ILQ74 (2 off)
- Miscellaneous**
 - P.c.b. No. PE022 available from PE PCB Service. D.c. or stepper motor

Next month: Testing, software and applications.

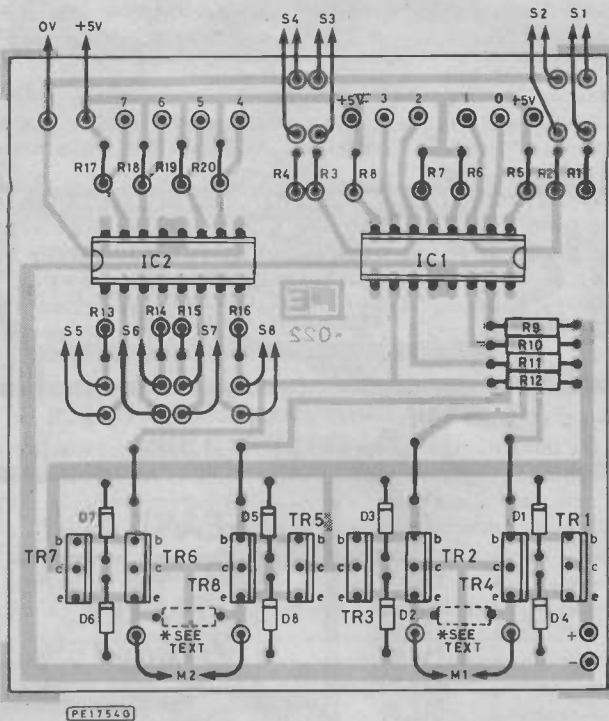

Fig. 3. Component layout (actual size)

Pins are also available for use with non-electrical switches, such as miniature micro-switches, for processing input signals, where a standard technique of disabling the output of the computer port is brought about by grounding the output signal through a 1k resistor. Provided care is taken, this should not be in any way dangerous as no external power supply is involved.

Provision is made for opto-isolated inputs should they be required, but for most applications signals for stopping motors are derived by grounding the relevant port set at logic '1' for output.

In the component layout bits 0 to 7 are numbered from right to left, with bits 0 to 3 set as outputs (with provision for pins to

Intruder Alarms and Accessories

A COMPLETE SECURITY SYSTEM FOR ONLY £39.95 + V.A.T.



contains Control Unit Enclosure & mechanical fixings Key Switch & 2 keys LED's 5 1/2" Horn Speaker 4 high quality surface mounting Magnetic Switches

With only a few hours of your time it is possible to assemble and install an effective security system to protect your family and property, at the amazingly low cost of £39.95 - V.A.T. No compromises have been made and no corners have been cut. The outstanding value results from volume production and direct supply. Assembly is straightforward with the detailed instructions provided. When installed you can enjoy the peace of mind that results from a secure home. Should you wish to increase the level of security, the system may be extended at any time with additional magnetic switches, pressure pads or ultrasonic sensors. Don't wait until it's too late - order today.

CA 1250
HW 1250
KS 3901
LED 1
HS 588
MS 1025

EXTENDED SYSTEM CS 1480 Price £62.50 + V.A.T.

This system contains, in addition to the CS 1370, an ultrasonic detector type US 5063 - its enclosure, an additional horn speaker and a further 2 magnetic switches. This system represents outstanding value for money for the high level of security provided.

SELF-CONTAINED ULTRASONIC ALARM UNIT CK 5063 only £37.00 + V.A.T.



Requires no installation. Easily assembled using our professionally built and tested modules.

- Adjustable range up to 25ft
- Built-in entrance and exit delay
- Built-in timed alarm
- Key operated switch Off, Test and Operate
- Provision for an extension speaker
- Fully self-contained
- Uses US 5063 PSL 1865 Key Switch 3901, 3" Speaker 3516

Now you can assemble a really effective intruder alarm at this low price using tried and tested Riscomp modules. Supplied with full instructions, the kit contains everything necessary to provide an effective warning system for your house or flat. With a built-in LED indicator and test position the unit is easily set up requiring no installation. It may simply be placed on a cupboard or desk. Movement within its range will then cause the built-in siren to produce a penetrating 90db of sound or even 110db with an additional speaker. All parts included and supplied with full instructions for ease of assembly. Size 200 x 180 x 70mm. Order as CK 5063.

RISCOMP LIMITED

Dept PE31
51 Poppy Road,
Princes Risborough,
Bucks. HP17 9DB
Princes Risborough (084 44) 6326

ALARM CONTROL UNIT CA 1250



Price £19.95+V.A.T.

The heart of any alarm system is the control unit. The CA 1250 offers every possible feature that is likely to be required when constructing a system whether a highly sophisticated installation or simply controlling a single magnetic switch on the front door.

- Built-in electronic siren drives 2 loud speakers
- Provides exit and entrance delays together with fixed alarm time
- Battery back-up with trickle charge facility
- Operates with magnetic switches, pressure pads, ultrasonic or IR units
- Anti-tamper and panic facility
- Stabilised output voltage
- 2 operating modes full alarm anti-tamper and panic facility
- Screw connections for ease of installation
- Separate relay contacts for external loads
- Test loop facility

HARDWARE KIT HW 1250

only £9.50 + V.A.T.

The attractive case is designed to house the control unit CA 1250, together with the appropriate LED indicators and key switch. Supplied with the necessary mounting pillars and punched front panel, the unit is given a professional appearance by an adhesive silk screened label. Size 200 x 180 x 70mm

SIREN & POWER SUPPLY MODULE PSL 1865

only £9.95 + V.A.T.

A complete siren and power supply module which is capable of providing sound levels of 110db at 2 metres when used with a horn speaker. In addition, the unit provides a stabilised 12V output up to 100mA. A switching relay is also included so that the unit may be used in conjunction with the US 5063 to form a complete alarm.

NEW

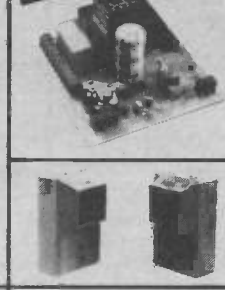

TIMER SWITCH & POWER SUPPLY MODULE DP 3570 Price £13.95 + V.A.T.

The DP 3570 consists of an adjustable timer switch and stabilised 12V power supply for use in a wide range of applications including security, lighting control and automatic switching.

The timer section of the module provides switching of loads up to 3A for pre-set times, the duration of which may be set by the user to between 10 secs and 5 mins. The timed period may be triggered by the opening of a loop or the closing of external contacts, with the timed period commencing instantaneously or delayed to provide a form of entrance delay.

The power supply section of the module provides a 12V output of up to 250mA which is sufficient for most applications. The module operates from either 240V a.c. supply or a 12V battery for which trickle charge facilities are included. Connections to the module are by means of screw terminal connectors with no soldering needed.

For mounting the unit an attractive moulded enclosure is available.

ME 357 only £2.85 + V.A.T.

INFRA-RED SYSTEM IR 1470 only £25.61+V.A.T.

Consisting of separate transmitter and receiver both of which are housed in attractive moulded cases, the system provides an invisible modulated beam over distances of up to 50ft operating a relay when the beam is broken. Intended for use in security systems, but also ideal for photographic and measurement applications. Size 80 x 50 x 35mm

DIGITAL ULTRASONIC DETECTOR US 5063

only £13.95 + V.A.T.

This advanced module uses digital signal processing to provide the highest level of sensitivity whilst discriminating against potential false alarm conditions.

ULTRASONIC MODULE ENCLOSURE

only £2.95 + V.A.T.

Suitable metal enclosure for housing an individual ultrasonic module type US 5063 or US 4012. Supplied with the necessary mounting pillars and screws etc. For US 5063 order SC 5063, for US 4012 order SC 4012.

RISCOMP THE SECURITY SPECIALISTS!

Add 15% to all prices.
Add 75p post and packing to all orders.
Units on demonstration Shop hours 9.00 to 5.30 pm
Closed Wednesdays
Please allow 7 days for delivery

FULL RANGE OF ACCESSORIES STOCKED SEND SAE FOR DETAILS

Marshall's

A. MARSHALL (LONDON) LTD

A. Marshall (London) Ltd.
Electronic Component Distributors
85 WEST REGENT STREET
GLASGOW G2 2AW
TELEPHONE: 041 332 4133

TEACH-IN '86 KITS

As in Everyday Electronics December 1985

| | |
|--|--------|
| Multimeter M-102BZ | £12.25 |
| Vero Plug Block with panel | £5.25 |
| Test Leads | £1.50 |
| PSU Components Complete | £16.50 |
| PSU Components Without Case | £10.00 |
| Regulator Unit Complete | £21.00 |
| Regulator Unit Without Case | £14.50 |
| LCR Bridge Complete | £23.85 |
| LCR Bridge Without Case | £17.35 |
| Diode Transistor Tester Complete | £18.76 |
| Diode Transistor Tester Without Case | £13.26 |
| Audio Signal Tracer | £14.50 |
| Audio Signal Tracer Without Case | £8.00 |
| Practical Assignments Parts 1 & 2 Oct, Nov '85 | £1.75 |
| Part 3 Dec '85 | £1.30 |
| Part 4 Jan '86 | £3.68 |
| Part 5 | £2.24 |

PLEASE ADD P+P 50p PER ITEM U.K. + VAT @ 15%

CATALOGUE £1.00 U.K. £1.50 EUROPE £2.00 REST OF WORLD 75p CALLERS

WHERE TO FIND US

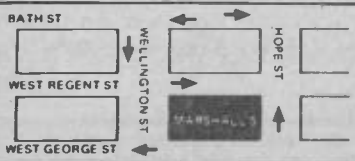

CALL IN AND SEE US

9-5.30 MON TO FRI
9-5.00 SAT
EXPRESS MAIL ORDERS
ACCESS/BARCLAYCARDS
WELCOME
SAME DAY SERVICE

MAIL ORDER

WE REGRET WE CANNOT ANSWER MAIL ORDER/ STOCK ENQUIRIES WITHOUT AN S.A.E. SAME DAY SERVICE TRADE AND EXPORT ENQUIRIES WELCOME

TELEPHONE

MAIL ORDER 041-332-4133
SHOP AND STOCK ENQUIRIES 041-332-4133/5
TELEX 261507 REF 2194

BBC Micro Forum...

David Whitfield MA MSc CEng MIEE

THIS month it is the turn of the serial data port to come under scrutiny.

RS423 PORT

The RS423 port is one of the truly general purpose data I/O ports provided on the *BBC Micro*. It is a serial interface which provides an improved version of the widely used and somewhat better known RS232C standard. The differences between the RS232C (also referred to as V24) and the RS423 standards are generally concerned with improving the earlier standard. For our purposes, however, the RS232C and the RS423 standards may be considered as compatible.

The serial port is essentially two serial data channels, one for output and one for input, with additional signals for controlling the flow of data. The two channels may be separately configured in various different ways by means of a number of *FX or OSBYTE calls. This degree of support for the RS423 port from the MOS allows it to be used for a great variety of purposes. These include: connecting a modem, connecting a serial printer, as a replacement or supplement for the keyboard, as an output in place of (or as well as) the display. The latter two applications can even open the way for using the *BBC Micro* as an intelligent terminal to another (possibly remote) computer. The RS423 system can also be used to control the cassette port.

the RS423 buffers. The first two elements are also involved in the cassette interface, explaining why the two interfaces are so closely related. The ACIA is responsible for changing data from parallel format (as used inside the micro) to serial format, and vice versa. The serial ULA provides the clock signals that determine how fast the ACIA sends and receives data (known as the baud rate). It also selects where the ACIA takes its input from, and where it sends its outputs to (i.e. cassette or RS423 buffers). The buffers provide the necessary line driving and level conversion to the RS423 standard.

THE CONNECTOR

The RS423 port connector on the *BBC Micro* is a rather unusual type for computer applications; indeed, it was introduced for use with headphones in hi-fi systems. The connector used is in no way similar to the industry standard 25-pin D-type connector used for RS232C. Instead, it is a DIN 5-pin socket, but with the pins not in either of the two usual arrangements. The arrangement is of the 'domino' type, with the connections as shown in Fig. 2. This figure also shows the correspondence between the pins of the *BBC Micro* connector and the standard RS232C connector. It is important to take particular note that this diagram shows the socket as viewed from the back of the micro.

Incredible though it may seem, it is

the plug to identify its orientation. A good way to do this is with a white spot (e.g. of Snopake) to denote which way should be 'up' when correctly inserted. This simple precaution can save many frustrating wrong connections!

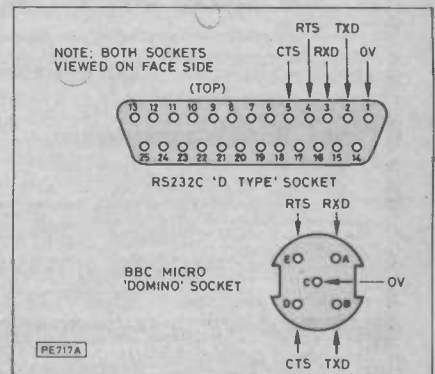

Fig. 2. RS423 connector

| Pin | Signal |
|-----|------------------------------|
| A | Data In (D _{IN}) |
| B | Data Out (D _{OUT}) |
| C | Ground (OV) |
| D | Clear to Send (CTS) |
| E | Request to Send (RTS) |

Table 1. RS423 signals

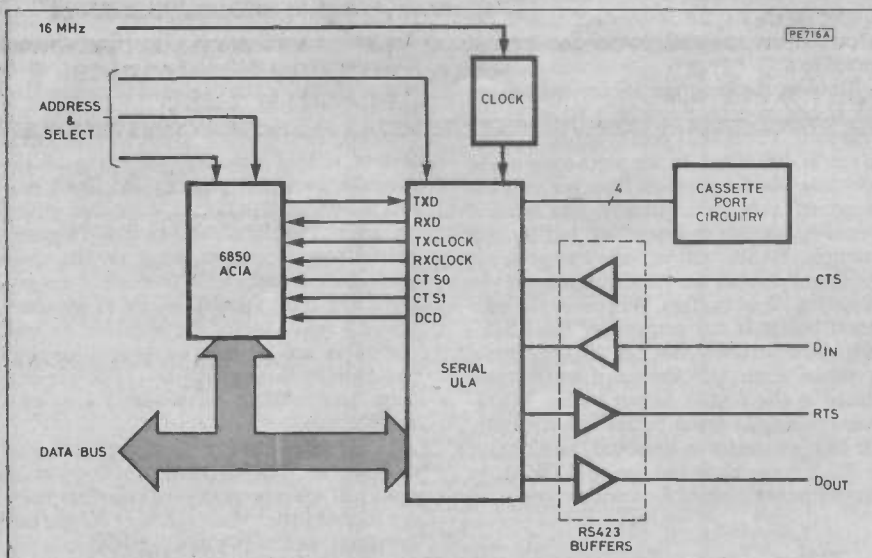

Fig. 1. Serial port configuration

The basic configuration of the hardware behind the RS423 port is shown in Fig. 1. This shows that there are three main components involved in the serial port: the serial ULA, the 6850 ACIA (Asynchronous Communications Interface Adaptor), and

actually possible to insert the plug into the RS423 connector either way round (!), without any difficulty at all. As you might guess, however, there is only one correct way to fit the plug for the port to work correctly. It is a wise precaution, therefore, to mark

RS423 SIGNALS

Signals on the RS423 port use levels of approximately +5 volts and -5 volts to represent the logic levels 0 and 1, respectively. The signals carried on the connector are identified in Table 1. As can be seen, the RS423 port on the *BBC Micro* only uses a (popular) subset of 5 signals from the possible 25 contained in the full V24 specification. These 5 signals, however, are more than enough for the vast majority of micro applications. In fact, many applications make do with only three of these connections.

The data in (D_{IN}) and data out (D_{OUT}) lines are the ones actually used for transferring data to and from the micro, respectively. Data is transferred serially along these lines, using a stream of bits to represent each byte or character. A number of different arrangements of bits can be used in different types of applications. Overall, each character is sent as a series of data bits, sandwiched between a start bit (indicating that a character is to follow) and one or more stop bits. In addition, a parity bit may also be added to the bits representing the character. This optional parity bit allows the receiving end to detect whether there has been an error on the link.

The various arrangements which are possible with the *BBC Micro* are listed in Table

2, and a typical data waveform is shown in Fig. 3. From this we can see that a character sent along a serial link may be represented by up to 11 bits. The number of bits sent per second is the Baud rate, and the conversion from Baud rate to character rate thus depends on the format being used.

Clear to send (CTS) is a signal to the micro from the equipment on the other end of the link to indicate that it is OK for the micro to send data. Request to send (RTS), on the other hand, is a signal from the micro which indicates to the equipment on the other end of the link that the micro is ready to receive data. Both CTS and RTS are active low, i.e. the micro sets RTS low when ready to receive data.

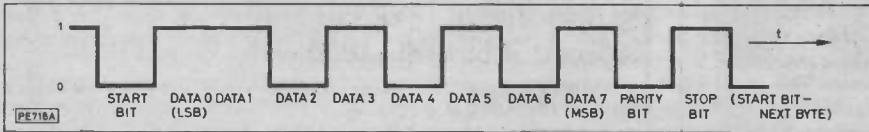

Fig. 3. Serial data waveform

Listing 1. RS423 demonstration

```

10 REM 60-character RS423 Terminal Demonstration
20 REM -----
30 :
40 ON ERROR GOTO 210
50 MODE 3
60 *FX 7,3
70 *FX 8,3
80 *FX 229,1
90 OSBYTE = &FFF4
100 :
110 LX=0
120 REPEAT
130 AX=138: XX=2: REM 1.e. OSBYTE 138
140 *FX2,2
150 IF ADVAL(-1)>0 AND ADVAL(-3)>0 YX=GET:
CALL OSBYTE
160 *FX 2,1
170 IF ADVAL (-2)>0 CharX=GET: VDU CharX:
LX=LX+1: IF CharX=13 VDU 10: LX=0
180 IF LX=60 VDU 10: VDU 13: LX=0
190 UNTIL FALSE
200 :
210 ON ERROR OFF: PRINT "ERROR AT LINE ":ERL
220 *FX 2,2
230 *FX 229,0

```

KEYBOARD VIA RS423

Rather than just list the *FX calls and other facilities available to control the serial port, it is probably more meaningful to look at how to use it in a practical situation. I will start, therefore, with a simple demonstration of use of the link to connect the BBC Micro's keyboard to the micro. Confused?... read on!

As already mentioned, the RS423 port can be used as the input stream to the micro instead of the keyboard. In addition, the RS423 port can be used as the destination for the output stream, e.g. as the destination for output from a program. What this demonstration does, therefore, is to use the MOS to direct the keyboard character stream to the program (as for the normal configuration) while also enabling the RS423 port. The program then re-directs the keyboard characters to the RS423 output. At the same time, the program checks the serial port for incoming characters. Any incoming characters are then output to the screen. Effectively, the normal direct link from keyboard to display is broken, and then re-made via the serial link. In order for the program in Listing 1 to run, it is necessary for links to be placed between D_{IN} and D_{OUT}, and between CTS and RTS. Routing the character stream in this way within a single micro is only useful as a demonstration, but if you have two micros, there are some interesting possibilities which become possible.

| Start Bit | Data Bits | Parity | Stop Bits |
|-----------|-----------|--------|-----------|
| 1 | 7 | Even | 2 |
| 1 | 7 | Odd | 2 |
| 1 | 7 | Even | 1 |
| 1 | 7 | Odd | 1 |
| 1 | 8 | None | 2 |
| 1 | 8 | None | 1 |
| 1 | 8 | Even | 1 |
| 1 | 8 | Odd | 1 |

Table 2. RS423 word formats

Before looking in any more detail at the program in Listing 1, we need to know something about the way in which the MOS can be used to configure the serial port. Table 3 shows the *FX calls which are used to set the receive and transmit Baud rates; for use from assembler, OSBYTE calls

| Baud Rate | Receive | Transmit |
|-----------|---------|----------|
| 75 | *FX7,1 | *FX8,1 |
| 150 | *FX7,2 | *FX8,2 |
| 300 | *FX7,3 | *FX8,3 |
| 1200 | *FX7,4 | *FX8,4 |
| 2400 | *FX7,5 | *FX8,5 |
| 4800 | *FX7,6 | *FX8,6 |
| 9600 | *FX7,7 | *FX8,7 |
| 19200 | *FX7,8 | *FX8,8 |

Table 3. *FX calls to control RS423 Baud rate

| Call | Input Selected | RS423 State |
|--------|----------------|-------------|
| *FX2,0 | Keyboard | Disabled |
| *FX2,1 | RS423 | Enabled |
| *FX2,2 | Keyboard | Enabled |

Table 4. Output stream control

should be made (to FFF4) with A = 7 or 8, and X = 1 to 8, as appropriate. Control of the input stream is by *FX2, and the effects of the various options are detailed in Table 4.

Running the program should then cause the screen to echo everything typed at the keyboard. The RS423 port is actually set up to run at 300 Baud. In the main loop of the program, multi-statement lines are used for speed of execution. Ideally this section would be written in assembler, but for this example, BASIC will suffice. The program continually scans the RS423 input and the keyboard input buffers. Whenever the keyboard buffer is not empty and the RS423 output buffer is not full, the next character is taken from the keyboard buffer and placed in the RS423 output buffer. Whenever the RS423 input buffer is not empty, the next character is removed, and output to the screen. Note the use of ADVAL to determine the state of the various buffers.

TERMINAL INTELLIGENCE

As a limited example of the processing which an intelligent VDU could perform, the program outputs a carriage return and line feed whenever a carriage return is encountered. In addition, a software controlled line length is implemented rather than use the default line length of 80 characters for mode 3. This may be altered

by changing the value of L%. In a full-scale emulation of an intelligent terminal, there would be many more such features provided, e.g. allowing user set-up of Baud rates, and support of ESCAPE sequences. The ESCAPE key is here disabled by the program, and so BREAK should be used to stop it running. With this in mind, it is important to save a copy of the program before running it for the first time.

Having this basic framework set up, it is clearly possible to explore many variations on the theme. For example, it is not necessary to have a simple direct link between D_{IN} and D_{OUT}. Instead, this could be to another micro, or even via an infra-red link (as used in remote control applications). The field of added intelligence for the terminal is limited as ever by ingenuity of the programmer. The production of a graphics character set is an example of such an interesting application; machine code is likely to be an absolute must for this type of job. Any offers for further applications?

I would be delighted to hear from readers with suggestions, hints for inclusion or problems, but would like to stress that any reply will only be through this column. Correspondence should be addressed to "BBC Forum Letters", at P.E.'s editorial address.

Book Corner

This month, a book on very much the same theme as this column. Practical Hardware Projects by Joe Telford is a book of 33 practical projects for the BBC Micro. Published by Century Publications at £8.95, this 158 page book is primarily aimed at those coming into the field of electronics from computing.

The first section of the book is a useful introduction to the practical skills required in the construction of hardware for interfacing to the BBC Micro. This instructional information covers tools, soldering, electronic components, tools and programming for I/O. The second section contains the projects, conveniently grouped into chapters of related projects, such as analogue projects, user port projects, etc. Each project is organised in the same manner, giving an overall description, circuit diagram, brief theory, constructional details, program listing and notes (including suggestions for applications). Many of the later projects make use of the earlier ones, and beginners are advised to work their way sequentially through the text. The projects culminate in ideas for building your own robot buggy.

In the presentation of each project, line drawings are used to illustrate all important points. It must be said, however, that these are indeed little more than very simple line drawings, and it is a great pity that a few photographs were not added in the early sections; these would have been of great value to real beginners. The listings of programs, on the other hand, are produced to a very high standard, with daisywheel output (after the style of the BBC Micro User Guide) used throughout.

Verdict: A useful and interesting introduction to practical hardware projects.

You can depend on

ELECTROVALUE

for your supplies of
world famous
QUALITY
COMPONENTS
by

SIEMENS

and other
leading
names

- I.Cs
- semi conductors
- capacitors
- inductors
- ferrites
- connectors

52 PAGE FREE CATALOGUE
Write, phone or call
● Priced & illustrated
● Over 8000 items
● Real discounts
● Prompt despatch

ELECTROVALUE LTD 28 St. Jude's Road, Englefield Green, Egham, Surrey TW20 0HB Phone Egham (0784) 33603. Telex 264475
North Branch, 680 Burnage Lane, Manchester M19 1NA
Telephone 061 432 4945
Please mention this publication when replying

BRITAINS FOREMOST QUALITY COMPONENT SUPPLIERS

DIGITAL ELECTRONICS

MADE
EASY



SUPERKIT £22.00
SUPERKIT II £16.00
(£35.00 if bought together)

The SUPERKIT series introduces beginners to practical digital electronics. SUPERKIT (SUP I) is the first kit, which contains an instruction manual, a solderless breadboard, and components (7 integrated circuits, switch, resistors, capacitors, LEDs and wire). It teaches boolean logic, gating, flipflops, shift registers, ripple counters and half adders. SUPERKIT II (SUP II) extends SUPERKIT. It contains an instruction manual and components (10 integrated circuits, 7-segment display, resistors, capacitors and wire), and explains how to design and use adders, subtractors, counters, registers, pattern recognisers and 7-segment displays.

DIGITAL COMPUTER LOGIC £7.00
DIGITAL COMPUTER DESIGN £9.50
MICROPROCESSORS & MICROELECTRONICS £6.50

The SUPERKIT series is backed by our theory courses. DIGITAL COMPUTER LOGIC (DCL), the beginners' course, covers the use and design of logical circuits, flipflops and registers. DIGITAL COMPUTER DESIGN (DCD), a more advanced course, covers the design of digital computers both from their individual logic elements and from integrated circuits. MICROPROCESSORS and MICROELECTRONICS (MIC) teaches what a microprocessor is, how it evolved, how it is made and what it can do.

GUARANTEE. If you are not completely satisfied, return the item to us in good condition within 28 days for a full refund. All prices include worldwide surface postage (ask for prepayment invoice for airmail). Orders despatched within 48 hours. Overseas payment by international credit card or by bank draft drawn on a London bank.

CAMBRIDGE LEARNING LTD, Unit 28, Rivermill Site, FREEPOST, St. Ives, Huntingdon, Cambs. PE17 4BR, England Telephone: 0480 67446.

VAT No. 313026022 Transcash No. 2789159 Reg. No. 1328762

Please send me (initial letters used):

..... SUP I @ £22.00 DCL @ £7.00
..... SUP II @ £16.00 DCD @ £9.50
..... SUP I + II @ £35.00 MIC @ £6.50

Full details of all your courses (please tick)

I enclose a cheque/PO payable to Cambridge Learning Ltd.

for £.....

Please charge my credit card.

No. Expiry date

Telephone orders from credit card holders accepted on 0480 67446 (24 hrs).

Name

Address

..... Signature

CAMBRIDGE LEARNING LTD
Unit 28, Rivermill Site, FREEPOST,
St. Ives, Huntingdon, Cambs PE17 4BR
England.



BAKER'S DOZEN PACKS

£1 EACH OR 13 FOR £12

Please add £1 post if order under £20
All new goods (except where marked s.h.)

| Pack No. | Qty | Description | Pack No. | Qty | Description |
|----------|-----|---|----------|-----|--|
| 1- | 5 | 13 amp ring main junction boxes | 51- | 1 | x 12v 2C 0 very sensitive relay |
| 2- | 5 | 13 amp ring main spur boxes | 52- | 1 | x 12v 4C 0 relay |
| 3- | 25 | 13 amp fuses for ring mains | 53- | 2 | mains operated relays 3 x 8a changeovers (second hand) |
| 4- | 5 | surface mounting switches | 54- | 10 | rows of 32 gold plated IC sockets (total 320 sockets) |
| 5- | 3 | flush switches white | 55- | 1 | miniature Uniselector with circuit for electric jigsaw puzzle |
| 6- | 5 | In flex line switches | 57- | 5 | dolls house switches |
| 7- | 4 | in flex line switches with neons | 58- | 2 | telephone handsets |
| 8- | 2 | 80 watts brass cased elements | 59- | 2 | flat solenoids - to make current transformer etc |
| 9- | 2 | mains transformers with 6v 1a secondaries | 60- | 5 | ferrite rods 4" x 5" - 16" dia |
| 10- | 2 | mains transformers with 12v 1/2a secondaries | 61- | 5 | ferrite slab aerials LW & MW |
| 11- | 1 | extension speaker cabinet for 6 1/2" speaker | 62- | 4 | 200 ohm ear pieces |
| 12- | 5 | octal bases for relays or valves | 63- | 1 | Mullard Thyristor trigger module |
| 13- | 12 | glass reed switches | 64- | 10 | assorted knobs 1/4 spindles |
| 14- | 4 | OCF 70 photo transistors | BD172 | 10 | 12v 6w bulbs Philips m.e.s. |
| 16- | 4 | tape heads, 2 record, 2 erase | BD174 | 2 | End of travel c/o switches mounted on metal plate 10A 25v |
| 17- | 2 | ultrasonic transmitters and 2 ditto receivers | BD175 | 1 | 200 rpm motor, mains operated, 2w |
| 18- | 2 | 15000 mid computer capacitors | BD176 | 4 | Heavy duty push switches - ideal for foot operation 3A 25v |
| 19- | 2 | I.d.r. similar ORP 12 | BD177 | 5 | Lilliput bulbs 12v |
| 20- | 5 | diff micro switches | BD178 | 3 | Oblong amber indicators with lilliputs 12v |
| 21- | 2 | mains interference suppressors | BD179 | 3 | Oblong amber indicators with neons 240v |
| 22- | 2 | 25 watt crossover units | BD180 | 6 | Round amber indicators with neons 240v |
| 23- | 1 | 40 watt 3 way crossover unit | BD181 | 100 | P.V.C. grommets for 3/8" hole |
| 25- | 1 | each water switches - 6p 2 way, 4p 3 way; 2p 6 way; 1p 12 way | BD182 | 1 | Short wave tuning condenser 50 pf with 1/4" spindle |
| 26- | 2 | tape deck counters | BD183 | 1 | Two gang short wave tuning condenser with 1/4" spindle |
| 27- | 1 | 6 digit counter 12v | BD184 | 1 | Three gang tuning condenser each section 500 pf with trimmers and good length 1/4" spindle |
| 28- | 1 | 6 digit counter mains voltage | BD185 | 4 | Ferrite rod aerials 8" x 3/8" rods with long and medium wave coils |
| 29- | 1 | BDAC in flight stereo unit (s.h.) | BD186 | 1 | 3 wafer switch 10 pole 2 way, 12 pole 3 way, 9 pole 4 way, 6 pole 6 way, 3 pole 12 way, your choice |
| 30- | 2 | NICAD battery chargers | BD187 | 2 | 2 wafer switches 8 pole 2 way, 8 pole 3 way, 6 pole 4 way, 4 pole 6 way, 2 pole 12 way any 2 your choice |
| 31- | 1 | key switch with key | BD188 | 1 | Plastic box sloping metal front, size 160x95mm average depth 45mm |
| 32- | 2 | humidity switches | BD191 | 6 | B.C. lamp holder adaptors |
| 33- | 2 | aerosol cans of ICI Dry Lubricant | | | |
| 34- | 96 | x 1 metre length colour-coded wires | | | |
| 35- | 4 | battery operated model motors | | | |
| 36- | 2 | air spaced 2 gang tuning condensers | | | |
| 37- | 2 | solid dielectric 2 gang tuning condensers | | | |
| 38- | 10 | compression trimmers | | | |
| 39- | 1 | Long & medium wave tuner kit | | | |
| 42- | 6 | rocker switches 10a mains SPDT | | | |
| 45- | 1 | 24 hour time switch mains operated (ISW) | | | |
| 46- | 1 | 6 hour clockwork time switch | | | |
| 47- | 2 | lever switches 4 pole changeover up and ditto down | | | |
| 48- | 2 | 6v operated reed switch relays | | | |
| 49- | 10 | neon valves - make good night lights | | | |
| 50- | 2 | x 12v DC or 24v AC 3C 0 relays | | | |

You can order night or day: 'phone 0444 454563

J.BULL (Electrical) Ltd.

(Dept. PE), 34-36 AMERICA LANE, HAYWARDS HEATH, SUSSEX RH16 3QU. **Established 30 YEARS**

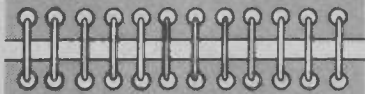

INDUSTRY NOTEBOOK

By Nexus



Pioneer

The impending closure of the GEC McMichael factory at Slough revives many a memory. Leslie McMichael was an outstanding example of an amateur experimenter developing an absorbing interest into a business.

He had begun experimenting with "wireless" as early as 1902 but it was 10 years later that the bug really bit hard after he had met a handful of other hobbyists and helped form, in 1913, the London Wireless Club, later the Wireless Society of London and today flourishing as the Radio Society of Great Britain.

He founded McMichael Radio in 1921 after serving in the Royal Flying Corps and the Royal Air Force. His partner was another pioneer experimenter, Rene Klein. Neither man had been professionally engaged in electrical or electronic engineering, Klein being in the family business of egg merchants and McMichael a laundry manager.

McMichael radio sets in the 1930s had the same reputation as Rolls-Royce in cars. They were distinguished by having a pair of loudspeakers in a heavy wooden cabinet giving superior "tone" which is how hi-fi was described in those days. Internally they were massively engineered and a feature was the pure copper screens, approaching 6 inches in diameter, enclosing each of the r.f. coils.

In 1939 production was switched to war work and when peace came the factory continued to manufacture defence and professional quality electronic equipment. An attempt to revive the McMichael name in the domestic radio and television market in the 1950s was not successful and the company stayed in the professional field.

It would be a pity if the McMichael name should be lost in the reorganisation now going on. Leslie McMichael died in 1951 aged 67 and deserves to be remembered not least for the start his company gave to many a young electronics enthusiast seeking employment in the industry.

Engineers?

The shambles at this year's Trades Union Congress confirmed my pessimism

that the squabbles inherent in leftist politics can never be contained. The AUEW was at the centre of the storm and the press had a field day. Unhappily, journalistic licence tends to shorthand the Amalgamated Union of Engineering Workers to the single word "engineers" which naturally gets up the nose of real engineers, particularly as The Engineering Assembly was having its first national forum in Birmingham at the same time as the TUC brothers were scrapping at Blackpool.

To put the record straight anyone can call himself an engineer but to be recognised professionally it is accepted that one should be Chartered and belong to a professional institution in the rank of Chartered Engineer, Technician Engineer or Engineering Technician, each requiring not only a degree, or lesser but still demanding qualification, but also working experience in one's field. An engineering worker needs no qualification to join the AUEW other than to be occupationally in the engineering industry, many members of course being craftsmen or foremen but not engineers as understood today.

I noted with interest that the IEE enrolled its 1,000th woman engineer this year. It sounds great until you realise that this is the grand total since the IEE enrolled its first woman member, reluctantly it's said, back in 1899. But the pace is quickening. Women membership has doubled since 1981 but is only 1.5 per cent of the total.

Power Play

Reverting for a moment to the TUC, the defence of vested interests is as intense as ever. The miners detest nuclear energy and would have it abolished. The electricians love it and want it expanded. The reason is simple. The mining unions are losing members at an alarming rate. The electricians argue that 40,000 people work directly in nuclear power generation and indirectly, in construction of new equipment and other services, 120,000 workers are involved.

The Social Democratic Party staged its conference at Torquay with a certain style and a refreshing freedom from acrimony. All the same I was disappointed that the debate on high technology, *Focus on the Future*, had such a lowly position, being squeezed in at the last moment before the Leader made his closing speech.

The proposal that 20 per cent of all honours should go to innovators was rejected. One speaker, clearly out of touch, suggested that ICL should co-operate with Japanese companies. This has already happened.

Jobs

The TUC and all the political parties had much to say on unemployment during the conference season. For the highly skilled there is no problem. Of the solutions to unemployment for the semi-skilled or unskilled one looks in vain.

Except, perhaps, to the United States where over six million new jobs have appeared and unemployment has fallen to about seven per cent compared with a rise in Europe to about 11 per cent and in the

UK alone to 13 per cent. The American success, in part at least, might be attributed to two characteristics. One is the attitude, encouraged from childhood, that all men are equal and the prize of becoming president of the nation or of a business corporation is open to all. In short, personal enterprise get-up-and-go is virtuous in a free society.

The other is a preference for job security rather than wage rises which, in times of difficulty, results in acceptance of wage freezes and in some cases wage cuts. Workers in US industry between 1972 and 1984 have had a fall in wages of about 13 per cent in real terms although money wages rose by 115 per cent in the same period. In contrast the UK worker looks to the government to create employment and demands wage increases in both money and real terms with scant regard to the trading environment in which his company has to operate.

Many people appear to believe that the job market is static. It may come as a surprise to them that in adult employment some 350,000 people change jobs every month, over four million a year. So there does exist a dynamic market of sorts although the figure for the jobless, everyone now agrees, will not see a substantial fall in the near term, perhaps never.

Too gloomy a view? Not when you consider another 750,000 expected entrants to the labour force in the next five years. You need to run fast to stand still in an intractable situation.

PC News

Sinclair QL personal computers are in the shops at huge discounts highlighting the decline in the home and hobby market. Apricot is reported to have unsold stocks, Commodore rumoured to be talking with bankers. But the remarkable Alan Sugar has taken up the challenge with what has the appearance of a professional product at a consumer price.

I refer of course to the Amstrad PCW8256, the complete package, computer, monitor, disc drive, printer and word-processing software for £399 + VAT. Most of the package is UK-designed but, you've already guessed, it's made in Korea.

The Amstrad model will appeal to the small business user as well as the hobbyist but at the higher priced professional end of the market at least one analyst is forecasting as much as a five-fold increase in PC sales in Western Europe by 1990 with IBM retaining a dominant position. Prices will come down but not so dramatically as in the home and hobby market.

At the far extreme of the supercomputers, the massive number-crunchers, the Crays and Cybers, there is still strong demand in research and defence applications although sales are mainly one-offs.

In the general mainframe business ICL is working on feasibility studies for a network for the UK Social Services. The network is planned to have 19,000 terminals in 500 local offices and is expected to cost £140 million. The computers themselves will cost some £30 million.



FROM



ILP Toroidal Transformers are now available through Jaytee. The UK Distributor with the availability and service to match the quality of the toroidals.

Jaytee Electronic Services
 Dept PE1, 143 Reculver Road, Beltinge,
 Herne Bay, Kent CT6 6PL.
 Telephone: (0227) 375254

FOR FREE DATA PACK PLEASE
 WRITE TO OUR SALES DEPT.

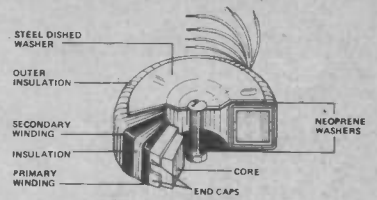
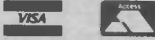

| TYPE | SERIES NO. | SEC. VOLTS | R.M.S. CURRENT |
|---|--|--|---|
| 15VA Regulation 19% 62 x 34 (See diagram) 0.35 Kgs Mounting bolt M4 x 12 | 03010 03011 03012 03013 03014 03015 03016 03017 | 6+6 9+9 12+12 15+15 18+18 22+22 25+25 30+30 | 1.25 0.83 0.63 0.50 0.42 0.34 0.30 0.25 |
| 30VA Regulation 18% Size A B C 70 35 37 0.45 Kgs Mounting bolt M5 x 50 | 13010 13011 13012 13013 13014 13015 13016 13017 | 6+6 9+9 12+12 15+15 18+18 22+22 25+25 30+30 | 2.50 1.66 1.25 1.00 0.83 0.68 0.60 0.50 |
| 50VA Regulation 13% Size A B C 80 40 43 0.9 Kgs Mounting bolt M5 x 50 | 23010 23011 23012 23013 23014 23015 23016 23017 23028 23029 23030 | 6+6 9+9 12+12 15+15 18+18 22+22 25+25 30+30 110 220 240 | 4.16 2.77 2.08 1.56 1.38 1.13 1.00 0.85 0.45 0.22 0.20 |
| 80VA Regulation 12% Size A B C 95 40 43 1.0 Kgs Mounting bolt M5 x 50 | 33010 33011 33012 33013 33014 33015 33016 33017 33028 33029 33030 | 6+6 9+9 12+12 15+15 18+18 22+22 25+25 30+30 110 220 240 | 6.66 4.44 3.33 2.66 2.22 1.81 1.60 1.33 0.72 0.36 0.33 |
| 120VA Regulation 11% Size A B C 95 45 50 1.2 Kgs Mounting bolt M5 x 50 | 43010 43011 43012 43013 43014 43015 43016 43017 43018 43028 43029 43030 | 6+6 9+9 12+12 15+15 18+18 22+22 25+25 30+30 35+35 110 220 240 | 10.00 6.66 5.00 4.00 3.33 2.72 2.40 2.00 1.71 1.09 0.54 0.50 |

| TYPE | SERIES NO. | SEC. VOLTS | R.M.S. CURRENT |
|---|---|---|---|
| 100VA Regulation 8% Size A B C 110 45 50 1.8 Kgs Mounting bolt M5 x 50 | 53011 53012 53013 53014 53015 53016 53017 53026 53028 53029 53030 | 9+9 12+12 15+15 18+18 22+22 25+25 30+30 40+40 110 220 240 | 8.89 6.66 5.33 4.44 3.63 3.20 2.66 2.00 1.45 0.72 0.66 |
| 225VA Regulation 7% Size A B C 110 50 55 2.2 Kgs Mounting bolt M5 x 60 | 63012 63013 63014 63015 63016 63017 63026 63028 63030 | 12+12 15+15 18+18 22+22 25+25 30+30 40+40 45+45 50+50 220 240 | 9.38 7.50 6.25 5.11 4.50 3.75 2.81 2.50 2.25 1.02 0.93 |
| 300VA Regulation 6% Size A B C 110 57 62 2.6 Kgs Mounting bolt M5 x 60 | 73013 73014 73015 73016 73017 73018 73026 73028 73029 73030 | 15+15 18+18 22+22 25+25 30+30 35+35 40+40 45+45 50+50 220 240 | 10.00 8.33 6.82 6.00 5.00 4.28 3.75 3.33 3.00 1.36 1.25 |
| 500VA Regulation 5% Size A B C 135 60 65 4.0 Kgs Mounting bolt M8 x 70 | 83018 83017 83018 83025 83033 83042 83028 83029 83030 | 25+25 30+30 35+35 40+40 45+45 55+55 110 220 240 | 10.00 8.33 7.14 6.25 5.55 4.54 4.54 2.27 2.08 |

| TYPE | SERIES NO. | SEC. VOLTS | R.M.S. CURRENT |
|---|---|---|---|
| 825VA Regulation 4% Size A B C 140 70 75 5.0 Kgs Mounting bolt M8 x 90 | 93017 93018 93026 93025 93033 93042 93028 93029 93030 | 30+30 35+35 40+40 45+45 50+50 55+55 110 220 240 | 10.41 8.92 7.81 6.94 6.25 5.68 5.68 2.84 2.60 |

ILP TRANSFORMERS ARE NOW SUPPLIED WITH DUAL PRIMARIES PERMITTING 110V OR 220/240V OPERATION

THE TOROIDAL POWER TRANSFORMER

Offers the following advantages:-
 SMALLER SIZE AND WEIGHT TO MEET MODERN 'SLIMLINE' REQUIREMENTS.
 LOW ELECTRICALLY INDUCED NOISE DEMANDED BY COMPACT EQUIPMENT.
 HIGH EFFICIENCY ENABLING CONSERVATIVE RATING WHILST MAINTAINING SIZE ADVANTAGES.
 LOWER OPERATING TEMPERATURE.

PRICES

| VA | SERIES NO. | £ | VA | SERIES NO. | £ |
|-----|------------|-------|-----|------------|-------|
| 15 | 0 | 8.37 | 160 | 5 | 14.95 |
| 30 | 1 | 9.67 | 225 | 6 | 16.33 |
| 50 | 2 | 10.70 | 300 | 7 | 17.84 |
| 80 | 3 | 11.96 | 500 | 8 | 23.37 |
| 120 | 4 | 12.71 | 625 | 9 | 25.96 |

SIZES

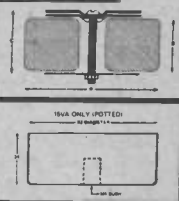

ALL ABOVE PRICES INCLUDE VAT AND CARRIAGE. QUANTITY DISCOUNTS AVAILABLE FOR 6 OR MORE OF ANY ONE TYPE

CT1000K CLOCK/TIMER KIT
24hr Digital clock with presettable ON and OFF time for output. Ideal for use with tape recorders, lighting etc
£14.90

REGULATORS
78 Series 50p
78L Series 30p

ANTEX SOLDERING IRONS
15w £5.20 25w £5.45

BEGINNERS PROJECT PACK
Build 10 fascinating projects including burglar alarm, intercom, thermostat etc on the solderless breadboard enclosed. Full circuit descriptions and layouts included
XK118 £12.50

VERO

Mk1 THERMOSTAT KIT
will control 1kW heater. Ideal for greenhouse ONLY £4.60

BT Phone connectors starter pack
£9.50

TOOLS
Side cutters £2.10
See Cat. for full range.

PANTEC KITS

XK113 M.W. RADIO KIT
A sensitive radio with wound aenal & earpiece requires 9V battery **£5.50**

TRIACS

FREE 28 page catalogue. Send 9x6 SAE NOW!
Telephone orders - Access & Barclaycard
RING 01-567 8910 (24hrs)

CMOS
4001 18p
4017 39p

VELLEMAN KITS

BOOKS
By Babani, Tl and Elektor

MULTIMETERS
Analogue from £6.50
Digital from £26.95

LINEAR ICs
555 21p
CMOS 555 55p
741 22p
LM3914 £2.65
LS7225 £2.60
+ Lots lots more in our Cat

ULTRA SENSITIVE DVM/THERMOMETER KIT
3½ Digit LCD design drawing a mere 150µA at 9v. 200 mV full scale or -20 to +150°C thermometer **£15.50**

BOXES
Plastic, diecast aluminium

LEDs
from 9p

PLUS A WIDE RANGE OF PLUGS, SOCKETS, RESISTORS, POTS, CAPS, VERO etc etc

ELECTRONICS
 13 BOSTON RD
 LONDON W7 3SJ
 Tel. Orders: 01-567 8910
 Enquiries: 01-579 9794
 Shop Hours: Mon-Fri. 9am-5pm
 Sat. 10am-4pm.

**ORDERING INFORMATION:
 ALL PRICES EXCLUDE VAT**

FREE P&P on orders over £20 (UK only), otherwise add 75p + VAT. Overseas P&P: Europe £2.75. Elsewhere £6.50. Send cheque/PO/Barclaycard/Access No. with order. Giro No. 529314002.

LOCAL AUTHORITY AND EXPORT ORDERS WELCOME
GOODS BY RETURN SUBJECT TO AVAILABILITY

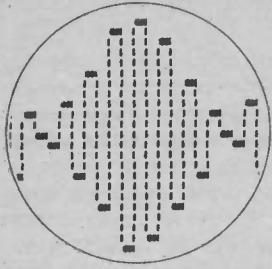

Micro-Scope

John M.H. Becker | Part 2

Computerised circuit tester for audio to visual display on Commodore PET or BBC

In Part 1 of this article, we discussed in detail the circuit operation of the Micro-Scope and to get you going on constructional aspects, we included the p.c.b. design and the components list.

CONSTRUCTION

As this project is aimed at the fairly advanced hobbyist, it is felt that little need be said about p.c.b. assembly as it is very straightforward. The wiring diagram of Fig. 5 illustrates how the controls should be connected to the p.c.b. and Fig. 6 shows the various computer ports which may be used with this project.

The following text continues with the application details of the Micro-Scope and should be followed in conjunction with the complete program listing which is available from our editorial offices (see Constructors' Note).

PEAK TO PEAK

The program routine finds the maximum and minimum levels the numbers reach, the difference between the two is stored and represents the peak to peak voltage value. Upon completion the program drops back to BASIC which then finally calculates and displays the voltage and frequency values in the top screen line. The keyboard will then be checked for a keypress and if none is found it will jump back to the first machine code routine for the next sampling block. Although BASIC is comparatively slower than machine code for the factor displays, leaving this routine in BASIC gives flexibility if anyone wants to put extra parameters into the program.

ACQUISITION RATE

Without any synchronisation or rate correction, the program acquires and displays data as fast as it can. The acquisition time is basically around 59 microseconds, so the 256 memory locations can be filled in about 15ms. The number of times that a full block is read and displayed is about four times per second. At any time while the main program is running any of the keys may be pressed, and during its drop back into BASIC the computer will assess which key has been pressed, and what action to take. Pressing any key except those stated in the menu options at the start will cause the program to request new information, whereupon synchronisation and rate factors can be changed. The rate at which data is acquired can be slowed down in steps of 10 microseconds over a range of 255 progressions. This is done by varying the length of a holding loop in the sampling program, the holding factor being set from BASIC. The maximum delay obtainable between each sample is about 2.5ms. This enables slow speed waveforms to be sampled and effectively compressed. The frequency counter corrects for this holding displacement. Note that the precise delay may vary depending on the memory location of the holding loop as page boundaries may affect it.

The point at which signal sampling takes place can also be set from BASIC at the same time that the rate is set. Normally acquisition occurs at the first available point in the frequency cycle, but by setting sync, the start of acquisition can be delayed until the signal slope has reached a point above the set level. This provides for a more stable signal display.

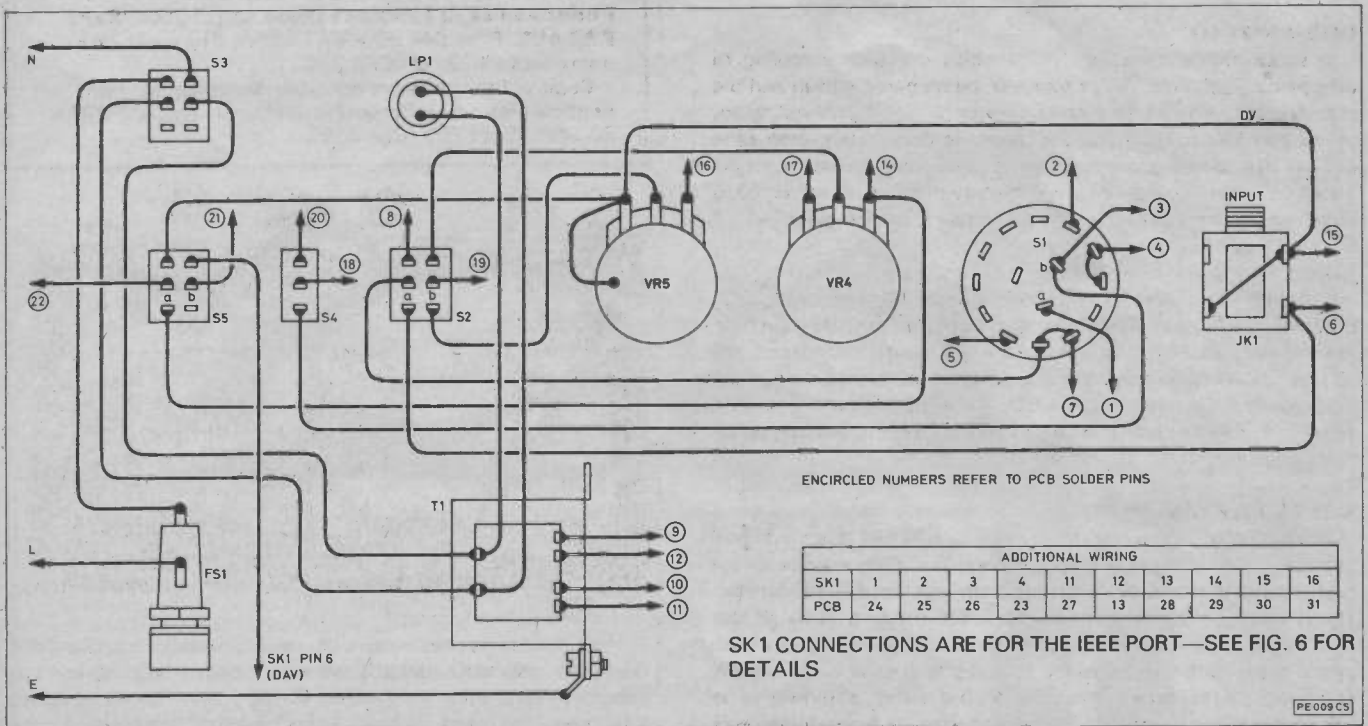

Fig. 5. Interwiring details of the Micro-Scope

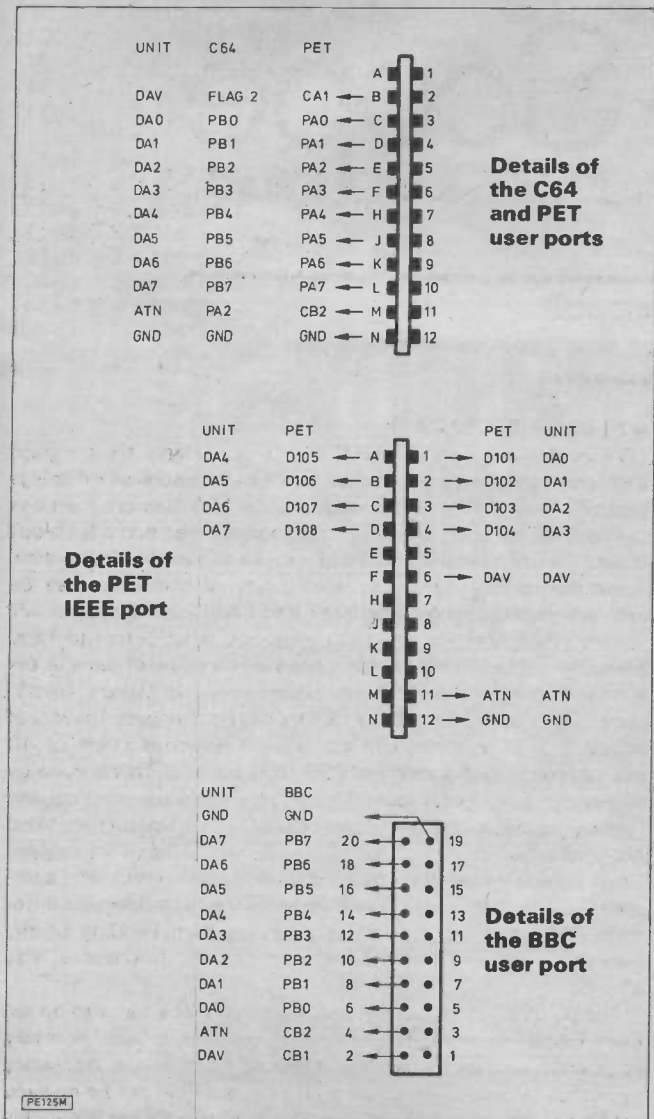

Fig. 6. Computer port connection details

ONE-SHOT (+)

In scope mode, pressing "+" enables one-shot sampling to take place. Each time "+" is pressed the memory is filled and the screen displayed and held indefinitely until "+" is pressed again, or another key to return to the menu. In conjunction with sync setting this allows the computer to wait for a particular signal transient, capture and display it for examination. If no signal is acquired the program will wait indefinitely after pressing "+".

PRINTER (P)

A paper read-out to a printer can also be achieved simply by pressing "P" when in the one-shot mode. Any data displayed on the screen will be printed out as a permanent record of the display, including frequency, voltage, sync and rate factors. If the control unit is connected to the IEEE line in addition to the printer, the switch S5 must be turned off to take IC2 off the bus before the printer will respond.

VOLTS BAR GRAPH (V)

Whilst in the scope mode, if "V" is pressed the mode will change to the voltage bar graph display. This allows either a.c. or d.c. voltage levels to be displayed both graphically and numerically in steps of 10mV from 0V to 2,540mV (see photo H last month). At 2,550mV and above the screen flashes to indicate an out of range condition. From the volts mode, pressing "S" returns the program to scope mode with the same parameters as previously set. Any other key pressed enables fresh parameters to be set.

HIGH RATE (!)

The final option comes from pressing "!" to put the program into non-interruptible scope mode in which only data acquisition and display are performed without frequency and voltage calculation. The result is a faster display rate, of about nine full screen blocks per second, but as the program does not drop back to basic, once set it cannot be interrupted without turning off the computer and the program reloaded. Therefore, sync and rate factors should be set immediately prior to the high speed mode.

For those wishing to convert the data statements for other computers, the following variables are used. Not all computers may require all equivalent registers to be set.

BA, RV and VE = Symbols for Bar Graph, Reverse Screen and Vertical Line respectively.

BN and BQ = 208 and 240 respectively if data register flag does not equal zero on receipt of DAV. They are 240 and 208 respectively if register flag equals zero at DAV. (208 is "BNE" in 6502 and 6510 machine code, and 240 is "BEQ".) DN and UP set the respective bit that toggles the ATN line. DR = Data Direction Register to be set for all Data lines to be used as inputs.

ML and MH = Low and High bytes respectively of Top of Memory pointers.

PI = Data Port output location.

RG = Interrupt Control Register that detects DAV.

SC = First Screen RAM location.

SE = Bit that is set upon receipt of DAV.

V1 = Data Port register that sends ATN.

Z0 and Z1 = Zero Page temporary storage locations, need to be consecutive.



Constructors' Note

The full kit of parts is available from **Becker-Phonosonics, 8 Finucane Drive, Orpington, Kent BR5 4ED**. Price £44.50 + VAT + P&P. The p.c.b. on its own costs £3.33. ☎ 0689 37821.

Copies of the software are available on request from *Practical Electronics* (Poole office). Please send SAE 230 x 300mm. (State PET, C64 or BBC).

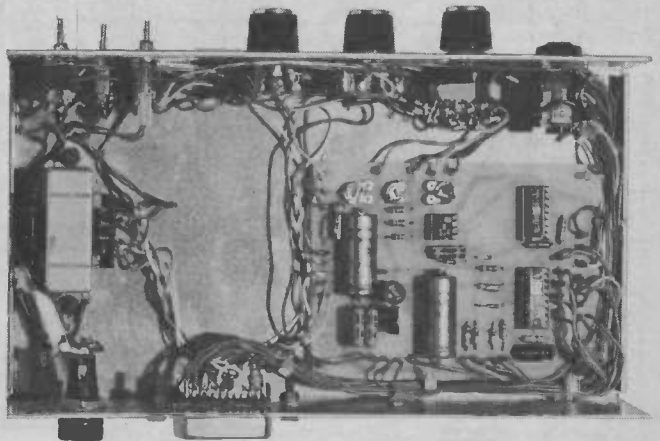

The Pet also requires location 59467 to have Bit 0 set for DAV detection (this automatically occurs in line 1340). Within the program listing other information for BBC users is also given as this computer does a few things slightly differently to the Commodores. ★

PRINTED CIRCUIT BOARD SERVICE

Printed circuit boards for certain PE constructional projects are now available from the PE PCB Service, see list. They are fully drilled and roller tinned. All prices include VAT and postage and packing. Add £1 per board for overseas airmail. Remittances should be sent to: **PE PCB Service, Practical Electronics Editorial Offices, Westover House, West Quay Road, Poole, Dorset BH15 1JG.** Cheques should be crossed and made payable to IPC Magazines Ltd.

Please note that when ordering it is important to give project title, order code and the quantity. Please print name and address in Block Capitals. Do not send any other correspondence with your order.

Readers are advised to check with prices appearing in the current issue before ordering.

NOTE: Please allow 28 days for delivery. We can only supply boards listed here.

| PROJECT TITLE | | Order Code | Cost |
|----------------------------------|----------|------------|-------|
| Spectrum Autosave | MAR '84 | 403-01 | £2.90 |
| Sustain Unit | | 405-02 | £2.90 |
| Audio Signal Generator | MAY '84 | 405-03 | £4.28 |
| " | | 405-04 | £2.90 |
| Cross Hatch Generator | JUNE '84 | 406-01 | £3.52 |
| Simple Logic Analyser I | | 407-01 | £7.73 |
| EPRM Duplicator | JULY '84 | 407-02 | £3.74 |
| Alarm System | | 407-03 | £3.19 |
| Oscilloscope Calibrator | | 407-04 | £4.23 |
| Comm. 64 RS232C Interface | | 408-01 | £3.02 |
| Field Measurement | AUG '84 | 408-02 | £3.19 |
| " | | 408-03 | £2.90 |
| Simple Logic Analyser II | | 408-05 | £2.93 |
| Parallel to Serial Converter | | 409-01 | £2.92 |
| Through the Mains Controller | SEPT '84 | 409-02 | £2.90 |
| " | | 409-03 | £2.90 |
| Logic Probe | OCT '84 | 410-01 | £2.90 |
| Computer DFM Adaptor | NOV '84 | 411-01 | £2.90 |
| Ni-Cad Charger | DEC '84 | 412-01 | £2.90 |
| Outrider Car Computer (Set of 2) | JAN '85 | 501-01 | £9.10 |
| Modular Audio Power System | | | |
| Pt-1: Power Amp Board | FEB '85 | 502-01 | £4.19 |
| Spectrum DAC/ADC Board | | 502-02 | £3.69 |

| | | | | |
|---|------------|-----------------|--------|-------|
| Modular Audio Power System | | | | |
| Pt-2: Pre-Amp/Line Driver | MARCH '85 | 503-01 | £5.00 | |
| Main Board | | 503-02 | £5.12 | |
| Heart Beat Monitor—Main Circuit Board | | 503-03 | £8.90 | |
| —Detector | | 503-04 | £6.62 | |
| Low Cost Speech Synthesiser | | 503-05 | £3.42 | |
| Power Control Interface | | 504-01 | £3.36 | |
| Disc Drive PSU | | 504-02 | £6.54 | |
| Modular Audio Power System | APRIL '85 | | | |
| Pt-3: Test Signal Source | | 504-09 | £4.20 | |
| Power Supply | | 504-10 | £4.17 | |
| Amstrad Synthesiser Interface | | 505-01 | £4.23 | |
| Rugby Clock Pt-2 | | 504-03 | £24.22 | |
| " | | 504-04 | £9.06 | |
| " | MAY '85 | 504-05 | £5.12 | |
| " | | 504-06 | £9.54 | |
| " | | 504-07 | £5.40 | |
| " | | 504-08 | £10.24 | |
| CBM64 Music Keyboard | | | | |
| Keyboard | JUNE '85 | 506-02 | £4.55 | |
| Main PCB | | 506-03 | £3.50 | |
| MTX 8 Channel A to D | JULY '85 | 507-01 | £3.92 | |
| Voltmeter Memory Adaptor | | 506-01 | £3.28 | |
| Envelope Shaper | AUGUST '85 | 508-01 | £3.73 | |
| Car Boot Alarm | SEPT '85 | 509-01 | £2.90 | |
| RS232 To Centronics Converter | | 509-03 | £4.95 | |
| Touch control PSU | | 001 | £3.17 | |
| Exp. with Robots (double-sided) | OCT '85 | 004 | £16.91 | |
| Modulated Syndrum | | 005 | £3.80 | |
| CBM User Port Expander | | 006 | £3.93 | |
| Model Railway Track Control | | 010 | £5.44 | |
| *Bytebox: ROM Board (double-sided) | | 002 | £12.75 | |
| ZIF Socket | NOV '85 | 003 | £2.90 | |
| RAM Board | | 007 | £4.95 | |
| Battery Backed RAM | | 008 | £3.74 | |
| EPRM Board | | 009 | £2.93 | |
| *Special Price—Complete set of 5 boards | | 00A | £23.00 | |
| Model Railway | | Rec Board—A | 016 | £3.90 |
| Track Control | DEC '85 | Rec Board—B | 017 | £4.86 |
| | | Rec Board—B Ext | 018 | £3.93 |
| Test Load | | | 019 | £2.90 |
| | JAN '86 | | | |
| Exp. with Robots | | 022 | £3.71 | |
| Spectrum Speech | | | | |
| Synth & 8-Bit I/O Port (double-sided) | | 023 | £6.49 | |

YOU'LL NEVER SEE IT'S LIKE AGAIN!

new **scientist's** Guide to Halley's Comet

After 76 years in distant orbit, Halley's Comet makes its long-awaited return this winter. New Scientist marks the big event with this definitive guide compiled by seventeen of Britain's leading comet experts. Complete the order form and post with cheque or P.O. to Post Haste, Unit 3, Roslin Square, Roslin Road, Acton, London, W3, allowing 28 days for delivery.



NEW SCIENTIST HALLEY'S COMET SPECIAL

Please send me.....copy/copies of the New Scientist Special, Halley's Comet, at £2.25 each (inc. p & p) for which I enclose cheque/P.O. for £.....payable to New Scientist. (Overseas readers: please add 75p per copy).

Name
(PLEASE PRINT)

Address

Post code

Post Haste, Unit 3, Roslin Square, Roslin Road, Acton, London, W3.



BOOK REVIEWS

THE ILLUSTRATED DICTIONARY OF ELECTRONICS 3rd EDITION

Authors Rufus P. Turner & Stan Gibilisco
Price £21 limp
Size 235 x 285mm. 595 pages
Publisher TAB Books Inc.
ISBN 8 8306 0866 4

WHAT can you say about a publication of this kind? It's a complete A to Z of electronic terms, abbreviations and concepts, with a generous helping of illustrations which clarify and enhance the written description. It may be the most comprehensive, dedicated electronics dictionary, but who needs it?

Unless you are in a position where regular reference to electronic terms is required, this book may be a luxury; nice to have but not really necessary. After saying that, however, for scientists, engineers and advanced hobbyists it could prove to be an extremely useful tool. Each description provides just enough information to enlighten without getting too involved.

The Illustrated Dictionary Of Electronics contains over 27,000 terms, acronyms and abbreviations, fully indexed and cross referenced. There is also a great deal of other useful information such as standard symbols, charts, formulae and data.

R.M.B.



GORG



THE OLD MAN



GENIE



CORYPLEX

DARE YOU BRAVE THE PERILS OF SHINDERG'S TOMB?

The year 2058 AD and Armageddon looms.

500 million geo-human lives in danger. It's up to you, the hero, to save the race. Recovery of the key of peace is vital. The grotesque creatures of the Anti-World must be conquered. A treacherous journey lies ahead in Proteus No.3.

FREE POSTER

Full-Colour (approx. 40x29cms)

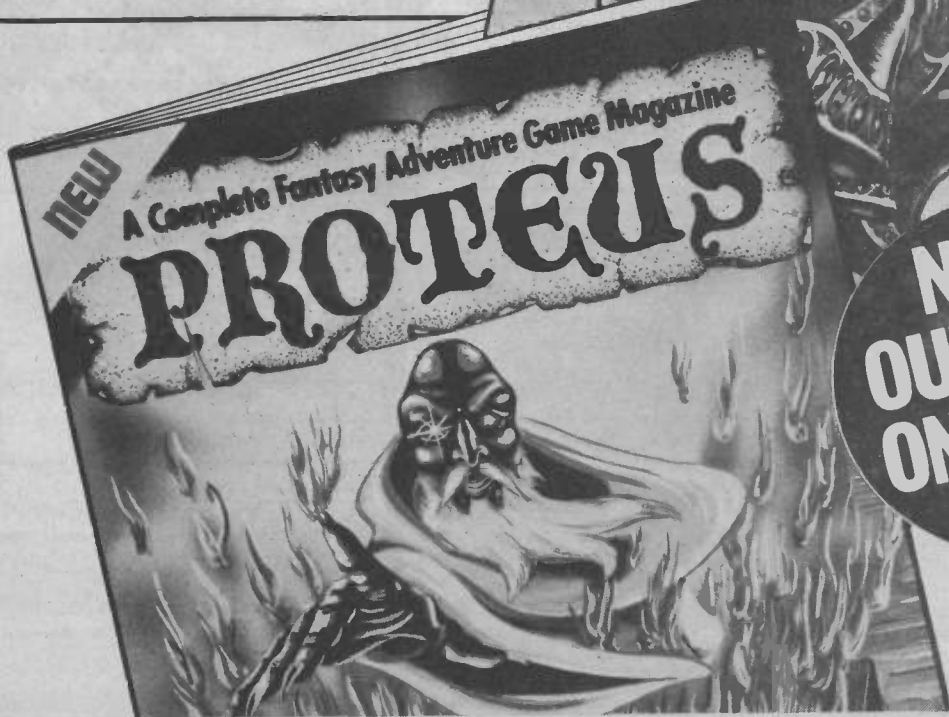

**No.3
OUT NOW
ONLY 80p**

Britain's least expensive fantasy adventure game magazine



When replying to Classified Advertisements please ensure:

- (A) That you have clearly stated your requirements.
 - (B) That you have enclosed the right remittance.
 - (C) That your name and address is written in block capitals, and
 - (D) That your letter is correctly addressed to the advertiser.
- This will assist advertisers in processing and despatching orders with the minimum of delay.

RECEIVERS AND COMPONENTS

MICRO TRANSMITTER 100-108MHz excellent range and sensitivity 9 volt operation. Ready built £12.50 kit £9.50. Transmitter as above built in a two way mains adaptor 240 volt operation uses earth as aerial £22.50. Logic probes try-state shows high state, low state and power on 5-15 volt operation built in hand held case £11.50. All prices include VAT, please add 50p P&P. **ELECTRONIC SERVICES** 69 Fistral Crescent, Stalybridge, Cheshire.

ELECTRONIC COMPONENT CATALOGUE NOW OUT including bargain list please send 50p (refunded with first order over £5.00). **JPG ELECTRONICS**, 276 Chatsworth Road, Chesterfield, S40 2BH. 0246-211202.

BOURNEMOUTH/BOSCOMBE. Electronic components specialists for 33 years. **FORRESTERS (NATIONAL RADIO SUPPLIES)**, Late Holdenhurst Road. Now at 36, Ashley Road, Boscombe. Tel. 302204. Closed Weds.

ESR ELECTRONIC COMPONENTS

- Full range of Components ● Speakers & Accessories
- Audio Connectors & Switches ● Amplifier Modules & Cases

FREE PRICE LIST AVAILABLE

13A STATION ROAD, CULLERCOATS,
NORTH SHIELDS, TYNE & WEAR NE30 4PQ.
TEL: 091 251 4363.

SMALL ADS

The prepaid rate for classified advertisements is 38 pence per word (minimum 12 words), box number 60p extra. Semi-display setting £12.60 per single column centimetre (minimum 2.5 cms). All cheques, postal orders etc., to be made payable to Practical Electronics and crossed "Lloyds Bank Ltd". Treasury notes should always be sent registered post. Advertisements, together with remittance should be sent to the Classified Advertisement Dept., Practical Electronics, IPC Magazines Limited, King's Reach Tower, H.H.204A Stamford St., London SE1 9LS. (Telephone 01-261 5846.)

NOTICE TO READERS

Whilst prices of goods shown in classified advertisements are correct at the time of closing for press, readers are advised to check with the advertiser to check both prices and availability of goods before ordering from non-current issues of the magazine.

RECEIVERS AND COMPONENTS - CONT.

TURN YOUR SURPLUS capacitors, transistors, etc into cash. Contact **COLES HARDING & CO.**, 103 South Brink, Wisbech, Cambs. Tel. 0945 584188. Immediate settlement.

BARGAIN NEW 2N4903 TO3 PNP POWER TRANSISTORS 1-£1.75, 2-£3.00 incl. p&p. Money refund guaranteed. 1 Conifer Drive, Camberley, Surrey.

Carbon Film Resistors 1/4W E24 series 0.51R to 10M - 1p
100 off per value - 75p 1000 off in even hundreds per value - £7
Metal Film 1/4W 10R to 1M 5% E12 series - 2p 1% E24 series - 3p
BC107/8/9 - 12p BC547/8/9 - 7p BC557/8/9 - 7p BC182L, 184L - 10p
BFY50/51/52 - 20p 2N3055 - 50p TIP31A, 32A - 25p TIP42 - 40p

Tantalum bead subminiature electrolytics (Mfds/Volts)
0.1/35, 0.22/35, 0.47/35, 1.0/35, 3.3/16, 4.7/16 - 14p 4.7/35 - 15p
2.2/35, 4.7/25, 10/6 - 15p 4.7/35, 6.8/16 - 16p 10/16, 22/6 - 20p

Aluminium Electrolytics (Mfds/Volts)
1/50, 2.2/50, 4.7/25, 4.7/50, 10/16, 10/25, 10/50 - 5p 22/16, 22/25 - 6p
22/50, 47/16, 47/25, 47/50 - 6p 100/16, 100/25 - 7p 100/50 - 12p
100/100 - 14p 220/16 - 18p 220/25, 220/50 - 10p 470/16, 470/25 - 11p
1000/25 - 25p 1000/35, 1000/40, 2200/25 - 35p 4700/25 - 70p

Miniature Polyester Capacitors 250V Wkg. Vertical Mounting
01, .015, .022, .033, .047, .068 - 4p 0.1 - 5p 0.15, .22 - 6p 0.47 - 8p

Mylar Capacitors 100V Wkg. Vertical Mounting E12 Series
1000p to 8200p - 3p .01 to .068 - 4p 0.1 - 5p 0.15, 0.22 - 6p

Subminiature Ceramic Plate 100V Wkg. E12 Series Vertical Mounting
2% 1P8 to 47P - 3p 56P to 330P - 4p 10% 390P to 470P - 4p

Polystyrene Capacitors 63V Wkg. E12 Series Axial Mounting
10P to 820P - 3p 1000P to 10,000P - 4p 12,000P - 5p
1N4148 - 2p 1N4002 - 4p 1N4006 - 6p 1N5404 - 14p W01 bridge - 25p
0A91 - 6p

Zener diodes E24 series 3V3 to 33V 400mW - 8p 1 watt - 12p
L.E.O's Red, Green & Yellow 3mm & 5mm - 10p 8mm - 35p
20mm fuse 0.1A to 5A quick blow - 5p 5P Anti Surge - 8p
High Speed drills 0.8mm, 1.0mm, 1.3mm, 1.5mm, 2mm - 25p Machines 12V - £6

Nicads AA - 80p HP11 - £2 PP3 - £4.20 Universal Chargers - £6
Glass reed switches single pole make contacts - 8p Magnets - 12p
VAT inclusive. Return postage 10p (free over £5). Lists free.

THE C.R. SUPPLY CO.,
127 Chesterfield Road,
Sheffield S8 0RN. Tel. 557771.

SOFTWARE

BBC ROBOT INTERFACE

4 Outputs for Motors, Lamps, Electromagnets
8 Inputs for the connection of Switches, Relays
2 Analogue inputs for Potentiometers, Photoresistors
Each output can be stopped and also reversed. Fischertechnik compatible.

INTERFACE ONLY £39.95 + £1.50 (p&p)
RED GIANT SOFTWARE LTD
6 Grove Road, Pinner, Middx. HA5 5HW.

HOME SECURITY

CENTURION[®] ALARMS

Manufacturers of Professional Alarm Equipment, for DIY & the TRADE. Send now for our New Full-page Brochure. Full of information & the lowest prices.



Tel: (0484)

21000

or 35527 24 hr.

CENTURION Dept PE
93 Wakefield Road,
Huddersfield,
HD5 9AB
W. Yorks.

® 'CENTURION' is a Registered Trademark of Centurion Alarms

WHO CAN PUT A PRICE ON PEACE OF MIND
PROFESSIONAL EQUIPMENT AT LOW! LOW! PRICES.
HOME SECURITY IS NOW AVAILABLE AT TRADE PRICES
ADVANCED SECURITY PRODUCTS LTD
2 Ealing Road, Aintree,
Liverpool L9 0HU, Merseyside.
Tel: 051-525 3440
FREE CATALOGUE PHONE OR S.A.E.

ORDER FORM PLEASE WRITE IN BLOCK CAPITALS

Please insert the advertisement below in the next available issue of Practical Electronics for

insertions. I enclose Cheque/P.O. for £.....
(Cheques and Postal Orders should be crossed Lloyds Bank Ltd. and made payable to Practical Electronics)

| | | |
|--|--|--|
| | | |
| | | |
| | | |
| | | |

NAME

ADDRESS

PRACTICAL ELECTRONICS

Classified Advertisement Dept., Room 2612,
King's Reach Tower, Stamford Street,
London SE1 9LS Telephone 01-261 5846

Rate:
38p per word, minimum 12 words. Box No. 60p extra.

TEST EQUIPMENT

TTL LOGIC PROBE Don't miss this SENSATIONAL OFFER!

A top quality 3-state Logic Probe to help you "see" your digital circuits working. 3 colour display, durable, ready to use with money back guarantee. Normally £14.50 - Yours for just £8.50 incl. p&p! Hurry whilst our limited stocks last. Cheques/P.O.s only to:

LYON ELECTRONICS
23 Langtoft Road, Stroud, Glos. GL5 1LS.

FOR SALE

PROMS - EPROMS - PALS

EPROMS from £3.25 (2716/2732/2764 etc)
PROMS from £1.50 (TBP/82S/63 series etc)
PALS from £4.25 (12H6/16C1/16L8 etc)
Full Programming Service available
SAE for full price list (incl. RAMs etc)
Any i.c. supplied - if it exists we will find it
PLS, 16 Wordsworth Drive, Chesham, Surrey SM3 8HF.
Phone 01-644 8095 (usually manned 0800-2000 hrs)
Private and professional enquiries welcome.

EDUCATION/TUITION

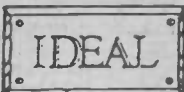

ELECTRONICS

Train for success with our easy home study course. Get a job and the money you want in the industry of the 80's.

Send for FREE BROCHURE, NO OBLIGATION.

IDEAL SCHOOLS
Dept. PE3, Freeport, Woking, Surrey
GU21 4BR (No stamp required).

COURSES

FULL-TIME TRAINING COURSES

2 YEAR

B-TEC National Diploma (OND)
ELECTRONICS &
COMMUNICATIONS ENGINEERING
(Television & Computing).

15 MONTHS

B-TEC National Certificate (ONC)
ELECTRONIC EQUIPMENT SERVICING
(Television & Video)

15 MONTHS

B-TEC National Certificate (ONC)
COMPUTING TECHNOLOGY

9 MONTHS

B-TEC Higher National Certificate (HNC)
COMPUTING TECHNOLOGY
& ROBOTICS

HIGH PERCENTAGE OF COLLEGE BASED
PRACTICAL WORK

SHORT COURSES WITH PREVIOUS
KNOWLEDGE

NO EXTRA CHARGES FOR OVERSEAS
STUDENTS

Prospectus from:

LONDON ELECTRONICS
COLLEGE

Dept: AA, 20 Penywern Road,
London SW5 9SU. Tel: 01-373 8721.

COMPUTERS

PAL EPD FPLA IFL PROGRAMMING SERVICE. Anything from circuit diagram through logic equation to fuse plots accepted to produce programmed devices. Send for details. Tel. 0438 727364 for sample pricing. KOSTADIN LIMITED, 57 Hardwick Road, Titchurst, Reading, Berks, RG3 4LF.

OUTRIDER CAR COMPUTER (PE Project Dec 84/Jan 85) 1/2 kit £29.95; full £59.95. MARK SPACE ENTERPRISES, 11 Churchgreen Road, Bletchley, Bucks, MK3 6BJ.

POWER SUPPLY: 0-20 VOLTS @ 1 AMP continuous. Over current indicator. Ideal for the professional and hobbyist workbench; £18.00. INTEC (INVERCLYDE) LTD, Electronics Department, 5 East Blackhall Street, Greenock, PA15 1HD.

SERVICE SHEETS

BELLS TELEVISION SERVICES for service sheets of Radio, TV, etc £1.50 plus SAE. Colour TV Service Manuals on request. SAE with enquiries to B.T.S., 190 Kings Road, Harrogate, N. Yorkshire. Tel. (0423) 55885.

MISCELLANEOUS

BURGLAR ALARM EQUIPMENT. Ring Bradford (0274) 308920 for our catalogue or call at our large showroom opposite Odsal Stadium.

CLEARING LABORATORY, scopes, generators, P.S.U.'s, bridges, analysers, meters, recorders etc. Tel. 0403-76236.

SUPERB INSTRUMENT CASES by Bazelli, manufactured from PVC. Faced steel. Vast range, competitive prices start at a low £1.50. Puncturing facilities at very competitive prices. BAZELLI, (Dept. 23), St. Wilfreds, Foundry Lane, Halton, Lancaster LA2 6LT.

FREE MEMBERSHIP to new national electronics club. For details and a free gift of components worth over £10 send only £1 P&P to NCC, Woodside, Dowsett Lane, Ramsden Heath, Essex CM11 1JL.

| THE SCIENTIFIC WIRE COMPANY 811 Forest Road, London E17. Telephone 01-531 1568 | | | | |
|---|-------|------|------|------|
| ENAMELLED COPPER WIRE | | | | |
| SWG | 1lb | 8 oz | 4 oz | 2 oz |
| 8 to 34 | 3.63 | 2.09 | 1.10 | 0.88 |
| 35 to 39 | 3.82 | 2.31 | 1.27 | 0.93 |
| 40 to 43 | 6.00 | 3.20 | 2.25 | 1.61 |
| 44 to 47 | 8.67 | 5.80 | 3.49 | 2.75 |
| 48 | 15.96 | 9.58 | 6.38 | 3.69 |
| SILVER PLATED COPPER WIRE | | | | |
| 14 to 30 | 9.09 | 5.20 | 2.93 | 1.97 |
| TINNED COPPER WIRE | | | | |
| 14 to 30 Fluxcore Solder | 3.97 | 2.41 | 1.39 | 0.94 |
| | 5.90 | 3.25 | 1.82 | 0.94 |

Prices include P&P VAT. Orders under £2 add 20p.
SAE for list of copper and resistance wire.
Dealenquiries welcome.

| PRACTICAL ELECTRONICS KITS | |
|--|----------------------------|
| Model Railway Track Control Type "A" | £31.95 Nov PE |
| Model Railway Track Control Type "B" | £42.55 Nov PE |
| P.E. Syndrome | October PE £23.25 |
| Touch Control Power Supply | October PE £28.95 + £1 p&p |
| Car Boot Alarm | September PE £11.90 |
| Article Reprints 60p | P&P 60p unless specified |
| ALL PRICES INCLUDE VAT | |
| CPL ELECTRONICS | |
| 8 Southdean Close, Helmington, Middlesbrough, Cleveland TS8 9HE. Tel: 0642 591157. | |
| Overseas £1 postage. Article reprints 60p. SAE for pictorial of other available kits, components, tools multimeters etc. | |

CABINET FITTINGS

Fretcloths, Coverings, Handles, Castors,
Flight Case Locks & Parts, Jacks, XLRs,
Bulgins, Reverb Trays, P & N mic Stands,
ASS Glassfibre Horns,
CELESTION POWER
Speakers.

Send
30p cheque/
P.O. for illustrated
catalogue. Adam Hall (PE Supplies),
Unit G, Carlton Court, Grainger Road,
Southend-on-Sea.



★ BAKER ★
GROUP P.A. DISCO
AMPLIFIERS post £2

150 watt Amplifier + 4 input Mixer pre-amp. Illustrated £99
150 watt Output, Slave 500 mv. Input 4-8-16 ohm. Outputs £80
150+150 watt Stereo, 300 watt Mono Slave 500 mv. Inputs £125
150 watt P.A. Vocal, 8 inputs. High/Low Mixer Echo Socket £129
100 watt Valve Model, 4 inputs, 5 Outputs. Heavy duty £125
60 watt Mobile 240v AC and 12v DC. 4-8-16 ohm-100 line £89
MIKES Dual Imp £20, Floor Stand £13, Boom Stand £22, PP £2.

Reverb Unit for Microphone or Musical Instruments £35 PP £1.
Electronic Echo Machine for mic/etc. £85. Deluxe £95 PP £1.

H+H 1000w mono, 500w stereo quality amplifiers, model
SS500, reconditioned, guaranteed £275 PP £5.

DISCO CONSOLE Twin Decks, mixer pre amp £145. Carr £10.
Ditto Powered 120 watt £199; or Complete Disco 120 watts £300.
150 watt £200; 360 watt £410, Carr £30.

DISCO MIXER. 240v, 4 stereo channels, 2 magnetic, 2 ceramic/
tape, 1 mono mic channel, twin v.u. meters, headphone monitor
outlet, slider controls, panel or desk mounting, matt black face.
Tape output facility. £59. Post £1.

DELUXE STEREO DISCO MIXER/EQUALISER as above plus L.E.D.
V.U. displays 5 band graphic equaliser, left/right fader, switchable
inputs for phone/line, mike/line. £129 PP £2

Headphone Monitor, Mike Talkover Switch
As above but 3 deck inputs, 4 line/aux inputs, 2 mic inputs, 2
headphone monitors £145.

R.C.S. DISCO LIGHTING EQUIPMENT
READY BUILT DELUXE 4 CHANNEL 4,000 WATT sound chaser +
speed + 4 programs £69. Mk2 16 programs, £89 PP £2.
PARTY LIGHT 4 coloured Flood Lamps Flashing to Music.
Self-contained Sound to Light 410 x 156 x 115mm £34.95 PPEZ.

| FAMOUS LOUDSPEAKERS - SPECIAL PRICES | | | | |
|--------------------------------------|----------------|--------------|--|---------------|
| SIZE ins | POWER WATTS | OHMS IMP | (PHYSICAL SIZE IS NOMINAL MAX FRAME DIMENSION) | PRICE POST |
| 3 1/2 | 10 | 8 | Audax Mini Woofer | £4 £1 |
| 5 | 20 | 4 or 8 | Goodmans Ford Car Radio | £35 £1 |
| 5 1/4 | 60 | 8 | Sound Lab Hi Fi Twin Cone Full Range | £10 £1 |
| 5 1/2 | 25 | 8 | Audax Bextrine Cone Woofer | £10.50 £1 |
| 5 1/2 | 60 | 8 | Sound Lab Hi Fi Twin Cone Full Range | £11 £2 |
| 6 1/2 | 4 | 8 or 16 | Audax Woofer | £15.50 £1 |
| 6 1/2 | 15 | 8 or 16 | EMI Woofer | £5.50 £1 |
| 6 1/2 | 35 | 8 | Audax Bextrine Cone woofer | £17.50 £1 |
| 6 1/2 | 30 | 8 | Goodmans Twin Cone, Hi Fi Full Range | £7.50 £1 |
| 8 | 25 | 4 | Far East Twin Cone, Hi Fi, Full Range | £5.35 £1 |
| 8 | 25 | 4 | Goodmans Woofer | £7.50 £1 |
| 8 | 30 | 8 | Wharfedale Roll Surround Woofer | £9 £1 |
| 8 | 30 | 8 | Audax Hi Fi Woofer | £7.50 £1 |
| 8 | 60 | 8 | I.M.F. Ribbed Bextrine Cone Woofer | £16 £2 |
| 8 | 40 | 8 | Audax Hi Fi Woofer Bextrine Cone | £16.50 £2 |
| 8 | 60 | 8 | Sound Lab Hi Fi Twin Cone Full Range | £14 £2 |
| 8 | 60 | 8 | Goodmans PA & Hi Fi Systems | £14 £2 |
| 8 | 60 | 8 | Goodmans Disco-Guitar-PA | £16 £2 |
| 10 | 30 | 4 or 8 | Far East Bass Woofer, Hi Fi | £14 £2 |
| 10 | 50 | 8 | SEAS Bass Woofer Hi Fi | £19.50 £2 |
| 10 | 15 | 8 | Rigonda General Purpose | £5 £1 |
| 10 | 25 | 8 or 16 | Celestion Disco-PA | £15 £2 |
| 10 | 50 | 8 or 16 | Baker Disco-Guitar-PA | £20 £2 |
| 10 | 50 | 8 or 16 | Celestion Disco-PA | £21 £2 |
| 10 | 60 | 8 | Sound Lab Twin Cone Full Range | £19.50 £2 |
| 10 | 300 | 8 | WEM Woofer | £26 £2 |
| 12 | 30 | 4 or 8 or 16 | Baker Twin Cone Full Range | £18 £2 |
| 12 | 45 | 4 or 8 or 16 | Baker Disco-Guitar-PA | £18 £2 |
| 12 | 80 | 8 | Baker Bass Woofer | £25 £2 |
| 12 | 80 | 8 | Baker 4 or 8 or 16 Baker Disco-Guitar-PA | £22 £2 |
| 12 | 100 | 8 | Goodmans Woofer | £30 £2 |
| 12 | 120 | 8 or 16 | Goodmans Disco-Guitar-PA | £36 £2 |
| 12 | 100 | 8 | H + H PA | £39 £2 |
| 12 | 100 | 8 or 16 | Baker Disco-Guitar-PA | £26 £2 |
| 12 | 150 | 8 | Celestion Disco-Bass Guitar | £35 £3 |
| 12 | 200 | 8 | H + H PA-Disco | £39 £3 |
| 12 | 300 | 8 | WEM Woofer | £44 £3 |
| 13 | 10 | 3 or 8 | EMI (450) Hi Fi with Tweeter | £5 £1 |
| 15 | 100 | 8 | Celestion Disco + Group | £39 £3 |
| 15 | 100 | 8 or 16 | Baker Disco-Guitar-PA | £39 £3 |
| 15 | 100 | 4 or 8 or 16 | H + H Disco Group | £43.50 £3 |
| 15 | 250 | 8 | Goodmans Disco + Group | £74 £3 |
| 18 | 230 | 8 | Goodmans Disco + Group | £97 £4 |
| 18 | 200 | 8 or 16 | Celestion Disco + Group | £110 £4 |

P.A. CABINETS (empty) Single 12 £34; Double 12 £40. Carr £10.
WITH SPEAKERS 45W £52; 75W £56; 90W £75; 150W £84.
200 Watt £100. 400 Watt £180. Carr £10.

300 WATT MID-N-TOP SYSTEM Complete £125 Carr £12.
TWEETER HORNBOXES 200 Watt £32, 300 Watt £38. PP £2.

WATERPROOF HORN SPEAKERS 8 ohms. 25 watt £20. 30 watt
£23. 40 watt £29. 20W plus 100 volt line £38. Post £2.

MOTOROLA PIEZO ELECTRONIC HORN TWEETER, 3 3/8in. square
100 watts. No crossover required. 4-8-16 ohm, 7/8x3 1/8in. £6
£10

METAL GRILLES 8in £3, 10in £3.50, 12in £4.50, 15in £5.50, 18in £7.50.

FULL STOCK OF COMPONENTS, PLUGS, LEADS, ETC.
MAINS TRANSFORMERS Price Post

250-0-250V 80mA. 6.3V 3.5A. 6.3V 1A. £7.00 £2
350-0-350V 250mA. 6.3V 6A CT £12.00 Shrouded £14.00 £2
220V 25mA. 6V 1 Amp £3.00 220V 45mA. 6V 2 Amp £4.00 £1
250V 60mA. 6.3V 2A. £5.00 £1

Low voltage tapped outputs available
1 amp, 6, 8, 10, 12, 16, 18, 20, 24, 30, 36, 40, 48, 60 £6.00 £2
ditto 2 amp £10.50 3 amp £12.50 5 amp £16.00 £2
31-26-0-26-33 volt 6 amp £14.00 £2

LOW VOLTAGE MAINS TRANSFORMERS £5.50 each post paid
9V, 3A; 16V, 2A; 20V, 1A; 30V, 1/2A; 30V, 5A+ 17-0-17V,
2A; 35V, 2A; 20-0-60V, 1A; 12-0-12V, 2A; 20-0-20V, 1A; 50V, 2A.

£8.50 post 50p MINI-MULTI TESTER
Pocket size instrument. A.C./D.C. volts, 15-150-500-1000.
DC current 0-150mA. Resistance 0-100K 1000 ohms p.v.
De-Luxe Range Doubler Meter, 50,000 ohms p.v. 7 x 5 x
2in. Resistance 0/20 meg in 5 ranges. Current 50mA to
10A. Volts 0.25/100V D.C. 10v/100V A.C. £25.00 PP £1

PANEL METERS 50mA, 100mA, 500mA, 1mA, 5mA, 100mA, 500mA,
1 amp, 2 amp, 5 amp, 25 volt, VU 2 1/4x2x1 1/4in. £5.50 post 50p

PROJECT CASES. Black Vinyl Covered Steel Top, Alum Base
4 x 2 1/2 x 2 1/4in. £2.50; 6 x 4 x 1 1/2in. £3.60; 8 x 5 x 2in. £4.00; 11 x
6 x 3in. £5.50; 1 1/4 x 6 x 5in. £9.00; 15 x 8 x 4in. £12.00.

ALUMINIUM PANELS 18 s.w.g. 12 x 12in. £1.80; 14 x 9in. £1.75;
6 x 4in. 55p; 12 x 8in. £1.30; 10 x 7in. 96p; 8 x 6in. 90p; 14 x 3in.
72p; 12 x 5in. 90p; 16 x 10in. £2.10; 16 x 6in. £1.30.

Allow extra PP

ALLUM BOXES. MANY OTHER SIZES IN STOCK.
4 x 2 1/2 x 2in. £1.20; 3 x 2 x 1in. £1; 6 x 4 x 2in. £1.90; 8 x 6 x 3
in. £3; 12 x 5 x 3in. £3.60; 6 x 4 x 3in. £2.20; 10 x 7 x 3in. £3.60

HIGH VOLTAGE ELECTROLYTICS 32+32/500V £2
16/450V 50p 220/400V £2 32+32/350V 50p
20/50V 75p 84-9/450V 75p 16+32+32/500V £2
32/350V 45p 20+20/350V 75p

RECORD PLAYER DECKS. P&P £2.

Make Drive Model Cartridge Price
BSR Single Belt 12 volt Ceramic £22
BSR Single Rim 240v Ceramic £22
AUTOCHANGER BSR 240v Ceramic £22
AUTOCHANGER GARRARD Ceramic £24

Many others in stock. Phone for details.

DECCA TEAK VENEERED PLINTH space for small amplifier.
Board cut for Garrard 18 3/4in. x 14 1/4in. x 4in. £5. Post £2

RADIO COMPONENT SPECIALISTS
Dept 4, 337, WHITEHORSE ROAD, CROYDON

ACCESS SURREY, U.K. Tel: 01-684 1665 VISA

Post 65p Minimum. Callers Welcome.

Full Lists 34p Stamps. Same day despatch. Closed Wednesday

OMP POWER AMPLIFIER MODULES

* PRICES INCLUDE V.A.T. * PROMPT DELIVERIES * FRIENDLY SERVICE * LARGE S.A.E. 28p STAMP FOR CURRENT LIST

OMP POWER AMPLIFIER MODULES

Now enjoy a world-wide reputation for quality, reliability and performance at a realistic price. Four models available to suit the needs of the professional and hobby market i.e. Industry, Leisure, Instrumental and Hi-Fi. etc. When comparing prices. NOTE all models include Toroidal power supply, Integral heat sink, Glass fibre P.C.B. and Drive circuits to power compatible Vu meter. Open and short circuit proof.

Supplied ready built and tested.



OMP100 Mk II Bi-Polar Output power 110 watts R.M.S. into 4 ohms, Frequency Response 15Hz - 30KHz -3dB, T.H.D. 0.01%, S.N.R. -118dB, Sens for Max output 500mV at 10K, Size 355 X 115 X 65mm. PRICE £33.99 + £3.00 P&P.



OMP/MF100 Mos-Fet Output power 110 watts R.M.S. into 4 ohms, Frequency Response 1Hz - 100KHz -3dB, Damping Factor 80, Slew Rate 45V/uS, T.H.D. Typical 0.002%, Input Sensitivity 500mV, S.N.R. -125dB, Size 300 X 123 X 60mm. PRICE £39.99 + £3.00 P&P.



OMP/MF200 Mos-Fet Output power 200 watts R.M.S. into 4 ohms, Frequency Response 1Hz - 100KHz -3dB, Damping Factor 250, Slew Rate 50V/uS, T.H.D. Typical 0.001%, Input Sensitivity 500mV, S.N.R. -130dB, Size 300 X 150 X 100mm. PRICE £62.99 + £3.50 P&P.



OMP/MF300 Mos-Fet Output power 300 watts R.M.S. into 4 ohms, Frequency Response 1Hz - 100KHz -3dB, Damping Factor 350, Slew Rate 60V/uS, T.H.D. Typical 0.0008%, Input Sensitivity 500mV, S.N.R. -130dB, Size 330 X 147 X 102mm. PRICE £79.99 + £4.50 P&P.

NOTE: Mos-Fets are supplied as standard (100KHz bandwidth & Input Sensitivity 500mV). If required, P.A. version (50KHz bandwidth & Input Sensitivity 775mV). Order - Standard or P.A.

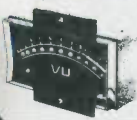

VU METER Compatible with our four amplifiers detailed above. A very accurate visual display employing 11 L.F.D. diodes (7 green, 4 red) plus an additional on/off indicator. Sophisticated logic control circuits for very fast rise and decay times. Tough moulded plastic case, with tinted acrylic front. Size 84 X 27 X 45mm. PRICE £8.50 + 50p P&P.

LOUDSPEAKERS 5" to 15" up to 400 WATTS R.M.S. Cabinet Fixing in stock. Huge selection of McKenzie Loudspeakers available including Cabinet Plans. Large S.A.E. (28p) for free details.



POWER RANGE
 8" 50 WATT R.M.S. Hi-Fi/Disco.
 20 oz. magnet. 1 1/2" ally voice coil. Ground ally fixing escutcheon. Res. Freq. 40Hz. Freq. Resp. to 6KHz. Sens. 92dB. PRICE £10.99 Available with black grille £11.99 P&P £1.50 ea.
 12" 100 WATT R.M.S. Hi-Fi/Disco
 50 oz. magnet. 2" ally voice coil. Ground ally fixing escutcheon. Die-cast chassis. White cone. Res. Freq. 25Hz. Freq. Resp. to 4KHz. Sens. 95dB. PRICE £28.60 + £3.00 P&P ea.

McKENZIE
 12" 85 WATT R.M.S. C1285GP Lead guitar/keyboard/Disco.
 2" ally voice coil. Ally centre dome. Res. Freq. 45Hz. Freq. Resp. to 6.5KHz. Sens. 98dB. PRICE £28.76 + £3.00 P&P ea.
 12" 85 WATT R.M.S. C1285TC P.A./Disco 2" ally voice coil. Twin cone.
 Res. Freq. 45Hz. Freq. Resp. to 14KHz. PRICE £29.80 + £3.00 P&P ea.
 15" 150 WATT R.M.S. C15 Bass Guitar/Disco.
 3" ally voice coil. Die-cast chassis. Res. Freq. 40Hz. Freq. Resp. to 4KHz. PRICE £54.99 + £4.00 P&P ea.
 10" 60 WATT R.M.S. 1060GP Gen. Purpose/Lead Guitar/Keyboard/Mid. P.A.
 2" voice coil. Res. Freq. 75Hz. Freq. Resp. to 7.5KHz. Sens. 99dB. PRICE £19.15 + £2.00 P&P.
 10" 200 WATT R.M.S. C10200GP Guitar, Keyboard, Disco.
 2" voice coil. Res. Freq. 45Hz. Freq. Resp. to 7KHz. Sens. 101dB. PRICE £51.00 + £3.00 P&P.
 15" 200 WATT R.M.S. C15200 High Power Bass.
 Res. Freq. 40Hz. Freq. Resp. to 5KHz. Sens. 101dB. PRICE £59.45 + £4.00 P&P.
 15" 400 WATT R.M.S. C15400 High Power Bass.
 Res. Freq. 40Hz. Freq. Resp. to 4KHz. Sens. 102dB. PRICE £85.00 + £4.00 P&P.

WEM
 5" 70 WATT R.M.S. Multiple Array Disco etc.
 1" voice coil. Res. Freq. 52Hz. Freq. Resp. to 5KHz. Sens. 89dB. PRICE £19.99 + £1.50 P&P ea.
 8" 150 WATT R.M.S. Multiple Array Disco etc.
 1" voice coil. Res. Freq. 48Hz. Freq. Resp. to 5KHz. Sens. 92dB. PRICE £29.49 + £1.50 P&P ea.
 10" 300 WATT R.M.S. Osco./Sound re-enforcement etc.
 1 1/2" voice coil. Res. Freq. 35Hz. Freq. Resp. to 4KHz. Sens. 92dB. PRICE £33.49 + £2.00 P&P ea.
 12" 300 WATT R.M.S. Disco./Sound re-enforcement etc.
 1 1/2" voice coil. Res. Freq. 35Hz. Freq. Resp. to 4KHz. Sens. 94dB. PRICE £41.49 + £3.00 P&P ea.

SOUNDLAB (Full Range Twin Cone)
 5" 60 WATT R.M.S. Hi-Fi/Multiple Array Disco etc.
 1" voice coil. Res. Freq. 63Hz. Freq. Resp. to 20KHz. Sens. 86dB. PRICE £9.99 + £1.00 P&P ea.
 6 1/2" 60 WATT R.M.S. Hi-Fi/Multiple Array Disco etc.
 1" voice coil. Res. Freq. 56Hz. Freq. Resp. to 20KHz. Sens. 89dB. PRICE £10.99 + £1.50 P&P ea.
 8" 60 WATT R.M.S. Hi-Fi/Multiple Array Disco etc.
 1 1/4" voice coil. Res. Freq. 38Hz. Freq. Resp. to 20KHz. Sens. 89dB. PRICE £12.99 + £1.50 P&P ea.
 10" 60 WATT R.M.S. Hi-Fi/Disco etc.
 1 1/2" voice coil. Res. Freq. 35Hz. Freq. Resp. to 15KHz. Sens. 89dB. PRICE £16.49 + £2.00 P&P

PANTEC HOBBY KITS. Proven designs including glass fibre printed circuit board and high quality components complete with instructions.



3 watt FM Transmitter

FM MICROTRANSMITTER (BUG) 90/105MHz with very sensitive microphone. Range 100/300 metres. 57 x 46 x 14mm (9 volt) Price: £8.62 + 75p P&P.
3 WATT FM TRANSMITTER 3 WATT 85/115MHz varicap controlled professional performance. Range up to 3 miles 35 x 84 x 12mm (12 volt) Price: £14.49 + 75p P&P.
SINGLE CHANNEL RADIO CONTROLLED TRANSMITTER/RECEIVER 27MHz. Range up to 500 metres. Double coded modulation. Receiver output operates relay with 2amp/240 volt contacts. Ideal for many applications. Receiver 90 x 70 x 22mm (9/12 volt). Price: £17.82 Transmitter 80 x 50 x 15mm (9/12 volt). Price: £11.29 P&P + 75p each. S.A.E. for complete list.

BURGLAR ALARM

Better to be 'Alarmed' than terrified. Thandar's famous 'Minder' Burglar Alarm System. Superior microwave principle. Supplied as three units, complete with interconnection cable. FULLY GUARANTEED.

Control Unit - Houses microwave radar unit, range up to 15 metres adjustable by sensitivity control. Three position, key operated fascia switch - off - test - armed. 30 second exit and entry delay.

Indoor alarm - Electronic swept freq. siren. 104dB output.

Outdoor Alarm - Electronic swept freq. siren. 98dB output. Housed in a tamper-proof heavy duty metal case.

Both the control unit and outdoor alarm contain rechargeable batteries which provide full protection during mains failure. Power requirement 200/260 Volt AC 50/60Hz. Expandable with door sensors, panic buttons etc. Complete with instructions.
SAVE £138.00 Usual Price £228.85
BKE's PRICE £89.99 + £4.00 P&P
 ? Why buy a collection of self-assembly boards!

IDEAL for Work-shops, Factories, Offices, Home, etc. Supplied ready built.



OMP LINNET LOUDSPEAKERS

The very best in quality and value. Made specially to suit today's need for compactness with high sound output levels. Finished in hard wearing black vinyl with protective corners, grille and carry handle. All models 8 ohms. Full range 45Hz - 20KHz. Size 20" X 15" X 12". Watts R.M.S. per cabinet. Sensitivity 1W. 1mtr. dB.



OMP 12-100 Watts 100dB. Price £149.99 per pair.
OMP 12-200 Watts 102dB. Price £199.99 per pair. Delivery: Securicor £8.00 per pair

OMP 19" STEREO RACK AMPS



Professional 19" cased Mos-Fet stereo amps. Used the World over in clubs, pubs, discos etc. With twin Vu meters, twin toroidal power supplies, XLR connections. MF600 Fan cooled. Three models (Ratings R.M.S. into 4ohms). Input Sensitivity 775mV
MF200 (100 + 100)W. £169.00 Securicor
MF400 (200 + 200)W. £228.85 Delivery
MF600 (300 + 300)W. £274.85 £10.00

1 K-WATT SLIDE DIMMER

* Control loads up to 1Kw
 * Compact Size 4 1/2" X 1" X 2 1/2"
 * Easy snap in fixing through panel/cabinet cut out
 * Insulated plastic case
 * Full wave control using 8 amp triac
 * Conforms to BS800
 * Suitable for both resistance and inductive loads. Innumerable applications in industry, the home, and disco's, theatres etc.
PRICE £13.99 + 75p P&P

BSR P295 ELECTRONIC TURNTABLE

* Electronic speed control 45 & 33 1/2 r.p.m. * Plus/Minus variable pitch control * Belt driven * Aluminium platter with strobed rim * Cue lever * Anti-skate (bias device) * Adjustable counter balance * Manual arm * Standard 1/2" cartridge fixings * Supplied complete with cut out template * D.C. Operation 9-14V O.C. 65mA
 Price £36.99 - £3.00 P&P.

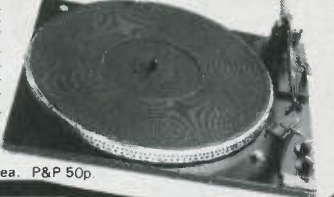

ADC Q4 mag. cartridge for above. Price £4.99 ea. P&P 50p

PIEZO ELECTRIC TWEETERS MOTOROLA

Join the Piezo revolution. The low dynamic mass (no voice coil) of a Piezo tweeter produces an improved transient response with a lower distortion level than ordinary dynamic tweeters. As a crossover is not required these units can be added to existing speaker systems of up to 100 Watts (more if 2 put in series). FREE EXPLANATORY LEAFLETS SUPPLIED WITH EACH TWEETER.

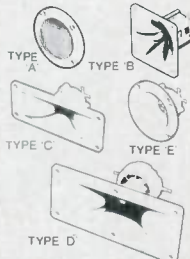

TYPE 'A' (KSN2036A) 3" round with protective wire mesh. Ideal for bookshelf and medium sized Hi-Fi speakers. Price £4.90 each + 40p P&P
TYPE 'B' (KSN1005A) 3 1/2" super horn. For general purpose speakers, disco and P.A. systems etc. Price £5.99 each + 40p P&P
TYPE 'C' (KSN6016A) 2" X 5" wide dispersion horn. For quality Hi-Fi systems and quality discos etc. Price £6.99 each + 40p P&P
TYPE 'D' (KSN1025A) 2" X 6" wide dispersion horn. Upper frequency response retained extending down to mid range (2KHz) Suitable for high quality Hi-Fi systems and quality discos. Price £9.99 each + 40p P&P
TYPE 'E' (KSN1038A) 3 1/2" horn tweeter with attractive silver finish trim. Suitable for Hi-Fi monitor systems etc. Price £5.99 each + 40p P&P
LEVEL CONTROL Combines on a recessed mounting plate, level control and cabinet input jack socket. 85 x 85 mm. Price £3.99 + 40p P&P

STEREO DISCO MIXER

STEREO DISCO MIXER with 2 X 5 band L & R graphic equalisers and twin 10 segment L.E.D. Vu Meters. Many outstanding features. 5 inputs with individual faders providing a useful combination of the following - 3 Turntables (Mag), 3 Mics, 4 Line plus Mic with talk over switch. Headphone Monitor. Pan Pot L & R. Master Output controls. Output 775mV. Size 360 X 280 X 90mm. Price £134.99 - £3.00 P&P

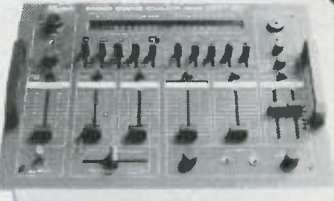

POSTAL CHARGES PER ORDER £1.00 minimum. OFFICIAL ORDERS WELCOME. SCHOOLS, COLLEGES, GOVERNMENT BODIES, ETC. PRICES INCLUSIVE OF V.A.T. SALES COUNTER VISA/ACCESS/C.O.D. ACCEPTED



B. K. ELECTRONICS Dept PE

UNIT 5, COMET WAY, SOUTHEND-ON-SEA, ESSEX, SS2 6TR TEL: 0702-527572

29 Windsor

Maplin

WELCOME TO THE MAPLIN ADVENTURELAND IN 1986...

The new Maplin catalogue for 1986 is a real adventureland for the electronics enthusiast. With hundreds of new lines and details of Maplin's new low low prices, it's the one event in the electronics year that no-one should miss. Packed with data and information on all the latest electronic products. Pick up a copy from any branch of W.H. Smith for just £1.45. Alternatively you can order your copy by post for just £1.85. For overseas customers the prices are as follows: Europe surface mail £2.50; Europe air mail £3.75. Outside Europe surface mail £2.50; Outside Europe air mail depending on distance £4.25/£5.50/£6.25. For surface mail anywhere in the world you may send eleven International Reply Coupons for payment in full.

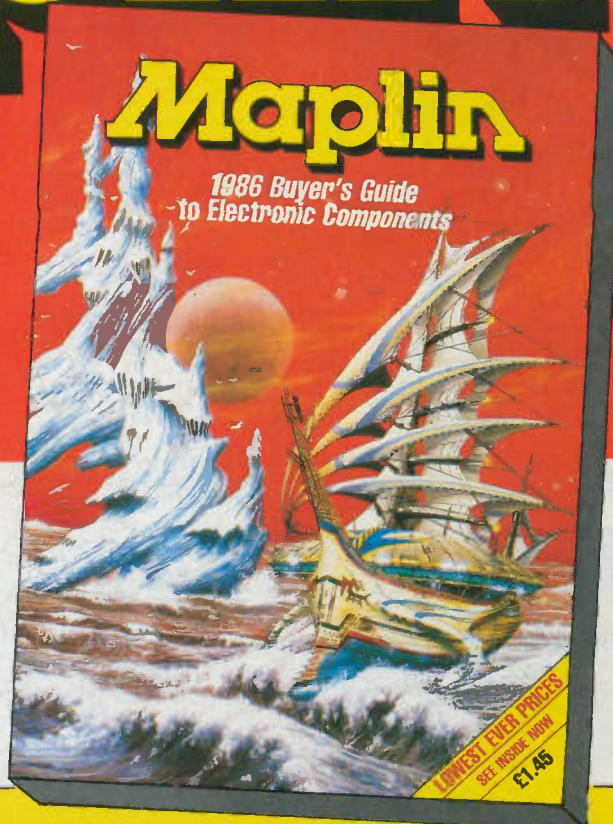

Post this coupon now for your copy of the 1986 catalogue.
Price £1.45 + 40p post and packing. If you live outside the U.K.
send £2.50 or 11 International Reply Coupons. I enclose £1.85.

Name

Address

PE.1.86

MAPLIN ELECTRONIC SUPPLIES LTD.

Mail Order: P.O. Box 3, Rayleigh, Essex SS6 8LR. Tel: Southend (0702) 552911

- SHOPS
- BIRMINGHAM Lynton Square, Perry Barr, Tel: 021-356 7292.
 - LONDON 159-161 King Street, Hammersmith, W6. Tel: 01-748 0926.
 - MANCHESTER 8 Oxford Road, Tel: 061-236 0281.
 - SOUTHAMPTON 46-48 Bevois Valley Road, Tel: 0703 225831.
 - SOUTHEND 282-284 London Rd, Westcliff-on-Sea, Essex. Tel: 0702-554000
- Shops closed all day Monday.

ON SALE NOW



ORDER YOUR COPY NOW