

PRACTICAL

ELECTRONICS

JUNE 1975

30p



ADAPTABLE
**SYSTEMS
MONITOR**

This issue includes
INDEX
for Vol. 10

ALSO

Electronic Multimeter · Reaction Timer

MAKING MUSIC WITH THE PE MINISONIC

NEW EDU-KIT MAJOR

COMPLETELY SOLDERLESS ELECTRONIC CONSTRUCTION KIT
BUILD THESE PROJECTS WITHOUT SOLDERING IRON OR SOLDER

TOTAL BUILDING COSTS

£7.23 P.P. & Ins. 58p
(Overseas Seamail P. & P. £3.40)
(+8% VAT 57p)

- 4 Transistor Earpiece Radio
- Signal Tracer
- Signal Injector
- Transistor Tester NPN - PNP
- 4 Transistor Push Pull Amplifier
- 5 Transistor Push Pull Amplifier
- 7 Transistor Loudspeaker Radio MW/LW.
- 5 Transistor Short Wave Radio
- Electronic Metronome
- Electronic Noise Generator
- Batteryless Crystal Radio.
- One Transistor Radio
- 2 Transistor Regenerative Radio
- 3 Transistor Regenerative Radio
- Audible Continuity Tester
- Sensitive Pre-Amplifier

Components include:

- 24 Resistors ● 21 Capacitors ● 10 Transistors ● 31 Loudspeaker ● Earpiece ● Mica Baseboard
- 3 12-way Connectors ● 2 Volume Controls ● 2 Slider Switches ● 1 Tuning Condenser ● 3 Knobs
- Ready Wound MW/LW/SW Coils ● Ferrite Rod ● 6½ yards of wire ● 1 yard of sleeving, etc.
- Parts price list and plans 55p (free with parts)

ROAMER TEN

Mk. II

WITH VHF INCLUDING AIRCRAFT

10 TRANSISTORS. 9 TUNABLE WAVEBANDS MW1, MW2, LW, SW1, SW2, SW3, TRAWLER BAND, VHF AND LOCAL STATIONS. ALSO AIRCRAFT BAND

Latest 4" 2 watt Ferrite Magnet Loudspeaker. Built-in ferrite rod aerial for MW/LW. Chrome plated 6 section telescopic aerial, can be angled and rotated for peak short wave and VHF listening. Push-pull output using 600mW transistors. Car Aerial and tape record sockets. 10 transistors plus 3 diodes. Ganged tuning condenser with VHF section. Separate coil for Aircraft Band. Volume/on/off, wave change and tone controls. Attractive case in black with silver blocking. Size 9in x 7in x 4in. Easy to follow instructions and diagrams. Parts price list and plans 50p (FREE with parts).

TOTAL BUILDING COSTS **£9.50** P.P. & Ins. 65p
(Overseas Seamail P. & P. £3.50)
(+8% VAT 76p)

POCKET FIVE

NOW WITH 3" LOUDSPEAKER

3 Tunable wavebands. MW/LW and Trawler Band. 7 stages, 5 transistors and 2 diodes, supersensitive ferrite rod aerial, attractive Black and Gold Case. Size 5½in x 1½in x 3½in approx. Plans and parts price list free with parts.

Total Building Costs **£2.95**
(+8% VAT 24p)
P.P. & Ins. 38p
(Overseas Seamail P. & P. £2.30)

ROAMER EIGHT

Mk. I

NOW WITH VARIABLE TONE CONTROL

7 TUNABLE WAVEBANDS: MW1, MW2, LW, SW1, SW2, SW3 AND TRAWLER BAND.

Built-in ferrite rod aerial for MW and LW. Chrome plated telescopic aerial can be angled and rotated for peak short-wave listening. Push-pull output using 600mW transistors. Car aerial and tape record sockets. Selectivity switch. 8 transistors plus 3 diodes. Latest 4" 2 watt Ferrite Magnet loudspeaker. Air spaced ganged tuning condenser. Volume/on/off, tuning, wave change and tone controls. Attractive case in rich chestnut shade with gold blocking. Size 9in x 7in x 4in approx. Easy to follow instructions and diagrams. Parts price list and plans free with parts.

TOTAL BUILDING COSTS **£6.98** P.P. & Ins. 65p
(Overseas Seamail P. & P. £3.50)
(+8% VAT 56p)

NEW JIFFY TESTER

Easy to build and operate, fits in the pocket. A quick checker for continuity of resistors, chokes, diodes, transistors, circuit wiring (not mains) and loudspeakers. Also for checking short circuits of capacitors, tuning capacitors and many other uses not listed here. See instruction sheet free with kit.

Complete with earpiece, jack plug and socket, resistors, capacitors, components, etc. Parts Price List and Easy Build Plans free with Parts.

Total Building Costs **£2.25**
(+8% VAT 18p)
P.P. & Ins. 22p (Overseas Seamail P. & P. £1.70)

NEW EVERYDAY SERIES

EV6

Attractive case in black with red grille, dial and black knobs with polished metal inserts. Size 9 x 5½ x 2½ins approx. 6 Transistors and 2 diodes. Powered by 9 volt Battery. Ferrite rod aerial. 3" loudspeaker, etc. MW/LW coverage. Push Pull Output. Parts price list and plans free with parts.

TOTAL BUILDING COSTS **£3.98** P.P. & Ins. 50p
(Overseas Seamail P. & P. £2.30)
(+8% VAT 32p)

TRANS EIGHT

8 TRANSISTORS

AND 3 DIODES

6 TUNABLE WAVEBANDS. MW, LW, SW1, SW2, SW3 AND TRAWLER BAND. Sensitive ferrite rod aerial for MW and LW. Telescopic aerial for short waves.

3in speaker. 8 improved type transistors plus 3 diodes. Attractive case in black with red grille, dial and black knobs with polished metal inserts. Size 9in x 6½in x 2½in approx. Push-pull output. Battery economiser switch for extended battery life. Ample power to drive a larger speaker. Parts price list and plans free with parts.

TOTAL BUILDING COSTS **£4.48** P.P. & Ins. 50p
(Overseas Seamail P. & P. £2.50)
(+8% VAT 36p)

"Edu-Kit"

Build Radios, Amplifiers, etc., from easy stage diagrams. Five units including master unit to construct.

Components include: Tuning Condenser; 2 Volume Controls; 2 Slider Switches; Fine tone 3" moving coil Speaker; Terminal Strip; Ferrite Rod Aerial; Battery Clips; 4 Tag Boards; 10 Transistors; 4 Diodes; Resistors; Capacitors; Three ½in Knobs. Units once constructed are detachable from Master Unit, enabling them to be stored for future use. Ideal for Schools, Educational Authorities and all those interested in radio construction. Parts price list and plans free with parts.

TOTAL BUILDING COSTS **£5.50** P.P. & Ins. 50p
(Overseas Seamail P. & P. £3.40)
(+8% VAT 44p)

Prices are subject to alteration without notice

★ Callers side entrance "Lavells" shop

★ Open 10-1, 2.30-4.30 Mon.-Fri. 9-12 Sat.

RADIO EXCHANGE LTD

To RADIO EXCHANGE CO., 61a HIGH STREET, BEDFORD MK40 1SA
Tel. 0234 52367 Reg. No. 788372

I enclose £ _____ for _____

ROAMER TEN	<input type="checkbox"/>	EV6	<input type="checkbox"/>
ROAMER EIGHT	<input type="checkbox"/>	TRANS EIGHT	<input type="checkbox"/>
JIFFY TESTER	<input type="checkbox"/>	MAJOR EDU-KIT	<input type="checkbox"/>
POCKET FIVE	<input type="checkbox"/>	EDU-KIT	<input type="checkbox"/>

Parts _____

Name _____

Address _____

PRACTICAL ELECTRONICS

VOLUME 11 No. 6 JUNE 1975

CONSTRUCTIONAL PROJECTS

SYSTEMS MONITOR *by L. J. Bell*

Comparator circuit monitoring explained with the aid of a car system monitor 470

P. E. JOANNA—2 *by A. J. Boothman*

Building the power supply and master tone generator 474

REACTION TIMER *by C. R. Masson*

Check your reaction time to the millisecond 492

ELECTRONIC MULTIMETER *by D. E. Crocker*

The complete high impedance multimeter from basics to finished item 497

GENERAL FEATURES

TRANSDUCERS—3 *by P. R. Allcock*

First section on the inductive transducer 483

SYMBIOSIS—1 *by M. Pointon*

A unique work composed for the P. E. Minisonic 488

INGENUITY UNLIMITED

Cutting Loudspeaker Baffles—Random Flashing Display 509

NEWS AND COMMENT

EDITORIAL—A Good Reference

469

SPACEWATCH *by Frank W. Hyde*

The Russian Science Programmes 480

MARKET PLACE

Live Rhythms, New Calculators, Theatre Mixers, Printed Circuit Kit 506

INDUSTRY NOTEBOOK *by Nexus*

What's happening inside industry 510

READOUT

Selection of readers' letters 513

MILD & BITTER *by A.P.S.*

Can we afford to be educated 514

ALSO WITH THIS ISSUE

INDEX for VOLUME 10

January to December 1974

Between pages 490/491

Our July issue will be published on Friday, June 13, 1975

© IPC Magazines Limited 1975. Copyright in all drawings, photographs and articles published in PRACTICAL ELECTRONICS is fully protected, and reproduction or imitations in whole or part are expressly forbidden. All reasonable precautions are taken by PRACTICAL ELECTRONICS to ensure that the advice and data given to readers are reliable. We cannot, however, guarantee it, and we cannot accept legal responsibility for it. Prices quoted are those current as we go to press. Publisher's Subscription Rate including postage for one year, Inland £4.80, Overseas £5.00. USA and Canada \$13.50. International Giro facilities Account No. 5122007. State reason for payment, "message to payee"



CHINAGLIA

THE PROFESSIONAL QUALITY
MINOR TEST EQUIPMENT

WITH

33 RANGES
20k Ω /V d.c.
4k Ω /V a.c.

- ROBUST CLASS 1.5 PRECISION MOVEMENT
- ACCURACY 2.5% D.C. AND 3.5% A.C.
- 12 MONTH GUARANTEE
- SELF-POWERED AND POCKET-SIZED
- OPTIONAL 30KV D.C. PROBE

PRICE £16.30 Inc.
VAT (P. & P. 80p)
PROBE £8.80

For details of this and the many other exciting instruments in the Chinaglia range, including multimeters, component measuring, automotive and electronic instruments please write or telephone:

CHINAGLIA
(U.K.) LTD. 19 Mulberry Walk, London
SW3 6DZ Tel: 01-352 1897



TRADE ENQUIRIES WELCOMED

GUARANTEED 48hr SERVICE!

SPECIAL OFFERS

SINCLAIR

Stereo 80 Pre-Amp	£11.35	Project 80 F.M. Tuner	£11.35
Z40 Amplifier	£5.10	Project 80 Decoder	£7.50
Z60 Amplifier	£6.60	Project 80 A.F.U.	£6.90
P25 Power Unit	£5.00	Cambridge Calc.	£11.25
P26 Power Unit	£7.50	Camb. Memory	£15.50
P28 Power Unit	£7.00	Scientific	£17.30
P220 Power Unit	£4.75	I.C. 20 Kit	£6.65

BC107	0.12	BC212L	0.13	2N3053	0.17	1N4001	0.07
BC108	0.11	BC214L	0.13	2N3055	0.50	1N4002	0.07
BC109	0.13	BCY70	0.17	2N5442	1.50	1N4148	0.05
BC182	0.11	BCY71	0.22	ZTX304	0.26	OA91	0.09
BC183	0.11	BCY72	0.13	ZTX504	0.35	709	0.38
BC184	0.11	BFY50	0.23	OC23	0.50	741	0.39
BC182L	0.11	BFY51	0.22	OC28	0.70	747	0.90
BC212	0.13	BSX20	0.22	OC35	0.60	SL301B	0.75
BC213	0.13	TIP41A	0.85	OC45	0.30	CA3048	0.75
BC214	0.13	TIP42A	0.95	OC170	0.25	NE555	0.65

7400	0.19	7420	0.20	7475	0.60	7492	0.70
7402	0.20	7430	0.20	7476	0.42	7493	0.67
7404	0.20	7472	0.34	7483	1.25	74107	0.45
7410	0.20	7473	0.48	7486	0.48	74121	0.51
7413	0.38	7474	v.42	7490	0.66	74141	1.00

DIECAST BOXES. 4 $\frac{1}{2}$ in x 2 $\frac{1}{2}$ in x 1in, 50p; 4 $\frac{1}{2}$ in x 2 $\frac{1}{2}$ in x 2in, 70p; 7in x 4 $\frac{1}{2}$ in x 2in, £1.50. **DIL SOCKETS:** 8, 14, 16 pin, 16p. **RESISTORS:** TR5, all values, 2.5p; TR6, 3.5p. **SOLDER:** 22 S.W.G., £1.90; 18 S.W.G., £1.80 $\frac{1}{2}$ kilo.

VAT INCLUSIVE! POST FREE OVER £3!

P.E.C. 49-51 ST. MARY'S ROAD, OATLANDS VILLAGE
WEYBRIDGE, SURREY, KT13 9PX
Mail Order Only.

Telephoned orders: walton-on-Thames (STD Code 98) 21324



CJL PRICES INCLUDE P&P AND V.A.T.

BIB HI-FI ACCESSORIES

- CASSETTE TAPE RECORDER CARE KIT . . . £1.95
- CASSETTE SPLICING AND EDITING KIT . . . £1.50
- HI-FI STEREO TEST CASSETTE . . . £2.10
- TAPE EDITING KIT . . . £1.35
- GROOV-KLEEN RECORD CLEANER . . . £1.85

COMPONENT PACKS

- CAPACITORS-Electrolytic-Tubular Submin-Mixed £0.50
- CAPACITORS-P.C.B. Polyester-Mixed Preferred £0.50
- RESISTORS-Carbon Film-Mixed Preferred . . . £0.50
- POTENTIOMETERS-Midget Carbon Track-Mixed £0.50
- EARPHONE, stethoscope style, 8 ohm dynamic £1.00
- HAND DRILL, (Laytool), compact precision drill, 5/16"chuck. Gears totally enclosed, S/L bearings . . . £2.99

INTEGRATED CIRCUITS

- AUDIO POWER AMPLIFIER (National) LM380 £1.00
- A.M. RADIO RECEIVER (RCA) CA3123E £1.40
- F.M. STEREO DECODER (Motorola) MC1210P £2.80
- TIMER (Signetics) NE555V £0.78
- VOLTAGE REGULATOR (Fairchild) uA7805 £1.70
- VOLTAGE REGULATOR (Signetics) NE550A £0.80
- D.I.L. SOCKETS (Pk of 3) 8 or 14 pin £0.50

- KEYNECTOR, rapid connect to mains-single/multiple leads. Built-in piano switches, neon & 13A fuse £3.20
- LOCKFLEX RULE, (Rabone Chesterman), 3m/10ft precision pocket rule. Easy to read, 13mm/ $\frac{1}{2}$ " wide steel tape. Blade length lockable-power return. A superb rule . . . £0.93

- MICROPHONE, lightweight dynamic, remote start stop, 20 Ω ohms, 100-10kHz, 6mV average output £1.80
- SIGNAL INJECTOR, audio through video signals, excellent for servicing amplifiers, radio & tv . . . £3.92

- SOLDERING IRON, 25 WATT, (Antex), X25, 240V, Very low leakage, 1/8" long life bit (interchangeable) £2.05
- 3/32" bit £0.47 3/16" bit £0.47 Element £1.10

- STAND, ST3, High grade base, chrome plated spring, sponges and accommodation for spare bits. £1.00

CJL CJL LTD. P.O. BOX 34, CANTERBURY, CT1 1YT

SAXON

Money saving high performance audio equipment
DIRECT FROM OUR OWN FACTORIES

GUARANTEED TESTED HIGH PERFORMANCE MODULES—now better value than ever

- | | | | |
|---|---------------|---------------|--|
| SA35
35W RMS 25-50V
7 transistors, 7 diodes | £6-60 | Carriage free | ★ 25Hz-25kHz
★ 0-2% distortion
★ Noise—80dB
★ 500mV into 20K
★ 4-16 ohms |
| SA50
50W RMS 25-65V
7 transistors, 7 diodes | £8-50 | Carriage free | ★ Simple wiring
★ Short and open circuit proof
★ Continuously rated |
| SA100
100W RMS 45-70V
10 transistors, 7 diodes | £12-50 | Carriage free | ★ Top-grade components |
- 120 watt module complete with built-in supply—extra heavy duty £24-75** Carr. 60p



THE SA100 MODULE

POWER SUPPLIES

- | | | | |
|---|---------------------------------|--------------|---------------|
| UNSTABILISED—READY WIRED AND FUSED | | | |
| PU45 | Suits 2 SA35 or 1 SA50 (4 ohm) | £6-50 | Carriage 50p |
| PU70 | Suits 2 SA50 or 2 SA100 (8 ohm) | £9-50 | Carriage 60p |
| STABILISED | | | |
| PS45 | Suits 2 SA35 or 2 SA50 (4 ohm) | £5-50 | Carriage free |
| MT45 | Transformer for above | £3-90 | Carriage 50p |
| PS70 | Suits 2 SA100 | £6-50 | Carriage free |
| MT70 | Transformer for above | £5-50 | Carriage 60p |

N.B. PS70 is not suitable for the SA50

Mk II STEREO DISCO MIXER £29-50

Carr. 50p

This well tried Pre-Amp mixes two decks, handles any ceramic cartridge, and features mic over-ride plus separate full range bass and treble controls on both mic and deck inputs. Ample headphone power is available for P.F.L. May be used for mono and is mains operated. Fitted with sturdy screening case. Controls: Mic vol, bass, treble. Left/Right fade, deck volume, bass, treble, h/phone select, vol, Mains. Size 17½in x 3in x 4in deep.



DISCO MODULE £12-50

Carr. 50p

Thousands sold of this extremely popular mono Pre-Amp. A mic input may be fitted using the VA30 (see below). Low consumption from a 9V battery. Features the same high standards of reproduction as the Stereo version. Controls: H/phone select, vol, Left deck vol, Right deck vol, bass, treble, master vol. Size 12½in x 3in x 2in deep.



3-CHANNEL SOUND-LITE £24-75

Carr. 50p

Only SAXON can supply such incredible value for money. This unit features 3kW power handling, full-wave control, bass, middle, treble AND master controls. Twin loudspeaker jacks for "through" connections. It may be used free standing or will panel mount next to either of the above. Also features unique CUT-BACK circuitry for extra wide range response. Size 12in x 3in x 2½in deep. Professional standards at a price you can afford!



SINGLE CHANNEL VERSION £7-90 Carr. free
High sensitivity, compact, handles 1kW. Full wave operation

Add 8% VAT to all orders

MULTI-PURPOSE MIXERS

M4HL £25-00 Carr. 60p
M6HL £35-00 Carr. 60p

Featuring multiples of our VA30 module, the M4HL and M6HL fulfil the requirements of all clubs, groups, etc. where a high quality mixer is required. Each channel has one high and one low impedance input, plus volume, treble and bass controls. Input impedances may, if required, be easily changed. The M4HL has four channels, and one output, and the M6HL six channels (12 inputs) and a master control and two outputs. Either unit may be used free-standing or panel mounted. These mixers will feed all types of amplifier. Recommended for their versatility and high performance, and excellent value for money.

VA30 CHANNEL MODULE £3-90 Carr. free

This is the basic channel module in the above mixers and may also be used for extra inputs on either the mono or stereo mixers. Fitted with volume, bass and treble controls, requires just a jack and supply (9-100V)

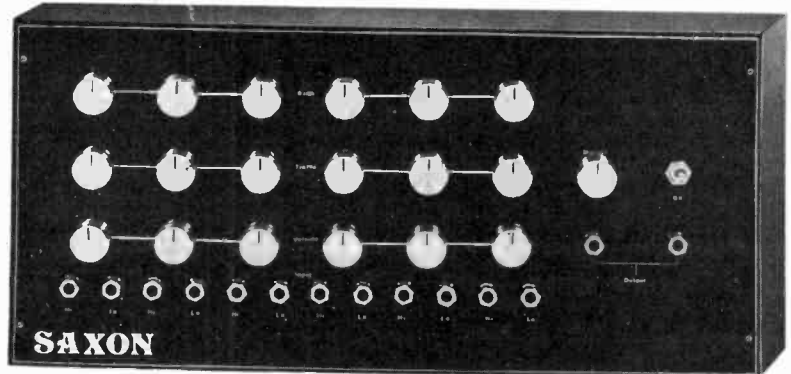

SAXON CSE 100
100W of speech and music—Two separately controlled inputs. Wide range bass and treble controls. Sturdy and attractive ynyd case. Twin outputs. Ideal for groups, discos, etc. Fully tested and guaranteed. 50W version identical in appearance.

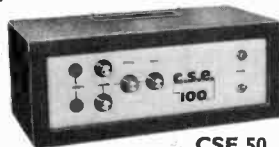

COMPLETE AMPLIFIER

£39-90
Carr. 60p

CSE 50
£33-00 Carr. 60p

NEW!!

SAXON MULTIMIX 100 £57 Carr. £1-00

100W RMS SLIDER controls PLUS master slider. Wide range bass and treble controls—fantastic value. Ideal for complete Disco's, Groups, Clubs, etc.

SAXON MULTIMIX 50 EXACTLY AS ABOVE £45
BUT 50W RMS

SEND 15p FOR OUR NEW 26-PAGE MANUAL—full circuits and details.

TERMS OF BUSINESS: C.W.O., C.O.D. or ACCESS (just send in card number). Send 50p. for C.O.D.

Please include S.A.E. with all enquiries.

VAT at 8% must be added to all orders including carriage charges.

CALLERS AND MAIL ORDER:

SAXON ENTERTAINMENTS LIMITED
327-333 WHITEHORSE ROAD • CROYDON CR0 2HS

(Please quote magazine when ordering)

SHOP HOURS: 9 a.m. 5 p.m. — LUNCH 12.30 1.30 p.m. MAIL ORDER DESK: 10 a.m. 3 p.m.
24-HOUR ANSWER SERVICE TEL. 01-684 6385. TECHNICAL ENQUIRIES 01-684 0098

TRANSFORMERS

SAFETY MAINS ISOLATING TRANSFORMERS
Prim. 120/240V, Sec 120/240V Centre Tapped and Screened

Ref. No.	VA (Watts)	Weight lb oz	Size cm.	P & P £ p
07	20	1 8	7.7 x 6.0 x 6.0	2.80 38
149	60	3 12	9.9 x 7.7 x 8.6	4.37 45
150	100	5 8	9.9 x 8.9 x 8.6	4.89 45
151	200	8 0	12.1 x 9.3 x 10.2	8.13 53
152	350	13 2	12.1 x 11.8 x 10.2	9.83 73
153	500	15 0	14.0 x 10.8 x 11.8	11.88 73
154	500	19 8	14.0 x 13.4 x 11.8	13.65 91
155	750	29 0	17.2 x 14.0 x 14.0	20.51 * *
156	1000	38 0	17.2 x 16.6 x 14.0	29.15 * *
157	1500	46 0	21.6 x 13.4 x 18.1	33.23 * *
158	2000	60 0	21.6 x 15.3 x 18.1	37.07 * *

AUTO TRANSFORMERS

Ref. No.	VA (Watts)	Weight lb oz	Size cm.	Auto Taps	P & P £ p
113	20	1 0	5.8 x 5.1 x 4.5	0-115-210-240	1.67 30
64	75	2 4	7.0 x 6.7 x 6.1	0-115-210-240	2.90 38
4	150	3 4	8.9 x 7.7 x 7.7	0-115-200-220-240	4.12 45
66	300	6 4	9.9 x 9.6 x 8.6	" " "	5.82 53
67	500	12 8	12.1 x 11.2 x 10.2	" " "	8.82 67
84	1000	19 8	14.0 x 13.4 x 14.3	" " "	13.68 91
93	1500	30 4	14.0 x 15.9 x 14.3	" " "	18.31 * *
95	2000	32 0	17.2 x 16.6 x 14.0	" " "	24.20 * *
73	3000	40 0	21.6 x 13.4 x 18.1	" " "	35.09 * *

CASED AUTO TRANSFORMERS

115V mains less input and U.S.A. 2-pin outlets, 20VA £3.13. P & P 38p. 500VA £10.45, P & P 80p. 1000VA £17.51, via B.R.S.

LOW VOLTAGE SERIES (ISOLATED)

Ref. No.	12V	24V	Amps.	Weight lb oz	Size cm.	Secondary Windings	P & P £ p
111	0.5	0.25	8	4.8 x 2.9 x 3.5	0-12V at 0.25A x 2	1.47 23	
213	1.0	0.5	4	6.1 x 5.8 x 4.8	0-12V at 0.5A x 2	1.74 30	
71	2	1	12	7.0 x 6.4 x 6.1	0-12V at 1A x 2	2.29 38	
18	4	2	3	8.3 x 7.7 x 7.0	0-12V at 2A x 2	2.86 38	
70	6	3	12	8.9 x 8.0 x 7.7	0-12V at 3A x 2	4.12 45	
108	8	4	5	8.9 x 8.9 x 8.6	0-12V at 4A x 2	4.56 45	
72	10	5	6	9.9 x 9.6 x 8.6	0-12V at 5A x 2	5.14 53	
116	12	6	6	9.9 x 10.2 x 8.6	0-12V at 5A x 2	5.52 53	
17	16	8	12	12.1 x 9.9 x 10.2	0-12V at 8A x 2	7.26 60	
115	20	10	11	14.0 x 9.6 x 11.8	0-12V at 10A x 2	10.39 73	
187	30	15	15	14.0 x 12.1 x 11.8	0-12V at 15A x 2	13.59 85	
226	60	30	32	17.2 x 15.3 x 14.0	0-12V at 30A x 2	16.83 * *	

30 VOLT RANGE

Ref. No.	Amps.	Weight lb oz	Size cm.	Secondary Taps	P & P £ p
112	0.5	1 4	6.1 x 5.8 x 4.8	0-12-15-20-24-30V	1.81 30
79	1.0	2 4	7.0 x 6.7 x 6.1	" " "	2.40 38
3	2.0	3 4	8.9 x 7.7 x 7.7	" " "	3.49 38
20	3.0	4 8	9.9 x 8.3 x 8.6	" " "	4.53 45
21	4.0	6 4	9.9 x 9.6 x 8.6	" " "	5.13 53
51	5.0	6 12	12.1 x 8.6 x 10.2	" " "	6.41 53
117	6.0	8 0	12.1 x 9.3 x 10.2	" " "	7.15 60
88	8.0	12 0	12.1 x 11.8 x 10.2	" " "	9.90 67
89	10.0	13 12	14.0 x 10.2 x 11.8	" " "	9.87 73

50 VOLT RANGE

Ref. No.	Amps.	Weight lb oz	Size cm.	Secondary Taps	P & P £ p
102	0.5	1 12	7.0 x 6.4 x 6.1	0-19-25-33-40-50V	2.58 30
103	1.0	2 12	8.3 x 7.4 x 7.0	" " "	3.38 38
104	2.0	5 8	7.9 x 8.9 x 8.6	" " "	4.68 45
105	3.0	6 12	9.9 x 10.2 x 8.6	" " "	5.81 53
106	4.0	10 0	12.1 x 10.5 x 10.2	" " "	7.60 67
107	6.0	12 0	14.0 x 10.2 x 11.8	" " "	12.10 67
118	8.0	18 0	14.0 x 12.7 x 11.8	" " "	12.98 85
119	10.0	25 0	17.2 x 12.7 x 14.0	" " "	16.99 * *

60 VOLT RANGE

Ref. No.	Amps.	Weight lb oz	Size cm.	Secondary Taps	P & P £ p
124	0.5	2 4	7.0 x 6.7 x 6.1	0-24-30-40-48-60V	2.33 38
126	1.0	3 4	8.9 x 7.7 x 7.7	" " "	3.41 38
127	2.0	6 4	9.9 x 9.6 x 8.6	" " "	5.08 45
125	3.0	8 12	12.1 x 9.9 x 10.2	" " "	7.52 60
123	4.0	13 12	12.1 x 11.8 x 10.2	" " "	8.75 67
40	5.0	12 00	14.0 x 10.2 x 11.8	" " "	9.75 73
120	6.0	15 8	14.0 x 12.1 x 11.8	" " "	11.30 85
121	8.0	25 00	14.0 x 14.7 x 11.8	" " "	15.00 * *
122	10.0	25 0	17.2 x 12.7 x 14.0	" " "	17.52 * *
189	12.0	29 00	17.2 x 14.0 x 14.0	" " "	19.98 * *

MINIATURE TRANSFORMERS WITH SCREENS

Ref. No.	mA	Weight lb oz	Size cm.	Volts	P & P £ p
238	200	2	2.8 x 2.6 x 2.0	3.0-3	1.54 10
212	1A, 1A	1	6.1 x 5.8 x 4.8	0.6, 0-6	1.84 30
13	100	4	3.9 x 2.6 x 2.9	9.0-9	1.41 13
235	330, 330	4	4.8 x 2.9 x 3.5	0.9, 0-9	1.56 19
207	500, 500	1.00	6.1 x 5.4 x 4.8	0.8-9, 0.8-9	1.92 30
208	1A, 1A	1.12	7.0 x 6.4 x 6.1	0.8-9, 0.8-9	3.30 38
236	200, 200	4	4.8 x 2.9 x 3.5	0.15, 0-15	1.43 19
214	300, 300	1	6.1 x 5.8 x 4.8	0.20, 0-20	1.93 30
221	700 (d.c.)	1	8.7 x 6.1 x 6.1	20-12, 0-12-20	2.17 38
206	1A, 1A	2.12	8.3 x 7.7 x 7.0	0.15-20, 0.15-20	3.46 38
203	500, 500	2	4.8 x 7.0 x 7.0	0.15-27, 0.15-27	3.00 38
204	1A, 1A	3 4	8.9 x 7.7 x 7.7	0.15-27, 0.15-27	3.85 38

*Carriage via B.R.S.

PLEASE ADD 8% FOR V.A.T. INCLUDING P. & P.

BARRIE electronics

3, THE MINORIES, LONDON EC3N 1BJ

TELEPHONE: 01-488 3316/8

NEAREST TUBE STATIONS ALDGATE & ALDGATE EAST

SYNTHESISER Modules by Dewtron®

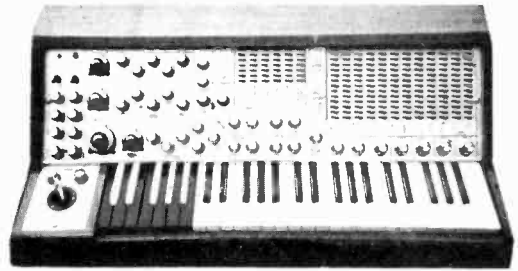

The synthesiser illustrated was built using Dewtron modules, as sold to constructors for some years now. With over 10 years' experience in mail-order, we have supplied many famous people and groups. Over 30 types of synthesis modules, some of extremely precision design, e.g. VCO-2 log-law oscillator; 3-wave o/p/s; sample/hold/envelope module; pitch-to-voltage module allowing a whole equipment to "play itself" in unison/harmony with any solo input or voice. Modules for sequencer construction, too. Famous "Modumatrix" patching system makes other patching a thing of the past! Send just 20p for full catalogue to:

D.E.W. LTD.

254 Ringwood Road, Ferndown
Dorset BH22 9AR



Phoenix Electronics (Solent) Ltd.

139-141 Havant Road
Drayton, Portsmouth, Hants
PO6 2AA

You already know us—get to know us better! Our catalogue is now only 20p—returnable on your first order.

Our prices on a wide range of semiconductors, i.c.'s and passive components include VAT, and, despite rising postal costs, carriage is only 20p, too!

THIS MONTH'S BARGAIN OFFER!

Small signal silicon transistor kit—5 each BC108, BC178, BC205, BC208, BFY51, ME1120, ME8003, 2N2924, 2N2926, 2N3394, ACY28—Catalogue value £7. Bargain pack PEP2A—£4.90.

Please send your catalogue — now!

Name _____

Address _____

INTERNATIONAL ELECTRONICS UNLIMITED

ORDER DIRECT FROM THE U.S. AND SAVE

SHIPMENT MADE WITHIN 3 DAYS FROM RECEIPT OF ORDER VIA AIR MAIL—POSTAGE PAID

TTL



7400	11	7448	11	74150	0.75
7401	11	7450	12	74151	60
7402	11	7451	13	74153	71
7403	11	7453	13	74154	1.05
7404	13	7454	14	74155	95
7405	13	7460	11	74156	71
7406	22	7464	21	74157	71
7407	22	7465	21	74161	95
7408	14	7472	22	74163	1.05
7409	14	7473	26	74164	1.25
7410	11	7474	26	74165	1.25
7411	16	7475	41	74166	1.15
7413	35	7476	26	74173	95
7415	22	7483	70	74175	95
7416	22	7485	80	74176	85
7417	22	7486	24	74177	95
7420	11	7489	1.50	74180	80
7422	22	7490	45	74181	2.50
7423	22	7491	71	74182	80
7425	22	7492	44	74184	1.55
7426	23	7493	44	74185	1.45
7427	22	7494	49	74186	95
7430	12	7495	49	74191	95
7432	22	7496	55	74192	90
7437	25	74100	1.25	74193	85
7438	21	74105	60	74194	95
7440	11	74107	27	74196	80
7441	60	74121	32	74196	1.00
7422	55	74122	50	74197	75
7443	55	74123	55	74198	1.70
7444	60	74125	50	74199	1.70
7445	75	74126	50	74200	3.90
7446	85	74141	68		
7447	80	74145	75		

LOW POWER

74L00	0.16	74L51	0.16	74L90	0.93
74L02	16	74L55	18	74L91	80
74L03	16	74L71	18	74L93	89
74L04	18	74L72	27	74L95	89
74L06	18	74L73	38	74L98	1.53
74L10	16	74L74	38	74L164	1.53
74L20	16	74L78	44	74L165	1.53
74L30	16	74L85	85		
74L42	89	74L86	38		

HIGH SPEED

74H00	0.16	74H21	0.16	74H55	0.20
74H01	16	74H22	18	74H60	21
74H04	16	74H30	18	74H61	21
74H08	16	74H40	16	74H62	20
74H10	16	74H50	16	74H74	32
74H11	16	74H52	18		
74H20	16	74H53	20		

8000 SERIES

8091	0.33	8214	0.93	8811	0.38
8092	33	8220	93	8812	60
8095	76	8230	1.42	8822	1.42
8121	49	8520	71	8830	1.42
8123	88	8551	91	8831	1.42
8130	1.20	8552	1.37	8836	27
8200	1.42	8554	1.37	8880	73
8210	1.92	8810	44		

9000 SERIES

9002	0.21	9309	0.49	9601	0.54
9301	63	9312	49	9602	49

Data sheets supplied only on request. Add 25p ea. for data supplied on items less than 50p ea.

CMOS

74C00	0.21	74C74	0.63	74C162	1.78
74C02	30	74C76	93	74C163	1.78
74C04	41	74C107	82	74C164	1.92
74C08	41	74C151	1.59	74C173	1.59
74C10	36	74C154	1.92	74C195	1.65
74C20	36	74C157	1.20	80C95	82
74C42	1.18	74C160	1.78	80C97	82
74C73	85	74C161	1.78		

INTRODUCTORY SPECIALS

5001	12 DIG 4 funct fix dec	Calculator	1.61	1103	256 bit RAM MOS	Memory	1.61
5002	Same as 5001 exc btry pwr		2.71	5260	1024 bit RAM		1.61
5005	12 DIG 4 funct w/mem		3.81	5261	1024 bit RAM		1.61
5725	8 DIG 4 funct chain & dec		1.23	5262	2048 bit RAM		4.36
5736	18 pin 6 DIG 4 funct		2.44	2102	1024 bit static RAM		3.81
5738	8 DIG 5 funct K & Mem		2.71	5203	2048 bit UV Eras Prom		10.88
5739	9 DIG 4 funct (btry sur)		2.71	HP50827414	4 digit common cathode	Led	
5311	28 pin BCD 6 dig mux	Clock	2.71		Fis 14 pin DIP - 11 bubble lens		1.51
5312	24 pin 1 pps BCD 4 dig mux		2.71	MAN 7	Red 7 seg. 270"		5.4
5313	28 pin 1 pps BCD 6 dig mux		2.71	MAN 66	Red 6" spaced seg		1.92
5314	24 pin 6 dig mux		2.71	MAN 6	Red 6" solid seg		2.47
5316	40 pin alarm 4 dig		3.26	8008	8 bit CPU prime quality		35.36

10% OFF ON ORDERS OVER £10

MEMORIES w/data

1101	256 bit RAM MOS	0.96
1103	1024 bit RAM MOS	2.72
5203	2048 bit erasable PROM	13.68
5260	1024 bit RAM Low Power	2.16
7489	64 bit RAM TTL	1.50
8223	Programmable ROM	2.72

CALCULATOR & CLOCK CHIPS w/data

5001	12 DIG 4 funct fix dec	2.17
5002	Same as 5001 exc btry pwr	4.36
5005	12 DIG 4 funct w/mem	4.63
MM5725	8 DIG 4 funct chain & dec	1.52
MM5736	18 pin 6 DIG 4 funct	2.72
MM5738	8 DIG 5 funct K & Mem	4.36
MM5739	9 DIG 4 funct (btry sur)	3.81
MM5311	28 pin BCD 6 dig mux	3.81
MM5312	24 pin 1 pps BCD 4 dig mux	3.81
MM5313	28 pin 1 pps BCD 6 dig mux	4.36
MM5314	24 pin 6 dig mux	4.90
MM5316	40 pin alarm 4 dig	4.90

LED & OPTO ISOLATOR

MV10B	Red TO 18	0.14
MV50	Axial leads	8
MV5020	Jumbo Vis. Red (Red Dome)	18
	Jumbo Vis. Red (Clear Dome)	18
ME4	infra red diff. dome	18
MAN 1	Red 7 seg. 270"	1.38
MAN 2	Red alpha num. 32"	2.72
MAN 4	Red 7 seg. 190"	1.18
MAN 5	Green 7 seg. 270"	1.62
MAN 6	6" high solid seg.	3.81
MAN 7	Red 7 seg. 270"	74
MAN 8	Yellow 7 seg. 270"	2.17
MAN 64	4" high solid seg.	2.45
MAN 66	6" high spaced seg.	2.55
DL 707	Red 7 seg. 3"	1.18
MCT2	Opto-iso transistor	38

DTL

930	10	937	10	949	10
932	10	944	10	962	10
936	10	946	10	963	10

4000 SERIES RCA EQUIVALENT

CD4001	0.31	CD4013	0.66	CD4023	0.31
CD4009	47	CD4016	69	CD4025	31
CD4010	47	CD4017	1.62	CD4027	74
CD4011	31	CD4019	74	CD4030	52
CD4012	31	CD4022	1.50	CD4035	1.56

LINEAR CIRCUITS



300	Pos V Reg (super 723)	TO-5	0.43
301	Hi Perf Op Amp	mDIP TO-5	18
302	Volt follower	TO-5	43
304	Neg V Reg	TO-5	49
305	Pos V Reg	TO-5	52
307	Op AMP (super 741)	mDIP TO-5	20
308	Micro Pwr Op Amp	mDIP TO-5	60
309K	5V 1A regulator	TO-3	91
310	V Follower Op Amp	TO-5 mDIP	65
311	Hi perf V Comp	mDIP TO-5	58
319	Hi Speed Dual Comp	DIP	71
320	Neg Reg 5.2, 12, 15	TO-3	34
322	Precision Timer	DIP	60
324	Quad Op Amp	DIP	107
329	Quad Comparator	DIP	92
340T	Pos Volt Reg		
370	ISV 8V-12V-15V-18V-24V	TO-220	1.07
372	AGC/Squelch AMPL	TO-5 or DIP	65
373	AF-IF Strip detector	DIP	44
376	AM/FM/SSB Strip	DIP	1.78
377	Pos. V Reg	mDIP	33
380	2w Stereo amp	DIP	1.47
381	2w Audio amp	DIP	81
382	6w Audio amp	mDIP	69
383	Lo Noise Dual preamp	DIP	98
384	Lo Noise Dual preamp	DIP	98
385	Pres V Reg	DIP	44
555	Timer	mDIP	54
560	Phase Locked Loop	DIP	1.50
562	Phase Locked Loop	DIP	1.50
565	Phase Locked Loop	DIP TO-5	1.45
566	Function Gen	mDIP TO-5	1.50
567	Tone Decoder	mDIP	1.62
709	Operational AMPL	TO-5 or DIP	16
710	Hi Speed Volt Comp	DIP	21
711	Dual Difference Compar	DIP	16
723	V Reg	DIP	38
739	Dual Hi Perf Op Amp	DIP TO-5	65
741	Comp Op Amp	mDIP TO-5	20
747	Dual 741 Op Amp	DIP or TO-5	44
748	Frig Adj 741	mDIP	21
1304	FM Mulp. Stereo Demod	DIP	65
1307	FM Mulp. Stereo Demod	DIP	45
1458	Dual Comp Op Amp	mDIP	38
LH2111	Dual LM 211 V Comp	DIP	1.07
3065	TV-FM Sound System	DIP	38
3075	FM Det-LMTR &	DIP	44
	Audio preamp	DIP	44
3900	Quad Amplifier	DIP	33
7524	Core Mem Sense AMPL	DIP	1.04
7534	Core Mem Sense Amp	DIP	1.42
8864	9 DIG Led Cath Drv	DIP	1.37
75451	Dual Peripheral Driver	mDIP	21
75452	Dual Peripheral Driver	mDIP	21
75453	(351) Dual Periph. Driver	mDIP	21
75491	Quad Seq Driver for LED	DIP	55
75492	Hex Digit Driver	DIP	50

Data sheets supplied only on request. Add 25p ea. for data supplied on items less than 50p ea.

ALL ITEMS ARE NEW, MARKED, TESTED FUNCTIONAL—SATISFACTION GUARANTEED. THE ABOVE PRICES DO NOT INCLUDE ANY TAXES LEVIABLE BY A PURCHASER'S COUNTRY OF RESIDENCE

The prices as listed are in British pounds and pence. Send bank cheque (U.S. funds) with order. If international postal money order is used, send receipt with order. Minimum order £2-50p.

INTERNATIONAL ELECTRONICS UNLIMITED
P.O. BOX 1708 MONTEREY, CA. 93940 USA
PHONE (408) 659-3171



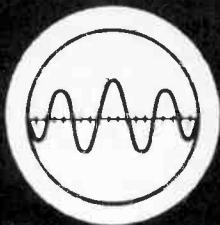

TUAC

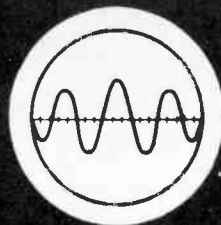

TRANSISTOR UNIVERSAL AMPLIFICATION CO. LTD.
163 MITCHAM RD. LONDON SW17 9PG 01-672 3137/9080

TUAC DISCOTHEQUE MIXER WITH AUTO FADE



Designed for the discerning D.J. of professional standard. Offering a vast variety of functions. Controls: Mic Vol; Tone, over-ride depth; auto; Manual Sw; Tape Vol; L & R Deck Faders; Deck Volume; Treble and Bass; H. Phon Vol Selector; Master Vol On/Off Sw. Max output 1V RMS.

Specification: Deck Inputs—50mV into 1M Ω ; Deck Tone Controls—treble +20 - 10dB at 12kHz. Bass +22 - 15dB at 40Hz. Mic Input—200 ohms upwards. 2mV into 10k Ω ; Mic Tone Control—Total Variation Treble 15dB, Total Variation Bass 10dB; Tape Input—30mV into 47k Ω ; Power Requirements—30-45 volts at 100mA.

£36.50
PANEL SIZE
18 x 4½ in.
DEPTH 3 in.

HOW TO ORDER BY POST

Make cheques/P.O.s payable to TUAC LTD (PE4)
or quote Access/Barclay Card No.
and post to TUAC LTD (PE4)

163 Mitcham Road, London, SW17 9PG

We accept phone orders against Access/Barclay Card Holders
Phone: 01-672 3137/9080

STOCKISTS—CALLERS ONLY

Arthur Sallis Ltd., 28 Gardner Street, Brighton, Sussex. Tel 65806.
Bristol Disco Centre, 86 Stokes Croft, Bristol 1. Tel. 41666. **Socodi**, 9
The Friars, Canterbury. Tel. 60948. **Cookies**, 132 West Street, Crewe. Tel.
4739 or 581202. **Calbarrie Audio**, 88 Wellington Street, Luton. Tel. 411733.
A1 Music Centre, 88 Oxford Street, Manchester. Tel. 061-236 0340.
Damon Electronics, 99 Carrington Street, Nottingham. Tel 53880.
Mitchell Electronics, 64 Winchester Street, Salisbury. Tel 23689. **Wec
Lighting**, 10 Commercial Road, Southampton. Tel. 28102.

3 CHANNEL LIGHT MODULATOR

- R.C.A. 8 Amp Triacs ● 1000W per channel ● Each channel fully suppressed and fused
- Master control to operate from 1W to 100W ● Full wave control—12 easy connections

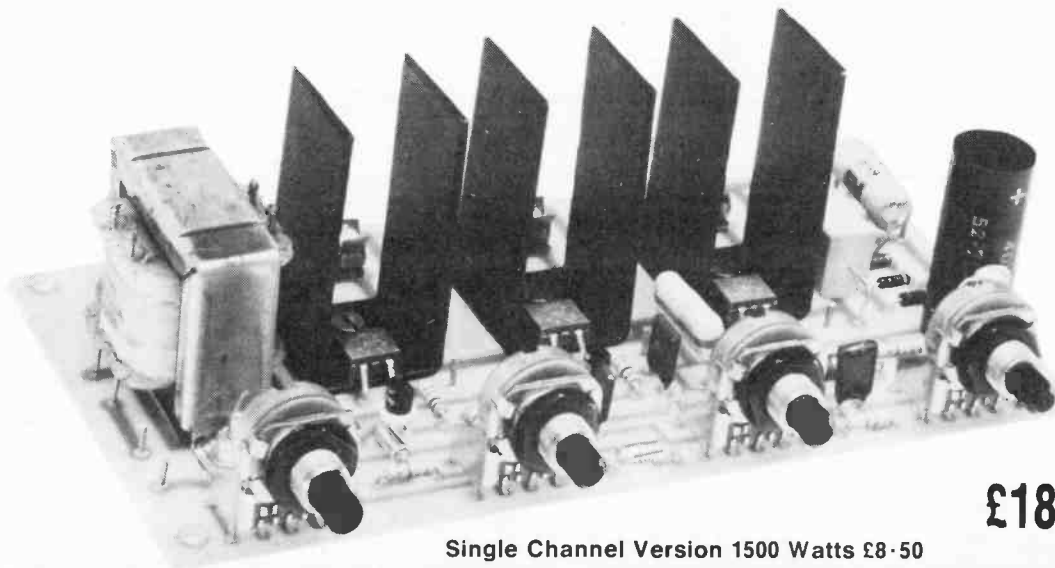

£18.00

Single Channel Version 1500 Watts £8.50

MANUFACTURERS OF ELECTRONIC AND AMPLIFICATION EQUIPMENT
SPECIALISTS IN QUALITY TRANSISTOR EQUIPMENT. OPEN 6 DAYS A WEEK 9.30am-6.00pm

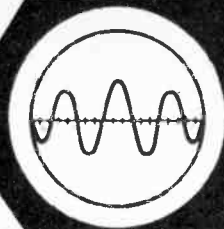

TUAC

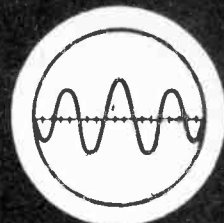

TRANSISTOR UNIVERSAL AMPLIFICATION CO. LTD.
163 MITCHAM RD. LONDON SW17 9PG 01-672 3137/9080

NEW TUAC POWER MODULES offering more power and quality than ever before.

Specification on all power modules:
All output power ratings ± 0.5 dB.
Output impedance 8-15 ohms. THD at full power 2% typically 1%. Input sensitivity 60mV into 10k Ω . Frequency response 20Hz-20kHz ± 2 dB. Hum and noise better than -70dB.

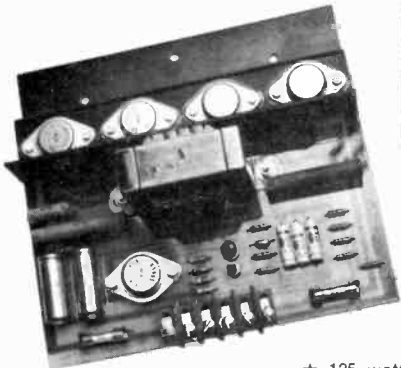

TP125
7 x 6 $\frac{1}{2}$ x 3in
£22.50

★ 125 watts RMS continuous sine wave output

★ 4 R.C.A. 150 watt 15 amp output transistors

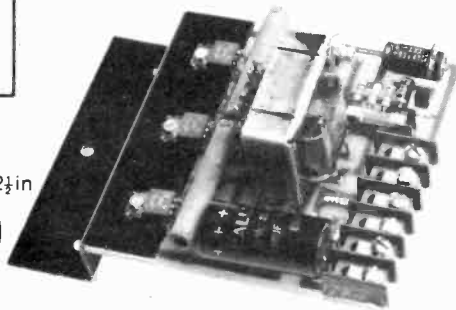

TL30
4 x 5 $\frac{1}{2}$ x 2 $\frac{1}{2}$ in
£9.00

★ 30 watts RMS continuous sine wave output
★ 2 R.C.A. 40 watt output transistors

★ Rugged layer wound driver transformer
★ Short—Open—and Thermal overload protection
★ Only 6 connections

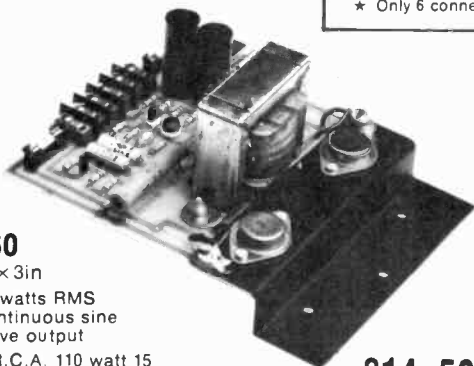

TL60
5 x 5 x 3in

★ 60 watts RMS continuous sine wave output

★ 2 R.C.A. 110 watt 15 amp transistors

£14.50

TL100
5 x 5 x 3in

★ 100 watts R.M.S. continuous sine wave output

★ 2 R.C.A. 150 watt 15 amp transistors

£17.50

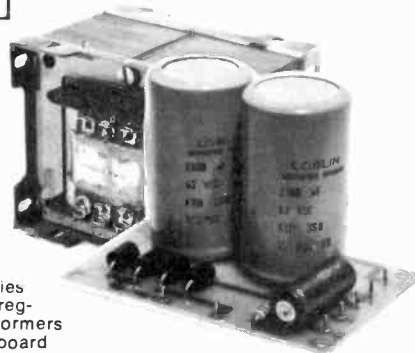

Power supplies vacuum impregnated Transformers with supply board incorporating pre-amp supply:

PS 125 ± 50 volts for one TP125	£14.25
PS 100 ± 45 volts for one TL100	£13.00
PS60 ± 40 volts for one TL60	£11.50
PS 30 ± 50 volts for one TL30	£7.00
PSU 2 for supplying disco mixer	£5.50

PREAMPLIFIERS

All TUAC audio modules are constructed on glass fibre P.C. board, are ready assembled and fully tested. Low noise silicon and FET transistors together with H.S. carbon film resistors are used throughout. Extensive research has gone into various wide range tone control circuits producing superb quality from any signal.

VA08 Vol. Treble, Mid and Bass controls Hi IMP. FET I/P suitable Mid. Guitar, Radio, Crystal/Ceramic P.U. Sensitivity 4mV. Treble +35dB at 16kHz. Mid +20-15dB at 1Hz Bass +20-10dB at 40Hz. **£6.75**

VA06 Vol. Treble and Bass controls. Sensitivity 8mV. Treble +28-15dB at 12kHz. Bass -18dB at 40Hz. **£5.75**

SVA01 Stereo Pre Amp Vol. Treble, Mid and Bass controls Hi. IMP. FET I/P suitable Mid. Guitar, Radio, Crystal/Ceramic P.U. Sensitivity 4mV. Treble +35dB at 16kHz. Mid +20-15dB at 4kHz. Bass +20-10dB at 40Hz. Plus Full Balance Control **£12.75**

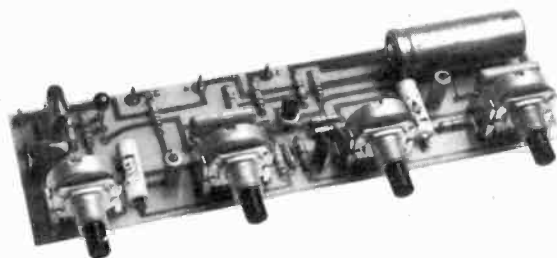

ALL PRICES INCLUDE V.A.T. (25%) AND POSTAGE AND PACKING

ACCESS & BARCLAY CARDS ACCEPTED JUST SEND OR PHONE US YOUR NUMBER H.P. ARRANGED THROUGH PAYBONDS

Principles of Transistor Circuits-5th Edition

S. W. AMOS

- Provides a clear and comprehensive account of the circuit applications of the sophisticated transistor devices now available.
- The edition has been revised to include important trends in the use of field effect transistors and integrated circuits in sound, television and digital equipment.
- Invaluable to aspiring circuit designers, students, home constructors; indeed anyone concerned with the applications of transistors should find the book of immense value.

320 pages 216 x 138 mm Illustrated—0 408 00161 5 (Limp) £3.50

Beginner's Guide to Transistors—2nd Edition

J. A. Reddihough, revised by R. Sinclair

- A full revision has ensured that this second edition incorporates the latest developments in integrated circuits; logic principles have been introduced.

160 pages 192 x 126 mm Illustrated ISBN 0 408 00145 3 £1.80 February 1975

ORDER NOW FROM YOUR LOCAL BOOKSELLER

For full details of our books on Radio and Television write or telephone

Newnes-Butterworths, Borough Green, Nr. Sevenoaks, Kent

Telephone: Borough Green 884567—Ansafone: Borough Green 882442—Telex: 95678



TRANSISTORS BC204 11p BC209C 11p BC182 10p BC184 11p BC212 14p BC214 16p BC213 15p BC213L 15p ZTX300 15p ZTX500 17p 2N2484 24p 2N2904 30p 2N2905 27p 2N2219 22p 2N3054 100p	VOLTAGE REGULATORS μ A7815 220p 723 180p ARRAYS ML3046P 75p CA3096AE 120p OP. AMPS 709/8 Dip 39p 710/TO5 39p 741 46p 748 46p FETMOPA 450p	P.E. POWER SLAVES Special components available while stocks last. High Voltage MPSL01 39p; MPSL51 41p; MPSU07 69p; MPSU57 85p; SDT9203 150p. Constantan Wire 0.03 ohms/cm as specified for the POWER SLAVES. 20cm lengths 10p.	LISTS New lists are available for the: P.E. SOUND SYNTHESISER; P.E. MINISONIC; P.E. RHYTHM GENERATOR Please include 7p stamp or 9 x 4in S.A.E. with all requests for lists or information.	<div style="text-align: center;"> <h1>PE MINISONIC</h1> </div> <p>MINISONIC P.C.B.'S</p> <p>EA008a (Main Board). £3.35. Post free.</p> <p>EA008b (Power supply and Temp. Stabilisation) £1.86. Post free.</p> <p>MINISONIC COMPONENT KITS—PRICES ARE DOWN</p> <p>V.C.O. (2 required) £3.07 V.C.F. (1 required) £4.24 ES/V.C.A. (2 required) £4.98 Voltage Ref. £0.54 Ring. Mod. (1 required) £3.62 Noise Gen. (1 required) £1.64 Kbd. Control (1 required) £3.70 HF Osc. and Det. £1.80 Power Amps £2.41</p> <p>All above prices are for single kits of each type and include VAT. P. & P. Full details are included in lists.</p> <p>Miscellaneous Items</p> <p>5 way 180° DIN sockets 27p 5 way 180° DIN plugs 34p Battery connectors 9p/pair Hook up wire, 36 colours, ½ metre of each 70p Min. DPDT toggle switch £1.20</p> <p>VAT should be added to quoted price of miscellaneous items.</p> <p>SAVE BY PURCHASING A COMPLETE SET OF KITS AS DETAILED TOGETHER WITH SWITCH, BATTERY CONNECTORS, HOOK-UP WIRE AND P.C.B. Price £38. U.K. post free:</p>
FETS 2N3819 46p 2N5459 60p DIODES 1N5401 21p 1N914 5p BA148 25p 1SJ50 12p 1GP7 10p NOISE DIODES Z1J 60p Z1M 120p RECTIFIERS REC41A 120p REC46 255p REC70 40p EA100/10 100p MDA942A/1 210p	SPECIAL PURPOSE LINEARS SG3402N 174p SG3402T 174p SG1495D 290p MFC6040 100p MFC4000B 70p T.T.L. 7402N 38p 7410PC 24p 7420N 24p 7430PC 23p 7473N 48p 7475N 75p 7476N 49p 7489N 680p 7493PC 89p 74121J 85p 74122N 89p 74123N 144p 74150N 210p	VERO CARD FRAME CASE SYSTEM As first advertised in P.E. May '75 issue. Build your modular project into this superbly styled economically priced case system. Send for illustrated leaflet and price list.	<p>VAT AT STANDARD RATE SHOULD BE ADDED TO FINAL TOTAL OF ORDER</p>	
RESISTORS Triple rated high stability carbon film. 7p for 5 0.5W metal oxide. 16p for 5 Stocked in E12 values from 4R7 to 3M9	POTS GALORE 24mm Carbon without switch. All values log. or lin. 5k Ω to 1M Ω 25p each Wirewound 1W semi-precision. All values 10 Ω to 25k Ω 82p each Min. horiz. carbon presets, 100 Ω to 2.2M Ω 10p each Cermet presets, horiz. mtg., 100 Ω to 1M Ω 45p each Helical 10 turn W/W, 1k Ω , 5k Ω , 10k Ω £3.40 each	<p>TERMS: MAIL ORDER ONLY. C.W.O.</p> <p>Cheques or P.O.'s payable to Eaton Audio. Orders over £5 free of P. & P. Otherwise please add 10p in the £1.</p>	<p>Each tape £1.06, post free. One of each for £1.86.</p> <div style="text-align: right;"> </div>	

EATON AUDIO

P.O. BOX 3, ST. NEOTS
 HUNTINGDON, CAMBS. PE19 3JB

BI-PRE-PAK

Bargains in Semi-Conductors, components, modules & equipment.

BARGAINS FROM OUR FREE CATALOGUE

8th edition 20 large pages filled with real bargains in transistors, I.C.s, components, equipment, etc. Send large S.A.E. with 8p stamp for your FREE copy by return. Meanwhile, for prompt delivery order from our ad. this month NOW.

X-HATCH GENERATOR MK.2



Rotary selector switch provides choice of four patterns—essential for colour TV alignment. Featuring plug-in IC's and a more sensitive sync-pick-up circuit. The reinforced fibre-glass case is virtually unbreakable—ideal for the engineer's toolbox—only measures 3in x 5½in x 3in. Operates from three U-2-type batteries (extra).

Ready built unit only **£9.93**
P & P. add 30p

Complete kit **£7.93**

PLASTIC POWER TRANSISTORS

40 WATT SILICON				90 WATT SILICON			
Type No.	Gain	VCE	Polarity Price	Type No.	Gain	VCE	Polarity Price
40N1	15	15	NPN 20p	90N1	15	15	NPN 25p
40N2	40	40	NPN 30p	90N2	40	40	NPN 35p
40P1	15	15	PNP 20p	90P1	15	15	PNP 25p
40P2	40	40	PNP 30p	90P2	40	40	PNP 35p

TRANSISTOR PACKS—ALL AT 50p EACH TESTED AND GUARANTEED

B79	4	IN4007 Sil. Rec. diodes 1,000 PIV 1 amp. plastic	H39	6	Integrated circuits 4 gate BMC 962 2 flip flops BMC 974
B81	10	Read Switches, 1in long 7in dia. Highspeed P.O. type	H41	2	BD131/BD132 Complementary Plastic Transistors
H35	100	Mixed Diodes, Germ. Gold bonded, etc. Marked and Unmarked	H61	4	40361 Type NPN Sil. transistors TO-5 can comp. to H66
H38	30	Short lead Transistors. NPN Silicon Planar types Ex-equipment	H66	4	40362 Type PNP Sil. transistors TO-5 can comp. to H65

UNMARKED AND UNTESTED

B1	50	Germanium Transistors PNP, AF and RF	H34	15	Power Transistors, PNP Germ. NPN Silicon TO-3 Can 3819N Channel FET's plastic case type
B66	150	Germanium Diodes Min. glass type	H67	10	
B84	100	Silicon Diodes DO-7 glass equiv. to OA200, OA202	OVER A MILLION TRANSISTORS IN STOCK—All most-needed types WAREHOUSED—TESTED—GUARANTEED—SEE CATALOGUE		
B86	100	Sil. Diodes min. 1N914 glass equivalent to 1N4148			

TO CLEAR

Hundreds of various portable transistor radio chassis FM and AM. Ideal for experimenters. Components electronically sound chassis not all perfect. No instructions, or tuning drives. A cheap way to make a radio set. **£1 Each**

MAINS TRANSFORMERS

P. & P. add 35p per unit
Type A—18V/1A (suit SS. 103) £1-50.
Type B—25V/2A (suit SS. 110) £2-00.
Type C—30V/2A (suit SS. 140) £3-25.

Bridge Rectifiers: Type A 27p; Types B & C 38p.

CAPACITOR DISCHARGE IGNITION KIT

Easy to assemble and fit to your car 12V. With instructions. (P. & P. add 30p) **£7.50**

TERMS OF BUSINESS

V.A.T. Prices shown do not include V.A.T. Please add V.A.T. at current rate to total value of your order including postage. No V.A.T. on overseas orders. POSTAGE Except where stated, add 20p for postage and packing in U.K. Overseas—add £1, any difference being charged or refunded.

PAYMENT Cash with order, Cheque or money order. Minimum value—£1. You can also pay by ACCESS.

IMPORTANT—Every effort is made to ensure accuracy of prices and description at time of preparing this advertisement and going to press. Prices are subject to alteration without notice.

BI-PRE-PAK LTD

Co Reg No B201919

222 224 WEST ROAD, WESTCLIFF-ON-SEA, ESSEX SSO 9DF.

TELEPHONE: SOUTHEND (0702) 46344.

WRITE ORDER SEPARATELY AND ATTACH COUPON IF NECESSARY

CHALLENGING VALUES!



Stirling Sound

STIRLING SOUND AUDIO MODULES come to you as basic units assembled on P.C.B.s enabling you to add required components in layouts of your own choice. Modules are tested and boxed before despatch and include well printed instructions.

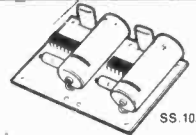

SS.103-3

AMPLIFIER MODULES

Pre-amplifiers; tone control

SS.100 Active tone control unit to provide bass, treble, balance and volume controls **£1.60**

SS.101 Pre-amp for ceramic cartridge, tape and radio **£1.60**

SS.102 Pre-amp for low output magnetic cartridge tape and radio. With R.I.A.A. correction ±1dB at 1kΩ **£2.25**

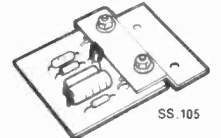

SS.105

POWER AMPLIFIERS

SS.103 Compact I.C. amp. with 3 watts R.M.S. output. Operating voltage 10-20. Size 3½in x 2in. **£1.75**

SS.103-3 Stereo version of above using one I.C. on each channel **£3.25**

SS.105 A compact and useful all-purpose amplifier which will run excellently on a 12V supply. With 5 watt output, two make a good stereo amp. Size 3½in x 2in. **£1.95**

SS.110 Similar in size to SS.105 but with a 10 watt output. Ideal for many domestic and small-size P.A. applications. Operates from 26-32V. **£2.40**

SS.140 Excellently designed 40 watt R.M.S. (into 4 ohms) hi-fi amplifier. S/N ratio better than 75dB T.H.D. better than 0.2%. Power requirements—45V d.c. With 0.15in centre edge connections. Two can be bridged to give 80 watts R.M.S. into 8 ohms. **£3.60**

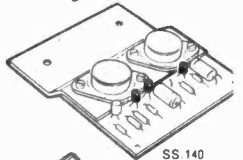

SS.140

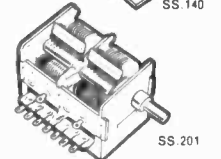

SS.201

BUILD A STEREO F.M. TUNER!

SS.201 Front end with ganged tuning and geared slow-motion drive in rugged housing. Excellent sensitivity. Tunes 88-108MHz. With A.F.C. facility. Operates from 6-16V. **£6.25**

SS.202 I.F. stage (with I.C.). Pre-tuned. A.F.C. connection. Operates from 4.5-14V. **£5.25**

SS.203 Stereo Decoder. Designed essentially for use with SS.201 and SS.202, this module can also be used on most mono F.M. tuners. A.L.E.D. may be attached. Operating voltage 9-16V d.c. **£5.62**

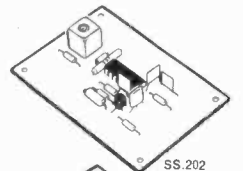

SS.202

SPECIAL MONEY SAVING OFFER!

Save £5—buy all 3 units (SS.201, SS.202 and SS.203) together for **£12.12**

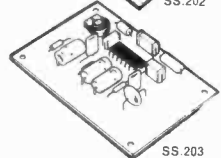

SS.203

POWER SUPPLY STABILISER

SS.300 Add this to an unregulated supply (say typically 45V output) to obtain a steady powerful working output adjustable from 12 to 60V. Essential for your audio and special systems. Money saving, very reliable and ideal for the workbench. **£3.25**

STIRLING SOUND DISCO MINOR

Twin turntable console with cross-fade mic (with over-ride) and headphone monitor jacks, etc. plus unique 'AMPOWER 40' speaker with built in 40 watt R.M.S. power amp. You can add up to ten to give 400 watts! Portable console and one AMPOWER.£100 plus £3-50 carr. U.K., plus VAT.

Have you had your FREE CATALOGUE?

To BI-PRE-PAK, 222-224 WEST ROAD, WESTCLIFF-ON-SEA, ESSEX

Please send

for which I enclose inc. V.A.T.

NAME

ADDRESS

PE6

Go quad for around £50

(including the speakers!)

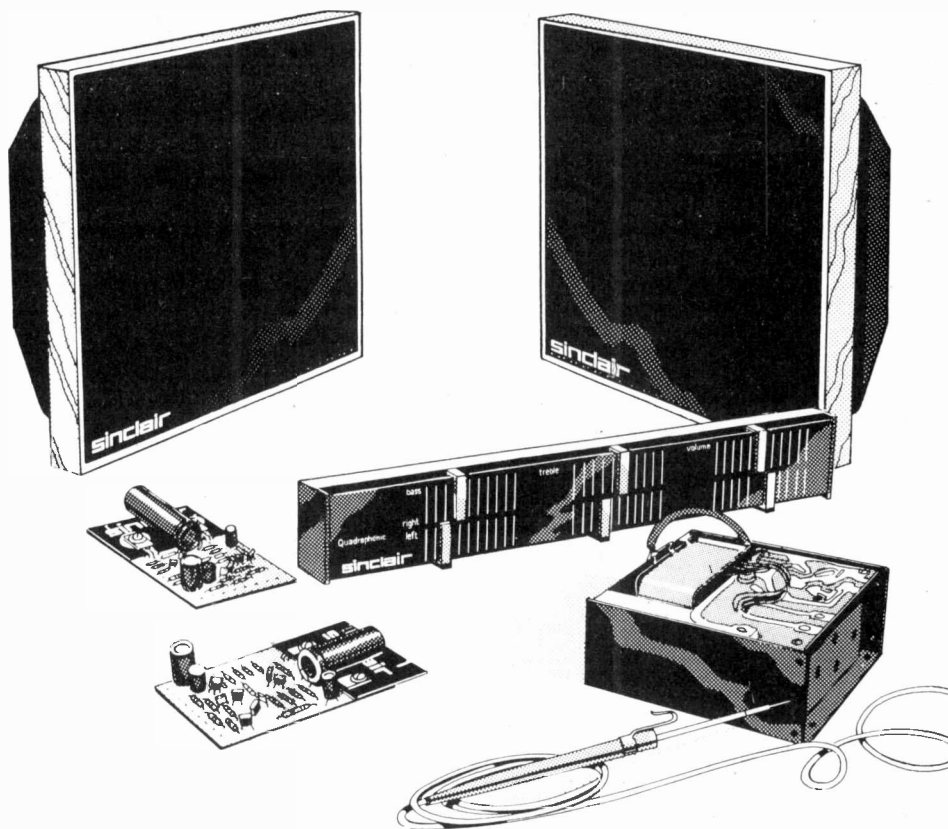

Sinclair Project 80 hi-fi modules

If you've thought of switching to quad, you've probably found it an expensive process. Do you part with your existing stereo amp – which probably cost you a lot in the first place – and replace it with an even more costly quad amp? Or do you buy an expensive add-on kit – often costing as much as £90 even *without* the extra speakers?

With Sinclair Project 80 hi-fi modules, you can keep your existing amplifier... add a quad decoder, two power amps and a power supply unit... a couple of Sinclair Q16 speakers and you've got a high-quality, true quad system which will have cost you only £50 or so to convert!

How does Sinclair Project 80 work?

Project 80 is a comprehensive set of hi-fi modules or sub-assemblies. Amps... pre-amps... FM tuner... quad decoder... control units... everything you need to assemble hi-fi units. They're all designed to look alike and are all completely compatible with each other. Simply decide on the specification of the unit (stereo or quad) you want to build... buy the necessary modules... connect them up and house them.

You can even build a quad amp entirely from Project 80 modules. Two power amplifiers, a control unit and a power

supply give you a stereo amp for as little as £31.80 plus VAT. The necessary add-on quad modules cost only £36.80 + VAT. Together, they make up a true hi-fi quad amp for only £68.60 + VAT!

And whenever you choose, you can add extra Project 80 refinements. An FM tuner... a scratch/rumble filter... higher-output power amps – Project 80 is an enjoyable way to develop your own hi-fi system!

Is it difficult to build?

Not at all. All Project 80 module circuitry is complete in itself – all you have to do is connect the external wiring to numbered solder points.

And if you're not so hot with a soldering iron? Use Project 805 kits. Project 805 uses Project 80 modules, but provides special clip-on tagged-wire connections – positively no soldering! There are two Project 805 kits – the basic 805 stereo amplifier kit, and the 805Q quad conversion kit.

805Q can be used to convert a Project 80 or 805 stereo system, or your existing stereo system.

You'll find more details and some system suggestions opposite.

Project 80 hi-fi modules – the easy way to true quadraphonics.

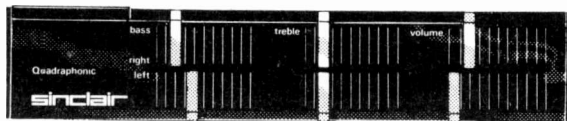

Project 80 SQ quadrasonic decoder

Combines with and exactly matches Project 80 control unit for true quadraphonics. This unit is based on the CBS SQ system and is a complete quadrasonic decoder, rear channel pre-amp and control unit.

Specification
(9½ in x 2 in x ¾ in.) Connects with tape socket on Project 80

Project 80 power amplifiers

Two different amplifiers, designed to be used separately or combined, with Project 80 modules or as add-ons to existing equipment. Protected against short circuits and damage from mis-use.

Z40 Specification
(2¼ in x 3 in x ¾ in.) 8 transistors
Input sensitivity: 100 mV
Output: 12 W RMS continuous into 8 Ω (35 V). **Frequency response:** 30 Hz – 100 kHz ± 3 dB
S/N ratio: 64 dB. **Distortion:** 0.1% at 10 W into 8 Ω at 1 kHz
Voltage requirements: 12 V – 35 V
Load imp: 4 Ω – 15 Ω; safe on open circuit. Protected against short circuit.

Price: £5.95 + VAT

Project 80 power supply units

Range of power supply units to match desired specification of final system.

PZ5 Specification
Unstabilised. 30 V output. Including mains transformer.

Price: £5.95 + VAT

PZ6 Specification
Stabilised. 35 V output. Including mains transformer.

Price: £8.95 + VAT

Project 80 SQ quadrasonic add-on kit

Converts your existing stereo hi-fi system to quad using solderless connections

Contains following Project 80 units:

Project 80 SQ quad decoder/rear channel pre-amp and controls unit

Sinclair Q16 speaker

Original and uniquely designed speaker of outstanding quality.

Specification
(10½ in square x 4½ in deep)
Pedestal base. All-over black front. Teak surround. Balanced

control unit or similar facility on any stereo amplifier. Separate slider controls on each channel for treble, bass and volume.
Frequency response: 15 Hz to 25 kHz ± 3 dB. **Distortion:** 0.1%
S/N ratio: 58 dB. **Rated output:** 100 mV. **Phase shift network:** 90°: 10, 100 Hz to 10 kHz.
Operating voltage: 22 V – 35 V.

Price: £18.95 + VAT

Z60 Specification
(2¼ in x 3½ in x ¾ in.) 12 transistors
Input sensitivity: 100 mV – 250 mV.
Output: 25 W RMS continuous into 8 Ω (50 V). **Frequency response:** 10 Hz to more than 200 kHz ± 3 dB. **S/N ratio:** better than 70 dB. **Distortion:** less than 0.1% at 12 W into 4 Ω at 1 kHz
Voltage requirements: 12 V – 50 V.
Load imp: 4 Ω min; max safe on open circuit. Protected against short circuit.

Price: £7.45 + VAT

PZ8 Specification
Stabilised. Output adjustable from 20 V to 60 V approx. Re-entrant current limiting makes damage from overload or even shorting virtually impossible. Without mains transformer.

Price: £8.45 + VAT

2 x Z40 power amps
PZ5 power supply unit
Masterlink unit
On/off switch
plus pre-cut wiring loom with clip-on tagged wire connections, nuts and bolts, instruction manual.

Price: £44.95 + VAT

sealed sound chamber. Special driver assembly. **Frequency response:** 60 Hz to 16 kHz
Power handling: up to 14 W RMS.
Impedance: 8 Ω

Price: £8.95 + VAT

Quad system suggestions from Sinclair

1. Add-on quad to existing system:

12 W per rear channel RMS

Quadrasonic decoder + 2 x Z40 amps + 1 x PZ6 power supply + (existing stereo amplifier) + 2 x Q16 speakers + (2 existing speakers) + (turntable). Total Project 80 cost: £57.70 + VAT.

2. Add-on quad to existing system:

25 W per rear channel RMS

Quadrasonic decoder + 2 x Z60 amps + 1 x PZ8 power supply + (mains transformer) + (existing stereo amplifier) + (2 x equivalent speakers) + (2 x existing speakers) + (turntable). Total Project 80 cost: £42.30 + VAT.

3. Quadrasonic system built from scratch:

12 W per channel RMS

Pre-amp/control unit + quadrasonic decoder + 4 x Z40 amps + 2 x PZ6 power supply + 4 x Q16 speakers + (turntable). Total Project 80 cost: £110.40 + VAT.

What more can we tell you?

All Project 80 modules are backed by the remarkable no-quibble Sinclair guarantee. Should any defect arise from normal use within a year, we'll service the modules free of charge. And our Consumer Advisory Service is always available if you run into any problems. You'll find Project 80 at stores like Laskys and Henry's – but before you look, why not get really detailed information? Clip the FREEPOST coupon for the fully-illustrated Project 80 folder – today!

Sinclair Radionics Ltd,
London Road, St Ives, Huntingdon, Cambs., PE17 4HJ.
Telephone: St Ives (0480) 64646.

sinclair

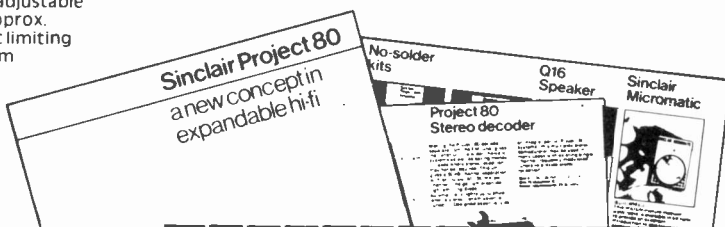

To: Sinclair Radionics Ltd, FREEPOST, St Ives, Huntingdon, Cambs., PE17 4BR.

Please send me, by return post, a copy of the fully-illustrated Project 80 folder.

Name _____

Address _____

PE/6/75

Please print FREEPOST – no stamp needed

Sound to Light Master Unit



▲ Front

600 watts per channel

Connects to your loudspeaker or loudspeaker socket. The unit can be connected to your existing spotlight fittings or to our type A or B fittings.

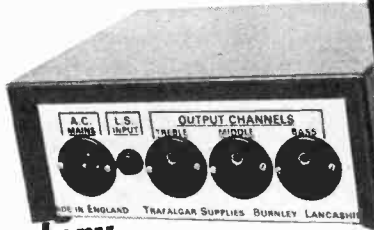

▲ Rear

Special Introductory Price

Including channel output plugs and mains input socket.

Only **£29.95** incl VAT plus p&p £1.00

Type B 3 BANK UNIT



B.C. fitting (less lamp)

£6.50 incl VAT plus p&p 40p each

Type A

(less lamp)

£1.60 incl VAT plus p&p 25p each.



B.C. fitting

100 WATT Red, pink, yellow, green, blue, clear.
SPOT LAMPS Only £1.00 each
Minimum 3 lamps £3.00 plus p&p 25p.
B.C. fitting

TRAFALGAR SUPPLIES
Dept. H.T., STANDISH STREET,
BURNLEY, LANCs.

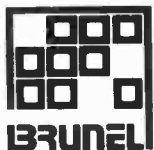

Brunel Technical College Bristol

Ashley Down, Bristol BS7 9BU

Faculty of Communications

Department of Marine and Aero Electronics

Radio and Electronic Officers

Interested in seeing the world and earning a good salary at the same time? There are excellent career prospects as a Marine Radio Officer and in the Civil Service. Full-time Courses in Radiocommunications, Radar and Marine Electronics start in September and January of each year.

Civil Aviation

Full-time Courses start in September of each year for prospective Licensed Aircraft Maintenance Engineers in either the Radio Category or in Airframes and Engines. The Courses are fully approved by the CAA and include practical work on College Aeroplanes.

Course Entry Requirements

Prospective entrants should have obtained or be studying for CSE or GCE Ordinary level passes in Mathematics, English and a Science subject, or have appropriate experience. All applicants will be interviewed before acceptance.

For further details of the above and of Courses for experienced Marine and Aeronautical personnel please contact: Mr. F. E. Barltrop, Head of Department of Marine and Aero Electronics, Brunel Technical College, Ashley Down, Bristol BS7 9BU. Tel. (0272) 41241

B. BAMBER ELECTRONICS

5 STATION ROAD, LITTLEPORT, CAMBS., CB6 1QE

Telephone: ELY (0353) 860185 (2 lines) Tuesday-Saturday

TV PLUGS, metal type, 6 for 50p.
TV SOCKETS, metal type, 5 for 50p.
TV LINE CONNECTORS (back to back sockets), 5 for 50p.
SOLDER (multicore) approx. 9yds., 25p.
OA81 DIODES, 15 for 25p.
OC200 TRANSISTORS, 6 for 50p.
BBY8A TRANSISTORS, 6 for 50p.
PL259 PLUGS, 50p each, or 5 for £2.25.
REDUCERS (for small co-ax) to fit above, 15p each.
SO239 SOCKETS (to fit PL259 plugs), 50p each, or 5 for £2.25.
TELEPHONE-TYPE EARPIECE INSERTS, 50p.
REEDS (for reed relays, single pole make), 5 for 30p.
MULLARD CERAMIC TUBULAR TRIMMERS, 1-18pF, 6 for 50p.
I.C.s (some coded, some unmarked), 14.
DIL types, mixed, untested, 20 for 25p.
SMALL NEONS, 6 for 25p.
24V, 2-8W LAMPS, MES type, 6 for 20p.
MINIATURE SLIDER SWITCHES, 2 pole, 5 way, 5 for 50p.
PNP SILICON AUDIO-TYPE TRANSISTORS, TO5 type, untested, 12 for 25p.
PLESSEY ELECTROLYTICS, 10,000µF at 63V, 75p each.
ITT ELECTROLYTICS, high grade, screw terminals, 6,800µF at 25V, complete with mounting clip, 50p each.

HIGH QUALITY SPEAKERS, 8 1/2 x 6 1/2 elliptical, only 2in deep. Inverse magnet, 4 ohms, rated up to 10W, £1.50 each, or 2 for £2.75 (qty. discount available).
TWIN HEAVY DUTY CABLE, PVC covered, 50/0.25mm, 15p per metre, or £10.20 per 100m reel.
MIXED WASHERS, 15p per pack.
5A MAINS CIRCUIT BREAKERS, 75p each.
MINIATURE EARPHONES with min. Jack plug, 2 for 50p.
3 PIN MIN. MAINS PLUG AND SOCKET, 40p set.
LF CHOKES on 1" x 2" cores, 5 for 20p.
I.C. AUDIO AMPS, TB800, rated 5W (sorry, no data), £1 each.

MAGNATIC DEVICES PROGRAMMERS, contain 9 microswitches, with 9 adjustable drums for period switching (needs slow motion motor to drive drum, not supplied), many switching applications, £1 each.
CURLY LEADS, 4 core telephone type, 2 for 20p.
TRANSISTOR HEATSINKS, to take 2 x TO18 transistor, screw in clamps, block size 1 x 1/2 x 1/4in, with holes for mounting, 3 for 50p.
VARIABLE STABILISED PSU, solid-state, 240V a.c. input, output 0-24V d.c. at 500mA, + 32V d.c. at approx. 50mA. Voltage controlled by external 5kΩ pot. Size 7/8 x 4 x 2 1/2in (less 5kΩ pot), 85p each.
THREE-TURN WIRE-WOUND POTS, 5kΩ, for above, 75p each.
LARGE DIE CAST BOXES (brand new ITT) 10 1/2 x 6 1/2 x 2 1/2in, £2 each.
25-WAY ISEP PLUGS AND SOCKETS, 40p set (1 plug + 1 socket).
DIN SPEAKER SOCKETS (2-pin) 4 for 30p.
BNC INSULATED SOCKETS (single-hole mounting) 85p each.

MAINS TRANSFORMERS
All 240V input, voltages quoted approx. RMS. (please quote type no. only when ordering).
TYPE 10/2, 10-0-10V at 2A, £1.50 each.
TYPE 16/6, 16V at 6A + 45V at 100mA, £4.
TYPE 28/4, 28V at 4A + 125V at 500mA, £4.
TYPE 63/1, 6-3V at 1A, 85p each or 2 for £1.50.
TYPE 129, 400V at 20mA + 200V at 10mA + 6-3V at 500mA, £1.25.
TYPE 72703, 400V at 10mA + 200V at 5mA + 6-3V at 400mA, £1.25.
TYPE 70462, 250-0-250V at 80mA + 6-3V at 2A, £1.75.
RADIO SPARES 500W AUTO TRANSFORMERS, 100-110-130-200-220-240-250V tapped input and output, step-up or step-down facility, ex-new equip. £8.

TERMS OF BUSINESS: CASH WITH ORDER (minimum order £1) POST FREE (UK ONLY). PLEASE ADD 8% VAT.

Export enquiries welcome. Callers welcome. Tues. to Sat. Please enclose S.A.E. with ALL enquiries.

ALL OUR PRICES INCLUDE V.A.T.

BSR HI-FI AUTOCHANGER STEREO AND MONO

Plays 12", 10" or 7" records. Auto or Manual. A high quality unit backed by BSR reliability with 12 months' guarantee. A.C. 200/250V Size 13 1/2 x 11 1/2 in.

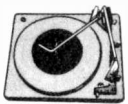

Above motor board 3 1/2 in. Below motor board 2 1/2 in. with STEREO and MONO CARTRIDGE **£9.25** Post 75p

PORTABLE PLAYER CABINET

Modern design. Resins covered. Vynair front grille. Chrome fittings. Size 17 x 15 x 8 in approx. **£5.25** Post 75p
Motor board cut for BSR or Garrard deck.

COMPLETE STEREO HI-FI SYSTEM

Two full size loudspeakers 13 1/2 x 10 x 3 1/2 in. Player unit clips to loudspeakers making it extremely compact, overall size only 13 1/2 x 10 x 8 1/2 in., 3 watts per channel, plays all records 33 r.p.m., 45 r.p.m. Separate volume and tone controls 240V a.c. mains.



Attractive Teak finish **£29** £1 carriage

SPECIAL OFFER! SMITH'S CLOCKWORK 15 AMP TIME SWITCH

0-60 MINUTES **£2.50** Post 50p
Single pole two-way. Surface mounting with fixing screws. Will replace existing wall switch to give light for return home, garage, automatic anti-burglar lights, etc. Variable knob. Turn on or off at full or intermediate settings. Brand new and fully guaranteed.



TEAKWOOD LOUDSPEAKER GRILLES will easily fit to baffle board. Size 18 1/2 x 10 1/2 in—75p. 10 1/2 x 7 1/2 in—45p

WEYRAD P50 — TRANSISTOR COILS

RA2W Ferrite Aerial 85p Driver Trans. LFD74. 85p I.F. P50/2CC 470 kc/s 40p 3rd I.F. P50/2CC 40p Spares Cores 3p P50/1AC 60p Mullard Ferrite Rod 8 x 1/2 in., 20p. 6 x 1/4 in., 20p. 3 x 1/2 in. 10p

VOLUME CONTROLS

5k Ω to 2M Ω . LOG or LIN. L/S 20p. D.P. 35p. STEREO L/S 55p. D.P. 75p. Edge 5K. S.P. Transistor 25p

80 Ohm Coax 5p yd.

BRITISH AERIALITE AERAXIAL-AIR SPACED 48 yd. £2. 60 yd. £3 FRINGE LOW LOSS Ideal 825 and colour **10p** yd

8in. or 10x6in. ELAC HI-FI SPEAKER

Dual cone plasticised roll surround. Large ceramic magnet. 50-16,000 c/s. Bass resonance 55 c/s. 4 ohm impedance. 10 watts. music power. **£4.35** Post 35p.

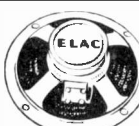

E.M.I. 13 1/2 x 8in. SPEAKER SALE!

With twin tweeters. And crossover. **£5.25** Post 35p
15 ohm. As illustrated. Post 35p

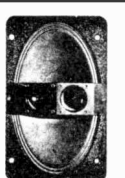

With flared tweeter cone and ceramic magnet. 10 watt. **£3.45**

Basic res. 45-80 c/s. Flux 10,000 gauss. Size 3 or 8 or 15 ohm. Post 35p

Bookshelf Cabinet

13in x 8in. Bass Woofer, 20 watts, £5.50 **£6.60** Post 75p

THE "INSTANT" BULK TAPE ERASER AND HEAD DEMONSTRATOR. Suitable for cassette, and all sizes of tape reels. A.C. mains 240V. Leaflet S.A.E. **£4.35** Post 30p



BLANK ALUMINIUM CHASSIS. 18 s.w.g. 2 1/2 in. sides 6 x 4 in 45p; 6 x 6 in 55p; 10 x 7 in 65p; 12 x 8 in 85p; 14 x 9 in 90p; 16 x 6 in 90p; 12 x 3 in 50p; 16 x 10 in £1. ALUMINIUM PANELS 18 s.w.g. 6 x 4 in 12p; 8 x 6 in 19p; 14 x 3 in 20p; 10 x 7 in 24p; 12 x 5 in 25p; 12 x 8 in 34p; 16 x 6 in 34p; 14 x 9 in 40p; 12 x 12 in 47p; 16 x 10 in 60p.

ELAC 9 x 5in HI-FI SPEAKER TYPE 59RM

This famous unit now available, 16 watts, 8 ohm. **£3.45** Post 35p

QUALITY LOUDSPEAKER ENCLOSURE

Teak veneered 3/4 in thick wood cabinet. Size 16 1/2 in x 10 1/2 in. Weight 23lbs. This cabinet features a wide mesh Silver Grill covering a separate compartment for mounting Tweeters or Mid-Range Horn. The fully sealed bass compartment is cut out for 6 1/2 in Woofer. £7.50 Carr. 85p. Rosewood Version £8.50 Carr. 85p. Baffle could be cut to take larger speaker.



RCS POWER PACK KIT

12 VOLT, 750mA. Complete with printed circuit board and assembly instructions. **£3.35** Post 25p
12 VOLT 300mA KIT, £3.15. 9 VOLT 1 AMP KIT, £3.35.

R.C.S. GENERAL PURPOSE TRANSISTOR PRE-AMPLIFIER—BRITISH MADE

Ideal for Mike, Tape, P.U., Guitar, etc. Can be used with Battery 9-12V or H.T. line 200-300V d.c. operation. Size: 1 1/2 x 1 1/2 x 1/2 in. Response 25 c/s to 25 kc/s. 26 dB gain. For use with valve or transistor equipment. **£1.25** Post 25p
Full instructions supplied. Details S.A.E.

ELECTRO MAGNETIC PENDULUM MECHANISM

1-5V d.c. operation over 300 hours continuous on SP2 battery, fully adjustable swing and speed. Ideal displays, teaching electro magnetism or for metronome, strobe, etc. **95p** Post 25p

BRITISH FM/VHF TUNING HEART

88 to 108 M/C/S British made. 2 Transistors ready aligned requires 10-7 M/C/S I.F. Complete with tuning gang. Connections supplied but some technical experience essential. **Our price £3.95** Post 25p
10-7 M/C/S I.F. strip £4.95 DECODER £4.95

MAINS TRANSFORMERS

ALL POST 50p each
250-0-250V 70mA, 6-3V, 2A £2.80
250-0-250 80mA, 6-3V 2-5A, 6-3V 1A or 5V 2A £4.80
350-0-350 80mA, 6-3V 3-5A, 6-3V 1A or 5V 2A £5.80
300-0-300V 120mA, 6-3V 4A C.T., 6-3V 2A £7.00
MINIATURE 200V 20mA, 6-3V 1A £1.10
MIDGET 220V 45mA, 6-3V 2A £1.25
HEATER TRANS. 6-3V 1/2 amp 85p, 3 amp £1.40
GENERAL PURPOSE LOW VOLTAGE. Tapped outputs at 2 amp, 2.4, 5, 6, 8, 10, 12, 15, 18, 25 and 30V £4.80
1 amp, 6, 8, 10, 12, 16, 18, 20, 24, 30, 36, 40, 48, 60 £4.80
2 amp, 6, 8, 10, 12, 16, 18, 20, 24, 30, 36, 40, 48, 60 £7.00
3 amp, 6, 8, 10, 12, 16, 18, 20, 24, 30, 36, 40, 48, 60 £8.70
5 amp, 6, 8, 10, 12, 16, 18, 20, 24, 30, 36, 40, 48, 60 £11.25
5, 8, 13V, 5 amp, £1.80, 6-0-4V 500mA 90V, 9V 1 amp 95p, 12V 300mA 75p, 12V 500mA 85p, 12V 750mA 95p, 10V, 30V, 40V, 2 amp, £2.20, 20V, 3 amp, £2.40, 2 amp, £2.50, 22-0-22V, 4 amp, £3.16V, 1/2 amp, 95p, 16V, 2 amp, £1.85, 0, 5, 8, 10, 16V, 1/2 amp, £1.60 20V 1/2 amp, £1.50.
AUTO TRANSFORMERS: 115V to 230V or 230V to 115V 150W £4.80; 500W £8.70; 750W £17.50; 1000W £21.
BATTERY CHARGERS. Ready built with leads and clips 4 amp £4; 5 amp £4.50.
FULL WAVE BRIDGE CHARGE RECTIFIERS: 6 or 12V outputs, 1/2 amp 40p; 2 amp 55p; 4 amp 85p.

MAINS ISOLATING TRANSFORMER

Primary 0-110-240V. Secondary 0-240V 3A 720W Insulated terminals. Varnish impregnated. Fully enclosed in steel case with fixing feet. OUR **£13.50** Carr. Famous make. (Value £19). PRICE **£13.50** 95p
Can be used as 800W auto transformers 240-110V. IDEAL FOR COLOUR T.V. OR GARDEN TOOLS.

NEW ELECTROLYTIC CONDENSERS

2/350V 14p	250/25V 14p	50 + 50/300V 50p
4/350V 22p	500/25V 20p	900/350V 95p
8/350V 22p	100 + 100/275V 85p	22 + 22/250V 20p
16/350V 25p	150 + 200/275V 70p	32 + 32/450V 60p
32/500V 50p	8 + 8/450V 22p	350 + 50/325V 85p
25/25V 10p	8 + 18/450V 25p	100 + 50 + 50/350V 85p
50/50V 10p	16 + 16/450V 40p	32 + 32 + 32/350V 85p
100/25V 10p	32 + 32/350V 40p	4700/83V 4.85p

LOW VOLTAGE ELECTROLYTICS

1, 2, 4, 5, 8, 16, 25, 30, 50, 100, 200mF 15V 10p.
500mF 12V 15p; 25V 20p; 50V 30p.
1000mF 12V 17p; 25V 35p; 50V 47p; 100V 70p.
2000mF 6V 25p; 25V 42p; 50V 57p.
2500mF 50V 82p; 3000mF 25V 47p; 50V 85p.
5000mF 6V 25p; 12V 42p; 25V 75p; 35V 85p; 50V 95p.

TRIMMERS 10pF, 30pF, 50pF, 50p, 100pF, 150pF, 50pF.

CERAMIC, 1pF to 0.01mF, 4p. Silver Mica 2 to 5000pF, 4p. PAPER 350V-0-17p, 0-5-13p; 1mF 150V 15p; 2mF 150V 15p. RESISTORS: 1W, 1/2W, 1/4W, 20p; 1/2W, 25p; 1/4W, 10p to 10M. HIGH STABILITY: 1W, 2% 10 ohms to 6 meg., 10p. Dito 5%. Preferred values 10 ohms to 10 meg., 4p. WIRE-WOUND RESISTORS 5 watt, 10 watt, 15 watt, 10 ohms to 100K 10p each. TAPE OSCILLATOR COIL Valve type 35p.

NEW MODEL "BAKER LOUDSPEAKER", 12in 50 WATT. GROUP 50/12, 8 OR 15 OHM HIGH POWER. **£16** Post 40p

BAKER MAJOR 12" £11.50



30-14,500 c/s, 12in. double cone, woofer and tweeter cone together with a BAKER ceramic magnet assembly having a flux density of 14,000 gauss and a total flux of 145,000 Maxwells. Bass resonance 40 c/s. Rated 20W. NOTE: 3 or 6 or 15 Ohms must be stated.

Module kit, 30-17,000 c/s with tweeter, crossover, baffle and instructions. **£14.50** Post 40p each
Please state 3 or 6 or 15 ohms.

BAKER "BIG-SOUND" SPEAKERS 3 or 48p each

'Group 25'	'Group 35'	'Group 50/15'
12in. 25W 3 or 8 or 15 ohm £9.50	12in. 35W 3 or 8 or 15 ohm £11.50	15in. 50W 8 or 15 ohm £22.00

TEAK VENEERED HI-FI SPEAKER AND CABINETS
For 12in or 10in dia. speaker 20 x 13 x 9in, £12.00 Post 75p
For 13 x 8in or 8in speaker 16 x 18 x 7in, £7.00 Post 60p
For 6 x 5in speaker 16 x 8 x 6in, £3.00 Post 40p
LOUDSPEAKER CABINET WADDING 18in wide, 20p ft

GOODMANS 6 1/2in. HI-FI WOOFER

4 ohm or 8 ohm. 10W. Large ceramic magnet. Special Cambric cone surround. Twin cones. Frequency response, 30-12,000 c/s. Ideal P.A. Columns. Hi-Fi Enclosure Systems, etc. **£4.60**



ELAC CONE TWEETER

The moving coil diaphragm gives a good radiation pattern to the higher frequencies and a smooth extension of total response from 1,000 c/s to 18,000 c/s. Size 3 1/2 x 2 1/2 in. deep. Rating 10W, 3 ohm. Crossover £1.60 Post 20p

SPEAKER COVERING MATERIALS. Samples Large S.A.E.

Horn Tweeters 2-18kc/s, 10W 8 ohm or 15 ohm £2.80.
De Luxe Horn Tweeters 2-18kc/c, 15W, 15 ohm £4.
CROSSOVERS, TWO-WAY 3,000 c/s 3 or 8 or 15 ohm £1.60.
LOUDSPEAKERS P.M. 3 OHMS: 744in., £1.25; 81in., £1.50; 85in., £1.60; 10in., £2.00; 8in., £1.75; 10x8in., £1.90.
SPECIAL OFFER: 8 ohm, 21in, 2 1/2in, 35 ohm, 2in., 3in., 25 ohm, 2 1/2in, dia., 3in, dia., 5in, dia., 6 ohm, 2 1/2in., 3in., 3 1/2in., 15 ohm, 3 1/2in, dia., 6x4in., 7x4in., 8x5in., **1c1 each**
3 ohm, 2 1/2in., 2 1/2in., 3in, dia.
RICHARD ALLAN TWIN CONE LOUDSPEAKERS, 8in. diameter 4W £2.50, 10in. diameter, 14W £2.85; 12in. diameter 6W £3.50, 3/8/15 ohms, please state. VALVE OUTPUT TRANS. 40p; MIKE TRANS. 50:1 40p. Mike trans. mu metal 100:1 £1.25.

Loudspeaker Volume Control 15 ohms 10W with one inch lead threaded bush for wood panel mounting: 1/2 in spindle. 85p each, Post 15p.

MAJOR 100 WATT ALL PURPOSE AMPLIFIER

All purpose transistorised. Ideal for Groups, Disco and P.A. 4 Input speech and music, 4 way mixing. Output 8/15 ohm. a.c. Mains. Separate treble and bass controls. **£59** Carr. £1.00 each
Guaranteed. Details SAE. NEW MODEL MAJOR—50 watt, 4 input, 2 vol. Treble and bass. Ideal disco amplifier. **£49.95**



BARGAIN 4 CHANNEL TRANSISTOR MONO MIXER.

Add musical highlights and sound effects to recordings. Will mix Microphone, records, tape and tuner with separate controls into single output. 8V. TWO STEREO CHANNELS VERSION **£6.85**

BARGAIN 3 WATT AMPLIFIER. 4 Transistor Push-Pull Ready Built, with volume, Treble and bass controls. 18 volt d.c. Mains Power Pack £3.

£4.50

COAXIAL PLUG 10p. PANEL SOCKETS 10p. LINE 16p.

OUTLET BOXES, SURFACE 40p. FLUSH 60p. Twin 85p. BALANCED TWIN BIFURC FEEDER 300 ohms. 7p yd. JACK SOCKET 8id. open-circuit 16p, closed circuit 23p. Chrome Lead-Socket 45p. Phone Plugs 8p. Phone Socket 8p. JACK PLUGS 8id. Chrome Plug, 3-5mm Chrome 15p. DIN SOCKET Chassis 3-pin 10p, 5-pin 10p. DIN SOCKETS lead 3-pin 25p, 5-pin 25p. DIN PLUGS 3-pin 16p, 5-pin 25p. VALVE HOLDERS, 10p; CERAMIC 10p; CANS 10p.

SPECIAL OFFERS

100 ohm 20 watt Rheostat 2 1/2in diam. Ceramic Former. Screw Terminals 1/2 in. diam. spindle, 85p. Post motion. A.C. mains relay 3 pole change over, 75p.

EMI TAPE MOTOR

EMI TAPE MOTORS. 240V a.c. 1,200 r.p.m. 4 pole 135mA. Spindle 8-18x70-75in. Size 3 1/2 x 2 1/2 in (illustrated). Post 40p
120V Model, £1.



RADIO COMPONENT SPECIALISTS

Radio Books and Component Lists 10p. (Minimum posting charge 25p.)

337 WHITEHORSE ROAD, CROYDON

Open 9-6. Wed. 9-1, Sat. 9-5 (Closed for lunch 1.15-2.30)
Buses 50, 68, 159. Rail Selhurst. Tel. 01-884 1665



"I MADE IT MYSELF"

Imagine the thrill you'll feel! Imagine how impressed people will be when they're hearing a programme on a modern radio you made yourself.

Now! Learn the secrets of radio and electronics by building your own modern transistor radio!

Practical lessons teach you sooner than you would dream possible.

What a wonderful way to learn—and pave the way to a new, better-paid career! No dreary ploughing through page after page of dull facts and figures. With this fascinating Technatron Course, you learn by building!

You build a modern Transistor Radio... a Burglar Alarm. You learn Radio and Electronics by doing actual projects you enjoy—making things with your own hands that you'll be proud to own! No wonder it's so fast and easy to learn this way. Because learning becomes a hobby! And what a profitable hobby. Because opportunities in the field of Radio and Electronics are growing faster than they can find people to fill the jobs!

No soldering—yet you learn faster than you ever dreamed possible.

Yes! Faster than you can imagine, you pick up the technical know how you need. Specially prepared step-by-step lessons show you how to: read circuits—assemble components—build things—experiment. You enjoy every minute of it!

You get everything you need. Tools. Components. Even a versatile Multimeter that we teach you how to use. All included in the course. AT NO EXTRA CHARGE! And this is a course anyone can afford. (You can even pay for it by easy instalments.)

So fast, so easy, this personalised course will teach you even if you don't know a thing today!

No matter how little you know now, no matter what your background or education, we'll teach you. Step by step, in simple easy-to-understand language, you pick up the secrets of radio and electronics.

You become a man who makes things, not just another of the millions, who don't understand. And you could pave the way to a great new career, to add to the thrill and pride you receive when you look at what you have achieved. Within weeks you could hold in your hand your own transistor radio. And after the course you can go on to acquire highpowered technical qualifications, because our famous courses go right up to City & Guilds levels.

Send now for FREE 76 page book—see how easy it is—read what others say!

Find out more now! This is the gateway to a thrilling new career, or a wonderful hobby you'll enjoy for years. Send the coupon now. There's no obligation.

POST TODAY FOR FREE BOOK

To: ALDERMASTON COLLEGE
DEPT. CPE03
READING RG7 4PF

CPE03

Yes, I'd like to know more about your course. Please send me free details—plus your big, 76-page book that tells about all your courses.

NAME _____

ADDRESS _____

POSTCODE _____

BIET

HOME OF BRITISH INSTITUTE OF ENGINEERING TECHNOLOGY



4½in x 3½in METER. 30µA, 50µA or 100µA, £3-85. 13p P. & P.

TAPE RECORDER LEVEL METER



500µA, 70p. 10p P. & P.

CARDIOID DYNAMIC MICROPHONE



Model UD-130. Frequency response 50-15,000c/s. Impedance Dual 50K and 600 ohms, £6-55. 13p P. & P.

42 x 42mm meters 100µA, 500µA, 1mA, 500mA, £2-76. 11p P. & P.

60 x 45mm meters 50µA, 100µA, 500µA and 1mA VU meter, £2-92. 11p P. & P.

Edgewise meters 90mm x 34mm 1mA, £3-40. 13p P. & P.

MULTI-METER

Model ITI-2

20,000 ohm/volt, £6-90. 16½p P. & P.



3 WATT STEREO (1½ + 1½) PER CHANNEL AMPLIFIER

£4-30. 12½p P. & P.



All above prices include 8% V.A.T. LARGE S.A.E. for List No. 11. Special prices for quantity quoted on request.

M. DZIUBAS

158 Bradshawgate • Bolton • Lancs. BL2 1BA

INDUSTRIAL PRICES FOR THE HOBBYIST
ALL 'BIG NAME' BRANDED GOODS
SAME DAY SERVICE
MONEY BACK GUARANTEE

LINEAR 1/C'S		DIODES		ZENER DIODES	
709C	0.24	IN4001	4	BZY88	400mW
710C	0.24	IN4002	4	Voltages 3.3v-30v	
741C (8P in Mindip)	0.20	IN4003	5	6p	
CA3046	0.50	IN4004	5	AUDIO 1/C'S	
LM309K	1.25	IN4005	6		
COS/MOS		IN4006	6		
CD4001	0.24	IN914	2	TAA661B	1.0
CD4009	0.40	OA47	4	CA3089E	1.5
CD4011	0.20	OA200	6	CA3090Q	3.0
CD4012	0.20	IN4148	1.5	CA3028	1.0
CD4018	1.50			CA3048	2.0
CD4029	1.50				

TRANSISTORS					
BC107	0.07	BFY60	0.14	2N696	0.15
BC108	0.07	BFY51	0.12	2N697	0.20
BC109	0.07	BFY52	0.15	2N706	0.10
BCY70	0.09	BFY90	0.60	2N930	0.18
BCY71	0.09	BSY95A	0.10	2N1302	0.16
BCY72	0.09	C426	0.28	2N1303	0.12
BFX29	0.16	40360	0.40	2N1304	0.20
BFX84	0.16	40361	0.40	2N1305	0.20
BFX85	0.16	40362	0.40	2N2160	0.50
BFX86	0.16	40669	0.80	2N2646	0.40
BFX87	0.16	40673	0.50	2N3053	0.15
BFX88	0.16	40602	0.40	2N3054	0.40
BC237	—08			2N3055	0.40

TERMS: CWO — 10p POST & PACKING — ADD 8% VAT

— ROWNSGEM LTD. —
Rosebank Parade, Plough Road, Yateley, Camberley, Surrey.
Phone No. 0252 871388

THE PROFESSIONAL ORGANISATION FOR THE 'HOBBYIST'



I.L.P. (Electronics) Ltd

SHEER SIMPLICITY!

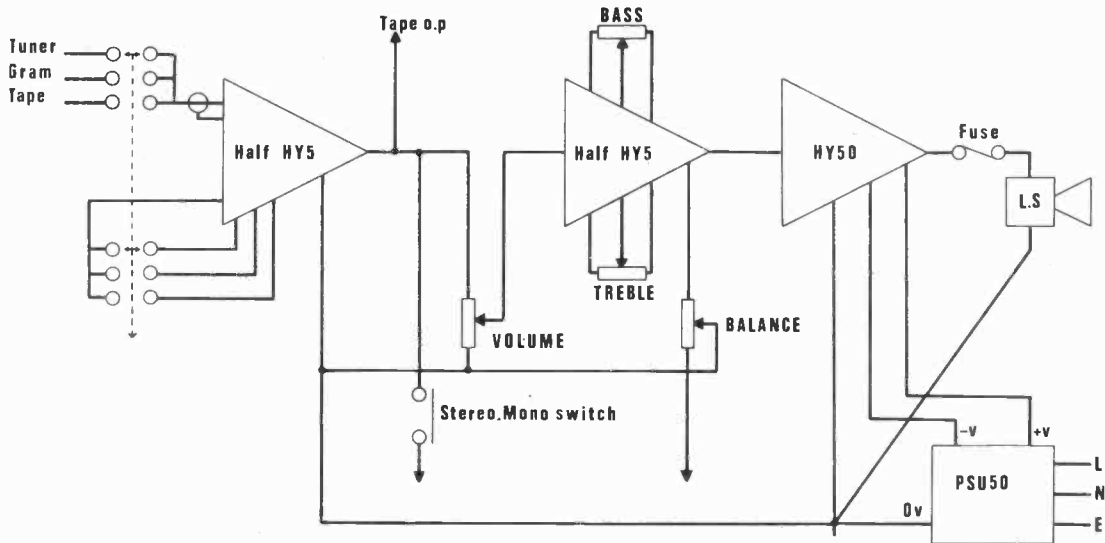

MONO ELECTRICAL CIRCUIT DIAGRAM WITH INTERCONNECTIONS FOR STEREO SHOWN

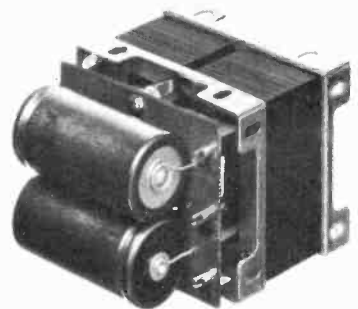
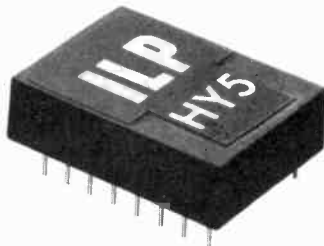

The HY5 is a complete mono hybrid preamplifier, ideally suited for both mono and stereo applications. Internally the device consists of two high quality amplifiers—the first contains frequency equalisation and gain correction, while the second caters for tone control and balance.

TECHNICAL SPECIFICATION
Inputs: Magnetic Pick-up 3mV RIAA; Ceramic Pick-up 30mV; Microphone 10mV; Tuner 100mV; Auxiliary 3-100mV; Input Impedance 47kΩ at 1kHz. Outputs: Tape 100mV; Main output 0db (0.775V RMS). Active Tone Controls: Treble = 12db at 10kHz; Bass = 12db at 100Hz. Distortion: 0.5% at 1kHz. Signal/Noise Ratio: 68db. Overload Capability: 40db on most sensitive input. Supply Voltage: = 16-25V.

The HY50 is a complete solid state hybrid Hi-Fi amplifier incorporating its own high conductivity heatsink hermetically sealed in black epoxy resin. Only five connections are provided, input, output, power lines and earth.

TECHNICAL SPECIFICATION
Output Power: 25W RMS into 8Ω Load Impedance: 4-16Ω. Input Sensitivity: 0db (0-775V RMS). Input Impedance: 47kΩ. Distortion: Less than 0.1% at 25W typically 0-05%. Signal/Noise Ratio: Better than 75db. Frequency Response: 10Hz-50kHz ± 3db. Supply Voltage: = 25V. Size: 105 x 50 x 25mm.

The PSU50 incorporates a specially designed transformer and can be used for either mono or stereo systems.
TECHNICAL SPECIFICATIONS
Output voltage: = 25V. Input voltage: 210-240V. Size: L.70, D.90, H.60mm.

PRICE £4.50

+ 36p VAT
P. & P. free

PRICE £5.98

+ 48p VAT
P. & P. free

PRICE £6

+ 48p VAT
P. & P. FREE

TWO YEARS' GUARANTEE ON ALL OUR PRODUCTS

I.L.P. Electronics Ltd.
Crossland House,
Nackington, Canterbury,
Kent CT4 7AD.
Tel. (0227) 63218

Please Supply
Total Purchase Price
I Enclose Cheque Postal Orders Money Order
Please debit my Access account Barclaycard account
Account number
Name and Address
Signature

-the lowest prices!

BRAND NEW TEXAS GERM. TRANSISTORS
 Coded and Guaranteed
 Pak No. Description Price
 T1 8 2G3713 OC71 0-54
 T2 8 D1374 OC75 0-54
 T3 8 D1216 OC81D 0-54
 T4 8 2G381T OC81 0-54
 T5 8 2G382T OC82 0-54
 T6 8 2G344B OC44 0-54
 T7 8 2G345B OC45 0-54
 T8 8 2G378 OC78 0-54
 T9 8 2G399A 2N1302 0-54
 T10 8 2G417 AF117 0-54
 All 64p each pak

ND120 NIXIE DRIVER TRANSISTOR
 Suitable replacement for
 BSX21, C407, 2N1893
 120vcb.
 1 25 100+
 0-19 0-17 0-16

Sil. trans. suitable for
 P.E. Organ, Metal TO-18
 Any. ZTX300 6p each.
 Any Quantity.

GP100 TO3 METAL CASE GERMANIUM
 V_{beo}=80V, V_{ceo}=50V,
 I.C.=10 amps, P_{tot}=
 30W, I_{fe}=30-170.
 Replaces the majority of
 Germanium power transistors
 in the OC, AD and NKT range.
 1 25 100+
 0-48 0-44 0-40

GP300 TO3 METAL CASE SILICON
 V_{beo}=15 amps, V_{ceo}=60V,
 I.C.=15 amps, P_{tot}=
 115W, I_{fe}=20, 100T7.
 Replaces suitable replacement
 for 2N3055, BDY11 or BDY20.
 1 25 100+
 0-65 0-53 0-51

NEW 9th EDITION
 over 300 pages
TRANSISTOR EQUIVALENTS BOOK
 Complete cross reference and
 equivalents book for
 European, American and
 Japanese Transistors.
 Exclusive to BI-PAK,
 £2.30 each.

A LARGE RANGE OF TECHNICAL AND DATA BOOKS ARE NOW AVAILABLE EX STOCK. SEND FOR FREE LIST.

GENERAL PURPOSE NPN SILICON SWITCHING TRANS. TO-18
 SIM TO 2N708/8. BSV-
 27/28/95A. All suitable
 devices in open or short
 circuits. ALSO AVAIL-
 ABLE in PNP Sim. to
 2N2906, BCY70. When
 ordering please state
 preference NPN or PNP.
 20 For 0-54
 50 For 1-08
 100 For 1-92
 500 For 8-25
 1000 For 14-30

SIL. G.P. DIODES 6p
 300mW 30 5-50
 40PIV(Min.) 100 1-85
 Sub-Min. 500 5-50
 Full Tested 1,000 8-90
 Ideal for Organ Builders.

ADI61/162
 PNP COMP. GERM.
 TRANS. OR LOW-
 EST PRICE OF 75p
 PER PAIR.

LOOK FOR OUR AUDIO AND ELECTRONIC COMPONENTS ADVERTISEMENTS
 PRACTICAL WIRELESS
 EVERYDAY
 ELECTRONICS AND
 RADIO CONSTRUCTOR

FULL RANGE OF ZENER DIODES
 RANGE
 2-33V, 400mW (DO-7
 Case) 9p ea. 11W (Top-
 Hat) 18p ea. 10W (SO-10
 Stud) 32p ea.

QUALITY TESTED SEMICONDUCTORS

Pak No.	Description	Price
Q 1	20 Red spot transistors pnp	0-54
Q 2	16 White spot R.F. transistors pnp	0-54
Q 3	4 OC77 type transistors	0-54
Q 4	6 Matched transistors OC44/45/81/81D	0-54
Q 5	4 OC75 transistors	0-54
Q 6	5 OC72 transistors	0-54
Q 7	4 AC128 transistors pnp high gain	0-54
Q 8	4 AC126 transistors pnp	0-54
Q 9	7 OC71 type transistors	0-54
Q10	7 OC71 type transistors	0-54
Q11	2 AC127/128 Complementary pairs	0-54
Q12	3 AP116 type transistors	0-54
Q13	3 AP117 type transistors	0-54
Q14	3 OC171 H.F. type transistors	0-54
Q15	7 2N2926 Sil. Epoxy transistors mixed colours	0-54
Q17	5 npn-2 x ST, 141 & 3 x ST, 140	0-54
Q18	4 MADT'S 2 x MAT 100 & 2 x MAT 120	0-54
Q19	3 MADT'S 2 x MAT 101 & 1 x MAT 121	0-54
Q20	4 OC44 Germanium transistors A.F.	0-54
Q21	4 AC127 npn Germanium transistors	0-54
Q22	20 NKT transistors A.F. R.F. coded.	0-54
Q23	10 OA202 Silicon diodes sub-min.	0-54
Q24	8 OA81 diodes	0-54
Q25	15 IN914 Silicon diodes 75PIV 75mA	0-54
Q26	8 OA95 Germanium diodes sub-min IN69	0-54
Q27	2 10A 600 PIV Silicon rectifiers IS425R	0-54
Q28	2 Silicon power rectifiers BYZ13	0-54
Q29	4 Silicon transistors 2 x 2N696, 1 x 2N697, 1 x 2N698	0-54
Q30	7 Silicon switch transistors 2N706 npn	0-54
Q31	6 Silicon switch transistors 2N708, npn	0-54
Q32	3 pnp Silicon transistors 2 x 2N1131, 1 x 2N1132	0-54
Q33	3 Silicon npn transistors 2N1711	0-54
Q34	7 Silicon npn transistors 2N2969, 500MHz (code P397)	0-54
Q35	3 Silicon pnp TO-9, 2 x 2N2904 & 1 x 2N2905	0-54
Q36	7 2N3846 TO-18 plastic 300MHz npn	0-54
Q37	3 2N3053 npn Silicon transistors	0-54
Q38	5 pnp transistors 3 x 2N3703, 2 x 2N3702	0-54

555IC 65p each

ALL PRICES INCLUDE V.A.T.
MAMMOTH I.C. PAK
 APPROXIMATELY 200 PIECES ASSORTED
 MANUFACTURERS' FALL-OUT INTEGRATED
 CIRCUITS INCLUDING LOGIC
 74 SERIES LINEAR and AUDIO AMPLIFIERS.
 MANY CODED also SOME UNKNOWN TYPES—YOU TO IDENTIFY.
PAK NO. M.I.C. 200
 PRICE £1.25 per PAK including P. & P. and VAT

INTEGRATED CIRCUIT PAKS
 Manufacturers' "Fall Outs" which include Functional and Part-Functional Units. These are classed as "out-of-spec" from the maker's very rigid specifications, but are ideal for learning about I.C.'s and experimental work.

Pak No.	Contents	Price	Pak No.	Contents	Price
UIC00	= 12 x 7400	0-54	UIC86	= 5 x 7486	0-54
UIC01	= 12 x 7401	0-54	UIC90	= 5 x 7490	0-54
UIC02	= 12 x 7402	0-54	UIC91	= 5 x 7491	0-54
UIC03	= 12 x 7403	0-54	UIC92	= 5 x 7492	0-54
UIC04	= 12 x 7404	0-54	UIC93	= 5 x 7493	0-54
UIC05	= 12 x 7405	0-54	UIC94	= 5 x 7494	0-54
UIC06	= 8 x 7406	0-54	UIC95	= 5 x 7495	0-54
UIC07	= 8 x 7407	0-54	UIC96	= 5 x 7496	0-54
UIC10	= 12 x 7410	0-54	UIC100	= 5 x 74100	0-54
UIC20	= 12 x 7420	0-54	UIC121	= 5 x 74121	0-54
UIC30	= 12 x 7430	0-54	UIC141	= 5 x 74141	0-54
UIC40	= 12 x 7440	0-54	UIC151	= 5 x 74151	0-54
UIC41	= 5 x 7441	0-54	UIC164	= 5 x 74164	0-54
UIC42	= 5 x 7442	0-54	UIC193	= 5 x 74193	0-54
UIC43	= 5 x 7443	0-54	UIC199	= 5 x 74199	0-54
UIC44	= 5 x 7444	0-54	UIC81	= 5 x 7481	0-54
UIC45	= 5 x 7445	0-54	UIC82	= 5 x 7482	0-54
			UIC83	= 5 x 7483	0-54

UICXI = 25 Assorted 74's 1-85

KING OF THE PAKS Unequaled Value and Quality

SUPER PAKS NEW BI-PAK UNTESTED SEMICONDUCTORS

Satisfaction GUARANTEED in Every Pak, or money back.

Pak No.	Description	Price
U 1	120 Glass Sub-Min. General Purpose Germanium Diodes	0-54
U 2	60 Mixed Germanium Transistors AF/RF	0-54
U 3	75 Germanium Gold Bonded Sub-Min. like OA5, OA47	0-54
U 4	40 Germanium Transistors like OC81, AC128	0-54
U 5	60 200mA Sub-Min. Silicon Diodes	0-54
U 6	30 Sil. Planar Trans. NPN like BSY95A, 2N706	0-54
U 7	16 Sil. Rectifiers TOP-HAT 750mA VLTG. RANGE up to 1000	0-54
U 8	50 Sil. Planar Diodes DO-7 Glass 250mA like OA200/202	0-54
U 9	20 Mixed Voltages, 1 Watt Zener Diodes	0-54
U10	20 BA Y50 charge storage Diodes DO-7 Glass	0-54
U11	25 PNP Sil. Planar Trans. TO-5 like 2N1132, 2N2904	0-54
U13	30 PNP-NPN Sil. Transistors OC200 & 2N 104	0-54
U14	150 Mixed Silicon and Germanium Diodes	0-54
U15	25 NPN Sil. Planar Trans. TO-5 like BFY51, 2N697	0-54
U16	10 3 Amp Silicon Rectifiers Stud Type up to 1000PIV	0-54
U17	30 Germanium PNP AF Transistors TO-5 like ACY 17-22	0-54
U18	8 6 Amp Silicon Rectifiers BYZ13 Type up to 600 PIV	0-54
U19	25 Silicon NPN Transistors like BC108	0-54
U20	12 1.5 Amp Silicon Rectifiers Top Hat up to 1000 PIV	0-54
U21	30 AF Germanium Alloy Transistors 2G300 Series & OC71	0-54
U23	30 MADT's like M1Z Series PNP Transistors	0-54
U24	20 Germanium 1 Amp Rectifiers GJM Series up to 300 PIV	0-54
U25	25 300MHz NPN Silicon Transistors 2N708, BSY27	0-54
U26	30 Fast Switching Silicon Diodes like IN914 Micro-Min.	0-54
U29	10 1 Amp SCR's TO-5 can. up to 600 PIV CR81/25-600	1-08
U32	25 Zener Diodes 400mW DO-7 case 3-18 volts mixed	0-54
U33	15 Plastic Case 1 Amp Silicon Rectifiers IN4000 Series	0-54
U34	30 Silicon PNP Alloy Trans. TO-5 BCY26 2S302/4	0-54
U35	25 Silicon Planar Transistors PNP TO-18 2N2906	0-54
U36	25 Silicon Planar NPN Transistors TO-5 BFY50/51/52	0-54
U37	30 Silicon Alloy Transistors BO-2 PNP OC200, 2S322	0-54
U38	20 Fast Switching Silicon Trans. NPN 400MHz 2N3011	0-54
U39	30 RF. Germ. PNP Transistors 2N1303/5 TO-5	0-54
U40	10 Dual Transistors 6 lead TO-5 2N2060	0-54
U43	25 Sil. Trans. Plastic TO-18 A.F. BC113/114	0-54
U44	20 Sil. Trans. Plastic TO-5 BC115/NPN	0-54
U45	7 3A SCR TO66 up to 600PIV	1-08
U46	20 Unijunction transistors similar to T1S43	0-54
U47	10 TO220AB plastic triacs 50V 6A	1-08
U48	9 NPN Sil. power transistors like 2N3055	1-08
U49	12 NPN Sil. plastic power trans. 60W like 2N5294/5296	1-08

Code Nos. mentioned above are given as a guide to the type of device in the pak. The devices themselves are normally unmarked.

FREE
 One 55p Pak of your own choice free with orders valued £4 or over

SIL. RECTS. TESTED

PIV	300mA	750mA	1A	1.5A	3A	10A	30A	
(DO7)(SO16) Plastic (SO16)(SO10)(SO10)(TO48)								
50	05	06	1N4001	05	08	15	21	60
100	05	07	1N4002	06	10	17	23	75
200	06	10	1N4003	07	12	22	25	100
400	08	15	1N4004	08	15	30	38	135
600	09	17	1N4005	10	18	38	48	180
800	12	19	1N4006	11	20	38	55	210
1000	14	30	1N4007	12	25	48	65	250
1200		35		30	58	75	300	

CADMIUM CELLS
 ORP12 48p

PIV	50	100	200	400	600	800
1A TO5	0-22	0-27	0-27	0-32	0-42	0-63
3A TO66	0-39	0-52	0-54	0-59	0-75	0-88
5A TO64	0-39	0-52	0-54	0-62	0-75	0-88
7A TO48	0-52	0-55	0-62	0-67	0-84	0-99
10A TO48	0-55	0-63	0-67	0-83	1-07	1-32
16A TO48	0-58	0-62	0-67	0-77	0-97	1-50
30A TO48	1-27	1-54	1-76	1-93		4-40

NEW LOW PRICED TESTED S.C.R.'S

PIV	50	100	200	400	600	800
DIACS FOR USE WITH TRIACS. BRI100 (D32) 25p each						
10 amp POTTED BRIDGE RECTIFIER on heat sink.						
100PIV. 99p each						

Giro No. 388-7006
 Please send all orders direct to warehouse and despatch department

BI-PAK
 P.O. BOX 6, WARE, HERTS
 Postage and packing add 20p. Overseas add extra for airmail.
 Minimum order 55p. Cash with order please.
Guaranteed Satisfaction or Money Back

2 Amp. BRIDGE RECTS.

50 v RMS	35p each
100 v RMS	40p ..
200 v RMS	45p ..
400 v RMS	50p ..
1,000 v RMS	55p ..
Size 16 mm x 16 mm.	

D1899 NPN SILICON DUAL TRANSISTOR
 (Similar to 2N2060).
 1 25 100+
 0-28 0-26 0-23

LINEAR INTEGRATED CIRCUIT PAKS
 Manufacturers' fall-outs

Pak No.	Contents	Price
ULIC709	10 x 709	0-54
ULIC710	7 x 710	0-54
ULIC711	7 x 741	0-54
ULIC747	3 x 747	0-54
ULIC748	7 x 748	0-54

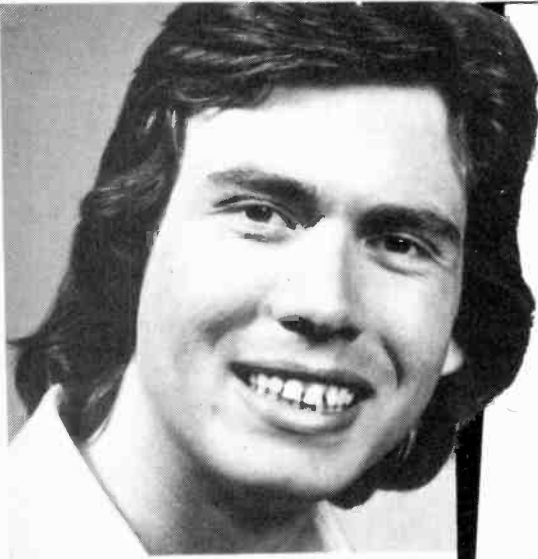

Recently I've been telling you just why I've been a customer of Home Radio Components for so long. I've given special emphasis to their superb catalogue, and now it's time to show you a typical page. The problem is—which one? There are 240 to choose from—for example, 17 pages of capacitors, 6 of resistors, 10 of switches and 8 of stylii. These are run-of-the-mill things, but here's a page that's specially interesting—page 94, showing a Short Wave Kit and an Etching Kit.

The managing director of Home Radio Components tells me there's quite a story behind these items. Briefly, Home Radio Components always listed a S.W. Kit, but eventually the firm making them ceased trading so H.R.C. decided to produce their own. When they looked around for an Etching Kit they were unable to find any at a sensible price, so again they said, "Right, we'll make our own!" Sounds simple, but the managing director told me that if you produce any kit within 12 months of deciding to go ahead you're doing very well. "As for the problems of producing an Etching Kit," he said, "I could write a book about it!" Incidentally, if you want to order either of these kits the prices are:

For Prices see Supplement

HOME RADIO (COMPONENTS) LTD.

CONSTRUCTIONAL KITS—Continued

KT4B Radiokit No. 4B. A unique one valve model with world-wide range. Continuous coverage from approx. 10 metres to 47 metres, this covers the usual long-distance broadcasts. Band spread tuning. This set which was designed by us, uses only the finest components. Jackson and Wavemaster capacitors, Wearie P. Coils and Mazda valves. Great fun both to build and to use. Under favourable atmospheric conditions you will be able to hear such far off places as Moscow, Australia and America.

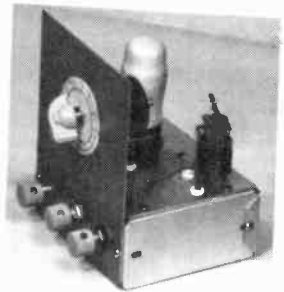

KT4B

AN ETCHING KIT

KT 253. Etching Kit. An ideal kit for the Constructor wishing to Etch his own Circuits. All essentials and detailed Instructions included in every Kit.



KT253

Contents:—

- (1) Plastic Dish.
- (2) Suitable pieces of copper clad board.
- (3) Laminator.
- (4) Ferric Chloride.
- (4A) Large Plastic Spoon.
- (5) Decon Etch resist pen (An alternative may be supplied if this is not available). If at any time items are not available the kit will be supplied minus these articles and the price adjusted accordingly.
- (6) Instructions (4 Pages).

94

ETCHING MATERIALS LISTED ON PAGE 95

KT4B. S.W. Kit—£4.75 plus VAT, plus 35p for P & P.
 KT253 Etching Kit—£3.75 plus VAT, plus 35p for P & P.

In any case, you'll surely want to study all the other pages in this famous catalogue. There are getting on for 2,000 illustrations by the way. Simply send the coupon below, with cheque or P.O. for 98p (65p plus 33p for post, packing and insurance). The catalogue contains 14 vouchers, each worth 5p when used as directed, so you can soon recover 70 pence of your investment. You just can't go wrong!

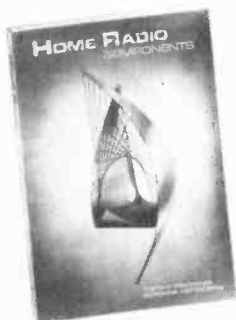

65p
 plus **33p** POST AND PACKING

Send off the coupon today

The price of 98p applies only to customers in the UK and to BFPO addresses

Please write your Name and Address in block capitals

NAME

ADDRESS

.....

.....



HOME RADIO (Components) LTD., Dept. PE, 234-240 London Road, Mitcham, Surrey CR4 3HD (Regn. No. London 912966)

A GOOD REFERENCE

ASSIDUOUS researchers and impatient instant-information seekers alike will all agree that any large work of reference is but "as good as its index". A quick and reliable assessment of a book's real worth usually can be made by examining and testing those final pages. There the reader should get the full measure of the subjects covered, with helpful cross-referencing to save him much time and trouble.

Periodicals, as opposed to books, may have but an ephemeral existence or, on the other hand, they may have staying power so that their useful life is extended far beyond their nominal period of public exposure. Publications in the latter class are of course often accumulated by their owners, and steadily build up into the proportions of a huge work of reference. In such cases an index does then become most essential if the stored material is to be fully utilised.

This undoubtedly is true in the case of **PRACTICAL ELECTRONICS**. We will therefore in future incorporate an index in every December issue, as a fitting completion of that volume. Because of this new policy separate indexes will not be offered for sale as hitherto. Therefore, in order to satisfy the present outstanding requirement, the index for Volume 10 has been included in this present issue.

Apart from its permanent reference value, an immediate perusal of this index should prove an interesting exercise. No doubt many things can be deduced from a sampling of 12 months' constructional projects. For instance, some readers might feel that the motorist is getting rather more than his fair share. Nine projects as opposed to three for the photographer. What does this indicate—deep and significant social changes? Or is it simply that camera manufacturers have been able to pack a lot of electronic gadgetry into their products whereas the motor car still remains a very accommodating vehicle for private constructors' ancillary units?

Audio retains a respectable portion of the cake, though the nine projects listed include but two solely for reproduction of music; it seems the truly adventurous are busy creating—not just *recreating*—sounds these days!

Intrumentation is a convenient term which can embrace a wide range of fascinating devices and systems. A total of seven such projects are listed, some still quite novel—like liquid crystal displays and gas detectors. Though technically important and exciting, many measuring and controlling instruments often take on an unglamorous role in real life. But in performing routine tasks, thermometer/controllers and their like are without doubt contributing to the current Save Energy Campaign.

And what of games? There are but two. So much for those complaints heard from time to time that electronics is used too flippantly.

But we are all entitled to our own prejudices and can analyse the listed items and draw what conclusions we wish!

More seriously, it is hoped this month's special inclusion will help our regular followers to extract the maximum usefulness from their stored issues with the least difficulty, whether now or sometime in the future. Casual readers should also benefit from this perspective of the immediate past. We hope it will help them to get the true measure of d.i.y. electronics.

F.E.B.

Editor
F. E. BENNETT

Editorial
R. D. RAILTON *Assistant Editor*
D. BARRINGTON *Production Editor*
G. GODBOLD *Technical Editor*

Art Dept.
J. D. POUNTNEY *Art Editor*
D. J. GOODING
R. J. GOODMAN
K. A. WOODRUFF

Advertisement Manager
D. W. B. TILLEARD
Phone: 01-634 4202

P. J. MEW
Phone: 01-634 4210

C. R. BROWN, *Classified*
Phone: 01-634 4301

Editorial & Advertising Offices:
Fleetway House, Farringdon St.
London EC4A 4AD
Phone: *Editorial* 01-634 4452
Advertisements 01-634 4202

ADAPTABLE SYSTEMS MONITOR

By L.J. BELL

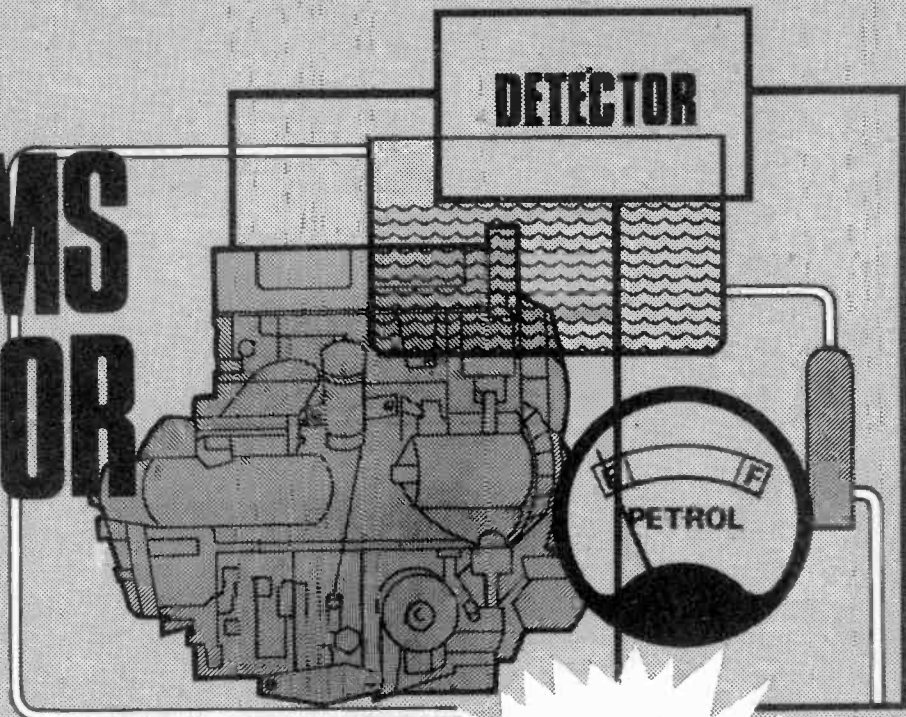

THE systems monitor is basically a device which will monitor a circuit and give an indication when an important parameter such as resistance, current or voltage (more often the last) lies outside a given value zone. The monitor discussed in the present article can be used for voltage monitoring in a wide variety of applications such as temperature, light level and other gauging areas and in security systems and the motor vehicle.

In the latter application a monitor can observe the state of any parameter which is measured using voltage, as in the normal petrol gauge and car thermometer.

BASIC CONCEPT

The present monitor is built around a Motorola comparator chip, the MC3302P, which contains four comparators. Selection of this device is based on its ability to operate from a single source, avoiding double power supplies, and its high input impedance which suits it to a very wide range of applications as it does not unduly load an observed circuit.

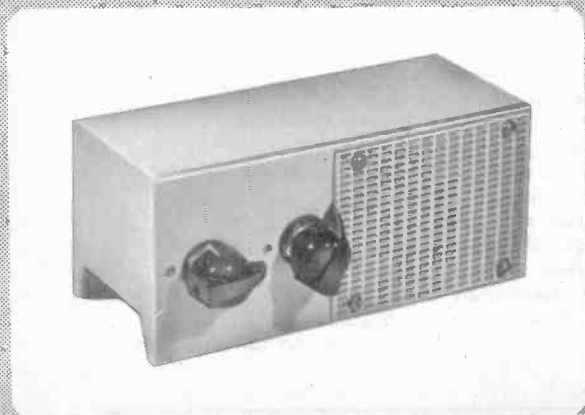

The MC3302P is a single chip i.c. and will in fact work with power potentials of from 2 to 28V. Thus the devices discussed may be powered from between 9 and 18V sources, suiting them to car applications amongst others.

The outputs from the MC3302P are so-called "open collector" so they should be connected to the positive supply via current limiting resistors which will hold the current to below 20mA.

COMPARATOR OPERATION

Whenever the voltage at the non-inverting input, the +ve input, is higher than that at the inverting or -ve input then the voltage at the output "goes high" as the output transistor in the comparator turns off and the full supply potential can be detected at the output.

Reverse the situation so that the voltage at the -ve input is higher than that at the +ve input and the reverse happens, the output "goes low" as the output transistor turns on and forms a low resistance path to earth.

One point of caution worth mentioning. The input potentials should not be allowed to either rise above the positive rail potential or drop to a negative value below zero volts.

FAMILIARISATION

To get the feel of a comparator it is a simple matter to wire one up on something like μ -DeC according to the circuit of Fig. 1. IC1a is one of the four comparators in the i.c., the pin connections for which are also shown. In fact it does not matter particularly which of the four is chosen, but for those who might wish to make a car systems monitor described later, the author's selection was based on being able to use some of the experimental circuit made up on Veroboard for a working model later.

If any form of experimental circuit is made up, it is suggested that an i.c. holder is used for the fairly obvious reasons that the chip is not damaged by soldering heat and is readily available for use elsewhere.

Assuming that the potentiometers are reasonably similar, one will be able to see clearly the way in which the output to the meter ME1 changes as the relationship of the voltages on the input pins changes.

Whenever the potential at the +ve input is higher than that at the -ve, the output will remain at nearly 9V but if the situation is reversed then the voltage drops to 0V. As a matter of interest an i.e.d. may be substituted for the meter if desired.

AUDIO OUTPUT

It is not difficult to convert a comparator into an oscillator or square wave generator by feeding the output back to the -ve input via a resistor as has been done in Fig. 2. The frequency of the output is governed by the RC combination C1, R4 and in fact the oscillator will not function unless the potential at pin 5 is about midway between +ve rail and 0V. R2 and R3 both act as base bias resistors for TR1 and provide the correct potential at pin 5.

Again one can try the circuit out on μ -DeC or other experimental layout or mount it on Veroboard.

SIMPLE MONITOR

Combining the circuits of Fig. 1 and Fig. 2 can create a simple monitor capable of giving audible indication of an increase in one voltage or decrease in another.

If this is done using the components of Fig. 1 and Fig. 2 in combination, then R1 of Fig. 1 and R2 of Fig. 2 become the same component and one of the potentiometers VR1 and VR2 is deleted. The comparator input which was connected to the deleted potentiometer becomes the input for the voltage to be sensed.

The circuit thus constructed will serve as quite a good voltage monitor capable of responding immediately to voltages which go outside the limits set by VR1. In fact in this circuit almost any potentiometer value from $1k\Omega$ to $1M\Omega$ may be used for VR1.

If accuracy of measurement is an important factor, then it is suggested that the circuit be modified in order to include some form of voltage stabilisation. A suggested circuit is shown in Fig. 3 where a Zener diode D1 is used to provide a stabilised voltage to one input of each of two comparators in the i.c. The Zener voltage can be up to three-quarters of the supply voltage.

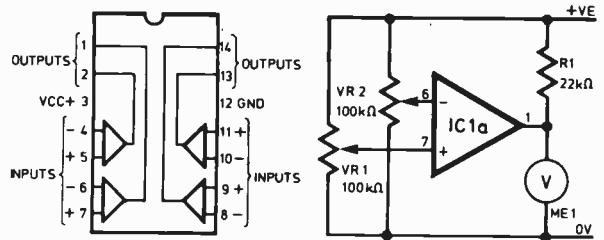

Fig. 1. The pin connections for the MC3302P i.c. and a basic circuit for familiarising oneself with the action of a comparator

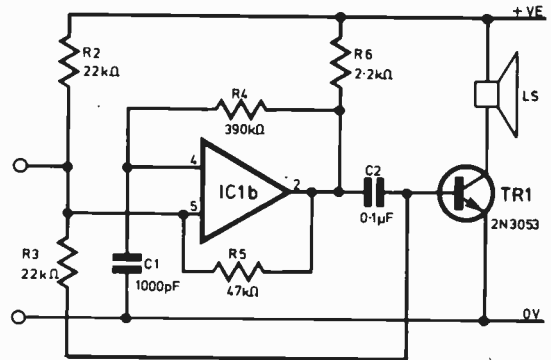

Fig. 2. Using a comparator to make up an audio oscillator

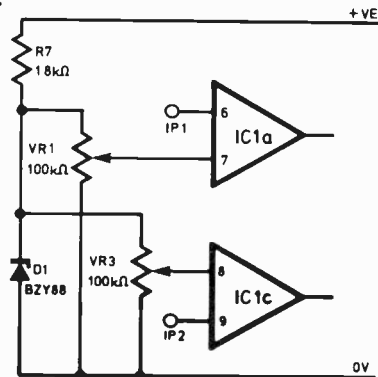

Fig. 3. Using a Zener diode to provide a stabilised reference voltage against which input voltages can be detected. Here two comparators are used to accept two separate and, if required, different inputs

APPLICATIONS

For the person who wants to monitor a simple voltage the foregoing will suffice. Indeed, the circuit can be used as a substitute for an oscilloscope for some purposes. If both inputs are joined together and set to react at very close or identical voltages, any alteration in input condition from the selected voltage will cause an output. Thus a varying input will cause an output.

As will be appreciated, the use of two input comparators in Fig. 3 presupposes the associated use of two audio oscillators and it is a simple matter to select the tone-deciding components so that two different tones are generated, one for a falling voltage and one for a rising voltage.

Thus the device could be used perhaps as a voltmeter for a blind person or where dark operation is required.

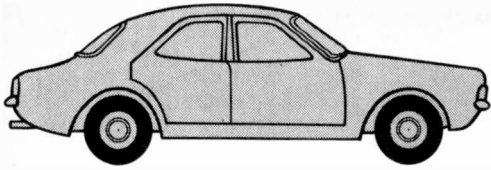

CAR SYSTEMS MONITOR

As mentioned earlier, one possible application of the monitor is in the automobile area where the system can be used to "observe" the state of, for example, the petrol gauge and the water temperature gauge.

Most vehicles have some form of automatic voltage control and the instruments in this case do not respond immediately to any change in parameter indicated. In fact, variations in battery voltage are compensated for by interrupting the supply voltage intermittently using a hot-wire thermostatic switch which operates at a few cycles per second.

The monitor in its simpler form would respond immediately to the variations caused by these interruptions and thus the circuit requires some modification. A suitable circuit is shown in Fig. 4 and here a degree of hysteresis is introduced by including resistors and capacitors on each input line. Using this arrangement the monitor only sounds the alarm if one of the observed voltages goes out of limit for more than a second.

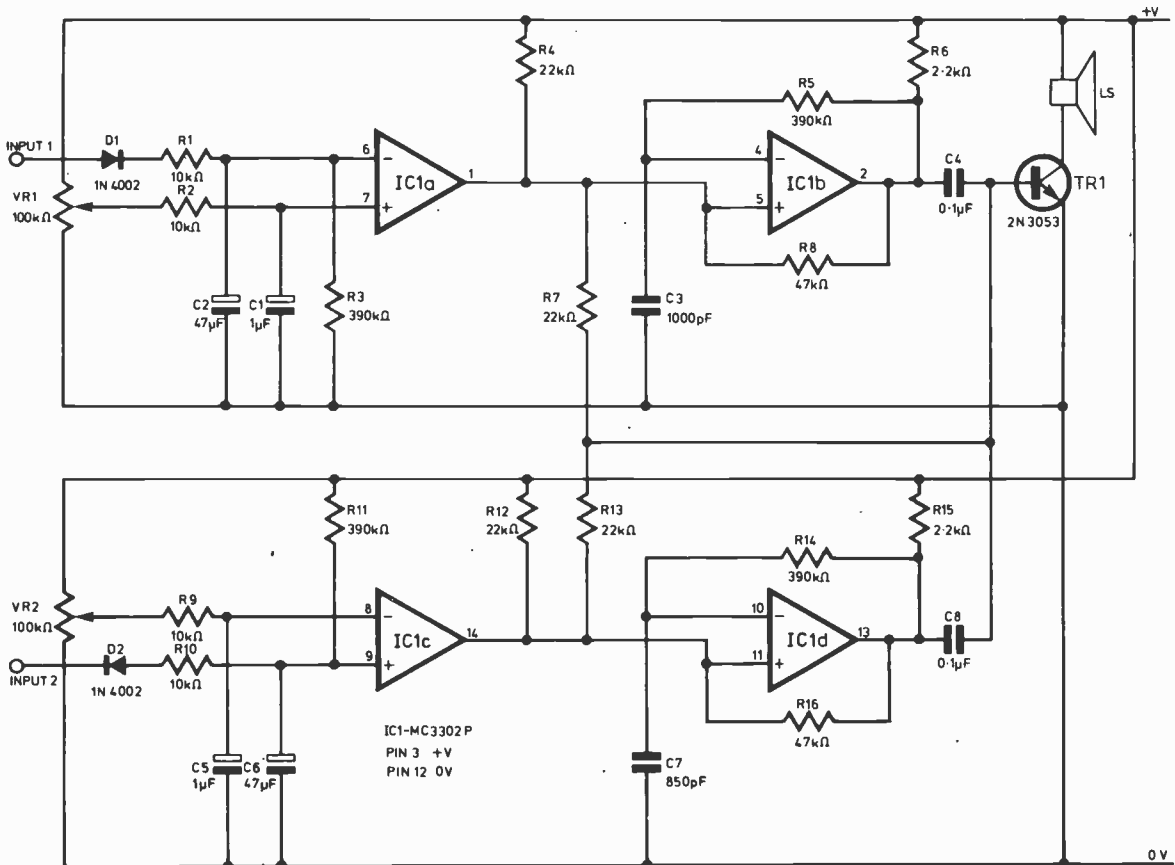
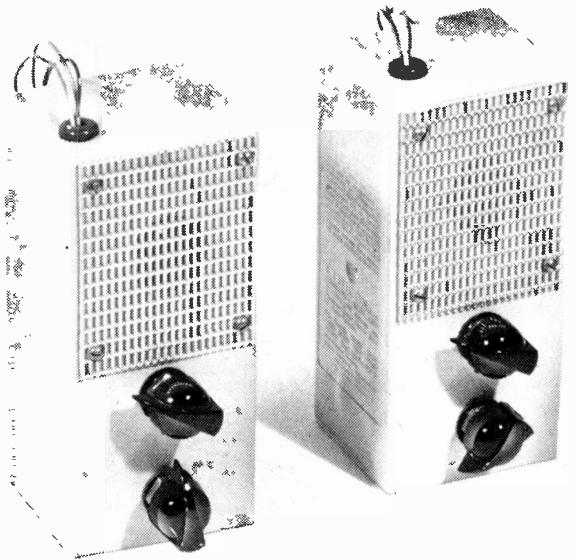

Fig. 4. Circuit diagram of a car systems monitor using the comparator i.c. For use on positive and negative earth vehicles see notes in the text

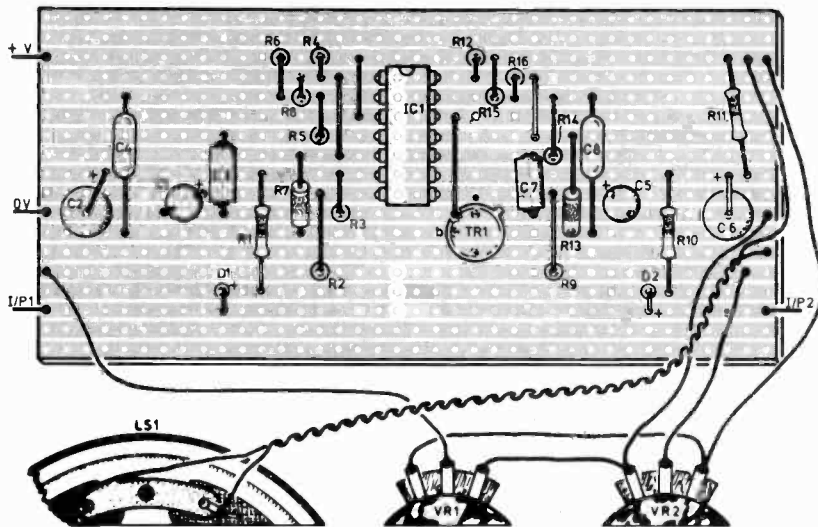

Fig. 5. Veroboard layout and cutting details for the car systems monitor of Fig. 4

COMPONENTS . . .

CAR SYSTEMS MONITOR

Resistors

R1	10k Ω
R2	10k Ω
R3	390k Ω
R4	22k Ω
R5	390k Ω
R6	2.2k Ω
R7	22k Ω
R8	47k Ω
R9	10k Ω
R10	10k Ω
R11	390k Ω
R12	22k Ω
R13	22k Ω
R14	390k Ω
R15	2.2k Ω
R16	47k Ω
All 5%, $\frac{1}{4}$ W	

Potentiometers

VR1	100k Ω lin (see text)
VR2	100k Ω lin (see text)

Semiconductors

IC1	Quad comparator MC3302P
TR ₁	2N3053 or similar n.p.n.
D1 and 2	1N4002

Capacitors

C1	1 μ F
C2	47 μ F
C3	1,000pF
C4	0.1 μ F
C5	1 μ F
C6	47 μ F
C7	850pF
C8	0.1 μ F

Miscellaneous

Veroboard; case, preferably plastic; wire; solder etc.

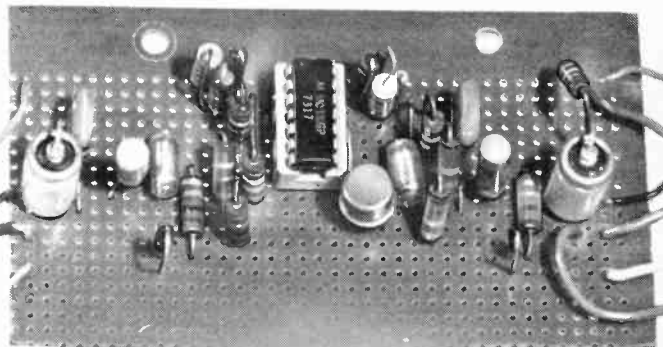

Providing that the unit is constructed in an insulated container with only power supply leads and alarm inputs, then there is no real problem over negative or positive earth vehicles. The polarity of the power supplies remains the same for each case and the input protection diodes are the only components to be altered.

For negative earth vehicles, orient both D1 and D2 as D1 and for positive earth orient as D2.

As can be seen from Fig. 4, only one loudspeaker is required and by selecting different values for C3 and C7 two tones are produced thus identifying which input has altered.

The loudspeaker can be mounted in the box with the circuit board shown in Fig. 5 but care should be taken to ensure that there is no risk that holding bolts for the Veroboard contact both tracks on the board and parts of the chassis of the carrying vehicle.

The two monitors illustrated in the accompanying photographs are a car systems monitor and a simple monitor. Both are housed in small plastic cases together with their associated loudspeakers. ★

THIS month, the Power Supply, Tone Generator and Top C Envelope circuitry are described.

POWER SUPPLY

The circuit of the power supplies is shown in Fig. 2.1 and is basically a simple unregulated system apart from the 5V logic supply which is provided by a three terminal integrated regulator.

Transformer T1 is rated at 17V, 2A, with a 9V tapping. Other suitable alternatives would be 9-0-9V or 10-0-10V, but in the latter case it would be necessary to increase the value of supply line resistors to compensate for the higher voltage. The potted bridge rectifier D1-D4 should have a p.i.v. rating of greater than 50V and a 2A capacity. Using the Norman CT2 transformer the input voltage to the 5V regulator is approximately 9V on load. The value at the high level output is 19V, with a 2V drop across R1 which is linked to the touch resistors on the key switch assembly.

The negative supply is obtained from a voltage doubler. The requirement here is for less than 50mA so that the current rating of diodes D5 and D6 can be very low, with a p.i.v. of greater than 70V. A number of manufacturers can supply miniature transformers suitable for T2; on the prototype an Eagle version was used which gave -22.5V on load.

SOCKET PANEL

All sockets for the Piano are integrated into the Power Supply chassis (see photograph) providing a convenient mounting point for the mains input, pedal input, external amplifier output, and headphone output sockets, and the mains input fuse.

COMPONENTS . . .

POWER SUPPLY UNIT

Resistor

R1 3.9Ω 2W

Capacitors

C1 1,000μF elect. 16V
C2 1,000μF elect. 16V
C3 4,700μF elect. 16V
C4 4,700μF elect. 25V

Diodes

D1-D4 C1406 bridge rectifier (Electrovalue)
D5-6 ZS171

Integrated Circuit

IC1 MC7805CP (Motorola)

Transformers

T1 Mains transformer—Norman CT2 (Electrovalue) (see text)
T2 Mains transformer—12V 100mA

Miscellaneous

FS1 200mA fuse, FS2 1 amp fuse, LP1 mains neon, S1 mains switch on level potentiometer, Aluminium sheet 10 $\frac{1}{4}$ in × 9 $\frac{1}{2}$ in, 8-way standard group board, tag strip, SK1 3 pin miniature mains socket, SK2 Standard $\frac{1}{4}$ in jack socket mono, SK3-SK4 Standard $\frac{1}{4}$ in jack socket stereo.

PE

JOANNA

PART 2

By A.J. BOOTHMAN B.Sc.



The zero level output of the Power Supply is used for connections to the other units in the Piano as will be shown later, but the earth input from the mains lead is connected to the output jack socket of the instrument, to avoid hum due to earth loops.

POWER SUPPLY ASSEMBLY

The plan/photograph view indicates the positions of all the major components in the Power Supply Unit. A piece of aluminium sheet 10 $\frac{1}{4}$ in × 9 $\frac{1}{2}$ in is required to make the chassis which should be cut into the L-shape shown in Fig. 2.2. $\frac{1}{8}$ in holes should be drilled on the centres indicated, and air vent holes made in the bottom of the base plate with a $\frac{1}{8}$ in drill. The positions of the air vent holes are not critical but it is essential that matching holes are drilled in the bottom of the cabinet to give a continuous air flow. When all holes have been drilled

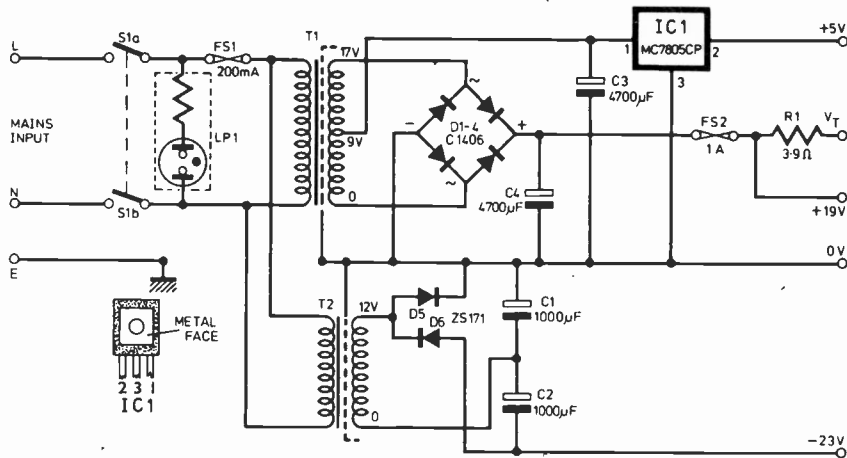

Fig. 2.1. Circuit of power supplies

in the aluminium sheet a paper pattern of the power supply base should be made. This will indicate the positions of all the holes such that when the cabinet is made the air vent positions can be transferred onto the woodwork, and in addition the positions of all screws (6BA) can be marked which allows the constructor to drill shallow holes in the cabinet to accommodate any form of protruding screw head used in the chassis assembly.

When the pattern is complete the chassis should be folded along the dotted lines shown in Fig. 2.2, folding upwards from the page. It is not necessary to fix the floating side of the chassis to the base since holes are provided for wood screws to fix into both the rear and the base of the cabinet when placed in position.

GROUP BOARD

The rectifiers and negative supply smoothing capacitors are mounted on a 16 terminal group board, the layout of which is shown in Fig. 2.3. The board is fixed to the chassis on pillars, consisting of threaded spacers 1½in long, in an inverted position. C1, C2 and D1-4 are soldered to the lugs whilst, D5, D6 and FS2 are fixed to the back of the group board.

POWER SUPPLY CONNECTIONS AND FUNCTIONAL CHECK

In order to make the Power Supply a self-contained unit, all terminations are brought out to a tag strip running the full length of the supply. When all

Fig. 2.2. Chassis drilling and bending detail for p.s.u.

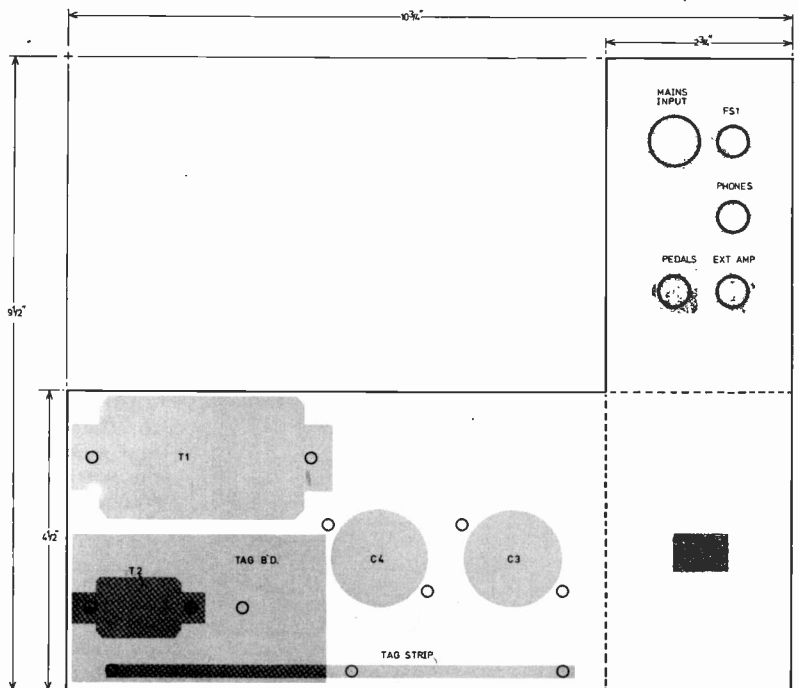

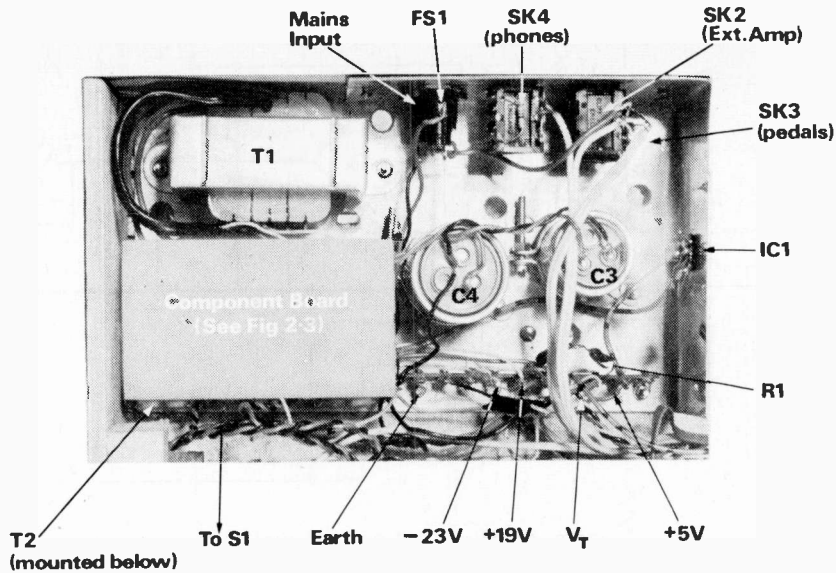

Position of major components in Power Supply unit

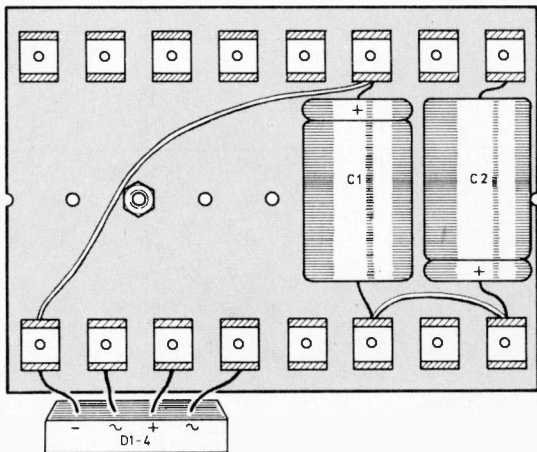
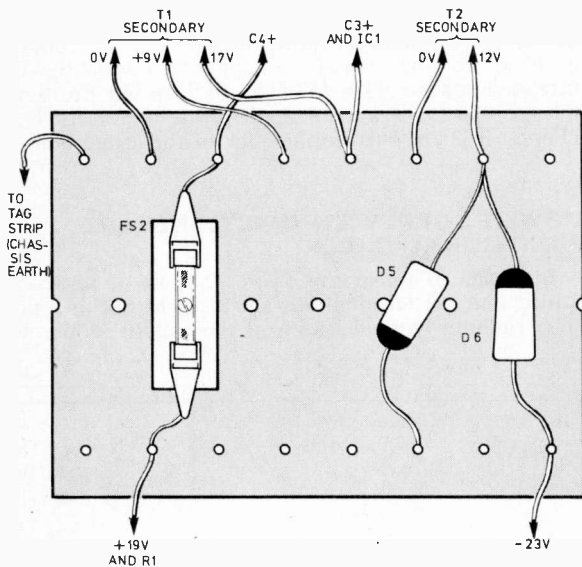

Fig. 2.3. Top and bottom views of group board

the interwiring has been completed the unit can be tested. Since both the internal resistance and the open circuit voltages of apparently similar transformers vary by a surprisingly high degree the unregulated voltage may have a fairly wide range.

The input to the 5V regulator should be in the region of 9-12V on a 600mA load but is not critical from the point of view of the regulator if it is in the range 8V to 15V. However, if for instance a 10-0-10V transformer is used, care should be taken not to exceed the voltage rating of C3. The +19V and -23V are on load measurements and are likely to be exceeded by at least 20 per cent when measured under open circuit conditions. Again if a transformer other than the Norman CT2 is used it would be advisable to use a higher voltage capacitor for C4. Open circuit voltages measured on the prototype were +24V, -30V, and +12V at the input to the 5V regulator.

TONE GENERATOR

Frequency generation in the Piano is dependent on the use of the General Instrument Microelectronics Master Tone Generator type AY-1-0212. This unit leads to the realisation of very accurate relative tuning across the keyboard, which is also extremely easy to adjust.

TUNING ACCURACY

Comparison of the top octave frequency values for the equal tempered scale and the chip indicate that maximum deviations occur in D, Eb, F and G, the worst representing 0.113 per cent of the absolute frequency. Experiments have been reported to have shown that the average person can distinguish an 0.7 per cent deviation if two tones are sounded simultaneously with this error, and that an excellent musician might approach 0.03 per cent (probably by luck). These tests were of course carried out under an unreal situation in that such a rigid comparison is not relevant to the intervals on a single piano keyboard. The author is convinced that the AY-1-0212 accuracy is irreproachable for this application,

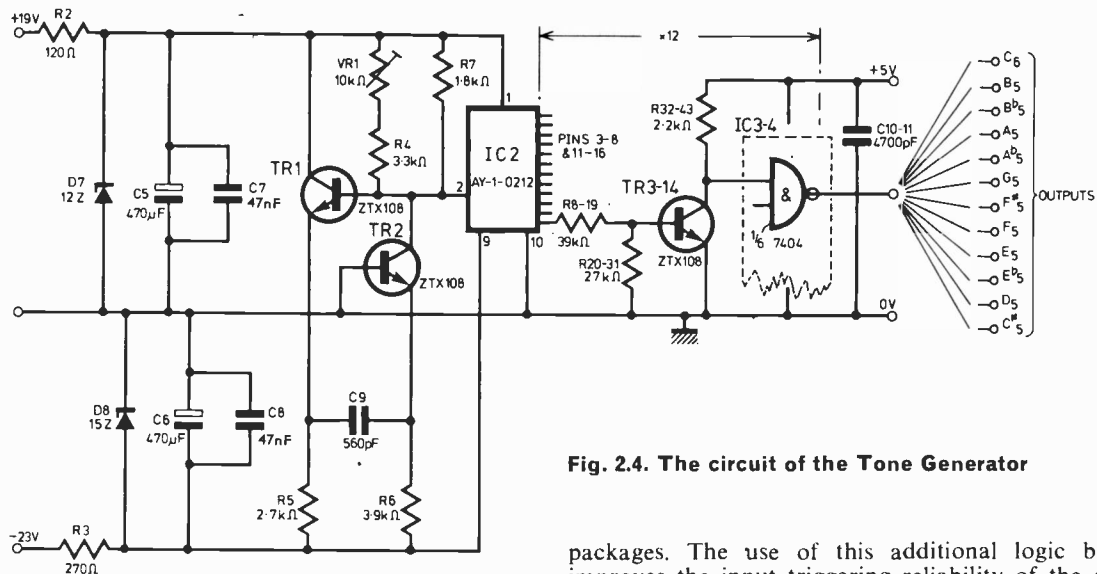

Fig. 2.4. The circuit of the Tone Generator

and the resulting chordal sounds from the keyboard are highly acceptable.

TONE GENERATOR CIRCUIT

The circuit of the Tone Generators is shown in Fig. 2.4. The raw supplies of 19V and -23V are regulated by Zener diodes to +12V and -15V respectively and supply a Bowes astable multivibrator driving the AY-1-0212. The Bowes astable is a non-saturating circuit easily capable of oscillating at the required frequency. The frequency of operation is determined by C9 and the combination of R7, VR1 and R4. For stability C9 should be mica or polystyrene, whilst R4 and R7 could be metal film.

The collector of TR2 swings between approximately 1V and 11V, which is the required input for the Master Tone Generator. The outputs of the AY-1-0212 are equivalent to a 3.5 kilohm resistor connected to a source alternately swinging between zero and 12V, and since the "Joanna" uses TTL dividers for economy it is necessary to have a buffer amplifier for each semitone of the top octave. TR3-TR14 perform this function, and each transistor is followed by a TTL gate in the hex inverter (7404)

packages. The use of this additional logic buffer improves the input triggering reliability of the quad divider packages, and is well worth the small additional cost of the two i.c.s.

TOP C ENVELOPE CIRCUIT

For layout convenience the Tone Generator Board also contains the Envelope Shaper Circuit for top C. The circuit is shown in Fig. 2.6, with the single divider (7472) which provides pitch C5. The detailed operation of the Envelope circuit will be described next month, and is not identical for all notes.

TONE GENERATOR BOARD ASSEMBLY

The Tone Generator and top C Envelope circuitry are combined on a single printed circuit board, the etching and drilling details of which are given in Fig. 2.5 with the component assembly details below.

To assemble the board, the terminal pins should be fitted, followed by resistors, capacitors, diodes and transistors. VR1 should be a linear track potentiometer with rotary drive. The printed circuit board has been planned to accept two popular versions of this component. IC3, 4 and 5, should be soldered into the board, and it is recommended that a socket be used in the IC2 position, ready to accept the Master Tone Generator. If metal can transistors

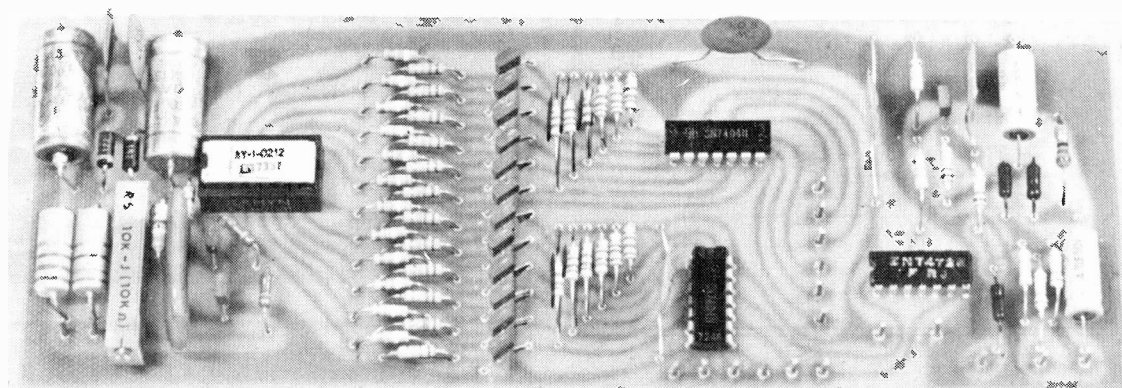

Photograph for M.T.G. and Top C Board

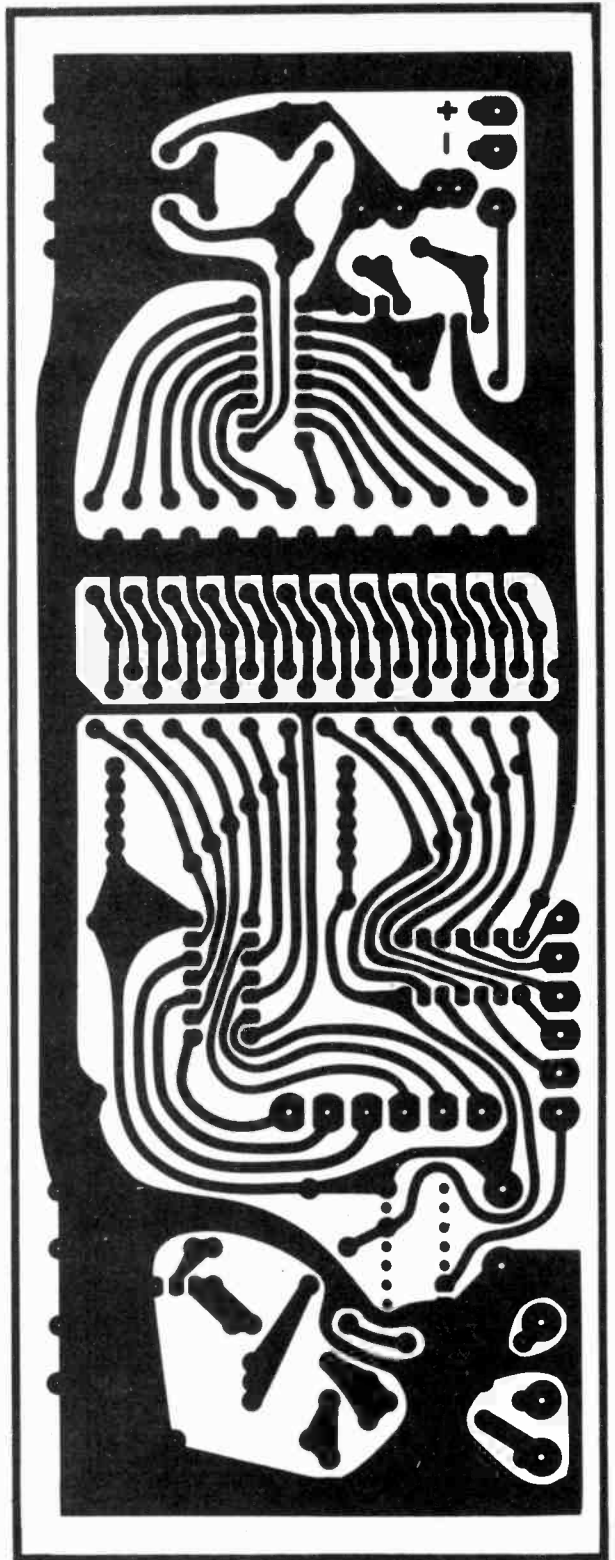
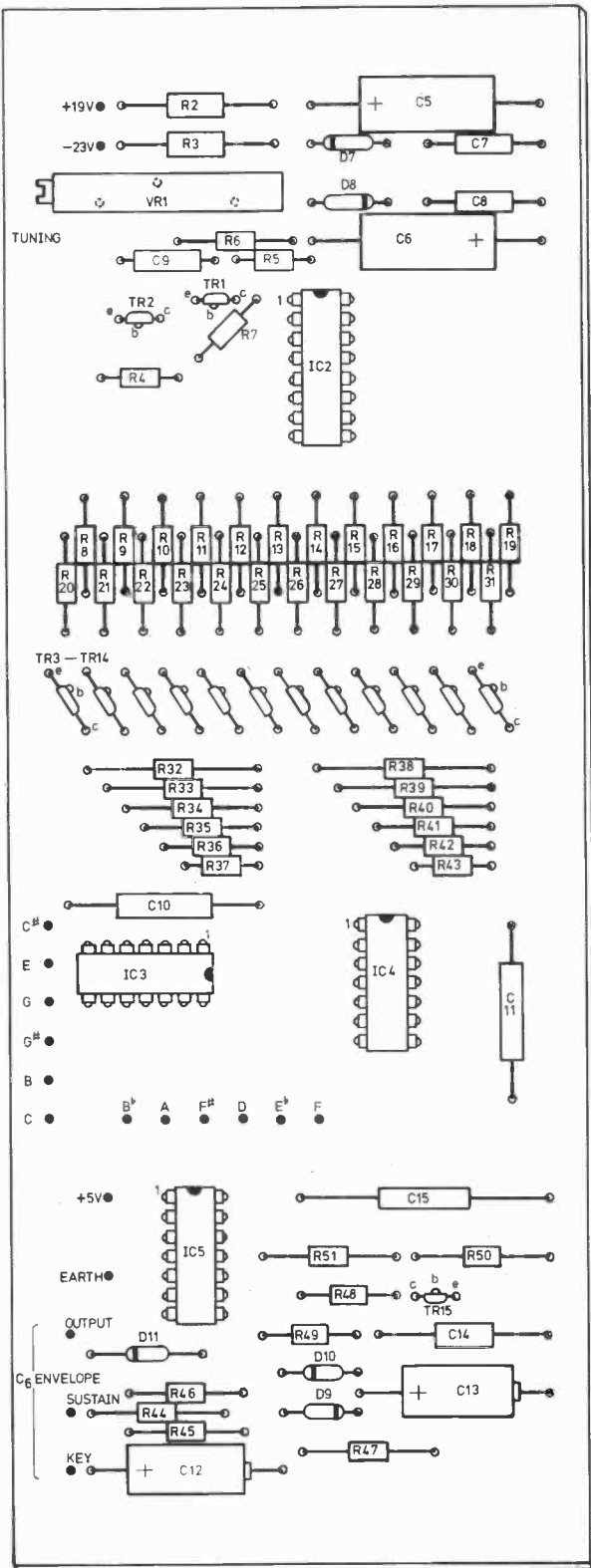

Fig. 2.5. Etching details and component layout for Master Tone Generator and Top C Board

are used instead of the ZTX 108, great care should be taken to ensure that the cans do not touch each other.

PRECAUTIONS WITH THE M.T.G.

The AY-1-0212 is an integrated circuit using MTOS (metal-thick-oxide-silicon) p-channel enhancement mode field effect transistors. Whilst General Instruments have designed protection circuits into the device it is wise to take a number of precautions in its use.

The devices are normally supplied packed in a conductive foam, and should not be removed from this until the constructor is ready to insert the unit into the socket. Handle the device carefully, having

COMPONENTS . . .

TONE GENERATOR BOARD			
Resistors			
R2	120Ω 1 watt	R32-43	2.2kΩ
R3	270Ω 1 watt	R44-45	120kΩ
R4	3.3kΩ metal film	R46	33kΩ
R5	2.7kΩ	R47	56Ω
R6	3.9kΩ	R48	150kΩ
R7	1.8kΩ metal film	R49	150kΩ
R8-19	39kΩ	R50-51	47kΩ
R20-31	27kΩ		
All ½ watt, 5%, except where stated otherwise			
Capacitors			
C5-6	470μF elect. 16V	C12	4.7μF elect. 25V
C7-8	47nF ceramic	C13	4.7μF elect. 16V
C9	560pF mica	C14	470pF
C10-11	47nF ceramic	C15	47nF
Potentiometer			
VR1	10kΩ multi-turn linear preset		
Diodes			
D7	12 volt Zener diode 1 watt		
D8	15 volt Zener diode 1 watt		
D9	11 Silicon diodes		
Transistors			
TR1-14	ZTX108	TR15	ZTX108
Integrated Circuits			
IC2	AY-1-0212 G.I.M.	IC5	ZN7472
IC3-4	ZN7404		

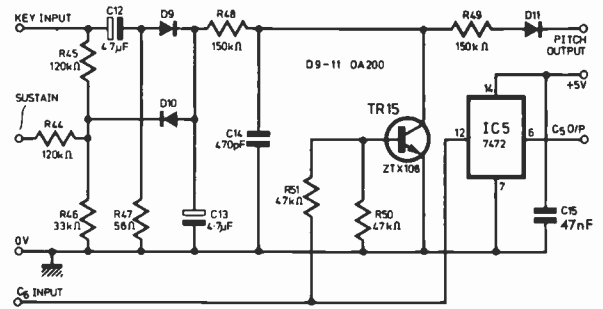

Fig. 2.6. Top C Envelope shaper

previously touched an earth lead, and if it is decided to risk avoiding the use of a socket then soldering should be carried out with a well earthed soldering iron.

EXPERIMENTING WITH THE TONE GENERATOR BOARD

The units built so far allow a test to be carried out, using the experimental keys and jig described last month. A test arrangement is shown in Fig. 2.7 in which one of the five experimental keyswitches is used to trigger the C6 envelope, and the resultant output can be checked using an external amplifier as described last month. The 12 semitones can also be checked and should give continuous square wave outputs.

When performing this experiment the power supply should first be loaded and the outputs measured to ensure that the voltages applied to the Tone Generator Board are correct, or damage to components on the board could result. For the touch mechanism to work correctly the four unused keyswitches must be in the grounded position, and the 39 ohm resistor used to give the correct touch voltage.

The 100 kilohm resistor soldered to the +19V terminal on the Tone Generator Board provides the correct level to check the Sustain pedal action on the single envelope. This part is only a crude test, and connection of the leads may introduce hum which should be ignored.

Next Month : The complete envelope generation system

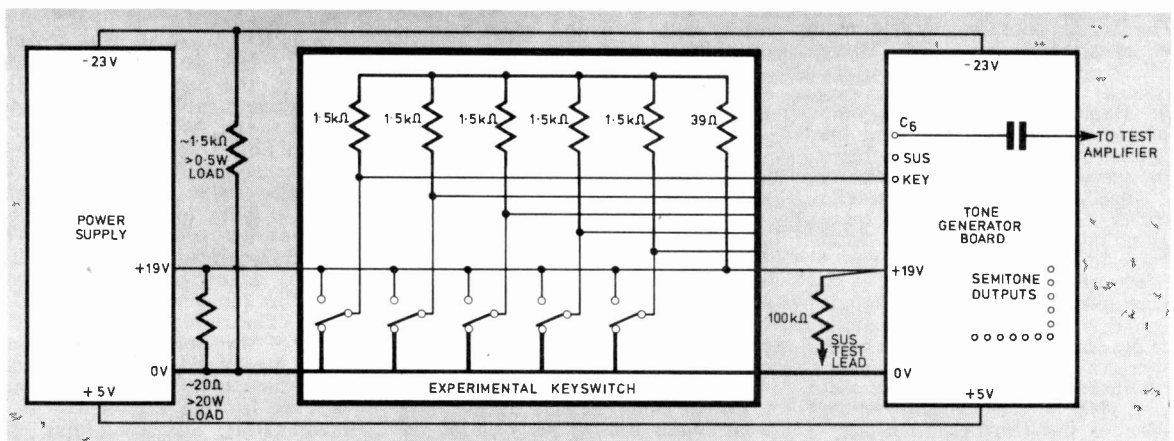

Fig. 2.7. Test set-up for the Tone Generator Board



BY FRANK W. HYDE

Our Space Commentator has just returned from a visit to the USSR. The Soviet Permanent Space Exhibition, Moscow was naturally one of the main items on his itinerary.

SOVIET ACTIVITIES

In December 1974 the *Salyut 4* orbital station was launched. This spacecraft has had a successful and profitable life so far. By March the station had made more than a thousand revolutions round the Earth.

The year 1974 was a very active one for Soviet space research. Academician Keldysh, President of the USSR Academy of Sciences, speaking at the general meeting, made special mention of the *Soyuz 16* satellite. This vehicle piloted by Anatoly Filipchenko and Nikolai Rukavishnikov, was launched to check the new systems and equipment to ensure the success of the *Soyuz-Apollo* mission.

The Intercosmos programme was also extended during 1974. Using satellites and meteorological rockets, specialists in the Soviet countries have studied the radiation of the Sun, ionospheric conditions and the magnetosphere. In addition there were special studies of the density and energies of micro-meteorite particles. A number of joint space exploration projects involving France, India and Sweden were also carried out during 1974.

The long term orbital stations *Salyut 3* and *Salyut 4*, had made it possible for a wider and more comprehensive exploration of the near-earth space as well as the processes taking place in the Sun and remote objects in the Universe. In near-earth activities the photography for

oil prospecting, gas exploration, the search for water resources and minerals was also a major part of the programme.

During 1974 it had been established, by automatic stations set up for the purpose, that there were no differences in the composition of the rocks found on Earth and the rocks found on Mars. It was also established that the magnetic field on Mars was more than a thousand times less than that on Earth. It had been noted that the Martian climate was continually changing. From the data received it was clear that at one time there must have been a very considerable amount of water on the planet.

MAN AND THE BIOSPHERE

At the time of writing there is another conference "Man and the Biosphere" taking place at Zvenigorod near Moscow. Among the items being discussed are the problems of the study of the Earth from space.

The Director of the USSR Space Research Institute, Academician Roald Sagdeyev, stressed that the main task of the conference was to work out unified systems for the study of Earth resources and the control of the environment by satellites. It was necessary to maintain a global watch in all areas of scientific activities.

He also said that it was important that not only was it necessary for all branches of science to co-operate, but also to consider international boundaries as less important. Pollution could spread over these boundaries and it was necessary therefore to consider close international co-operation to tackle such problems.

NEW LAUNCHINGS

In the first quarter of 1975 already there has been intense activity over a wide field. In February a single rocket launched eight satellites of the *Cosmos* series. They are all travelling in their calculated orbits with a period of revolution of 115.5 minutes.

The *Cosmos 719* was launched in March for studies of outer space. It has an extended orbit with a perigee of 182km and an apogee of 329km. The orbital period of revolution was initially 89.3 minutes. The angle of the orbit is 65°.

METEORITES IN THE USSR

A meteorite which weighed 2,276 grammes was found in Chukotka, North East Siberia. It was discovered when a brook was being cleared by a team from the Academy of Sciences.

Cobalt and nickel traces have been found but 90 per cent of the meteorite is iron. Behind the oxide

layers it is possible to discern in-grown laminae and crystals which are between 2 and 3cm in size.

The second meteorite find is perhaps the most significant so far as scientific history is concerned. It relates to the Tungus meteorite which fell to Earth in 1908 causing great damage over an enormous area. Trees were flattened over a very wide area, some completely charred. It was seen from many places in Asia and Europe.

A BLACK HOLE?

No pieces of the object were found in spite of many searches. The area was swampy and it was concluded that it probably vaporised or at least disintegrated into very small particles.

Recently there was a suggestion that it was not a meteorite but a small black hole which passed through the Earth. Support for this was claimed because there was an intense blue shaft of light seen at the time. This was not accepted generally as sufficient evidence.

However, the mystery has now at least been modified for it is now confirmed that the meteorite was in fact the nucleus of a small comet. Final confirmation of this will help to evolve a theory of destruction of the nuclei in planetary atmospheres.

In a peat bog, near the centre of the disaster area, a profusion of molten glass spheres with bubbles of gas inside were found at a depth of 25.4cm. The composition of the particles is unusual. The silicates included in them have a high content of silicon and alkaline metals. The bubbles of some of the spheres are filled with carbon dioxide or hydrogen sulphide.

THE CONTINUING SEARCH

The comet hypothesis is supported by the fact that a glow in the sky persisted for several days and was seen as far off as Southern France. This could have been the comet's tail scattered by the pressure of the Sun's rays and which was caused to deviate to the west of the site of the fall.

The Soviet scientists believe that a considerable part of the comet exploded as it entered the atmosphere. The matter would have liquified or even vaporised. This would result in an aerosol cloud which stratospheric winds would carry in the direction of the north west. The result would be that the bulk of the debris would fall at a point a hundred kilometres or more from the centre of the explosion. It is now in that direction that the investigators are continuing their search.

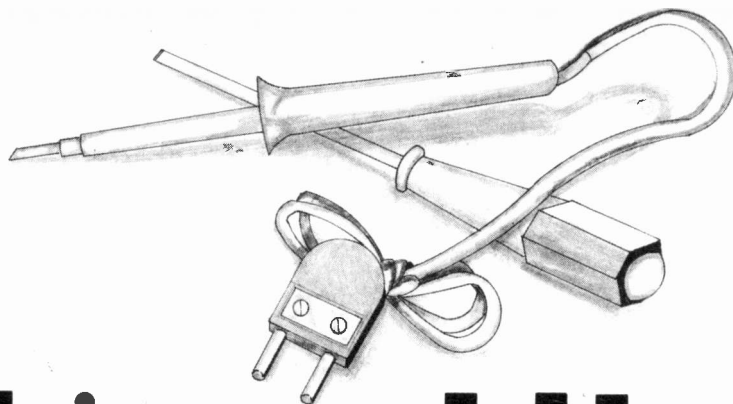

This could lead to something big.

A soldering iron and a screw driver. If you know how to use them, or at least know one end from the other, you know enough to enrol in our unique home electronics course.

This new style course will enable anyone to have a real understanding of electronics by a modern, practical and visual method. No previous knowledge is required, no maths, and an absolute minimum of theory.

You build, see and learn as, step by step, we take you through all the fundamentals of electronics and show you

how easily the subject can be mastered and add a new dimension not only to your hobby but also to your earning capacity.

This course is accepted by and used in a large number of schools and colleges and forms an invaluable grounding for professional training in the subject. All the training is planned to be carried out in the comfort of your own home and work in your own time. You send them in when you are ready and not before. These culminate in a final test and a certificate of success.

1

Build an oscilloscope.

As the first stage of your training, you actually build your own Cathode ray oscilloscope! This is no toy, but a professional test instrument that you will need not only for the course's practical experiments, but also later if you decide to develop your knowledge and enter the profession. It remains your property and represents a very large saving over buying a similar piece of essential equipment.

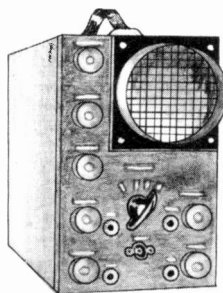

2

Read, draw and understand circuit diagrams.

In a short time you will be able to read and draw circuit diagrams, understand the very fundamentals of television, radio, computers and countless other electronic devices and their servicing procedures.

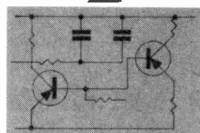

3

Carry out over 40 experiments on basic circuits.

We show you how to conduct experiments on a wide variety of different circuits and turn the information gained into a working knowledge of testing, servicing and maintaining all types of electronic equipment, radio, t.v. etc.

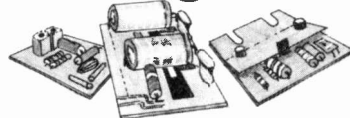

PLUS

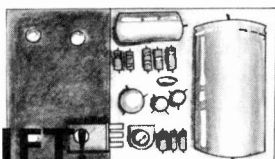

FREE GIFT

ALL STUDENTS ENROLLING IN OUR COURSES RECEIVE A FREE CIRCUIT BOARD ORIGINATING FROM A COMPUTER AND CONTAINING MANY DIFFERENT COMPONENTS THAT CAN BE USED IN EXPERIMENTS AND PROVIDE AN EXCELLENT EXAMPLE OF CURRENT ELECTRONIC PRACTICE

To find out more about how to learn electronics in a new, exciting and absorbing way, just clip the coupon for a free colour brochure and full details of enrolment.

WAA

Brochure without obligation to:
BRITISH NATIONAL RADIO & ELECTRONICS SCHOOL, Dept. EL65
P.O. Box 156, Jersey, Channel Islands.

NAME.....

ADDRESS.....

(Block caps please)

TRANSDUCERS

PART 3 Inductive Devices & Physical Parameters

By P.R. ALLCOCK

INDUCTIVE transducers make use of the properties of magnetic systems involving magnetic materials, coils and air gaps, and they may be either passive or self generating. The self generating type relies on the principle of relative motion between a conductor and a magnetic field inducing a voltage in a conductor. In self generating transducers this relative motion is provided by changes in the measurand and consequently only dynamic measurements are possible with this device.

Self generating transducers can be conveniently grouped into four categories based on the way in which the output signal is generated by the magnetic system in response to the input measurand.

MOVING COIL SYSTEMS

All transducers that employ the principle of a coil moving in a magnetic field can be called moving coil transducers, the motion employed to cause coil movement depending on the details of the application. Thus the motion might be linear as in a moving

coil microphone, or angular as in the simple generator or a.c. tachometer.

These two cases are illustrated in Fig. 3.1 and Fig. 3.2 respectively. In Fig. 3.1 the measurand is sound pressure on the diaphragm and changes in this pressure cause linear displacements of the moving coil along the axis indicated. The concentric pole pieces of the permanent magnet system ensure a reasonably uniform radial flux in the air gap and only when the coil moves will there be a voltage induced in it.

Fig. 3.2 illustrates the principles of a coil that rotates in a fixed magnetic field and in this case two slip rings are required to make connection to the moving coil. The common moving-coil meter has a similar construction but is used to transform an electrical input into the angular displacement of a needle. Similarly, the moving coil loudspeaker uses

* North Staffordshire Polytechnic

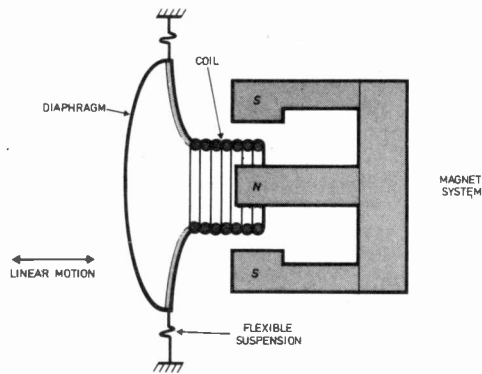

Fig. 3.1. The moving coil microphone

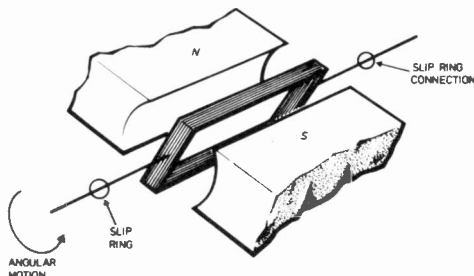

Fig. 3.2. The simplest form of a.c. tachometer using a moving coil

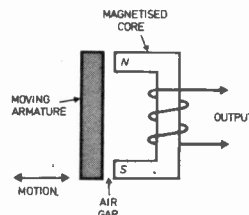

Fig. 3.3. The variable reluctance transducer

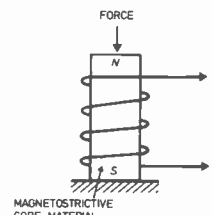

Fig. 3.4. The magnetostrictive transducer

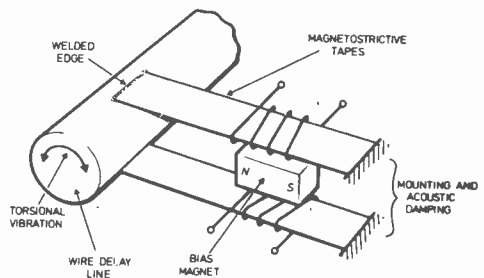

Fig. 3.5. The Scarrot-Naylor torsional transducer which makes use of magnetostrictive effects

the principle of Fig. 3.1 but the input is again the electrical signal and the audio output results from the displacement of air by the cone.

In all the moving coil transducer systems, the amplitude of the output signal will depend on the rate of change of the flux-linkage and so will be proportional to the linear or angular velocity. The linear moving coil system can indicate the sense or direction of movement as well as the velocity since the output polarity depends on the direction of movement of the coil.

The angular transducer on the other hand produces an alternating output which ever way the coil revolves. In some devices the coil is stationary and a moving magnet is used to give a velocity dependent voltage output, thus simplifying the problem of coil connections.

VARIABLE RELUCTANCE TRANSDUCERS

Transducers in this group utilise variation in the reluctance of the magnetic flux path and the principle is illustrated in Fig. 3.3. The armature moves through changes in the measurand, thus varying the lengths of the air gaps which form a significant part of the magnetic circuit. As the air gap increases the flux in the coil changes and a voltage is induced in the coil.

The output voltage can be calibrated in terms of changes in the measurand but since the flux variation with armature position is approximately an inverse law the output is only roughly proportional to armature velocity for small armature displacements. The armature is attracted to the magnet and must therefore be restrained by some flexible support system so that an air gap exists even with zero input.

The reluctance of the magnetic path is normally dominated by the reluctance of the two air gaps and under this condition the reluctance is approximately proportional to air-gap length.

MAGNETOSTRICTIVE TRANSDUCERS

Some ferromagnetic materials exhibit changes in their permeability when subject to mechanical stress. Consequently a coil wound on a core of such material will experience changes in its flux pattern when under stress. The voltage induced will depend on both the magnitude and the rate of change of the applied stress and the principle is shown in Fig. 3.4. Typical magnetostrictive materials include permalloys, nickel, cobalt and certain ferrites. The main areas of use are those in which high power levels are encountered, ultrasonic applications such as thickness gauging and underwater sonar detection systems.

The magnetostrictive behaviour of these materials is reversible in that suitable magnetic excitation will produce dimensional changes in the material. These effects have been used in some computer delay lines and one such application is illustrated in Fig. 3.5. The delay is produced by the propagation time of torsional waves transmitted down the nickel wire. The waves are initiated by causing the wire to twist as the two magnetostrictive tapes expand and contract due to the applied magnetisation. The magnet provides a permanent flux to which is added the flux due to the signal in the coils. The magnetisation is so arranged that one tape expands whilst the other shrinks giving a kind of push-pull drive to the delay wire. The receiving transducer is basically similar to the transmitter.

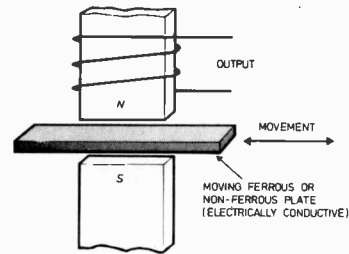

Fig. 3.6. Principle of operation of the eddy current transducer

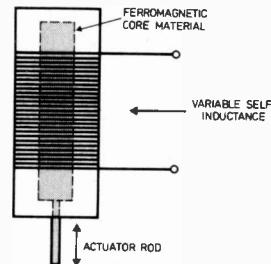

Fig. 3.7. Self-inductive version of the passive inductive transducer

EDDY CURRENT TRANSDUCERS

Referring to Fig. 3.6, if the plate is moved in the direction shown, eddy currents are set up within the plate in proportion to the plate velocity. These currents create their own magnetic field which tends to oppose the main field of the magnet system but as long as the velocity is constant there is no output signal. However, a changing velocity will cause changes in the magnetic flux which gives rise to an output which is roughly proportional to the acceleration of the plate.

PASSIVE INDUCTIVE TRANSDUCERS

Passive inductive transducers require power from some external source and the transducer is normally used to modulate, say, the current flow in the excitation circuit. Both static and time varying measurands can be handled and converted to quantitative output signals, the normal unmodulated excitation level acting as the zero reference. As with the self generating types, four main categories can be identified.

VARIABLE INDUCTANCE

The self or mutual inductance of a coil system can be made dependent on the position of a core of ferromagnetic material as illustrated in Fig. 3.7 and Fig. 3.8. In Fig. 3.7 the self inductance of the coil increases as the core enters the coil, reaching a maximum value when the core is in the central position.



Already we know of 22,000 people who like our ideas.

In October of last year we ran several ads announcing a brand-new service for amateur electronics enthusiasts.

The new service was called Doram.

And it promised the first-ever professional electronics service for amateurs.

We said that if you didn't get your order within seven days we'd refund your money. So you'd have no long wait.

We said that we'd only give you top quality, big-name components.

We said that we'd give you a no-quibble guarantee and replace any component which arrived faulty.

And finally we said that we'd offer you a choice of millions of components on over 4,000 product lines.

Buy the Doram catalogue for 25p, we said, and you'll get a fantastic electronic component mail

order service.

We were as good as our word.

And your letters of thanks flooded in. Thousands tried our service. Hundreds went out of their way to write congratulating us.

'Your storeman must be power assisted', you said.

'I think you are a good firm and live up to your advertisement well', you said.

'How nice to find a firm which actually stocks all the items in its catalogue', you said.

And an awful lot more we'd blush to admit.

The Doram catalogue is still available, price 25p.

To encourage you to try us we'll give a £10 voucher to the first catalogue buyer out of the post bag on 30th June. And a £5 voucher to the next 19 new buyers.

Similarly, on 31st July, we'll give a £10 voucher to the first new

catalogue buyer. And a £5 voucher to the next 19 new buyers.

Use the coupon now while the offer lasts. Only these coupons are eligible, and all unsuccessful coupons from the June draw will also be entered for the July draw.

£10 VOUCHERS AND £5 VOUCHERS TO BE WON

I enclose 25p and look forward to receiving my Doram catalogue.

Doram Electronics Ltd., PO Box TR8, Wellington Road Industrial Estate, Leeds LS12 2UF.

Name _____

Address _____

PE 6/75

DORAM



for fast easy reliable soldering
EASY TO USE DISPENSERS AND REELS
IDEAL FOR HOME CONSTRUCTORS

Ersin Multicore Solder contains 5 cores of non-corrosive flux, instantly cleaning heavily oxidised surfaces. No extra flux is required.

SAVBIT handy solder dispenser



A coil of Ersin Multicore Savbit Solder in a dispenser 7ft 6 in of 18 s.w.g. (2.2 metres of 1.22mm). The Solder that reduces the wear of soldering iron bits.

Size 5 32p

SAVBIT solder for general purpose work

A handy plastic reel of SAVBIT alloy, 63ft of 18 s.w.g. (19.2 metres of 1.22mm)

Size 12 £1.72



ALU-SOL for soldering aluminium

New Multicore Alu-sol flux-cored solder in 16 s.w.g. No extra flux needed. Plastic reel holds 36ft. Supplied with full instructions. Also available in solder dispenser.

Size 4 £2.32



Fine gauge solder for soldering small components

Fine gauge solder for soldering small components 138ft of 22 s.w.g. (42.0 metres of 0.71mm) Ersin Multicore 5 core solder wound on a plastic reel. Suitable for intricate work and small components.

Size 10 £1.44



For soldering fine joints

Dispensers of Ersin Multicore Solder make those small jobs easier. 21ft of 22 s.w.g. (6.4 metres of 0.71mm) solder, specially suitable for soldering fine wires, small components and for repairing printed circuits.

Size 15 36p

Or size 19A for kit wiring or Radio and T.V. repairs 7ft. (2.1 metres) of 18 s.w.g. (1.22mm) Ersin Multicore Solder.

Size 19A 34p



NEW BIB WIRE STRIPPER & CUTTER

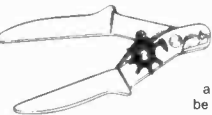

Fitted with unique 8 gauge selector with handle locking device and easy grip handles. Spring incorporated for automatic opening. Strips insulation from flex and cables in seconds and can also be used as a cutter.

Model 8B.80p

NEW SOLDER WICK



Absorbs solder instantly, from tags and printed circuits. Only needs 40 to 50 Watt soldering iron. Quick and easy to use. Does not need flux and is non-corrosive.

Size 18 90p

Bib Hi-Fi Accessories Limited,
 Sole U.K. Sales Concessionaires, P.O. Box 78 Hemel Hempstead, Herts. HP2 4RH

Prices shown are recommended retail excluding V.A.T. From Electrical and Hardware Shops. If unobtainable, send 15p P&P. Prices and specifications subject to change without notice.

The Shop Window for the Very Best...



COMBINED PRECISION COMPONENTS (PRESTON) LTD

Department PE
 194-200 North Rd.
 Preston PR1 1YP
 Tel: 55034
 Telex: 677122

TOSHIBA VALVES			DIODES			INTEGRATED CIRCUITS			
Type	Price Each (p)	Type	Price Each (p)	Type	Price Each	Type	Price Each		
DY87	30.0	AD149	40	BD124	75	BA115	7	TAA550	49p
DY802	30.0	AD161	38	BD131	45	BA145	14	TAA700	£2.95
ECC82	28.0	AD162	38	BD132	39	BA148	19	TBA120AS	£1.00
EF80	29.5	AF114	24	BD160	£1.39	BA154/201	11	TBA120SQ	£1.00
EF183	34.5	AF115	21	BD235	49	BY126	11	TBA480Q	£1.40
EF184	34.5	AF116	22	BD237	52	BY127	12	TBA520Q	£2.35
EH90	35.5	AF117	19	BDX32	£2.40	BY199	27	TBA530Q	£1.75
PC900	24.5	AF118	50	BF115	20	BY206	21	TBA540Q	£1.75
PCC89	40.0	AF139	35	BF160	15	BY238	25	TBA560C	£2.40
PCC189	45.0	AF178	45	BF167	20	OA90	6	TBA800	£1.50
PCF80	31.5	AF180	45	BF173	20	OA202	7.5	TBA920Q	£2.90
PCF86	39.0	AF181	45	BF178	35	IN50/OA91	5	TBA990Q	£2.90
PCF801	42.0	AF238	40	BF179	40	NEW TOSHIBA TUBES			
PCF802	40.0	AF240	60	BF180	31	19" A49/191X	£48.95	TCA270Q	£2.90
PCL82	39.0	BC107	11	BF181	32	20" 510DJ822	£50.75	ETD6016	£2.00
PCL84	39.0	BC108	10	BF184	25	22" A56/120X	£54.25	SN76013ND	£1.50
PCL85	44.5	BC109	14	BF185	25	EHT MULTIPLIERS MONOCHROME (BRC)			
PCL86	41.0	BC109C	14	BF194	9	Price Each			
PLF200	59.5	BC113	13	BF195	8	2HD 950MK1	960		£1.70
PL36	55.5	BC116A	19	BF196	10	2TQ 950MK2	1400		£1.85
PL84	25.0	BC117	14	BF197	12	2DAK 1500 (17" & 19")			£1.85
PL50A	64.5	BC125B	15	BF198	23	2TAK 1500 (23" & 24")			£2.00
PL50B	67.0	BC132	25	BF200	25	EHT MULTIPLIERS - COLOUR			
PL619	£1.50	BC135	15	BF218	30	11TAQ IIT GCVI 2 & 3			£4.50
PY88	35.5	BC137	19	BF224	23	11TA GEC/Sobell			£4.50
PY800	33.0	BC138	26	BF268	24	11TA2 GEC 2110			£4.50
PY500A	85.0	BC142	23	BF336	28	11TAM Philips G8			£4.50
		BC143	25	BF337	35	11TBD Philips 550			£4.50
		BC147A	11	BF355	54	31CW Pye 691/693			£3.50
		BC148	10	BFX66	28	11H Decca 30 Series			£4.50
		BC149	10	BFY50	19	11TAQ Decca 'Bradford'			£4.50
		BC153	15	BFY52	20	3TCU Thorn 3000/3500			£5.00
		BC154	15	BFY52	35	11HAA Thorn 8000			£1.90
		BC157	15	BT106	£1.20	11HAB Thorn 8500			£4.25
		BC158	10	BU105/02	£1.95	PRICES SUBJECT TO 8% V.A.T.			
		BC159	11	BU108	£2.10	All goods subject to settlement discount of 5% 7 days and 2% monthly.			
		BC173	18	BU208	£2.95	No postage charges or minimum order values.			
		BC178B	11	E1222	30	Write or phone for full details now.			
		BC182L	12	MJE340	45				
		BC183L	12	OC72	16				
		BC187	25	R2008B	£2.00				
		BC214L	15	R2108	£2.00				
		BC328	28	RCA16334	80				
		BC337	19	RCA16335	80				

...In Prices, Quality and Service.

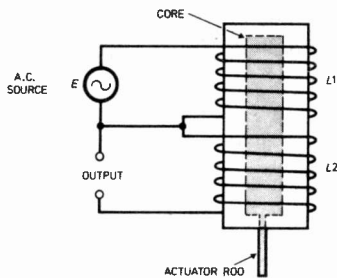

Fig. 3.8. Mutual inductance version of the passive inductive transducer

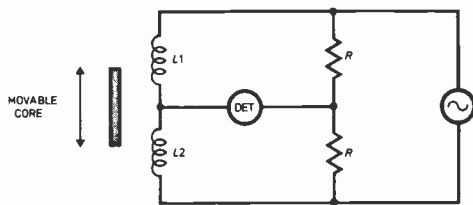

Fig. 3.9. A two-coil variable inductance transducer

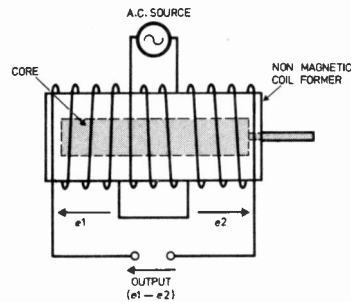

Fig. 3.10. The linear variable differential transformer (LVDT) in which displacement of the core to one or other side of a centre position gives a negative or a positive output

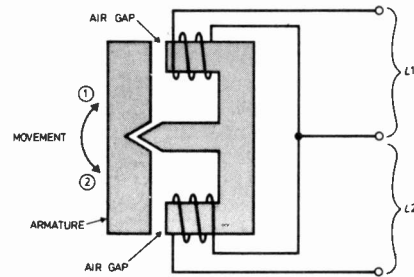

Fig. 3.11. A passive variable reluctance transducer in which armature movement will be caused by small angular or linear displacement

In Fig. 3.8 the mutual inductance coupling between the two coils L_1 and L_2 depends on the core position and hence the output voltage across L_2 can be calibrated, in terms of position, providing the excitation E is held constant. An alternative arrangement, Fig. 3.9, uses a coil system similar to Fig. 3.8 but with L_1 and L_2 connected as two ratio arms of an a.c. bridge.

As the core moves from the central position the effective inductance of, say, L_1 increases whilst that of L_2 decreases, thus causing an unbalance of the bridge and consequently the output detector can be calibrated as before. Since the changes in L_1 and L_2 act together to unbalance the bridge the sensitivity is effectively doubled.

Directional information can be determined from all of these arrangements although the method shown in Fig. 3.8 would require a phase-sensitive detector system since a simple a.c. detector would respond only to the degree of unbalance between L_1 and L_2 and would not indicate the sense of core displacement from the central position.

DIFFERENTIAL TRANSFORMER

The so-called linear variable differential transformer or LVDT is shown in Fig. 3.10. The device consists of three coils wound on a common former. The centre coil is connected to an alternating voltage source whilst the two outer coils are connected so that their induced voltages are in phase opposition.

When the core is central the induced voltages are equal and the output is zero. Any displacement of the core from the central position gives rise to a difference between the two voltages and an output

signal is then produced. The relative phase of the output voltage depends on the direction of displacement.

A core displacement to the right of centre is considered positive and the magnitude of the output is zero when the core is central. The change in phase either side of the zero position can be detected and used to indicate the sense of core movement.

The LVDT can be used with d.c. excitation in which case it becomes a dynamic transducer since no output occurs except when the core is in motion. The output amplitude is now proportional to the rate of change of the core displacement with time and thus gives a velocity-proportional signal. Rotary differential transformers are also available but the variation of output signal usually follows a sinusoidal variation. The output amplitude is approximately a linear function of angular displacement over a range of $\pm 30^\circ$.

VARIABLE RELUCTANCE (PASSIVE)

This class of devices relies on the change of inductance by virtue of a change of reluctance. Unlike the self generating system the core is not normally magnetised by the inclusion of a permanent magnet but relies on the external excitation. A double coil system for use in an a.c. bridge would be similar to Fig. 3.9 except that the changes in L_1 and L_2 would be the result of changes in reluctance due to, say, a changing air gap as shown in Fig. 3.11. Movement in the direction (1) increases L_1 and decreases L_2 .

Next Month: Synchro Transformers

SYMBIOSIS...

A composition for the

PE

MINISONIC

By M. POINTON

B.Mus.



NOT so very many years ago the electronics engineer and the musician seemed poles apart. A quick passing of the time of day as the serviceman finished his mammoth task of tracking down an intermittent crackle in the radio set was the sum total of their contact. Today that contact is more intimate, although it is often the electronics enthusiast who shows a greater interest in electronically produced music than the average musician. I find this sad. However through my contact with PRACTICAL ELECTRONICS I have discovered that there is a large body of people which believes, as I do, that a very big slice of our musical future will reflect, in some form or another, advances in electronic technology.

Many of these people will no doubt be the first to admit that their interest was really awakened by the appearance of the do-it-yourself synthesisers. The steady trickle of interested parties which followed the publication of the PE Sound Synthesiser details in 1973-4 is threatening to become a flood as the Minisonic makes its impact. There is no doubt at all that the low cost of this latest arrival is a significant factor in its popularity, and this can only be for the good. The more people can begin to appreciate the satisfaction of producing their own music the better.

demands little more than a superficial knowledge of how voltages can be made to interact, a reasonable pair of ears and an enthusiasm to do something new. And the sonic result of his efforts is not just a one-finger-dabble but an arrangement of sound events which, in sheer complexity and wealth of colour, can outshine the most virtuoso symphonic work in the repertoire.

SCORING FOR MINISONIC

This project makes use of some of the many effects to be found in the Minisonic, and although it is basically a re-creative exercise in that it centres on my composition "Symbiosis" there is plenty of leeway built into the score to allow for individual interpretation. To some extent this element of chance in what appears to be a rigid format was dictated by the synthesiser itself. It is extremely difficult to pinpoint precisely the many control settings without recourse to sophisticated external measuring equipment. In my own version of the work no measuring device was necessary so I consciously allowed for individual "error" in subsequent realisations.

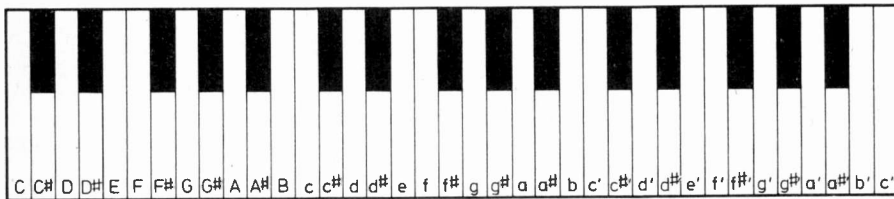

Fig. 1. The keyboard showing the letter names of the notes

MAKING MUSIC

With traditional acoustic musical instruments the way to expertise is a hard one; difficult techniques have to be learnt. Rapid and precise finger movement, subtle muscular control and, if you play with others, an almost telepathic rapport take years to achieve and a lifetime to perfect. Most of us do not have the time to devote to these necessary skills and we give up almost before we've started and resort to the secondhand—records, cassettes and radio.

The electronic sound synthesiser fulfils the amateur musician's needs admirably. In his hands lies the means to a musical creation which is his alone and

The equipment required for a performance of "Symbiosis" is not esoteric, comprising the Minisonic, a stereo tape machine with separate record and playback heads, another tape machine, a simple stereo mixer with at least five inputs, three outputs and channel switching facility, and a mono or stereo amplifier and speaker(s) for monitoring purposes. The Minisonic is the only sound source used. Although the stylus keyboard is not ideal from a performance point of view I have avoided the temptation to patch in a standard keyboard and this has meant that the kind of material used in the piece is relatively simple. Paradoxically the very

limitations imposed by the stylus have resulted in several accidental discoveries!

The sound patterns in the work have been kept fairly straightforward in the sense that I have tried not to overtax the resources of the performer by writing extended passages which require a considerable amount of dexterity both in stylus manipulation and rapid knob control. A diagram of the keyboard is given (Fig. 1) together with the letter names of the notes, as they are referred to in the text.

LAYOUT FOR PATCHING

In order to simplify the description of patching arrangements the original front panel lay-out of the Minisonic has been reorganised so that a matrix of input and output sockets could emerge. (Fig. 2) Throughout the text reference will be made exclusively to this diagram.

sound events in sequence. Each sub-section of the piece is marked off by vertical lines with a timing in seconds given at the top. The boxed upper-case letters, A to S, are for reference purposes only as the performer works through the data. Most of the events themselves are not meticulously annotated in order to allow for individual variation although their visual appearance often gives some clue to the kind of sound that is expected. The strict measurements of time are not meant to be adhered to rigidly—they merely give a sense of scale. An error of plus or minus ten seconds in sixty will not upset the piece unduly. The total duration of the work should be around seven minutes.

Before getting down to the work make sure that you have brand-new batteries in the Minisonic; although, as was mentioned in the constructional articles, most of the units will function down to $\pm 7.8V$.

Fig. 2. Reorganised panel layout to simplify control references

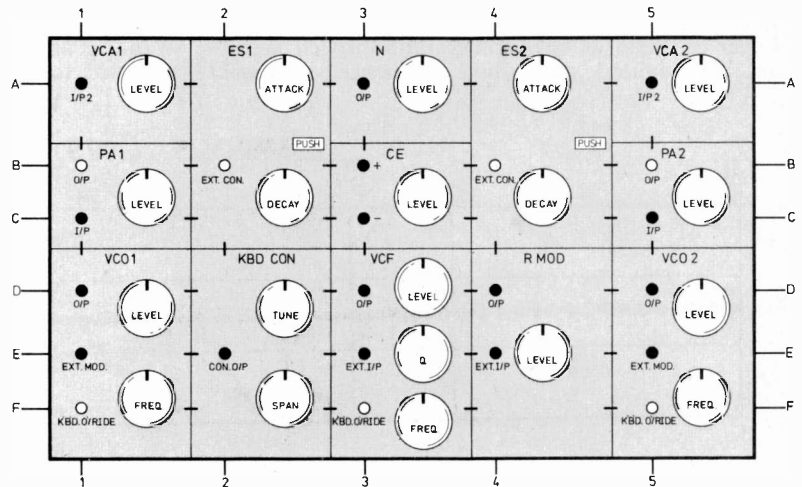

The units themselves are abbreviated as follows:

- VCO1, VCO2 : Voltage Controlled Oscillators
- VCA1, VCA2 : Voltage Controlled Amplifiers
- ES1, ES2 : Envelope Shapers
- PA1, PA2 : Power Amplifiers
- VCF : Voltage Controlled Filter
- RMOD : Ring Modulator
- KBD : Keyboard
- KBD CON : Keyboard Control
- CE : Control Envelope
- N : Noise Generator

The control settings for the Re-an skirted knobs used on the prototype (measured 1 to 12 over almost 360 degrees) are included too. With the potentiometers used the settings range from 1 (minimum) to 11 (maximum). It must be borne in mind that the settings given in this text may not accurately match those on any other machine. Where a particular configuration is critical hints will be given on achieving it.

THE SCORE FOR SYMBIOSIS

The musical score of "Symbiosis" (Fig. 3) is laid out pretty imprecisely as regards virtually every parameter and is simply a graphic representation of the

SEQUENCE A TO D

The v.c.o.s have first to be tuned, in the first instance to only one note. Unfortunately the v.c.o.s in the Minisonic are prone to frequency drift and the way to stabilise them is to patch in to the keyboard hold circuit. This is achieved quite simply by taking a lead with a miniature crocodile clip at each end and attaching the stylus tip to the bottom resistor on the keyboard chain. Normally one could hold the stylus on the keyboard but for this particular section of the piece both hands will be needed at the controls. The control settings are as follows:

- RMOD — Level 11
- KBD CON — Tune 3-8; Span 5
- VCF — Level 11; Q 1; Freq 5
- VCO1 — Level 11; Freq 7
- VCO2 — Level 11; Freq 7

With these settings you should be very close to requirements. The only additional adjustment is to KBD CON; rotate the knob until VCO2 gives out a middle C (check this with a piano or any other fixed-pitch instrument or tune to about 262Hz).

Patch-cords: 3E to 4D; 3D to 1C; 5D to 4E. With this set-up you should hear nothing. Advance VCF frequency to about 8 and both v.c.o.s will be heard out of tune. Adjust VCO1 frequency very slowly until a steady single pitch is heard. Next move the control very slowly indeed until a beat frequency of about 2Hz is heard. You are now ready to start recording the first section of the piece. Return VCF frequency to 5 or less.

Letter A in the score is silence; from A to B very gradually increase VCF frequency until the 2Hz beat is heard softly but comfortably. At letter B rotate VCO1 frequency clockwise very slowly until the beat frequency becomes, at C, a rasping noise. Immediately after C the effect of ring modulation appears as you continue, at an even, infinitesimally slow, rate, to rotate the knob. Continue this slow progress until about a minute has elapsed. The final eight seconds before D show that you have arrived at a distinguishable beat frequency of about 2Hz. (You will have passed several of these on your way up, shown by an inclined dotted line.) If you happen to like certain modulation effects, do not be afraid to linger on them or back-track and approach them again. Throughout the whole sequence increase

VCF frequency very slowly so that it reaches a peak in the middle of the eight-second "throb" at the end of the top line of music.

This done, cut the tape just before the last dying strain.

SEQUENCE D TO I

The setting-up procedure here is quite straightforward. No patch-cords are required since the relevant links are made internally. The only possible problem may be the tuning of the two v.c.o.s an octave apart. Initially set up as follows:

- VCO1 and 2 — Level 11, Freq 6
- ES1 and 2 — Attack 1, Decay 1
- VCA1 and 2 — Level 7
- KBD CON — Tune 5; Span 5

Tune the two v.c.o.s to the same pitch, then decrease VCO1 frequency to approximately 5.6 until they sound in tune.

Since this sequence is interrupted by two bouts of noise and a silence, sufficient material must be recorded to cover about 55 seconds. I suggest you

SYMBIOSIS (1975)

Malcolm Ponton

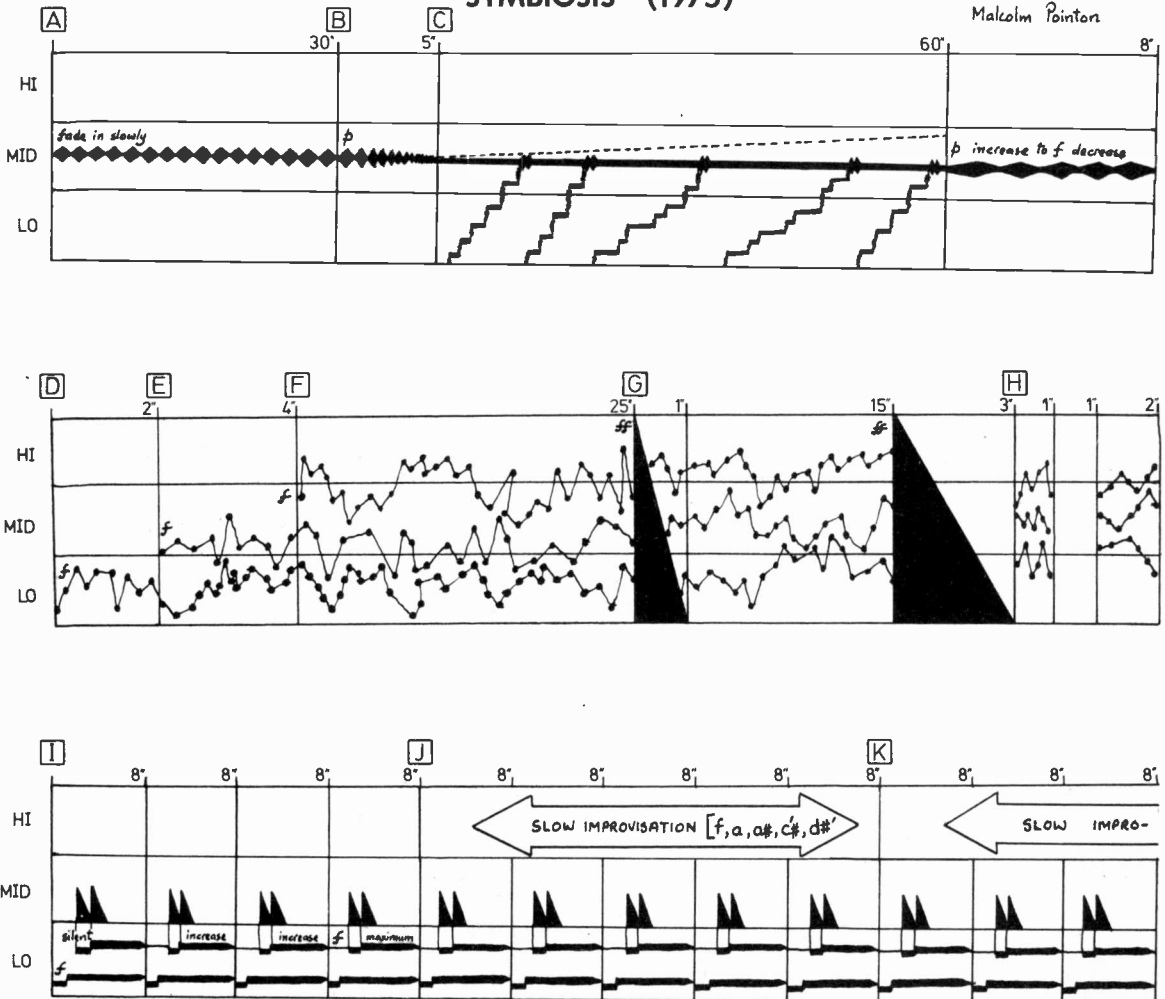

make 90 seconds' worth so that you can hack out the bits you like for the two interpolations after H.

On track one of your stereo machine record the bottom line of linked black dots. This should sound as it looks—pretty random in pitch and rhythm. Using the stylus dodge around the whole range of the keyboard as you like but without playing any long-held notes. The effect must be of short, rapid stabs.

Having recorded this, play back track one as you record the same kind of thing again on to track two. This time advance KBD CON tuning to 6, thus increasing the overall frequency by about an octave.

Play back both tracks through the mixer into your second tape machine whilst you play a third "random" sequence on the keyboard, this time with the KBD CON tuning set at 7.2, another approximate octave higher. The result is a piece of three-part counterpoint moving rapidly and nervously.

The noise at letter G is added, when all the foregoing has been completed, by playing the sequence back on to the first tape machine, your finger being

poised above the push button on ES1. The setting-up procedure for this noise is as follows:

VCO1 and 2 — Level 1
 ES1 — Attack 1; Decay 4
 VCF — Level 11; Q 11; Freq 7
 CE — Maximum clockwise
 N — Level 11

Patch-cords: 3F to 3C; 3A to 3E; 3D to 1C

This should give a one second decay time; if not, adjust ES1 decay accordingly.

This second splash of noise is recorded on to virgin tape and spliced on to the end of the contrapuntal sequence. For this noise the ES1 decay is advanced to give a three second envelope. On to this is spliced a one second cutting from the excess counterpoint, followed by a one second piece of clean tape and a two second stretch of counterpoint. The whole sequence can now be added to the end of sequence A to D.

Next Month: Symbiosis is concluded

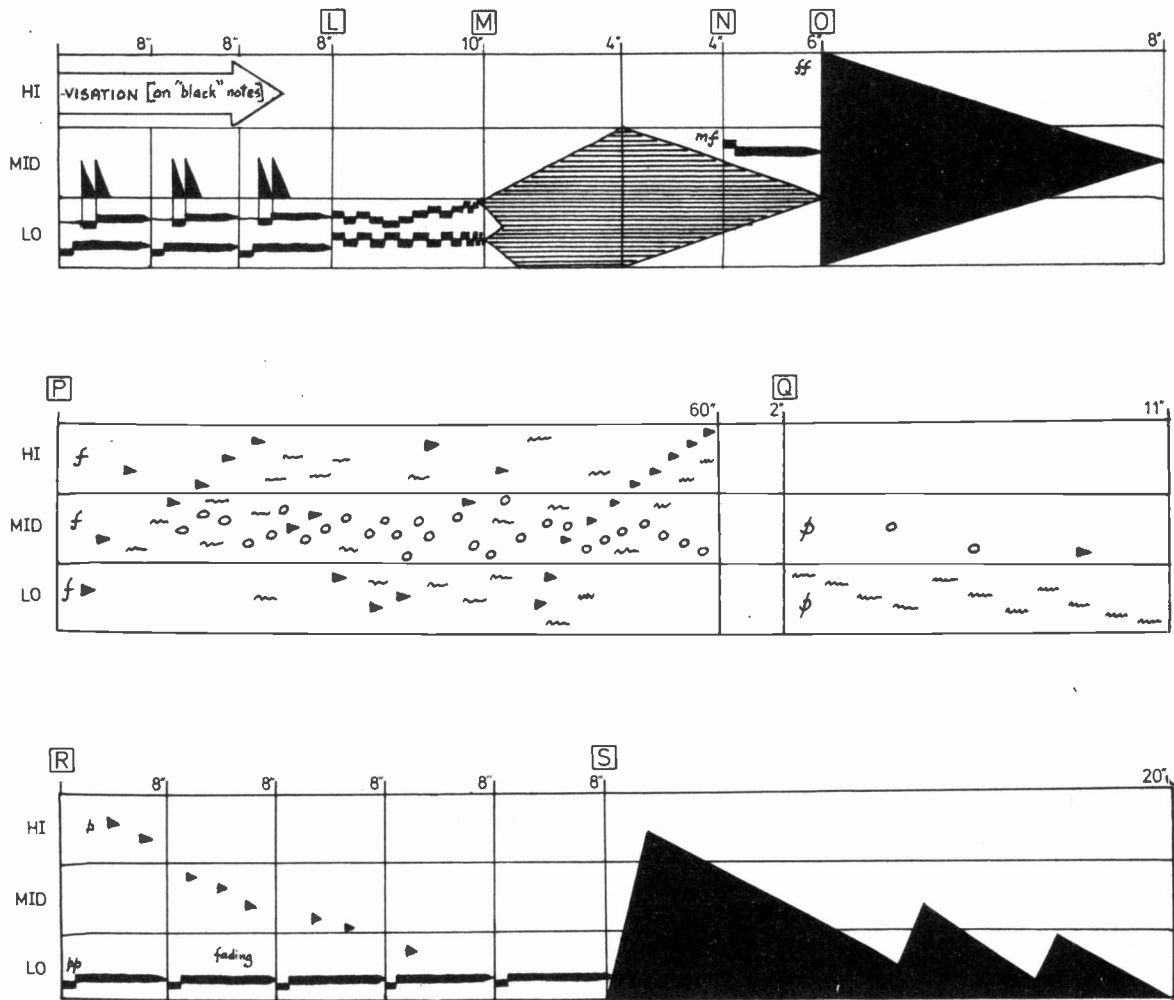
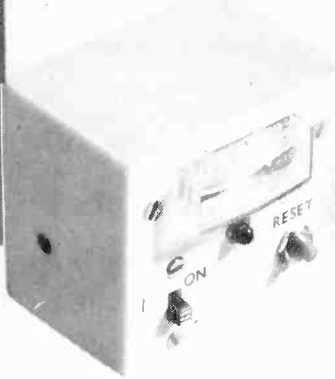

Fig. 3. Musical score of "Symbiosis"

REACTION TIMER

By C.R. MASSON



REACTION time is an aspect of human performance which is important in many situations. This article describes a pocket-sized device which measures the speed of reaction to a visual stimulus. It is possible to use the timer to find, for instance, the effect of alcohol on reaction time, and so should prove a fund of amusement around the local in one of its applications. However, whether lighthearted or more serious the uses are manifold.

THE UNIT IN USE

The person whose reactions are being tested presses a button which resets the previous reading and initiates the operation. After a delay of up to 10 seconds, a light appears and the subject has to release the button as quickly as possible. The time interval between the appearance of the light and the release of the button is measured and displayed on a moving-coil meter. The meter reading remains steady until the next time the button is pressed.

If the delay between the pressing of the button and the appearance of the light is constant, the sub-

ject will soon learn when to expect the light. To prevent this, the delay varies unpredictably between 0 and 10 seconds.

Most people's reaction times are about 150ms and nobody reacts faster than 100ms. Because readings on a linear time scale would be rather cramped, the reaction timer has a suppressed zero scale with the meter zero corresponding to about 100ms and mid scale to 150ms.

CIRCUIT DIAGRAM

The circuit diagram is given in Fig. 1 and a timing diagram illustrating one complete cycle of operation is shown in Fig. 2. Until the button S2 is pressed, the oscillator TR1, TR2 runs continuously, producing a short pulse every 10 seconds. The oscillator output is shown in waveform (a) and the press button voltage is shown in waveform (b). On the first pulse after the button has been pressed, the bistable is set. Waveform (c) shows the state of the bistable which controls the l.e.d. and the timing circuit. Waveform (d) is the voltage across the timing capacitor C3. When the button is released, the bistable is immediately reset, turning off the light and stopping the timing circuit.

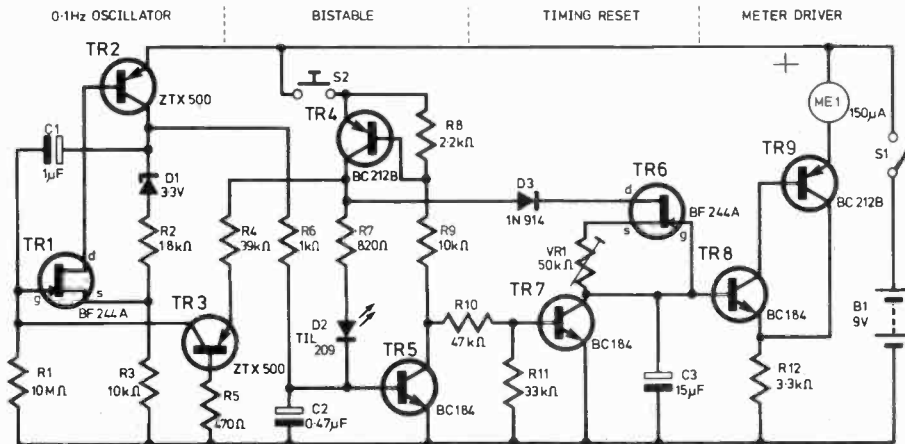

Fig. 1. Circuit diagram of Reaction Timer

Since the delay time between the pressing of the button and the appearance of the light is dependent on the phase of the 0.1Hz oscillator which is unknown to the user, it is not predictable and will vary randomly in the range 0 to 10 seconds. However, the phase of the oscillator at the point where the bistable is turned on is known precisely and does not vary from one cycle of operation to the next. If no precautions were taken, the delay time for any test would be a simple function of the time interval since the end of the previous one. To avoid this, the phase of the oscillator must be altered by an unknown amount after the bistable has been triggered. During the time that the bistable is set, the oscillator frequency is increased to approximately 100Hz. This suffices to produce delay times which are, in practice, completely unpredictable.

The charge on the timing capacitor will decay because of leakage and the current taken by the meter. To minimise the rate at which the charge is lost, a unity gain amplifier with a high input impedance is interposed between the capacitor and the meter. In the prototype, the decay time constant is 1,500s which is more than adequate.

The timing capacitor is discharged when the button is first pressed but, of course, the discharge must be inhibited while the timing of the reaction is taking place.

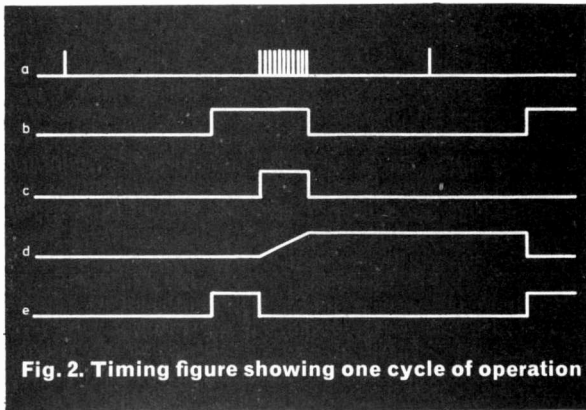

Fig. 2. Timing figure showing one cycle of operation

OSCILLATOR

The 0.1Hz oscillator is an unusual circuit employing an *n*-channel f.e.t. and a *pn*p transistor in a complementary arrangement. This produces pulses whose period is determined by the time constant $R1/C1$.

The duty cycle of the oscillator can be altered by making the charge and discharge paths of $C1$ different. In the Reaction Timer, $R1$ is 10 megohms and on positive half cycles it is shunted by the series combination of $R5$ and the forward-biased collector base junction of $TR3$.

The duty cycle given by this arrangement is about 0.005 per cent, with the transistors conducting for only $500\mu\text{s}$ in every 10s. With such a low duty cycle the current drain is negligible since the average current is only a few microamps.

BISTABLE

A complementary circuit is also used for the bistable, again to reduce power consumption. The necessary control of the bistable by the press switch is obtained by switching the supply to the bistable.

COMPONENTS . . .

Resistors

R1	10M Ω	R7	820 Ω
R2	1.8k Ω	R8	2.2k Ω
R3	10k Ω	R9	10k Ω
R4	39k Ω	R10	47k Ω
R5	470 Ω	R11	33k Ω
R6	1k Ω	R12	3.3k Ω

Capacitors

C1	1 μF 35V tantalum bead
C2	0.47 μF 35V tantalum bead
C3	15 μF 20V tantalum

Transistors

TR1	BF244 A
TR2-3	ZTX500
TR4	BC212B
TR5	BC184
TR6	BF244 A
TR7-8	BC184
TR9	BC212B

Switches

S1	Miniature d.p.d.t. slide
S2	Press-to-make

Potentiometer

VR1	50k Ω linear preset
-----	----------------------------

Diodes

D1	BZX61 3.3V 400mW Zener
D2	T1L209 or equivalent
D3	1N914

Miscellaneous

B1	9V PP3 battery
M1	150 μA meter (see text)
Box,	printed circuit, hardware

This means that the bistable will turn off as soon as the switch is released. The bistable is coupled to the 0.1Hz oscillator by $R6$.

The light is produced by an l.e.d., $D2$, which is driven directly by the bistable to save components. An l.e.d. is used because it is small and provides adequate light output from a current of less than 10mA whereas a filament bulb would probably require several times this current.

While the bistable is set, $TR4$ connects the top end of $R4$ to the positive supply to produce an emitter current of $200\mu\text{A}$ in $TR3$. On positive half cycles, the collector-base junction is forward biased as before and the current from $R4$ flows through the base lead of $TR3$. On negative half cycles, $TR3$ operates as a common base amplifier and its emitter current flows through the collector lead, increasing the rate of charge of $C1$ and hence raising the oscillator frequency.

$C3$ is the timing capacitor which is supplied with a constant charging current by $TR6$ while the bistable is set. Since the current is constant, the voltage across the capacitor is a linear function of time. A tantalum capacitor is used in this position because it has a low leakage current and a tolerance of 10 per cent. A tantalum bead could be used but the tolerance is worse. The total discharge current must be kept as low as possible so that the meter reading remains steady. Leakage through $TR6$ is prevented

NEW LOW PRICES!

Sinclair Scientific kit

(Was £19.95 - save £5!)

£14.95
(INC. VAT)

Britain's most original calculator now in kit form

The Sinclair Scientific is an altogether remarkable calculator.

It offers logs, trig, and true scientific notation over a 200-decade range - features normally found only on calculators costing around £100 or more.

Yet even ready-built, the Sinclair Scientific costs a mere £21.55 (including VAT).

And as a kit it costs under £15!

Forget slide rules and four-figure tables!

With the functions available on the Scientific keyboard, you can handle directly

- sin and arcsin,
- cos and arccos,
- tan and arctan,
- automatic squaring and doubling,
- log₁₀, antilog₁₀, giving quick access to x^Y (including square and other roots),
- plus, of course, addition, subtraction, multiplication, division, and any calculations based on them.

In fact, virtually all complex scientific or mathematical calculations can be handled with ease.

So is the Scientific difficult to assemble?

No. Powerful though it is, the Sinclair Scientific is a model of tidy engineering.

All parts are supplied - all you need provide is a soldering iron and a pair of cutters. Complete step-by-step instructions are provided, and our Service Department will back you throughout if you've any queries or problems.

Of course, we'll happily supply the Scientific or the Cambridge already built, if you prefer - they're still exceptional value. Use the order form.

Components for Scientific Kit (illustrated)

1. Coil
2. LSI chip
3. Interface chips
4. Case mouldings, with buttons, windows and light-up display in position
5. Printed circuit board
6. Keyboard panel
7. Electronic components pack (diodes, resistors, capacitors, etc)
8. Battery assembly and on/off switch
9. Soft carrying wallet
10. Comprehensive instructions for use

Assembly time is about 3 hours.

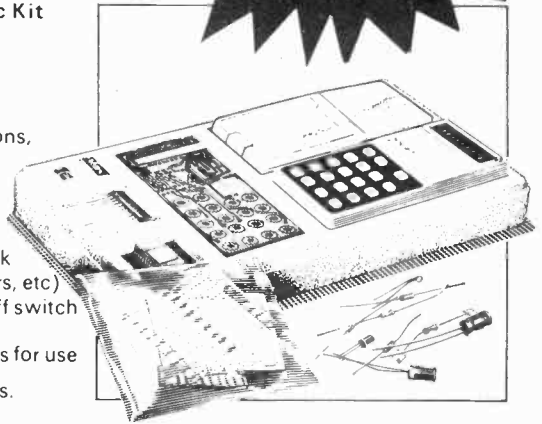

Features of the Sinclair Scientific

- **12 functions on simple keyboard**
Basic logs and trig functions (and their inverses), all from a keyboard as simple as a normal arithmetic calculator's. 'Upper and lower case' operation means basic arithmetic keys each have two extra functions.

- **Scientific notation**
Display shows 5-digit mantissa, 2-digit exponent, both signable.

- **200-decade range**
10⁻⁹⁹ to 10⁺⁹⁹

- **Reverse Polish logic**
Post-fixed operators allow chain calculations of unlimited length - eliminate need for an = button.

- **25-hour battery life**
4 AAA manganese alkaline batteries (e.g. MN2400) give 25 hours continuous use. Complete independence from external power.

- **Genuinely pocketable**
4 1/3" x 2" x 11/16". Weight 4 oz. Attractively styled in grey, blue and white.

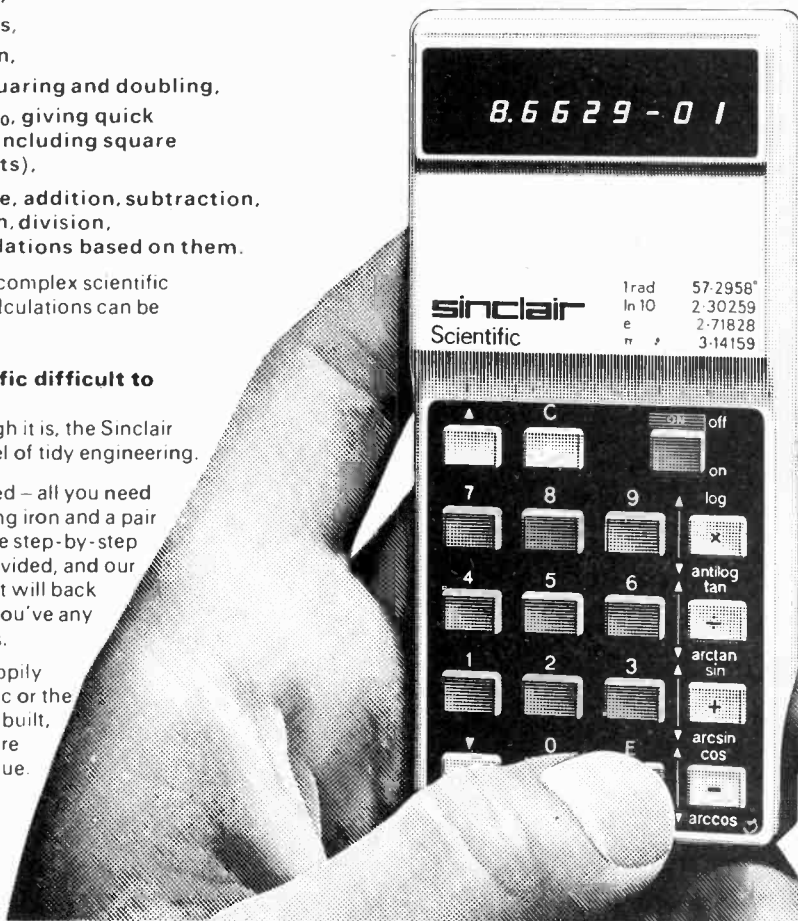

NEW LOW PRICES!

Sinclair Cambridge kit

(Was £14.95—save £5!)

At its new low price, the original Sinclair Cambridge kit remains unbeatable value.

In less than a year, the Cambridge has become Britain's most popular pocket calculator.

It's not surprising. Check the features below — then ask yourself what other pocket calculator offers such a powerful package at such a reasonable price.

Components for Cambridge Kit

1. Coil
2. LSI chip
3. Interface chip
4. Thick film resistor pack
5. Case mouldings, with buttons, window and light-up display in position
6. Printed circuit board
7. Keyboard panel
8. Electronic components pack (diodes, resistors, capacitors, transistor)
9. Battery clips and on/off switch
10. Soft wallet

Assembly time is about 3 hours.

Now only
£9.95
(INC. VAT)

Take advantage of this money-back, no-risk offer today

The Sinclair Cambridge and Scientific kits are fully guaranteed. Return either kit within 10 days, and we'll refund your money without question. All parts are tested and checked before despatch — and we guarantee any correctly-assembled calculator for one year. (This guarantee also applies to calculators supplied in built form.)

Simply fill in the preferential order form below and slip it in the post today.

Scientific

Price in kit form £14.95 inc. VAT

Price built £21.55 inc. VAT.

Cambridge

Price in kit form £9.95 inc. VAT.

Price built £13.99 inc. VAT.

Features of the Sinclair Cambridge



- Uniquely handy package. 4 1/3" x 2" x 11/16", weight 3 1/2 oz.
- Standard keyboard. All you need for complex calculations.
- Clear-last-entry feature.
- Fully-floating decimal point.
- Algebraic logic.
- Four operators (+, -, x, ÷), with constant on all four.
- Powerful constant with separate 'K' button.
- Constant and algebraic logic combine to act as a limited memory, allowing complex calculations on a calculator costing less than £10.
- Calculates to 8 significant digits.
- Clear, bright 8-digit display.
- Operates for weeks on four AAA batteries.

To: Sinclair Radionics Ltd,
FREEPOST St Ives,
Huntingdon, Cambs. PE17 4BR

Please send me

- Sinclair Scientific kit at £14.95
- Sinclair Scientific built at £21.55
- Sinclair Cambridge kit at £9.95
- Sinclair Cambridge built at £13.99

All prices include 8% VAT.

*I enclose a cheque for £....., made out to Sinclair Radionics Ltd, and crossed.

*Please debit my *Barclaycard/ Access account. Account number

--	--	--	--	--	--	--	--	--	--	--	--

*Delete as required.

Signed _____

Name _____

Address _____

Please print. FREEPOST — no stamp needed.

PE/8/75

sinclair

Sinclair Radionics Ltd,
FREEPOST St. Ives,
Huntingdon, Cambs. PE17 4BR.

Reg. No: 699483 England. VAT Reg. No: 213 8170 88.

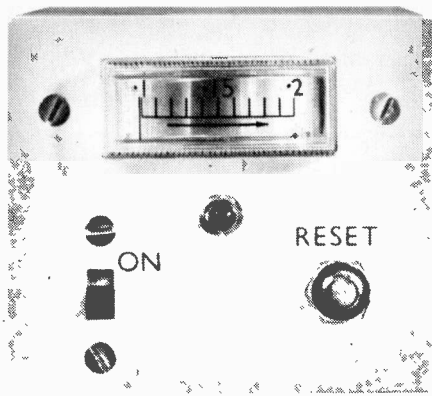

by D3. The presence of R11 reduces the leakage through TR7. The maximum value of I_{CBO} for this type of transistor is low enough to be ignored. The buffer amplifier, which has a current gain greater than 10,000, takes only about 10nA at f.s.d.

RESET DRIVE

The base drive for the reset transistor, TR7, comes from the press switch via R8, R9 and R10 until it is shunted through TR5 when the bistable turns on. C2 was found to be necessary to prevent contact bounce from affecting the operation. If this component is omitted, the contact bounce will cause the reading to be set to zero as the switch is released and there may also be a tendency for the bistable to turn on as the switch is pressed.

METER SCALING

In the prototype, the meter reads from 100-200ms. The suppressed zero is obtained by virtue of the fact that the base-emitter voltage of TR8 must reach 0.5V before it conducts. The base-emitter voltage of TR8 is about 500mV so the resistor R12 is chosen to drop 500mV at f.s.d.; i.e. the value is given by:

$$R12 = \frac{0.5}{\text{full scale current}}$$

A $150\mu\text{A}$ meter was used in the prototype but any other may be used if R12 is changed to the appropriate value.

Since the author did not have access to a timer during development, an indirect method was used to calibrate the meter. After 150ms, the voltage across C3 should be 750mV and the meter should read midscale. After a time t , the voltage E across C3 is:

$$E = \frac{It}{C3}$$

where I is the current provided by TR6 in microamps.

If a resistor is placed in parallel with C3 and the current is applied for a sufficient time, the voltage will be:

$$E = IR$$

where R is the value of the resistor.

By comparing the two equations above, it can be seen that the voltage when a 10 kilohm resistor is present is the same as that after 150ms when the resistor is not present. To calibrate the meter, a 10 kilohm resistor is temporarily connected in parallel with C3 and the press switch is held down until the l.e.d. turns on. VR1 is then adjusted until the meter reads mid-scale. The resistor is then removed. The accuracy of calibration obtained with

Continued on page 504

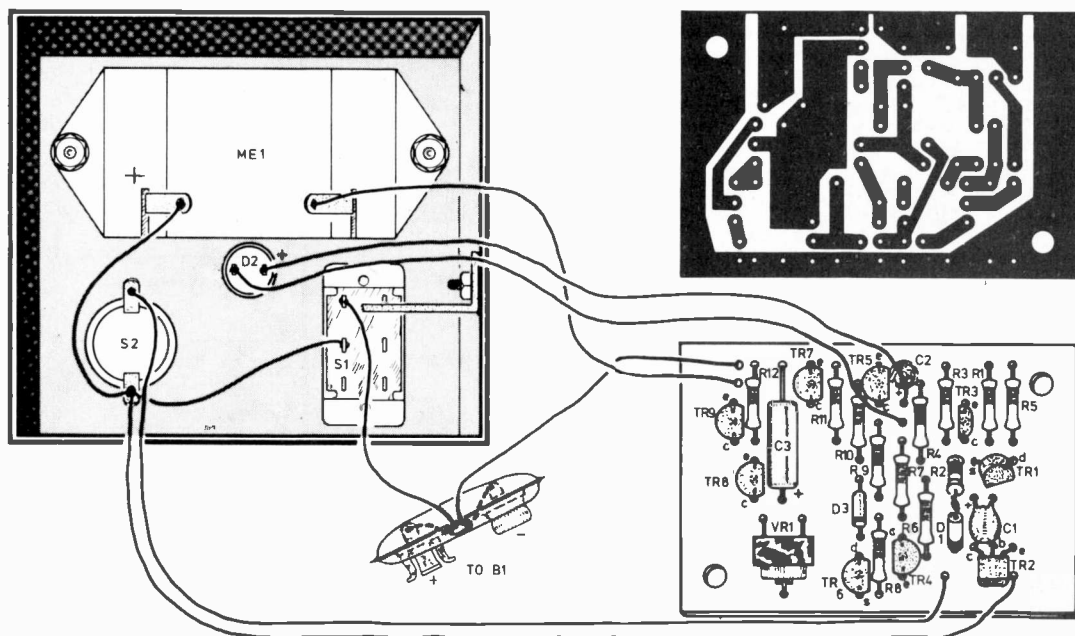
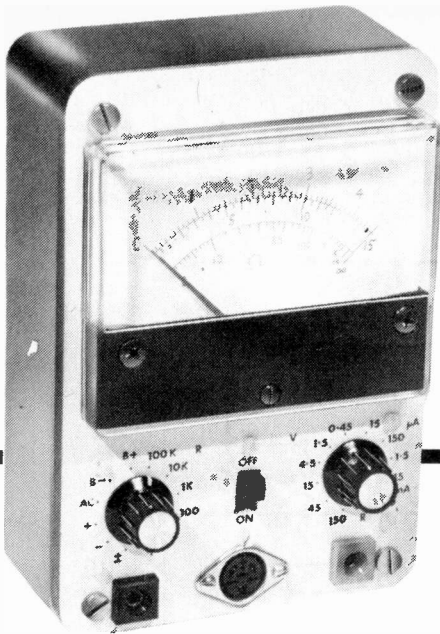

Fig. 3. Assembly details for Reaction Timer

ELECTRONIC MULTIMETER

By D.E. CROCKER



MODERN semiconductors are often operated at very low current levels so that the connection of a voltmeter drawing about $50\mu\text{A}$ may significantly change the potential which the user attempts to measure. Hence the need for an electronic multimeter in which the current for the meter movement is not taken from the circuit under test.

The multimeter to be described has an input resistance of $8\text{M}\Omega$ on all voltage ranges and thus draws negligible current. Unlike a conventional multimeter, it is suitable for the measurement of small alternating voltages since the effect of voltage drop and non-linearity in the rectifier diodes is eliminated while an amplifying probe further extends the sensitivity.

AMPLIFIER CONFIGURATIONS

Each of the circuit configurations shown in Fig. 1 can be used to increase meter sensitivity. Fig. 1a gives a current amplification of $1 + R2/R3$, $R1$ acting as a multiplier as in a conventional voltmeter. This requires very high values of $R1$ on the higher voltage ranges if switching between ranges is to be kept simple.

The arrangement of Fig. 1b is better in this respect, since ranges are altered using a potentiometer, $VR1$, giving constant input resistance. Furthermore, frequency compensation is easier since the loop gain is constant and phase shift in the feedback loop is smaller; this allows a wider bandwidth to be obtained. However, the operational amplifier must have a very low input current, otherwise this will flow through the potentiometer giving rise to a range-dependent zero error.

Since the feedback essentially controls the current through the meter movement, the inclusion of a bridge rectifier as in Fig. 1c will not significantly

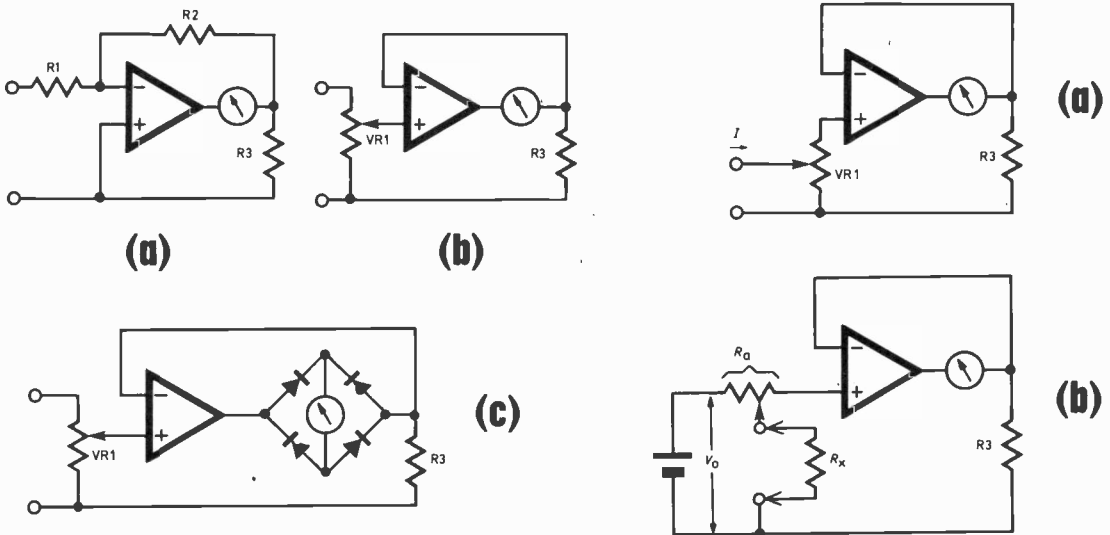

Fig. 1. Various methods of increasing meter sensitivity

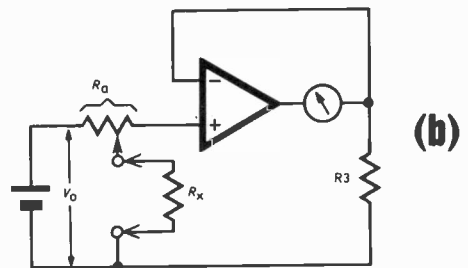

Fig. 2. Current and resistance measurement with an operational amplifier

MULTIMETER CIRCUIT DETAILS

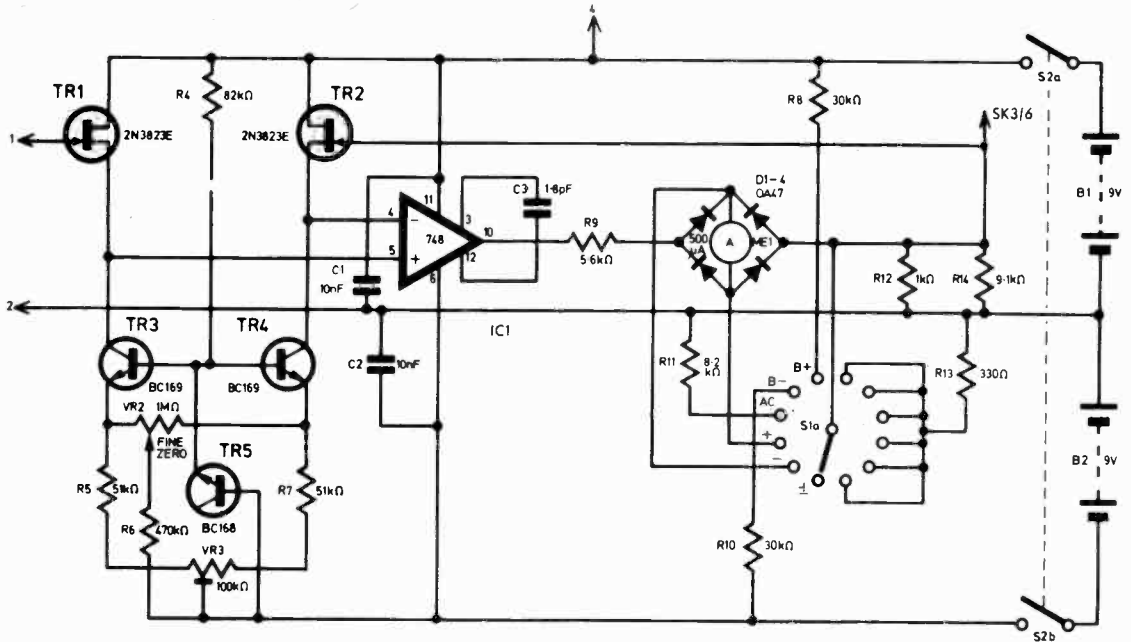

Fig. 3. Circuit diagram of a complete multimeter using f.e.t.s and an operational amplifier to give a high input impedance

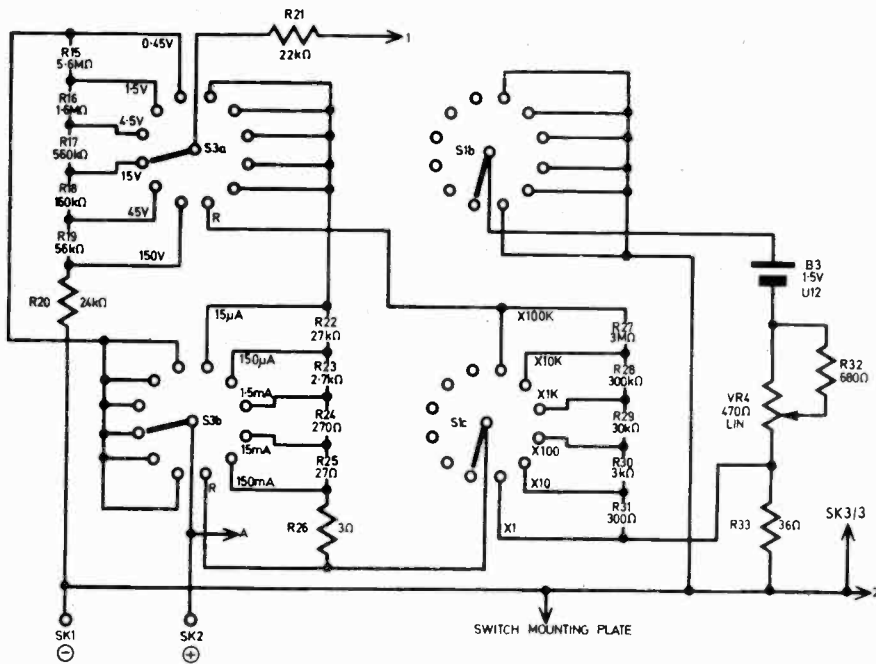

Fig. 4. Switching details for the circuit of Fig. 3

SPECIFICATION . . .

Voltage Ranges

0.45/1.5/4.5/15/45/150V a.c./d.c. f.s.d.

Input Resistance

8M Ω

Current Ranges

15/150 μ A/1.5/15/150mA a.c./d.c. f.s.d. Voltage drop 0.45V at f.s.d.

Bandwidth

Reading 2% down at 200kHz.

Resistance Ranges

6 forward reading ranges giving scale calibrations from 1 Ω to 100M Ω

Facilities

Can be set to respond to either polarity of input or both polarities. Internal batteries can be checked.

Accessories

$\div 10$ a.c. range multiplier

Diode probe can be used for r.f. measurement.

alter the linearity of the circuit. This allows the meter to be used on a.c. as well as d.c. and protects the movement from incorrect input polarity.

Current ranges can be provided by measuring the voltage drop across a resistance through which the current flows; this is the lower half of the potentiometer VR1 in Fig. 2a.

The resistance ranges can use the resistance to be measured in a potential divider fed with a constant voltage V_0 ; the voltage across the unknown resistance R_X is given by $V = V_0 \cdot R_X / (R_A + R_X)$ —see Fig. 2b, where R_A is that section of the potentiometer inserted between V_0 and R_X . This gives a non linear scale which is, however, forward reading.

THE AMPLIFIER

Using a basic circuit sensitivity of 450mV in the circuit of Fig. 3, a difference between the amplifier input terminals of 4.5mV would give a 1 per cent error. Since the output voltage for f.s.d. is about 4V (due to the inclusion of a series resistance R9 for overload protection) the amplifier open loop gain must be at least 1,000 for an error of less than 1 per cent.

The 748 amplifier used has a gain in excess of 10,000 so that the sensitivity could be increased to 45mV if required. A low input current is obtained by adding source followers TR1 and TR2, the source currents being stabilised by TR3, TR4 and TR5 used as a low current Zener diode, in order to eliminate drift with changing battery voltage.

S1 provides battery check facilities using R8/R10. In the a.c. position the sensitivity is increased to give an r.m.s. reading on sinusoidal a.c. By shorting out one of the diodes, the meter can be made to respond to one polarity of input only, hence the + and - positions. On resistance ranges the sensitivity is increased to reduce the current taken from the battery B3.

Fig. 4 shows the complete range switching circuitry. The number of ranges provided has been limited so that only two 12-way switches are required (S1 and S3).

COMPONENTS

The meter movement chosen for the prototype was an SW100 type as this is a convenient size. Unfortunately only the tip of the needle is knife-edged, but this covers the two principal scales.

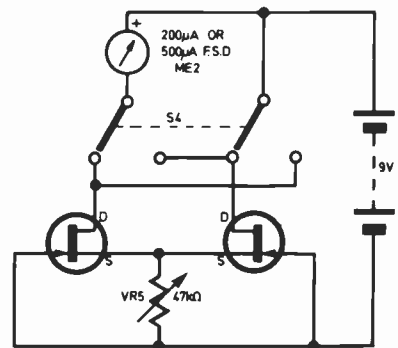

Fig. 5. F.e.f. matching circuit

The only critical components are the field effect transistors TR1 and TR2 as it is essential that these have low gate leakage. 2N3819 types were found unsatisfactory in this respect, but the 2N3823E type specified was found to have typically less than 50pA leakage. A matched pair of transistors is needed, ideally matched for drain currents differing by less than 50 μ A when the gate-source voltages are equal and the average drain current is 200 μ A, although a pair matched for similar gate-source voltages proved satisfactory in the prototype.

In the prototype the f.e.t.s were matched by Electrovalue Ltd. for similar gate-source voltages at a specified drain current. The matching can be carried out using the circuit of Fig. 5 and here, to determine if a pair of devices shown are reasonably matched the meter is switched to read the drain currents alternately.

The 46k Ω potentiometer is slowly reduced until the sum of the two readings is 200 μ A. If the difference between the pair is less than 50 μ A they are suitable.

The range selection resistors are specified as 1 per cent tolerance although a fair accuracy is obtained with 2 per cent types. The 5.6M Ω and 1.6M Ω resistors may have to be selected from 5 per cent components using a bridge.

VR2 and VR4 were miniature potentiometers with a screwdriver slot on the rear; type P20 is suitable. Larger types will not fit the circuit board shown.

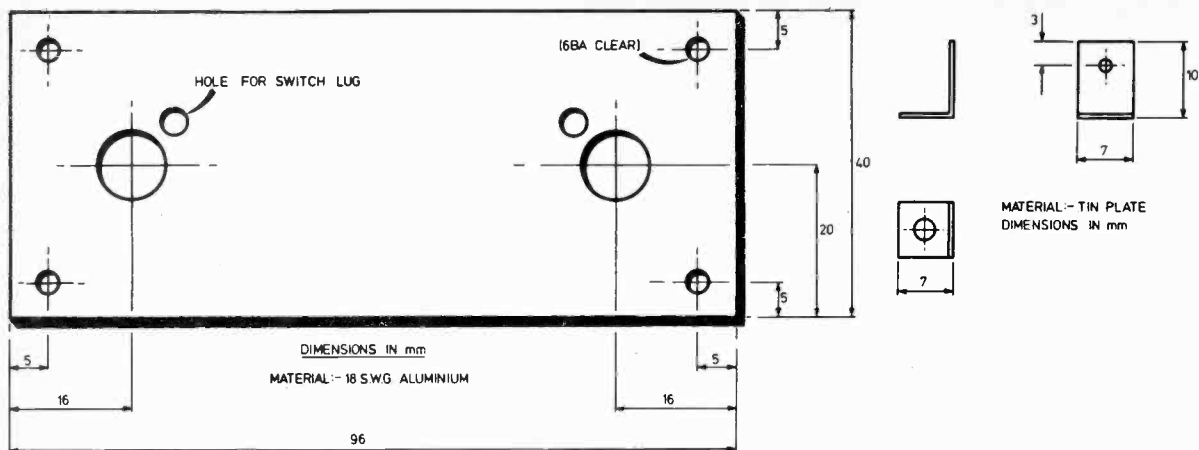

Details of switch mounting plate and battery brackets

The on/off switch employed was a slider type; this takes up less space than a rotary type but has only two poles so the cell used on resistance ranges is switched by S1 instead.

CONSTRUCTION

The multimeter should be housed in a well insulated case, and in the present instance a 160 × 105 × 55mm p.v.c. box was used. The amplifier, and the cell used for resistance ranges, are mounted on a Veroboard panel fixed on the meter movement. The Vero and component layout is shown in Fig. 6.

R14 and C3 are mounted above the board on Veropins for easy adjustment.

Range selection resistors are mounted on the associated switch wafers and the switches are fixed to an aluminium panel which provides a degree of screening. The batteries are fitted on the same panel, between the switches and the panel is fixed to the front of the p.v.c. box using 1/4in. 6BA tapped pillars.

S2 and SK3 are fitted under the aluminium panel and this requires the tags to be cut short due to the small clearance involved. The accompanying photographs show the layout in the p.v.c. box. Nylon bolts are used for fixings to the front panel for safety.

COMPONENTS . . .

Resistors		R21	22k Ω	} 1%
R1, 2, 3	See text	R22	27k Ω	
R4	82k Ω	R23	2.7k Ω	
R5	51k Ω	R24	270 Ω	
R6	470k Ω	R25	27 Ω	
R7	51k Ω	R26	3 Ω	
R8	30k Ω 2%	R27	3M Ω	
R9	5.6k Ω	R28	300k Ω	
R10	30k Ω 2%	R29	30k Ω	
R11	8.2k Ω	R30	3k Ω	
R12	1k Ω (see text)	R31	300 Ω	} 2%
R13	330 Ω	R32	680 Ω	
R14	9.1k Ω (see text)	R33	36 Ω 2%	
R15	5.6M Ω	R34	22k Ω	
R16	1.6M Ω	R35	10M Ω	
R17	560k Ω	R36	18k Ω	
R18	160k Ω	R37	47k Ω	
R19	56k Ω	R38	4.7k Ω	
R20	24k Ω	R39	47k Ω	
		R40	100 Ω	
		R41	100k Ω	

All 1/8W, 5% carbon film unless otherwise stated

Potentiometers

- VR1 See text
- VR2 1M Ω Lin. Miniature (see text)
- VR3 100k Ω Subminiature horizontal preset
- VR4 470 Ω Lin. Miniature (see text)
- VR5 47k Ω

Capacitors

- C1, 2 0.01μF disc ceramic
- C3 1.8pF ceramic (see text)
- C4, 5 0.068μF polyester or polycarbonate
- C6 10μF elect.
- C7 1,000pF ceramic

Integrated Circuit

- IC1 748 d.i.l. operational amplifier

Transistors

- TR1, 2 2N3823E matched pair of f.e.t.s (see text)
- TR3, 4 BC169 (2 off)
- TR5 BC168
- TR6 2N3823E
- TR7 BC258B

Diodes

- D1-4 OA47 (4 off)
- D5 OA79

Switches

- S1 3-pole, 12 way rotary (Doram, Maka)
- S2 2-pole slider
- S3 2-pole, 12 way rotary (Doram, Maka)
- S4 2-pole change-over

Miscellaneous

- ME1 500μA f.s.d. meter (SW100, Laskey)
 - ME2 200μA or 500μA, see text
 - SK1, 2 4mm black and red sockets
 - SK3 6-pole DIN socket
 - PL3a, c, d 5-pole DIN plugs
 - PL3b 6-pole DIN plug
 - B1, 2 9V, PP3
 - B3 1.5V U12
- Case, 160 × 105 × 55mm p.v.c.; Veroboard, 0.1in matrix 95 × 95mm; 18 s.w.g. aluminium sheet, 106 × 40mm; PP3 battery clips; 6BA pillars, wire etc.

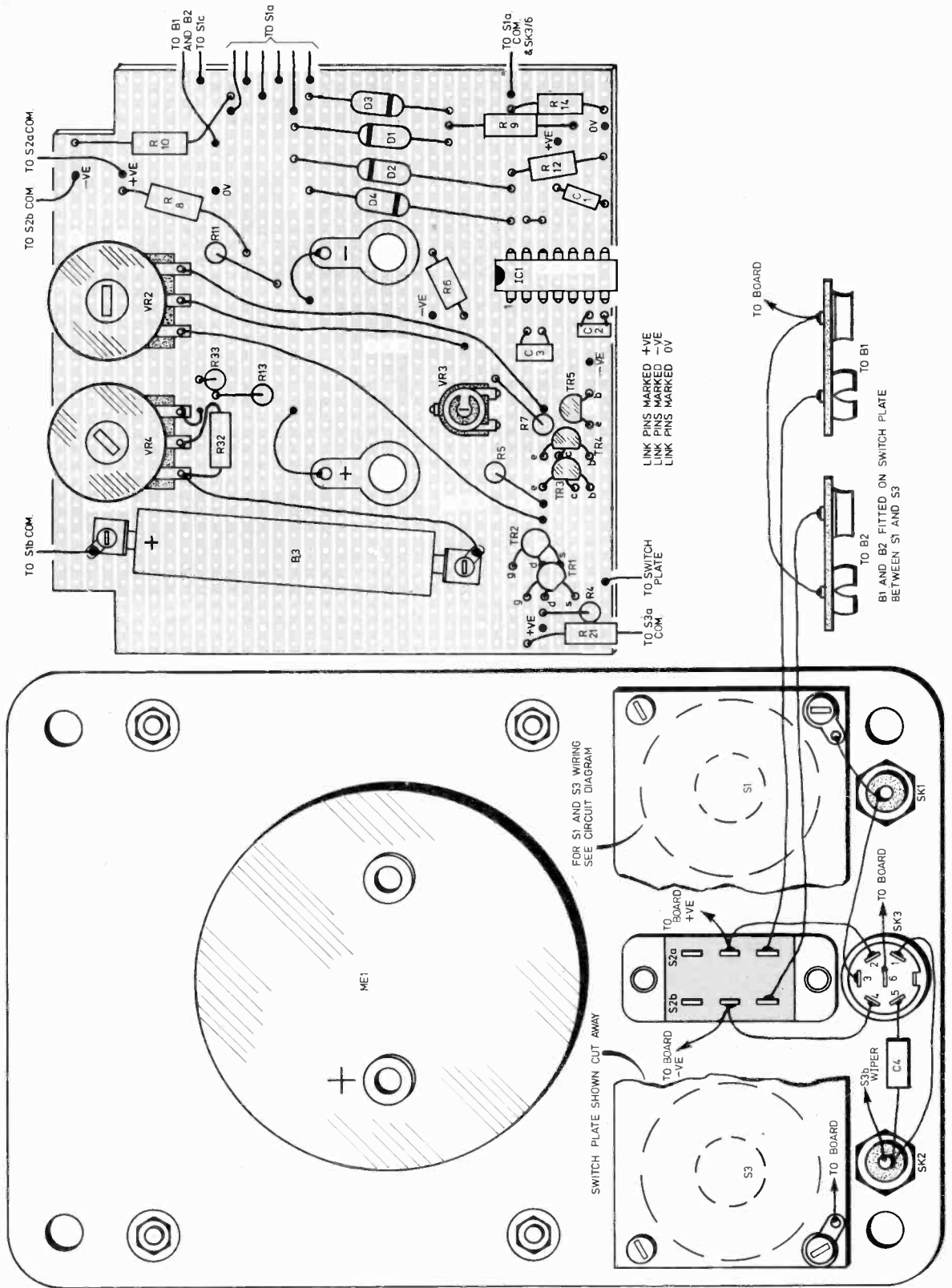

Fig. 6. Component layout and Veroboard cutting details

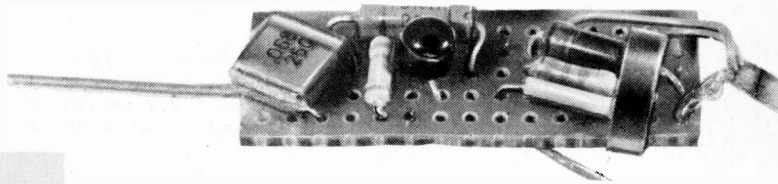
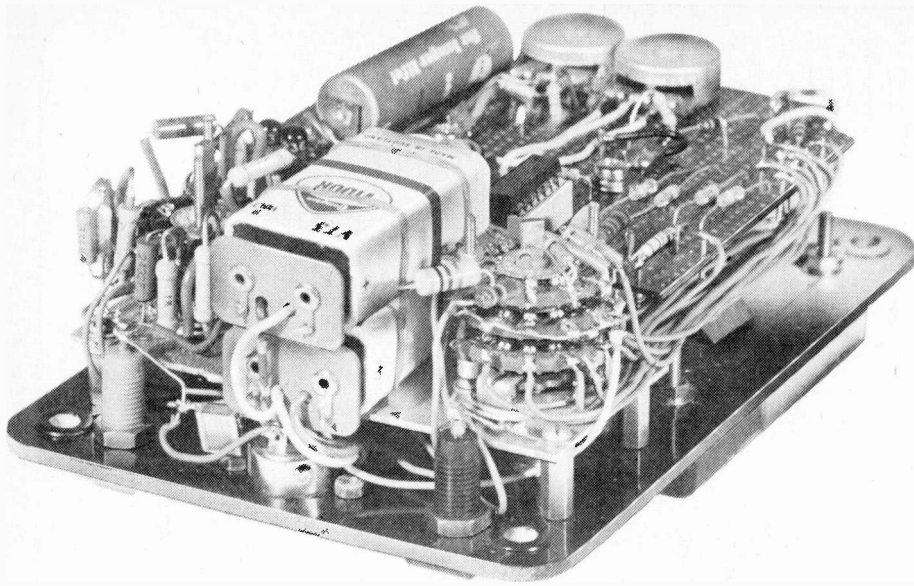

Table 1

Scale marking	Degrees	Scale marking	Degrees
0	0	40	49.1
1	2.6	45	51.7
2	5.1	50	54.0
3	7.4	60	57.9
4	9.6	70	61.0
5	11.7	80	63.5
6	13.7	90	65.7
7	15.6	100	67.5
8	17.4	150	73.6
9	19.1	200	77.1
10	20.8	300	81.0
15	27.9	400	83.1
20	33.75	500	84.4
25	38.6	1k	87.1
30	42.6	Infinity	90.0
35	46.1		

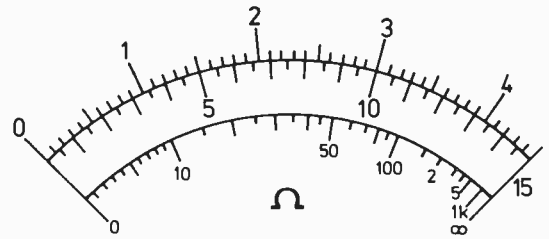

Fig. 7. Scales used on the prototype instrument

SCALING THE METER

The choice of ranges in multiples of 4.5 and 15 makes scaling easy since using a movement having a 90° full scale deflection (such as the SW100), increments of 0.1 on the 0 to 4.5 scale occur at intervals of 2° while increments of 0.5 on the 0 to 15 scale are at intervals of 3°. These scales are thus easily marked off using a protractor.

The non-linear resistance scale may be produced from Table 1. The scales are marked out on white paper which can be glued to the existing aluminium scale. The arrangement of the scales can be seen from Fig. 7.

SETTING UP

Select the 150V range and switch on. The meter should be zeroed by adjustment of the preset VR3, using VR2 as a fine adjustment. If this is impossible, the amplifier may be unstable (increase C3) or TR1 and TR2 may be mismatched.

Once zeroed, sensitivity can be adjusted by variation of R14 using a standard cell or other standard voltage. If no standard is available, R12 may be 1kΩ 1 per cent and R14 may be 9.1kΩ 5 per cent; this will give reasonable accuracy. If a signal generator is available, C3 may be optimised. With C3 too low the meter will oscillate or show a peak in sensitivity at about 500kHz, while increasing C3 too far reduces the bandwidth.

USING THE MULTIMETER

For voltage or current measurement select the range on S3 and set S1 to AC, +, - or ± as appropriate. If one side of the input is "earthy" this should be connected to SK1 (black socket).

MULTIMETER PROBE DETAILS

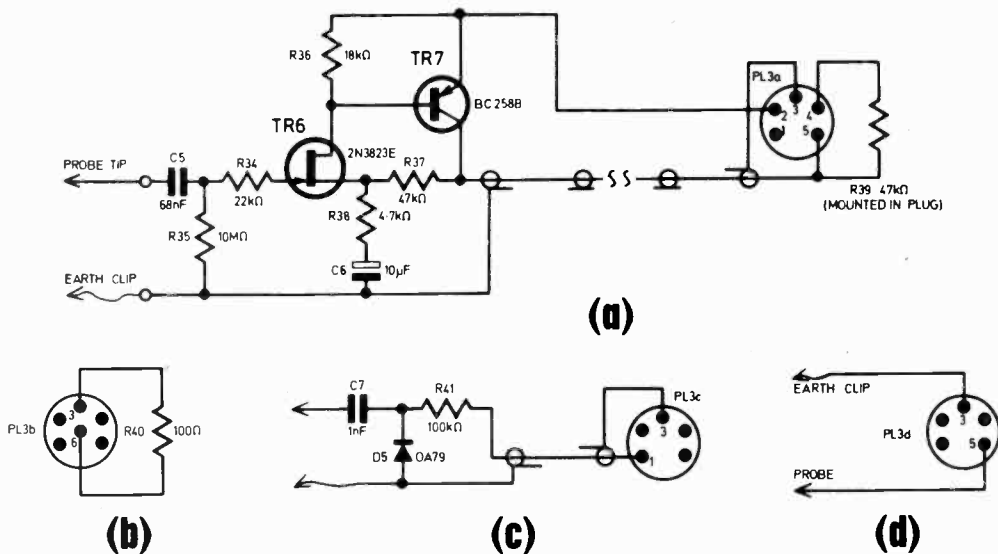
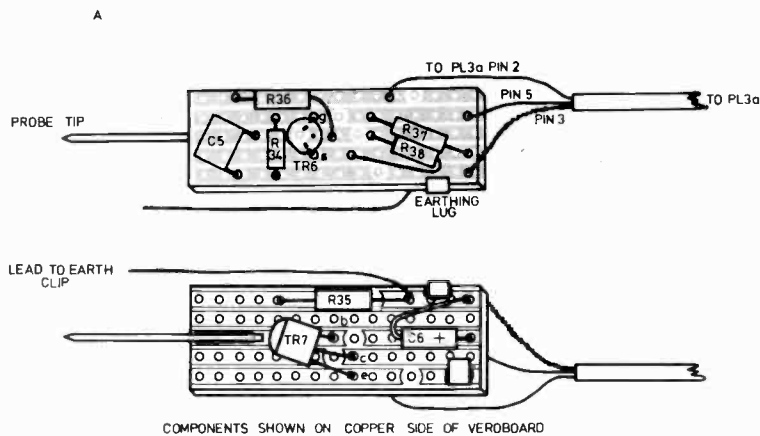
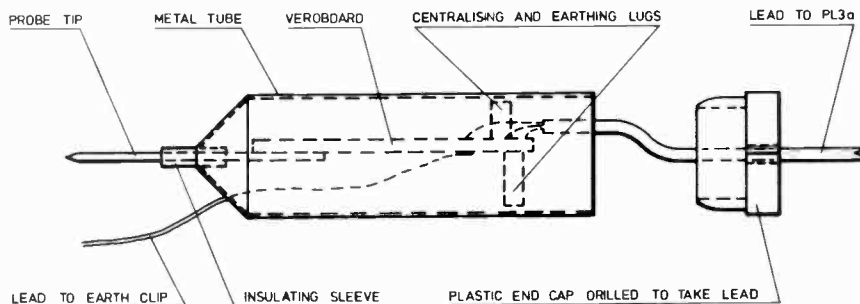

Fig. 8. Various probe and extender circuits for use with the multimeter. The plug numbering is as viewed from the rear (wire side) of the plugs



A.c. probe wiring and layout



A.c. probe case details



this method depends on the accuracy of the 10 kilohm resistor and the 15 μ F capacitor C3. A more precise calibration may be achieved by applying a pulse of known duration to the drain of TR6.

CONSTRUCTION

The prototype was built into a small plastic box as shown in the photograph. Exact measurements are not given because the size of box used will depend on the sizes of the components chosen by the constructor. Most of the components are mounted on a small printed circuit board (Fig. 3).

COMPONENTS

The bipolar transistors may be replaced by any reasonably high gain alternatives such as BC108, BC178, etc. The f.e.t. TR1 may be replaced by any *n*-channel f.e.t. with V_p less than 2.5V if C1 is altered to compensate for any change in frequency of the oscillator. If TR6 is replaced by a different f.e.t., it may be necessary to use a different value of resistance for VR1.

The meter used in the prototype was a cheap, rather non-linear tuning meter. If an accurate reading of time is desired, a better meter and a linear buffer amplifier should be used. ★



For measuring resistance, set S3 to R and select the range of multiplier on S1. Accuracy is greatest about one third way up the scale. Note that current is drawn from B2 whenever S1 is set to a resistance range, even with the meter switched off, so S1 should not be left in this position. Unlike a conventional ohm meter, the resistance range is "zeroed" by adjusting VR4 to set the reading to infinity with the leads open circuit. VR4 is accessed through a hole in the back of the case as there is insufficient room on the front panel; however, adjustment is needed only to compensate for battery ageing and not between ranges.

The batteries may be checked by selecting B+ or B- on S1 (preferably with the test leads unplugged), reading the battery voltage directly from the 0 to 15 scale. B1 and B2 should always be replaced together.

RANGE EXTENSION

The sensitivity of the voltage and current ranges may be extended by inserting into SK3 a 6 pole DIN plug with a 100 Ω resistor wired between pins 3 and 6 (Fig. 8b). On current ranges this has the advantage of reducing the maximum voltage drop across the multimeter from 450mV to 45mV. However, accuracy and bandwidth are both reduced.

For a.c. measurements an amplifying probe is preferred. The design of Fig. 8a has a gain of ten times and can be made conveniently small.

R.F. measurements can be made using a diode probe, such as the one in Fig. 8c.

When measuring a.c. voltages where a d.c. potential is present, the blocking capacitor C4 may be employed by using the probe of Fig. 8d. ★

... with outdoor leisure activities in mind we present the

PE Portable **GAS IGNITOR**

The first D.I.Y. design for a portable electronic gas ignitor powered from a 1.5V dry cell.

The ignitor produces a continuous stream of high voltage sparks capable of lighting natural, town and bottled gases.

Ideal for camping, boating and caravanning as well as for use in the kitchen.



Also... **SINE/SQUARE WAVE SIGNAL GENERATOR**

Output frequency is variable from 10Hz to 100kHz in four switched ranges. The output signal, which is 10V peak, can be attenuated down to 1mV. The output signal will drive loads down to 600Ω on the 1 to 10mV ranges and 100kΩ above 20mV.

The square wave facility is very useful for testing audio amplifiers. Some of the principles behind square wave testing techniques as particularly applicable to the hi-fi field will be given.

GUITAR EFFECTS PEDAL

Add eight—yes eight!—different sounds to your guitar by building this special effects pedal. Using an oscillator, a voltage controlled filter and a voltage controlled amplifier this pedal gives eight basic effects, all of which can be varied.



PRACTICAL **ELECTRONICS**

JULY 1975 ISSUE ON SALE JUNE 13, 1975—PRICE 30p

PLACE A FIRM ORDER WITH YOUR NEWSAGENT TO AVOID DISAPPOINTMENT

MARKET PLACE

Items mentioned in this feature are usually available from electronic equipment and component retailers advertising in this magazine. However, where a full address is given, enquiries and orders should then be made direct to the firm concerned. All quoted prices are those at the time of going to press.

NEW CALCULATORS

In a bid to win a larger share (if that's possible) of the lucrative European calculator market, Sinclair Radionics have just announced the first models of a new range of calculators called the Oxford.

The three models, which are mains/battery portables, are the Sinclair Oxford 100, 200 and the 300 Scientific. The recommended retail prices are £13.98, £21.55 and £32.35 respectively.

The new Oxfords are designed as mains operated desk units, but with the facility for operating for several weeks from an internal 9V battery. All models include excellent large press keys and an angled red display for easy viewing.

The Oxford 200 has the addition of a memory and an automatic percentage key.

The optional mains adaptor unit for use with each of the Oxford calculators has a recommended retail price of £3.19.

Full details and addresses of nearest stockists of Sinclair calculators can be obtained from Sinclair Radionics Ltd., London Road, St Ives, Huntingdon.

THEATRE MIXERS

A range of high quality, transportable stereo sound mixing desks, specifically developed for theatre use, is announced by Cambridge Electronic Workshop.

The standard desk has 10 channels and contains cue lights, show relay/intercom systems, a monitoring system, loudspeaker switching and tape remote controls, all mounted on the front panel for ease of operation during performances.

The desks are capable of absorbing up to 30dB of overload at 0.1 per cent, enabling a good mix using the channel faders. The equalisation frequencies have been chosen for theatre use, bass tip-up filters are included and the presence frequency is continuously variable. Noise is claimed to be better than 126.5dB.

Further technical details and prices are available from Cambridge Electronic Workshop, 4 Water Lane, Oakington, Cambridge, CB4 5AL.

PRINTED CIRCUIT KIT

A new printed circuit kit containing all the necessary materials for producing "one off" boards is available from Home Radio (Components) Ltd.

By using one of the now familiar "special" marking pens, it is claimed that with a little care and by following instructions even the inexperienced can produce acceptable fairly complex printed circuit boards.

The kit contains two pieces of copper clad board, ferric chloride, etch resist pen, plastics etchant trough, tweezers, spoon and a laminate cutter. Also included in the kit is a booklet of instructions which readers are advised to read before handling the ferric chloride etchant.

The price of kit is £3.50 plus VAT and is available from Home Radio (Components) Ltd., 234-240 London Road, Mitcham, Surrey, CR4 3HD.

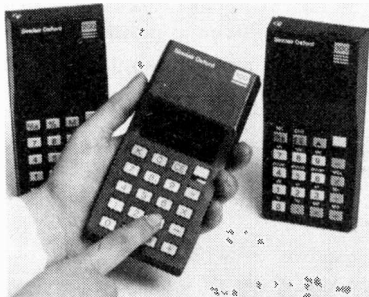

Oxford range of calculators from Sinclair Radionics

LIVE RHYTHMS

Probably the severest criticism of electronic rhythm generators is the monotony of the single bar sequences produced. Any owner of an electronic organ soon becomes very sparing in its use for this reason. A new development from Scotland claimed as the world's first fully synchronised continuous "live" rhythm unit departs entirely from the standard version.

Called the "Powerhouse", it uses 4 in multi-track continuous loop tape in eight cassettes. In all, 32 live rhythms have been recorded and each rhythm may be played in three different fashions: basic rhythm, more complex rhythm and a combination of both in synchronisation.

A mix control has been incorporated into the machine to facilitate the adjustment of the two volume levels in relation to each other.

When a musician wishes to change rhythms he can do so either by using a button on the front of the Powerhouse, or by using the special

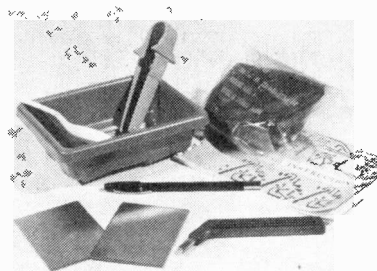

Home Radio Printed Circuit Kit

rhythm control foot pedal. A mute mechanism is another of the Powerhouse's features; once again it can be operated from the main control panel or by the special foot pedal.

A sophisticated electronic speed governor allows the musician to vary the tempo over a very wide range to coincide with his own requirements. Once set, the speed is electronically locked until the tempo control is reactivated.

The Powerhouse will produce sounds in mono or stereo, depending on the amplifier used. Coupled to a conventional hi-fi stereo amplifier, it will double as a superb quality 8-track stereo cartridge player.

Retailing at approximately £140, the unit will be available from distributors as specified by Bandmast Limited of Gloucester Street, Glasgow.

IMPORTANT NOTICE

BUDGET, APRIL 1975

Prices quoted in this issue may be subject to alterations arising from the new Budget proposals

The Bandmaster Powerhouse Rhythm Unit



RESISTORS

The standard ranges of Resistors stocked are either E12 or E24 and the values are all in multiples of ten times the decade shown below. The E12 items are only those in bold type. The E24 items are both those in bold and light type.

10	18	33	56
11	20	36	62
12	22	39	68
13	24	43	75
15	27	47	82
16	30	51	91

CARBON FILM $\frac{1}{4}$ watt \pm 5% tol. 2p ea.
E12 Series 10 to 330K

CARBON FILM $\frac{1}{2}$ watt \pm 5% tol. 1p ea.
E24 Series 10 to 10M

'CERMET' THICK FILM $\frac{1}{2}$ watt \pm 2% tol. 8p ea.
E12 series 56 to 150K

METAL OXIDE FILM $\frac{1}{2}$ watt \pm 2% tol. 43p ea.
E12 series 10 to 1M

CARBON COMPOSITION $\frac{1}{2}$ watt 43p ea.
2.2 ; 2.7 ; 3.3 ; 3.9 ; 4.7 ; \pm 0.5 tol.
5.6 ; 6.8 ; 8.2 \pm 10% tol.

CARBON COMPOSITION 1 watt 53p ea.
2.2 ; 2.7 ; 3.3 ; 3.9 ; 4.7 ; \pm 0.5 tol.
5.6 ; 6.8 ; 8.2 \pm 10% tol.

CARBON FILM 1 watt \pm 5% tol. 33p ea.
E12 series 10 to 10M

CARBON FILM 2 watt \pm 5% tol. 63p ea.
E12 series 10 to 10M

WIREWOUND $\frac{2}{3}$ watt \pm 5% tol 0.22 to 0.47 15p
E12 series \pm 10% tol 11 to 270K 13p

WIRE WOUND 5 WATT 13p ea.

1	25	250	1.5K
1.8	30	270	1.8K
2.2	39	390	2K
2.7	50	330	2.2K
3.3	60	350	2.5K
3.9	68	400	2.7K
4.7	75	470	3K
5.6	82	500	3.3K
6.8	100	550	3.5K
7.5	125	600	3.9K
8.2	133	680	4.7K
10	150	750	5K
15	180	820	5.6K
20	200	1K	6.8K
25	220	1.2K	8.2K

WIRE WOUND 10 watt 14p ea.
All the values shown in bold in the 5 watt range

WIRE WOUND 10 watt \pm 5% tol. 20p ea.
10K ; 15K ; 20K ; 25K

WIRE WOUND 15 watt 133p ea.
All the values from 10 upward shown in bold in the 5 watt range.

POTENTIOMETERS



5K	250K	Log or Lin Less Switch (and 1K Lin)	14p
10K	500K	Log or Lin with Switch	26p
25K	1 Meg	Dual Less Switch	46p
50K	2 Meg	1 Meg Log only	57p
100K		10K Log + 10K Antilog Less Switch	46p

Sliders

10K	Single	33p
25K	DUAL	55p
50K		
100K		

Presets

Vertical or Horizontal			
.1 Watt 53p		.25 Watt 7p	
100	1K	10K	100K
250	2.5	25K	250K
500	5K	50K	500K
		1Meg	5Meg

Cermets

100	2.5K	25K	250K
500	5K	50K	500K
1K	10K	100K	1Meg

40p

CAPACITORS

Ceramic Plate
Mullard C333 Series 63 Volts Wkg.
all at 53p each

1.8pF	= 0.2pF	12pF = 2%	68pF = 2%
2.2pF		15pF	82pF
3.3pF		18pF	100pF
3.9pF		22pF	120pF
4.7pF		27pF	150pF
5.6pF		33pF	180pF
6.8pF		39pF	220pF
8.2pF		47pF	270pF
10 pF		56pF	330pF

Mullard 630 series 40 volts = 10% tol
629 series 100 volts
all at 53p each

390 pF	1000 pF	3300 pF
470 pF	1200 pF	3900 pF
560 pF	1500 pF	4700 pF
680 pF	1800 pF	* 10 nF
820 pF	2200 pF	* 22 nF
	2700 pF	

Eric Monolithic Ceramic 30 Volts Wkg.
27 nF 11p; 47 nF 13p; 100 nF 17p

Low Voltage Disc Ceramics
all at 53p each

0.01 uF	18v	0.1 uF	30v
0.022 uF	18v	0.22 uF	6v
0.047 uF	18v	0.47 uF	3v

Mylar Film 100 Volts Wkg.

1000 pF	23p	0.05 uF	33p
2000 pF	23p	0.068uF	5p
5000 pF	23p	0.1 uF	6v
0.01 uF	33p	0.2 uF	63p
0.02 uF	33p	0.47 uF	7p
0.04 uF	33p		

Polystyrene

MULLARD C295 Series 63 volts
Tolerance \pm 1%
8.800pF (6.8nF) C295 AH/D6K8 11p
8.800pF (8.2nF) C295 AH/D8K2 11p
13.000pF (13nF) C295 AH/D13K 15p
18.000pF (18nF) C295 AH/D18K 15p
20nF (0.02uF) C295 AH/D20K 15p
30nF (0.03uF) C295 AH/D30K 18p
39nF (0.039uF) C295 AH/D39K 18p
51nF (0.051uF) C295 AH/D51K 25p

Polystyrene 160 volts Wkg.
Tolerance = pF up to 33pF \pm 5% 47pF up
to 10 pf to 10,000 pf (0.01 uF) in multiples of:
10 ; 15 ; 22 ; 33 ; 47 ; 68.

Nimarks 0.22uF \pm 5% 1000 11p
Wima MKS 0.22uF
= 5% 100V 11p

Mullard C280 Series. 250 Volts Wkg.
Metalised Polyester Film

0.01 uF	33p	0.22 uF	53p
0.015 uF	33p	0.33 uF	7p
0.022 uF	33p	0.47 uF	9p
0.033 uF	33p	0.68 uF	12p
0.047 uF	33p	1.0 uF	143p
0.068 uF	4 p	1.5 uF	22p
0.1 uF	43p	2.2 uF	263p
0.15 uF	43p		

Mullard C281 series 400 volts Wkg
Metalised Polycarbonate Film 10%

0.01 uF	5p	0.1 uF	8p
0.015 uF	5p	0.15 uF	9p
0.022 uF	5p	0.22 uF	11p
0.033 uF	6p	0.33 uF	153p
0.047 uF	63p	0.47 uF	163p
0.068 uF	63p		

VDR's & Thermistors

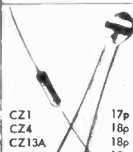

CZ1	17p
CZ4	18p
CZ13A	18p
CZ19	18p
E298CDA258	13p
E298EDA258	13p
E298EDA260	13p
E298EDA262	13p
E298EDA265	13p
E298EDP268	13p
E298EZ05	13p
E298ZZ06	13p
E299DDP336	14p
E299DDP338	14p
E299DDP342	14p
E299DDP348	14p
GL16	E1.21
GL23	E1.21
RS3	E1.49
RS4	E1.61

VA1005	16p
VA1026	16p
VA4033	16p
VA1034	16p
VA1039	16p
VA1040	16p
VA1053	16p
VA10555	16p
VA10565	16p
VA10665	17p

VA10675	19p
VA1077	19p
VA1098	21p
VA1104	31p
VA1107	29p

CAPACITORS



Silvered Mica 350V.
Tol. \pm 0.5pf 11p each
2.2 pf 18pf 30pf
3.3 pf 20pf 33pf
5 pf 22pf 39pf
10 pf 25pf 47pf

Tol. \pm 1% 11p each
50pf 150pf
56pf 180pf
68pf 82pf
75pf 100pf
82pf 120pf

250pf	330pf	500pf
270pf	390pf	680pf
300pf	470pf	820pf
	500pf	

12p each

1000 pf 1500pf 17p each
1800pf 220pf
2700pf 3600pf 5000pf
4700pf 8200pf

6800pf 8200pf 10000pf

Mixed Dielectric 600 Volts Wkg.
0.01 uF 8p ; 0.1 uF 9 p
0.022 uF 8p ; 0.22 uF 173p
0.033 uF 8p ; 0.47 uF 263p
0.047 uF 8p ; 1 uF 33p
0.068 uF 9p ;

Mixed Dielectric 1000 Volts Wkg.
1000 uF 63p ; 0.022uF 11p
2200 pf 63p ; 0.047uF 13p
3300 pf 7p ; 0.1 uF 13p
4700 pf 7p ; 0.22 uF 243p
0.01 uF 10p ; 0.47 33p

Solid Tantalum Beads all at 163p
0.1 uF 35v ; 10 uF 6.3v
0.22 uF 35v ; 10 uF 15v
0.47 uF 35v ; 10 uF 22v
1.0 uF 35v ; 22 uF 15v
2.2 uF 35v ; 47 uF 6.3v
4.7 uF 35v ; 100 uF 3v

Feed-through Ceramics
1000 pf 350v 6p

Disc Ceramics all at 53p each
750 Volt Wkg.
470 pf; 1000 pf; 5000 pf; 0.01 uF

Tubular HI-K Ceramics 750 Volts Wkg.
1000 pf 53p 3000 pf 53p
1500 pf 53p 5000 pf 53p
2000 pf 53p 0.01 uF 53p

Pulse Ceramics all at 10p each
12 kv. D.C. Wkg
10pf 120pf 200pf
22pf 140pf 220pf
68pf 150pf 250pf
82pf 100pf 270pf
100pf 200pf 300pf

VAT INCLUSIVE PRICES AT 8%

OVERSEAS CUSTOMERS DEDUCT $\frac{2}{27}$
VAT INVOICES ON REQUEST
P&P On U.K. Orders 15p Overseas Orders at Cost

Connoisseur

THE B.D.2 TURNTABLE ASSEMBLY

The Famous B.D.2 belt drive turntable with press button speed change has now been developed to feature a newly designed mat and brushed aluminium trim, and the perspex cover has an easy 'hinged-on, hinged-off' movement. The B.D.2 is available as a chassis unit or spring mounted on a wood plinth.

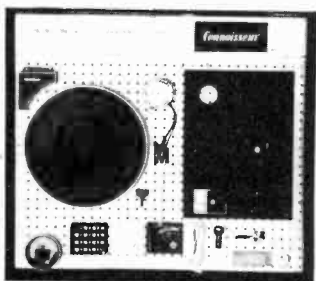

B.D.1 TURNTABLE KIT

The B.D.1 well known for its superb performance and quality is available in kit form. Construction is simplicity itself with no soldering required. Now it's so easy to own the best.

Contact your dealer for information or send a stamp for brochure.

A. R. SUGDEN & CO. (ENGINEERS) LTD

Atlas Mill Road, Brighouse HD6 1ER Telephone: Brighouse (04847) 2142. Telegrams and cables: Connoisseur, Brighouse

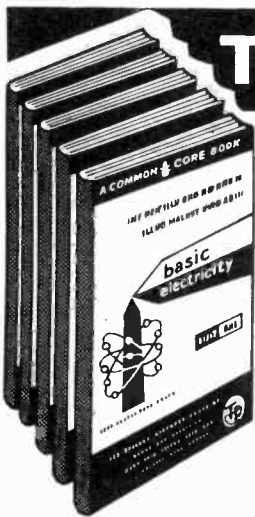

The Pictorial Method

BASIC ELECTRICITY (5 vols) ELECTRONICS (6 vols) TELEVISION (3 vols)

You'll find it easy to learn with this outstandingly successful PICTORIAL METHOD. The essential facts are explained in the simplest language, one at a time, and each is illustrated by an accurate cartoon-type drawing. These clear and concise illustrations make study a real pleasure. The books are based on the latest research into simplified learning techniques. This easy approach-to-learning method has proved beyond doubt that acquiring knowledge can be an enjoyable experience.

**YOUR
100%
GUARANTEE**

Should you be, in any way dissatisfied with the MANUALS your money will be refunded by return of post.

The series will be of exceptional value in training mechanics and technicians in Electricity, Radio and Electronics.

WHAT READERS SAY

I didn't know this subject could be so easily presented. *J. K., Earlsfield*
Pleased to say how understandable your books are—I now have a sound knowledge of the subject. *A. K., Hull*
Invaluable for my training as a Technician. *W. J., Stockport*
They have an easy approach to learning that a mathematical idiot like myself can easily understand. *K.L.Y., Ashton-u-Lyme*
Thank you for the excellent publication: the best in form and type I have ever come across. *T.L.O., Shanklin*
I find the Basic Manuals the best in their class and a real help in my work in phototype electronics. *C.L.P., Cardiff*

To The SELRAY BOOK CO., 60 HAYES HILL, HAYES, BROMLEY, KENT. BR2 7HP

Please find enclosed P.O./Cheque value £.....

BASIC ELECTRICITY 5 parts £6.50

BASIC ELECTRONICS 6 parts £7.50

BASIC TELEVISION 3 parts £4.25

Tick Set(s) required. Prices include Postage

YOUR 100% GUARANTEE. If after 10 days examination you decide to return the Manuals your money will be refunded in full.

NAME

BLOCK LETTERS

FULL POSTAL

ADDRESS

POST NOW FOR THIS OFFER!

INGENUITY UNLIMITED



A selection of readers' suggested circuits. It should be emphasised that these designs have not been proven by us. They will at any rate stimulate further thought. Any idea published will be awarded payment according to its merits. Why not submit YOUR IDEA?

CUTTING LOUDSPEAKER Baffles

THE chances are that when you come to construct a loud-speaker cabinet using only a modest supply of tools you will drill a ring of holes using a power or hand drill and then cut between the holes with a padsaw for the loudspeaker baffle holes.

This is a laborious and rarely attractive method which can be avoided quite simply by using a home-made trepanning tool.

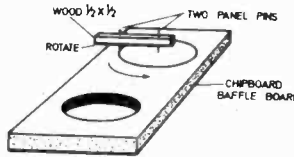

Fig. 1

As can be seen in Fig. 1, a bit of scrap wood about $\frac{1}{2}$ in. square with a couple of panel pins hammered through does the job. One of the nails is hammered through close to one end of the wood arm whilst the second is hammered through at a distance equal to the radius of the required hole from the first.

The first pin can now be hammered into the board at the centre of the required hole and the timber arm used as a lever to draw the other round the board to cut a path through the board.

It will be necessary to progress the cut from both sides of the board so as to avoid breaking of the hole edges when the cut is being finished.

This method was developed to cut holes in chipboard, always a difficult material to cut cleanly, and can no doubt be used on other materials with a little experiment. It could for example be improved by sharpening the tip of the cutting nail to an edge and by perhaps using heavier nails.

Using the original suggestion it takes about 10 minutes to cut a normal hole in chipboard and it should be remembered that the method can equally well be used in conjunction with a suitably sharp chisel to cut the recesses required for some loudspeakers such as the KEF T27.

K. J. Honour.
Kent.

RANDOM FLASHING DISPLAY

BASIS of operation of the flashing light display unit shown in Fig. 1 is fairly simple. TR1, TR2 form an astable multivibrator (they can be any general purpose switching transistors), TR2 is in the on state for about 0.01s which brings the collector voltage close to ground potential, logic 0.

This output is inverted by the first NAND gate in IC1 to make the output compatible with TTL. Thus one input of the second NAND gate in IC1 is at logic 1. Under these circumstances the three loop-connected gates in IC1 will now oscillate and in the prototype this was found to occur at about 24MHz.

During oscillation the four bistables in IC2 and IC3 will count something like 240k pulses, a number which will vary by about 1 per cent by virtue of the variation in oscillation frequency. In this way the count will be randomised.

The outputs of the bistables are monitored by transistors TR3 to TR6. If a bistable output is at logic 1 the associated transistor will be on and the series-connected relay

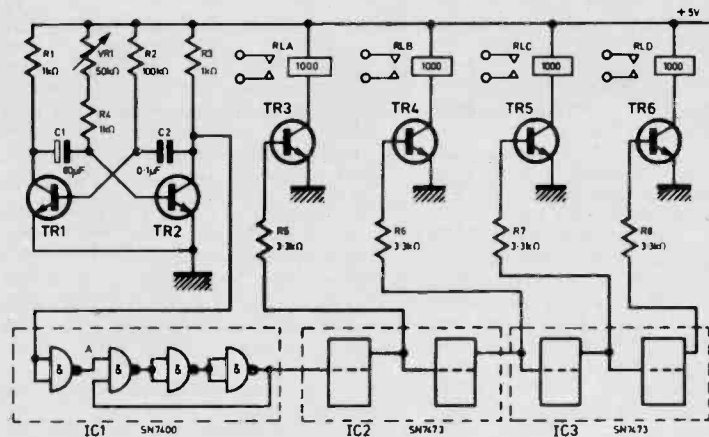

Fig. 1

switched. In the prototype the relays were used to switch coloured lights at 60W.

If a linear potentiometer is used for VR1 the time interval between light changes will be found to be directly proportional to the angle of rotation of the pot. Indeed, with careful timing the equipment can be

made to appear music-controlled when used with sound equipment.

The J, K and Clear inputs of the two SN7473's must be at logic 1 so they should be connected together and then to the +5V rail via a 1k Ω resistor.

P. Hobson,
Sheffield.

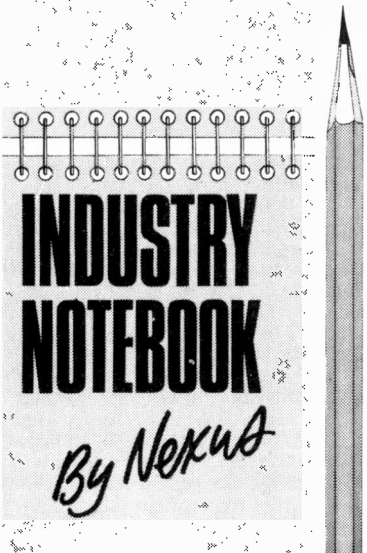

INDUSTRY NOTEBOOK

By Nexus

GOOD AND BAD

First the bad news. Last month I reported that Transiron had pulled out of semiconductor production in Europe to concentrate on manufacture in the United States. Now I have to record that Microsystems International Ltd., the Canadian manufacturer, is closing down semiconductor manufacture altogether following heavy losses due, it is said, to an accelerated drop in demand and substantial price erosion in a softening market.

Microsystems International had made quite a splash in the industry since starting up in 1968. The company was regarded as something of a showpiece with a high level of technology, especially in MOS memories. The Canadian Government backed the venture with cash and sales were going well, running at 30 million dollars in 1974. But although this figure was nearly 9 million dollars up on 1973 so were the losses which increased to 12 million dollars.

However, Northern Electric, MIL's parent company, has been enjoying record profits and sales and it may yet turn out that MIL will have some role in the group though, apparently, not as a semiconductor manufacturer.

GOOD BAROMETER?

The ebb and flow of the fortunes of semiconductor manufacturers ought to be a good barometer for the international electronics industry as a whole. After all they are the people who make the fundamental building blocks of almost any modern equipment and, to a large extent, determine the trend of technology. But this particular barometer needs observing with a

sceptical eye. It tends to overshoot and undershoot and is nearly always out of phase with what is actually happening.

In short, it is very tricky to make forecasts of future demand in what is always a volatile situation, and even more tricky to strike the right balance of production capacity which must be enough to satisfy demand in good times and not so much as to produce big losses when times are bad and the manufacturing capacity, installed at great expense, is under-utilised.

The manufacturers like to work along with the equipment builders to get some idea of future trend. They beg customers to let them know of future requirements. But if the equipment builders themselves don't know how much they are going to sell, say, over the next two years, this is hardly helpful.

So the semiconductor manufacturers are forced to base forecasts on the trend of current orders and they don't like what they see. They then cut labour capacity as a precautionary measure and also cut investment in modernisation of plant. It is thought that world wide, semiconductor manufacturing capacity is already 50 per cent down through outright closures and other cut-backs. When good times come back there will be severe shortages and these could start as early as next year.

BUT IN THE FUTURE

In 1976 or 1977 when the semiconductor manufacturers have more orders than they can cope with and quote six months or more delivery time, it is then that the equipment manufacturers start ordering far more than they need and on more than one manufacturer in the hope of meeting their requirements. Just like trade unions asking for a £40 rise in the expectation of settling for £10. Faced with a seemingly unprecedented demand, the semiconductor manufacturers expand and are once again faced with over capacity.

How this unhappy cycle of events can be overcome is completely unknown and presumably we shall have to live with it for as long as world trade remains cyclic.

Everything, however, is not all gloom and doom. The Microelectronics Division of the French company CIT-Alcatel is planning to double turnover by 1980. And the Spanish company Piher, currently only making discrete devices, is planning to expand into i.c.s. Plessey has just introduced a non-volatile MNOS memory, claimed to be a world first, and with many new applications.

The latest problem is armed invasion. Indians of the Navajo tribe recently occupied Fairchild's Shiprock, New Mexico, plant in protest against redundancies. What next?

BRITISH IS BEST

It's not often that the British sell automotive industry equipment to the big boys in Detroit. It was quite a triumph, then, for Herbert Controls and Instruments to supply an electronic gauging equipment for the manufacture of diesel engines.

Weighing 28 tons, it's the biggest piece of test gear I've ever seen and, at £150,000, the most expensive. An all singing, all dancing, gauging system, it measures 94 parameters on diesel engine cylinder blocks at the rate of 35 blocks an hour. Every block is compared with a master block, deviations are listed on a computer print-out and the HCIL equipment even stamps one of five coded categories on the block to instruct the next stage of manufacture which size cylinder liner to fit. The computer programme can be switched to read dimensions in metric if required. Accuracy is such that the block classification is in steps of 0.0005 inches.

This is mechanical automatic testing on the grand scale. A mass of performance statistics is available but a discreet silence is maintained on how many manual inspectors the machine will make redundant in the hard-pressed Detroit manufacturing complex. But it is doubtful whether any human inspector, using conventional gauges, could take so many measurements without mistake, and he would have no chance at all on a time scale of less than two minutes.

GREAT SCOT

Perhaps even more unforgivable than getting a person's name wrong is getting his nationality wrong. In reporting on ITT Components Group Europe in a recent issue I wrote with British pride that the 16,000-strong organisation was run by Doug Stevenson whom I described as "another Englishman". He is, in fact, a Scot, and I hasten to amend the record.

ITT Components Group is feeling the pinch on entertainment components but otherwise doing quite nicely. Plenty of new products are in the pipeline and, despite current uncertainties, high technology developments are being brought forward, an example being a plasma display panel suitable for a data terminal which could be in the market place by the end of the year.

Complete the coupon and we'll send you our new catalogue. Completely free.



The new Heathkit catalogue is now out. Full as ever with exciting, new models. To make building a Heathkit even more interesting and satisfying.

And, naturally, being Heathkit, every kit is absolutely complete. Right down to the last nut and bolt. So you won't find yourself embarrassingly short of a vital component on a Saturday evening—when the shops are shut.

You'll also get a very easy to understand instruction manual that takes you step by step through the assembly.

Clip the coupon now and we'll send you your free copy to browse through.

With the world's largest range of electronic kits to choose from, there really is something for everyone.

Including our full range of test equipment, amateur radio gear, hi-fi equipment and many general interest kits.

So, when you receive your catalogue you should have hours of pleasant reading.

And, if you happen to be in London or Gloucester, call in and see us. The London Heathkit Centre is at 233 Tottenham Court Road. The Gloucester showroom is next to our factory in Bristol Road.

At either one you'll be able to see for yourself the one thing the catalogue can't show you.

Namely, how well a completed Heathkit performs.

Heath (Gloucester) Limited, Dept. PE-65, Bristol Road, Gloucester, GL2 6EE. Tel: Gloucester (0452) 29451.

A new oscilloscope from the Heathkit range.

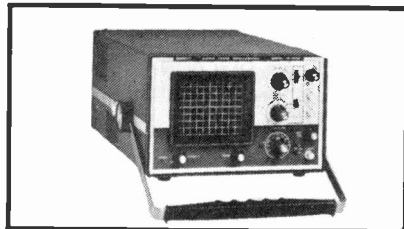

Marine direction finder with digital read-out.

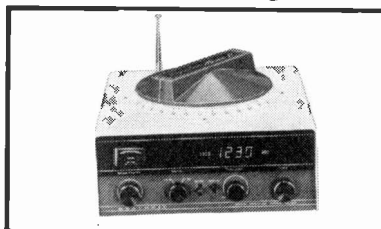

Stereo cassette deck with built-in Dolby.

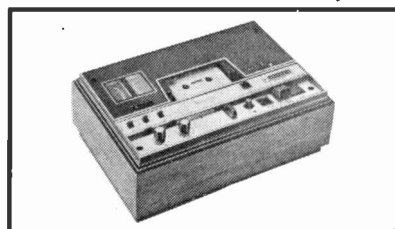

The new Heathkit catalogue. Out now. FREE.

To: Heath (Gloucester) Limited, Dept. PE-65, Gloucester, GL2 6EE. Please send me my free Heathkit catalogue.

Name _____ Address _____

Postcode _____

Remember easy terms are available with the Heathkit Monthly Budget Plan.



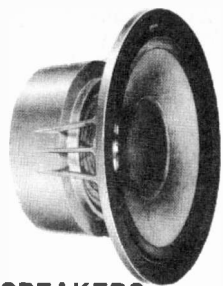

WILMSLOW AUDIO

THE Firm for speakers!

SPEAKERS

Baker Group 25 3, 8 or 15 ohm £7-75
 Baker Group 35 3, 8 or 15 ohm £8-50
 Baker Group 50/12 8 or 15 ohm £12-50
 Baker Deluxe 12in d/cone £10-75
 Baker Major 12in d/cone £8-50
 Baker Regent £7-75
 Baker Superb £14-50
 Baker Auditorium 12 £12-50
 Celestion MH1000, 8 or 15 ohm £10-95
 Celestion PS8 for Unilux £3-25
 Celestion G12M 8 or 15 ohm £12-00
 Celestion G12H 8 or 15 ohm £15-00
 Celestion G15C 8 or 15 ohm £24-00
 Celestion G18C 8 or 15 ohm £33-00
 Coral 6in d/cone roll surr. 8 ohm £2-50
 Coral 8in d/cone roll surr. 8 ohm £3-25
 EMI 13in x 8in 3, 8 or 15 ohm £2-25
 EMI 13in x 8in 150 d/c 8 ohm £2-50
 EMI 13in x 8in type 350 8 or 15 ohm £8-25
 EMI 13in x 8in 20W bass £3-00
 EMI 6in 93850 4 or 8 ohm £3-00
 EMI 5in 14A.7030 mid range 8 ohm £2-50
 EMI 8 x 5 d/cone, roll surr. 10W £2-50
 EMI 2 1/2in tweeter 97492AT £0-85
 Eagle DT33 30W tweeter £5-45
 Eagle HT15 horn tweeter £3-80
 Eagle CT5 cone tweeter £1-75
 Eagle CT10 tweeter 8 or 16 ohm £2-55
 Eagle MHT10 horn tweeter £3-80
 Eagle crossover CN23, CN28, CN216 £1-50
 Eagle FR4 £5-30
 Eagle FR65 £3-35
 Eagle FR8 £10-85
 Elac 9 x 5 59RM109 15 ohm, 59RM114 8 ohm £2-80
 Elac 6in 6RM171 d/c roll surr. £3-50
 Elac 6in 6RM220 d/cone £2-85
 Elac 4in tweeter TW4 £1-50
 Elac 10in d/cone 10RM239 8 ohm £2-65
 Elac 8in BCS175 3 ohm £2-50
 Fane Pop 15W 12in £5-25
 Fane Pop 25T 30W 12in £7-25
 Fane Pop 50W 12in £12-00
 Fane Pop 55 80W 12in £12-50
 Fane Pop 60W 15in £13-25
 Fane Pop 70W £15-95
 Fane Pop 100W 18in £24-50
 Fane Crescendo 12A 100W 12in £29-00
 Fane Crescendo 12B bass £28-00
 Fane Crescendo 15in 100W £36-00
 Fane Crescendo 18in 150W £51-95
 Fane 8017 8in d/c roll surr. £7-00
 Fane 807T 8in d/c roll surr. £3-85
 Fane 808T 8in d/c £2-75
 Fane 701 twin ribbon horn £35-00
 Fane 910 horn £12-75
 Fane 920 horn £33-00
 Goodmans 8P or 15 ohm £5-00
 Goodmans 10P 8 or 15 ohm £5-30

Goodmans 12P 8 or 15 ohm £12-95
 Goodmans 12P-D 8 or 15 ohm £16-75
 Goodmans 12P-G 8 or 15 ohm £15-75
 Goodmans Audiomax 12AX 100W £38-50
 Goodmans Audiomax 15AX £40-25
 Goodmans 15P 8 or 15 ohm £21-00
 Goodmans 18P 8 or 15 ohm £36-00
 Goodmans Hifax 750 £16-00
 Goodmans Axent 200 tweeter £7-25
 Goodmans Audiom 100 12in £7-25
 Goodmans Axiom 402 12in £17-25
 Goodmans Twinaxiom 8 £8-25
 Goodmans Twinaxiom 10 £8-00
 Kef 127 £5-25
 Kef T15 £8-00
 Kef B110 £7-25
 Kef B200 £8-25
 Kef B139 £14-25
 Kef DN8 £2-00
 Kef DN12 £4-85
 Kef DN13 £3-30
 STC4001G super tweeter £5-70
 Richard Allan CG8T d/c r/surr. £8-35
 2 1/2in 64 ohm, 70mm 80 ohm, 70mm 8 ohm £0-65
 2 1/2in 75 ohm £0-50
 7in x 4in 3 or 8 ohm £1-40
 8in x 5in 3 or 8 ohm £1-50
 10in x 5in 3, 8 or 15 ohm £2-30
 Complete Radford range in stock.

SPEAKER KITS

Baker Major Module each £10-75
 Decca London Ribbon Horn £28-00
 Decca London Crossover £8-50
 Goodmans Mezzo Twinkit pair £36-50
 Helme XLK25 pair £22-00
 Helme XLK30 pair £14-95
 Helme XLK50 pair £39-95
 Jordan Watts Module £14-75
 Kefkit 1 each £20-95
 Kefkit 3 each £38-75
 Peerless Dome tweeter £6-95
 Radford BD25 £14-75
 Radford MD9 £8-95
 Radford HD3 £7-95
 Radford FN12 £8-95
 Richard Allan Twinkit each £8-95
 Richard Allan Triple 8 each £13-75
 Richard Allan Triple each £18-95
 Richard Allan Super Triple each £23-75
 Super 8 RS/D £8-95
 Wharfedale Linton 2 kit pair £19-25
 Wharfedale Glendale 3 kit pair £34-50
 Wharfedale Dovedale 3 kit pair £52-50
 Baker, Linear and Eagle PA disco amplifiers in stock.
 Send stamp for list.

FREE with speaker orders over £7

Hi-Fi Loudspeaker Enclosures book.
 All units guaranteed new and perfect. Prompt despatch. Carriage and packing, speakers 38p each, 12in and up, 50p each, speaker kits 75p each (£1-50 pair), tweeters and crossovers 25p.
 Send stamp for free booklet! *Choosing a Speaker
 ALL PRICES QUOTED INCLUDE VAT

WILMSLOW AUDIO (Dept. PE)

Loudspeakers: Swan Works, Bank Square, Wilmslow, Cheshire, SK9 1HF.
 Discount Radio, PA, Hi-Fi: 10 Swan Street, Wilmslow.



Agfa Cassettes

The best buy!

Agfa Low Noise Cassettes AT LESS THAN HALF PRICE!	1		2		10	
	C80	37p	C90	59p	C120	63p
AGFA HIGH DYNAMIC SUPER	C80 - 6	50p	C90 - 8	68p	C120	99p
	C80 - 6	50p	C90 - 8	68p	C120	99p
	C80	50p	C90	68p	C120	99p
AGFA STEREO-CHROM CHROMIUM DIOXIDE	C80	50p	C90	68p	C120	99p
	C80	50p	C90	68p	C120	99p

SAME DAY DESPATCH. P. & P. 15p per order

WILMSLOW AUDIO (DEPT. PE)

10 SWAN STREET, WILMSLOW, CHESHIRE, SK9 1HF

Cut-price prerecorded cassettes—send stamp for list

VEROBOARD

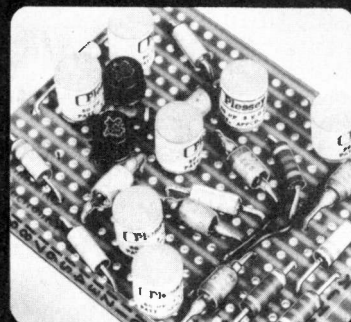

VEROBOARDS GIVE A PROFESSIONAL FINISH TO YOUR WORK

0.1" and 0.15" pitch, plain and copper clad universal circuit boards.

AVAILABLE FROM YOUR LOCAL RETAILER.

TRADE DISTRIBUTOR N. Ross (Electrical) Ltd., London, W.C.1.



VERO ELECTRONICS LTD.
 Industrial Estate, Chandler's Ford,
 SO5 2ZR Tel: Chandler's Ford 2352

INTERLOCKING PLASTIC STORAGE DRAWERS



NEARLY WAREHOUSING STOCK!
 DISCOUNT PRICES

Newest, neatest system ever devised for storing small parts and components:

resistors, capacitors, diodes, transistors, etc. Rigid plastic units interlock together in vertical and horizontal combinations. Transparent plastic drawers have label slots. 1D and 2D have space dividers. Build up any size cabinet for wall, bench or table top.

BUY AT DISCOUNT PRICES!

SINGLE UNITS (1D) (5ins x 2 1/2ins x 2 1/2ins). £2 DOZEN.

DOUBLE UNITS (2D) (5ins x 4 1/2ins x 2 1/2ins). £3-50 DOZEN.

TREBLE (3D) £3-50 for 8.

DOUBLE TREBLE 2 drawers, in one outer case (6D2), £4-90 for 8.

EXTRA LARGE SIZE (6D1) £4-50 for 8.

PLUS QUANTITY DISCOUNTS!

Orders over £20, less 5%.
 Orders over £60, less 7 1/2%.

PACKING/POSTAGE/CARRIAGE: Add 50p to all orders under £10. Orders £10 and over, please add 10% carriage.

QUOTATIONS FOR LARGER QUANTITIES Please add 8% V.A.T. to total remittance

FLANLINE (Dept. PE6), 124 Cricklewood Lane, Broadway, London, N.W.2
 Tel. 01-450 4844

Readout—

A SELECTION FROM OUR POSTBAG

Readers requiring a reply to any letter must include a stamped addressed envelope. We regret that we cannot answer any technical queries on the telephone.

“Bow, bow, ye lower middle classes”

Sir,—I would like to congratulate Mr C. J. Allen, “Musical Doorbell”, on a most amusing and enjoyable project.

May I add another specimen matrix, see Fig. 1, which plays a tune which will be recognised by devotees of Gilbert and Sullivan as accompanying the appropriate words:

“Bow, bow, ye lower middle classes.”

This version is suitable for the back door; or can be sold to Rolls Royce drivers. I have further modified my version so as to make it a plug-in change between doorbell and car horn status; also, in the latter application, nickel cadmium batteries are trickle charged from the car's 12V system.

W. H. Jarvis,
Perthshire.

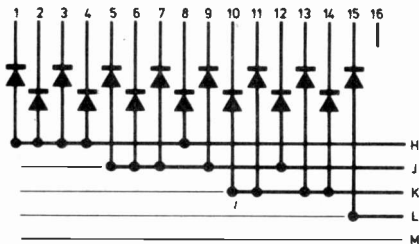

Fig. 1

Get With It!

Sir—With reference to the “Strictly Instrumental” article by Mr. K. Lenton-Smith in P.E. April 1975.

Mr. Lenton-Smith obviously has a good understanding of electronics. However, as for music, surely he has not done much research and is speaking purely and simply to provide a laugh for certain members of the older generation.

I refer specifically to the final paragraph in the article, in which he gives the impression that all pop groups sound alike, i.e.—rubbish.

Obviously, he has got no further than watching “Top of The Pops”.

For example, has he ever listened to the following:

Emerson, Lake and Palmer—“Trilogy”.

Black Sabbath—“Sabbath Bloody Sabbath” (track “Who are You”).

Also various tracks from early Elton John Albums.

Surely these must be rated amongst the highest in terms of best use of the synthesiser.

Yes, there are groups who abuse their instruments, but these are few and far between. Also, the few efforts at electronic classical music that I have heard have been O.K., but I would rather have had the original pieces and time.

Many of today's musicians have been using electronic instruments since they were first made available. Indeed, correct me if I am wrong, but did not E.L.P. (referred to earlier) develop the only synthetic drum device in current use?

It is far too easy to scoff at the work done, by the younger generation, but could Mr. Lenton-Smith achieve the title of “Best Keyboards” (NME 1973, Rick Wakeman or was it Keith Emerson), both in the pop field?

Finally, thank you for an excellent magazine, which I have been reading since about 1968.

P. D. Scargill,
Northumberland.

Tell It To The Marines

Sir—In your April Editorial “Vital Links”, you state, in reference to semiconductor devices “sensing” various stimuli, that “Only taste appears to be lacking at present”.

Like smell, taste is a chemical sense, strictly speaking, sensitive only to sweet, bitter, sour and salty stimuli (possible alkaline or basic also).

Electrochemistry is older than semiconductors. For a long time pH meters have “sensed” or “tasted” acid and alkaline (H and OH) ions by means of glass and calomel electrodes among others. Mercury electrodes used with polarographs have

sensed metallic ions at least, possibly others also. I am not sure if sweet and bitter tastes have been detected electrochemically, but some “tastes” at least have been so detected.

“Taste lacking . . . ?” Tell that to the Marines—chemists won't believe it!

M. Knight,
Shooters Hill.

pH meters do not use semiconductor sensors. True these well known instruments detect “taste”—but in a very limited fashion. Sweet substances cannot be “tasted” by conventional pH electrodes, nor probably can many other distinctive tastes. Any analogy with the human taste buds is very tenuous.

The likelihood of a semiconductor device being produced that would respond to a wide range of tastes seems extremely doubtful, on theoretical grounds—but we remain inveterate optimists where electronics is concerned.—F.E.B.

Full Marks

Sir—I would like to refer to your December 1974 issue of P.E.

I have recently completed the Dwell Meter described in an article by a Mr. S. Jones. Not only did it work first time, but it required no calibration whatever. It is extremely accurate, having been checked and compared with a commercial meter.

With petrol at its present price, the dwell meter is not just another gadget, it is a very useful piece of equipment. I give Mr. Jones full marks for both the design of the meter and the excellent presentation of his article.

M. McDermott,
Crawley,
Sussex.

Motionless

Sir—I have read the letter from the Rev. Canon Guest, Readout May, and would comment on it as follows:

The circuit in my article, “Car Clock Repairs” (Feb. issue), was arrived at after considerable experimenting, initially with circuits of the type recommended by the Rev. Canon. In a new clock with unworn contacts, his circuit will be satisfactory, and eliminate arcing and consequent wear of contacts, but in an old clock with badly worn contacts the simple circuit does not provide a full solution. It is difficult to bend the contacts exactly back to the original position to give correct operation over a period of time and with pitted, dirty contacts there will be intermittent contact, which will not be cured by the single transistor circuit.

The circuit given in the article, while it is of the monostable type, acts in this case as a pulse stretcher,

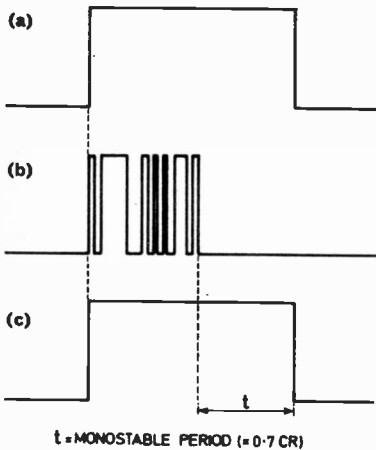

Fig. 1. Monostable pulse shapes from the circuit, all at the same arc of swing. (a) normal pulse (b) intermittent pulse due to worn contacts (c) pulse using monostable

giving a fixed delay after the contacts open. This compensates for both contact wear and intermittent contact in the manner shown, see Fig. 1.

The self-compensating action, mentioned by the Rev. Canon in his letter still occurs, as the period of the monostable starts from the end of the normal contact period.

In my circuit (including the supply decoupling), there are two diode forward voltage drops and one transistor V_{ce} in series with the clock coil when current is flowing.

This means that the clock is working on 10V normally, up to 12V or so when the engine is charging the battery. I found it would work down to below 8V, and there was no problem with "over banking" with the component values suggested.

I did not recommend oiling in my article, as any excess of oil (the correct quantity is minute) will have a detrimental effect, and may even stop the clock working at all. It is really necessary to dismantle the clock to oil it properly, and this is not recommended by the inexperienced.

While I agree that a stabilised power supply is beneficial, I found it unnecessary, as the simple diode/capacitor I suggested works well in practice. In any case, it is better to

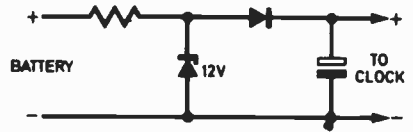

Fig. 2. Stabiliser circuit for car clocks

include the series diode, to guard against falling voltage while the starter, etc., are operated (see Fig. 2) and to increase the capacitor value as I recommended originally.

D. L. Cooper,
Dorset.

SORRY FOLKS

We would like to apologise to the two authors of *Ingenuity Unlimited* items published last month for omitting their names. The first item was the "Telephone Bell Synthesiser" by Mr M. Rudin, and the second was "Two-wire Signalling System" by Mr G. Rutter.

MILD & BITTER

CAN WE AFFORD TO BE EDUCATED By A.P.S.

"ONE must never confuse education with training."—This profound statement was made by a prominent member of the teaching Establishment. The implication being that the one is noble and the other—well just useful.

From an electrical viewpoint, we might rephrase it to:

"One must never confuse the gold leaf electroscope with the multimeter". With the former, given a dry day and the wretched thing is not in "one of its turns", the students are rubbing shoulders with the aristocracy of the past, Coulomb, Volta and the Venerable Bede. Fascinating properties of the pith ball can be deduced from observation of the two little gold foils.

To bring an AVO into such a gathering would be as outrageous as introducing Bingo into the House of Lords. How could one possibly detect the voltaic twitching of a frog's leg with such a common and above all useful instrument?

It must be very puzzling for an A level physics student to be cast out into the sordid environment of the real world.

He may soon be wishing that his tutors had been a little more earthy, a little more concerned

with circuitry, voltage drops, and simple filter action and a little less concerned with iron filings, magnetic lines, tangent galvanometers and the other relics of the traditional classroom. It is argued, and with justification, that students should be given a thorough grounding in the fundamentals of electrical science, particularly the historical background.

But must we go quite so far back? In these days of the computer, the integrated circuit, the phase-locked loop and quadraphonic sound does it really matter a damn if Newton, Leibnitz or Mick Jagger discovered the calculus? It would be wrong to throw out everything prior to 1940 but the Establishment might find it profitable to take a long hard look at the period prior to 1640—they may find that the lodestone could be discreetly laid to rest without causing serious discontinuity in the syllabus.

The pace of technology is frightening and is no longer subordinate to pure science. It is doubtful if we can really afford to waste so many teaching hours on the loftier aspects. Very, very few A-level students become involved in pure science so why not do a little more training and a

little less educating. The after-dinner chit-chat may lose a few dBs of sparkle but the money saved on ruined test equipment would go some way towards solving the balance of payments problem.

It is not unusual for BSc (Honours) graduates to solve 3rd order partial differential equations in the morning and attempt to measure the source impedance of the live mains in the afternoons, using a multimeter on the "Ohms" range.

To criticise established teaching methods requires chrome vanadium nerve and the temperament of a bomb disposal expert.

The writer has none of these—he is simply aged, cynical and a resentful taxpayer who has very little left over from his salary as a teacher!

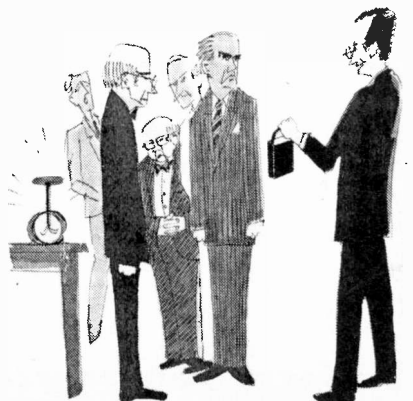

SPARKRITE MK2

CAPACITIVE DISCHARGE ELECTRONIC IGNITION KIT

Sparkrite Mk 2 is a high performance, high quality capacitive discharge, electronic ignition system. Because of the superb design of the Sparkrite circuit it completely eliminates problems of the contact breaker. There is no misfire because contact breaker bounce is eliminated electronically by a pulse suppression circuit which prevents the unit firing if the points bounce open at high R.P.M. Contact breaker burn is eliminated by reducing the current to about 1/50th of the norm. It will perform equally well with new, old, or even badly pitted points and is not dependent upon the dwell time of the contact breaker for recharging the system.

Sparkrite incorporates a short circuit protected inverter which eliminates the problems of SCR lock on and therefore eliminates the possibility of blowing the transistors or the SCR. (Many capacitive discharge ignitions are not completely foolproof in this respect.)

NOTE—FUEL CONSUMPTION:
The fitting of a Sparkrite Mk 2 should reduce fuel consumption although the amount of the reduction will vary. A fair estimate of the savings which could be expected, based on reports by our customers and upon our own experience, are as follows:
any 4-cylinder vehicle, 10% improvement
any 6-cylinder vehicle, 15% improvement
any 8-cylinder vehicle, 20% improvement
It is worth remembering that while fuel saving is important there are many other advantages to be gained from fitting a Sparkrite ignition system.

Voted best of 8 ignition systems tested by leading Motoring Magazine

THE KIT COMPRISES EVERYTHING NEEDED. Ready drilled pressed steel case coated in matt black epoxy resin, ready drilled base and heatsink, top quality 5-year guaranteed transformer and components, cables, coil connectors, printed circuit board, nuts, bolts, silicon grease, full instructions to make the kit negative or positive earth, and 10 page installation instructions.

WE SAY IT IS THE BEST SYSTEM AT ANY PRICE.

OPTIONAL EXTRAS

Electronic R.P.M. limiter
This can be included in the unit to prevent over revving an advantage to most companies, hire firms, high performance drivers, etc.
Electronic/conventional Ignition switch.
Gives instant changeover from 'Sparkrite' ignition to conventional ignition for performance comparisons, static timing, etc. and will also switch the ignition off completely as a security device. Includes: switch, connectors, mounting bracket and instructions. Cables excluded.

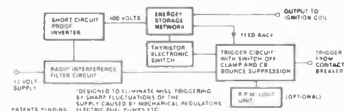

PRICES: D.I.Y. assembly kit £10.93*. Ready built unit £13.86* (both to fit all vehicles with coil/distributor ignition up to 8-cylinders).
Switch for instant changeover from 'Sparkrite' ignition to conventional ignition £2.79*. R.P.M. limiting control £2.42* (fitted in case on ready built unit; dashboard mounting on kit).
* including VAT, post and packing.
We can supply units for any petrol-engined vehicle (boat, motorcycle, etc.) with coil/contact breaker ignition. Details on request.
CALL IN AND SEE US FOR A DEMONSTRATION.

ELECTRONICS DESIGN ASSOCIATES of WALSALL

ALUMINIUM BOXES

These project boxes are manufactured from 18-gauge aluminium and come complete with lids and screws. The prices shown include VAT (at 8%) but 18p should be added to the total order value for postage and packing.

Order No.	Length (in)	Width (in)	Height (in)	Price (inc. VAT)
7	5½	2½	1½	47p
8	4	4	1½	48p
9	4	4	2½	49p
10	5½	4	1½	49p
11	4	2½	1	49p
12	3	2	1	38p
13	6	4	2	58p
14	7	5	2½	75p
15	8	6	3	83p
16	10	7	3	£1.14

Boxes can be made to any size but the minimum order for special sizes is 500. General trade enquiries welcome.

FLUORESCENT LIGHT KIT

You can build this reverse polarity protected 12V, 8W, fluorescent light. You will receive all of the necessary parts: white enamelled ready drilled metalwork, ready drilled heatsink, printed circuit board, high quality components and transformer, end caps and cable, the fluorescent tube, nuts, bolts and washers, etc. and simple assembly instructions and operating instructions.

When complete the light has a wide variety of uses such as workshop and workbench illumination, garage lighting, emergency lighting, lighting for camping, caravanning or boating, as an inspection lamp and many more.

If you can't spare the time to put the light together then we will supply it ready built (for a few extra pence).
PRICES
Assembly kit £3.19 (inc. VAT, post and packing).
Ready built £3.78 (inc. VAT, post and packing).
Diffuser 59p extra (inc. VAT, post and packing).

ORDER NOW

To: ELECTRONICS DESIGN ASSOCIATES DEPT. P.E. 6
82 Bath Street, Walsall WS1 3DE. Phone 33652

From Name

Address

Please Supply

Quantity

	SPARKRITE Mk. 2 DIY assembly kits at £10.93	
	SPARKRITE Mk. 2 ready built negative earth at £13.86	
	SPARKRITE Mk. 2 ready built positive earth at £13.86	
	Ignition changeover switches at £2.79	
	R.P.M. Limit systems in the above units at £2.42	
	Fluorescent light assembly kits at £3.78	
	Fluorescent light built units at £3.78	
	Diffusers for the above at 59p	
	of number	alum. boxes at
	of number	alum. boxes at
	of number	alum. boxes at

I enclose cheque/P.O. for £. Cheque No. (Send S.A.E. if brochure only required)

FABULOUS—FANTASTIC

P.E. ORION

FULL KIT OF PARTS. £38.
Transformer and Screen Printed Board. £11.
Complete Semiconductor Kit. £9.50.
H.M. Bookend Case. £4.
As above but drilled, punched with Silk Screened Front Panel, £5.80.

ASTRO IGNITION SYSTEM

Complete Kit of Parts for this well proven Transistorised Ignition System. £9.50
Ready-built with only 2 connections to alter. £12.50
Thousands of these units are in use today and have been proven to give the following advantages: fuel economy, faster acceleration, excellent cold start, smoother running, no contact-breaker burning and many more.

Money back guarantee if you are not satisfied. Please state whether positive or negative earth.

Postage included in above prices but add V.A.T. at 8%.

ASTRO ELECTRONICS

Spring Bank Road, West Park, Chesterfield, Derbyshire

NEW!

SOUP UP YOUR TUNER!

New De-Luxe I.F. Strip

- SHARP SKIRT SELECTIVITY
- CONTROLLABLE SQUELCH
- CENTRE ZERO TUNING METER + SIGNAL STRENGTH METER OUTPUT

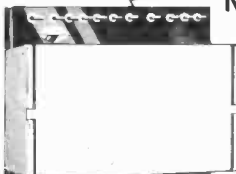

This I.F. Amp. has a low noise pre-amplifier stage. Matching two 10-7MHz filters into an I.C./I.F. amp. Full application notes available. send S.A.E. + 8p.

SEND **£6.99** + 56p VAT - 20p P & P. Total **£7.75**

Sole U.K. Agents: **REEDHAMPTON LTD**

182-184 Addington Road, Selston, Surrey CR2 8LB

RTVC

* COMPLETE STEREO SYSTEM

System 1a. £62.00

40 Watt Amplifier. Viscount III - R102 now 20 watts per channel (40 watts peak). All systems include:

Viscount III amplifier - volume, bass, treble and balance controls, plus switches for mono/ stereo, on/off function and bass and treble filters. Plus headphone socket.

Specification:

20 watts per channel into 8 ohms 40W peak. Total distortion @ 10W @ 1kHz 0.1%. P.U.1 (for ceramic cartridges) 150mV into 3 Meg. P.U.2 (for magnetic cartridges) 4mV at 1kHz into 47K, equalised within ± 1 dB R.I.A.A. Radio 150mV into 220K. (Sensitivities given at full power). Tape out facilities: headphone socket, power out 250mW per channel. **Tone controls and filter characteristics:** Bass: +12dB to -17dB @ 60Hz. Bass filter: 6dB per octave cut. Treble control: treble +12dB to -12dB @ 15kHz. Treble filter: 12dB per octave. **Signal to noise ratio:** (all controls at max.) -58dB. Crosstalk better than 35dB on all inputs. Overload characteristics, better than 26dB on all inputs. Size approx. 13 1/4" x 9" x 3 1/2".

Garrard SP 25 deck with magnetic cartridge, de luxe plinth and cover.

Two Duo Type IIa matched speakers - Enclosure size approx. 19 1/4" x 9 1/2" x 7 1/4" in simulated teak. Drive unit 13" x 8" with 3" tweeter. 15 watts handling. 30 watts peak.

Complete System with these speakers £62.00 + £5.50 p & p.

System 2. £82.00

Viscount III amplifier (As System 1a)
Garrard SP 25 deck (As System 1a)

Two Duo Type III matched speakers - Enclosure size approx. 27" x 13" x 11 1/4" Finished in teak simulate. Drive units 13" x 8" bass driver, and two 3" (approx.) tweeters. 20 watts RMS. 8 ohms frequency range - 20 Hz to 18,000 Hz.

Complete System with these speakers £82.00 + £6.50 p & p.



Scotland P & P. Surcharge
System 1a £1.75 System 2 £3.50

PRICES: SYSTEM 1a

Viscount III R102 amplifier	£27.00 + £1.60 p & p
2 Duo Type IIa speakers	£26.00 + £5.50 p & p
Garrard SP 25 with Mag. cartridge de luxe plinth and cover	£21.00 + £2.80 p & p

Total if purchased separately: £74.00

Available complete for only: **£62.00**
+ £5.50 p & p

PRICES: SYSTEM 2

Viscount III R102 amplifier	£27.00 + £1.60 p & p
2 Duo Type III speakers	£39.00 + £6.40 p & p
Garrard SP 25 with Mag. cartridge de luxe plinth and cover	£21.00 + £2.80 p & p

Total if purchased separately: £87.00

Available complete for only: **£82.00**
+ £6.50 p & p

EMI SPEAKERS AT FANTASTIC REDUCTIONS

LE-4 SPEAKERS

Superb performance and beautifully finished in selected teak veneers. A professional standard four-way speaker system giving 25 watts RMS power handling. Bass unit is 14" x 9" with 8" x 5" unit for mid-range and twin 3" high frequency units to give monitor type quality and performance.

Specification - Size 33" x 14" x 16" approx. Impedance 8 ohms. Power handling 25W RMS. (Peak 50 watts.) Frequency range 35 Hz-20 KHz.

Our Price £29.00
(normally £56.97) + £5 p & p.

EMI 350 KIT

System consists of a 13" x 8" approx. woofer with a 3" tweeter, crossover components and circuit diagram. Frequency response: 20 Hz to 20 KHz. Power handling 15 watts RMS into 8 ohms. (Peak 30 watts.)

Complete with crossover. Components and circuit diagram **£5.50** + £1 p & p.

EASY TO BUILD SPEAKER KITS

These superb simulated teak-finished speaker kits have been specially designed by RT-VC for the cost-conscious hi-fi enthusiast who wants top quality speakers but doesn't want to spend the earth. Built to EMI's exacting specification, these new RT-VC speaker kits (350 type kit) incorporate 13" x 8" woofer, 3 1/2" tweeter and matching crossover.

Easily put together with just a few basic tools. **Specification (each speaker):** Impedance 8 ohms. Power handling 15 watts RMS (30 watts peak). Response 20-20,000Hz. Size 20" x 11" x 9 1/2" approx. Comparable built units (EMI LE3) sold elsewhere for over £45 pair.

£18.95 pair complete
+ £4.50 p & p. Complete with crossover Components and circuit diagram



INCREASED VAT MAY 1
FROM MAY 1st ALL PRICES ARE SUBJECT TO THE NEW VAT RATE - TO ARRIVE AT THE NEW PRICE SIMPLY ADD 16% TO ADVERTISED PRICES INC. P. & P.

DECCA STEREO AMPLIFIER CHASSIS

Specification: 4+4 watts into 8 ohms. Input Sensitivity 4mV into 47K (for magnetic cartridges). AC Mains only 240V. Controls - volume, bass, treble, on/off, mono/stereo switch. Chassis size 11" x 5 1/2" x 3 1/2" approx.

£5.95 + £1 p & p.

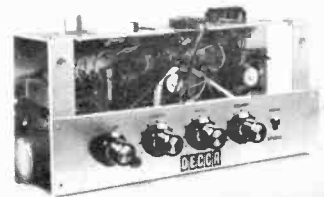

PUSH BUTTON CAR RADIO KIT— THE TOURIST TT*



NO SOLDERING REQUIRED

NOW BUILD YOUR OWN PUSH BUTTON CAR RADIO

Easy to assemble construction kit comprising fully completed and tested printed circuit board on which no soldering is required. All connections are simple push fit type making for easy assembly. Fine tuning push button mechanism is fully built and tested to mate with printed circuit board.

TECHNICAL SPECIFICATION: (1) Output 4 watts RMS output. For 12 volt operation on negative or positive earth. (2) Integrated circuit output stage, pre-built three stage IF Module.

Controls volume manual tuning and five push buttons for station selection, illuminated tuning scale covering full, medium and long wave bands. Size chassis 7" wide 2" high and 4 1/2" deep approx. **£8.00 + 90p o & p.**

Speaker including baffle and fixing strip **£1.65 + 37p p & p.** Car Aerial Recommended — fully retractable **£1.37 + 32p p & p.**

The Tourist 1 Kit For the experienced constructor. If you can solder on a printed circuit board you can build this model. Same technical specification as Tourist TT. **Price £7.00 + 90p p & p.**

*STEREO 21 QUALITY SOUND FOR LESS THAN £20.00

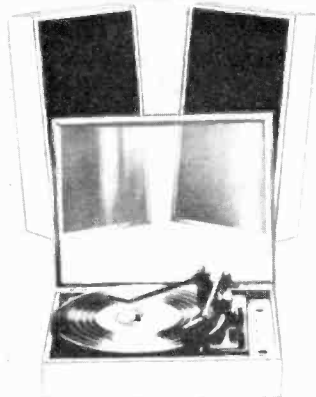

Stereo 21, easy to assemble audio system kit. No soldering required.

The unit is finished in white P.V.C. and the acrylic top presents an unusually interesting variation on the modern deck plinth.

Includes — BSR 3 speed deck, automatic, manual facilities together with stereo cartridge.

Two speakers with cabinets.

Amplifier module. Ready built with control panel, speaker leads and full, easy to follow assembly instructions.

Specifications — For the technically minded:

Input sensitivity 600mV. Aux input sensitivity 120mV. Power output 2.7 watts per channel. Output impedance 8–15 ohms. Stereo headphone socket with automatic speaker cutout. Provision for auxiliary inputs — radio, tape, etc., and outputs for taping discs.

Overall Dimensions. Speakers approx 15 1/2" x 8" x 4". Complete deck and cover in closed position approx. 15 1/2" x 12" x 6".

Complete only £19.95 + £2.60 p & p.

Extras if required. Optional Diamond Stylus **£1.37.**

Specially selected pair of stereo headphones with individual level controls and padded earpieces to give optimum performance. **£5.00.**

*DISCO AMPLIFIER

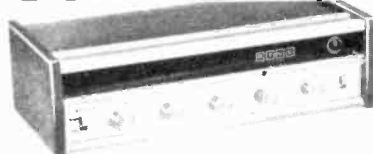

Reliant Mk IV Mono Amplifier, ideal for the small disco or house parties. Output 20 watts RMS into 8 ohms (suitable for 15 ohms).

Inputs *4 electrically mixed inputs. *3 individual mixing controls. *Separate bass and treble controls common to all 4 inputs. *Mixing employing F.E.T. (Field Effect Transistors). *Solid State circuitry. *Attractive styling.

INPUT SENSITIVITIES — Input — 1). Crystal mic, guitar or moving coil mic. 2 and 10mV. (Selector switch for desired sensitivity.) — Inputs — 2), 3), 4). Medium output equipment — ceramic cartridge, tuner, tape recorder, organs, etc. — all 250mV sensitivity. AC Mains, 240V operation. Size approx: 12 1/2" x 6" x 3 1/2".

£17.00 + £1.15 p & p.

*8 TRACK HOME CARTRIDGE PLAYER



Elegant self selector push button player for use with your stereo system. Compatible with Viscount III system. Unisound module and the Stereo 21. Technical specification Mains input, 240V. Output sensitivity 125mV. Comparable unit sold elsewhere at £24.00 approx. Yours for only

£12.95 + £1.45 p & p.

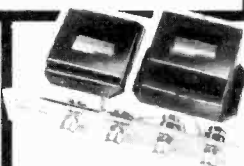

BUILD YOUR OWN *STEREO AMPLIFIER

For the man who wants to design his own stereo — here's your chance to start, with Unisound — pre-amp, power amplifier and control panel. No soldering — just simply screw together. 4 watts per channel into 8 ohms. Inputs: 120mV (for ceramic cartridge). The heart of Unisound is high efficiency I.C. monoolithic power chips which ensure very low distortion over the audio spectrum. 240V. AC only.

Also available with 2 speakers (7" x 4") **£9 + £1.50 p & p. £7.64 + 90p p & p.**

PORTABLE DISCO CONSOLE*



INCORPORATES: Pre-Amp with full mixing facilities, including switched input for mic with volume control, switched input for auxiliary with volume control, bass and treble controls, volume control and blend control for turntables. Two B.S.R. MP60 type single play professional series decks, fitted with crystal cartridges.

TECHNICAL SPECIFICATION:

Pre-amp — Output — 200mV. Auxiliary inputs — 200mV and 750mV into 1 meg. Mic input — 6mV into 100K 240 volt operation. **Turntables capacity —** 7", 10" or 12" records. **Rumble, wow and flutter** Rumble Better than — 35dB. Wow Better than 0.2%. Flutter Better than 0.06% (Gaumont kalee meter). **Finish —** Satin black mainplate with black turntable mat inlaid with brushed aluminium trim. Tonearm and controls in black and brushed aluminium.

Console size —

Unit Closed — 17 1/2" x 13 1/2" x 8 1/2" (app.)
Unit Open — 35 1/2" x 13 1/2" x 4 1/2" (app.)
This disco console is ideally matched for the Reliant IV and Disco 50 or any other quality amplifier. The unit is finished in black PVC with contrasting simulated teak edging, diamond spun control knobs with matching control panel.

Yours for only

£49.00 + £5.60 p & p.



DO NOT SEND CARD

Just write your order giving your credit card number

Mail orders to Acton. Terms C.W.O. All enquiries stamped addressed envelope. Goods not despatched outside U.K. Leaflets available for all items listed thus * Send stamped addressed envelope. All items subject to availability. Prices correct at 1st April 1975 and subject to change without notice. All prices include V.A.T. at 8% rate.



21D HIGH STREET, ACTON, LONDON W3 6NG
323 EDWARE ROAD, LONDON W2

Personnal Shoppers EDWARE RD: 9 a.m.—5.30p.m. Half day Thurs
ACTON: 9.30a.m.—5p.m. Closed all day Wed.

ELECTRONICS DEVELOPMENT ENGINEER

A new opening has been created in the Ealing area for a highly skilled Electronics Engineer to join a new team within a newly created small research and development laboratory within a new small production and prototype unit.

The Engineer required will have strong innovative abilities as well as sound modern technical skills to design, develop and prove advanced circuitry. He will work with two highly skilled Industrial Designers and other support staff to bring an idea through to a full production item.

While the area of electronic interest ranges over all aspects of advanced security devices, the prime ability of the man required will be in the RF field. Transmitters, receivers, scanners, RF detection systems and associated audio.

The interests of the C.D.I. group of companies covers military, paramilitary electronics; police support electronics; technical intelligence retrieval devices and systems; pulse induction metal detectors; night vision systems and body armour.

The group is relatively new having been formed in June 1972 and to date has concentrated on building a marketing capability to support its already existing strong innovative abilities. It is now filling in the centre sections thereby creating a very good opportunity for a young man of outstanding ability to grow with the group. Profit sharing, health and pension schemes are operated.

Please write to the Managing Director giving complete and thorough details of your qualifications in relation to our needs and your expected salary requirements. All replies will be held in strict confidence.

FREELANCE CONTRACT ELECTRONIC DESIGN AND DEVELOPMENT ENGINEERS

In addition to the staff Development Engineer required we are also seeking very high calibre Design and Development Engineers to work on specific projects on a freelance contract basis.

We are also interested in purchasing outright or on a royalty basis fully developed devices which fall within our areas of interest.

We are open to discuss sound ideas which we can develop, manufacture and market or any combination which makes sound commercial sense.

If any of this interests you then please write to the Managing Director clearly stating what you have to offer.

G.D.I. HOLDINGS LIMITED

3 Old Pye Street, London, SW1P 2LB

Technical Security Ltd.

Pulse Induction Ltd.

Night Vision Systems Ltd.

Body Armour Ltd.

WORLD RADIO T.V. HANDBOOK 1975

Price £3-85

TOWERS' INTERNATIONAL TRANSISTOR SELECTOR by T. D. Towers. Price £3-30.

THE RADIO AMATEUR'S HANDBOOK 1975 by A.R.R.L. Price £3-65.

110 OPERATIONAL AMPLIFIER PROJECTS FOR THE HOME CONSTRUCTOR by R. M. Marston. Price £1-95.

RADIO SERVICING POCKET BOOK by V. Capel. Price £2-25.

BEGINNER'S GUIDE TO TRANSISTORS by J. A. Reddihough. Price £2-00.

THE AUDIO HANDBOOK by G. J. King. Price £5-25.

HANDBOOK OF IC CIRCUIT PROJECTS by J. Ashe. Price £1-65.

COLOUR T.V. WITH PARTICULAR REFERENCE TO THE PAL SYSTEM by G. N. Patchett. Price £5-20.

TAPE RECORDING FROM A TO Z by D. Crawford. Price £2-10.

RADIO CONTROL HANDBOOK by H. G. McEntee. Price £2-15.

★ TOTAL INCLUDES POSTAGE ★

THE MODERN BOOK CO.

BRITAIN'S LARGEST STOCKIST of British and American Technical Books

19-21 PRAED STREET LONDON W2 1NP

Phone 01-723 4185
Closed Saturday 1 p.m.

OSMABET LTD

We make transformers amongst other things

AUTO TRANSFORMERS 110-200/220/240V 30W, £2-10; 50W, £2-70; 75W, £3-45; 100W, £4; 500W, £12; 750W, £18-50; 1000W, £20-25, etc.

LOW VOLTAGE TRANSFORMERS

Prim. 200/240V a.c. 5V 1A, 60p; 6.3V 1-5A, £1-45; 3A, £1-80; 6A, £3-80; 12V 1-5A, £1-80; 3A, £3-30; 6A CT, £4-50; 18V 1-5A CT, £3-30; 24V 1-5A CT, £3-30; 3A CT, £4-50; 5A, £8-75; 6A, £8-70; 12A, £12-40; 40V 3A CT, £8; 50V 6A CT, £15-75; 25V 2A + 25V 2A, £8-40; 12V 4A + 12V 4A, £8-40.

LT TRANSFORMERS TAPPED SEC. Prim 200/240V

0-10-12-14-16-18V 2A, £3-30; 4A, £4-50.
0-12-15-20-24-30V 2A, £4-30; 4A, £8.
0-5-20-30-40-60V 1A, £4-20; 2A, £8.
0-40-50-60-80-90-100-110V 1A, £8-40.

MIDGET RECTIFIER TRANSFORMERS

For FW rect. 200/240V a.c. 6-0-6V 1-5A or 9-0-9V 1A £1-65 each, 12-0-12V 1A or 20-0-20V 0-75A or 9-0-9V 0-3A or 12-0-12V 0-25A or 20-0-20V 0-15A or 6V 0-5A + 6V 0-5A or 9V 0-35A + 9V 0-35A or 12V 0-25A + 12V 0-25A or 20V 0-15A + 20V 1-5A, all at £1-90 each.

MAINS TRANSFORMERS

Prim. 200/240V a.c. TX6 sec. 425-0-425V 500 MA, 6-3V CT 6A, 6-3V CT 6A, 0-6-6-3V 3A £18-75; TX1 425-0-425V 250 MA, 6-3V CT 4A, 6-3V CT 4A, 0-6-6-3V 3A, £11-25; MT3 Prim 0-110-240V, sec. 250V 100 MA, 6-3V 2A, £/S, £3-75.

O/P TRANSFORMERS FOR POWER AMPLIFIERS

P.P. sec. tapped 0-5-15 ohms, A-A 6-6kΩ 30W £8-75; A-A 3kΩ-50W £10-15; 100W (£L24-K700, etc.), £17-25.

G.E.C. MANUAL OF POWER AMPLIFIERS

Covering valve amplifiers of 30W to 400W 95p.

HI-FI SPEAKERS

5in 8Ω, £1-15; 7 x 4in 15Ω, £1-80; 8 x 5in 3, 8, 15 or 25Ω, £1-75 each; 8in 4Ω, £1-50; EMF 13 x 8in 8Ω, £2-20; 8 x 5in 3, 8 or 10Ω, £1-75.

LOUDSPEAKERS

2 1/2in 8 or 75Ω, 2 1/2in 8 or 25Ω, 3 1/2in 3, 8, 25 or 35Ω, 3 1/2in 8Ω, 15Ω or 80Ω, 95p each; 5in 3, 8 or 25Ω, 5 x 3in 3 or 8Ω, £1-15; 7 x 4in 3 or 15Ω, 10 x 6in 3Ω, £1-50.

SPEAKER AUTO MATCHING TRANSFORMER

12W 3 to 8 or 15Ω up or down, £1-50.

TAPE RECORDER MOTORS

New, blowers, fans, etc., 110V a.c. 60p, £1 pair.

"INSTANT" BULK TAPE/CASSETTE ERASER

Instant erasure, any diameter tape spools, cassettes, demagnetises tape heads, 200/240V a.c., £3-75.

SYNCHRONOUS GEARED MOTORS, 200/240V a.c.

Brand new, Smiths. Built-in gearbox, 2r.p.h., 75p each.

Carriage and VAT extra on all orders

S.A.E. ENQUIRIES, LISTS. MAIL ORDER ONLY

46 Kenilworth Road, Edgware, Middx. HA8 8YQ

Tel. 01-958 9314

4 STATION INTERCOM



£16-15

Solve your communication problems with this 4-Station Transistor Intercom system (1 master and 3 Subs), in robust plastic cabinets for desk or wall mounting. Call/talk/listen from Master to Subs and Subs to Master. Ideally suitable for Business, Surgery, Schools, Hospitals, Office and Home. Operates on one 9V battery. On/off switch. Volume control. Complete with 3 connecting wires each 66ft and other accessories. P. & P. 65p.

MAINS INTERCOM NEW MODEL

No batteries—no wires. Just plug in the mains for instant two-way, loud and clear communication. On off switch and volume control. Price £28-75 per pair. P. & P. 65p.

NEW! AMERICAN TYPE CRADLE TELEPHONE AMPLIFIER



ONLY £11-95 + VAT 95p

Latest transistorised Telephone Amplifier with detached plug-in speaker. Placing the receiver on to the cradle activates a switch for immediate two-way conversation without holding the handset. Many people can listen at a time. Increase efficiency in office, shop, workshop. Perfect for "conference" calls: leaves the user's hands free to make notes, consult files. No long waiting, saves time with long-distance calls. On/off switch, volume. Direct tape recording model at £12-95 + VAT £1-04 P. & P. 60p. 10-day price refund guarantee.

WEST LONDON DIRECT SUPPLIES (PE6)
169 KENSINGTON HIGH STREET, LONDON, W.8

Our noise reducer is something to shout about!



If you're interested in high quality tape reproduction you'll probably know of the Dolby B noise reducing system. And you'll know it's not cheap. Now you can build your own add-on Dolby processor and save money – with help from Wireless World. Our exclusive construction design – the first of its kind available – is for use with both open reel and cassette recorders to reduce tape distortion or hiss. The complete kit is available, including solid mahogany case, and needs no special test gear for setting up.

PART 2 OF OUR EXCLUSIVE DOLBY DESIGN IN THIS ISSUE. ALL CONSTRUCTIONAL DETAILS. COMPLETE KIT AVAILABLE – INCLUDING MAHOGANY CASE. NO SPECIAL TEST GEAR REQUIRED.

Wireless World

June (published May 21) 30p

ENGINEERS

FREE

YOURSELF FOR A BETTER JOB WITH MORE PAY!

Do you want promotion, a better job, higher pay? "New Opportunities" shows you how to get them through a low-cost home study course. There are no books to buy and you can pay-as-you-learn.

This helpful guide to success should be read by every ambitious engineer. Send for this helpful 76 page FREE book now. No obligation and nobody will call on you. It could be the best thing you ever did.



CUT OUT THIS COUPON
CHOOSE A BRAND NEW FUTURE HERE!
 Tick or state subject of interest. Post to the address below.

- | | | |
|---|---|--|
| <input type="checkbox"/> Practical Radio and Electronics (Technatron) | <input type="checkbox"/> C. & G. Radio, TV Electronics, Mechanics | <input type="checkbox"/> C. & G. LI Installations and Wiring |
| <input type="checkbox"/> Electronic Engineering | <input type="checkbox"/> Radio Amateurs | <input type="checkbox"/> General Electrical Engineering |
| <input type="checkbox"/> Television Maintenance and Servicing | <input type="checkbox"/> Colour Television | <input type="checkbox"/> Society of Engineers (Electrical Engineering) |
| <input type="checkbox"/> General Radio and TV Engineering | <input type="checkbox"/> Computer Electronics | <input type="checkbox"/> Electrical Installations and Wiring |
| <input type="checkbox"/> Radio Servicing, Maintenance and Repairs | <input type="checkbox"/> C. & G. LI Radio-TV Servicing cert. | <input type="checkbox"/> C. & G. Electrical Technicians (Primary) |
| | <input type="checkbox"/> Post Master General 1st & 2nd class certs. | <input type="checkbox"/> C. & G. Telecommunications |
| | <input type="checkbox"/> C. & G. Electrical Engineering Practise | |

TO ALDERMASTON COLLEGE
 Dept. EPE06, Reading RG7 4PF

NAME (Block Capitals Please)
 ADDRESS

Other subjects
 Accredited by C.A.C.C.

POSTCODE _____ Age _____
 Member of A.B.C.C.

BRITISH INSTITUTE OF ENGINEERING TECHNOLOGY

PC ETCHING KIT

Contains 1lb ferric chloride, 100sq.in copper clad board, DALO etch-resist pen, abrasive cleaner, etching dish and instructions £3.30.

FERRIC CHLORIDE

Anhydrous to Mil-spec. in 1lb double sealed packs. 1lb 90p; 3lb £1.80; 10lb £4.65.

COMPUTER PANELS

Large quantity always available. 3lb assorted £1.60; 7lb £2.85; 56lb £15. Pack with 10 200V 1A SCRs + 120 other parts £1.10.

71b BARGAIN PARCELS

Hundreds of new components—resistors, capacitors, switches, pots, + PC boards with transistors and diodes, also loads of odds and ends. Contents always changing. Only £2.60.

POWER SUPPLY UNIT

G101: Mains transformer, 2A thermal cut-out, bridge rect., will give 1.7-10.5V output with 2 extra capacitors (provided). With data £1.30.

All prices include 8% VAT and U.K. postage. S.A.E. list, enquiries.

GREENWELD (PE6)

51 Shirley Park Road, Southampton, SO1 4FX. Tel. 772501

Also callers at 21 Deptford Broadway SE8. Tel. 01-692 2009 and 38 Lower Addiscombe Road, Croydon. Tel. 01-688 2950.

8-PIN DIL 741s

10 + 26p; 25 + 23p; 100 + 21p; 150 + 20p.

555 TIMERS

3 + 60p; 10 + 50p; 25 + 46p; 100 + 43p.

IN4001/2/3/4/5/6/7

10 of each type—all marked and full spec. 70 diodes for £3.50.

2N3055's FULL SPEC.

10 + 38p; 25 + 32p; 100 + 30p.

7 SEGMENT LEDS

14-pin DIL package 19 x 11mm TTL compatible (7447 driver) 4 for £3.60, 6 for £5.20.

VEROBOARD

About 8 pieces, total 100sq.in assorted sizes and pitches £1.15.

TRANSFORMERS

All mains primary. 6-0-6V at 100mA 85p; 9-0-9V at 100mA 90p; 12-0-12V at 100mA 95p; 24-0-24V at 500mA £2; 17V at 1A £1.80; 3, 4, 5, 6, 8, 9, 10, 12, 15, 18, 20, 24 or 30V at 1A, also 12-0-12 or 15-0-15V £2.70; 2A version £3.90.

RESISTORS & CAPACITORS

400 asstd. carbon £1.30; 250 Hi-stabs 1, 2 and 5% £1.20; 100 wirewounds, 2-15V £1.80; 200 poly, mica, ceramic, etc., caps £1; 100 C280 polyesters £1.15; 200 miniature electrolytics, but mostly unmarked so only £1.30.

HEAT SINKS

6 x 5 x 3in finned aluminium with 2 x OC29/35, only £1.20.

At Home Soldering ?

You should be - with the LITESOLD CONQUEROR.

A superbly handling lightweight iron, fully insulated and earthed for safety. Bits are interchangeable, non-seize, and are available in 16 different shapes and sizes, from 1/16" up to 1/4", in copper and long-life types. (Standard fitting, 1/8" copper single chisel shape). Covers a range of work often needing several different irons.

A special spring stand gives safe, easy location of the iron and spare bits. The heavy heat-resistant base is complete with non-slip pads and bit cleaning sponge.

Send cheque/PO direct, or ask for leaflet.

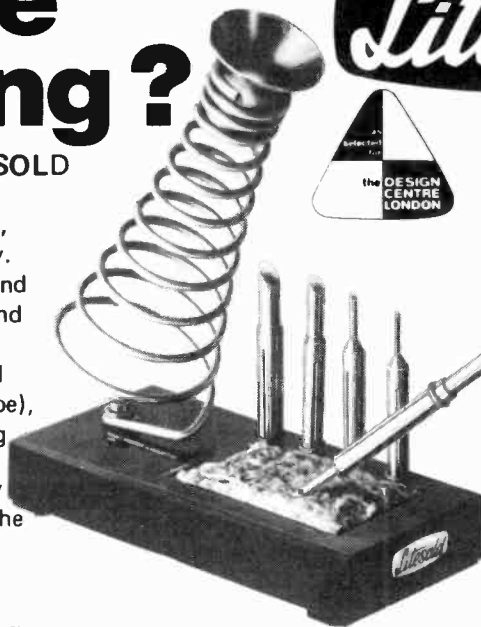

Litesold



Conqueror Iron Only £3.08
Iron & Spring Stand £5.39
Iron, Stand & set of
4 spare copper bits £6.90
(Prices include 8% VAT
and p.&p.)

LIGHT SOLDERING DEVELOPMENTS LTD

97 - 99, Gloucester Road, Croydon, CR0 2DN. 01-689 0574

LS/M

GUEST ELECTRONIC DISTRIBUTION LIMITED

Guest, normally supplying electronic components to industry, are making available packs of specially selected components for the home constructor. These components are of professional quality at hard to beat prices.

PACK 1—CAPACITOR PACK

30 Miniature vertical mounting electrolytic capacitors 50V working.

5 × 0.47μF	5 × 10μF	
5 × 1.0μF	3 × 22μF	£2.00 (one pack)
5 × 2.2μF	2 × 33μF	£3.50 (two packs)
5 × 3.3μF		

PACK 2—RESISTOR PACK

Pack of 200 medium power (0.75 + 1W) resistors. Assorted values throughout E.24 range 5%. £2.00 (one pack)

PACK 3—POTENTIOMETER PACK

Pack of skeleton potentiometers linear 1/2W.

4 × 250Ω	4 × 10kΩ	
4 × 500Ω	4 × 50kΩ	£2.50 (one pack)
4 × 1kΩ	4 × 100kΩ	
4 × 2.5kΩ	4 × 2.5MΩ	

PACK 4

A special pack designed for the constructor who is "stocking up" generally and seeks excellent value.

Comprising: Selection of electrolytic capacitors (30+) Comprehensive selection of medium power resistors (5%) E.24 series (100+) Selection of skeleton potentiometers (32+) Selection of lampholders (5+) and lamps Miniature 250V 2A toggle switches, 3 or 4 poles (2+) £5.50 (one pack)

All prices include VAT and post and packing.

Please send cheque/P.O./cash, clearly stating pack required and address to:

Brian Woods, (Ref. S.C.) Marketing Services, Guest Distribution, Redlands, Coulsdon, Surrey CR3 2HT

Dimmit

range of light dimmers and lighting control systems

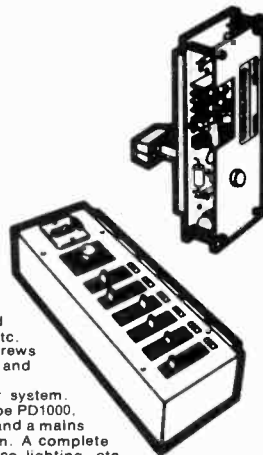

Illustrated is the popular PMSD1000 module. A 1kW slider control dimmer. Interference suppressed, 60mm slider range size 12 × 5 × 4cm. Ideal for low cost stage and disco lighting. Used by schools, theatres, studios, etc. Complete with scale plate; fixing screws and full instructions. £8.40 inc. VAT and P. & P.

Illustrated is the DD61 dimmer system. Contains: six 1 kW slider dimmers type PD1000, six outlet sockets, a master control and a mains on/off switch. Size 59 × 22 × 12cm. A complete system in one unit for stage or disco lighting, etc. Also available DD261 dimmer system, as above, but with 2-preset arrangement. Future systems available with 2 kW dimmers. Specials made. DD61 £110 inc. VAT and P. & P. DD261 £131.60 inc. VAT and P. & P.

The Dimmit range includes standard wall mounting models for home and office, etc. Professional modules for industrial heating applications, etc. Rotary and slider control versions. Ratings: 1000W; 2000W; 3000W; 110V and 240V.

Model SL800 sound to light converter. Modulates the light in time with sound. Built-in microphone. No connections to speaker required. Simple wiring—similar to dimmer. Rating 800W.

All products are guaranteed and are supplied with full instructions and applications. Full after-sales service. Technical advice given. For full information on all modules and lighting control systems send 15p for our illustrated catalogue and price list. Callers welcome, visit our showroom for a demonstration of any of the modules or systems. Mon-Fri. 9.30 to 6.0 p.m. Sat. by arrangement.

YOUNG ELECTRONICS LTD.

184 Royal College Street, London NW1 9NN.

Tel. 01-267 0201

PE SCORPIO Mk2 ignition system kit new from ELECTRO SPARES

* 6 OR 12 VOLT
* +VE AND - VE GROUND

Here's the new, improved version of the original PE Scorpio Electronic Ignition System - with a big plus over all the other kits - the PE Scorpio Kit is designed for both positive and negative ground automotive electrical systems. Not just +ve ground. Nor just -ve ground. But both! So if you change cars, you can be almost certain that you can change over your PE Scorpio Mk. 2 as well.

Containing all the components you need, this Electro Spares PE Scorpio Mk. 2 Kit is simply built, using our easy to follow instructions. Each component is a branded unit by a reputable manufacturer and carries the manufacturer's guarantee. Ready drilled for fast assembly. Quickly fitted to any car.

When your PE Scorpio Mk. 2 is installed, you instantly benefit from all these PE Scorpio Mk. 2 advantages:

- ★ Easier starting from cold
- ★ Firing even with wet or oiled-up plugs
- ★ Smoother running at high speed
- ★ Fuel saving
- ★ More power from your engine
- ★ Longer spark plug life
- ★ No more contact-breaker burn.

Electro Spares prices:

De luxe Kit only £10.85 inc. VAT and p & p.
Ready Made Unit £13.65 inc. VAT and p & p.
State 6V or 12V system.

Send SAE now for details and free list.

FM VARICAP STEREO TUNER

As featured in the May 1973 issue of 'Practical Electronics'. Superb Hi-Fi tuner Kit now available from Electro Spares. Including cabinet and all components - pre-set Mullard modules for R.F. and I.F. circuits. Motorola I.C. Phase Lock Loop Decoder for perfect stereo reception. No alignment needed. Guaranteed first time results - or send it back, and we'll return it in perfect order (for a nominal handling charge). Electro Spares price only £29.50 inc. VAT and p & p.

'GEMINI' STEREO AMPLIFIER

A superb unit with a guaranteed output of 30 watts RMS per channel into 8 ohms. Full power THD is a mere 0.02%, and frequency response is -3 dB from 20 Hz to 100 kHz into 8 or 15 ohms. Electro Spares have already sold 100s and 100s of these Kits. Get yours now! Depending on your choice of certain components, the price can vary from £50 to £60 inc. VAT and p & p.

- ★ All components as specified by original authors, and sold separately if you wish.
- ★ Full constructional data book with specification graphs, fault finding guides, etc. 55p plus 9p postage.
- ★ Price List only. Please send S.A.E. (preferably 9 x 4 minimum) for full details. Please allow minimum of 14 days for delivery.

ELECTRO SPARES



The Component Centre of the North
288 ECCLESALL RD., SHEFFIELD S11 8PE (D)
Tel: Sheffield (0742) 668888

NEW PRACTICAL PAPERBACKS FROM FOULSHAM-TAB

THE COMPLETE SHORTWAVE LISTENER'S HANDBOOK, by Hank Bennet	£2.10
ELECTRONICS AND PHOTOGRAPHY, by Robert M. Brown and Mark Olsen	£1.85
GETTING THE MOST OUT OF YOUR ELECTRONIC CALCULATORS, by William L. Hunter	£1.85
INDEXED GUIDE TO MODERN ELECTRONIC CIRCUITS, by Robert L. Goodman	£1.90
MODEL SAIL AND POWER BOATING ... by remote control, by George Siposs	£1.80
RF AND DIGITAL TEST EQUIPMENT YOU CAN BUILD, edited by Wayne Green	£1.95
AMATEUR FM CONVERSION AND CONSTRUCTION PROJECTS, by Ken Sessions, Jr.	£2.10
CAR STEREO SERVICE AND INSTALLATION by Paul Dorweiler and Harry Hansen	£1.95
COLOUR TV TROUBLES (FACTBOOK), by the Editors of Electronic Technician/Dealer	£2.30
ELECTRONIC TEST EQUIPMENT—and how to use it, by Joe Risse	£1.85
ELECTRONICS UNRAVELLED—A new commonsense approach, by James Kyle	£1.90
SIMPLIFIED COMPUTER PROGRAMMING—The easy RPG way, by Kelton Carson	£1.95



FOULSHAM-TAB LTD.
YEOVIL ROAD, SLOUGH, BERKS

UNREPEATABLE VALUE

BRANDED TESTED COMPONENTS

RESISTORS 100 for £1

Mixed quantities of 5% or 1% $\frac{1}{4}$ and $\frac{1}{2}$ watt, including 10 Ω , 100 Ω , 200 Ω , 390 Ω , 750 Ω , 1K, 1K5, 2K2, 2K7, 3K3, 8K2, 10K, 25K, 47K, 100K, 220K, 750K, and many more.

LIGHT EMITTING AND RECEIVING DIODES £1 set DIODE IN751A MOTOROLA 10 for £1

TRANSISTORS
AND I.C.s. 10 for £1
Mixed: 2N5294, 2N3638,
2N3567, 2N5457, MCR1064.

I.C.s

SP322B

CAPACITORS 25 for £1

Including 220pF, 5000pF,
10,000pF, 0.1 μ F, 0.47 μ F, 1 μ F,
10 μ F, 100 μ F and many more.

SPEAKERS 2 $\frac{1}{4}$ " 8 Ω 2 watt 45p

VHF AERIALS only 25p

FUSEHOLDERS Panel MTG L675 60p

REED RELAY Radiospares Type RR18 50p

Postage 10p per order VAT included in prices. C.W.O. to:
GEORGE WASHINGTON LIMITED
HARBOUR ESTATE, SHEERNESS, KENT ME12 1RZ
Telephone: Sheerness 3076 Telex: 965088
A Technograph Group Company

MEN! **£90 p.w.** **can be yours**

Jobs galore! Tens of thousands of new computer personnel needed over the next few years alone. With our revolutionary, direct-from-America, course, you train as a Computer Operator in only 4 weeks!

It can pay around £35 p.w. as a starter and can reach over £90 p.w. After training, our exclusive appointments bureau — one of the world's leaders of its kind — introduces you FREE to world-wide opportunities. Write or 'phone TODAY, without obligation.

London Computer Operators
Training Centre Y36, Oxford Hse.
9-15 Oxford St., W.1. Tel. 01-734 2874

EDUCATIONAL

C AND G EXAMS

Make sure you succeed with an ICS home study course for Cand G Electrical Installation Work & Technicians, Radio/TV/Electronics Technicians, Telecomms Technicians and Radio Amateurs.

COLOUR TV SERVICING

Make the most of the current boom! Learn the techniques of servicing Colour and Mono TV sets through new home study courses, approved by leading manufacturers.

TECHNICAL TRAINING

Home study courses in Electronics and Electrical Engineering, Maintenance, Radio, TV, Audio, Computer Engineering and programming. Also self-build radio kits. Get the qualifications you need to succeed.

Free details from:

INTERNATIONAL
CORRESPONDENCE SCHOOLS
Dept. 730, Intertext House, London
SW8 4UJ
Or phone 01-622 9911 (All hours)

One of the best ways of taking A DEGREE IN ELECTRICAL or ELECTRONIC ENGINEERING and also qualifying to become a CHARTERED ELECTRICAL ENGINEER is to join the NORTH STAFFORDSHIRE POLYTECHNIC at Beaconside, Stafford.

We can introduce you to industrial firms for your practical training periods. In most cases these contacts lead to permanent staff appointment in industry upon graduation. Advice on course, accommodation and training from:

The Head of the Department of Electrical & Electronic Engineering, Room C16, North Staffordshire Polytechnic, Beaconside, Stafford. Tel.: Stafford 52331.

ELECTRONIC CRAFTSMEN

Is your present job routine and uninteresting?

We are a research establishment and our craftsmen are engaged on a wide variety of work in the fields of prototype and small batch wiring and assembly, test and inspection, maintenance fault finding and repair. Why not join us and enjoy working in first class conditions in the country.

You can expect gross earnings including overtime of £45 per week, and we can offer good housing at low rental (for applicants who reside outside the radius of our Assisted Travel Area) together with 3 weeks' paid holiday with holiday bonus, free pension and excellent sick benefit scheme.

Applicants who should have served a recognised apprenticeship or have had equivalent training together with experience in one of the fields detailed should 'phone Tadley 4111 (STD 073-56 4111) Ext. 5230, or write to:

Industrial Recruitment Officer
(PA/55/PE) Procurement Executive
Ministry of Defence
AWRE Aldermaston
Reading, Berks. RG7 4PR

BRITISH NUCLEAR FUELS LIMITED

Windscale and Calder Works

Sellafield • Near Seascale • Cumbria

If you are a time served

INSTRUMENT MECHANIC

we can offer you varied and interesting work in a modern, expanding industry, covering the maintenance of flow, level and pressure measuring instruments, electronic and nucleonic instruments and complex pneumatic and electronic control systems and computers.

- *Rate of Pay : £47-60 a week, including bonus earnings
- *Good Holidays
- *Assisted Travel Scheme
- *Contributory Pension Scheme
- *Excellent Sports and Social Facilities
- *External education concessions
- *Housing at economic rents within easy reach of Wasdale, Eskdale and Ennerdale
- *Hostel accommodation for single men and married men awaiting housing

Men of skilled status with relevant experience are invited to write for an application form (quoting reference SE202) to the Work Labour Manager at the above address or telephone Seascale 333, Extension 291, between 8.30 a.m. and 4.00 p.m. on any weekday.

RADIO ENGINEER/TECHNICIAN FOR CENTRAL AMERICA

Needed to work with the Radio Schools Movement in Guatemala, training a team of Guatemalans in the maintenance and repair of station equipment.
A British Volunteer Post.

Information: **PADDY COULTER**, Overseas Volunteers CIIR
41 Holland Park, London W11 3RP

APPOINTMENTS

If you are seeking experienced Technicians, Service Engineers, Estimators, Electronic Craftsmen, etc., an announcement on these pages could be the answer to your problems.

It costs only 11p a word or £8.50 per single column inch to advertise in

PRACTICAL ELECTRONICS

MISCELLANEOUS CONT'D

LOW COST I.C. MOUNTING. 100 I.C. pin sockets 60p. Quantity rates. S.A.E. details and sample. 7 and 8 hole plastic supports 5p/pair. (P. & P. 5p/order). LED (MLE1500) 20p each post free. Quantity rates. P.K.G. ELECTRONICS, Oak Lodge, Tansley, Derbyshire, DE4 5FE.

MINI ACCUMULATORS

2 volt MULTI-USE Sealed Lead Acid Rechargeable Cells.

Size L450—1.4" x 1.1" x 0.44". 3 for £1.85 inc. P. & P.

Size GA2—1.7" x 1.3" x 0.5". 3 for £2.35 inc. P. & P.

GARFIELDS, 269 Rye Lane, London, S.E.15

GOODMANS 8P £4.70; 10P £5.10; 12P £12.40; 121P £15.70; 121PG £14.20. 6in oil wheels £4.90. Effects cassettes £5.50. Post 10in 45p; 12in 75p. Wheels 25p. ADRIAN CREW, 56 Markham Road, Winton, Bournemouth.

HOME SCIENTISTS

Get the key to a FANTASTIC WORLD of previously UNHEARD-OF PROJECTS. The NEW Boffin catalogue lists LOTS of HIGHLY UNUSUAL, LOW-COST BARGAINS, READY-BUILT MODULES.

Here are just a few examples, there are stacks more!

Dazzling MINI-STROBE (pocket size) £2.90
PEOPLE DETECTOR .. £3.20
Big-Ear SOUND-CATCHER .. £3.20
Mini DREAM LABORATORY .. £3.20

Don't take our word for it though! GET A COPY AND SEE! SEND ONLY 20p and we'll RUSH YOU A COPY (YOU'LL GET THE 'GOODIES' JUST AS QUICKLY TOO!)

BOFFIN PROJECTS
4 Cunliffe Road, Stoneleigh
Ewell, Surrey

(Mail Order U.K. only)

4 x 741 (8 DIL) £1

15 x BC108 EQUIV. IN PLASTIC CASE (BC148)
£1. 30 x IN4148 £1.

FULL SPEC. DEVICES. PRICES INCLUDE 8% VAT. P. & P. 15p. ON ORDERS UNDER £3.
SCOTT ELECTRONICS (Dept. P.E.)
P.O. Box 42, Wembley, Middx.

BUILD A PROFESSIONAL POWER SUPPLY WITH A VOLTAGE REGULATOR

o HIGH PERFORMANCE WITH MANY UNIQUE FEATURES...

o Voltages 1-40v

o Current to 2amps

o Single resistor programmes current or voltage

o 55W peak. 33W continuous maximum. dissipation INTEGRAL HEATSINK

o Safe-operating area protection

R2A (2amp) £9.70

also RSA (5amp) £16.40
includes logic shutdown I/P and thermal switch

HIGH RELIABILITY SEMICONDUCTORS 100% TEMPERATURE CYCLED AND TESTED

		WATTS	V _C	I _C	I _C	H _{FE}	h _{FE}	h _{FE}	h _{FE}	PRICE
TRANSISTORS	2N3055	115	60v	15A	20-70	4A	75p			£2.00
	2N3051	5	40v	700mA	50-250	150mA	28p			£2.20
	2N3055	90	60v	15A	20-70	4A	70p			£6.50
	2N3057	40	70v	7A	30-150	3A	60p			£5.00
	BC182D/BC207D	30	50v	200mA	200	2mA	14p			£1.30
DIODES	1N4148	—	100V	—	—	—	—	—	—	50p
	1N914E	—	30v	—	—	—	—	—	—	80p
I.C.'s	74195/9700	—	—	—	—	—	—	—	—	£1.00
	74121	—	—	—	—	—	—	—	—	£8.00
CAPACITORS	0.01M20/250v	—	—	—	—	—	—	—	—	50p
	0.033M20/250v	—	—	—	—	—	—	—	—	50p
HEATSHIMS	REPRINT 44	1.5	50v	—	—	—	—	—	—	80p
TERMS	CASH WITH ORDER. ORDERS UNDER £2 PLUS 25p POST & PACKING.									

DAVINI (Instruments) Ltd
(DEPT H5) 52 Cardigan Street,
LUTON
BEDS

TELEPHONE — Blackmoor (Hants) 449

FANTASTIC NEW MICROTEST 80

MEASURES
ONLY

90 x 70 x 18mm
ELECTRONIC ZERO Ω



Amazing Value at £11.95
8 fields of measurement
and 40 ranges

PRINTED CIRCUIT
BOARD IS REMOVABLE
WITHOUT SOLDERING

Volts d.c. 6 ranges: 100mV, 2V, 10V, 50V, 200V, 1.000V (20kΩ/V) 2% precision on d.c. and a.c.
Volts a.c. 5 ranges: 1-5V, 10V, 50V, 250V, 1.000V (4kΩ/V)
Amp. d.c. 6 ranges: 50μA, 500μA, 5mA, 50mA, 500mA, 5A
Amp. a.c. 5 ranges: 250μA, 2.5mA, 25mA, 250mA, 2.5A
Ω 4 ranges: Low Ω, Ω x 1, Ω x 10, Ω x 100 (from 1/10 Ω to 1M Ω)
V Output 5 ranges: 1-5V, 10V, 50V, 250V, 1.000V
Decibels 5 ranges: +6dB, +22dB, +36dB, +50dB, +62dB
Capacity 4 ranges: 25μF, 250μF, 2.500μF, 25.000μF

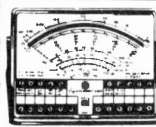

SUPERTESTER 680R ICE
20,000 Ohm per Volt sensitivity
Fully screened against external magnetic fields
Scale width and small case dimensions (128 x 95 x 32mm)
Accuracy and stability (1% in D.C., 2% in A.C.) of indicated reading
Simplicity and ease of use and readability
Full ranges of accessories

1,000 times overload
Printed circuit board is removable without de-soldering
More ranges than any other meter. Ask for free catalogue.
£18.50
Accessories Extra

Accessories (extra) available to convert Microtest 80 and SuperTester 680R into following: LIGHTMETER, GAUSS METER, ELECTRONIC VOLTMETER, AMPER-CLAMP, TRANSISTOR TESTER, TEMPERATURE PROBE, PHASE SEQUENCE INDICATOR, Ω x 100kΩ Multiplier, SIGNAL INJECTOR—Send for details.

MORE RANGES FOR LESS MONEY!

AC/DC Multimeter type U4324

A-DC 0.06-3A-6 Ranges
A-AC 0.3-3A-5 Ranges
V-DC 0.6-1200V-9 Ranges
V-AC 3-900V-8 Ranges

Frequency in the range of 45 to 20kHz, Resistance 500 ohm to 5 Mohm—5 ranges, Decibel—10 to +12dB, Accuracy: ±2.5%, DC +4%, A.C. Dimensions: 167 x 98 x 63mm
Only **£8.85**



ALPHANUMERIC NIXIE TUBES B7971

The Alphanumeric NIXIE tube has the ability to display all the letters of the alphabet, numerals 0 thru 9 and special characters in a single tube. From the standpoint of both readability and electrical characteristics, the Alphanumeric NIXIE tube provides many unique benefits including * 170V-21mA * All d.c. operation * Uniform, continuous line characters of equal height * Memory with simple solid state drive circuits * Readability in high ambient light * 200 footcandle brightness * Long life with no loss of brightness * Character height 2 1/2in.

Bases for above 60p each.
Price only 99p each plus 16p P./P.

JUST ARRIVED! NUMERIC INDICATOR TUBES

Ultra-long life, high quality, 0-9 and 2 independent decimal points. Supply voltage 200V d.c. Current 14mA. Pulse duration 100us. Character height 0.51, overall size 1 1/4.

Brand new, guaranteed. Surplus to manufacturer's requirements. Type B5859t

1-25 £1.00; 25+ 90p; 100+ 80p;
1,000+ price on application.
Add 8% VAT to all items + 35p P. & P.
ELECTRONIC BROKERS LTD.
49-53 Pancras Road, London NW1 2QB
Tel. 01-837 7781

FREE!

Over 150 ways to engineer a better future

HIGHER PAY

A BETTER JOB

SECURITY

find out how in just 2 minutes

That's how long it will take you to fill in the coupon. Mail it today and we'll send you full details and a free book. We have successfully trained thousands of men at home—equipped them for higher pay and better, more interesting jobs. We can do as much for YOU. A low-cost home study course gets results fast—makes learning easier and something to look forward to. There are no books to buy and you can pay-as-you-learn.

Why not do the thing that really interests you? Without losing a day's pay, you could quietly turn yourself into something of an expert. Complete the coupon (or write if you prefer not to cut the page). No obligation and nobody will call on you... but it could be the best thing you ever did.

Others have done it, so can you

"Yesterday I received a letter from the Institution informing that my application for Associate Membership had been approved. I can honestly say that this has been the best value for money I have ever obtained, a view echoed by two colleagues who recently commenced the course."—Student D.I.B., Yorks.
 "Completing your course, meant going from a job I detested to a job that I love, with unlimited prospects."—Student J.A.O., Dublin.
 "My training quickly changed my earning capacity and, in the next few years, my earnings increased fourfold."—Student C.C.P., Bucks

FIND OUT FOR YOURSELF

These letters, and there are many more on file at Aldermaston College, speak of the rewards that come to the man who has given himself the specialised know-how employers seek. There's no surer way of getting ahead or of opening up new opportunities for yourself. It will cost you a stamp to find out how we can help you. Write to:

ALDERMASTON COLLEGE

Dept. TPE06, Reading RG7 4PF

HOME OF BRITISH INSTITUTE OF ENGINEERING TECHNOLOGY

Practical Radio & Electronics Certificate course includes a learn while you build **3 transistor radio kit.**

Everything you need to know about **Radio & Electronics** maintenance and repairs for a **spare time income** and a **career** for a better future.

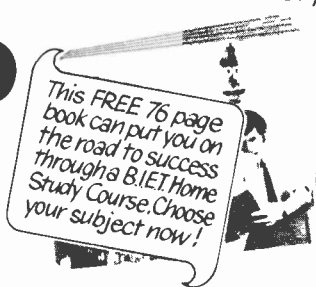

CUT OUT THIS COUPON

Tick or state subject of interest. Post to address below.

- | | | |
|---|---|---|
| <input type="checkbox"/> ELECTRICAL ENGINEERING
City & Guilds
Wiring and Installations
C. G. Electrical Tech—Primary
Gen. Electrical Eng | <input type="checkbox"/> RADIO & TV
Gen. Radio and TV Eng
Radio Servicing
Maintenance and Repairs
Practical Radio & Electronics (with self-build kit)
Radio Amateurs Exam | <input type="checkbox"/> General Draughtsmanship
Architectural Draughtsmanship
Technical Drawing |
| <input type="checkbox"/> AERONAUTICAL ENGINEERING
Air Registration Board Certificates
Gen. Aero Engineering | <input type="checkbox"/> ELECTRONIC ENGINEERING
Gen. Electronic Eng.
Practical Electronics (with kit) | <input type="checkbox"/> CONSTRUCTION & BUILDING
Institute of Building
Construction
Surveyor's Inst. Clerk of Works
Diploma
C & G Building Quantities
General Building
General Civil Eng
Heating, Ventilating & Air Conditioning
Carpentry & Joinery
Painting & Decorating
Plumbing
C.E.I. (Part 1)
Inst. Cost & Management
Accountants
Works Management |
| <input type="checkbox"/> AUTO ENGINEERING
City & Guilds Auto Engineering
Practice
Inst. Motor Industry
M.A.A. I.M.I. Management Diploma
Gen. Auto Engineering
Auto Diesel Maintenance
Motor Mechanics
Service Station and Garage Management | <input type="checkbox"/> AGRICULTURAL ENG. REFRIGERATOR SERVICING | |
| <input type="checkbox"/> TELE-COMMUNICATIONS
City & Guilds
Telecommunications | <input type="checkbox"/> MECHANICAL ENGINEERING
Society of Engineers
Inst. Engineers and Technicians
General Mechanical Eng.
Welding
Maintenance Eng
General Diesel Eng | <input type="checkbox"/> DRAUGHTSMANSHIP
Institute of Engineering
Draughtsmen & Designers |

G.C.E.
—58 'O' & 'A'
Level Subjects—
over 10,000 Group
Passes!

POST TODAY FOR A BETTER TOMORROW

To Aldermaston College, TPE06
Dept. TPE06, Reading RG7 4PF

NAME
Block Capitals Please
ADDRESS

OTHER SUBJECTS

Accredited by C.A.C.C. Member of A.B.C.C.

Published approximately on the 15th of each month by IPC Magazines Ltd., Fleetway House, Farringdon Street, London, EC4A 4AD Printed in England by Chapel River Press, Andover.
 Hants Sole Agents for Australia and New Zealand—Gordon & Gotch (A/sia) Ltd., South Africa—Central News Agency Ltd.
 Publisher's Subscription Rate including postage for one year, Inland £4.80, Overseas £5.00, U.S.A. and Canada \$13.50
 International Giro facilities Account No. 5122007. Please state reason for payment, "message to payee".
 Practical Electronics is sold subject to the following conditions, namely, that it shall not, without the written consent of the Publishers first given, be lent, resold, hired out or otherwise disposed of by way of Trade at more than the recommended selling price shown on the cover, excluding Eire where the selling price is subject to V.A.T., and that it shall not be lent, resold or hired out or otherwise disposed of in a mutilated condition or in any unauthorised cover by way of Trade, or affixed to or as part of any publication or advertising, literary or pictorial matter whatsoever.

