

PRACTICAL ELECTRONICS

AUGUST 1969

THREE SHILLINGS

SPLIT PHASE CONDUCTIVITY BRIDGE

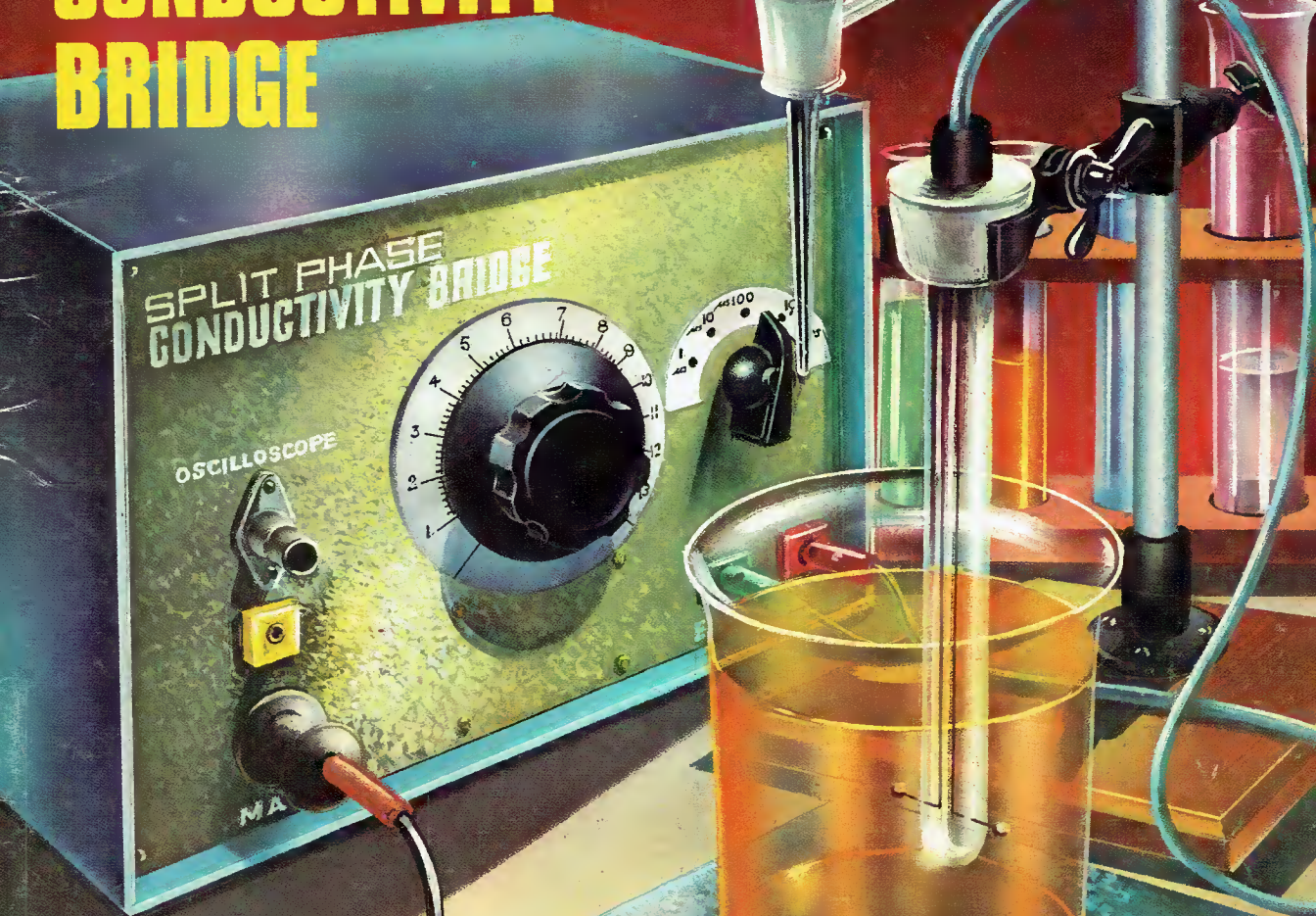

Also Featured....

SPRING LINE REVERBERATION UNIT

ADCOLA

PRODUCTS LIMITED
(Regd Trade Mark)

THE RELIABLE SOLDERING INSTRUMENT!



SEND COUPON FOR LATEST LEAFLET

ADCOLA PRODUCTS LTD
ADCOLA HOUSE
GAUDEN ROAD
LONDON SW4

NAME

ADDRESS

.....

.....

.....

PE170

ORGAN TRANSISTORS

ZTX300 .. 1/11	ZT1701 .. 22/6	ZS170 .. 1/11
ZTX302 .. 3/-	ZT3055 .. 20/6	OC28 .. 19/-
ZT44 .. 12/9	KR54 .. 27/6	ACY21 .. 5/4
ZT1613 .. 7/9	KR56 .. 24/9	ACY22 .. 4/-
ZT1700 .. 17/9	ZR12 .. 16/9	OAZ203 .. 12/-

Mullard LA2300 9/5

All above transistors direct from manufacturer.
Unmarked silicon planar transistors suitable for use in divider circuits:—1/6 each or £5 per 100.

LIGHT-SENSITIVE DEVICES

GIANT-SIZE SELENIUM SOLAR CELLS—PRODUCE UP TO 6MA FROM DAYLIGHT! 67mm diameter 10/- each. 50mm × 37mm. 2 for 10/-.

Transistors similar to OCP71 2/- each.

ORP12 CADMIUM SULPHIDE LIGHT-SENSITIVE RESISTORS 9/- each. Light-sensitive diodes 10/- per dozen.

WIRE-WOUND RESISTORS

Mains dropper type. Up to 30 watts. Some multi-tapped. Fraction of normal price! 10/- per dozen.

MULLARD POLYESTER CAPACITORS FAR BELOW COST PRICE! 0.001μF 400V 3d., 0.0015μF 400V 3d., 0.0018μF 400V 3d., 0.0022μF 400V 3d., 0.01μF 400V 3d., 0.15μF 160V 6d., 0.22μF 160V 6d., 0.27μF 160V 6d., 1μF 125V 1/-.

RECORD PLAYER CARTRIDGES. COMPLETE WITH NEEDLES GP67/2 Mono 15/-, GP91/3 Compatible £1, GP93/1 Crystal Stereo 25/-, GP94/1 Ceramic 30/-.

TRANSISTORISED SIGNAL INJECTOR KIT 10/-.

SIGNAL TRACER KIT 10/-.

VEROBOARD

2½ × 1" 0.15 matrix 1/3	17 × 3½" 0.15 matrix 14/8
3½ × 2½" 0.15 matrix 3/3	3½ × 2½" 0.1 matrix 4/2
3½ × 3½" 0.15 matrix 3/11	3½ × 3½" 0.1 matrix 4/9
5 × 2½" 0.15 matrix 3/11	5 × 2½" 0.1 matrix 4/7
5 × 3½" 0.15 matrix 5/6	5 × 3½" 0.1 matrix 5/6
17 × 2½" 0.15 matrix 11/-	

Spot Face Cutter 7/6. Pin Insert Tool 9/6. Terminal Pins 3/6 for 36. Special Offer! Spot Face Cutter and 5 2½ × 1" boards. . . . 9/9 only.

PAPER CONDENSERS. Mixed bags 0.001μF to .5μF, 12/6 per 100. **SILVER-MICA, Ceramic, Polystyrene Condensers.** Well assorted. Mixed types and values, 10/- per 100.

RESISTORS. Mixed types and values, ¼ to 1 watt. 6/6 per 100. 55/- per 1,000. Wire-wound resistors. 1 watt to 10 watts. Mixed values. 20 for 10/-.

TRANSISTORS. Mixed, unmarked, mainly O.K. 7/6 for 50.

12 VOLT TRANSISTORISED FLUORESCENT LIGHTS. HALF NORMAL PRICE.

8 Watt 12" tube. Reflector type £2.19.6. 15 watt 18" Batten type £3.19.6.

IDEAL FOR CAMPING OR CARAVAN HOLIDAYS! A BRIGHT LIGHT FOR VERY LITTLE CURRENT!

ELECTROLYTIC CONDENSERS

0.25μF 3 volt 4μF	4 volt 10μF	25 volt 64μF	9 volt 100μF
1μF 6 volt 4μF	12 volt 20μF	6 volt 320μF	9 volt 320μF
1μF 20 volt 4μF	25 volt 25μF	6 volt 320μF	4 volt 320μF
1.25μF 16 volt 5μF	6 volt 25μF	12 volt 320μF	10 volt 320μF
2μF 3 volt 6μF	6 volt 25μF	25 volt 400μF	6.4 volt 400μF
2μF 350 volt 8μF	3 volt 30μF	6 volt All at 1/- each.	20 assorted.
2.5μF 16 volt 8μF	12 volt 30μF	10 volt (our selection)	
3μF 25 volt 8μF	50 volt 50μF	6 volt 10/-	
3.2μF 64 volt 10μF	6 volt 64μF	2.5 volt 10/-	

Orders by post to:

G. F. MILWARD, DRAYTON BASSETT, NEAR TAMWORTH, STAFFS.

Please include suitable amount to cover post and packing. Minimum order 10/-. Stamped addressed envelope must accompany any enquiries.

For customers in Birmingham area goods may be obtained from Rock Exchanges, 231 Alum Rock Road, Birmingham 8.

Lasky's

MIDLAND Model 10-502 VHF AIRCRAFT BAND CONVERTER

Brings instant reception of the ground-to-air, air-to-ground wave-band. For use with any standard AM or FM radio covering 535 to 1,605kc/s, 88 to 108Mc/s respectively—with no electrical conversion or connection required. The Model 10-502 (self powered by one 9V (PP3 type) battery) is merely placed close to the receiving set and then tuned over 110 to 135Mc/s which covers the whole aircraft communications band. Volume and reception effectiveness is adjusted by moving both sets to the most favourable position and balancing the volume controls of each accordingly. The Model 10-502 has a smartly designed black plastic cabinet with brushed metal front panel and 18in chrome telescopic antenna, size only 4 x 2 1/2 x 2 1/2in (inc. knobs). Complete with battery and full instructions.



LASKY'S PRICE 79/6 Post 5/-

TMK Model PL-436

20,000 O.P.V. Multitester for the amateur or professional. Features mirror scale and wood grain finish front panel. Spec.: D.C./V ranges: 0.6, 3, 12, 30, 120, 600V at 20K/O.P.V. A.C./V ranges: 3, 30, 120, 600V at 8K/O.P.V. D.C. current: 50µA, 500, 60, 600mA. Resistance: 10K, 100K, 1M and 10M ohms end scale (65, 650, 6.5K and 65K ohms centre scale). Decibels: -20 to +57dB in four ranges. Operates on 2 x 1.5V U7 type batteries. Size: 5 1/2 x 4 1/2 x 2 1/2in. Complete with test leads, batteries and instructions.

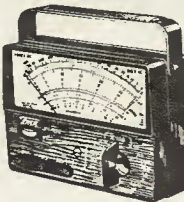

LASKY'S PRICE £7.19.6 Post 5/-

TTC Model C-1051

20,000 O.P.V. pocket multimeter with mirror scale and built in thermal protection circuit. Exceptionally large easy to read meter with D'Arsonval movement. Colour coded scales. Single positive click-in, recessed selection switch for all ranges. Ohms zero adjustment. Range spec. A.C. volts: 0.6-30-300-1200V at 10K/ohms/V. D.C. volts: 0.3-15-150-300-1.2KV at 20K/ohms/V. Resistance: 0-60K-6megs. D.C. current: 0-60µA-300mA. Decibels: -20dB to +17dB. Hand calibration gives extremely high standard of accuracy on all ranges. Uses one 1 1/2V penlight battery. Strong impact resistant plastic cabinet—size only 4 1/2 x 3 1/2 x 1 1/2in. Two colour buff/green finish. Complete with test leads and battery. Original list price 69s.

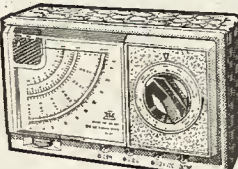

LASKY'S PRICE 75/6 Post 2/6

NEW INTERNATIONAL TAPE FAMOUS AMERICAN MADE BRAND TAPE at RECORD LOW PRICES

3in Message tape, 150ft.....	2 8	5 1/2in Standard play, 850ft Mylar ..	11 6
3in Message tape, 225ft.....	3 8	5 1/2in Long play, 1,200ft Mylar ..	15 0
3in Message tape, 300ft.....	7 8	5 1/2in Triple play, 2,400ft Mylar ..	45 0
2 1/2in Triple play, 600ft Mylar.....	10 6	7in Standard play, 1,200ft Acc-tape ..	12 6
4in Triple play, 900ft Mylar.....	17 6	7in Long play, 1,800ft Mylar ..	19 6
5in Double play, 1,200ft Mylar ..	25 0	7in Standard play, 1,200ft Mylar ..	12 6
5in Long play, 900ft Acetate ..	10 0	7in Long play, 1,800ft Mylar ..	19 6
5in Standard play, 600ft PVC ..	8 6	7in Double play, 2,400ft Mylar ..	25 0
5in Triple play, 1,800ft Mylar ..	25 0	7in Long play, 1,800ft Acetate ..	15 0
5 1/2in Double play, 1,800ft Mylar ..	22 6	7in Triple play, 3,600ft Mylar ..	50 0
5 1/2in Long play, 1,200ft Acetate ..	12 6		

P. & P. 1/- extra per reel. 4 reels and over Post Free. Special quotes for quantities.

BUDGET PRICED CASSETTES

OVERTURE High quality cassettes from the U.S.A. C.60-10/6 C.90-15/- C.120-20/-

Post 1/- each. 4 and over Post Free. Special quotes for quantities.

SPECIAL OFFER: 6-C.60 cassettes for 59/6 POST FREE

DENSHI BOARD KITS NEW EXPERIMENTAL AND EDUCATIONAL CIRCUIT SYSTEM

The DENSHI BOARD system enables the young experimenter and electronics hobbyist to produce a wide range of transistor circuits of increasing sophistication—without soldering or the use of any tools at all! Basically the system comprises a slotted circuit board into which plug-in components and bridge pieces are set to produce up to 30 different circuits. The components are encapsulated in transparent plastic blocks bearing the appropriate circuit symbol and value thus enabling even the complete novice to visually grasp the fundamentals of circuitry after only a few moments study. In addition each DENSHI BOARD KIT comes complete with an 80 page manual of circuits and data.

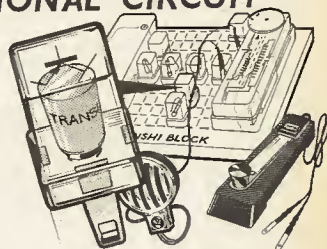

THESE ARE JUST A FEW OF THE CIRCUITS YOU CAN BUILD IN MINUTES: VARIOUS RADIO RECEIVERS, AMPLIFIERS, MORSE CODE PRACTICE DEVICE, CONTINUITY TESTER, SIGNAL INJECTOR, SIGNAL TRACER, WIRELESS MICROPHONE, ETC., ETC.

DENSHI BOARD KIT SR-1A comprises:

Base board; tuner block; 4 resistors; choke oil; transformer; 2SA transistor for RF; 2 diodes; 3 capacitors; battery block; morse key; antenna lead; crystal earphone; various bridge and connecting pieces and 80 page manual. This kit permits the building of 16 basic circuits.

LASKY'S PRICE £4.19.6 Post 3/6

DENSHI BOARD KIT SR-2A as SR-1A but with the following additional parts: 2SA transistor for AF; 2 resistors; 1 capacitor; crystal microphone; test probe; electrode; additional connecting pieces; 9V battery. This kit permits the building of 30 circuits.

LASKY'S PRICE £7.2.6 Post 3/6

LASKY'S ENCAPSULATED SOLID STATE MODULES

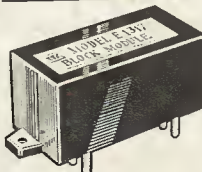

8 completely new special function circuit modules. Size of each module only 1 1/2 x 1 1/2 x 1/2 in. Ready for immediate use—just connect to power source (usually 9V battery), input and output. Encapsulated modules are shockproof and almost indestructible. Comp. with full ins. Post 1/6 each.

- E-1311 Phono Pre-amp Module—max. output 30mW, input imp. 100kΩ, gain 28dB, RIAA compensation. 29/6
- E-1312 Tape Head Pre-amp Module—max. output 4V, RMS, input 50mV, input imp. 100kΩ, gain 28dB, NARTB compensation. 29/6
- E-1313 Microphone Pre-amp Module—max. output 4V, RMS, input 50mV, input imp. 100kΩ, gain 28dB, response 10-50Kc/s. 29/6
- E-1314 Power Amplifier Module—max. output 300mW, input imp. 1kΩ, gain 20dB, response 50-10Kc/s, distortion 3% at 20mW. 29/6
- E-1315 Electronic Organ (tone oscillator) Module—frequency 200-1,000c/s, output 80mW. For use with keyboard, variable resistors and 8Ω speaker. 25/-
- E-1316 Morse Code Practice Oscillator Module—frequency 400c/s, output 80mW. For use with morse key and speaker. 25/-
- E-1317 Modulated Wireless Signal Transmitter for use in test bench fault finding—frequency 400c/s-30Mc/s, tone freq. 400c/s. For use with any AM receiver. 25/-
- E-1318 Lamp Flasher Module—flashes two miniature lamps alternately. For use with 6V, 100/200mA bulbs and 6V power supply. 25/-

GET YOUR LASKY'S AUDIO-TRONICS PICTORIAL FREE 16 colour page catalogue in large 16 x 11in. format packed with 1,000's of items from our vast stocks. Hi-Fi, Radio, Electronics, Test Equipment, Components, etc., etc.

Send 1/- for post only and inclusion on our regular mailing list. (5/- overseas)

SEND FOR FREE CATALOGUE OF MUSICASSETTES — OVER 600 TITLES NOW AVAILABLE.

Lasky's Radio Limited

Branches

207 EDGWARE ROAD, LONDON, W.2

Tel. 01-723 3271

33 TOTTENHAM CT. RD., LONDON, W.1

Tel. 01-636 2605

Open all day, 9 a.m.—6 p.m. Monday to Saturday

152/3 FLEET STREET, LONDON, E.C.4

Tel. 01-353 2833

Open all day Thursday, early closing 1 p.m. Saturday

High Fidelity Audio Centres

42-45 TOTTENHAM CT. RD., LONDON, W.1

Tel. 01-580 2573

Open all day, 9 a.m.—6 p.m. Monday to Saturday

118 EDGWARE ROAD, LONDON, W.2

Tel. 01-723 9789

Open all day Saturday, early closing 1 p.m. Thursday

ALL MAIL ORDERS AND CORRESPONDENCE TO: 3-15 CAVELL STREET, TOWER HAMLETS, LONDON, E.1

LASKY'S RADIO ESTABLISHED OVER 36 YEARS

Kinver for Components

Selection from our range of STOCK transistors

ACY18	4/5	BC184L	3/2	TI550	3/9	2N2924	4/4
ACY19	5/3	BC212L	3/9	2N696	4/9	2N2926	3/-
ACY20	4/6	BC213L	3/9	2N697	5/-	2N3053	6/8
ACY21	4/11	BC214L	4/-	2N706	3/3	2N3055	19/6
ACY22	2/10	BCY70	5/4	2N1132	10/9	2N3702	3/6
ASY27	6/2	BCY71	10/4	2N1302	3/11	2N3703	3/3
ASY26	8/-	BCY72	4/6	2N1303	3/11	2N3704	3/9
ASY28	6/2	BD121	18/-	2N1304	5/-	2N3705	3/4
ASY29	8/-	BFY50	5/-	2N1305	5/-	2N3707	4/-
BC107	3/3	BFY51	4/6	2N1306	6/5	2N3708	2/5
BC108	3/-	BSY52	5/-	2N1307	6/5	2N3819	9/-
BC109	3/3	BSY95A	3/11	2N1308	9/6	2N3820	18/9
BC182L	3/2	TI544	1/9	2N1309	9/6	2N4058	4/6
BC183L	2/5	TI549	2/6	2N2906	13/-	2N4059	3/5

Linear Integrated Circuits in stock

G.E. Type PA230 Low Level Amplifier	21/-
G.E. Type PA234 1 Watt Audio Amplifier	23/-
G.E. Type PA237 2 Watt Audio Amplifier	34/-
RCA Type CA3020 1/2 Watt Wide Band Amplifier	32/-
RCA Type CA3035 Ultra High Gain Amplifier	30/-
Mullard Type TAA263 General Purpose A.F. Amplifier	15/9
Mullard Type TAA310 Record/Playback Amplifier	32/-
Mullard Type TAA320 MOS FET with Bipolar Transistor	13/5
G.E. Type 2N5306 Darlington Pair	11/6
G.E. Type DI3T1 Programmable Unijunction Transistor	10/8

Add 1/- each to the above for data sheets for i.c. if required. Data sheets may be purchased separately at 1/6 each post free.

PROFESSIONAL COMPONENTS AT REALISTIC PRICES!

Send NOW for our brand new COMPONENTS CATALOGUE, at only 2/- post free. This catalogue is packed with information on a host of up-to-the-minute components by leading manufacturers. Included are International Rectifier Products, Resistors, Capacitors, Veroboard, Plugs and Sockets, Switches, etc.

Please note that all goods supplied by us are brand new and guaranteed to fully conform to the manufacturer's published specifications.

DISCOUNTS: Order value of £5—10%; Order value over £10—15%. Cash with order please. Post and packing 1/6 per order.

ELECTRONICS LTD

Kinver

STONE LANE · KINVER
STOURBRIDGE WORCS
Telephone: KINVER 2099

NEW! ELECTROSTATIC—IT'S FANTASTIC

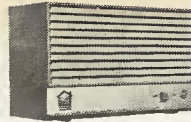

SMELL KILLER AIR FRESHENER

No moving parts, fans, filters, chemicals. A sealed set of ELECTRODES produces nascent oxygen which mixes with the oxygen in the air to produce OZONE. OZONE is the most powerful SMELL KILLER/AIR CLEANER known to science. Ozone breaks up the airladen molecules of smell—completely dispersing all smells—not disguising them. Its EFFICIENCY will amaze you in kitchens, living rooms, offices, etc. Less than a 1d a week to run. No maintenance. Lifetime's wear. Portable.

Fully guaranteed. 220/40v AC. Over 6000 sold at Ideal Home Exhibition. NEVER BEFORE AN ELECTROSTATIC CLEANER

£6. 19. 6

FOR Post 4/6 Distributed by

ANDREW STEPHENS (1947) CO.

61 DICKSON RD., BLACKPOOL. 0253-23755

SENSATIONAL STEREO OFFERS!

SAVE
UP TO
33 1/3%
OFF OUR
STEREO
SYSTEMS

As Britain's Largest Specialists our tremendous purchasing power enables us to offer you the famous makes—Garrard, Goldring, Rogers, Goodmans, Arena, Philips, Decca, etc., etc.—at unbelievable low prices. We offer 20 Hi-Fi Stereo Systems utilising these famous makes and all showing substantial savings off normal prices.

Every Nu Sound Stereo System is complete with all leads, plugs, etc., fully guaranteed, and backed by 100% Nu Sound after-sales service.

Illustrated literature and technical data sent by return of post (Dept. PE/AT).

NuSound
BRITAIN'S LARGEST SPECIALISTS

24 Oxford St., London, W.1
Tel. 01-580 4638, 4639, 5755
50 yards Tottenham Ct. Rd. Tube
Open 6 days a week

YOURS FREE FOR 7 DAYS

The 'New Picture-Book' way of learning BASIC ELECTRICITY (5 VOLS.) BASIC ELECTRONICS (6 VOLS.)

You'll find it easy to learn with this outstandingly successful NEW PICTORIAL METHOD—the essential facts are explained in the simplest language, one at a time, and each is illustrated by an accurate, cartoon-type drawing. The books are based on the latest research into simplified learning techniques. This has proved that the PICTORIAL APPROACH to learning is the quickest and soundest way of gaining mastery over these subjects.

TO TRY IT, IS TO PROVE IT

The series will be of exceptional value in training mechanics and technicians in Electricity, Radio and Electronics.

WHAT READERS SAY

"I am highly delighted with the books; I didn't know a complicated subject could be so easily presented."

J. K., Earlsfield.

"I am pleased to say how understandable your books are. I have now quite a sound knowledge of Electronics."

P. S., Southgate.

"I know your Manuals will prove invaluable for my training and career as a technician."

J. L., S. Shields.

To The SELRAY BOOK CO., 60 HAYES HILL, HAYES, BROMLEY, KENT BR2 7HP

Please send me WITHOUT OBLIGATION TO PURCHASE, one of the above sets on 7 DAYS FREE TRIAL, I will either return set, carriage paid, in good condition within 7 days or send the following amounts. BASIC ELECTRICITY 75/-. Cash Price or Down Payment of 20/- followed by 3 fortnightly payments of 20- each. BASIC ELECTRONICS 90/-. Cash Price or Down Payment of 20/- followed by 4 fortnightly payments of 20/- each. This offer applies to UNITED KINGDOM ONLY. Overseas customers cash with order, prices as above.

Tick Set required (Only one set allowed on free trial)

BASIC ELECTRICITY

BASIC ELECTRONICS

Prices include Postage and Packing.

Signature

(If under 21 signature required of parent or guardian)

NAME

BLOCK LETTERS

FULL POSTAL

ADDRESS

A TECH-PRESS PUBLICATION

POST NOW FOR THIS OFFER!!

a complete stereo system for 28 gns!



The new Duo general purpose two way speaker system is beautifully finished in polished teak veneer with matching vynair grille. It is ideal for wall or shelf mounting either upright or horizontally. **SPECIFICATION:** Impedance 10 ohms. It incorporates Goodmans high flux 6 x 4in speaker and 2in tweeter. Teak finish 12 x 6 1/2 x 5 1/2 in. 4 guineas each, P. & P. 7/6. Garrard Changers from £7.19.6, P. & P. 7/6. Cover and Teak finish Plinth £4.15.0, P. & P. 7/6.

The Duo

Integrated Transistor Stereo Amplifier

The Duo is a good quality amplifier, attractively styled and finished. It gives superb reproduction previously associated with amplifiers costing far more. **SPECIFICATION:** R.M.S. power output: 3W per channel into 10 ohms speakers. Input Sensitivity: Suitable for medium or high output crystal cartridges and tuners. Crosstalk better than 30dB at 1Kc/s. Controls: 4-position selector switch (2 pos. mono and 2 pos. stereo) dual ganged volume control. Tone Control: Treble lift and cut. Separate on/off switch. A preset balance control.

9 GNS
+ 7/6 P. & P.

The Classic



8 1/2 GNS
P. & P. 7/6

Specification: Sensitivities for 10W output at 1KHz. Tape head: 3mV (at 32 i.p.s.). Mag. P.U.: 2mV. Cer. P.U.: 80mV. Radio: 100mV. Aux.: 100mV. Tape/Rec. output: 100mV. Equalisation for each input is correct to within ±2dB (R.I.A.A.) from 20Hz to 20KHz. Tone control range: Bass ±13dB at 60Hz. Treble ±14dB at 15KHz. Total distortion: (for 10W output) <1.5%. Signal noise: <-60dB. A.C. mains 200-250V. Size 12 1/2 in long, 4 1/2 in deep, 2 1/2 in high. Teak finished case.



The Viscount

Integrated High Fidelity Transistor Stereo Amplifier

SPECIFICATIONS: Output: 10W per channel into 3 to 4 ohms speakers (20W monoral). Input: 6 position rotary selector switch (3 pos. mono and 3 pos. stereo). P.U.: Tuner, Tape and Tape Rec. out. Sensitivities: All Inputs 100mV into 1-8M ohm. Frequency response: 40Hz-20KHz ±2db. Tone controls: Separate bass and treble controls. TREBLE 13db lift and cut (at 15KHz). BASS 15db lift and 25db cut (at 60Hz). Volume controls: Separate for each channel. A.C. mains input: 200-240V. 50-60Hz. Size: 12 1/2 x 6 x 2 1/2 in teak finished case. Built and tested. P. & P. 7/6.

13 1/2 GNS
+ 7/6 P. & P.

THE DORSET (600mW Output)

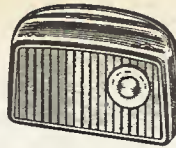

7-transistor fully tunable M.W.-L.W. superhet portable—with baby alarm facility. Set of parts. The latest modulated and pre-alignment techniques make this simple to build. Sizes: 12 x 8 x 3in. MAINS POWER PACK KIT: 9/6 extra.

Price **£5.5.0**

Plus 7/6 P. & P. Circuit 2/6 FREE WITH PARTS.

THE ELEGANT SEVEN Mk. III (350mW Output)

7-transistor fully tunable M.W.-L.W. portable. Set of parts. Complete with all components, including ready etched and drilled printed circuit board—back printed for foolproof construction. MAINS POWER PACK KIT: 9/6 extra.

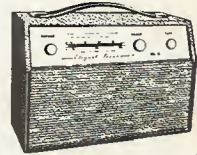

Price **£4.9.6** + 7/6 P. & P.

Circuit 2/6 FREE WITH PARTS.

50 WATT AMPLIFIER A.C. MAINS 200-250V

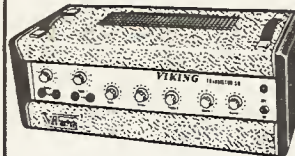

An extremely reliable general purpose amplifier—with six electronically mixed inputs. Suitable for use with: mics, guitars, gram, tuner, organs, etc. Separate bass and treble controls. Output impedance 3, 8 and 15 ohms.

Price **27 GNS** + 20/- P. & P.

THE RELIANT

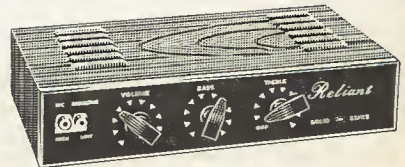

SOLID-STATE GENERAL PURPOSE AMPLIFIER

Specifications: Output: 10W R.M.S. Output impedance: 3 to 4 ohms. Inputs: 1. Xtal mic 10mV; 2. Gram/radio 250mV. Tone controls: Treble control range ±12dB at 10KHz; Bass control range ±13dB at 100Hz. Frequency response (with tone controls central): Minus 3dB points are 20Hz and 40KHz. Signal to noise ratio: better than -60dB. Transistors: 4 silicon Planar type and 3 Germanium type. Mains input: 220-250V a.c. Size of chassis: 10 1/2 in long, 4 1/2 in wide x 2 1/2 in deep. A.C. Mains, 200-250V. For use with Sd. or L.P. records, musical instruments, all makes of pick-ups and mikes. Separate bass and treble lift control. Two inputs with control for gram and mike. Built and tested. 8 x 5in speaker to suit: Price 14/6 plus 1/6 P. & P. Crystal mike to suit: 12/6 plus 1/6 P. & P. Mk. I as above, less teak case 5 1/2 gns. + 7/6 P. & P.

RELIANT Mk. II **6 1/2 GNS** + 7/6 P. & P. In teak-finished case



POCKET MULTI-METER

Size 3 1/2 x 2 1/4 x 1 1/2 in. Meter size 2 1/2 x 1 1/2 in. Sensitivity 1,000 O.P.V. on both a.c. and d.c. volts. 0-15, 0-150, 0-1,000 d.c. current 0-150mA. Resistance 0-100kohms. Complete with test prods, battery and full instructions. 42/6. P. & P. 3/6. **FREE GIFT** for limited period only. 30W Electric Soldering Iron Value 15/- to every purchaser of the Pocket Multi-Meter.



OUR PRICE
12 for **30/-**
extra postage 4/6
G.E.C. 13 amp surface mounting switched sockets in brown. Listed at 6/6.



12 for 21/-
Postage 4/6
W. & D. 13 amp flush sockets in green.

CYLDON 2 TRANSISTOR U.H.F. TUNER. BRAND NEW. COMPLETE WITH CIRCUIT DIAGRAM

£2.10.0 + 1/- P. & P.

B.S.R. TD2 TAPE DECK

This tape deck takes 5 1/2 in spools complete with two-track heads. Size 13 1/2 in long by 8 1/2 in wide.

£8.19.6 Plus 7/6 P. & P.

THREE-IN-ONE HI-FI 10 WATT SPEAKER

A complete Loud Speaker system on one frame, combining three matched ceramic magnet speakers with a low loss cross-over network. Peak handling power 10W. Impedance 15 ohms. Flux density 11,000 gauss. Resonance 40-60c/s. Frequency range 50c/s to 20kc/s. Size 13 1/2 in X 8 1/2 in X 4 1/2 in. By famous manufacturer. List price £7. Our price 74/6 plus 5/- P. & P. Similar speaker to the above minus tweeters in 3 & 15 ohms 44/6 + 5/- P. & P.

RADIO & TV COMPONENTS (ACTON) LIMITED

Goods not despatched outside U.K. Terms C.W.O. All enquiries s.a.e. ALL ORDERS BY POST TO OUR ACTON ADDRESS
21d High Street, Acton, London, W.3 also at 323 Edgware Road, London, W.2

RACAL RA-17

First ministry release of these world famous communication receivers. Frequency range 500 Kc/s-30 Mc/s. Available in excellent condition fully tested and guaranteed. £150. Carr. 40/-.

CLASS D WAVEMETERS

Acrylcast controlled heterodyne frequency meter covering 1.7-8 Mc/s. Operation on 8V d.c. Ideal for amateur use. Available in good used condition. £5.19.8. Carr. 7/6. Or brand new with accessories. £7.19.8. Carr. 7/6.

CLASS D WAVEMETERS No. 2

Crystal controlled. 1.2-19 Mc/s. Mains or 12V d.c. operation. Complete with calibration charts. Excellent condition. £12.10.0. Carr. 30/-.



MARCONI CT44/TF956 AF ABSORPTION WATTMETER

1 μ/watt to 6 watts. £20. Carr. 20/-.

LELAND MODEL 27 BEAT FREQUENCY OSCILLATORS

Frequency 0-20 Kc/s on 2 ranges. Output 500 Ω or 5k Ω. Operation 200/250V A.C. Supplied in perfect order £12/10/-, Carr. 10/-.



AVOMETERS

Supplied in excellent condition, fully tested and checked. Complete with prods, leads and instructions. Model 47A 99.19.8 P. & P. 7/6.

SOLARTRON CD. 1016 OSCILLOSCOPE

Double beam. d.c. To 6 Mc/s. Excellent condition. £55 each. Carr. 20/-.

AM/FM SIGNAL GENERATORS

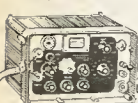

Oscillator Test No. 2. A high quality precision instrument made for the ministry by Airmecc. Frequency coverage 20-50Mc/s. AM/FM. Incorporates precision dial level meter, precision attenuator 1μV-100mV. Operation from 12V d.c. or 0/110/200/250V a.c. Size 12 x 8 1/2 x 9 in. Supplied in brand new condition complete with all connectors fully tested. £45. Carr. 20/-.

GEARED MAINS MOTORS

Paralux type SD19 250/250V a.c. Reversible. 30 RPM. 40 lb in. Complete with capacitor. Excellent condition. 99/8. Carr. 10/-.

SINCLAIR EQUIPMENT



Z12 12 watt amplifier, 99/8
PZ4 Power Supply Unit 99/8
Stereo 25 Preamp., 99.19.8
Q14 Speakers, 27.19.8
Micromatic Radio Kit, 49/8. Built 59/6
ALL POST PAID

SPECIAL OFFER

Two Z12 Amps., PZ4 Power Supply, Stereo 25 Preamplifier, £22, or with two Q14 speakers, £37.

NEW SINCLAIR 2000 SYSTEM

35 watt Integrated Amplifier £29. Carr. 5/-
Self powered F.M. Tuner. £25. Carr. 5/-

ECHO HS-606 STEREO HEADPHONES



Wonderfully comfortable. Lightweight adjustable vinyl headband. 6ft. cable and stereo jack plug. 25-17,000 cps. 8 ohm imp. 67/6 P. & P. 2/6.

UNR-30 4-BAND COMMUNICATION RECEIVER

Covering 550 Kc/s-30 Mc/s. Incorporates BFO. Built-in speaker and phone jack. Metal cabinet. Operation 220/240V a.c. Supplied brand new, guaranteed with instructions. Carr. 7/8. 13 gns.

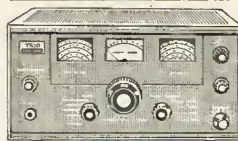

TRIO COMMUNICATION RECEIVER MODEL 9R-59DE

4 band receiver covering 550Kc/s to 30Mc/s. continuous and electrical bandspread on 10, 15, 20, 40 and 80 metres. 8 valve plus 7 diode circuit. 4/8 ohm output and phone jack. 5SB-CW & ANL. Variable BFO. S meter & Sep. bandspread dial. IP 445Kc/s. Audio output 1.5W. Variable RF and AF gain controls. 115/250V A.C. Mains. Beautifully designed. Size: 7 x 15 x 10in. With instruction manual and service data. £42.10.0. carriage paid.

TRIO COMMUNICATION TYPE HEADPHONES. Normally £5.19.8. OUR PRICE £3.15.0 if purchased with above receiver.

TRIO JR-500SE 10-80 METRE AMATEUR COMMUNICATION

£69.10.0. Carr. Paid.

SPECIAL BONUS OFFER! TRIO SP5D Matching Speaker Mate and TRIO H54 Communication Headphones. Normal Value £10.7.0. FREE OF CHARGE with every JR-500SE purchased.

HAMMARLUND SP600JX COMMUNICATION RECEIVER

High quality professional dual conversion communication receivers. Few available again in this country at a reasonable price. Frequency range 540 Kc/s-54 Mc/s in 6 bands, variable tuning or 6 channel crystal controlled. 2.5 watt output into 600 ohms. Input 110/230V a.c. 20 valve circuit incorporating Xtal filter, B.F.O., A.N.L., Xtal calibrator, S meter etc. Size 19 x 12 x 22in. (List £520.) Offered in excellent condition fully tested and checked. £100 each.

LAFAYETTE LA-224T TRANSISTOR STEREO AMPLIFIER

19 transistors, 8 diodes, 1HF music power, 30W at 8Ω. Response 30-20,000 ± 2dB at 1W. Distortion 1% or less. Inputs 3mV and 250mV. Output 3-16Ω. Separate L and R volume controls. Treble and bass control. Stereo phone jack. Brushed aluminium, gold anodised extruded front panel with complementary metal case. Size 10 1/2 x 9 1/8 x 7 1/8 in. Operation 115/230V A.C. £28. Carriage 7/6.

MARCONI TEST EQUIPMENT

EX-MILITARY RECONDITIONED.
TF 144F STANDARD SIGNAL GENERATORS, 85Kc/s-25Mc/s, £25, carr. 30/-, TF 885, VIDEO OSCILLATOR, 0-5Mc/s, £45, Carr. 30/-, T.F. 195M, BEAT FREQUENCY OSCILLATOR 0-40Kc/s, 200/250V a.c. £20, carr. 30/-, TF 142E, Distortion Factor Meter, £20, carr. 20/- All above offered in excellent condition fully tested and checked. TF 1100 VALVE VOLTMETER, Brand New, £50. T.F. 1267 TRANSMISSION TEST SET, Brand New £75. TF 1371, Wide Band Millivolt Meter, £50.

MULTIMETERS for EVERY purpose!

LAFAYETTE DE-LUXE 100 KΩ VOLT "LAB TESTER"

Giant 6 1/2 in. scale. Built-in meter protection. 0.5/2.5/10/50/250/500/1,000V d.c. 0.7/3/10/50/250/500V a.c. 1/1,000V a.c. 0/10/100μA/10/100/500 MA/2.5/10A/0.1K/10K/100K/10M/10MΩ -10 to 49.4dB £18.8.0. P. & P. 5/-.

MODEL AS-100D. 100KΩ/VOLT. 5in. mirror scale.

Built-in meter protection. 0/3/12/60/120/300/600/1,200V d.c. 0/6/30/120/300/600V a.c. 0/10μA/6/60/300MA/12 Amp. 0.2K/200K/2M/200MΩ. -20 to +17dB. £12.10.0. P. & P. 3/6.

MODEL TE-90 50,000 O.P.V. MIRROR SCALE OVERLOAD PROTECTION

0/3/12/60/300/600/1,200V d.c. 0/6/30/120/300/1,200V a.c. 0.03/6/60/600MA d.c. 16kΩ/160kΩ/1.6/16MΩ. -20 to +63dB. £7.10.0. P. & P. 3/-.

MODEL TE-70 30,000 O.P.V. 0/3/15/60/300/600/1,200V d.c. 0/6/30/120/600/1,200V a.c. 0/30μA/3/30/300mA. 0/16K/160K/1.6M/16megohm. £5.10.0. P. & P. 3/-.

MODEL PT-34 1,000 O.P.V. 0/10/50/250/500/1,000V a.c. and 0/1/100/500mA d.c. 0/100KΩ 99/6. P. & P. 1/6.

MODEL TE12 20,000 O.P.V. 0/0/6/30/120/600/1,200/3,000/6,000V d.c. 1/6/30/120/600/1,200V a.c. 0/80μA/6/60/600MA. 0/16K/160K/1.6M/6M/60. Megohm 50FF. 2 MFD £5.19.8. P. & P. 3/6.

MODEL TE12. 20,000 O.P.V. 0/0/6/30/120/600/1,200/3,000/6,000V d.c. 1/6/30/120/600/1,200V a.c. 0/80μA/6/60/600MA. 0/16K/160K/1.6M/6M/60. Megohm 50FF. 2 MFD £5.19.8. P. & P. 3/6.

MODEL TE12. 20,000 O.P.V. 0/0/6/30/120/600/1,200/3,000/6,000V d.c. 1/6/30/120/600/1,200V a.c. 0/80μA/6/60/600MA. 0/16K/160K/1.6M/6M/60. Megohm 50FF. 2 MFD £5.19.8. P. & P. 3/6.

MODEL TE12. 20,000 O.P.V. 0/0/6/30/120/600/1,200/3,000/6,000V d.c. 1/6/30/120/600/1,200V a.c. 0/80μA/6/60/600MA. 0/16K/160K/1.6M/6M/60. Megohm 50FF. 2 MFD £5.19.8. P. & P. 3/6.

MODEL TE12. 20,000 O.P.V. 0/0/6/30/120/600/1,200/3,000/6,000V d.c. 1/6/30/120/600/1,200V a.c. 0/80μA/6/60/600MA. 0/16K/160K/1.6M/6M/60. Megohm 50FF. 2 MFD £5.19.8. P. & P. 3/6.

MODEL TE12. 20,000 O.P.V. 0/0/6/30/120/600/1,200/3,000/6,000V d.c. 1/6/30/120/600/1,200V a.c. 0/80μA/6/60/600MA. 0/16K/160K/1.6M/6M/60. Megohm 50FF. 2 MFD £5.19.8. P. & P. 3/6.

TE-900 20,000 Ω VOLT GIANT MULTIMETER

6in. full view meter. 2 colour scale, overload protection. 0/2.5/10/250/1,000/5,000V a.c. 0/25/12.5/150/250/1,000/5,000V d.c. 0/50μA/110/100/500MA 10A d.c. 20K/200K/20MΩ. £18. P. & P. 5/-.

LAFAYETTE 57 Range Super 50,000 O.P.V. Multimeter. D.c. Volts 125V/1,000V A.c. Volts 1.5V-1,000V D.c. Current 25μA-10 Amp. Ohms. 0-15 MegΩ d.b. -20 to +81dB. Overload Protection. £12.10.0. Carr. 3/6.

PROFESSIONAL 20,000 O.P.V. LAB. TESTER

Automatic overload protection, mirror scale. Ranges: 1/10/50/250/500/1,000 volts, d.c. and a.c. 0-500μA, 10mA, 250mA. Current: 0/20K, 200K, 2 megohm. Decibels: -20 to +22dB. £5.19.8. P. & P. 2/6.

MODEL TE 80, 20,000 O.P.V. 0/10/50/100/500/1,000V a.c. 0/5/25/50/250/500/1,000V d.c. 0.5μA. 5/50/500mA/0.6K/60K/600K/6 Meg. £4.17.8. P. & P. 3/-.

MODEL TE12. 20,000 O.P.V. 0/0/6/30/120/600/1,200/3,000/6,000V d.c. 1/6/30/120/600/1,200V a.c. 0/80μA/6/60/600MA. 0/16K/160K/1.6M/6M/60. Megohm 50FF. 2 MFD £5.19.8. P. & P. 3/6.

MODEL TE12. 20,000 O.P.V. 0/0/6/30/120/600/1,200/3,000/6,000V d.c. 1/6/30/120/600/1,200V a.c. 0/80μA/6/60/600MA. 0/16K/160K/1.6M/6M/60. Megohm 50FF. 2 MFD £5.19.8. P. & P. 3/6.

MODEL TE12. 20,000 O.P.V. 0/0/6/30/120/600/1,200/3,000/6,000V d.c. 1/6/30/120/600/1,200V a.c. 0/80μA/6/60/600MA. 0/16K/160K/1.6M/6M/60. Megohm 50FF. 2 MFD £5.19.8. P. & P. 3/6.

MODEL TE12. 20,000 O.P.V. 0/0/6/30/120/600/1,200/3,000/6,000V d.c. 1/6/30/120/600/1,200V a.c. 0/80μA/6/60/600MA. 0/16K/160K/1.6M/6M/60. Megohm 50FF. 2 MFD £5.19.8. P. & P. 3/6.

MODEL TE12. 20,000 O.P.V. 0/0/6/30/120/600/1,200/3,000/6,000V d.c. 1/6/30/120/600/1,200V a.c. 0/80μA/6/60/600MA. 0/16K/160K/1.6M/6M/60. Megohm 50FF. 2 MFD £5.19.8. P. & P. 3/6.

MODEL TE12. 20,000 O.P.V. 0/0/6/30/120/600/1,200/3,000/6,000V d.c. 1/6/30/120/600/1,200V a.c. 0/80μA/6/60/600MA. 0/16K/160K/1.6M/6M/60. Megohm 50FF. 2 MFD £5.19.8. P. & P. 3/6.

MODEL TE12. 20,000 O.P.V. 0/0/6/30/120/600/1,200/3,000/6,000V d.c. 1/6/30/120/600/1,200V a.c. 0/80μA/6/60/600MA. 0/16K/160K/1.6M/6M/60. Megohm 50FF. 2 MFD £5.19.8. P. & P. 3/6.

MODEL TE12. 20,000 O.P.V. 0/0/6/30/120/600/1,200/3,000/6,000V d.c. 1/6/30/120/600/1,200V a.c. 0/80μA/6/60/600MA. 0/16K/160K/1.6M/6M/60. Megohm 50FF. 2 MFD £5.19.8. P. & P. 3/6.

MODEL TE12. 20,000 O.P.V. 0/0/6/30/120/600/1,200/3,000/6,000V d.c. 1/6/30/120/600/1,200V a.c. 0/80μA/6/60/600MA. 0/16K/160K/1.6M/6M/60. Megohm 50FF. 2 MFD £5.19.8. P. & P. 3/6.

MODEL TE12. 20,000 O.P.V. 0/0/6/30/120/600/1,200/3,000/6,000V d.c. 1/6/30/120/600/1,200V a.c. 0/80μA/6/60/600MA. 0/16K/160K/1.6M/6M/60. Megohm 50FF. 2 MFD £5.19.8. P. & P. 3/6.

MODEL TE12. 20,000 O.P.V. 0/0/6/30/120/600/1,200/3,000/6,000V d.c. 1/6/30/120/600/1,200V a.c. 0/80μA/6/60/600MA. 0/16K/160K/1.6M/6M/60. Megohm 50FF. 2 MFD £5.19.8. P. & P. 3/6.

MODEL TE12. 20,000 O.P.V. 0/0/6/30/120/600/1,200/3,000/6,000V d.c. 1/6/30/120/600/1,200V a.c. 0/80μA/6/60/600MA. 0/16K/160K/1.6M/6M/60. Megohm 50FF. 2 MFD £5.19.8. P. & P. 3/6.

MODEL TE12. 20,000 O.P.V. 0/0/6/30/120/600/1,200/3,000/6,000V d.c. 1/6/30/120/600/1,200V a.c. 0/80μA/6/60/600MA. 0/16K/160K/1.6M/6M/60. Megohm 50FF. 2 MFD £5.19.8. P. & P. 3/6.

MODEL TE12. 20,000 O.P.V. 0/0/6/30/120/600/1,200/3,000/6,000V d.c. 1/6/30/120/600/1,200V a.c. 0/80μA/6/60/600MA. 0/16K/160K/1.6M/6M/60. Megohm 50FF. 2 MFD £5.19.8. P. & P. 3/6.

TO-2 PORTABLE OSCILLOSCOPE

A general purpose low cost economy oscilloscope for everyday use. Y amp. Bandwidth 2 CF-1 MHz. Input imp. 2 megΩ 25 P.F. Illuminated scale. 2in tube. 115 x 180 230mm. Weight 8lb. 220/240V a.c. Supplied brand new with handbook £22.10.0. Carr. 10/-.



FIELD TELEPHONES TYPE L

Generator ringing, metal cases. Operates from two 1.5v. batteries (not supplied). Excellent condition. £4.10.0. per pair. Carr. 10/-.

T.E.40

HIGH SENSITIVITY A.C. VOLTMETER
10 meg. input 10 ranges: 0.1/0.03/1/3/10/30/100/300V. R.M.S. 4c/s-1.2Mc/s. Decibels -40 to +50dB. Supplied brand new complete with leads and instructions. Operation 230V a.c. £17.10.0. Carr. 5/-.



AUTO TRANSFORMERS

0/115/230v. Step up or step down. Fully shrouded.
150 W. £1.12.6. P. & P. 3/6
300 W. £2.7.6. P. & P. 3/6
500 W. £3.10.0. P. & P. 6/6
1,000 W. £5.10.0. P. & P. 7/6
1,500 W. £6.10.0. P. & P. 8/6
7,500 W. £15.10.0. P. & P. 20/-

TE22 SINE SQUARE WAVE AUDIO GENERATORS

Size: 20c/s to 200 Kc/s on 4 bands. Square: 20c/s to 30Kc/s. Output impedance 5,000 ohms. 200/250V. A.C. Supplied brand new and guaranteed with instruction manual and leads. £16.10.0. Carr. 7/6.



TE111. DECADE RESISTANCE ATTENUATOR
Variable range 0-11dB. Connections. Unbalanced T and Bridge T. Impedance 600 Ω range (0.1dB x 10) + (1dB x 10) + 10 + 20 + 30 + 40dB. Frequency: d.c. to 200KHz (-3dB). Accuracy: 0-05dB. ± indication dB x 0-01. Maximum input less than 4W (60V). Built in 600 Ω load resistance with internal/external switch. Brand new £27.10.0. P. & P. 5/-.

TV75 AUDIO SIGNAL GENERATOR

Sine Wave 20c/s to 200Kc/s. Square Wave 20c/s to 30Kc/s. High and low impedance output. Output variable up to 6 volts. 220/240 volts a.c. Size 210 x 150 x 120mm. Brand new with instructions. £18. Carr. 7/6.

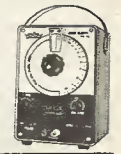

CAR LIGHT FLASHERS

Heavy duty light flasher employs a condenser discharge principle operating on electro-mechanical relay. (As inset.) Housed in strong plastic case. Flashing rate between 60-120 per minute. 12 volt DC operation. Maximum load 6 amps. Size 2 1/16" dia. x 4". Supplied brand new at a fraction of original cost. 6/6 each P. & P. 2/6. (3 for 17/6 P. & P. 4/6).

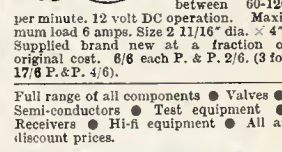

G. W. SMITH & CO (RADIO) LTD.
Also see oppo. page

NEW CATALOGUE

Nearly 200 pages giving full details of a comprehensive range of **COMPONENTS, TEST EQUIPMENT, COMMUNICATION EQUIPMENT AND HI-FI EQUIPMENT.** Each section greatly enlarged and fully illustrated. Thousands of items many at bargain prices. **FREE DISCOUNT COUPONS VALUE 10%.**

SEND NOW—ONLY 7/6 P&P!

GARRARD

FULL CURRENT RANGE OFFERED, BRAND NEW AND GUARANTEED AT FANTASTIC SAVINGS

- | | | | |
|-------------------|----------|-----------|----------|
| SRP22 Stereo | £5.19.6 | *SL55 | £11.19.6 |
| *1025 Mono | £7.10.0 | A70 MKII | £12.10.0 |
| *1025 Stereo | £7.15.0 | *AT60MKII | £13. 5.0 |
| *2025 Stereo | £7.19.6 | *SL65 | £14.14.0 |
| *2025TG | | AP75 | £17.17.0 |
| *2025 Mono Stereo | £8.17.6 | 401 | £28. 7.6 |
| *3000 Stereo | £9.19.6 | SL75 | £28.10.0 |
| *SP25 MKII | £11.19.6 | SL95 | £35. 0.0 |

Carriage/insurance 7/6 extra any model. WB4 Bases £3.19.6. Perspex covers £3.10.0. *Special offer base and cover available for these models at £4.15.0. Carr. 5/-. Full range of Garrard accessories available.



TYPE 13A DOUBLE BEAM OSCILLOSCOPES



An excellent general purpose D/B oscilloscope. T.B. 2 c/s-150 Mc/s. Bandwidth 5.5 Mc/s. Sensitivity 33 mV/cm. Operating voltage 0/110/200/250 V. a.c. Supplied in excellent working condition. £22.10.0. Or complete with all accessories, probe, leads, lid, etc. £25. Carriage 30/-.

ADMIRALTY B.40 RECEIVERS

Released by the Ministry. High quality 10 valve receiver manufactured by Murphy. Coverage in 5 bands 600 kc/s-30 Mc/s. I.F. 500 kc/s. Incorporates 2 R.F. and 3 I.F. stages, band-pass filter, noise limiter, crystal controlled B.F.O., callibrator. O/F output, etc. Built-in speaker, output for phones.



Operation 150/200 V. a.c. Size 19 1/2 x 13 1/2 x 16 in. Weight 114 lb. Offered in good working condition. £22.10.0. Carr. 30/-. With circuit diagrams. Also available B.41 L.F. version of above. 15 Kc/s-700 Kc/s. £17.10.0. Carr. 30/-.

R209 MK II COMMUNICATION RECEIVER

11 valve high grade communication receiver suitable for tropical use. 1.20 Mc/s on 4 bands. AM/CW/EM operation. Incorporates precision vernier driver, BFO, Aerial trimmer, internal speaker and 12 V d.c. internal power supply. Supplied in excellent condition, fully tested and checked.



£15 Carr. 20/-.

ADVANCE TEST EQUIPMENT

Brand new and boxed in original sealed cartons.

VM.76 VALVE VOLTMETER R.F. measurements in excess of 100Mc/s and d.c. measurements up to 100V with accuracy of ±2% d.c. range 300 MV to 1kV a.c. range 300 MV to 300V R.M.S. Resistance 0.2-500Ω. Price £125.

VM.78 A.C. MILLIVOLT METER. Transistorised 1 MV-300V. Frequency 1 c/s to 1 Mc/s. Price £55.

VM.79 UHF MILLIVOLT METER. Transistorised. A.c. range 10 MV-3V. D.c. current range 0-0.1μA-0.3 MA. Resistance 1 ohm-10 megohms. Price £125.

H1B AUDIO SIGNAL GENERATOR. 15 c/s-50 kc/s. sine or square wave. Price £30.

J1B AUDIO SIGNAL GENERATOR. 15 c/s-50 kc/s. Price £30.

J2B AUDIO SIGNAL GENERATOR. As per J1B except fitted with output meter. Price £35.

TT1S TRANSISTOR TESTER. £37.10.0 Carriage 10/- per item.

SOLARTRON MONITOR OSCILLOSCOPE TYPE 101

An extremely high quality oscilloscope with time base of 10μsec to 20m/sec. Internal V. amplifier. Separate mains power supply 200/250V. Supplied in excellent condition with cables, probe, etc., as received from Ministry. £3.19.6. carriage 50/-.



LAFAYETTE PF-60 SOLID STATE VHF FM RECEIVER

A completely new transistorised receiver covering 152-174 Mc/s. Fully tuneable or crystal controlled (not supplied) for fixed frequency operation. Incorporates 4 INTEGRATED CIRCUITS. Built in speaker and illuminated dial. Squelch and volume controls. Tape recorder output. 75Ω aerial input. Headphone jack. Operation 230V. A.C./12V. D.C. Neg. earth. £37.10.0. Carr. 10/-.



Variable Voltage TRANSFORMERS

Brand new, guaranteed and carriage paid. High quality construction. Input 230 V 50-60 cycles. Output full variable from 0-250 V. Bulk quantities available. 1 amp.—£5.10.0; 2.5 amp.—£8.15.0; 5 amp.—£9.15.0; 8 amp.—£14.10.0; 10 amp.—£18.10.0; 12 amp.—£21.0.0; 20 amp.—£37.0.0.



CLEAR PLASTIC PANEL METERS

First grade quality Moving Coil panel meters available ex-stock. S.A.E. for illustrated leaflet. Discounts for quantity.

Type MR 38P. 1 1/2" square fronts.			
500-0-500μA	25/-	150V. D.C.	25/-
1mA	25/-	300V. D.C.	25/-
1-0-1mA	25/-	500V. D.C.	25/-
2mA	25/-	750V. D.C.	25/-
5mA	25/-	15V. A.C.	25/-
10mA	25/-	50V. A.C.	25/-
750mA	25/-	150V. A.C.	25/-
1 amp.	25/-	300V. A.C.	25/-
2 amp.	25/-	500V. A.C.	25/-
5 amp.	25/-	20V. D.C.	25/-
20mA	25/-	8 MU meter	28/6
500μA	25/-	10V. D.C.	25/-

Postage Extra. Larger sizes available—send for lists.

TRANSISTORISED L.C.R. A.C. MEASURING BRIDGE

A new portable bridge offering excellent range and accuracy at low cost. Ranges: R. 1Ω-11.1 megΩ. 6 Ranges ±1%. L.I. μH - 1 I 1 HENRY'S 6 Ranges -2% c. 10pF ±110 pF d. 6 HENRY'S 6 Ranges -2% c. 10pF ±110 pF d. 6

Ranges ±2%. TURNS RATIO 1:1/1000. 6 Ranges ±1%. Bridge voltage at 1,600 cps. Operated from 9 volts. 100μA. Meter indication. Attractive 2 tone metal case. Size 7 1/2 x 5 x 2 1/2 in. £20. P. & P. 6/-.

TE-65 VALVE VOLTMETER

High quality instrument with 28 ranges. D.c. volts 1.5-1,500V. A.c. volts 1.5-1,500V. Resistance up to 1,000 megohms. 220/240V a.c. operation. Complete with probe and instructions. £17.10.0. P. & P. 6/-. Additional Probes available: R.F. 35/-, H.V. 42/6.



AMERICAN TAPE

First grade quality American tapes. Brand new. Discount on quantities.

3in. 225ft. L.P. acetate	3/6
3in. 600ft. T.P. mylar	10/-
6in. 600ft. std. plastic	8/6
6in. 900ft. L.P. acetate	10/-
6in. 1,200ft. D.P. mylar	15/-
6in. 1,200ft. L.P. acetate	12/6
6in. 1,200ft. L.P. mylar	16/-
6in. 1,800ft. D.P. mylar	22/6
6in. 2,400ft. L.P. mylar	39/6
7in. 1,200ft. std. acetate	12/6
7in. 900ft. L.P. acetate	15/-
7in. 1,800ft. L.P. mylar	20/-
7in. 2,400ft. D.P. mylar	25/-
7in. 3,600ft. T.P. mylar	45/-

Postage 2/- Over £3 post paid.

RECORDING HEADS

Reuter 1-track. As fitted to Collaro Mk. IV and Studio Decks. High imp. record play back, low imp. erase. Lower track only. Brand new. 19/6 pair. COSMOCORD 1-track heads. High imp. record/playback 65/-, Low imp. erase 20/-, MARRIOTT 1-track heads. High imp. record/playback 65/-, Low imp. erase 20/-, Post extra.

★ TRANSISTORISED FM TUNER ★

TRANSISTOR HIGH QUALITY TUNER. SIZE ONLY 6x4x2 1/2 in. 3 I.F. stages. Double tuned discriminator. Ample output to feed most amplifiers. Operates on 9V battery. Coverage 88-108 Mc/s. Ready built ready for use. Fantastic value for money. £6.7.6. P. & P. 2/6. Stereo multiplex adaptors 90/6.

TRANSISTORISED TWO-WAY TELEPHONE INTERCOM

Operative over amazingly long distances. Separate call and press to talk buttons, 2-wire connection. 1000's of applications. Beautifully finished in ebony. Supplied complete with batteries and wall brackets. £8.19.6. P. & P. 3/6.



TE-16A Transistorised Signal Generator

400 kHz-30 MHz. An inexpensive instrument for the handyman. Operates on 9V battery. Wide, easy to read scale. 800 kHz modulation. 5 1/2 x 5 1/2 x 3 1/2 in. Complete with instructions and leads. £7.19.6. P. & P. 4/-. Operates on 9V battery. Wide, easy to read scale. 800 kHz modulation. 5 1/2 x 5 1/2 x 3 1/2 in. Complete with instructions and leads. £7.19.6. P. & P. 4/-.



MODEL ZQM TRANSISTOR CHECKER

It has the fullest capacity for checking on A, B and Ico. Equally adaptable for checking diodes, etc. Spec.: A: 0.7-0.9987. B: 5-200. Ico: 0-50 microamps 0-5 mA. Supplied for diode 200 Ω-1 MΩ. Supplied complete with instructions, battery and leads. £5.19.6. P. & P. 2/6.



TE-20RF SIGNAL GENERATOR

Accurate wide range signal generator covering 120 kc/s-260 Mc/s on 6 bands. Directly calibrated variable R.F. attenuator. Operation 200/240V a.c. Brand new with instruction. £15.0.0. P. & P. 7/6. S.A.E. for details.

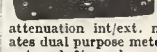

ARF-100 COMBINED AF-RD SIGNAL GENERATOR

A.F. SINE WAVE 200-2,000,000 c/s. Square wave 20-30,000 c/s. O/P. HIGH IMP. 21V. P/P600 0-3.8 V. P/P. TF 100 kc/s-300 Mc/s. Variable R.F. attenuation int/ext. modification. Incorporates dual purpose meter to monitor AF output and % mod. on R.F. 220/240 V a.c. £30.0.0. Carr. 7/6.

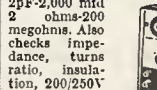

LAFAYETTE TE46 RESISTANCE CAPACITY ANALYSER

2pF-2,000 mfd 2 ohms-200 megohms. Also checks impedance, turns ratio, insulation, 200/250V a.c. Brand New £17.10.0. Carr. 7/6.



NOW OPEN IN EDGWARE ROAD

Our new walk around shop is now open at 311 Edgware Road fully stock with all Hi-Fi, Communication and Test Equipment. Call into your nearest shop—Edgware Road for all Equipment—Lisle Street for all Equipment and Components.

GW SMITH & CO (RADIO) LIMITED

3 and 34, LISLE STREET, LEICESTER SQ., LONDON, W.C.2
311, EDGWARE RD., LONDON, W.2

(ALL MAIL ORDERS TO - 3, LISLE STREET, LEICESTER SQUARE, LONDON, W.C.2)

9 a.m. to 6 p.m. Mon. to Sat. (Edgware Road) 3 day Thurs.) Trade supplied.

prepare now for tomorrow's world

Today there is a huge demand for technologists such as electronics, nuclear and computer systems engineers, radio and television engineers, etc. In the future, there will be even more such important positions requiring just the up-to-date, advanced technical education which CREI, the Home Study Division of McGraw-Hill Book Co., can provide.

CREI Study Programmes are directly related to the problems of industry including the latest technological developments and advanced ideas. The individual tuition given by the CREI panel of experts in each specialised field is comparable in technological content with that of technical colleges.

Take the first step to a better job now — enrol with CREI, the specialists in Technical Home Study Education.

CREI Programmes are available in:

Electronic Engineering Technology * Industrial Electronics for Automation * Computer Systems Technology * Nuclear Engineering * Mathematics for Electronics Engineers * Television Engineering * Radar and Servo Engineering * City and Guilds of London Institute: Subject No. 49 and Advanced Studies No. 300.

CREI (London), Walpole House,
173-176 Sloane Street, London S.W.1.
A Subsidiary of McGraw-Hill Inc.

Post this coupon today for a better future

To C.R.E.I. (London), Walpole House, 173-176 Sloane Street, London S.W.1.
Please send me (without obligation) details of your Educational Programmes

please tick
My interest is City and Guilds General

Name

Address

Electronics experience

PE16

STEREOGRAM CABINET £19

An elegant Stereogram Cabinet in modern Veneered Mahogany and cloth covered Front Panel

BLACK LEATHERETTE SIDE PANELS
Dimensions: 52" x 17½" x 12". Speaker positions for Twin 10" x 5" Speakers



SPEAKERS 6/6

2"—75Ω. 2½"—35Ω. P. & P. 2/6.

ACOS MICS. 35/- STANDARD

STICK MIC. 2gns. P. & P. 3/6.

ASSORTED CONDENSERS

10/- for 50. P. & P. 7/6.

ASSORTED RESISTORS

10/- for 50. P. & P. 4/6.

ASSORTED CONTROLS

10/- for 25. P. & P. 7/6.

TRANSISTORS

MULLARD MATCHED

OUTPUT KIT

9/- OC81D—2 OC81's.

P. & P. FREE.

FERRITE RODS 3/6

6", 8" x ¾" complete with LW/MW COILS. P. & P. FREE.

17in.—£11.10.0 Carr. 30/-

19in. SLIM-LINE
FERGUSON 24 gns.

TWO-YEAR GUARANTEE
EX-RENTAL TELEVISIONS

FREE ILLUSTRATED
LIST OF TELEVISIONS
17"—19"—21"—23"



WIDE RANGE OF MODELS
SIZES AND PRICES
DEMONSTRATIONS DAILY

RECORD PLAYER CABINET

49/6.
Cloth covered. Size 16½" x 14½" x 8"
Takes any modern autochanger.
P. & P. 7/6.

SINGLE PLAYER CABINETS

15/6. P. & P. 7/6.

TRANSISTOR CASES 19/6.

Cloth covered, many colours.

Size 9½" x 6½" x 3½". P. & P. 3/6.

Similar cases in plastic 7/6.

TWO-YEAR GUARANTEED REGUNNED TUBES

70° & 90° 14in.—69/6. 17in.—

89/6. 21in.—99/6. 110° 17in.—

19in. & 21in.—99/6. 23° (not

bonded)—119/6. Exchanged

Bowls. Carr. 10/6.

DUKE & CO. (LONDON) LTD.

621/3 Romford Road, Manor Park, E.12

Phone 01-478 6001-2-3

Stamp for Free List.

MARTIN IS HIGH FIDELITY

plus

ADD-ON-ABILITY

THRILLING POWER

DEPENDABILITY

GENUINE ECONOMY

How would you like to start with a simple amplifier, say, and add to it until it became a fully stereo twenty watt amplifier with FM tuner and facilities to take the most sensitive low output pickups ever made? With Martin Audiokits it's easy, for with these superbly engineered all-transistor prefabricated units, success is built in from the start and you build to your own preferred plan. IT'S A MONEY SAVING SCHEME, TOO.

Details from:—

● Trade enquiries invited.

MARTIN ELECTRONICS LTD., 155 High Street, Brentford,
Middlesex. ISLeworth 1161

To MARTIN ELECTRONICS, 155 High Street
Brentford, Middlesex

I have not had your leaflets before. Please send them on
AMPLIFIERS FM TUNER RECORDAKITS
(Tick as required)

NAME

ADDRESS

PE

PREMIER RADIO

23, TOTTENHAM COURT ROAD, LONDON, W.1

Tel: 01-636 3451



COMPLETE STEREO SYSTEM

FOR ONLY

39 GNS

CARRIAGE 35/-



The Premier Stereo System consists of an all transistor stereo amplifier, Garrard Model 2025 auto/manual record player unit fitted stereo/mono cartridge and mounted in teak finish plinth with perspex cover and two matching teak finish loudspeaker systems. Absolutely complete and supplied ready to plug in and play. The 10 transistor Amplifier has an output of 5 watts per channel with inputs for pick-up, tape and tuner also tape output socket. Controls: Bass, Treble, Volume, Selector. Power on/off, stereo/mono switch. Brushed aluminium front panel. Black metal case with teakwood ends: Size 12" x 5 1/4" x 3 1/4" high (Amplifier available separately if required £14.19.6 Carr. 7/6).

WIDE RANGE OF HI-FI STEREO EQUIPMENT ON DEMONSTRATION

All leading makes available including Rogers, Armstrong, Dulci, Wharfedale, Goodmans, Goldring, Shure, etc. etc.



E.M.I. 13 x 8in HI-FI SPEAKERS

Fitted two 2 1/2in tweeters and crossover network. Impedance 3 & 15 ohms. Handling capacity 10W. Brand new. 99/6. P. & P. 7/6. Also available without tweeters. 49/6. P. & P. 7/6.

TEAK FINISHED CABINET. Size 17 1/2 x 10 x 7 1/2in. Ideal for above speakers. £5.10.0. P. & P. 7/6.

PICK-UP CARTRIDGES AT MONEY SAVING PRICES!

GOLDRING G500 (Stereo)	£9.19.6
R & O SP1 (Stereo)	£5. 5.0
PICKERING V16/AC2 (Stereo)	£8.10.0
SONOTONE 9TAHC/Diamond (Stereo)	£2.15.0
ACOS GP91/18C (Mono compatible)	£1.18.5
ACOS GP83-4 (Stereo)	£2. 8.7
ACOS GP94 (Stereo)	£2.14.8
B S R X3M (Mono compatible)	£1.16.5
B S R X3H (Mono compatible)	£1.16.5
RONETTE 105 (Stereo)	£1.15.0
RONETTE 106 (Stereo)	£1.15.0

All complete with mounting brackets and instructions. Post and Packing 1/6 each

SPECIAL OFFER OF SHURE STEREO CARTRIDGES

Look at our special prices!

M3D	List £8.10.6	Premier Price £8.19.6
M44-5	List £14.9.1	Premier Price £11.11.0
M44C	List £12.9.0	Premier Price £10.10.0
M44E	List £17.8.4	Premier Price £13.19.6
M55E	List £20.15.1	Premier Price £18.19.6
M75-6	List £17.8.4	Premier Price £13.19.6
M75E	List £25.18.10	Premier Price £21.0.0

Post and Packing 1/6 each

"PREMIER" TAPE CASSETTES



C60	(60 min.)	10/6
C90	(90 min.)	15/-
C120	(120 min.)	20/-

P. & P. 1/-



CASSETTE HEAD CLEANER

Removes unwanted deposits from delicate tape heads. Fits all cassette recorders. 15/- P. & P. 1/-



HI-FI STEREO HEADPHONES

Designed to the highest possible standard. Fitted 2 1/2in speaker units with soft padded ear muffs. Adjustable headband. 8 ohm impedance. Complete with 6ft lead and stereo jack plug. 59/6 P. & P. 5/-

MONO HEADPHONES 2,000 ohm 14/6 P. & P. 2/6.
STEREO STETHOSCOPE SET Low imp. 25/- P. & P. 2/-
MONO STETHOSCOPE SET Low imp. 10/6 P. & P. 2/-

"PREMIER" SPEAKER SYSTEM



Specially designed oiled teak cabinet with vynair front. Size 12 1/2in high, 7 1/2in wide, 6 1/2in deep. Fitted 6 1/2in EMI 8 ohm Bass speaker with rolled surround and matching 3in E.M.I. tweeter. Fully lagged. £7.19.6 Carr. 7/6



MULTI TESTERS

MODEL D14. A really versatile instrument that makes a handy pocket size tool. Measures a.c. or d.c. voltage in three ranges of 0-15-150-1,000 volts. Resistance 0-100,000 ohms. Current 0-150mA d.c. Size only: 3 3/8 x 2 1/4 x 1 1/2in. Complete with battery, test leads and 49/6 P. & P. instructions. 2/6.



POCKET SIZE MODEL. With wide-angle, jewelled meter movement, ceramic long-life, low-loss switching, tough impact resisting case. Sensitivity 20,000 ohms/volt d.c. 10,000 ohms/volt a.c. 19 Ranges: 0-5-25-50-250-500-2,500 volts d.c. 0-10-50-100-500-1,000 volts a.c. 0-50µA-2-5mA-250mA d.c. 0-6,000 ohms-6 megohms, 10µF µF-0.001 mF-1 mF. -20 to +22dB. Complete battery, test lead and instructions. £4.19.6 P. & P. 3/6.

WELLER SOLDERING TOOLS



"Expert" Solder Gun. Saves time and simplifies soldering in the home and service dept. Two position trigger gives instant dual heat. 87/6 P. & P. 2/-
"Marksman" Soldering Iron. Lightweight, conventional 1/4in pencil bit. Ideal for regular bench use and all those jobs around the home. 25 watts. 240 volt a.c. 31/6 P. & P. 2/-

MONO GRAM AMPLIFIER

2 1/2 watts output. Uses EL84 valve, double wound mains transformer. Ideal for use with any record deck. Volume/on/off and tone controls on flying leads. Output impedance 3 ohms. Size overall 5 1/2in. x 5 1/2in. x 3 1/2in. a.c. 200/240V. ONLY 69/6. P. & P. 5/-

JULIETTE NA.5018 5 BAND 18 TRANSISTOR MAINS BATTERY RADIO

Covers AM 540-1,600kc/s. Marine 1.6-4.8Mc/s. FM 88-108Mc/s. VHF 108-134Mc/s. PB 145-174Mc/s. Ferrite bar aerial for AM/MB. Telescopic aerial for FM/VHF/PB. 4in P.M. Speaker. Operates on a.c. 250V or d.c. by four 1.5V batteries. Size: 9 1/2 x 5 1/2 x 3 1/2in.
PREMIER 33 GNS.
PRICE 33 P. & P. 10/-

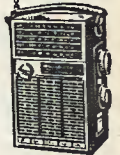

TWO STATION TRANSISTOR INTERCOM.

Complete with battery and 50ft connecting wire. Compact size, two way call system. Ideal for home, office, factory, etc. 65/- P. & P. 4/-

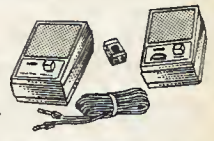

FOUR STATION INTERCOM. Master unit and 3 slaves. Ideal for office and home. Complete with battery and connecting wire £7.19.6 P. & P. 5/6.

"VERITONE" RECORDING TAPE

SPECIALLY MANUFACTURED IN U.S.A. FROM EXTRA STRONG PRE-STRETCHED MATERIAL. THE QUALITY IS UNEQUALLED.

TENSILISED to ensure the most permanent base. Highly resistant to breakage, moisture, heat, cold or humidity. High polished splice free finish. Smooth output throughout the entire audio range. Double wrapped - attractively boxed.

LP3 3'	250'	P.V.C.	5/6	DT6 5 1/2'	1800'	POLYESTER	22/6
TT3 3'	450'	POLYESTER	7/6	TT6 5 1/2'	2400'	POLYESTER	37/6
DT3 3 1/2'	600'	POLYESTER	11/6	SP7 7'	1200'	P.V.C.	12/6
SP5 5'	600'	P.V.C.	8/6	LP7 7'	1800'	P.V.C.	15/-
LP5 5'	900'	P.V.C.	10/-	DT7 7'	2400'	POLYESTER	25/-
DT5 5'	1200'	POLYESTER	15/-	TT7 7'	3600'	POLYESTER	50/-
LP6 5 1/2'	1200'	P.V.C.	12/6				

TAPE SPOOLS 3" 1/-, 5", 5 1/2", 7" 1/0. TAPE CASES 5", 5 1/2", 7" 2/6.
Post and Packing 3" 1/-, 5", 5 1/2" 1/6, 7" 2/- (3 reels and over Post Free.)



DIOTRAN SALES

P.O. BOX 5
WARE, HERTS
TEL.: WARE 3442

EX-COMPUTER PANELS I.B.M. Size
2in. x 4in. with TRANSISTORS, DIODES,
RESISTORS, CAPACITORS, etc. Over
1 million already Sold out to the Trade.
70,000 only left at our Ridiculous Price of
£3 per 100 panels or £28 per 1,000 panels.
Plus carriage 6/- per 100 panels.

Post and Packing costs are continually rising.
Please add 1/- towards same. **CASH WITH
ORDER PLEASE**

**OVERSEAS QUOTATIONS BY RETURN
SHIPMENTS TO ANYWHERE IN THE
WORLD**

OVER 3 MILLION SILICON ALLOY & GERM. TRANSISTORS AVAILABLE FOR IMMEDIATE DELIVERY

TRANSISTORS

Type and Construction

A 1 Germ. A.F. PNP T0-1	= AC127, NKT773, AC157, ASY86	£3.10	100	1,000	10,000
A 2 Germ. A.F. PNP T0-5	= ACY17-21, NKT237-245	£1	50	500	5,000
A 3 Germ. A.F. PNP T0-1	= AC128, NKT271, 2G381	£1	50	500	5,000
A 4 Germ. R.F. PNP T0-1	= OC44-45, NKT72/125, ASY54	£1.10	£4.10	£7.10	£60
A 5 Germ. R.F. PNP T0-5	= 2N1303, NKT164-7, 2G301-3	£1.10	£4.10	£7.10	£60
A 6 Germ. V.H.F. PNP T0-1	= AF116-7, KNT667, 2G417	£3.10	£15	£25	£200
A 7 Assorted Germ. A.F.-R.F. PNP mixed cases, general purpose		15s.	£2.10	£4	£32
A 8 Germ. A.F. 50-2 PNP	= 2G371-89, ACY27-31, OC71-75	£2	£7.10	£12.10	£100
A 9 Sil. Alloy PNP T0-5	= 2S301-5, BCY17-29, BCY30-34	£2	£7.10	£12.10	£100
A 10 Sil. Alloy PNP 50-2	= 2S321-325, OC200-205	£2	£7.10	£12.10	£100

A1 to A7 Guaranteed 80%. Good usable Transistors ideal for low cost production work and experimental use. A8 to A10 are all perfect devices, factory tested, no open or short circuit Transistors in these lots.

BRAND NEW FULLY TESTED EPOXY CASE UNIJUNCTION TRANSISTORS. Type T1543 and BEN 3000 and replacement for 2N2646. Full data available. **LOWEST PRICE AVAILABLE ANYWHERE.** 100 off 4 each = £20; 500 off 3 6 each = £87.10; 1,000 off 3 each = £150. Sample devices 7 each on request.

HIGH QUALITY SILICON PLANAR DIODES. SUB-MINIATURE DO-7 Glass Type, suitable replacements for OA200, OA202, BAY38, 1S130, 1S940. 200,000 to clear at £4 per 1,000 pieces. **GUARANTEED 80% GOOD.**

SILICON PLANAR PLASTIC TRANSISTORS. 2N3708A VcB30 Hfe 20-60. All marked, fully tested and guaranteed. 1 off 1 6 each; 100 off 10d. each; 500 off 9d. each; 1,000 off 7½d. each.

TO-18 METAL CAN SILICON PLANAR TRANSISTORS. VERY HIGH QUALITY 99% good. Type 2N706 BS27 £7.10 per 500 pieces; £12.10 per 1,000 pieces.

FULLY TESTED DEVICES AND QUALITY GUARANTEED—SURPLUS TO REQUIREMENTS
OA202 Silicon Diode. Fully Coded.
150 PIV 250mA Qty. Price £30 per 1,000 pieces.
ORP12 Cadmium Sulphide Cell.
1-24 9 each; 25-99 7 each; 100-999 6 each; 1,000 up 5 6 each. Made in Holland.
BY100 SIL. RECT'S 800 PIV 550mA.
1-49 2 6 each; 50-99 2 3 each; 100-999 2 each; 1,000 up 1/10 each. Fully Coded. 1st Qty.

TTL IC'S 4- EACH
DUAL INLINE 14-16 PIN PLUG IN PACKAGE.

MANUFACTURERS' OUT OF SPECIFICATION FALL OUTS, BUT ALL GOOD FUNCTIONAL UNITS.
DATA AVAILABLE.

Part No.

SN7400N	—Quaduple 2-input Positive NAND Gate
SN7491N	—Quaduple 2-input NAND Gate with free collector outputs
SN7410N	—Triple 3-input Positive NAND Gate
SN7420N	—Dual 4-input Positive NAND Gate
SN7430N	—8-input Positive NAND Gate
SN7440N	—Dual 4-input Positive NAND "Power" Gate
SN7450N	—Dual EXCLUSIVE-OR Gate with Expander Inputs
SN7451N	—Dual EXCLUSIVE-OR Gate
SN7472N	—Master-slave J-K Flip-flop
SN7473N	—Dual Master-slave J-K Flip-flop
SN7474N	—Dual Latch
SN7483N	—Quad high speed full adder
SN7490N	—Decode counter

ORDER AS CODE No. SHOWN ABOVE
ALL ONE PRICE 4/- EACH.

1/- TESTED TRANSISTORS 1/- each

each	ONE PRICE ONLY PNP. NPN. SILICON PLANAR 1/- EACH	1/- each
BC108	2N696	2N1132
BC109	2N697	2N1133
BFY50	2N706	2N1711
BFY51	2N708	2N2904
BFX84	2N929	2N2905
BFX86	2N930	2N2924
BFX88	2N1131	2N2926
		2N2220
		2N3707
		2N3711
		2S107
		2S103
		2S104
		2S732
		2S733

From Manufacturers' Over-runs—Unmarked Plastic and Metal cases. Devices similar to above Nos.

GERM. PNP AND NPN TRANSISTORS FULLY TESTED. UNMARKED SIMILAR TO 1/6 EACH

AC125	ACY22	ACY36	NKT677	OC81	2G381
AC126	ACY27	NKT141	NKT713	OC82	2G382
AC127	ACY28	NKT142	NKT773	2G301	2G399A
AC128	ACY29	NKT212	OC44	2G302	
AC130	ACY30	NKT213	OC45	2G303	
AC131	ACY31	NKT214	OC71	2G308	
AC132	ACY32	NKT215	OC72	2G371	
AC133	ACY33	NKT271	OC75	2G374	

POWER TRANSISTORS

OC25	OC35	NKT403	ASZ17	5/-
OC26	AD130	NKT404	T13027	
OC28	AD140	NKT405	T13028	
OC29	AD149	NKT452	T13029	

Manufacturers' Surplus Germ. A.F. All similar to above.

TRANSISTOR EQVT. BOOK

2,500 cross references of transistors—British, European, American and Japanese. A must for every transistor user. Exclusively distributed by DIOTRAN SALES. 15/- EACH.

TEXAS 2G371A/B

EQVT. OC71. GERM. GEN. PURPOSE TRANS.

1-99	...	1/6 each
100-499	...	1/3 each
500-999	...	1/- each
1,000 up	...	9d each

Vast mixed lot of subminiature glass diodes. Comprising of Silicon, Germ., Point Contact and Gold Bonded types plus some Zeners. 500,000 available at Lowest of Low Price. 1,000 pieces £3.00, 5,000 pieces £13.10.0, 10,000 pieces £23.

TRANSISTOR ELECTRONIC ORGANS

FOR THE AMATEUR
NEW ED. BY DOUGLAS. 21/3

- 110 SEMICONDUCTOR PROJECTS FOR THE HOME CONSTRUCTOR by Marston. 19/-.
- VHT-UHF MANUAL by Jessop, R.S.G.B. 22 6.
- AMATEUR RADIO TECHNIQUES by R.S.G.B. 14/-.
- DESIGNERS GUIDE TO BRITISH TRANSISTORS by Kampel. 26 6.
- PRINCIPLES OF TRANSISTOR CIRCUITS new ed. by Amos. 26/6.
- PRINCIPLES OF PAL COLOUR T.V. by Sims. 22 6.
- PRACTICAL OSCILLOSCOPE HANDBOOK by Turner. 26 6.
- ELECTRONIC NOVELTY DESIGNS by Kampel. 9 6.
- R.C.A. SILICON POWER CIRCUITS MANUAL. 24/-.
- F.E.T. PRINCIPLES, EXPERIMENTS, AND PROJECTS by Noll. 42/-.
- BEGINNERS GUIDE TO TRANSISTORS by Reddihough. 16/-.

Above prices include U.K. postage.

UNIVERSAL BOOK CO.
12 LITTLE NEWPORT ST., LONDON, W.C.2
(Leicester Square Tube Station)

NEW RANGE BBC 2 AERIALS

All U.H.F. aerials now fitted with tilting bracket and 4 element grid reflectors.

Loft Mounting Arrays, 7 element, 37/6.
11 element, 45/-; 14 element, 52/6; 18 element, 60/-.
Wall Mounting with Cranked Arm, 7 element, 60/-; 11 element, 67/-; 14 element, 75/-; 18 element, 82/6.
Mast Mounting with 2in. clamp, 7 element, 42/6; 11 element, 55/-; 14 element, 62/-; 18 element, 70/-.
Chimney Mounting Arrays, Complete, 7 element, 72/6; 11 element, 80/-; 14 element, 87/6; 18 element, 95/-.
Complete assembly instructions with every unit. **Low Loss Cable, 1/6 yd. U.H.F. Pre-amps from 75/-.** State clearly channel number required on all orders.

BBC-ITV AERIALS

BBC (Band 1). Telescopic loft, 25/-; External S/D, 30/-; "H", 22.15.0.
ITV (Band 2). 3 element loft array, 30/-; 5 element, 40/-; 7 element, 50/-; Wall mounting, 3 element, 47/6; 5 element, 52/6.
Combined BBC/ITV. Loft 1+3, 40/-; 1+5, 50/-; 1+7, 60/-; Wall mounting 1+3, 57/6; 1+5, 67/6; Chimney 1+3, 67/6; 1+5, 75/-.
VHF transistor pre-amps, 75/-.

COMBINED BBC-ITV-BBC2 AERIALS
1+3+9, 70/-; 1+5+9, 80/-; 1+5+14, 90/-; 1+7+14, 100/-.
Loft mounting only. Special leaflet available.

F.M. (Band 2). Loft S/D, 15/-; "H", 32/6.
3 element, 55/-.
External units available. Co-ax. cable, 8d. yd. Co-ax. plugs 1/4. Outlet boxes, 5/-.
Diplexer Crossover Boxes, 13/6. C.W.O. or C.O.D. P. & P. 6/-. Send 6d. stamps for illustrated lists.

CALLERS WELCOME

OPEN ALL DAY SATURDAY

K.V.A. ELECTRONICS (Dept. P.E.)
40-41 Monarch Parade
London Road, Mitcham, Surrey
01-648 4884

CRESCENT RADIO LTD.

(electronic component specialists)
For all regular components try
40 Mays Road, Wood Green, N.22
For surplus components and equipment try
11 Mays Road, Wood Green, N.22

Printed circuit board, 8 x 6in 2/- each
Zener diode 8-2 volt, 400mW 2/6 each

BARGAIN BOARDS

Transistors, diodes, resistors, capacitors and various components all mounted on computer board, 2/- each, 3 for 5/-, 7 for 10/- and 15 for 20/-

MODEL MOTOR

12 volt, 9,000r.p.m., 400mA 4/6 each

TRANSISTORS & DIODES

AC127	9	4/6 each
2N2926		5/- each
BC147		3/6 each
BYZ12		4/6 each
OA47		7/6 each
AA120		1/- each
OA6		2/6 each
M3		1/6 each

BARGAIN PACK

50 unmarked and untested transistors 10/6 per pack

SILICON DIODE RECTIFIERS

750mA, 800p.i.v. 3/3 each

COMPONENT BARGAINS

D.P. switches	2/- each
Car fuseholders complete with lead and tags	1/3 each
Low impedance transistor earpiece	1/6 each
Slab aerial transistor type	2/9 each
LA3 type pot core 45mh	4/6 each
2 1/2in. transistor loudspeaker	80 ohm
Rev counters (tape recorder type)	5/6 each

CASSETTES

12/6 each
18/6 each
With our new premises in Mays Road we can now offer an even wider selection of components for the home constructor and enthusiast.

POSTAGE WITH ORDER PLEASE; P.S.
Our new catalogue is now available at 1/6 per copy

L.S.T. ELECTRONIC COMPONENTS LTD.

1N914	2/-	AC107	14/6	BF159	15/-	0AZ242	3/6
1S113	2/6	AC126	4/-	0L2343	6/6	0AZ243	3/6
1S120	2/6	AC127	4/-	BF167	6/6	0AZ246	3/6
1S130	2/6	AC128	4/-	BF173	7/6	0AZ269	3/6
1S201	2/6	AC176	12/-	BF180	7/6	0AZ270	3/6
2G201	3/9	AC178	12/-	BF181	7/6	0AZ271	3/6
2G202	3/9	AC179	12/-	BF182	7/6	OC19	3/6
2G239A	5/-	AC18	3/6	BPV58	7/6	OC22	13/-
2G274	5/-	AC19	3/6	BPV59	6/6	OC23	13/-
2G281	5/-	AC20	3/6	BPV60	6/6	OC24	13/-
2G291	5/-	AC21	3/6	BFX13	4/6	OC25	13/-
2N354	15/-	AD122	4/6	BFX22	3/6	OC26	13/-
2N388A	6/-	AD140	15/-	BFY50	6/-	OC28	12/-
2N496	6/-	AD149	11/6	BFY51	6/-	OC29	13/-
2N597	6/-	AD161	6/-	BFY52	6/-	OC30	7/6
2N598	4/6	AD162	6/-	BFY53	6/-	OC35	9/6
2N706	6/-	AD170	12/6	BS202	3/6	OC36	13/-
2N708A	6/6	AF102	18/-	BSX21	8/-	OC41	3/6
2N708	4/-	AF114	4/6	BSY27	6/-	OC42	4/6
2N711	7/6	AF115	4/6	BSY56A	3/6	OC44	3/6
2N711A	7/6	AF116	4/6	BTX39/600	120/-	OC45	3/6
2N722	5/6	AF117	4/6	BUY11	15/-	OC71	3/6
2N730	6/6	AF118	16/6	BY100	5/-	OC72	4/6
2N131	9/6	AF124	6/6	BYX10	4/9	OC73	3/6
2N132	7/6	AF127	12/6	BYZ10	9/-	OC75	5/-
2N1302	4/6	AF139	15/-	BYZ12	6/-	OC76	2/6
2N1303	4/6	AF129	12/-	BYZ13	5/-	OC77	8/6
2N1304	5/-	AF186	11/-	GET102	6/-	OC81D	3/6
2N1305	5/-	AF212	11/9	GET103	6/-	OC82	4/6
2N1306	6/6	AS276	5/6	GET113	5/-	OC82D	4/6
2N1307	6/6	AS277	5/6	GET373	7/6	OC83	4/6
2N1308	6/6	AS278	4/6	GND3788	6/6	OC84	4/6
2N1309	9/6	AS279	4/6	MA101	5/6	OC89	4/6
2N1613	6/6	AS221	11/-	MAT101	5/6	OC89	4/6
2N1617	17/-	AUT10	39/6	MY210	4/3	OC92	12/-
2N1618	12/6	BA115	2/8	HAT21	5/6	OC10	4/6
2N1620	14/-	BA130	3/6	HPF102	9/6	OC17	4/6
2N1628	6/6	BA131	2/6	KNT210	4/5	OC20	6/6
2N1629	5/6	BA138	3/6	KNT212	4/5	OC20	6/6
2N2569A	7/6	BC108	2/9	KNT214	4/5	OC24	6/6
2N2646	10/-	BC108	2/9	NKT216	10/5	OC202	16/6
2N2696	6/6	BC108A	2/9	NKT217	10/5	OC203	16/6
2N2724	5/-	BC109	2/9	NKT218	10/5	OC203	16/6
2N2925	5/6	BC113	5/6	NKT262	4/3	OC205	8/6
2N2926	5/6	BC114	18/6	NKT264	4/3	OC206	8/6
Green	2/-	BC115	13/6	NKT271	4/3	OC207	10/6
Yellow	2/-	BC116	9/6	NKT272	4/3	OC271	16/6
Orange	2/-	BC118	18/6	NKT274	4/3	OC272	16/6
Red	2/-	BC125	14/-	NKT275	3/6	ORP61	8/6
3N3853	8/6	BC126	14/-	NKT276	3/6	ORP62	9/6
3N3854	15/-	BC127	14/-	NKT281	5/6	SK161	7/6
3N3855	15/-	BC147	6/6	NKT403	15/-	SK636	16/6
3N3702	4/6	BC148	6/6	NKT404	15/-	SK638	16/6
3N3703	4/6	BC149	6/6	NKT405	15/-	SK639	16/6
3N3704	4/6	BC154	12/-	NKT773	5/4	SYC1	17/4
3N3705	4/6	BC130	7/6	DAF74	4/6	CA46	8/6
3N3706	3/6	BCY31	9/6	OAS	3/8	P3A6	9/6
3N3707	4/6	BCY32	9/6	OAT70	1/6	EC402	4/6
3N3708	3/6	BCY33	4/6	OAT70	1/6	EC402	4/6
3N3709	3/6	BCY34	4/6	OAT73	1/6	EC402	4/6
3N3710	3/6	BCY38	6/6	OF79	1/6	C115	16/6
3N3711	4/6	BCY39	27/4	OAB1	1/6	C400	9/6
3N3819	9/6	BCY43	13/6	OB85	1/6	C411	45/9
3N3820	23/6	BCY54	15/3	OA90	1/6	ZC425	12/6
3N4058	7/6	BCY70	4/6	OA91	1/6	EA403	3/6
3N4059	6/6	BCY71	4/6	OA92	1/6	EA403	3/6
3N4060	6/6	BCY72	6/6	OA200	2/-	M1491	30/3
3N4061	6/6	BCY87	8/6	OA202	2/-	M1481	27/3
3N4062	6/6	BC211	10/4	OA210	2/-	6031	13/3
3N4254	9/6	BD119	15/6	OA2201	3/6	40362	16/6
3N4255	8/6	BD121	15/6	OA2202	3/6	ST140	5/-
2S018	8/6	BD124	17/6	OA2206	3/6	ST141	5/-
2S224	28/-	BF152	13/6	OA2207	7/6	—	—
2S24	15/-	BF124	9/-	OA2241	6/6	—	—

CHEAPEST EVER SOLID-STATE SALE

BEST VALUE IN BRITAIN

10 BFY50/1/2 Type NPN TO 5 Planar. Tested, uncoded. 10/-

40 Silicon Planar Transistors. TO-18 case. NPN and PNP mixed. Similar V4D5A, P346A, etc. Not tested or coded. Guaranteed minimum 50% good.

10 Silicon Planar PNP 3 watt similar BSX40 2N2904A, etc. TESTED. Not coded.

30 Silicon Planar Transistors. TO-18 case. NPN. type similar BC107/8/9 range. Not tested or coded. Guaranteed minimum 50% good.

3 Silicon Power Transistors similar to BUY11. TO-3 case. Not tested or coded. Gold plated cases.

20 Germanium Transistors 2G371B. Case SO-2. Fully tested to makers specifications PNP. Equal to OC71 range. Not coded.

25 Silicon NPN VHF Transistors. TO-18 case. Similar to BSY27, etc. Not tested or coded.

20 Silicon Planar Transistors. Plastic type. NPN. Similar to 2N3705/7 range. Not tested or coded. Guaranteed minimum 50% good.

20 Silicon Planar Transistors. Plastic type. PNP. Similar to 2N3702. Not tested or coded. Guaranteed minimum 50% good.

16 2N15 Rectifiers. Top-Hat case. 750mA + α 100-1,000 piv. Guaranteed minimum 80% good.

12 Silicon Avalanche Rectifiers. Top-Hat case 1 1/2 amp @ up to 1,200 piv. Guaranteed minimum 80% good.

15 Silicon Epitaxial Planar Diodes—Sub-miniature. Type SD19 Plessey. Exact substitute for 1N914. Case 100% perfect. Not coded.

30 Part made Top-Hat Rectifiers (top connection broken, but plenty room to solder) 750mA up to 800 piv. Guaranteed minimum 80% good.

2G371B and SD19 are Manufacturers' tested devices. Any other uncoded stock are given type numbers as a guide only. Money refunded if not satisfied.

All above packs post free in UK.

EXPORT SPECIAL: 10% of the above SALE goods are reserved for export until August 1969.



S-DeCs Single "DeC" with accessories and project manual. 29/6

"2-DeC" kit contains two "DeCs", component tray, accessories, instruction book, all packed in attractive plastic box. 99/6

"4-DeC" kit contains four "DeCs", accessories, manual, etc. 117/6

BOOKS FOR STOCK

"General Electric Transistor Manual", 660 pages of data and circuits. 29/6

"RCA Transistor Manual", 554 pages includes SCR circuits. 28/-

"Designers Guide to British Transistors". Excellent data book lists over 1,000 common types plus computer selected substitution chart. 25/-

(ADD 2/6 POST & PACKING FOR ALL BOOKS)

NEONS

Signal neons for many types of circuit type "N" Price 1/6 each 16/- dozen

HEATSHINKS. Suitable for 2 x OC35, etc. As used in commercial equipment. Type 10D 6/-

ALUMINIUM CHASSIS

6 x 4 x 2 1/2 in with reinforced corners 6/9 each (P. & P. 1/6). Ailly panel to fit, 1/6. Facilin panel to fit, 2/-. Many other sizes in stock up to 12 x 8 x 2 1/2 in (see catalogue)

X-LINE MODULES YOU CAN OPEN!

X-161 2 Watt Amplifier	35/-
X-461 Siren	38/-
X-471 Burglar Alarm	38/-
X-561 Microphone	38/-
X-761 Morse Oscillator	38/-
X-491 Lamp Flasher (Double)	38/-
X-361 Pic Transmitter	38/-
X-271 Telephone Transmitter	38/-
X-241 R-Flayr Transmitter	38/-
X-391 Guitar Transmitter	38/-
X-371 Wireless Sentries	38/-

Generous discounts to Retailers given on all X-line products. Send for details now.



SILICON RECTIFIERS

PIV	200mA	750mA	2 Amp	10 Amp
50	1/-	2/3	4/6	6/6
100	9d	1/6	2/3	4/6
200	1/3	2/-	2/9	5/-
400	2/-	2/6	4/-	8/-
600	—	3/-	4/6	9/6
800	3/-	3/9	11/3	600
1000	—	6/-	6/6	14/-

THYRISTORS - SCRs

PIV	1A	3A	10A	30A	100A
50	7/6	9/6	7/6	25/-	20/-
100	—	10/-	10/-	30/-	22/-
200	8/6	—	12/6	—	—
300	—	11/-	—	51/-	35/-
400	9/6	12/6	—	60/-	45/-
600	—	—	15/-	84/-	120/-
800	—	—	—	—	—

ZENER DIODES

1 Watt 10% Tolerance	12 ALL		
3-0	4-7	7-5	—
3-3	5-1	8-2	13 ONE
3-6	5-6	9-1	15 ONE
3-9	6-2	10	16
4-3	6-8	11	17
4-7	7-5	8	18

See IR Panel for 1 watt types. Full range 5 watt also in stock.

BC107/8/9 NPN 2/9

2N3819 TEXAS FET 8/-

5 page Data and Circuits

2N2646 DIODE-JUNCTION 10/-

Larger quantity prices (100+ and 1,000+ on application)

GRS3/40AF STD SILICON AVALANCHE TRIYRISTOR 400V 3A 12/6

25 + 11/- 100 + 10/3

SC41D BE TRIAG 400V 5AMP 37/-

TD716 TUNNEL DIODE 12/-

BF180 MULLARD DIFF AMPLIFIER 6/-

2N3055 115 WATT POWER SILICON NPN 15/-

25 + 13/- 100 + 11/-

2N2926 POPULAR PLANAR NPN 2/-

2N4871 MOTOROLA UNIJUNCTION 6/9

EQUIV. T1S49 2N2646, ETC.

LOGIC

1-6	7-11	12+	
uL900	11/-	9/6	8/4
uL914	11/-	9/6	8/4
uL923	11/-	12/6	11/9

5 page Data and Circuits

Larger quantity prices (100+ and 1,000+ on application)

LINEAR AMP. IC'S

CA3020 $\frac{1}{2}$ watt output 9 volt supply (price includes free circuit for Guitar/PA Amplifier!)

TAA263 Tiny Mullard linear only 17/6—data on request

CA3012 Wide band with built in regulation..... 27/6

CA3014 3 stage amp. with Darlington output..... 32/6

SL701 Plessey lin. amp. for PE circuits..... 18/-

ULTRASONIC TRANSDUCERS

Operate at 40kc/s. Can be used for remote control systems without cables or electronic links. Type 1404 transducers can transmit and receive.

FREE: With each pair our complete transmitter and receiver circuit.

PRICE: £5.18.0 Pair (sold only in pairs)

ZENER KIT

DD170 Bargain pack—contains 5 popular 1 watt diodes plus free project manual..... 19/6

TRANSISTOR SUBSTITUTION

Our TR01-C to TR10-C range are universal replacements for over 700 JEDEC (QN.....) types. Prices in our FREE Catalogue. FULL SEMICONDUCTOR CENTRE LISTINGS, DOZENS OF INTERESTING DEVICES IN OUR CATALOGUE.

COMPONENTS

RESISTORS 1 OR $\frac{1}{2}$ WATT 5% LOW NOISE CARBON FILM

10, 12, 15, 18, 22, 27, 33, 39, 47, 56, 68, 82 ohms and decades ($\times 10, \times 100, \times 1,000, \times 10,000$) 1 Meg each to 8.2 Megohms (10% tolerance. PRICES: 1-25, 44, 26-99, 34, 100+... 2d (per selection of 10 and/or 100 was mixed)

SKELETON PRESET POTS. 20% Tol. Linear. Low noise. Available in sub-miniature or standard size. Horizontal or vertical. 100, 250, 500, 1k, 2.5k, 5k, 10k, 25k, 50k, 100k, 250k, 500k. 1 Meg, 2.5 Meg, 5 Meg. NEAR PRICE: 1/- each or any selection of 12 pieces 10/-

ELECTROLYTIC CAPACITORS (Mullard)—10% to +50% Tol.

Subminiature (all values in uF)	8	32	64	125	250	400
4V	—	—	—	100	200	320
6.4V	—	—	—	16	32	64
10V	—	—	—	20	40	80
16V	—	—	—	25	50	125
25V	—	—	—	64	125	250
40V	—	—	—	4	8	16
64V	—	—	—	5	10	20
Price	1/6	1/3	1/2	1/-	1/1	1/2

MIN. POLYESTER CAPACITORS. Printed circuit type 250V d.c. working. 0.01, 0.015, 0.022, 7d each. 0.033, 0.047, 6d each. 0.068, 0.10, 9d.

VEROBARD 0-15in Matrix FLUX COATED 2 1/2 in x 3 1/2 in, 3 1/2 x 5 in, 3 1/2 x 3 1/2 in, 3 1/2 x 5 in, 5 x 5 in, 5 x 8 in, 8 in.

BARGAIN PACK of 36 square inches all good size pieces only 18/- each.

VEROBARD 0-15in Matrix. 3 1/2 in x 2 1/2 in, 3 1/2 in x 5 in, 5 in x 8 in, 36 pieces 3/-

VERO-CUTTER. 9/- each plus Free sample piece

I MUST SEND FOR THAT NEW L.S.T. CATALOGUE

L.S.T. 7 COPTFOLD ROAD BREXWOOD ESSEX

Prices quoted are current at time of going to press and may be subject to variation. Semi-conductors offered bear Manufacturers' original markings and are subject to our full replacement guarantee if not so published specifications. We DO NOT offer "Re-marked" semi-conductors. New catalogue available Mid-July. Post and Packing (Free class) 1/- per order. Retail and Trade supplied. Export enquiries particularly welcome.

TELEPHONE No. 388-3159

SINCLAIR

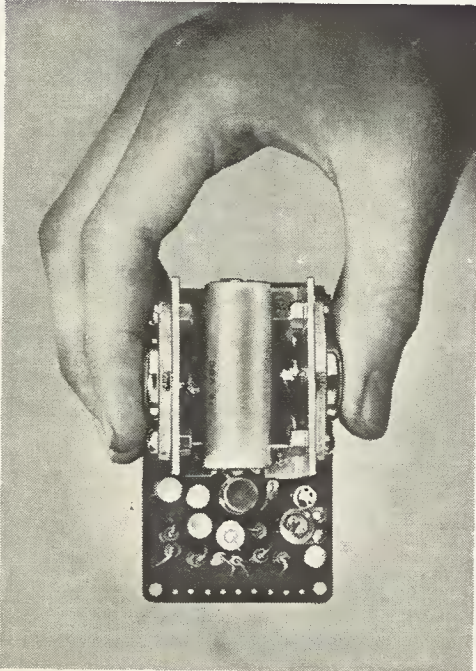

With Sinclair you can buy a total stereo assembly or choose units to add to or modify existing installations. Each of the products shown here is the result of intensive research and development, representing a new and original approach in each case to users' needs. Each product has achieved unsurpassed standards of performance, quality and value, while for individual radio listening, there is the very efficient Micro-matic, which is also the world's smallest radio.

Z.12 12 WATT HIGH-FIDELITY AMPLIFIER AND INTEGRATED PRE-AMP

SPECIFICATIONS

Compact, powerful 12W high fidelity amplifier and integrated pre-amp. 8 special transistors are used. The ultra-linear Class B output is suitable for loudspeakers from 3 to 15 ohms (two 3-ohm speakers may be used in parallel) Output power—12W R.M.S. continuous sine wave (24W peak) 15W music power (30W peak). Frequency response 15-50,000Hz. ± 1 dB. Input sensitivity 2mV into 2K ohms. Signal to noise ratio is better than 60dB. With power requirements from 6 to 20V d.c., the Z.12 can be run from a car battery or the P.Z.4 for example. Size $3 \times 1\frac{1}{4} \times 1\frac{1}{4}$ in. Supplied ready built, tested and guaranteed.

APPLICATIONS

Hi-fi system (2 required for stereo): car radio. P.A. systems: electric guitar: electronic organ: intercom system: record player: laboratory and industrial use, etc.

89/6

Q.14 HIGH FIDELITY LOUDSPEAKER

SPECIFICATIONS

Compact high-fidelity loudspeaker of outstandingly good performance and value it has smooth frequency response from 60 to 16,000Hz; loading capacity up to 14W R.M.S. Input impedance—4 ohms. With special drive unit in a sealed, seamless pressure chamber ensures excellent presence and transient response. Size—9 $\frac{1}{2}$ in square \times 4 $\frac{1}{2}$ in deep on pedestal base; black matt finish with aluminium bar trim. It is the speaker which has won so much praise from reviewers in the technical press.

APPLICATIONS

For good hi-fi audio systems: As hi-fi extension speaker(s) for listening in conditions of restricted space. May be shelf or wall mounted or positioned to maximum advantage in any environment.

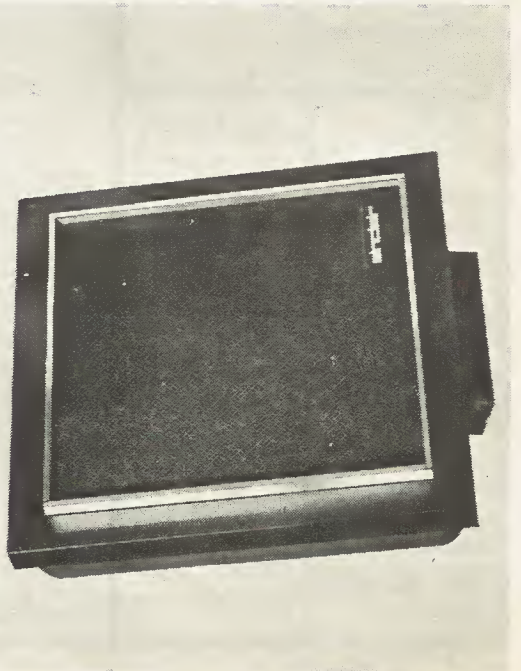

£7.19.6

+ 2/11 P/T Surcharge

STEREO 25 PRE-AMP AND TONE CONTROL UNIT

SPECIFICATIONS

Pre-amplifier and tone control unit with treble boost/cut from +12dB to -10dB at 10KHz, bass boost/cut from +15dB to -12dB at 100Hz. Stereo balance, volume and selector switch controls. Inputs—Mic. 2mV into 50K ohms, P.U.—3mV into 50K ohms, Radio 20mV into 20K ohms. P.U. input corrected to within ±1dB on R.I.A.A. curve from 50 to 20KHz. Front panel in brushed and polished aluminium. Size $6\frac{1}{2} \times 2\frac{1}{2} \times 2\frac{1}{2}$ in plus solid aluminium knobs.

APPLICATIONS

For use with two Z.12's and PZ.4, can also be used with other good stereo amplifier systems.

£9.19.6

PZ.4 STABILISED POWER SUPPLY UNIT

SPECIFICATIONS

Stabilised mains power supply unit, delivering 17.5V d.c at 1.5 amps. Assured constant output under severest operating conditions. For a.c. mains 200/250V 50Hz.

APPLICATIONS

Systems using one or two Z.12's and Stereo 25, etc.

99/6

SINCLAIR MICROMATIC

Britain's smallest radio. Measures only $1\frac{1}{2} \times 1\frac{1}{8} \times \frac{1}{2}$ in. Available as kit or ready built. Tunes by slow motion control over medium waveband with bandspread on higher frequencies for good reception of Radio 1. A.G.C. counteracts fading from distant stations. The powerful output is fed to the high quality magnetic earpiece provided. Power comes from two self-contained Mallory Mercury Cells Type RM.675 which give months of life with average use. In black case with aluminium front panel and dial.

Kit in fitted pack with ear-piece, solder, etc.

49/6

+11d P/T
Surcharge

Built and tested with magnetic earpiece

59/6

+11d P/T
Surcharge

Mallory Mercury Cell type RM.675 (2 required) 2/9 each

GUARANTEE

Should you not be completely satisfied with your purchase when you receive it from us, your money will be refunded, once and without question.

FULL SERVICE FACILITIES AVAILABLE TO ALL PURCHASERS.

Goods sent post free in U.K. and overseas by surface mail. Air-freight charged at cost.

Please send POST FREE

NAME

ADDRESS

For which I enclose cash/cheque/
money order

PE.869

SINCLAIR RADIONICS LTD., 22 NEWMARKET ROAD, CAMBRIDGE

O233 52731

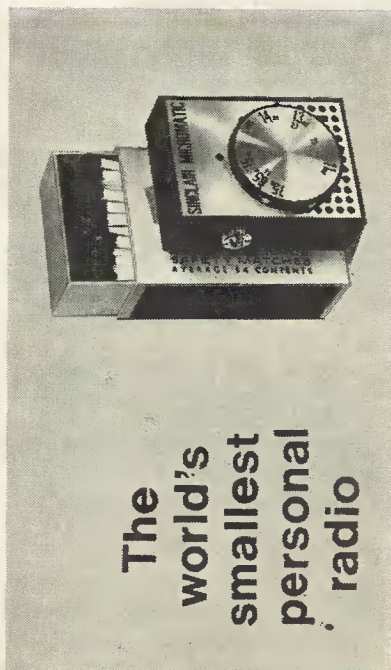
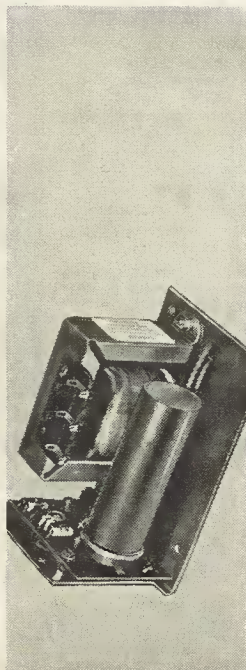
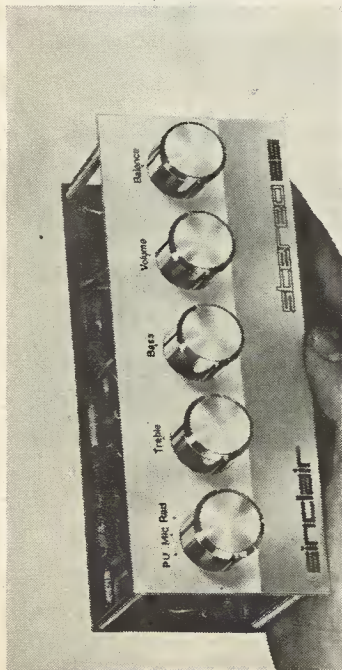

The world's smallest personal radio

Sinclair

SOLDER ON WITH



CN 15 Watts. Ideal for miniature and micro miniature soldering. 18 interchangeable spare bits available from .040" (1mm) up to 3/16" For 240, 220, 110, 50 or 24 volts. **from 32/6**

If you want the best in soldering, Antex irons are for you. Pin point precision, fingertip control, interchangeable bits that slide over the elements and do not stick, sharp heat at the tip, reliable elements and full availability of spares. World-wide users, both enthusiasts and professionals solder with Antex. It's time you joined them. Antex soldering irons are stocked by quality electrical dealers, or order direct from Antex by sending Cash. A free colour catalogue will be supplied on request.



PRECISION MINIATURE SOLDERING IRONS

Antex, Mayflower House, Plymouth, Devon.
Telephone : Plymouth 67377/8. Telex 45296. Giro No.258 1000



Model CN 240/2
15 watts - 240 volts

Fitted with nickel plated bit (3/32") and in handy transparent pack. From Electrical and Radio Shops or send cash to Antex.

31/-

Complete precision soldering kit



This kit—in a rigid plastic "tool-box" — contains everything you need for precision soldering.

- Model CN 15 watts miniature iron, fitted 3/8" bit.
- Interchangeable spare bits. 3/32", 1/8", 3/16".
- Reel of resin-cored solder
- Felt cleaning pad
- Stand for soldering iron
- Space for stowage of lead and plug

PLUS 36-page booklet on "How-to-Solder"—a mine of information for amateur and professional.

From Electrical and Radio Shops or send cash **49/6** to Antex.



G 18 watts. Ideal for miniature work on production lines. Interchangeable spare bits. 3/32", 1/8", 3/16", and 1/4". For 240, 220 or 110 volts. 32/6.



E 20 watts. Fitted with 1/4" bit. Interchangeable spare bits 3/32", 1/8", 3/16". For 240, 220, 110 or 24 volts. from 35/-



ES 25 watts. Fitted with 1/8" bit. Interchangeable bits 3/32", 3/16" and 1/4". Ideal for high speed production lines. For 240, 220, 110, 24 or 12 volts. from 35/-



F 40 watts. Fitted 5/16" bit. Interchangeable bits 1/4", 3/16", 1/8", 3/32" Very high temperature iron. Available for 240, 220, 110, 24 or 20 volts. from 42/6 Spare bits and elements for all models and voltages immediately available from stock.

- Please send me the Antex colour catalogue
 Please send me the following irons

Quantity	Model	Bit Size	Volts	Price
.....
.....
.....

To: Antex, Mayflower House, Plymouth, Devon

I enclose cheque/P.O./cash value

NAME

ADDRESS

P.E.8 Telephone:

OUT OF SPACE

THIS is the day and age of instant communication, and nowhere is this better epitomised than in space exploration. Some of the impact the imminent moon landing should have on us earth dwellers will be blunted through familiarity with previous space voyages brought right into our homes by television. It is all so matter-of-fact, or so the marvels of electronics make it seem to the viewing millions. Let us hope minds will not be too jaded to sense the magnitude of the achievement and to thrill to the momentous occasion when man sets foot on earth's own satellite, the moon, for the first time.

Yet we fear discordant voices will be heard again, even on this unique occasion. One of the charges that could be made against instant communication is the ease with which minds can be conditioned by over exposure to the television screen. So it is to be expected that a chorus of complaints will arise from some of those temporarily deprived of their favourite programme. There are those who are intolerant of any disturbance of their cosy dream world populated by fictional characters, whose performances as often as not are pre-recorded and later resuscitated from film or video tape by electronic devices. The live show going on in space has tough competition!

Communications systems are the life line of every space project, and not only manned spacecraft. The less spectacular unmanned satellites perform a variety of useful functions. The communications satellites have been much in the public eye, since they already contribute regularly to the relaying of television programmes, amongst other services. Less is generally known about the proposed remote sensing satellites.

These, it is forecast, could perform broad scale surveys of earth agricultural, forestry, and mineral resources; and gather data about ocean currents, movement of icebergs, flow rate of rivers, and so on. With their aid it would be possible to obtain data from areas of the earth not otherwise accessible to man.

A host of specially developed electronic instruments would be carried in these survey satellites. Included would be sensors operating in all parts of the electromagnetic spectrum: long waves through to microwaves, and infra-red and light waves. Neither the land regions nor the ocean depths would be able to conceal their secrets from these electronic or photographic eyes.

The vast expenditure on space is often challenged, and the value of the return in the form of commercial "spinoffs" open to question. Nevertheless it would be churlish to deny the exciting prospect of international economic betterment opened up through the use of data collecting satellites, which would have the whole globe under surveillance.

F. E. Bennett—Editor

THIS MONTH

CONSTRUCTIONAL PROJECTS

SPRING LINE REVERBERATION UNIT	566
R.F. WATTMETER	580
SPLIT PHASE CONDUCTIVITY BRIDGE	587
P.E. ORGAN—4	596

SPECIAL SERIES

OPERATIONAL AMPLIFIERS—3	608
--------------------------	-----

GENERAL FEATURES

ELECTRONICS FOR THE BOAT OWNER	572
-----------------------------------	-----

NEWS AND COMMENT

EDITORIAL	565
SPACEWATCH	579
COMPONENTS 69	582
POINTS ARISING	586
ELECTRONORAMA	594
READOUT	616

*Our September issue will be published on
Friday, August 15*

© IPC Magazines Limited 1969. Copyright in all drawings, photographs and articles published in PRACTICAL ELECTRONICS is fully protected, and reproduction or imitations in whole or in part are expressly forbidden.

All reasonable precautions are taken by PRACTICAL ELECTRONICS to ensure that the advice and data given to readers are reliable. We cannot, however, guarantee it, and we cannot accept legal responsibility for it. Prices quoted are those current as we go to press.

Subscription Rates including postage for one year, to any part of the world, 42s.
All correspondence intended for the Editor should be addressed to Tower House, Southampton St., London, W.C.2. Phone: 01-836 4363.
Address correspondence regarding advertisements to Advertising Manager, Fleetway House, Farringdon St., London, E.C.4. Phone 01-236 8080.

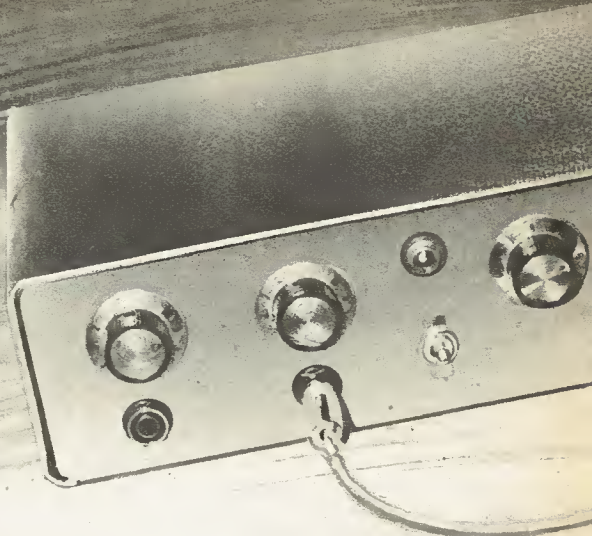
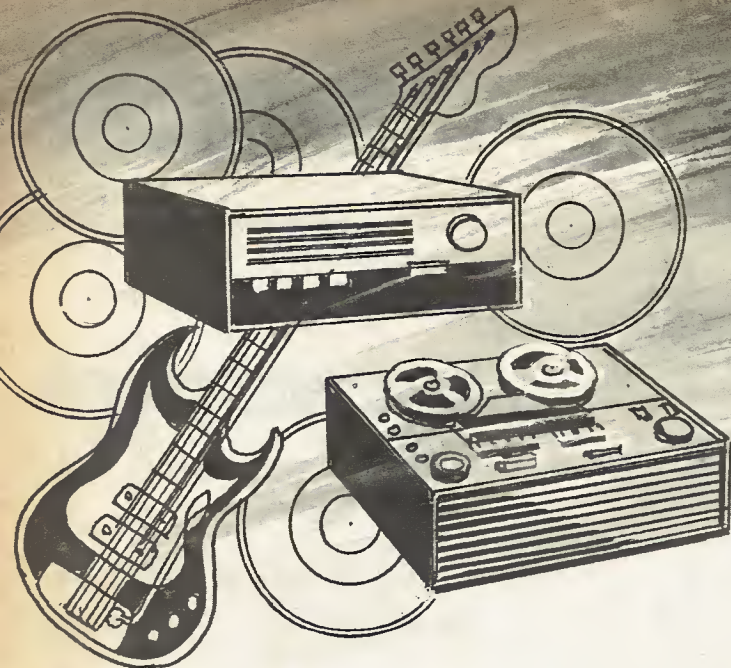

SPRING LINE REVERBERATION

THE SPEED of sound through air, water, and metal is quite slow when compared with its speed in the form of an electrical signal through wires. Good use can be made of this to create echo and reverberation, by employing an arrangement like that shown in Fig. 1. Here the direct electrical sound signal is mixed with its delayed acoustic counterpart after the latter has travelled via the loudspeaker and microphone. This is the principle of the so-called "echo chamber".

However, the real object of the system is not to create separate and distinctive echoes, like those obtained with a magnetic tape system, but rather a series of very short duration echoes gradually, but eventually, completely dying away.

This is called reverberation and is achieved by the use of hard surfaced walls which cause the sound to bounce backwards and forwards until it decays completely. A degree of reverberation varying from that of a small room to a large church hall can be produced by controlling a mixture of the reverberant and direct signals.

A rather more sophisticated but very expensive arrangement, known as metal plate reverberation, is now used by recording and broadcasting studios. The idea is similar to that of the echo chamber illustrated in Fig. 1 but employs metal instead of air as the delay medium.

The main component is a thin steel plate approximately 6ft by 3ft suspended in a tubular metal frame (see Fig. 2). The plate is excited into vibration at one end by means of a moving coil driving unit and these vibrations are picked up at the other end by special contact microphones. However, the vibrations continue to travel backwards and forwards along the plate until they die away, thus producing the "reverberation" effect previously described.

The spring line system (Fig. 3) operates in much the same way as a plate reverberator, the echo time being a few milliseconds, but the reverberation time is long—up to about two seconds. The spring line is driven by an electro-magnetic unit and the signals are picked up at the far end by another. The signals from the line output are mixed with the direct signals as in Fig. 4.

A spring line reverberator requires fairly large signals to drive it and, since the output signals are small, these must be amplified to bring them to a level approximately equal to the direct signal. A block diagram of the system is shown in Fig. 4.

SPRING LINE REVERBERATION

The circuit given in Fig. 5 employs a spring line unit type HR42 (see components list). Reverberation times from a fraction of a second up to approximately 2.5 seconds are available and with the reverb. control off the through signals are of course "dry", i.e. no reverberation. The unit can therefore be used to simulate reverberation varying from that of a small room to a large empty hall.

Two medium impedance inputs are provided, each of which can be mixed, the input signal requirements being from about 100mV minimum up to 1 volt maximum. The input signals are first amplified by TR1 and TR2, the output from TR2 being divided through R9 to the line driver TR5 and through R10 to the output amplifier TR3 and TR4.

The output signals from the spring line unit are first amplified by TR6 and TR7 and then returned via the reverb. control VR4 and R11 to the output amplifier. The direct and reverberated signals are therefore mixed at the junction of R10 and R11.

As the signals from the spring line unit are added to the direct signals, it is quite easy to overload the output

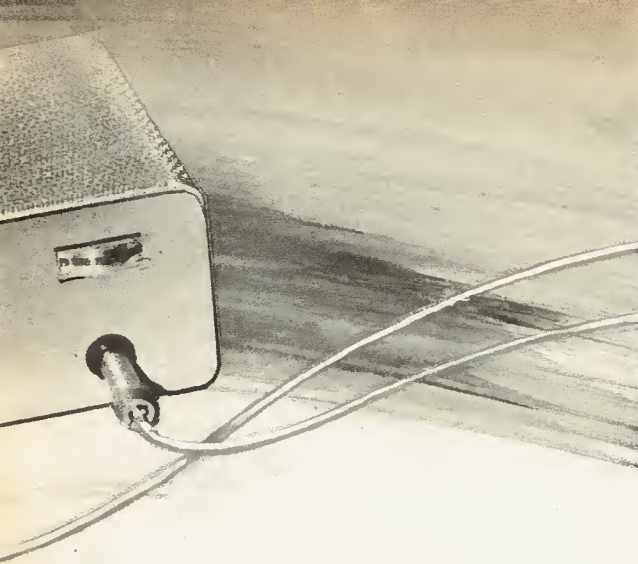

UNIT

By F. C. JUDD

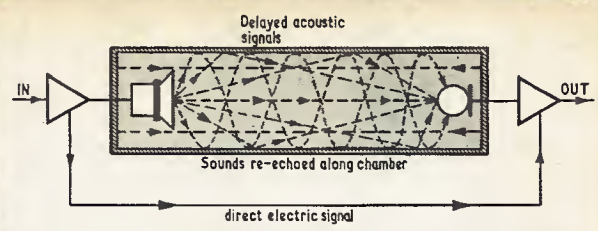

Fig. 1. The echo chamber system in diagrammatic form with the direct bypass line

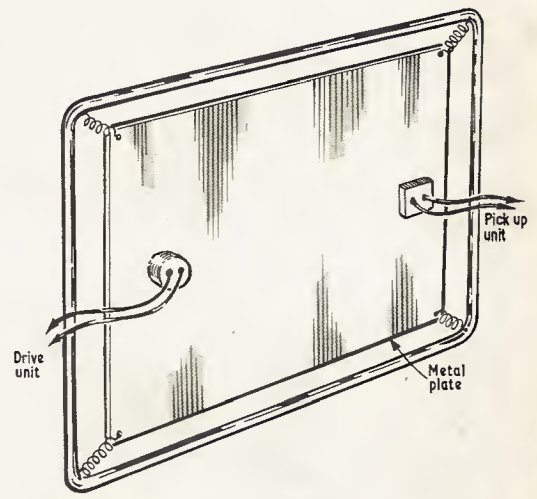

Fig. 2. Basic idea of the metal plate reverberator

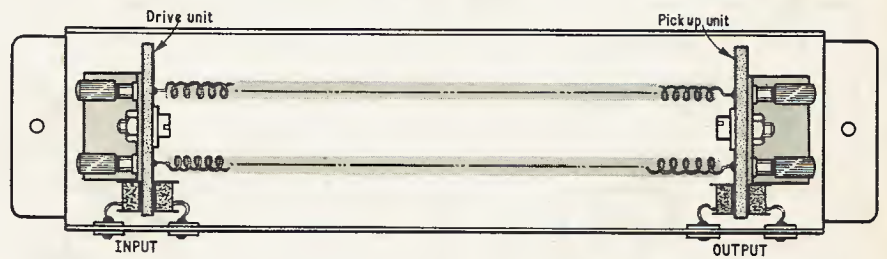

Fig. 3. Basic spring line reverberation system

SPECIFICATION . . .

Frequency range	20 to 20,000kHz
Frequency response	-3dB at 20Hz, -2dB at 20kHz (ref. level at 1kHz)
Distortion (without reverb.)	Less than 0.5 per cent
Reverb. frequency range	Approx. 100 to 4,000Hz
Signal to noise ratio	Better than 50dB
Minimum input required with VR1 or VR2 set to full gain	100 to 150mV
Maximum signal output	1 volt
Input impedance (either channel)	10 kilohms
Output load impedance	Not less than 1,000 ohms or 600Ω at reduced output signal level)

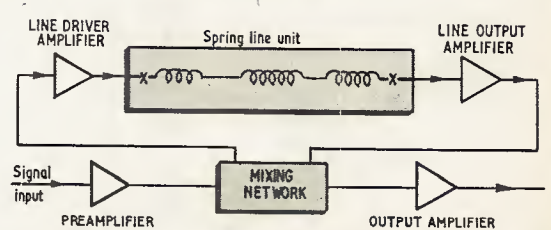

Fig. 4. Block diagram of the complete spring line reverberation system described in this article

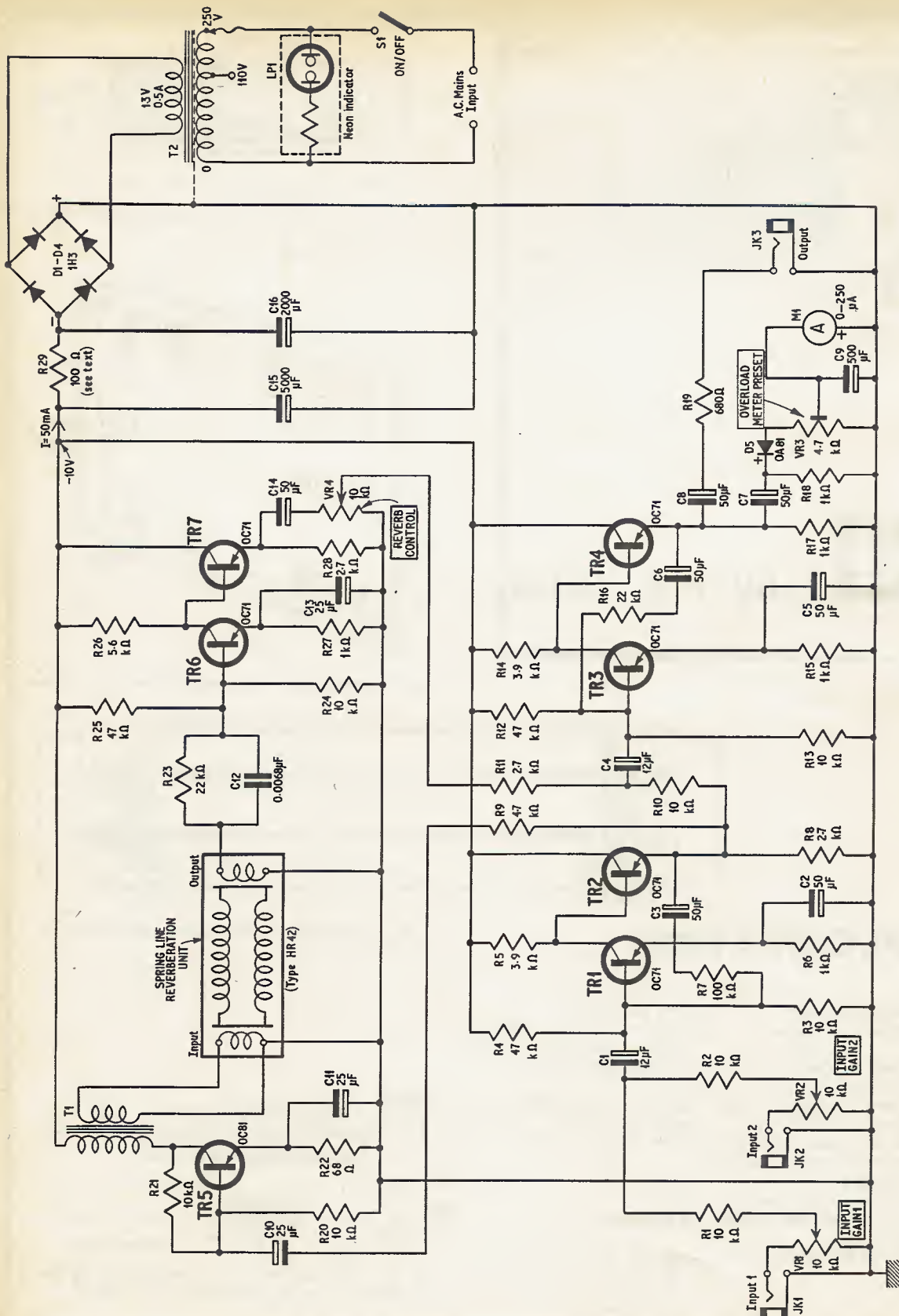

Fig. 5. Circuit diagram of the complete spring line reverberation unit

COMPONENTS . . .

Resistors

R1 10k Ω	R11 2.7k Ω	R21 10k Ω
R2 10k Ω	R12 47k Ω	R22 68 Ω
R3 10k Ω	R13 10k Ω	R23 22k Ω
R4 47k Ω	R14 3.9k Ω	R24 10k Ω
R5 3.9k Ω	R15 1k Ω	R25 47k Ω
R6 1k Ω	R16 22k Ω	R26 5.6k Ω
R7 100k Ω	R17 1k Ω	R27 1k Ω
R8 2.7k Ω	R18 1k Ω	R28 2.7k Ω
R9 4.7k Ω	R19 680 Ω	R29 100 Ω
R10 10k Ω	R20 10k Ω	

(see text)

Potentiometers

VR1 10k Ω log.
VR2 10k Ω log.
VR3 4.7k Ω or 5k Ω log. preset
VR4 10k Ω log.

Capacitors

C1 12 μ F elect. 25V	C9 500 μ F elect. 25V
C2 50 μ F elect. 12V	C10 25 μ F elect. 15V
C3 50 μ F elect. 12V	C11 25 μ F elect. 15V
C4 12 μ F elect. 25V	C12 0.0068 μ F paper 200V
C5 50 μ F elect. 12V	C13 25 μ F elect. 15V
C6 50 μ F elect. 12V	C14 50 μ F elect. 12V
C7 50 μ F elect. 12V	C15 5,000 μ F elect. 15V
C8 50 μ F elect. 12V	C16 2,000 μ F elect. 25V

Transformers

T1 3.75:1 2 watt car radio output transformer; secondary 3 to 5 ohms (Repanco type TT12)
T2 Primary 0-110, 250V mains; sec. 13V 0.5A with electrostatic screen. Type PS12/5

Spring Reverberation Unit

Model HR42 (full details in Henry's Radio catalogue)

Transistors

TR1, 2, 3, 4, 6, 7 OC71 (6 off)
TR5 OC81

Diodes

D1 to 4 30V 400mA Contact cooled bridge rectifier type 1H3 (one unit)
D5 OA81

Meter

M1 250 μ A 280 ohms level meter type V250

Lamp

LPI Neon mains indicator with ballast resistor
--

Switch

S1 Single-pole, on/off, toggle

Jacks and plugs

JK1, JK2, JK3 Tip and sleeve standard jacks with screened plugs

Miscellaneous

Perforated s.r.b.p. 0.15in pitch without copper strips 5in \times 3in (2 off)
Angle aluminium strip $\frac{3}{8}$ in to support perforated boards
Aluminium case 11 $\frac{1}{4}$ in \times 6 $\frac{1}{2}$ in \times 3 $\frac{1}{2}$ in (Electroniques type 2222)
Control knobs with numbered skirts

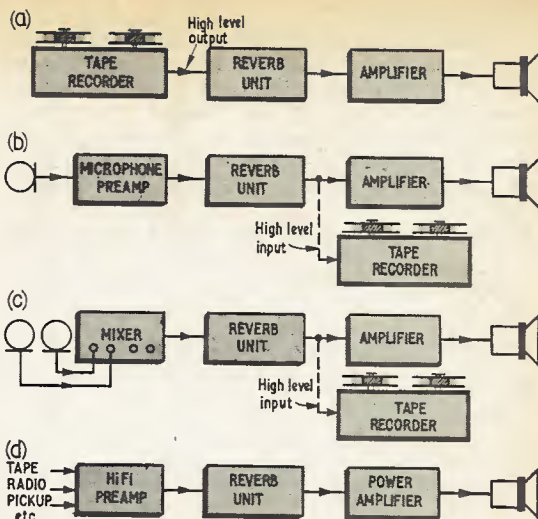

Fig. 6. Various ways in which the unit can be used: (a) adding reverb to a pre-recorded tape; (b) recording from a microphone; (c) mixing two microphone signals for recording; (d) adding reverberation effects to any sound source

mixing amplifier. An overload meter has therefore been provided which can be adjusted by the preset control VR3 to indicate the onset of overload when the pointer reaches approximately 0.75 of full scale reading.

The meter should have a 250 μ A movement; the one chosen for the prototype reverb unit has a horizontal scale type used for recording level indication on tape recorders. It is coloured red above about 0.75 of full scale. An ordinary round scale meter could of course be used.

PERFORMANCE

As the current consumption of the unit is a little on the high side (50mA) for economical battery operation, a mains power supply consisting of T2, the bridge rectifier D1 to D4, and the smoothing components C15, C16 and R29 have been included.

The ample smoothing ensures negligible ripple on the supply, in fact the total hum and noise level of the unit is around 50dB below an output signal level of 1 volt. Note that the value of R29 may have to be adjusted slightly to obtain the correct line voltage if the supply transformer is other than that used for the prototype (see components list).

The frequency range of the unit extends from 15Hz to well over 20,000Hz, the response being -3dB at 20Hz and -2dB at 20,000Hz (reference 1,000Hz). Note that the response of the spring line amplifier section has been adjusted to suit the characteristics of the HR42 unit. The performance of the unit is given in the specification.

The circuit provides for fairly flexible use; for instance, it can be fed from signal sources with impedances ranging from about 600 ohms up to one megohm or so, and it can be coupled to a following amplifier or tape recorder with input impedances ranging from about 1,000 ohms to a megohm or more.

The prototype has been tested with microphone mixers, tape recorders and amplifiers of different types and can be used in various ways as shown by the block diagrams in Fig. 6. The unit has insufficient sensitivity for the direct connection of microphones or pick-up cartridges; a pre-amp will be necessary to achieve the required signal level in this case.

CONSTRUCTION

The entire circuitry was built in an Electronics aluminium case type 2222, as shown in the photographs. Details of the panel layout and the distribution of the amplifier boards and power supply components within the case are given in Fig. 7. The two amplifier sections are assembled on perforated s.r.b.p. boards cut to size and fitted with a mounting bracket as shown in Fig. 7.

The layouts of the components on the two amplifier

boards shown in Figs. 8 and 9 are as used in the prototype. Note that the components for the overload control (C7, C9, R18, the meter rectifier D5 and pre-set control VR3) are located on board B. The OC81 transistor (line driver) on this board must be provided with a wrap round type heat sink.

It is most important that the spring line unit is mounted with the output end furthest from the mains transformer T2, otherwise there is a risk of hum being induced in the spring line pick-up coil.

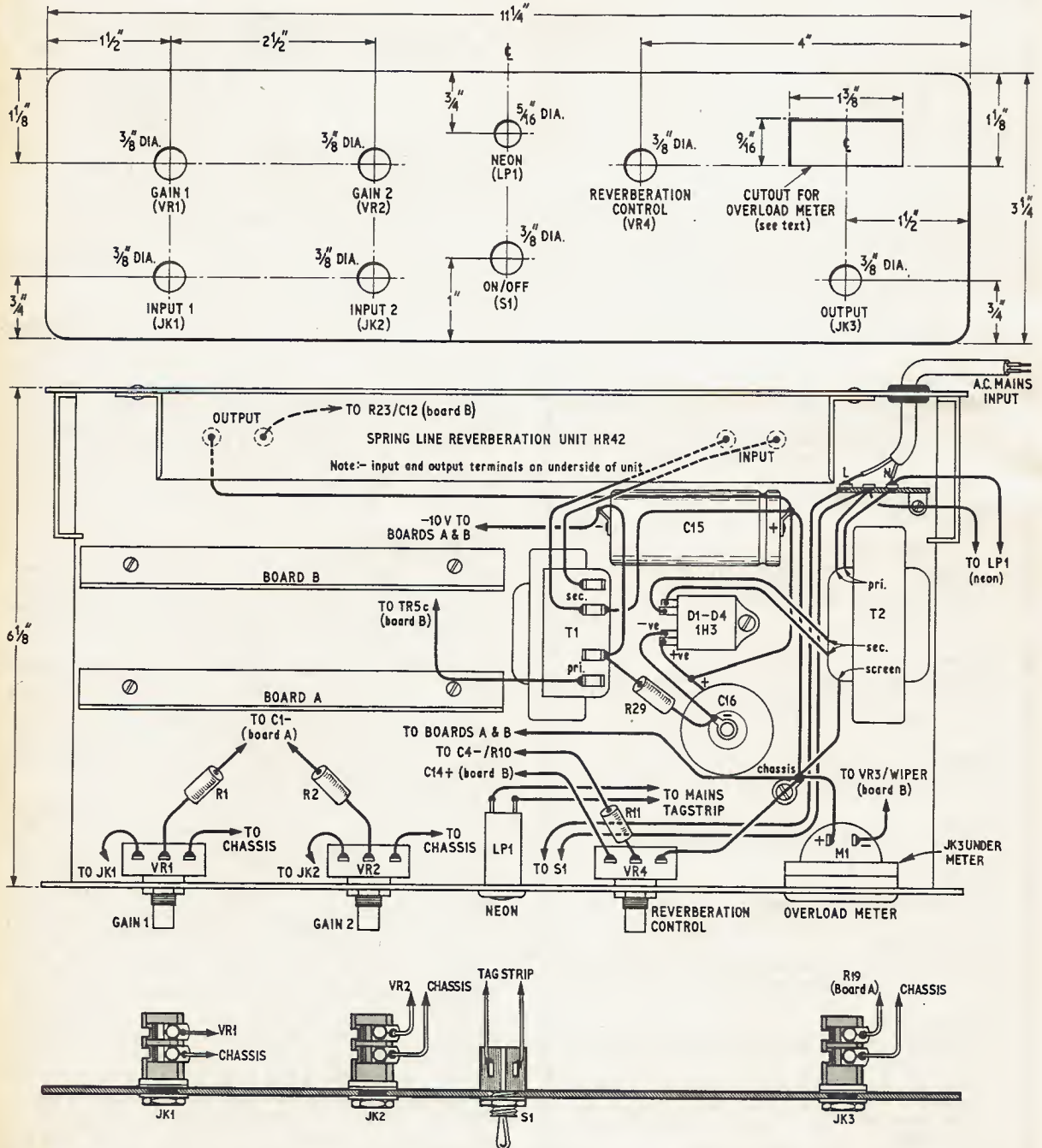

Fig. 7. Drilling details for front panel and layout of boards and components in the case

TESTING THE UNIT

A satisfactory performance will be obtained if the unit can be tested with an audio signal generator and high impedance transistor or valve voltmeter. First test the unit with the reverb control off.

With an input signal of 100 to 150mV r.m.s. (either input) the output should be approximately 1 volt r.m.s. The input gain control in use should be at maximum for this.

Now reduce the input signal until the output level is approximately 300mV. The preset control VR3 is now adjusted until the overload meter reads approximately half scale. The onset of overload will be indicated (with or without the reverb on) when the meter reads approximately 0.75 full scale or at the beginning of the red section if the meter is as indicated in the components list.

The frequency response curves given in Fig. 10 may be useful for checking each of the amplifier sections. The overall response is of course that between input and output with the reverb control turned off.

The response of the spring line driver amplifier only (TR5) can be checked between C10 and the secondary of T1, and should approximate to that shown in Fig. 10.

The response of the spring line output amplifier TR6/TR7 can be checked between the input to C12/R23 (with the spring line disconnected) and the output at the

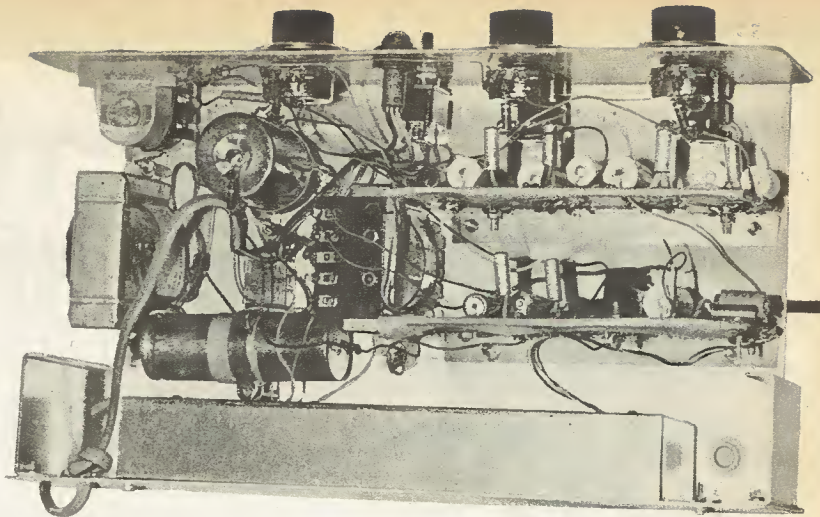

The interior showing the position of the circuit boards, the spring line unit and the layout of the power supply components, etc.

junction of VR3 and C14. The response should approximate to that in Fig. 10 and has been adjusted to suit the characteristics of the spring line unit.

REVERB UNIT IN USE

A unit of this nature is intended for the simulation of reverberation in varying degrees ranging from that of a small empty room to the longer and slightly more hollow sounding reverberation of a large hall.

If used excessively, especially on music, the effect can be unpleasant or at least unnatural. The real object of this form of reverberation is to introduce an effect, i.e. to simulate changes in acoustic environment, in plays for instance, where the speaker moves from the open air to an interior.

It can also be used by vocalists to create the "singing-in-a-cathedral" sound which is perhaps more pleasant than the tape-head type of echo for this particular application.

One final point concerns the placement of the unit when in use. Spring lines are very sensitive to mechanical vibration and can give an effect like valve microphony. Do not place the unit too close to a loudspeaker that carries reverberated signals. Avoid knocking the unit whilst it is in use; it may be worthwhile standing the unit on a rubber cushion.

Finally, a note on components: all components are readily available. Deviation from the recommended types in the components list could result in inadequate performance compared with the given specification. ★

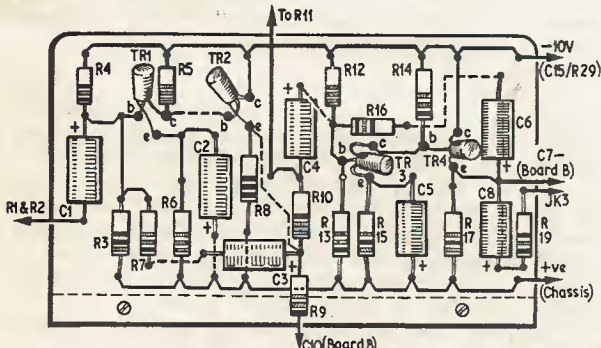

Fig. 9. Assembly board "A". Layout of components for the input and output amplifiers

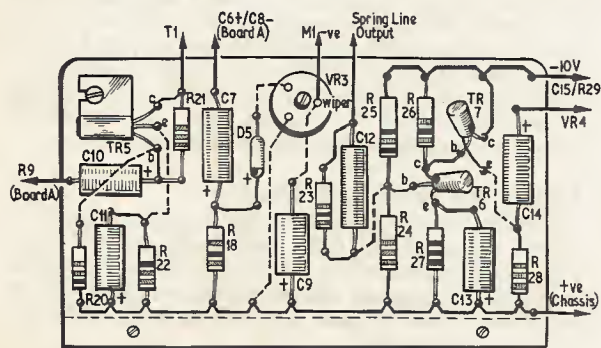

Fig. 8. Assembly board "B" layout of components. This contains the spring line driver amplifier, its output amplifier and the components for the overload meter

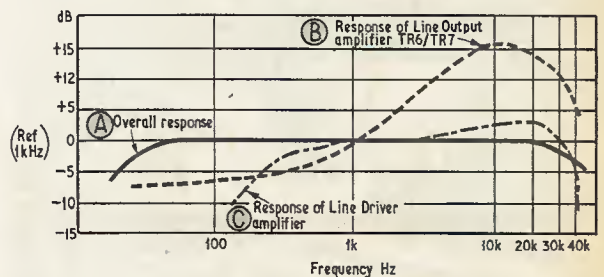

Fig. 10. Frequency responses: (a) overall response of the spring line reverberation unit; (b) line output amplifier and (c) line driver amplifier



ELECTRONICS for the BOAT OWNER

By M. Kenward

AVAILABLE RANGE OF EQUIPMENT

Over the last ten years the introduction of electronic navigational and emergency warning devices to craft of all sizes has become more widespread. Specialist electronic firms have done much for the development of suitable equipment in this field and now produce high quality units that have been carefully designed, manufactured and tested with the smaller boat owner in mind.

The evolution of the highly scientific racing yacht has also brought about electronic racing aids. The use of electronics in racing yachts is restricted in the various classes but nowadays most of the cruising classes and the boats in the junior offshore group are well equipped with various instruments as are the larger offshore power boats.

Instruments showing relative wind direction to boat heading and boat speed are now available for the smaller craft and are beginning to be introduced in racing dinghys, although their use has recently been restricted.

The first and main interest of the larger yacht owner is one of navigation and positional "fixes" especially during bad weather. The range of electronic equipment now available for this purpose is vast and covers a field from electronic gyroscopic compasses and marine radar as used in large vessels, down to direction finding (d.f.) accessories that can be used with transistorised radios.

Nowadays marine radar is fairly standard on the larger motor yachts (for those who can afford such luxuries) and one system that appears repeatedly is the Decca 101. The photograph shows a typical installation with the aerial and transceiver unit mounted on the cabin roof and the display and power supply units inside the cabin. The major advantages of this system is the absence of wave-guide and the associated installation problems that can often be very costly.

AIDS FOR SMALLER CRAFT

Coming down in boat size to the now very popular 15 to 30ft range. Many firms manufacture small "aids" to the yachtsman which are mainly operated from their own internal batteries. These instruments are designed to be water resistant and can thus be mounted in the cockpit if so desired.

Most firms list instruments covering the range, boat speed and distance travelled through the water (not allowing for currents), depth of water, apparent wind

MANY thousands of small craft are driven, blown, rowed and even pedalled off shore, up-river or around lakes every weekend and, as with almost every other sport, electronics is there if required to aid every captain and helmsman.

Many of the smaller craft that are used for racing and cruising from the host of clubs both on inland waterways and around the coast find little call for electronics aboard. Often these craft are protected by various electronic aids supplied by their clubs and by such people as the coast guards, the R.N.L.I., the R.N. and the R.A.F.

Owners of larger craft do however find a greater need for electronic aids of one kind or another.

The Decca 101 marine radar installed in a yacht. The display unit can be seen through the cabin window



direction (in two scales—one for sailing “on the wind”), and windspeed indicators.

Recently introduced equipment by Brookes and Gatehouse is the “Hadrian” automatic dead reckoning computer and the “Helios” radio compass.

The d.r. computer is an innovation in the range of electronic gear for small craft and has been designed for use with the Harrier log and Hestia electronic compass from the same firm. This computer has an accuracy, depending on the calibration of Harrier and Hestia, of 180ft per mile sailed maximum (neglecting errors in tidal and leeway allowances).

Repeater meters are available for most of the instruments and some firms market special housings for mounting repeaters. The bottom photograph shows a typical layout of instruments in a modern racing yacht. The cost of such an installation would be in the region of £400 to £1,000.

As any readers who are also concerned with such racing craft will know, these instruments are now considered necessary by owners and the cost is just another addition to their already expensive sport.

Many readers may have previously considered the possibility of constructing their own instruments and some suggestions will be made later in this article. A great saving in cost can be achieved by constructing some of the various aids.

For the dinghy sailor and runabout owner, the range of electronic instruments is limited and many people argue that these instruments detract from the enjoyment of small boat sailing. However, instruments such as boat speed and revolution counters for power craft and apparent wind direction indicators for sailing dinghys are available although, unless these devices are home constructed, the price may be prohibitive.

Commercial equipment can cost as much as a small boat—about £60 for a wind indicator. Such instruments are normally only used by the “experts”. Once again, boat owners must check if such instruments are allowed by class rules if they are to be used when racing.

RADIO EQUIPMENT

Radio equipment for small craft can mean anything from a small emergency distress signaller—not necessarily a communication link—to a telephone transmitter-receiver. There are many firms marketing equipment in this range and the price of distress beacons is no longer prohibitive when one considers their life saving ability.

The photographs in this article show examples of distress and radio equipment used by small craft. Most small receivers are available with d.f. equipment and some have this facility built in.

Generally radio direction finding equipment relies on the operator getting a null indication, either on a meter or earphones, of the signals transmitted by the various navigational beacons around the coast and, in the case of aircraft beacons, inland. This process has the disadvantage that the result is ambiguous and the operator has a choice of two directly opposite readings; however, results can be verified by taking a second reading on another beacon.

It should be pointed out that such instruments cannot give an exact positional “fix”; they are intended as an aid to navigation and are in this respect excellent instruments.

DESIGN POINTS FOR THE CONSTRUCTOR

The amateur constructor in this field must restrict himself to the more simple equipment and, unless



The Nova Pal portable radio direction finder. This instrument receives three radio frequency bands: beacon, broadcast and marine. It has a built in d.f. aerial (on top) and a distress signaller

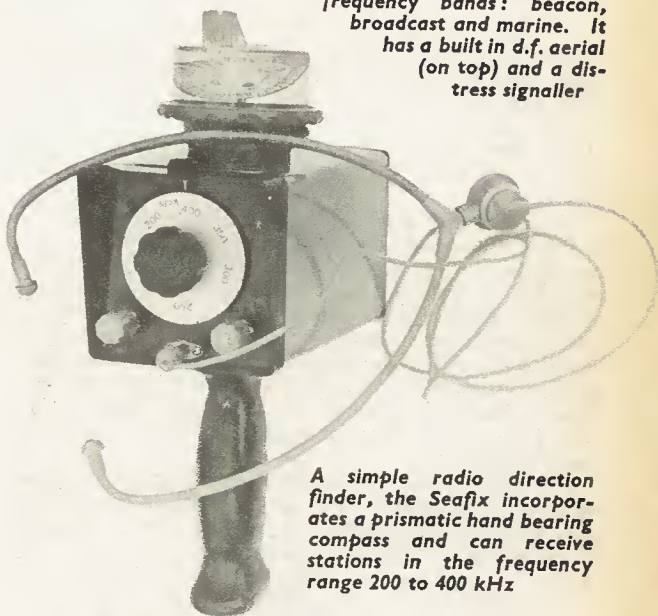

A simple radio direction finder, the Seafix incorporates a prismatic hand bearing compass and can receive stations in the frequency range 200 to 400 kHz

A complete installation of Brookes and Gatehouse instruments showing repeaters mounted in a special console where they are easily seen by the helmsman. The navigator is shown taking a radio fix on a beacon

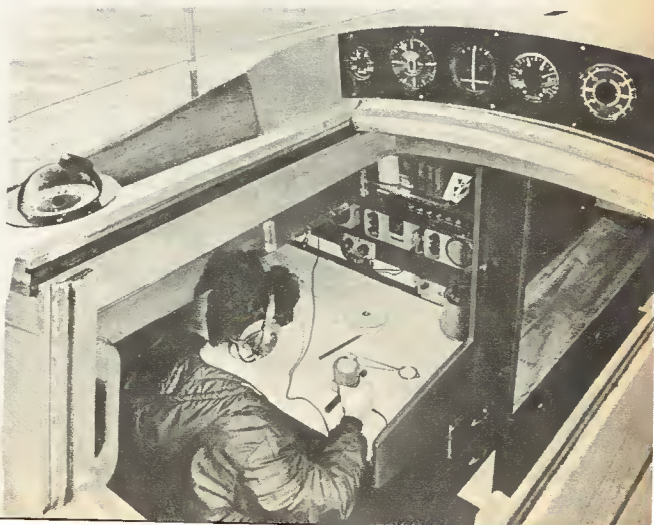

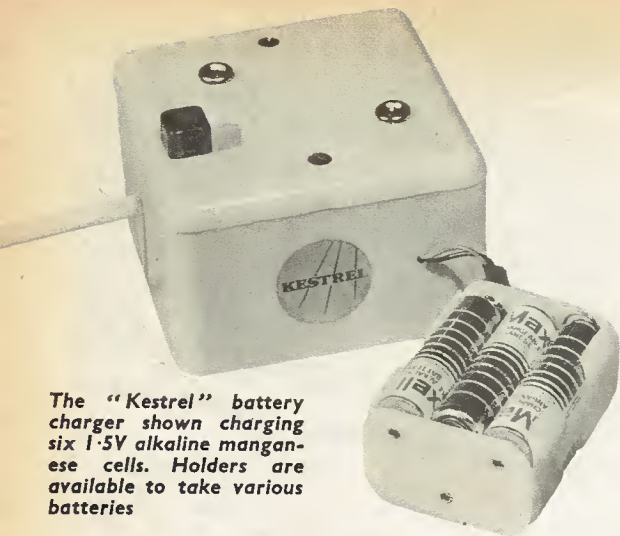

The "Kestrel" battery charger shown charging six 1.5V alkaline manganese cells. Holders are available to take various batteries

calibration facilities are available to him, equipment upon which his safety does not depend! Although this rules out such instruments as direction finders and possibly depth sounders, because of the circuit complexity and the need for accurate readings, the constructor still has a large range of possibilities open to him.

There are, of course, certain special considerations to be made when designing and building equipment to be used afloat. The major factors to be taken into account are those concerned with protecting equipment from the elements, shock and misuse.

When installed in small craft the instruments are very likely to get sprayed or even covered in salt water and protection must be afforded them for this reason. Careful choice of material for cases and meters is a must and all materials should be protected by a marine paint of some kind.

The shock factor may at first seem slightly odd but after sailing in a small boat, punching into a heavy sea, this suggestion will appear more reasonable. Shock also comes under the term misuse.

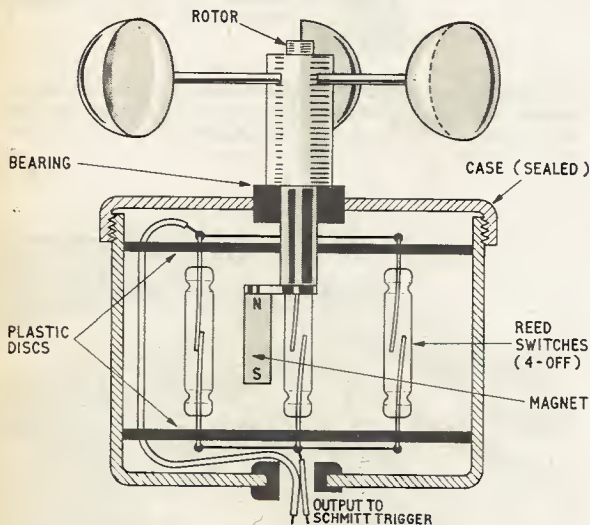

Fig. 1. Mechanical construction of wind speed indicator using reed switches

Many sailors have no knowledge of electronics and if a reading is disbelieved the unknowing person will flick switches and try to "persuade" the instrument to correct itself with a friendly "pat on the back".

Not all boats use the same supply voltage; on most small craft this can be 12, 24 or 36 volts. This voltage must be checked before the circuit is designed and fitted if it is to be supplied from the boat's internal power.

Many proprietary devices are equipped with internal batteries (but this can prove expensive) and a battery voltage checking facility should be provided. There are some small battery chargers now available for recharging alkaline manganese cells and these can result in a saving of battery costs—one unit for this purpose is the "Kestrel" battery charger available from DCB Instruments and Lighting as shown left.

A few items that the home constructor, having some knowledge of electronics, should be able to construct and install are given below with suggested operational methods and the various difficulties that may arise. (This magazine hopes to be able to publish some constructional articles of the following nature in the future—Ed.)

It is suggested that all the electronic parts of the various aids are enclosed in die-cast metal cases of the type often used for "normal" electronic work. These cases should be carefully painted both inside and out and as few holes as possible made in the outer surface; lids should be sealed by thin strips of rubber.

Protection to the circuit board itself can be carried out in many ways but generally this prevents components being changed and should not be necessary if the case is carefully sealed.

WIND SPEED INDICATOR

The main design problem connected with the wind speed indicator is the type of "transducer" to be used. One of the easiest ways of measuring wind speed is to convert the revolutions of a normal anemometer speed indicator into electrical pulses and measure the frequency of the resultant output.

The conversion of rotation to an electrical signal must be done with little or no friction being applied to the rotor. Two possible methods of arranging this conversion are:

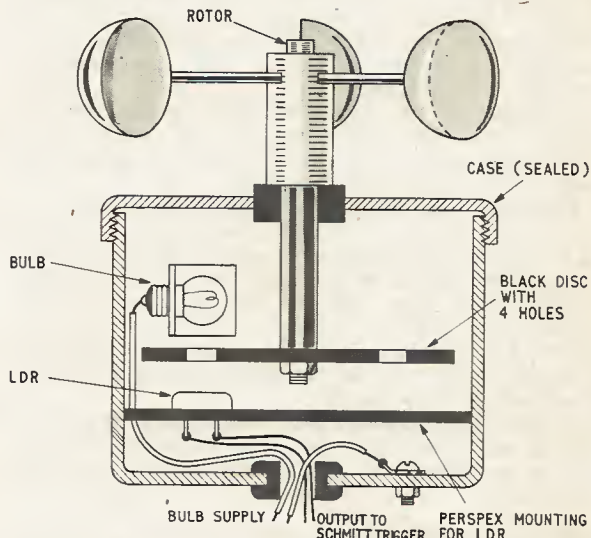

Fig. 2. Mechanical construction of wind speed indicator using an l.d.r.

BUILD YOURSELF A QUALITY TRANSISTOR RADIO—FULL AFTER SALES SERVICE!

THE MAGNIFICENT ROAMER 7

SEVEN WAVEBAND PORTABLE

7 FULLY TUNABLE WAVE BANDS—MW1, MW2, LW, SW1, SW2, SW3 and Trawler Band. Extra Medium waveband provides easier tuning of Radio Luxembourg, etc. Built in ferrite rod aerial for Medium and Long Waves. 5 Section 22in chrome plated telescopic aerial for Short Waves—can be angled and rotated for peak S.W. listening. Socket for Car Aerial. Powerful push-pull output, 7 transistors and two diodes including Micro-Alloy R.F. Transistors. Famous make 7 × 4in P.M. speaker. Air spaced ganged tuning condenser. Volume/on/off control, wave change switches and tuning control. Attractive case with carrying handle. Size 9 × 7 × 4in approx. First grade **Total building costs** Parts price list and diagrams make the Roamer 7 a pleasure to build. **£5.19.6 P. & P.** easy build plans 3/- (FREE with parts).

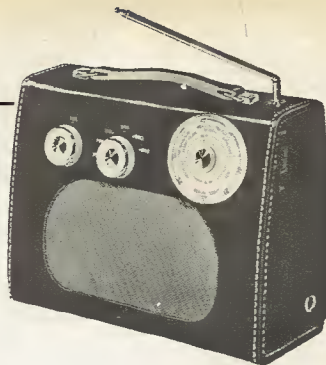

Personal Earpiece with switched socket for private listening, 5/- extra.

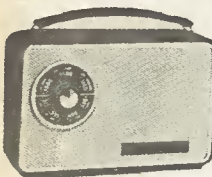

"NEW LOOK" MELODY SIX MED. AND LONG WAVES WITH SPEAKER AND EARPIECE

6 transistors and 2 diodes. Push-pull output, tuning condenser, high "Q" ferrite rod aerial, 3in speaker, and personal earpiece with switched socket for private listening. 5½ × 4 × 2in. Total Building Costs 69/6. P. & P. 4/3. Plans and parts list 2/- (free with parts).

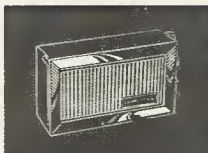

**POCKET FIVE
MED. and LONG WAVES AND
TRAWLER BAND** to approx. 50 metres. **WITH SPEAKER AND EARPIECE.** 5 transistors and 2 diodes, ferrite rod aerial, tuning condenser, moving coil speaker, etc. 5½ × 1½ × 3½in. Total Building Costs 44/6. P. & P. 2/6. Plans and Parts list 1/6 (free with parts).



**ROAMER SIX
6 WAVEBANDS — MW1, MW2,
SW1, SW2, LW AND TRAWLER
BAND.** 6 transistors and 2 diodes. Ferrite rod and telescopic aerials. 3in speaker. Top grade components. Size 7½ × 5½ × 1½in. Total Building Costs 79/6. P. & P. 4/6. Plans and parts list 2/- (free with parts).



**TRANSONA FIVE
MED. AND LONG AND TRAWLER
BAND** to approx. 50 metres **WITH SPEAKER AND EARPIECE.** 5 transistors and 2 diodes, ferrite rod aerial, tuning condenser, volume control, moving coil speaker. 6½ × 4½ × 1½in. Total Building Costs 47/6. P. & P. 3/9. Plans and Parts list 1/6 (free with parts).



**SUPER SEVEN
MED. LONG AND TRAWLER
BAND.** 7 transistors and 2 diodes. 3in speaker, 2 R.F. stages, push-pull output, etc. 7½ × 5½ × 1½in. Total Building Costs 69/6. P. & P. 4/6. Plans and parts list 2/- (free with parts). Personal Earpiece with switched socket for private listening, 5/- extra.

RADIO EXCHANGE LTD

DEPT. PE8, 61a HIGH STREET, BEDFORD 0234 52367

Callers side entrance Stylo Shoe Shop. Open 10-1, 2.30-4.30 Monday - Friday 9-12.30 Saturday



If it's
components
you're after...

Its the finest, most comprehensive Catalogue we have ever produced—this latest edition. It has 330 pages, over 8,000 items listed, over 1,500 of them illustrated. Everything for the keen constructor—including tools and test gear. With each Catalogue we supply a 30-page Price Supplement, a bookmark giving electronic abbreviations, and an order form. All for only 8/6 plus 3/6 post, packing and insurance. Moreover, every catalogue contains 6 vouchers, each worth 1/- when used as directed.

... you need the

HOME RADIO CATALOGUE

POST COUPON
NOW with P.O.
or cheque for 12/-

Please write your Name and Address in block capitals

Name _____

Address _____



Home Radio Ltd., Dept. PE, 234-240 London Rd., Mitcham CR4 3HD

The Price of 12/- applies only to catalogues purchased by customers residing in U.K.



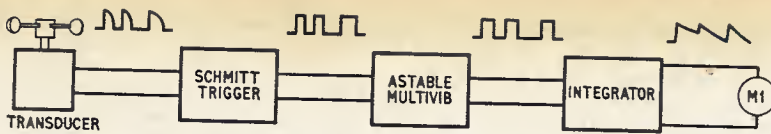

Fig. 3. Block diagram of basic circuit for the wind speed indicator

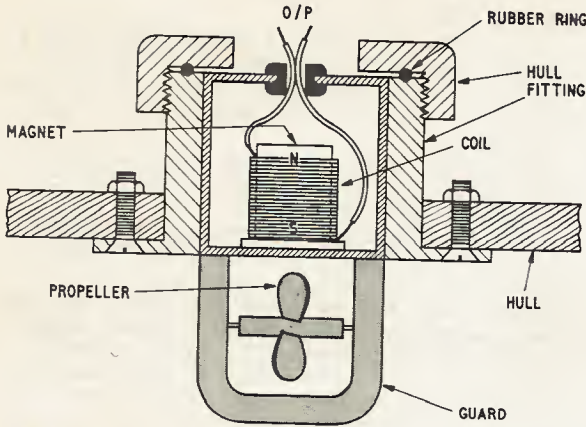

Fig. 4. Mechanical construction of boat speed indicator showing the hull fitting

(1) By firing reed switches with a magnet attached to the rotor (see Fig. 1).

(2) By arranging a rotating mask with holes in to block the light from a bulb falling on a light dependent resistor. Thus the resistance of the l.d.r. will change each time the holes in the mask allow light to fall on its sensitive surface (see Fig. 2).

Method (1) is fairly simple to make and set up but, to give a steady meter reading at low wind speeds, three or four reed switches should be used to step up the frequency.

Method (2) has the obvious disadvantage that a supply to feed the bulb must be provided. However, if the case around the l.d.r. is made light-proof apart from one hole, the ambient light can be used during daylight hours to operate the l.d.r. It is possible that the mast-head light on larger sailing craft could be used for firing the circuit at night but this calls for careful arrangement of the anemometer which may not always be possible or practical.

WIND SPEED CIRCUITRY

The circuitry used for both measuring methods would be essentially the same and should consist of a Schmitt trigger to shape the pulses coming from the transducer and provide a square wave output. This square wave is then used to trigger an astable multivibrator circuit which will provide a train of equal duration pulses, the frequency of which will vary in sympathy with the speed of rotation of the "transducer".

The pulse length must be carefully chosen to accommodate the maximum possible frequency or the frequency corresponding to the highest wind speed to be measured.

These pulses are then fed to an integrator circuit which will provide an output, the amplitude of which will vary with the frequency of the input. Thus a meter reading can be obtained that varies linearly with wind speed. Fig. 3 shows a block diagram of the electronics involved in the windspeed indicator.

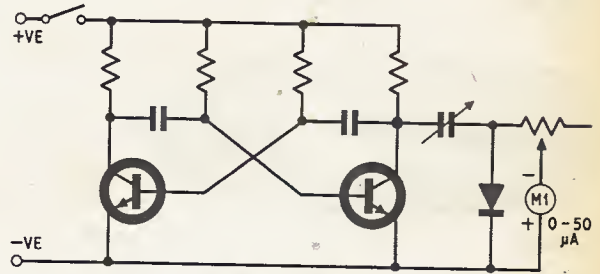

Fig. 5. Basic circuit for the apparent wind direction indicator. Circuit values depend on supply voltage and the value of the variable capacitor used

BOAT SPEED INDICATOR

Once again the design and manufacture of a transducer presents a greater problem than the electronics. The most suitable method is to use a small propeller, that is driven around by the water moving past the boat, to induce a frequency into a coil by placing the propeller in a magnetic field. The induced signal can then be amplified by a single transistor stage and the frequency measured—possibly by the same method as given above—to produce a voltage output and thus a meter reading of boat speed.

There are various pitfalls in this method, the major one being that slip of the propeller is not taken into account and an accurate calibration method must be found. The accuracy of the instrument can be altered quite drastically depending on its underwater position.

A suggested transducer arrangement is shown in Fig. 4. If possible the transducer should be made removable in order to free it of any weed or other debris that may foul it.

It is normal practice to link the speed indicator to an electronic log that indicates distance travelled through the water, but this can be difficult for the amateur and if attempted the final unit must be accurate if it is to be of any use. Again this type of instrument would be difficult to calibrate accurately.

WIND DIRECTION INDICATOR

This is probably one of the easiest instruments that the boat owner can construct and also one of the most useful, especially when sailing on the wind or when sailing at night. The transducer is simply a variable capacitor of about 100pF. To this capacitor is attached the wind vane. The bearings should be made free running by degreasing them before installation, and the capacitor must be of the continuously rotating type; able to be varied from 1-2pF to its maximum value.

The variable capacitor is placed in circuit as shown in Fig. 5 and the potentiometer set to give an f.s.d. reading on the meter with maximum capacitance in circuit. The meter is then calibrated 90-0-90 degrees

corresponding to the increase of the capacitance from minimum to maximum (see Fig. 6). It may be necessary to suppress the meter zero point slightly by using the manual "set zero" control.

With the vane set on the capacitor as shown in Fig. 7 the meter will read from 0 degrees to 90 degrees as the

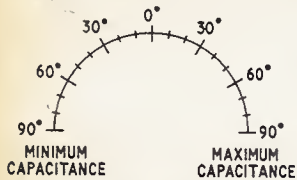

Fig. 6. Meter calibration for the apparent wind direction indicator

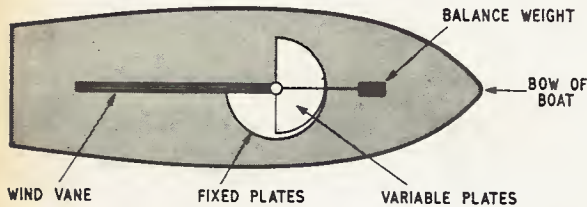
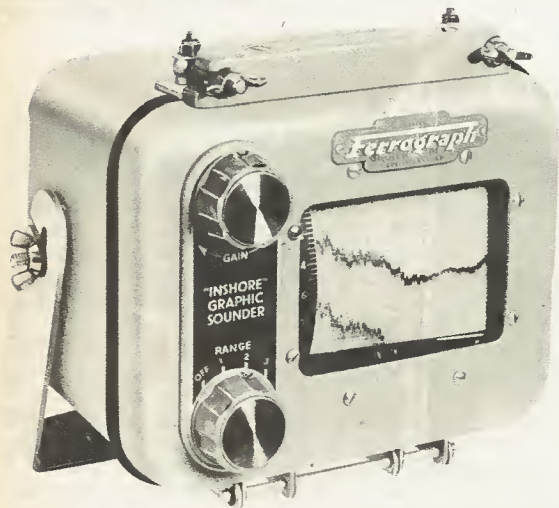

Fig. 7. Showing arrangement of the wind vane and capacitor plates with respect to the boat



The Ferrograph graphic echo sounder that gives a continuous permanent record of depth



A marine radiotelephone giving 25 watts of transmitted power and covering the frequency ranges 1.6 to 3.8MHz (transmitter) and 160kHz to 4,100kHz (receiver). Manufactured by Ajax Electronics Ltd

apparent wind direction to the boat varies from head-on to abeam, and then return from 90 degrees to 0 degrees as the wind direction moves from abeam to dead astern. Thus, by this method wind position all around the boat can be shown although some ambiguity may arise when the apparent wind is at 90 degrees to the boat's heading.

WATER LEVEL ALARM

It is very easy to forget to pump the bilge during a prolonged passage and, whilst this is hardly ever dangerous, water in storage lockers and all over the floor and engine can be very annoying and possibly expensive.

Again an electronic gadget of simple design and construction can be used to give advanced warning of the depth of bilge water.

Water level is sensed by two wire probes across the base emitter junction of a *pn*p transistor. When the probes are not under water the resistance across them is almost infinite and the transistor is turned off. As soon as water covers both probes a current path is formed between them thus turning on the transistor.

By the use of one or two stages, and a suitable power transistor or relay, the circuit can be made to turn on a warning device of some description.

OTHER ELECTRONIC AIDS

Various other simple gadgets are also useful aboard small boats, many of which are described in these pages from time to time. A few examples are as follows.

Light operated switch. This device can be very useful when moored in an area where riding lights are necessary. The switch can be wired up to turn on the light in the evening and off again at dawn. This can result in power saving and the worry of remembering to switch on and off.

D.C.-A.C. converter. This equipment can be useful in many ways and is fairly simple to construct although the power output is limited. Such things as fluorescent lights, electric shavers and other low power a.c. equipment can be operated from the boat's d.c. supply.

Burglar alarm. Many boats are left moored in rivers, often amongst hundreds of others, and are vulnerable to theft. Although a burglar alarm may not necessarily prevent this, it is a great deterrent to the would-be thief.

All that is necessary is a number of microswitches on the hatches, wired in parallel to a latching relay circuit that feeds on alarm. The relay should be connected to a simple time switch to turn it off after two or three minutes, and reset for subsequent readiness.

By this method the alarm will be sounded as soon as a hatch is opened and will continue to sound, even if the hatch is then closed, until the timing circuit resets it.

Although not electronic, radar deflectors, generators and rotary converters are also very useful items to have aboard.

There are many other uses for electronics in sailing and not only for use aboard small craft, e.g. power amplifiers for use by clubs to give directions to members and for starting signals.

There are also many devices such as detectors for gas and petrol fumes and distress signallers that have not been discussed because of design considerations and calibration problems. However, perhaps the more inventive readers of this magazine may be able to overcome some of the inherent problems. ★

SPACEWATCH

By Frank W. Hyde

OTHER MOONS

It has been suggested by J. Bagby of the Hughes Aircraft Company that Earth has at least ten natural satellites. This claim is based on recent telescopic and photographic observations. The data gathered together by Bagby on suspected observations, when added to the indirect evidence available, indicated that several moonlets existed. From this evidence orbits were calculated.

A thorough search carried out last year with a camera having a very large field of view revealed two satellites in the orbits that had been predicted. The size of these moonlets is of the order of 100 feet in diameter.

The indirect evidence for the existence of such bodies comes from the perturbations of the orbits of artificial satellites. In particular *Explorer 26* showed a marked jump in its orbit inclination, and also in its apogee and perigee distance in December 1965. This was caused, it is said, by moonlet IIIc, and it is a fact that natural satellites could cause the anomalies that have been noted in more than 150 cases.

On theoretical grounds it is quite possible for Earth to capture small bodies but it has not been generally accepted that it has done so. The important thing about this present claim is that if the orbits are projected backwards in time it suggests that there was a large natural satellite circling the Earth until December 1955, at which time it broke up leaving the debris in orbit.

STARS WITH PLANETS

Some of the results of a lifetime study of nearby stars has been released by Peter van de Kamp. According to his special observations of sixty of the near stars, no less than seven have planetary companions. They are dark and unseen so a special technique is required to establish their existence.

Briefly the technique is to watch the star over long periods of years by regular photographic exposures. The photographs are compared in a special viewing unit which shows up any variations or wobble against the background stars.

Van de Kamp has photographs which cover the last thirty years of observations and the wobble he has detected indicates the effects of gravity caused by the unseen companion.

One star, 61 Cygni, is some eleven light years away and has a planet

that revolves round its parent in approximately five years. Its mass is about one hundredth that of the Sun. Another star known as Barnard's star has a very rapid motion across the sky and in this case it is easy to detect small changes in its motion. It is probable that it has two planets.

Of the seven stars with planets, Van de Kamp has calculated the masses of five of the planets that accompany them. These masses are not greater than the masses of Saturn or Jupiter and it is not thought that they could support life as we know it.

For example, Barnard's star, as a sun to its possible two planets, is too cold to have conditions like Earth. However, should some of the other stars such as 61 Cygni have intelligent life it will be eleven years before they learn of earthmen journeying to the moon.

MORE MASCONS ON THE MOON

The number of known "mascons" (mass concentrations) is now increased to twelve according to a report from the Jet Propulsion Laboratory of California Institute of Technology. Radio tracking of the lunar orbiter spacecraft has revealed six more areas which show the characteristic change in gravity.

Four of the new mascons are under typical ringed plains and these are well delineated and are named Mare Orientale, Grimaldi, Mare Humboldtianum and Mare Smythii. Although the other two have the appearance of partially obliterated mare areas, they have not been considered significant enough to be given names, and are therefore known by their latitude and longitude co-ordinates.

There is still an open mind on these oddities and what they are; two current suggestions are that at one time there was considerable water on the moon and the other a simple suggestion that in fact the maria are at a much higher level than was originally thought. Here is one project at least for the lunar explorer of the future.

JETS MAY CHASE LUNAR SHADOW

On the 7 March 1970, there will be a total eclipse of the Sun and it is hoped that it may be possible to chase the shadow with a jet aircraft for about ninety minutes, thus keeping in view the chromosphere and corona.

So much has to be done in the short period of totality (about 3-5 minutes) that any extension of the period must be of great value to observers. The U.S. Air Force reconnaissance aircraft *SR-71A* could follow the track of the shadow at a supersonic speed of 1,400 knots or so.

In 1970 the path of totality runs from south west of Mexico north

eastward over the Gulf of Mexico and Florida and thence over Newfoundland. If the aircraft flew between 65,000 and 75,000ft unique observations could be made, as the eclipse would be seen against a dark cloudless sky with only about a thirtieth of the atmosphere above the plane and clear of all water vapour.

This would enable so many important observations to be made at the same time that the million dollars required for the conversion would be well worth while, particularly as the same plane could be used for subsequent eclipses, of which there are six in the next ten years.

SIZE OF ICARUS

Caltech's Jet Propulsion Laboratory have determined that the asteroid Icarus, which comes very close to Earth on occasions, is about 900 metres in diameter. It has a rotation period of between 1.5 and 3.3 hours.

The measurements were made over a three day period at the Goldstone tracking station where one of the 26 metre aerials was fitted with a 450kW transmitter operating at 2,388MHz. The receiving aerial was at Goldstone's 64 metre aerial located 23 miles from the transmitter.

The distance of Icarus at that time was 6×10^6 km from Earth so that the round trip of the radar pulses was about 43 seconds. The echoes were faint but readable and while the composition of the minor planet cannot be determined from such measurements the indications are that it is jagged, and in the words of Dr R. M. Golstein "somewhat oval and rough like a peach stone".

The Apollo 11 Lunar Module in which astronauts Armstrong and Aldrin will descend to the surface of the moon

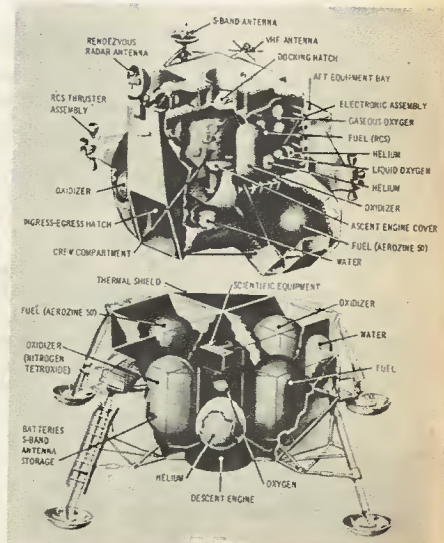

QUANTITATIVE measurements at very high radio frequencies usually involve expensive test gear or, alternatively, somewhat devious methods of obtaining the desired result. This is particularly so when relatively low voltages and currents are to be measured.

This r.f. wattmeter is a simple instrument, devised to give accurate readings of power over an extremely wide frequency range, extending to the v.h.f. band.

One well tried method of establishing the magnitude of an r.f. current is to use it to heat a short, straight length of resistance wire, then to assess the amount of heat developed. The virtues of this system are that the current path is short, the wire has a very small self-capacitance, and a minimum of self-inductance, thus making calibration virtually independent of frequency.

Starting at 60mW, the scale proceeds by divisions of 3mW up to the maximum reading of 120mW, corresponding to the full scale deflection of the meter. By the use of shunts, described later, a much wider range can be covered.

No on-off switch is necessary in the instrument, as the dark current of the ORP60 is a minute fraction of a microamp. The probe leads should, however, always be disconnected whenever the bulb is removed from its tube, as ambient light could overload the meter.

SIMPLE ASSEMBLY

The prototype was built in a small box, measuring 4in square by 2½in deep (Fig. 3). This can be made from plastics materials, wood, or hardboard. A large hole

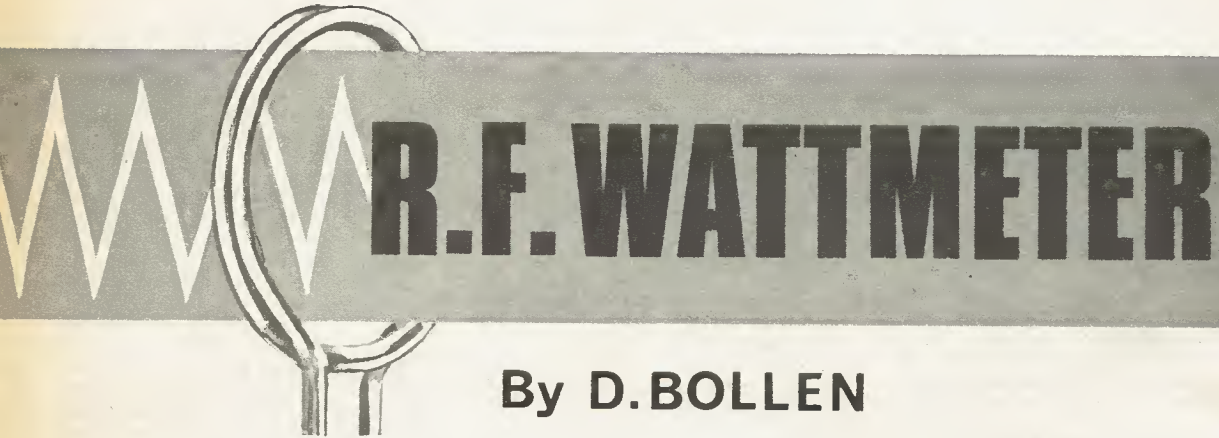

R.F. WATTMETER

By D. BOLLEN

Thermocouple ammeters and hot-wire ammeters work in this way but have the disadvantages of being somewhat insensitive and very prone to burn out when overloaded. Another even simpler method is the familiar flash-lamp bulb and loop, used to give rough indications of power maxima when coupled to small transmitters.

A refinement of this is the photometric method of comparing the brilliance of the bulb when illuminated by an r.f. current with its brilliance when fed from a known d.c. source.

With a suitable bulb, outputs of less than 100 milliwatts can be accurately measured, and if the bulb blows it can be replaced without difficulty and at low cost.

Normally, photometric methods of measurement are somewhat cumbersome but if a light meter is used, directly calibrated in terms of electrical power, the device becomes very simple. Taking this as a starting point, the following circuit was evolved.

LIGHT PROOF CYLINDER

The bulb is contained in a small light-proof cylinder together with a light dependent resistor (l.d.r.). As the bulb glows, the resistance of the l.d.r. drops and this change is measured by the simple ohmmeter circuit of Fig. 1. With suitable adjustment of VR1, a linear reading can be obtained over a major portion of the meter scale, allowing direct calibration.

The graph in Fig. 2 shows that there is a serious departure from linearity below the 100µA division on the meter, but this is, if anything, an advantage as the result is a usefully expanded scale with a suppressed zero.

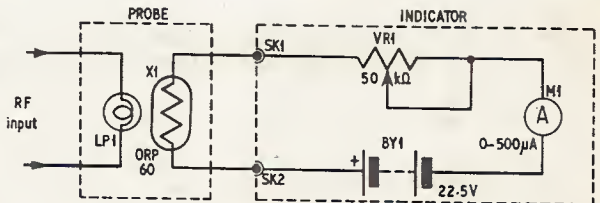

Fig. 1. Complete circuit of the r.f. wattmeter

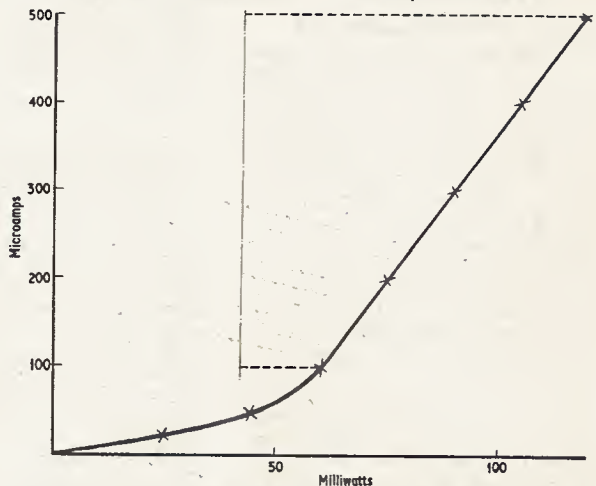

Fig. 2. Graph showing the relationship between the 500µA meter scale and the power measurement calibration required

is cut into the lid to take the meter movement. Sufficient space must be allowed when positioning so that the potentiometer (VR1) and the terminals can also be fitted to the lid. These terminals can be of the press stud variety, taken from transistor radio batteries, or screw terminals could be employed if first-class contact is to be assured.

The $22\frac{1}{2}$ volt hearing-aid battery specified is small enough to be clamped to the back of the meter and with normal use should last almost as long as its shelf life.

PROBE ASSEMBLY

The probe can be made from a cylinder of several layers of gummed paper wound on a $\frac{1}{2}$ in former, afterwards being painted or covered with self-adhesive plastic. When thin leads have been soldered to the

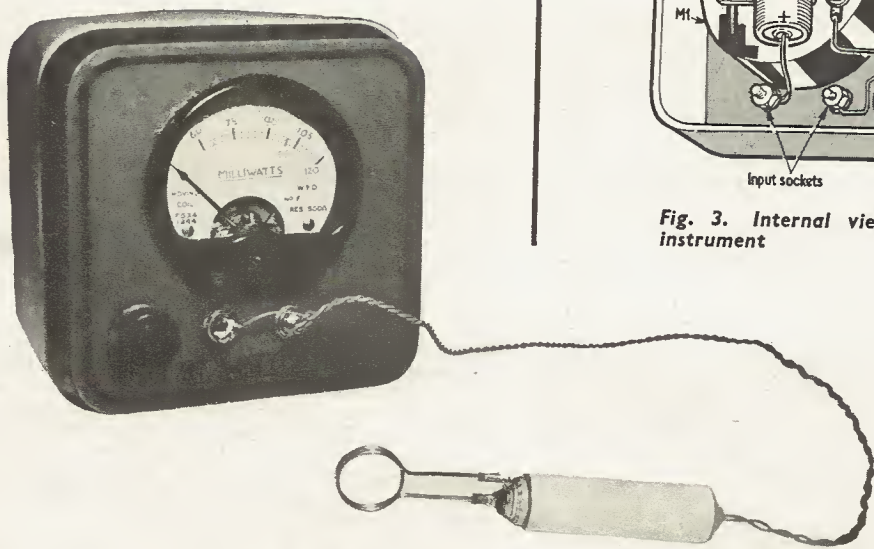

COMPONENTS . . .

- VR1 50k Ω preset miniature potentiometer
 - X1 ORP60 light dependent resistor
 - M1 500 μ A meter
 - BY1 $22\frac{1}{2}$ volts, hearing aid battery
 - LPI Lamp 6V 0.06mA m.e.s.
 - SK1 & SK2 Wander plug sockets (2 off)
- Materials for case and tube (see text)

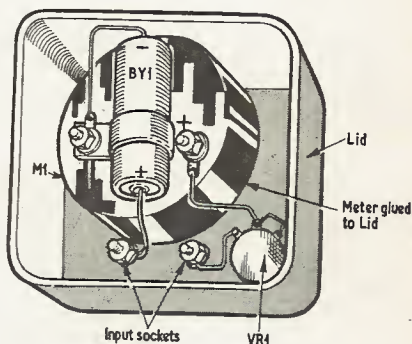

Fig. 3. Internal view of the instrument

l.d.r., taking care not to bend the wires too close to the encapsulation, a suitable rubber grommet is pushed into the tube so that the l.d.r. is firmly held in place (Fig. 4). The leads can then be threaded through a small cap which fits the end of the tube.

Thin strips of gummed paper are wound round the threads of the bulb, to allow a good sliding fit in the cylinder so that the bulb position can be easily adjusted during setting up. To the bulb are soldered two sockets taken from a B7G valve holder. These can be carefully pressed out of the moulding if all surplus solder is first removed from the tags.

METER SCALE

The meter scale can be modified quite easily without unscrewing the scale. After removing the meter cover, erase the existing numerals with a typewriter rubber and also the divisions. Inscribe the new numerals with a sharp soft pencil (as in Fig. 5), taking care not to damage the exposed pointer and movement.

Any mistakes can be removed with the rubber. If the meter is not calibrated 0-500 or if it is not wished to modify the meter, a suitable conversion chart can be pasted to the front face of the wattmeter.

The range of the instrument can be multiplied in exactly the same way as an ammeter, although it is not

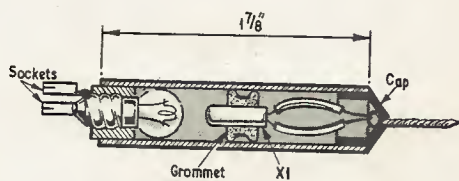

Fig. 4. Sectional view of the interior of the probe tube with lamp and l.d.r.



Fig. 5. New meter scale calibrated in milliwatts

Continued on page 593

components



P.E. LOOKS AT CURRENT TRENDS AT THE INTERNATIONAL LONDON ELECTRONIC COMPONENTS SHOW

MUCH HAS been talked about the financial costs of providing a colour television service in this country in recent months. It can only be expected that sales of colour receivers would be slow due to present-day credit restrictions and high capital costs. But in spite of this, the manufacturing industry is forging ahead developing new components specifically for this luxury commodity in preparation for an assumed mass audience of tri-channel coverage.

This development in particular is, to say the least, speculative and, in the interests of the health of the domestic electronics industry, one hopes it proves worthwhile and profitable.

In another field of technical endeavour, the public at large finds much to criticise in the expenditure of vast sums on exploration of outer space, without really realising that the by-products of such efforts are widely applied to industrial developments using electronic equipment in other fields. *Concorde* has also become victim of some unjust criticism.

The biennial Electronic Components Show, this year turned international for the first time and held at Olympia from May 20 to 23, was a real eye-opener to those who tend to take domestic luxuries and necessities for granted. Although a few of these developments are mentioned in this review, it must not be forgotten that, were it not for such stimulating projects as previously mentioned, the strength of the British electronics industry in the overseas market would not be as prominent as it certainly is. The amateur market also derives considerable benefit from these beginnings in the use of improved techniques.

The average British man (and woman) can tend to be a little insular when watching *Apollo* on television and before criticising would do well to spare a thought for the expertise gained in all channels of communication for the general betterment of his mode of life.

SEMICONDUCTORS

Semiconductor devices often imply transistors, which in turn (to the mass population) spell pocket radios. Lest we forget, the term semiconductors also includes diodes, thyristors, special purpose transducers, integrated circuits and so on. In fact the whole electronics industry is virtually revolutionised around the use in some form or other of silicon slices.

Mullard, for example, devoted half their massive stand to semiconductor devices applicable to television circuitry. We should be seeing some of their new integrated circuits incorporated in colour receivers which must bring the size, complexity and price of colour television down to manageable domestic proportions; reliability should also be improved.

A new transistor designed for television line output stages, the BU 105, claims a high V_{CB} rating of 1,500V and current rating of 2.5A. Two of these in series will provide adequate line output voltage for colour.

Thyristors are called for to stabilise the line deflection supplies and are superior to using transistor circuitry here due to simplicity and higher reliability.

VARIABLE CAPACITANCE DIODES

It looks as if the days of the troublesome turret tuner are definitely numbered, and service engineers and viewers will look forward to seeing the "Varicap" tuner. No mechanical linkage between tuner and control is required in the form of rotary selectors. The new tuner will use push buttons to apply d.c. potentials to variable capacitance diodes in the r.f. and local oscillator stages. Consequently tuning drift is eliminated because the switches do not have to carry vulnerable high frequencies.

Also of interest on the Mullard stand was a new 30W power amplifier using pulse width modulation digital techniques. Typical harmonic distortion is given as 0.25 per cent with 30dB of feedback. But here is the rub! The pop singer or guitarist will be able to carry it in his pocket (being no bigger than a cigarette packet) thanks to integrated circuits.

INTEGRATED CIRCUITS

Several smaller or otherwise engaged firms have developed their own integrated circuit plant for prototype and small batch production. It is particularly encouraging to see them making maximum use of their resources for outside contract work.

Technograph International Developments offer a "customer service" using ceramic based circuits with copper, nickel and gold conductors, specially aimed at high frequency applications.

Dual-in-line active hybrid modules on thick film are now being supplied to customers' requirements by A.B. Electronic Components (see photograph below).

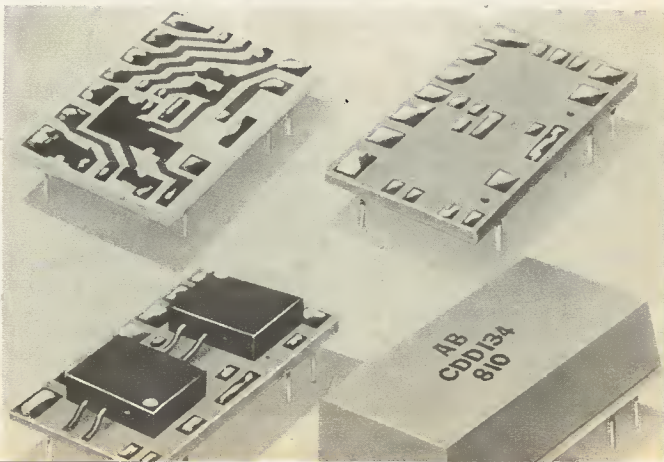



Granulated glass and sintered preforms made from Pilkington glass by Mansol (Great Britain) Ltd.

A new range of monolithic wideband amplifiers, suitable for audio hi fi, video, instrumentation, and high speed analogue computers, is under development by SGS (United Kingdom) Ltd. A 4kHz bandwidth telephone amplifier for electronic exchanges has been produced in integrated circuit form; its gain is in excess of 16dB for an output power of 40mW into 600 ohms.

SMALLER CHIPS

A significant advance in silicon growth and epitaxial layer deposition has enabled S.G.S. to carry out deposition at a lower temperature, so avoiding impurity diffusion out of the substrate slice. The benefits expected are in increased yield through smaller chip size and increased performance through greater design freedom.

A good example of space saving was illustrated by the new Plessey MOS circuits. A complete eight-channel balanced multiplexer has been designed for aircraft data handling, feeding information from strategically positioned transducers in the aircraft to the flight recorder (black box). The multiplexer is built on a silicon chip.

PASSIVE COMPONENTS

The fundamental discrete electronic components—resistors and capacitors—are still sold in increasing quantities despite the advances being made in the integrated circuit field. The trend in discrete components is towards smaller physical size combined with improved performance and reliability. Many components are becoming more specialised in application and new materials are continually being developed to meet users' demands.

Glass plays a very large part in the manufacture of electronic components and it is appropriate that the large Pilkington group should co-operate with the electronics industry in development work. Their latest is a solid state ultrasonic delay line glass for colour television, being supplied to the British STC Components group within the I.T.T., now being recognised with the new name ITT Components.

CAPACITORS

The available range of capacitors is ever increasing and this is one field where new materials play an important role in development of improved smaller types. Tantalum capacitors are one instance of a new material making available the type of components required by industry for microelectronic work, and a vast future for these and the new polypropylene types is foreseeable. In particular polypropylene has been dubbed the "material of the 70's"; the use of this material will decrease the size and increase the working temperatures of electrolytics of the future.

Many types of capacitors were on display at the exhibition and Mullard displayed their new range of polycarbonate film a.c. capacitors. These types are available covering the capacitance range 1.5 to 10 μ F with tolerances of ± 10 per cent.

Chip capacitors for integrated circuits were shown on the Plessey stand. A special feature of these small size capacitors is the use of palladium for the electrodes; palladium has less tendency to dissolve in solder than silver.

Demonstrating the advances being made in capacitors the new ITT range of solid tantalum types covers capacitance values from 1.2 to 680 μ F at working voltages up to 35V d.c.

RESISTORS

As with capacitors the demand for resistors increases as their size decreases; for applications where discrete components are used with integrated circuits, size and accuracy are of paramount importance. New materials are assisting in improving quality and in the production of special types, although it is generally the case that new materials are being used with old manufacturing methods. This is the case with the precision wirewound resistors displayed by Muirhead Ltd.

Claimed to be the smallest wirewound resistor available, the RBO3 is made of a new type of wire which ensures greatly increased stability. Also marketed by Muirhead is the RBO6 which is mounted in a TO5 "transistor type can" having standard lead spacing (three leads, one resistor?). It is claimed that using this type of case the assembly of instruments can be streamlined.

Many firms displayed metal film and metal oxide resistors and Electrosil showed their glass-tin oxide range of resistors. These are manufactured in all sizes from $\frac{1}{16}$ W up to 6,000W.

POTENTIOMETERS

Perhaps one of the most diverse fields of components is the potentiometer types. Various versions of everything from a small preset or trimmer to large high resolution vernier types were displayed on many stands around the show.

Size reduction is a good selling point for presets but many "front panel" types are the same size as in previous years since there is no point in making them any smaller. Among the smallest of all the potentiometers on display was the $\frac{1}{16}$ in cermet type from Painton. This component is

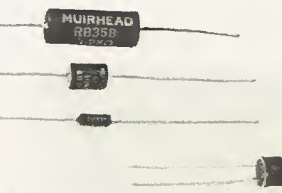

Muirhead precision wire-wound resistors (left)

Chance-Pilkington delay line glass for colour television (left)

Painton sub-miniature cermet potentiometer (right)

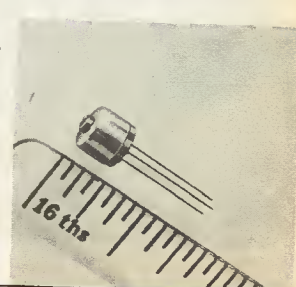

a single turn type in a cylindrical case measuring only $\frac{1}{4}$ in long, it is available in resistance values ranging from 100 ohms to 100 kilohms and can handle a maximum input voltage of 300V d.c. at a power rating of 0.5W.

Ferranti announced a new range of conductive plastic potentiometers that have been developed over the last few years to provide a range of environmentally proven components of high stability and very high resolution. The new potentiometers are continuously rotatable and have a claimed life expectancy of better than ten million sweeps.

An interesting development in potentiometers is a new type from Computer Controls which incorporates solid state circuitry to provide low output impedance and high input impedance.

RELAYS

Although relays cannot truly be considered electronic they are still a necessity for many applications of electronics. Over the last few years the design of relays has improved vastly and with new manufacturing techniques and materials they are no longer the bulky mechanical nightmare of days gone by.

Most firms were showing small encapsulated reed relays generally with printed circuit pins. The photograph shows the type R12 manufactured by B. and R. Relays. This design is typical of the latest types and incorporates two normally open reed switches mounted on either side of the operating coil. Positioning the switches in this way ensures the effects of thermal e.m.f., due to the operating temperature of the coil, are kept to a minimum.

The previously more common solenoid type have also been improved in many ways other than size. Most firms now produce their relays in some form of plastics cover and one firm, Oliver Pell Control Ltd., are marketing what they claim to be the only direct mounting printed circuit board relay available in this country.

INDUCTIVE COMPONENTS

Miniaturisation and improved performances are to the fore in transformer and inductor manufacture and these requirements are being fulfilled mainly by improved design. Ferrite pot cores appeared on numerous stands and many were designed for printed circuit applications. Of particular interest in this field is the new square module pot cores from ITT. These cores, shown in the photograph, are designed to plug straight into printed circuit boards and their shape is such that an increased packing density is achieved.

Other firms displayed numerous types of mains, audio and auto-transformers as well as a large variety of inductive components. Gardners Transformers showed a new range of inverter transformers and modules and were giving away a newly published manual describing their complete range. Inductive components for computer applications were to be found on a few stands and the advent and development of such devices will no doubt aid the design of the more commonplace mains and audio transformers.



Relay type R12 by B & R Relays designed for printed circuit boards

PANEL METERS

Once again the range of meters available is extensive and the general trend is to larger and more clearly defined scales. The latest designs use virtually the whole meter face area for the scale and are thus conservative of space whilst still being easily read. Displayed by Taylor Electrical Instruments were their latest wide angle miniature moving coil panel meter. This instrument has a scale length of $4\frac{1}{2}$ in and a panel width of only just over $2\frac{1}{2}$ in.

General trend in this field is for wider angle scales and plain faces. Most instruments now have back-of-panel fixing; this also helps to provide an uncluttered face and more room for scale markings.

SOLDER AND SOLDERING TECHNIQUES

At first there does not seem to be any great changes in this field but, when a closer scrutiny is made, a number of improvements come to light. One of the main advances has been the higher purity attained in solders during manufacture.

Multicore Solders introduced "Extrusol" solder which is primarily designed for solder machines. This solder is available in bars, solid wire and pellets, is claimed to have less dross on initial melting, improved "wetting" of components and circuit boards, and fewer reject joints. Various melting temperature grades of solder are now available. Both Multicore Solders and Enthoven Solders are producing preforms for assembly line techniques with temperature melting points to specification. Superspeed preforms in the production of television receivers was demonstrated on the Enthoven stand.

Weller Electric demonstrated the versatility of their established temperature controlled irons for soldering and desoldering. For the latter, they demonstrated how 16 and 14 lead integrated circuit packs could be desoldered using their SK137 and SK126 tips. They also showed their simple suction desoldering tool in operation.

PRINTED CIRCUITS AND WIRING BOARDS

This area was widely represented and is probably the most interesting, although confined largely to machine and chemical manufacturing techniques.

The main improvement seems to be the use of glass fibre to give greater resistance to leakage between copper strips. Glass fibre board is also able to withstand varying temperature changes and robust handling.

On the G. T. Schjeldahl stand their Mini-etcher was shown producing flexible printed circuits. The flexible printed circuits can be produced to fit directly to the rigid type of printed board.

Formica displayed several grades of laminates suitable both for flexible and rigid printed circuit boards. One of Electrosil Advanced Products Division exhibits was the Augat 8136 Series of high density boards, with solder tab or wire-wrap facility. These boards are specially designed for i.c.'s and can be rack mounted in cases.

A printed circuit development pack was one of many items on show from Guest Electronics. This pack costs approximately £15 and contains 50 perforated boards;

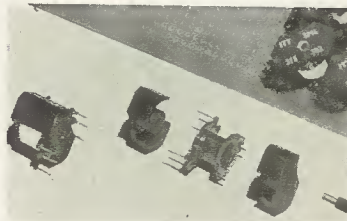

Square module pot cores by ITT (above)

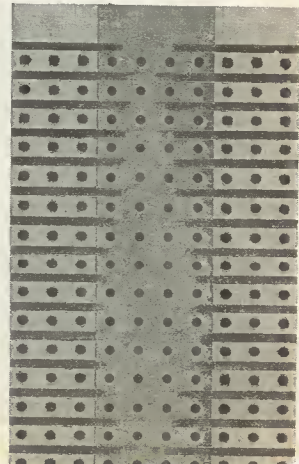

New style Veroboard component group board (right)

300ft self-adhesive copper tape 0.062in wide and 100ft 0.125in wide; 6 pieces self-adhesive copper sheets; reel of transparent insulating tape; tube of soldering pins with insertion tool; surgical knife; pair of tweezers and a bottle of lacquer and lacquer brush.

To make up any prototype printed circuit or one-off unit the copper is cut to size, the backing paper removed and the copper pressed firmly into position on a perforated board. Once the adhesive has been allowed to dry for four hours, solder connections can be made direct to the copper, or in the case of integrated circuit modules the push-fit pins can be used as termination points. The lacquer is included to protect the copper against oxidation, and includes a fluxing agent so that any subsequent soldering can be carried out through the protective coating.

A new type of component group panel was one of the new products of interest to the experimenter on Vero Electronics stand. These boards are like strips of standard Veroboard; a wide centre channel with no copper strips saves material for component grouping. The strips are easily cut to the required number of component groups.

Another wiring board very similar to Veroboard was shown by Radiatron. Here the board composition is of fibre glass, giving greater electrical insulation; the copper strips and hole matrix has a reference grid printed on the underside. This, we feel, is an excellent improvement and we hope to see it on the retail market in the near future.

SWITCHES

The range of switches currently available is not surprisingly large and the one noticeable advance apart from miniaturisation is the use of coloured mouldings to provide for colour coding of controls.

Many heavy-duty and miniature rotary switches were prominent at most stands. A new general purpose rotary switch from A.B. Electronic Components was announced. This switch, type Nu-M, is available as 1-pole 12-way to 4-pole 3-way with make-before-break or break-before-make contacts. The switch is also available with printed circuit mounting contacts.

A miniature rotary thumbwheel switch, called the Miniswitch 500, was one of the many varied switches exhibited by Painton. Another type of thumbwheel switch, claimed to be the smallest produced, was announced by Kynmore Engineering. Designated Mini-Stat, the switch is available in binary coded decimal or straight decimal 10-positions.

Microswitches were displayed in abundance and the various types of operating techniques was very interesting. Cozet England Ltd., had microswitches with various methods of lever, sprung and press-button operating dollies suitable for alarms, timers, automobiles, and so on. One of the Plessey exhibits was the recently introduced Licon microswitch rated 10A at 250 volts a.c.

A 25-way reed switch from FR Electronics was one of their more interesting products. Once this switch is assembled the number of contacts can easily be increased or decreased as desired.

"Mini-Stat" thumbwheel switch by Kynmore Engineering



Painton "Miniswitch 500"

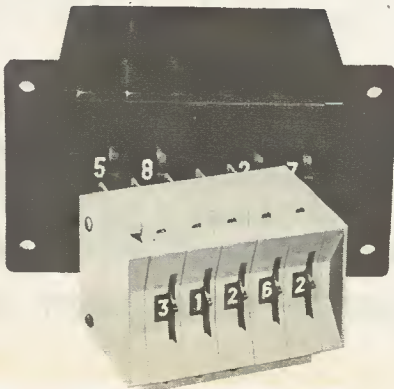

A dry reed relay uniselector with a memory circuit was displayed for the first time on the B & R Relays stand. The relays are mounted on plug-in printed circuit cards. The drive circuit incorporates a pulse generator relay which stores the input pulse and passes it on to the selected circuit when the pulse ceases. The pulse generator relay can be delayed for a given time to offset any effects of contact bounce.

Numerous lever switches, push-button and toggle switches were shown; representative of these was the 250V 2A a.c. lever switch from N.S.F. Bulgin have improved versions of their large range of toggle switches and both Bulgin and Arrow Electric Switches had illuminated push-button switches to offer.

CONNECTORS

Connectors play an important part in the electronics field and were well represented at the show. Belling-Lee, probably the largest supplier, had connectors for coaxial leads to ribbon cable forms on show. The use of stand-off insulators, solder pins and lead through connectors were shown by Henry & Thomas.

CASES

The range of equipment cases seems to be on the increase each year. This year plastics and metal cases were in abundance and were all designed with both aesthetic and practical considerations in mind.

The West Hyde Developments Contil cases, Vero circuit board cabinets, Imhof cases and racking equipment, Lektrokit systems from A.P.T. Electronics Industries, and Datum cases by Bedco were all well represented. Some very colourful finishes were conspicuous on some stands, although we understand that these are usually specials and cost a little more than the standard battleship grey kind of finish.

BATTERIES

Better performance and reliability was the claim at the battery manufacturers' stands. Nickel cadmium, alkaline, and mercury cells were the main topics at Deac (Great Britain), Mallory Batteries, Ever Ready, Cadmium Nickel Batteries and many other exhibitors' stands.

The present aim seems to be towards the more popular use of rechargeable types, although the prices will have to fall slightly if they are to achieve massive sales.

EQUIPMENTS

A new mast-head amplifier for colour and monochrome television reception was announced by Wolsey Electronics. The amplifier can also be mounted on the rear of a television and is ideal for fringe areas.

Daystrom displayed their usual range of Heathkit audio equipment, although there were many more test and laboratory equipments. We were told that in the next few months we should see many more pieces of test apparatus appearing on the market as they intend to make a concerted effort in this lucrative field.

Dry reed uniselector by B & R Relays

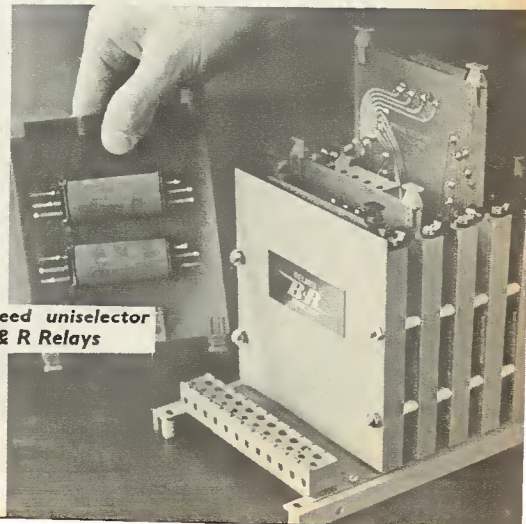



RESINS AND LUBRICANTS

The increasing use of silicones, resins and lubricants was shown by Midland Silicones, CIBA (A.R.L.), and Electro-lube. CIBA had various items that had been impregnated with Araldite resins.

A wire with a p.v.c. covering that does not shrink back when in contact with a hot iron was exhibited on the ITT Components Group stand.

The increasing use of dry transfer circuit symbols for aiding the electronics draughtsman were the main products shown by Circuitape. These transfers are self-adhesive backed and can be used on prototype printed circuit layouts for preparing for silk-screen printing, litho printing and for photographic enlarging.

STANDARDS

British Standards are fast becoming international standards through the International Electro-technical Commission, at any rate as far as other European countries are involved. The important every day role to be played by adopting the metric system of measurements will undoubtedly be seen by many as the key to simplified units and multiples. The Ministry of Technology's B.S.I. representation, related to the electrical industry, discussed the metric system to visitors and introduced the BS 9000 scheme.

The BS 9000 is a new comprehensive system of specifications for electronic components, backed by several years of research and discussion with leading professional bodies in the electronics industry. The publication of generic specifications and a qualified parts list (GPL) will help purchasers and designers to specify their requirements under a common language. ★

POINTS ARISING

POCKET RADIATION MONITOR (April 1969)

We have been informed by Fortiphone Ltd., that they no longer manufacture miniature transformers, and that the transformer side of their business has been taken over by Messrs Parmeko Ltd., who supply ex-Fortiphone type transformers.

PHOTOGRAPHIC TIMER (March 1969)

Plessey "Double High Cap" capacitor 68 μ F 75V is available from Southwell Radio and T.V. Electric Engineering, 5, Southall, Hornsey, Yorkshire.

Southwell are not an official Plessey supplier but have been kind enough to distribute these capacitors to readers, price £1 11s 11d including postage and packing.

OSCILLOSCOPE PRE-AMPLIFIER

(Ingenuity Unlimited July 1969)

It should be noted that TR2 collector should be connected to R3, R5 and SK2 output socket.

COLD CATHODE TUBES—PART 4

We regret that, due to shortage of space this month, Part 4 of Cold Cathode Tubes has been held over. It will appear in the September issue.

TWO IMPORTANT FEATURES IN THE SEPTEMBER ISSUE

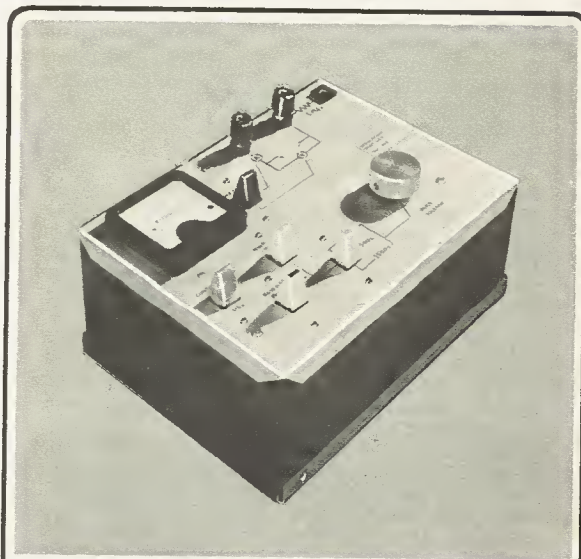

INSULATION AND DIODE TEST SET

A versatile tester for your workshop. Basically an e.h.t. generator, this test set can be used for continuity, capacitor insulation, Zener diode, and rectifier diode testing. The voltage output is continuously variable from 0 to 1500 volts and a switchable ammeter/voltmeter is incorporated.

CINE/TAPE SYNCHRONISER

Use your tape recorder to add a sound channel to your films. Sound and visual synchronisation is achieved with an 18 frames per second projector. Using sprocketed tape, synchronisation of better than two frames in 200 feet is achieved.

3/- September Issue on sale Friday August 15

PRACTICAL ELECTRONICS

ORDER YOUR COPY NOW!

By M.L.MICHAELIS M.A.

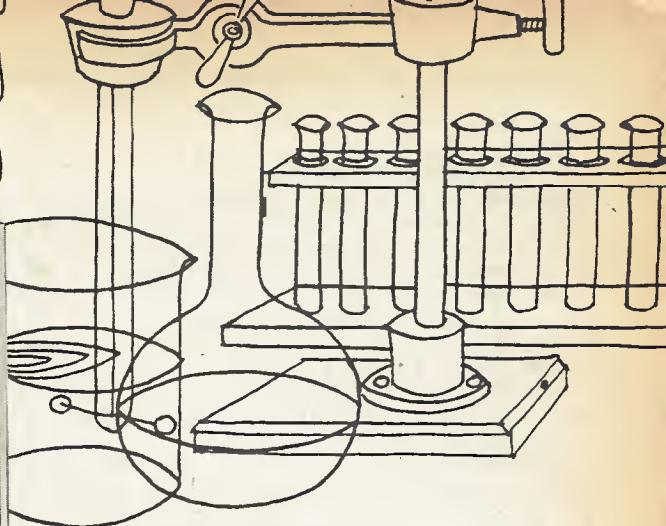

Split Phase conductivity bridge

An improved type of instrument of high resolving power for electrolyte conductivity measurements, such as are commonly used to indicate reaction progress in analytical chemistry.

ALL chemical reactions give rise to characteristic electrical effects, which can be detected and measured with suitably designed electronic equipment of adequate sensitivity. This is true in particular for electrolytes and electrolyte reactions.

One of the simplest classes of electrical measurements which can be performed on electrolyte solutions is the determination of electrical conductivity. Many of the standard, less expensive instruments designed for this purpose do however suffer certain limitations.

Conventional derivatives of the Wheatstone bridge using a small transformer or induction coil, a slidewire, headphones and a resistance box, generally suffer from poor balance-point sharpness because they attempt to measure the out-of-balance voltage of the bridge to determine when this voltage reaches zero at balance. In fact it never reaches zero, because stray capacitances and electrode capacitances produce phase-shifts and spurious bypass currents.

Very many conductivity bridge circuits found in school textbooks of chemical analysis have not progressed beyond this primitive stage, whose attendant inaccuracy and, above all, very poor differential resolution has prevented appreciation of the true power of the conductometric method.

SPLIT PHASE BRIDGE

A much better approach is to sense the peak voltage in each bridge arm, in a manner irrespective of the relative phase angle between the voltage waveform peaks, and then to detect when these peak voltages are equal. This can be done by rectifying each waveform separately with a peak rectifier, then applying the two rectified voltages to a null detector. This merely involves the insertion of a rectifier and reservoir capacitor on each side of the balance meter in a conventional bridge circuit, but it completely fails to remove the second cause of poor balance readings which lies in the absence of a nominal balance marker.

This can be provided by feeding the voltage waveforms from the two bridge arms alternately via an electronic switch to an oscilloscope or magic eye indicator, using a fast timebase in the former case. This gives a double raster on the oscilloscope screen, or a double sector on the magic eye. At balance the double raster coincides to a single raster or the magic eye sectors coincide to a single sharp-edged sector.

EXTREMELY SHARP BALANCE

This type of balance indication is *extremely sharp*, and not disturbed even to the slightest extent by very large

capacitive shunts and phase-shifts. It may be thought that this arrangement can be realised only at the price of undue circuit complexity, but a glance at Fig. 1 and Fig. 2 shows that the additional outlay with respect to a conventional bridge circuit is negligible. The trick is to operate the two bridge arms in antiphase from a centre-tapped transformer as shown in Fig. 1b. The same centre-tapped winding drives two switch transistors in phase cross-over to function as an electronic switch. The entire electronic switch thus uses nothing more than two transistors, two diodes and six resistors.

Especially when used in conjunction with a fairly large-screen conventional oscilloscope, this circuit principle leads to such high differential resolution that a number of titrations with large non-participating ionic background become readily possible.

Furthermore, on account of its complete tolerance of even very large capacitive phase shifts, the split phase bridge can work with the 50Hz mains frequency even when highly conducting solutions are used. This obviates the audio oscillator providing the necessary higher supply frequency under such conditions in conventional bridges. Since the electronic switch used in the present design is very much simpler than an audio oscillator and associated switching, the split phase bridge is altogether simpler, apart from its superior performance.

READOUT DEVICES

The oscilloscope is not an essential necessity for the read-out section; an ordinary magic eye circuit as used in conventional bridges is also usable at somewhat reduced differential resolution.

(A later article will provide full constructional details for a simple magic eye balance indicator as a separate unit which may be used by those readers who do not have an oscilloscope available and do not wish to go to the expense of procuring one. There is of course no objection to integrating the split phase bridge and the magic eye indicator into a single cabinet. Details can safely be left to the individual constructor, because there are no special problems involved in such an integration.)

REQUIRED RANGE

We find that actual resistances of the electrolyte between the electrodes with solutions of any strength likely to be encountered in ordinary routine analyses, are normally greater than 10 ohms but less than 1 megohm. This total range must be expressed in reciprocal units, since we are interested in determining the conductance values.

The reciprocal ohm is still known conventionally as the mho, but the author finds this nomenclature clumsy. In several continental countries the siemens, abbreviated S, is being applied as the new name for the reciprocal ohm as conductance unit. Thus 1 siemens (1S) and 1 mho are identical. We shall use the siemens for the remainder of this article. The required resistance range from 10 ohms to 1 megohm corresponds to a conductance range from 1 microsiemens (μS) to 100 millisiemens (mS).

PRACTICAL BRIDGE CIRCUIT

The full circuit of the practical split phase conductivity bridge is shown in Fig. 2. The bridge arm containing the electrolyte cell consists of SK1, SK2 and the resistor selected by the range switch S1B. The other bridge arm consists of R3 (shunted by R4, R5 in the highest range) and the bridge potentiometer VR1 in series with its range limiting resistor R6. These two bridge arms are fed in antiphase from T1.

To ensure that the antiphase voltages are truly of equal magnitude, T1 secondary should be wound bifilar and the nominal current rating must be about ten times the maximum actual current. This calls for a transformer rating of at least 1 amp, although normally only 100 to 150mA maximum current is drawn by the bridge. If it is not possible to have a transformer wound to suit these requirements, then the standard component given in the components list will generally prove quite adequate in many cases.

The same antiphase voltages, in cross-over connection, drive the bases of two switch transistors TR1 and TR2, respectively, connected to the centre points of the bridge arms. Each drive connection is via a diode (D1 and D3). The arrangement is such that each

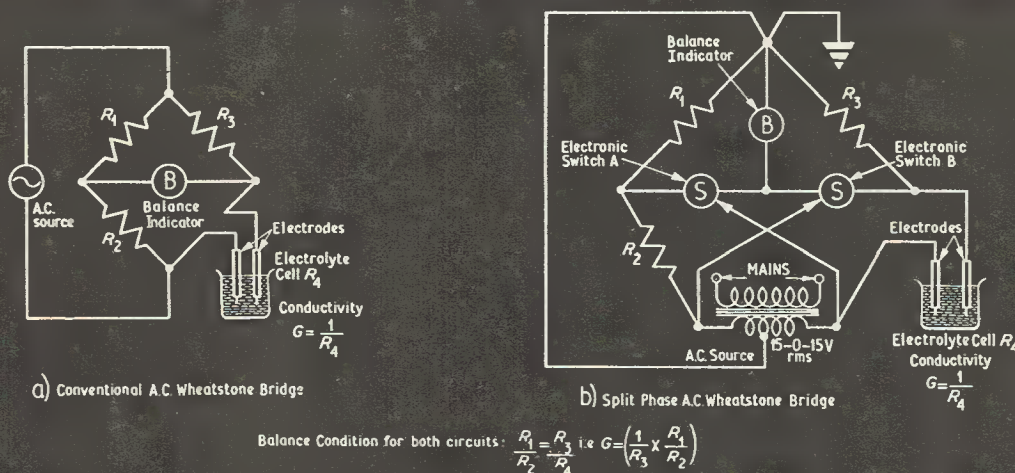

Fig. 1. Basic circuits illustrating the difference between the conventional Wheatstone type bridge (a) and the split phase arrangement as used in this design (b)

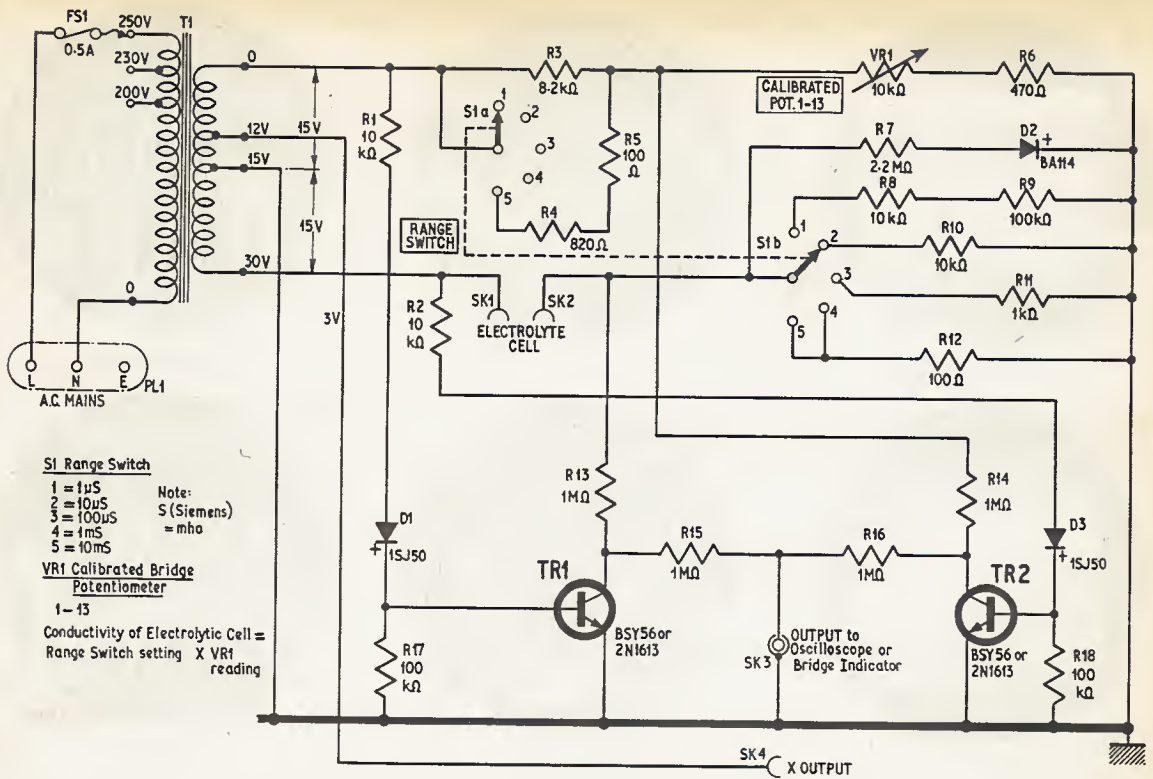

Fig. 2. Circuit diagram of the split phase conductivity bridge

transistor short-circuits the negative half-cycles of the bridge waveform it is sensing, as seen at the bottom end of R13 or R14. These two resistors are inserted to avoid short-circuiting of the bridge itself on negative half-cycles. However, the net impedance seen by the electrolyte cell bridge arm would be slightly lower on negative half-cycles, because R13 then shunts the resistors on S1B directly via TR1, but only indirectly via the remainder of the switching resistor network R15, R16 and TR2 on the positive half-cycles when TR1 is cut off. This amounts to slight partial rectification in this bridge arm and R7 and D2 just cancel this by imposing the right amount of additional loading on the positive half-cycles too.

COMPENSATION PROBLEMS

This form of compensation is satisfactory only if the highest bridge arm impedance (highest value of resistor selected by S1B in the lowest conductivity range) is at most 10 per cent of the electronic switch impedance. The latter is nominally a megohm to match standard oscilloscopes and magic eye indicators, so that we are limited to a maximum bridge resistor value of 100 kilohms (which has to be corrected to 110 kilohms with R8 to allow for the switch shunting effect).

We require a total range from 1 microsiemens to 100 millisiemens, i.e. five decades. Thus if we switch the bridge resistor down in five decades starting at 100 kilohm, we would arrive at 10 ohm in the highest range. This is not permissible, since 100 ohm is the smallest usable bridge resistor without exceeding the polarisation range. Thus we have had to retain the 100 ohm bridge resistor R12 of range 4 for range 5 too,

instead reducing the impedance of the corresponding branch in the opposite bridge arm by a factor of ten, by shunting R3 with R4, R5 when switching from range 4 to range 5. This slightly sacrifices differential resolution at the extreme top end of the highest range.

ELECTRONIC SWITCH OPERATION

The electronic switch operates entirely with a.c. voltages, requiring no separate rectified collector supply. Considering either transistor alone, when the bridge arm feeding its collector is describing a positive half-cycle, the transistor collector is receiving normal polarity, but the base is cut off because zero voltage is applied to it. The diode in series with the base drive holds off the actual negative voltage applied from the other bridge arm, which is just describing its negative half-cycle. Without the diode, reverse breakdown would occur between base and emitter of the transistor.

Now consider the negative half-cycle in the bridge arm feeding the collector. This inverts the transistor, i.e. interchanges the roles of collector and emitter, a condition leading to particularly small residual switch voltages. At the same time the other bridge arm is now describing its positive half-cycle, so that the base diode conducts and turns the transistor hard on. The transistor thus behaves as a very efficient short-circuit to chassis, especially as it is running inverted in this phase period. Only the signal from the *other* bridge arm, which is describing the positive half-cycle, can get through to the output terminal SK3. Thus the composite signal at SK3 is a train of positive sinewave half-cycles, with alternate ones belonging to the respective bridge arms.

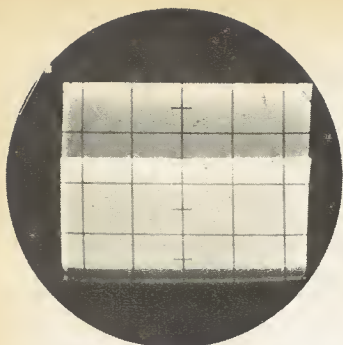

UNBALANCED



UNBALANCED

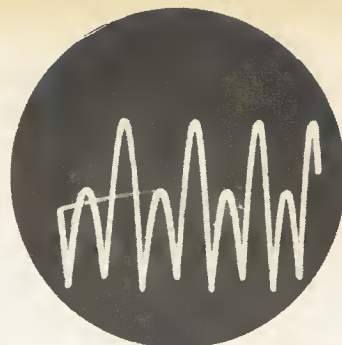

UNBALANCED

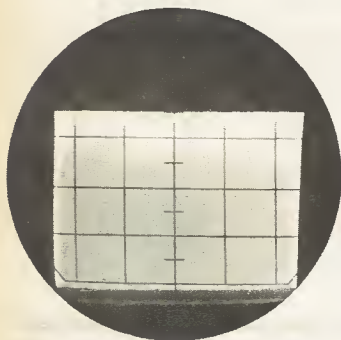

BALANCED

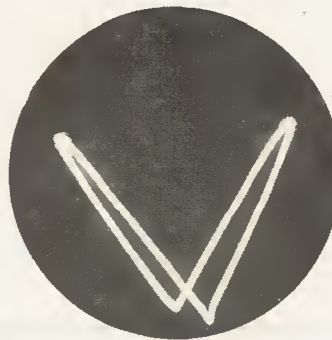

BALANCED

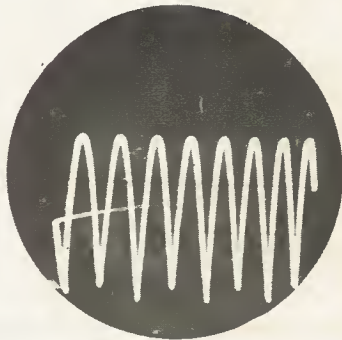

BALANCED

Types of split phase bridge displays on an oscilloscope (left) double bright-edge raster; (centre) phase pointers; (right) direct display of switch output waveform

MAGIC EYE INDICATOR

If this signal is applied to an amplifier feeding a magic eye, we obtain two luminous sectors of differing apex angles as long as the bridge is out of balance and thus alternate half-cycles at SK3 are of unequal amplitude. When the bridge is balanced, all half-cycles at SK3 become of equal amplitude and the two luminous sectors of the magic eye coincide exactly to constitute a single sector. The actual width of this sector is unimportant and can be set to any convenient size by adjusting the amplifier gain control. Note the very clean action of the electronic switch as demonstrated by the oscillograms.

USE OF OSCILLOSCOPE

If the signal from SK3 is applied to an oscilloscope, three forms of display may be used, of which the double bright-edge raster type is the best for general work. Here the signal from SK3 is fed to the Y-amplifier input and the internal timebase is set unsynchronised to the highest available repetition frequency, at least 20kHz and preferably 100kHz. Numerous timebase strokes will thus be traced during each mains-frequency half-cycle, so that we obtain a raster in a manner similar to a television raster. However, since the sinewave spends much more time near its peak value, many more timebase traces will fall there, giving the raster a sharp bright upper edge.

When the bridge is still unbalanced, each half-cycle amplitude will produce its own bright-edge raster. The two bright edges coincide to a single bright edge at balance. This balance criterion is *extremely sharp*, irrespective of polarisation, giving an outstandingly good differential resolution. The slightest off-balance is evident at once as a split-up of the single bright edge

into two sharp bright edges. Differential resolutions of much better than 0.1 per cent are easily obtainable with a 3in oscilloscope.

The magic eye type of indicator does not produce bright edges, but only sharp edges of the sectors, because a given voltage produces a full sector and not merely the sector limit lines. Thus light integration is always towards the centre of the sector when applying a varying voltage to a magic eye. This makes the double sector display on a magic eye inherently poorer than the double bright-edge raster on an oscilloscope, especially if the gain control is set too high, giving a large sector. Always set the gain control to give a sector as small as possible whilst allowing clear balance observation.

The second type of oscilloscope display is the phase pointer diagram. This is obtained by feeding the signal from SK3 as before to the Y-amplifier input, but now switching to external X-input and feeding a sample of the drive voltage of one bridge arm from SK4 to the X-input of the oscilloscope. This produces two pointers on the screen, like the hands of a clock. The bridge is balanced when both pointers rest at the same height. Provided the working conditions do not involve too large polarisation, this type of display is visually very good for demonstrations given to complete classes.

Alternatively, as the third type of display, the waveform from SK3 may be 'scoped directly in the normal manner to show the train of successive half cycles. The bridge is balanced when all half-cycles are of the same peak amplitude. Only the double bright-edge raster display can be accurately balanced, and only it is quite free from disturbance through polarisation phase shifts. Thus this display alone is recommended for routine work.

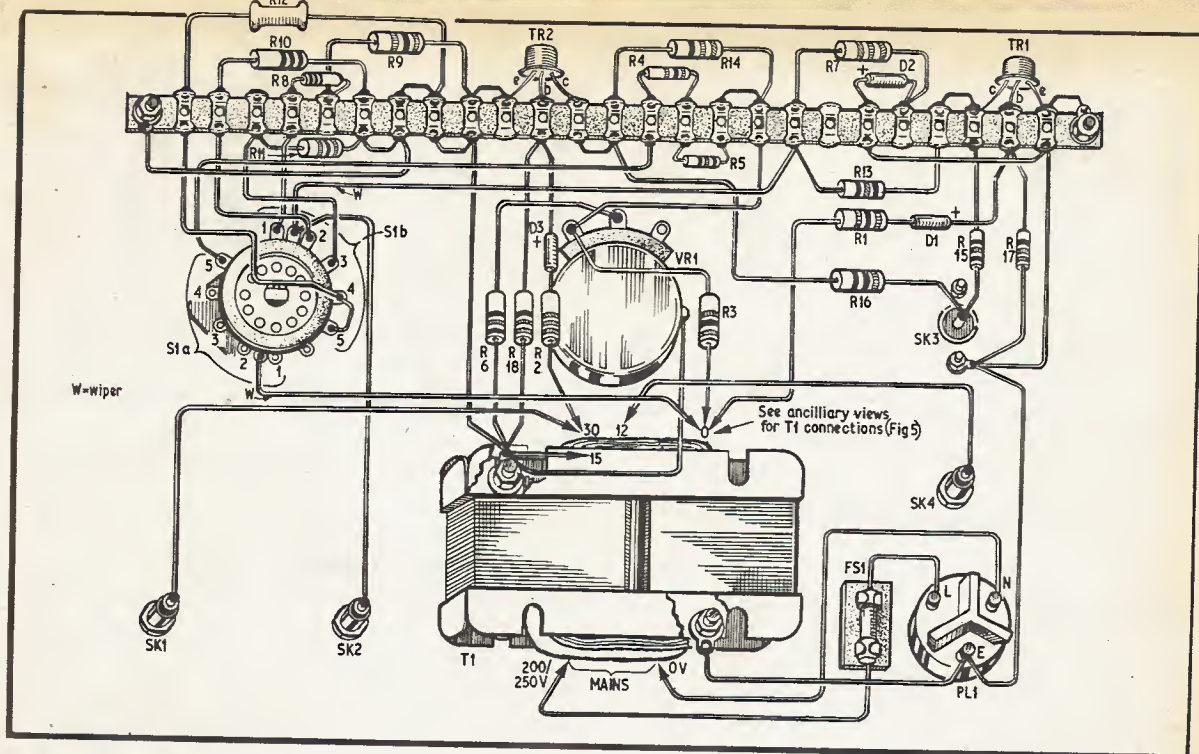

COMPONENTS . . .

Resistors

R1	10k Ω \pm 10% 1W	R10	10k Ω \pm 1% 1W
R2	10k Ω \pm 10% 1W	R11	1k Ω \pm 1% 1W
R3	8.2k Ω \pm 5% 1W	R12	100 Ω \pm 1% 5W ww
R4	820 Ω \pm 5% 1W	*R13	1M Ω \pm 5% 1W
R5	100 Ω \pm 5% 1W	*R14	1M Ω \pm 5% 1W
R6	470 Ω \pm 5% 1W	*R15	1M Ω \pm 5% 1W
R7	2.2M Ω \pm 10% $\frac{1}{2}$ W	*R16	1M Ω \pm 5% 1W
R8	10k Ω \pm 5% $\frac{1}{2}$ W	R17	100k Ω \pm 10% 1W
R9	100k \pm 1% 1W	R18	100k Ω \pm 10% 1W

All carbon except R12

* Mutually matched to \pm 1%, if possible

Potentiometer

VR1 10k Ω carbon track potentiometer, linear. Standard large volume control type

Semiconductors

D1, D3 Silicon rectifier 1S150 (Radiospares) (2 off)

D2 Silicon diode BA114 (Mullard)

TR1, 2 Silicon transistor, BSY56 or 2N1613 (2 off)

Miscellaneous

S1 2-pole 5-way wafer switch (Radiospares Makaswitch)

T1 Mains transformer. Secondary tapped at 12, 15, 20, 24, 30V 2A. Douglas MT3AT

or Rewind secondary of 6.3V 5A heater transformer to provide bifilar double 15V winding—see text

FS1 Fuse cartridge and holder, 0.5A

PL1 Mains panel connector 3pin, 5A and cable socket (Bulgin SA1861)

SK1, 2, 4 Insulated wanderplug sockets; yellow, black and red (3 off)

SK3 Coaxial socket

Case 12 $\frac{1}{2}$ in \times 7 $\frac{1}{2}$ in \times 5 $\frac{1}{2}$ in (Olson 27A—Home Radio)

One small pointer knob. One large instrument type skirted knob (with pointer). Tag strip, 25 way

Electrodes

Materials as specified in Fig. 6b

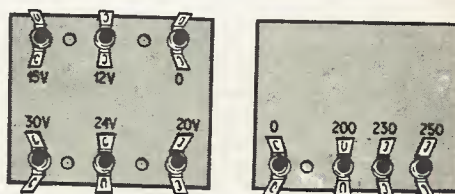

Fig. 3. Rear view of front panel. This shows all components and wiring. Details of the mains transformer connections are given in the inset diagram

CONSTRUCTIONAL DETAILS

The entire circuitry for the split phase bridge is assembled on the front panel of a standard instrument case, measuring 12.25in by 7.5in by 5.5in deep. The 16 s.w.g. steel front panel is sufficiently rigid to carry the mains transformer.

Fig. 3 and Fig. 4 show full constructional details. Layout is uncritical and there are no special problems involved.

Observe the component tolerance limits specified in the components list. The resistors on S1b should be mutually matched in decimal steps, so that continuity of differential linearity is preserved if it is necessary to switch over to a different range in the course of a titration.

In general, try to avoid range switching during a titration. If, for example, conductivity falls in the course of the titration, arrange to start with a reading close to the upper limit of a range. If the reading falls below 50 per cent of the optimum range, switch down to the next lower range and add more water until the reading comes in at the top of the new range. Conversely, for cases where conductivity rises in the course of the titration.

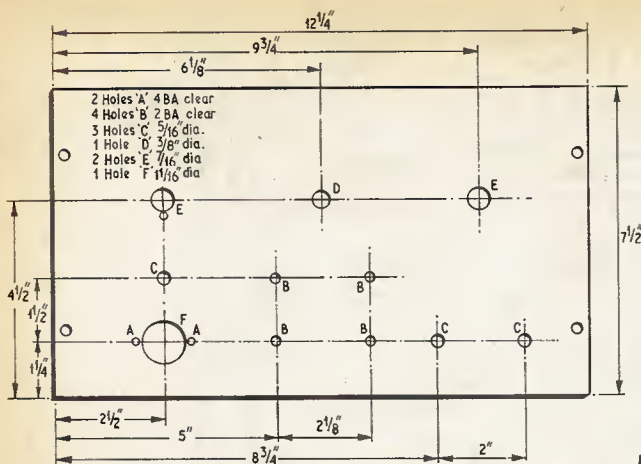

Fig. 4. Drilling details for the front panel

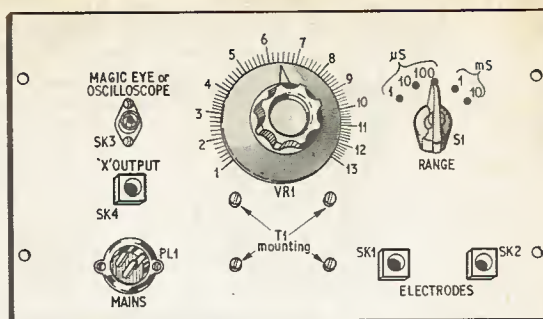

Fig. 5. General view of front panel with all components in position

CALIBRATION

Provided that resistors conforming to the tolerance limits specified have been used, it is merely necessary to provide VR1 with a scale calibrated from 1 to 13 such that the numerical reading multiplied by the unit conductance value selected with S1 gives the absolute conductance seen between SK1 and SK2. It is best to use graded standard resistors connected to these sockets, e.g. a resistance substitution box.

Calibrate in range 3 to strike the best compromise between low impedance and low current. The calibration should hold on all ranges if the resistors on S1B have been properly matched. Pad the resistors of the other ranges if necessary. Finally, check that differential continuity is preserved when switching from range 4 to range 5, correcting any discrepancies by padding R4, R5 accordingly.

ELECTRODE CONSTRUCTION

Fig. 6 shows some common electrode constructions for conductivity.

Type (a) is strongly recommended, but usually has to be purchased commercially and is not cheap (prices range to 5 guineas and more). Note the lateral horizontal ball-ended electrode pins. Any heating at the electrodes here sets up immediate convection, so that fresh liquid at the mean temperature of the bulk is continuously presented to the electrode pins. Furthermore, if the polarisation does exceed the electrolysis threshold during brief phase angles in each cycle, the gas bubbles can escape upwards without building pockets between the electrode pins, so that balance fluctuations and errors are minimised even under these extreme conditions.

The type of electrode shown in Fig. 6a is thus least subject to giving trouble under arduous conditions. It

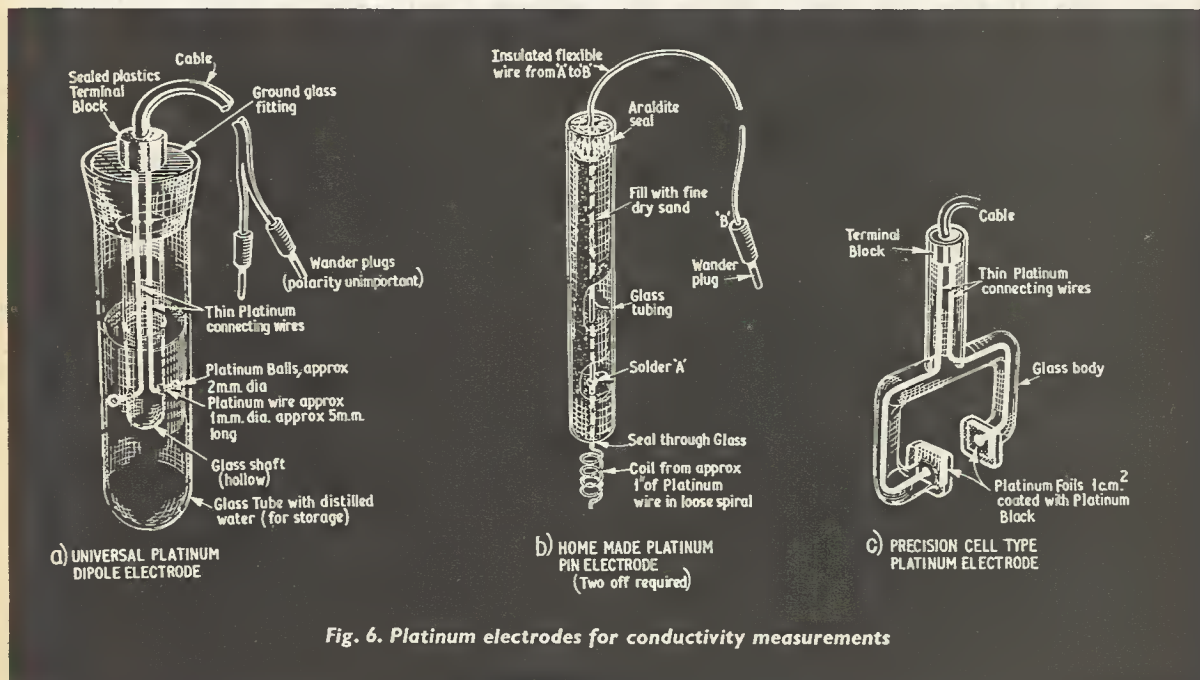

Fig. 6. Platinum electrodes for conductivity measurements

R.F. WATTMETER

Continued from page 581

often works well even in the absence of stirring, and should be used if at all possible when no magnetic stirrer is available and intermittent manual stirring with a glass rod is resorted to.

Electrodes constructed according to Fig. 6b are easily home-made and give very good performance in conjunction with efficient stirring. The length and diameter of the platinum wire, or the dimensions of the spiral, are in no way critical, but do not use excessive length or too thin a wire gauge. The spiral form promotes convection. The required amount of platinum wire costs only a few shillings from chemical apparatus dealers, the remaining items costing only a few pence.

The electrode type shown in Fig. 6c is normally used when the intention is to make absolute measurements, as distinct from the mere differential methods involved in conductometric titrations. This type of electrode gives more definite geometric conditions which can be related to specific conductivity for unit cube of the electrolyte. It is expensive and not to be recommended for the work envisaged by this article.

All electrodes used for conductometry should be coated with platinum black, an amorphous form of platinum which vastly increases the effective surface area and thus boosts the polarisation capacitance value, and so the maximum alternating current which can be accommodated within the polarisation range for a given frequency.

COATING THE ELECTRODES

Platinum electrodes of types shown in Fig. 6a or b are coated with platinum black according to the procedure now described.

Take the bright platinum electrode(s) and support them in concentrated nitric acid diluted with two parts of distilled water. Switch the split phase bridge to the highest conductivity range (switch setting 10mS) and connect up to the mains and to the electrodes. Brisk electrolysis with gas evolution will be observed, because the polarisation capacitance of the blank electrodes is too small to accommodate the 150mA current.

After 5 minutes, the gas evolution will have slowed down markedly, and after some 10 to 15 minutes it should have ceased altogether. The electrode pins are now covered with a silky black layer. The actual active agent in this process is the trace of hydrochloric acid present in almost all specimens of nitric acid. If the sample of acid is too pure, marked by persistent electrolysis, add a few drops of concentrated hydrochloric acid.

When electrolysis has ceased completely, carefully wash the electrodes several times with distilled water, and store in distilled water in a jacket tube as shown in Fig. 6a.

The deposit of platinum black formed in this simple manner is very delicate and easily rubbed off. However, it is not disturbed by agitated solutions during normal titrations, even if suspended precipitates are formed in the course of reactions. If allowed to go dry, the platinum black deposit falls off of its own accord. Thus wash the electrode carefully with distilled water and return to the storage tube after use.

If damaged mechanically or by going dry, rub off the entire deposit, clean the electrode with fine emery paper and then repeat the coating process. This is also advisable if the deposit has become poisoned by certain substances and balance readings consequently fluctuate erratically.

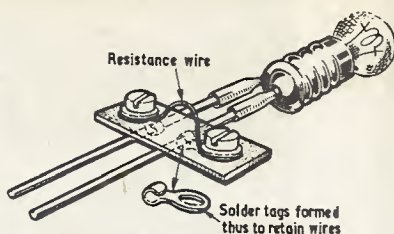

Fig. 6. Construction of the r.f. shunt strip and probe wire on the bulb

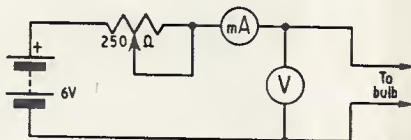

Fig. 7. Calibration circuit for the ammeter

desirable of course, to introduce switching to cover the ranges at radio frequencies.

An r.f. shunt is shown in Fig. 6. A strip of s.r.b.p. on which two solder tags are screwed, can be soldered to the parallel input wires as illustrated. The resistance wire, taken from suitable wirewound resistors, is clamped between washers under the heads of the screws and adjusted in length until the correct value is found.

The resistance wire should not be coiled as this will introduce appreciable self-inductance. It is better to find the right gauge of wire of roughly the length to match the distance between the screws.

If the wire is too thin it will run at white heat, thus quickly leading to its deterioration in free air and a large change in its resistance at high temperatures. Both of these effects will destroy calibration accuracy.

As a guide, if the scale is to be multiplied by ten to read 1,200 milliwatts full scale the shunt resistance should be 8.3 ohm, and wire taken from a 500 ohm 10 watt resistor was found to be suitable.

Obviously the whole range of possible shunts cannot be described here. For audio applications, however, ordinary carbon resistors of the correct rating can be employed. Non-inductive resistors will also serve as shunts for the lower radio frequencies.

CALIBRATION

To calibrate the wattmeter on its basic range, a 50mA meter and a 5V meter are arranged as in Fig. 7. Adjust the bulb consumption until it is exactly 60mW, then slide the bulb in or out of the probe tube until the wattmeter pointer is on the 100 μ A division. Set the bulb consumption to 120mW and adjust VR1 until the wattmeter reads full scale. Repeat the procedure again until no further adjustment is required, then lightly glue the bulb to the tube. It should be found that the intermediate divisions on the wattmeter scale correspond to the product of volts \times milliamps shown by the calibration rig. To calibrate any shunts, replace the 50mA meter with one giving a multiple of 100mW.



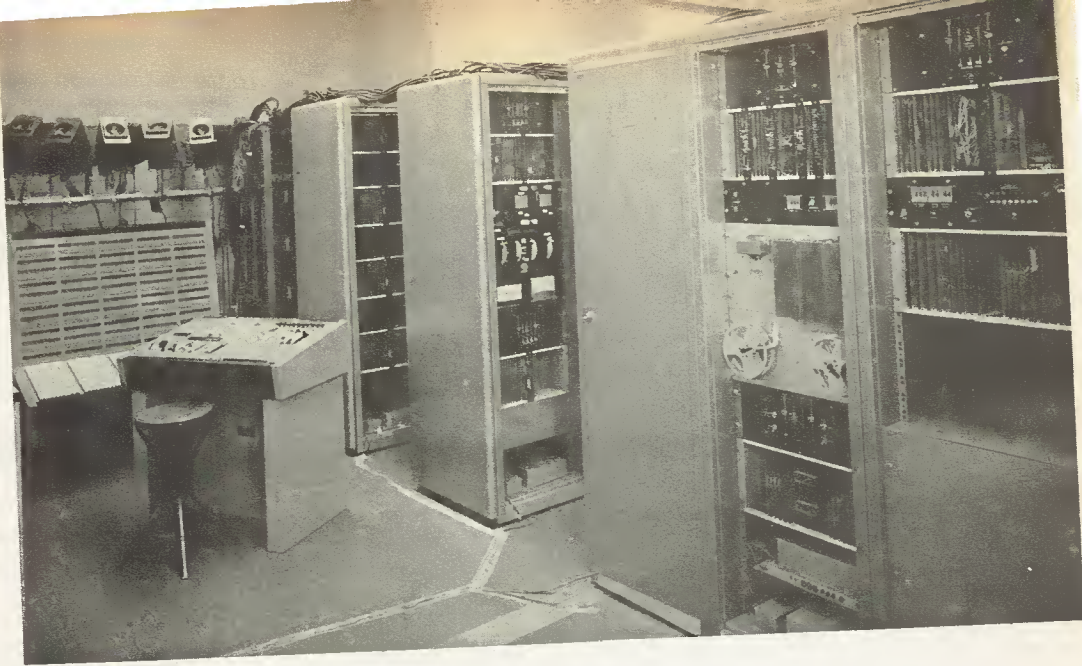

LIGHTING CONTROL

THE opening on May 31 in Ottawa of Canada's National Centre for Performing Arts attracted attention to two of the world's most advanced stage lighting control systems that have been installed in the main hall and theatre of the Centre.

The lighting control systems, which have been made in Britain and exported to Canada by the Strand Electric Company, depend for their memory on Sperry memory systems which incorporate magnetic storage drums.

The main hall lighting system controls 250 lighting circuits and 300 combinations of these circuits together with their light intensities are recorded on the magnetic storage drum making it possible to reproduce, night after night, the exact lighting sequences chosen by the lighting director during rehearsal.

The theatre lighting system is similar to that of the main hall except that it controls 200 combinations of 180 channels.

The lighting systems are extremely flexible in operation and it is possible to modify the lighting during a performance without affecting the light settings already recorded. There is also provision for permanently recording a complete lighting script on punched paper tape for future use. To repeat a performance, the paper tape is fed back into the system and the lighting sequences are automatically reset.

Type-out facilities are also provided to enable lamp settings to be recorded in an easily-read manner.

The photograph shows the memory system for the larger lighting system undergoing tests at Sperry's Research and Development Centre.

PRINTED CIRCUIT MANUFACTURE

THE latest technique developed at Palmer's Camberley factory is the production of multi-layer circuits which, they say, will soon allow them to produce up to 16 layers at a time. Among other new methods of manufacture is a plated-through process by which boards can be produced as easily as a conventional etched double-sided panel.

Prior to "printing" an operative at Palmer Aero Products' printed circuit factory, removes boards from the copper pyrophosphate tank during the production of plated-through circuits. The ping-pong balls on top of the tank help to keep the solution's heat constant by preventing the escape of steam.

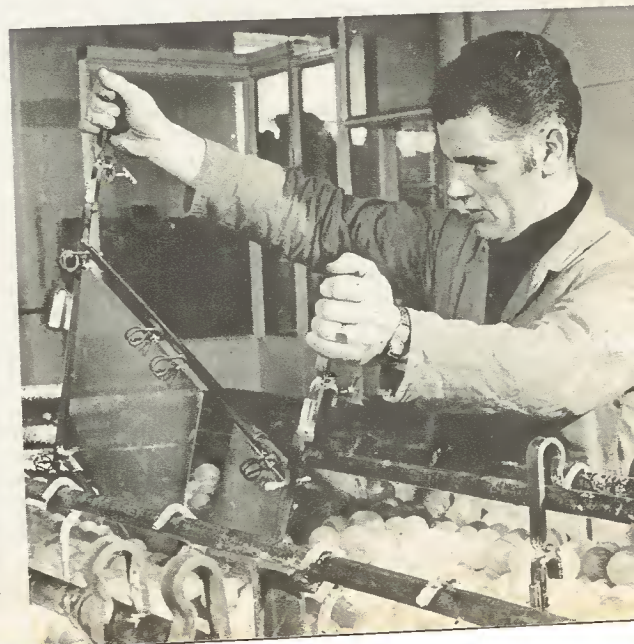

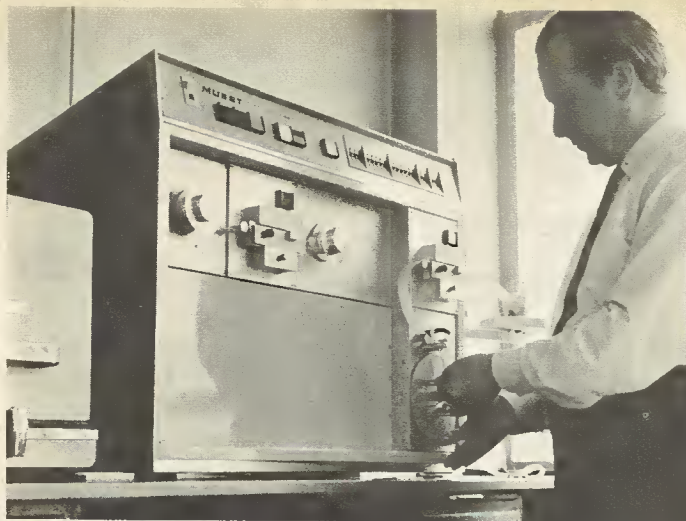

AUTOMATIC TYPE COMPOSING

BRITAIN's latest automatic type composing equipment, which is equally suitable for large and small printers, was exhibited for the first time anywhere in the world, at the International Exhibition of Modern Printing Machinery—Inpolygraphmash 69—in Moscow from July 9 to 23.

Muset K-380-B, shown above, which is claimed to be the simplest and lowest-priced computer capable of 100 per cent correct word hyphenation, has been developed and manufactured by Muirhead Limited. Muset uses the latest solid state microcircuits, does not require air-conditioning or temperature control, consumes only 360 watts and occupies only four and a half square feet of tabletop space.

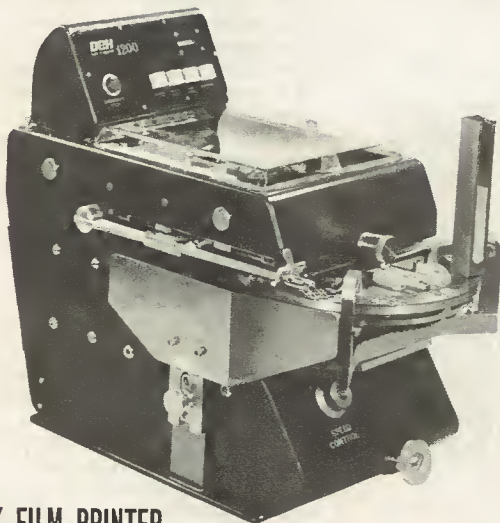

THICK FILM PRINTER

The DEK 1200 fully automatic substrate printer (shown above) for thick film circuits has been designed and manufactured in Britain by DEK Printing Machines Ltd. It embodies all the features required for repetitive work.

Controlled setting of squeegee pressure, length of print stroke, distribution of medium on return stroke and gap between substrate and underside of screen. Print stroke speed is smooth and adjustable by calibrated setting, up to 1500 impressions per hour; substrates can be fed by magazine or vibratory bowl.

When displayed at the Paris Components Show considerable interest was shown by representatives of various companies from five countries outside Britain, including Russia.

ANOTHER MEMORY

EUROPE's fastest commercially viable computer memory, the Plessey Mark 1 S250, has been delivered to the Ministry of Technology by the Automation Divisions of Plessey Electronics Group. It is shown, below, being commissioned.

This memory system has a 290 nanosecond cycle time and offers substantial improvements in performance margins and simplicity with immediate cost advantages over ferrite core and film techniques at 300 nanoseconds cycle time and less.

The system operates in the destructive read-out mode using plated wire storage elements: the elements are formed at the crosspoints of beryllium copper wires which are continuously plated with nickel iron and the word strip lines which are printed on to flexible sheets. Thus the stack design uses normal production techniques and avoids the high labour content associated with core memories.

The system electronics is based on high speed TTL integrated circuits. Full self test facilities were designed into the system so that comprehensive performance monitoring can be carried out independently from the main processor.

The Mark 1 S250 has a capacity of 100,000 bits and represents an important breakthrough for the British electronics industry.

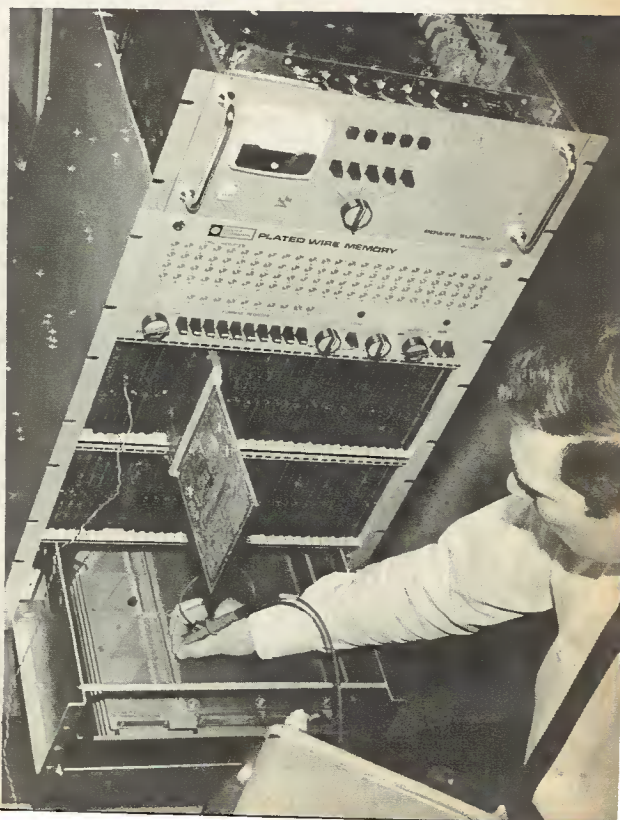

PEOPORAN PART 4

LAST month we ended with the pedal cables attached at one end to the upper manual printed circuit board. Now we must terminate these free ends.

PEDAL RESISTOR BOARDS

Just as we have anti-robbing resistors in the manual contact assemblies so we require them in the tone outlets, to the pedals. As there are 30 16ft pitch wires and 30 8ft pitch wires emanating from the upper manual, two 30 way miniature tag boards are required for mounting the pedal resistors.

These are made up from four, 18-way tag boards each being screwed to the back of the kneeboard using backing bakelite plates as insulators (see photograph). Reference to the console rear view photograph in Part Two will clarify their positioning.

Across each pair of turret lugs connect a 100 kilohm $\frac{1}{2}$ watt 10 per cent resistor. When the pedal cable wiring is completed these resistors will be in series with the tone outlets and in due course with the pedal contacts—when we get onto that part of the organ.

First connect the 30 16ft pitch wires to two of the boards. Fig. 4.1 shows the order of these connections in terms of the wiring colour code adopted for the 16ft pitch wires only. The black wire, 32·7Hz, is soldered on at turret tag marked X, then the brown wire to the tag adjacent until all 30 wires are used up. The wiring of the 30 8ft pitch wires to their two boards is identical in its sequence but now the black wire, 65·4Hz, goes to the tag marked X and wiring continues till all 30 wires are exhausted.

Pedal resistor boards in position on console kneeboard. Here the pedal plugs are shown mated to the sockets



PLUGS AND SOCKETS

To mate the pedals to the console, a floating plug arrangement was decided on as this makes it much easier for the constructor to set and adjust the contacts on the pedals, away from the organ.

Two pairs of 32-way plugs and sockets are required, although only the sockets are used at this stage; the plugs will be attached later to the pedal board.

In Fig. 4.1 is shown the top side of the 16ft pitch socket. To make the connections from this to the

COMPONENTS . . .

PEDAL RESISTOR BOARDS

R1-60 100k Ω $\frac{1}{2}$ watt 10% resistors (60 off)

PL1, 2 32-way plugs (2 off) }
SK1, 2 32-way sockets (2 off) } Electronics,
Harlow, Essex.

Miniature 18 way tag boards (4 off)
Bakelite backing plates (4 off)

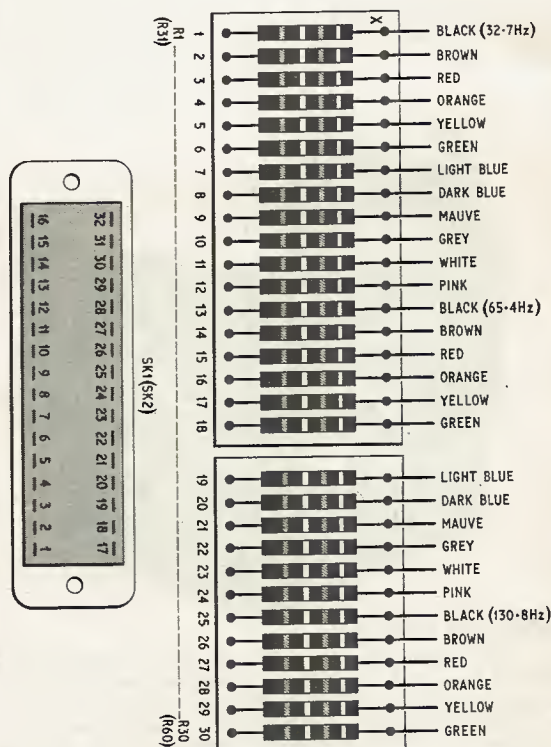

Fig. 4.1. Upper manual wiring to 16ft pitch pedal resistor boards and socket SK1. For the 8ft pitch boards a black lead (65·4Hz) is connected to tag X and subsequent note wires attached until all 30 tags are terminated. Pins 31 and 32 on the sockets will eventually be terminated with the 16ft and 8ft busbar return wires from the pedals

MAIN AMPLIFIERS & POWER UNITS

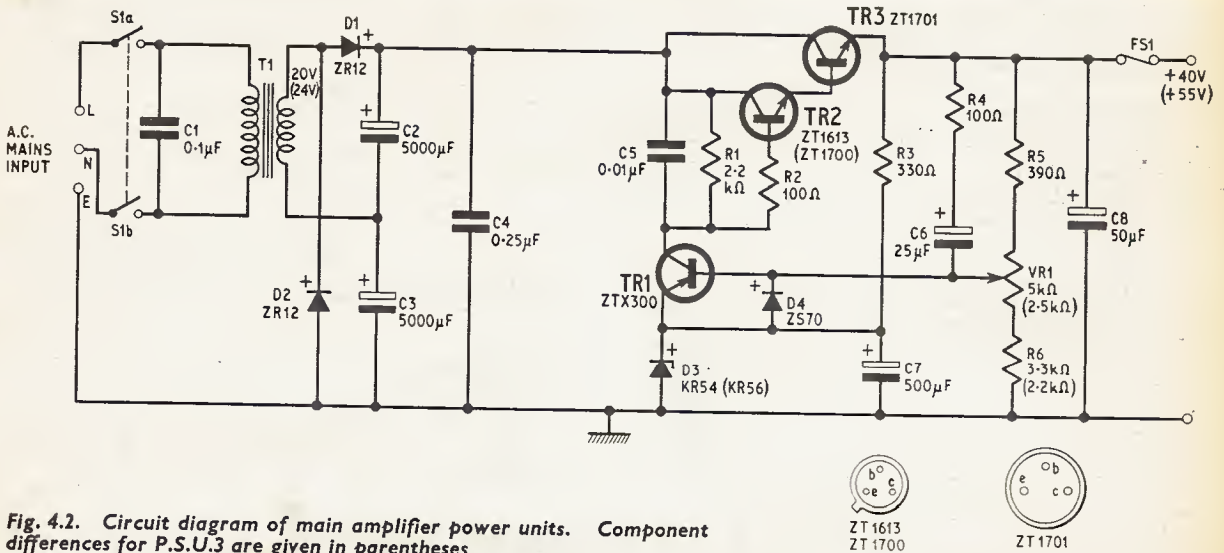

Fig. 4.2. Circuit diagram of main amplifier power units. Differences for P.S.U.3 are given in parentheses

resistors on the 16ft pitch tag boards merely means joining with short insulated wire lengths between the commonly numbered tags, that is, one to one, two to two, etc.

For the 8ft pitch boards the other socket is used, the numbering and wiring being the same. The sockets should now be carefully fixed to the kneeboard using 6B.A. countersunk screws and $\frac{3}{4}$ in spacers.

AMPLIFIERS AND POWER SUPPLIES

Since we decided on silicon planar transistors for the tone generating system, the choice of this advantageous semiconductor is a natural one for the amplifiers and power supplies.

For the pedals a 7 watt amplifier is used, and a 15 watt unit for the two manuals. Both employ transformerless Class B circuits capable of delivering the full specified power into their respective 15 ohm loudspeaker loads in the frequency range 20Hz to 20kHz with a total harmonic distortion of less than 0.25 per cent.

With the large current taken by Class B output stages the power supply units need to be stabilised. This feature results in the associated power amplifier having a much greater low frequency stability.

The following details of the amplifiers and power supplies are reproduced with acknowledgement to Ferranti Ltd.

P.S.U.2 AND P.S.U.3

Reference to Fig. 1.1, the block diagram of the organ, shows that the power supplies P.S.U.2 and P.S.U.3 feed the pedal amplifier P.A.1, and the manual amplifier P.A.2, respectively.

The circuit diagram for both power units is given in Fig. 4.2. As can be seen the basic configuration applies for the two units, the only difference being in the com-

ponents required. Changes for P.S.U.3 are shown in parenthesis.

CIRCUIT DETAILS

The stabiliser circuit is fed from a voltage doubler comprising of D1, D2, C2 and C3. The reference voltage is developed across the Zener diode D3 which is compared with a proportion of the output voltage by TR1. This transistor is directly coupled to TR2 and TR3 and controls the voltage dropped across them.

If the output voltage should rise the base potential of TR1 rises; the current in TR1 increases resulting in a larger voltage drop across R1. This is transferred to the output via TR2 and TR3 as a voltage drop. The capacitor C8 ensures a low output impedance at high frequencies. A good feature of this circuit is the delayed switching effected by the capacitor C5, which obviates unpleasant transients in the output.

CONSTRUCTION

Since there are only slight component value differences in the power units, the chassis wiring layout of Fig. 4.3 can be applied to both.

A 3in miniature tag board is used for small component mounting, this being mounted on two $\frac{3}{4}$ in spacers and fixed by 1in 6B.A. nuts and bolts.

For those who prefer a printed circuit board alternative, an etched wiring and component layout is given in Fig. 4.4 and Fig. 4.5.

Diode D3 should be bolted to the power supply chassis which serves as a heat sink. Transistors TR2 and TR3 are mounted on a common heat sink of 4in \times 4in \times $\frac{1}{16}$ in aluminium which is insulated from the chassis by three nylon feed-through bushes.

Both the transistors heat sink and diode mounting to chassis can be seen in the photograph.

POWER SUPPLIES WIRING

COMPONENTS . . .

P.S.U.2 AND P.S.U.3

Component differences for P.S.U.3 are given in parentheses

Resistors

R1 2.2k Ω	R4 100 Ω
R2 100 Ω	R5 390 Ω
R3 330 Ω	R6 3.3k Ω (2.2k Ω)
All 10%, $\frac{1}{2}$ watt carbon	

Potentiometers

VR1 5k Ω lin. (2.5k Ω lin)

Capacitors

C1 0.1 μ F
C2 5,000 μ F elect. 50V
C3 5,000 μ F elect. 50V
C4 0.25 μ F
C5 0.01 μ F
C6 25 μ F elect. 25V
C7 500 μ F elect. 60V
C8 50 μ F elect. 100V

Transistors

TR1 ZTX300 (Ferranti)
TR2 ZT1613 (ZT1700) (Ferranti)
TR3 ZT1701 (Ferranti)

Diodes

D1 ZR12 (Ferranti)
D2 ZR12 (Ferranti)
D3 KR54 33V Zener (KR56 47V Zener) (Ferranti)
D4 Z570 (Ferranti)

Transformers

T1 Douglas MT3AT. Prim. 230V Sec. 20V 2A. (Prim. 230V Sec. 24V 2A) (Home Radio)

Switches

S1 Mains double pole on/off

Fuses

FS1 1 amp

Miscellaneous

Fuse holder, Chassis 8in \times 6in \times 2 $\frac{1}{2}$ in
18 s.w.g. Heat sink 4in \times 4in \times $\frac{1}{2}$ in.
Miniature 12-way tag board 2 $\frac{3}{4}$ in
long. Two-way terminal block.

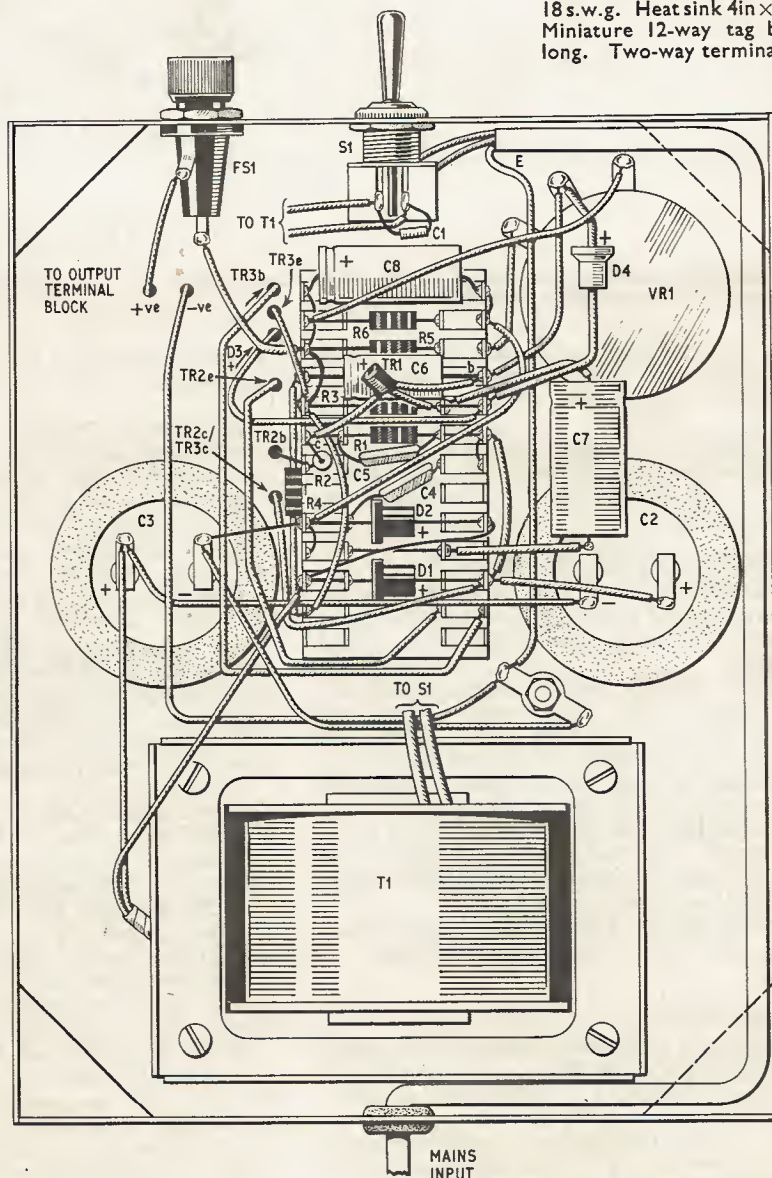

Fig. 4.3. Wiring layout which can be applied for both P.S.U.2 and P.S.U.3. The d.c. output wires go to the terminal block shown in the chassis top-side layout in the photograph opposite

PRINTED CIRCUIT VERSION WIRING



Fig. 4.4 (above). Printed circuit board alternative for power supplies, full size

Fig. 4.5 (right). Component layout and wiring for the printed circuit version

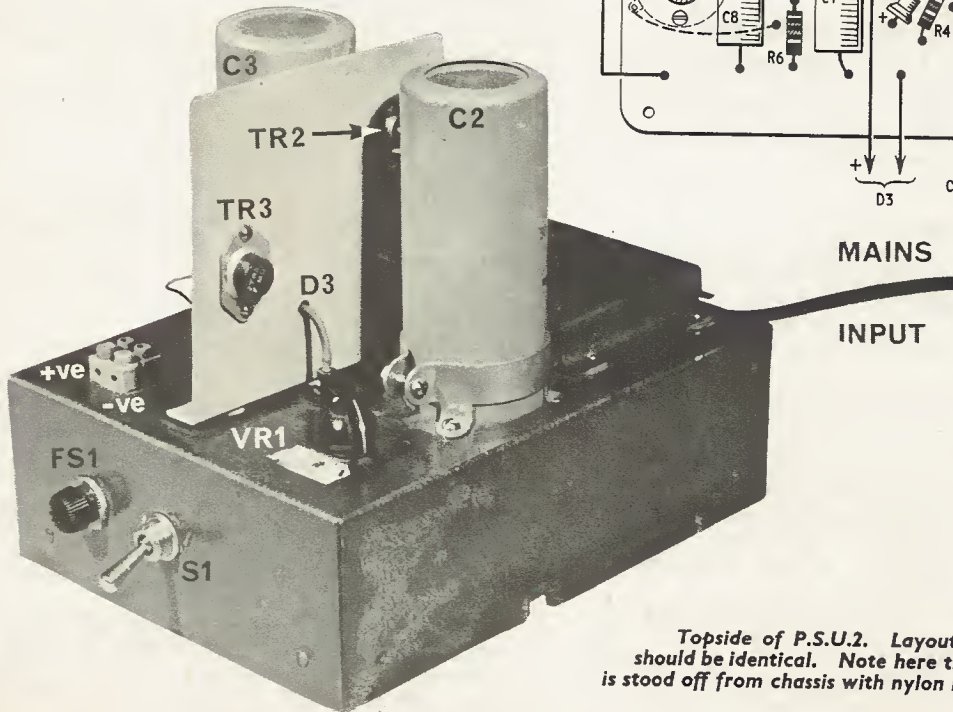
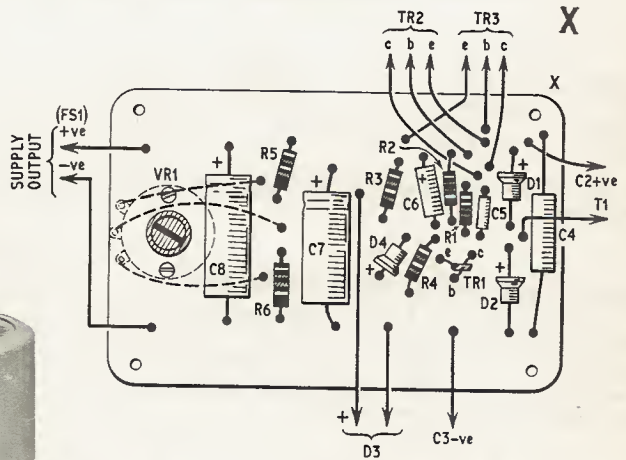

Topside of P.S.U.2. Layout for P.S.U.3 should be identical. Note here that heat sink is stood off from chassis with nylon insulators

AMPLIFIER CIRCUIT

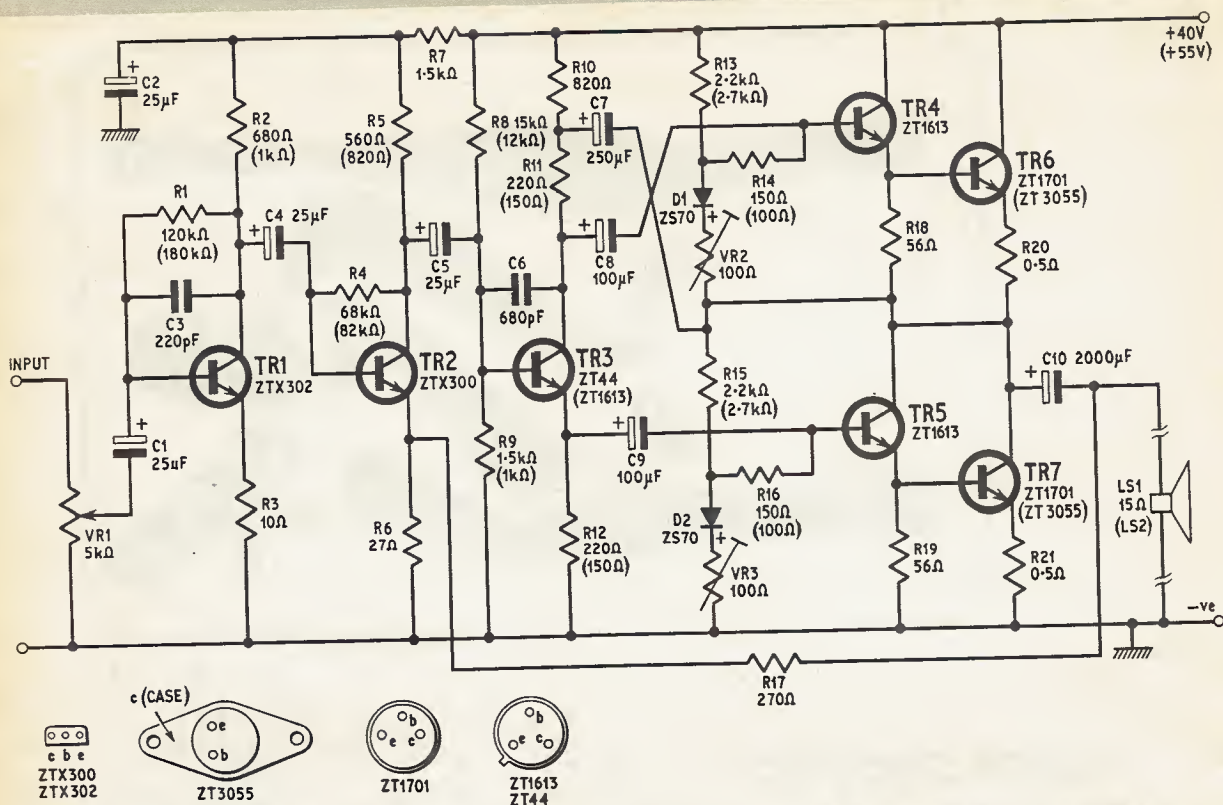

Fig. 4.6. Circuit diagram for pedal (P.A.1) and manual (P.A.2) amplifier. Component differences for P.A.2 are given in parentheses

PEDAL AND MANUAL AMPLIFIERS

The audio amplifier circuit to be described serves to supply 7 watts for the pedal output (P.A.1) and 15 watts for the manuals (P.A.2). The circuit given in Fig. 4.6 is fundamental to both, component differences for P.A.2 being shown in parentheses.

CIRCUIT DESCRIPTION

The input is fed via the volume control potentiometer VR1 and amplified through the two a.c. coupled, common emitter stages, TR1 and TR2. These have local feedback from collector to base, while overall feedback from the output is taken to the emitter of TR2 by way of R17.

TR3 is a split load phase inverter which provides the necessary asymmetrical drive to the two halves of the driver stages TR4 and TR5. Diodes D1 and D2 serve to provide a stable bias for the drivers, which being directly coupled to the output stage, produce a standing current in the output transistors which eliminates crossover distortion. Positive bootstrap feedback, developed across R10 via C7, is used to equalise the power gain of the two halves.

The output stage is basically symmetrical with TR6 connected as an emitter follower and TR7 in the common emitter mode. The low source impedance presented by the emitter follower drivers to this stage does much to enhance the high frequency response and minimise harmonic distortion.

SPECIFICATION . . .

Nominal input impedance	approximately 1 kilohm
Nominal output impedance	less than 1 ohm
Sensitivity	20mV for rated output
Nominal power output (P.A.1)	7 watts
Nominal power output (P.A.2)	15 watts
Total harmonic distortion	less than 0.25 per cent
Frequency response	Within 1dB over range 20Hz to 20kHz
Total current for full power output at 1kHz	
P.A.1	300mA
P.A.2	500mA

CONSTRUCTION

The design is intended for construction on a printed circuit board but as lead lengths are of no great consequence other methods can be employed; but it is essential that a low impedance earth path is provided when laying out to prevent instability arising.

In the prototype organ both tag board and printed board assemblies were used in the construction of the amplifiers and power units to prove that variations in layout would not affect performance.

Whilst latitude is permissible in component layout, it is important that no attempt should be made to integrate an amplifier and power unit on a single chassis. Separate unit construction minimises the adverse effect of ripple current flow.

LOOK!

PRACTICAL!

VISUAL!

EXCITING!



a new 4-way method of mastering
ELECTRONICS
by doing — and — seeing . . .

1 ▶ **OWN and HANDLE a**

complete range of present-day **ELECTRONIC PARTS and COMPONENTS**

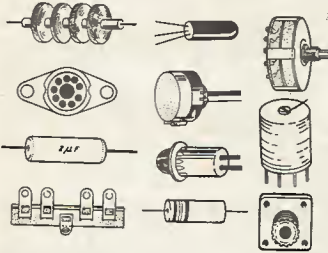

2 ▶ **BUILD and USE**

a modern and professional **CATHODE RAY OSCILLOSCOPE**

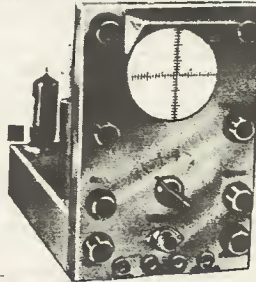

3 ▶ **READ and DRAW and**

UNDERSTAND CIRCUIT DIAGRAMS

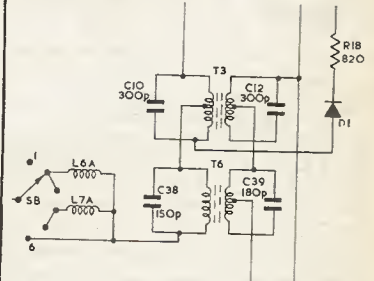

4 ▶ **CARRY OUT OVER 40 EXPERIMENTS ON BASIC ELECTRONIC CIRCUITS AND SEE HOW THEY WORK . . . INCLUDING . . .**

- VALVE EXPERIMENTS
- TRANSISTOR EXPERIMENTS
- AMPLIFIERS
- OSCILLATORS
- SIGNAL TRACER
- PHOTO ELECTRIC CIRCUIT
- COMPUTER CIRCUIT
- BASIC RADIO RECEIVER
- ELECTRONIC SWITCH
- SIMPLE TRANSMITTER
- A.C. EXPERIMENTS
- D.C. EXPERIMENTS
- SIMPLE COUNTER
- TIME DELAY CIRCUIT
- SERVICING PROCEDURES

This new style course will enable anyone to really understand electronics by a modern, practical and visual method—no maths, and a minimum of theory—no previous knowledge required. It will also enable anyone to understand how to test, service and maintain all types of Electronic equipment, Radio and TV receivers, etc.

FREE POST NOW
for
BROCHURE

or write if you prefer not to cut page

To: **BRITISH NATIONAL RADIO SCHOOL, READING, BERKS.** Please send your free Brochure, without obligation, to: we do not employ representatives

NAME..... **BLOCK CAPS**

ADDRESS..... **PLEASE P.E. 8**

DE LUXE STEREO AMPLIFIER

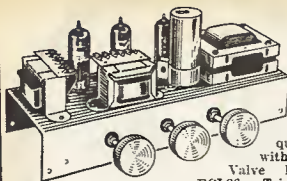

A.c. mains 200-240 volts. Using heavy duty fully isolated mains transformer with full wave rectification giving adequate smoothing with negligible hum. Valve line up—2x ECL86 Triode Pentodes.

1x EZ80 as full wave rectifier. Two dual potentiometers are provided for bass and treble control, giving bass and treble boost and cut. A dual volume control is used. Balance of the left and right hand channels can be adjusted by means of a separate 'balance' control fitted at the rear of the chassis. Input sensitivity is approximately 300mV for full peak output of 4 watts per channel (8 watts mono), into 3 ohm speakers. Full negative feedback in a carefully calculated circuit, allows high volume levels to be used with negligible distortion. Supplied complete with knobs, chassis size 11in. x 4in. x 4in. Overall height including valves 5in. Ready built and tested to a high standard. Price 8 gns. P. & P. 8/-.

TRANSISTOR STEREO 8 + 8 MK II

Now using Silicon Transistors in first five stages on each channel resulting in even lower noise level with improved sensitivity. A really first-class Hi-Fi Stereo Amplifier Kit. Uses 14 transistors giving 8 watts push pull output per channel (16W mono). Integrated pre-amp. with Bass, Treble and Volume controls. Suitable for use with Ceramic or Crystal cartridges. Output stage for any speakers from 3 to 15 ohms. Compact design, all parts attractive front panel, knobs, wire, solder, nuts, bolts—no extras to buy. Simple step by step instructions enable any constructor to build an amplifier to be proud of. Brief specification: Freq. response $\pm 3dB$, 20-20,000c/s. Bass boost approx. to +12dB. Treble cut approx. to -18dB. Negative feedback +8dB over main amp. Power requirements 25V at 0.6 amp. PRICES: AMPLIFIER KIT £10.10/-; POWER PACK KIT £3.0/-; CABINET £3.0/- All Post Free. Circuit diagram, construction details and parts list (free with kit) 1/6. (S.A.E.).



SPECIAL PURCHASE!
E.M.I. 4-SPEED PLAYER
Heavy 8 1/2in. metal turntable. Low fitter performance 200 V shaded motor (90 V tap). Complete with latest type lightweight pick-up arm and mono cartridge with 1/2 styli for LP/78. ONLY 85/- P. & P. 6/6.

4-SPEED RECORD PLAYER BARGAINS

Mains models. All brand new in maker's packing. B.S.R. UA25 with latest mono compatible cart... £6.18/6 All plus Carriage and Packing 6/6.

LATEST GARRARD MODELS. All types available 1025, 2025, SP25, 3000, AT60 etc. Send S.A.E. for Latest Prices; **FLINTH UNITS** cut out for Garrard Models 1025, 2025, 3000, 3000, AT60, SP25. With rigid perspex cover. O.U.P. PRICE 5 gns. complete. P. & P. 8/6.

SONOTONE STALCH compatible Stereo Cartridge with diamond stylus 50/- P. & P. 2/-.
LATEST RONETTE T/O Stereo Compatible Cartridge for EP/LP/Stereo/78. 32/6 P. & P. 2/-.
LATEST RONETTE T/O Mono Compatible Cartridge for EP/LP/78 mono or stereo records on mono equipment. 30/- P. & P. 2/-.
FEW ONLY! ADOS HIGH-G Mono Cartridge for EP and LP. Only 10/- P. & P. 2/-.

HIGH GAIN 4 TRANSISTOR PRINTED CIRCUIT AMPLIFIER KIT

Type TAI

● Peak output in excess of 1 1/2 watts.
● All standard British components.
● Built on printed circuit panel size 6 x 3in.
● Generous size Driver and Output Transformers.
● Output transformer tapped for 3 ohm and 15 ohm speakers.
● Transistors (GET114 or S1 Mullard AC128D and matched pair of AC128 o/p).
● 9 volt operation.
● Everything supplied, wire, battery clips, solder, etc.
● Comprehensive easy to follow instructions and circuit diagram 2/6 (Free with Kit). All parts sold separately.
SPECIAL PRICE 45/- P. & P. 3/-. Also ready built and tested, 52/6 P. & P. 3/-.

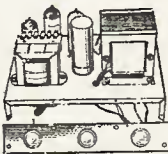

3-VALVE AUDIO AMPLIFIER HA34 MK II

Designed for Hi-Fi reproduction of records. A.C. Mains operation. Ready built on plated heavy gauge metal chassis, size 7 1/2in w. x 4in. d. x 4 1/2in. h. Incorporates ECC83, EL84, EZ80 valves. Heavy duty, double wound mains transformer and output transformer matched for 3 ohm speaker. Separate volume control and now with improved wide range tone controls giving bass and treble lift and cut. Negative feedback line. Output 4 1/2 watts. Front panel can be detached and leads extended for remote mounting of controls. Complete with knobs, valves, etc., wired and tested for only £4.15.0. P. & P. 6/6.

10/14 WATT HI-FI AMPLIFIER KIT

A stylishly finished monaural amplifier with an output of 1 1/4 watts from 2 EL84s in push-pull. Super reproduction of both music and speech, with negligible hum. Separate inputs for mike and gram allow records and announcements to follow each other.

Fully shrouded section wound output transformer to match 3-15 ohm speaker and 2 independent volume controls, and separate bass and treble controls are provided giving good lift and cut. Valve line-up 2 EL84s, ECC83, EF86 and EZ80 rectifier. Simple instruction booklet 2/6 (Free with parts). All parts sold separately. ONLY 47.9.6. P. & P. 8/6. Also available ready built and tested complete with sid. input sockets, £9.5.0. P. & P. 8/6.

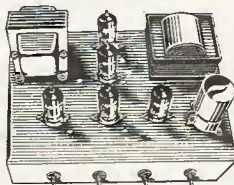

BRAND NEW 3 OHM LOUSPEAKERS

5in. 14/- 6in. 18/6; 8in. 27/-; 7 x 4in. 18/6; 10 x 6in. 27/6. E.M.I. 8 x 5in. with high flux magnet 21/- E.M.I. 13 1/2 x 8in. with high flux ceramic magnet 42/- (15 ohm 45/-). E.M.I. 13 x 8in. with two inbuilt tweeters and crossover network. 3 or 15 ohms 4 gns. P. & P. 5in. 2/- 6 1/2 x 8in. 2/6, 10 x 12in. 3/6 per speaker.

BRAND NEW. 12in. 15W H/D Speakers, 3 or 15 ohms. By well-known British maker. Now with Hi Flux ceramic ferobar magnet assembly. £5.10.0. P. & P. 5/- Guitars Models: 25w. 48; 35w. 28.
E.M.I. 3in. HEAVY DUTY TWEETERS. Powerful ceramic magnet. Available in 3 or 8 ohms 15/- each; 15 ohms 18/6 each. P. & P. 2/6.

VYNAIR AND BEXINE SPEAKERS AND CABINET FABRICS app. 54in. wide. Usually 35/- yd., our price 13/6 yd. length. P. & P. 2/6 (min. 1 yd.). S.A.E. for samples.

NEW! HSL.700 MONO TRANSISTOR AMPLIFIER

A really high fidelity monaural amplifier with performance characteristics to suit the most discriminating listener. 6 transistor circuit with integrated pre-amp assembled on special printed sub panel. AD161-AD162 operating in symmetrical complementary pair. Output transformer coupled to 3 ohm and 15 ohm pair. Standard phono input sockets. Full wave bridge rectifier power supply for a.c. mains 200-240V. Controls: bass, treble, volume/on/off. Function selector for PU1, PU2, tape, radio. The HSL.700 is strongly constructed on rigid steel chassis bronze hammer enamel finish, size 9 1/2 x 4 1/2in. high.

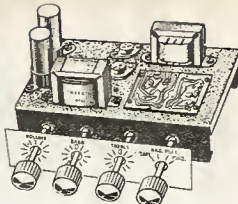

Performance figures:
Sensitivity—PU1—50mV, 56K input impedance.
PU2—110mV, 1 meg input impedance.
Radio—110mV, 1 meg input impedance.
Tape—110mV, 1 meg input impedance.
Output power measured at 1K—6-2 watts RMS into 3 ohms, 5-8 watts RMS into 15 ohm. Overall frequency response 30c/s-18Kc/s. Continuously variable tone controls. Bass, +8dB to -12dB at 100c/s. Treble, -10dB to -10dB at 10Kc/s.

The HSL.700 has been designed for true high fidelity reproduction from radio tuner, gramophone deck and tape recorder pre amp but is also capable of being used in conjunction with a guitar by connecting to PU1 socket and the peak output power will then be in the region of 15 watts. Supplied ready built and tested, complete with knobs, attractive anodised aluminium front escutcheon panel, long spindles (can be cut to suit your housing requirements) full circuit diagram and operating instructions.

OUR SPECIAL PRICE £7.19.6. P. & P. 7/6.

COLLARO MAGNAVOX 363 STEREO TAPE DECK. 3-speeds, 4 track, up to 7in. spools. £18.10.0. Carr. 10/-
HIGH IMPEDANCE CRYSTAL STICK MIKES. OUR PRICE 21/- P. & P. 1/6.
CARBON MIKE INSERTS. Brand New. 2 1/2in. dia. 5/- P. & P. 1/6.

QUALITY RECORD PLAYER AMPLIFIER MK II

A top-quality record player amplifier employing heavy duty double wound mains transformer, ECC83, EL84, EZ80 valves. Separate Bass, Treble and Volume controls. Complete with output transformer matched for 3 ohm speaker. Size 7in. w. x 3 1/2 x 6 1/2in. Ready built and tested. PRICE 75/- P. & P. 6/- Also AVAILABLE mounted on board with output transformer and speaker ready to fit into cabinet below. PRICE 97/6 P. & P. 7/6.

DE LUXE QUALITY PORTABLE R/P CABINET MK II Uncut motor board size 14 1/2 x 12in., clearance 2in. below, 13 amp. and 20V at 1.2 amp; secs. can be connected in series for 36V at 1.5 amp. Ideal for transistor power supplies. Drop through mounting. Stack size 2 1/2 x 3 1/2 x 7in. 15/- P. & P. 6/-.

MAINS TRANSFORMER. Primary 200-240V two separate 1/2 wave secondaries giving approx. 16V at 1 amp and 20V at 1.2 amp; secs. can be connected in series for 36V at 1.5 amp. Ideal for transistor power supplies. Drop through mounting. Stack size 2 1/2 x 3 1/2 x 7in. 15/- P. & P. 6/-.

MAINS TRANSFORMER. For transistor power supplies. Pri. 200/240V. Sec. 9-0-9 at 500mA. 11/- P. & P. 2/6. Pri. 200/240V. Sec. 12-0-12 at 1 amp. 14/6 P. & P. 2/6. Pri. 200/240V. Sec. 10-0-10 at 2 amp. 27/6 P. & P. 3/6.

MATCHED PAIR OF 2 WATT TRANSISTOR DRIVER AND OUTPUT TRANSFORMERS. Stack size 1 1/2 x 1 1/2 x 1in. Output trans. tapped for 3 ohm and 15 ohm output. 10/- pair plus 2/- P. & P.

Open all day Saturday
Early closing Wed. 1 p.m.

A few minutes from South Wimbledon
Tube Station

HARVERSON SURPLUS CO. LTD.

170 HIGH ST., MERTON, LONDON, S.W.19 Tel. 01-540 3985

SEND STAMPED ADDRESSED ENVELOPE WITH ALL ENQUIRIES

(Please write clearly)

PLEASE NOTE: P. & P. CHARGES QUOTED APPLY TO U.K. ONLY. P. & P. ON OVERSEAS ORDERS CHARGED EXTRA.

WENTWORTH RADIO

SEND S.A.E. FOR
NEW STOCK LIST

104 SALISBURY ROAD
HIGH BARNET

01-449 3087

SPECIAL NO. 1	SPECIAL NO. 2	SPECIAL NO. 3			
AC127	4/-	BC108	3/3	OC35	7/6
NKT123	4/11	OA200	2/3	2N3704	5/6
NKT124	8/9	OA81	1/6	ACY20	4/9
NKT125	5/9	OA95	1/6	ACY21	5/-
NKT126	6/3	OC44	4/6	ACY22	3/3
NKT135	5/3	OC45	1/8	ACY32	5/3
NKT137	7/6	OC70	1/6	ACY40	3/6
NKT14	7/6	OC71	2/3	AC126	4/6
NKT275	4/-	OC72	2/6	AF14	5/-
NKT277	5/-	OC74	3/9	AF15	3/9
NKT453	8/-	OC75	3/9	AF16	2/9
NKT603F	6/-	OC78	5/-	AF17	2/9
NKT613F	5/6	OC81	2/3	BC107	4/9
NKT674F	6/6	OC81D	2/3	BC109	4/-
NKT715	5/3	OC170	2/3		
NKT734	5/4	OC171	3/3		
NKT736	6/6	OC172	3/6		
NKT773	4/9	RESISTORS \pm W 3d.			

HOW TO BUILD YOUR OWN HOME
All the money-saving details in the August issue of
PRACTICAL HOUSEHOLDER
OUT NOW TWO SHILLINGS

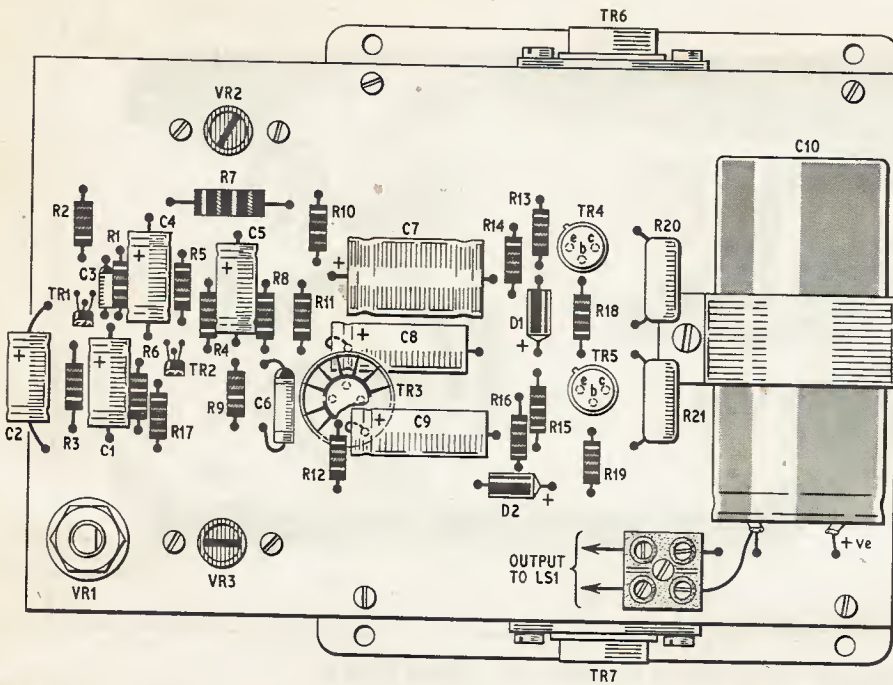

Fig. 4.7. Component layout on top side of printed circuit board for P.A.1 and P.A.2. For details of heat sink see Fig. 4.10. Note the radial cooler for TR3

P.A.1 AND P.A.2
Component differences
for P.A.2 are given in
parentheses

Resistors

R1	120k Ω (180k Ω)
R2	680 Ω (1k Ω)
R3	10 Ω
R4	68k Ω (82k Ω)
R5	560 Ω (820 Ω)
R6	27 Ω
R7	1.5k Ω 1W
R8	15k Ω (12k Ω)
R9	1.5k Ω (1k Ω)
R10	820 Ω
R11	220 Ω (150 Ω)
R12	220 Ω (150 Ω)
R13	2.2k Ω (2.7k Ω)
R14	150 Ω (100 Ω)
R15	2.2k Ω (2.7k Ω)
R16	150 Ω (100 Ω)
R17	270 Ω
R18	56 Ω
R19	56 Ω
R20	0.5 Ω 2W
R21	0.5 Ω 2W

All 10%, $\frac{1}{2}$ watt carbon
unless otherwise stated

Capacitors

C1	25 μ F elect. 12V
C2	25 μ F elect. 25V
C3	220pF
C4	25 μ F elect. 12V
C5	25 μ F elect. 12V
C6	680pF
C7	250 μ F elect. 12V
C8	100 μ F elect. 12V
C9	100 μ F elect. 12V
C10	2,000 μ F elect. 50V

Potentiometers

VR1	5k Ω lin.
VR2	100 Ω preset
VR3	100 Ω preset

Transistors

TR1	ZTX302
TR2	ZTX300
TR3	ZT44 (ZT1613)
TR4, 5	ZT1613
TR6	ZT1701 (ZT3055)

All Ferranti types

Diodes

D1, 2	ZS70 (Ferranti)
-------	-----------------

Loudspeakers

LS1	WB. HF1016
LS2	WB. HF1214

Miscellaneous

Printed circuit boards.
Aluminium heat sinks
(minimum area 4 sq. in.)
Radial cooler for TR3
Components and printed
circuit boards for the
amplifiers and power
supplies can be obtained
from: Welbrook Engineering and
Electronics Ltd., Brooks
Street, Stockport,
Cheshire

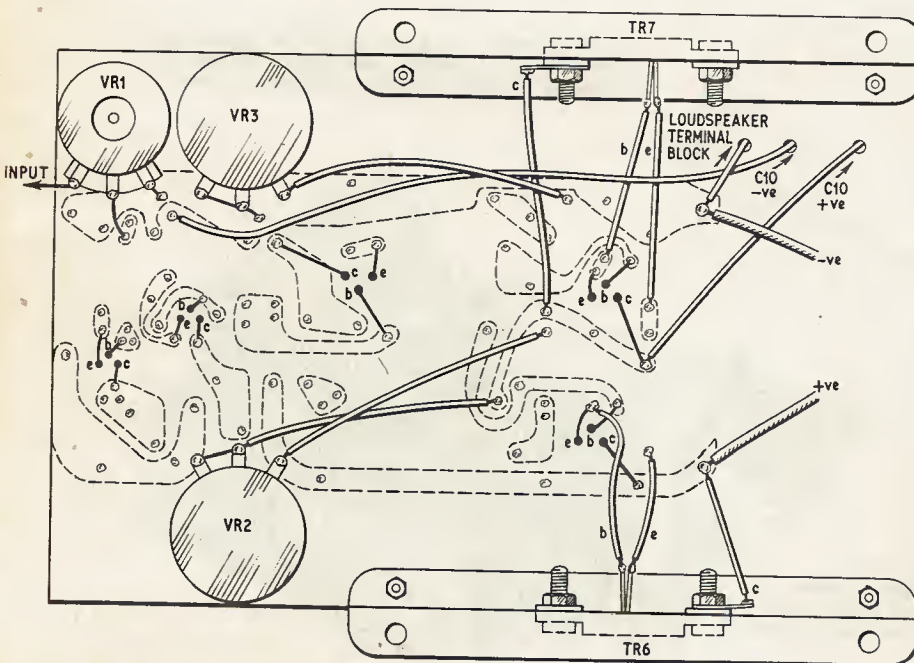

Fig. 4.8. Wiring of potentiometer and transistors to underside of amplifier printed circuit boards

AMPLIFIER WIRING



Fig. 4.9. Printed circuit board for P.A.1 and P.A.2, full size

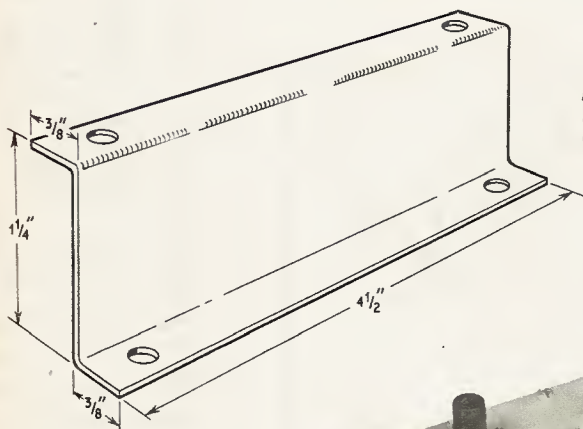
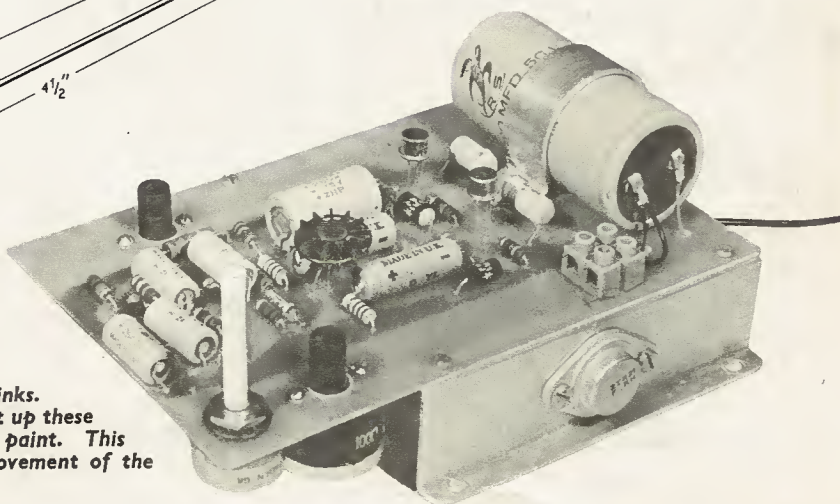

Fig. 4.10 (left). Heat sink details for amplifiers. Lead holes for output transistors should be drilled to conform with their relevant geometries

View of P.A.2 standing on heat sinks. When the preset resistors are set up these should be marked with a spot of paint. This will indicate any accidental movement of the wiper when installing



LIND-AIR OPTRONICS LTD

See our vast range of Electronic Components and Accessories at our enlarged Component Centre 25 Tottenham Court Road

MAINS KEYNECTOR SAVES TIME—SAFELY!

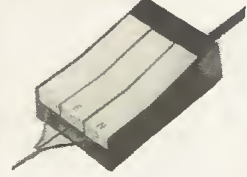

Our mains "Keyector" instantly and safely connects electrical appliances to mains supply without the use of a plug. A number of appliances may be used simultaneously up to the full 13 amp rating of this device. A red light glows when "live". The "Keyector" is fused and has its own robust switch which is interlocked to prevent connections when "live".

Invaluable to handymen, servicemen, demonstrators, etc.

39/6 P. & P. 3/-

VHF AIRCRAFT BAND CONVERTER.

When placed within lin. of a MW band radio full coverage of VHF Aircraft Band 108-135Mc/s. can be obtained. All-transistor, 9V battery operation. Fully tunable 18lin. x 7-section tele-scope aerial. Size 4 1/2" x 1 1/2" 79/6. P. & P. 3/6.



MODEL MAKER'S MOTOR

No. 15RN. Voltage 11-5V.

Current 400mA. Torque 12g.cm. Body size 1 1/2" x long x 1" dia.

Shaft 3/8" long x 1/8" dia. Ideal for small models and toys. 5/6 each.



DE-LUXE STEREO HEADPHONES

With soft rubber earpieces. Impedance 8-16 ohms. Frequency response 23-13,000cps. With lead and stereo plug. Only 59/6. P. & P. 3/6.



NEW STEREO/MONO HEADPHONES.

SDH-7. Soft rubber earpieces with slide switch for mono/stereo listening and ind. vol. controls. Impedance 8-16 ohm. Freq. response 23-15,000cps. With lead and stereo plug. 28.8.0. P. & P. 3/6.



VENNER SYNCHRO US MOTOR UNIT

Brand New. Mains voltage (200/250V), 1 rev. per hour. Precision movement (enclosed in case), self starting, silent running. Shaft complete with knurled clamping nut. Overall dimensions: 2 1/2 in diam., 2 1/2 in deep (including shaft). Shaft diam. 3/32 in. 27/6. P. & P. 3/6.

HI-TONE RECORDING TAPE

BRITISH MADE TOP QUALITY			
J1001	3"	Long Play PVC	225ft 5/6 P. & P. 1/2
J1002	3"	Triple Play Poly	600ft 10/6 P. & P. 1/2
J1003	5"	Long Play PVC	900ft 10/- P. & P. 1/8
J1004	5"	Double Play Poly	1200ft 15/- P. & P. 1/8
J1005	5 1/2"	Long Play PVC	1200ft 12/6 P. & P. 2/-
J1006	5 1/2"	Double Play Poly	1800ft 22/6 P. & P. 2/-
J1007	7"	Standard Play PVC	1200ft 12/6 P. & P. 2/6
J1008	7"	Long Play PVC	1800ft 17/6 P. & P. 2/6
J1009	7"	Double Play Poly	2400ft 25/- P. & P. 2/6
J1010	7"	Triple Play Poly	3600ft 50/- P. & P. 2/6



Visit our Brand New Hi-Fi Demonstration Room, Tape, Record Bar and Scientific Show of Microscopes, Binoculars, Telescopes and Watches at 18 Tottenham Court Road

TRANSFORMERS

AUTO WOUND TRANSFORMERS

All winding voltage ratings and tappings 0-115-200-220-240V, except MT113 0-115-210-240V

Model	Power	Size	Weight	Price
MT113	20W	2 1/2" x 1 1/4" x 1 1/2"	11oz	12/6 (P. & P. 2/6)
MT64	75W	2 1/2" x 2 1/2" x 2 1/2"	11b 14oz	21/9 (P. & P. 4/6)
MT4	150W	3 1/2" x 2 1/2" x 3in	3b 2in	33/- (P. & P. 6/-)
MT65	200W	3 1/2" x 4" x 4in	41b	39/6 (P. & P. 6/-)
MT66	300W	4" x 4" x 3 1/2in	61b 7oz	59/4 (P. & P. 9/-)
MT110	400W	4 1/2" x 4 1/2" x 4 1/2"	113b	85/- (P. & P. 10/6)
MT67	500W	5 1/2" x 4" x 4 1/2"	121b 8oz	89/- (P. & P. 10/6)
MT68	750W	4 1/2" x 4 1/2" x 4 1/2"	131b 4oz	95/7 (P. & P. 10/6)
MT64	1000W	4 1/2" x 5 1/2" x 5 1/2"	161b	142/2 (Carr. extra)
MT93	1600W	5 1/2" x 5 1/2" x 5 1/2"	281b 9oz	170/6 (Carr. extra)
MT94	1750W	5 1/2" x 6 1/2" x 6 1/2"	311b	195/- (Carr. extra)
MT95	2000W	7" x 6 1/2" x 8 1/2"	401b	211/2 (Carr. extra)
MT73	3000W	6 1/2" x 7 1/2" x 8 1/2"	451b 8oz	300/- (Carr. extra)

LOW VOLTAGE 12V RANGE

Model	Primary	Secondary	Weight	Price
MT111	0-5A	2 1/2" x 2 1/2" x 1 1/2"	12oz	15/3 (P. & P. 2/6)
MT71	2A	2 1/2" x 2 1/2" x 2 1/2"	11b	19/- (P. & P. 3/9)
MT69	4A	3 1/2" x 2 1/2" x 2 1/2"	21b 4oz	28/- (P. & P. 6/-)
MT70	6A	4" x 3" x 3 1/2in	31b 3oz	36/- (P. & P. 6/-)
MT72	10A	3 1/2" x 4 1/2" x 4 1/2"	61b 3oz	51/- (P. & P. 9/-)
MT115	20A	4 1/2" x 4 1/2" x 4 1/2"	111b 13oz	95/- (P. & P. 9/-)
MT187	30A	5 1/2" x 4 1/2" x 4 1/2"	161b 12oz	180/- (P. & P. 13/6)

LOW VOLTAGE 24V RANGE

Model	Primary	Secondary	Weight	Price
MT58	1A	2 1/2" x 2 1/2" x 2 1/2"	11b 7oz	23/9 (P. & P. 4/6)
MT114	3A	2 1/2" x 3" x 2 1/2"	31b 6oz	38/- (P. & P. 6/-)
MT72	5A	4" x 3 1/2" x 3 1/2in	51b 12oz	53/10 (P. & P. 6/-)
MT17	8A	4 1/2" x 3 1/2" x 4 1/2"	71b 8oz	72/7 (P. & P. 9/-)
MT115	10A	4 1/2" x 4 1/2" x 4 1/2"	111b 13oz	95/- (P. & P. 11/-)

LOW VOLTAGE 30V RANGE

Model	Primary	Secondary	Weight	Price
MT112	0-5A	3 1/2" x 2 1/2" x 1 1/2"	11b 4oz	17/4 (P. & P. 3/9)
MT79	1A	2 1/2" x 2 1/2" x 2 1/2"	21b	23/- (P. & P. 6/-)
MT60	3A	4" x 3 1/2" x 3 1/2in	41b 6oz	46/2 (P. & P. 6/-)
MT51	5A	4 1/2" x 3 1/2" x 4in	61b 8oz	60/9 (P. & P. 9/-)
MT88	8A	5 1/2" x 3 1/2" x 4 1/2in	91b 6oz	82/4 (P. & P. 11/-)
MT69	10A	5 1/2" x 4 1/2" x 4 1/2in	121b 2oz	108/6 (P. & P. 11/-)

LOW VOLTAGE 50V RANGE

Model	Primary	Secondary	Weight	Price
MT102	0-5A	2 1/2" x 2 1/2" x 2 1/2"	11b 11oz	21/3 (P. & P. 6/-)
MT104	2A	4" x 3 1/2" x 3 1/2in	51b	45/8 (P. & P. 6/-)
MT106	4A	4 1/2" x 4" x 4"	91b 4oz	77/- (P. & P. 9/-)
MT118	8A	5 1/2" x 5 1/2" x 4 1/2in	181b 9oz	132/- (P. & P. 13/6)
MT119	10A	6 1/2" x 4 1/2" x 6 1/2in	191b 12oz	165/- (P. & P. 15/6)

LOW VOLTAGE 60V RANGE

Model	Primary	Secondary	Weight	Price
MT124	0-5A	3 1/2" x 2 1/2" x 2 1/2"	21b 4oz	24/- (P. & P. 6/-)
MT127	2A	4" x 3 1/2" x 3 1/2in	51b 6oz	52/10 (P. & P. 6/-)
MT123	4A	4 1/2" x 3 1/2" x 4 1/2in	101b 6oz	89/- (P. & P. 11/-)
MT122	10A	6 1/2" x 5 1/2" x 6 1/2in	231b 2oz	152/- (Carr. extra)

MAINS H.T. RANGE

Model	Primary	Secondary	Weight	Price
MT1AT	250-0-250V	80MA 6-3V 3-5A 5/6-3V 1A 3 1/2" x 3 1/2" x 3 1/2"	6/-	6/-
MT3AT	250-0-250V	100MA 6-3V 3-5A 5/6-3V 1A 4" x 3 1/2" x 3 1/2"	6/-	6/-
MT110	250-0-250V	120MA 6-3V 3-5A 5/6-3V 1A 4" x 4" x 3 1/2"	6/-	6/-
MT11AT	300-0-300V	100MA 6-3V 3-5A 5/6-3V 1A 4" x 3 1/2" x 3 1/2"	6/-	6/-
MT12AT	300-0-300V	120MA 6-3V 4A 5/6-3V 1A 4" x 3 1/2" x 3 1/2"	6/-	6/-
MT33AT	300-0-300V	150 6-3V 4A 5/6-3V 1A 4" x 4" x 3 1/2"	9/-	9/-
MT2AT	350-0-350V	80 6-3V 3-5A 5/6V 1A 4" x 3 1/2" x 3 1/2"	6/-	6/-
MT7	350-0-350V	100 6-3V 3-5A 5/6-3V 1A 4" x 3 1/2" x 3 1/2"	6/-	6/-
MT8	350-0-350V	120 6-3V 3-5A 5/6-3V 1A 4" x 3 1/2" x 3 1/2"	6/-	6/-

BATTERY CHARGER TYPES

Model	Primary	Secondary	Weight	Price
MT77	1A	2 1/2" x 2 1/2" x 2 1/2"	11b 6oz	15/- (P. & P. 4/6)
MT45	1-5A	2 1/2" x 2 1/2" x 2 1/2"	11b 9oz	21/9 (P. & P. 4/6)
MT46	2A	3 1/2" x 2 1/2" x 2 1/2"	21b 4oz	25/4 (P. & P. 6/-)
MT47	3A	4" x 3 1/2" x 3 1/2in	31b 8oz	29/4 (P. & P. 6/-)
MT5	4A	4" x 2 1/2" x 3 1/2in	31b 11oz	33/- (P. & P. 6/-)
MT8	5A	4" x 3 1/2" x 3 1/2in	51b 4oz	42/- (P. & P. 6/-)
MT86	6A	4" x 3 1/2" x 3 1/2in	51b 12oz	48/- (P. & P. 6/-)
MT48	7A	4" x 4" x 3 1/2in	61b	56/7 (P. & P. 9/-)
MT146	8A	3 1/2" x 4" x 4in	61b 4oz	75/- (P. & P. 9/-)
MT49	9A	4 1/2" x 3 1/2" x 4in	71b 8oz	99/- (P. & P. 9/-)
MT47	10A	4 1/2" x 3 1/2" x 4in	91b 3oz	105/- (P. & P. 9/-)
MT50	12-5A	5 1/2" x 4 1/2" x 4in	111b 14oz	125/- (P. & P. 11/-)

Amperages are d.c. with nominal selenium bridge rectifiers. MAINS ISOLATING RANGE also available

TTC.C1001 MULTITESTER in leather case. 20,000 o.p.v. AC volts 10, 50, 250, 1,000V. DC volts 5-25, 125, 500, 2,500V. D.C. Current 0-50uA, 0-250mA Resistance 0-60K, 0-6 Megohm. Decibels -20 to +22dB. Size of meter 4 1/2" x 3 1/2". 85/- P. & P. 3/6.



SHIRA 62D MULTITESTER 20,000 o.p.v. DC voltage: 5-25-50-250-500-2.5K (20,000 ohms per volt). AC Voltage: 10-50-100-500-1000 volts (10,000 ohms per volt). DC Current: 0-50uA, 0-2.5mA, 0-250mA. Resistance: 0-6K, 0-6Mg (300 ohm and 30K at centre scale). Capacitance: 10pf. to 0.01 mfd., 0.01uf to 1uF. Decibels: -20 to +22dB. Size 4 1/2" x 3 1/2". Complete with case 77/- P. & P. 3/6.



S-DeC BREAD BOARD



British made

Solderless breadboard panels, for fast reliable component connections. Single DeCa. One S-DeC with Control Panel, Jig and Accessories for solderless connections to controls, etc., with booklet "Projects on S-DeC" giving construction details for a variety of circuits. 29/6. P. & P. 2/6.

4-DeCK Kit. Four S-DeCs with two Control Panels, Jigs and Accessories, all the booklet "Projects on S-DeC" all contained in a strong attractive plastic case. Ideal for the serious user. 55.17.6. P. & P. 3/6.

GARRARD DECKS



SRP22 less cartridge	25. 9.8
1025 Stereo/Mono with cart.	46.18.6
2025 Stereo/Mono with cart.	47.19.6
3000S Stereo/Mono with cart.	48.18.6
3000D Stereo/Mono with cart.	410.19.6
SP25 less cartridge	411.19.6
SP25 with Decca Deram cart.	417. 4.6
SL55 less cartridge	411.19.6
SL55 with Decca Deram cart.	417. 4.6
SL65 less cartridge	414. 8.6
Covers for above	42.19.6
Bases for above	42.10.0
AP75 less cartridge	418.18.0
SL75 less cartridge	428. 7.0
SL95 less cartridge	438.18.6
Bases for above	44.19.6
SPECIAL OFFER!	
SP25 less cart., with base	413.10.0
P. & P. Decks 12/6, Base 4/6, Base 4/6.	
P. & P. Deck/Cover/Base 17/-	

MINIATURE SOLDERING IRON British made and designed for use with transistor circuitry but ideal for many other uses. A.C. 240V, 18W. Length 7 1/2 in. tin slide on bit. Price 32/6. P. & P. 2/-.



LIND-AIR OPTRONICS LTD

18, 25 & 53 TOTTENHAM COURT ROAD, LONDON W.1.

Telephone: 01-580 2255/4532/7679

Shops open 9-6 pm. Monday to Saturday. Thursday until 7pm.

ALL MAIL ORDERS To Dept. PE 869 54a Tottenham Court Road, London, W.1

In addition, the earth line connection between amplifier and attendant power line unit must be made to the earth line at the output end of the amplifier, not to the end where the potentiometer VR1 is connected to the earth line.

The amplifier component layout and wiring is given in Fig. 4.7 and Fig 4.8, the etched printed circuit pattern is depicted full size in Fig. 4.9.

The output transistors TR6 and TR7 are each mounted on an aluminium heat sink. Since these transistors have case collectors they must be insulated from the aluminium with suitable mica washers. Details of one of the heat sinks is given in Fig. 4.10. Reference to the photograph of a completed amplifier (P.A.2) shows how the sinks afford a mounting base for the printed circuit board.

To complete the amplifiers the wiring of the potentiometers and transistors to the underside of the printed board is given in Fig. 4.8

SETTING UP

The preset resistors VR2 and VR3 shown in Fig. 4.8 provide a means of setting the standing current of the output transistors for elimination of crossover distortion and ensuring maximum voltage swing across the loud-speaker load.

To adjust these in each of the amplifiers a millimeter is inserted in the positive supply line from the serving power supply unit. A d.c. voltmeter is then connected from TR7 collector to the earth line. With the relevant power unit switched on, each of the 100 ohm preset resistors is adjusted from minimum resistance until the current in the milliammeter increases by approximately 15 milliamps. At the same time it is necessary to ensure that the d.c. collector voltage at TR7 is approximately half the value of the supply voltage.

Both in the setting up and with any dynamic checks that might be made on the amplifiers the loudspeaker loads should be included.

With the completion of the setting up of the amplifiers these should be temporarily placed to one side.

END CHEEKS FOR S.K.A. KEYBOARDS

In Part One of this series we gave as an alternative to

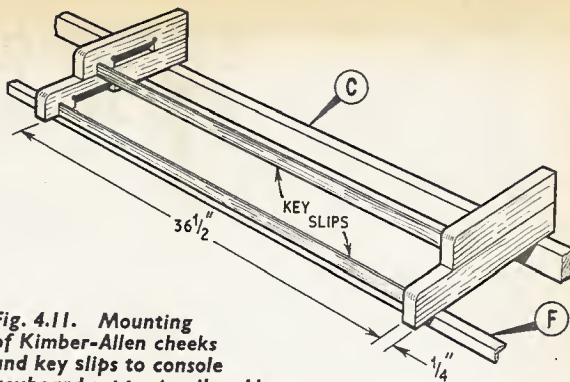

Fig. 4.11. Mounting of Kimber-Allen cheeks and key slips to console keyboard support rails. Here cheek recesses can be clearly seen

the Goddard keyboards those manufactured by Kimber-Allen Ltd. Unfortunately, the geometry of the latter keyframes precludes fitting in the cheek assembly given in Fig. 1.9. Since then Kimber-Allen Ltd. have produced special hardwood end cheeks which are slotted in such a way to enable the 61 note S.K.A. keyboards to be pushed in, then screw-attached.

It follows, of course, that complete accuracy of fitting is ensured with these manufactured cheeks since both keyboards are finally held in their proper relative positions. For purchasers of the keyboards and end cheeks, fully dimensional drawings are shown in Fig. 4.11 and Fig. 4.12 to enable the fixing of these to the keyboard supports C and F as shown in Fig. 1.4.

The Harmonics contact assemblies will fit quite easily under the Kimber-Allen plastic keys; should the holes for the actuators come in the wrong place by any mischance, the keys are easily taken off while new holes are drilled. It should be noted that the plastic actuators fitted to the Kimber-Allen keys are not now required and simply pull out, leaving the dollies of the Harmonics contact assemblies to contact the underside of the keys directly.

Next month we will introduce the tone forming circuits.

To be continued

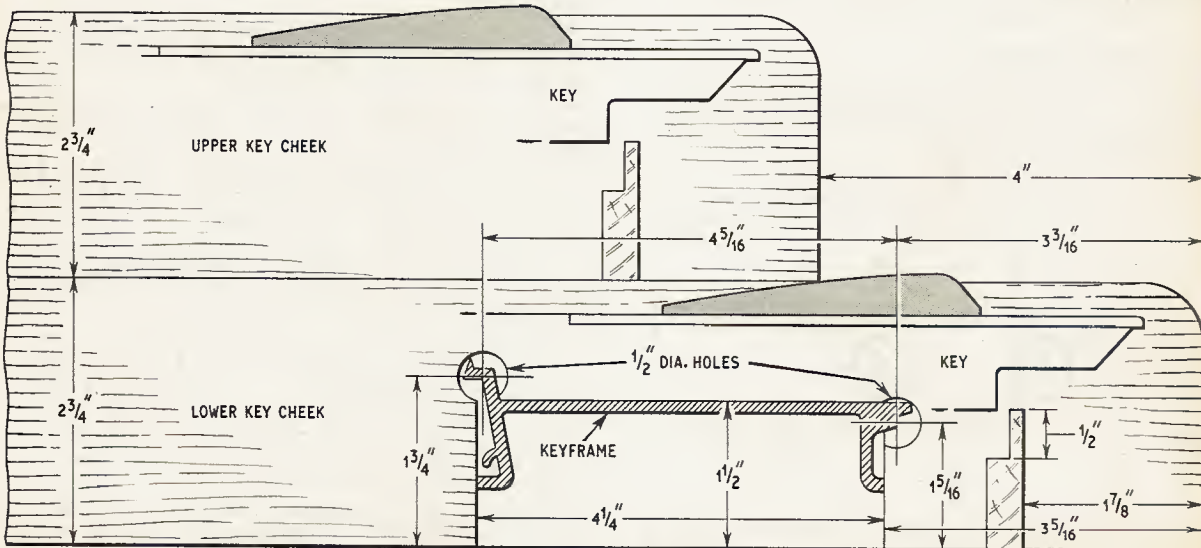

Fig. 4.12. Details of two end cheeks required for Kimber-Allen keyframes. The recess depths for keyframes and keyslips are 1 in and 1/2 in respectively

KEY SLIP TO CONCEAL KEY FRAME

EXPERIMENTS WITH THE OPERATIONAL AMPLIFIER

By G. K. FAIRFIELD

Part 3 Design criteria

THIS concluding article will consider the design of some typical operational amplifiers which can be used in any of the applications described in the two previous articles.

As explained earlier, the greater the open-loop gain of the amplifier, then the less important will be the deterioration of its active elements (valves or transistors) and the voltage stability of its power supplies. A high gain also allows its gain with feedback components added to be determined only by the value of these components. Finally a high gain permits a high input impedance to be obtained, which facilitates certain applications such as the meter described last month.

Operational amplifiers used in highly accurate analogue computers have open loop gains of the order 10^6 to 10^8 . Such large stable d.c. gains can only be obtained by elaborate chopper stabilised amplifier designs and, as such, are expensive to purchase and quite difficult to design. However, if the required gain can be reduced to about 10^4 then considerable simplification is possible in a practical design.

Such a gain is quite adequate for the amplifiers used in the applications quoted previously, as the requirements are by no means as stringent as is the case with an analogue computer. Two transistorised examples of such an amplifier are described below.

AMPLIFIER DESIGN

The most important feature of a high gain d.c. amplifier is its performance with regard to change of temperature at its output terminal when the amplifier input is short-circuited.

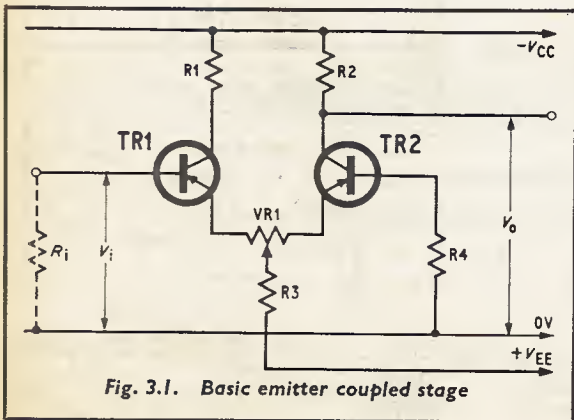

Fig. 3.1. Basic emitter coupled stage

This is known as the d.c. drift of the amplifier and is usually stated as so many microamps per degree C, and refers to the equivalent drift of its output current, assuming all of this occurs at the input terminals. Thus the drift of the output current due to temperature change is the number of microamps per degree C multiplied by the overall amplifier gain.

There are very many ways of compensating for the inevitable drift that occurs in a practical amplifier. A well-known method is to use a temperature sensitive resistor at some point in the circuit, whose purpose is to introduce an equal and opposite current change to cancel out that due to change in transistor characteristics. This requires fairly careful design however and the compensation technique is never completely successful.

An alternative method which, although using more amplifier components, is easier to apply and is known as the emitter coupled transistor amplifier. The fundamental principle is to assume that a pair of transistors will drift a similar amount and to arrange the circuit so that these drifts will cancel out and not be added to the d.c. level of the signal being amplified.

EMITTER-COUPLED TRANSISTOR AMPLIFIER

The basic emitter coupled stage is shown in Fig. 3.1. The two transistors should have similar characteristics and ideally be mounted in the same can. The static collector currents must be identical and a potentiometer VR1 is included to permit adjustment of these currents to equality.

The circuit operation is as follows. Provided that R3 is large, the signal voltage is divided equally between R_i , the base-emitter diode of TR2 and R4 in the ratio of their resistance values. Assuming that the transistors are identical then the voltage across the base-emitter diodes are the same, causing equal and opposite inputs to the two transistors.

Where R4 is zero a voltage $V_i/2$ appears at the mid-point of VR1. However, more usually R_i is fairly large and R4 must be made equal to it. For this reason an appreciable part of the input voltage V_i appears across R4 and as a result the gain of the stage is reduced.

The large value of R3 causes the sum of the two emitter currents, and hence the collector currents to be stabilised as $-V_{EE}/R_3$. Hence the in-phase changes of current through the two transistors are almost completely prevented, and current changes due to identical variation of the temperature-dependent transistor parameters are considerably reduced. In a similar

BI-PRE-PAK LIMITED

FULLY TESTED AND MARKED

AC107	3/-	OC170	3/-
AC126	2/6	OC171	4/-
AC127	2/6	OC200	3/6
AC128	2/6	OC201	7/-
AC176	5/-	2G301	2/6
AC177	3/-	2G303	2/6
AF114	4/-	2N711	10/-
AF115	3/6	2N1302-3	4/-
AF116	3/6	2N1304-5	5/-
AF117	3/6	2N1306-7	6/-
AF239	12/6	2N1308-9	8/-
AF186	10/-	2N3844A	5/-
AF139	10/-	Power	
BFY50	4/-	Transistors	
BSY25	7/6	OC20	10/-
BSY26	3/-	OC23	10/-
BSY27	3/-	OC25	8/-
BSY28	3/-	OC26	5/-
BSY29	3/-	OC28	7/6
BSY95A	3/-	OC35	5/-
OC41	2/6	OC36	7/6
OC44	2/6	AD149	10/-
OC45	2/6	AU10	30/-
OC71	2/6	2N3055	15/-
OC72	2/6	Diodes	
OC73	3/6	AA42	2/-
OC81	2/6	OA95	2/-
OC81D	2/6	OA70	1/9
OC83	4/-	OA79	1/9
OC139	2/6	OA81	1/9
OC140	3/6	IN914	1/6

TRY OUR X PAKS FOR UNEQUALLED VALUE

XA PAK

Germanium PNP type transistors, equivalents to a large part of the OC range, i.e. 44, 45, 71, 72, 81, etc.

PRICE £5 PER 1000

POST & PACKING 4/6 U.K.

XB PAK

Silicon TO-18 CAN type transistors NPN/PNP mixed lots with equivalents to OC200-1, 2N706s, BSY27/29, BSY95A.

PRICE £5.50 PER 500

PRICE £10 PER 1000

POST & PACKING 2/6 U.K.

XC PAK

Silicon diodes miniature glass types, finished black with polarity marked, equivalents to OA200, OA202, BAY31-39 and DK10, etc.

PRICE £5 PER 1000

POST & PACKING 2/6 U.K.

NEW TESTED AND GUARANTEED PAKS

B2	4	Photo Cells, Sun Batteries inc. Book of Instructions	10/-
B15	5	ASY66 Bidirectional Trans. Simultaneous 2 way signal	10/-
B77	2	AD161-AD162 NPN/PNP Trans. Comp. Output. Pair	10/-
B79	4	IN4007 Sil. Rec. Diodes 1000 P.I.V. 1 amp. Miniature	10/-
B81	10	Reed Switches, mixed types large and small	10/-
B89	2	5SP5 Light Sensitive Cells. Light Res. 400 Ω Dark 1M Ω	10/-
B91	8	.NKT163/164 PNP Germ. TO-5 equivalent to OC44, OC45	10/-
B92	4	NPN. Sil. Trans. AO6=BSX20, 2N2369 500 MHz, 360mV	10/-
B93	5	GET113 Trans. equiv. to ACV17-21 PNP Germ.	10/-
B94	6	NPN Sil. Planar Epitaxial Trans. CS4 similar to BSY38 or BC108	10/-
B96	5	2N1336 PNP Sil. Trans. TO-18, HFE 100-300 I.C. 600mA, 200 MHz	10/-
B98	10	XB112 and XB102 equiv. to AC126, AC156, OC81/2, OC71/2, NKT271, etc.	10/-
B99	200	Capacitors, Electrolytics paper, silver mica, etc. Post and packing, this Pak 2/6	10/-

FREE!

PACKS OF YOUR OWN CHOICE UP TO THE VALUE OF 10/- WITH ORDERS OVER £4

ALL THE ABOVE UNTESTED PACKS HAVE AN AVERAGE OF 75% OR MORE GOOD SEMICONDUCTORS. FREE PACKS SUSPENDED WITH THESE ORDERS. ORDERS MUST NOT BE LESS THAN THE MINIMUM AMOUNTS QUOTED PER PACK.

TRANSISTORS ONLY 1/- EACH

SILICON • PLANAR • N.P.N. • P.N.P.

All these types available

2N929	2N706	2S131	2S103	2N696	2N1613	2S733	BFY10
2S501	2N706A	2S512	2S104	2N697	2N1711	2N726	2S731
BSY38	2N3011	2S102	2N2220	2N1507	2N1893	2N2484	2S732

All tested and guaranteed for gain and leakage—unmarked. Manufacturers' fall outs from the new PRE-PAK range.

SPECIAL OFFER

Stock clearance of Manufacturers' Rejects. Limited Number.

UHF/VHF Tuner Units. Consisting of: 2 AF186, 2 AF178, Tuning Condensers, Coils and Comps etc.

Price 10/- each.

Post & packing U.K. 2/6d.

NEW UNMARKED UNTESTED PAKS

B78	12	Integrated Circuits, Data and Circuits of types, supplied with orders	10/-
B80	8	Dual Trans. Matched O/P pairs NPN. Sil. in TO-5 can	10/-
B82	10	OC45, OC81D and OC81 Trans. Mullard glass type	10/-
B83	200	Trans. manufacturer's rejects all types NPN, PNP, Sil. and Germ.	10/-
B84	100	Silicon Diodes DO-7 glass equiv. to OA200, OA202	10/-
B66	150	High quality Germ. Diodes. Min. glass type	10/-
B86	50	Sil. Diodes sub. min. IN914 and IN916 types	10/-
B87	100	Germ. PNP Trans. equiv. to OC44, OC45, OC81, etc.	10/-
B88	50	Sil. Trans. NPN, PNP, equiv. to OC200/1, 2N706A, BSY95A, etc.	10/-
B60	10	7 Watt Zener Diodes Mixed Voltages	10/-

PRE-PAK. N.605 POWER TRANSISTOR EQUIVALENT TO NKT301-2-3-4 **5/- each**

COMPLIMENTARY SET NPN/PNP GERM. TRANS. **2/6 pair**

RETURN OF THE UNBEATABLE P.I PAK. NOW GREATER VALUE THAN EVER

FULL OF SHORT LEAD SEMICONDUCTORS AND ELECTRONIC COMPONENTS, APPROX. 170. WE GUARANTEE AT LEAST 30 REALLY HIGH QUALITY FACTORY MARKED TRANSISTORS PNP AND NPN, AND A HOST OF DIODES AND RECTIFIERS MOUNTED ON PRINTED CIRCUIT PANELS. IDENTIFICATION CHART SUPPLIED TO GIVE SOME INFORMATION ON THE TRANSISTORS.

PLEASE ASK FOR PAK P.I ONLY 10/- 2/- P. & P. on this Pak.

Make a Rev. Counter for your Car. The 'TACHO BLOCK'. This encapsulated block will turn any 0-1mA meter into a linear and accurate rev. counter for any car.

20/- each

FREE CATALOGUE AND LISTS for:—

ZENER DIODES
TRANSISTORS, RECTIFIERS
FULL PRE-PAK LISTS
& SUBSTITUTION CHART

MINIMUM ORDER 10/- CASH WITH ORDER PLEASE. Add 1/- post and packing per order. OVERSEAS ADD EXTRA FOR AIRMAIL.

THERE IS ONLY ONE
BI-PRE-PAK LTD
BEWARE OF IMITATIONS

FREE! A WRITTEN GUARANTEE WITH ALL OUR TESTED SEMICONDUCTORS

BI-PRE-PAK LTD

DEPT. A, 222-224 WEST ROAD, WESTCLIFF-ON-SEA, ESSEX
TELEPHONE: SOUTHEND (0702) 46344

110 SEMICONDUCTOR PROJECTS FOR THE HOME CONSTRUCTOR

By R. M. Marston

18/-

Postage 1/-

TRANSISTOR ELECTRONIC ORGANS FOR THE AMATEUR, by Alan Douglas. 20/-. Postage 1/-.

COLOR TV TROUBLESHOOTING PICT-O-GUIDE, by R.C.A. 10/-. Postage 1/-.

VHF-UHF MANUAL, by G. J. Jessop. 21/-. Postage 1/6.

QUESTIONS & ANSWERS COLOUR TELEVISION, by J. A. Reddihough. 10/-. Postage 6d.

COLOUR TELEVISION PAL SYSTEM, by G. N. Patchett. 40/-. Postage 1/-.

SOLID STATE HOBBY CIRCUITS MANUAL, by R.C.A. 17/6. Postage 1/-.

49 EASY TRANSISTOR PROJECTS, by Robert M. Brown. 16/-. Postage 1/-.

THE RADIO AMATEUR'S HANDBOOK 1969, by A.R.R.L. 45/-. Postage 4/6.

CATALOGUE, 2/-.

THE MODERN BOOK CO.

BRITAIN'S LARGEST STOCKIST of British and American Technical Books
19-21 PRAED STREET
LONDON, W.2

Phone: PADdington 4185
Closed Saturday 1 p.m.

4-STATION INTERCOM



£7/15/0

Solve your communication problems with this 4-Station Transistor Intercom system (1 master and 3 Subs), in de-luxe plastic cabinets for desk or wall mounting. Call/talk/listen from Master to Subs and Subs to Master. Ideally suitable for Business, Surgery, Schools, Hospital, Office and Home. Operates on one 9V battery. On/off switch. Volume control. Complete with 3 connecting wires each 66ft. and other accessories. P. & P. 7/6.

MAINS INTERCOM

No batteries—no wires. Just plug in the mains for instant two-way, loud and clear communication. On/off switch and volume control. Price 12 gns. P. & P. 7/6.

INTERCOM/BABY ALARM



65/-

Same as 4-Station Intercom for two-way instant communication. Ideal as Baby Alarm and Door Phone. Complete with 66ft. connecting wire. Battery 2/6. P. & P. 4/6.

Transistor TELEPHONE AMPLIFIER



59/6

Why not boost business efficiency with this incredible De-Luxe Telephone Amplifier. Take down long telephone messages or converse without holding the handset. A useful office aid. On/off switch. Volume control. Battery 2/6 extra. P. & P. 3/6. Full price refunded if not satisfied in 7 days.

WEST LONDON DIRECT SUPPLIES (PE/3)
189 KENSINGTON HIGH STREET, LONDON, W.8

BUY QUALITY FROM US GET GUARANTEED RESULTS

MORSE OSCILLATOR KIT. P.C. board, transistors, high stab. components. Battery carrier, earpiece. Adj. tone. Just attach your key. Drives phones or speaker. 15/6, P. & P. 2/-.

METRONOME KIT. Variable beat, listen whilst you play and keep in the groove. Easy to build, pocket sized with personal mini earphone. 25/-. P. & P. 2/6.

VOX SWITCH. This sound operated switch is ideal for mobile T.X. work, tape recorder switching, etc., etc., you speak it switches. High and med. imp. inputs. A.F. take off point drives your 12 volt relay. 42/6, P. & P. 2/6.

All the above kits come complete with easy to follow instructions, P.C. board and finest quality components. Satisfaction guaranteed or instant refund without question.

6-8-12 VOLT D.C. 1 AMP POWER SUPPLY. A robust, versatile, well filtered, very low ripple D.C. power supply for operating and servicing—radios, tuners, intercoms, tape recorders, amplifiers, transistors, appliances, experiments, etc. Mains 1/P. Front panel illuminated voltage meter. Housed in attractive ventilated metal case, 6 3/4 x 2 1/2 in. Only 27.4.8, P. & P. 5/6.

REVERBERATION AMPLIFIER. Completely self-contained transistorised battery operated. Reverberation is an entirely different approach to sound reproduction. Normally sound reproduction from a single source has a flat one dimensional effect; with this proper sound delay through "reverberation" tones are created with a truly third dimension for concert hall originality. Two controls adjust reverberation and volume. No complicated wiring, simply plug microphone, guitar, etc. in and the O/P into your amplifier. Supplied in a beautiful walnut cabinet, 7 1/2 x 8 x 4 1/2 in. 210.4.0, P. & P. 2 Ins. 6/-.

AMPLIFIERS. Built and tested—where else can you buy at this price a thousand and one uses.
1 WATT amp. 9 volt 52/6, P. & P. 2/6
3 WATT amp. 9 volt 67/6, P. & P. 2/6

SEMICONDUCTORS. Surplus but guaranteed tested 10/- per pack 10 x 2N706 or 8 x 2N2926 or 25 signal diodes.

C.W.O. or C.O.D. to
AUDIO EFFECTS, 5 Shaw Lane, Halifax, Yorks.

HEATHKIT ELECTRONICS

Join the creative men who build Heathkit electronics. It's the exciting leisure-time way to superior equipment at lowest cost



FREE! CATALOGUE

Describes these and many more kits and ready-to-use models for Stereo Hi-Fi, Domestic Radio, Record Players, Tape Recorder, Amateur Radio, Short Wave, Test, Educational, Home and Hobby. Save money with Heathkit models. Mail coupon or write to Daystrom Ltd., Gloucester. Tel: 29451.

DAYSTROM LTD., Dept. RC/8
GLOUCESTER Tel. 29451

Please send FREE Heathkit Catalogue.

Name _____

(Please Print)

Address _____

City _____

Prices and specifications subject to change without notice.

way the output is reasonably independent of supply voltage variations.

In order to achieve a high value for R3 this resistor is often replaced by a transistor having a common-base configuration so that three transistors are required for one emitter-coupled stage.

PRACTICAL CIRCUIT

An operational amplifier using several d.c. emitter-coupled stages is shown in Fig. 3.2. The input is applied to the base of TR1 (single-ended input) or where a push-pull balanced signal is available to the bases of both TR1 and TR2, through input resistors R_{i1} and R_{i2} . If no signal is applied via R_{i1} , then its free end is connected to ground.

This first pair of transistors TR1 and TR2 makes use of a transistor (TR7) connected to give a very high impedance in the common emitter supply lead. Potentiometer VR1 is adjusted to give a total current through R1 of about 0.5mA, and the balance potentiometer VR2 is adjusted to give equality of collector currents for TR1 and TR2. A simple way to check this is to connect a high resistance millivoltmeter between the collectors and adjust for a null reading.

The second emitter coupled pair TR3 and TR4 is directly coupled to TR1 and TR2 and no adjustment should be necessary to the junction point of R7 and R8. If these transistors are slightly out of balance then a compensating adjustment to VR2 can be made.

The final stage draws rather more current through its common emitter lead in order that the output impedance may be reasonably low in comparison with the value of the feedback resistors R_{fb1} and R_{fb2} . An adjustment is made to the common emitter current by means of VR3. The purpose of this is to enable the output terminal at the collectors of TR5 and TR6 to be adjusted to zero potential in the absence of an input signal to TR1 and TR2.

The input and feedback impedances are shown connected by dotted lines in the diagram. The gain with feedback is R_{fb1}/R_{i1} or R_{fb2}/R_{i2} ; although R_{fb2} can be omitted when R_{i2} is connected to ground (single ended input) it is advisable to keep the circuit completely symmetrical by making $R_{fb1} = R_{fb2}$ and $R_{i1} = R_{i2}$ if only one input and one output is to be used. This is to avoid any possibility of instability when a large loop gain is used.

The amplifier design has a gain of 10,000 at frequencies up to 100kHz; phase compensating capacitors C1 and C2 enable a level frequency response up to this frequency to be obtained.

With several of the applications mentioned earlier, it may not be possible to duplicate the input and feedback impedances in the way described above. In such cases R_{i2} is grounded and R_{fb2} is omitted so that the circuit becomes a single-ended amplifier. The gain is a little reduced and more care must be taken with the initial balancing to avoid instability, otherwise the connection is quite straightforward.

The complete amplifier can be constructed by soldering the components directly on to a printed wiring board.

Setting-up of the amplifier is quite simple. VR1 is first adjusted to give a current of about 0.5mA through R1. The output current of 3mA is then adjusted by VR3 with the current meter placed in series with VR3.

Finally with a high resistance, low current meter connected between the collectors of TR5 and TR6, VR2 is adjusted to give a null reading on the meter. It may then be necessary to readjust VR3 to obtain the required current of 3mA.

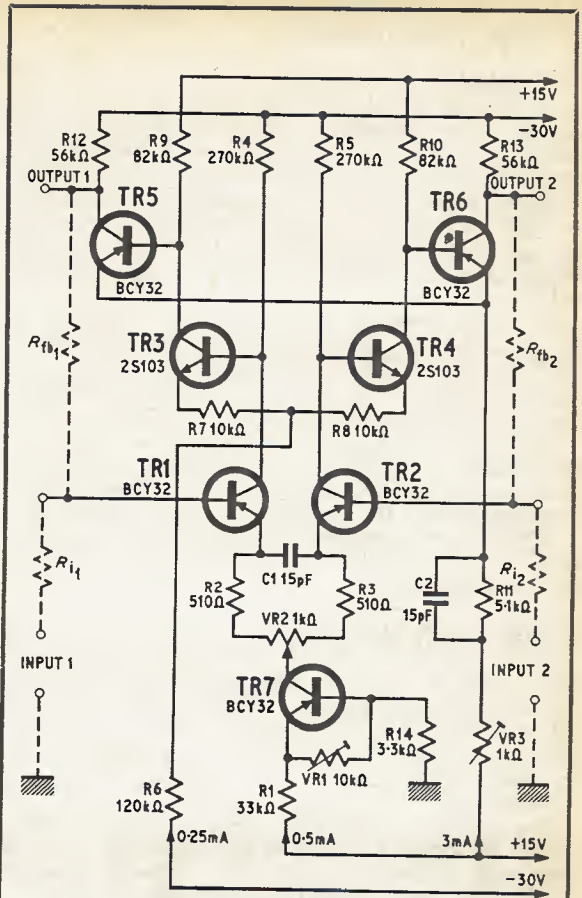

Fig. 3.2. Practical operational amplifier design with a gain of 10,000

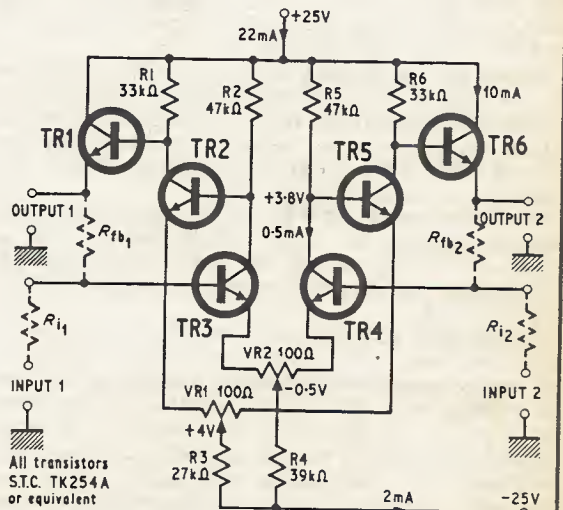

Fig. 3.3 Simple balanced pair design with a gain of 8,000

All of these adjustments should be carried out with the input terminals grounded.

ALTERNATIVE DESIGN

One of the difficulties in providing a good match for the pairs of transistors used in the emitter-coupled amplifier is due to the fact that the transistors were often manufactured separately and will not necessarily have identical characteristics. Fortunately manufacturers are becoming aware of the need for matched pairs and are able to supply transistors made from the same "chip" of semiconductor material and mounted in the same can.

A design based on transistor pairs of this type is shown in Fig. 3.3. This uses the S.T.C. dual transistors TK254A or equivalent. The design is a little simpler than the one given in Fig. 3.2 and only two potentiometers are necessary for balance adjustment.

The drift characteristics of this amplifier are very good, due to the similar characteristics of the transistor pairs, and is about $10\mu\text{A}/\text{degrees centigrade}$, which compares favourably with some computer amplifiers.

The open loop gain will depend upon the spread in gain for the transistors, but a gain of at least 8,000 should be realised.

INTEGRATED CIRCUITS

This series of articles on the operational amplifier would not be complete without a mention of the integrated circuit amplifier. The question the reader will probably pose in this connection is whether he should take advantage of the recent developments in integrated circuits and purchase, instead of construct, the amplifier.

The cost of an integrated circuit amplifier having a similar performance to the designs described above is now quite comparable to the cost of the components required for a unit constructed of discrete elements.

Operational amplifiers are now produced by several manufacturers, fabricated on a single chip of silicon, including all the interconnecting resistors, and mounted in a single transistor can. The complexity of the sort of design realised in this way can be judged from the schematic diagram of the integrated circuit amplifier, type 702A, shown in Fig. 3.4a. The eight leads to the amplifier are brought out of the can and are shown in the connection diagram Fig. 3.4b.

A loop gain of 10,000 is available which is adequate for the applications described previously. If the high frequency response of the amplifier is important, which may be the case where it is used as, say, an oscilloscope pre-amplifier, then a small capacitor should be connected across terminals 5 and 6.

The actual value depends on the closed loop gain required and can be found by experiment. For a typical closed loop gain of 100 then a value of 500pF will permit a level frequency response of up to 30MHz to be obtained.

A monolithic construction is used for the integrated circuit amplifier. This means that all the transistors and resistors are fabricated under identical conditions and situated very close to one another on the same silicon chip. Consequently the matching between critical components is very good and under operating conditions the temperature differential from one component to another is quite small causing minimum d.c. drift.

The integrated circuit is produced by diffusing layers of *n*- and *p*-type material into the silicon chip in order to fabricate the circuit by purely chemical means. A

cross-section of a part of a Texas Instruments operational amplifier (type SN523a) is shown in Fig. 3.5 to give an idea of this form of construction.

ADVANCED OPERATIONAL AMPLIFIER APPLICATION

To complete this series of articles the use of an operational amplifier to produce a simple frequency filter will be described.

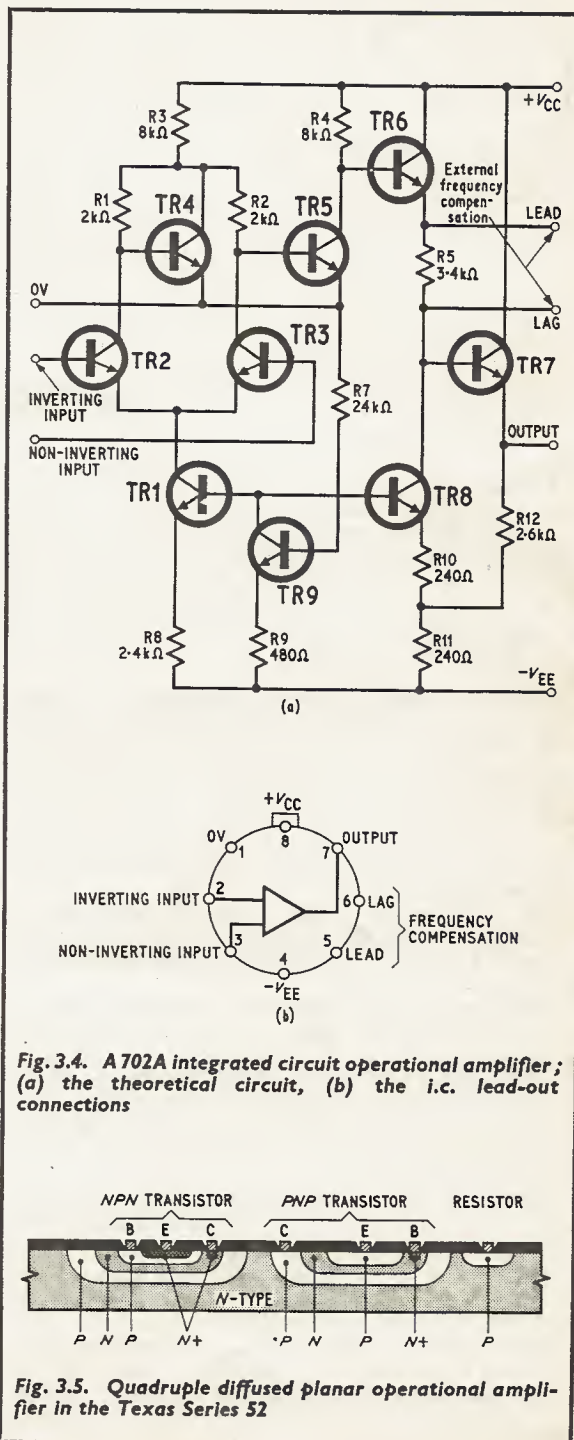

Fig. 3.4. A 702A integrated circuit operational amplifier; (a) the theoretical circuit, (b) the i.c. lead-out connections

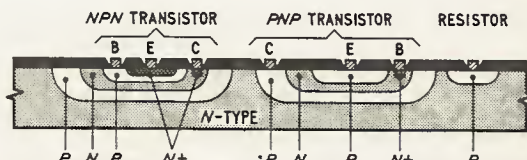

Fig. 3.5. Quadruple diffused planar operational amplifier in the Texas Series 52

NEW PRICES ON NEW COMPONENTS

RESISTORS

High stability, carbon film, low noise. Capless construction, molecular termination bonding.

Dimensions (mm): Body: $\frac{1}{4}$ W; 8 x 2.8
 $\frac{1}{2}$ W; 10 x 4.3
 Leads: 35

10% ranges; 10 Ohms to 10 Megohms (E12 Renard Series)
 5% ranges; 4.7 Ohms to 1 Megohm (E24 Renard Series)

Prices—per Ohmic value.

	each	10 off	25 off	100 off
$\frac{1}{4}$ W 10%	2d	1/6	3/3	10/4
$\frac{1}{2}$ W 10%	2½d	1/9	3/8	11/8
$\frac{1}{4}$ W 5%	2½d	1/9	3/8	11/7
$\frac{1}{2}$ W 10%	2½d	1/9	3/8	11/7
$\frac{1}{4}$ W 5%	3d	2/-	4/-	12/10

CAPACITORS

Subminiature Polyester film, Modular for P.C. mounting. Hard epoxy resin encapsulation. Radial leads.

±100% tolerance. 100 Volt Working.

Prices—per Capacitance value (µF)

	each	10 off	25 off	100 off
0.001, 0.002, 0.005, 0.01, 0.02	6d	4/3	8/4	30/-
0.05	8d	6/-	12/6	41/8
0.1	10d	7/1	15/6	51/-
0.2	1/2	10/-	20/10	68/6
0.5	2/-	17/6	37/6	125/-

Polystyrene film, Tubular, Axial leads. Unencapsulated. ±5% or ±1pf tolerance. 160 Volt Working.

Prices—per Capacitance value (µF)

	each	10 off	25 off	100 off
10, 12, 15, 18, 22, 27, 33, 39, 47, 56, 68, 82, 100, 120, 180, 220, 270, 330, 390	5d	3/7	7/9	24/-
470, 560, 680, 820, 1,000, 1,500	6d	4/-	8/8	26/8
2,200, 3,300, 4,700, 5,600	7d	5/-	10/10	33/4
6,800, 8,200, 10,000, 15,000	8d	6/-	13/-	40/-
22,000	9d	6/9	18/-	45/4

Polystyrene film, Tubular, Axial leads. Professional Grade. Hard Epoxy Resin encapsulation. ±1% tolerance. 100 Volt Working.

Prices—per Capacitance value (µF)—except where stated

	each	10 off	25 off	100 off
100, 120, 150, 180	1/3	10/2	21/2	64/6
220, 270, 330, 390, 470, 560, 680, 820	1/3	10/8	23/1	71/-
1,000, 1,200, 1,500, 2,200, 2,700	1/6	13/10	29/11	92/-
3,300, 3,900, 4,700, 5,600	1/9	14/11	31/-	96/-
6,800, 8,200, 10,000, 12,000	1/9	15/2	32/10	101/-
15,000, 18,000	2/-	15/11	34/9	107/4
22,000, 27,000	2/3	17/3	37/10	115/-
33,000, 39,000	2/6	20/1	43/6	133/9
47,000, 56,000	2/9	22/1	47/10	147/4
68,000	3/-	24/9	53/8	165/4
82,000	3/3	26/1	56/6	173/9
0.1µF	3/6	27/5	59/4	182/8
0.12µF	3/9	30/3	65/10	202/-
0.15µF	4/3	34/2	73/7	228/-
0.18µF	5/-	37/10	81/11	252/3
0.22µF	6/-	47/-	101/10	313/4
0.27µF	6/9	53/9	116/8	358/4
0.33µF	7/3	58/10	126/11	390/-
0.39µF	7/9	65/-	140/10	433/4
0.47µF, 0.5µF	9/9	75/2	137/7	500/-

POTENTIOMETERS (Carbon)

Miniature, fully enclosed, rear tags, carbon brush wiper. Long life, low noise. Body dia. $\frac{3}{16}$ in. Spindle, $\frac{1}{16}$ in. x $\frac{1}{16}$ in. $\frac{1}{4}$ W at 70°C. ±20% $\frac{1}{4}$ M, ±30% $\frac{1}{2}$ M Lin. 100 Ohms to 10 Megohms, Log. 5 Kohms to 5 Megohms.

Prices—per ohmic value.

	each	10 off	25 off	100 off
	2/3	20/-	45/10	186/8

GANGED STEREO POTENTIOMETERS (Carbon)

$\frac{1}{4}$ W at 70°C. Long Spindle.

Logarithmic and Linear: 5k + 5k to 1M + 1M.

Prices per ohmic value

	each	10 off	25 off	100 off
	8/-	70/-	162/6	575/-

SKELETON PRE-SET POTENTIOMETERS (Carbon)

High quality pre-sets suitable for printed circuit boards of 0.1in. P.C.M. 100 Ohms to 5 Megohms (Linear only).

Miniature: 0.3W at 70°C. ±20% below $\frac{1}{4}$ M, ±30% above $\frac{1}{4}$ M. Horizontal (0.7in. x 0.4in. P.C.M.) or Vertical (0.4in. x 0.2in. P.C.M.).

Subminiature: 0.1W at 70°C. ±20% below 2.5M, ±30% above.

Prices—per ohmic value

	each	10 off	25 off	100 off
Miniature (0.3W)	1/-	8/9	18/9	66/8
Subminiature (0.1W)	10d	7/1	14/7	46/8

JACK PLUGS

$\frac{1}{4}$ in. Type P1. Standard. Screened. Heavily chromed.
 $\frac{1}{4}$ in. Type SE/P1. Side-entry version of type P1.
 $\frac{1}{4}$ in. Type P2. Standard. Unscreened. Unbreakable moulded cover.
 $\frac{1}{4}$ in. Type P3. Tip-Ring-Sleeve Stereo version of Type P1.
 $\frac{1}{4}$ in. Type P4. Tip-Ring-Sleeve Stereo version of Type P2.
 3.5mm Type P5. Standard. Screened. Aluminium cover.
 3.5mm Type P6. Standard. Unscreened. Unbreakable moulded cover.

Prices—

	each	10 off	25 off	100 off
P1.	3/-	26/8	62/6	233/4
SE/P1.	3/6	30/10	66/8	280/-
P2.	2/6	23/4	54/2	200/-
P3.	6/6	60/-	137/6	500/-
P4.	6/2	56/6	127/6	455/-
P5.	2/2	19/2	43/9	158/4
P6.	1/8	15/-	33/4	116/8

JACK SOCKETS

$\frac{1}{4}$ in. Type S3. Stereo version for use with P3 or P4 plugs.
 $\frac{1}{4}$ in. Type S5. Standard. Moulded body. Chrome insert.
 3.5mm Type S6. Standard. Moulded body. Chrome insert.
 Available with make or break contacts on Tip, Ring and Sleeve.

Prices—

	each	10 off	25 off	100 off
S3	3/3	30/-	68/9	250/-
S5	2/9	25/-	56/8	216/8
S6	1/6	13/4	33/4	100/-

ELECTROLYTIC CAPACITORS (Mullard). —10% to +50%.

Subminiature (all values in µF)

	each	10 off	25 off	100 off
4V	8	32	64	125
6.4V	6.4	25	50	100
10V	4	16	32	64
16V	2.5	10	20	40
25V	1.6	6.4	12.5	25
40V	1	4	8	16
64V	0.64	2.5	5	10
Price	1/4	1/3	1/2	1/-

Small (all values in µF)

4V	800	1,250	2,000	3,200
6.4V	640	1,000	1,600	2,500
10V	400	640	1,000	1,600
16V	250	400	640	1,000
25V	160	250	400	640
40V	100	160	250	400
64V	64	100	160	250
Price	1/6	2/-	2/6	3/-

POLYESTER CAPACITORS (Mullard)

Tubular, 10%, 160V: 0.01, 0.015, 0.022µF, 7d. 0.033, 0.047µF, 8d. 0.068, 0.1µF, 9d. 0.15µF, 11d. 0.22µF, 1/-, 0.33µF, 1/3. 0.47µF, 1/6. 0.68µF, 2/3. 1µF, 2/8.

400V: 1,000, 1,500, 2,200, 3,300, 4,700pF, 6d. 6,800pF, 0.01, 0.015, 0.022µF, 7d. 0.033µF, 8d. 0.047µF, 9d. 0.068, 0.1µF, 11d. 0.15µF, 1/2. 0.22µF, 1/6. 0.33µF, 2/3. 0.47µF, 2/8.

Modular, metallised, P.C. mounting, 20%, 250V: 0.01, 0.015, 0.022µF, 7d. 0.033, 0.047µF, 8d. 0.068, 0.1µF, 9d. 0.15µF, 11d. 0.22µF, 1/-, 0.33µF, 1/5. 0.47µF, 1/8. 0.68µF, 2/3. 1µF, 2/9.

SEMICONDUCTORS: OA5, OA81, 1/9. OC44, OC45, OC71, OC81, OC81D, OC82D, 2/-, OC70, OC72, 2/3. AC107, OC75, OC170, OC171, 2/6. AFI15, AFI16, AFI17, ACY19, ACY21, 3/3. OC140, 4/3. OC200, 5/-, OC139, 5/3. OC25, 7/-, OC35, 8/-, OC23, OC28, 8/3.

SILICON RECTIFIERS (0.5A): 170 P.I.V., 2/9. 400 P.I.V., 3/-, 800 P.I.V., 3/3. 1,250 P.I.V., 3/9. 1,500 P.I.V., 4/-, (0.75A): 200 P.I.V., 1/6. 400 P.I.V., 2/-, 800 P.I.V., 3/3. (6A): 200 P.I.V., 3/-, 400 P.I.V., 4/-, 600 P.I.V., 5/-, 800 P.I.V., 6/-.

SWITCHES (Chrome finish, Silver contacts): 3A 250V, 6A 125V. Push Buttons: Push-on or Push-off 5/-. Toggle Switches: SP/ST, 3/6. SP/DT, 3/9. SP/DT (with centre position) 4/-. DP/ST, 4/6. DP/DT, 5/-.

ROTARY SWITCHES (Wafer)

High quality. Rear tags. Long spindle, $\frac{1}{8}$ " Dia.

1p/12w, 2p/6w, 3p/4w, 4p/3w, 2p/3w.

Prices—

	each	10 off	25 off	100 off
All Types	4/6	38/4	83/4	283/4

PRINTED CIRCUIT BOARD (Vero).

0.15in Matrix: 3 $\frac{1}{2}$ in x 2 $\frac{1}{2}$ in, 3/3. 5 $\frac{1}{2}$ in x 2 $\frac{1}{2}$ in, 3/11. 3 $\frac{1}{2}$ in x 3 $\frac{1}{2}$ in, 3/11. 5in x 3 $\frac{1}{2}$ in, 5/6.
 0.1 Matrix: 3 $\frac{1}{2}$ in x 2 $\frac{1}{2}$ in, 4/-. 5in x 2 $\frac{1}{2}$ in, 4/6. 3 $\frac{1}{2}$ in x 3 $\frac{1}{2}$ in, 4/6. 5in x 3 $\frac{1}{2}$ in, 5/3.

Send S.A.E. for January, 1969 Catalogue

DUXFORD ELECTRONICS (PE)

97/97A MILL ROAD, CAMBRIDGE

Telephone: CAMBRIDGE (0223) 63687

(Visit us—at our new Mail Order, Wholesale & Retail Premises) MINIMUM ORDER VALUE 5/- C.W.O. Post and Packing 1/6

S.E.S. YOUR COMPLETE SUPPLIER

196 Regent Road, SALFORD 5, Lancashire

TELEPHONE 061-872 5187

(Member of the Harrop Industrial Group)

C.W.O. please 1/- p. & p. for orders of components under £1
 Orders of Lektrokitt: 2/- handling charge on orders under £1
 5/- handling charge on orders under £5

RESISTORS: All brand new, Hi-Stab, low noise, 5% tol. carbon film.
 1W E12 series 4.7 ohm to 10M, 2d. each or 15/- per 100 of one value. 1W
 E24 series 4.7 ohm to 10M, 2d. each or 15/- per 100 of one value. 1W E12
 series 2.2 ohm to 3.9 ohm, 8d. each. 1W E12 series 10 ohm to 10M. (10%
 tol.), 3d. each. 3W—wirewound—0.5 ohm to 12 ohm, 1/6 each. 5W—
 wirewound—15 ohm to 82kohm, 1/9 each. S.E.S. Pre-Pack gives you 5 off
 each, 5% resistors from 4.7 ohm to 1M either 1/ or 1/2 watt. 65 different
 values (E12)—ONLY £2 12s. 6d. ***NOW—1W carbon film 5%, E12 series
 10 ohm to 100kohm, 2d. each.

PRE-SETS: Min. skeleton carbon track, low noise with good stability;
 Values—Lin: 1k, 2.5k, 5k, etc., to 5M; Log: 5k, 10k, 25k, etc., to 1Mohm,
 only 10d. each. Sub-Min skeleton Lin. track: 1k, 2.5k, 5k, etc., to 5M, only
 9d. each. Slider pre-sets wirewound 1W rating Lin: 10 ohm to 5k, 2/3 each.
 3W wirewound fully enclosed Lin. tracks. 10 ohm to 30k, 3/9.

POTENTIOMETERS: Min. enclosed, carbon track and wiper contact only
 2/6; Values—Lin: 1k, 2.5k, 5k, etc., to 10M; Log: 5k, 10k, 25k, etc., to
 5Mohm. Min. with double-pole switch, insulated spindles only 5/6. Values
 —Lin: 25k, 50k, 100k; Log: 3k, 5k, 10k, 250k, 500k, 1M, 2M. 3W wirewound
 Lin. tracks 50 ohm to 100kohm, 7/4 each.

CAPACITORS: New genuine Mullard Electrolytics

	(Min.)				(Small)			
	6.4	2.5	100	200	320	640	1,000	2,500
6.4V	4	16	32	64	125	200	400	1,000
10V	4	16	32	64	125	200	400	1,000
16V	2.5	10	20	40	80	125	250	640
25V	1.6	6.4	12.5	24	50	80	160	250
40V	4	8	16	32	50	100	160	250
64V	0.64	2.5	5	10d.	20	32	64	100
Prices: 1/-							1/3	1/6

	(Large)				(Multi ples)			
	25V	50V	100V	200V	500V	8-8µF	6/6	7/6
25V	800	1,250	2,000	4,000	500V	16-16µF	7/6	8/6
40V	500	800	1,250	2,500	350V	32-32µF	7/3	8/3
64V	320	500	800	1,600	2,500	50-50µF	9/6	10/6
Prices: 5/-		6/6	8/6	12/6	15/-			

(all values in Microfarads)
 Mullard Miniature Metallised Polyester 250V. 0.01, 0.015, 0.022, 0.033, 0.047, 0.068µF, 6d. each. 0.1, 0.15, 0.22µF, 7d. each.
 Mullard Polyester Film and Foil 400V. 0.001, 0.0015, 0.0022, 0.0033, 0.0047, 0.0068, etc., to 0.033µF, 6d. each. 0.047 to 0.1µF, 8d. each. 0.15µF, 10d. each. 0.22µF, 1/-. 0.33µF, 1/6. 0.47µF, 1/9.
 Disc Ceramics (Erie) 500V, 1,000, 4,700pF, 5d. each. Silver Micas 1% tol. 500V, 2.2pF to 82pF, 1/- each. Polystyrene 160V, 100-1,000pF, 5d. each.
 ***NOW—Bead Tanalums (polarised) 35V (1e-47), 0.68, 1µF, 2/6 each. 2.2, 3.3, 4.7, 6.8µF, 3/4 each. 20V 10µF, 15V 22µF, 10V 33µF, 6V 47µF, 3/9 each. Low Voltage Disc Ceramics 20V—0.01, 0.022, 0.047µF, 10d. each. 0.1, 0.22, 1/3 each. Midget Tubular Ceramics—0.002, 0.003µF, 10d. each.

SEMICONDUCTORS: All New and Unused
 Mullard; OA5, 4/6; OA81 3/4; OA2022/3; OC71 4/-; OC72 4/6; OC44 7/9; OC45 6/-; BC107, 109 3/9 each; BC108 3/6; BFY51 4/6; MPF 105 9/6.
 Silicon Rectifiers—(0.5A) 400piv 2/9; 800piv 3/-; 1,500 piv 3/6; (1.2A) 400piv 6/-; 800piv 7/-; 1,500piv 7/6; (2.5A) 400piv 6/6; 800piv 7/6; 1,500piv 10/6. (1.2A and 2.5A types are stud mounted—Anode). ***NOW—2N2924 3/6; 2N2926 (Brown or Red) 2/6, (Orange) 2/9, (Yellow) 3/-, (Green) 3/3; 2N3643 8/6; 2N3794, 2N4289 4/- each; 1N4148 1/6.

SWITCHES: 100 series—SPST 3/8; SPDT 3/11; DPST 4/6; DPDT 4/8. 400 series SPST 3/2; SPDT 3/6; SPDT (with centre stop) 3/8. Series 500—push-to-make or push-to-break 3/11 each (push buttons available in white/red, black, green). Slide Switch 3/4; Wave Change switches 5/9 each. Miniature "Maka-Switch" also available—Switches 5/-; Wafers 5/4 each.

PLUGS AND SOCKETS: Min. Plugs (black or red) 6d. Min. Sockets to fit 7d. Banana Plugs (black or red) 9d. 4mm Sockets to fit (black, red, green) 9d. Co-Ax Plugs 1/2. Co-Ax Sockets 1/2. Sub-Min Jack Plugs and Sockets 2/- each. Min. Jack Plugs and Sockets 3/- each. Recorder Plugs 3-way 2/7 5-way 3/-. Recorder Sockets 3-way 1/2, 5-way 1/4.

WIRE: Min. Stranded (available in 10 colours) 3d. yd. Solid Core 3d. yd. 14/0-0076in. Stranded 4d. yd. Min. Mains Lead 1/3 yd. Min. Microphone cable 1/6 yd. Co-Ax cable 1/3 yd.

LAMPS: Min. Wire Ended Neons 2/-; Panel Neon Indicator 6/4; Pilot Light +12V bulb 8/-; Min. Flange Light +12V bulb 11/-.

SOLDERING IRONS: A.N.T.E.X. CN240 15W mains operated, small, 32/6. E240 20W mains operated, specially shaped handle, 35/- Spare bits and elements available. Also stands for above irons, 11/6 each. ***NOW—SOLDER by Multicore—At Reduced Prices to Everyone! Size A—Approx. 20ft coil 60/40 Alloy 22 s.w.g. in dispenser. Recommended retail price 3/-. OUR PRICE 2/9. Size B—Approx. 200ft reel 60/40 Alloy 22 s.w.g. individually packed. Recommended retail price 15/- OUR PRICE 12/6. BIB Wire Strippers: strips insulation without nicking wire. Recommended retail price 4/6, OUR PRICE 4/-.

LEKTROKIT: Chassis construction system—the professional look to a home construction. Parts to build a chassis 8 1/2" x 4 1/2".—2 chassis rails 1/10 each. 2 side plates 4/4 each. Front panel (covered in crack-proof paint) 8/3. Perforated cover 5/6. 2 plain covers 4/3 each. 4 rubber feet 9d. 7 boards available each 4 1/2" x 4 1/2".—Thus 2 boards fit above chassis. Plain perforated aluminium board 2/2. Aluminium board drilled for 6 valveholders 87G. BBA, B9A, 2/6. Aluminium board drilled for 2 valveholders international octal, UX4, etc., 2/4. 0.1in. perforated grid SRBP board, 2/9. Veroboard 0.1in. and 0.2in. 6/6 each. Cloverleaf aluminium board 6/-. (Cloverleaf lead throughs 6d. each. Pins for SRBP board 4/6 100.)

For full details of all our stocks send 3/6 for our bright explanatory 120 page catalogue, or 6d. stamp for Data Sheet.

VALVES SAME DAY SERVICE NEW! TESTED! GUARANTEED!

SETS

1R5, 1S5, 1T4, 3S4, 3V4, DAF91, DF91, DK91, DL92, DL94.
 Set of 4 for 18/8, DAF96, DF96, DK96, DL96, 4 for 28/6

OZ4	4/6	20F2	13/6	DK96	7/-	EL41	10/8	PCL85	8/-	UCC84	7/9
1A7GT	7/6	20P3	11/8	DL35	5/-	EL84	4/9	PCL86	8/-	UCC85	6/9
1H6GT	7/3	20P4	11/8	DL92	6/9	EL90	5/-	PEN44	12/6	UCF80	8/3
1X6GT	7/9	25L6GT	5/-	DL94	6/-	EL500	12/6	PEN36C15	8/6	UCH42	9/9
1R6	6/9	30FL12	14/6	DL96	6/9	EM80	5/9	PFL26012	6/6	UCH81	6/9
1S5	4/3	30C1	6/6	DY86	5/9	EM81	6/9	PL363	9/9	UCL62	7/3
1T4	2/9	30C15	13/-	DY87	5/9	EM84	6/6	PL81	7/3	UCL83	11/8
3S4	5/9	30C17	18/-	EAB80	6/6	EM87	7/6	PL82	7/-	UF41	10/6
3V4	6/-	30C18	11/6	EAF42	8/9	EY51	7/3	PL83	7/-	UF80	7/-
3Y4	4/6	30F5	18/6	EB91	2/3	EY86	6/6	PL84	6/6	UF85	6/9
6Y3GT	5/9	30FL1	13/9	EBC33	8/-	EZ40	7/6	PL600	13/-	UF89	6/9
6Z4	7/6	30FL12	14/6	EBC41	9/9	EZ41	7/6	PL504	13/6	UL41	10/6
630L2	12/-	30FL14	12/-	EBF80	6/9	EZ80	4/6	PL508	23/6	UL44	20/-
6AL5	2/3	30L1	6/6	EBF89	6/3	EZ81	4/9	PL802	14/8	UL84	7/-
6AM6	3/6	30L15	14/-	ECC82	4/9	EZ82	9/9	PMB4	7/9	UM84	7/6
6AQ5	4/9	30L17	15/6	ECC82	4/9	EZ84	9/9	PX25	10/6	UY41	8/3
6AT6	4/-	30P4	12/-	ECC83	7/-	KT61	8/9	PY31	5/6	UY85	5/9
6AU6	4/6	30P12	13/9	ECC85	5/9	KT66	18/-	PY32	10/-	VP40	10/-
6BA6	4/6	30P19	12/-	ECC84	12/-	M140016	8/-	PY33	10/-	VP431	9/6
6BE6	4/9	30P13	13/9	ECF80	7/-	N78	14/9	PY81	5/3	Z77	3/6
6BJ6	7/-	30P13	15/6	ECF82	5/9	PAB80	7/6	PY82	5/3	Z77	3/6
6BW6	13/-	30P14	15/6	ECH35	6/-	PC86	10/3	PY83	5/9	AC127	2/6
6R13	3/6	35L6GT	8/-	ECH42	10/6	PC88	10/3	PY88	6/9	AD140	7/6
6R14	9/-	35W4	4/6	ECH81	5/9	PC96	8/3	PY800	7/6	AF102	18/-
6R17	14/3	35Z4GT	5/-	ECH84	7/6	PC97	8/6	PY801	6/9	AF115	3/-
6K7G	2/6	6083	12/6	ECL30	6/9	PC800	6/9	R19	6/6	AF116	3/6
6K8G	4/3	AC/VP210	6/-	ECL82	9/9	PC884	6/6	U2	12/6	AF124	3/3
6L18	6/-	AZ31	9/6	ECL83	9/-	PC885	6/6	TH21C	9/6	AF124	3/3
6V6GT	6/6	B729	12/6	ECL86	8/3	PC888	6/9	U25	13/-	AF125	3/6
6X4	4/3	COH35	10/6	EF37A	6/6	PC889	10/6	U26	12/6	AF126	7/6
6X6GT	5/9	CL33	18/6	EF39	4/9	PC189	11/6	U47	13/6	AF127	3/6
7B7	7/-	CT81	6/9	EF41	10/9	PC880	6/6	U49	13/6	OC26	5/9
7C6	6/9	DAC32	7/3	EF80	4/9	PC892	6/6	U52	4/6	OC44	2/3
7X4	6/6	DAF91	4/3	EF85	6/-	PC886	9/6	U78	4/3	OC45	2/3
10F1	14/-	DAF96	6/6	EF86	6/3	PCF20013	6/6	U191	12/6	OC71	2/6
10P13	15/6	DF33	7/9	EF89	5/3	PCF80018	6/6	U801	19/6	OC72	2/6
12AL8	35/-	DF91	3/6	EF91	3/6	PCF801	6/9	UA8C80	8/9	OC75	2/6
12A7	4/9	DF96	6/6	EF94	4/6	PCF802	9/6	UA8F42	9/6	OC81	2/6
12AUG	4/9	DE77	4/-	EF183	8/-	PCF803	11/6	UB41	6/6	OC81D	2/3
12AUX	4/9	DE81	10/9	EF184	5/6	PCF808	12/-	UBC41	8/6	OC82	2/3
12AX7	4/9	DK32	7/6	EH90	6/3	PCL82	7/-	UBF80	6/6	OC82	2/3
12K6GT	7/-	DK91	5/9	EL33	8/9	PCL83	9/-	UBF89	6/9	OC82D	2/6
19B66T7/8	17/8	DK92	9/3	EL34	10/3	PCL84	7/6	UC92	5/-	OC170	8/6

READERS RADIO (P.E.)

85 TORQUAY GARDENS, REDBRIDGE, ILFORD, ESSEX. Tel. 01-550 7441

Postage on 1 valve 9d. extra. On 2 valves or more, postage 6d. per valve extra. Any Parcel Insured against Damage in Transit 6d. extra.

ELECTROVALUE

EVERYTHING BRAND NEW AND TO SPEC. NO SURPLUS

SPECIALIST SUPPLIERS OF TRANSISTORS

IN TYPES TO SUIT ALL APPLICATIONS

- COMPETITIVE PRICES
- HIGH QUALITY COMPONENTS FOR TRANSISTOR CIRCUITS
- PEAK SOUND AS ADVERTISED
- CATALOGUE Our latest 1969 catalogue is packed with up-to-the-minute items and invaluable information. Send 1/6 for your copy now.
- DISCOUNTS 10% on orders for components for £3 or more. 15% on orders for components for £10 or more.
- POSTAGE for orders for £1, add 1/-. FREE on orders for £1 or over. Overseas orders welcome—Carriage charged at cost.

ELECTROVALUE

(DEPT. PE), 32a ST. JUDES RD., ENGLEFIELD GREEN, EGHAM, SURREY

Telephone: Egham 5533 (STD 0784-3)

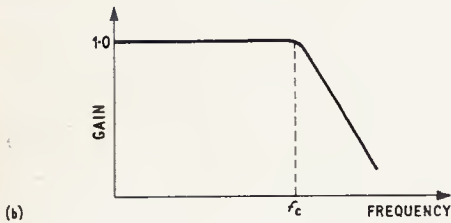
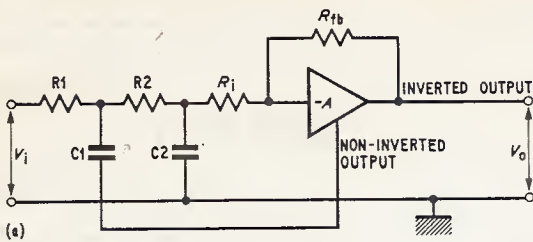

Fig. 3.6. Low pass filter circuit (a) and the typical frequency response (b)

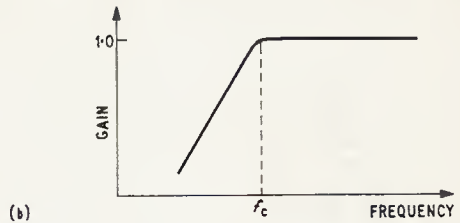
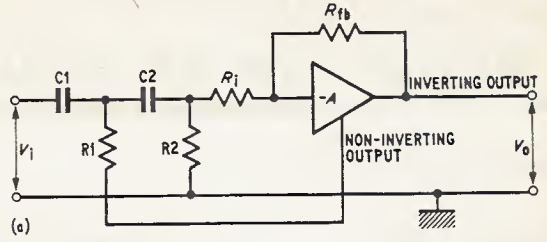

Fig. 3.7. High pass filter circuit (a) and the typical frequency response (b)

For this application an operational amplifier is required that does not invert the signal applied to its input. This is easily obtained with emitter-coupled amplifiers shown in Figs. 3.2 and 3.3. Since outputs can be obtained from either collector output terminal, one will be inverted and used for stabilising feedback and the other is required for filter feedback purposes.

The circuit for a low-pass filter is shown in Fig. 3.6a. This circuit will pass signals of a frequency lower than the turn-over frequency f_c without any attenuation. At frequencies higher than this the signals are considerably reduced. This is shown in Fig. 3.6b which gives the filter gain performance.

With $R_i = R_{fb} = 100\text{k}\Omega$ and $R1 = 100\text{k}\Omega$ and $R2 = 600\text{k}\Omega$ then the cut-off frequency of the filter depends on the values chosen for $C1$ and $C2$. The relationship is:

$$C1 = \frac{2.1}{f_c} \mu\text{F}$$

and

$$C2 = \frac{0.35}{f_c} \mu\text{F}$$

where f_c is the turn-over frequency in hertz.

Thus if we required a filter to cut all frequencies higher than 9kHz, then with the resistance values given above,

$$C1 = \frac{2.1 \times 10^6}{9,000} = 233\text{pF}$$

and

$$C2 = \frac{0.35 \times 10^6}{9,000} = 40\text{pF}$$

The counterpart of this filter is the high-pass filter which attenuates all signals below the turn-over frequency, f_c . The circuit is given in Fig. 7a.

Here $R_i = R_{fb} = 100\text{k}\Omega$ as before, and with $R1 = 250\text{k}\Omega$ and $R2 = 1\text{M}\Omega$ the capacitors are given as;

$$C1 = C2 = \frac{0.5}{f_c} \mu\text{F}$$

again with f_c given in hertz.

This filter might be used to cut out turntable rumble in a record reproducing system. For example, if we let $f_c = 60\text{Hz}$ then with the resistance values given above,

$$C1 = C2 = \frac{0.5}{60} = 0.083\mu\text{F}$$

The component values need to be accurate to ± 10 per cent if the correct cut-off frequency is to be obtained.

It is possible by using two operational amplifiers to assemble a bandpass filter quickly from a combination of a low-pass filter in series with a high-pass filter. This may be useful where a particular frequency or band of frequencies are to be excluded from a signal extending over a range of frequencies.

It is hoped that these three articles have illustrated the wide versatility of the operational amplifier. Many other applications are possible than those given and will suggest themselves to the user as familiarity is gained in the use of the amplifier. Indeed the experimenter may well find the operational amplifier becoming an indispensable part of his workshop tool kit for solving almost any electronic problem!



Readout —

A SELECTION FROM OUR POSTBAG

correspondents wishing a reply must enclose a stamped addressed envelope

Tongue Tied

Sir—The article *An International Technical Language* by R. Spathaky in June P.E. made me wonder if fellow readers are aware that a working international language already exists? Esperanto, spoken by several million people throughout our world, meets all the requirements for a simple technical language.

Technical books in Esperanto are all available through the "Brita Esperantista Asocio", Holland Park Avenue, London, W.1.

The International Electrotechnical Commission, which your article mentions in its opening paragraph, include Esperanto in their multi-language dictionary of technical terms.

I enclose a copy of a translation of the first two paragraphs of your article about voltage indicators.

Tensiaj Indikiloj

Miniaturaj neonaj diodoj kiuj enhavas malgrandajn elektrodojn ofte troviĝas en hejma aparataro. La speco de cirkvito kiun oni povas uzi montriĝas per figuro 2.1. La diodoj posedas du identajn elektrodojn por ke la kurento tra ili povas flui ambaŭdirekten sen troa damaĝo; la diodoj kiuj montriĝas en la cirkvito estas tial reprezentataj per simetria simbolo, ĉiu elektrodo kombinas la simbolojn de la anodo kaj malvarma katodo.

Kiam la ŝaltilo fermiĝas, la neona diodo arkas tuj kiam la momenta tensio de la alterniga linia enfluo atingas la arkan tension de la diodo uzata. La tubo estingiĝos kiam la linia tensio falas sub la subtenanta tensio ĉe la fino de ĉiu duonciklo sed ekbrilos denove dum la sekvanta duonciklo. Tial la tubo eligas 100 ekbrilojn po sekunde sed la okulo vidas plene konstantan lumadon.

A. McConachie,
Great Malvern.

Computer Collaboration

Sir—I should like to get in touch with any of your readers who have built and are now using the PRACTICAL ELECTRONICS analogue computer PEAC, with a view to discussing further modifications and applications of this apparatus.

J. G. Boylan,
Langley Park School for Boys, Kent.

Alarm circuitry

Sir—I was interested to read Mr Bollen's excellent article on his modulated light burglar alarm but I was surprised to see his complicated solution to the problem of an a.c. latching relay. Might I propose a simpler circuit which would not require delicate setting up adjustments? See Fig. 1 below.

Though I have not had an opportunity of verifying this, I feel sure that the output of Mr Bollen's amplifier would operate a suitable low impedance relay or reed relay without biasing.

I also have another suggestion which I discovered in another connection; a greater modulated light output may be obtained from a low voltage filament bulb by operating it on unfiltered half-wave rectified a.c. rather than plain a.c. (see Fig. 2 below).

It is safe to increase the supply voltage slightly.

J. Wrigley,
Cambridge.

Although the relay system chosen for the I.R. Alarm might appear to be complicated and difficult to set up, a closer examination will show that it offers several advantages when compared with more familiar systems.

Firstly, a magnetically biased reed relay will operate at inputs of typically less than 8mW, an unbiased reed relay at 30mW, and a similar priced conventional armature relay at more than 200mW. Also, bearing in mind that a changeover reed switch costs four times as much as a "make and break" reed switch, the price of a biased reed relay, including magnet, works out at about two thirds that of a reed or armature latching relay. It follows from the above that the magnetically biased reed switch was chosen for the I.R. Alarm because it offered the best sensitivity for the lowest cost, and is, in fact, not at all difficult to adjust and set up.

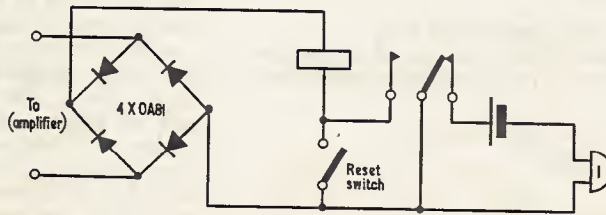

Fig. 1. Simple a.c. latching relay circuit

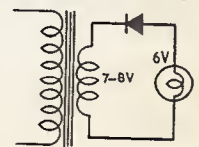

Fig. 2.

Mr Wrigley's second point concerning the use of unfiltered half-wave rectified a.c. to supply the bulb is quite valid, and should increase the maximum beam path of the I.R. Alarm by giving a greater depth of modulation of the light.

D. Bollen

Strobe Effect

Sir—I feel I must write to you with a serious warning about the use of stroboscopes at low frequencies.

It is well known in neurological circles that a light flashing at a rate of 10 to 15Hz can induce an epileptic fit into some members of our species—especially if the eyes are closed or if the ambient light level is low. For this reason if a stroboscope is used at these frequencies it must be in conditions of high ambient lighting and for short periods only. Also for this reason it is advisable to have some form of push button switch on the light unit itself so that should epilepsy set in the light will cease to operate.

One word of consolation—although the experience is very unpleasant it should leave no after effects and the condition ceases as soon as stimulation is removed.

Anyone interested in this phenomena would do well to read Dr Gray-Walter's book the *Living Brain* which not only deals with this subject but also has quite a lot of space devoted to two "animals" *Machina speculatrix* and *Machina doeilis*.

C. J. Manwell,
University of Wales Institute of
Science & Technology,
Penylan, Cardiff.

Mobile Rally

Sir—I would be very grateful if you could find space in your next issue to publish details of our first mobile rally.

Called the "White Rose Mobile Rally", it will be held on the July 27 at Allerton Girls' High School, Leeds, Yorkshire. There is ample car parking facilities and talk-in is on 160 and 2 metres.

There will be a demonstration station, refreshments, and something for XYLS and children.

R. Short, G3YEE,
Padsey and District Radio Club,
Bramley Liberal Club,
Bramley, Leeds.

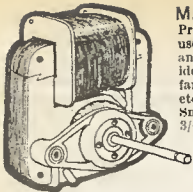

MAINS MOTOR
Precision made — as used in record decks and tape recorders—ideal also for extractor fans, blower, heater, etc. New and perfect. Snip at 9/6. Postage 3/- for first one then 1/- for each one thereafter. 2 and over post free.



ROTISSERIE MOTOR
Very powerful 7 r.p.m., operates from standard A.C. mains. 29/6, plus 3/6 P. & P.

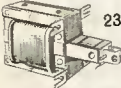

120 VOLT SOLENOID
1in. stroke. Size 2 1/2in. x 2in. x 1 1/2in. 14/6, postage 2/9.

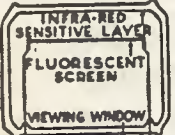

INFRA-RED SENSITIVE LAYER
Famous war-time "cat's eye" used for seeing in the dark. This is an infra-red image converter cell with a silver caesium screen which lights up (like a cathode ray tube) when the electrons released by the

infra-red strike it. A golden opportunity for some interesting experiments. 7/6 each, post 2/6. Data will be supplied with cells, if requested.

MAINS TRANSFORMER SNIP

Making a power pack for amplifier or other equipment? These transformers have normal mains primaries (230/40V) and isolated secondaries two types (1) 12V 500mA at 8/6; (2) 15V 500mA at 8/6.

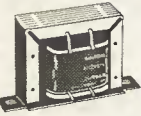

SPRING COIL LEADS
as fitted to telephones, 4 core 2/6 each, 3 core 2/- each.

PP3 ELIMINATOR Play your pocket radio from the mains! save 6s. Complete component kit comprises 4 rectifiers—mains dropper resistances, smoothing condenser and instructions, only 6/6 plus 1/- post.

QUADRUPLE TAPE
Quadruple tape on 3in. spool giving 600ft. Of the finest quality by very famous maker. Especially suitable for message tapes and portable equipment. Regular price 30/- per spool. Our price 7/6 plus 2/9 p. & p. or 3 for 22/6 post paid.

EXTRACTOR FAN

Cleans the air at the rate of 10,000 cubic feet per hour. At the pull of a cord it extracts grease, grime and cooking smells before they dirty decorations. Suitable for kitchens, bathrooms, factories, changing rooms, etc. it's so quiet it can hardly be heard. Compact, 6in. casing with 3 1/2in. fan blades. Suitable wherever it is necessary to move air fast. Kit comprises motor, fan blades, steel casing, pull switch, mains connector and fixing brackets. 39/6 plus 6/6 post and insurance.

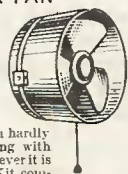

TRANSISTOR SET CASE

Very modern cream cabinet, size 5 1/2 x 3 x 1 1/2in. with chrome handle, tuning knob and scale. Price 4/6 plus 2/- postage. Printed circuit board for this case 2/6.



BATTERY CHARGER FOR NICADS

This is in plastic case, size 5 1/2 x 4 x 3in. approx. All wired up with 3 core output lead and 3 core mains input lead. Contains mains transformer with 40V 250mA secondary and standard 200/240 primary. Also contains full wave bridge rectifier, neon indicator, wired up with resistors to charge 2 Nicad batteries simultaneously. Charge rates of 30mA and 25mA respectively. Batteries up to 30 volts may be charged. Price 39/6 each, plus 3/6 postage and insurance.

VARYLITE

Will dim fluorescent or incandescent lighting up to 600 watts from full brilliance to out. Fitted on M.K. flush plate, same size and fixing as standard wall switch so may be fitted in place of this, or mount on surface. Price complete in heavy plastic box with control knob 23.19.6.



NICAD RECHARGEABLE BATTERIES

3-6V 500mA size 1 1/2 x 1 1/2in. dia. type ref. DKZ500 really powerful will deliver 1 amp for 1 hr. Regular price 32/6 our price 17/6 each. New and guaranteed. Other voltages available, single cell 1.2V 6/6, 5 cell 6V 29/6.



ELECTRIC CLOCK WITH 20 AMP SWITCH

Made by Smith's these units are as fitted to many top quality cookers to control the oven. The clock is mains driven and frequency controlled so it is extremely accurate. The two small dials enable switch on and off times to be accurately set—also on the left is another timer or alarm—this may be set in minutes up to 4 hours. At the end of the period a bell will sound. Ideal for switching on tape recorders. Offered at only a fraction of the regular price—only 45/-, less than the value of the clock alone—post and insurance 2/9.



THIS MONTH'S SNIP

BATTERY OPERATED TAPE DECK

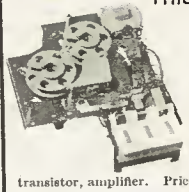

With Capstan control. This unit is extremely well made and measures approx. 6 x 5 x 2in. deep. Has three piano key type controls for Record, Playback and Rewind. Motor is a special heavy duty type intended for operation off 4.5 volts. Supplied complete with 2 spools ready to install. Record, Replay head is the sensitive M4 type intended for use with transistor, amplifier. Price 59/6. Post and insurance 4/6.

DISTRIBUTION PANELS

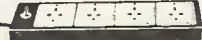

Just what you need for work bench or lab. 4 x 13 amp sockets in metal box to take standard 13 amp fused plugs. Supplied complete with 6 feet of heavy cable and 13 amp plug. Similar advertised at 45. Our price 39/6 plus 3/6 post and ins.



DRILL CONTROLLER

Electronically changes speed from approximately 10 revs. to maximum. Full power at all speeds by finger-tip control. Kit includes all parts, case, everything and full instructions. 19/6 plus 2/6 post and insurance. Or available made up 29/6, plus 2/6 post.



PROCESS TIME CONTROLLER



Made by Smith's, motorised and mains driven, enables 15A circuit to be started up to 18 hours in advance and to stay on for a period from 15 minutes to 3 hours. Totally enclosed in metal box with glass front and chrome surround. 49/6 plus 4/6 post and insurance.

REED SWITCH

Suitable for dozens of different applications, such as burglar alarms, conveyor belt switching. These are simply glass enclosed switches which can be operated by a passing permanent magnet coil. A special buy enables us to offer these at 2/6 each, or 24/- a dozen. Suitable magnets are 1/- each.

MOVING COIL METER BARGAIN

Panel meters are always being needed and they are jolly costly when you have to buy them in a hurry—so you should take advantage of this offer: 2in. moving coil flush mounting meters only 9/6. These are actually R.F. meters and cost about 23 each but if you don't want them for R.F. then all you have to do is to remove the thermocouple and you will have a 2-3 m.a. meter which you can make into almost anything by adding shunts or series resistor. New and unused.

MOTORIZED CAM SWITCH

Made by the famous meter company Chamberlain and Hookham, these have a normal mains 200-240V motor which drives a ratchet mechanism so geared to give one ratchet action per minute on a wheel with 60 teeth thus a complete revolution of the cam takes place in one hour. The cam operates 8 switches (6 changeover and 2 on/off thus 480 circuit changes per hour are possible). Contacts, rated at 15 amps have been set for certain switch combinations but can, no doubt, be altered to suit a special job. Also other switch wafers or devices can be attached to the shaft which extends approximately one inch. 47/6, p. & ins. 4/6.



MAINS TRANSISTOR POWER PACK

Designed to operate transistor sets and amplifiers. Adjustable output 6V, 9V, 12V for up to 500mA (class B working). Takes the place of any of the following batteries: PP1, PP3, PP4, PP6, PP7, PP9, and others. Kit comprises mains transformer rectifier, smoothing and load resistor, condensers and instructions. Real snip at only 18/6, plus 3/6 postage.

FLEX CABLE BARGAIN

23/0076 triple core P.V.C. covered, circular, normally sold at 1/6 yd. Our price 100 yd. coil 23.19.6. Post and insurance 6/6.

Where postage is not stated then orders over £3 are post free. Below £3 add 2/9. Semiconductors add 1/- post. Over £1 post free. S.A.E. with enquiries please.

Multi Purpose Neon Test Unit. Robust, useful and instructive, tests insulation, capacity, continuity, resistor, volume controls, also acts as signal injector and L.T. fault finder, kit comprises neon indicator, 4-way water-washer, ebontite tubes; resistors-condensers, terminals, etc., with diagram, only 9/6, plus 2/- post and insurance.

Tuning Condenser, solid dielectric -0005mfd. variable 2/6 each, 24/- dozen.

A.E.I. Fractional H.P. Motor. 200/250V 50/60 c.p.s. enclosed, continuous rating 1/40 h.p., ex equip. Perfect order, 19/6, plus 4/6 post.

Experimenting with ultra violet? Philips U.V. lamp, 16/6; holder and control gear 18/6 plus 4/6 post.

G.E.C. Black Light Tube for experiments and special lighting effects—40 watt 2ft. tubes only, 14/6 each; holders and control gear, 19/6, plus 4/6 post.

Clock Motor. 230V 50 c.p.s. synchronous—self starting 3/6.

Pentode Output Transformer. Standard size, 40-1, 5/6 each.

E.H.T. Condenser. 0-1 mfd. 5kV, 8/6 each.

Neon Mains Tester, 1/3 each, 12/- doz.

Flood Lamp Control. Our dim and full switch is ideal for controlling photo flood lamps; it gives two lamps in series, two lamps full brilliance and lamps off. Similar control of other appliances can be arranged where used in pair or where circuit can be split exactly in half. Technically the switch is known as a double-pole change over with off. Our price 6/6.

Sub-Minature Silicone Diodes. General purpose type with gold-plated leads, 1/- each or 7/6 per dozen.

Message Tapes. 225ft. Tape on 3in. spools, normally 4/6 each, we offer 4 tapes for 12/6.

Circular Flex. Non-ink, ideal for vacuum cleaners, etc., twin made by BICC. Usually 8d. yd., 100 yd. coil for 30/-, plus 6/- postage.

Edgewise Control. Morganite as fitted many transistor radios, 2K or 5K with switch, 2/6 each or 24/- per dozen.

12V Inverter. Full transistorised for operating a 20-watt fluorescent tube, size 6in. long x 1 1/2 x 12. 10.0. Post and insurance 3/-.

Silicon Rectifier. Equiv. BY100 750mA 400V, 10 for 20/-.

Miniature Pickup for 7in. records made by Cosmo-code, crystal cartridge with sapphire stylus only 3/9 or 36/- dozen.

Headphones. EX WD, unused and perfect, low resistance. Single with headband 4/6, Double with headband 8/6.

Midget Recons for mains indicators, etc., 1/3 each or 12/- dozen.

Compression Trimmers. Twin 100P.F. 1/- each; 9/- per dozen.

3in. PM Loudspeakers. 3 ohm, 12/6; 80 ohm, 8/6.

Rotary Cam Operated Switch. 12 positions each of which close a separate pair of contacts except the last which leaves them all open. Contacts rated at 250V 16 amps, 15/- each.

Rotary Cam Operated Switch. 4 positions: 1st position all contacts open; 2nd contact 1 closed; 3rd contacts 1 and 2 closed; 4th contacts 1, 2 and 3 closed. Contact rated 250V 16 amps, 8/6 each.

Pocket Test Meter, measures AC volts (3 ranges), DC Volts (3 ranges), ohms, milli amp, ideal to carry around. Complete with instructions and test leads. 39/6 plus 2/6 p. & p.

Breast Microphone. Fine American made dynamic type, adjustable on breast plate with neck straps, 7/- post 4/6.

Circular Fluorescent. 22 watt, 9in. diam. tube complete with choke, starter, holders and chrome clips, 29/6, post, etc. 4/6.

Midget Relay twin 250 ohm coils, size approx. 1 1/2in. x 1in. x 1in. 2 pairs changeover contacts, 7/- each.

1,000W Fire Spiral, replacement for most fires, 1/3 each, 12/- doz.

50 ohm 50 watt Wire Wound Pot-meters, 8/6 each.

1 Meg Miniature. Pot-meter Morganite standard 1 1/2in. spindle 1/- each; 9/- per dozen.

1 Meg Miniature. Pot-meter Morganite preset screwdriver control. 9d. each; 8/- per dozen.

Pre-Set 100K by Welwyn with intricate bakelite knob, 1/- each; 9/- per dozen.

100K Pot-Meter. Miniature type with double pole switch and standard 1 1/2in. spindle, by Morganite, 2/- each; 18/- per dozen.

Battery Motor 1 1/2in. long, 1 1/2in. dia., operates from 3V upwards, reversible, speed variable by changing voltage or resistance 4/6 each, 50/- doz.

Thermal Relay. Can be used to delay the supply of HT while heaters warm up, or will enable 15A loads to be controlled by miniature switches or relays. Regular list price over £2, price 7/6 each.

Toggle Switch Bargain. 10A 250V normal one hole fitting 2/9 each; or 30/- per doz.

QUICK CUPPA

Mini Immersion Heater. 350W 200/240V. Boils full cup in about two minutes. Use any socket or lamp holder. Have at bedside for tea, baby's food, etc. 19/6, post and insurance 1/6. 12V car model also available.



ELECTRONICS (CROYDON) LTD
Dept. PE, 266 London Road, Croydon CRO 2TH
Also 102/3 Tamworth Road, Croydon

SEMICONDUCTORS

BRAND NEW AND FULLY GUARANTEED

IN914	1/6	2N2904	8/-	ACY18	5/-	BF181	8/6	MJ490	22/6
IN916	1/6	2N2904A	8/-	ACY19	5/-	BF184	7/6	MJ491	29/6
IS010	3/-	2N2905	8/-	ACY20	4/-	BF194	6/6	MPF102	8/6
IS020	3/6	2N2906	8/-	ACY21	5/6	BFX12	5/6	MPF103	7/6
IS021	4/-	2N2906A	8/-	ACY22	4/-	BFX13	5/6	MPF104	7/6
IS025	5/-	2N2906A	8/-	ACY28	4/-	BFX29	12/6	MPF105	8/-
IS113	3/-	2N2907	8/-	AD140	8/-	BFX30	8/6	NKT0013	8/6
IS120	2/6	2N2907A	8/-	AD149	8/-	BFX35	19/6	NKT126	10/6
IS130	2/6	2N2923	5/-	AD161	7/6	BFX43	8/6	NKT217	8/6
IS131	2/6	2N2924	5/-	AD162	7/6	BFX44	8/6	NKT261	4/6
IS132	2/6	2N2926	5/6	AF114	5/-	BFX68	13/6	NKT262	4/6
IS44	2/-	Green 3	4/-	AF117	5/-	BFX84	8/-	NKT264	4/6
2G301	4/-	Yellow 2/9	AF118	12/6	BFX85	10/-	NKT272	4/6	
2G302	4/-	Orange 2/6	AF124	5/-	BFX86	8/-	NKT274	4/6	
2G303	4/-	2N3011	5/-	AF127	5/-	BFX87	10/-	NKT275	4/6
2G371	3/-	2N3053	6/6	AF181	6/6	BFX92A	12/6	NKT281	5/6
2N695	5/-	2N3054	15/-	AF186	11/-	BFX93A	15/-	NKT403	15/-
2N697	5/6	2N3055	19/6	AF239	7/6	BFY10	4/6	NKT405	15/-
2N698	4/6	2N3056	4/-	AF212	4/6	BFY11	4/6	NKT613	6/6
2N706	2/6	2N3703	4/6	ASY26	4/6	BFY17	4/6	NKT674	5/6
2N706A	2/6	2N3704	5/6	ASY27	8/6	BFY18	4/6	NKT677	5/6
2N708	4/6	2N3705	4/6	ASY28	6/6	BFY19	4/6	NKT713	3/6
2N929	5/6	2N3706	4/6	ASY29	4/6	BFY43	13/6	NKT781	3/6
2N930	6/6	2N3707	4/-	ASZ21	4/6	BFY50	4/6	NKT20329	8/6
2N1090	6/6	2N3708	4/-	BAX13	2/6	BFY51	4/6	NKT8011	15/6
2N1091	6/6	2N3709	4/-	BAX16	2/9	BFY52	4/6	NKT8012	19/6
2N1131	9/6	2N3710	4/6	BAX31	1/6	BFY76	9/6	NKT8013	22/6
2N1132	9/6	2N3711	4/6	BAY31	3/6	BSX20	5/6	OA5	2/6
2N1302	4/6	2N3712	4/6	BC107	3/6	BSX21	8/-	OA9	2/-
2N1303	4/6	2N3713	4/6	BC108	3/6	BSX22	10/6	OA73	1/6
2N1304	3/6	2N3819	9/6	BC109	3/6	BSX29	10/6	OA79	2/-
2N1305	5/6	2N3820	2/6	BC109	3/6	BSX60	19/6	OAB1	1/6
2N1306	6/6	2N3823	17/6	BC109	3/6	BSX61	12/6	OAB5	1/6
2N1307	6/6	2N4058	6/6	BC113	6/6	BSY26	4/-	OA90	1/6
2N1308	8/-	2N4059	5/-	BC118	6/6	BSY27	4/-	OA91	1/6
2N1309	8/-	2N4060	5/-	BC125	13/6	BSY28	4/6	OA95	1/6
2N1507	5/6	2N4061	5/-	BC147	5/-	BSY29	4/6	OA200	2/-
2N1613	6/6	2N4062	6/6	BC148	4/6	BSY38	4/6	OC26	6/6
2N1614	6/6	2N4284	3/6	BC148	4/6	BSY39	4/6	OC28	6/6
2N1889	8/-	2N4255	8/6	BC169	3/6	BSY40	5/6	OC35	6/6
2N1893	8/-	2N4284	3/6	BC182	4/6	BSY51	10/6	OC36	6/6
2N2102	13/6	2N4285	3/6	BC183	4/6	BSY52	6/-	OC44	3/6
2N2147	17/6	2N4286	3/6	BC184	4/6	BSY53	9/-	OC45	3/6
2N2148	12/6	2N4287	3/6	BCY30	7/6	BSY54	9/-	OC71	2/6
2N2160	14/6	2N4288	3/6	BCY31	7/6	BSY59	4/6	OC72	2/6
2N2193	3/6	2N4289	3/6	BCY32	5/6	BY100	4/6	OC75	4/6
2N2193A	5/6	2N4292	6/6	BCY33	4/6	BYX10	5/6	OC81	4/-
2N2194A	5/6	2N40361	12/6	BCY34	5/6	BYZ11	9/-	OC83	4/6
2N2217	6/-	2N40362	14/6	BCY38	5/6	BYZ12	9/-	OC81D	3/-
2N2218	6/-	2N4289	5/-	BCY39	6/6	BYZ13	6/-	OC135	6/6
2N2219	6/-	3N128	18/6	BCY40	7/6	BYZ14	6/-	OC140	6/6
2N2220	5/-	AAZ13	2/-	BCY42	6/6	GET103	5/-	OC200	5/6
2N2221	5/-	AAZ17	2/6	BCY43	6/6	GET103	5/-	OC201	5/6
2N2222	5/-	AAZ17	2/6	BCY54	6/6	GET113	4/-	OC202	8/6
2N2368	6/6	AC107	8/6	BCY70	9/6	MJ480	20/6	OC202	8/6
2N2369	7/6	AC127	3/-	BCY72	5/-	MJ481	27/6		
2N2369A	5/-	AC128	4/-	BD124	12/-				
2N2539	4/6	AC176	6/-	BF115	4/6				
2N2540	4/6	AC187	12/-	BF167	6/6				
2N2646	11/6	AC188	12/-	BF173	7/6				
2N2696	6/6	ACY17	5/-	BF180	9/-				

RECORDING TAPES

Fully Guaranteed

7"	STD	1,200'	7/3
7"	L/P	1,800'	12/3
7"	D/P	2,400'	19/-
5 1/2"	STD	900'	6/6
5 1/2"	L/P	1,200'	9/-
5 1/2"	D/P	1,800'	14/9
5"	STD	600'	5/3
5"	L/P	900'	7/3
5"	D/P	1,200'	10/9
3"	D/P	185'	2/3
3"	L/P	225'	3/-
7"	D/P	300'	4/-
Concords: 3,000' 33/6			
Spools: 8 1/2" 6/3, 7" 2/6, 5 1/2" 2/3, 5" 2/3, 4" 2/-, 3 1/2" 1/9, 3" 9d, 2 1/2" 1/10.			

CASSETTE TAPES

C-60	13/6, C-90	18/6
C-120	25/6	
Post and Packing up to 3 reels 2/9, otherwise 4/6.		

SPEAKERS (3ohm)

10" x 6"	37/6
9" x 4"	23/6
8" x 5"	19/6
7" x 4"	15/6
5" x 3"	12/6
3" 9/6, 5" 14/6, 8" 27/6, 12" 39/6.	
Post and Packing 1/6	

VERBOBOARD

33"	31/-
33"	31/-
Cutter 9/-	
33"	5" 5/6
17"	3 1/2" 16/-
5"	2 1/2" 4/3

SEND 6d. STAMP FOR CATALOGUE P.P. per Components 1/6 per order

THYRISTORS

1 AMP: 50V 5/-, 100V 5/6, 200V 7/-, 400V 9/6.
3 AMP: 50V 6/-, 100V 7/6, 200V 8/-, 400V 10/-.
ZENERS: 1 1/2 WATT 2.7-33V 4/6
400m/w 3.0-33V 5/-

INTEGRATED CIRCUITS

R.C.A.
CA3005, 3013, 3014, 3018 30/-
CA3019, 3020 27/6 CA3011, 3036 20/-
CA3021 42/6 CA3023 32/6 CA3012 25/-
FAIRCHILD
L900, 914 11/- L923 14/-
DATA SHEETS FOR RCA DEVICES 2/- per type

Pots std., horiz. or vert. Potentiometers, LogLin

MFD	V	Price	MFD	V	Price	MFD	V	Price
1	15	1/6	25	10	1/6	125	4	1/6
1	40	1/9	25	25	1/6	200	16	2/-
2	15	1/6	25	50	1/6	250	25	2/9
2	350	2/0	32	15	1/6	250	50	3/9
4	15	1/9	32	450	1/6	320	10	1/6
4	40	4/9	40	16	1/6	400	16	2/9
4	350	2/3	50	12	1/6	500	6	2/6
5	15	1/6	50	15	1/6	500	25	3/9
6-4	6-4	1/9	50	25	1/6	640	16	3/6
6	15	1/6	60	20	2/-	1000	12	3/9
8	40	1/6	64	25	1/6	1000	16	4/6
8	450	3/-	80	6-4	1/6	1000	25	5/6
10	15	1/6	80	16	1/6	1000	50	9/-
10	25	1/6	100	12	1/6	2000	25	8/6
12-5	25	1/9	100	15	1/6	2000	50	12/6
15	18	1/6	100	25	1/6	2500	25	9/6
25	6-4	1/6	100	50	2/6	5000	25	12/6

RESISTORS

1/2 watt 10%, 4d.
1/2 watt 5%, 5d.
3/4 watt 5%, 6d.
1 watt 5%, 1/6
5 watt 2/-
1 watt Metal Oxide, 1/9

A. MARSHALL & SON
28 CRICKLEWOOD BROADWAY, LONDON, N.W.2
01-452 0161/2/3 CALLERS WELCOME

Yarn Clearer made by Bendix

The best buy in years. Photo transistor Control Clearer, 1000's of uses, complete, only requires 2-9 volt batteries to operate. Capable of intercepting slub or variation in diameter of thread whilst passing lens at 60ft per second. Circuit comprises of OCP71 photo transistor, discriminator, amplifier optical system, including servo controlled light source to provide accurate sensitivity constantly, temperature compensated.

Contains OCP71, OC71, 6-OC76, V15/10PD power transistor, relay pots, zener, diodes, etc. Complete with cinch 8-way plug and socket, lens system and light source all encased in diecast unit, at a very minimal fraction of cost.

£4 18s 6d

including post and packing, circuit and details. Only 150 left. C.W.O. please.

Tested, in new condition. Not junk but high-class professional equipment.

Return of post delivery guaranteed.

Southern Electronics Ltd.
7 South Terrace, Cork, Ireland

CITY AND COUNTY OF BRISTOL BRISTOL TECHNICAL COLLEGE CAREERS IN RADIO AND RADAR

Marine Radio Officers

2 year full-time course leading to the Second and First Class P.M.G. Certificates and the B.O.T. Radar Maintenance Certificate.

Conversion Course (Second Class to First Class).
R.T. Licences (Full or Restricted).

Licensed Aircraft Radio Engineers

2 year full-time course covering the Aircraft Radio Engineers Licences categories A & B, issued by the Board of Trade (Civil Aviation) followed by a 6-months' course for Radar Rating (A & B) in association with the above.

Courses for Qualified Marine Radio Officers

Single Side Band Techniques (2 weeks)
Marine Electronics Diploma Course (3 months)
Advanced Marine Electronics Diploma Course (3 months)

Training is given on the latest types of Marine and Aircraft equipment in approved Laboratories at
THE SCHOOL OF RADIO AND RADAR
Senior Lecturer-in-Charge: F. E. Bartrop

For further information, apply:

Registrar
Bristol Technical College
Ashley Down
BRISTOL 7

AMAZING MINI-DRILL

Indispensable for precision drilling, grinding, polishing, etching, gouging, shaping. Precision power for the enthusiast. Shockproof. Completely portable power from 4 1/2 volt external battery. So much more scope with MINI-DRILL. Super Kit (extra power, interchangeable chuck) 79/6 p.p. 2/6. De Luxe Professional Kit with 17 tools 130/- p.p. 4/6. Money Ref. Guarantee.

FOR PRECISION MODEL WORK

ABRASIVE
SPEAR DRILL
BURR
MOP
BRUSH

+ 6 TOOLS

ONLY 39/6
R.P.24

MERLIN SUPPLY CO.
Dept. PE8D, Nailsea, Bristol BS19 2LP

VALUE ALL THE WAY

INTEGRATED CIRCUITS

BI-PAK MONOLITHIC DIGITAL CIRCUITS (10 lead TO-5)

BP905A, 8-Input AND gate, 9/6 each.
 BP14A, 7-Input NOR gate, 9/6 each.
 BP315A, Dual 3-Input NOR gate, 9/6 each.
 BP316A, Dual 2-Input NOR gate (expandable), 9/6 each.
 BP20A, J-K-Binary element, 11/6 each.
 BP322A, Dual 3-Input OR gate, 9/6 each.

BI-PAK MONOLITHIC AMPLIFIERS (TO-5 8 lead)

BP709C, Operational amplifier, 15/- each.
 BP701C, Operational amplifier (with Zener output), 12/6 each.
 BP702C, Operational amplifier (with direct output), 12/6 each.
 BP601, Wide band amplifier, 18/- each.
 BP221, Logarithmic wide band amp., 14/- each.
 BP210C, General purpose amplifier (TO-5 8 lead), (voltage or current amp.), 12/6 each.
 I.C. Operational Amplifier with Zener output.
 Type 701C. Ideal for P.E. Projects. 8 Lead TO-5 case. Full data.

Our price **12/6** each 5 off/11- each. Large Qty. Prices quoted for.

OTHER MONOLITHIC DEVICES

BP424, Zero voltage switch, 8/6 each.
 This device is a monolithic I.C. that acts as combined threshold detector and trigger circuit for controlling a triac. It is designed to pulse the gate of a thyristor at the point of zero supply voltage, and therefore eliminate radio frequency noise used with interference loads.
 D13D1 Silicon Unilateral switch 10/- each.
 A Silicon Planar, monolithic integrated circuit having thyristor electrical characteristics, but with an anode gate and a built-in "Zener" diode between gate and cathode. Full data and application circuits available on request.
FAIRCHILD (U.S.A.) FULL MICROLOGIC INTEGRATED CIRCUITS
 Epoxy case T-8-5 lead temp. range 15°C. to 85°C. U.L900, Buffer, 10/6 each.
 U.L914, Dual two-input gate, 10/8 each.
 U.L923 J-K-flip-flop, 14/- each.
 Complete data and circuits for the Fairchild I.C.'s available in booklet form priced 1/6.

MULLARD I.C. AMPLIFIERS

TAA243, Operational amplifier, 70/- each.
 TAA265, Linear AF amplifier, 18/6 each.
 TAA293, General purpose amplifier, 21/- each.

CA3020 RCA (U.S.A.) LINEAR INTEGRATED CIRCUITS

Audio Power Amplifier, 30/- each.
 Owing to the mass of I.C. printed matter often required by customers in connection with the I.C.'s themselves we ask you to help us in the cost of reproducing this literature by adding 2s. towards same. This is only necessary when a number of different sheets are required.

Sil. trans. suitable for P.E. Organ. Metal TO-18 Evt. ZTX300 1/- each. Inv. Qty.

AD161 NPN

AD162 PNP

MATCHED COMPLEMENTARY PAIRS OF GERM. POWER TRANSISTORS.

For mains driven output stages of Amplifiers and Radio receivers.

OUR LOWEST PRICE OF 12/6 PER PAIR

HIGH POWER SILICON PLANAR TRANSISTORS TEXAS 28034 NPN TO-3.

VCB100 1c 4A FT. 15W/cs
 VCE100 Plot. 40W
 VEB8 hFE(min.)
 60 Price 15/- each

FREE

One 10/- Pack of your own choice free with orders valued £4 or over.

SEMICONDUCTOR HANDBOOK (VOLUME 2)

with introduction to basic circuits, registered transistor and diode types, full specifications. Eleven languages including English, Dutch, French, German, Swedish, Spanish and Italian. 240 pages of semiconductor information. Price 28/6. Money refunded if not fully satisfied.

NPN DIFFUSED SILICON PHOTO-DIODE TYPE IS701 (2N2175) for Tape Readout, high switching and measurement indicators, 50V, 250mW. OUR PRICE 10/- EACH, 50 OR OVER 8/6 EACH. FULL DETAILS.

SIL. G.P. DIODES

300mV 30 10/-
 25PIV (Min.) 100 25/-
 Sub-Min. 500 25
 Fully Tested 1,000 28
 Ideal for Organ Builders.

CADMIUM CELLS

ORP60 ORP61 8/- each ORP12 8/6

FULL RANGE OF ZENER DIODES VOLTAGE RANGE 2-16V.
 400mW (DO-7 Case) 2/6 each
 1-5W (Top-Hat) 3/6 each
 10W (SO-10 Stud) 5/- each
 All fully tested 5% tol. and marked state voltage required.

TRANSISTOR EQVT. BOOK 52 pages of cross references for trans. and diodes, types include British, European, American and Japanese. Specially imported by BI-PAK 10/- each

BRAND NEW TEXAS GERM. TRANSISTORS Coded and Guaranteed

Pak No.	EQVT.	Price
T1	8 2G3710 OC71	10/-
T2	8 2G374 OC75	10/-
T3	8 2G3744A OC81D	10/-
T4	8 2G381A OC81	10/-
T5	8 2G382T OC82	10/-
T6	8 2G344A OC44	10/-
T7	8 2G340A OC40	10/-
T8	8 2G378 OC78	10/-
T9	8 2G389A 2N1302	10/-
T10	8 2G47 AF117	10/-

KING OF THE PAKS SUPER PAKS

Unequaled Value and Quality NEW BI-PAK UNTESTED SEMICONDUCTORS

Satisfaction GUARANTEED in Every Pak, or money back.

- Pak No.
- U1 120 Giga Sub-min. General Purpose Germanium Diodes 10/-
 - U2 60 Mixed Germanium Transistors AF/RF 10/-
 - U3 75 Germanium Gold Bonded Diodes sim. OA5, OA47 10/-
 - U4 40 Germanium Transistors like OC81, AC128 10/-
 - U5 60 200mA Sub-min. Sil. Diodes 10/-
 - U6 40 Silicon Planar Transistors NPN sim. B8Y95A, 2N706 10/-
 - U7 16 Silicon Rectifiers Top-Hat 750mA up to 1,000V 10/-
 - U8 60 Sil. Planar Diodes 250mA OA/200/202 10/-
 - U9 20 Mixed Volta 1 watt Zener Diodes 10/-
 - U11 30 PNP Silicon Planar Transistors TO-5 sim. 2N1132 10/-
 - U12 12 Silicon Rectifiers EPOXY BY126/127 10/-
 - U13 30 PNP-NPN Sil. Transistors OC200 & 2S104 10/-
 - U14 150 Mixed Silicon and Germanium Diodes 10/-
 - U15 30 NPN Silicon Planar Transistors TO-5 sim. 2N697 10/-
 - U16 10 3-Amp Silicon Rectifiers Stud Type up to 1000 PIV 10/-
 - U17 30 Germanium PNP AF Transistors TO-5 like ACY 17-22 10/-
 - U18 8 6-Amp Silicon Rectifiers BYZ13 Type up to 600 PIV 10/-
 - U19 30 Silicon NPN Transistors like BC108 10/-
 - U20 12 1.5-amp Silicon Rectifiers Top-Hat up to 1,000 PIV 10/-
 - U21 30 A.F. Germanium alloy Transistors 2G300 Series & OC71 10/-
 - U22 10 1-amp Glass Min. Silicon Rectifiers High Volts 10/-
 - U23 30 Madt's like MAT Series PNP Transistors 10/-
 - U24 20 Germanium 1-amp Rectifiers GJM up to 300 PIV 10/-
 - U25 25 300Mc/s NPN Silicon Transistors 2N708, B8Y27 10/-
 - U26 30 Fast Switching Silicon Diodes like IN914 Micro-min 10/-
 - U28 Experimenters' Assortment of Integrated Circuits, untested. Gates, Flip-Flops, Registers, etc. 8 Assorted Pieces 20/-
 - U29 10 1 amp SCR's TO-5 can up to 600 PIV CRS1/25-600 20/-
 - U30 15 Plastic Silicon Planar trans. NPN 2N2994-2N2926 10/-
 - U31 20 Sil. Planar NPN trans. low noise AM 2N3707 10/-
 - U32 25 Zener diodes 400mW D07 case mixed Volts, 3-18 10/-
 - U33 15 Plastic case 1 amp Silicon rectifiers IN4000 series 10/-
 - U34 30 Sil. PNP alloy trans. TO-5 BCY26, 2S302/4 10/-
 - U35 25 Sil. Planar trans. PNP TO-18 2N2906 10/-
 - U36 25 Sil. Planar NPN trans. TO-5 BFY50/51/52 10/-
 - U37 30 Sil. alloy trans. SO-2 PNP, OC200 2S322 10/-
 - U38 20 Fast Switching Sil. trans. NPN, 400Mc/s 2N3011 10/-
 - U39 30 RF Germ. PNP trans. 2N1303/5 TO-5 10/-
 - U40 10 Dual trans. 6 lead TO-5 2N2060 10/-
 - U41 30 RF Germ. trans. TO-1 OC45 NKT72 10/-
 - U42 10 VHF Germ. PNP trans. TO 1 NKT667 AF117 10/-

Code Nos. mentioned above are given as a guide to the type of device in the Pak. The devices themselves are normally unmarked

QUALITY-TESTED PAKS

- 6 Matched Trans. OC44/46/81/81D 10/-
- 20 Red Spot AF Trans. PNP 10/-
- 16 White Spot RF Trans. PNP 10/-
- 6 Silicon Rects. 3 A 100-400 PIV 10/-
- 2 10 A Silicon Rects. 100 PIV 10/-
- 2 OC1 140 Trans. NPN Switching 10/-
- 1 12 A SCR 100 PIV 10/-
- 3 Sil. Trans. 2S303 PNP 10/-
- 4 Zener Diodes 240mW 2-15V 10/-
- 3 200 Mc/s Sil. Trans. NPN B8Y26/27 10/-
- 2 Zener Diodes 1W 83V 5% Tol. 10/-
- 4 High Current Trans. OC42 Evt. 10/-
- 2 Power Transistors 1 OC26 1 OC35 10/-
- 5 Silicon Rects. 400 PIV 250mA 10/-
- 4 OC75 Transistors 10/-
- 3 Power Trans. OC20 100V 10/-
- 10 OC202 Sil. Diodes Sub-min. 10/-
- 2 Low Noise Trans. NPN 2N2929/30 10/-
- 1 Sil. Trans. NPN VCB 100 ZT86 10/-
- 8 OA81 Diodes 10/-
- 4 OC72 Transistors 10/-
- 4 OC77 Transistors 10/-
- 4 Sil. Rects. 400 PIV 300mA 10/-
- 6 GET884 Trans. Evt. OC44 10/-
- 6 GET883 Trans. Evt. OC45 10/-
- 2 2N708 Sil. Trans. 300Mc/s NPN 10/-
- 3 GT31 LF Low Noise Germ. Trans. 10/-
- 6 IN914 Sil. Diodes 75 PIV 70mA 10/-
- 3 OA35 Germ. Diodes Sub-min. IN69 10/-
- 3 NPN Germ. Diodes NKT773 Evt. 10/-
- 2 OC22 Power Trans. Germ. 10/-
- 2 OC25 Power Trans. Germ. 10/-
- 4 AC128 Trans. PNP High Gain 10/-
- 4 AC127/128 Comp. pair PNP/NPN 10/-
- 3 2N1307 PNP Switching Trans. 10/-
- 7 OC62H Germ. Diodes Evt. OA71 10/-
- 3 AF115 Type Trans. 10/-
- 12 Assorted Germ. Diodes Marked 10/-
- 4 AC126 Germ. PNP Trans. 10/-
- 4 Silicon Rects. 100 PIV 750mA 10/-
- 3 AF117 Trans. 10/-
- 7 OC81 Type Trans. 10/-
- 3 OC717 Trans. 10/-
- 5 2N2926 Sil. Epoxy Trans. 10/-
- 7 OC71 Type Trans. 10/-
- 2 2S701 Sil. Trans. Texas 10/-
- 13 2 Volt Zener 400mW 10/-
- 2 10 A 600 PIV Sil. Rects. IS40B 10/-
- 3 BC108 Sil. NPN High Gain Trans. 10/-
- 1 2N910 NPN Sil. Trans. VCB 100 10/-
- 2 1000 PIV Sil. Rect. 1.5 A R5330 AF 10/-
- 3 B8Y95A Sil. Trans. NPN 200Mc/s 10/-
- 3 OC200 Sil. Trans. 10/-
- 2 GET850 Low Noise Germ. Trans. 10/-
- 1 AF199 PNP High Freq. Trans. 10/-
- 3 NPN Trans. 1 ST141 & 2ST140 10/-
- 4 Madt's 2 MAT101 & 2 MAT121 10/-
- 4 OC44 Germ. Trans. AF 10/-
- 3 AC127 NPN Germ. Trans. 10/-
- 1 2N3906 Sil. PNP Trans. Motorola 10/-
- 2 Sil. Power Rects. BYZ13 15/-
- 1 Sil. Power Trans. NPN 100Mc/s. TK201A 15/-
- 6 Zener Diodes 3-15V Sub-min. 15/-
- 1 2N1132 PNP Epitaxial Planar Sil. 15/-
- 3 2N697 Epitaxial Planar Trans. Sil. 15/-
- 4 Germ. Power Trans. Evt. OC16 15/-
- 1 Unijunction Trans. 2N2846 15/-
- 2 Sil. Trans. 200Mc/s 60Veb ZT83/84 15/-
- 1 Tunnel Diode A6Y11 1050 Mc/s 15/-
- 2 2N2719 Sil. Epoxy Planar HFE226 15/-
- 8 BY100 Type Sil. Rects. 20/-
- 2 Sil. and Germ. Trans. Mixed, all marked, New 30/-

FET'S

2N 3819 10/-
 2N 3820 25/-
 MFP105 8/-
 OCPT71 Type 8/6

UNIUNCTION

UT46, Evt. 2N2646, Evt. T1S43. BEN3000
7/6 EACH
 25-99 5/- 100 UP 4/-

TESTED SCR'S

PIV	1A	7A	16A	30A
25	5/6	7/6	8/6	10/6
50	7/6	8/6	10/6	12/6
100	8/6	10/6	12/6	15/6
200	12/6	15/6	20/6	25/6
300	15/6	20/6	25/6	30/6
400	17/6	25/6	35/6	40/6
600	20/6	25/6	45/6	55/6
800	25/6	30/6	45/6	55/6
1000	30/6	40/6	50/6	60/6

SIL. RECTS. TESTED

PIV	750mA	3A	10A	30A
50	1/2	2/3	4/6	8/6
100	1/3	3/3	4/6	15/6
200	1/9	4/6	4/6	20/6
300	2/3	4/6	6/6	22/6
400	2/6	5/6	7/6	25/6
500	3/6	6/6	8/6	30/6
600	3/6	6/6	8/6	37/6
800	3/6	7/6	11/6	40/6
1000	5/6	9/6	13/6	50/6
1200	6/6	11/6	15/6	50/6

BI-PAK



500 CHESHAM HOUSE
 150 REGENT STREET
 LONDON, W.1

KING OF THE PAKS BI-PAK GUARANTEE SATISFACTION OR MONEY BACK

Practical Electronics Classified Advertisements

MISCELLANEOUS

BUILD IT in a DEWBOX quality cabinet 2in x 2½in x any length. DEW LTD., Ringwood Road, Ferndown, Dorset. S.A.E. for leaflet. Write now—right now.

ETCHED PRINTED CIRCUIT BOARD KITS. Full instructions. 19/6, c.w.o. CIR-CUITETCH, 12 Cambridge Rd., St. Albans, Herts.

MUSICAL MIRACLES. Send S.A.E. for details of Rhythm Modules, Versatile Bass-pedal unit, self-contained with unique effects, kits for sea-waa pedals. Also new 50mA meters 25/- post paid. HURRY! D.E.W. LTD. 254 Ringwood Road, Ferndown, Dorset.

UFO DETECTOR CIRCUITS, data. 10s. (refundable). Paraphysical Laboratory (UFO Observatory), Downton, Wilts.

ELECTRONIC SOLITAIRE. Build this game from complete kit. Over 32,000 combinations. Hours of intrigue, relaxing, challenging! Full kit and instructions 55/-. Educates in binary logic. D.E.W. LTD., 254 Ringwood Road, Ferndown, Dorset.

ONE OFF PRINTED CIRCUIT BOARDS. Cheaply made to customers' requirements. Send s.a.e. for details: D. R. MANN, 12 Randolph St., Nottm.

ROCK BOTTOM PRICES for P.C. Boards from 1/-, FOX, Ridgeway, Farnsfield, Notts.

CLEARING LABORATORY, scopes, V.T.V.M.'s, V.O.M.'s, H.S. recorders, transcription turntables, electronic testmeters, calibration units, P.S.U.'s, pulse generators, D.C. null-potentiometers, bridges, spectrum analysers, voltage regulators, sig-gens, M/C relays, components, etc. Lower Beeding 236.

PROJECT BUILDERS note—Having trouble obtaining special components? We will endeavour to supply ALL parts for your project, specials, e.g., coils, p.c. boards, etc., as well as standard items. SRY ELECTRONICS, 11 Rosedene Ave., Croydon, CRO 3DN. 01-684 0402.

ROBOTS

Synthetic Animals with "BRAINS" of their own. The NEW range of projects include: an electronic 'animal' which "LEARNS", an Electro Chemical device capable of "REPRODUCING" itself! Other projects SURE TO INTRIGUE YOU are an audio transmitter/receiver which has quite an amazing range and requires NO LICENCE; also a machine which "recognizes" itself, and an electronic dog whistle, etc., etc. HOSTS OF EASY-TO-CONSTRUCT projects, for anyone with a basic knowledge of Electronics.

SEND 2/6 for your list—NOW!
To: 'BOFFIN PROJECTS'

incorporating
BIONIC DESIGNS, 4 CUNLIFFE RD.
STONELEIGH, EWELL, SURREY
Designed by GERRY BROWN and
JOHN SALMON and presented
on T.V.

Send 1/- for
STATE OF THE ARTISTS LIST OF
Comps and full data, applications on latest dc/uhf low noise NUFET 2N5245, 10/- ea. also Sprague 'UNICIRCUIT' ULN2111A, d.i.l. for FM/SSB det, 6db wdeband amp/lm, etc. £1.10.6 ea. C.W.O. 6d. p.p. per order to:
T. ADVISER
2 Crown Acre, Brockenhurst, Hants

RATES: 1/3 per word (minimum 12 words). Box No. 1/6 extra.

Advertisements must be prepaid and addressed to Advertisement Manager,

"Practical Electronics"
IPC MAGAZINES LTD.,
Fleetway House, Farringdon Street,
London, E.C.4

MISCELLANEOUS (continued)

PROFESSIONALLY MADE CONTROL PANELS from 4d. sq. in. 16/18 gauge aluminium, cut, drilled, spray painted and legend. Send full size drawing for quotation. C. S. CONDUIT, 7 Millbrook, Salisbury, Wilts.

FOR SALE

£6,000 IN VOUCHERS GIVEN AWAY. See free Cat. for details. Tools, Materials, Mechanical, Electrical, thousands of interesting items. WHISTON, Dept. PYE, New Mills, Stockport SK12 4HL.

MINIATURE DYNAMIC MICROPHONES. High impedance size ½in x ¼in x ¼in. Also work as mini speakers; suit transistor circuits, 7/6 each, 3 for 20/-. Tested, guaranteed. DREW, 77 The Crescent, Southwick, Sussex.

SURPLUS to requirements, various small electronic components. S.A.E. for list. Box No. 20.

MORSE MADE EASY !!

FACT NOT FICTION. If you start RIGHT you will be reading amateur and commercial Morse within a month (normal progress to be expected). Using scientifically prepared 3-speed records you automatically learn to recognise the code RHYTHM without translating. You can't help it, it's as easy as learning a tune. 18 W.P.M. in 4 weeks guaranteed.

For details and course C.O.D. ring S.T.D. 01-660 2896 or send 8d. stamp for explanatory booklet to:
G3HSC (Box 19), 45 GREEN LANE, FURLEY, SURREY

BOOKS AND PUBLICATIONS

SURPLUS HANDBOOKS

19 set Circuit and Notes	6/6 P.P. 6d
1155 set Circuit and Notes	6/6 P.P. 6d
H.R.O. Technical Instructions ..	5/6 P.P. 6d
38 set Technical Instructions ...	5/6 P.P. 6d
46 set Working Instructions ...	5/6 P.P. 6d
88 set Technical Instructions ...	7/- P.P. 6d
BC. 221 Circuit and Notes	5/6 P.P. 6d
Wavemeter Class D Tech. Instr	5/6 P.P. 6d
18 set Circuit and Notes	5/6 P.P. 6d
BC.1000 (31 set) Circuit & Notes	5/6 P.P. 6d
CR.100/B.28 Circuit and Notes 10/-	P.P. 9d
R.107 Circuit and Notes	7/- P.P. 6d
A.R.88D. Instruction Manual ...	18/- P.P. 6d
52 set Circuit and Notes	6/6 P.P. 6d
62 set Sender & Receiver Circuits 7/6.	post free
Circuit Diagrams: 5/- each post free.	
R.1116/A, R.1224/A, R.1355, R.F. 24, 25, & 26.	
A.1134, T.1154, CR.300, BC.342, BC.312.	
BC.348, J.E.M.P. BC.624, 22 set.	
Resistor Colour Code Indicator ...	2/6 P.P. 6d

S.A.E. with all enquiries please.
Postage rates apply to U.K. only.

Mail order only to:
Instructional Handbook Supplies
Dept. P.E., Talbot House, 28 Talbot Gardens
Leeds 8

BOOKS AND PUBLICATIONS

(continued)

GOVT. SURPLUS WIRELESS EQUIPMENT HANDBOOK

This useful Handbook gives detailed information and circuit diagrams for British and American Government Surplus Receivers, Transmitters and Test Equipment, etc.; also contained are some suggested modification details and improvements for the equipment. Incorporated in this revised edition is a surplus/commercial cross referenced valve and transistor guide. This book is invaluable to radio enthusiasts, radio clubs, universities and laboratories. The latest edition, Third Edition, at 45/- per volume, plus 5/- P. & P., C.O.D. a pleasure, is obtainable from us at

GILTEXT (LEEDS) LTD

Dept. P.E., 24 Stansfield Chambers
Gt. George Street, Leeds 1
S.A.E. with all enquiries, please. Extra postage for all foreign orders. Individual circuits and information on most surplus equipment now available.

SERVICE SHEETS

RADIO TELEVISION, over 8,000 Models. JOHN GILBERT TELEVISION, 1b Shepherds Bush Rd., London, W.6. SHE 8441.

SERVICE SHEETS, Radio, TV, 5,000 models. List 1/6. S.A.E. enquiries. TELRAY, 11 Maudland Bank, Preston.

LARGE SUPPLIER OF SERVICE SHEETS

T.V., RADIO, TRANSISTORS, TAPES, CAR RADIOS

Only 5/- each, plus LARGE S.A.E.

(Uncrossed P.O.'s please, returned if service sheets not available.)

FREE TV FAULT TRACING CHART OR TV LIST ON REQUEST

C. CARANNA

71 BEAUFORT PARK, LONDON, N.W.11

MAIL ORDER ONLY

SERVICE SHEETS (1925-69) for televisions, radios, transistors, tape recorders, record players, etc., by return post, with free fault-finding guide. Prices from 1/- . Over 8,000 models available. Please send S.A.E. with all orders/enquiries. HAMILTON RADIO, 54 London Road, Bexhill, Sussex.

EDUCATIONAL

ENGINEERS. A technical certificate or qualification will bring you security and much better pay. Elem. and adv. private postal courses for C.Eng. A.M.I.E.R.E., A.M.S.E. (Mech. & Elec.), City & Guilds, A.M.I.M.T., A.I.O.B. and G.C.E. exams. Diploma courses in all branches of Engineering—Mech., Elec., Auto., Electronics, Radio, Computers, Draughts., Building, etc. For full details write for FREE 132-page guide. BRITISH INSTITUTE OF ENGINEERING TECHNOLOGY (Dept. 125K), Aldermaston Court, Aldermaston, Berks.

GET INTO ELECTRONICS—big opportunities for trained men. Learn the practical way with low-cost Postal Training, complete with equipment. A.M.I.E.R.E., R.T.E.B., City & Guilds, Radio, T/V, Telecoms., etc. For FREE 100-page book, write Dept. 856K, CHAMBERS COLLEGE, 148 Holborn, London, E.C.1.

RADIO OFFICERS see the world. Sea going and shore appointments. Trainee vacancies in Sept. and Jan. Grants available. Day and Boarding students. Stamp for prospectus. WIRELESS COLLEGE, Colwyn Bay, Wales.

TECHNICAL TRAINING in Radio, TV & Electronics thro' world-famous ICS. For details of proven home-study courses write: ICS, Dept. 561, Intertext House, Stewarts Road, London, S.W.8.

CITY & GUILDS AND R.T.E.B. EXAMS. Specialised ICS home-study course will ensure success. For details of wide range of exam. and diploma courses in Radio, T.V. and Electronics, also new practical courses with kits, write to ICS (Dept. 577), Intertext House, Stewarts Road, London, S.W.8.

SITUATIONS VACANT

A.M.I.E.R.E., A.M.S.E. (Elec.), City & Guilds, G.C.E., etc., on "Satisfaction or Refund of Fee" terms. Wide range of Home Study Courses in Electronics, Computers, Radio, T.V., etc. 132-page Guide—FREE. Please state subject of interest. BRITISH INSTITUTE OF ENGINEERING TECHNOLOGY (Dept. 124K), Aldermaston Court, Aldermaston, Berks.

SERVICE ENGINEERS—we are an old established electronics company, but headed by a young management team, and we need you to help us. Age is no barrier to a high salary as you will find out when you join us. If you have experience in T.V., Radio or Hi-Fi Service and want a job that looks ahead, phone MICHAEL ADLER at 01-636 9600.

GLASGOW ENTHUSIAST WANTED, willing to assist with simple but interesting wiring, two or three evenings per week—financially rewarding. Tel. 041-942 3233.

RADIO TECHNICIANS VACANCIES TO BE FILLED BY OCTOBER 1969

A number of suitably qualified candidates are required for unestablished posts, leading to permanent and pensionable employment (in Cheltenham and other parts of the UK, including London). There are also opportunities for service abroad.

Applicants must be 19 or over and be familiar with the use of Test Gear, and have had practical Radio/Electronic workshop experience. Preference will be given to such candidates who can also offer "O" Level GCE passes in English Language, Maths and/or Physics, or hold the City and Guilds Telecommunications Technician Intermediate Certificate or equivalent technical qualifications. A knowledge of electro-mechanical equipment will be an advantage.

Pay according to age, e.g. at 19 — £869 at 25 — £1,130 (highest age pay on entry) rising by four annual increments to £1,304.

Prospects of promotion to grades in salary range £1,217-£2,038. There are a few posts carrying higher salaries.

Annual Leave allowance of 3 weeks 3 days rising to 4 weeks 2 days. Normal Civil Service sick leave regulations apply.

Application forms available from: Recruitment Officer (RT/54) Government Communications Headquarters Oakley, Priors Road Cheltenham, Glos. GL52 5AJ

SILICON PLANAR TRANSISTORS. 100% tested and full spec. supplied with orders. NPN types for organ projects, 25 for £1. PNP types sim. to 2N3702 and germanium sim. to ACY22, 50 for £1. Post free. WESTEK, P.O. Box 7, Rickmansworth, Herts.

R & R RADIO

51 Burnley Road, Rawtenstall
Rossendale, Lancs

Tel.: Rossendale 3152

VALVES BOXED, TESTED & GUARANTEED

BF80	3/-	PCC84	3/-	PY81	3/6
EBF89	3/6	PCF80	3/-	PY82	3/-
ECC82	3/-	PCF82	3/6	UI91	4/6
ECL80	3/-	PCL82	4/-	6F23	5/-
EF80	1/6	PCL83	4/-	30F5	2/6
EF85	3/-	PL36	5/-	30L15	5/-
EY86	4/-	PL81	4/-	30P12	4/6
EZ40	4/6	PL83	4/-	30C15	5/-
EBC41	4/6	PY33	5/-	50CD6G	7/6

Transistor Audio Pack, 2G339A, 2G381A, 2G371B
10/- each post 6d.

POST, ONE VALVE 9d. TWO TO SIX 6d.
OVER SIX POST PAID.

TRANSISTORISED REVERBERATION

Six transistor circuit, all components £7.10.0, post free. (Case 34/- extra, P. & P. 2/6). Circuit and construction details 1/- (free with kit).

TRANSISTORISED SIGNAL INJECTOR 19/6 P. & P. 1/6. Catalogue of components etc. 1/- Wilsic Electronics Ltd, 6 Copley Road, Doncaster, Yorks.

(continued)

TERRIFIC TRANSISTORS !

High-gain low-noise npn planars
20V, 220mV, 200mA peak Ic, hfe up to 900.
BC168 = BC148 (sim. BC108, BC170, BC183,
2N2925, 2N2926), hfe = 250-900
BC169 = BC149 (sim. BC109, BC151, BC154,
2N3391A, etc.), hfe = 450-900
Prices: BC168, 5 for 10/-, 50 for 90/-.
BC169, 5 for 11/3, 50 for £5.

Brand new, mint, makers' trade marks. Full list with data, components, circuits, kits 6d. FREE WITH ORDERS.

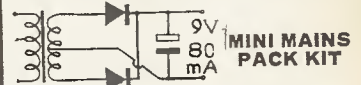

Can be built to size of PP6 battery. Components and data sheet, 17/6. Transformer only, 0-230-250/9-0-9V, 80mA, size 1 1/2 x 1 1/2", with data sheet, 11/-. Eagle transformers (same size) MT6, 6-0-6V, 100mA, MT12, 12-0-12V, 50mA, 13/6 each. All these can be used with bridge rectifiers giving double the voltage at half the current. Submin. selenium bridge to suit, 3/6.

AMATRONIX LTD. (Mail order only)
396 Selsdon Rd., South Croydon, Surrey
CR2 0DE

INTEGRATED CIRCUITS at lowest price. GE Type PA234 1 Watt Audio Amplifier. Few only at 17/6 each inc. data P. & P. C.W.O. JEF ELECTRONICS, 12 York Drive, Grappenhall, Warrington, Lancs. Mail order only.

SITUATIONS VACANT

TECHNICAL TRAINING by ICS IN RADIO, TELEVISION AND ELECTRONIC ENGINEERING

First-class opportunities in Radio and Electronics await the ICS trained man. Let ICS train YOU for a well-paid post in this expanding field.

ICS courses offer the keen, ambitious man the opportunity to acquire, quickly and easily, the specialized training so essential to success. Diploma courses in Radio/TV Engineering and Servicing, Electronics, Computers, etc. Expert coaching for:

- * C. & G. TELECOMMUNICATION TECHNICIANS' CERTS.
- * C. & G. ELECTRONIC SERVICING.
- * R.T.E.B. RADIO AND TV SERVICING CERTIFICATE.
- * RADIO AMATEURS' EXAMINATION.
- * P.M.G. CERTIFICATES IN RADIOTELEGRAPHY.

Examination Students Coached until Successful.

NEW SELF-BUILD RADIO AND ELECTRONIC COURSES

Build your own 5-valve receiver, transistor portable, signal generator, multi-meter and valve volt meter—all under expert guidance.

POST THIS COUPON TODAY and find out how ICS can help YOU in your career. Full details of ICS courses in Radio, Television and Electronics will be sent to you by return mail.

MEMBER OF THE ASSOCIATION OF BRITISH CORRESPONDENCE COLLEGES

INTERNATIONAL CORRESPONDENCE SCHOOLS

A WHOLE WORLD OF KNOWLEDGE AWAITS YOU !

International Correspondence Schools
(Dept. 152), Intertext House, Stewart Road,
London, S.W.8.

NAME

Block Capitals Please

ADDRESS

7/69

RECEIVERS AND COMPONENTS

(continued)

COMPONENTS

Samples from our catalogue:— Gearing motors 300rpm-1r/24H from 7/6, 15v. 300mw. Zeners 3/-, 10K + 10K 2's, 3' ganged pots 20/-, 220 ohm 200 watt resistors 7/6, 6d. stamp for catalogue.

F. HOLFORD & CO.

6 Imperial Square, Cheltenham

BRAND NEW ELECTROLYTICS, 15 volt, 0.5, 1, 2, 5, 6, 8, 10, 15, 20, 30, 40, 50, 100, 200 mfd's., 7/6 dozen, postage 1/-.. THE C.R. SUPPLY CO., 127 Chesterfield Rd., Sheffield, S8 0RN.

TAPE HEADS

BSR BRAD. 39/6 pair
2 TRACK
MICHIGAN REC./PLAY MED. IMP. 45/-
4-TRACK
BSR MARR 39/6 pair
4 TRACK
BOGEN ERASE UL1218/6 27/6
4-TRACK
REUTER — COLLARO ERASE 15/-
4-TRACK
COSMOCORD ERASE T.E. 2/9 15/-
4-TRACK

TRANSISTORISED FM TUNER
6 TRANSISTOR HIGH QUALITY TUNER. SIZE ONLY 6in x 4in x 2in 3 I.F. stages. Double tuned discriminator. Ample output to feed most amplifiers. Operates on 9V battery. Coverage 88-108Mc/s. Ready built ready for £6.70 use. Fantastic value for money

SUB-MIN. TRANSISTOR LW/MW/FM TUNER
Similar to above. Complete with aerial, meters, dial and instructions £14

TUNER DULCI FMTS STEREO £23

COMPACT TRANSISTOR FM TUNER
Oiled Walnut cabinet, brushed gold front panel, vertical styling, internal batteries £9.19.6

FM MULTIPLEX STEREO ADAPTOR
Printed circuit board, 4 trans. 6 diodes 9V with full instructions £4.19.6

LOUDSPEAKERS

12" TWIN CONE 10 watt PEAK 15 or 35/-
3 ohm
12" 25 watt, 15 ohm, GUITAR SPEAKER 45.7.0
26-13K
10" 10 watt, 15 ohm, CERAMIC — 49/6
MAGNET — 2" 40 ohm 6/6
24" 80 ohm

CABINET Teak 231 x 13 1/2 x 9 1/2, contemp. 12" legs for Tape Recorder and Tuner 4 pole changeover, ideal for models. 11 x 11 x 4 1/2, 700 ohm 9-24v, 185 ohm 6-12v. 99/6

RELAYS 3" 16 ohm, 10W CR/0.3k Ω, 18,000 c/s 25/-
Horn type Hi-Fi
CROSSOVER NETWORK 3k/s, 16 or 3 ohm 14/-

MULTIMETERS CHARGER TRANSFORMER. 4 Amp. 2/6/12 volt 21/6
from 32/- 3/ P/P

SUPER SILICON RECT. T.V., etc., 1,200 PIV 800mA, 5/-; or complete with instr. resistor, condenser, 6/8; 400 PIV HW 6A, 6/-; 200 PIV HW 6A, 6/-.. B1100 type, 6 for 10/-.

Jumper lead 6': Croc clips to Phono plug and Strl. Jack Adaptor 7/6

TRANSISTORS
AD140 8/6 BC108 3/6 NKT226 5/6 OC200 5/6 AP186 11/6 NKT213 5/6 OC45 3/- OA31 1/6 GET103-113-116-118-119-887-889-890-896-7-8 3/-

CHANGER DECKS
UA25 BSR with template, Mono. List £8.19.6
UA25 BSR with template, Stereo. List £7.9.6
1025 Garrard with template, Mono. List £7.7.6
1025 Garrard with template, Stereo. List £7.17.6

PLINTH in simulated teak. Complete with Clearview rigid perspex cover for 1025. P/P on Decks, Plinth and Cover 7/6

SWITCH ROTARY RECIPROCATING 4 Position, 15amp. Single hole fixing, with instructions. List 14/7 5/6

C60 CASSETTE 10/3. C90 14/3. 3 Post free
Stamped envelope for full selection and bargain offers in MULTIMETERS, RADIOS, BABY ALARMS, INTERCOMS, WALKIE-TALKIES, RECTIFIERS, SINCLAIR, DULCI, AND EAGLE Lists. UNDER 21—P. & P. 6d., £1 to £3—1/6. over £3—2/6. C.O.D. 3/6. MAIL ORDER ONLY.

DURHAM SUPPLIES
367 KENSINGTON STREET
BRADFORD 8, YORKSHIRE

RECEIVERS AND COMPONENTS

(continued)

WE ARE BREAKING COMPUTERS

EX COMPUTER PRINTED CIRCUIT PANELS 2in x 4in packed with semi-conductors and top quality resistors, capacitors, diodes, etc. Our price, 10 boards 10/-.. P. & P. 2/-. With a guaranteed minimum of 35 transistors.

SPECIAL BARGAIN PACK. 25 boards for £1. P. & P. 3/6. With a guaranteed minimum of 85 transistors. 100 boards 65/-.. P. & P. 6/6. With a guaranteed minimum of 350 transistors.

GIANT PANELS. 5 1/2in x 4in, min. 20 transistors, 9 x 56 Micro H inductors, resistors, diodes, etc. 3 for £1. P. & P. 2/-.
PANELS with 2 power transistors sim. to OC28 on each board + components. 2 boards (4 x OC28) 10/-.. P. & P. 2/-.
TRIM POTS on 2in x 4in boards + Ta caps and other components. 100Q, 500Q, 15K, 20K. State requirements. 5 boards 10/-.. P. & P. 2/-.
NPN GERMANIUM TOS 1 WATT POWER TRANSISTORS on small heat sink, on 2in x 4in panel. 5 for 10/-.. P. & P. 2/-.
POWER TRANSISTORS sim. to 2N174 ex ept. on Finned Heat Sink (10D). 4 for £1. P. & P. 5/-.
ORGAN BUILDERS' SPECIAL 300 TOS TRANSISTORS + 200 SI DIODE GATES on panels. £4. P. & P. 6/-.
OVERLOAD CUT OUTS. Panel mounting in the following values... 5/- each. 2, 3, 4, 10 amp. P. & P. 1/-.
Ex-Computer "MEMORY" FERRITE CORESTORES. 4,000 bits per plane. 25/- + 3/- P. & P.
PAPST FANS. Powerful Extractor/Blower fans. 230/250V. 100 c.f.m., 2,800 r.p.m. 35/- + 5/6 P. & P. each.
MICRO SWITCHES. Miniature button type. 10/- doz. P. & P. 1/6.
NEW RECORDING TAPE. 900ft on 5in reels, low noise 1/2in tape. £1 per reel, post free.
NEW SPRAGUE. 0.22µF 250V small capacitors. 5/- doz. P. & P. 1/-.
NEW SPRAGUE ELECTROLYTICS. 4µF 150V. 5/- doz. P. & P. 1/-.
LARGE CAPACITY ELECTROLYTICS 4 1/2in, 2in diam. Screw terminals. All at 6/- each + 1/6 each P. & P.
4,000µF 72V d.c. wkg.
10,000µF 25V d.c. wkg.
25,000µF 12V d.c. wkg.
KEYTRONICS, 52 Earls Court Road London, W.8. Mail order only
COLD CATHODE TUBES
XN-5 NUMERAL INDICATORS. New, with data 7/6 each. DEKATRON counter tubes, new, 10-way 15/-, 12-way 20/-. Silicon power diodes for HT supplies—10/- per dozen. RESISTORS—Grade 1 Histab 20k to 2.4 Meg—2/8 per dozen. CAPACITORS—Metal cased tubular 0.01µF/500V 3/6 dozen; ceramic 0.01µF/1-5KV 5/- dozen; 680pF polystyrene 2/9 dozen. These are only a few from our bargain list of components. Send S.A.E. for FREE LIST. Quantity prices on request. Please include P. & P., minimum 3/6. No C.O.D.
I. S. PARTRIDGE — G3PRR
122a Eskdale Avenue, Chesham, Bucks.
Whether Buying or Selling a Classified Advertisement in PRACTICAL ELECTRONICS, could be the answer to your Problem.
For details write to:—
Classified Advertisement Dept., PRACTICAL ELECTRONICS, Fleetway House, Farringdon Street, London, E.C.4

RECEIVERS AND COMPONENTS

(continued)

TRANSISTOR PANELS

INTEGRATED CCT'S TAKEN FROM PANELS

A—Quad 2 1/2 P Gate 5/- With Circuit
B—Dual 4 1/2 P Gate 5/- and Pin
C—Dual 2 Level Gate 5/- Connections
D—Dual "D" Flip Flop 5/-
E—Single 1/2 P Gate 5/- Post Paid

EX GOVMT. RECEIVER R.209 covering 1—20 mc/s 12V D.C. Input £15 Post Paid (Tested)

50 VARIOUS TRANSISTORS on Panels 15/- Post Paid.
20—OC45 £1
20—OC76 £1
40—TK28c £1

COMPUTER PANELS with 40 sil. pnp or npn transistors, Diodes and res., 22/6 Post Paid.

COMPUTER PANELS WITH SEMI-CONDUCTORS. Postage 6d per panel
OC42 or GET875 + 2—OA81 7/6
24—A1678 (V405A) 550 mc/s PNP + 24 Diodes 15/-
4—OC170 + 2—OC139 + 2—OC42 7/6
9—AS220 + 1—T2040 + 27 Diodes 7/6
4—OC42 + 6—GET875 + Diodes 7/6
2—OC170 + 1—2G306 + OC42 4/-
5—OC23 + 15—OA338 25/-
6—2N388 + 2—2G403 + 2—T2040 4/-
4—OC36 + 8—GET103 + 4—ZS31A 25/-
8—AS220 + 80 Diodes 7/6
6—AS221 + 15—OA91 6/-
9—SB240 + 18—OA47 10/-
12—2G106 + 24 Diodes 9/6
8—OC72 + 8—OA10 5/-
6—OC44 5/-
6—2N388 7/6
8—OC76 + 8—OA10 7/6
12—2N388 10/-
12—A1678 (V405A) 550 mc/s PNP + 22 Diodes 10/-
36—OA5 6/-
6—GET872 + 8—OA10 5/-
OC42 3/-
12—AS220 + 80 Diodes 9/6
4—GET872 + 8—OA10 3 for 12/-
4—2G106 + 1—2N2410 4/-
2—OC42 + 8—OA47 3/-
2—GET872 + 4—OA10 + RF Chokes 3 for 10/-
24—Sil. h.f. Transistors 15/-
3—GET872 + 3—GE3541, ETC 22/6
3—OC23 + 6—OA10 + 2—OA5 16/-

TEST CARDS. 6 transistors 20 for 20/-
ELECTROLYTICS 25,000 @ 12V, 16,000 @ 12V, 15,000 @ 10V, 10,000 @ 30V, 4,000 @ 60V, 3,000 @ 80V, 2,000 @ 50V, 1,200 @ 180V, 8/6 Post Paid.

ZENER DIODES—2.4, 2.7, 3.6, 4.75, 5.25, 5.75, 6.2, 6.8, 7.5, 13, 15, 16, 18, 20, 27, 30, 33 volts, 3/6 each, mostly 1 watt.

POLYSTYRENE CAPACITORS. 125V, 18; 22, 120, 220, 270, 330, 390, 560, 820, 1,000, 1,200, 1,800, 2,200, 2,700, 3,300, 3,900, 4,700, 5,600, 6,800, 8,200, 0.01, 0.012, 0.015, 2/6 doz. Post/Packing 1/6.

BRAND NEW BOXED CHASSIS containing 2—OC35, 2—OC29 12 WW resistors 25/-.. Postage 1/6

NEW CROSS RADIO
6 OLDHAM ROAD, MANCHESTER 4

TAPE RECORDERS

TAPE TO DISC—using finest professional equipment—45 r.p.m. 22/-. S.A.E. leaflet, DELROY, High Bank, Hawk Street, Carnforth, Lancs.

ELECTRICAL



240 VOLT ELECTRICITY ANYWHERE
BEST EVER 200/240 VOLT "MAINS" SUPPLY FROM 12 VOLT CAR BATTERY
Exclusive World Scoop Purchase. The fabulous Mk.2D American Heavy Duty Dynamotor Unit with a Massive 220 watt output and giving the most Brilliant 200/240 volt performance of all time. Marvellous for Television, Drills, Power Tools, Mains Lighting, AC Fluorescent Lighting and all 200/240 volt Universal AC/DC mains equipment. Made at tremendous cost for U.S.A. Govt. by Delco-Remy. This magnificent machine is unobtainable elsewhere. Brand New and Fully Tested. Only £4.19.6 + 10/6 postage. C.O.D. with pleasure, refund guarantee. Please send S.A.E. for illustrated details.
Dept. PE, STANFORD ELECTRONICS
Rear Derby Road, North Promenade
BLACKPOOL, Lancashire

AIRCRAFT- PLUS GENERAL TELECOMMUNICATIONS V.H.F. BAND REC.

Listen to the thrills of Aircraft, Pilots, and Airports at work. Also Civil Depts., Fire and Ambulance services. Gas and Electricity Depts. Ideal for receiving 2 metre amateurs. Gives super reception within the range of all transmissions. A fully transistorised receiver covering 97-150mc/s VHF broadcast. Robust attractive finished metal cabinet size approx. 9" x 6" x 3". Operates from 9V internal batteries. Speaker output. Simple to use. Available from us at the pre-devaluation price of £8.19.6, carriage and insurance 10/6. CWO or COD.

STANDARD DESK TELEPHONE

Another scoop purchase enables us to offer a limited quantity only of these standard desk telephones at a fraction of their original cost. Complete with dial, magnets, cradle, line, connection block, receiver etc. Not new but workable. Suitable for all applications. Only 19/6 each. P. & P. 5/-. Two for 39/8 post free. Four for 65/- post free.



SURPLUS PORTABLE TRANS/REC'S TYPE BC117A

A Compact handy Trans/Rec. Consists of a fully transistorised self-contained transmitter and receiver, microphone, aerial, etc. Operates from standard dry batteries. As used by Armed forces on manoeuvres. Regulations state must not be operated in U.K. So when ordering please mention "For Dismantling Purposes only." Price £3.19.6 each, P. & P. 10/6. Two sets for £8 post free. Four sets £14 post free. Bulk sale of 8 sets for £25 post free. Export enquiries invited.

TELEPHONE SPARES

DIALS not new but working. Only 6/- each, P. & P. 1/6. Four for £1 post free. Telephone bells not new but working, 5/- each, P. & P. 2/-. Four for £1 post free. Complete telephones less handset only 7/6 each, P. & P. 3/6.

TELEPHONE EXCHANGES

FMBX type. Ex-GPO in good condition. Complete and ready to use. Cordless type. Only £15.10.0. Carr. 75/-, Cord type £12.10.0. Carr. 75/-.

Radiation meters. Price now 15/- each. P. & P. 5/-. Two for 30/- post free.

G.P.O. Telephone handsets. Brand new. Now 15/- each. P. & P. 5/-.

PRECISION PANEL METERS

Brand new, boxed and fully guaranteed. With fixing nuts and bolts. Size approx. 3 1/2 in. square. 0-500 volts FSD. As used by leading laboratories. Ex-stock, only 25/-, P. & P. 5/-. Two for 50/-, post free. 150 ma. meters, same dimensions as above. Only 27/6. P. & P. 5/-.

HEAVY DUTY POWER SUPPLY UNITS

Bulk Purchase. Famous manufacturer. Must have cost nearly £40 each. Input 200/250 volts 50c/s a.c. Output 250 volts d.c. at approx. 175 m.a. 6-1/2 1/2 volts at approx. 4 amps a.c. Robust metal rack mounting cabinet, size approx. 19 x 16 x 8 in. Price only 65/-, carriage and insurance 15/-, All units are fully fused and metered.

SMOOTHING UNITS

"CURE YOUR HUM PROBLEMS"

Beautifully made pieces of equipment. 12 volts or 24 volts d.c. input gives a fully smoothed fully regulated d.c. output. Worth £30 each. Robust metal cabinet with provision for standby battery. Brand new in maker's cartons. Price 55/-, P. & P. 15/-

GLOBE SCIENTIFIC LTD
DEPT. F.E.33, BRIDGEND, LEEDS 1

ORGAN BUILDERS!

Use our bistable dividers for your tone sources and cut your costs by more than half.

A small printed board with four complete transistor dividers will cost you only 18/6 including postage so why pay more?

Removed from working equipment, each circuit is meticulously inspected and tested before dispatch.

Just send a S.A.E. for free details to:

Roger Allen
13 Millways
Great Totham, Essex

DIMMASWITCH



This is an attractive dimmer unit which fits in place of the normal wall light switch. The mounting plate is ivory to match modern fittings and the control knob is in bright chrome. An ON/OFF switch is incorporated to control up to 500 watts at mains voltages from 200-250 volts, 50 Hz.

These are normally sold at £4 19s. 6d.—our price is £3 5s. We also offer at £2 15s. a complete kit of parts with simple instructions enabling you to build this dimmer yourself.

The circuit uses the latest miniature RCA triac and new diac triggering device to give complete reliability. Radio interference suppression is included.

DEXTER & COMPANY

14 Endsleigh Gardens, Chester CH2 1LT
Chester 26432

BATTERY ELIMINATORS

The ideal way of running your TRANSISTOR RADIO, RECORD PLAYER, TAPE RECORDER, AMPLIFIER, etc. Types available: 9v; 7 1/2v; 6v; 4 1/2v (single output) 39/6 each. P. & P. 2/9. 9v + 9v; 6v + 6v; or 4 1/2v + 4 1/2v (two separate outputs) 42/6 each. P. & P. 2/9. Please state output required. All the above units are completely isolated from mains by double wound transformer ensuring 100% safety.

R.C.S. PRODUCTS (RADIO) LTD.
(Dept. P.E.), 31 Oliver Road, London. E17

FASTER — NEATER than nuts and bolts PROFESSIONAL RIVETING

EVEN WHEN ONLY ONE SIDE IS ACCESSIBLE!
Ideal for constructors, car and sheet metal applications. British made. Complete with rivets and instructions. Rivets obtainable at Halfords, etc. Plastic wallet for storage.

PITTVILLE PRODUCTS, 41 CANTERBURY WALK,
CHELTENHAM, GL51 5HN



Send only 22/6
+ 2/6 p/p.

RELAX WITH PRACTICAL MOTORIST



- * Holiday motoring tips
 - * Smooth control advice
 - * Trim improvement know-how
- But if you want to work you'll discover . . .
- * How to de-coke a B-series
 - * Ways of coping with the cooling
 - * The best methods of tappet adjustment
- Plus your favourite regular features all in

PRACTICAL MOTORIST

August issue on sale
Tuesday July 15—2/6

There is scope,
variety and
responsibility as a

RADIO TECHNICIAN

in Air Traffic Control

Join the National Air Traffic Control Service, a Department of the Board of Trade, as a Radio Technician and you have the prospect of a steadily developing career in a demanding and ever-expanding field.

Entrance qualifications: you should be 19 or over, with practical experience in at least one of the main branches of telecommunications.

Once appointed and given familiarisation training, you will be doing varied and vital work on some of the world's most advanced equipment, including computers, radar and data extraction, automatic landing systems and closed-circuit television. Work is based on Civil Airports such as Heathrow, Gatwick and Stansted, Air Traffic Control Centres, Radar Stations and other specialist establishments.

Starting salary is £869 (at 19) to £1,130 (at 25 or over): scale maximum £1,304 (higher rates at Heathrow), and some posts attract shift-duty payments. Your career prospects are excellent and every opportunity and assistance is given to study for higher qualifications. The annual leave allowance is good and there is a non-contributory pension scheme for established staff.

Send this coupon for full details and application form:
To: Mr. A. J. Edwards, C.Eng., M.I.E.E., M.I.E.R.E.
Room 705, The Adelphi, John Adam Street,
London, WC2 marking your envelope 'Recruitment.'

Name.....

Address.....

..... PE/A1

Not applicable to residents outside the United Kingdom

NATCS National Air Traffic Control Service

PRINTED CIRCUIT KIT

BUILD 40 INTERESTING PROJECTS on a PRINTED CIRCUIT CHASSIS with PARTS and TRANSISTORS from your SPARES BOX

CONTENTS: (1) 3 Copper Laminate Boards 4 1/2" x 2 1/2", (2) 1 Board for Matchbox Radio, (3) 1 Board for Wristwatch Radio, etc. (4) Resist. (5) Resist Solvent. (6) Etchant. (7) Cleanser/Degreaser. (8) 16-page Booklet *Printed Circuits for Amateurs*, (9) 2 Miniature Radio Dials SW/MW/LW. Also free with each kit. (10) Essential Design Data, Circuits, Chassis Plans, etc. for 40 TRANSISTORISED PROJECTS. A very comprehensive selection of circuits to suit everyone's requirements and constructional ability. Many recently developed very efficient designs published for the first time, including 10 new circuits.

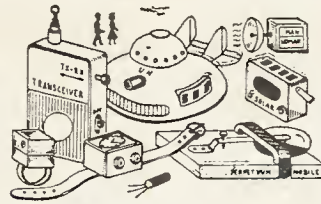

EXPERIMENTER'S
PRINTED CIRCUIT KIT
8/6

Postage & Pack. 1/6 (UK)
Commonwealth:
SURFACE MAIL 2/-
AIR MAIL 8/-
Australia, New Zealand
South Africa, Canada.

- (1) Crystal Set with biased Detector. (2) Crystal Set with voltage-quadrupler detector. (3) Crystal Set with Dynamic Loudspeaker. (4) Crystal Tuner with Audio Amplifier. (5) Carrier Power Conversion Receiver. (6) Split-Load Neutralised Double Reflex. (7) Matchbox or PhotoCell Radio. (8) "TRI-FLEXION" Triple Reflex with self-adjusting regeneration (Patent Pending). (9) Solar Battery Loudspeaker Radio. The smallest 3 designs yet offered to the Home Constructor anywhere in the World. (10) 3 Subminiature Radio Receivers based on the "Triflexion" circuit. Let us know if you know of a smaller design published anywhere. (11) Postage Stamp Radio. Size only 1-62" x .95" x .25". (12) Ring Radio 7" x .70" x .55". (13) Bacteria-powered Radio. Runs on sugar or bread. (14) Radio Control Tone Receiver. (15) Transistor P/P Amplifier. (16) Intercom. (17) 1-valve Amplifier. (18) Reliable Burglar Alarm. (19) Light-Seeking Animal, Guided Missile. (20) Perpetual Motion Machine. (21) Metal Detector. (22) Transistor Tester. (23) Human Body Radiation Detector. (24) Man/Woman Discriminator. (25) Signal Injector. (26) Pocket Transceiver (Licence required). (27) Constant Volume Intercom. (28) Remote Control of Models by Induction. (29) Inductive-Loop Transmitter. (30) Pocket Triple Reflex Radio. (31) Wristwatch Transmitter/Wireless Microphone. (32) Wire-less Door Bell. (33) Ultrasonic Switch/Alarm. (34) Stereo Preamplifier. (35) Quality Stereo Push-Pull Amplifier. (36) Light-Beam Telephone "Photophone". (37) Light-Beam Transmitter. (38) Silent TV Sound Adaptor. (39) Ultrasonic Transmitter. (40) Thyristor Drill Speed Controller.

YORK ELECTRICS

333 YORK ROAD, LONDON, S.W.11

Send a S.A.E. for full details, a brief description and Photographs of all Kits and all 52 Radio, Electronic and Photoelectric Projects Assembled.

12in. "SUPERB" £15

The exceptional quality and performance of the "Superb" brings truly exceptional sound from a single loudspeaker, recreating the musical spectrum virtually flat ± 5 db. 20 to 17,000 c.p.s. The unit consists of the latest double cone, woofer and tweeter cone together with a massive Baker "FERROBA" magnet assembly having a flux density of 16,500 gauss and a total flux of 176,000 Maxwells. Bass resonance 22-26 c.p.s. Rated 20 watts. Voice coils available 8 or 15 ohms. Suitable for all High Fidelity Systems. A high quality loudspeaker providing clear reproduction of the deepest bass and highest treble.

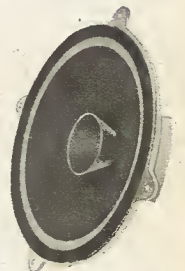

Further details and 48 page Enclosure Manual 5/9 post paid.

Baker Reproducers Ltd

Bensham Manor Road Passage, Thornton Heath, Surrey. 01-684-1665

RESISTORS

Mixed parcel, 200 fixed. 20/-. P. & P. 2/6.
Mixed parcel, 30 variable. 20/-. P. & P. 2/6.

CHASSIS UNITS

13 valves, ECC82 (5), EB91 (6), EF91 (2). 60 resistors, capacitors, etc. Valve cans and bases. Multicon plugs. 30/-. P. & P. 6/-. Flexible metal tubing. Galvanised 3/8 in. int. dia. 35/- 100ft. P. & P. 7/6.
Field telephones Type F. 32/6. P. & P. 7/6.
Mixer units Type 18: H.F., M.F., L.F. Valve 882. 10/-. P. & P. 2/6.

TRANSFORMERS

SSTR894. Pri. 220-230-250V. Sec. 6.3V (2A), 300-350-390V (35mA), 80-90-100V (10mA). 30/-. P. & P. 5/-.
SSTR073. Pri. 220-230V. Sec. 35V (0.5A), 6.3V (2A), 225-0-225V (27mA). Oil filled. 25/-. P. & P. 5/-.
SSTR009. Pri. 230V. Sec. 50V (50mA), 4V (1A), 6.3V (8A). 25/-. P. & P. 5/-.
Two core cable rubber covered, 1/- per yard, inc. P. & P.

STATUS SUPPLIES Status House, Wilkinson Avenue, Blackpool

VALUABLE NEW HANDBOOK FREE TO AMBITIOUS ENGINEERS

Have you had your copy of "Engineering Opportunities"?

The new edition of "ENGINEERING OPPORTUNITIES" is now available—without charge—to all who are anxious for a worthwhile post in Engineering. Frank, informative and completely up to date, the new "ENGINEERING OPPORTUNITIES" should be in the hands of every person engaged in any branch of the Engineering industry, irrespective of age, experience or training.

On 'SATISFACTION OR REFUND OF FEE' terms

This remarkable book gives details of examinations and courses in every branch of Engineering, Building, etc., outlines the openings available and describes our Special Appointments Department.

WHICH OF THESE IS YOUR PET SUBJECT?

ELECTRONIC ENG.

Advanced Electronic Eng.—
Gen. Electronic Eng.—
Applied Electronics—
Practical Electronics—
Radar Tech.—
Frequency Modulation —
Transistors.

ELECTRICAL ENG.

Advanced Electrical Eng.—
General Electrical Eng. —
Installations—
Draughtsmanship —
Illuminating Eng. —
Refrigeration —
Elem. Elec. Science —
Elec. Supply —
Mining Elec. Eng.

CIVIL ENG.

Advanced Civil Eng.—
General Civil Eng. —
Municipal Eng. —
Structural Eng. —
Sanitary Eng.—
Road Eng. —
Hydraulics —
Mining —
Water Supply —
Petrol Tech.

RADIO & T.V. ENG.

Advanced Radio—
General Radio—
Radio & TV Servicing —
TV Engineering —
Telecommunications —
Sound Recording —
Automation —
Practical Radio —
Radio Amateurs' Examination.

MECHANICAL ENG.

Advanced Mechanical Eng.—
Gen. Mech. Eng.—
Maintenance Eng. —
Diesel Eng. —
Press Tool Design —
Sheet Metal Work —
Welding Eng. —
Pattern Making —
Inspection —
Draughtsmanship —
Metallurgy —
Production Eng.

AUTOMOBILE ENG.

Advanced Automobile Eng.—
General Auto. Eng. —
Auto. Maintenance —
Repair —
Auto. Diesel Maintenance —
Auto. Electrical Equipment —
Garage Management.

WE HAVE A WIDE RANGE OF COURSES IN OTHER SUBJECTS INCLUDING CHEMICAL ENG., AERO ENG., MANAGEMENT, INSTRUMENT TECHNOLOGY, WORKS STUDY, MATHEMATICS, ETC.

Which qualification would increase your earning power? A.M.I.E.R.E., B.Sc.(Eng.), A.M.S.E., A.M.I.P.E., A.M.I.M.I., A.R.I.B.A., A.I.O.B., A.M.I.Ex., A.R.I.C.S., M.R.S.H., A.M.I.E.D., A.M.I.Mun.E., C.ENG., CITY & GUILDS, GEN. CERT. OF EDUCATION, ETC.

BRITISH INSTITUTE OF ENGINEERING TECHNOLOGY
316A ALDERMASTON COURT, ALDERMASTON, BERKSHIRE

THIS BOOK TELLS YOU

- ★ HOW to get a better paid, more interesting job.
- ★ HOW to qualify for rapid promotion.
- ★ HOW to put some letters after your name and become a key man . . . quickly and easily.
- ★ HOW to benefit from our free Advisory and Appointments Depts.
- ★ HOW you can take advantage of the chances you are now missing.
- ★ HOW, irrespective of your age, education or experience, YOU can succeed in any branch of Engineering.

164 PAGES OF EXPERT CAREER - GUIDANCE

PRACTICAL EQUIPMENT

Basic Practical and Theoretic Courses for beginners in Electronics, Radio, T.V., Etc., A.M.I.E.R.E. City & Guilds Radio Amateurs' Exam. R.T.E.B. Certificate P.M.G. Certificate Practical Electronics Electronics Engineering Practical Radio Radio & Television Servicing Automation

INCLUDING TOOLS

The specialist Electronic Division of B.I.E.T. NOW offers you a real laboratory training at home with practical equipment. Ask for details.

B.I.E.T.

You are bound to benefit from reading "ENGINEERING OPPORTUNITIES"—send for your copy now—FREE and without obligation.



POST COUPON NOW!

TO B.I.E.T., 316A ALDERMASTON COURT, ALDERMASTON, BERKSHIRE.

Please send me a FREE copy of "ENGINEERING OPPORTUNITIES." I am interested in (state subject, exam., or career).

NAME

ADDRESS

WRITE IF YOU PREFER NOT TO CUT THIS PAGE

THE B.I.E.T. IS THE LEADING INSTITUTE OF ITS KIND IN THE WORLD

Published about the 15th of the month by IPC Magazines Ltd., Tower House, Southampton Street, London, W.C.2, at the recommended maximum price shown on the cover. Printed in England by THE CHAPEL RIVER PRESS, Andover, Hants. Sole Agents—Australia and New Zealand: GORDON & GOTCH (A/sia) Ltd.; South Africa and Rhodesia: CENTRAL NEWS AGENCY LTD.; East Africa: STATIONERY & OFFICE SUPPLIES LTD. Subscription rate including postage for one year: To any part of the World £2 2s. 0d.

ENGLANDS LEADING COMPONENT & EQUIPMENT CENTRES

SOLID STATE—HIGH FIDELITY AUDIO EQUIPMENT

Mono or Stereo Audio, Equipment developed from Dinsdale Mk. II—each unit or system will compare favourably with other professional equipment selling at much higher prices.

COMPLETE SYSTEMS FROM £15.5.0

THE FINEST VALUE IN HIGH FIDELITY—CHOOSE A SYSTEM TO SUIT YOUR NEEDS AND SAVE POUNDS



All units available separately

SEND FOR FREE BROCHURE (No. 21) TODAY! DEMONSTRATIONS DAILY AT '303' EDGWARE ROAD



INTEGRATED TRANSISTOR AMPLIFIERS

MA66 6 WATTS MONO OR 12 WATTS STEREO

We are pleased to offer two new designs with the choice of either mono or stereo systems. These BRITISH DESIGNED UNITS favour the user in so many ways—with fantastic power and quality with far greater adaptability, with freedom for battery or mains operation.

MAT MONO £8.10.0 OR STEREO MA66 POST-PACKING—EITHER MODEL *£16.10.0

OPTIONAL MAINS UNIT PS20 £2.60 p.d.

Illustrated leaflets 12 and 14 FREE on request

for complete listening satisfaction choose either—



DO IT YOURSELF MW/LW PORTABLE

New printed circuit design with full power output. Fully tuneable on both mw/lw bands. 7 transistors plus diode, push-pull circuit. Fitted 5 inch speaker, large ferrite aerial and Mullard transistors. Easy to build with terrific results. All local and Continental stations.

TOTAL COST £6.19.6. TO BUILD

P.P. 4/6

BUILD A QUALITY TAPE RECORDER

To get the best out of your MAGNAVOX DECK, you need a MARTIN RECORDAKIT. This comprises a special high quality 8 valve amplifier and pre-amplifier which comes to you assembled on its printed circuit board—in fact everything needed down to the last screw FOR MAKING A SUPERB TAPE RECORDER, which, when built, will compare favourably with instruments costing twice as much, yet you need no experience or technical skill to bring this about. THE INSTRUCTIONS MANUAL MAKES BUILDING EASY AND SUCCESS ASSURED.



2 Track 36 gns.

4 Track 39 gns.

P.P. 2/6 either model
Kit comprises: Deck, Amplifier, Cabinet and speaker, with MICROPHONE 7 in 1, 200 ft. tape, spare spool. ALL UNITS AVAILABLE SEPARATELY. ASK FOR BROCHURE 8

Today's Value £86.



NEW MODELS NOMBREX TRANSISTORISED Test Equipment

MODEL		PRICE	Leaflet
29s	R.F. Generator	21 0 0	No.
29s	Xtal R.F. Generator	29 10 0	35
30	Audio Generator	19 10 0	24
31	R.F. Generator	12 10 0	25
32	C.R. Bridge	10 10 0	26
33	Inductance Bridge	20 0 0	29

VHF FM SUPERHET TUNER MKII

MULLARD TRANSISTORS & 4 DIODES - 300 Kc/s BANDWIDTH - PRINTED CIRCUIT CONSTRUCTION - HIGH FIDELITY REPRODUCTION MONO AND STEREO

A popular VHF FM Tuner now used throughout the country for quality reception of monophonic and, with the decoder stereophonic broadcasts. There is no doubt about it—VHF FM gives the real sound. Excellent stability, economically priced. PARTS TOTAL COST £6.19.6. DECODER £3.19.6. (CABINET 20/-) ASK FOR LEAFLET 3.



TRANSISTORS

MANUFACTURERS—DISTRIBUTORS

We publish a QUANTITY, SEMI-CONDUCTOR BULLETIN listing over 500 different devices available FROM STOCK in medium to large quantities at KEEN PRICES coupled with PROMPT DELIVERIES. TO OBTAIN YOUR COPY, WRITE TO US (on Company Headed Notepaper please) requesting our SEMI-CONDUCTOR BULLETIN. FOR TELEPHONE QUOTATIONS, We purchase medium to large quantities of Transistors and Devices excess to Manufacturers and Distributors' requirements. Write or Phone Extn 4.

ELECTRONIC ORGANS KITS TO BUILD YOURSELF AND COMPLETE UNITS

The MAYFAIR Acclaimed by everyone

A completely new development in portable electronic musical instruments and a new field for the home constructor. The 'MAYFAIR' produces a multitude of the most pleasing sounds with a wide range of tone colours suitable for classic or popular music. The organ is fully polyphonic, that is full chords can be played over the entire keyboard. Includes 155 transistors, printed circuit panels, special fully sprung and depth of touch adjusted keyboard, attractive vinyl covered cabinet with carry handles.

Offered terms available COMPLETE KIT Deposit £29.19.6 12 monthly payments of £7. Total £112.19.6 BUILT AND TESTED of tone colours suitable for classic or popular music. £8. Total £141.8



THE MAYFAIR 99 GNS BROCHURE 9

A complete detailed and illustrated construction manual is provided with circuits and full parts list. All items may be purchased separately. All parts supplied are fully guaranteed. Full after sales service.

★ THE GROSVENOR

The Grosvenor is designed for the more ambitious musician and has a much wider range than most commercial organs. It comprises two four-octave (49 note) keyboards and a thirteen-note pedal board. It has four pitches (i.e. 8th, 4th, 2nd, 1st) on the upper or solo keyboard, three pitches (i.e. 16th, 8th, 4th) on the lower or accompaniment keyboard, two pitches (i.e. 16th, 8th) on the pedal board. Variable sustain on the solo keyboard and variable vibrato on both keyboards. It has 15 voices in the solo tone-forming unit, 10 voices in accompaniment tone-forming unit and 4 voices in the pedal tone-forming unit. All components and kit sections are available separately including the Oak Console at £25.19.0.

A complete detailed and illustrated construction manual is provided with circuits and full parts list. All items may be purchased separately. All parts supplied are fully guaranteed. Full after sales service and advice freely available. Once built the 'MAYFAIR' or 'GROSVENOR' will then provide years of enjoyable entertainment. Call in—See them for yourself.



THE GROSVENOR KITS FROM £220 terms available BROCHURE 9B

PRACTICAL ELECTRONICS—ELECTRONIC ORGAN KIT

We are able to supply Parts as described in this series. Details on request

ORGAN COMPONENTS: COMPLETE RANGE IN STOCK + 49 AND 61 NOTE KEYBOARDS + 2 TO 5 PAIR GOLD CONTACTS + COILS AND CHOKES + REGENERATION SERVICES + 87 TOP TAPS AND ASSEMBLES + PEDALS + MODIUM AND GOLD CLAD WIRE. ALSO PRINTED CIRCUITS ETC. COMPLETE RANGES FOR TRANSISTORISED ORGANS. ASK FOR NEW PRICE LISTS WITH DETAILS LEAFLET 9B ALL ENQUIRIES TO: ORGAN DEPT.—MR. ELVINS



QUALITY CAR RADIOS

A precision engineered car radio that's perfect company for long hours on the road. Has quick push-button operation for immediate station selection. Includes 33 watts amplifier for wide frequency. Output of 33 watts ensures crisp, top quality sound even at high motorway speeds. Includes full accessories and instructions.

POSITIVE-NEGATIVE EARTH PRICE £12.19.6, pp. 4.6

MANUAL as above £19.8 but with single MW/LW Push Button.

*SCOOP! STARR RECORD PLAYER

Deck. Plays 33, 45, 78 records 9 volt operated. With mono cartridge. Brand new. As illustrated.

59/6 post 3/6

*MULLARD 1 WATT AMPLIFIER

9 volt, 5 transistor unit complete with volume control. Output to 3 ohms. Ideal for use with Starr Record Deck.

45/- post 3/6. Send for leaflet 2



GARRARD RECORD DECKS

ALL BRAND NEW at huge savings

Model	Price	£ s. d.
2025 Mono/Stereo GKS 25		8 8 0
3000 LM Mono/Stereo 9 TAHC		9 19 6
SP25 Mk II		11 19 6
AT60 Mk II		13 0 0
AP75		13 0 0
SL55		11 19 6
SL65		14 14 0
SL75		29 0 0
ML85		36 0 0
A70 Mk II		12 12 0
B.S.R. UA25 Mono		6 19 6
B.S.R. MA65		9 19 6
B.S.R. MA70		12 12 0
B.S.R. MA75		16 5 0
401 Garrard		28 10 0

Carriage/Packing 7/6d. all models. Complete range of accessories available. Send for New 8 page brochures 16 17

NEW—MALLORY LONG LIFE MERCURY BATTERIES 50% OFF LIST PRICES

*RM12 1.35 volts 3000 mAh
*RM22 1.35 volts 3000 mAh
*RM62 1.35 volts 3000 mAh
Pack of 6. Size 2 1/2 dia.
OUR PRICE 10/- each
Each cell into eight 1.35v cells.
These cells are ideal for any application where SMALL SIZE HIGH CAPACITY and LONG LIFE are required. QUANTITIES AVAILABLE.

TRANSISTORS—SEMICONDUCTORS

COMPLETELY NEW 1969 LIST OF 1000 types. Send for your FREE COPY TODAY. (list 36) S.C.R.'s from 5/- Field Effect Transistors from 7/6 Power Transistors from 5/- Diodes and Rectifiers from 1/-

HI-FI equipment to suit EVERY POCKET

VISIT OUR NEW HI-FI CENTRE at 309 EDGWARE ROAD AND SAVE UP TO £25 ON SEPARATE UNITS OR THE SYSTEM OF YOUR CHOICE for all leading makes

- AMPLIFIERS
- TUNERS
- DECKS
- SPEAKERS
- MICROPHONE
- TEST EQUIPMENT
- HEADPHONES
- CARTRIDGES, etc.

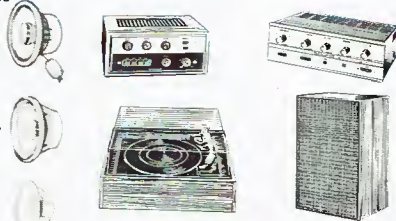

All with Terrific Savings

It will PAY YOU to pay us a VISIT!

COMPLETE SYSTEMS from £46—Saves £12.10.0! SEND FOR NEW 8-PAGE ILLUSTRATED HI-FI LIST 16/17

Fully Illustrated CATALOGUE

COMPLETELY NEW 9th EDITION (1969)

The most COMPREHENSIVE—CONCISE—CLEAR COMPONENTS CATALOGUE

Complete with 10/- worth discount vouchers FREE WITH EVERY COPY

- 32 pages of transistors and semi-conductor devices, valves and crystals.
- 210 pages of components and equipment.
- 70 pages of microphones, decks and Hi-Fi equipment.



6,500 ITEMS

320 BIG PAGES

Send today 7'6 Post etc 2'

HENRY'S RADIO LTD



OPEN MON.—SAT. 9 a.m.—6 p.m. THURS. 9 a.m.—1 p.m.

303 Edgware Road, London, W.2. Mail Order Dept. all types of Components, Organ Dept. (01) 723-1008/9
309 Edgware Road, London, W.2. High Fidelity Sales, P.A. and Test Equipment, Record Decks (01) 723-6963