

# Practical Electronics

SEPTEMBER 1966

PRICE 2/6

## SOLID STATE IGNITION

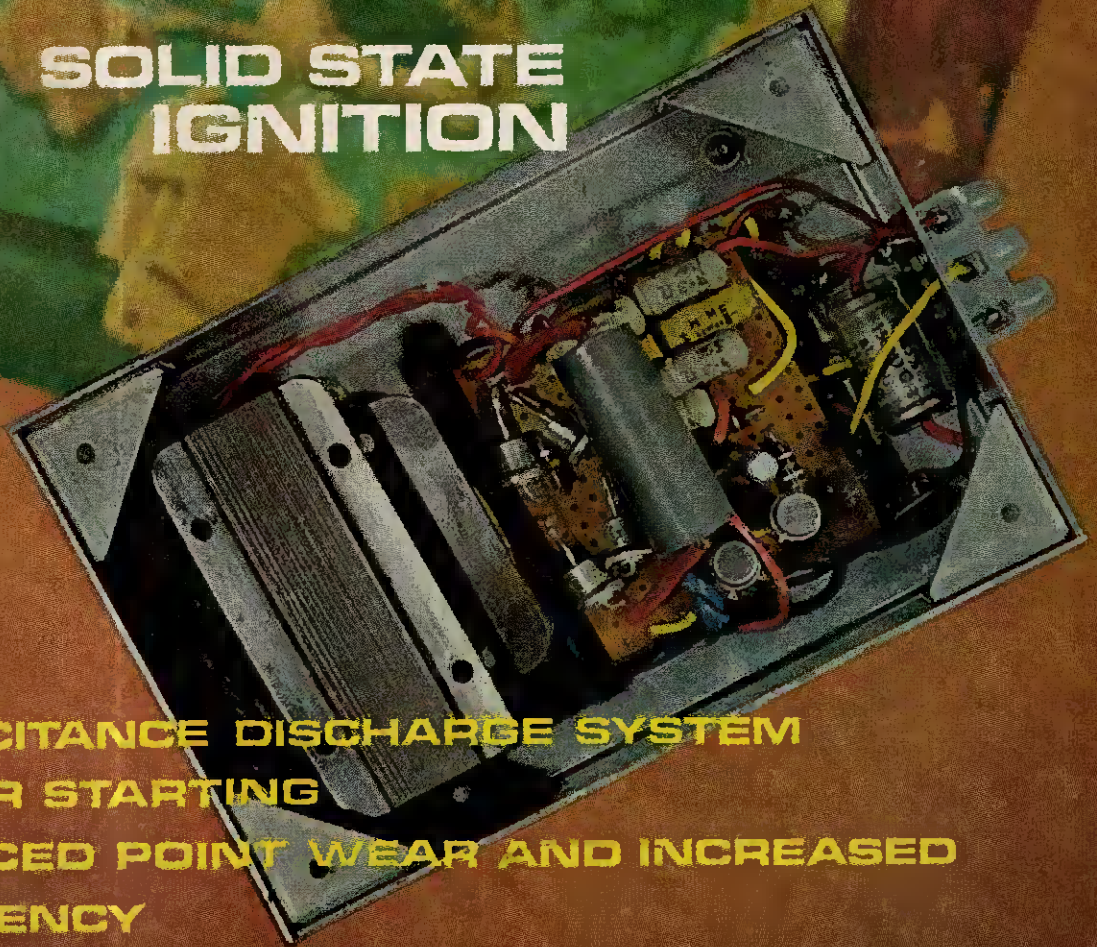

\*CAPACITANCE DISCHARGE SYSTEM

\*EASIER STARTING

\*REDUCED POINT WEAR AND INCREASED  
EFFICIENCY

# ADCOLA

PRODUCTS LIMITED  
(Regd. Trade Mark)

SOLDERING EQUIPMENT

*for the*

## DISCRIMINATING ENTHUSIAST



ILLUSTRATED:  
L64  $\frac{3}{8}$ " BIT INSTRUMENT IN  
L700 PROTECTIVE SHIELD

APPLY DIRECT TO:  
SALES & SERVICE DEPT.  
ADCOLA PRODUCTS LTD.  
ADCOLA HOUSE  
GAUDEN ROAD  
LONDON, S.W.4  
TELEPHONE: MACAULAY 0291/3

## ERSIN Multicore SOLDER

### For quick, easy faultless soldering

Ersin Multicore 5-core solder is easy to use and economical. It contains 5 cores of non-corrosive flux, cleaning instantly heavily oxidised surfaces. No extra flux is required. Ersin Multicore Savbit Alloy considerably reduces the wear of copper soldering iron bits.



#### HANDY SOLDER DISPENSER

12 ft. of 18 s.w.g.  
SAVBIT alloy in a  
continuous coil, used  
direct from free-  
standing dispenser.  
2/6 each



#### LOW TEMPERATURE SOLDER

Size 9 pack contains  
24 ft. of 60/40 high  
tin quality 22 s.w.g.  
2/6 each  
Size 10 pack 212 ft.  
15/- each.



#### SAVBIT SIZE 1 CARTON

Contains approx. 30 ft.  
of 18 s.w.g. SAVBIT  
alloy. Also available  
in 14 and 16 s.w.g.  
5/- each



#### BIB WIRE STRIPPER AND CUTTER

Strips insulation,  
cuts wire cleanly.  
Adjusts to any size.  
4/- each

Available from all Electrical and Hardware shops.  
If unobtainable write to:

**MULTICORE SOLDERS LTD.**

Multicore Works, Hemel Hempstead, Herts. Hemel Hempstead 3636  
M.4/B



## D.I.Y. with GOODMANS HIGH FIDELITY MANUAL

A new, larger and more colourful edition—revised and completely up-to-date. It contains articles of particular interest to the D.I.Y. enthusiast—including special beginners page, advice on stereo, stage-built systems and full cabinet drawings. Whether building or improving your own audio set-up or choosing a complete speaker system, you'll find it useful and interesting as well as informative. Ask your Goodmans dealer or send coupon for your FREE copy.

Please send me a free copy of the Goodmans High Fidelity Manual

Name .....

Address .....

P.E.9

## GOODMANS

GOODMANS INDUSTRIES  
Axiom Works, Wembley, Middlesex  
Telephone: WEMbley 1200  
A Division of Radio Rentaset Products Ltd



### LAFAYETTE HA-63 COMMUNICATION RECEIVER

7 valves plus Rectifier. 4 Bands. 550 kc/s-31 Mc/s. "B" Meter—BFO—ANL—Bandspread Tuning. 200/250 v. A.C. Brand New 24 Gns. Carr. Paid.

### LAFAYETTE KT-340 COMMUNICATION RECEIVER SEMI-KIT

Build this wonderful receiver and save Pounds! Supplied semi-completed, main components ready mounted, R.F. section already wired and aligned. Full and precise instructions supplied. Specification: 8 valves + rectifier, 4 bands covering 550 Kc/s-30 Mc/s. Incorporates 1 R.F. and 2 I.F. stages, "Q" multiplier, B.F.O., A.N.L. "B" meter, bandspread, aerial trimmer, etc. Operation 115/230v. A.C. Price 25 GNS. Carr. 10/-



### LAFAYETTE HA-55A AIRCRAFT RECEIVER

108-136 Mc/s. High selectivity and sensitivity. Incorporates 2 RF stages including 6CW4 Navigator, 8 tubes for 11 tube performance, solid state power supply, adjustable squelch control, slide rule dial, built in 4in. speaker and front panel phone jack. 220/240V. A.C. Supplied brand new and guaranteed. £19.7.8. Carr. 10/- 108-176 Mc/s Ground Plane Antenna 59/6.



### HAM-I COMMUNICATION RECEIVER

5 valve superbet receiver covering 550 Kc/s-30 Mc/s on 4 bands. Special features include slide rule dial, Bandspread tuning, "S" meter, B.F.O. Built in 4" speaker. Operation 220/240 v. A.C. Brand New with instructions. 16 GNS. Carr. 10/- S.A.E. for details.



### MAIN LONDON AGENTS FOR CODAR EQUIPMENT

All items available as advertised

### SINCLAIR TRANSISTOR AMPLIFIERS

Z12 Amplifier 69/6; PZ.3. Power Pack 79/6; X10 Amplifier Built 26.18.0, Kit 25.19.8; X10 Power Pack 54/-; X20 Amplifier Built 26.18.8, Kit 27.19.8. X20 Power Pack £11.8.8. Micro FM Radio Kit 25.19.8. Micro 0, 59/6; Micro amp 28/6; Micro Injection 27/8. Post Paid.

### TRANSISTORISED TWO-WAY TELEPHONE INTERCOM.

Operative over amazingly long distances. Separate call and press to talk buttons. 2-wire connection. 1000's of applications. Beautifully finished in ebony. Supplied complete with batteries and wall brackets. £6.10.0. pair. P. & F. 3/6.



### LAFAYETTE 2-WAY RADIOS

Superb quality. Brand new and guaranteed. 3 Transistor 27.18.0 pr. 6 Transistor £17.10.0 pr. 10 Transistor with range boost £22.10.0 pr. Post extra. These cannot be operated in U.K.

### MODEL ZQM TRANSISTOR CHECKER

It has the fullest capacity for checking on A, B and Ico. Equally adaptable for checking diodes, etc. Spec: A 0-7; 0-9997; B 5-200; Ico: 0-50 microamps; 0-5 mA. Resistance for diode 200Ω - 1 MΩ. Supplied complete with instructions, battery and leads. £6/19/8. P. & P. 2/6.

### VARIABLE VOLTAGE TRANSFORMERS

Brand New—Fully Shrouded. Input 236v. 50/60 c/s. Output 0-260 Volts.

1 Amp. ....	24.10.0
2.5 Amp. ....	25.17.8
5 Amp. ....	29.0.0
8 Amp. ....	23.10.0
10 Amp. ....	27.0.0
12 Amp. ....	219.10.0
20 Amp. ....	232.10.0
2.5 Amp. Portable—Metal Case with Meter, Fuses, etc. £9/17/8.	

### SILICON RECTIFIERS

200 v. P.I.V. 200mA. ....	2/6
200 v. P.I.V. 8 amp. ....	5/6
400 v. P.I.V. 3 amp. (S.C.R.) ....	10/-
400 v. P.I.V. 3 amp. ....	7/6
1,000 v. P.I.V. 650 mA. ....	6/6
800 v. P.I.V. 500mA. ....	5/6
800 v. P.I.V. 5 amp. ....	7/6
70 v. P.I.V. 1 amp. ....	3/6
400 v. P.I.V. 500mA. ....	3/6
150 v. P.I.V. 160mA. ....	1/-

Discounts for quantities. Post extra.

### AMERICAN TAPE

First grade quality American tapes. Brand new. Discounts for quantities.

3in. 225ft. L.P. acetate. ....	4/-
3 1/2in. 600ft. T.P. mylar. ....	10/-
5in. 600ft. std. plastic. ....	8/6
5in. 1,200ft. L.P. acetate. ....	10/-
5in. 1,200ft. D.P. mylar. ....	15/-
5in. 1,800ft. T.P. mylar. ....	35/-
5in. 1,200ft. L.P. acetate. ....	12/6
5in. 1,800ft. D.P. mylar. ....	22/6
5in. 2,400ft. T.P. mylar. ....	45/-
7in. 1,200ft. std. mylar. ....	12/6
7in. 1,800ft. L.P. acetate. ....	15/-
7in. 1,800ft. D.P. mylar. ....	23/-
7in. 2,400ft. D.P. mylar. ....	35/-
7in. 3,600ft. T.P. mylar. ....	55/6

Postage 2/- Over £3 post paid.

### CALLERS WELCOME!

Open 9 a.m. to 6 p.m. every day Monday to Saturday. Trade supplied.

## TEST EQUIPMENT

### PORTABLE OSCILLOSCOPE CT.52

A compact (9" x 8" x 16 1/2") general purpose scope. T/B 10 c/s-40 kc/s. Band width 1 Mc/s. Mullard DG 7/5 2 1/2" CRT. For operation on 200/230 v. A.C. Supplied complete with metal transit case, strap, test leads, and visor hood. Brand new, £22.10.0. Carr. 10/-. Supplied complete with instructions.

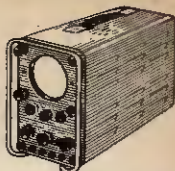

### OS/88/U OSCILLOSCOPES

High quality Portable American Oscilloscope. 3" c.r.t. T/B 3 c/s-50 kc/s X Amp: 0-500 kc/s Y Amp: 0-3 Mc/s. Power requirements 105-125v. A.C. Supplied in brand new condition, fully tested. £28. Carr. 10/- Suitable 200/115v. Transformer 16/6.



### ERSKINE TYPE 13 DOUBLE BEAM OSCILLOSCOPE

Time base 2 c/s-753 kc/s. Calibrators at 100 kc/s and 1 Mc/s. Separate Y1 and Y2 amplifiers up to 5.5 Mc/s. Operation 110/230 volt A.C. Supplied in perfect working order. £22.10.0. Carriage 20/-.

### TE-20 RF SIGNAL GENERATOR

Accurate wide range signal generator covering 120 kc/s-260 Mc/s on 6 bands. Directly calibrated. Variable R.F. attenuator. Operation 200/240 v. A.C. Brand new with instructions, £12.10.0. P. & F. 7/8. S.A.E. for details.

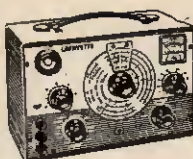

### LAFAYETTE TE-46 RESISTANCE CAPACITY ANALYZER

2 PF—2,000 MFD. 2 ohms—200 Megohms. Also checks impedance, turns ratio, insulation 200/250v. A.C. Brand New £15. Carr. 7/6.

### LAFAYETTE NUVISTOR GRID DIP METER

Compact true one hand operation. Frequency range 1.7-180 Mc/s. 230v. AC operation. Supplied complete with all coils and instructions. £12.10.0. Carr. 5/-. S.A.E. for details.



### TE22 SINE SQUARE WAVE AUDIO GENERATORS

Sine 20 cps to 200 kc/s. on 4 bands. Square: 20 cps to 20 kc/s. Output impedance 6,000 ohms. 200/240 v. A.C. operation. Supplied Brand New and Guaranteed with instructions manual and leads. £15. Carr. 7/8.



### NOMBEX EQUIPMENT

Transistorised Audio Generator 10-100,000 c/s. Sine or square wave. £18.15.0. Transistorised Signal Generator 150 kc/s. 350 Mc/s. £10.10.0. Transistorised resistance capacity bridge 1Ω. 100 MΩ. 1 pf-100μF. \$9. Transistorised Induction bridge 1μN-100H. £18. Mains operated Transistor power supply unit, output 1-15v. up to 100 mA. £6.10.0. All above post paid with battery.

### CLEAR PLASTIC PANEL METERS

First grade quality. Moving Coil panel meters, available ex-stock. S.A.E. for illustrated leaflet. Discounts for quantity. Available as follows: Type MB, 3P, 1 21/22in. square fronts.

100-0-100μA. ....	27/6	200mA. ....	22/6	100V D.C. ....	22/6
500-0-500μA. ....	22/6	300mA. ....	22/6	150V D.C. ....	22/6
1-0-1mA. ....	22/6	400mA. ....	22/6	300V D.C. ....	22/6
1mA. ....	22/6	750mA. ....	22/6	500V D.C. ....	22/6
2mA. ....	22/6	1A D.C. ....	22/6	750V D.C. ....	22/6
5mA. ....	22/6	2A D.C. ....	22/6	15V A.C. ....	22/6
10mA. ....	22/6	5A D.C. ....	22/6	50V A.C. ....	22/6
20mA. ....	22/6	10V D.C. ....	22/6	150V A.C. ....	22/6
50mA. ....	22/6	100V D.C. ....	22/6	300V A.C. ....	22/6
100mA. ....	22/6	20V D.C. ....	22/6	500V A.C. ....	22/6
200μA. ....	22/6	50V D.C. ....	22/6	"S" Meter 10A. ....	22/6
500μA. ....	22/6				
50-0-50μA. ....	22/6				

POST EXTRA. Larger sizes available—send for lists.

### TE-51 NEW 20,000V/VOLT MULTIMETER

0 / 5 / 80 / 120 / 3,200V. A.C. 0 / 3 / 30 / 60 / 300 / 600 / 3,000V. D.C. 0 / 60μA / 12 / 300 MA. D.C. 0 / 50K / 6 Meg. Ω 85/- P. & P. 2/6.



### MODEL PV-58 VALVE VOLTMETER

11 meg. input. 7 D.C. volt ranges. 1.5-1,500 v. 7 A.C. volt ranges 1.5-1,500 v. 4,000 Peak to Peak. Resistance 2 ohm to 1,000 megohm. Decl. Supplied brand new with instructions, leads and probe. £12/10/-. P. & P. 3/6.



### TS-76 20,000 O.P.V. PUSH BUTTON MULTI-TESTER

Simple operation. D.C. volts up to 1,000 v. A.C. volts up to 1,000 v. Resistance up to 10 megohm. Current up to 250 mA. Decl. — 20 to + 36 db. £5.5.0. P. & P. 2/-. S.A.E. for details.



MODEL 500. 30,000 o.p.v. 0 / 5 / 15 / 50 / 25 / 100 / 250 / 500 / 1,000v. D.C. 0 / 2.5 / 10 / 25 / 100 / 1,000 A.C. 0 / 50μA / 5 / 50 / 500mA. 12 amp. D.C. 0 / 50K / 8 Meg. / 60. Meg Ω. £5/17/8 Post Paid.

# GW SMITH & CO (RADIO) LIMITED

Phone: GERRARD 8204/9155  
Cables: SMITHEX LESQUARE  
3-34 LISLE STREET, LONDON, W.C2

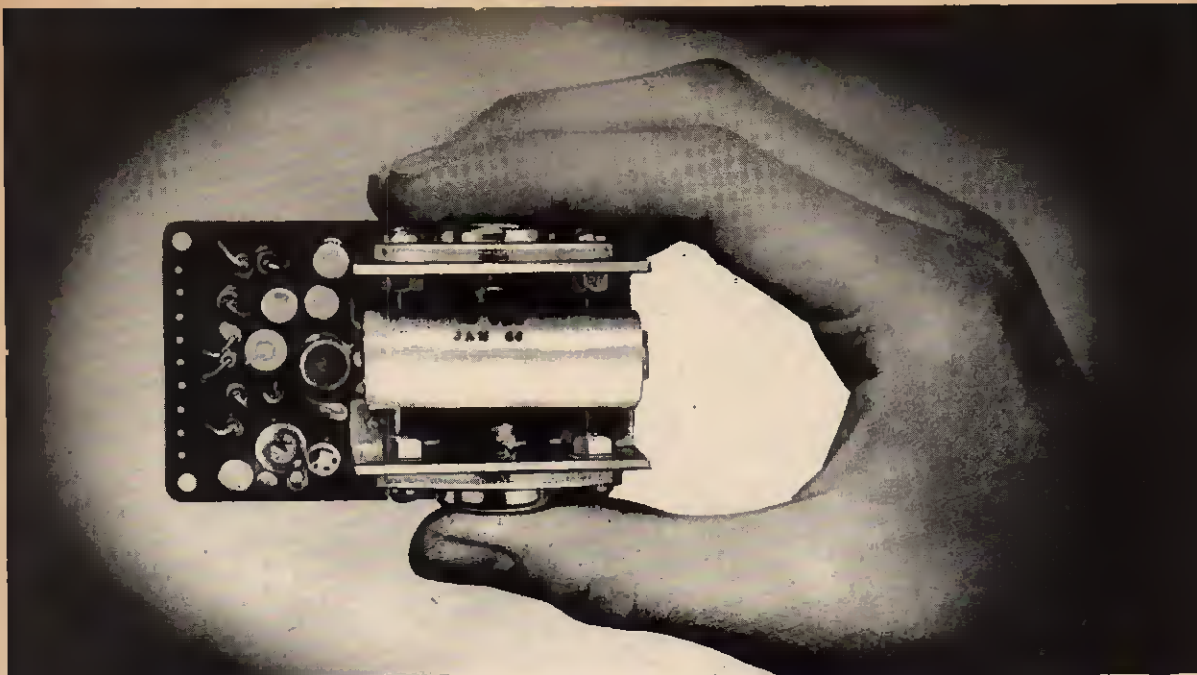

## SINCLAIR MICRO FM

The world's most remarkable  
FM tuner/receiver

Less than 3in. x 1 1/2in. x 3/4in. and professional in every way, this seven transistor FM superhet uses pulse counting discriminator for superb audio quality. Low I.F. makes alignment unnecessary after building. Tunes 88-108 Mc/s., and telescopic aerial included suffices for good reception in all but poorest areas. Signal to noise ratio —30dB at 30 microvolts. Takes standard 9 v. battery. One outlet feeds to amplifier or recorder, other for using set as self-contained pocket portable. Brushed and polished aluminium front, spun aluminium dial.

Complete kit inc. aerial, case, earpiece and instructions.



£5.19.6

## SINCLAIR MICRO - 6

The world's smallest radio.

Six stage receiver (2 R.F., double diode detector, 3 A.F.) in white, gold and black case only 1 1/2in. x 1 1/4in. x 3/4in. Tunes over M.W., A.G.C. to counteract fading. Bandspread for Luxembourg. Plays anywhere with amazing power and quality. Complete kit of parts, inc. transistors, case, earpiece and instructions. 59/6

FULL SERVICE FACILITIES AVAILABLE TO ALL SINCLAIR CUSTOMERS



# SINCLAIR Z.12

## INTEGRATED 12 WATT AMPLIFIER AND PRE-AMPLIFIER

THE SINCLAIR Z.12 has been developed to the highest possible standards for an amplifier of its size and power. At the same time its rugged construction and its amazing adaptability make it possible to use just one type of amplifier in an exceptionally wide variety of applications. It has the characteristics demanded of any quality amplifier, irrespective of price, yet costs well under £5, including its own integrated pre-amplifier stage! The Z.12 will function efficiently from anything between 6 and 20 volts, making it convenient to run it from a car battery,

for example. Where it is required to run the Z.12 from mains supply, the PZ.3 is recommended. Detailed instructions for connecting mono and stereo inputs are given in the manual supplied with every unit, which includes a variety of matching control networks. The Z.12 can be used entirely on its own, but those wishing to have the very finest pre-amplifier and control system can connect inputs via the STEREO 25, described opposite, and designed to produce the very finest hi-fi you have ever heard.

### ● TECHNICAL SPECIFICATION

The Sinclair Z.12 uses eight H.F. transistors in an original design developed by Sinclair Radionics to ensure exceptional standards of reproduction. The pre-amp incorporated accepts all types of inputs. For the very best possible hi-fi stereo, two Z.12's should be used with the Sinclair Stereo 25 described opposite.

- OUTPUT—Class B, ultra-linear, with generous negative feed-back
- FREQUENCY RESPONSE—15, to 50,000 c/s ±1dB
- INPUT SENSITIVITY—2 mV into 2 K ohms
- SIGNAL TO NOISE RATIO—better than 60dB
- OUTPUT IMPEDANCE—suitable for 3, 7.5 and 15 ohm loudspeakers. Two 3 ohm speakers may be used in parallel.
- POWER REQUIREMENTS—6 to 20 volts D.C. or Sinclair PZ.3 mains power supply unit

BUILT, TESTED AND GUARANTEED **89/6**

### SINCLAIR PZ.3



Designed specially for the very high standards of the Z.12, this entirely NEW power supply unit uses advanced transistorised circuitry to achieve exceptionally good smoothing. Ripple is a barely measurable 0.05V. The PZ.3 will power two Z.12's and the Stereo 25 with ease. 79/6

# sinclair

sinclair radionics Ltd.  
22 newmarket road, cambridge

Telephone 52731



# SINCLAIR STEREO 25

**A NEW DE-LUXE PRE-AMPLIFIER AND CONTROL UNIT  
DESIGNED TO THE BEST HIGH FIDELITY STANDARDS**

Sinclair's newest unit, the Stereo 25 has been designed specially to obtain the very finest results used in conjunction with the Sinclair Z.12 for stereo reproduction. The best quality components, individually tested before acceptance, are used in its construction, ganged controls are carefully checked for matching, whilst the overall appearance of this very compact de-luxe pre-amp control unit reflects the professional elegance which characterises all Sinclair designs. The front panel is in solid brushed and polished aluminium with

beautifully styled solid aluminium knobs. Mounting and connecting the unit is simple, and the generous output of the PZ.3 is more than enough to power the Stereo 25 together with two Z.12's for stereo. Hi-fi enthusiasts seeking the ultimate in equipment for domestic listening will find all they want from this combination of Sinclair units, and with a Micro FM to provide the radio, their installation will compare favourably with anything costing up to **FOUR TIMES** as much.

**A complete high fidelity  
stereo assembly for £22.18.0**

All you need is one Stereo 25 Pre-amp Control Unit (£9.19.6), two Z.12's (£8.19.0) and one PZ.3 Mains Power Supply Unit (£3.19.6) to possess the finest possible hi-fi stereo installation. As a very desirable optional extra, you could include the Micro FM (£5.19.6) described on page one of our advertising. The overall saving to you in cash will be staggering, and you will have an installation second to none irrespective of price.

## ● TECHNICAL SPECIFICATION

Performance figures were obtained using the Sinclair Stereo 25 fed to two Z.12's and the entire assembly powered by a PZ.3 Power Supply Unit.

● **SENSITIVITY** for 10 watts into 1.5 ohms load per channel  
Mic.—2 mV into 50 K ohms  
Pick-up—3 mV into 50 K ohms  
Radio—20 mV into 4.7 K ohms

● **FREQUENCY RESPONSE** (Mic. and Radio)—25 c/s to 30 kc/s  $\pm$ 1dB extending to 100 kc/s  $\pm$ 3dB

● **EQUALISATION FOR P.U.**—Correct to within  $\pm$ 1dB on RIAA curve from 50 c/s to 20 kc/s.

## ● TONE CONTROLS

Treble  $\pm$ 12dB to  $\pm$ 10dB at 10 kc/s  
Bass  $\pm$ 15dB to  $\pm$ 12dB at 100 c/s

**SIZE**—6½ × 2½ × 2½ ins. overall, plus knobs.  
**FINISH**—Front panel in brushed and polished solid aluminium with solid aluminium knobs. Black flguring on front panel.

**BUILT,  
TESTED AND  
GUARANTEED**

**£9.19.6**

## SINCLAIR USERS WRITE

"May I congratulate you on the Micro F.M. Performance has amazed me."

(Signed) D.J.B., Swaziland.

"I am extremely pleased with its (Z.12) performance. Thank you for your prompt delivery."

(Signed) B.R.L., Auckland, N.Z.

"I am using a Z.12 in a home-made recorder. The results are outstanding when used with a good quality speaker."

(Signed) P.D.S., London, E.13.

"I am very pleased with the Micro-6."

(Signed) J.M.W., Burnham-on-Sea.

"The firm of Sinclair will always rate highly in my esteem."

(Signed) B.C., Glasgow.

If you prefer not to cut this page, please mention PE.9 when writing your order.

## Your Sinclair Guarantee

If you are not completely satisfied when you receive your purchase from us, your money will be refunded at once in full and without question.

**sinclair**

To **SINCLAIR RADIONICS LTD., 22 NEWMARKET ROAD, CAMBRIDGE**

Please send.....

for which I enclose.....

CASH/CHEQUE/MONEY ORDER for  
£ s. d.

NAME.....

ADDRESS.....

PE.9



# LASKY'S RADIO

## For the Finest Value and Service to HOME CONSTRUCTORS & ELECTRONICS ENTHUSIASTS

We consider our construction parcels to be the finest value on the home constructor market. If on receipt you feel not competent to build the set, you may return it as received within 7 days, when the sum paid will be refunded less postage.

### TAPE RECORDERS

#### JUST ARRIVED — THE NEW GARRARD STEREO DECK

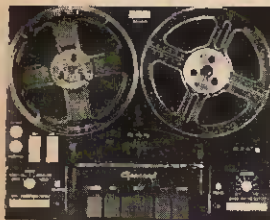

Carriage and Packing Free

Now available from stock — superb specification. Three  $\frac{1}{2}$  track stereo/mono heads; 3 speeds—1 $\frac{1}{2}$ , 3 $\frac{1}{2}$ , 7 $\frac{1}{2}$  i.p.s.; takes 7in. spools; fast forward and rewind; tape position indicator; pause control; separate record, replay and erase heads—4 tracks; piano key controls interlocked for all functions; stop/start can be remotely controlled; auto., tape-end stop. Heavy duty motor, capacitor start and run, large dynamically balanced flywheel. Deck finished in grey plastic, size: 14 $\frac{1}{2}$  x 12 x 6 in., depth below plinth 4in. For 110 v. 50 c.p.s. Mains operation. Auto-transformer for 200/250 v. included free.

**LASKY'S PRICE 29 $\frac{1}{2}$  GNS.**

#### MAGNAVOX-COLLARO 363 TAPE DECKS

The very latest 3 speed model—1 $\frac{1}{2}$ , 3 $\frac{1}{2}$ , 7 $\frac{1}{2}$  i.p.s. available with either  $\frac{1}{2}$  track or 1 track head. Features include: pause control; digital counter; fast forward and rewind; new 4 pole fully screened induction motor; interlocking keys. Size of top plate: 13 $\frac{1}{2}$  x 11 x 5 $\frac{1}{2}$ in. deep below unit plate. For 200/250 v. A.C. mains, 50 c.p.s. operation. New unused and fully guaranteed.

**LASKY'S PRICE  $\frac{1}{2}$  track £10.10.0**

**LASKY'S PRICE  $\frac{1}{2}$  track £13.9.6**

Carriage and Packing 7/6 extra.

**SPECIAL FOR OVERSEAS CUSTOMERS** — the new Magnavox-Collaro 363 Deck for 110/125 v. 50 or 60 c.p.s. mains now available, prices as above. Post to any part of the world 35/.



### SPECIAL INTEREST ITEMS!

#### TEST METER ADAPTOR

Type P.E. 220—this is a fully transistorised device which enables any 50 microamp D.C. Multimeter to be used in place of a valve volt meter. On the 1V. range an impedance of 1 megohm is offered which increases on the 1000 V. range to 100 megohms. 7 ranges: 1 to 1000 volts. Designed for immediate connection to Avo 8 and similar size meters but quite suitable for use with any other 50 microamp meter. Size 6 x 6 x 5 in. New and boxed. List Price 7 Gns.

**LASKY'S PRICE 39/6**

Post 2/6. Set of batteries 7/5 extra.



#### SPECIAL PURCHASE—UHF/VHF T.V. TUNERS

Well known British makers' surplus stocks. Now available for the first time to the Home Constructor.

##### TRANSISTORISED UHF MINIATURE MODEL

Shielded metal case only 3 $\frac{1}{2}$  x 1 $\frac{1}{2}$  x 3in. Fully tunable—complete with two AF 138 transistors. **LASKY'S PRICE 39/6**

##### VALVE UHF MODEL (illustrated)

In metal case size 4 x 6 x 1 $\frac{1}{2}$ in. Fully tunable—complete with PCC86 and PCC88 valves. **LASKY'S PRICE 32/6.** Without valves 19/6.

##### TRANSISTORISED VHF MODEL 1

Miniature turret type fitted with 12 sets of coils and 3 Mullard AF102 transistors. In metal case size 4 x 2 x 3 $\frac{1}{2}$ in. **LASKY'S PRICE 29/6**

##### TRANSISTORISED VHF MODEL 2

Sub-miniature turret type fitted with 12 sets of coils and 3 Mullard AF102 transistors. In metal case size 3 x 1 $\frac{1}{2}$  x 2 $\frac{1}{2}$ in. **LASKY'S PRICE 37/6**

Add 2/6 Post and Packing on each.

207 EDGWARE ROAD, LONDON, W.2 Tel: PAD 3271  
33 TOTTENHAM CT. RD., LONDON, W.1 Tel: MUS 2605

Both open all day Saturday. Early closing Thursday.

Please address all Mail Orders and Correspondence to 3-15 Cavell St., Tower Hamlets, London, E.1.

### CONSTRUCTORS BARGAINS

#### The "Sixteen" Multirange METER KIT

This outstanding meter was featured by *Practical Wireless* in the Jan. '64 issue. Lasky's are able to offer the complete kit of parts as specified by the designer.

**RANGE SPECIFICATION:** D.C. volts: 0.2-5-25-50-250-500 at 20,000 $\Omega$ ; A.C. volts: 0.25-50-250-500 at 1,000 $\Omega$ ; D.C. current: 0-50 $\mu$ A, 0.25-50-250 $\mu$ A. Resistance: 0-2,000 $\Omega$ , 0-200k $\Omega$ , 0-20 M $\Omega$ . Basic movement: 40 $\mu$ A f.s.d. moving coil. With universal shunt full scale deflection current is 50 $\mu$ A. Black plastic case—3 $\frac{1}{2}$  x 5 $\frac{1}{2}$  x 1 $\frac{1}{2}$ in. Controls: 12 position range switch; separate slide switch for A.C. volts—D.C. ohms; ohms zero adjustment pot, meter, meter zero. Power requirements: One 1.5v. and one 1.5v. batts. Complete with all parts and full construction details. H.P. Terms available.

**LASKY'S PRICE £5.19.6.** P. & P. 5/-



Data and circuit available separately, 2/6; refunded if all parts bought. Pair of batteries 2/- extra.

#### NEW—LASKY'S MINIATURE TRANSISTOR AMPLIFIER MODULES

Incorporating the very latest circuitry to provide high sensitivity and good quality in conjunction with extreme small size and compactness. High quality Newmarket transistors used throughout. All designed to operate on 9v. miniature battery. Add 1/- on each for post & packing

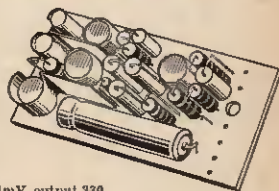

**TYPE PG 1.** 3 transistor. Input sens. 50 mV, output 150 mW, output imp. 40 $\Omega$ , size 2 x 1 x 1 $\frac{1}{2}$ in. .... **PRICE 27/6**

**TYPE PG 2.** 5 transistor. Input sens. 1mV, output 320 mW, output imp. 15 $\Omega$ , size 2 $\frac{1}{2}$  x 1 $\frac{1}{2}$  x 1 $\frac{1}{2}$ in. .... **PRICE 22/6**

**TYPE PG 3.** 5 transistor. Input sens. 5 mV, output 400 mV, output imp. 15 $\Omega$ , size 2 $\frac{1}{2}$  x 1 $\frac{1}{2}$  x 1 $\frac{1}{2}$ in. .... **PRICE 25/-**

**TYPE PG 4.** 5 transistor. Input sens. 160 mV, output 380 mV, output imp. 15 $\Omega$ , size 2 $\frac{1}{2}$  x 1 $\frac{1}{2}$  x 1 $\frac{1}{2}$ in. .... **PRICE 22/6**

**TYPE PG 5.** 6 transistor. Input sens. 8mV, output 3W, output imp. 8 $\Omega$ , size 5 $\frac{1}{2}$  x 1 $\frac{1}{2}$  x 1in. .... **PRICE 59/6**

**TYPE PG 7.** 6 transistor. Input sens. 8mV, output 1W, output imp. 8 $\Omega$ , size 3 x 1 $\frac{1}{2}$  x 1in. .... **PRICE 39/6**

#### SINCLAIR SUPER MINIATURES

We stock the complete range. Write for details of package deals.

**THE MICRO-6** miniature radio only 1 $\frac{1}{2}$  x 1 $\frac{1}{2}$  x 1 $\frac{1}{2}$ in. .... **£2 19 6**

**THE SLIMLINE 9**-transistor pocket radio ..... **£2 9 6**

**THE MICRO-FM.** (tuner/receiver) ..... **£5 19 6**

**THE X-20** 20 watt P.W.M. amplifier ..... **£7 19 6**

Available ready built, tested and guaranteed ..... **£7 19 6**

**THE X-10** 10 watt amplifier and pre-amp. .... **£5 19 6**

Available ready built, tested and guaranteed ..... **£5 19 6**

**THE Z-12** 12 watt amplifier and pre-amplifier. Fully built and tested. .... **£4 9 6**

#### VEROBOARD —

High grade laminated board with copper strips bonded to it and pierced with holes.

Boards	Accessories
42/1503 2 $\frac{1}{2}$ x 5 in. ....	Terminal pins — pkt. of 50 ..... 3/-
43/1504 2 $\frac{1}{2}$ x 3 $\frac{1}{2}$ in. ....	Spot face outer tool ..... 8/6
45/1507 3 $\frac{1}{2}$ x 6 in. ....	Pin inserting tool ..... 9/9
46/1508 3 $\frac{1}{2}$ x 3 $\frac{1}{2}$ in. ....	Post 6d. per item extra.
44/1506 3 $\frac{1}{2}$ x 17 in. ....	Orders of 10/- and over post free.

#### TRANSISTORS

ALL BRAND NEW AND GUARANTEED

GET 81, GET 85, GET 86 2/6; 873A, 874F 3/8; OC45, OC71, OC81D 4/8; OC 44, OC 70, OC 76, OC 81 5/8; pair (10/6); AF 117, OC 200 6/8; OC 42, OC 43, OC 73, OC 82D 7/6; OC 201, OC 204 15/-; OC 205, OC 206 19/8; OC 28 24/8; OC 75 8/-.

#### TRANSFILTERS By BRUSH CRYSTAL CO. Available from stock.

TO—01B 465 kc/s.  $\pm$  2 kc/s. TO—02D 470 kc/s.  $\pm$  1 kc/s. **7/6 EACH**  
TO—01D 470 kc/s.  $\pm$  2 kc/s. TR—01B 465 kc/s.  $\pm$  2 kc/s.  
TO—02B 465 kc/s.  $\pm$  1 kc/s. TR—01D 470 kc/s.  $\pm$  2 kc/s. **Post 6d.**

#### GORLER UT 340 FM/VHF TUNING RANGE

Permeability tuned — covering 87 to 108 Mc/s. For use with one ECC85 valve. In metal case, size 3 x 2 $\frac{1}{2}$  x 1 $\frac{1}{2}$ in. Circuit supplied **LASKY'S PRICE 15/11** Post 2/-, ECC85 valve 9/- extra

42 TOTTENHAM CT. RD., LONDON, W.1 Tel: LAN 2573  
152/3 FLEET STREET, LONDON, E.C.4 Tel: FLE 2833

Both open all day Thursday. Early closing Saturday.

Tel.: STE 4821/2

## LASKY'S FOR SPEEDY MAIL ORDER SERVICE

# EXCEL

in

# ELECTRONICS

## Through this ICS 3-way Training Method:

### MASTER THE THEORETICAL SIDE

**1** From basic principles to advanced applications, you'll learn the theory of electronic engineering, quickly and easily through ICS. That's because each course is set out in easy-to-understand terms.

### MASTER THE PRACTICAL SIDE

**2** ICS show you how to develop your practical abilities in electronic engineering—alongside your theoretical studies. It's the only sure way to success. All training manuals are packed with easy-to-follow illustrations.

### MASTER THE MATHEMATICAL SIDE

**3** To many this aspect is a bitter problem. Even more so because no electronic engineer is complete without a sound working knowledge of maths. But new ICS teaching makes mathematics easier to learn.

Wide range of courses available include: Radio/T.V. Engineering and Servicing, Closed Circuit T.V., Electronics, Electronics Maintenance, Instrumentation and Servomechanisms, Telemetry, Computers, etc. **NEW!** Programmed Course on Electronic Fundamentals

#### EXPERT COACHING FOR:

INSTITUTION OF ELECTRONIC AND RADIO ENGINEERS  
CITY AND GUILDS TELECOMMUNICATION TECHNICIANS  
CITY AND GUILDS SUPPLEMENTARY STUDIES  
R.T.E.B. RADIO/T.V. SERVICING CERTIFICATE  
RADIO AMATEURS' EXAMINATION  
P.M.G. CERTIFICATES IN RADIOTELEGRAPHY

And there are practical "learn as you build" radio courses as well.

Member of the Association of British Correspondence Colleges

FOR **FREE** HANDBOOK POST THIS COUPON TODAY

I.C.S., Dept. 151, INTERTEXT HOUSE,  
PARKGATE ROAD, LONDON, S.W.11

NAME .....

ADDRESS .....

OCCUPATION.....AGE..... 9.66

**INTERNATIONAL CORRESPONDENCE SCHOOLS**

## The SUPER 6 LONG AND MEDIUM WAVE TRANSISTOR RADIO



★ 6 transistors and diode. ★ 350mW. ★ Superhet, Ferrite rod aerial.  
★ Component positions and references printed on back of board. ★ Wooden cabinet, 11 x 7 1/4 x 3 1/2 in. ★ Vinyl covered. ★ 6 x 4 in. speaker. ★ Booklet 2/-, Free with kit. ★ Lining up service. ★ All parts supplied separately. Write for list. S.A.E. please. VT9 or P.P.9. (3/9 with kit).

**COMPLETE SET OF PARTS ONLY £4.0.0**

OR FULLY BUILT £6.7.6 Tax & Carr. Paid

(PLUS 6/- POST)

**AM/FM (V.H.F.) RADIO GRAM CHASSIS £15.15.0**



Chassis size 16 x 6 1/2 x 5 1/2 in. high. New manufacture. Dial 1 1/2 x 4 in. in cream and red. 200-250v. A.C. only.  
Pick-up, Ext. Speaker, A.C. B., and Dipole Sockets. Five pushbuttons—L.W., M.W., S.W., F.M. and Gram. Aligned and tested. Tone control. 1000-1900 Mc.; 200-550 M.; 88-100 Mc/s; 6-17 Mc/s. EZ.80 rect., ECH81, EF89, EABC80, EL84, ECC85. 3-ohm speaker required. 9 x 6 in. Elliptical Speaker 25/-.  
**TERMS:** £5.5.0 down and 5 monthly payments of £2.5.0. Total H.F. price £16.10.0. Circuit diagram 2/6. V.H.F. Dipole 12/6. Feeder 6d. yd. Carr. to N. Ireland 20/- extra.

### NEW 6 PUSHBUTTON STEREOGRAM CHASSIS

M.W.; S.W.1; S.W.2; VHF; Gram; Stereo Gram. Two separate channels for Stereo Gram with balance control. Also operates with two speakers on Radio. Chassis size 16" x 7" x 6 1/2" high. Dial cream and red 15" x 3". ECC85; ECH81; EF89; 2 x ECL86; EM84 and Rect. 190-550M; 18-51M; 80-187M; 88-100 mc/s. Price £18.10.0 carr. paid or £21.0.0 deposit and 5 monthly payments of 56/6 Total H.F. price £20.15.5. Carriage to N. Ireland, 20/- extra.

## GLADSTONE RADIO

66 ELMS ROAD, ALDERSHOT, Hants.

(3 mins. from Station and Busca.) Aldershot 22240

CLOSED WEDNESDAY AFTERNOON CATALOGUE 6d.

BULK ENQUIRIES INVITED FOR EXPORT

### SAMSON'S ELECTRONICS LTD.

9-10 CHAPEL STREET  
LONDON, N.W.1

Tel: PAD 7851

Tel: AMB 5125

### ADVANCE COMPONENTS CONSTANT VOLTAGE D.C. POWER SUPPLY UNITS TYPE D.C.8

A.C. Input 200-250v. D.C. Output 48 volts 4 amps. Stabilised within  $\pm 1\%$  at full load, with Supply Voltage Variations up to  $\pm 15\%$ . The stabilisation at half full load is generally better than  $\pm 1.5\%$ . These units are particularly suitable for use with transistorised equipments. The components are mounted on a chassis size 17 x 5 1/2 x 6 1/2 ins. which is suitable for mounting on a standard 19 in. Rack Panel. These units are supplied Brand New with Instruction Manual. £12/19/6, Carr. 10/-. Instruction Manual sent on a returnable 10/- deposit.

### SOLARTRON POWER SUPPLY SUB-UNIT TYPE AS955/2

A.C. input 100-125v. and 200-240v. Stabilised D.C. output continuously variable between 100 and 200v. at 200 mA. Also two 6.3v. A.C. at 6s. and one at 2a. Supplied BRAND NEW with instruction manual. Manual sent on a returnable deposit of 10/-. £9/19/6 and Case 10/-.

### VENNER ELECTRIC TIME SWITCHES

A.C. 200-250 v. Type MD1BP. One on, one off every 24 hours, 30A A.C. 250 v. contacts. Beautifully finished in black Bakelite case, size 8" x 5 1/4" x 4 1/2". Brand new at a fraction of maker's price, £3.19.6, p.p. 5/- Arms for extra switching, 6/6 per pair.

### SPECIAL OFFER OF PARMEKO H.T. TRANSFORMERS

Primaries taped 230 and 115v. No. 1 960v. CT 500 mA R.M.S. Terminal block connect-ns. Base mounting unshrouded. Brand new, 55/-. Carr. 7/6.

No. 2. 950-0-950v. 30 M/A and 575-0-575v. 50 mA R.M.S. 5v. 2a. completely sealed chassis mounting. Brand new, 39/6. Carr. 6/-.  
Parmeko Chokes 4 Henries, 550 mA D.C. res. 40  $\Omega$  25/, P.P. 6/-.

### MULTI-TAPPED TRANSFORMERS

All Primaries 200, 230, 250 v.

Type	Sec. Taps	Amps
A	3-4-5-6-8-9-10-12-15-18-20-24-30 v.	2 29/6 4/-
B	3-4-5-6-8-9-10-12-15-18-20-24-30 v.	4 42/6 4/6
C	3-4-5-6-8-9-10-12-15-18-20-24-30 v.	5 49/6 5/6
D	3-4-5-6-8-9-10-12-15-18-20-24-30 v.	8 65/- 7/-
E	6-7-8-10-14-15-17-19-25-31-33-40-50 v.	3 49/6 5/6
F	6-7-8-10-14-15-17-19-25-31-33-40-50 v.	6 97/6 7/6
G	12-18-20-24-30 v.	10 77/6 7/6

### SMITH'S 4 MINUTE TIMERS

Single-pole switch. 15 Amp., 250 v. contacts. Complete with chrome bezel and control pointer knob. Size 2 in. dia., depth 3 1/2 in. 17/6, p.p. 2/6.

### FIELD TELEPHONE TYPE TELE "P"

Perfect condition. Generator bell ringing. Complete with hand set and batteries. £4.19.6 per pair, carr. 10/6.

### FIELD TELE CABLE

Type "D3" Single, 1/3 mile drums unused. 45/- per drum, p.p. 7/6.



# Why

## NOT BUILD ONE OF OUR PORTABLE TRANSISTOR RADIOS...

FIRST FOR PERFORMANCE, QUALITY AND PRICE!

BACKED BY OUR SUPER AFTER SALES SERVICE

"A wonderful range of transistor radios using first grade components for guaranteed results"

### NEW ROAMER SEVEN Mk IV

7 WAVEBAND PORTABLE OR CAR RADIO  
 ★ Now with PHILCO MICRO-ALLOY R.F. TRANSISTORS  
 ● 9 stages—7 transistors and 2 diodes  
 Amazing performance and specification  
**FULLY TUNABLE ON ALL WAVEBANDS**  
 Covers Medium and Long Waves, Trawler Band and three Short Waves to approx. 15 metres.  
 Push-pull output for room filling volume from rich toned 7" x 4" speaker. Air spaced ganged tuning condenser. Ferrite rod aerial for M & L Waves and telescopic aerial for S Waves. Real leather-look case with gilt trim and shoulder and hand straps. Size 9" x 7" x 4" approx.  
 The perfect portable and the ideal car radio. (Uses PP7 batteries available anywhere.)  
 ★ **EXTRA BAND FOR EASIER TUNING OF PIRATE STATIONS, etc.** Total cost of parts now only **£5.19.6** P. & P. 5/6

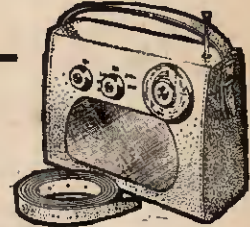

Parts Price List and easy build plans 3/- (Free with kit)

### NEW MELODY MAKER SIX

3 WAVEBAND PORTABLE. ● 8 stages. Six transistors and two diodes.

Covers Medium and Long Waves and extra Band for easier tuning of Pirate Stations, etc. Top quality 3" Loudspeaker for quality output. Two RF stages for extra boost. High 'Q' 6" Ferrite Rod Aerial. Approx. 350 Milliwatts push pull output. Handsome pocket size case with gilt fittings. Size 6½ x 3½ x 1½ in. (Uses long-life PP6 battery). Carrying strap 1/6 extra.

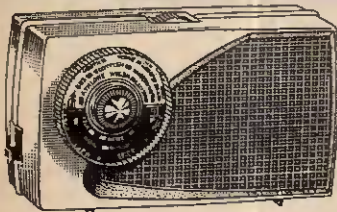

This amazing receiver may be built for only

**£3.9.6** P. & P. 3/6

Parts Price List and easy build plans 2/- (Free with kit)

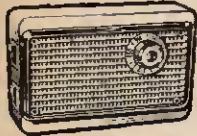

### NEW TRANSONA FIVE

"Home, Light, A.F.N. Lux. all at good volume"  
 G.P., Durham

● 7 stages—5 transistors and 2 diodes

Fully tunable over Medium and Long Waves and Trawler Band. Incorporates Ferrite rod aerial, tuning condenser, volume control, new 6½ x 4½ x 1½ in. speaker, etc. Attractive case. Size 6½ x 4½ x 1½ in. with red speaker grille. (Uses 1289 battery available anywhere.)

Total cost of all parts now only

**42/6** P. & P. 3/6

Parts Price List and easy build plans 2/- (Free with kit)

### POCKET FIVE

● 7 stages—5 transistors and 2 diodes.

Covers Medium and Long Waves and Trawler Band, a feature usually found in only the most expensive radios. On test Home, Light, Luxembourg and many Continental stations were received loud and clear. Designed round super-sensitive Ferrite Rod Aerial and fine tone 2½ in. moving coil speaker, built into attractive black and gold case. Size 5½ x 1½ x 3½ in. (Uses 1289 battery, available anywhere.)

Total cost of all parts now only

**42/6** P. & P. 3/6

Parts Price List and easy build plans 1/6 (FREE with Kit)



STOP PRESS!

Pocket 5 Med and Long wave version with miniature speaker

**29/6** P. & P. 3/-

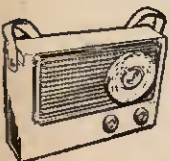

### NEW ROAMER SIX

NOW WITH PHILCO MICRO-ALLOY R.F. TRANSISTORS

● 6 WAVEBAND !!  
 ● 8 stages—6 transistors and 2 diodes

Listen to stations half a world away with this 6 waveband portable. Tunable on Medium and Long Waves, Trawler Band and two Short Waves. Sensitive Ferrite rod aerial and telescopic aerial for short waves. Top grade transistors. 3-inch speaker, handsome case with gilt fittings. Size 7½ x 5½ x 1½ in. (Carrying Strap 1/6 extra.)

★ **EXTRA BAND FOR EASIER TUNING OF LUX, etc.**

Total cost of all parts now only

**£3.19.6** P. & P. 3/6

Parts Price List and easy build plans 2/- (Free with kit)

### TRANSONA SIX

● 8 stages—6 transistors and 2 diodes

This is a top performance receiver covering full Medium and Long Waves and Trawler Band. High-grade approx. 3in. speaker makes listening a pleasure. Push-pull output. Ferrite rod aerial. Many stations listed in one evening including Luxembourg loud and clear. Attractive case in grey with red grille. Size 6½ x 4½ x 1½ in. (Uses PP4 battery available anywhere.) Carrying Strap 1/- extra.

Total cost of all parts now only

**59/6** P. & P. 3/6

Parts Price List and easy build plans 1/6 (Free with kit)

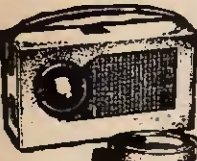

### MELODY SIX

● 8 stages—6 transistors and 2 diodes

Our latest completely portable transistor radio covering Medium and Long Waves. Incorporates pre-lagged circuit board, 3in. heavy duty speaker, top grade transistors, volume control, tuning condenser, wave change slide switch, sensitive 6in. Ferrite rod aerial. Push-pull output. Wonderful reception of B.B.C. Home and Light, 208 and many Continental stations. Handsome leather-look pocket size case, only 6½ x 3½ x 1½ in. approx. with gilt speaker grille and supplied with hand and shoulder straps.

Total cost of all parts now only

**£3.9.6** P. & P. 3/6

Parts Price List and easy build plans 2/- (Free with kit)

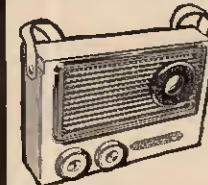

### SUPER SEVEN

● 9 stages—7 transistors and 2 diodes

Covers Medium and Long Waves and Trawler Band. The ideal radio for home, car, or can be fitted with carrying strap for outdoor use. Completely portable—has built-in Ferrite rod aerial for wonderful reception. Special circuit incorporating 2 RF Stages, push-pull output, 3in. speaker (will drive large speaker). Size 7½ x 5½ x 1½ in. (Uses 9v battery, available anywhere.)

Total cost of all parts now only

**£3.19.6** P. & P. 3/6

Parts Price List and easy build plans 2/- (Free with kit)

Callers side entrance  
 Barratts Shoe Shop.

## RADIO EXCHANGE Ltd

Open 9—5 p.m.  
 Saturdays 9—12.30 p.m.

61a HIGH STREET, BEDFORD. Phone: 52367

# HI-FI AMPLIFIERS — TUNERS — RECORD PLAYERS

20 + 20  
STEREO  
AMP.  
AA-22U



GARRARD  
PLAYER  
AT-60



**TRANSISTOR MIXER.** Model TM-1. A must for the tape enthusiast. Four channels. Battery operated. Similar styling to Model AA-22U Amplifier. Kit £11.16.6 Assembled £16.17.6

**20 + 20W TRANSISTOR STEREO AMPLIFIER.** Model AA-22U. Outstanding performance and appearance. Kit £39.10.0 (less cabinet). Attractive walnut veneered cabinet £25.0 extra. Assembled incl. cabinet, £59.15.0

**GARRARD AUTO/RECORD PLAYER.** Model AT-60, less cartridge £13.1.7. With Decca Deram pick-up £17.16.1 incl. P.T. Many other Garrard models available, ask for Lists.

**HI-FI MONO AMPLIFIER.** Model MA-5. A general purpose 5W Amplifier, with inputs for Gram., Radio. Modern functional appearance. Kit £11.9.6 Assembled £15.15.0

10W  
POWER  
AMP.  
MA-12



9 + 9W  
STEREO  
AMP.  
S-99



**HI-FI MONO AMPLIFIER.** Model MA-12. 10W output, wide freq. range, low distortion. Use with control unit.

Kit £12.18.0 Assembled £16.18.0

**3 + 3W STEREO AMPLIFIER.** Model S-33. An easy-to-build, low cost unit. 2 inputs per channel. Kit £13.7.6 Assembled £18.18.0

**DE LUXE STEREO AMPLIFIER.** Model S-33H. De luxe version of the S-33 with two-tone grey perspex panel, and high sensitivity necessary to accept the Decca Deram pick-up. Kit £15.17.6 Assembled £21.7.6

**HI-FI STEREO AMPLIFIER.** Model S-99. 9+9W output. Ganged controls. Stereo/Mono gram, radio and tape inputs. Push-button selection. Printed circuit construction. Kit £28.9.6 Assembled £38.9.6

**POWER SUPPLY UNIT.** Model MGP-1. Input 100/120V, 200/250V, 40-60 c/s. Output 6.3V, 2.5A A.C. 200, 250, 270V, 120mA max. D.C. Kit £5.12.6 Assembled £7.2.6



## Make the most of your leisure time..

### FOR THE INSTRUMENTALIST



PA-2

**TRANSISTOR PA/GUITAR AMPLIFIER, PA-2.** 20 Watt amplifier. Two heavy duty speakers. Four inputs. Two channels. Variable tremolo. Speed and depth controls. Weight 51lb. 18" high x 29" wide x 10" deep. Kit £44.19.0 Assembled £59.10.0

**VALVE PA/GUITAR AMPLIFIER, PA-1.** 50 Watt amplifier. Kit £54.15.0 Assembled £74.0.0 Castors or legs available as extras.

### TRANSISTOR RECEIVERS



Oxford

**"OXFORD" LUXURY PORTABLE Model UXR-2.** Specially designed for use as a domestic or personal portable receiver. Many features, including solid leather case. Kit £14.18.0 incl. P.T.



UXR-1

**TRANSISTOR PORTABLE. Model UXR-1.** Pre-aligned I.F. transformers, printed circuit. Covers L.W. and M.W. Has 7" x 4" loudspeaker. Real hide case. Kit £12.11.0 incl. P.T.

**JUNIOR EXPERIMENTAL WORKSHOP. Model EW-1.** More than a toy! Will make over 20 exciting electronic devices, incl.: Radios, Burglar Alarms, etc. 72 page Manual. The ideal present! Kit £7.13.6 incl. P.T.



GC-1U

**"MOHICAN" GENERAL COV. RECEIVER for Amateur or Short Wave listening.** Send for leaflet. Kit £37.17.8 Assembled £45.17.8

### TEST INSTRUMENTS

Our wide range includes:

**3" LOW-PRICED SERVICE OSCILLOSCOPE. Model OS-2.** Compact size 5" x 7 1/2" x 12" deep. Wt. only 9 1/2 lb. "Y" bandwidth 2 c/s-3 Mc/s ± 3dB. Sensitivity 100mV/cm T/B 20 c/s-200 kc/s in four ranges, fitted mu-metal CRT Shield. Modern functional styling. Kit £23.18.0 Assembled £31.18.0

**5" GEN.-PURPOSE OSCILLOSCOPE. Model 10-12U.** An outstanding model with professional specification and styling. "Y" bandwidth 3 c/s-4.5 Mc/s ± 3dB. T/B 10 c/s-500 kc/s. Kit £35.17.6 Assembled £45.15.0

**DELUXE LARGE-SCALE VALVE VOLT-METER. Model IM-13U.** Circuit and specification based on the well-known model V-7A but with many worth-while refinements. 6" Ernest Turner meter. Unique gimbal bracket allows operation of instrument in many positions. Modern styling. Kit £18.18.0 Assembled £26.18.0

**AUDIO SIGNAL GENERATOR. Model AG-9U.** 10 c/s to 100 kc/s, switch selected. Distortion less than 0.1%, 10V sine wave output metered in volts and dB's. Kit £23.15.0 Assembled £31.15.0

**VALVE VOLTMETER. Model V7-A.** 7 voltage ranges d.c. volts to 1,500. A.C. to 1,500 r.m.s. and 4,000 peak to peak. Resistance 0.1 Ω to 1,000M Ω with internal battery. D.C. input resistance 1M Ω. dB measurement, has centre-zero scale. Complete with test prods, leads and standardising battery. Kit £13.18.6 Assembled £19.18.6

**MULTIMETER. Model MM-1U.** Ranges 0-1.5V to 1,500V a.c. and d.c.; 150A to 15A d.c.; 0.2 Ω to 20M Ω 4 1/2" 50A meter. Kit £12.18.0 Assembled £18.11.6

**R.F. SIGNAL GENERATOR. Model RF-1U.** Up to 100 Mc/s fundamental and 200 Mc/s on harmonics. Up to 100mV output. Kit £13.18.0 Assembled £20.8.0

**SINE/SQUARE GENERATOR. Model 1G-82U.** Freq. range 20 c/s-1 Mc/s in 5 bands less than 0.5% sine wave dist. less than 0-15 μ sec. sq. wave rise time. Kit £25.15.0 Assembled £37.15.0

**TRANSISTOR POWER SUPPLY. Model IP-20U.** Up to 50V, 1.5A output. Ideal for Laboratory use. Compact size. Kit £35.8.0 Assembled £47.8.0



OS-2



VVM, IM-13U



V-7A



RF-1U



1G-82U

Prices and specifications subject to change without notice

WELCOME TO OUR LONDON HEATHKIT CENTRE  
233 Tottenham Court Road  
We open MONDAY-SATURDAY 9 a.m.-5.30 p.m.  
THURSDAY ... 11 a.m.-2.30 p.m.  
Telephone No: MUSEUM 7349  
WHEN YOU ARE IN TOWN, WE HOPE YOU WILL VISIT US THERE

## TAPE AMPLIFIERS — TAPE DECKS — CONTROL UNITS



**FM TUNER  
FM-4U**

**HI-FI FM TUNER, Model FM-4U.** Available in two units. R.F. tuning unit (£2.15.0 incl. P.T.) with I.F. output of 10.7 Mc/s and I.F. amplifier unit, with power supply and valves (£13.13.0). Total Kit **£16.8.0**



**STUDIO-MATIC  
TAPE DECK**

**STUDIOMATIC "353" TAPE DECK.** The finest buy in its price range. Operating speed: 1½", 3½" and 7½" p.s. Two tracks, "wow" and "flutter" not greater than 0.15% at 7½" p.s. £13.10.0 With TA-1M Tape Pre-amplifier kit **£31.5.6**

**HI-FI AM/FM TUNER, Model AFM-1.** Available in two units which, for your convenience, are sold separately. Tuning heart (AFM-T1—£4.13.6 incl. P.T.) and I.F. amplifier (AFM-A1—£22.11.6). Printed circuit board, 8 valves. Covers L.W., M.W., S.W., and F.M. Built-in power supply. Total Kit **£27.5.0**



**TRUVOX  
TAPE DECK**

**TRUVOX D-93 TAPE DECKS.** High quality stereo/mono tape decks. D93/2, ½ track, **£36.15.0** D93/4, ¼ track, **£36.15.0**



**AM/FM  
TUNER**

**TAPE RECORDING/PLAYBACK AMPLIFIER.** Thermometer type recording indicators, press-button speed compensation and input selection.

Mono Model TA-1M.  
Stereo Model TA-1S.

Kit **£19.18.0** Assembled **£28.18.0**  
Kit **£25.10.0** Assembled **£35.18.0**

**MONO CONTROL UNIT, Model UMC-1.** Designed to work with the MA-12 or similar amplifier requiring 0.25V or less for full output. 5 inputs. Baxandall type controls. Kit **£9.2.6** Assembled **£14.2.6**

**STEREO CONTROL UNIT, Model USC-1.** Push-button selection, accurately matched ganged controls to ±1dB. Rumble and variable low pass filters. Printed circuit boards. Kit **£19.19.0** Assembled **£27.5.0**

## Enjoy building a Heathkit model



### SPEAKER SYSTEMS



**SSU-1**

**HI-FI SPEAKER SYSTEM, Model SSU-1.** Ducted-port bass reflex cabinet "in the white". Two speakers. Vertical horizontal models with legs, Kit **£12.12.0**, without legs, Kit **£11.17.6** incl. P.T.

The **BERKELEY SLIM-LINE SPEAKER SYSTEM**, fully finished walnut veneered cabinet for faster construction. Special 12" bass unit and 4" mid/high frequency unit. Range 30-17,000 c/s. Size 26" x 17" only 7½" deep. Modern attractive styling. Excellent value. Kit **£19.10.0** Assembled **£24.0.0**

**COTSWOLD SPEAKER SYSTEMS.** Outstanding performance for price. **MFS:** Size 36" x 16½" x 14" deep. Kit **£25.12.0** Assembled **£33.17.0**

**STANDARD:** Size 26" x 23" x 14½" deep. Kit **£25.12.0** Assembled **£33.17.0**



**Berkeley**

### HI-FI CABINETS

A wide range available including kits, ready assembled cabinets or assembled and fully finished cabinets, for example:

**GLOUCESTER.** Kit **£18.10.0** incl. P.T.

**MALVERN.** Kit **£18.1.0** incl. P.T.

**CHEPSTOW.** Kit **£11.18.6** incl. P.T.



**Malvern**

**SEND FOR THE LATEST  
FREE CATALOGUE**

Deferred terms available in UK over £10  
Prices quoted are Mail Order prices

**DAYSTROM LTD**

Dept. P.E.—9  
GLOUCESTER

### "AMATEUR" EQUIPMENT

**80-10M TRANSMITTER, DX-40U.** Power inputs 75W. C.W., 60W peak CC phone. Output 40W to aerial. Provision for VFO. Kit **£29.19.0** Assembled **£41.8.0**

**SSB ADAPTOR, SB-10U**  
Kit **£39.5.0** Assembled **£45.18.0**

**AMATEUR BANDS RECEIVER, Model RA-1.** To cover all the Amateur Bands from 160-10 metres. Many special features, including: half-lattice crystal filter; 8 valves; signal strength "S" meter; tuned R.F. Amp. stage. Kit **£39.6.6** Assembled **£52.10.0**

**160-10M TRANSMITTER, Model DX-100U.** Careful design has achieved high performance and stability. Completely self-contained. Kit **£81.10.0** Assembled **£106.15.0**

**COMMUNICATIONS TYPE RECEIVER, Model RG-1.** A high performance, low cost receiver for the discriminating listener. Frequency coverage: 600 kc/s-1.5 Mc/s and 1.7 Mc/s-32 Mc/s. Kit **£39.16.0** Assembled **£53.0.0**

**REFLECTED POWER METER and SWR BRIDGE, Model HM-11U.** Indicates reliability, but inexpensively, whether the RF power output of your TX is being transferred efficiently to radiating antenna. Kit **£8.10.0** Assembled **£10.15.0**

**OUTSTANDING "AMATEUR" EQUIPMENT**  
A wide range of American Amateur SSB equipments is now available in the U.K. Why not send for full details of range, for example:

**FILTER TYPE SSB TRANSCIEVERS**  
Models for 80, 40 or 20 metre bands.  
Model HW-12 (80M) **£67.10.0** Kit.  
Model HW-22 (40M) **£66.0.0** each Kit.  
Model HW-32 (20M) } price incl. duty, etc.



**DX-40U**



**RA-1**



**HM-11U**



**80M Transceiver  
HW-12**

Without obligation please send me (Tick here)

**FREE BRITISH HEATHKIT CATALOGUE**.....

**FULL DETAILS OF MODEL(S)**.....

(Please write in BLOCK CAPITALS)

NAME .....

ADDRESS .....

**DEPT. P.E.9**

# take your pick!



## from IR semiconductor centers

Over 100 IR semiconductor devices are available from your dealer, many with free instruction manuals and project and experiment details.

Look for the floor-standing 'Semiconductor Center,' or the counter-top 'Minicenter.'

**EXPERIMENTER SEMICONDUCTOR KITS**  
**MOUNTING KITS AND HEAT SINKS**  
**SILICON BRIDGE RECTIFIERS**  
**UNIUNION TRANSISTORS**  
**SELENIUM PHOTO CELLS**  
**INSTRUMENT RECTIFIERS**  
**AUTOMOTIVE RECTIFIERS**  
**SILICON SOLAR CELLS**  
**SILICON RECTIFIERS**  
**GERMANIUM DIODES**  
**THYRISTORS (S.C.R.)**  
**ZENER DIODES**  
**TRANSISTORS**  
**SELENIUM STACKS**



Write for the free illustrated catalogue and price-list, also the name and address of your nearest IR SEMICONDUCTOR CENTER

**INTERNATIONAL RECTIFIER**  
 HURST GREEN • OXTED • SURREY • Tel.: OXTED 3215

Dealers—write for details of how you can start your own IR SEMICONDUCTOR CENTER.

**IR semiconductor centers**

### THE MOTORISTS' REV COUNTER FULLY TRANSISTORISED



Suits 4 or 6 cyl. engine. Would cost at least £8 to buy. Kit contains moving coil movement and all parts including transistors, a circuit diagram, maximum reading 8,000 r.p.m., and full instructions. Send P.O. for 21/6, which includes 2/- postage.

#### CYLDON U.H.F. TUNER

complete with PC.88 and PC.86 Valves. Full variable tuning. New and unused. Size 4½" × 5½" × 1½". Complete with circuit diagram. 35/- plus 2/6 P. & P.



#### 3 to 4 WATT AMPLIFIER KIT



comprising chassis 8½" × 2½" × 1". Double wound mains

transformer, output transformer, volume and tone controls, resistors, condensers, etc. 6V6, ECC81 and metal rectifier. Circuit 1/6 free with kit. 29/6 plus 4/6 P. & P. The above Amplifier built and tested 10/6 extra.

#### 8-watt 5-valve PUSH-PULL AMPLIFIER & METAL RECTIFIER

Size: 9 × 6 × 1½" A.C. Mains 200-250v. 5 valves. For use with Std. or L.P. records, musical instruments, all makes of pick-ups and mikes. Output 8 watts at 5 per cent total distortion. Separate bass and treble lift controls. Two inputs, with controls, for gram. and mike. Output Transformer tapped for 3 and 15 ohms speech coils. Built and tested. £3.19.6. P. & P. 10/-

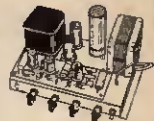

#### "MUSETTE" 6-TRANSISTOR SUPERHET PORTABLE RADIO

- ★ 2½" Speaker.
- ★ 6 Transistors Superhet Output 200 mw.
- ★ Plastic Cabinet in red, size 4½" × 3" × 1½" and gold speaker louvre.
- ★ Horizontal Tuning Scale.
- ★ Ferrite Rod Internal Aerial.
- ★ IF 460 Kc/s.
- ★ All components Ferrite Rod and Tuning Assembly mounted on printed board.
- ★ Operated from PP3 Battery.
- ★ Fully comprehensive instructions and point-to-point wiring diagram.

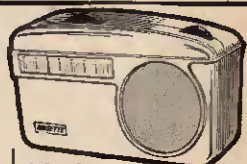

**39/6** Inc. carrying strap. Circuit Diagram 2/6— P. & P. 3/6 free with parts

- ★ Printed Circuit Board.
- ★ Tunable over medium and long waveband.
- ★ Car aerial and earpiece socket.

#### TRANSISTORISED SIGNAL GENERATOR

Size 5½" × 3½" × 1½". For IF and RF alignment and AF output, 700 c/s frequency coverage 460 Kc/s to 2 Mc/s in switched frequencies. Ideal for alignment to our Elegant Seven and Musette. Built and tested. 39/6. P. & P. 3/6.

#### ELEGANT SEVEN Mk.II

Combined Portable and Car Radio  
 The Radio with the "Star" Features

- ★ 7-transistor superhet. Output 350 mW.
- ★ Wooden cabinet, fitted handle with silver-coloured fittings, size 12½ in. × 8½ in. × 3½ in.
- ★ Horizontal tuning scale, size 11½ in. × 2½ in. in silver with black lettering.
- ★ All stations clearly marked.
- ★ Ferrite-rod internal aerial.
- ★ Operated from PP3 battery.
- ★ I.F. neutralisation on each stage 460 kc/s.
- ★ D.C. coupled output stage with separate A.C. negative feed back.
- ★ All components, ferrite rod and tuning assembly mounted on printed board.
- ★ Fully comprehensive instructions and point-to-point wiring diagram.
- ★ Printed circuit board, back-printed with all component values.
- ★ Fully tunable over medium and long waveband.
- ★ Car aerial socket.

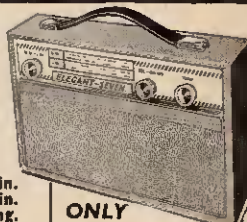

**ONLY £4.4.0**  
 Plus 6/6 Post & Packing

**POWER SUPPLY KIT** to purchasers of Elegant Seven parts, incorporating mains transformer, etc. A.C. mains 200-250v. Output 9v. 50mA, 7/6d, extra.

4 in. SPEAKER. Parts list and circuit diagram 2/6. FREE with parts. Shop Hours 9 a.m. — 6 p.m. Early Closing Wednesday

All enquiries stamped addressed envelope  
**RADIO & T.V. COMPONENTS (ACTON) LTD.**  
 21D, HIGH STREET, ACTON, LONDON, W3

# THE MOST FANTASTIC RADIO OFFER EVER!

ANOTHER GOLD FOR RUSSIA!

GETS WORLD WIDE RECEPTION  
THOUSANDS OF STATIONS & TRANSMISSIONS!

NOT JUST A  
RADIO BUT  
TECHNOLOGICAL  
MAGIC!



## 8 WAVE BAND 10 TRANSISTOR PORTABLE RADIO

### £10.19.6 OR LOW DEPOSIT

BOX & POST 4'6

**29½ GNS.  
PERFORMANCE**

What a  
wonderful  
Gift!

YES, up to 29½ gns. performance yet we offer at this amazing cash price—only £10.19.6, box and post 4/6, or send £3 dep., balance 18 fortnightly payments of 11/11 (total credit sale price 274/6) + post. The impossible has been done! The Russians have triumphed in producing this fantastic 8 wave band Radio that YOU can have for hardly more than the cost of an ordinary single wave cheap Transistor! Another proof of the fantastic ability of Russia in the field of electronics! 'H & G' Britain's great discount house, has secured a huge quantity allocated to the U.K. They've just arrived! Brand spanking new and ready for use. YOU GET THIS AMAZING SET FROM US AT A PRICE THAT BEARS NO RELATION TO ITS TRUE VALUE! Yes, 8 separate wave bands, including Standard Long, Medium and Short to cover the entire world. Unique slide control wave band selection unit gives incredible ease of station tuning! Hurry and test for yourself—thousands of stations and different transmissions at your fingertips 24 hours a day, even including amateur 'Hams,' 'Pirate' radio stations, ships, etc.—truly nothing is secret! The Radio enthusiast can have the world in the palm of his hand! You must hear it for yourself to believe it! Listen to the superb sweet tone! Control it from a whisper to a roar that will fill a hall! Runs economically on standard batteries—take it anywhere. Perfect also for use in your car—any speed, any direction! SIZE 10½" x 7½" x 3½". Made to give years of perfect service. Beautifully designed. Attractive contrasting colours. Complete with internal ferrite rod aerial and 'built-in' telescopic aerial extending to full 38" length. Also coloured Radio manual, including simple operating instructions, and circuit diagram. Can also be used as extension amplifier for record player, radiogram, tape recorder or public address. 12 months' guarantee.

**Headquarter & General Supplies**

(Dept. PE/8), 196-200 Coldharbour Lane, Loughboro, Junc., London, S.E.5. (Wed. 1), 37 High Holborn (Thurs. 1), 267 Oxford Street (Wed. 1, Thurs. 8, Fri. 6), 166 North End, Croydon (Wed. 1), 149 High Street, Guildford (Thurs. 7), 121 High Street, Colchester (Thurs. 1).  
Stores open 6 p.m. Saturday, Friday 7 p.m.

# RADIONIC

## RADIO & ELECTRONIC CONSTRUCTION SYSTEM

**ABSORBING  
AND  
EXCITING!**

Unique and brilliantly simple. Hundreds of educational establishments—Universities, Technical Colleges, Schools, the Armed Forces—are already using Radionic for electronic instruction. Enthusiastic owners range from 9 to 82 years of age. Selected by the Council of Industrial Design for all British Design Centres. Featured in Sound and Television broadcasts.

The system is beautifully engineered from top quality British components. No soldering. No mains. No prior knowledge needed. Simply arrange components on perforated transparent panel, position brass connecting strip underneath, fix with 6BA nuts and circuit works with full efficiency. You can then dismantle and build another circuit. Your results are guaranteed by our Technical Department and News Letter Service. All parts available separately for conversion or expansion of sets.

- UNIQUE!** Our "No soldering" printed circuit board for superhet portable. Simply insert components and tighten nuts.
- No. 1 Set £5.18.6. 14 Circuits (Earphone)
  - No. 2 Set £5.19.6. 20 Circuits (Earphone)
  - No. 3 Set £10.19.6. 22 Circuits (7 x 4in. Loudspeaker output)
  - No. 4 Set £14.19.6. 26 Circuits (include 6 Transistor and reflex superhets)
- Prices (Post Free)

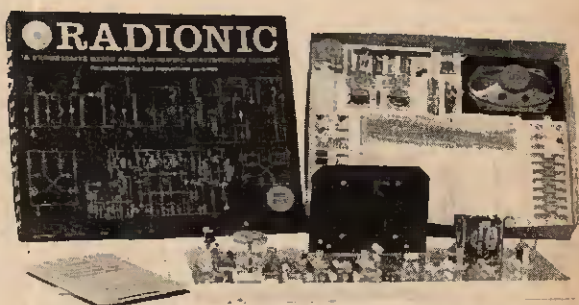

A No. 4 SET and 6-TRANSISTOR SUPERHET

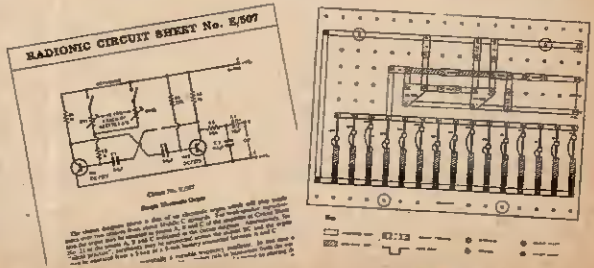

Theoretical Circuit  
Our 'E' Series of basic electronic circuits is available separately.  
Send for details of E/508, our do-it-yourself computer.

Full details from:  
**RADIONIC PRODUCTS LIMITED**  
STEPHENSON WAY, THREE BRIDGES  
CRAWLEY, SUSSEX

Tel.: CRAWLEY 28700 Trade Enquiries Invited

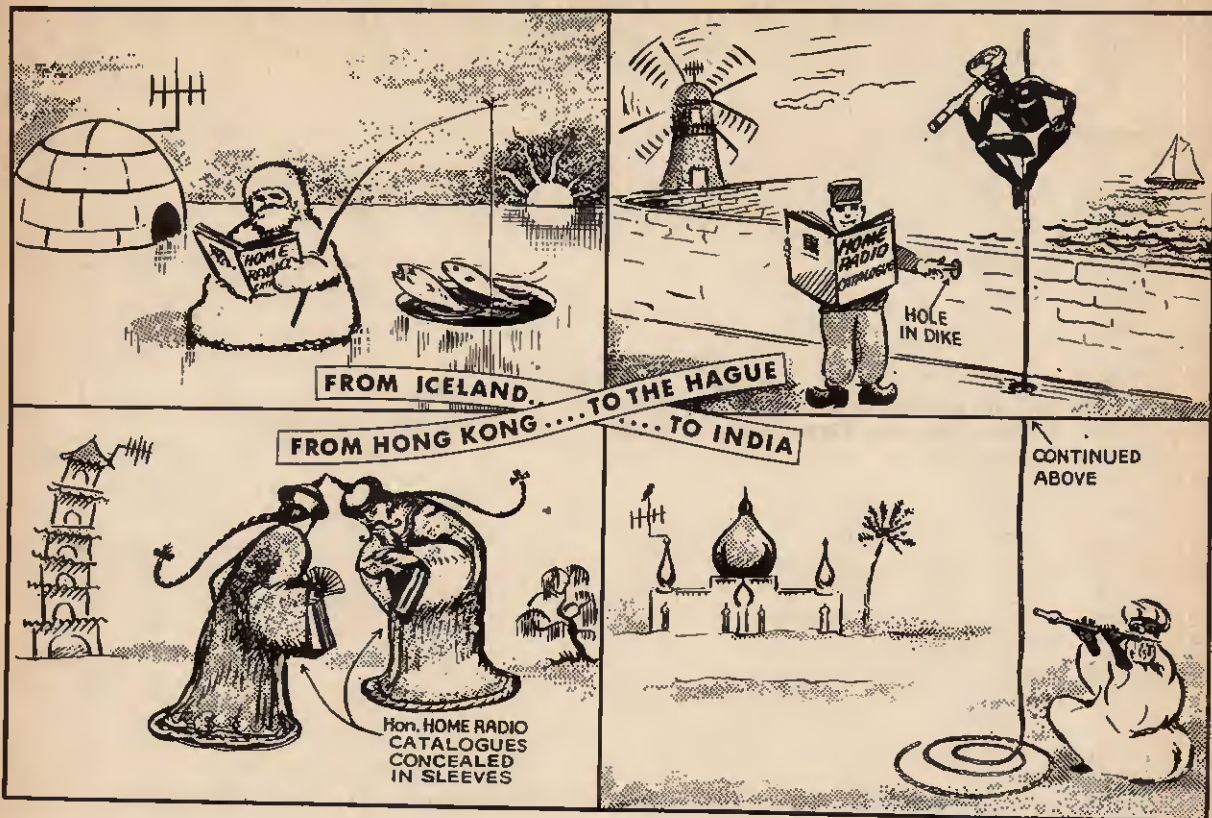

In our office at Mitcham we have a large map of the world. We stick a pin in it to mark each new area to which we have despatched our famous Components Catalogue. Our world has become a pin cushion! Yes, it's not only from Mitcham to Morden that our Catalogue is being used, nor even only from Putney to Pimlico . . . we know for instance that it is being used by the British Antarctic Survey Team at the South Pole, and as far North as the Arctic Circle. Fiji, Pekin and Budapest are just three more of the hundreds of places marked on our map. It is not by chance that the demand for the Home Radio Catalogue is world-wide. It is due to its reputation for accuracy, clarity and comprehensiveness. We have always set ourselves a high standard on these matters and we ensure that each edition is better than its predecessors.

Even if you *don't* live in Timbuktu or Wogga Wogga we shall be delighted to send you a copy of our catalogue. The price is still 7/6 plus 1/6 postage and packing. And remember—every copy contains five coupons, each worth one shilling when used as directed. Fill in the coupon on the right and send it today with your P.O. or cheque for nine shillings. Your catalogue will be sent by return post.

*Please write your Name and Address in block capitals*

Name.....

Address.....

.....

.....

.....

Home Radio Ltd., Dept. PE, 187 London Road, Mitcham, Surrey

## KEEPING IN TOUCH

THE need for a simple, inexpensive but reliable communication system to enable old people, particularly those who are housebound, to get in touch with a near neighbour, has long been recognised by social workers. Experiments at present being undertaken by the Post Office and the North Western Electricity Board in conjunction with Manchester Corporation Welfare Services Department confirm this genuine need and give hope that a suitable system will shortly be devised.

Various ideas have been suggested from time to time to ensure that a handicapped or immobilised person could summon assistance at any time without delay. One big problem is how to ensure that the system, which may be a simple signalling circuit, or a two-way speech channel, can be brought into operation from any part of the house, since the need for help may arise unexpectedly and the exact whereabouts of the individual cannot of course be predicted. Perhaps the ideal system which would adequately cover all foreseeable requirements would be far too involved an installation to be a feasible proposition. Relative simplicity is a basic requirement, since economic and practical considerations must be taken into account.

It is to be hoped that the experiment at Manchester will resolve most of these problems, and lead in time to the establishment of a national service based on the use of a standardised device. In the meanwhile, enterprising and public spirited amateurs can play their part by devising and installing electronic devices for old folk in their immediate neighbourhood. Many amateurs have indeed been providing just such a "service" for long past, entirely of their own initiative. Perhaps, by drawing attention to this subject, this band of volunteers may grow even larger.

Unfortunately the kind of need we have been discussing is rarely obvious to the passer-by and often not even to a close neighbour. If this has not already occurred to you, why not look around your own locality—there may be someone in such circumstances requiring the kind of assistance you can quite easily provide. The few hours spent building and installing a warning system—whether this be an elementary bell or lamp type of alarm, or something rather more ambitious—will surely never be grudged.

## THIS MONTH

### CONSTRUCTIONAL PROJECTS

SOLID STATE IGNITION	628
WIDE RANGE SIGNAL GENERATOR	644
MODEL CONTROL TRANSMITTER	654
BEAM SWITCHING UNIT	661

### SPECIAL SERIES

SHORT CUTS—I	649
BEGINNERS START HERE—23	652

### GENERAL FEATURES

RAILWAY ELECTRONICS	622
DRY REED SWITCHES	635
INGENUITY UNLIMITED	640
EXPERIMENTS IN LOGIC DESIGN—4	658

### NEWS AND COMMENT

EDITORIAL	621
BOOK REVIEWS	639
AUDIO TRENDS	642
ELECTRONORAMA	650
DETACHED PARTICLES	671
READOUT	672

Our October issue will be published on  
Thursday, September 15

# RAILWAY ELECTRONICS

by B.K.COOPER

*Railways were early users of electricity for telegraphy, and soon applied electric locking devices to signalling controls. Until the large scale development of electric traction, however, railways tended to remain outside the stream of general industrial development, being served by their own specialised suppliers. The advent of the 25 kilovolt 50c/s a.c. system of traction in the 1950's, calling for the rapid adaptation of new techniques to railway operation, brought electronics into the railwayfield.*

It is often forgotten that railways grew up side by side with electricity. Michael Faraday's discoveries in electromagnetic induction were published a year after the opening of the Liverpool and Manchester Railway, and in 1937, when Euston Station had just been opened, the electric telegraph was far enough advanced for it to be tried out between Euston and Camden in North London.

Communications were essential to train operation and safety from the earliest days, and various special forms of telegraph were soon developed which served both for exchanging messages between signalmen and for applying safeguards against incorrect signalling procedures. This situation, now infinitely more sophisticated, has lasted into the era of electronics. Signal engineers are only beginning to think seriously of doing away with the fixed lineside signal, which remains the basis of railway traffic control, although it may be supported by automatic systems to ensure that its message cannot be ignored.

Both signalling and electric traction have felt the impact of electronics in more recent years. In the

1930's the pumpless mercury-arc rectifier, in its glass bulb and steel tank forms, revolutionised traction supply practice by enabling sub-stations to be unattended and remotely controlled. It also made it possible to feed railway sub-stations from the 50c/s distribution systems.

Previously rotary converters had been used to provide direct current for the trains, but there had been some difficulty in designing them to operate satisfactorily on the standard frequency supply. Railways had therefore built their own power stations, which generated at a lower frequency such as 25c/s. Today the mercury-arc rectifier for railway service is giving place to arrays of silicon diodes just as is happening in industry.

Another feature of the 1930's was the development of "push-button" signalling, based on electromechanical relays which controlled signals and points. They also ensured by their contact arrangements that once a movement had been signalled, the circuits capable of signalling a conflicting movement could not be energised.





## SIGNALLING CONTROL

Electric signalling greatly extended the area that could be controlled from a signal box compared with what was possible by manual methods. Electronics have enabled a most important further stride in this direction to be taken. A signal box with direct control of an electric signalling scheme of the type just described can also use an electronic link to control numerous similar satellite schemes spread over many route miles of line.

All railway signalling control systems must be "supervisory". That is to say, not only must they send operational commands to the remote equipment, but they must also carry return information which provides the signaller with a continuously updated picture of all signal aspects and the lie of points throughout his territory. Such a system can only be economic if all the equipment shares a common control and indication channel.

Electronic remote control of signalling began modestly on a branch line in the Isle of Sheppey in 1959. It has since been used in the most important power signalling installations on the recently electrified main London Midland Region line between Euston, Manchester and Liverpool. One of the systems on this route is the "Westronic" of the Westinghouse Brake and Signal Company. In principle this may be considered as providing a single circuit between the signal box and all the signalling equipment at the satellite location. Each control switch is connected to the circuit in turn for a fraction of a second in a continuously repeated cycle.

Simultaneously, the various items of remote equipment are connected to the other end of the circuit in a cycle synchronised with the first, so that each switch is interconnected momentarily with the item it controls (Fig. 1). During this interconnection, an impulse corresponding to the position of the control switch is sent to the satellite, and an impulse is returned showing the state of the controlled equipment. Only two conditions have to be represented—a switch open or closed, or relay contacts "up" or "down"—and these requirements are met by four frequencies, two for controls and two for return indications.

The sequence of interconnections is controlled by a master pulse generator which drives a series of transistor "flip-flop" circuits at each end of the system. Pulses are supplied to all stages in parallel, but clamping circuits ensure that only one can respond at a time.

When the first circuit switches, it releases the second in readiness for the next pulse, and so on. In changing over, each stage sends a signal to its associated transistor oscillator, causing it to transmit a frequency corresponding to the state of the linked equipment.

"Westronic" is a time division multiplex (t.d.m.) system. Where less information has to be handled, groups of different frequencies are allotted and transmitted simultaneously by frequency division multiplex (f.d.m.) systems.

## TRACK CIRCUITS

The various remote control systems for railway signalling are quite distinct from the safety circuits which prevent the signalling of conflicting train movements. If a signaller operates a control switch incorrectly, the "command" will travel out to the satellite, but the interlocking provided by the local relays will prevent the points and signals from responding unless it is safe for them to do so. Interlocking is a form of logic, and would seem an obvious area for

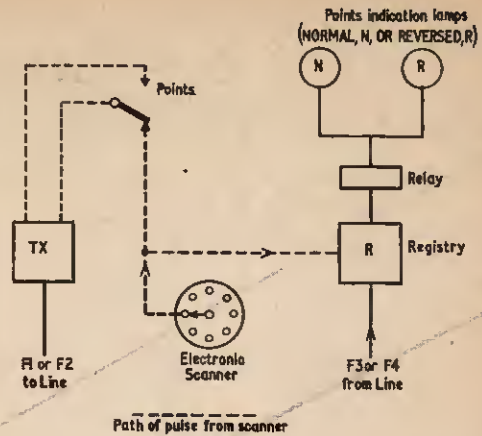

Fig. 1a. Control end equipment of a Westronic system

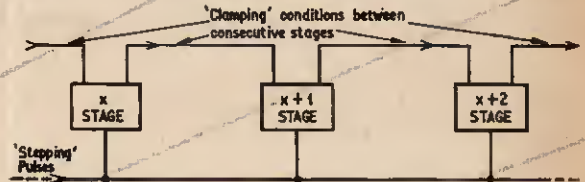

Fig. 1b. Operation of "Westronic" step-by-step scanner

electronics. In practice, railway signals engineers are proceeding cautiously in this direction.

An experimental static interlocking system using ferrite cores and transistors has been in service experimentally at Henley-on-Thames since late 1961, controlling access to three terminal platforms from a single running line. The equipment was developed for British Railways by Mullard Equipment Ltd. (now The M.E.L. Equipment Co. Ltd.). Ferrite elements are also used in a small interlocking installation on the London Midland Region electrified main line from Euston at Great Bridgeford, Staffs., by the Westinghouse Brake and Signal Company for controlling crossovers.

All signalling schemes depend on information on train movements derived from track circuits. In its simplest form a track circuit is a length of track insulated electrically from its neighbours, with a battery connected across the rails at one end, and a relay at the other. When no train is present, the battery current flows through the relay coil, using the rails as the circuit conductors. As soon as a train enters such a track circuit, its wheels and axles short-circuit the coil so that the relay is released (Fig. 2). The relay has multiple contacts, some open and some closed in the released condition, so that it performs a number of signalling functions.

Main-line electrification with 25kV, 50c/s a.c. gave an impetus to the use of electronic track circuits. It was essential to separate the frequencies of traction and signalling currents, and when d.c. could not be employed for track circuits it was necessary to resort to audio frequencies.

In the system of AEI-GRS Limited the feed to the track is taken from a vibrating reed device driven by a transistor oscillator at a frequency between 363 and 378c/s. Currents induced in the pick-up coils surrounding the reed are amplified and fed to the track.

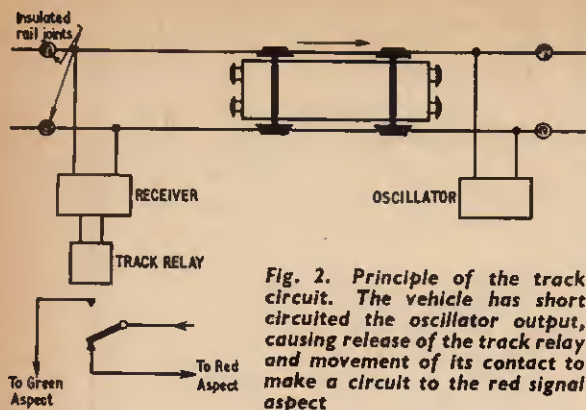

**Fig. 2. Principle of the track circuit. The vehicle has short circuited the oscillator output, causing release of the track relay and movement of its contact to make a circuit to the red signal aspect**

At the relay end of the track circuit they drive a reed receiver tuned to the same frequency. Currents induced in the receiver pick-up coils are amplified and rectified to operate a d.c. relay.

The essential feature of these devices is that each contains two reeds with the same natural frequency of vibration, mounted on a baseplate which provides mechanical coupling between them. When one is made to vibrate, the second reed follows suit due to the energy transmitted through the baseplate. Together they form a highly selective filter, permitting frequencies spaced by only 3c/s to be used without risk of a receiver responding to currents not intended for it.

### CIRCUITING PROBLEM

Tunnels present a track circuiting problem in that damp may provide sufficient leakage between the rails to shunt the relay when no train is present. This is a "fail safe" condition, but can cause serious operating delays. A solution used in the 1 mile 666 yard Kilsby tunnel near Rugby, on the main line from Euston, is to feed the rails with a very low a.f. voltage, which is transformed up at the relay end.

Feed frequencies of 125c/s or 175c/s are generated by transistor oscillators and coupled to the track through a step-down transformer. This low-level signal is raised in voltage by the relay end transformer, amplified and rectified for relay operation. The equipment was developed by the Compagnie de Signaux et d'Entreprises Électriques of Paris, and supplied to the London Midland Region by S.G.E. Railway Signals Limited.

At junctions where one line is relatively little used, a poorly conducting film on the rail head may make normal track circuiting unreliable. Raising the voltage is likely to cause leakage and waste of energy. An alternative is to apply a high voltage to the rails in the form of pulses. Equipment supplied by the Lucas organisation to meet these conditions employs a transistor relaxation oscillator to generate positive d.c. pulses with a peak amplitude of 20 or 40 volts from a 4 volt d.c. input. At the other end of the track circuit the pulses pass to a conventional half-wave rectifier with reservoir capacitor for energising a relay.

### OVERHEATED AXLEBOXES

Remote control of signalling by electronic systems has greatly reduced the number of signal boxes needed on main lines. It follows, however, that trains are less often under observation than in the past and there may be delay in spotting faults. Serious attention

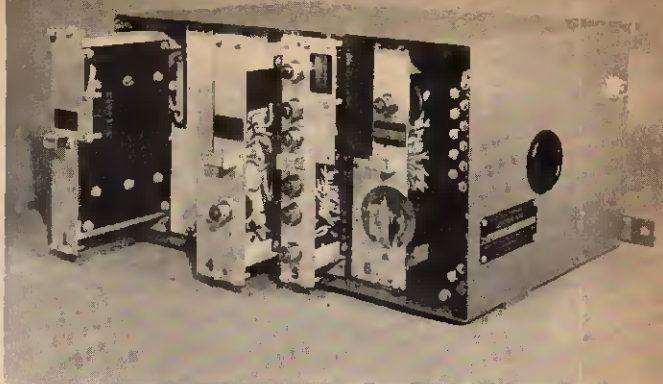

**Control box of AEI speed indicating equipment for locomotives**

is therefore being given to methods of detecting overheated axleboxes in freight or passenger rolling stock, and transmitting a warning so that the train can be stopped. A technique used at several places on the French National Railways uses infra-red detectors of indium antimonide mounted close to the rails.

In order to obtain high sensitivity, the indium antimonide is "polarised" by being situated in the field of a permanent magnet, which gives it photo-emissive properties and results in an output of about 1 microvolt in the presence of infra-red radiation from an axlebox at 50 degrees C. This minute signal is amplified and applied to a pulse transmitter connected by a telephone cable to a monitoring point where the pulses appear on a chart recorder.

**Part of the control panel in Rugby signal box, from which remote interlockings are operated by an electronic supervisory system**



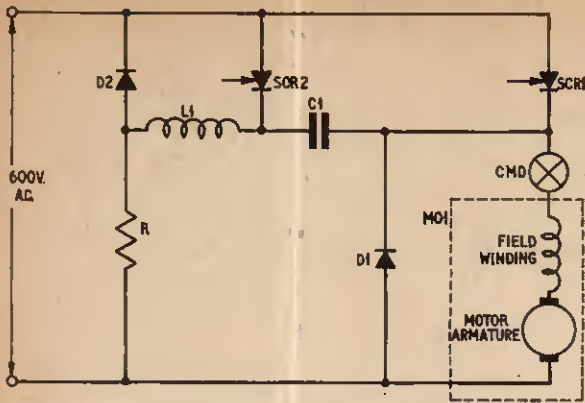

Fig. 3. Circuit for thyristor control of a traction motor

Semiconductor rectifiers, first of germanium and then of silicon, have been used in electric railway motive power since 1956. It is clear that the next step is to replace diodes with thyristors. At present traction motor voltage is controlled by resistances in d.c. traction, and by a tap-changer on the transformer in a.c. traction. Both forms of control operate in a number of steps, which is a compromise between the ideal of "stepless" voltage variation and the practicable cost and complexity of the equipment. Thyristors offer an alternative to each method.

### STEPLESS CONTROL

Experiments have been conducted with a 600V d.c. motor coach in which stepless control was provided by thyristors, no resistors or contactors being used. The basic circuit is shown in Fig. 3. Control is effected by varying the length of the "on" and "off" periods of thyristor SCR1, this being done automatically through the current monitoring device CMD in the motor circuit. While SCR1 is "off", current continues flowing round the loop provided by diode D1 due to the armature inductance. A second thyristor, SCR2, is used to switch T1 off, acting in conjunction with the circuit components D2, L1, C1 and R.

In a.c. traction the thyristors would replace the normal rectifying diodes and would turn off automatically in the negative half-cycles of the supply.

The preferred method at present is to use thyristor control in two steps. At starting, the traction motors would be connected to a half-voltage tapping on the transformer, and the firing of the thyristors would be controlled so that the motor voltage was raised smoothly from zero to that value. At this point the motors would be reconnected across the whole of the secondary, and the thyristors would repeat their firing cycle to raise the motor volts from half to full. If it were decided to do away with tap-changing altogether, it is likely that a scheme which varied the length and repetition frequency of the pulses would be preferred to simple phase-angle control of firing.

Thyristor circuits can also be arranged to invert, so that current generated by the motors of a locomotive when coasting down a gradient can be returned to the overhead line as a.c., thus developing a braking effort. The mercury-arc equivalent of the thyristor is the grid-

controlled rectifier, and 95 electric locomotives of the French National railways equipped with rectifiers of this type make use of their inverting property for braking.

The efficacy of "regenerative braking", as this system is called, depends on other loads being available to absorb the regenerated power. Where there are long gradients, and the traffic pattern is such that descending trains are balanced by others travelling in the opposite direction, regeneration can at the same time save wear of the mechanical brake gear and economise in consumption of electric power.

An unusual application of static inverters is to be tested in some Russian 3,000V d.c. locomotives. In order to increase the power that can be transmitted from the sub-stations, it is proposed to connect two sub-stations in series and feed the overhead line at 6,000V. This supply will be changed into a.c. by inverters in the locomotives, transformed down to 3,000V and then rectified to feed the normal 3,000V d.c. power circuits.

### THYRISTOR INVERTERS

Already traction engineers are looking beyond thyristor control of d.c. motors to the use of thyristor

*Remote control cubicle installed in the relay room at Watford signal box*

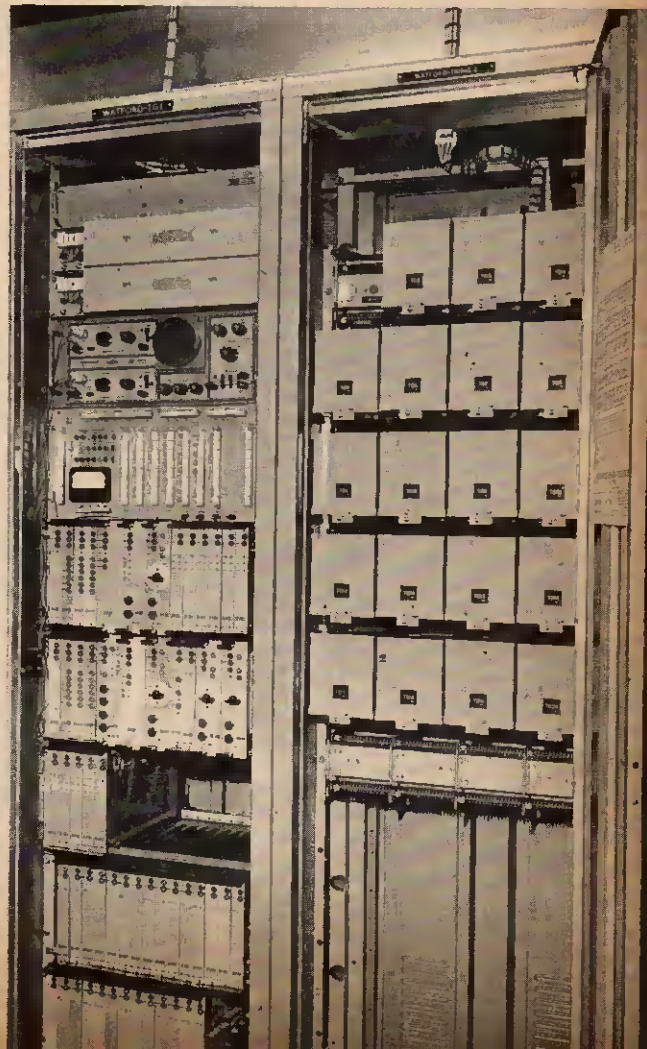

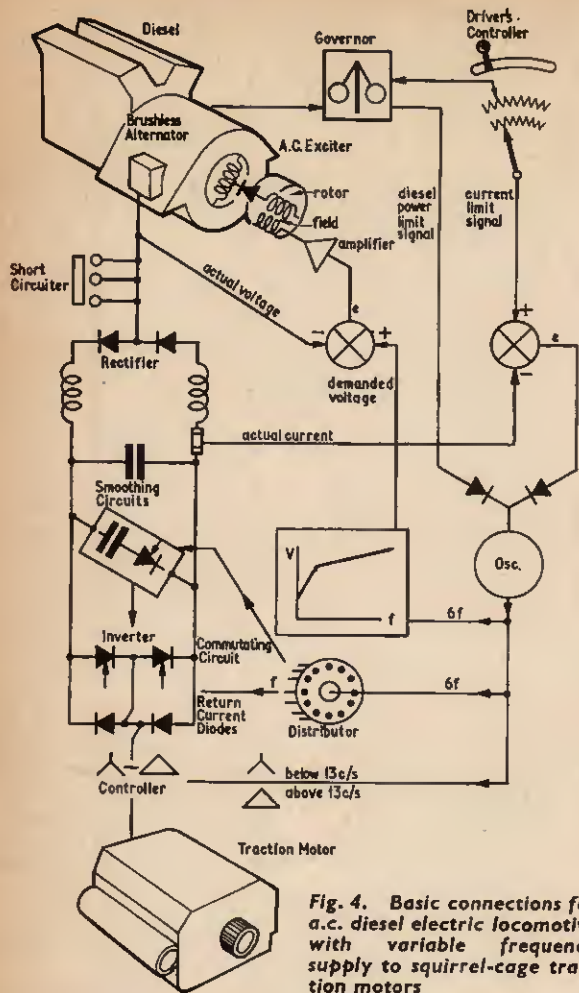

Fig. 4. Basic connections for a.c. diesel electric locomotive with variable frequency supply to squirrel-cage traction motors

inverters feeding a.c. at variable frequency to induction motors. A project of this kind is already in being, for the Brush Electrical Engineering Company has collaborated with British Railways in converting an existing diesel electric locomotive for this method of working.

## RESEARCH LOCOMOTIVE

The locomotive, known as the "Hawk", is powered by a 1,000 h.p. diesel engine driving a 1,000kW, 100c/s alternator. After rectification by silicon diodes, the alternator output passes to four thyristor inverters, each of which provides a variable frequency supply to a squirrel-cage traction motor (Fig. 4).

A similar scheme could be used in an a.c. electric locomotive, the difference being that a.c. power would be collected from the overhead line instead of being generated internally. Many years' experience has enabled d.c. traction motors to be built which achieve high reliability in the severe conditions of railway service, but few engineers would regret the passing of commutators and brushgear, and the inspection and maintenance they require.

The "Hawk" is a research project, and so far as locomotives in day-to-day service are concerned the main applications of electronics at present are to provide contactless switching in low-current control circuits rather than in power circuits. Some 750V d.c. locomotives on the Southern Region of British Railways use a Ward-Leonard control system instead of resistance control.

In one of these the usual generator field control contactors have been replaced by thyristors, giving stepless control of excitation, and hence of the traction motor voltage. However, a beginning has been made with the use of thyristors in the main power circuits, for a motor coach in the Eastern Region, which was fitted formerly as an experiment with control by a continuously variable transformer, has now been equipped with thyristor control.

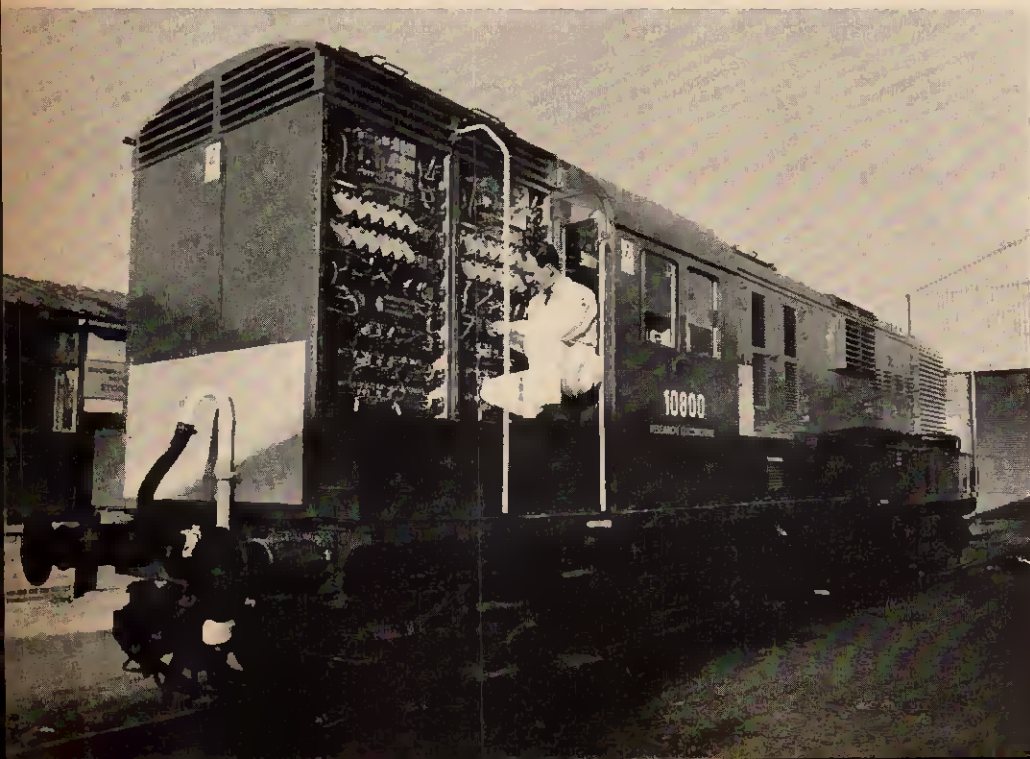

Electronic apparatus compartment in the "Hawk" experimental diesel-electric locomotive with variable-frequency speed control

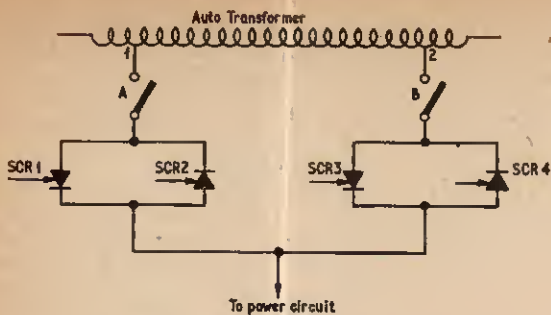

Fig. 5. Thyristor controlled tap-changing

### THYRISTOR TAP CHANGE

On the Continent thyristors have been used in conjunction with an ordinary tap-changer in an a.c. locomotive to relieve the tap-changer contacts of the duty of breaking heavy currents. This is in the 8,000 h.p. "EO3" class of the German Federal Railway, which during the International Transport Exhibition in Munich in 1965 worked demonstration trains between Munich and Augsburg at speeds of up to 125 m.p.h. The basic circuit is shown in Fig. 5.

Before a tap-change from Tap 1, thyristors SCR1 and SCR2 are switched on and conduct on alternate half-cycles. When the tap-change is made, the gate current is cut off and, as soon as the motor current passes through its next zero, the thyristors switch automatically to the blocking condition. At this instant contact "A" opens off-load, contact "B" closes, and thyristors SCR3, SCR4 are switched on. This occurs so rapidly that there is no interruption in the flow of current to the traction motors.

In a conventional tap-changer, similar continuity of supply has to be achieved by allowing two tappings to be momentarily connected to the power circuit at the same instant, providing transition resistors which are cut in and out of circuit on each tap-change to prevent the flow of short-circuit current between the two tappings. In the German scheme the thyristors are only brought into circuit when a tap-change is about to take place. They are thus able to handle starting currents of some 700A, although the nominal rating of each parallel circuit is only 440A, and no provision for forced air cooling is necessary.

### SOLID STATE SERVO

Solid-state devices are coming into use in British diesel-electric locomotives to replace hydraulic or electric servo systems previously used to control a variable resistance in the generator field circuit so that the electrical output matches the power input from the diesel engine.

In a system developed by the English Electric Company, which will be used in fifty 2,700 h.p. locomotives being built for British Railways, a transistor multi-vibrator is used to control two thyristors which apply a control voltage across the generator field. A potentiometer linked with the engine governor controls the duration of two square wave outputs from the multi-vibrator which trigger the "on" and "off" thyristors. The ratio of "on" to "off" periods determines the mean field current.

Among many ancillary electronic devices now coming into use in electric and diesel-electric traction, the various forms of electronic speedometer have some of the most important possibilities. In addition to the accurate presentation of speed to the driver, their output can be used for controlling speed at a selected level. Thus they could be essential elements in automatic train operation, either in accordance with instructions from the driver, or with command signals received through an inductive link with the track. ★



Siemens EO3 electric locomotive



# SOLID STATE

**D**URING recent years there has been an increasing number of electronic ignition systems offered for sale. This article sets out to enable the experimenter to build himself a system of compatible design to the commercial units but at a cost more suited to his pocket.

Before entering a detailed discussion of the relative merits of electronic ignition systems a brief description of the conventional battery/coil ignition system as used in most cars will be helpful.

## CONVENTIONAL FORM

Fig. 1 shows a typical car ignition circuit. When the ignition switch is closed the battery is connected across the primary of the ignition coil while the contact breaker points are in the closed position. This allows the current through the coil to build up to a maximum value determined by the battery voltage and primary coil resistance.

When the engine is rotated the points are opened and the current ceases. The field built up around the coil by the current through it then collapses inducing a voltage in the primary. Since the primary winding is magnetically coupled to the secondary, a voltage is also developed in the secondary winding equal to the primary voltage multiplied by the turns ratio as in any normal transformer.

Typical primary values can be between 200 and 400V and secondary values between 20,000 and 40,000V. The high tension voltage is then applied to each plug in turn by the distributor. This system however has several disadvantages listed below:

- (1) The high current broken causes arcing and hence a high rate of wear of the points.
- (2) As engine speed increases so the "dwell" time during which the points are closed decreases. This means that the time available for the current to rise to its final value is reduced and hence the output voltage is decreased.

- (3) When the points close at high engine speeds they bounce due to mechanical inertia reducing further the time available for the current to rise. The total effect of items (2) and (3) is to reduce the output voltage drastically as engine speed increases.

- (4) At low speeds the system is inefficient because the current drawn from the battery is excessively high, since the points are allowing the current to flow after it has reached its maximum value. This wastes energy in heating up the coil. In fact it is well known to readers with cars that at zero engine speed with the ignition left on and points closed the coil will eventually burn out.

So an improved ignition system requires that current through the points be reduced or in fact the points should be removed altogether. This is done by using an inductive pick-off to provide the trigger pulses for the electronic ignition systems of many racing cars. Secondly, the high voltage output should remain essentially constant over the entire speed range of the engine and the current drain should be reduced at low speeds. Electronic systems meet these needs quite well.

## ELECTRONIC SYSTEM

Because most cars already utilise points, it is difficult (unless designing a system from scratch) to replace them, so they are retained in most available commercial systems. Most of these get over the other problems mentioned by using the points to switch the base current of a transistor which in turn switches the much greater primary coil current by its collector/emitter.

The transistor has to be capable of withstanding peak voltages of 400V or more and peak currents of several amperes. In addition a different coil with a higher turns ratio must be used to get the best results, enabling the primary voltage to be reduced and the rise time of the secondary voltage to be improved.

# IGNITION

by E. BARNETT

Fig. 1. Typical conventional ignition circuit

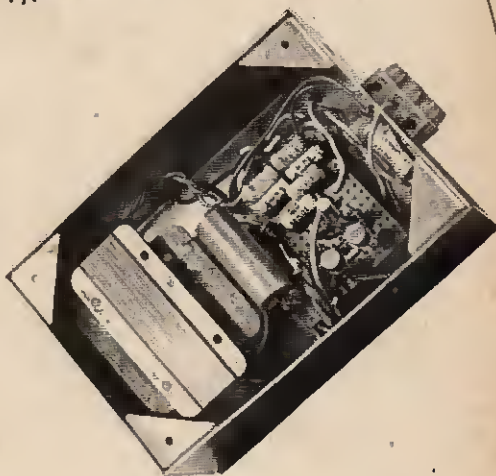
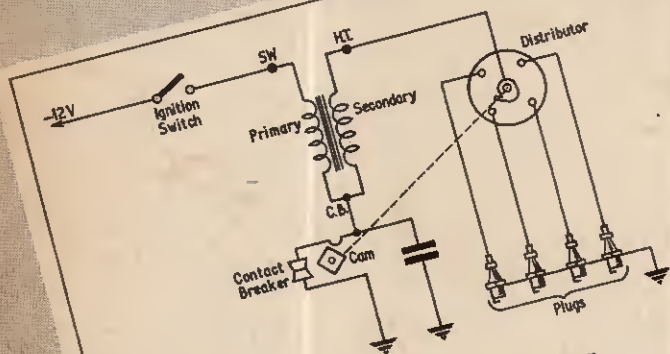
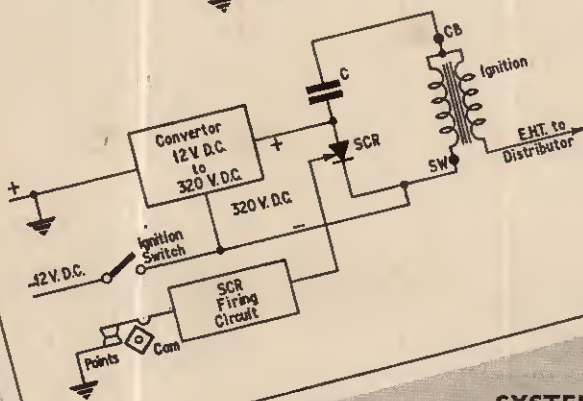

Fig. 2. Capacitor discharge system



Both of these items are costly in the single transistor and coil system.

A second approach, as used in this article, is the capacitive discharge method. Quite simply; a capacitor is charged to the required primary voltage during the "dwell" period of the points, and is then connected across the coil when the points open, thus discharging into the coil.

## SYSTEM DESCRIPTION

Fig. 2 shows a schematic diagram of the capacitive discharge system. The d.c. supply for charging the capacitor is generated by a normal converter circuit which charges the capacitor to about 300V d.c.

The points are connected to a trigger circuit, the output of which is connected to the gate of a silicon controlled rectifier (s.c.r.) or thyristor. When the points open the trigger circuit applies a pulse to the thyristor causing it to "fire" and connect the capacitor across the primary of the ignition coil to discharge into the coil.

When the oscillatory current through the ignition coil reverses, allowing the thyristor to turn off and the power supply to start again the capacitor recharges.

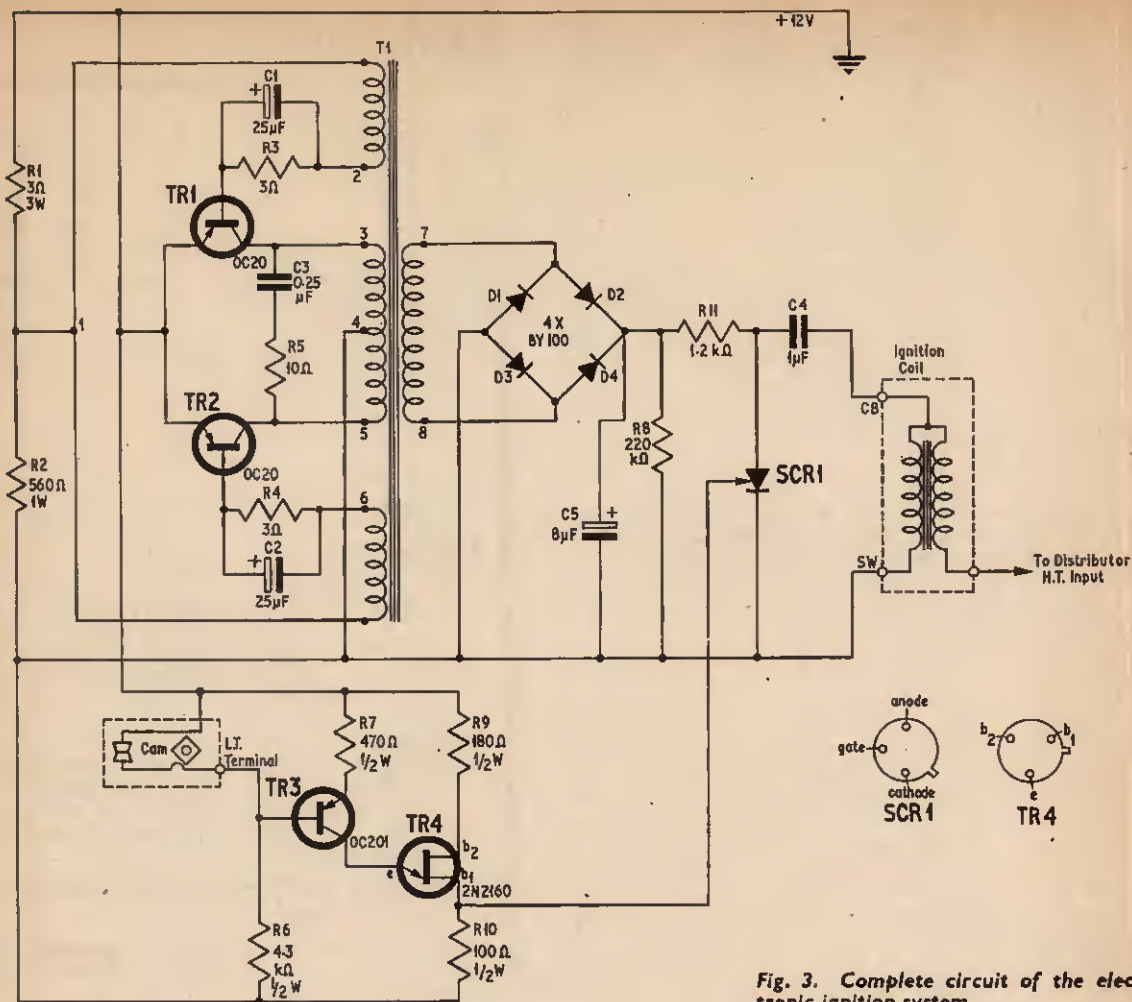

Fig. 3. Complete circuit of the electronic ignition system

## CONVERTER

The heart of the converter consists of two *pnp* transistors TR1 and TR2, and the transformer T1, which together form an inverter oscillator (see Fig. 3). When the ignition switch is closed the voltage applied to the circuit causes bias current to flow through TR1 and TR2 base-emitter junctions and R2.

Due to the slight differences that usually exist even between matched transistors, one of the two transistors conducts more than the second. The one which conducts more current (via its collector-emitter junction through its relevant half of the transformer primary winding) induces a feedback voltage in a positive direction to its own base and turns itself on. At the same time it induces feedback voltage in a negative direction to the second transistor, causing that transistor to turn off.

The current in the first transistor rises linearly with time, whilst the voltages across its half of the primary feedback winding and the secondary winding remain constant, i.e. square wave output. The primary voltage is derived from the 12V battery supply, whilst the secondary provides a stepped up voltage determined by the turns ratio to approximately 320V peak.

The current eventually reaches the saturation level of the transformer core and/or the conducting transistor "bottoms". Whichever occurs first, there is no longer any increase in collector current of the conducting transistor to maintain a magnetic field about the transformer.

At the instant of saturation the current in the conducting transistor rises sharply to a value limited by the gain of the transistor multiplied by its base current, so the transistors used are quite robust electrically. The field about the transformer collapses, reversing the voltages previously induced in the transistor feedback windings and causing the second transistor to turn on and the first to turn off. The process then repeats cyclically. The transformer output voltage is fed into a bridge rectifier, the d.c. output of which is used to charge C4.

## CAPACITOR DISCHARGE

While the contact breaker points are closed the thyristor presents a high resistance in its forward direction and C4 remains charged to the maximum output of diode bridge D1-D4. When the points open,

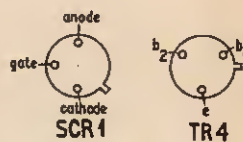



the firing circuit applies a trigger pulse to the thyristor gate electrode. When it fires the thyristor discharges C4 into the primary of the ignition coil. A high voltage, with a waveform like that shown in Fig. 4, is induced in the secondary of the ignition coil, where it is applied to one of the spark plugs via the distributor.

The thyristor is turned off when C4 has fully discharged into the ignition coil. The field built up around the coil collapses causing the voltage on terminal SW on the coil to swing negative with respect to that on the CB terminal (point "a" in Fig. 4). At this point the current through the thyristor falls to zero causing the thyristor to be reverse biased and hence turn off. At the end of the negative voltage swing across the coil, the capacitor retains a small positive charge (point "b" in Fig. 4). Most of the energy in the field around the coil has been dissipated by this time and the converter starts up again quickly recharging C4.

## FIRING CIRCUIT

The requirements of a thyristor gate firing circuit are that it should provide a pulse of very fast rise time, short duration and of amplitude great enough to fire the thyristor under all conditions, yet be less than the gate maximum ratings. The unijunction transistor (u.j.t.) has been developed specifically for this purpose.

The "earthy" side of the points in most British cars is connected to the positive side of the battery via the engine and bodywork (positive "earth" car electrical systems) and so the trigger circuit has been designed to work from this type. *This system will not operate on negative "earth" systems.* When the points are closed the base of TR3 is held positive with respect to its emitter holding the transistor cut off. With TR3 off the emitter-base one ( $b_1$ ) of the u.j.t. is non-conducting due to the high "off" impedance between TR3 collector and emitter. Only the interbase ( $b_2$  to  $b_1$ ) bias current of a few milliamps flows through R9 and R10, the voltage across R10 thus being negligible.

When the points open the positive bias is removed from TR3, which is turned hard on by its base-emitter current through R6 and R7. Due to the negative resistance characteristic of the u.j.t. emitter-base one ( $b_1$ ) junction, the voltage at the u.j.t. emitter rises rapidly to approximately six to eight volts before it conducts, producing a short pulse across R10 firing the thyristor.

## COMPONENTS . . .

### Resistors

R1	3.3Ω	3W	wire wound	R6	4.3Ω
R2	560Ω	2W	carbon	R7	470Ω
R3	3.3Ω	3W	wire wound	R8	220kΩ
R4	3.3Ω	3W	wire wound	R9	180Ω
R5	10Ω			R10	100Ω
				R11	1.2kΩ 2W

All resistors 10%, ½W carbon except where otherwise quoted

### Capacitors

C1	25μF	elect.	25V
C2	25μF	elect.	25V
C3	0.25μF	paper	150V
C4	1.0μF	polyester	400V
C5	8μF	elect.	400V

### Transformer

T1 Repanco Type TT51

### Semiconductors

TR1, TR2	OC20 (Mullard)	(2 off)
TR3	OC201 (Mullard)	
TR4	2N2160 (International Rectifier, Hurst Green, Oxted, Surrey.)	
SCR1	2N1599 (Davis & Whitworth Ltd., 220-4, West Road, Westcliff-on-sea, Essex.)	
DI-D4	BY100 (4 off)	

### Miscellaneous

Chassis 6in × 4in × 2in with cover plate  
Vero-board, 2in × 2½in, 0.015in hole matrix  
Heat sink compound (International Rectifier)  
Terminal block strip, bushes and mica insulators  
Solder tags

## CONSTRUCTION

The majority of the circuitry is mounted on Vero-board which is housed in a small aluminium box chassis measuring 6in × 4in × 2in deep along with the converter transformer T1.

The converter transistors TR1 and TR2 are chassis mounted; it is important that all burrs are removed after drilling the mounting holes as it is so easy to puncture the mica insulator that is used to insulate collector from chassis. Heat sink compound (silicon grease) should be applied to the undersides of the power transistor to effect a good heat transfer to the chassis. In view of the degree of vibration that the unit will experience, locking or shakeproof washers should be used under all nuts.

There should be no difficulty with the wiring and component layout if Figs. 5 and 6 are followed; however it should be noted that the silicon rectifiers DI-D4 and the higher wattage resistors should be mounted about ½in away from the board to allow maximum air circulation.

The simplest form of stand-off mounting for the board is a section of terminal block with a 4BA, ½in screw holding the board and block to chassis with a nut and lock-washer fixing.

## PRELIMINARY CHECKS

If possible it is wise to test the various parts of the circuit before attempting to instal it in the car.

To check converter output, join a wire link from the centre connection of the terminal block (2) to chassis; apply a 12 volt d.c. source to the circuit board with

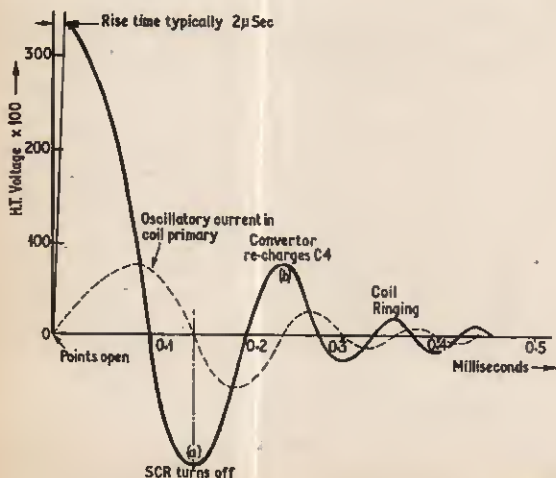

Fig. 4. Voltage induced in the coil secondary winding

negative to terminal block 1 and positive to chassis. The output from the d.c. side of the diode bridge D1-D4 should be approximately 300 to 350 volts.

Next, to check the thyristor and trigger circuit operation, connect a 100 kilohm resistor in series with a small neon indicator lamp between chassis and connection 3 of the terminal block; keep the wire link that was used in the first test. Switch on the 12V power supply and open the wire link. The neon should flash once at the instant of opening the link. Immediately afterwards turn off power supply.

## INSTALLATION

When installing the unit it is most important to mount it in the coolest place possible. A cable run of 4ft is permissible and it may be possible to use more according to the user's individual experiences. For front-engined cars the space between the front grill and

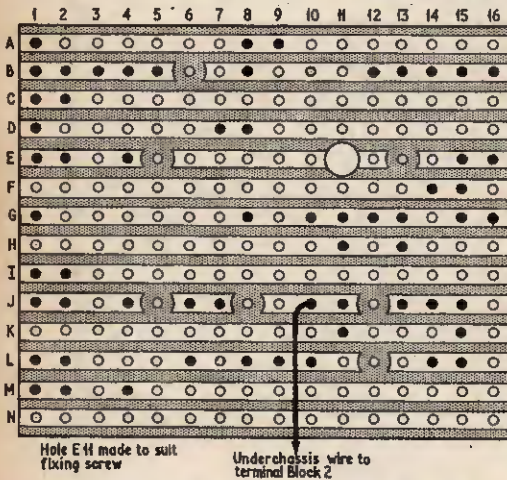
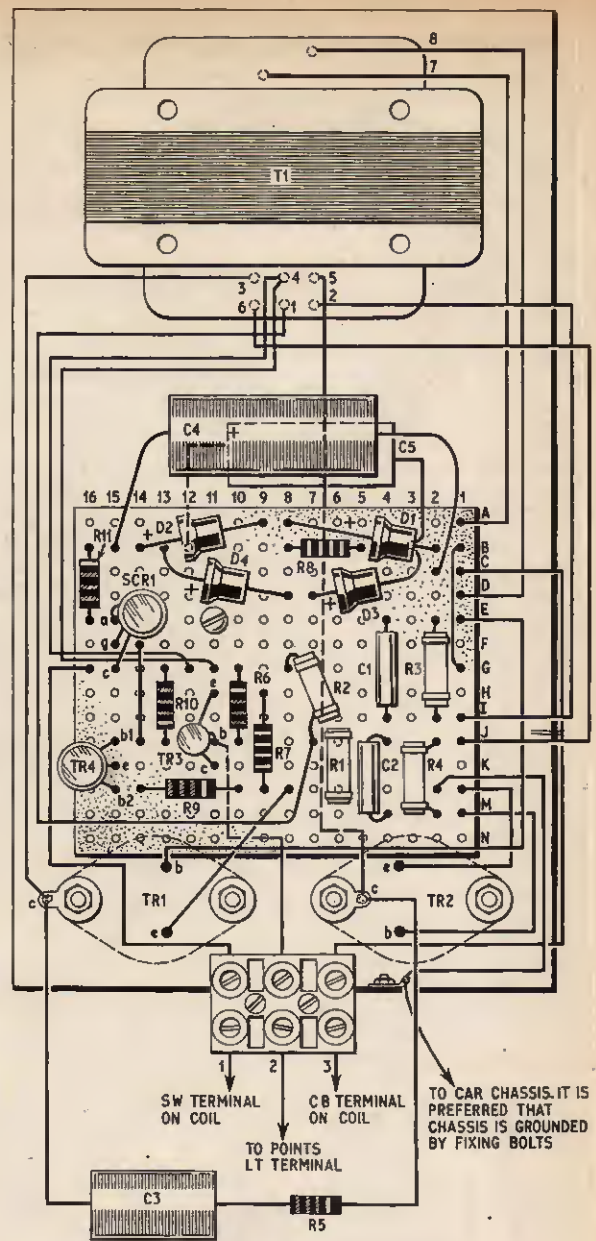

Fig. 5a (above). Underside view of the component board showing the copper strip breaks and connections

Fig. 5b (right). Layout of the complete circuit in the chassis box. TR1 and TR2 are mounted on the outside of the chassis; connections are as viewed underneath



radiator can be used where the airflow is maximum. On rear-engined cars the unit can be mounted beneath the rear so that the airflow keeps it cool.

For good heat transfer from the unit to car chassis; bolts or screws with generously dimensioned washers should be used so that the washers transfer any heat away from the transistors and chassis; locking washers under the fixing nuts will provide a shakeproof mounting.

The chassis of the unit is at earth potential (i.e. + ve battery) so ensure a good connection exists between it and the car bodywork by cleaning away any paint or rust before tightening up the fixing nuts.

To connect the unit into the existing system is a very simple operation. A cable-form of three 7/0076 p.v.c. covered wires must be made up and fixed to the "terminal" block on the ignition unit. The following steps are then carried out with reference to Fig. 6.

- Remove the lead from the "CB" terminal on the ignition coil and connect it to terminal position 2.
- Connect terminal 3 to the "CB" terminal on the ignition coil.
- Connect terminal 1 to the "SW" terminal on the coil.

## PERFORMANCE

Improvements in overall petrol consumption will depend upon many things: manner of driving, the size, condition and efficiency of the engine. But if only a 2 m.p.g. improvement is obtained over 9,000 miles on a car which normally does 30 m.p.g. the total saving more than covers the cost of the unit.

Needless to say the life of the contact breaker points is virtually the same as that of the car and although financially this improvement is small, in convenience it is worthwhile.

When the starter turns the engine over slowly the greater efficiency of the unit will provide a far better spark. Also the plugs will remain cleaner and last longer. In fact the plugs that would normally be rejected for use with a conventional ignition system should work perfectly well with this system. ★

# G

## GET A GOLDRING HI-FI TURNTABLE UNIT FOR YOUR AMPLIFIER



### GOLDRING-LENCO G.99

Incorporates the unique Goldring-Lenco continuously variable speed control and vertical drive features. Machined 8 lb. non-magnetic turntable. Push-button switching. Neon-lit stroboscope. Speed constant within 1% for up to 13% mains voltage change. £21.19.5d.

### GOLDRING-LENCO GL 68

Continuously variable speed control with adjustable click-in positions for standard speeds. Arm takes interchangeable head-slides, and is raised and lowered by on/off switch. Wired for mono and stereo. £19.10.7d.



There's a Goldring, or Goldring-Lenco unit to match *any* amplifier—whether you build it or buy it. At the modest end of the scale there's the G.66 integrated hi-fi unit that comes complete with pick-up arm and cartridge for as little as 11 gns. Then there's the highly popular GL 68 (see left) and, for the man who wants the best he can get there's the GL 70 transcription unit with integrated transcription arm at a little under £30, or the sophisticated G 99 without arm, at around £22. Goldring hi-fi equipment includes transcription arms from 7 gns. upwards and a wide choice of cartridges. The coupon will bring you full descriptive leaflets.

### GOLDRING HI-FI EQUIPMENT



To: **GOLDRING MANUFACTURING CO. (G.B.) LTD.**, 486-488 High Road, Leytonstone, London, E.11.

*Please send me descriptive leaflets on*

- TURNTABLE UNITS     TRANSCRIPTION ARMS  
 MONO & STEREO CARTRIDGES     HI-FI ACCESSORIES

Name \_\_\_\_\_

Address \_\_\_\_\_

To: Goldring Manufacturing Co. (G.B.) Ltd., 486 High Road, Leytonstone, London, E.11. Telephone: Leytonstone 8343

# VARIABLE VOLTAGE TRANSFORMERS

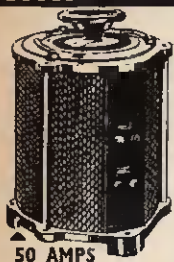

50 AMPS



3 AMP

INPUT 230/240v. A.C. 50/60—  
OUTPUT VARIABLE, 0-260v.  
BRAND NEW Carriage Pad.  
Buy direct from the importer,  
keenest prices in the country.  
All Types (and Spares) from  
1/2 to 50 amp. from stock.

OPEN TYPE (Panel Mounting)  
1/2 amp, £3. 3. 0. 1 amp, £4. 17. 6.  
2 1/2 amps, £5. 12. 6.

SHROUDED TYPE  
1 amp, £4. 10. 0. 2.5 amps,  
£5. 17. 0. 4 amps, £8. 7. 6.  
5 amps, £9. 0. 0. 8 amps,  
£13. 10. 0. 10 amps, £17. 0. 0.  
12 amps, £19. 10. 0. 15 amps,  
£22. 0. 0. 20 amps, £32. 10. 0.  
37.5 amps, £65. 0. 0. 50 amps,  
£85. 0. 0.

PORTABLE TYPE  
2.5 amps, Portable £9. 17. 6.

## LIGHT SENSITIVE SWITCH

Kit of parts, including ORP12 Cad-  
mium Sulphide Photo-cell, Relay,  
Transistor and Circuit, etc., price  
25/- plus 2/6 P. & P. ORP 12 in-  
cluding circuit, 10/6 each, plus  
1/- P. & P.



## A.C. MAINS MODEL

Incorporates Mains Transformer, Rectifier  
and special relay with 3, 5 amp mains c/o  
contacts. Price inc. circuit 47/6 plus 2/6  
p. & p.

## NEW! PHOTO ELECTRONIC COUNTER

Can be set for counts of up to 500 per  
minute. 210-250 v. A.C. powered. Kit of  
Components including photo cell. High  
speed non-resettable counter. Trans-  
former relay, etc., together with clear circuit  
diagram. £3.2.6, plus 2/6 P. & P.

## 100 WATT POWER RHEOSTATS (NEW)

AVAILABLE IN THE FOLLOWING VALUES

10 ohm, 3 a.; 25 ohm, 2 a.; 50 ohm,  
1.4 a.; 100 ohm, 1 a.; 250 ohm, .7 a.;  
500 ohm, .45 a.; 1,000 ohm, 280 mA;  
1,500 ohm, 230 mA; 2,500 ohm, .2 a.  
Diameter 3 1/2 in. Shaft length 3 in.,  
dia. 1/2 in. All at 27/6 each. P. & P. 1/6.

## NOW ALSO AVAILABLE IN 25 WATT

10 ohm, 1.5 a.; 25 ohm, 1 a.; 50 ohm,  
.75 a.; 100 ohm, .5 a.; 250 ohm, .3 a.;  
500 ohm, .2 a.; 1,000 ohm, .15 a.; 1,500  
ohm, .12 a.; 2,500 ohm, .1 a.; all at  
14/6. P. & P. 1/6.

## "GABY" MULTI-RANGE TEST METER

Model B40, D.C. volt. 0-5 v., 2-5 v. at 10,000  
ohm per volt. Ideal for  
transistor circuit testing.  
A.C. and D.C. volt. 10 v., 50 v., 250 v.,  
500 v., 1,000 v. at 4,000  
ohm per volt. Resistance,  
2K ohm, 200 K ohm, 2 meg., 20 meg.  
Repair service available

Price includes Test Leads, Battery,  
Instruction book, Packing and Post  
(U.K.). £6.2.6. 3 additional models  
available from 54/- to £14.14.0.  
Leaflet gladly sent on request.

## 5 Amp. AD/DC VARIABLE VOLTAGE

OUTPUT UNIT  
Input 230v. AC  
Output 0-260v. AC  
Output 0-240v. DC  
Fitted large Scale  
Ammeter and Volt-  
meter, Neon Indicator, Fully Fused. Strong  
attractive metal case 15" x 8 1/2" x 6".  
Weight 24lbs. Infinitely Variable, smooth  
stepless Voltage Variations over full range.  
Price £30. C. & P. £2.



## LATEST HIGH SPEED MAGNETIC COUNTERS

4 figure 10 impulses per second. Type 100D, 4.1 ohm  
coil, 3-6 v. D.C. operation. Type 100A, 500 ohm coil,  
18-24 v. D.C. operation. Type 100B, 2,300 ohm coil,  
36-48 v. D.C. operation. Any type, 15/- each, plus  
1/6 P. & P.

## CHANGE OF ADDRESS

From September 1st, 1966 our new address for mail order and  
correspondence will be:

**57 BRIDGEMAN ROAD  
ACTON, LONDON, W.4**

Phone 995 1560

Callers welcome. Ample Parking Space. Large Showrooms. Many Bargains.  
CLOSED SATURDAY

# SERVICE TRADING CO

Personal callers only: 9 LITTLE NEWPORT STREET, LONDON, W.C.2. Tel.: GERrard 0576

# EVERYDAY ELECTRONICS

Thomas Roddam

This book provides a broad  
introduction to the various  
aspects of electronics, suitable  
for 'A' Level and O.N.C.  
students and the technically-  
oriented layman.

Line diagrams C. 22s 6d

# BRAINS and COMPUTERS

A. M. Andrew, B.Sc., Ph.D.

One of the "Focus on  
Science" Series edited by  
Dr Tom Margerison. "Deals  
briskly with the technology  
of computers" — *Glasgow  
Herald*. "A brief, well-  
written account" — *Shell  
Magazine*. Illustrated 10s 6d

## HARRAP BOOKS

## CRESCENT RADIO LTD.

40 MAYES ROAD  
WOOD GREEN, N.22  
BOWES PARK 3206

LONDON'S ELECTRONIC CENTRE  
BEST QUALITY—KEEN PRICES

### EXAMPLES FROM OUR LARGE STOCK OF TRANSISTORS

AC107 3/6	OC35 11/6	AF115 4/6
AC127 4/6	OC28 11/6	AF114 5/6
AC128 4/6	OC26 11/6	AF116 4/6
AC176 4/6	OC170 5/6	AF117 4/6
ADY23 10/-	OC171 5/6	AF127 4/6

Cadmium Sulphide Photoconductive Cell  
= ORP12 .. .. . 10/-

### E.M.I. TWEETERS

3 1/2 inch at 3 ohm	13/6
2 1/2 inch at 3 ohm	9/6

### EXAMPLES FROM OUR SELECTION OF SPEAKERS

3 inch at 25 ohm	15/6
5 inch at 3 ohm	15/-
6 1/2 inch at 3 ohm	16/-
8 inch job stock at 3 ohm	12/6
12 inch at 15 ohm	30/-
6 x 4 inch at 3 ohm	12/6

### SPECIAL LINES

Small 5 k ohm Volume Controls with  
1/2 inch spindle .. .. . 9d. each  
1 m ohm skeleton Pre-set Controls 3d. each  
Low impedance Ear Pieces less plugs 1/6 each  
Silicon Diodes, 125 volt at 250 mA. 1/6 each  
Printed Circuit Board 9 x 5 inch .. 1/11 each  
Crystal Pick-up Cartridges .. 8/6 each

### VERO BOARD

2 1/2 x 5 inch 3/8	3 1/2 x 3 1/2 inch 3/8
2 1/2 x 3 1/2 inch 2/6	3 1/2 x 5 inch 5/2
Terminal Pins 1/- per doz.	

### EMPTY TAPE SPOOLS

7 inch 2/9	4 inch 2/3
5 1/2 inch 2/6	3 1/2 inch 1/6
5 inch 2/-	3 inch 1/3

We have large stocks of electronic components  
and feel that a visit to our premises would be  
to your advantage.  
Send 1/- for a Catalogue showing our stocks of  
Mullard, Newmarket, Texas, Mazda Transistors  
and vast component stock.  
Please include postage with your order.

# DRY REED SWITCHES

by B.H. BAILY

Few simple electro-mechanical devices lend themselves to such versatile applications as the dry-reed switch. Simple in principle and construction as the device is, it seems incredible that it was not developed until fairly recently.

## FERROUS SPRINGS

The simplest form of dry-reed switch consists of a pair of ferrous spring contacts sealed into a short glass tube containing an inert gas. The contact ends inside the tube slightly overlap, but are positioned so as to be "normally open".

If a magnetic field of suitable strength is created in the vicinity of the sealed contacts, they become magnetised so that they attract one another. This attraction causes the contacts to close and complete the electrical circuit into which they may be connected. The circuit remains closed until the magnetic field is weakened or removed, when the contacts quickly lose their magnetism, and spring apart.

There are, of course, other variations on the simple version, but the purpose of this article is to provide "food for thought" as to the tremendous scope offered by the simplest, cheapest version of this reliable switch. Just a few of the tremendous number of possible applications are listed later. Let us first consider some of the possible circuit configurations.

## SIMPLE SWITCH

Fig. 1 shows a switch operated by the field of a simple bar-magnet. The switch contacts close when the magnet is brought sufficiently close to the switch, and open when the magnet is moved away. The magnet in this case has to be fairly strong.

In Fig. 2 the magnet is replaced by a coil of wire wound around the glass envelope of the switch. This may be done by constructing a bobbin to slip over the switch, or, for up to about 300 turns, it may be hand-wound directly onto a layer of insulating tape over the glass. The normally-open contacts are closed by the passage of direct-current through the winding. Current may be passed in either direction to operate the contacts, but d.c. must be used or the contacts, which respond very quickly to current change, will chatter on frequencies as low as about 50c/s. The number of turns and wire gauge must suit the voltage and current capacity of the operating source, and the total ampere-turns must be sufficient to close the contacts.

## NORMALLY CLOSED VERSION

The above examples are of normally open contact types. The same type of dry-reed switch can, however, be used to provide the opposite effect, i.e. a normally closed circuit. Fig. 3 shows such an arrangement, in

which a strong magnet is permanently fixed close to the switch, so that its field causes the contacts to be firmly held together. The contacts may then be made to separate by neutralising the field of this magnet either by bringing another magnet of opposite polarity close to the fixed magnet and switch, or by energising a coil wound around the switch and fixed magnet by a direct current, polarised such that its magnetic field neutralises that of the fixed magnet. In the absence of either of these influences or if they were of the wrong polarity, the contacts will again close.

So far, we have dealt with configurations in which the switch contacts are self-restoring; that is, they change back to their normal position as soon as the influence of the externally applied "signal" is removed. The following examples, however, are bistable. Once the contacts are made to close (or open) the new state is maintained automatically, even after the operating "signal" is removed.



Fig. 1. Normally open switch, mechanical operation

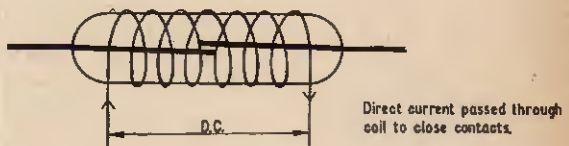

Fig. 2. Normally open switch, electrical operation

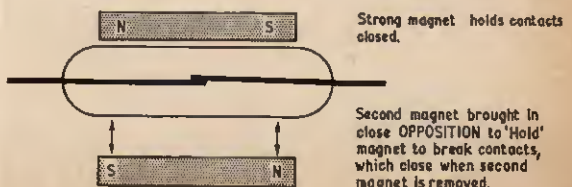

Fig. 3. Normally closed switch, mechanical operation

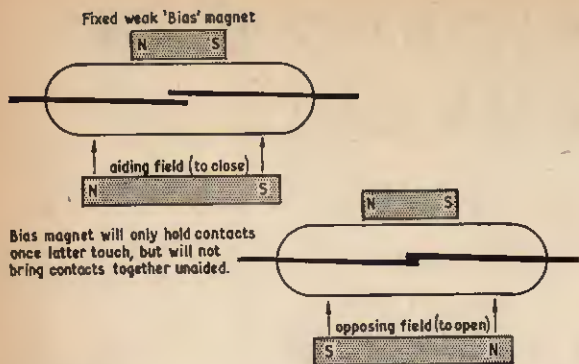

Fig. 4. Bistable or two state switch ("toggle") in which the state is changed by momentary influence of aiding or opposing field of second strong magnet

### BISTABLE: MECHANICAL CONTROL

Fig. 4 shows one method of producing a "toggle" action, that is, a magnetic bistable switch. A small "bias" magnet is fixed close to the glass envelope of the switch. This magnet produces a magnetic field which, whilst being too weak to cause the contacts to come together unaided, is sufficiently strong to ensure that, once they have been brought together by some external influence, there is sufficient magnetic field strength to keep the contacts together.

If another magnet of correct polarity is now brought near the switch, the "bias" field is strengthened by the lines of force from the second field. Hence, the contacts experience sufficient field strength to cause them to close.

In this instance, the second magnet must be positioned such that its north pole and south pole align with the north and south poles of the bias magnet, respectively. Once the contacts are closed, the second magnet may be removed, and the contacts will remain closed. If, however, the second magnet is now reversed, and again brought close, its reversed field will oppose that of the bias magnet, and the contacts will again separate due to the weakened field. Again, the contacts will not close if the magnet is once more removed, but only if it is brought near, in aiding polarity.

### BISTABLE: ELECTRICAL CONTROL

Fig. 5 shows an electrically operated version of the bistable or "toggle" of Fig. 4. The movable magnet is replaced by a coil wound over the bias magnet and switch assembly. A pulse of current through the coil in one direction will close the contacts, whilst a pulse in the opposite direction will open them. Since only a short pulse of current is required to change the bistable from one state to the other, the switching can be performed quite well by using push-button switches.

This results in extremely long battery life, because current is drawn only during the brief changeover period, when one or other of the switches is pushed.

The 10 ohm resistor is included to protect the batteries from accidental surge should both buttons be pressed simultaneously! Even "Pen-Lite" cells can be usefully employed in such a circuit, since they will give good service when called upon to deliver short pulses intermittently, and they are easily accommodated in a small remote control box.

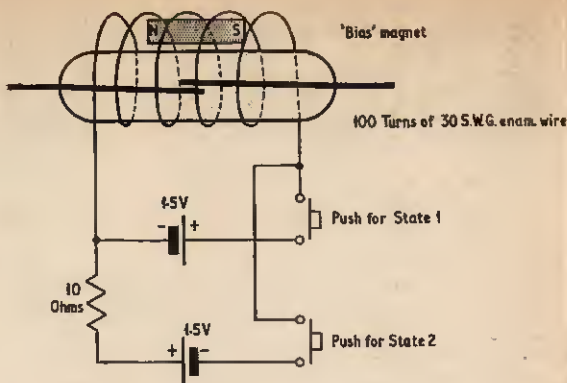

Fig. 5. Electrically operated bistable switch using a two-battery supply

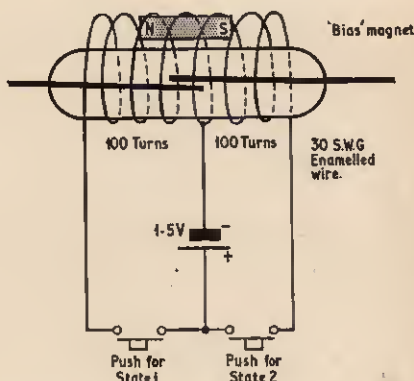

Fig. 6. Single battery bistable switch

Fig. 6 shows a single-battery version of Fig. 5. For this, the winding around the switch is doubled, and the centre-tap brought out as a third connection. Energising one half of the coil will operate the contact, whilst-energising the other half will separate them.

### SUGGESTED APPLICATIONS

The following are just a few ideas to start the experimenter thinking:

Fig. 1. Door lock controlled by electromagnet. Dry-reed switch could be embedded in a wall or door post, and magnetic "key" used to unlock door. Revolution counter transmitter (magnet rotates).

Figs. 2 & 3. Limit switch: the magnet would be mounted on a motorised door. Door operated cupboard light switch: magnet on door.

Fig. 4. Model train points control. Switch can be mounted on the track with the bias magnet. The operating magnet is carried under the train. Two units are mounted at the approach to and beyond the points to ensure that the points change as required. Limit switch for controlling motorised door action, by triggering contactors.

Figs. 5 & 6. Any application requiring a bistable circuit where no "standing" current for hold-in can be tolerated. Particularly suitable for battery powered remote control of television, lights, radio, or other household appliance.

# BSR C1 CERAMIC cartridge

FOR PROFESSIONAL QUALITY

Outstanding performance and dependability make the C1 Ceramic Cartridge the natural choice of the professional because, to him, quality is absolutely essential. You, too, can buy this remarkable cartridge which has a performance comparable with designs costing twice as much.

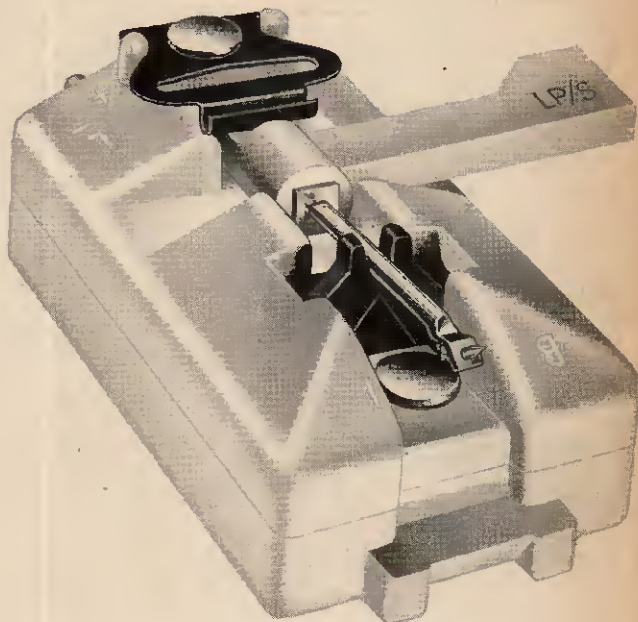

## Technical Data

Compliance . . . . .	5.2 x 10 <sup>-6</sup> cm/dyne
Sensitivity at 1 Kc/s using Decca SXL 2057 record — 1 cm/sec. . . . .	0.110 volts ± 2 db
Stylus pressure . . . . .	2-3 grammes
Equivalent capacity . . . . .	600 pF
Loading . . . . .	2 MΩ 100 pF
Channel difference . . . . .	less than 3 db
Channel separation at 1 Kc/s . . . . .	20 db

C1ST3 **£2 . 6 . 5** incl. tax. Stereo cartridge with double tipped sapphire stylus.

C1ST4 **£3 . 0 . 11** incl. tax. With diamond LP/S tip.



## UA15 SS 3B 4 speed Automatic Record Changer

Tubular, low mass pick-up arm for featherweight pressure. Large turntable for stability. Manual play facilities. Wow and flutter lowest ever. The ultimate in quality performance and dependability.

UA15 SS 3B fitted with C1ST3 **£10 . 18 . 11** incl. tax.

UA15 SS 3B fitted with C1ST4 **£11 . 13 . 5** incl. tax.

Send for details of the complete range of BSR equipment and address of your nearest BSR stockist.



**BSR LIMITED/MONARCH WORKS/OLD HILL/STAFFS**

The world's largest manufacturers of Record Changers & Tape Decks.

# TRAIN AS A TECHNICIAN

*If you are aged 17-25, here's  
your chance to train as one of the  
Army's top technicians in:*

## ELECTRONICS or AIRCRAFT

Your 18-month technical training course will take you up to City and Guilds standard. Six months after completing the course successfully you are promoted to Corporal. Then it's up to you! Promotion's wide open in the technical field today!

You'll be working on the exciting and advanced equipment today's Army uses when it swings into action: radio transmitters, closed circuit TV, gun-fire control equipment, radio transceivers, helicopters.

There are also opportunities for young men aged 15-17 to join as Junior Entrants and train as technicians or tradesmen.

## GOOD PAY!

This year every soldier in the Army is better off. Trainee Technicians get £477 a year from age 17—and all your food and lodging are free! At the end of 18 months, your pay will go up automatically to £714; at the end of two years, to £805! From there, you'll be given every chance to work for promotion and *still* better pay.

**WANT TO KNOW MORE?  
SEND OFF THE COUPON TODAY!**

TO: ARMY CAREERS MP6(A),  
LANSDOWNE HOUSE, LONDON W.1

*Please send me full details of how to become a Technician*

NAME .....

ADDRESS .....

TOWN .....

COUNTY .....

DATE OF BIRTH .....

M731401 (You must be resident in the UK)

## BI-PAK SEMICONDUCTORS

VALUE PAK 50 TRANSISTORS MIXED UNTESTED 10/-

3 OC139 Trans. NPN Mullard.....	10/-
2 Drift Trans. 2N1225 Germ. PNP 100 M/Cs RCA.....	10/-
6 Matched Trans. 1 OC44, 2 OC45, -1 OC81D, 2 OC81	10/-
4 OA10 Diodes Mullard 30 PIV 1 amp .....	10/-
15 Red Spot AF Trans. PNP Factory Tested .....	10/-
15 White Spot RF Trans. PNP Factory Tested .....	10/-
4 Silicon Rect. 3 amp. 100-400 PIV Unmarked .....	10/-
4 NPN Switching Trans. Assorted OC139, 2N1308, etc.	10/-
2 10 amp. Silicon Rect. 50 and 100 PIV .....	10/-
8 Germ. Diodes 4 OA70 4 OA79 Mullard .....	10/-
1 12 amp Silicon Controlled Rect. 100 PIV .....	10/-
3 Sil. Trans. 25303 PNP VCB25 Ic 100 mA Texas .....	10/-
10 Assorted Computer Diodes.....	10/-
4 Zener Diodes 250 mW 5-1 6-8 10-0 12-0 vltz .....	10/-
4 2G417 Texas Trans. Eqvt. AFI16/117 Mullard .....	10/-
2 200 M/Cs Sil. Planar Trans. NPN BSY26/27 STC .....	10/-
2 Bi-Directional Trans. ASY66 PNP STC .....	10/-
3 Zener Diodes 400 mW 3-3 8-2 15-0 vltz. 5% .....	10/-
4 Germ. Trans. High Current Mullard OC42 .....	10/-
2 Power Transistors 1 OC26, 1 OC35 .....	10/-
5 Sil. Rect. 400 PIV 250 mA I.R. ....	10/-
3 OC71 Transistors Mullard .....	10/-
3 OC75 Transistors Mullard .....	10/-
3 NPN Sil. Trans. 70 M/Cs ZT43 Ferranti .....	10/-
1 Power Trans. OC20 100 vltz. 45 watts. Mullard.....	10/-
5 OA47 Gold Bonded Diodes Mullard .....	10/-
4 OA202 Sil. Diodes Subminiature Mullard .....	10/-
2 Low Noise Trans. NPN NF 4 dB 2N929/30 .....	10/-
1 Sil. Trans. NPN VCB 100 200 M/Cs ZT86 Ferranti	10/-
8 OA81 Diodes Subminiature (CV448) Mullard .....	10/-
3 Sil. Rect. 400 PIV. 500 mA BY101, BY114 .....	10/-
5 Metal Alloy Transistors Mat Type .....	10/-
5 Texas 2G344A Trans. Eqvt. OC44 Mullard.....	10/-

"FREE" One 10/- pack from the above free "FREE"  
with all orders valued £4 (Four "FREE"  
Pounds) or over.

### LOW COST SILICON CONTROLLED RECTIFIERS

50 PIV 1 Amp.....	8/6	400 PIV 7 Amp.....	30/-
100 PIV 7 Amp.....	10/6	100 PIV 16 Amp.....	16/6

Free Circuit Diagrams for Light Dimmers, Speed Controllers, AC Power Switch, etc. with SCR orders.

### SCOOP PURCHASE NEVER BEFORE OFFERED

#### Logic Modules

All Plug in units

and, or, Gates Double and Single Modules, Memory Units, Power Amplifiers, Timer Units, Fanout Multipliers, 1 and 5 amp. SCR Modules, Permanent Memory Units, Power Supply Units 24 vltz.  
Full details on request

Unijunction Transistors 2N2646.....	15/-
Tunnel Diodes IN3720 (TD-5).....	15/-
6 Sil. Rect. Type BY100 800 PIV 550 mA .....	20/-
40 Mixed Semiconductors Marked New .....	40/-

Our vast stocks change daily with hundreds of Semiconductor bargains becoming available. We will be glad to put you on our mailing list and rush you our latest stock lists, eqvt. charts, free offers, etc. Just send 2/6 to cover 3 months. mailing.

Minimum order 10/- cash with order please. Add 1/- postage and packing per order.  
By Return Postal Service Mail only.

**BI-PAK SEMICONDUCTORS**  
8 RADNOR HOUSE, 93/97 REGENT STREET  
LONDON, W.1



## WINDING NOTES

The coils may be wound by hand directly onto the glass envelope of the dry-reed switch if preferred. Where a fixed magnet is used, i.e. in Figs. 3 to 6, the magnet may be taped onto the glass and the coil wound directly on the whole assembly.

When winding centre-tapped coils, wind the first half, then make a loop in the wire, about 3 inches across, flatten and twist it into a double wire connection for the centre-tap, and continue winding in the same direction until the second half is complete.

## MODEL RAILWAY IDEAS

An interesting additional feature of the mechanically operated bistable of Fig. 4 is illustrated in Fig. 7, in which the switch operation is sensitive to the direction in which a passing magnet is travelling. The small bias magnet is again placed close to the reed switch, and the whole assembly is mounted on or near the train track. The operating magnet is mounted vertically on the train, so that the lower pole passes close to the switch assembly as the train passes.

Now, if the train passes in a direction such that the active (lower) operating pole is the same polarity as the second pole of the bias magnet to be passed, the switch will be left in its closed state. If the train passes in the opposite direction, the latter pole of the bias magnet to be influenced will be opposite in polarity to the operating pole, and its field will be momentarily weakened, causing the switch to change and remain in its open state. The train can thus be made to work signals, points, crossing gates, and lights.

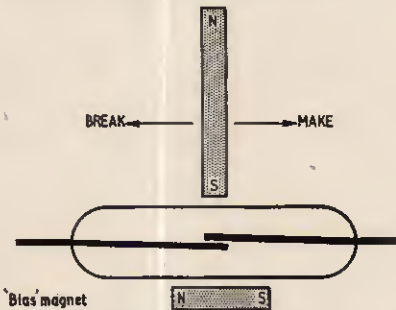

Fig. 7. Method of using a dry reed switch for switching signals on a model railway system

When two trains are used, one may be fitted with an operating magnet with, say, the north pole down, whilst the second train has a south pole pointing downwards. The state to which the switch will now set will depend on which train passes it, and the direction in which this train was moving. For a given direction, one train will produce the opposite effect to the other.

By using more than one switch, one train could be made to divert automatically to a different route from the other train; e.g. a goods train could be made to bypass a passenger platform whilst the passenger train would take an alternative route and perhaps stop at the station.

When mounting the biased reed assemblies, care must be taken not to fix them too close to any magnetic objects. This is particularly applicable to model railway track. Test the rails first with a magnet and if they are attracted, mount the assembly at least  $\frac{1}{4}$  in away. Similar precautions must be taken when mounting the operating magnet; brass clamps or glue should be used to secure them. ★

# Book reviews

## TRANSISTORS FOR TECHNICAL COLLEGES

By L. Barnes

Published by Iliffe Books Ltd.

194 pages, 8 $\frac{1}{2}$ in  $\times$  5 $\frac{1}{2}$ in. Price 42s

STUDENTS of electrical engineering often complain that courses do not contain enough about practical circuit design. The author has tried to meet this criticism by providing "an elementary design text", not very mathematical, "to bring the student up to the design of simple circuits quickly by graphical methods." The author also hopes that the book will serve "many industrial engineers with a limited knowledge of electronics".

In fact, only 30 pages out of some 200 are devoted to detailed design, and the only worked-out designs are of one-stage low-frequency class A amplifiers. No mention is made of transistor noise, or the effects of resistor tolerances. The rest of the book is taken up with transistor physics and an introduction to the transistor as a device (33 pages), parameters and equivalent circuits at low and high frequencies (34 pages), switching circuits (21 pages), experiments (22 pages), and a liberal collection of appendices (57 pages). There is also an index, which does not contain "amplifier", "oscillator", or "receiver". Apparatus required for the experiments includes: a 5 micro-amp d.c. meter, an a.c. millivoltmeter with 3mV f.s.d., a two-channel oscilloscope, and a 50c/s–50kc/s sine-wave source. In one experimental circuit a 500mV signal is applied to a 100mV meter, and in another a 10mA meter monitors the current to a transistor whose base can be connected directly to a 10V collector supply. G.W.

## BASIC ELECTRONIC CIRCUITS

By Van Valkenburgh, Nooger and Neville

Published by the Technical Press Ltd.

228 pages, 10in  $\times$  6 $\frac{1}{2}$ in. Price 42s

THIS is one of the Common-Core series of technical training primers that have proved so popular in their pictorial and informal manner of presenting electronics.

It is written in the mode of the preceding series of text book—"Basic Electronics"—where the aim is to group circuit families. In pulse circuitry, with which this book is concerned, such families abound and it is in the identification of a member of the group and its function that makes for an easy interpretation of a complex circuit diagram.

Although this book does not set out to be comprehensive in its coverage of pulse techniques, it does explain the most recurrent and commonly encountered circuits in both their valve and transistor configurations.

The book really falls into three parts; the first being composed of waveform definitions and pulse responses in passive and active circuit elements which provide a very necessary introduction to the pulse family groups which make up the second part. Here, each page of text is faced by a circuit, many of them practical, and representative waveforms which are analysed with reference to their forming components.

The third part deals in the main with application and principles of time bases ending with a short section on strobe pulse generators. G.G.

# INGENUITY

# UNLIMITED!

IN THIS feature we hope, from time to time, to be able to publish suggestions submitted by some of our readers on the possible improvement of projects previously described in PRACTICAL ELECTRONICS; short contributions on other subjects may be included. The aim is not to find fault or undermine the abilities or knowledge of our contributors. It may well be that the original article is *par excellence* but it could be improved or adapted to suit individual requirements. The views expressed by readers are not necessarily those of the Editor.

WHEN an engineer designs a meter for measuring current or voltage, he usually attempts to make the scale of the instrument approach as closely as possible to a linear law.

There are however many occasions when a requirement could be met more effectively by means of a meter with a very different scale. An example of this requirement is found in a meter designed to indicate the state of charge of a car battery. The voltage of a single cell varies from about 1.8V at full discharge to 2.3V at full charge. The voltage on charge may rise to about 2.6 volts. Thus in the case of a 12 volt car battery the meter should indicate voltages between 10.5 volts and 15.5 volts. If a standard meter is used and adjusted to have a full scale reading of 16 volts, then in the case of a 2in diameter meter with a scale length of 1.5in, each increment of 1 volt will be represented by 0.1in of scale. If on the other hand the meter is designed to operate between 10 and 16 volts then the voltage scale can be made much easier to read.

One way in which this object can be achieved is by the use of a Zener diode. An OAZ202 Zener diode was available and was used in conjunction with a potentiometer network. The Zener voltage of course varies with the current passing through the diode and also the variation from one specimen to another is quite large. It will therefore be necessary to vary the values of resistor used until the desired coverage is obtained.

The circuit is shown in Fig. 1. The meter used required a current of 500µA to produce full scale deflection and the resistance of the meter was 350 ohms. Fig. 2 shows the new scale.

This meter forms a useful addition to the instrumentation on a motor car dashboard and will help to give early warning of the impending failure of the car battery. It will also give warning if the average discharge from the battery exceeds the average charge thus giving the driver the opportunity to rectify the trouble before he is left stranded with a flat battery.

## "BANDSPREAD" VOLTMETER

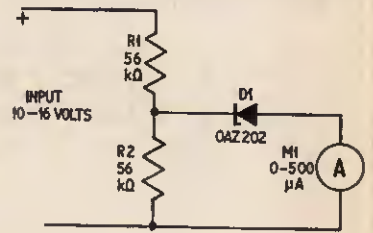

Fig. 1.

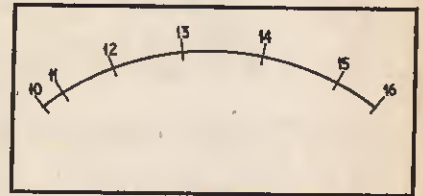

Fig. 2.

R. L. A. Borrow,  
Newport,  
Monmouthshire

## CAR WARNING DEVICE

READ with considerable interest an article you published on an audible warning system for a car. I then decided to design a circuit which would sound the car's horn whenever the doors, bonnet or boot were opened, and keep sounding the horn for a pre-determined time after they were closed. The protection device being immobilised by a switch S1 fitted to the car door. Use was made of the interior light switches on the car's doors. If these are not fitted, microswitches will have to be used for the doors, boot, and bonnet.

G. R. Williams,  
Blackpool,  
Lancs.

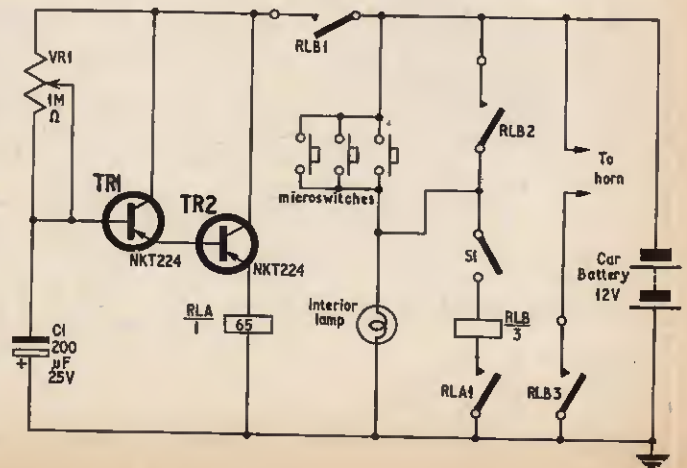

# 'PRINTED WIRING' BOARD FREE

INSIDE NEXT MONTH'S

# Practical Electronics

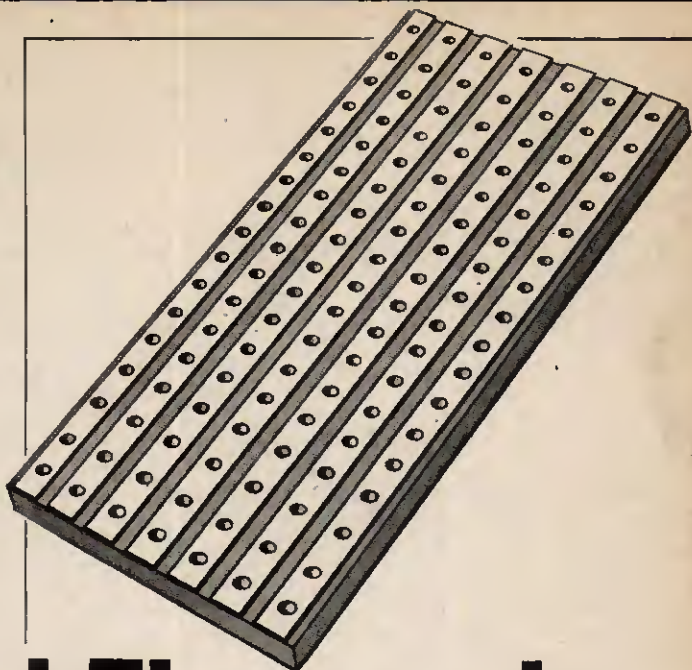

OCTOBER ISSUE  
ON SALE SEPT. 15

**STRONG  
EXTRA DEMAND!  
MAKE SURE  
OF YOUR COPY!**

**PLUS How-to-Build details of  
all these projects:**

**LIGHT OPERATED SWITCH** May be used as car parking light switch, lamp economy unit, burglar alarm, basis of counting unit.

**WIEN BRIDGE OSCILLATOR** Instructional unit for apprentices, experimenters. Can be used or modified as fixed or variable frequency generator.

**TUNED AMPLIFIER (1 kc/s)** Ideal for use in receiver section of a radio control system. Sound-operated servo-mechanism.

**DIRECTION INDICATOR** Car turn indicator. Sound "bleeper" or other device requiring repetitive automatic switching at about 1 c/s.

**TIME SWITCH** Gives time delays from fraction of a second to few minutes. Useful for "holding-on" car or hall lights in the dark.

**PUSH-PULL 200 mW AMPLIFIER** For use as audio section of radio, tape recorder, record reproducer, intercom, baby alarm and audio signal tracer.

# Audio TRENDS...

## A Commentary on Sound Reproducing Equipment by Clement Brown

THIS month's selection of equipment includes a few items for which space could not be found in the July *Audio Trends*.

New from the U.S.A., where it has been in use for upwards of a year, is the Euphonics "Miniconic" pick-up, which is imported by A. C. Farnell Ltd. The cartridge, described as a semiconductor device, employs tiny silicon elements, and the makers claim for it such characteristics as very small tip mass, wide response and ability to track at less than 1 gramme pressure.

As a modulating device rather than a conventional voltage generator, the pick-up requires an external voltage supply. A unit, suitable for connection to a.c. mains, is available to supply this voltage; it is also possible to draw the supply from an audio amplifier. A cartridge with half-thou stylus costs £14 12s 5d and can be used in any good arm. Alternatively the device can be purchased as a plug-in head for Euphonics' own low-mass arm.

Other stereo cartridges include model STS322E, latest in a long line of moving-magnet devices by Elac. Priced at £23 12s 6d, this model has an elliptical stylus tip, average output of 6mV and crosstalk rejection of 26 dB at 1,000c/s. The same cartridge with a half-thou tip costs a few pounds less.

Elac transcription player units now include the "Miracord 50H", which has such features as an anti-skating control for the arm, a means of checking arm tracking geometry, and turntable characteristics generally of studio standard.

Technical test records are normally of little help to amateurs, who may even damage their equipment through incorrect use. However, the *Hi-Fi Stereo Review* stereo test disc represents a new attempt to provide technical checks through listening tests and without measuring instruments. A variety of pick-up, loudspeaker and systems checks are provided, and one side of the disc contains a classical music programme. Of American origin, the disc is sold in the U.K. at 3 guineas.

### New Lowther f.m. tuner

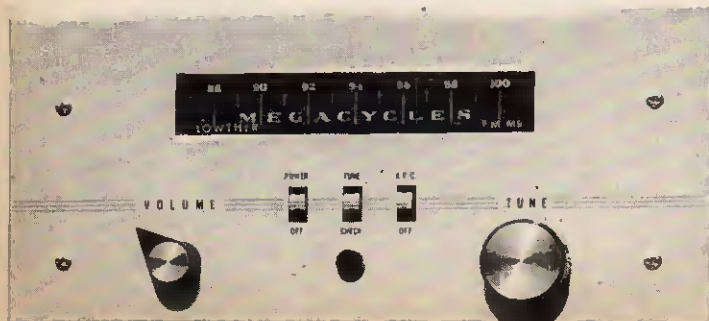

### ACCESSORIES

Many pick-up arms have built-in control devices which enable the head to be lowered gently on to the disc—and ensure that the shaky-handed operator does not damage the record when doing so. Owners of lightweight pick-ups lacking such devices—increasingly regarded as essential—can choose from a variety of ingenious accessories.

A new and exceptionally well-made example is the Colton "Varilift" (£3 10s 6d) which has a hydraulically damped action and is intended for use with practically all designs of arm. Like many arm controls, it has a support rod which helps the user to select particular bands on the record.

Another type of device, desirable if not essential, is the "bias compensator" which corrects inward side-thrust of the pick-up arm.

Although no longer new, Decca's magnetic compensator demands a mention in view of the wide popularity of this company's pick-ups. Type A is for the simpler Decca arms and type B for the more costly professional arm; both versions are sold as accessories at 21s each. Agreeably uncomplicated, the device depends on interaction between a fixed yoke and a rotating magnet which is a push fit on the arm bearing.

Most experimenters make up their own connecting cables and adaptors to suit various input and output sockets. Those who are feeling lazy—or bemused by permutations of jacks and plugs—may care to investigate the "Hi-Fi Cable Kit" made by Eagle Products. For 26s 3d one gets a collection of adaptors and screened linking leads in a wallet.

### MICROPHONES

A.K.G. microphones are among the best known continental models used in the U.K. A recent addition is the D202 cardioid dynamic, which is unusual in that it has separate h.f. and l.f. capsules. This arrangement, it is claimed, gives a very smooth response and a cardioid characteristic independent of frequency.



A.K.G. type D202 microphone

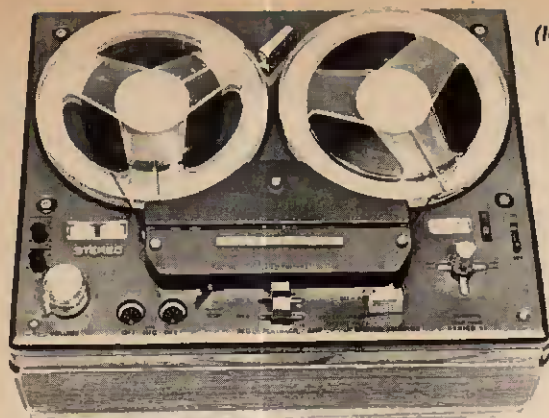

(left) Tandberg Series 12 tape recorder

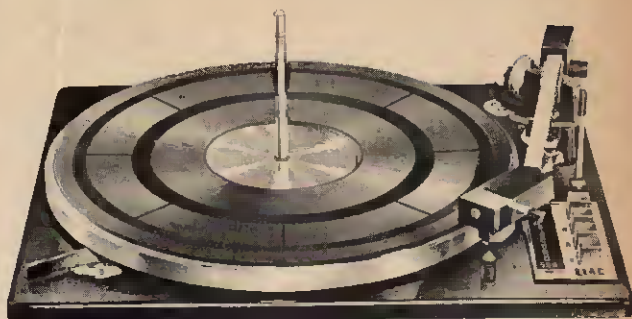

(above) New Elac "Miracord 50H" transcription player

Other new A.K.G. models are the C61 condenser microphone and the D109, which can be used either in the hand or, with boosted h.f. response, on a neck sling. The D109 costs £11.

Enthusiasts with a limited amount to spend on such components may like to be reminded that the Philips omni-directional microphone type EL7500 is sold in kit form at 7 guineas. It is suitable for use with most tape recorders and can be suspended on a neck sling or fitted to a desk or floor stand.

An improved Jetlite headset, type JL26, is offered by Amplivox at £9 1s 6d. The impedance is 200 ohms per earpiece and handling capacity is 1 watt. Alternative connections for single channel and binaural listening are easily made. A communications version of the headset has a small boom microphone attached.

Lowther have revised their amplifier range. The single-channel power amplifier chassis L18 (£25 10s) uses high efficiency output pentodes type EL506 to provide 18 watts in distributed load circuitry. A stereo version, essentially a pair of L18 amplifiers on one chassis, is available. The firm's control units have modified styling and new f.m. tuners are announced.

A new transistorised f.m. tuner by Heathkit matches the firm's recently introduced AA-22U stereo amplifier. Features include an assembled and pre-aligned r.f. tuning section and a four-stage i.f. amplifier. The tuner is mains powered and has automatic frequency control. Mono and stereo models are available and the main sub-assemblies are separately priced. Total price of a mono kit is £20 19s plus £2 5s for the walnut cabinet.

#### TAPE EQUIPMENT

Japanese machines continue to feature prominently on the tape recording scene. Model TC260 by Sony is a four-track stereo recorder, fully transistorised and with three tape speeds. At 95 guineas, including microphones and other accessories, it falls within semi-professional range of machines. Smooth and wide frequency response, smart modern design and ease of operation are notable features.

Many Japanese products are designed for the American market: this applies to Sony and is also true of Akai, whose range is now extensive, although concentrated in the professional category. A recent model is the X-IV, one of the few high quality stereo machines offering genuine portability (it weighs about 11 lb). This firm also makes a tape deck.

The new Tandberg Series 12 is a three-speed model housed on a teak plinth and priced at 105 guineas. It is a solid-state recorder which, with the unusually high output of 10 watts per channel, can also be used for public address work. This machine is designed for four-track operation and has erase and combined record/playback heads.

Of somewhat similar type is the Grundig TS340, rated at 8 watts per channel and fitted in a walnut case with Perspex lid. An alternative version of this three-speed stereo machine is the TK340, built in transportable form. Features include separate recording and playback amplifiers, monitoring off the tape and multiple synchronised recording.

#### SPEAKER SYSTEMS

Heathkit's new slimline loudspeaker system the "Berkeley", is housed in a walnut cabinet and costs £18 10s in kit form or £23 assembled. Dimensions of the cabinet are 26in by 17in by 7½in, and the drive units are 12in for bass and 4in for mid-range and treble.

As mentioned in July, the Rectavox "Ambi" speaker costs £36 10s, but it should also be noted that the enclosure is available separately at £15. This system, like the earlier "Omni", is based on K.E.F. bass and treble units. Literature describing "conversion systems"—the upgrading of simple systems to more elaborate ones—is obtainable from The Rectavox Company, Central Buildings, Wallsend, Northumberland.



Colton "Varilift" for pick-ups

Akai 4-track stereo tape recorder X-IV



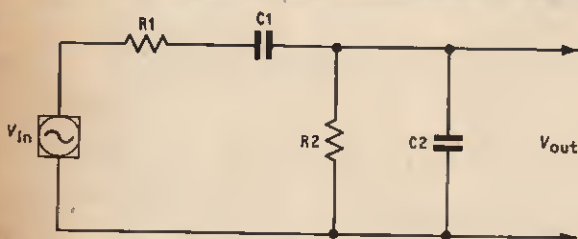
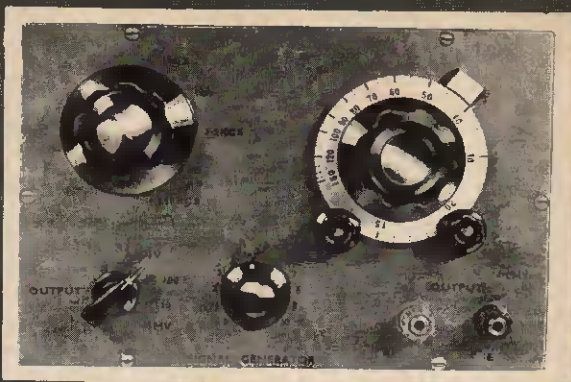

Fig. 1. Wien bridge configuration on which this instrument is based

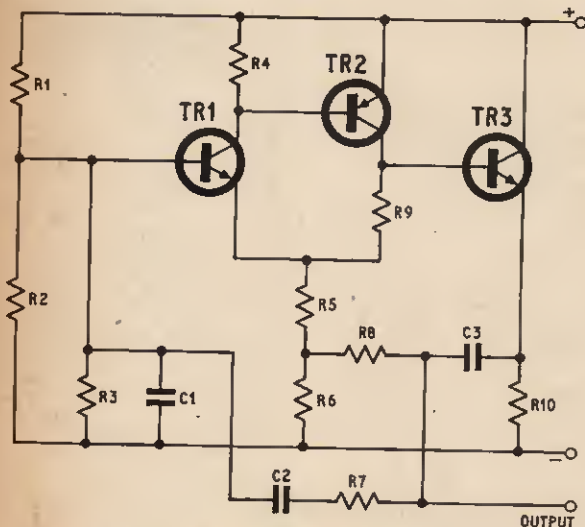

Fig. 2. Simple Wien bridge oscillator

THE signal generator described in this article is based upon the well known Wien Bridge, shown schematically in Fig. 1, where the tuning components comprise R1, C1, R2, and C2. In order to promote oscillation a phase change of 180 degrees must occur in the amplifier and the overall gain must be in the order of three times.

This may be occasioned by the use of two stages, however, the requirement of low output impedance and relatively high input impedance, the latter so as not to shunt R1 and C1, is not compatible with the output characteristics of a transistor in grounded emitter.

### SIMPLE WIEN BRIDGE

A simple, yet very effective, circuit for a practical Wien Bridge oscillator is shown in Fig. 2. The tuning components here are R3, C1, R7, and C2. The high input impedance is attained by the application of a considerable degree of negative feedback via R8 to the emitter of TR1. The low output impedance is achieved by the introduction of TR3 as an emitter follower, the output impedance being approximately equal to  $R_8 / \beta_{TR3}$  where  $R_8$  is the source impedance and  $\beta_{TR3}$  is the current gain of TR3 in grounded emitter configuration.

The circuit of Fig. 2 will provide an output with good sinusoidal characteristics which would be satisfactory for most applications. The frequency would be fixed and determined by R3, C1, R7, and C2.

In order to introduce a continuously variable frequency coverage we could replace C1 and C2 by a ganged variable capacitor. As the value of these capacitors would be in the order of  $1\mu\text{F}$  on the low frequency range, this would be impractical. Instead a ganged potentiometer replaces R3 and R7 as shown in Fig. 3; C1 and C2 are different switched values giving coarse frequency selection.

A further drawback of the circuit in Fig. 2 is that the output will not be of constant amplitude for changes in supply voltage, temperature and external loading.

### SPECIFICATION

- FREQUENCY RANGE**
1. 15c/s to 150c/s
  2. 150c/s to 1.5kc/s
  3. 1.5kc/s to 150kc/s
  4. 15kc/s to 150kc/s
  5. 150kc/s to 1.5Mc/s
- In five steps on the following ranges,  
 $\pm 1.0\text{dB}$  on ranges 1 to 4



# SIGNAL GENERATOR

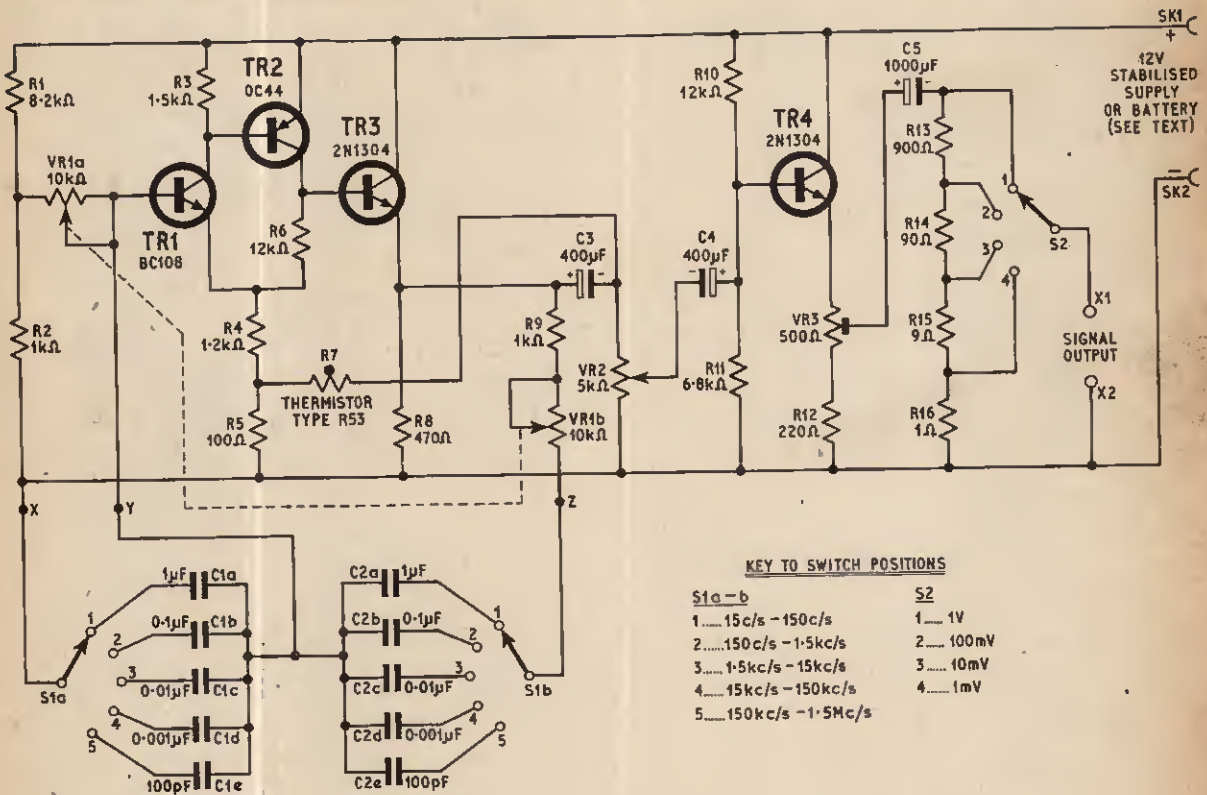

Fig. 3. Final complete circuit diagram of the signal generator

**DISTORTION  
OUTPUT**

**OUTPUT IMPEDANCE**

**RANGE OVERLAP  
POWER CONSUMPTION**

Better than 0.7 per cent r.m.s. at 1kc/s  
From 1mV to 1V in 20dB steps with continuously variable fine control.  $\pm 1.0$ dB, relative to level at 1kc/s, on ranges 1 to 4  
Approximately 10 $\Omega$  on the 1 volt range with VR3 at maximum output  
10 per cent at the upper end of each frequency range  
Approximately 13mA d.c., at 12V

In order to minimise these changes, R8 is replaced by a suitable thermistor which increases or decreases the negative feedback, depending upon the output voltage at TR3 emitter. This is due to the change in resistance with temperature that is inherent in these devices.

Professional signal generators using thermionic valves often have an output impedance of 600 ohms which is considered to be sufficiently low not to be seriously affected by the relatively high impedance of valve input circuits. This preserves a high degree of accuracy in relation to the output voltage indicated by the output controls of the signal generator.

Since the incorporation of semiconductors into most forms of electronic circuitry, the input impedance reflected by these devices is not usually more than a few kilohms. This effectively nullifies any accurate indication of output voltage that may be supposed from reference to output level controls.

In order to ease the task of the constructor in avoiding the necessity for a continuously visible check of the output in the form of an a.c. millivoltmeter, a further transistor, TR4, has been introduced as shown in Fig. 3. This provides an emitter follower output which reduces the output impedance of the circuit in Fig. 2 even further. The resultant output impedance of the circuit in Fig. 3 would then be approximately  $R_8/\beta_{TR3} \times \beta_{TR4}$  disregarding the intermediate components.

This allows an external circuit with an input impedance as low as  $200\Omega$  to be connected across the output terminals and yet only change the indicated output voltage by 1dB.

## FINAL CIRCUIT

In the final circuit (Fig. 3) the d.c. action of the circuit is as follows: TR1 is biased by R1 and R2 via VR1 so that a collector current of  $66\mu\text{A}$  flows through TR1. The subsequent voltage drop across R3 biases TR2 for a collector current of approximately  $75\mu\text{A}$ . The voltage at TR2 collector in turn biases TR3 for an emitter current of 5mA. The final emitter follower TR4 is biased in a conventional fashion by R10 and R11 to promote an emitter current of 7.5mA.

Temperature stability is maintained over the range 10-55 degrees C by employing a low leakage silicon device in the position of TR1 and a relatively low leakage germanium transistor as TR2. Also further stabilising action is provided by the direct coupling arrangement of TR1 and TR2. As the temperature rises so the collector current of TR1 increases thus making TR1 collector and TR2 base more negative.

Consequently the collector current of TR2 increases making TR2 collector and TR1 emitter more positive. This increasing positive voltage at the emitter of TR1 tends to reduce the collector current of TR1 and restores the circuit to its original d.c. condition. TR4 is held stable over the temperature range indicated by virtue of the emitter follower action.

From an a.c. point of view TR1, TR2, and TR3 form a directly coupled amplifier, terminating in TR3 which acts as an emitter follower thus providing the required low output impedance drive to the output network. The high input impedance is derived by virtue of the negative feedback to the emitter of TR1.

There are two feedback loops, one between TR2 collector and TR1 emitter due to the common load R4 and R5, and the other loop from the emitter of TR3 to the emitter of TR1 via the thermistor R7. The latter feedback path, through the thermistor, holds the output voltage constant at TR3 emitter.

## COMPONENTS . . .

### Resistors

R1	8.2k $\Omega$	R12	220 $\Omega$
R2	1k $\Omega$	R13	900 $\Omega$ (750 + 150 $\Omega$ in series)
R3	1.5k $\Omega$	R14	90 $\Omega$ (68 + 22 $\Omega$ in series)
R4	1.2k $\Omega$	R15	9 $\Omega$ (18 + 18 $\Omega$ in parallel)
R5	100 $\Omega$	R16	1 $\Omega$ 3W wire- wound
R6	12k $\Omega$		
R8	470 $\Omega$		
R9	1k $\Omega$		
R10	12k $\Omega$		
R11	6.8k $\Omega$		
R7	5k $\Omega$ at 20°C		Thermistor type R53 (S.T.C.)

All  $\frac{1}{4}$ W,  $\pm 5\%$  carbon high stability except where otherwise stated

### Potentiometers

VR1a	10k $\Omega$	} ganged linear carbon
VR1b	10k $\Omega$	
VR2	5k $\Omega$	linear carbon
VR3	500 $\Omega$	linear wirewound.

### Capacitors

C1a, C2a	1.0 $\mu\text{F}$ metallised polyester 160V	} (Wima)
C1b, C2b	0.1 $\mu\text{F}$ metallised polyester 160V	
C1c, C2c	0.01 $\mu\text{F}$ metallised polyester 400V	
C1d, C2d	0.001 $\mu\text{F}$ silver mica 350V	} (Radiospares)
C1e, C2e	0.0001 $\mu\text{F}$ silver mica 350V	
All $\pm 1\%$ , 2 off each value		
C3	400 $\mu\text{F}$ elect. 10V	
C4	400 $\mu\text{F}$ elect. 10V	
C5	1,000 $\mu\text{F}$ elect. 16V	

### Transistors

TR1	BC108	(Newmarket)
TR2	OC44	(Mullard)
TR3	2N1304	(Mullard)
TR4	2N1304	(Mullard)

### Switches

S1a and b	2-pole, 5-way rotary plus spare wafer
S2	3-pole, 4-way rotary (only 1 pole used)

### Sockets and terminals

SK1, SK2	Wander plug sockets, red and black (Radiospares)
X1, X2	Screw terminals 4mm, red and black (Radiospares)

### Miscellaneous

Perforated board, hole matrix 0.2in or printed circuit board
Dial unit 2.75in dia (Waycom)
Aluminium panel 8.5in $\times$ 5.75in
Plywood for box 8.5in $\times$ 5.75in $\times$ 2.5in
Three knobs

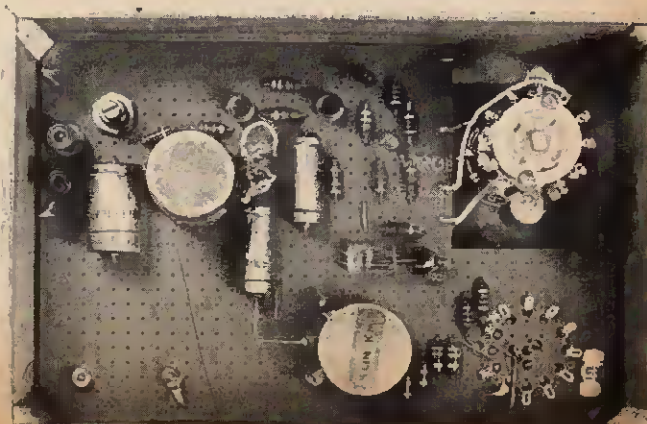



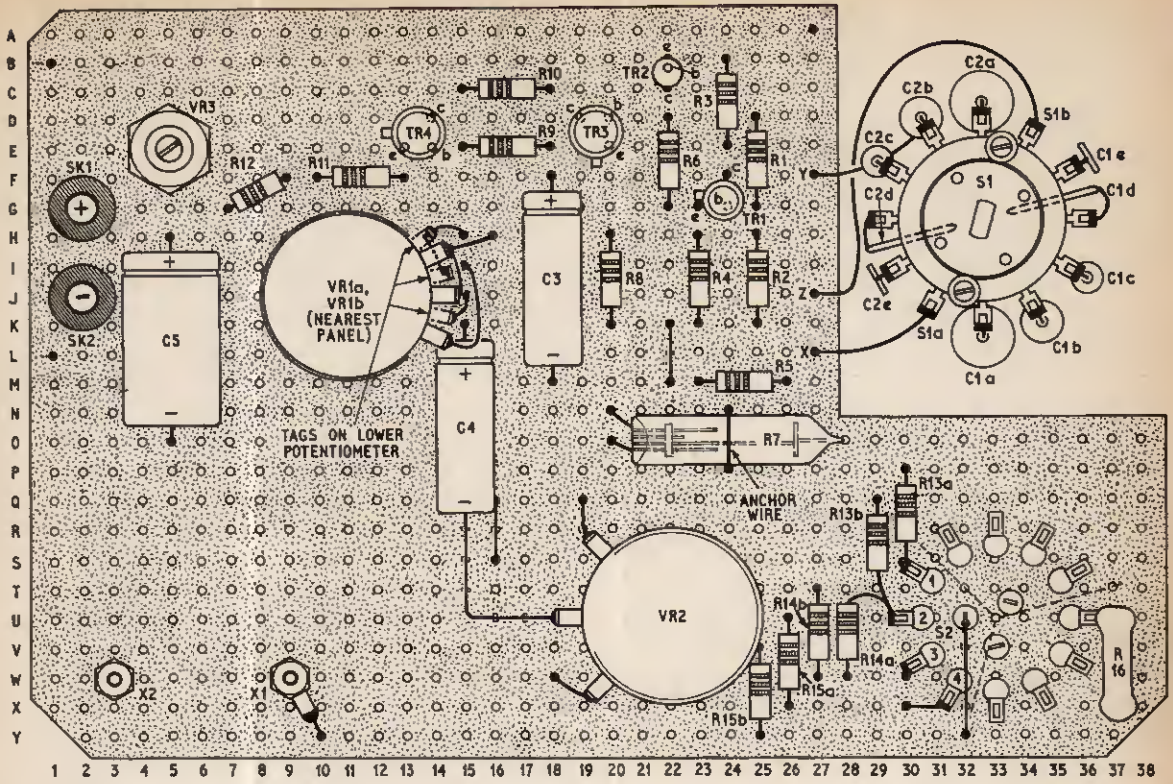

**Fig. 4a.** Layout of components on perforated board. Wafer switch S1 is furthest away from front panel. A second dummy wafer is mounted on the same shaft near the panel, all tags of which are wired together and taken to point "Y"

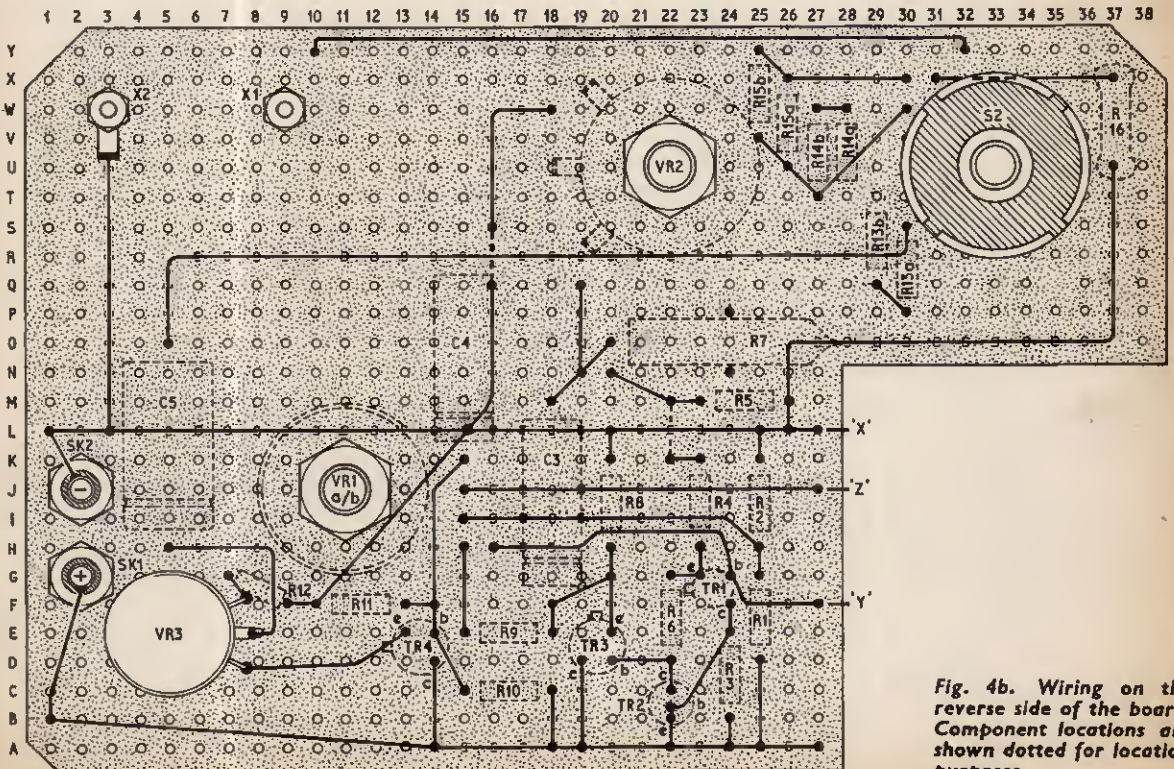

**Fig. 4b.** Wiring on the reverse side of the board. Component locations are shown dotted for location purposes

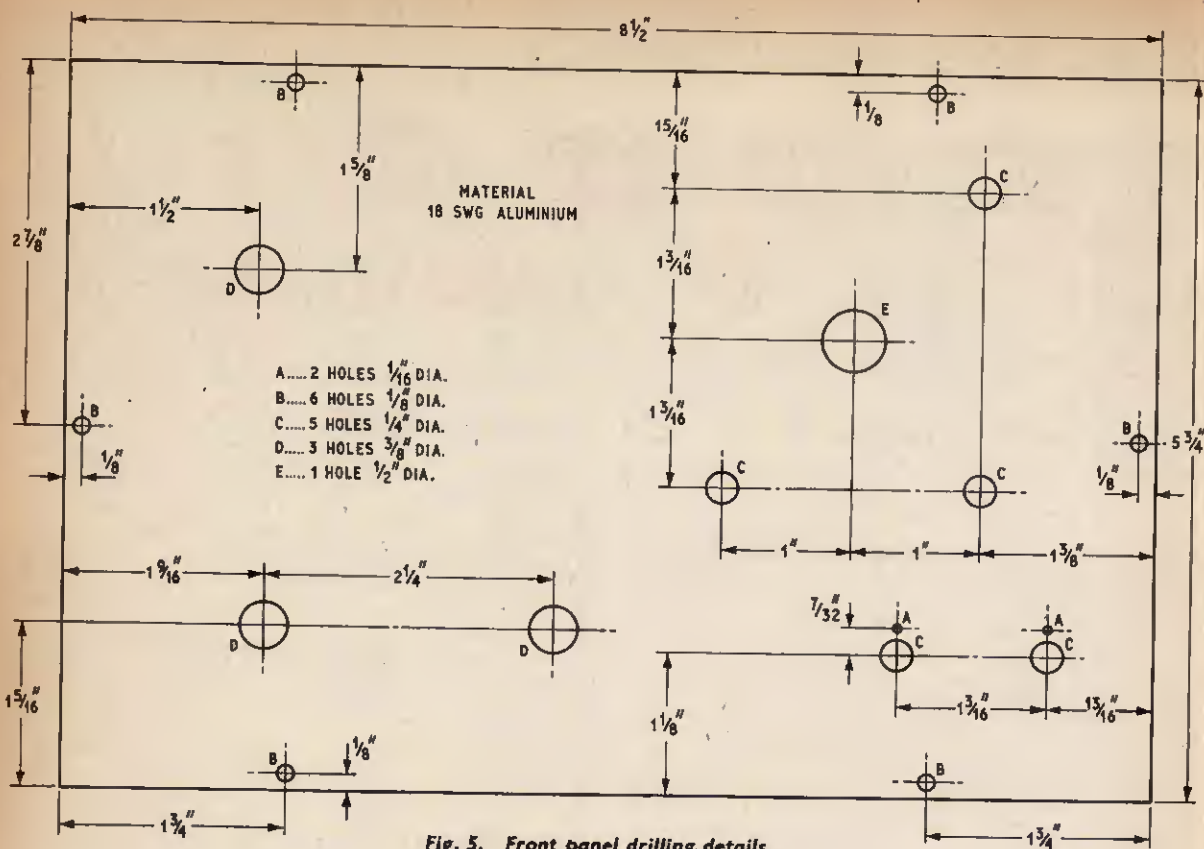

Fig. 5. Front panel drilling details

VR3 is preset for an output of 1V r.m.s. at the junction of C5 and R13, this being the maximum output voltage available. R13, R14, R15, and R16 form a 20dB per step attenuator giving respective outputs of 1V, 100mV, 10mV and 1mV with VR2 acting as a fine output voltage control.

#### POWER SUPPLIES

The unit as a whole was designed to work from the Stabilised Power Supply to be described next month.

A dry battery can be used (type PP4) and can be fixed as an internal source of supply giving approximately 25 hours of useful service. The distortion with a supply of 9V may increase but should not be more than 1.5 per cent.

#### MAKING AND SETTING UP

The unit may be constructed using perforated board (hole matrix 0.2in) or a complete printed circuit card. Layout and wiring are shown in detail in Fig. 4 and should not need further description. Front panel dimensions are given in Fig. 5. The fine frequency scale unit has to be re-calibrated as shown in Fig. 6 and care should be taken to ensure that this scale is reproduced accurately. The more accurate the scale and the closer the tolerance of C1 and C2, then obviously the more accurate will be the final unit. If a commercial signal generator is available the calibration is made easier by comparing the two signals on an oscilloscope at set frequencies. The two signals should appear to be in sync.

The capacitors listed as C1a-e and C2a-e must be close tolerance types. Those quoted are  $\pm 1$  per cent,



Fig. 6. Calibration of the fine frequency scale (VR1a and b). The frequency marks should be compared with another signal generator of proven accuracy

the Wjma capacitors being obtainable direct from the U.K. agents Waycom Limited, Wokingham Road, Bracknell, Berkshire.

The only setting up required is the adjustment of VR3 for an output at the output terminals of 1V r.m.s. or 2.8V peak to peak with S2 in the "1V" position and VR2 set at maximum output.

by G. WAREHAM

# SHORT CUTS IN CALCULATION

## PART ONE—MANY R's MAKE LIGHT WORK

THE formula for a number of resistances in parallel is

$$1/R = 1/R_1 + 1/R_2 + 1/R_3 + \dots$$

and so on where  $R$  is a single resistance equivalent to a combination of all the others in parallel. Academically minded people, who abhor vulgar fractions, will immediately write, instead of the above,

$$G = G_1 + G_2 + G_3 + \dots + G_N$$

where the  $G$ 's are conductances. This looks better, but makes the arithmetic no easier.

Fortunately there is a simple practical approach to the problem. This is based on the fact that if a number of resistances of the same value are connected in parallel, the arithmetic is easy. Thus, two 1,000 ohm resistances in parallel are equivalent to  $1,000/2 = 500$  ohms, three in parallel to  $1,000/3 = 333$  ohms, four to 250 ohms, five to 200 ohms and so on. One simply divides the common value by the number of resistances.

In practical circuits the resistances are usually of different sizes. The trick is to convert each one to a number of resistances of the same standard size. Then the problem can be solved simply, as above.

Suppose, for example, that 10 kilohms and 30 kilohms are connected in parallel; what is the equivalent? Here 10 kilohms is the same as three 30 kilohm in parallel. The combination of 10 kilohms and 30 kilohms is the same as four 30 kilohm resistors in parallel, and the equivalent is therefore  $30/4$  kilohms = 7.5 kilohms.

### STAGE GAIN

In practice, circuits may not be quite so accommodating, but often yield to a little common sense. Referring to Fig. 1.1a, which shows part of an audio amplifier, let us calculate the mid-band gain of V1.

"Mid-band" means that we can ignore  $C$ , because it should have negligible impedance at mid-band frequencies. The equivalent circuit is then as shown in Fig. 1.1b, where V1 is replaced by a current generator in parallel with the anode resistance  $r_a$ . The load is effectively  $R_L$  and  $R_g$  in parallel. The gain is given by  $g_m R_p$ , where  $R_p$  is the equivalent of all three resistances in parallel.

Since  $\mu = g_m \times r_a$ , it follows that  $r_a = 100$  kilohms, hence the net resistance is given by

$$\frac{1}{R_p} = \frac{1}{100,000} + \frac{1}{220,000} + \frac{1}{1,000,000}$$

First attempt: 100 kilohms is the same as ten 1 megohms in parallel, so the net effect of  $r_a$  and  $R_g$  is 1 megohm/11 = 90.9 kilohms. Unfortunately 220 kilohms is *not* given by any number of 1 megohm resistances in parallel. Five would give 200 kilohms (too low) and four 250 kilohms (too high).

We could use both values and then take an average, or we could apply the formula for two resistances in parallel  $(R_1 R_2)/(R_1 + R_2)$ , which, with our examples above becomes  $(90.9 \times 220)/(90.9 + 220)$ , which looks like hard work.

Second attempt: A little low cunning shows that the whole problem can be made much easier. Trial and error soon provides us with the useful fact that 220 kilohms is very nearly 2 megohms/9, or nine 2 megohm resistors in parallel. Since 1 megohm is the same as two 2M $\Omega$  in parallel, and 100 kilohms is the same as twenty 2 megohm resistors in parallel,  $R_p$  is the same as  $2M\Omega/(9 + 2 + 20) = 2 \times 10^6/31$  ohms. The slide rule gives this as 64.5 kilohms, but if you haven't a slide rule it's clearly reasonable to take  $2 \times 10^6/30$ ,

which introduces an error of about one part in 30 or roughly 3 per cent. This gives 66.7 kilohms. The gain is thus  $g_m \times 66.7 = 64.5$  (accurately) or 67 (approximately).

Accustomed as we are to valve and component tolerances, we would interpret either result as "around 65" and leave it at that. In other words, our approximate result is quite accurate enough, and we have obtained it without repeatedly solving formulae like  $R_1 R_2/(R_1 + R_2)$ , and without using log tables.

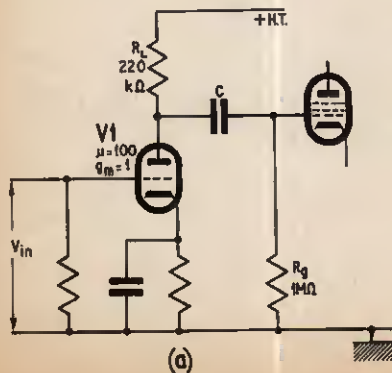
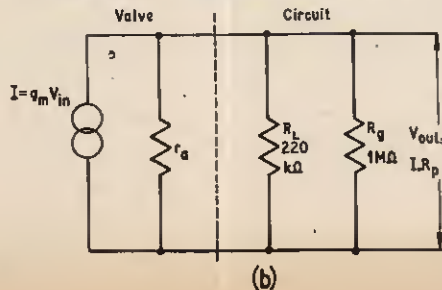

Fig. 1.1a (left). Part of a typical valve audio amplifier circuit

Fig. 1.1b (below). Equivalent circuit of Fig. 1.1a



# ELECTRONORAMA

## HIGHLIGHTS FROM THE CONTEMPORARY SCENE

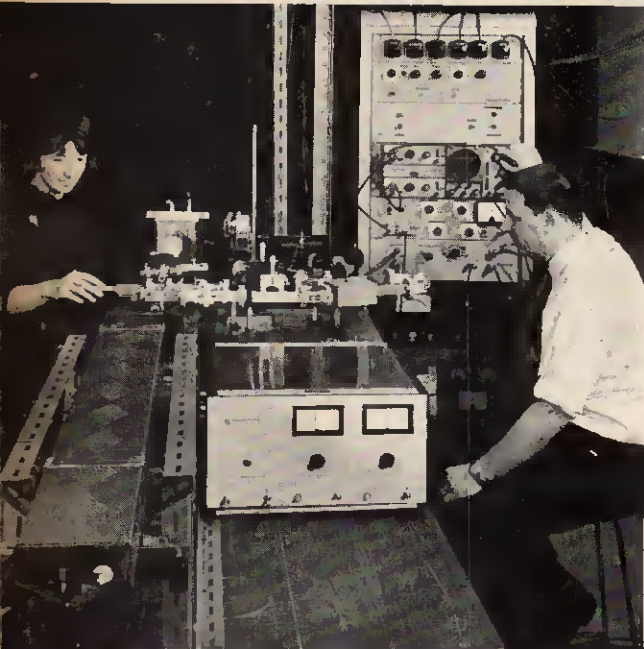

### Light Beam Modulation

SCIENTISTS at the National Physical Laboratory, Teddington, have found a way of modulating the light generated by a helium-neon laser. By using a crystal of potassium dihydrogen phosphate (KDP), a 9,000Mc/s signal from a small magnetron is "mixed" with the light beam. This method can have far reaching applications in space communications.

The demonstration set-up shown left illustrates the effect more clearly by adding an audio frequency modulation to the microwave signal. The light beam is then double demodulated so that the audio signal is recovered and relayed to a loudspeaker.



### New Language Laboratory

THE Cybervox language laboratory at the Brighton College of Technology has been officially installed and is shown above being tried out by members of the Education Committee, Chamber of Commerce, and Press, who are listening to courses in French, Italian, German, and Russian.

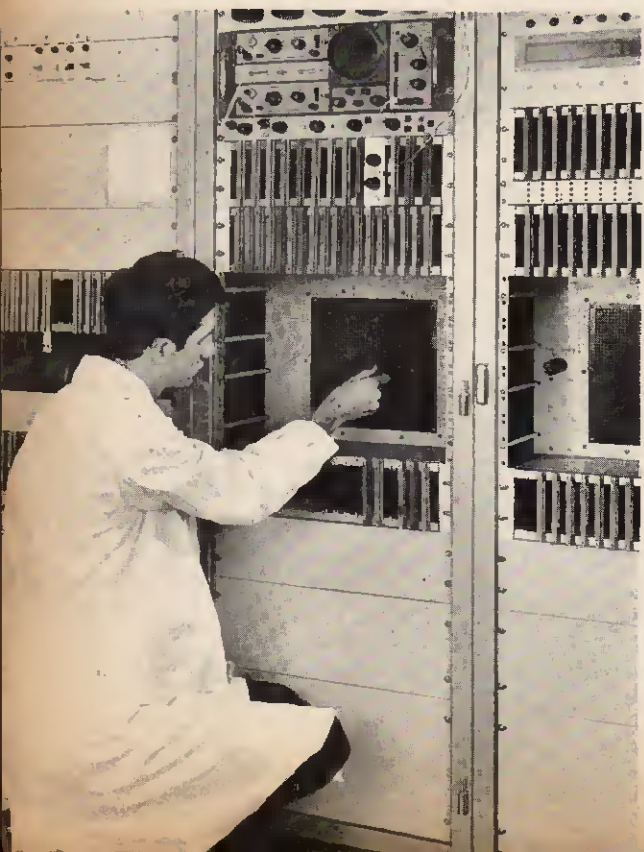

### Print Recognition

THE Autonomics Division of the National Physical Laboratory have built a machine capable of recognising printed numerals from a specified style at the rate of 3,000 per second. A video signal is produced corresponding to the character shapes it "sees". Unknown characters are copied and displaced by passing the signal through tapped delay lines. By inserting plugs into the board shown left, sets of copies are compared with each other to give areas of match. These measures, used with a suitable decision logic on a similar plugboard, enable the character to be read.

The equipment is now being developed by the Plessey Company for application to banking, postal sorting, and similar functions.

## Laser System May Speed Up Computers

**A** LIGHTNING fast laser device, which might lead to optical computer memories in place of the slower magnetic core storage systems currently in use, has been developed by I.B.M.

The experimental device, developed under contract to the U.S. Army Electronics Command, allows a shaft of light to be positioned more than 100,000 times a second on up to 131,072 distinct points in an area smaller than a match head.

By throwing the beam through a mask inscribed with alphabetic characters and other symbols it would be possible to provide smaller, faster and more accurate printers which would not need keys or type bars. The beam would then be deflected onto photo-sensitive paper to produce a printed sheet.

### Thin Film Tools

The electron beam evaporator on page 578 last month was developed by G. V. Planer Ltd. The thermocompression bonder is a Ferranti-Planer product.

## British Satellite Tracking System

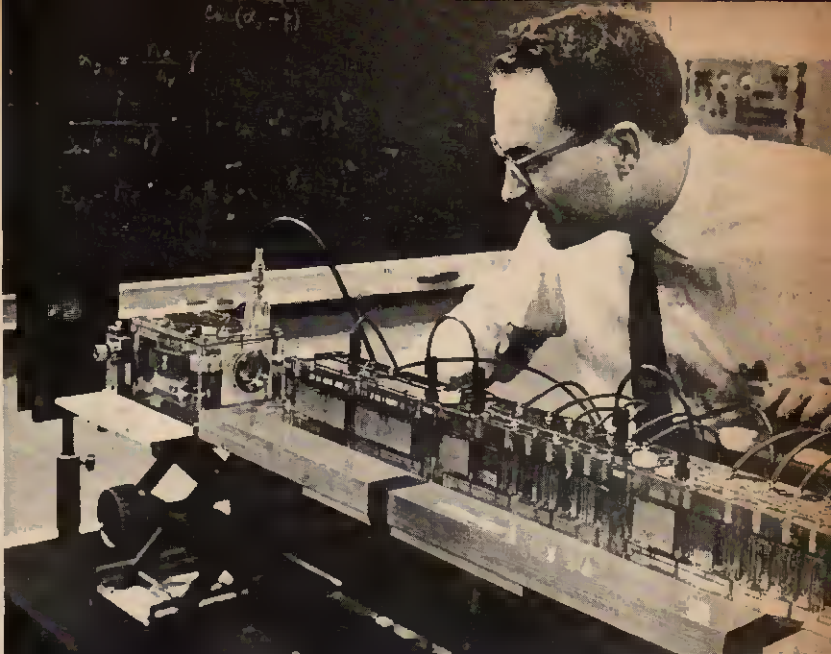

**W**ORK was started in October 1965 to design, develop and build a satellite tracking station which will be installed on the Ascension Island in September.

Final checking and testing was completed by the manufacturers the Marconi Company at the beginning of July after only nine months' work.

The station on the island will be linked to Andover in the U.S.A. via a synchronous satellite Intelsat II in orbit over West Africa.

The picture (left) shows the 42ft diameter steerable parabolic dish aerial. Above the platforms are two identical cubicles (one on standby) which house the signal transmitting equipment operating in the 6,000Mc/s band, with final output power of 15kW.

A rotating cassegrain is mounted at the focus of the dish to produce a conical scanning motion of the aerial beam. This produces variations in the received signal when the axis of the aerial is not pointing exactly at the satellite. The noise temperature of the receiving system is kept low by using cryogenic parametric amplifiers operating at  $-253^{\circ}\text{C}$  in a helium system.

The dish is capable of being steered in azimuth and elevation by complex servo auto-follow systems designed to locate and lock on to the satellite.

After installation and final tests on the Ascension Island the Marconi Company will hand over the station to Cable and Wireless Limited, who will operate it in conjunction with the APOLLO "man-on-the-moon" project.

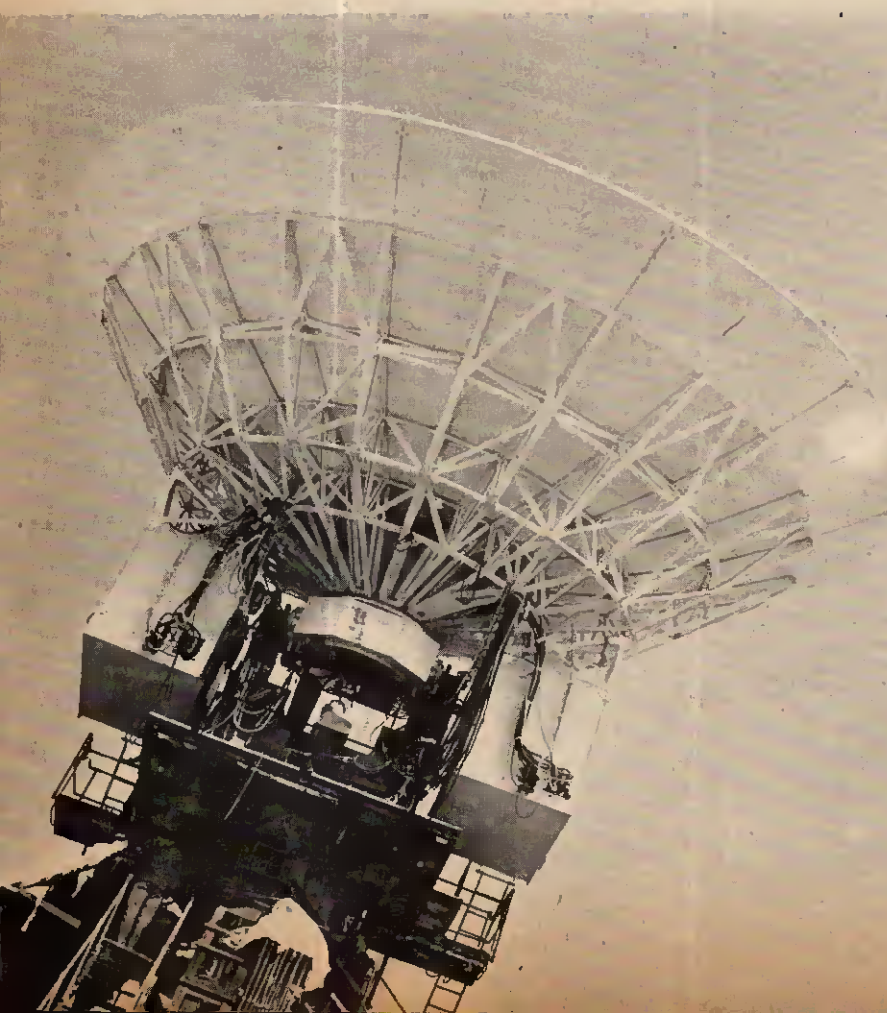

# BEGINNERS start here... 23

*An Instructional Series for the Newcomer to Electronics*

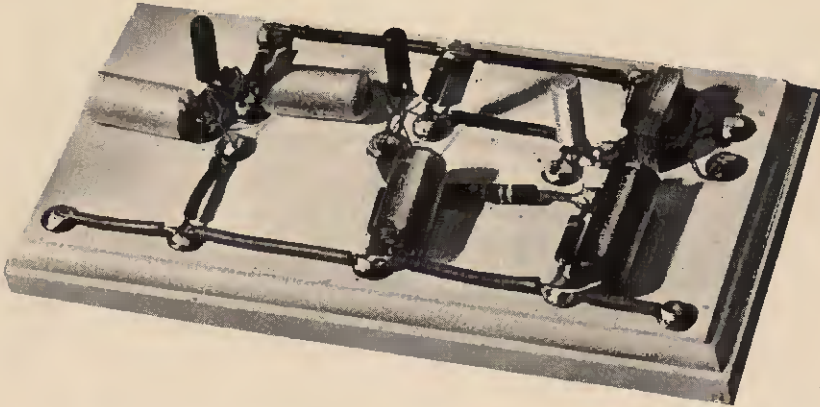

WE have already noted in passing the effects an amplifier has on signals in general. This can be summarised under three headings. (a) The signal *amplitude* is changed (usually increased). (b) The *phase* is altered. (The signal is delayed in time, and/or "inverted" in phase.) (c) The *shape* is altered (this is called the distortion, usually undesirable, but not always).

In this month's article, we describe a transistor amplifier suitable for general purpose linear amplification, that is with little distortion. It has two sections, the pre-amplifier and the power output stage. A number of uses should occur to you. The amplifier is particularly useful for some experiments in school laboratories.

Using the board layout, the whole unit can be assembled and working in an evening. Before covering the constructional points, we will describe the action of the circuit, see Fig. 23.1.

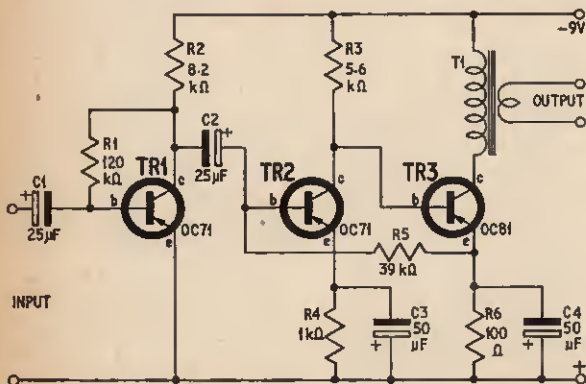

Fig. 23.1. The theoretical circuit of the three stage amplifier. TR1 is a pre-amplifier stage. TR2, TR3 form a d.c. coupled pair. TR3 delivers approximately 60mW to a 3 ohm load

## THREE STAGE AMPLIFIER

The first transistor TR1 amplifies the tiny currents from the particular transducer being used. The alternating signal appearing at the collector of TR1 is fed to the base of the second transistor, TR2. Further amplification occurs here, and the now relatively fairly large signal currents are fed directly to the base of the third stage TR3.

TR2 and TR3 are an example of a directly coupled pair. The bias current for TR3 is also fed from the collector of TR2 together with the signal. The base bias current for TR2 is produced by the voltage at the emitter of TR3. Thus a complete d.c. path from TR3 emitter, through TR2, back to TR3 base, exists. This arrangement makes for very good temperature stabilising. The base bias for TR1 is obtained via R1 connected to its collector.

The strong current flowing in TR3 collector passes through the primary of the transformer T1 and the changing magnetic field produced induces currents in the secondary which then operate the transducer (say, a loudspeaker, or tape head).

## TEMPERATURE STABILISATION

We must now mention the special precautions that have been taken to stabilise the amplifier against drift (and even destruction of the transistors) by temperature changes.

It is a fact that the resistance of germanium falls when the temperature is raised. This means that more current tends to flow, which in turn tends to heat up the transistor, eventually destroying it in extreme cases. (The current is called the "leakage", and the destruction is termed "thermal runaway".)

Now let us explain the methods of stabilising used in this amplifier.

In the first stage, by connecting the bias resistor R1 to the collector of the transistor, we obtain an automatic regulation of the bias current. If the temperature tends to increase the current through the collector

resistor R2 the collector voltage falls, thus reducing the bias current and this tends to reduce the current through the transistor.

In the case of the output pair (TR2 and TR3), the increasing current through TR2 lowers its collector voltage, this in turn reduces the current through TR3, and the emitter voltage falls. This reduces the bias to TR2 (via R5) and the current in this stage tends to fall.

The above is typical of the tricks we must get up to on occasions in order to keep the circuits operating correctly.

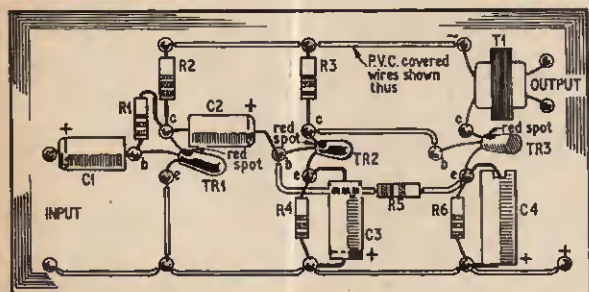

Fig. 23.2. The layout follows our normal "baseboard" pattern. The components follow roughly the same arrangement as in the theoretical circuit diagram

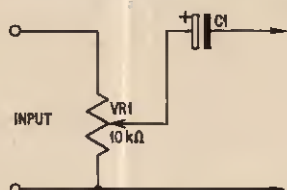

Fig. 23.3. A volume control can be added as shown. The potentiometer VR1 can be a pre-set component, or preferably a normal one with a control knob attached

## COMPONENTS . . .

### Resistors

R1	120kΩ	R4	1kΩ
R2	8.2kΩ	R5	39kΩ
R3	5.6kΩ	R6	100Ω

All 10%, 1/4W carbon

### Potentiometer

VR1 10kΩ potentiometer

### Capacitors

C1	25μF elect. 12V	C3	50μF elect. 12V
C2	25μF elect. 12V	C4	50μF elect. 12V

### Transistors

TR1	OC71	} (Mullard)
TR2	OC71	
TR3	OC81	

### Transformer

T1 Miniature output transformer, 3Ω secondary

### Miscellaneous

Wooden baseboard. Brass wood screws. Wire and sleeving.

## SYMBOLS OF UNITS

A	ampere	<b>Prefixes denoting multiples or Sub-multiples of units</b>	
V	volt	<i>Multiples</i>	
W	watt	G	giga × 10 <sup>9</sup>
Ω	ohm	M	mega × 10 <sup>6</sup>
F	farad	k	kilo × 10 <sup>3</sup>
H	henry	<i>Sub-multiples</i>	
dB	decibel	d	deci × 10 <sup>-1</sup>
in	inch	c	centi × 10 <sup>-2</sup>
ft	foot	m	milli × 10 <sup>-3</sup>
yd	yard	μ	micro × 10 <sup>-6</sup>
m	metre	n	nano × 10 <sup>-9</sup>
s	second	p	pico × 10 <sup>-12</sup>
min	minute	<i>Examples</i>	
c/s	cycle per second	Mc/s	megacycles per second
g	gramme	kΩ	kilohm
oz	ounce	kW	kilowatt
lb	pound	cm	centimetre
°C	degree Celsius (centigrade)	mA	milliampere
°F	degree Fahrenheit	μV	microvolt
		pF	picofarad (micro-microfarad)

## SOME COMMONLY USED ABBREVIATIONS

a.c.	alternating current	p.f.	power factor
a.f.	audio frequency	r.f.	radio frequency
d.c.	direct current	r.m.s.	root-mean-square
p-p	peak-to-peak		

## CONSTRUCTION

Using the baseboard method we have developed for earlier designs in this series, the amplifier components can be laid out approximately according to their positions in the theoretical circuit. Refer to Fig. 23.2.

Solder the component leads to the screw heads, carrying out the precautions against overheating as mentioned in the earlier projects. Note the polarity of the electrolytic capacitors, it is always important to connect these components the correct way round in any circuit.

No volume control is incorporated in the actual circuit shown, but, if desired, a potentiometer can be positioned at the input for this purpose, as shown in Fig. 23.3.

The amplifier can be used to drive a 3ohm loud-speaker and the input signal can be derived from a gramophone pick-up. If a crystal pick-up is used, an 82 kilohm resistor can be wired in series with the input lead, to reduce the top notes slightly.

A crystal receiver has given very good results when coupled to this amplifier. If you feel like experimenting with a photo-transistor at the input, then that would make a good project—perhaps detecting a modulated light beam.

By now you should have a working knowledge of circuits, and the normal methods of construction are open to you. Just study the other constructional articles in our magazine.

Whatever your next project, remember the few rules of the game we have covered, and best of luck with your efforts. Next time we shall discuss briefly that important device the transducer.

# First of three miniature R/C designs

**F**OLLOWING the general trend that is apparent in other branches of electronics, model control equipment is getting smaller. Relayless receivers of matchbox size enable model cars to be steered between chair legs in the living room. A simple conversion job on a toy plastic boat will allow it to be navigated between the lily pads on a fish pond, or even around the sponge in the domestic bath tub.

On this small scale of operations it is obviously inconvenient to use a transmitter of such a size that it has to be supported by both hands, with weighty batteries capable of pushing a signal a mile or more.

It is possible, on the other hand, using tiny yet sensitive receivers, to control a model with only the minute output from a signal generator, but walls, trees, even human bodies, can do strange things to a low power transmitter's radiation pattern. Perhaps the most important single factor with radio control is reliability and to some extent this is influenced by radiated power, or rather, the lack of it.

To meet the need for a compatible transmitter, the described unit was constructed, to strike a happy balance between power and portability within the confines of a box measuring 4in x 2½in x 1½in. Very small models do not admit, as yet, the more complex systems of control, such as multi-tone reed or filter, and mark-space proportional, so such refinements are not included. Miniaturisation has not been so conscientiously applied to servos and other mechanisms as to

the purely electronic circuits which direct them, probably because of expense.

This transmitter was intended for use with a simple super-regenerative receiver arranged to respond to plain carrier and modulated carrier, giving in effect two channels. With simple escapements and motorised actuators, the transmitter supply need only be switched on when a command is given.

Even with "hold-on" of transmitter power for right and left manoeuvres, it is seldom that a model will be expected to circle for any lengthy period, and here consumption would be reasonable. Small transistor radio batteries are considered adequate for this type of transmitter and were therefore used.

The unit may be held and operated by one hand, pulsed with the thumb, and modulated or unmodulated carrier selected by a finger. Its total weight, including batteries and aerial, is 8 ounces. With a mounted 34in telescopic aerial extended, and no counterpoise, a reliable range of 200 yards was obtained, bearing in mind that a transmitter is only as good as its aerial.

If a thin wire counterpoise is connected, and the transmitter held high, the range is extended to half a mile in open country. Further improvements to the aerial system were not attempted as the range was more than enough for the small models contemplated. A much longer centre-loaded whip would undoubtedly produce a dramatic increase in performance, if the wrist were strong enough to support it single-handed.

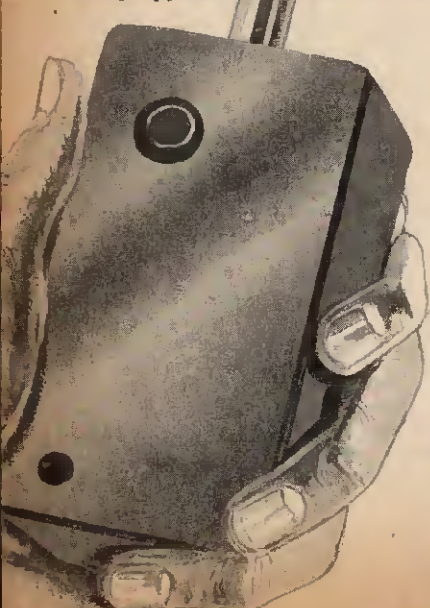
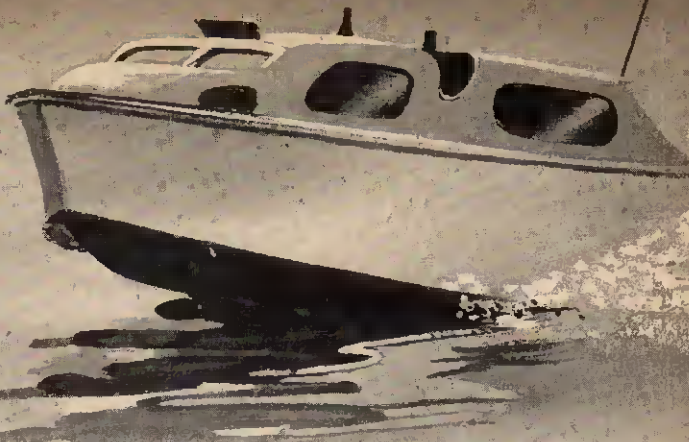

# MODEL CONTROL TRANSMITTER



## R.F. OSCILLATOR

Starting with the r.f. oscillator section of Fig. 1, it will be seen that two *npn* silicon planar transistors are employed in a kalitron circuit. This oscillator is very tolerant to transistors with wide spread on their characteristics; unbalance may be corrected by adjustment of feedback capacitors (trimmers) TC1 and TC2. Also, the loop gain of such a circuit is high, so oscillation is readily obtained. R4 and R5 slightly bias the transistors in the "on" state, to ensure easy starting, although the circuit will function without them at normal room temperatures.

It will be noted that no r.f. choke is used at the centre tap of L2. This is because the frequency of operation may be determined by the inductance of the choke rather than that of L2 under some conditions; this can be undesirable if strict adherence to a narrow permitted frequency band is essential, as is the case with radio control of models. The r.f. oscillator has inherently good frequency stability and its maximum output was measured with an r.f. wattmeter at 250mW.

Obviously, this method cannot be used with standard transmissions of speech and music as severe distortion would result, but in this application such distortion is of little consequence, efficiency being far more important.

The multivibrator is tuned by VR1, covering the approximate range 300c/s to 1,500c/s. The frequency may be raised or lowered by altering the values of C1 and C2. The switch S2 open-circuits the collector of TR1 and stops the multivibrator functioning. The r.f. oscillator then radiates an unmodulated carrier. TR2, still being in series, limits the input current to the oscillator, which would normally be much higher when unmodulated.

Once again, the circuit is not critical and transistor "spreads" or substitution of different types (within reasonable limits) may be tolerated, provided the collector emitter voltage and current rating is not exceeded. At full power this lies in the region of 50mA at 18 volts, or half that when a single battery is used.

The jack socket JK1 is included to allow an independent power supply to be plugged in for extended range

Fig. 1. Complete circuit of the transmitter

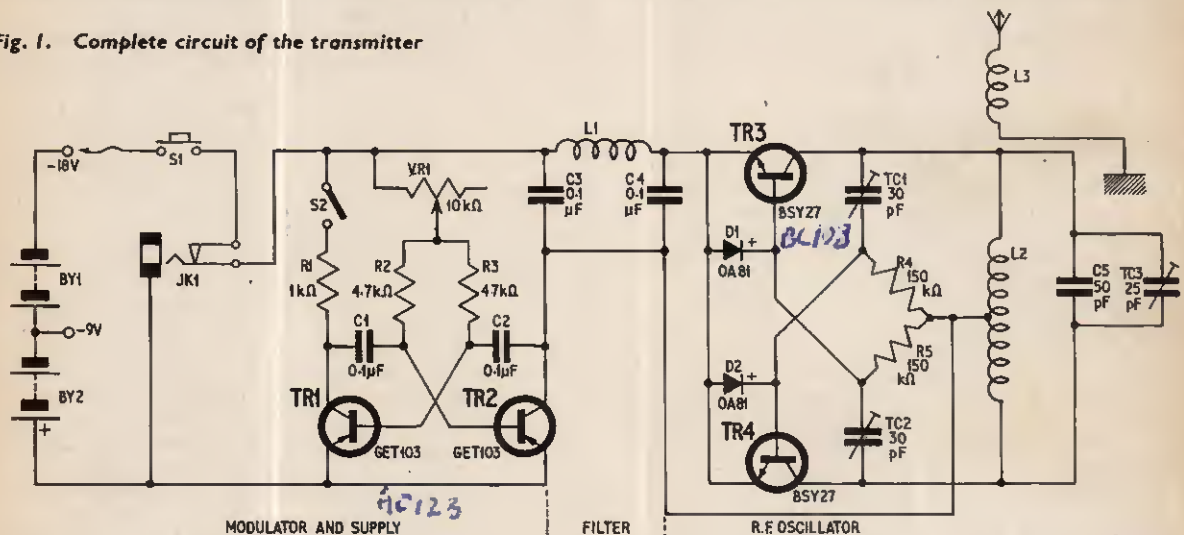

## MODULATION AND FILTER

Instead of being modulated by a sine wave the r.f. section is switched on by a square wave pulse. The purpose of the filter (L1, C3, and C4, in Fig.1) is to remove unwanted harmonics and prevent them finding their way to the aerial. The inductor L1 in the prototype model was a pi winding taken from a valve type i.f. transformer, less dust core. This was estimated to have an inductance around 1 millihenry. A standard 1.5 millihenry choke may be utilised if space can be found for it, the value is not too critical.

Close inspection of the circuit will reveal that TR2 is in the joint collector circuit of TR3 and TR4. As TR2 forms part of a multivibrator circuit the r.f. oscillator is either switched on or off, depending on which "state" TR2 is in. This is, in fact, a form of series modulation and removes the need for a bulky transformer or choke.

When a self-excited oscillator is modulated by a sine wave, its supply potential is constantly varying, giving rise to f.m. as well as a.m. modulation. With switching, provided a "clean" square wave is applied, as with slow speed keying, the variation of voltage can only occur during the transition between off and on; a comparatively smaller space of time.

and trimming tests, where the transmitter needs to be switched on for long periods. Both internal batteries and keying switch S1 are automatically disconnected by its break contact. The jack may also be used as an input from a proportional control contained in a separate box, thus extending the scope of the transmitter at a later date.

Two PP3 batteries, connected in series, fit neatly into the base of the transmitter box. For short range working one battery alone will serve. Even with a 3 volt supply there is still enough power for reliable room to room operation. The constructor would obviously experiment a little in this respect.

## CONSTRUCTION

To avoid the additional complication of planning and preparing a printed circuit, components were mounted on an s.r.b.p. panel. This form of construction is recommended for one off units because, once the major components are positioned, smaller items may be juggled around to make the best use of limited space.

The s.r.b.p. panel, which measures 2½in × 2in, can be clamped in a vice, or screwed to two wooden blocks on the bench. After marking with a scribe, holes are

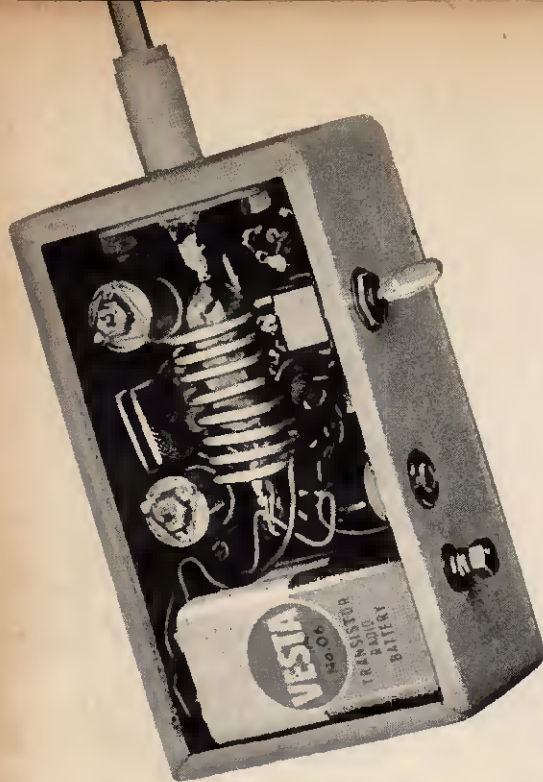

drilled to take the formed leads of components. These are soldered underneath the panel to short lengths of single strand connecting wire, insulated where necessary.

To illustrate the method, TR3 is mounted, in the position shown in Fig. 2, with its leads inserted through three small holes drilled with the same spacings as the transistor wires. The transistor sits with its case almost touching the panel, below the coil L2. The leads of TR3 may be splayed out underneath and soldered at least  $\frac{1}{8}$  in from the holes, to avoid overheating the transistor.

After construction is completed the underside of the panel should be covered with self-adhesive tape, to hold the wires in place. However, the assembly is surprisingly rigid as it stands.

L2 is wound on a  $\frac{1}{8}$  in diameter former; the wire ends are bent as shown in Fig. 3. Thick wire 14 s.w.g. is recommended to ensure a low r.f. resistance and, as it is self supporting, physical stability. The coil is retained in the panel by solder blobs run through the mounting holes. For this a large soldering iron is an advantage.

After winding the aerial coil L3 on a  $\frac{1}{8}$  in former it may be insulated by a thin cylinder of adhesive tape and slid inside L2. One end of L3 is soldered direct to the tag at the base of the aerial; the other end is connected to the earth counterpoise terminal by a short wire.

When assembly of the chassis panel is completed

## COMPONENTS . . .

### Resistors

R1	1k $\Omega$	R4	150k $\Omega$
R2	4.7k $\Omega$	R5	150k $\Omega$
R3	4.7k $\Omega$		

All 10%  $\frac{1}{4}$  watt carbon

### Potentiometer

VR1 10k $\Omega$  sub-miniature preset skeleton

### Capacitors

C1	0.1 $\mu$ F	miniature polyester 250V
C2	0.1 $\mu$ F	miniature polyester 250V
C3	0.1 $\mu$ F	miniature polyester 250V
C4	0.1 $\mu$ F	miniature polyester 250V
C5	50pF	silver mica 2%

### Trimmer Capacitors

TC1	30pF	"beehive" trimmer
TC2	30pF	"beehive" trimmer
TC3	25pF	ceramic disc trimmer

### Inductors

L1 1mH (see text)  
L2, L3 wound from 14 s.w.g. tinned copper wire (see text)

### Transistors

TR1	ACY28 or GET103	(Mullard)
TR2	ACY28 or GET103	(Mullard)
TR3	BSY27	
TR4	BSY27	

### Diodes

D1, D2 OA81 (Mullard) (2 off)

### Switches

S1 Single pole, on/off, push button (Type MP 14, Bulgin)  
S2 Single pole, on/off, toggle

### Socket

JK1 3.5mm miniature jack with break contact (Radiospares)

### Batteries

BY1, BY2 9V type PP3 (2 off)

### Miscellaneous

Hardboard for case, telescopic aerial 34—38in  $\times$   $\frac{1}{4}$ in, coil formers, miniature screw terminal.  
Battery connectors, s.r.b.p. panel 2.5in  $\times$  2in.

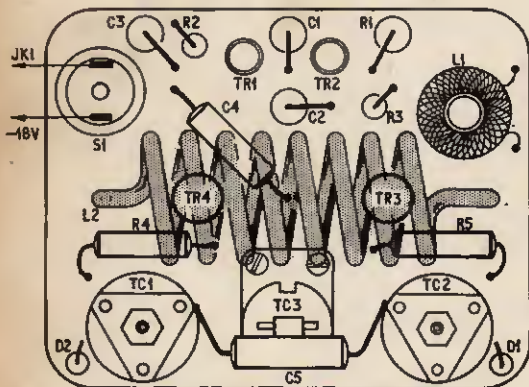

Fig. 2a. Component layout on the s.r.b.p. panel

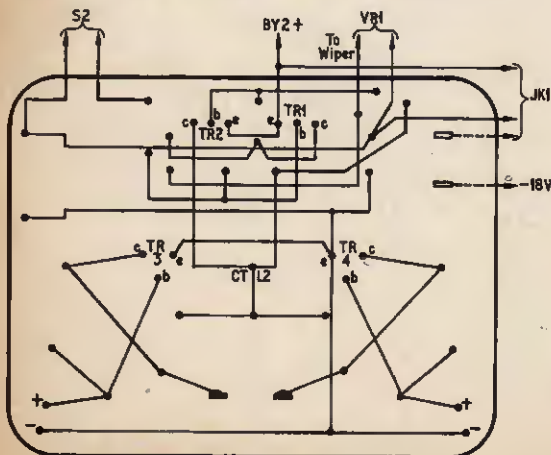

Fig. 2b. Wiring on the underside

a test can be made by temporarily shorting S2 leads and connecting to a 9 volt supply. With TC1 and TC2 screwed half way in, and L2 tuned by trimmer TC3, a tone should be heard in a nearby receiver, or an indication obtained with a field strength meter close to the transmitter chassis. The battery consumption should be about 20mA.

The box was constructed of  $\frac{1}{8}$ in hardboard, glued at the corners. A  $\frac{7}{16}$ in diameter coil former takes the aerial, and is shown in Fig. 4. The base of the aerial was wrapped with a 2-thou shim of steel, given a coat of clear rubberised adhesive, then was pushed into the coil former and allowed to dry.

After the box has been sanded, a covering of aluminium foil will ensure adequate screening without significantly adding to the weight. This may be glued on and bent over at the back to connect to the earth terminal. Afterwards, a further covering of self-adhesive plastics sheet will give a clean appearance. VR1 should be glued to the inside of the front face of the box.

### TESTING AND ALIGNMENT

As the model control band has a bandwidth of only 320kc/s, with a centre frequency of 27.120Mc/s, an accurate means of determining the transmitter's frequency is essential, preferably to within  $\pm 1$  per cent. A sensitive transistorised field strength meter, pre-checked against a crystal calibrator, would serve. Alternatively, a crystal controlled superhet receiver may be used to set the transmitter output to within close limits.

Unscrew trimmers TC1 and TC2 to their fullest extent, so that the concentric vanes are unmeshed, and open circuit switch S2. Insert a 100mA meter in series with an 18 volt external supply and plug the supply into JK1. The meter should indicate around 40mA.

Screw down one trimmer about  $1\frac{1}{2}$  turns, whereupon the meter reading should increase, then screw down the companion trimmer for a "dip" in the reading. As the trimmer is screwed down it will be seen that consumption decreases and then begins to rise again. The correct point corresponds precisely to the lowest reading. A 6 volt 60mA bulb, connected to the aerial and earth counterpoise terminal by short leads, should glow with reasonable brilliance.

If the current to the transmitter falls suddenly and drastically, screw down TC1 and TC2 just a little more, once again aligning for maximum dip. This time the bulb should glow. When S2 is closed, applying modulation, the meter reading should drop slightly.

As a final check, the current can be made to increase by touching the aerial, thus absorbing energy. Set the frequency of operation by means of trimmer TC3, giving a final trim if necessary when the internal batteries are installed. The transmitter is now ready for use.

When a longer range than usual is contemplated, or when operating in "difficult" surroundings, connect 2 yards of thin wire to the earth terminal and hold the transmitter rather high, at arms length, to improve aerial efficiency.

The small size of the transmitter suggests a particularly interesting application. It can be combined with existing receiving equipment in a larger model so that it monitors the functioning of control gear. In the event of a failure or fault the transmitter would proceed to emit a warning signal, and provide a "beacon" to home on, a valuable insurance against the loss of an airborne model.

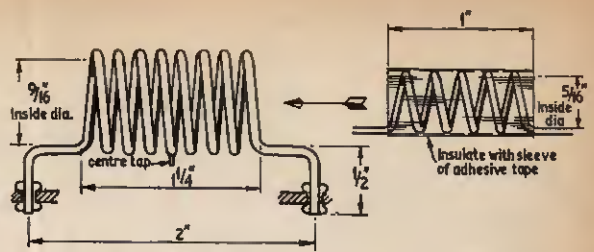

Fig. 3. Coll winding details for L2 and L3 using 14 s.w.g. wires

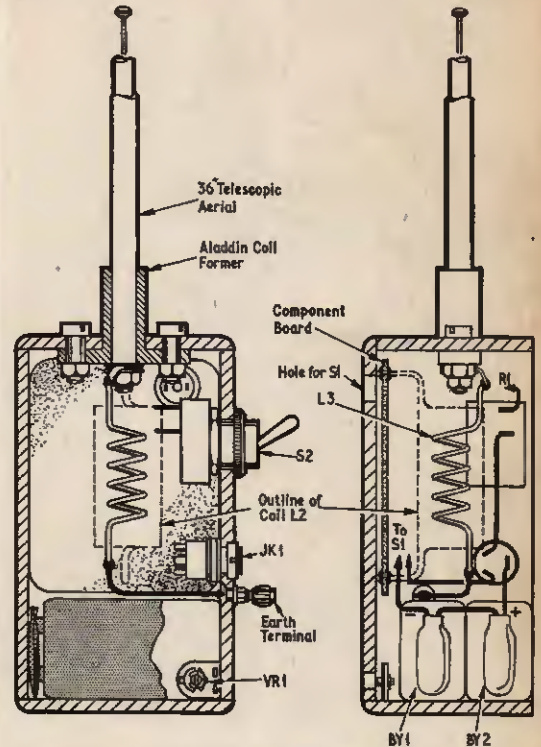

Fig. 4. Layout of major parts in the case: rear view left, side section right

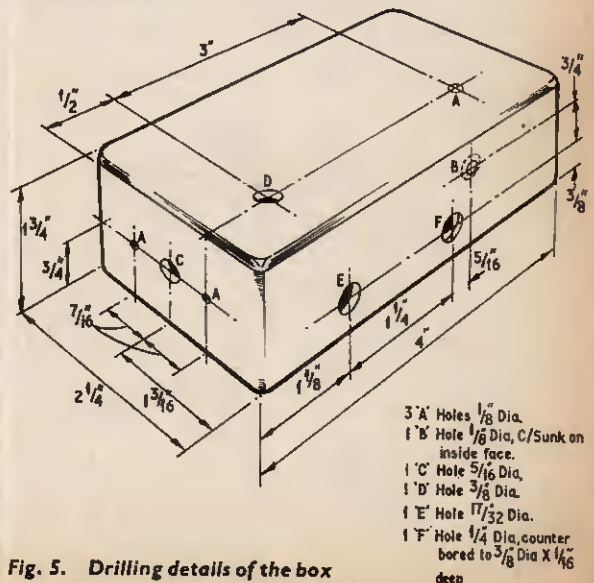

Fig. 5. Drilling details of the box

## 4

# EXPERIMENTS in LOGIC DESIGN

by S. T. ANDREWS

**P**ART 3 concluded with a discussion on the logical shift facility. We now proceed to consider how this facility can be applied to the technique of multiplication.

Moving a number logically up, i.e. to the left, by one place multiplies the number by two, shifting it twice multiplies by four, and so on. This is all very well but the method cannot be used directly for multiplying by, say, 6, since it only works for multipliers which are exact powers of two. To multiply by other numbers a somewhat more advanced system is required; the principle of this can now be discussed in some detail. (It is, naturally, possible to multiply two numbers  $x$  and  $y$  by adding  $x$  to itself  $y$  times or *vice versa*, however this can be extremely tedious and is not the method to be used here.)

## THEORY OF MULTIPLICATION

Multiplication in decimal is familiar enough as a process but it is worth doing a little theory on it as well. The sum  $9152 \times 237$  means:

$$(9152 \times 7) + (9152 \times 30) + (9152 \times 200)$$

which is probably rather obvious. Now, the binary sum  $10110 \times 1011$ , when similarly expanded, comes out as:

$$(10110 \times 1) + (10110 \times 10) + (10110 \times 000) + (10110 \times 1000) = 10110 + 101100 + 0 + 10110000$$

which is equally obvious. The answers to the individual sums in brackets are called partial products and the final answer to the calculation is formed by adding all the partial products together. Each partial product is a power of 2 and can thus be formed by a logical shift of  $x$ , where  $x = 10110$  in the example. By progressively shifting  $x$  up, one place at a time, all the possible partial products are formed and it is only necessary to find a way of deciding which ones are to be remembered and later added to give the final result. The decision depends on the other operand,  $y$ , which is considered one bit at a time, starting with the least significant digit, and has each bit tested to see if it is a 0 or a 1.

If, at any stage, the bit tested is a 1 then the current value of  $x$  is a partial product, if the bit of  $y$  is a 0 the partial product is ignored and  $x$  is shifted up one place. Then using this new shifted value of  $x$  the next bit of  $y$  is tested in the same way. The process is seen to be a repetitive loop and is repeated until all the bits in  $y$  have been tested, then all the partial products are added and the result is obtained.

Considering the example given before, using  $x = 10110$  and  $y = 1011$ , the process would be as follows: initially  $x = 10110$  and the first step is to test the least significant bit of  $y$ . This is a 1 so the starting value of  $x$ , 10110, is taken as a partial product. Then  $x$  is

shifted one place left, giving 101100 and the next bit of  $y$  is tested, again it is a 1 so 101100 is the next partial product. The next shift gives  $x = 1011000$  but this time testing  $y$  we find a 0 so 1011000 is *not* a partial product. A final shift of  $x$  gives 10110000 and since the corresponding bit of  $y$  (the left-hand bit) is a 1, this figure is the third, and final, partial product. Adding these partial products gives the answer to the calculation as 11110010. The whole process can be summarised in a flow diagram as in Fig. 4.1a.

It is necessary to have a "last character" indicator after the final (left-hand) digit of  $y$  so that the machine knows when all the bits in  $y$  have been tested. When it comes across this last character signal it leaves the loop, adds the partial products, and thus ends the calculation. It is left to the reader to show that, in the above example, the same result is obtained if  $x = 1011$  and  $y = 10110$ , initially.

## IMPROVED METHOD

By taking the above method we have a simple but effective method of doing multiplication which consists of a repetitive loop: test  $y$  for 0 or 1, form, or do not form, partial product, then shift  $x$  up one place and repeat up to the "last character" signal, finally add all the partial products formed. This system would certainly work but it does have snags. The main objection is that the partial products are all stored as individuals and only added at the end, this requires extra storage registers and extra gates, etc. Also, since it is only possible to add two numbers at a time, the time taken to add all the partial products would be considerable. Finally, the adder itself would stand idle during most of the calculation since the repetitive loop does not require any additions.

A far better system would be one in which each partial product was added to the sum of all the previous ones, i.e. as soon as the second partial product was formed it was added to the first and only the total was held in storage. The third, and successive, partial products are added to the accumulating total as soon as they are formed, so at any one time only one total has to be remembered instead of all the partial products. Since they are being added as fast as they are being produced, the adder is in more constant use and is not used in just a single burst at the end. Fig. 4.1b shows the modified flow diagram.

The overall block diagram of the multiplication section using this technique is shown in Fig. 4.2. It has one new register which, for want of a better name, we will call  $Q$ , the  $y$  operand is written into  $Q$  and is read, one bit at a time, when required. Each bit is put through a discriminator which senses if it is a 1 or a 0 and sends appropriate signals to the control unit.

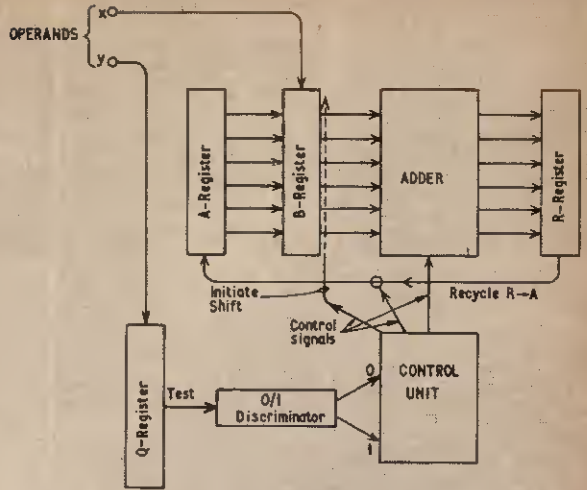
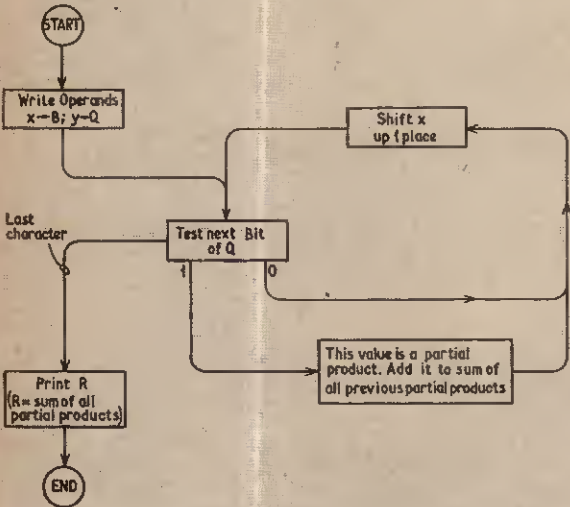
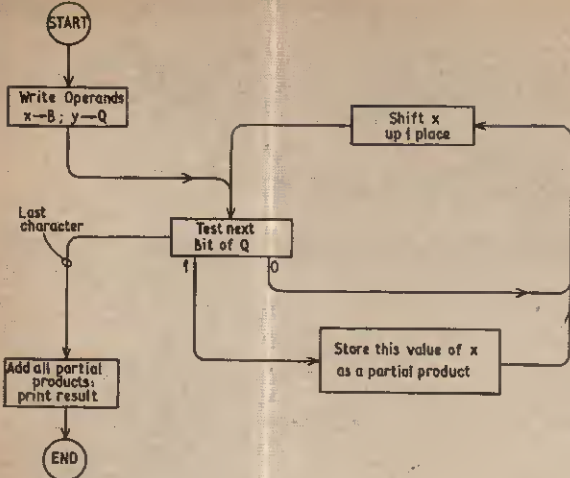
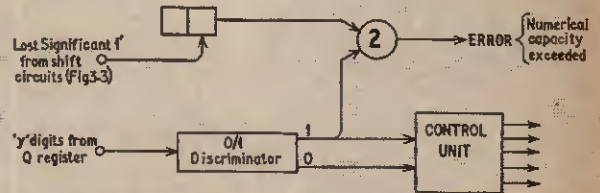

Fig. 4.1a (above left). Basic flow diagram for first type of multiplication

Fig. 4.1b (left). The modified basic flow diagram for multiplication.

Fig. 4.2 (above right). Basic set-up for the more advanced type of multiplication

Fig. 4.3 (below). Checking circuits to detect numerical overflow



Bearing this in mind, the criterion for deciding if numerical capacity has been exceeded is this: if a 1 is lost off the top of a shift and a subsequent test of y brings up a 1, only then has the capacity been exceeded. Losing a 1 will not, by itself, cause an error to be reported if y only has 0's after this stage; similarly if y brings up a 1 without a 1 previously having been lost by the shift, again there is no error. It is only when a 1 is lost by the shift and then a 1 is found in y that an error is reported.

It is not difficult to arrange for this to happen. When discussing the logical shift circuits we saw that the input STARTSHIFT pulse was AND-gated with the content of the top bistable and this produced an output pulse if the bistable held a 1 which it would then lose as the shift proceeded. It is possible to use this pulse to set a bistable which will then remember if a 1 has been lost. By AND-gating the output from this bistable with the 1-output from the y discriminator, we have the required safety check, shown in Fig. 4.3. The bistable remembers if a 1 is lost at any stage off the shifting, if this does happen and then a 1 is found in y, the AND gate passes a signal which starts appropriate action, for example printing an "error found" message.

### SAFETY CHECK CIRCUIT

Before going on to discuss the detailed flow diagrams it is worth explaining one of the safety checks in the circuit. When multiplying it is quite possible that the answer will exceed the numerical capacity of the machine, for example if the adder can handle numbers of up to ten bits and an attempt is made to multiply 110111 by 110010 the answer is 10101011110 which contains more than ten bits. What would happen in practice is that during the shifting of x some 1's would be lost and incorrect partial products would be formed giving a wrong answer. Clearly, it is essential to have some kind of check to prevent significant 1's from being lost without the machine realising it.

It would be possible to arrange matters so that whenever a 1 is lost off the top of the shifted register an error is signalled, but this does not necessarily indicate a fault condition. Suppose that x is a large number with many 1's in it but y has 1's in only the lowest two bits. In this case although 1's will be lost from x during the sequence of shifts this will not matter because by the time it starts to happen the tests of y will be bringing up only 0's and no partial products are being produced anyway.

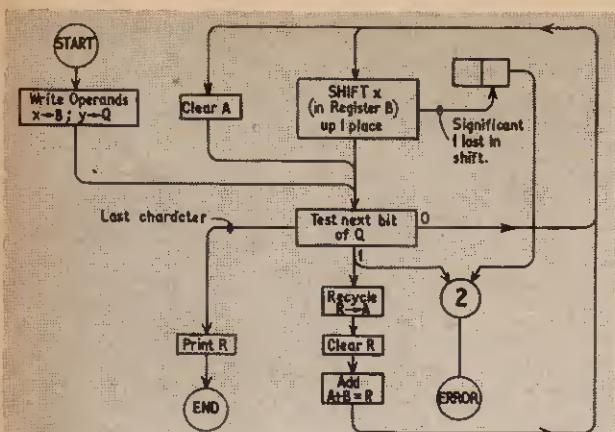

Fig. 4.4. Multiplication flow diagram

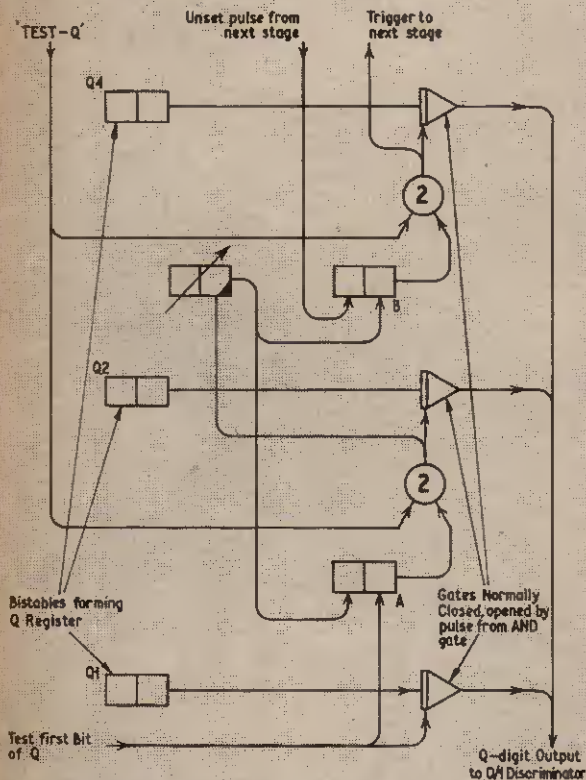

Fig. 4.5. "Test-Q" and Q-register logic

## FLOW DIAGRAM

The overall flow diagram for multiplication is given in Fig. 4.4. The main repetitive loop is seen and also the circuits to prevent exceeding numerical capacity.

Ignoring, for the moment, how  $y$  is tested, the sequence is as follows: with  $x$  written into the B input register and  $y$  written into Q, the first (right-hand) bit of  $y$  is tested for 0 or 1. If it is a 0 then B register, containing  $x$ , is shifted logically up one place, an automatic check being made to see if a 1 is lost. If  $y$  has a 1 when tested then the content of R is transferred back to A, this is not necessary in the first case but is

required after this, R is then cleared and A and B are added. The loop is joined at the point where it starts if the  $y$  bit were a 0, so A is cleared and  $x$  shifted.

This process is repeated for each bit of  $y$  until the "last character" signal appears. This means that all the bits of  $y$  have been tested and the result of the calculation is in R (assuming that numerical capacity was not exceeded, of course).

The reason for the sequence of events when  $y$  has a 1-bit is quite simple. If  $y$  brings up a 1 at some stage this means that the number in B, a shifted value of  $x$ , is one of the required partial products of the result. The sum of all the previously-formed partial products is held in R so this is transferred to A and added to the shifted value of  $x$  in B, thus adding this next partial product into the total.

## MULTIPLICATION CIRCUITS IN PRACTICE

Converting the theoretical flow diagram into a practical logic diagram is not unduly difficult since it can be done in several stages. The logical shift itself has been discussed already and is done by a series of logical elements connected directly to the B adder input register. The next section to be developed is the Q register circuit and the 0/1 discriminator. It will be recalled that an input "test-Q" pulse is applied each time the loop is used, and that this will produce an output on one of two wires depending on whether a given bit is a 1 or a 0; also successive tests are applied to different bits of the number in Q.

Fig. 4.5 gives the basic "test-Q" logical set-up. The bistables marked Q1, Q2, Q4, etc, are the ones making up the Q register itself. Each bistable has its output passed through a gate (normally closed) into a common output line which feeds the 0/1 discriminator. The first test is performed by a special input pulse which directly opens the Q1 output gate allowing the stored digit to leave; the same pulse also sets a bistable A. All successive tests of the bits in Q are made by a single pulse passing down the "test-Q" line. When this happens for the first time the pulse passes through the AND gate which also has bistable A as an input, and so it thus opens the Q2 gate. It also initiates a delay element which, after the "test-Q" pulse has ended, sets bistable B and unsets A. As a result the next "test-Q" pulse will open the Q4 gate by being AND-gated with the output from B. This in turn operates a delay unit which unsets B and sets the corresponding bistable for Q8, this is therefore the digit which will be read next.

## PRACTICAL TELEVISION

Modifying for BBC 2  
Video and sync troubles  
Video circuit experiments  
Low sensitivity faults

August 18

2s

## PRACTICAL WIRELESS

Crystal controlled oscillators and transmitters  
Mods to the "Ten-Five"  
Beginners' short-wave two

Out now

2s 6d

# beam switching unit

by M. L. MICHAELIS M.A.

## PART TWO

THE essential sections of the beam switching unit are built-up on four etched circuit boards. These constitute *module 1*, the Y1 (leader) attenuator, pre-amplifier and sync. amplifier; *module 2*, the Y2 (dependant) attenuator and pre-amplifier; *module 3*, the commutation oscillator; and *module 4*, the combination amplifier. The respective circuit diagrams are shown in Figs. 2 to 5 whilst Fig. 6 depicts the interconnection of these modules to constitute the main circuit. (These diagrams were included in Part One of this article.)

A few components are seen to be external to the circuit cards, for example the input coupling capacitors C74 and C76. These may be called upon to block d.c. voltages up to 500V and have thus been kept off the circuit cards to minimise dust attraction and consequent leakage track formation thereon.

Full size drawings of the printed circuit patterns for these four modules are given in the following pages, see Figs. 9 to 16 inclusive.

It is essential to treat the foil side of the etched circuit cards with a coat of insulating varnish (purchasable from printed circuit materials suppliers). This protective coating is applied with a small water-colour paintbrush after all other construction operations and soldering have been completed, and it further helps to avoid leakage tracks due to gradual dirt deposits.

### MODULE 2

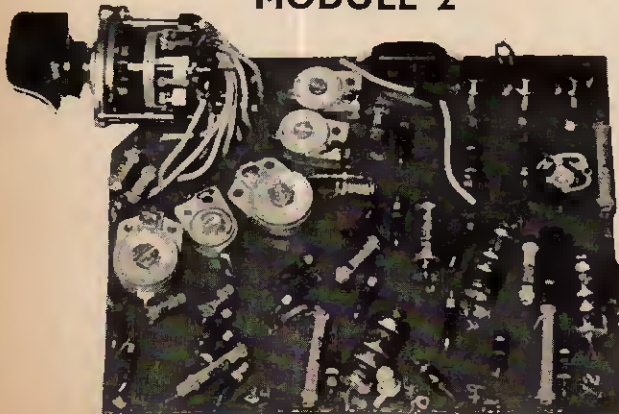

### PERFORMANCE DETAILS

#### OPERATING MODES

- (1) DOUBLE-TRACE TWO-SIGNAL UNIT (normal function): maximum 0.5V pp output (5c/s to 1.5Mc/s  $\pm$  6dB)
- (2) SQUARE WAVE SIGNAL GENERATOR FOR AMPLIFIER TESTING: Frequency range 20c/s to 10kc/s: output 2.5V positive;  $R_i = 5$  kilohms
- (3) SINGLE CHANNEL PRE-AMPLIFIER FOR ONE-SIGNAL OSCILLOSCOPE

Input: "Y1 INPUT"

Output: "SYNC OUTPUT" (in phase with Y1 input) maximum 5V pp (10c/s to 30kc/s  $\pm$  3dB) undistorted output

Gain =	20 in setting	1	} of Y1 attenuation factor
	4	5	
	2	10	
	0.4	50	
	0.2	100	

#### Y1, Y2 INPUTS

Maximum peak-to-peak a.c. signal handling without distortion:  $f$

Attenuation Factor	Without Probe	With Probe
1	500mV	5V
5	2.5V	25V
10	5V	50V
50	25V	250V
100	50V	500V

Up to 500V d.c. safely blocked in all settings

#### SYNC OUTPUT

In phase with Y1

#### NOISE

Maximum mains hum and thermal noise for published design, measured  $50\mu\text{V}$  r.m.s., equals better than 70dB down on full drive wanted signal (mains powered version)

#### TEST SIGNAL

Frequency: equals setting of commutation frequency  $f$

Waveform: symmetrical square wave. Positive going from chassis 2.5V

Rise: maximum 1/15f sec

Fall: maximum 1/100f sec

MODULE I — YI ATTENUATOR, PRE-AMPLIFIER, AND SYNC AMPLIFIER

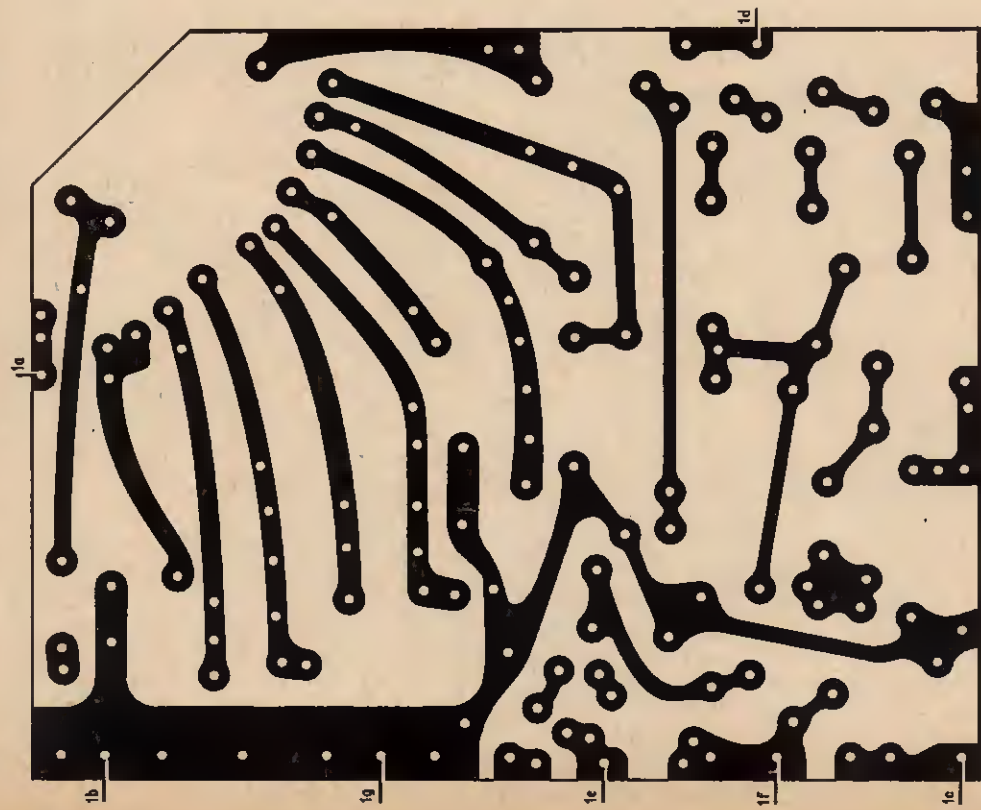

Fig. 9. Printed wiring — full size

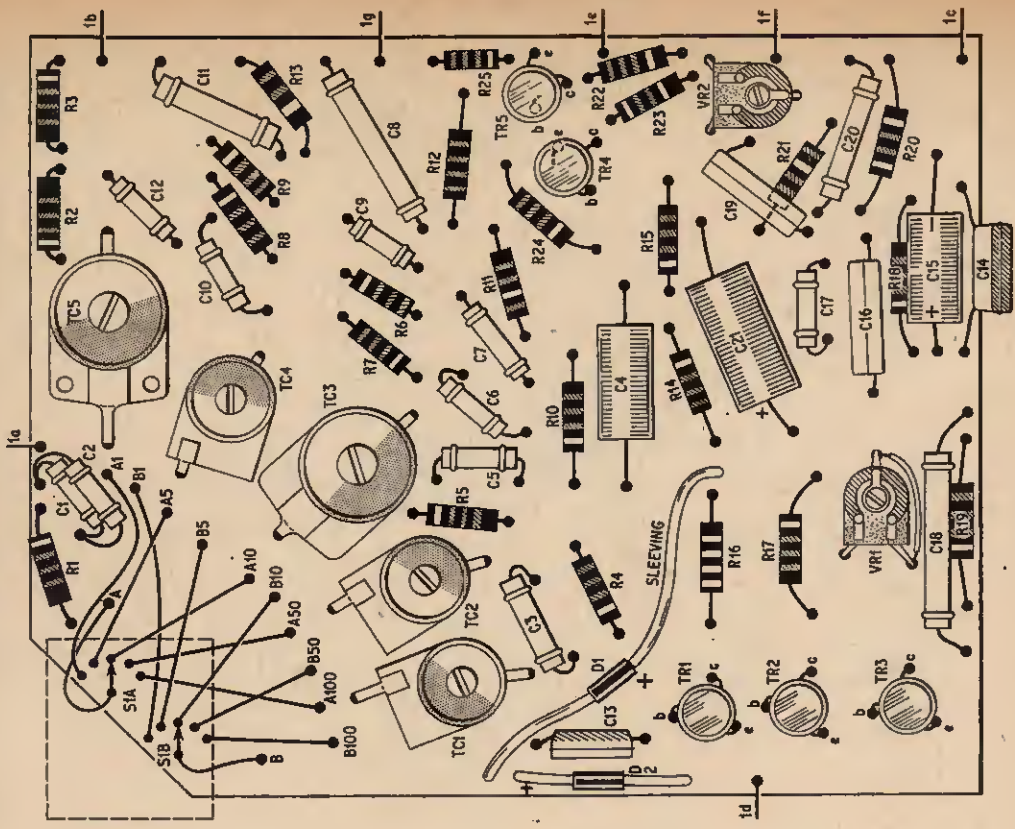

Fig. 10. Component layout



# MODULE 2 — Y2 ATTENUATOR AND PRE-AMPLIFIER

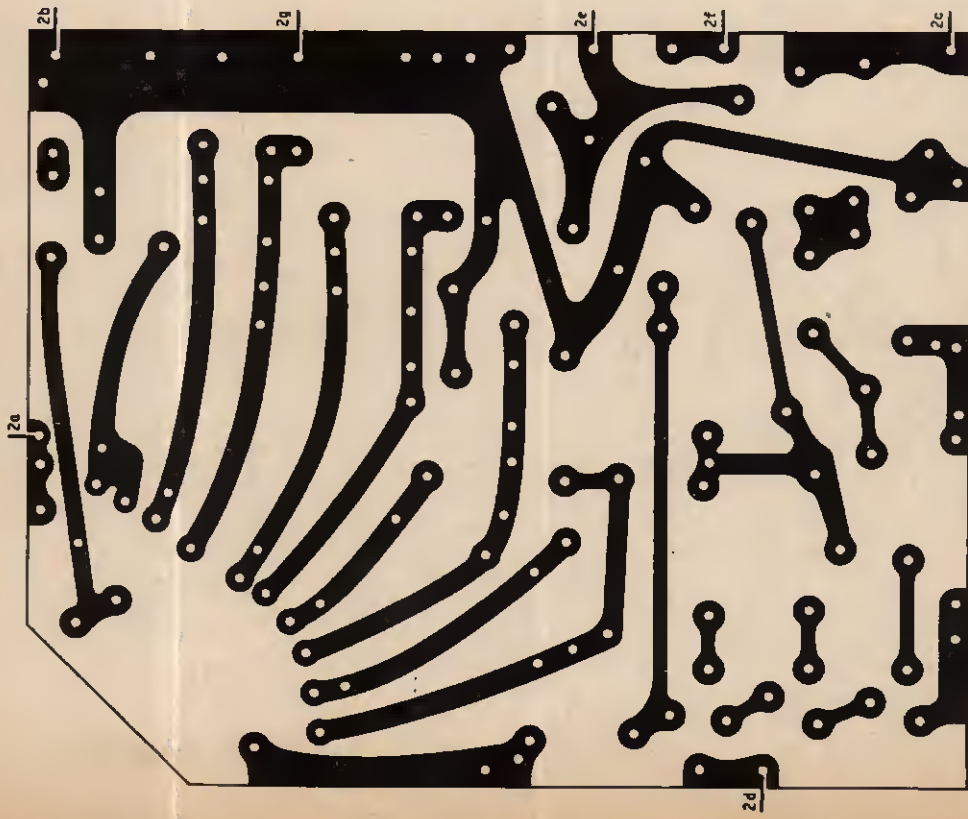

Fig. 11. Printed wiring — full size

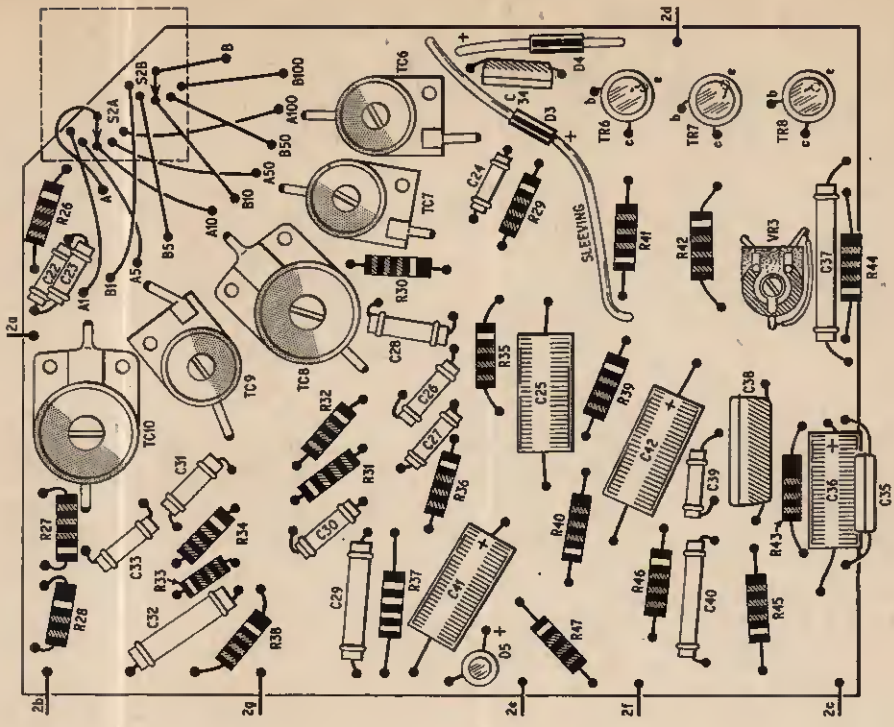

Fig. 12. Component layout

# COMPONENTS . . .

## Resistors

R1	27k $\Omega$	R22	27k $\Omega$	R43	470 $\Omega$	R64	10k $\Omega$
R2	5.6M $\Omega$	R23	47k $\Omega$	R44	270 $\Omega$	R65	470k $\Omega$
R3	5.6M $\Omega$	R24	220k $\Omega$	R45	47k $\Omega$	R66	100k $\Omega$
R4	1M $\Omega$	R25	2.7k $\Omega$	R46	270 $\Omega$	R67	470 $\Omega$
R5	1M $\Omega$	R26	27k $\Omega$	R47	270 $\Omega$	R68	470k $\Omega$
R6	10M $\Omega$	R27	5.6M $\Omega$	R48	27k $\Omega$	R69	270 $\Omega$
R7	1M $\Omega$	R28	5.6M $\Omega$	R49	27k $\Omega$	R70	270 $\Omega$
R8	4.7M $\Omega$	R29	1M $\Omega$	R50	100k $\Omega$	R71	10k $\Omega$
R9	1M $\Omega$	R30	1M $\Omega$	R51	100k $\Omega$	R72	5.6M $\Omega$
R10	10k $\Omega$	R31	10M $\Omega$	R52	470k $\Omega$	R73	100 $\Omega$ 1W
R11	22k $\Omega$	R32	1M $\Omega$	R53	470k $\Omega$	R74	100 $\Omega$ 1W
R12	120k $\Omega$	R33	4.7M $\Omega$	R54	3.3M $\Omega$	R75	100 $\Omega$ 1W
R13	220k $\Omega$	R34	1M $\Omega$	R55	2.2M $\Omega$	R76	100 $\Omega$ 1W
R14	2.2M $\Omega$	R35	10k $\Omega$	R56	2.7k $\Omega$	R77	1k $\Omega$
R15	2.2M $\Omega$	R36	22k $\Omega$	R57	100k $\Omega$	R78	1k $\Omega$
R16	47k $\Omega$	R37	120k $\Omega$	R58	1k $\Omega$	R79	3.3M $\Omega$
R17	10k $\Omega$	R38	220k $\Omega$	R59	820 $\Omega$	R80	3.3M $\Omega$
R18	470 $\Omega$	R39	2.2M $\Omega$	R60	5.6M $\Omega$	R81	3.3M $\Omega$
R19	270 $\Omega$	R40	2.2M $\Omega$	R61	270 $\Omega$	R82	3.3M $\Omega$
R20	47k $\Omega$	R41	47k $\Omega$	R62	470k $\Omega$	R83	3.3M $\Omega$
R21	270 $\Omega$	R42	10k $\Omega$	R63	10k $\Omega$	R84	3.3M $\Omega$

All  $\pm 10\%$ ,  $\frac{1}{2}$ W carbon unless otherwise stated.

## Potentiometers

VR1	1k $\Omega$	} miniature skeleton, linear
VR2	2M $\Omega$	
VR3	1k $\Omega$	
VR4	50k	

linear

## Capacitors

C1	680pF	tubular ceramic, 500V
C2	1,000pF	tubular ceramic, 500V
C3	20pF	tubular ceramic, 500V
C4	3,300pF	plastic, 500V
C5	20pF	tubular ceramic, 500V
C6	1,000pF	tubular ceramic, 500V
C7	680pF	tubular ceramic, 500V
C8	330pF	tubular ceramic, 500V
C9	20pF	tubular ceramic, 500V
C10	20pF	tubular ceramic, 500V
C11	220pF	tubular ceramic, 500V
C12	20pF	tubular ceramic, 500V
C13	1 $\mu$ F	micro-foil, 60V
C14	0.22 $\mu$ F	micro-foil, 60V
C15	100 $\mu$ F	elect, 12V
C16	1 $\mu$ F	micro-foil, 60V
C17	75pF	tubular ceramic, 500V
C18	330pF	tubular ceramic, 500V
C19	1 $\mu$ F	micro-foil, 60V
C20	330pF	tubular ceramic, 500V
C21	100 $\mu$ F	elect, 12V
C22	680pF	tubular ceramic, 500V
C23	1,000pF	tubular ceramic, 500V
C24	20pF	tubular ceramic, 500V
C25	3,300pF	plastic, 500V
C26	1,000pF	tubular ceramic, 500V
C27	680pF	tubular ceramic, 500V
C28	20pF	tubular ceramic, 500V
C29	330pF	tubular ceramic, 500V
C30	20pF	tubular ceramic, 500V
C31	20pF	tubular ceramic, 500V
C32	220pF	tubular ceramic, 500V
C33	20pF	tubular ceramic, 500V
C34	1 $\mu$ F	micro-foil, 60V
C35	0.22 $\mu$ F	micro-foil, 60V
C36	100 $\mu$ F	elect, 12V
C37	330pF	tubular ceramic, 500V
C38	1 $\mu$ F	micro-foil, 60V
C39	75pF	tubular ceramic, 500V
C40	330pF	tubular ceramic, 500V
C41	100 $\mu$ F	elect, 12V
C42	100 $\mu$ F	elect, 12V
C43	150pF	tubular ceramic, 500V
C44	150pF	tubular ceramic, 500V
C45	0.22 $\mu$ F	micro-foil, 60V

C46	1 $\mu$ F	micro-foil, 60V
C47	1 $\mu$ F	micro-foil, 60V
C48	100pF	tubular ceramic, 500V
C49	100 $\mu$ F	elect, 12V
C50	220pF	tubular ceramic, 500V
C51	330pF	tubular ceramic, 500V
C52	470pF	tubular ceramic, 500V
C53	680pF	tubular ceramic, 500V
C54	1,000pF	tubular ceramic, 500V
C55	2,200pF	micro-foil, 60V
C56	4,700pF	micro-foil, 60V
C57	0.01 $\mu$ F	micro-foil, 60V
C58	0.022 $\mu$ F	micro-foil, 60V
C59	0.047 $\mu$ F	micro-foil, 60V
C60	0.1 $\mu$ F	micro-foil, 60V
C61	220pF	tubular ceramic, 500V
C62	330pF	tubular ceramic, 500V
C63	470pF	tubular ceramic, 500V
C64	680pF	tubular ceramic, 500V
C65	1,000pF	tubular ceramic, 500V
C66	2,200pF	micro-foil, 60V
C67	4,700pF	micro-foil, 60V
C68	0.01 $\mu$ F	micro-foil, 60V
C69	0.022 $\mu$ F	micro-foil, 60V
C70	0.047 $\mu$ F	micro-foil, 60V
C71	0.1 $\mu$ F	micro-foil, 60V
C72	100 $\mu$ F	elect, 12V
C73	100 $\mu$ F	elect, 12V
C74	0.1 $\mu$ F	micro-foil, 500V
C75	0.22 $\mu$ F	micro-foil, 500V
C76	0.1 $\mu$ F	micro-foil, 500V
C77	100 $\mu$ F	elect, 12V
C78	100 $\mu$ F	elect, 12V
C79	500 $\mu$ F	elect, 12V
C80	500 $\mu$ F	elect, 12V
C81	100 $\mu$ F	elect, 12V
C82	100 $\mu$ F	elect, 12V
C83	500 $\mu$ F	elect, 12V
C84	500 $\mu$ F	elect, 12V
C85	20pF	tubular ceramic, 500V
C86	20pF	tubular ceramic, 500V

## Trimmers

TC1	3-15pF	TC5	6-30pF	TC9	10-45pF
TC2	3-15pF	TC6	3-15pF	TC10	6-30pF
TC3	10-45pF	TC7	3-15pF	TC11	3-15pF
TC4	10-45pF	TC8	10-45pF	TC12	3-15pF

All miniature ceramic

## Transistors

TR1	BSY53	TR7	BSY53	TR13	BSY56
TR2	BSY53	TR8	BSY51	TR14	BSY56
TR3	BSY51	TR9	BSY56	TR15	BSY53
TR4	BSY53	TR10	BSY56	TR16	BSY53
TR5	BSY53	TR11	BSY53		
TR6	BSY53	TR12	BSY51		

## Diodes

DI-D4	OA202	Silicon (Mullard)
D5	Z2A62F	Zener (6.2V) (S.T.C.)
D6	Z2A30F	Zener (3.0V) (S.T.C.)
D7	REC50A	Silicon (Radiospares)
D8	REC50A	Silicon (Radiospares)

## Switches

S1	2-pole, 5-way, rotary
S2	2-pole, 5-way, rotary
S3	2-pole, 11 way, rotary on two wafers.
All low capacitance miniature types	
S4	Mains on/off S.P.S.T. toggle (panel mounting)

## Plugs and Sockets

PL1	Mains connector, 3-pin, panel mounting
SK1-SK5	Coaxial socket, panel mounting (5 off)

## Miscellaneous

TI	Small bell transformer, 8V output
FS1	Fuse cartridge 0.5A and holder
Four pointer knobs. Five rubber grommets.	
Material for chassis and printed wiring modules.	

# KEDOCO

ADAMS-NORKEN LIMITED

## TRANSISTORISED MODULES BRING TOP-QUALITY TO HOME CONSTRUCTION HI-FI TAPE EQUIPMENT — AT INCREDIBLY LOW COST!

**KEDOCO STAR FEATURES** ■ Kedoco quality control ensures high product performance — always ■ Transistorised modules ready-assembled for simple, speedy wiring into circuit ■ Units operate from 12 volts — ideal for out-and-about recording ■ Miniaturization of modules permits compact packaging ■ Complete flexibility in design from eight basic units ■ Money-back guarantee on all products

### CLASSIC TRANSISTORISED 20-WATT AMPLIFIERS

SS20/7 £9/19/6

The now well proven model as illustrated comprising pre-amplifier measuring 4.7" x 2.3" and main amplifier measuring 4.5" x 4" both mounted on base plate and supplied complete with bass, treble and volume on/off controls.



SS20/8 11 GNS.

A de luxe version complete in itself and ready to mount into your cabinet. Supplied with three controls mounted on the front of the stove enamelled chassis and has moulded plastic and spun aluminium control knobs fitted as standard. A tag strip mounted on the back of the chassis in addition to facilitating the L/S and H.T. connections provides separate inputs for crystal, ceramic cartridge, magnetic pick-up, radio and tape recorder. The max. dimensions of the whole unit are 6 1/2" x 9 1/2" x 2".

SS20/9 19 GNS.

A beautiful table model version with its own power supply and in keeping with the modern trend to build hi-fi systems from self contained separate and compact units. Ready to operate and to connect to tape, gram and radio via coax. sockets at the back of the cabinet. The amplifier and power supply are housed in an attractive pressed steel case finished in a subdued grey stoved enamel and embellished with a gilt brushed aluminium front panel engraved and displaying the four controls. Treble, bass, volume on/off and two position input selector. Cabinet measurements 8" x 7" x 2 1/2".

#### TECHNICAL SPECIFICATION

All three models employ similar circuits, have the same electrical specification and are fully transistorised. Six silicon planar transistors and two germanium power. Two diodes. All have benefits of negligible noise and distortion, high efficiency, low power consumption, compact design and no warm up time when switching on. The amplifiers are D.C. coupled throughout (no distortion) and there is a transformerless coupled output having a very low output impedance. Power output, 20 watts R.M.S. into 3 ohm speaker. Input impedance, selected to suit input. Output impedance, 0.25 ohms. Bass boost, 12dB at 100c/s max. Treble boost, 12dB at 16Kc/s max. Distortion 0.1% typical. Frequency response, 16c/s to 20Kc/s. Noise, 80dB down on max. output. Power requirements, SS20/7 and SS20/8 only, 20mA quiescent. 3 amps peak. 30 volts.

### TAPE EQUIPMENT

#### TAPE PRE-AMP SSTR/7

All silicon transistor. Zero hum. High gain and equalised at 7 1/2" per sec. to give flat response output. Simple mod. described in accompanying instructions allows equalisation at all speeds. Suitable for all medium impedance heads. Dimensions 40 x 50 x 15mm. ASSEMBLED 29/6.

#### MINICLASSIC PRE-AMP SSPA/50

Tone controlled high gain preamplifier designed specially for application with the SS3/10. All silicon transistor. Zero hum requires 12 volt + H.T. Dimensions 70 x 40 x 35mm. Separate inputs for crystal ceramic cartridge and radio. ASSEMBLED 42/-.

#### MINICLASSIC 12/12 AND SS3/10

Two high fidelity amplifiers providing adequate power for normal domestic listening or portable equipment. The 12/12 is the more powerful and provides a maximum of 12 watts into a 3 ohm speaker. The SS3/10 provides 4 watts into 3 ohms and has the advantage of working from a 12 volt rail. Specification: Frequency response, 16c/s to 30Kc/s. Input Sensitivity 1 volt. Both will operate directly from crystal pickup and make complete tape amplifier with SSTR/7. 6 transistor 2 diode. HT + 12/12. SS3/10 12 volt. Dimensions 50 x 105 x 22mm. SS3/10 69/-, 12/12 89/-.

RECORD PRE-AMP SR/8 couples SSH9/3 to ribbon and dynamic mic. High gain all silicon transistor. 29/6.

#### TAPE OSCILLATOR SSO/13

Complete unit incorporating push pull silicon transistor oscillator giving adequate erase power and recording bias. The only unit on the market at such an economical price. Ferrite pot core oscillator. Frequency 50-60Kc/s. Unit also provides high voltage D.C. rail for the record amplifier. A high efficiency oscillator operating from 12 volt supply at approx. 250mA. Dimensions 90 x 54 x 35mm. COMPLETE 69/6.

#### RECORD AMPLIFIER SSH9/3

Fully transistorised High voltage H.T. rail derived from oscillator. Provides substantially constant current record signal. 1 volt input sensitivity. Input impedance 5k. Power requirements 1mA 75V. derived from SSO/13 and 1mA 12V. This is a gain stabilised low distortion circuit. Dimensions 45 x 40 x 20mm. ASSEMBLED 45/-.

#### LEVEL METER AMPLIFIER

##### SSLA/3 43/6.

A gain stabilised amplifier specifically designed to operate with our level meter but will operate with any 100 to 200µA meter movement.

### TAPE

Highest quality PVC recording tape from well-known British manufacturer. Longplay.

3"	225 ft.	3/11
5"	900 ft.	12/6
5 1/2"	1,200 ft.	15/9
7"	1,800 ft.	£1.18

### KEDOCO COMPONENTS

A COMPLETE RANGE TO SATISFY ALL YOUR NEEDS

#### POWER SUPPLIES

30 volt, 3 amp. Ready built and ideal for your Kedoco Classic. Will power two of them. 69/-.

FIRST ZENER STABILISED SUPPLY. 12 VOLT, 0.5 AMP.

Zener stabilised to ensure accurate and reproducible conditions during tape recording. A.C. mains operated and provides a steady 12 volts D.C. supply with negligible ripple content irrespective of loading. 69/-.

18 volt, 1.5 amp. 59/-.

#### RECEIVERS

F.M. TUNER £8.19.6. S55F 8 transistor and assembled ready to operate. Miniature printed circuit construction with integral accurately calibrated tuning dial. Covers whole 88-100 mc/s band and ready to mount into cabinet.

A.M. TUNER £4.9.6. S54AM subminiature and assembled. A superhet A.M. tuner which will complete your High-Fi system.

#### TV BOOSTER

Mains operated and tunable to any band frequency. Please state band when ordering. 45/-.

#### NEW BROCHURE

SEND 6d. TO COVER COST OF POSTAGE FOR BEAUTIFULLY ILLUSTRATED BROCHURE DESCRIBING COMPLETE RANGE OF KEDOCO PRODUCTS.

#### MICROPHONES

##### CRYSTAL MICROPHONE

Complete with detachable desk stand; smooth slim round design with satin chrome finish. Supplied with locking on/off switch, 7 ft. cable. Response 60 to 10,000 cps. £1.19.0.

##### OMNI-DIRECTIONAL DYNAMIC MICROPHONE

A beautifully finished professional microphone. Response 30 to 13,000 cps. Supplied with desk stand and cable. £3.19.6.

##### LAPEL DYNAMIC MICROPHONE.

1" diameter. Very sensitive and supplied with long lead and plug. 12/6.

##### LEVEL METER

Miniature moving coil meter specially produced for level indication in tape recording. £1.4.9.

All KEDOCO products are fully guaranteed. Should you not be completely satisfied we will immediately refund your money if purchases are returned within seven days of receipt.

## KEDOCO ELECTRONICS SHOWROOMS AND MAIL ORDER DEPARTMENT

SUBSIDIARY OF ADAMS-NORKEN LIMITED

Department PE, 76 Victoria Road, Swindon. Personal callers welcome.

TELEPHONE: SWINDON (OSW3) 27660

Open 9 a.m. — 6.30 p.m.  
9 a.m. — 1.00 p.m. Wednesdays

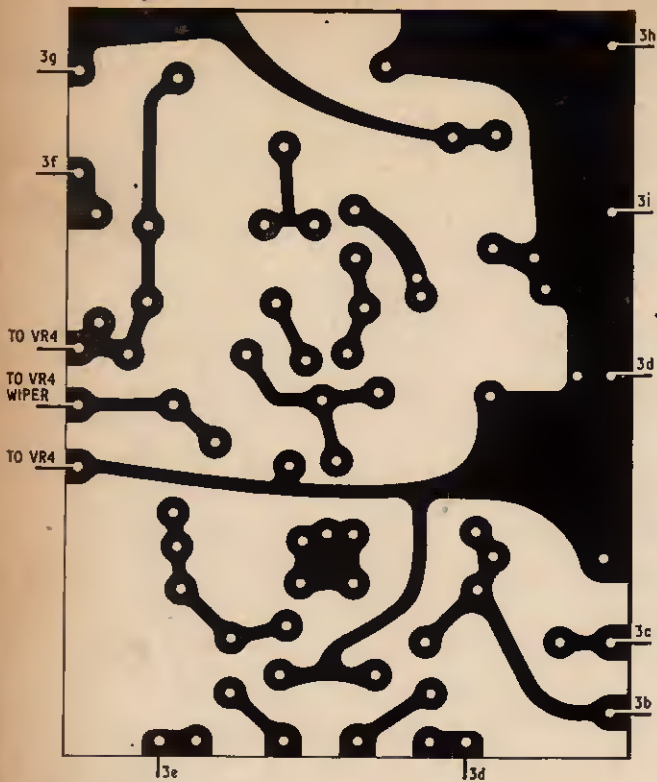

Fig. 13. Printed wiring — full size

MODULE 3 — COMBINATION AMPLIFIER

Fig. 14. Component layout

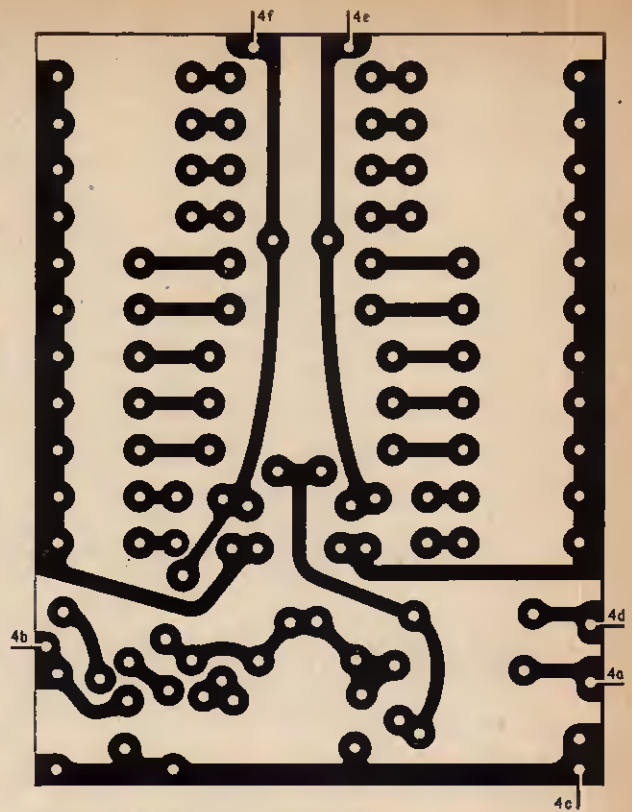
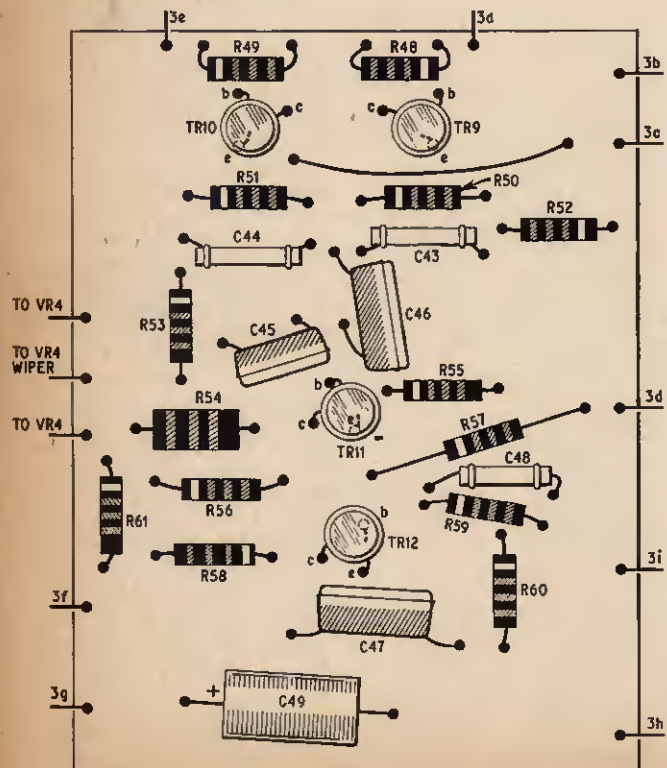
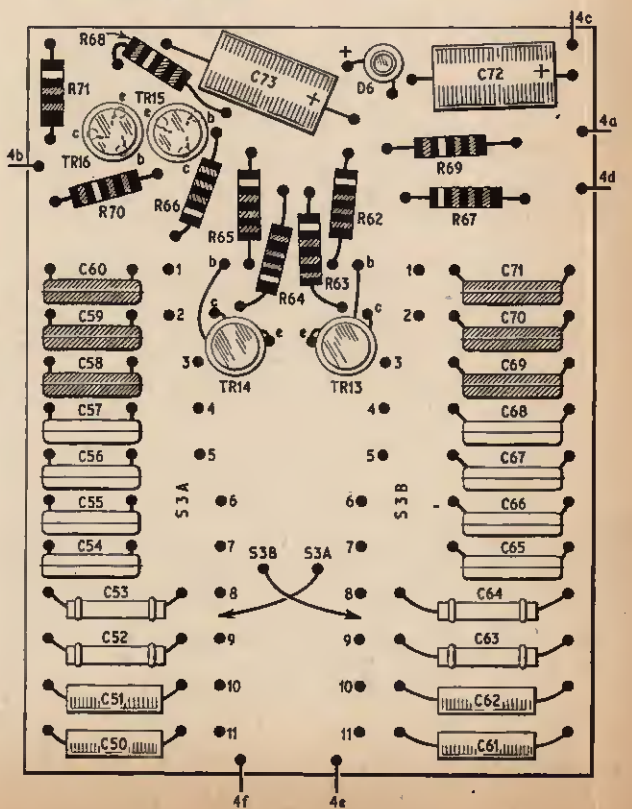

Fig. 15. Printed wiring — full size

MODULE 4 — COMMUTATION OSCILLATOR

Fig. 16. Component layout



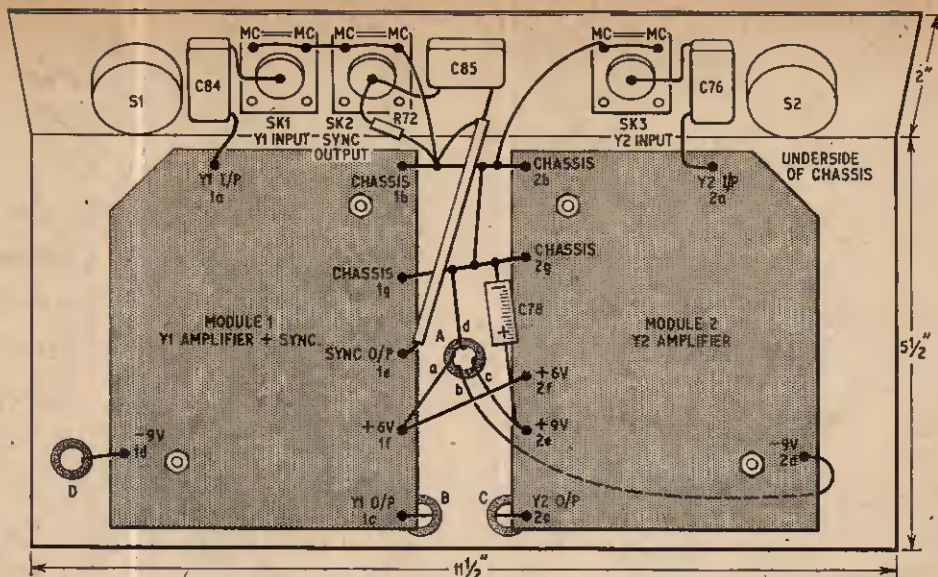

Fig. 17. Underside of chassis layout and wiring

## CHASSIS ASSEMBLY

The four modules are installed in a chassis assembly measuring  $11\frac{1}{2}$  in  $\times$   $5\frac{1}{2}$  in  $\times$  2 in deep. Modules 1 and 2 occupy the underside, and modules 3 and 4 the top of the chassis (see Figs. 17 and 18).

Most of the power supply circuit components are mounted on two group panels and these are fitted to the top rear portion of the chassis. All operating controls, plugs and sockets, and the mains fuse are mounted on the front panel which measures approximately 12 in  $\times$  4  $\frac{1}{2}$  in.

## ADJUSTMENTS

The trimmer capacitors of both attenuator networks, the gain controls in the output stages of both pre-amplifiers (VR1 and VR2), and the sync amplifier preset potentiometer (VR2) all require alignment. The following procedure should be adopted, *in the order given*. The commutation oscillator module can be used as signal generator for aligning the attenuator networks before connecting the modules together in the final manner.

- (1) Take the completed commutation oscillator module (Fig. 5) and connect two appropriate batteries between the +6V and -9V points and the chassis point 4c. Connect 4c to any chassis point of the Y1 plus sync module, and join the +6V points of the two modules.

Connect the track of a 5kiloohm potentiometer and a  $0.1\mu\text{F}$  paper capacitor in series between the square wave output connections 4b, 4c of the oscillator module. Take the slider to the Y1 input connection 1a on the Y1 module.

Connect the Y1 output of the Y1 module, 1c, straight to the oscilloscope, using the shortest possible connection and no probe.

- (2) Switch the oscillator module to the 2 to 10kc/s steps, whichever one gives optimum clarity of the effects described immediately below.

Set the Y1 attenuator to "5" and adjust the output potentiometer connected to the oscillator and the oscilloscope gain for a convenient amplitude of the synchronised square wave display. (Make sure that the oscilloscope is not itself distorting the square wave, by first feeding it in directly from the oscillator.) The display via the Y1 module in setting "5" will be either rounded or peaked at the switching flanks. Adjust trimmer TC4 with a non-metallic trimming tool until the flanks of the square wave are neither rounded nor peaked with overswing beyond the roof.

If the whole roof of the square wave takes on a slope in the critical setting between rounding and peaking, the combined value of C1 and C2 is not quite correct. Modify by experiment, until the square wave roof is flat at the critical point. Check at all frequencies between 2kc/s and 10kc/s with the oscillator.

- (3) Now switch to position "10" on the Y1 attenuator and suitably re-adjust the oscillator output potentiometer and/or the oscilloscope Y-gain.

Adjust trimmer TC3 until the critical point between flank rounding and flank overswing is reached. If the roof of the square wave is then not flat at all frequencies between 2kc/s and 10kc/s, slightly adjust C8 either way until the roof is as flat as possible at the new critical setting of TC3.

- (4) Same procedure in "50" setting, adjusting TC2 for minimum rounding or overswing of the flanks and C6/C7 if the roof is then not flat.
- (5) Finally, repeat in "100" setting, adjusting TC1 for dead-beat flanks and C4 for flat roof if necessary. The display may here be very small in amplitude, but if the focus of the oscilloscope is good it should be observable.



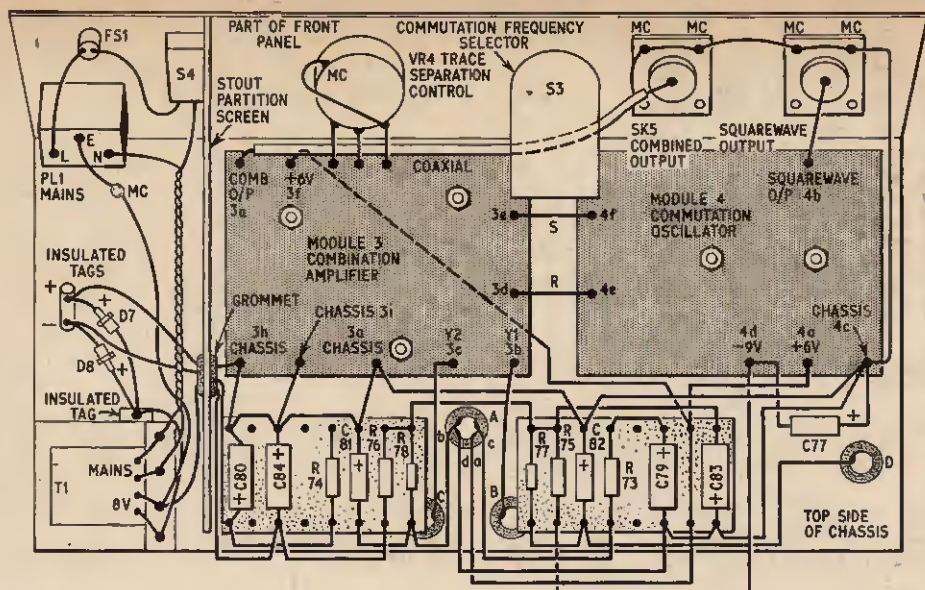

Fig. 18. Top side of chassis layout and wiring

- (6) Now disconnect the oscillator from 1a, and connect there the Y1 probe and its 0.1 $\mu$ F blocking capacitor. Connect the prod of the probe to the oscillator. Set the attenuator to "5" and adjust the trimmer capacitor in the probe for dead-beat flank of the square wave display. If the previous adjustments have been carried out exactly, the roof of the square wave will then also be flat.
- (7) Now finally switch to "1" and adjust TC5 until the flanks of the displayed square wave are once again dead beat. The Y1 attenuator network together with its probe is now correctly aligned.
- (8) Repeat the same procedure analogously, adjusting correspondingly positioned components at each stage, for the Y2 attenuator network and its probe.

NOTE.—It is advisable to have built the Y1 and Y2 modules into the chassis and cabinet assembly for these adjustments, so that the actual stray capacitances are taken full account of. The oscillator module should still be loose and the combination amplifier laid aside.

The adjustments will converge to a correct overall alignment only if carried out strictly in the order given.

- (9) Now complete the assembly, mounting the oscillator and combination amplifier in their correct positions on the chassis and completing all wiring.
- (10) Feed a suitable sine wave signal of about 0.25V peak to peak amplitude (heater transformer and voltage dividing resistors) at mains frequency directly to the oscilloscope input and observe the height of the trace exactly in a convenient setting of the gain.

Transfer the same signal to the Y1 input (without probe) set to "1", and adjust VR1 until the height of the oscilloscope display of the combination output is the same as on direct display.

- (11) Connect the Y1 and Y2 inputs together and to the same mains frequency sine wave signal. Turn the trace separation to zero. Adjust VR3 such that the two sine waves are completely coincident at all points, especially at positive and negative peaks.
- (12) Connect the same signal once again to Y1, without probe and setting "1" of Y1 attenuator. Gradually advance the input amplitude until distortion commences (oscilloscope input to sync output of Y1 module).

Adjust VR2 in conjunction with the input amplitude such that the commencement of distortion is symmetrical on positive and negative peaks of the sine wave.

The entire beam switching unit is now correctly aligned for all functions.

#### Circuit diagram corrections

##### Module 1 and Module 2 (Fig. 2)

Top end of R2 (R27) should go to junction of C1 (C22), R1 (R26), C2 (C23) and S1A (S2A) rotor.

##### Module 4 (Fig. 5)

Common side of C50-C60 should go to base of TR14. Common side of C61-C71 should go to base of TR13.

The practical wiring given in the diagrams in this issue is correct. ★

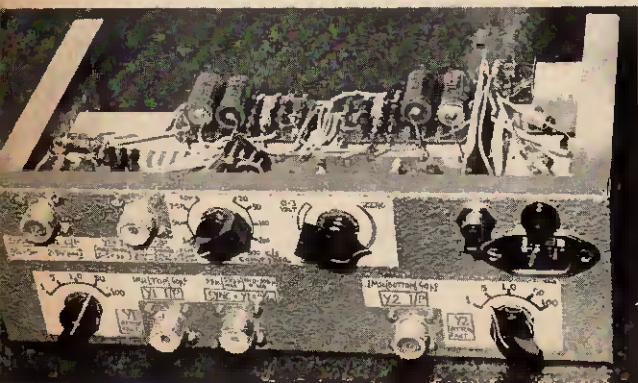

# LOOK!

**PRACTICAL!**

**VISUAL!**

**EXCITING!**



a new 4-way method of mastering  
**ELECTRONICS**  
 by doing — and — seeing . . .

**1** ▶ **OWN and HANDLE a**

complete range of present-day **ELECTRONIC PARTS** and **COMPONENTS**

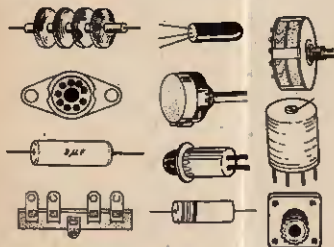

**2** ▶ **BUILD and USE**

a modern and professional **CATHODE RAY OSCILLOSCOPE**

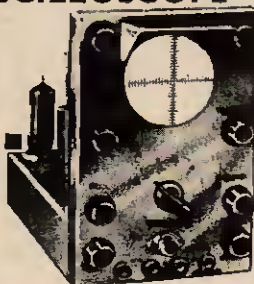

**3** ▶ **READ and DRAW and**

**UNDERSTAND CIRCUIT DIAGRAMS**

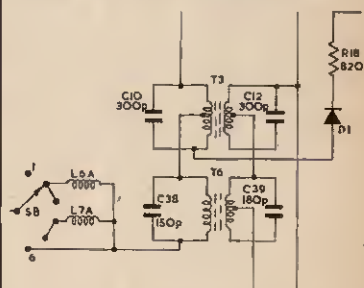

**4** ▶ **CARRY OUT OVER 40 EXPERIMENTS ON BASIC ELECTRONIC CIRCUITS AND SEE HOW THEY WORK . . . INCLUDING . . .**

- VALVE EXPERIMENTS
- TRANSISTOR EXPERIMENTS
- AMPLIFIERS
- OSCILLATORS
- SIGNAL TRACER
- PHOTO ELECTRIC CIRCUIT
- COMPUTER CIRCUIT
- BASIC RADIO RECEIVER
- ELECTRONIC SWITCH
- SIMPLE TRANSMITTER
- A.C. EXPERIMENTS
- D.C. EXPERIMENTS
- SIMPLE COUNTER
- TIME DELAY CIRCUIT
- SERVICING PROCEDURES

This new style course will enable anyone to really understand electronics by a modern, practical and visual method—no maths, and a minimum of theory—no previous knowledge required. It will also enable anyone to understand how to test, service and maintain all types of Electronic equipment, Radio and TV receivers, etc.

**FREE** POST NOW  
 for  
**BROCHURE**

or write if you prefer not to cut page

To: **BRITISH NATIONAL RADIO SCHOOL, READING, BERKS.** Please send your free Brochure, without obligation, to: we do not employ representatives

NAME..... **BLOCK CAPS**

ADDRESS..... **PLEASE PE9**

**3-VALVE AUDIO AMPLIFIER**



**MODEL HA34**  
Designed for Hi-Fi reproduction of records. A.C. Mains operation. Ready built on plated heavy gauge metal chassis, size 7 1/2 in. x 4 in. d. x 4 1/2 in. h. Incorporates ECC83, EL84, EZ80 valves. Heavy duty, double wound mains transformer and output transformer matched for 3 ohm speaker, separate iBass, Treble and volume controls. Negative feedback line. Output 4 1/2 watts. Front panel can be detached and leads extended for remote mounting of controls. The HA34 has been specially designed for us to offer your quantity order enables us to offer them complete with knobs, valves, etc., wired and tested for only **£45.00** P. & P. 6/-.

**QUALITY RECORD PLAYER AMPLIFIER**  
This top-quality amplifier was used in a 29 gn. player, employs heavy duty double wound mains transformer, ECC83, EL84, EZ80 valves. Separate Bass, Treble and Volume controls. Complete with output transformer matched for 3 ohm speaker. Size 7 in. w. x 2 1/2 in. d. x 5 1/2 in. h. Ready built and tested. **PRICE 69/6.** P. & P. 4/9.

**QUALITY PORTABLE R/P CABINET**  
Uncut motor board. Will take above amplifier and B.S.R. or GARRARD Autochanger or Single Record Player Unit. Size 18 x 14 x 8 1/2 in. **PRICE £39/6.** Carr. 7/6.

**SPECIAL OFFER! FM/AM TUNER HEAD**

Beautifully designed and precision engineered by Derner and Wadsworth Ltd. Supplied ready fitted with twin .0005 tuning condenser for AM connection. Prealigned FM section covers 86 - 102 Mc/s. I.F. output 10.7 Mc/s. Complete with ECC85 (6L12) valve and full circuit diagram of tuner head. Another special bulk purchase enables us to offer these at 27/6 each. P. & P. 3/-. Order quickly! Limited number also available with precision geared 3:1 reduction drive. 30/- P. & P. 3/-.

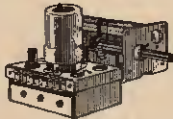

Open all day Saturday  
Early closing Wed. 1 p.m.  
A few minutes from South Wimbledon Tube Station.

**STEREO AMPLIFIER**

Incorporating 2 ECC82s and 1 EZ80, heavy duty, double wound mains transformer. Output 4 watts per channel. Full tone and volume controls. Absolutely complete.

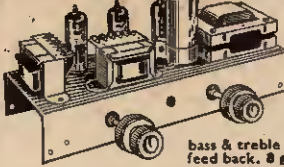

**ONLY £4.19.6**  
P. & P. 6/6  
Super De-luxe version with ECL86 valves, sep. bass & treble controls, full feedback. 8 gns. P. & P. 6/6

**HSL 'FOUR' AMPLIFIER KIT**

A.C. Mains 200/250v., 4 watt, using ECC83, EL84, EZ80 valves. Heavy duty double-wound mains transformer with electrostatic screen. Separate Bass, Treble and Volume controls, giving fully variable boost and cut with minimum insertion loss. Heavy negative feedback loop over 2 stages ensures high output at excellent quality with very low distortion factor. Suitable for use with guitar, microphone or record player. Provision for remote mounting of controls or direct on chassis. Chassis size 7 1/2 in. wide x 4 in. deep. Overall height 4 1/2 in. All components and valves brand new. Very clear and concise instructions enable even the inexperienced amateur to construct with 100% success. Supplied complete with 3 ohm output transformer. (No extras to buy.) **PRICE 79/6.** P. & P. 6/-. Comprehensive circuit diagram, practical layout and parts list 2/6 (free with kit). This kit is similar in appearance to HA34 but employs entirely different and advanced circuitry.

**HIGH GAIN 4 TRANSISTOR PRINTED CIRCUIT AMPLIFIER KIT Type TA1** Peak output in excess of 1 1/2 watts. All standard British components. Built on printed circuit panel, size 6 x 3 in. Generous size Driver and Output Transformers. Output transformer tapped for 3 ohm and 15 ohm speakers. Transistors (GET 114 or ST Mullard OC81D and matched pair of OC81 ofn). 9 volt operation. Everything supplied, wire, battery clips, solder, etc. Comprehensive easy to follow instructions and circuit diagram 1/6 (Free with Kit). All parts sold separately. **SPECIAL PRICE 45/-.** P. & P. 3/-. Also ready built and tested, 52/6. P. & P. 3/-. A pair of TA1s are ideal for stereo.

**10/14 WATT HI-FI AMPLIFIER KIT**

A stylishly finished monaural amplifier with an output of 14 watts from 2 EL84s in push-pull. Super reproduction of both music and speech, with negligible hum. Separate inputs for mike and gram allow records and announcements to follow each other. Fully shrouded section wound output transformer to match 3-15Ω speaker and 2 independent volume controls, and separate bass and treble controls are provided giving good lift and cut. Valve line-up 2 EL84s, ECC83, EF86, and EZ80 rectifier. Simple instruction booklet 1/6. (Free with parts.) All parts sold separately. **ONLY £79/6.** P. & P. 8/6. Also available ready built and tested complete with std. input sockets. £95/- P. & P. 8/6. Carrying Case for above 28/6. P. & P. 7/6.

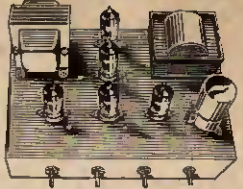

**4-SPEED PLAYER UNIT BARGAINS**  
All brand new in maker's original packing.  
**SINGLE PLAYERS**  
B.S.R. TU/12 ..... £23/9/6 Carr. 5/6.  
GARRARD SP25 De Luxe... £13/10/6 Carr. 5/6.  
B.S.R. GU7 with unit mounted pickup arm. £41/8/8 Carr. 5/6.

**AUTO. CHANGERS**  
Latest B.S.R. UA25 Super slim ..... £6 2 6  
GARRARD Auto-Slim ..... £5 10 0  
GARRARD AT6 £9.10.0 Carr. 6/6 on each.  
All the above units are complete with top mono head and sapphire styli or can be supplied with compatible stereo head for 12/6 extra.

**WELL-KNOWN MAKERS SURPLUS! ONE TRANSISTOR PRE-AMP.**  
Suitable for use with Medium or High Impedance mikes, guitars, gram pickups, tape decks, etc. For operation from 200/300 volt H.T. rail or 9 volt battery. Gain approx. 14:1. Fully isolated input by Mu-Metal screened transformer. Size 4 1/2" x 1". Ready built complete with full circuit diagram and instructions. **ONLY 15/-.** Post free.

**MINIATURE PRECISION AIR SPACED 2-GANG TUNING CONDENSER.** 176 x 176pF. Size 1 1/2" x 3/4" x 1 1/2" with vanes open. Built in trimmers. 5/- P. & P. 1/-.

**HARVERSON SURPLUS CO. LTD.**

170 HIGH STREET, MERTON, S.W.19 CHerrywood 3985  
SEND STAMPED ADDRESSED ENVELOPE WITH ALL ENQUIRIES

**4-STATION INTERCOM**



**£7/10/0**  
Solve your communication problems with this 4-Station Transistor Intercom system (1 master and 3 Subs), in de-luxe plastic cabinets for desk or wall mounting. Call/talk/listen from Master to Subs and Subs to Master. Ideally suitable for Business, Surgery, Schools, Hospital, Office and Home. Operates on one 9V battery. On/off switch. Volume control. Complete with 3 connecting wires each 6ft. and other accessories. P. & P. 4/6.

**INTERCOM/BABY ALARM**



Modernize business or home with this new two-way Portable Transistor Intercom, consisting of Master and Sub, in strong plastic cabinets with chromium stands. Designed as a two-way instant communication system. Call/talk/listen from Master to Sub and Sub to Master. Operates on one 9V battery. Complete with 60 ft. wire. Battery 2/- P. & P. 2/6

**TELEPHONE AMPLIFIER**

Why not boost business efficiency with this incredible De-luxe Telephone Amplifier. Take down long telephone messages or converse without holding the handset. A status symbol? Yes, but very useful one. On/off switch. Volume Control. Operates on one 9V. battery (supplied). P. & P. 2/6  
Full money refunded if not satisfied in 7 days.  
**WEST LONDON DIRECT SUPPLIES (P2/9)**  
189 KENSINGTON HIGH STREET, LONDON, W.8

**TRANSISTOR POCKET BOOK**

by R. G. Hibberd, B.Sc., M.I.E.E., Sen. M.I.E.E.E.

- Manager of the Research & Development Department of Texas Instruments Ltd.  
25/- Postage 1/-  
GEC. Inter. TRANSISTOR MANUAL, 7th. 18/- Postage 1/6  
ADVANCED RADIO CONTROL, by E. L. Safford. 25/- Postage 1/-  
AN ELECTRONIC ORGAN FOR THE HOME CONSTRUCTOR, by A. Douglas. 20/- Postage 1/-  
EVERYDAY ELECTRONICS, by T. Riddam. 22/6 Postage 1/-  
NEW SKILL-BUILDING TRANSISTOR PROJECTS & EXPERIMENTS, by L. E. Garner. 24/- Postage 1/-  
TROUBLESHOOTING WITH THE OSCILLOSCOPE, by R. G. Middleton. 20/- Postage 1/-  
TRANSISTOR IGNITION SYSTEMS H'BOOK, by B. Ward. 22/6 Postage 1/-  
ELECTRONICS POCKET BOOK, by J. P. Hawker & J. A. Reddihough. 21/- Postage 1/-  
MULLARD MAINTENANCE MANUAL. 16/- Postage 1/-

COMPLETE CATALOGUE 1/-

**THE MODERN BOOK CO.**

BRITAIN'S LARGEST STOCKISTS  
British and American Technical Books  
19-21 PRAED STREET  
LONDON, W.2  
Phone: PADdington 4185  
Open 6 days 9-6 p.m.

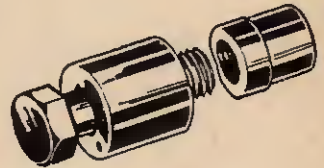

The PUNCH you need!

**HOLE PUNCHES**

Instant Type	...	...	...	6/10 ea.
3/8" diameter	...	...	...	8/6 "
1/2" diameter	...	...	...	9/- "
3/4" diameter	...	...	...	9/6 "
1" diameter	...	...	...	10/2 "
1 1/8" diameter	...	...	...	10/8 "
1 1/4" diameter	...	...	...	11/8 "
1 1/2" diameter	...	...	...	13/4 "
1 3/4" diameter	...	...	...	16/2 "
2" diameter	...	...	...	18/10 "
2 1/4" diameter	...	...	...	21/8 "
2 1/2" diameter	...	...	...	24/4 "
2 3/4" diameter	...	...	...	33/2 "

Complete Set £9.3.6.

No extra charge for postage and packing in the U.K.

Now supplied by:  
**TOMPKINS & LONGMAN LTD.**  
237 GIPSY ROAD  
WEST NORWOOD, S.E.7  
Tel.: Gipsy Hill 5000



# detached particles

JOHN VALENCE

## NOT EVERYONE'S PAL

The "Choose a Colour System" marathon continues.

The art of effecting a compromise is supposedly a typically British characteristic. Unfortunately if this is so, then our image must be somewhat blemished by the attitude adopted by our representatives at the conference of the International Radio Consultative Committee in Oslo last month.

Italy and France have both been extremely critical of our alleged firm adherence to the PAL system, despite the move to introduce the new SECAM IV as a compromise system for adoption throughout Europe.

Is there truth in the suggestion that British television industry is already deeply committed to designing and producing receivers for the PAL system?

The chances of achieving harmony in colour amongst the European countries seem as remote as ever, alas.

## STRANGE ALLIES

Curiouser and curiouser are the uses to which modern technology is being applied. Even so, a more unlikely association than that between the common bed bug and electronics would seem hard to imagine. As you will probably have read, much interest and amusement has been aroused from the proposed harnessing of this unsavoury insect for military operations by backroom boys in the U.S.A.

It seems that although we have inorganic devices that will effectively detect phenomena such as light, heat, pressure and so on, there is no similar device that will respond to smell. There is no substitute for the nose apparently.

In this day and age of micro-miniaturisation it is not so very surprising that thoughts turn to the employment of the sensitive nasal organs of tiny members of the animal or insect world; in particular, to the *Cimex lectularius*, which we are

informed is highly sensitive to the presence of a human. Upon sensing a member of *homo sapiens*, our bug "transducer" reacts in a most peculiar way by stamping its feet madly!

Once this fact had been established, the rest was plain sailing . . . Catch a dozen or so bugs and then house them in a cunningly contrived container whose floor is actually the diaphragm of a microphone. This container provides "scent" screening for the operator who carries this strange box of tricks and directs the spout-like opening towards the spot where the concealed enemy is suspected to be lurking.

Immediately the imprisoned host smells human blood, a real jive session gets under way. The tiny feet hammer out a frenzied rhythm on the diaphragm and an electronic amplifier raises this to a level suitable for human ears.

## EVERYWHERE

As I am sure I have said on previous occasions, there is no escaping from the ubiquitous "electronic". This term (not always entirely correctly applied) crops up there, there, and everywhere.

For example, halting on the motorway, one's ablutions are simplified by the "electronic hand drier". Insertion of the hands into a cylindrical compartment breaks a light beam and so actuates the electric heater and blower.

In the U.S.S.R., I see they have taken this idea for automated ablutions a stage further. A new washstand for surgeons with a photoelectric cell controlling the faucet has been designed at the Moscow Institute of Sanitary Engineering. Just pass the hand under the faucet and the electromagnetic membrane valve turns on the water. (What you save on the water rate, you pay on the electricity bill—for this device I note consumes 50W).

Anyhow, nice to envisage the Ideal, electronically run, home of the future.



# Readout —

## A SELECTION FROM OUR POSTBAG

### War on the "bug"

Sir—I was glad to see your condemnation of "bugging". Too few journals openly disapprove of undesirable employments of technology; if more did, the lay public would regard science with less suspicion and hostility.

Bugging ethically and morally resembles torture as a cowardly, lazy, stupid and inefficient way of obtaining information for unscrupulously dishonest and greedy purposes. There is a case of sorts to be made for the use of torture and bugging in military activities, but all ethical and moral considerations are notoriously ignored in military spheres; in civilian life, bugging, like torture, is absolutely inexcusable. For my own part, if I were to find any bugging equipment, I would instantly smash it and I fancy the owner of the equipment would get very little sympathy or recompense if he took me to law about it.

Again—thanks and approval for publicly condemning an indecent misuse of scientific discovery and of technology.

W. H. Cazaly,  
Clayhall,  
Ilford,  
Essex.

### Nightlight relay

In the Auto Nightlight article, published in the April 1966 issue of Practical Electronics, the relay suggested was the Omron Type 2051. I have since heard from Messrs Keyswitch Relays Limited, however, that this relay is no longer a stock item. A relay suggested as an alternative by the firm is the "standard" 48V DC 1051 relay, and it is further suggested that this can be used in conjunction with the Mullard RPY15 photoconductive cell. This cell, however, is not readily available in the London area, but since the 1051 relay is relatively sensitive, operating with a current of 8.3mA at 48 volts, the Mullard ORP12 as recommended in the article can be used with the relay provided the transformer used is capable of producing not less than 50V d.c. across VR1.

The relay has a coil resistance of 5,800 ohms. Thus, assuming a maximum of 60V across VR1, the voltage across the cell will be 30V when its resistance is also about 5,800 ohms and maximum power dissipation will then occur. This will rise to a maximum a little above 160mW which is still within the 200mW rating of the ORP12.

G. J. King,  
Devon.

### CAN YOU HELP?

Letters for inclusion under this heading should be as brief as possible. Replies should be made direct to the readers concerned.

Sir—I am starting a Radio Club in the school where I teach. I am intending to use the simpler articles from your magazine as a basis for instruction.

Unfortunately I am short of the July 1965, September 1965 and the January 1966 issues. Can any of your readers help?  
J. Webb, 24, Beresford Crescent,  
Westlands, Newcastle-under-Lyme,  
Staffs.

Sir—I require the following issues, complete with blueprints and data booklets, of Volume 1; November, December 1964, January, February and May 1965.  
M. W. Hudson, 30, Merrill Way,  
Allenton, Derby.

Sir—Can any reader supply any circuit for a Fletcher-Munson curves type volume control and/or where could I buy a "Compentrol" five terminal volume control? The extra two terminals are tapped off the control at either end. I require a 500 kilohm or 1 megohm type.  
A. Patterson, 28, Emerson Road,  
Ilford, Essex.

Sir—We are most anxious to obtain certain back copies of your magazine—namely the following: November 1964; January, March and May 1965; February and March 1966.  
Dr. M. Kropman, Bromhead & Denison Ltd., 310-312, Regent Street,  
London, W.1.

Back numbers are usually very quickly exhausted. We strongly advise all our readers that a standing order be placed with their newsagent to avoid any future disappointment.

### Plastics semiconductors

Sir—I have read with interest Mr. J. B. H. Gould's excellent article on Superconductivity in the July issue, and note that he has omitted to mention what may be the most interesting aspect of this subject, i.e. room-temperature superconductivity. Whilst the latter phenomenon is probably not possible in known forms of metallic element or alloy, scientists have calculated that certain non-metallic substances may display superconductivity at room temperature or even above 300°K. These substances may also be amenable to production as plastics. Related plastics are known to act as semiconductors.

It is well known that many organic substances exhibit, at room temperature, properties of diamagnetism. In some instances, might this not be due to superconductivity phenomena, or something closely related?

Possibly an investigation of the diamagnetic properties of certain organic compounds and organic semiconductors, especially of nucleo-proteins and some of their derivatives or degradation products, might reveal the presence of superconducting loops. Superconducting chains might be revealed by resonance experiments; indeed much detailed information might be obtained by an investigation of the various frequencies.

A dye commonly used for photographic purposes, diethyl-cyanine iodide, has been suggested as a basis for a high-temperature superconductor. Another compound which is known to induce in plastics saturated with it a conductivity approaching that of metals is: 7,7,8,8, tetracyanoquinodimethan; or TCNQ for short. The conduction mechanism is electronic, and appears very promising from the point of view that superconducting properties might be developed.

It would appear that organic superconductors play an extensive role in biology, and that improved knowledge of such compounds could lead to much improved, and more effective, treatment of cancers, in addition to opening the way to "all-plastic" electronically active devices.

A. J. Bassett,  
Chorley,  
Lancs.

## TAPE RECORDER BARGAIN



### Capstan Driven, 5 Transistors

**SPECIFICATION:** 2000/7,000 c.p.s.—400 mW, output—double track—twin speed (3 $\frac{1}{2}$  and 7 $\frac{1}{2}$ ) fast rewind time—5in. spool gives an hour playing with standard tape, weight 7 lb. Size 8 x 11 x 3 $\frac{1}{2}$ . Complete with batteries, microphone—tape spool and instruction manual. Nothing to go wrong if you use a good tape and keep heads clean. Demonstration gladly given at our Croydon shop. Special Snp Price This Month £11/11/-, post and insurance 6/6.

12in. High fidelity loudspeaker. High flux permanent magnet type with either 3 or 15 ohm speech coil. Will handle up to 10 watts. Brand new by famous maker. Price 29/6, with built-in tweeter 35/- plus 3/6 post and insurance.

### HI-FI SPEAKER BARGAIN



**MAINS POWER PACK** designed to operate transistor sets and amplifiers. Adjustable output 60-9 to 12 volts up to 600mA (class B working). Takes the place of any of the following batteries. PP1, PP3, PP4, PP5, PP7, PP8, and others. Kit comprises: mains transformer-rectifier, smoothing and load resistor, 5,000 and 500 mfd. condensers, zener diode and instructions. Real snip at only 14/6, plus 3/6 post.

### ACOS GP83 TURNOVER PICK-UP CARTRIDGE



For Stereo—LP— and 78 records, fitted with two Styl. Diamond for LPs, Sapphire for 78s. This is mounted in standard replacement for most record players using Garrard—B.S.R.—Collaro, etc. etc. The regular price of this cartridge is 55/-. We offer these new and perfect for 25/- (less than the price of styl.) plus 3/6 post and insurance.

**DEAC RECHARGEABLE BATTERIES** These nickel cadmium cells have negligible internal resistance. Will deliver current you require, reduce distortion and are completely reliable. They may be recharged indefinitely. Replacements for PP3, PP7, U7, 12/6, U2 32/6, U11 22/6 or send for list.



### SNIPSCOPE

Famous war-time "cat's eye" used for seeing in the dark. This is an infra-red image converter cell with a silver caesium screen which lights up (like a cathode ray tube) when the electrons released by the infra-red strike it. A golden opportunity for some interesting experiments. 5/- each, post 2/-. Date will be supplied with cells, if requested.

### TWO WAY RADIOS

Give communication over 2 miles. FULLY transistorised—crystal controlled, built-in telescopic aerial—press button operation—PP3 batteries—pair instruments complete and ready to use. £6/12/6 plus 5/- post and insurance. Big 8-mile range model £12/12/6 plus 5/- post & ins. These cannot be operated in U.K.



**MOVING COIL METER BARGAIN** Panel meters are always being needed and they are jolly costly when you have to buy them in a hurry—you should take advantage of this offer: 2in. moving coil flush mounting meters only 5/6. These are actually R.F. meters and cost about 23 each but if you don't want them for R.F. then all you have to do is to remove the thermocouple and you will have a 2-3 m.a. meter which you can make into almost anything by adding shunts or series resistor. These are ex-government, of course.

Where postage is not definitely stated as an extra then orders over £3 are post free. Below £3 add 2/6.

## GOOD COMPANION Mk. V

**SAVES YOU WORK—IT'S PARTLY BUILT**  
Like its predecessors this latest Companion has full-rf performance—such as only a good wooden cabinet and hi-fi speaker can give, and due to its being partly built you will have it done in an evening. Note these features:  
● All Mullard Transistors including 3 x AF117.  
● Two-tone Cabinet size 11in. x 6in. x 3in.  
● All circuit requirements—Push pull output—A.V.C and feed back etc.  
● Printed circuit board all wired only connections to Vol. control, W.C. Switch and Tuning Condenser.  
● Pre-aligned IF stages.  
● Complete with full instructions.  
Price only £4/12/6, plus 5/6 post and ins.



### NIM COMPUTER

This computer will play games and do simple tricks and will provide endless amusement as well as education into computerisation. Kit comprises all the components, the printed front panel and full instructions. The box is not included but this can be made very simply from plywood. Price £4/17/6 plus 3/6 post & ins.



### ADJUSTABLE TIMER & DELAY MECHANISM

This is a fine American made unit designed for precision. The time period is adjusted by a knurled screw. The delay period can be set anywhere from hours or seconds. The end of the delay operates a microswitch—and reeking can be remote controlled or manually reset. The unit is for wall mounting and is approx. 4in. x 7in. x 4 $\frac{1}{2}$ in.—price 39/6 plus 3/6 post and ins.



### DIS-BOARDS FOR QUICK MAINS

These are 4 x 15amp sockets mounted on a metal box all ready for wiring to your power plug—intended for mounting on bench or wall—for use in workshops—laboratories—exhibitions—displays, etc. They avoid the use of dangerous bakelite multi-plugs and adaptors and other hook-ups—price only 19/6 plus 3/6 post and ins.



### CORONET PARCEL

Here's a bargain for you—parcel comprises: plastic case, printed circuit board, two dial knobs, volume control, earphone socket and plastic carrying case all for 8/6 plus 1/6 post.

### AUTOCHANGER BARGAIN GARRARD AUTO RECORD PLAYER Model 2000



This is one of the latest products of the World's most experienced maker of fine record reproducers—its superior features include—automatic playing of up to 8 mixed size records—stopping and starting without rejecting—manual playing—pick-up pivots to give low stylus pressure—large diameter turn-table for max. stability—adjustments include pick-up height—pick-up drooping position and stylus pressure. Size is 13in. x 11 $\frac{1}{2}$ in. clearance for stereo—and mono., L.P. and 78. Supplied complete with mounting template and service sheet. Offered this month at the Special Snp price of 26.9.6 plus 7/6 carriage and insurance.

### YAXLEY SWITCHES

Number of Ways or Positions		1 way	2 way	3 way	4 way	5 way	6 way	8 way	11 way	12 way
1 pole	2 way	3/-	3/1	3/6	3/9	3/11	4/5	5/-	5/-	5/2
2	3/8	4/1	4/6	5/3	5/5	6/7	7/8	8/2	8/2	8/2
3	4/4	5/-	5/9	7/8	8/5	8/9	10/8	11/8	11/8	11/8
4	5/-	5/11	6/8	8/8	9/6	10/8	13/9	14/8	14/8	14/8
5	5/8	6/8	7/8	9/1	10/6	11/10	16/8	18/9	20/6	20/6
6	6/8	7/8	8/8	10/6	12/-	15/-	19/9	24/8	27/6	27/6
8	8/8	9/8	11/6	14/6	18/6	24/8	30/-	35/-	35/-	35/-
10	11/-	11/6	13/6	16/6	21/6	28/8	35/-	42/-	42/-	42/-
12	13/6	13/6	16/-	17/6	21/6	28/8	35/-	42/-	42/-	42/-
14	15/6	16/-	20/6	25/-	31/6	39/8	48/-	56/-	56/-	56/-
16	17/6	18/-	21/-	26/6	33/6	42/8	51/-	60/-	60/-	60/-
1 pole	24 way	15/-	2/-	2/-	2/-	2/-	2/-	2/-	2/-	2/-

### 125 watt MERCURY VAPOUR SPOT LAMP

In addition to the normal uses in photography and lighting generally you will find that a spot light shining over your shoulder is a great boon when working on intricate and micro-circuits. This month due to a fortunate purchase we are able to offer a complete "Phillips" outfit for about one-fifth of its proper price thus showing a saving of 80%. The outfit comprises 125 watt SPOT LAMP (gives approx. same light as 500 watt ordinary lamp)—Polyester filled choke starter and adjustable mounting bracket, with lamp holder—listed at over £10 we offer the complete outfit in perfect order—unused but a little store soiled only 37/8 plus 6/6 post and insurance.



## ELECTRICAL BARGAINS SWAN KETTLE ELEMENTS



Made by famous "Beat" company suitable for most kettles—1900 watts 230V/250V—normally 30/- each—our price only 19/6 each.

## G.E.C. 13A SWITCHED SOCKETS



suitable for ring mains etc. Like the modern fused plug—surface or sunk (flush) mounting type, 4/6 each, 54/- doz.

## 750V INFRARED WALL HEATER



750 watt airtight enclosed element, elliptical polished reflector. —bracket mounting—pull-cord switch. Made to sell at £4. You can buy at only 32/6. P. & Ins. 3/6. Money back if nec.

## SPECIAL BARGAIN Dry Reed Switches 6/6 each Magnets 1/- each

## CIRCULAR FLUORESCENT



Brings sunshine into your home. 100 watts of light but uses only 40w. Beautiful fittings with glass, non plastic centre, fluorescent tube and choke control. Made by Phillips. Regular price £4/15/0. Special Bargain Price 65/-, plus 3/6 car. & ins. Please state colour of glass centre, white, pink, blue, red, black, yellow or cream. Also whether plug into lamp holder or ceiling mounting model. 60 watt mdl. 89/6.

## FLUORESCENT LIGHT KITS



Our 80 watt kit for 5ft. fluorescent tube is the best money can buy, it contains latest slim line (easy to hide away) choke made by one of England's largest companies—starter—tube ends—two chrome clips. All wired up ready to fit in a jiffy with just a few screws—price only 22/6 complete plus 4/6 post and ins., or complete as listed but not wired up 17/6 plus 4/6.

## SEMI-CONDUCTOR BARGAINS

Type No.	Price	Type No.	Price	Type No.	Price
2N1727 16/-		MAT101 8/6		OC71	4/-
2N1728 10/0		MAT120 7/6		OC72	6/-
2N1742 25/-		MAT121 8/6		OC75	6/-
2N1747 25/-		OA5	5/-	OC76	5/-
2N1748 10/0		OA10	6/-	OC77	7/-
AC107 9/-		OA47 2/-		OC78	6/-
AC127 9/-		OA70 2/-		OC78D	5/-
AC117 8/6		OA78 3/6		OC81	6/-
AC118 5/6		OA81 2/6		OC81D	5/-
AC119 5/6		OA85 3/6		OC82	5/-
AC120 5/6		OA90 2/6		OC83	5/-
AC121 5/6		OA91 2/6		OC84	5/-
AC122 4/6		OA299 3/2		OC139 3/6	
AF114 7/-		OC29 17/6		OC140 12/6	
AF115 6/6		OC22 4/3		OC170 5/-	
AF116 7/-		OC23 17/6		OC171 8/-	
AF117 5/-		OC24 22/6		OC200 9/6	
AF118 12/6		OC26 7/6		OC201 12/6	
AF119 12/6		OC28 15/-		OC202 13/6	
AF120 19/6		OC29 17/6		OC203 12/6	
AF212 15/-		OC35 12/6		OC271 19/6	
AS221 15/-		OC36 15/6		ORP12 8/6	
BC107 14/6		OC42 6/6		ORP90 5/6	
BY100 5/6		OC44 5/6		SB975 8/6	
BY113 7/6		OC45 4/-		SB985 8/6	
MZ150 7/6		OC70 4/-		SB251 10/-	

## ELECTRONICS (CROYDON) LIMITED

102/3 TAMWORTH ROAD, CROYDON, SURREY (Opp. West Croydon Station)  
post orders to: Dept. PE, SPRINGFIELD ROAD, EASTBOURNE, SUSSEX

# Practical Electronics Classified Advertisements

## TRANSFORMERS

### TELEVISION:!

From your OWN Car Battery

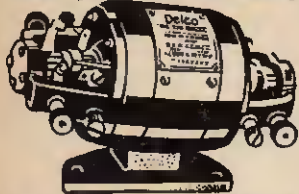

Famous **DELCO TRANSFORMER** transforms 12 or 24v. supply to mains Power for TV, 1" drills, etc. **Now £5-10-0** C.O.D. 2/6 extra. **ONLY**

**VIBRATOR POWER-PAK.** Step 12v. up to MAINS output. For Universal AC/DC razors, small fluorescent fittings, **32/6** radios, etc. **Only**

**HOOVER ROTARY TRANSFORMERS.** 6v. input, 250v. output, 12v. input, 490v. output, 32 watts. **25/-**

**GENERATING SETS.** Brand New. **TINY TIM.** 12v. 300 watts. In packing case. **SELF STARTING.** Normal List Price **£76.** Price Delivered **£35**

Send NOW—Delco by return  
**JAMES WALKER, ELECTRONICS DIVISION**  
School House, Wood Walton, Huntingdon  
Phone Abbots Ripton 368. 9 am. to 10 pm.

## TAPE RECORDERS, TAPES, ETC.

**TAPES TO DISC**—using finest professional equipment—45 r.p.m. 18/- S.A.E. leaflet. **DEROY, 52 Host Bank Lane, Lancaster.**

## BOOKS AND PUBLICATIONS

### SURPLUS HANDBOOKS

19 set Circuit and Notes ..... 4/6 P.P. 6d  
1155 set Circuit and Notes ..... 4/6 P.P. 6d  
H.R.O. Technical Instructions ..... 3/6 P.P. 6d  
38 set Technical Instructions ..... 3/6 P.P. 6d  
46 set Working Instructions ..... 3/6 P.P. 6d  
88 set Technical Instructions ..... 5/- P.P. 6d  
E.C. 221 Circuit and Notes ..... 3/6 P.P. 6d  
Wavemeter Class D Tech. Instr. .... 3/6 P.P. 6d  
18 set Circuit and Notes ..... 3/6 P.P. 6d  
BC.1000 (31 set) Circuit & Notes ..... 3/6 P.P. 6d  
CR.100/B.28 Circuit and Notes ..... 8/6 P.P. 9d  
R.107 Circuit and Notes ..... 5/- P.P. 6d  
A.R.88D. Instruction Manual ..... 15/- P.P. 1/6  
62 set Circuit and Notes ..... 4/6 P.P. 6d  
Circuit Diagrams 3/- each post free.  
R.1116/A, R.1224/A, R.1355, R.F. 24, 25 and 26, A.1134, T.1154 (all models), BC.342, BC.348, BC.348, BC.312, BC.624 (E.M.P.)  
Resistor colour code indicator 1/6 P.P. 6d. S.A.E. with all enquiries please.  
Postage rates apply to U.K. only.

Mail order only to:

**Instructional Handbook Supplies**  
Dept. P.E., Talbot House, 28 Talbot Gardens  
Leeds 8

## FOR SALE

**HEATHKIT OS-1** oscilloscope new, all issues  
Practical Electronics, Radio Constructor Vols. 17, 18, 19 **£16.** **BARKER, "Return",** Childswickham, Broadway, Worcs.

**FOR SALE.** Oscilloscopes—Galvanometers—Evershed & Vignolles Meggers. Also other items and components. Free list. Stamp please. **R. & E. MART, Box 9, G.P.O.,** Tunbridge Wells, Kent.

**RATES: 1/3 per word (minimum 12 words). Box No. 1/6 extra. Advertisements must be pre-paid and addressed to Advertisement Manager "Practical Electronics" Tower House, Southampton St. London, W.C.2**

## FOR SALE

(continued)

**TERRIFIC BARGAINS** in high class Hi-Fi Radio, Gramophone and Tape equipment always available. Save £££'s. Send now for latest **BARGAIN LIST** or call Mon-Fri 9-6, Sat 9-4 or phone **PRIMROSE 3314.** NRS Dept. PE., 16 King's College Road, off Adelaide Road, London, N.W.3.

**BBY55A TRANSISTORS** New: Tested **7/6.** Also: 28302/A 6/6; 2S104 20/- ACY17 2G802 OC203 OC205 IS113. Many more. Very low prices. Lists S.A.E. Box No. 5.

**TRANSISTORS UNMARKED UNTESTED.** 40 for 10/-. P. & P. 1/-. 4 packets post free. Relays, thousands of types, special catalogue free. General Catalogue of Mechanical & Electrical Gear, Tools, etc., 5,000 items, free. **K. R. WHISTON (Dept. PET),** New Mills, Stockport.

## TRANSCEIVERS

**W.S. 38 A.F.V.** New condition. Complete set of valves, 17/6, p. & p. 4/-; 30/- pair, p. & p. 7/6. G.P.O. Licence required to operate. Circuit Diagram 2/6.

**GOVERNMENT SURPLUS.** Electrical and Radio Equipment. Our new catalogue No. 16 now ready. 2/6 Post. Free, cost refunded on purchase of goods over £2. **ARTHUR SALLIS,** Radio Control Ltd., 83, North Road, Brighton.

**ADHESIVE STRIP LABELS.** 1/2" embossed Glossy, P.V.C. various colours. 13d. letter. C.W.O. and S.A.E. to:—**Mr. BROWN, 1 Effie Place, London, S.W.6.**

**CRACKLE PAINT.** Black or Grey. 1/2 pint tins 4/-, post 6d. from the component specialists. **SERVIO RADIO, 156-8 Merton Road, Wimbledon, London, S.W.19.**

**VENNER TIME SWITCHES.** Reconditioned, 14 day clock, once on once off every 24 hours. Jewelled movement, fully guaranteed, 15 amp. 37/6. P. & P. 2/6. **A. R. BATCHELOR, (E.M. Dept.) 4 Park Road, Bromley, Kent.**

## ELECTRIC SOLDERING IRON



**FANTASTIC BARGAIN OFFER ONLY**

**Lightweight Pistol Grip handle, 40 watt, 240 - 250v. A.C., detachable handle forms cover for iron when not in use. With 4ft. Safety 3-core flex. Indispensable for every home handyman. A boon to model makers and a necessity for every electronics enthusiast. Offered to you at this new amazing price.**

**C. H. SERVICE (Dept. PE)**  
Lusted Hall Lane, Tatsfield, Kent.

## FOR SALE

(continued)

### HAMMERITE

HAMMER PATTERN BRUSH PAINT FOR PANELS AND BOXES

★ THE PATTERN IS IN THE TIN ★  
ALL YOU DO IS BRUSH IT ON!  
2 1/2 oz. tins 3/6 1/2 gallon 35/-\*  
1/2 pint 7/6 1/2 gallon 58/-\*  
1 pint 12/- (\*sent by road)  
Carriage: Orders up to 5/-, 9d; up to 10/-, 1/9; over 10/-, 2/9. Colours: Blue, Silver, Black or Bronze. Return of post service, Monday to Friday. From your component shop or direct from the manufacturer.  
**FINNIGAN SPECIALTY PAINTS (PE)**  
Mickley Square, Stocksfield, Northumberland  
Tel. Stocksfield 2280

**A.C. STANDARD.** Mains Motors Fractional H.P. 3/4in dia x 4in long with 1/4in spindle. Many uses. Brand new, 25/- each. P. & P. 2/6d. Small Battery Motors 1/4in dia x 2in long—4 1/2 to 9 volts. Heavy construction; only 7/6d. each. P. & P. 1/-. **WALTONS WIRELESS STORES, 15 Church Street, Wolverhampton.**

## Something Different ?

Then just send Stamped Addressed Envelope for our list of unusual Radio/Electronic Spares at ridiculous prices

**JACK PORTER LIMITED**  
EST. 1928  
30/31 COLLEGE STREET  
WORCESTER

## EDUCATIONAL

**B.Sc. (ENG.), A.M.I.Mech.E., A.M.I.E.R.E.** City & Guilds, etc., on "Satisfaction or Refund of Fee" terms. Wide range of expert Home Study Courses in Electronics, Computers, Radio, T.V., etc. 156-page Guide—FREE. Please state subject of interest. **BRITISH INSTITUTE OF ENGINEERING TECHNOLOGY, 124k College House, Wright's Lane, London, W.8.**

Full-time courses in **RADAR** and **RADIO-TELEGRAPHY** for prospective marine Radio Officers. Govt. approved exam. centre.

Also courses in basic **ELECTRONICS, RADIO, TELEVISION** and **COMPUTERS.**

Apply:—Director, British School of Telephony, 20 Penywern Road, Earls Court, London, S.W.5

**HOME STUDY COURSES** in Practical Electronics. Free Brochure without obligation from: **BRITISH NATIONAL RADIO SCHOOL, Reading, Berks.**

**A.M.I.Mech.E., A.M.I.E.R.E.** City & Guilds, G.C.E., etc. Become a Technician or Technologist for high pay and security. Thousands of passes. For details of Exams. and Courses in all branches of Engineering, Building, Electronics, etc., write for 156-page handbook—FREE. **B.I.E.T. (Dept. 125k), London, W.8.**

## EDUCATIONAL

(continued)

**STUDY RADIO, TELEVISION AND ELECTRONICS** with the world's largest home study organisation. I.E.R.E., City & Guilds, R.T.E.B., etc. Also Practical Courses with equipment. All books supplied. Write for FREE Prospectus stating subject to I.C.S. (Dept. 577), Intertext House, Parkgate Road, London, S.W.11.

## SITUATIONS VACANT

### EARN AS YOU LEARN

A NUMBER of young men, aged 17-21, required with electrical or electronics background.

APPLICANTS will be introduced to the latest transistorised equipment and will be trained in prototype construction, testing and fault finding.

GOOD rates of pay according to experience. We are however, prepared to accept applicants with little or no experience as long as they want to get ahead, and would like to form part of a vigorous team with an expanding young company operating in the exciting solid state field.

Apply in writing or phone:—

**Solid State Controls Ltd.**  
30-40 Dalling Road  
London, W.6  
RIVerside 2437 (3 lines)

### RADIO TECHNICIANS

A number of suitably qualified candidates will be required for training, leading to permanent and pensionable employment. (Normally at Cheltenham but with opportunities for service abroad or appointment to other U.K. establishments including London).

Applicants must be 19 or over and be familiar with the use of Test Gear and have had Radio/Electronic workshop experience. They must offer at least "O" level GCE passes in English Language, Maths and/or Physics, or hold the City and Guilds Telecommunications Technician Intermediate Certificate or equivalent technical qualifications.

Pay according to age, e.g. at 19 £747, at 25 £962 (highest age pay on entry) rising by four annual increments to £1,104.

Prospects of promotion to grades in salary range £1,032—£1,691. There are a few posts carrying higher salaries.

Annual Leave allowance of 3 weeks 3 days, rising to 4 weeks 2 days.

Normal Civil Service sick leave regulations apply.

Apply

Recruitment Officer (RT/54)  
Government Communications Headquarters  
Oakley  
Priors Road  
CHELTENHAM, Glos.

## SITUATIONS VACANT (continued)

**PROFESSIONAL FIRM** in London requires assistants to edit and revise, Patent Specifications, in the electronic, electrical and mechanical fields. Applicants must be British subjects and should be of O.N.C. to Inter B.Sc. standard: Starting salary in range £800-£950 depending on age and qualifications. Applications in own handwriting to Box 668 REYNELL'S, 88/99 Chancery Lane, W.C.2.

**ELECTRICAL/ELECTRONICS TECHNICIAN** required for employment in Mechanical Engineering laboratories. Salary, according to age and qualifications, within the scale £040 to £1,250 per annum. Apply, in writing, quoting reference MST to the Secretary, BOROUGH POLYTECHNIC, Borough Road, London, S.E.1.

Can Earn £20+ per week

### TRANSISTOR RADIO SERVICE ENGINEERS

Applicants must have practical experience in all types of Transistor Receivers.

Write or phone for appointment to

Mr. H. GEE  
Perdio Products Ltd.  
Lowther Road, Stanmore, Middlesex  
Telephone: Wordsworth 0020

## TECHNICAL TRAINING by ICS IN RADIO, TELEVISION AND ELECTRONIC ENGINEERING

First-class opportunities in Radio and Electronics await the ICS trained man. Let ICS train YOU for a well-paid post in this expanding field.

ICS courses offer the keen, ambitious man the opportunity to acquire, quickly and easily, the specialized-training so essential to success. Diploma courses in Radio/TV Engineering and Servicing, Electronics, Computers, etc. Expert coaching for:

- \* INSTITUTION OF ELECTRONIC AND RADIO ENGINEERS
- \* C. & G. TELECOMMUNICATION TECHNICIANS' CERTS.
- \* C. & G. SUPPLEMENTARY STUDIES.
- \* R.T.E.B. RADIO AND TV SERVICING CERTIFICATE.
- \* RADIO AMATEURS' EXAMINATION.
- \* P.M.G. CERTIFICATES IN RADIOTELEGRAPHY.

Examination Students Coached until Successful.

### NEW SELF-BUILD RADIO COURSES.

Build your own 5-valve receiver, transistor portable, signal generator and multi-test meter—all under expert tuition.

POST THIS COUPON TODAY and find out how ICS can help YOU in your career. Full details of ICS courses in Radio, Television and Electronics will be sent to you by return mail.

MEMBER OF THE ASSOCIATION OF BRITISH CORRESPONDENCE COLLEGES.

### INTERNATIONAL CORRESPONDENCE SCHOOLS

A WHOLE WORLD  
OF KNOWLEDGE  
AWAITS YOU!

International Correspondence Schools  
(Dept. 152), Intertext House, Parkgate Road,  
London, S.W.11.

NAME .....

Block Capitals Please

ADDRESS .....

9.66

CONTINUED OVERLEAF

# YOU TOO CAN MAKE A CAREER IN AUTOMATION...

... if you grasp this opportunity to train as an IBM Engineer, in the Data Processing Division's Machine Overhaul Centre at South Ruislip, Middlesex. After studying at the nearby Engineering Education Centre, you will gain progressive experience through overhaul and repair of punched card machines. There will be further opportunities to progress to electronic computers if you show the necessary aptitude and ability. There are openings NOW for several men who:

1. Have an aptitude for the repair, adjustment and testing of light mechanisms and electrical circuits.
2. Are studying for or have ONC/HNC (Electrical or Electronics). It would be an advantage if applicants have radar or tele-communications experience.
3. Think logically and clearly.
4. Are between 18 and 30 years of age.

Experience in this type of work would be an advantage. Starting salaries will be in the range of £700-£1,000 per annum. The Company runs non-contributory Pensions and Life Insurance Plans: working conditions are good and the prospects for able men are excellent. Write for Personal History form to: Miss S. A. Jones, Personnel Selection Dept., IBM United Kingdom Limited, 101 Wigmore St., London, W.1. quoting reference C/PE/497 on letter and envelope please.

# IBM

## ELECTRONICS ENGINEERS

Intermediate and junior development and test engineers required by young and expanding Electronics Company. Some knowledge of transistor techniques necessary.

Please apply to:

Chief Engineer  
D.J.M. Production & Development Ltd.  
Winchester House  
Chertsey Road  
St. Margarets  
Twickenham  
Telephone: POPesgrove 6234

## RECEIVERS AND COMPONENTS

### LIGHT REACTIVE SEMICONDUCTORS

OC73 19/6 (or equivalent @ 9/6)  
ORP12 9/-. Photo-power transistors with circuits 30/- each. ONLY TYPE IN ENGLAND. 300 mc/s PLANAR 2N706 4/9 each or 2 for 8/-.

BY100 Mullard branded 5/- each. Try us for Mullard transistors: OC73 @ 4/-. AC128 @ 4/-. Just two examples, we have many popular types.

SILICON CONTROLLED RECTIFIERS

400 p.i.v. 7 amp 27/6.

THERMISTORS KS31W @ 1/-. G15 type 5/-, cheapest anywhere!!

We cannot print our whole catalogue here but 6d stamp will bring you one. Nine full pages, every device you need, including:-

OUR FAMOUS 25 TRANSISTORS FOR 10/- OFFER.

Thousands of packets sold; Audio types, R.F. types or Switching types, state preference. Includes postage and packing!!

L.S.T. COMPONENTS

23 NEW ROAD, BRENTWOOD, ESSEX

## RECEIVERS AND COMPONENTS (continued)

## R. & R. RADIO & TV SERVICE

Dept. P.E.

44 Market Street, BACUP. Tel. 465

### SALVAGE VALVES

6F13	4/6	PCC84	4/-
6F15	5/-	PCF80	4/-
6K25	10/-	PCL83	5/-
6U4GT	5/-	PL81	5/-
6BW6	5/-	PL82	4/-
6/30L2	5/-	PL83	4/-
EB91	1/-	PY81	3/6
EBF80	3/-	PZ30	5/-
EF80	1/6	U801	7/6
EP91	2/6	U301	6/-
FF85	5/-	U329	5/-
ECC82	4/-	10P13	5/6
EY86	4/-	10P14	5/-
ECL80	4/-	PY800	5/-
20P3	5/-	20D1	2/-
20P4	7/6	20P5	6/6
30F5	5/-	30FL1	6/6
30PL1	5/-	30PI2	5/-
EF37A	7/6	30P4	7/6
PL36	7/6	PY32	6/-
PY33	7/6	PY82	5/-

Postage on valves 6d.—3 or more post free.

1 Pole 8-way switch, complete with 8 resistors 2 @ 1K, 2 @ 15K, one each of 22K, 15K, 18K, 6.8K. 3/6 incl. post.

Fireball Tuners less cover cans otherwise O.K. 8/6d post paid. Speakers ex T.V. 6 x 4 inch 3/6d. 8 inch rmd 7/6 post 2/3d. Meters 2 inch rmd 1.5 ma D.C. ex equip. 15/- post 3/-.

New Valves.

6K8, 6R7 4/6d.

6K7, 6F6, 6B8G 3/-d.

S.A.E. with all enquiries.

## SPECIAL OFFER

1 Watt S.T.C. 300 MC/S N.P.N.  
Silicon Planer. 100% Transistors.  
Limited Stocks. £1 for 6.

3/- each. OC44, OC45, OC70,  
OC71, OC81, OC81D, OC200,  
Get 16, Get 20.

4/- each. AF114, AF115, AF116,  
AF117, OC170, OC171.

5/- each. OC139, OC140, Get  
7, Get 8, Get 9, XC141, BY100,  
OA211.

## SUN SOLAR CELL KITS

24 Page Booklet on Experiments  
inc. 4 Solar Cells 11/- Set.

G.P.O. DIAL TELEPHONES  
20/- each. 35/- pair.

Send 6d. for full lists: inc. S.C.R.  
Zeners.

# Cursons

78 Broad Street  
Canterbury  
Kent

## RECEIVERS AND COMPONENTS

(continued)

**COMPONENTS BONANZA!** S.A.E. for big list! A. J. BASSETT, 28 Park Road, Chorley, Lancs.

### FIRST GRADE SEMICONDUCTORS

2N2926  $\beta$  55-110 @ 4/3  $\beta$  90-180 @ 4/6  
 2N2926  $\beta$  150-300 @ 4/9  $\beta$  235-470 @ 5/6  
 OC45, 4/-; OC71, 4/6; 2N1302 5/-; 2N1303, 5/-;  
 2N696, 10/-; 2N706, 7/6; OC36 10/6; OC83, 5/6;  
 DIODES BY100, 5/-; A1D 6/6  
 S.C.R. C22D 400 P.I.V. 7.4 amps @ 35/-  
 U.J.T. 2N2646 to trigger S.C.R. C22D @ 13/6

### MILLS ELECTRONICS

1 Ullswater Road, Leverstock Green  
 Hemel Hempstead, Hertfordshire  
 C.V.O. Post Free S.A.E. List Mail Order Only

**COMPONENTS, VALVES, TRANSISTORS, etc.**  
 Call or send 6d. for list. ROGERS, 31 Nelson Street, Southport.

## A NEW DIMENSION IN ECONOMY AND RELIABILITY

These new Silicon Planar NPN ceramic/epoxy resin transistors give extreme reliability at a new low cost. Electrically equivalent to the popular 2N2926, the CS2926 has a dissipation of 300mW max. (an increase of 50%) and has the standard TO-18 terminations.

Prices and selections are as follows:

red,  $\beta$ 55 to 110 3/6  
 orange,  $\beta$ 90 to 180 3/9  
 yellow,  $\beta$ 150 to 300 4/-  
 green,  $\beta$ 235 to 470 4/9

This encapsulation is additionally useful for model control and other applications involving severe vibration.

SILICON Power Transistors, type 40250, 50V, 29V max., or 16W @ 100°C case, 17/-

PNP planar, 2N3702,  $\beta$ 150-300, 6/-

Also UHF, HV and ultra high gain silicon in stock

Photoconductive cells, very sensitive, 5/3

Resistors, new, 1W, 5%, 4-7  $\Omega$  to 10M, 2/3 doz.

Receivers, BY238, 850V PIV, 1A, 4/6

### ELECTROVALVE

6 Mansfield Place • A80T • Berkshire

**SEMICONDUCTORS.** Close equivalents: OC35 4/9; OC72 2/-; OC170 2/6; OC44 2/-; OC71 1/9; BY100 4/3; OA70 8d. P. & P. 9d. A. P. WINE, 19 Harbeck Rd., Bournemouth, Hants.

## COMPONENTS POSTAL SERVICE

- ★ **SWITCHES**—Quality push-button and 12 way rotaries made to order. Send details for quotation.
- ★ **SLIDER SWITCHES**—Professional grade D.P.D.T. Special silver contacts, 2 off ... 5/9
- ★ **POTENTIOMETERS**—SK Preset 2 off ..... 3/3
- ★ **RESISTORS**—5% Hi-Stab Carbon Film 75  $\Omega$  to 1M  $\Omega$  (1 watt); 10 off, one preferred value ..... 4/-
- ★ **CAPACITORS**—Polyester Foil: 160 VDC/100 VAC.  
 33 pF to .1  $\mu$ F: 5 off, one preferred value 3/6  
 .15  $\mu$ F to .47  $\mu$ F: 5 off, one value ..... 5/-
- ★ **ASSORTED RESISTORS**—Hi-Stab, 300 off (5% or better, worth £3) ..... 15/- (P. & P. 1/6 per order, C.V.O.)

### ELMBRIDGE INSTRUMENTS LTD.

26 Ganhill, Guildford, Surrey

**1 WATT TRANSISTOR AMPLIFIERS 81.** Push Pull Output, Complementary Symmetry, Matches 15  $\Omega$  Speaker, Transformers not required, British Make, Size 2 1/2" x 1" x 1", 9 volt battery operation. ROBERTSON, 38 Silverhill Dr., Denton, Newcastle upon Tyne, 5.

## MISCELLANEOUS

"P.E." A.C. Millivoltmeter. Flash Guns Beam Switching Unit. Photographic Process Timer. Computer for Nim. Thyristor Control Unit and all constructional projects going back to issue 1. S.A.E. for itemised price lists. Please state lists required. AJAX ELECTRONICS, 18A Rumbold Road, Fulham, London, S.W.6.

## MISCELLANEOUS

(continued)

**CONVERT ANY TV SET** into an Oscilloscope. Diagrams and Instructions, 12/6. REDMOND, 42 Dean Close, Portslade, Sussex.

**PRINTED CIRCUIT BOARDS** only 6d. sq. in. Component bargains. S.A.E. lists. BEEJAY ELECTRONICS (P.E.) 106 Reddicap Heath Road, Sutton Coldfield, Warwickshire.

**YUKON SELF-SPRAY** AIR DRYING MODERN WRINKLE (CRACKLES) EGG SHELL FINISH

Black same price as Hammer finishes (see our main advert., page 680)

Like our hammers? Now have a crack at our **WRINKLES!**

**TRANSFORMERS** Rewound. Output or mains. Specials made to order. Reasonable prices. S.A.E. enquiries. RATCLIFFE, 27 Station Road, Holmfirth, Yorks.

### BERNIESOUND (AUDIO ENGINEERS)

Design-Build-Repair-Modify

All types of Electronic Equipment

For estimates write to:—

Mr. Brown, 1 Effie Place, London, S.W.6.

## SERVICE SHEETS

**SERVICE SHEETS** for all makes Radio, T/V, Tape Recorders, 1925-1966. Prices from 1/-. Catalogue 6,000 models, 2/6. Free fault-finding guide with all sheets. All types of Valves, Components, Books, S.A.E. lists. Please send stamped addressed envelope with all orders/enquiries. HAMILTON RADIO, Western Road, St. Leonards, Sussex.

## SERVICE SHEETS

4/- each, plus postage.

We have the largest supply of Service Sheets for all makes and types of Radios and Televisions, etc. in the country. Speedy Service.

To obtain the Service Sheet you require, please complete the attached coupon:

From:

Name: .....

Address: .....

To: S.P. DISTRIBUTORS  
 44 Old Bond St., London, W.1  
 Please supply Service Sheets for the following:

Make: .....

Model No.: ..... Radio/TV

Make: .....

Model No.: ..... Radio/TV

Make: .....

Model No.: ..... Radio/TV

I also require the new 1966 list of Service Sheets at 1/6 plus postage.

(please delete items not applicable)

I enclose remittance of .....

which includes postage

MAIL ORDERS ONLY Sept. PE

## SERVICE SHEETS

(continued)

**CIRCUIT, COMP., VALUES,** Avo model 7. 2/6 plus S.A.E. TELRAY, Maudland Bank, Preston.

**STATE MODEL NO.** Radio 1/6. TV 3/-. S.A.E. DARWIN, 10 George Street, St. Helens, Lancs.

Ex N.E.V., C.C.T.V. Camera and Monitor Circuit Diagrams. S.A.E. for list. LOWE, 62 Brownswood Road, London, N.4.

## ABC'S OF SILICON CONTROLLED RECTIFIERS

An introduction to SCR's explaining what they can do and how they do it, by Lytel. 17/-

**ELECTRONIC GUITAR AMPLIFIER HANDBOOK,** by Darr. 25/-

**ABC'S OF COMPUTERS,** by Lytel. 17/-

**PROXIMITY DETECTORS AND METAL LOCATORS, HOW TO BUILD,** by Shields. 21/-

**UNDERSTANDING DIGITAL COMPUTERS,** by Benrey. 17/-

**TRANSISTORS IN LOGICAL CIRCUITS,** by Altes. 17/-

**CIRCUITS FOR AUDIO AND TAPE RECORDING,** by Judd. 8/3

**PRACTICAL OSCILLOSCOPE HANDBOOK,** by Turner. 26/-

**FUNDAMENTALS OF DATA PROCESSING,** by Lytel. 41/6

**TRANSISTOR SPECIFICATIONS AND SUBSTITUTION HANDBOOK,** by Techpress. 16/-

All prices include U.K. postage

Where possible 24-hour service guaranteed

## UNIVERSAL BOOK CO.

12 LITTLE NEWPORT ST., LONDON, W.C.2  
 (Leicester Square Tube Station)

### 10W SILICON AMPLIFIER PACKAGE: 30/-

The very latest! Matched set of 5 silicon transistors and two stabilizing diodes, to make 10W transformerless audio amplifier with guaranteed performance. Flat 30-30,000 c/s. 15  $\Omega$  load. Sensitivity 100  $\mu$ A. Distortion under 2% at 8V. Works from 40V, 400mA supply. Circuit and data supplied. Brand new transistors in makers' package (SGS Fairchild). Price 30/- U.K. post paid.

**Silicon Planar Transistors:** 2N2926,  $\beta$  = 90-180, 4/-; 150-300, 4/6; 235-470, 5/6. 2N3702 (PNP Class B) 5/6; 2N3707,  $\beta$  = 100-500 at 100  $\mu$ A. Low noise, 6/-; 2N3704, P<sub>c</sub> = 360mW. 6/-; T1407, 450Mc/s cut-off, low noise h.f. amp. 7/-; Complementary matched pairs 2N3702/3704 11/- U.K. post paid. C.V.O. Mail order only.

### AMATRONIX LTD.

398 SELSDON RD., CROYDON, SURREY

# MARTIN Audiokits

HI-FI, F.M.  
AND TAPE

AND RECORDAKITS



20 WATT INTEGRATED STEREO

ADD-ON UNIT SYSTEM

F.M. TUNER

THE EASY WAY TO BUILD AND SAVE

Coupon brings latest leaflets

From good stockists everywhere.

Martin Electronics Ltd  
184-155 High St., Brentford,  
Middlesex. 15Leworth 1161/2

MARTIN AUDIOKITS comprise an ingeniously designed series of fully-transistorised units by means of which you can build up a hi-fi assembly starting with a simple mono amplifier system and adding to it to make a fully integrated 20-watt stereo installation, for well under £30. This can be used with low output as well as crystal pick-ups, radio, tape-heads, microphones, etc. Building is pleasantly easy. Quality is outstanding. Other units include F.M. Tuner and new complete amplifier assembly for Magnavox 363 Tape deck.

**MARTIN ELECTRONICS LTD.**  
154-155 HIGH ST., BRENTFORD, MIDDXX  
Martin Leaflet on Audiokits

FM Tuner  New Recordakits  please

NAME .....

ADDRESS .....

P.E.9 .....

## 10/- BARGAIN SALE! 10/-

- 10/- 20 Assorted Transistor Electrolytics.
- 10/- 3 Television Smoothing Condensers. 200/100, 200/200, 125/300/50uf., 275 V.
- 10/- 50 assorted 1/4 Watt 5% Resistors. (Long leads).
- 10/- 100 assorted low wattage types (including printed circuit).
- 10/- 100 assorted 1/2 watt to 3 watt (10 cards each of 10 resistors).
- 10/- 100 assorted Silver Mica/Ceramic Condensers (mixed).
- 10/- 50 ASSORTED PAPER CONDENSERS .001 to .5uf. 500 volt.
- 10/- 100 miniature paper condensers (mixed).
- 10/- 50 untested transistors.
- 10/- 6 Switching Transistors NPN type. Min. 200 m/cs.
- 10/- 6 Switching Transistors PNP type.
- 10/- ACOS mono pick-up head.
- 10/- 3 miniature earpieces.
- 10/- 20 DIODES. VERY HIGH QUALITY.
- 10/- Magnetic Lapel Microphone with plug and lead.
- 10/- 3", 4" or 5" loudspeaker. Low impedance.
- 10/- Signal Injector. Parts and Circuit to make.
- 10/- Motor Car Rev. Counter. Parts and circuit (excl. meter).
- 10/- 12 pre-set pots. 10 ohm., 50K. ohm., 1K. ohm., mixed.
- 10/- FREE! 10/- FREE! 10/- FREE! 10/- FREE!
- 10/- ANY ELEVEN ITEMS FOR £5/-! 10/- FREE!

Rush your order now! These prices cannot be repeated!

**G. F. MILWARD**

17 Peel Close, Drayton Bassett, Nr. Tamworth, Staffs.

Phone: TAMWORTH 2321

POST ONLY

## WENTWORTH RADIO

GENUINE HIGH QUALITY COMPONENTS  
GENUINE LOW PRICES

OC44 2/6	OC77 3/-	AC128 3/3
OC72 2/6	OC200 3/3	OC170 3/-
OC81 2/6	AF117 2/6	GET573 12/6
AF115 4/6	OC35 10/-	MAT120 7/9
OC26 10/-	MAT101 8/6	BY100 6/-
MAT100 7/9	OA95 1/-	AF114 4/6
MAT121 8/6	OC71 2/6	AF116 4/6
OC45 2/6	OC81D 2/6	OC172 4/6
		OC201 10/6

4 PIN TRANSISTOR SOCKETS 9d.

MINIATURE POTS. LIN. 5KΩ, 10K, 10KLOG, 25K, 50K, 100K, 250K, 500K, 1M, 2M, 2/- each

We welcome enquiries for all types of components. Lists. S.A.E. Terms, cash with order, P.P. add 9d. for orders under £2

**JACKSON "OO" TUNERS**  
208PF - 176PF with SCREEN and TRIMMERS  
ONLY 7/6  
P.P. 1/3 each

**MINIATURE CRYSTAL EARPIECES**  
COMPLETE WITH LEAD  
1/6 each  
P.P. 6d.

AD140 10/-  
250MW ZENERS 4/- each

1a Wentworth Court, Aiston Road, Barnet, Herts

BAR 3087

RETURN OF POST ORDER AND QUOTE SERVICE

1/2 - 1/4W RESISTORS 10Ω - 22M 2d.

1/4W 10% MINIATURE 10Ω - 1M 6d.

CERAMIC CAPACITORS 4d. 30/- 100

SILVER MICA 10PF-1000PF 6d.

HI-STABS 1% 1/4W 1/-

MINIATURE TRANSISTOR ELECTROLYTICS, FULL RANGE 1/2. MAGNETIC EARPIECES WITH PLUG 3/-. CRYSTAL 4/4

## DIGITAL COMPUTER

A simple digital Adder/Subtractor using switches and lamps only. A fascinating demonstration of Binary Arithmetic. Full circuit, with notes on the Binary System 3/6, post free.

**1% WIREWOUND RESISTORS**  
More stable than High Stability Carbon, these resistors are ideal for instruments. Your value would order 1 ohm to 5,000 ohms 1%, 3/3; 1/2%, 3/6; up to 20kΩ 1%, 4/6; 1/4%, 4/9. Special prices for quantities of one value, manufacturers' enquiries welcomed.

**1/2W 1% HIGH STAB. CARBON RESISTORS**

Good stocks held, with most special multimeter values, 2/- each, 10Ω to 10MΩ. Stock list for s.a.e.

PLANET INSTRUMENT CO.  
25(E), DOMINION AVENUE, LEEDS 7

## BATTERY ELIMINATORS

The ideal way of running your TRANSISTOR RADIO, RECORD PLAYER, TAPE RECORDER, AMPLIFIER, etc. Types available: 9v; 6v; 41v (single output) 39/6 each. P. & P. 2/9. 9v + 9v; 6v + 6v; or 41v + 41v (two separate outputs) 42/6 each. P. & P. 2/9. Please state output required. All the above units are completely isolated from mains by double wound transformer ensuring 100% safety.

R.C.S. PRODUCTS (RADIO) LTD.  
(Dept. P.E.), 11 Oliver Road, London, E.17

## "PRACTICAL ELECTRONICS" CONSTRUCTIONAL DESIGNS

All specified 1st grade Components, complete Metalwork, full range of Materials, engraved Panel Plates, Ancillary Equipment and Assembled Units. Comprehensive lists available for each "P.E." Constructional Article.

Please send 6d. in stamps for each design  
**MALVYN ENGINEERING WORKS**  
Engineers to the Radio and Electronic Industries  
7 CURRIE STREET, HERTFORD, HERTS  
TELEPHONE: HERTFORD 2264

## BUILD THIS 27mcs REMOTE CONTROL TRANSMITTER

Kit of Parts  
excl. case **£8.10.0**

1 watt output. Crystal control.

1 1/2 miles ground range.

Printed Circuit

All transistor.

Tone modulated.



Type 200JPE

**TELERADIO** 325/7 Fore Street  
London, N.9  
Radio Control Specialists



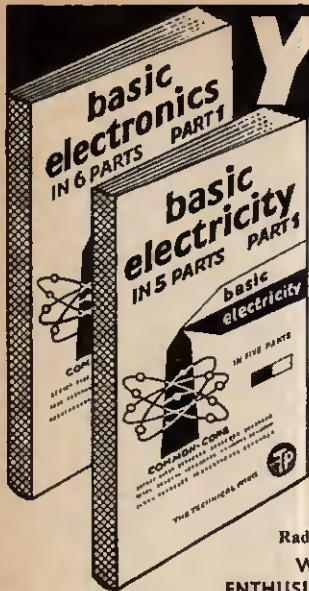

# YOURS FREE FOR 7 DAYS

## The New 'Picture-Book' way of learning **BASIC ELECTRICITY (5 VOLS.)** **BASIC ELECTRONICS (6 VOLS.)**

You'll find it easy to learn with this outstandingly successful new pictorial method—the essential facts are explained in the simplest language, one at a time; and each is illustrated by an accurate, cartoon-type drawing.

The books are based on the latest research into simplified learning techniques. This has proved that the Pictorial Approach to learning is the quickest and soundest way of gaining mastery over these subjects.

The series will be of exceptional value in training mechanics and technicians in Electricity, Radio and Electronics.

**WHAT THIS MONTH'S ENTHUSIASTIC READERS SAY**

"... I have viewed a number of such books in an effort to obtain the necessary knowledge for the layman to understand easily, and find that only your own publication can do this, and does so very well indeed..."  
D. E. F., TROWBRIDGE

"... I find that the new pictorial method is so easy to understand and I will undoubtedly enjoy reading the following five volumes, thank you for a wonderful set of books..."  
C. B., LONDON

A TECH-PRESS PUBLICATION

To Selray Book Co.

60 Hayes Hill, Hayes, Bromley, Kent

Please send me Without Obligation to Purchase, Basic Electricity/Basic Electronics on 7 Days' Free Trial. I will either return set, carriage paid, in good condition within 8 days or send down payment of 15/- (Basic Electricity) followed by 6 fortnightly payments of 10/-. Down payment of 15/- (Basic Electronics) followed by 6 fortnightly payments of 12/6. Alternatively, I will send 68/- (Basic Electricity—5 parts), 81/- (Basic Electronics—6 parts) post free. This offer applies to United Kingdom only.

Tick against set required (only one set allowed on free trial).

BASIC ELECTRICITY  BASIC ELECTRONICS

Signature.....  
(If under 21, signature of parent or guardian)

Name.....  
BLOCK LETTERS BELOW

FULL POSTAL Address..... P.E.9

**POST NOW FOR THIS OFFER !!**

**SILICON RECTIFIERS I.R. IN2374** 1000v. 250mA 4/6d. P.P. 1/-. Westinghouse S10AR2 1000v. 800mA 9/6d. P.P. 1/-.

**RESISTORS** 100 well assorted values and types, 1/4w. to 2w., 1% to 10%, hy-stabs, etc. A super buy at 7/6d. P.P. 1/6d.

**CAPACITORS** Parcel of 100 well assorted silver mica, ceramics, papers, electrolytics, air spaced variables, etc. 10/-. P.P. 1/6d.

**VALVEHOLDERS**

B7A paxolin. 2/- per dozen. P.P. 1/6d. 1/Octal low-loss ceramic 11 for 10/-. P.P. 1/-. UX4 low-loss ceramic. 6 for 9/-. P.P. 1/-.

**HEADPHONES** German made with cushioned ear pads. 5 and 2000 ohm versions. 29/-. P.P. 2/-.

**MARCONI CRYSTAL CALIBRATOR No. 5 MKII.** 1 Mc/s precision crystal calibrator complete with spares and handbook. Brand new in transit case. £7.10.0. Carr. 10/-.

**POTENTIOMETERS** 5 kilohm linear, 10K lin, 15K lin, 50K lin, 100K lin, 250K lin, 1M log, 1M lin, 2M log, 2M lin. 1/- each. P.P. 6d.

With double pole switch 500K log, 1M log, 1.5M log, 2/- each. P.P. 6d.

With single pole switch 10K lin, 50K lin. 2/- each. P.P. 6d.

Pre-set potentiometers 5K lin, 250K lin, 300K lin, 500K lin, 1.5M log, 2M lin. 1/- each. P.P. 6d.

**RADIO AMATEURS' EXAMINATION MANUAL** 5/9d. post paid.

**COMMUNICATIONS RECEIVERS** RG-1 £37.10.0, Hallcrafters £39E £15, Eddystone 888 £69, Marconi CR150 £35, Hallcrafters SX140 £27.10.0, R.C.A. AR-88D £55, etc. A large selection always in stock.

**BRIAN J. AYRES & CO.**

Dept. EA, 8 Hartfield Road  
Wimbledon, London, S.W.19  
Telephone: Wimbledon 6963

### NEW RANGE U.H.F. AERIALS FOR BBC 2 (625) line transmissions

All U.H.F. aerials now fitted with tilting bracket and 4 element grid reflectors.

**Loft Mounting Arrays,** 7 element, 35/-, 11 element, 42/6, 14 element, 50/-, 18 element, 57/6. **Wall Mounting with Cranked Arm,** 7 element, 68/-, 11 element, 67/-, 14 element, 75/-, 18 element, 82/6. **Miss Mounting with 2in. clamp,** 7 element, 42/6; 11 element, 55/-; 14 element, 62/-; 18 element, 70/-. **Chimney Mounting Arrays, Complete,** 7 element, 72/6; 11 element, 80/-; 14 element, 87/6; 18 element, 95/-. Complete assembly instructions with every unit. **Low Loss Cable,** 1/8 yd. U.H.F. Pre-amps from 75/-. State clearly channel number required on all orders.

### BBC · ITV · F.M. AERIALS



**BBC (Band 1).** Telescopic loft, 21/-. External S/D, 30/-, "H", £2.10.0.

**ITV (Band 3).** 3 element loft array, 25/-. 5 element, 35/-. Wall mounting, 3 element, 35/-. 5 element, 45/-.

**Combined BBC/ITV.** Loft 1+3, 41/9; 1+5, 48/9; Wall mounting 1+3, 35/9; 1+5, 63/9; Chimney 1+3, 63/9; 1+5, 71/6. **VHF** transistor pre-amps from 75/-.

**F.M. (Band 2).** Loft S/D, 12/6, "H", 30/-. 3 element, 52/6. External units available. Co-ax. cable, 8d. yd. Co-ax. plugs, 1/5. Outlet boxes, 4/6. Diplexer Crossover Boxes, 12/6. C.W.O. or C.O.D. P. & P. 4/6. Send 6d. stamps for illustrated lists. Quotations for special arrays available on request.

**K.V.A. ELECTRONICS (Dept. P.E.)**  
27 Central Parade, New Addington  
Surrey  
LOD 2246

# VARI-STAT

**thermostatic soldering iron for controlled temperature**

Miniature Model 50 watt 55/-  
Instrument Model 70 watt Mk. 1 (Micro-Switch) 79/6  
Instrument Model 70 watt Mk. 11 (Magnetic Contact Breaker) 72/-

Both Models give excellent bit and element life since the thermostat completely eliminates overheating and controls the reserve heating capacity, which makes possible continuous soldering without chilling of the bit. The consistent temperature makes these irons ideal for printed circuit work.

**CARDROSS ENGINEERING CO. LTD., WOODYARD ROAD, DUMBARTON.**  
Tel.: Dumbarton 2655.

# ASTONISHING LOW PRICED RADIOS & KITS FROM CONCORD

New RADIO Anyone Can Build in 2-3 Hours

ONLY **19/6**



**EVEN THE OLDEST CHILDREN BUILD THEM!**  
... no soldering - only 16 connections. Then bear trench out bringing in station after station. 4 1/2" x 2 1/2" x 1 1/2".

Many Testimonials:—M.H. of Bradford, writes: "I have just completed one of your sets successfully. It is the first time I have ever tackled anything like a radio and I must state here and now, I am amazed how easy it is to a layman like me. Your instructions and plan have obviously been very carefully thought out so that even the most dim can follow them... 19/6 plus 2/6 post, etc.



**MAKE 5 DIFFERENT TRANSISTOR RADIOS for 35/-**

Amazing Radio Construction Set! Become a radio expert for 35/-. A complete Home Radio Course. No experience needed. Parts include instructions for each design, Step-by-Step plan, all Transistors, loudspeaker, personal phone, knobs, screws, etc., all you need. Box size 14" x 10" x 2" (parts available separate). Originally 40. **NOW 35/-** plus 3/6 p. & p.

**UNIQUE NEW PORTABLE RADIO NOW A FRACTION OF THE NORMAL PRICE. ONLY 35/-**

**WHY PAY MORE.** All the latest refinements are packed into this new MULTI STATION ALL transistor radio - the internal aerial picks up even remote stations and the powerful built-in speaker gives room filling volume. Individual tuning, first-class reception. Purchase with confidence - packed in original manufacturers' cartons. (Personal amplifier & battery, 4/6) Send 35/- plus 4/6 P. & P.



**ASTONISHING CIGARETTE RADIO! ONLY 18/6**



Yes a perfectly ordinary packet of cigarettes - but it fetches in station after station, loud and clear! Holds 10 cigarettes - yet cleverly conceals highly sensitive, fully transistorised circuit (incl. thy battery). Even a young boy can assemble it in under 2 hours. No soldering. No experience necessary. Only 18 Connec-tions. From our bulging testimonial file, Mr. D. B. of Huddersfield writes: "... I have fitted the parts in and it is working wonder-fully..." ALL PARTS including Semi-Conductors, A.B.C. Plans, etc. **ONLY 18/6** plus 2/6 post, etc.

CONCORD ELECTRONICS LTD. (Dept. PE28) · 87-89 TABERNACLE ST · E.C.2

## DE LUXE PLAYERS

4-speed Flangers 3-tone Cans 17x15x9 1/2 in. High flux loudspeaker and High Quality Amplifiers ready built. Quality output. Volume and Bass controls. All items fit together perfectly. Special instructions enable assembly in 30 minutes, only 5 wires to join. 12 months' guarantee.



POST FREE

TO BUILD YOURSELF

Portable Cabinet 59/6. As illustrated. To fit any standard player or auto-changer. RCS 3 watt amplifier 59/6. Ready made and tested. Complete with UCL52 triode pentode valve and loudspeaker. SINGLE PLAY UNITS BSR Junior 23. 9.6 BSR GUY 24.19.6 Garrard SRP12 24.19.6 Garrard SRP25 210.19.6 Garrard A70 219.19.6 Garrard LAB30 224.19.6 Garrard 401 229.19.6

Superior Amplifier 59/6. Ready made and tested. Guaranteed better sound! Fully isolated AC Mains Transformer 4 watt output. ECL58 triode pentode valve. Volume and tone controls with knobs. High Flux Quality Loudspeaker. AUTOCHANGE UNITS BSR Monarch 24.19.6 Garrard 1000 26. 9.6 Garrard 2000 26.19.6 Garrard 3000 28. 9.6 Garrard AT60 with diecast turntable 210.19.6

## NEW ELECTROLYTICS FAMOUS MAKES

TUBULAR	TUBULAR	CAN TYPES
2/250 v. .... 2/3	100/25 v. .... 2/-	8/600 v. .... 9/-
4/250 v. .... 2/3	250/25 v. .... 2/6	16/600 v. .... 12/-
8/450 v. .... 2/3	500/10 v. .... 3/-	16-18/600 v. 7/6
16/450 v. 3/-	8-8/450 v. 3/6	32-32/450 v. 6/-
32/450 v. .... 3/6	8-16/450 v. 3/9	50-50/350 v. 7/6
25/25 v. .... 1/9	16-18/450 v. 4/3	64-120/350 v. 11/-
50/50 v. .... 2/-	32-32/350 v. 4/6	100-200/275 v. 12/6

## PAPER TUBULARS

350v.-0.1 9d., 0.5 1/9; 1 mfd. 3/-; 2 mfd. 150v. 3/-; 500v.-0.001 to 0.05 9d.; 0.1 1/-; 0.25 1/6; 0.5 2/6; 1.000v.-0.001, 0.0022, 0.0047, 0.01, 0.02, 1/8; 0.047, 0.1 2/-; 0.22, 0.47, 3/-; 2.000v.-0.005, 0.01, 0.02 2/6; 0.05 3/6; E.H.T. CONDENSERS. 0.001mfd., 7kV. 6/6; 20kV., 10/6.

SUB-MIN. ELECTROLYTICS. 1, 2, 4, 5, 8, 16, 25, 30, 50, 100, 500, 1,000 mfd. 15v. 2/6; 1,000 mfd. 50v. 7/6; 2,000/50 11/6. CERAMIC. 500 v. 1 pf. to 0.01 mfd. 9d. DISC CERAMICS 1. PULS. CERAMICS 10 pf. to 150 pf., 18 kV. 2/6. SILVER MICA. Close tolerance (plus or minus 1 pf.). 5- to 47 pf. 1/-; ditto 1 1/2, 50 to 800 pf. 1/-; 1,000 to 5,000 pf. 2/-. TWIN GANG. "0-0" 200 pf. +170 pf., 10/8; 385 pf., 10/8. miniature 100/-; 500 pf. standard with trimmers, 9/-; midget, 7/6; midget with trimmers, 9/-; 600 pf. slow motion, standard 8/-; small 8-gang 500 pf. 15/8; single 100 500 pf. 7/6. SHORT WAVE. Single 10 pf., 25 pf. 50 pf., 75 pf., 100 pf., 150 pf., 5/6 each. Can be gauged. Couplers 8d. each. TUNING. Solid dielectric. 100 pf., 300 pf., 500 pf., 3/6 each. TRIMMERS. Compression ceramic 30, 50, 70 pf., 8d.; 100 pf., 150 pf., 1/3; 250 pf., 1/8; 600 pf., 750 pf., 1/6.

## BEST BRITISH PVC RECORDING TAPES

L.P. 7in. 1800ft. .... 19/6 D.P. 7in. 2400ft. .... 29/6  
L.P. 5in. 1200ft. .... 14/6 D.P. 5in. 1800ft. .... 24/6  
L.P. 5in. 900ft. .... 11/6 D.P. 5in. 1200ft. .... 18/6  
Spare Spools 2/6. Tape Splitter 2/6. Leader Tape 4/6.  
Tape Heads: Collaro 2 track 28/8 pair. 4 track 70/- pair.

## MAINS TRANSFORMERS

250-0-250, 80 mA., 6.3 v. 3.5 a. Rectifier 6.3 v. 1 a. or 5 v. 2 a. 25/-; Dkto 350-0-350, 29/8; Mt. 510/500-0-300 v. 120 mA., 6.3 v. 4 a. .... 25/6  
MIRIATURE 200 v. 20 mA., 6.3 v. 1 a. .... 10/8  
MIDGET 220 v. 45 mA., 6.3 v. 2 a. .... 15/8  
SMALL, 300-0-300 v. 70 mA., 6.3 v. 4 a. .... 19/6  
HEATER TRANS. 0.3 v. 1 1/2 a., 7/6; 0.3 v. 4 a. .... 10/6  
Dkto tapped sec. 1.4 v. 2, 3, 4, 5, 6.3 v. 1 amp. .... 10/6  
GENERAL PURPOSE LOW VOLTAGE. Outputs 5, 6, 6.3, 8, 9, 10, 12, 15, 18, 24 and 30 v. at 2 a. .... 25/-  
Ditto, 1 amp., 5, 10, 15, 20, 25, 30, 35, 40, 55, 80, ... 28/8  
Sub-Min. Mains to 9 v. 80 mA. 1 x 1 1/2 x 1 1/2 in. .... 7/8  
AUTO TRANS. 150 w., 0.115 v., 230 v., 25/-; 500 w. 32/6

## Q MAX CHASSIS CUTTER

Complete: a die, a punch, an Allen screw and key  
1in. 14/6 1 1/2 in. 18/- 1 1/2 in. 22/6  
1 1/2 in. 14/9 1 3/4 in. 18/- 2in. 34/3  
2in. 15/6 1 1/2 in. 18/6 2 1/2 in. 37/9  
1 1/2 in. 15/9 1 3/4 in. 20/- 2 1/2 in. 44/3  
1in. 18/- 1 1/2 in. 20/6 1in. sq. 31/6

## CRYSTAL MIKE INSERTS

1) x 1in. 6/6; BM3 1 x 1in. 7/6; ACOB 1 x 1in. 9/6  
TANNOY CARBON MIKE with Switch ..... 5/6  
MOVING COIL HEADPHONES 100 ohms ..... 12/6  
(Slightly soiled but guaranteed!)  
BARGAIN XTAL PICK UP ARM Complete with ACOB LP-75 Turnover Head and Styl 20/-; Stereo 30/-

RETURN OF POST DESPATCH Minimum P.P. Charge 1/6 per order unless otherwise stated, Full List 1/-, C.O.D. 2/6 extra. CALLERS WELCOME RADIO COMPONENTS SPECIALISTS 337 WHITEHORSE ROAD, WEST GROYDON

Written guarantee with every purchase. (Export: Send remittance and extra postage, no C.O.D.) Buses 133, 68 pass door. S.R. Stn. Selhurst. Tel.: THO 1665

## YUKAN SELF-SPRAY AEROSOL WAY!

### GET THIS AIR DRYING HAMMER FINISH NOW!

YUKAN Aerosol spraykit contains 16 ozs. fine quality durable easy instant spray. No stove baking required. Available in Grey, Blue, Gold, Bronze at 14/11 at our counter or 15/11, carriage paid, per pushbutton self-spray can. SPECIAL OFFER: 1 can plus optional transferable snap-on trigger handle (value 5/-) for 18/11 carriage paid.

Choice of 13 self-spray plain colours and primer (motor car quality) also available

Please enclose cheque or P.O. for total amount to:

**YUKAN · DEPT. PE/9 · 307a EDWARE ROAD · LONDON · W.2**

Closed Thurs. afternoons

## TECHNICAL TRADING Co.

All items previously advertised available, also see items advertised in Practical Wireless. Huge Hi-Fi and Components stocks at all branches.

TAPE		Top British mylar/P.V.C.	
Standard Play		Double Play	
3" 150ft. 2/8	3" 300ft. 4/-	4" 600ft. 15/-	4" 1200ft. 27/-
4" 300ft. 4/6	5" 600ft. 7/6	5" 1200ft. 12/6	5" 2400ft. 27/-
5" 900ft. 10/6	5" 1800ft. 19/6		
7" 1200ft. 13/6			
Long Play		Triple Play	
3" 225ft. 2/9	4" 900ft. 12/-	5" 1800ft. 24/-	5" 2400ft. 34/-
4" 450ft. 5/6	5" 900ft. 10/8	5" 1800ft. 17/6	5" 3600ft. 44/-
5" 900ft. 10/8	5" 1800ft. 18/-		
5" 1200ft. 13/6	5" 1800ft. 18/6	Quadruple Play	
		3" 600ft. 8/-	

Post 1/-

10 TOTTENHAM COURT RD., LONDON, W.1. Tel: MUS 2639  
350/352 FRATTON RD., PORTSMOUTH. Tel: 22034  
72 EAST STREET, SOUTHAMPTON. Tel: 25851  
ALL MAIL ORDER AND RETAIL SHOP

**PARK CRESCENT PLACE, BRIGHTON**

# VALUABLE NEW HANDBOOK FREE TO AMBITIOUS ENGINEERS

Have you had your copy of "Engineering Opportunities"?

The new edition of "ENGINEERING OPPORTUNITIES" is now available—without charge—to all who are anxious for a worthwhile post in Engineering. Frank, informative and completely up to date, the new "ENGINEERING OPPORTUNITIES" should be in the hands of every person engaged in any branch of the Engineering industry, irrespective of age, experience or training.

## On 'SATISFACTION OR REFUND OF FEE' terms

This remarkable book gives details of examinations and courses in every branch of Engineering, Building, etc., outlines the openings available and describes our Special Appointments Department.

### WHICH OF THESE IS YOUR PET SUBJECT?

**MECH. ENGINEERING**  
Gen. Mech. Eng.—Maintenance Eng.—Diesel Eng.—Press Tool Design—Sheet Metal Work—Welding—Eng. Pattern Making—Inspection—Draughtsmanship—Metallurgy—Production Eng.

**RADIO ENGINEERING**  
General Radio—Radio & TV Servicing—TV Eng.—Telecommunications—Electronics—Sound Recording—Automation—Practical Radio—Radio Amateurs' Exam.

**CIVIL ENGINEERING**  
General Civil Eng.—Municipal Eng.—Structural Eng.—Sanitary Eng.—Road Eng.—Hydraulics—Mining—Water Supply—Petrol Tech.

**ELEC. ENGINEERING**  
General Electrical Eng.—Installations—Draughtsmanship—Illuminating Eng.—Refrigeration—Elem. Elec. Science—Elec. Supply—Mining Elec. Eng.

**AUTO ENGINEERING**  
General Auto Eng.—Auto. Maintenance—Repair—Auto. Diesel Maintenance—Auto. Electrical Equipment—Garage Management.

**BUILDING**  
General Building—Heating & Ventilation—Plumbing—Architecture—Carpentry—Painting—Decorating—Specifications & Quantities—Surveying—Architectural Draughtsmanship.

WE HAVE A WIDE RANGE OF COURSES IN OTHER SUBJECTS INCLUDING CHEMICAL ENG., AERO ENG., MANAGEMENT, INSTRUMENT TECHNOLOGY, WORKS STUDY, MATHEMATICS, ETC.

Which qualification would increase your earning power?  
A.M.I.Mech.E., A.M.S.E., A.M.I.C.E., A.M.I.E.R.E., B.Sc.,  
A.M.I.P.E., A.M.I.M.I., A.R.I.B.A., A.I.O.B., A.M.I.Chem.E., A.R.I.C.S.,  
M.R.S.H., A.M.I.E.D., A.M.I.Mun.E., CITY & GUILDS, GEN. CERT. OF  
EDUCATION, ETC.

BRITISH INSTITUTE OF ENGINEERING TECHNOLOGY  
316A COLLEGE HOUSE, 29-31 WRIGHT'S LANE, W.8

### THIS BOOK TELLS YOU

- ★ HOW to get a better paid, more interesting job.
- ★ HOW to qualify for rapid promotion.
- ★ HOW to put some letters after your name and become a key man . . . quickly and easily.
- ★ HOW to benefit from our free Advisory and Appointments Depts.
- ★ HOW you can take advantage of the chances you are now missing.
- ★ HOW, irrespective of your age, education or experience, YOU can succeed in any branch of Engineering.

156 PAGES OF EXPERT CAREER - GUIDANCE

#### PRACTICAL EQUIPMENT

Basic Practical and Theoretic Courses for beginners in Radio, T.V., Electronics, Etc., A.M.I.E.R.E., City & Guilds Radio Amateurs' Exam. R.T.E.B. Certificate P.M.G. Certificate Practical Radio Radio & Television Servicing Practical Electronics Electronics Engineering Automation

#### INCLUDING TOOLS

The specialist Electronic Division of B.I.E.T. NOW offers you a real laboratory training at home with practical equipment. Ask for details.

### B.I.E.T.

You are bound to benefit from reading "ENGINEERING OPPORTUNITIES", and if you are earning less than £30 a week you should send for your copy now—FREE and without obligation.

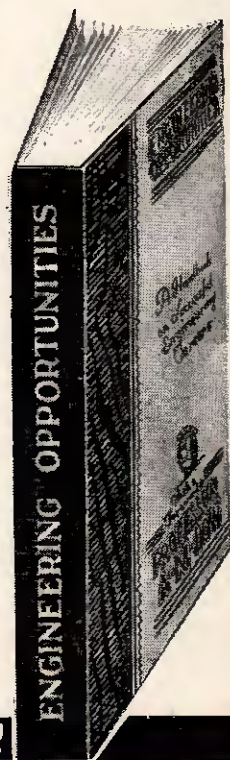

## POST NOW!

TO B.I.E.T., 316A COLLEGE HOUSE,  
29-31 WRIGHT'S LANE, W.8.

3d. stamp if posted in  
an unsealed envelope.

Please send me a FREE copy of "ENGINEERING OPPORTUNITIES." I am interested in (state subject, exam., or career).

NAME .....

ADDRESS .....

WRITE IF YOU PREFER NOT TO CUT THIS PAGE

**THE B.I.E.T. IS THE LEADING INSTITUTE OF ITS KIND IN THE WORLD**

Published about the 15th of the month by GEORGE NEWNES LIMITED, Tower House, Southampton Street, London, W.C.2. Printed in England by THE CHAPEL RIVER PRESS, Andover, Hants. Sole Agents for Australia and New Zealand: GORDON & GOTCH (A/asia) Ltd.; South Africa and Rhodesia: CENTRAL NEWS AGENCY LTD.; East Africa: STATIONERY & OFFICE SUPPLIES LTD. Subscription rate including postage for one year: To any part of the World £1 16. 0.

PRICE REDUCTIONS FOR MANY ITEMS THIS MONTH



(6)

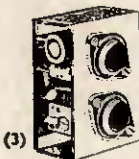

(3)



(2)

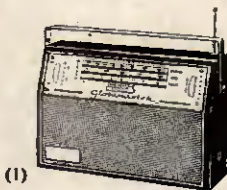

(1)



(8)



(16)

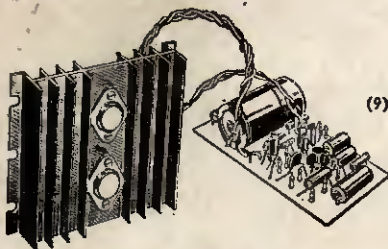

(9)



(10)



(12)



(7)

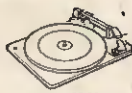

(11)



(14)



(5)

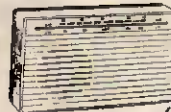

(13)



(15)

LET US QUOTE FOR COMPONENTS AND EQUIPMENT FOR YOUR CIRCUIT

SILICON CONTROLLED RECTIFIERS

THYRISTORS } 100 PIV. 1 Amp 7/6  
 100 PIV. 3 Amp 10/6  
 400 PIV. 7 Amp 25/-  
 NEW 14-PAGE TRANSISTOR/RECTIFIER CATALOGUE NOW READY. MANY NEW DEVICES—PLENTY OF PRICE REDUCTIONS. Send 3d. stamp for free copy.

WE CAN SUPPLY FROM STOCK MOST OF THE PARTS SPECIFIED ON CIRCUITS IN THIS MAGAZINE. SEND LIST FOR QUOTATION. ASK FOR NEW 4-PAGE CATALOGUE SUPPLEMENT ALSO LIST OF SPECIAL HI-FI COMBINATIONS.

1966 CATALOGUE

Fully detailed and illustrated. 150 pages of components, equipment, etc. Over 5,000 stock items. PRICE 6/-, post paid. Free discount vouchers with every catalogue.



(1) GLOBEMASTER MW/LW/SW PORTABLE RADIO TO BUILD

Special purchase reduces price Full 3-waveband tuning. Pushbutton wavechange. Superhet printed circuit. Black-chromed cabinet 11 x 7 1/2 x 3 1/2 in. (SW 17-50 metres). Ear/Record sockets.

TOTAL COST £7.19.6 P.P. 3/6. TO BUILD

(5) TOURMASTER CAR RADIO

7-Transistor MW/LW Car Radio. 12 volt operated. 3 watt output. Pushbutton wavechange. RF stage. Supplied built, boxed, ready to use with Speaker and Baffle. Car fixing kit and manufacturers' current guarantee. Special Bargain Offer. Buy Now!

PRICE £9.9.0 P.P. 3/6

10 AND 20 WATT MONO AND STEREO TRANSISTOR AMPLIFIERS

(9) POWER AMPLIFIERS. 10 watts RMS output. 100mV input. 30 c/s to 20kc/s ±1dB. 6-Transistor Push-pull. Panel size 4 x 2 1/2 x 1 1/2 in. H/S 4 x 4 in. TPA10/15 12-16 ohm spkr. £5.5.0, p.p. 2/6 (Mains unit for 1 or 2 amplifiers, 5/9/6, p.p. 2/6)

(10) PREAMPLIFIERS. 8 input selector. Treble, bass, volume, filter-controls. 15mV to 300mV inputs. Battery operated or from Mains Unit. Output up to 150mV RMS.

MP2 Mono 9 1/2 x 2 1/2 x 2 in. £5.10.0, p.p. 2/6 (brown and gold front panel 8/6)

SP4 Mono/Stereo, 9 x 3 1/2 x 1 1/2 in. £10.19.6, p.p. 3/6 (front panel plate 12/6)

The Finest High Fidelity at Unbeatable Prices

(8) BUILD A QUALITY TAPE RECORDER

Three speeds—3 watts. Complete kits with new "363" decks. Supplied as preassembled sections. Complete with portable cabinets and Speaker—excellent quality, 7" 1,200ft. tape and spool and Acos 45 microphone. 2 track 10 gns. 4 track £13.10.0, P.P. 5/- "363" decks with tape and Acos mic.

(3) 5 WATT AMPLIFIER

6-Transistor Push-pull, 3 ohms. 6mV into 1k. 12/18V supply. 2 1/2 x 2 x 1 1/2 in. BUILT AND TESTED 6/9/6 P.P. (optional mains units 54/-) 2 1/2-watt version 5/9/6. New matching Preamplifier, 6 inputs, treble/bass/selector/volume controls. 6-10mV o/put. 9-18V supply. 7/9/6, p.p. 2/- For use with any Transistor Amplifier

★ TWO TRACK ★ FOUR TRACK

£26 P.P. 8/6 £30 P.P. 9/6

DEAC CHARGER

To charge 3-6 volt and 9-6 volt packs. Fully mains isolated in moulded case. 45/- P.P. 2/-

(13) REGENT-6 MW/LW POCKET RADIO TO BUILD

6-Transistor superhet. Geared tuning. Push-pull output. Moulded cabinet 5 x 3 x 1 1/4 in. Phone socket. TOTAL COST 6/9/6 P.P. TO BUILD 2/- Special purchase reduces price

(15) HI-FI EQUIPMENT

Special parcel prices. Let us have your enquiries for equipment. See catalogue for complete range.

(6) 25 WATT AMPLIFIER

New 8-Transistor design. Push-pull output for 7 1/2 to 16ohm speaker. 150mV input. 30c/s to 20kc/s ±1dB. For use with valve or transistor preamplifiers as item (10) above. Size 2 1/2 x 2 1/2 x 6 1/2 in. PRICE BUILT AND TESTED £7.19.6 P.P. TO BUILD 3/- (Mains unit 7/9/6, p.p. 2/6)

(4) DEAC CELLS

RECHARGEABLE BATTERIES ● 3-6 volt 500 mA/H. Size: 1 1/2 x 1 1/4 dia. . . 12/6, p.p. 1/6 ● 9-6 volt 225 mA/H. Size: 2 1/4 x 1 1/4 dia. . . 20/-, p.p. 1/6 BRAND NEW Offered at a fraction of normal retail price.

(16) VHF FM TUNER TO BUILD

87/105 Mc/s Transistor Superhet. Geared tuning. Terrific quality and sensitivity. For valve or transistor amplifiers. 4 x 3 1/2 x 2 1/2 in.

TOTAL COST £6.19.6 P.P. TO BUILD 2/6 (Cabinet Assembly 20/- extra)

(11) GARRARD DECKS

(p.p. 5/- any type) 1000 mono £5.19.6. stereo £6. 6.0 2000 mono £6. 6.0. stereo £6. 6.0 \*SP25 mono £10.10.0. stereo £10.19.6 AT5 mono £6. 6.0. stereo £6. 6.0 \*AT6 mono £8.19.6. stereo £9.10.0 \*AT60 mono £10.10.0. stereo £10.19.6 3000LM stereo £8.8.0

(12) MULTI-METERS

PT34 1kV 39/6 TP55 20kV £5.19.6 MI 2kV 49/6 EP30k 30kV £6.10.0 TP10 2kV 75/- EP50k 50kV £8.15.0 EP10k 10kV 79/6 500 30kV £8.17.6 ITI-2 20kV 69/6 EP100k 100kV £10.10.0 EP20k 10kV 99/6

(\*Deram cartridge add 60/- to mono price). All autochange (except SP25), complete with cartridge. Brand new. Latest complete list on request.

(7) VHF FM TUNER

Supplied as 2 Preassembled Panels, plus metal work Superhet design, 88-108 Mc/s, 9 volt operated. Total cost to assemble £12.17.6, p.p. 2/6.

(14) MW/LW QUALITY TRANSISTOR RADIO TUNER

Fully tunable superhet with excellent sensitivity and selectivity. Output up to 1/2 volt peak. Complete with front panel, etc. 9 volt operated. For use with any amplifier or tape recorder. TOTAL COST £3.19.6 P.P. TO BUILD 2/6

HENRY'S RADIO LTD.

303 EDGWARE RD., LONDON, W.2 PADDINGTON 1008/9 Open Mon. to Sat. 9-6. Thurs. 1 p.m. Open all day Saturday.

(2) NOMBREX TEST UNITS

\*150 kc/s—350 m/c/s RF Generator £9.10.0 All Transistor \*10 c/s—100 kc/s Transistor Audio Generator £16.15.0