

Practical Electronics

MARCH 1966

PRICE 2'6



**SPECIAL
ISSUE**

- * **HOW TO MAKE PRINTED CIRCUITS**
- * **BONANZA BOARD PROJECTS**

ADCOLA
PRODUCTS LIMITED
(Regd. Trade Mark)

**SOLDERING
EQUIPMENT**

Preferred by Experts

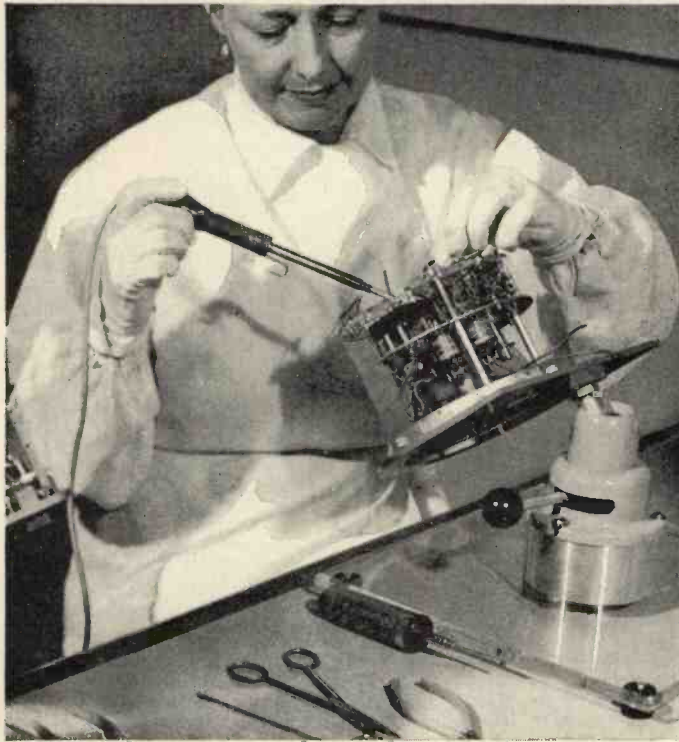

Photograph by the courtesy of Submarine Cables Ltd.

FOR SALES & SERVICE APPLY DIRECT TO:

**ADCOLA PRODUCTS LTD.
ADCOLA HOUSE
GAUDEN ROAD
LONDON, S.W.4**

**TELEPHONE:
MACAULAY 4272 & 3101**

**TELEGRAMS:
SOLJOINT, LONDON S.W.4**

VALUE IN VALVES

GUARANTEED 3 MONTHS BY RETURN OF POST

Satisfaction or Money Back Guarantee on goods if returned unused within 14 days. ALL VALVES ARE NEW UNLESS OTHERWISE INFORMED. FREE TRANSIT INSURANCE. POSTAGE 1 valve 9d., 2-11 1/3. Free over 12.

OZ4	4/8	8K80T	8/3	1487	14/8	EB41	6/3	EZ40	6/6	FZ30	9/8
1A7GT	8/6	8K25	8/6	19A45	7/9	EB51	5/9	EZ41	5/9	F219	9/8
IC6GT	7/6	8L1	9/6	20D1	8/8	EBF80	7/8	EZ80	5/9	SP41	2/3
1H5GT	8/9	8L6	7/6	20F2	9/6	EBF89	7/8	EZ81	6/-	SP61	2/3
1N6GT	8/9	8L6G	9/6	20L1	16/-	EBL21	9/9	FC4	8/-	T41	6/9
1B5	4/9	8L18	7/9	20P1	9/6	EBL31	19/6	GZ32	7/6	TD44	7/9
1B8	7/8	8L19	12/6	20P3	11/-	EC32	4/9	KT39	3/9	U14	7/6
2D2T	3/8	8LD20	7/9	20P4	17/-	EC32	4/-	KT38	14/-	U18	7/6
3A4	4/-	8P28	6/8	25A6G	8/-	EC34	9/-	KT44	6/-	U22	6/9
3A5	6/-	8P28	9/9	25L6GT	7/9	EC40	6/9	KT45	8/6	U24	12/6
3D6	4/-	8Q7G	4/-	25Z4G	7/-	EC81	4/9	KT61	8/6	U25	8/3
3Q4	5/-	8Q7GT	8/-	30F5	6/-	EC82	4/9	KT63	5/9	U28	7/-
6BA4G	8/9	88A7	5/9	30FL1	9/6	EC83	5/9	KT66	13/-	U28	12/6
5U4G	4/-	88G7	4/9	30L15	8/9	EC84	7/8	KT76	9/6	U50	4/6
5Y3G	4/8	88K7	5/-	30P4	9/6	EC85	6/-	KT88	13/6	U107	12/6
5Y3GT	4/-	88L7GT	5/8	30P12	7/-	EC88	9/8	KTW81	5/9	U181	9/6
5Z4	9/-	88N7GT	4/6	30PL1	9/3	ECF90	6/-	KTW63	5/-	U281	9/6
5Z4G	7/-	88Q7	5/9	35C5	8/8	ECF82	8/3	KTZ63	7/-	U282	15/6
5Z4GT	9/8	8D4GT	8/-	35L6GT	8/-	ECH21	11/6	MU14	7/-	U301	12/6
6B0L2	9/8	8V6	4/6	35W4	6/-	ECH35	7/8	N37	10/8	U329	8/6
6AG5	7/9	8Y8GT	8/-	35Z4GT	5/8	ECH42	8/8	N78	13/-	U301	19/9
6AK5	4/3	8Y8	4/6	50L6GT	8/8	ECH51	7/8	N108	13/6	UA8C90	7/-
6A45	5/-	8X5G	5/-	80	5/-	ECH83	6/3	PC86	10/-	UAF42	7/6
6AT6	5/-	8X5GT	5/6	185BT	19/8	ECL80	6/8	PC97	7/8	UB41	6/6
6A08	7/-	7B6	9/-	185BTA	19/8	ECL82	8/-	PC84	6/8	UBC41	7/6
6AV6	6/-	7B7	5/6	807	7/6	ECL83	10/8	PC85	8/8	UBC81	6/6
6E4A	5/6	7C5	7/8	813	4/9	ECL88	10/8	PC88	11/8	UBF90	7/9
6E8E	5/6	7C6	7/8	866A	2/8	EP36	3/-	PC89	9/8	UBF99	7/9
6G8G8	15/-	7E7	7/8	874	3/8	EP39	3/8	PC139	13/8	UC82	7/8
6BH6	5/-	787	14/8	955	2/8	EP40	11/-	PCF80	9/9	UC92	7/9
6B16	5/-	7Y4	4/8	956	2/-	EP41	3/-	PCF82	6/-	UC98	7/8
6B27	8/8	10C1	9/-	9001	3/8	EP50	3/3	PCF84	12/-	UCF90	8/8
6B9E	6/9	10C2	14/6	9002	4/9	EP80	3/8	PCF86	7/8	UCHE1	9/8
6B9W7	5/-	10F1	4/9	9003	5/8	EP86	6/-	PCL82	7/8	UCHE9	7/8
6C4	3/3	10LD11	14/6	ATP4	2/6	EPL35	6/-	PCL83	7/8	UCHE11	7/9
6C5	5/6	10P13	8/6	AZ31	6/-	EPF9	6/9	PC184	7/8	UC82	8/-
6C8	5/6	10P14	8/6	AZ41	7/-	EPF1	3/-	PCL85	7/8	UC183	10/-
6C9	11/-	12A17	7/-	B36	4/8	EPF2	3/-	PCL86	10/8	UF41	6/8
6CD6G	17/-	12A18	9/-	CB131	19/8	EPF2	3/-	PCN25	8/9	UP42	4/8
6D6	3/-	12A76	6/8	CL33	9/-	EPF13	9/9	PCN45	8/8	UP80	6/8
6F1	4/9	12A77	4/8	CY31	7/6	EPF14	9/8	PCN46	4/8	UP85	7/8
6F6G	3/8	12A78	8/-	DAF4	4/6	EPL33	6/8	PL36	3/8	UP89	5/8
6F13	4/8	12A79	3/9	DAF8	7/8	EPL36	6/8	PL38	9/8	UL41	7/8
6F14	9/8	12A76	6/8	DF91	3/8	EL34	11/6	PL38	17/8	UL44	14/-
6F15	9/8	12A77	6/8	DF92	3/8	EL35	6/-	PL81	7/8	UL46	8/3
6F23	6/8	12BA6	7/-	DF96	7/8	EL38	12/8	PL82	6/8	UL84	7/-
6J5G	3/-	12BE6	6/8	DK91	5/8	EL41	8/-	PL83	6/8	UR10	7/8
6J6GT	4/8	12B77	8/9	DK92	7/-	EL42	7/9	PL84	7/8	UR80	9/8
6J6	2/6	12E1	17/8	DK96	7/8	EL84	6/6	PY31	8/-	UB8	11/-
6J7G	4/9	12I7GT	8/-	DL92	5/-	EM34	8/8	PY32	9/8	VP41	5/8
6J7G	7/8	12K7GT	4/-	DL94	6/8	EM50	7/9	PY33	9/8	UY21	9/8
6K8GT	8/-	12K8	8/9	DL96	7/8	EM61	6/9	PY80	6/8	UY41	6/-
6K7	5/9	12K8GT	8/8	EABC80	8/8	EM84	8/9	PY81	5/9	UY85	5/8
6K7G	4/-	12Q7GT	8/-	EAFA2	3/3	EM86	8/8	PY82	5/9	VE105	5/8
6K8GT	8/8	12SA7	6/8	EB41	5/-	EY81	7/8	PY83	8/9	VE150	7/9
6K8	8/8	12SK7	2/9	EB81	2/-	EY86	7/3	PY88	9/-	X66	7/9
6K9G	5/-	12SQ7	7/8	EB83	4/9	EY88	8/8	PY90	6/3	Z66	8/8

TUBES

SATISFACTION GUARANTEED

Carr. & Ins. 12/6			6 Months	12 Months	NEW TYPES
MOST MULLARD, MAZDA, COSSOR, EMITRON, EMI-SCOPE, BRINAR, FERRENTI TYPES, PROCORBED IN OUR OWN FACTORY	12in.	£2. 0. 0	£3. 0. 0	AW47-91	
	14in.	£2. 10. 0	£3. 10. 0	£5. 15. 0	
	15-17in.	£3. 5. 0	£4. 5. 0	AW50-81	
	19in.	£3. 5. 0	£4. 5. 0	£7. 10. 0	
	21in.	£3. 15. 0	£5. 15. 0	AW43-80	
	23in.	£3. 15. 0	£5. 15. 0	£5. 5. 0	

RECORD DECKS LATEST GARRARD

All Factory Fresh. All with cartridge.

Stereo cartridges fitted for 17/6 extra.

SRP15 Mono (Single) Player	44/19/-
SP25 Semi-Transcription (Single)	£11/19/-
AUTOBLIM Standard Auto.	£5/19/-
AT5 Slimline—similar to AT6	27 15/-
Model 1,000—chucker, 10 records	£6 19/-
Model 3,000—large turntable	£7/19/-
Model 3,000—wear	£10/19/-
AT60	£11/19/-
A70—Automatic	£27/19/-
LAB90—Transcription	£19/19/-
401—Transcription	£29/19/-
Model 80—Automatic	£9/19/-

B.S.R.

TU1—Single player	59/-
GU7—Single Deck Complete	£4/5/-
UA16—Auto Changer	£4/17/6
UA16—Blue-silver	£5/10/0
UA25—Super 8mm	£5/15/0

F.M. TUNER HEADS

Famous make covering Band II. Standard I.P. frequency output. Complete with drive coil and ECC85 valve 29/-.

HITACHI PORTABLE TAPE RECORDER

Latest Hitachi. Fabulous quality and reproduction of music. 6-transistor. 1 1/2in. and 3 1/2in. speeds. Output 500 mW into high quality speaker. Ingenious single control knob. Fast forward and rewind. Battery level and record level meter. Fast load. Precision capstan drive with dynamic earpiece monitor recording. Radio recording leads. Outstanding speaker facilities. The most outstanding portable in the country. Size 8 1/2 x 3 1/2 x 6 1/2 in. Genuine normal price of 35 gns. Unrepeatable. 12 months' guarantee. All spares available. With tape, take **19 Gns.**

HITACHI 4 TRACK MODEL TRA-505

This superb 48 gns. recording machine is on limited very special offer. Two channel recording. Plays stereo tapes. 1 1/2in. and 3 1/2in. per sec. One track can be listened to on an earphone whilst recording on the second track, and thereafter both tracks played simultaneously through the loudspeaker. Ideal for languages, singing to music, etc. Excellent reproduction through high-flux elliptical speaker. A.C. erase. Dimensions: 1 1/2 x 1 1/2 x 5 1/2 in. Weight 12 lb. Dynamic mike. Sound level meter. Postage indicator. Two mixed inputs. **29 Gns.**

100 HI-STABS 9/6

1% to 5% 100Ω to 5MΩ. CO-AX, low loss, 6d. yds. 1/6; 50 yds. 22/-; 100 yds. 42/6. Co-ax Plugs, 1/3. Wall outlet boxes 3/6.

100 RESISTORS 6/6

Excellent. Sizes 1/3 watt.

HITACHI XM1002 AM/FM RADIOS

Unusual opportunity to purchase the up-to-the-minute wonderfully guaranteed 10-transistor with full long and medium waves. Size 9 1/2 x 6 1/2 x 1 1/2 in. Magnificent reproduction. 12 months' guarantee against faulty manufacture. Genuine retail price £28.75. Unrepeatable. **176ns.**

ANNOUNCEMENT

CUSTOMERS WELCOMED AT OUR

NEW BRANCH

OPEN AT 10 TOTTENHAM COURT ROAD LONDON, W.1

TRANSISTORS

GUARANTEED TOP QUALITY

Huge reduction. Red Spot standard LF type now only **1/6**

White Spot B.P. **2/-**

Mullard Matched Output Kits OC81D and 2-OC61 **12/6**

R.F. Kits OC44, OC45 (2) **12/6**

AF114	8/-	OC44	5/6
AF115	7/6	OC45	5/6
AF116	7/6	OC72	5/6
AF117	6/-	OC81	5/6
AF127	7/6	OC81D	5/6
OC26	9/-	OC82	6/-
OC36	14/-	OC170	8/6
		OC171	8/6

GERMANIUM DIODES

General Purpose miniature detector A.V.C. etc. **8d.**

Gold Bonded highest quality Individually tested. **1/-**

9/8 doz. **1/-**

SILICON RECTIFIERS

Guaranteed performance. Top makes. Tested 250 v., working. **7/6**

120 ma. **3/9** 500 ma. **4/6**

(3 for 8/6) (3 for 19/6)

CRM141. CRM142. Special bulk purchase enables us to offer these tubes at this low price (carr. 9/-). **39/-**

BASE SPEAKERS

25 WATT. Very heavy cone 12in. cast chassis. There is nothing to touch it for power handling and **£4.19.0**

quality at the price

Plus 5/- p.p.

CONNECTING WIRE

P.V.C. Bright Colours. Five 25ft. coils only. **4/-**

EXCELLENT FOR ANY TAPE RECORDER. PRICES REDUCED BY ENORMOUS PURCHASE. GUARANTEED. APPROX. HALF PRICE. WORLD FAMOUS MAKE.

★ TAPE ★

We offer you fully tensioned polyester/mylar and P.V.C. tapes of identical quality hi-fi, wide range recording characteristics as top grade tapes. Quality control manufacture. Not sub-standard in any way. They are truly worth a few more coppers than acetate, sub-standard, jointed or cheap imports. TRY ONE AND PROVE IT YOURSELF!

Standard Play		Double Play		
3in. 1500ft.	2/8	3in. 3000ft.	4/8	
4in. 3000ft.	7/6	4in. 6000ft.	8/6	
5in. 6000ft.	7/6	5in. 1,200ft.	18/6	
5 1/2in. 9000ft.	10/6	5 1/2in. 1,800ft.	19 6	
7in. 1,200ft.	18/6	7in. 2,400ft.	37/6	
Long Play Triple Play				
3in. 225ft.	2/9	4in. 900ft.	13/6	
4in. 450ft.	5/6	5in. 1,800ft.	25/6	
5in. 900ft.	10/6	5 1/2in. 2,400ft.	34/6	
5 1/2in. 1,200ft.	13/6	7in. 3,600ft.	44/6	
7in. 1,800ft.	18/6	Quadraple Play	3in. 600ft.	8/6

Postage 1/- or Post Free less 5% on three reels.

Quantity and Trade enquiries invited.

STEREO PORTABLE CABINETS

Latest black and silver metal finish. Consisting of centre cabinet size 18 1/2 in. x 13 1/2 in. x 8 in. deep with lift up lid together with two 10 x 6 speaker cabinets which clip on ends of main cabinet size 4 1/2 in x 13 1/2 in. x 8 in. making overall size of 25 1/2 in. x 13 1/2 in. x 8 in. High quality chrome fittings. Will take almost any autochanger or tape deck. Approx. half price at **£3.19.0**

MICROPHONE CABLE

Highest quality black, grey, white, 1/2-yard.

DULCI(VHF) FM TUNERS

MODEL FMT/8. Self powered 200/250 v. A.C. A.P.C. High sensitivity for fringe and long distance reception. Size 1 1/2 x 3 1/2 x 3 1/2 in. high. Weight 7 1/2 lb. In case finished in satin chrome and black. Due to fortunate purchase we can offer these high fidelity instruments. Normally £21/13/6. Limited number only at **15 Gns.**

ARMSTRONG EQUIPMENT. Stocked at all branches.

LOUDSPEAKERS. 30 Top Makers. 6 1/2in. **7/6** 5in. **8/6** 7 x 4in. **8/6**

MAINS TRANSFORMERS

Excellent Quality Guaranteed Upright mounting 250 v., 60mA. **9/6**

6.3 v. 3 A. Primary 230 v.

TRANS/CEIVERS

TYPE RT35. The very latest Silver/Black finish. They give an excellent performance with reliability, long telecopic, aerial, crystal controlled. Note, a licence is required to transmit. They compare with much dearer models. 2/6 p.p. **£8.19.0**

100 CONDENSERS 9/6

Miniature Ceramic and Silver Mica Condensers, 3pF to 5,000 pF. LIST VALUE OVER 25.

10 x 5in. SPEAKERS

High Flux "pancake" magnets. Hammered gold finish. Most excellent reproduction 3d. **25/-**

TECHNICAL TRADING CO.

FOR — IMMEDIATE — DESPATCH — PHONE — US — TODAY

DE LUXE RECORD PLAYER KITS

4-Speed Players 2-tone Cabinets 17" x 15" x 8 1/2". High class loudspeakers and with Famous Make Amplifier ready built. Quality output. Volume and Bass controls. All items fit together perfectly. Special instructions enable assembly in 30 minutes, only 5 wires to join 12 months' guarantee.



TO BUILD YOURSELF

Absolutely complete as above with:
B.S.R. GUY Simple Play £9/19/6 P.P. 7/6
B.S.R. Monarch Autochange £10/19/6 P.P. 7/6
Garrard "1000" Autograph £11/19/6 P.P. 7/6
Garrard Model 50 £12.10.0; **AT80** £14.15.0. P.P. 7/6

OR AVAILABLE SEPARATELY
 Cabinet with board out to choice £3/9/6 P.P. 5/6
 Amplifier with speaker £3/12/6 P.P. 3/6
AUTOCHANGERS (Stereo 10/- extra)
B.S.R. UA25 or UA14 Mono 25/19/6 P.P. 3/6
Garrard "1000" Mono 26/10/- P.P. 3/6
Garrard AT50 Mono £8.10.0; AT80 Mono £10.10.0 P.P. 5/6
SOLE PLAYERS B.S.R. Junior 23/7/6 P.P. 2/6
B.S.R. GUY Auto Stop Start £4/17/6 P.P. 2/6
GARRARD SRP12 Auto Stop Start £4/17/6 P.P. 2/6
TRANSCRIPTION Garrard SP25 £11/0/0 P.P. 6/6
Garrard A70 £21; LAB80 £25; 401 £30 P.P. 5/6 each

Q MAX CHASSIS CUTTER

Complete: a die, a punch, an Allen screw and key
 1/2 in. 14/6 1 1/8 in. 18/- 1 1/2 in. 22/6
 1 3/8 in. 14/9 1 3/4 in. 18/- 2 in. 34/9
 1 1/2 in. 15/6 1 3/4 in. 18/6 2 1/8 in. 37/3
 1 3/4 in. 15/9 1 1/2 in. 20/- 2 1/4 in. 44/3
 1 1/2 in. 18/- 1 1/2 in. 20/6 1 in. sq. 31/6

CRYSTAL MIKE INSERTS

1 1/2 x 1/2 in. 6/6; BM3 1 x 1/2 in. 7/6; ACOS 1 1/2 x 1/2 in. 8/6
TANNOY CARBON MIKE with Switch 5/8
BARGAIN XTAL PICK-UP ARM Complete with ACOS LP-78 Turnover Head and Stylus 120/- Stereo 30/-
SPEAKER FRET Tygan various colours, 52in. wide, from 10/- ft.; 26in. wide from 5/- ft. Samples 3 A.E.
EXPANDED METAL Gold or Silver 12 x 12 in. 6/-

FULL WAVE BRIDGE SELENIUM RECTIFIERS: 2, 6 or 12 v. outputs, 1 1/2 amp.; 8/9; 2 a. 11/3; 4 a., 17/6.
CHARGER TRANSFORMERS: Tapped input 200/250 v. for charging at 2, 6 or 12 v. 1 1/2 amps., 15/8; 2 amps., 17/6; 4 amps., 25/- Circuit included. Amp meter 5 amp. 10/6.

MOVING COIL MULTIMETER TK 20s.

0-1,000v. A.C./D.C., ohms 0 to 100k. etc., 47/6.
MOVING COIL MULTIMETER EP10K.
 0-1,000v. A.C./D.C., ohms 0 to 3 meg. etc., 79/6.
MOVING COIL MULTIMETER EP20K.
 0-2,500v. L.C. 20,000 ohms per volt. 0-1,000v. A.C. Ohms 0-6 meg. 50 Microamps. 99/6.

NEW MULLARD TRANSISTORS

OC71 6/-; OC72 7/6; OC8D 7/6; OC81 7/6; AP115 10/6; AF114 11/-; OC44 8/-; OC45 8/-; OC171 9/-; OC170 8/6; AP117 9/6. OC28 12/6; Transistor Holders 1/3.

VALVE HOLDERS. EA50 6d. MOULDED Int. Oct. 6d. Mazda Oct. 6d.; B7G, B8A, B8G, B9A, 9d.; B7G with kn. 18d. B9A with kn. 18s. Ceramic OCTAL, EP50, B7G, B8A, 1/- Valve base plugs B7G, EA9, Int. Oct., 2/3.

TRANSISTOR MAINS ELIMINATORS 29/6

PP1-6 volt, PP9-9 volt (All same sizes as batteries) 80 mA. DOUBLES 42/6. PP1+PP1, PP9+PP9, PP11+4+4. POWER PACK 9v. 300 mA. Full wave. Fully smoothed. Tapped mains input. Chassis size 5 x 4 x 2 in. 45/-

WEYRAD P50 - Transistor Coils

RA2W 6 in. Ferrite Aerial with Spare Cores 6d.
 Osc. P50/1AC 12/6
 Osc. P50/1AC 5/4
 1st and 2nd I.F. P50/2C 9/6
 470 kc/s each 5/7
 3rd I.F. P50/3C 6/-

Volume Controls 80 Ohm CABLE COAX

Long spindles. Midget Size 5 K. ohms to 2 Meg. LOG or L/R 3/-; D.P. 5/-; Stereo L/S 10/6, D.P. 14/6. Linear or Log Tracks.
COAXIAL PLUG 1/-. PANEL SOCKETS 1/-; LINE SOCKETS 2/-; OUTLET BOXES, SURFACE OR ETHER 4/6.
BALANCED TWIN FEEDERS 6d. yd., 80 or 300 ohms.
TWIN SCREENED FEEDER 1/8 yd., 80 ohms.
TELESCOPIC OHMME AERIALS. 12in. extends to 33in. 6/6 each. CAR AERIAL PLUGS 1/6. Sockets 1/3.

NEW ELECTROLYTICS FAMOUS MAKES

TUBULAR	TUBULAR	CAN TYPES
2/350 v. 2/3	100/25 v. 2/-	8/800 v. 9/-
4/350 v. 2/3	250/25 v. 2/8	16/800 v. 12/-
5/450 v. 2/3	500/15 v. 3/-	18+18/800 v. 7/6
16/450 v. 3/6	8+8/45 v. 3/8	32+32/450 v. 6/-
32/450 v. 4/9	8+16/45 v. 3/9	50+50/350 v. 7/-
25/25 v. 1/9	16+16/450 v. 4/3	64+120/350 v. 11/6
50/50 v. 2/-	32+32/350 v. 4/6	100+200/275 v. 12/6

PAPER TUBULARS

350v.-0.1 9d., 0.5 1/9; 1 mid. 3/-; 2 mid. 150v. 3/-.
 500v.-0.001 to 0.05 9d.; 0.1 1/-; 0.25 1/6; 0.5 2/6.
 1,000v.-0.001, 0.002, 0.0047, 0.01, 0.02, 1/8; 0.047, 0.1 2/-;
 0.22, 0.47, 3/-; 2,000v.-0.005, 0.01, 0.02 2/8; 0.05 3/8.
PAPER CONDENSERS. 0.001mid., 7kV. 6/6; 20kV. 10/6.

SUB-MIN. ELECTROLYTICS. 1, 2, 4, 5, 8, 16, 25, 30, 50, 100, 500, 1,000 mfd. 15v. 2/6; 1,000 mfd. 50v. 7/6; 2,000/50 11/8.
CERAMIC. 500 v. 1 pF. to 0.01 mfd., 9d. DISC CERAMICS 1/-.
PULSE CERAMICS 10 pF. to 180 pF., 12 kV., 2/6.
SILVER MICA. Close tolerance (plus or minus pF.). 5 to 47 pF., 1/-; ditto 1% 50 to 800 pF., 1/-; 1,000 to 5,000 pF., 2/-.
TWIN GANG. "0-0" 208 pF. + 176 pF., 10/8; 385 pF., miniature 10/-; 500 pF. standard with trimmers, 9/-; midget, 7/6; midget with trimmers, 9/-; 500 pF. slow motion, standard 9/-; small 3-gang 500 pF., 19/8. Single "0" 385 pF. 7/6.
SHORT WAVE. Single 10 pF., 25 pF., 50 pF., 75 pF., 100 pF., 150 pF., 180 mfd. Can be ganged. Collars 9d. each.
TUNING. Solid dielectric, 100 pF., 300 pF., 500 pF., 3/6 each.
TRIMMERS. Compression ceramic 30, 50, 70 pF., 9d.; 100 pF., 150 pF., 1/3; 250 pF., 1/8; 800 pF., 750 pF., 1/9.

BEST BRITISH PWC RECORDING TAPES

L.P. 7in. 1800ft. 14/6 D.P. 7in. 2400ft. 25/6
 L.P. 5in. 1200ft. 14/0 D.P. 5in. 1800ft. 24/6
 L.P. 5in. 900ft. 11/6 D.P. 5in. 1200ft. 18/6
 Spare Spools 2/6. Tape Splicer 5/- Leader Tape 4/6.
 Tape Heads: Collaro 2 track 28/6 pair, 4 track 70/- pair.

MAINS TRANSFORMERS

250-0-250, 80 mA. 6.3 v. 3.5 a. or 4 v. 4 a. Rectifier 6.3 v. 1 a. or 5 v. or 4 v. 2 a. 25/-; Ditto 350-0-350, 29/6;
 300-0-300 v. 120 mA. 6.3 v. CT 4 a. 0.5, 6.3 v. 2 a. 35/6
MINIATURE 200 v. 20 mA. 6.3 v. 1 a. 10/6
MIDGET 220 v. 45 mA. 8.3 v. 2 a. 15/8
SMALL 300-0-300 v. 70 mA. 6.3 v. 4 a. 19/6
HEATER TRANS. 6.3 v. 1 a., 7/6; 6.3 v. 4 a. 10/8
 Ditto tapped sec. 1.4 v., 2.3, 4, 5, 6.3 v. 1 1/2 amp. 8/6
GENERAL PURPOSE LOW VOLTAGE. Outputs 3, 4, 5, 6, 8, 9, 10, 12, 15, 18, 24 and 30 v. at 250 mA. 25/-
 Ditto, 1 amp., 5, 10, 15, 20, 25, 30, 40, 45, 50, 55, 60 29/6
Sub-Min. Mains to 9 v. 80 mA. 1 x 1 1/2 x 1 1/2 in. 7/8
AUTO TRANS. 150 v., 0, 115 v., 230 v., 25/-; 500 v. 82/6

HIGH GAIN TV. PRE-AMPLIFIER BAND I B.B.C.

Tunable channels 1 to 5. Gain 18 dB. ECC84 valve. Kit price 32/6 or 55/- with power pack. Details 6d. (PC84 valves if preferred for 0.3a heater chassis).
BAND III I.T.A. - same prices. Tunable channels 7 to 13. Gain 17 dB.
 Band I or III Coils and circuit only, 9/6. Chassis 4/9.

1966 GRAM CHASSIS



Three Wavebands: Five Valves: ECH81, Longs, Med., Short. EP89, EBC81, EL84, EZ80, 12-month guarantee. A.C. 200-250 v. Ferrite Aerial A.V.C. Negative Feedback. 5 watts 3 ohm. Chassis 13 1/2 x 7 1/2 in. high x 5 1/2 in. deep. Glass dial size 1 3/4 x 4 1/4 in. 12in. x 1 1/2 in. 15/-
ALUMINIUM PANELS 18 s.w.g. 12 x 12 in. 5/6; 14 x 9 in. 4/6; 12 x 8 in. 3/6; 10 x 7 in. 2/6; 8 x 6 in. 2/-; 6 x 4 in. 1/6.

BRAND NEW £9.19.6

Matched speakers 10 x 6 in. 22/6, 13 x 8 in. 45/-
STEREO RADIOGRAM CHASSIS £14.19.6 Post 5/6
 With Long, Med. and Short Wavebands, 16in. x 7in. x 9in.

BLANK ALUMINIUM CHASSIS. 18 s.w.g. 4 sides, riveted corners, lattice fixing holes. 2 1/2 in. sides, 7 x 4 in., 5/6; 9 x 7 in., 6/6; 11 x 3 in., 6/6; 11 x 7 in., 7/6; 13 x 9 in., 9/6; 14 x 1 1/2 in. 12 1/2 in. 15/-
ALUMINIUM PANELS 18 s.w.g. 12 x 12 in. 5/6; 14 x 9 in. 4/6; 12 x 8 in. 3/6; 10 x 7 in. 2/6; 8 x 6 in. 2/-; 6 x 4 in. 1/6.

NEW GARRARD GRAM MOTORS

also suitable for models, tape decks, etc.
 100-130 v. A.C. 15/- pair for 200/250 v. (in series)

THE INSTANT BULK TAPE ERASER AND RECORDING HEAD DEMAGNETISER



Leaflet 3 A.E.
 200/250 v. A.C. 35/-

BAKER LOUDSPEAKERS

NEW HI-FIDELITY MODELS

12in. 15w. STALWART 3 or 15 ohms, 45-1300 lines £5.5
 c.p.s., 12,000 lines



12in. DE LUXE Foam Suspension 14,000 lines, 15 w. 25-16,000 c.p.s. £9

12in. AUDITORIUM 25 w. 25-15,000 c.p.s. £12.10

12in. SUPERB 20 w. 20-17,000 c.p.s. £15

GROUP MODELS FOR VOCALS, BASS LEAD AND RHYTHM GUITARS

"Group 25" 15in. dia., 25 watt, 20-10,000 c.p.s. 5gns.

"Group 35" 12in. dia., 35 watt, 20-10,000 c.p.s. 8 1/2 gns.

"Group 50" 15in. dia., 50 watt, 20-10,000 c.p.s. 18gns.

LOUDSPEAKERS P.M. 3 OHMS. 2 1/2 in., 3 in., 4 in., 5 in., 7 1/2 x 4 in., 15/8 each; 8 in., 17/6; 8 in., 18/6; 12in. 30/-; (15 ohms 35/-); 10in. x 6in. 22/6; 8in. x 5in. 21/-; 8in. x 6in. 21/-; E.M.I. Double Cone 13 x 8 in., 3 or 15 ohm models, 45/-; Stentorian 10in. HF1012, 92/-; 8in. HF812 75/6. Crossover 30/-; Horn Tweeters 3-16 Kcs./s. 10 w 29/6; 20 w 20 Kcs. 99/6.

T.V. REMOTE CONTROLLER. For Philips 19TG11A, 12LA, 12SA, 14A2, 23TG11A, 113A, 121A, 131A, Stella ST1033A, 39A, 43A, 53A. Coscor CT1910A, 21A, CT2310A, 21A, 31A. Ready to plug in, with 11ft 7 way cable, dual pot Volume and Brightness, OA81 diode, etc. etc. List 3/6ns. NEW, BOXED, OUR PRICE 12/6 POST FREE.

WAVE-CHANGE SWITCHES WITH LONG SPINDLES

2 p. 2-way, or 2 p. 6-way, or 8 p., 4-way or 1 p. 12-way; ea. 3/6
 2 p. 2-way, or 4 p., 3-way, 3/6; 8 p. 4-way, 2 wafers, 6/8
 Wavechange "MAKITS" 1 p. 12-way, 2 p. 6-way, 3 p., 4-way, 4 p., 3-way, 6 p., 2-way. Prices include click spindles, adjustable stops, spacers, etc. 1 wafers, 8/6; 2 wafers, 12/6; 3 wafers, 16/-; 4 wafers, 19/6; 5 wafers, 23/-; extra wafers, 2/6.
TOGGLE SWITCHES, s.p., 2/-; d.p., 3/6; d.p.d.t., 4/6.

★ RADIO BOOKS ★ (Postage 9d.)

Radio, T.V. Valves, Diodes, Transistor equivs. 10/8
 Mullard Maintenance Manual. 16/-
 Hi-Fidelity Speaker Enclosures. 5/-
 Transistor Superhet Commercial Receivers. 7/6
 Radio Valve Guide, Books, 1, 2, 3, 4, or 5 each 9/6
 Mullard Audio Amplifier Manual. 5/-
 Practical Radio Inside Out. 4/6
 TV Fault-Finding, fully illustrated 6/-
 Transistor Audio Amplifier Manual 6/-
 Shortwave Transistor Receivers 5/-
 Transistor Communication Sets. 6/-
 Modern Transistor Circuits, Beginners 2/8
 International Radio Stations List 7/6
 Sub-Miniature Transistor Receivers 5/-
 How to Receive Foreign T.V. 5/-

JACK SOCKETS Std. open-circuit 2/6, closed-circuit 4/6.
 Lead 6/-, Grundis 3-pin; Lead 3/6.
 Phone Plugs 1/-, Socket 1/-; Banana Plugs 1/-, Sockets 1/-.
JACK PLUGS STANDARD. Screened 3/-. Grundis 3-pin 3/6.
BULGIN NON-REV PLUGS and SOCKETS. P74 2-pin 4/3; P73 3-pin 4/6; P194 6-pin 6/6; P486 6-pin 12/6; P380 4/-.
RESISTORS. Preferred values, 10 ohms to 10 meg. 4 w., 1/2 w., 1 w., 20% 4d.; 1 w. 8d.; 2 w., 1/2 s. 10% 6d. **OHM STABILITY.** 1 w. 2/-; Preferred values. 10 ohms to 10 meg. Ditto 5%, 10 ohms to 22 meg., 9d. 5 watt 0.5 to 8.2 ohm 3 w. 1/8
 10 watt WIRE-WOUND RESISTORS 1 1/2
 15 watt 10 ohms to 6,800 ohms 2/-
 10K, 15K, 20K, 25K, 10W.
MAINS DROPPERS. Midget. With sliders. 0.3 a., 1K., 0.2 a., 1.2 K., 0.35 a., 1.5 K., 0.1 a., 1 w., 8/- each.
LINE CORE 100 ohms lit. 3-way 1/- ft.
WIRE-WOUND Pots. 3 WIRE-WOUND 4-WATT
WATT Miniature T.V. STANDARD SIZE POTS.
 Type. All values 10 ohms LONG SPINDLE VALUES
 25 K., 3/-; 30 K., 4/-; Carbon 30 K. to 2 meg., 2 ohms for OC72, OC81 11/-
SPEAKER-FRET. Tygan various colours, 52in. wide from 10/- ft.; 26in. wide from 5/- ft. Samples, large, 8 A.E.
EXPANDED METAL. Gold or Silver 12 x 12 in. 6/-.
ARBENTINE TRANSISTOR TRANSFORMERS
 DB365, 7.5 CT : 1 Push Pull to 3 ohms for OC72, OC81 ... 11/-
 DB364, 1.75 : 1 CT. Push Pull Driver for OC72, OC81 ... 11/-
 DB358, 11.5 : 1 Output to 3 ohms for OC72, OC81 ... 11/-
 D239, 4.5 : 1 Driver; D240, 8.5 : 1 Driver ea. 11/6
ARBENTINE TRANSISTOR POT. 5 K. switched VC1545 5/3
 Anti-Parasitic beads (ferrite) dos. 3/6
PRINTED CIRCUIT (Copper laminate) board 14 1/2 x 7 1/2 5/-

C.R.T. BOOSTER TRANSFORMERS
 for heater cathode short circuit or tubes with failing emission. Full instructions supplied, mains input. Optional 25% and 50% boost 2v. or 6.3v. or 12.6v. State voltage required. PRICE 15/6

RETURN OF POST DESPATCH Minimum P.P. Charge 1/6 per order unless otherwise stated. Full List 1/-, C.O.D. 2/6 extra. CALLERS WELCOME

RADIO COMPONENT SPECIALISTS

337 WHITEHORSE ROAD,
 WEST CROYDON Telephone
 THO 1665

Written guarantee with every purchase. (Export. Send remittance and extra postage, no C.O.D.) Buses 133, 68 pass door. S.R. Stn. Selhurst.

YOU ARE ALWAYS AHEAD WITH A SINCLAIR DESIGN

The world's smallest radio

SINCLAIR MICRO-6

No transistor set has ever yet compared in its class with the Micro-6 for size, power performance and design. Everything except the lightweight earpiece is contained within the smart minute white, gold and black case which weighs under one ounce in working order. Quality of reproduction is outstandingly good so you are certain to derive enormous pleasure from this fantastic set. Order your Micro-6 now. See why it cannot be too highly recommended to build and to use. You can easily have it working in an evening!

SIZE: $1\frac{1}{5}'' \times 1\frac{1}{10}'' \times \frac{1}{2}''$
WEIGHT: Under 1 oz.
FANTASTIC RANGE AND POWER

... and an amazing letter

I have had one of your Micro-6 receivers here in Sydney for about a year and I must say that its performance is very good. The sensitivity is high and the selectivity is quite adequate (it has to separate no less than 8 local stations) and all of them legal too. It is quite a miniature masterpiece!

Congratulations on the release of your F.M. set. You certainly are the leaders in miniature electronics. I shall look forward to the release of the Sinclair shirt-pocket colour T.V. receiver with micro-alloy CRT. Thanking you in anticipation and with best wishes for the future.

(signed) P. K. Vaucluse, N.S.Wales

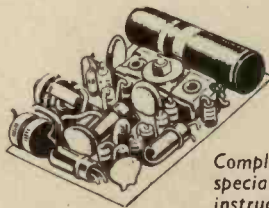

AMAZING CIRCUITRY

The six-stage circuit uses three special transistors to provide two stages of R.F. amplification with double diode detector and high gain 3-stage A.F. amplifier. A.G.C. counteracts fading from distant stations: band-spread brings in Luxembourg like a local station. Plugging in earpiece switches set ON. Tunes over medium waveband by vernier-type dial. Two self-contained batteries give about 70 hours working life.

Complete kit of parts inc. special earpiece and instructions

59/6

MALLORY MERCURY CELL TYPE ZM.312

(2 required)
Pack of six

each 1/11
10/6

**NEW
SINCLAIR
DESIGNS**

see next page

THE WORLD'S MOST ADVANCED AMPLIFIER

SIZE: $8\frac{1}{4}'' \times 3\frac{1}{4}'' \times 1''$

OUTPUT:
20 WATTS RMS

**SINCLAIR
X-20**

- 20 WATTS R.M.S. OUTPUT INTO 7.5 ohms
- 20—20,000 c/s ± 1 dB
- Constant square wave amplitude
- 95% conversion efficiency at output
- Input sensitivity—1mV into 5K ohms
- Power requirements—36V.d.c. at 700 mA

The only amplifier in the world to use Pulse Width Modulation, which, with circuitry developed specially by Sinclair gives power and quality years ahead of anything in its class. You can feed any signal source into the X-20—including modern high quality pick-up, radio tuner, guitar. The X-20 manual shows circuits by which pick-ups, etc. can be matched to the integrated pre-amplifier of the X-20 both in mono and stereo. When you have built this 12-transistor amplifier you use it in the same way as any other top quality hi-fi unit except that it is smaller, costs less and behaves perfectly.

Complete kit of parts including transistors and X-20 manual in sealed carton

£7.19.6

Built and tested with X-20 manual in sealed carton

£9.19.6

X-20 Power Pack sufficient to drive two X-20's **£4.19.6**

THE X-20 MANUAL details tone and volume control systems for X-20. Mono and Stereo. FREE WITH EVERY X-20. Available separately—2/- post free.

FULL SERVICE FACILITIES AVAILABLE TO ALL SINCLAIR CUSTOMERS

sinclair

SINCLAIR RADIONICS LTD.
COMBERTON, CAMBRIDGE Telephone: COMBERTON 682

A BRILLIANT NEW TUNER

THE WORLD'S FIRST POCKET-SIZE F.M. TUNER-RECEIVER



100%
BRITISH
PRODUCT



- SIZE 2 $\frac{1}{8}$ " × 1 $\frac{5}{8}$ " × $\frac{3}{4}$ "
- 7 TRANSISTORS
- 2 DIODES
- 2 OUTPUTS
- NO ALIGNING
- PULSE-COUNTING DISCRIMINATOR
- HI FI STANDARDS

*A joy for anyone
to build!*

Use it as —

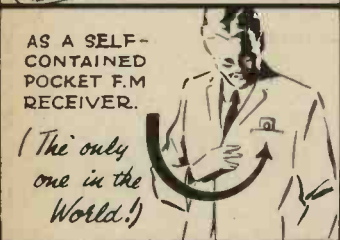
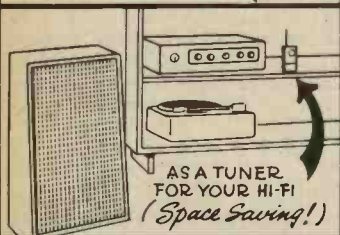

In styling, the Sinclair Micro FM is the most elegant, most professional looking design in miniaturised equipment ever made available to constructors. It is also the most original FM design in years. This high quality FM tuner has one output for feeding to hi-fi amplifier or tape recorder; a second output enables it to be used independently as a self-contained pocket FM receiver for personal listening. Barely half the size of a packet of twenty cigarettes, this fully fledged 7 transistor design incorporates many unique and original design features to achieve fantastically good standards of performance. Thanks to Sinclair designers, you can at last build an FM receiver without alignment problems, so that your Micro FM is ready to use the moment you finish building it. With pulse counting detection for better audio quality, excellent sensitivity and A.F.C. for easy tuning, the set's own telescopic aerial will suffice for good reception almost everywhere. **THE MICRO FM COSTS POUNDS LESS AND MEANS THAT ANYONE CAN ENJOY THE ADVANTAGES OF FM AT ITS BEST TO-DAY.**

Seven transistor, two diode FM superhet for use as a tuner and as a self-contained pocket receiver. The R.F. amplifier is followed by a self oscillating mixer. Low I.F. dispenses with the need for alignment. A three stage I.F. amplifier produces a square wave of constant voltage which is fed into the pulse counting discriminator. This is converted into uniform pulses, the average output from which is directly proportional to the signal frequency, reproducing the original modulation exactly. After equalisation, the signal is fed to the audio output socket and to the receiver's own audio amplifying stage for using the Micro FM as an independent self-contained receiver. A.F.C. "locks" on each station automatically. THE SINCLAIR MICRO FM is self-contained within a neat black plastic case faced by an elegantly designed front panel of brushed and polished aluminium with spun aluminium tuning dial to match.

- TUNES FROM 88-108 Mcs.
- ONE OUTPUT FOR HI-FI AND TAPE, ONE FOR PERSONAL LISTENING
- STANDARD 9-VOLT BATTERY HOUSED IN CASE
- AUDIO RESPONSE 10-20,000 c/s + 1db
- SIGNAL TO NOISE RATIO 30db at 30 microvolts

Complete kit including telescopic aerial, case, dial, earpiece and instructions

£5.19.6

FULL SERVICE FACILITIES AVAILABLE TO ALL SINCLAIR CUSTOMERS

sinclair

SINCLAIR RADIONICS LTD., COMBERTON, CAMBRIDGE

Telephone: COMBERTON 682

A BRILLIANT NEW AMPLIFIER

USE IT FOR YOUR HI-FI, FOR YOUR CAR RADIO, FOR P.A.

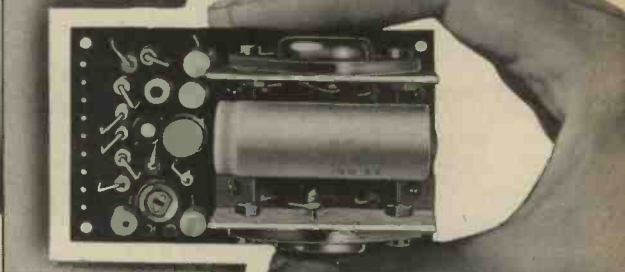

QUALITY RADIO (with MICRO FM)

FOR GUITARISTS

WITH YOUR SINCLAIR F.M., FOR MUSIC, ETC.

SINCLAIR Z.12 COMBINED 12 WATT HI-FI AMPLIFIER AND PRE-AMP

THE ULTIMATE IN SIZE, POWER, QUALITY AND PRICE

3" x 1 1/4" x 1 1/2"

WEIGHS 3 oz.

12 WATTS R.M.S. (24 WATTS PEAK)

USE IT WITH THE MICRO-6 OR MICRO F.M.

IDEAL FOR USE WITH A 12V BATTERY

Here is the hi-fi amplifier you have always dreamed of—very small, very powerful and of the highest possible quality. Sinclair's latest design, the Sinclair Z.12 meets all these requirements AND MORE to give you the most versatile, dependable amplifier system ever. In conformity with original Sinclair design, the Z.12 incorporates its own special pre-amplifier to which you add whichever of the tone and volume control circuits shown in the Z.12 manual suits you best. The Z.12 achieves even greater versatility, since it operates efficiently from any power supply between 6 and 20 volts, D.C. This makes it as attractive for use in car radios, guitars, P.A. systems, etc. as for the very best hi-fi it is designed for. In fact, the Z.12 is the ideal amplifier wherever the need is for great power and quality from the smallest possible unit. The Sinclair Z.12 comes to you ready built, tested and guaranteed. The Z.12 manual included makes simple work of installing and using the unit.

Technical Details: 8 transistor hi-fi amplifier with pre-amp and ultra-linear class B output. Special H.F. transistors are used in original circuitry to achieve laboratory standards of performance. Superb quality is assured by generous negative feedback. **FREQUENCY RESPONSE**—15-50,000 c/s ± 1 dB. **OUTPUT**—12 watts RMS continuous sine wave (24 watts peak), 15 watts RMS music power (30 watts peak). **OUTPUT IMPEDANCE**—suitable for 3, 7.5 and 15 ohm speakers. Two 3-ohm speakers can be used in parallel if required. **INPUT**—2mV into 2K ohms. **POWER SUPPLY**—6 to 20V d.c. from power unit available or batteries. **SIGNAL TO NOISE RATIO**—better than 60dB. **QUIESCENT CURRENT CONSUMPTION**—only 15mA. **IDEAL FOR BATTERY OPERATION.**

Z.12 Amplifier and pre-amp ready built, tested and guaranteed

Sinclair Power Pack for above £2.14.0

89/6

Recommended for everyone!

"I am extremely pleased with the performance of the Z.12," writes M.H., Bolton, Lancs. "The quality is excellent and is better with one 8" speaker than a hi-fi amplifier which I have complete with 3 speakers. It is far more sensitive and produces a very pleasing tone with a 12V. supply. With no signal input I can detect no noise whatsoever. I shall recommend this little amplifier to everyone."

GUARANTEE ORDER FORM

To: SINCLAIR RADIONICS LTD. COMBERTON CAMBRIDGE

Please send me

for which I enclose Cash/Cheque/Money Order value £.....s.....d.

NAME.....

ADDRESS.....

Should you not be completely satisfied with your purchase when you receive it from us, your money will be refunded in full and at once without question. It is important to quote Pr.E36 should you prefer to write your order instead of cutting out this coupon.



SINCLAIR RADIONICS LTD.
COMBERTON, CAMBRIDGE
Telephone: COMBERTON 682

157

Z & I AERO SERVICES LTD.

Head Office and Warehouse: 44A WESTBOURNE GROVE, LONDON, W.2.

Retail Shop: 85 TOTTENHAM COURT ROAD, LONDON, W.1
Tel.: LAngham 8403 Open all day Saturday
Tel.: PARK 5641/2/3



0A2 6/-	6AF4 10/-	6BR7 12/6	6Q7G 6/-	128Q7GT/6	EBF80 7/6	EF93 5/-	EZ21 5/6	PFL20017/6	UBF80 7/-
0B2 6/-	6AF6G 11/-	6BR8 9/-	6R7 8/-	128Y7 6/-	EBF83 8/-	EF94 6/-	EZ20 4/-	PL36 10/-	UBF89 7/6
0B3 6/-	6AG7 6/-	6BW6 5/6	6K7 5/-	1487 20/-	EBF95 7/6	EF95 5/-	GZ30 8/-	PL38 16/-	UBL21 11/-
0C3 6/-	6AJ5 9/-	6BW7 10/-	6X4 6/-	19A25 5/-	EBL1 14/-	EF97 12/6	GZ32 10/-	PL81 8/-	UCC84 10/-
0D2 5/-	6AK5 5/6	6BZ6 6/-	6Y6G 10/-	20F2 16/-	EBL21 11/-	EF98 12/6	GZ34 10/-	PL82 7/6	UCC85 7/-
1A3 9/-	6AG7 7/-	6C4 2/8	7B5 10/-	20P1 14/-	EBL31 18/-	EF183 8/-	K788 22/-	PL83 7/6	UCR80 10/-
1B3GT 7/-	6AL7 8/-	6C5 8/-	7B6 11/-	20P2 14/-	ECC84 7/-	EF184 8/-	N78 15/-	PL84 7/6	UOH21 9/6
1C3GT 7/-	6AL5 8/-	6CB6 3/-	7B7 7/-	20P4 14/-	ECC85 6/6	EF604 21/-	N81 25/-	PL87 7/6	UCH21 9/6
1D5 7/6	6AM6 4/-	6CBG 10/6	7C8 10/-	20P5 12/-	ECC86 7/-	EF604 21/-	N82 25/-	PL302 14/-	UCH43 9/6
1G6GT 7/-	6AN4 15/-	6CH6 6/-	7C6 6/-	20P6 12/-	ECC88 10/-	EF604 21/-	N83 25/-	PL500 15/-	UCR81 7/-
1L4 3/6	6AN5 15/-	6CL6 9/-	7C7 8/-	26AG 10/-	ECC189 12/-	EL38 17/6	N84 25/-	P8C80 7/6	UCR82 8/6
1N5GT 8/-	6AN8 10/-	6CW4 12/-	7K7 7/6	26C5 10/-	ECC190 8/-	EL41 9/6	N85 25/-	PAB28 12/6	UCL83 10/6
1E4 6/-	6AQ4 5/-	6CY5 10/-	787 18/-	26FGT 8/-	CL33 9/-	EL42 9/6	N86 25/-	PC84 12/6	UCL84 10/6
1R5 5/-	6AR5 6/-	4DK6 6/-	7Y4 8/-	26Z4G 8/-	42 5/-	EL50 6/-	N87 25/-	PC96 9/6	UF41 9/-
185 4/6	6AR6 6/-	6E48 11/-	7Z4 6/-	26Z6GT 11/-	50A5 12/-	EL81 9/6	N88 25/-	PC97 9/6	UF42 9/-
174 3/-	6AR8 17/6	6F14 12/-	12AC6 8/-	27M1 60/-	50B5 7/-	EL83 9/6	N89 25/-	PC805 12/6	UF43 8/-
175GT 6/-	6AR5 5/-	6F7 5/-	12AD6 8/-	28D7 7/-	50C5 6/6	EL85 9/6	N90 25/-	PC86 12/6	UF80 8/-
1U4 5/-	6AB6 5/-	6F8G 5/-	12AL5 7/-	29C1 20/-	50L6GT 6/6	EL86 8/6	N91 25/-	PC88 12/6	UF85 8/-
1U5 6/-	6A7G 20/-	6F9G 5/-	12AQ5 7/-	29C1 20/-	50A5 12/-	EL88 8/6	N92 25/-	PC89 12/6	UF90 8/-
1X2B 7/-	6A7E 4/6	6F11 6/-	12AT6 5/-	30C1 7/8	50B5 7/-	EL89 8/6	N93 25/-	PC91 12/6	UF95 8/-
2A3 5/-	6AU4GT 9/-	6F13 6/6	12AT7 4/-	30C15 11/-	50C5 6/6	EL90 6/6	N94 25/-	PC92 12/6	UF96 11/-
2D21 6/-	6AU8 9/-	6F14 18/-	12AU6 6/-	30C17 13/-	50D5 7/-	EL91 2/6	N95 25/-	PC93 12/6	UF97 11/-
2X2 3/-	6AV6 9/-	6F15 11/-	12AU7 5/6	30C18 11/-	50E5 7/-	EL95 6/6	N96 25/-	PC94 12/6	UF98 11/-
3A4 4/-	6AW8A 14/-	6F17 6/-	12AV6 6/-	30FL1 12/6	50F5 7/-	EL96 8/6	N97 25/-	PC95 12/6	UF99 11/-
3A5 7/-	6AX6GT 12/-	6F23 11/6	12AV7 8/-	30FL12 12/6	50G5 7/-	EL97 8/6	N98 25/-	PC96 12/6	UF99 11/-
3C4 5/6	6AX6GT 12/-	6F24 11/6	12AV8 8/-	30FL13 12/6	50H5 7/-	EL98 8/6	N99 25/-	PC97 12/6	UF99 11/-
3Q5GT/6/6	6B7 18/6	6F25 12/-	12AV9 8/-	30FL14 12/6	50I5 7/-	EL99 8/6	N100 25/-	PC98 12/6	UF99 11/-
384 5/-	6B8 7/6	6F26 6/6	12AY7 10/-	30L1 6/6	50J5 7/-	EL99 8/6	N101 25/-	PC99 12/6	UF99 11/-
3V4 6/-	6B8GT 5/-	6F28 10/6	12BA6 8/-	30L15 12/6	50K5 7/-	EL99 8/6	N102 25/-	PC100 12/6	UF99 11/-
5R4GY 9/-	6BA6 5/-	6F32 8/-	12B6 6/6	30L17 14/6	50L5 7/-	EL99 8/6	N103 25/-	PC101 12/6	UF99 11/-
5T4 8/-	6BE6 5/6	6F34 9/-	12B7A 7/-	30P12 10/-	50M5 7/-	EL99 8/6	N104 25/-	PC102 12/6	UF99 11/-
5U4G 8/6	6BGG 18/-	6J4 9/-	12B7B 7/-	30P19 14/6	50N5 7/-	EL99 8/6	N105 25/-	PC103 12/6	UF99 11/-
5V4GB 6/6	6BEG 7/6	6J5G 4/6	12BY7A10/-	30PL1 12/6	50O5 7/-	EL99 8/6	N106 25/-	PC104 12/6	UF99 11/-
5V4G 9/-	6B36 8/-	6J6 3/6	12E1 20/-	30PL12 12/6	50P5 7/-	EL99 8/6	N107 25/-	PC105 12/6	UF99 11/-
5Y3GT 5/-	6BK4 25/-	6J7 9/-	12F5GT 7/6	30PL14 12/6	50Q5 7/-	EL99 8/6	N108 25/-	PC106 12/6	UF99 11/-
5X4G 8/-	6BK7A 9/-	6K6G 6/-	12J7GT 7/6	30PL15 12/6	50R5 7/-	EL99 8/6	N109 25/-	PC107 12/6	UF99 11/-
5Z3 7/6	6BL7GT 9/-	6K7GT 5/-	12Q7GT 8/6	35A3 12/-	50S5 7/-	EL99 8/6	N110 25/-	PC108 12/6	UF99 11/-
5Z4G 8/-	6BN6 7/6	6K8 8/-	12S4T 7/-	35A5 11/-	50T5 7/-	EL99 8/6	N111 25/-	PC109 12/6	UF99 11/-
6/30L2 11/-	6BQ6 11/6	6L6GA 8/-	12SC7 8/-	35C5 6/6	50U5 7/-	EL99 8/6	N112 25/-	PC110 12/6	UF99 11/-
6AB4 6/6	6BQ7 8/-	6P25 12/6	12SFGT 9/-	35D5 12/-	50V5 7/-	EL99 8/6	N113 25/-	PC111 12/6	UF99 11/-

SEMI CONDUCTORS—please write for leaflet with specifications of General Purpose Germanium and Silicon Diodes, Microwave Diodes, Transistors, etc.
HIGH VOLTAGE ZENER DIODES 1.5 watts, 5% tolerance. ZNB20 (20V) 9/6. ZNB10 (10V) 9/6.
CATHODE RAY TUBES 3GP1—as recommended in the Practical Electronics Oscilloscope in March and April issues. £2.10.0. P.P. 5/-. Base 6/8. DG7-5 2 1/2" screen; 6.3V heaters; EHT required 800V; Deflection Sensitivity 125 mm/V for X and 200 mm/V for Y; Green phosphor medium persistence. £2.15.0. P.P. 5/-. Base 1/8.
FOR P.E. SCALER AND TIMER
 G810H DEKATRONs. 40/- Base 3/6. Indicator shield 1/8. P.P. 1/6 per set.
FERRITE ROD AERIALS
 PW/FRI for LW/MW pocket superhet, 5" rod. 8/6. RA2W for LW/MW Transistor sets with aerial coupling. 12/6. Ferrite Rods only 1" dia. x 6" long. 1/8.
LA2 POT CORE ASSEMBLY
 Complete with coil former. For use up to 100 kc/s. Max. Q at 80kc/s-175. 65 turns for 1mH 7/8. P.P. 1/6.
HEADPHONES
 DLR5, Low Impedance, balanced armature. Earpieces can be used as sound powered Microphones. 10/-.
 CLR, High Impedance (2000 Ω per insert). 18/-.
NO. 10 Assembly:
 Moving Coil Headphones with moving coil Hand Microphone fitted with press-to-talk switch. Rubber earpads. Cord terminated with army type 6-point moulded connector. Low Impedance. Brand new. 20/- ea.
 Small quantity available of second hand assemblies, checked, in perfect order. 8/6 ea. P. & F. 3/6 per set.

PLEASE SEND BAE (FOOLSCAP) FOR FULL PRICE LIST

Please add 2/6 in £ for postage. Minimum charge 2/-. No C.O.D. Orders Accepted. Please address all correspondence to the Head Office.

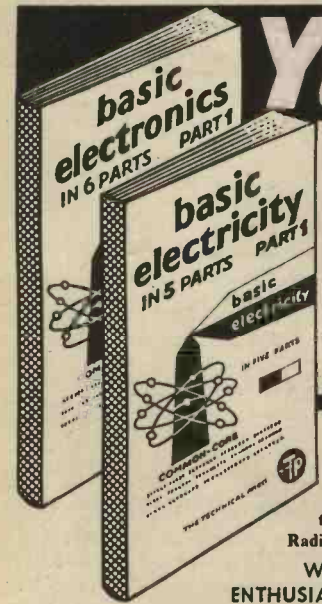

YOURS FREE FOR 7 DAYS

The New Picture-Book way of learning BASIC ELECTRICITY (5 VOLs.) BASIC ELECTRONICS (6 VOLs.)

You'll find it easy to learn with this outstandingly successful new pictorial method—the essential facts are explained in the simplest language, one at a time; and each is illustrated by an accurate, cartoon-type drawing.

The books are based on the latest research into simplified learning techniques. This has proved that the Pictorial Approach to learning is the quickest and soundest way of gaining mastery over these subjects.

The series will be of exceptional value in training mechanics and technicians in Electricity, Radio and Electronics.

WHAT THIS MONTH'S ENTHUSIASTIC READERS SAY

"... I am pleased to inform you that I shall be recommending BASIC ELECTRONIC CIRCUITS, Part 2, to my students. I would like to retain the inspection copy for my own use..."
 K.C.J., DAGENHAM

"... I consider this series of books would be cheap at double the price..." A.C.P., CHESHIRE

A TECH-PRESS PUBLICATION

POST NOW FOR THIS OFFER!!

To Selray Book Co.
 60 Hayes Hill, Hayes, Bromley, Kent

Please send me Without Obligation to Purchase, Basic Electricity/Basic Electronics on 7 Days' Free Trial. I will either return set, carriage paid, in good condition within 8 days or send down payment of 15/- (Basic Electricity) followed by 6 fortnightly payments of 10/-. Down payment of 15/- (Basic Electronics) followed by 6 fortnightly payments of 12/6. Alternatively, I will send 68/- (Basic Electricity—5 parts), 81/- (Basic Electronics—6 parts) post free. This offer applies to United Kingdom only.

Tick against set required (only one set allowed on free trial).
 BASIC ELECTRICITY BASIC ELECTRONICS

Signature.....
 (If under 21, signature of parent or guardian)

Name.....
 BLOCK LETTERS BELOW
 FULL POSTAL Address.....



Enjoy yourself and Save Money by Building Heathkit models

A wide range of well designed quality kit sets to choose from

A KIT FOR EVERY INTEREST... HOME, SERVICE WORKSHOP, LABORATORY

Ease of assembly is guaranteed

Even for those without previous experience—by the comprehensive, yet simple step-by-step construction manuals supplied with every Heathkit model.

Save £ £'s building the models

Heathkit units cost considerably less than comparable pre-assembled equipment. You cannot buy the parts any other way as cheaply.

Guaranteed performance

Every Heathkit product—assembled in accordance with our comprehensive construction manuals is guaranteed to meet published performance specifications, or your money will be cheerfully refunded.

Convenient credit terms

By taking advantage of our credit terms—you can enjoy your model right away—and pay for it in easy monthly instalments. Deferred terms available over £10 in U.K.

AUDIO

Cabinets, Turntable units, Mono and Stereo Amplifiers, Pick-ups, Speakers, Speaker Systems, Mono and Stereo Control Units, Tape Pre-amplifiers, Tape Decks, Transistor Mixer.

RADIO

AM/FM and FM Tuners, Transistor Radios, SW and Communication Receivers.

TEST INSTRUMENTS

A wide range of Audio Test, Home Workshop, Service and Laboratory Instruments.

AMATEUR GEAR

A wide range of equipment.

MISCELLANEOUS

Hobby kits for the youngster, Tool kits, Intercoms, Electronic Organs, PA/Guitar Amplifiers, etc.



'SCOPES



POWER SUPPLIES



TRANSISTOR TESTER



SIGNAL GENERATORS



VALVE VOLTMETERS



TV ALIGN. GENERATORS

Instruments for Test, Service, Home Workshop

3 in. **LOW-PRICED OSCILLOSCOPE**, Model OS-2. Ideal for servicemen. Compact: 5" x 7 1/2" x 12". Wt. 9 1/2 lbs. "Y" bandwidth 2 c/s—3 Mc/s. T/B 20 c/s—200 kc/s in 4 ranges. Kit £22.18.0. Assembled £30.8.0.

MULTIMETER, Model MM-1U. Ranges 0-1.5v to 1,500 v A.C. and D.C. 150 µA to 15A D.C.; 0.2 to 20 MΩ. 4 1/2 in. 50µA meter. Kit £12.18.0. Assembled £18.11.6.

5 in. **FLAT-FACED OSCILLOSCOPE**, Model IO-12U. Lab. performance at utility 'scope price. "Y" bandwidth 3 c/s to 4.5 Mc/s. T/B 10 c/s to 500 kc/s in 5 steps. Built in lv calibrator. Dim: 8 1/2" w x 14" h x 17" deep. Kit £35.17.6. Assembled £45.15.0.

TRANSISTOR TESTER, Model IM-30U. Unmatched in quality, performance and price. Provides complete d.c. analysis of PNP, NPN transistors and diodes. Internal battery for tests up to 9 v. Kit £24.18.0. Assembled £35.10.0.

R.F. SIGNAL GENERATOR, Model RF-1U. Freq. coverage from 100 kc/s-100 Mc/s on six bands on fundamentals and up to 200 Mc/s on calibrated harmonics. Kit £13.8.0. Assembled £19.18.0.

6 in. **DE LUXE VALVE VOLTMETER**, Model IM-13U. Measures ac and dc volts 0-1.5 to 1,500 V in 7 ranges. Res. to 1,000 MΩ in 7 ranges. Modern styling, with gimbal mount. Kit £18.18.0. Assembled £26.18.0.

TV ALIGNMENT GENERATOR, Model HFV-1. 3.6 to 220 Mc/s on fundamentals. Unique electronic sweep oscillator. Built-in fixed and variable marker generators (5 Mc/s crystal). Kit £37.18.0. Assembled £47.10.0.

DECADE RESISTANCE, Model DR-1U. Range 1-99,999 Ω in 1 Ω steps. Kit £10.8.0. Assembled £14.8.0.

DECADE CAPACITOR, Model DC-1U range, 100µF to 0.111 µF in 100 µµF steps. Kit £7.5.0. Assembled £10.8.0.

FULL RANGE OF MODELS IN FREE CATALOGUE
SIMPLY SEND COUPON BELOW TO
Dept. PM, Gloucester

Kits for Hi-Fi, Audio, Radios, Miscellaneous construction kits

"MALVERN" HI-FI EQUIPMENT CABINET. Will house all your Hi-Fi equipment. Left "in the white." Size 39 1/2 x 32 x 21 1/2 in. Kit £18.1.0 (inc. P.T.). A wide range of other cabinets.

HI-FI FM TUNER. Range 88-108 Mc/s. Available in two units, sold separately. **TUNER (FMT-4U)** 10.7 Mc/s IF £2.15.0 (inc. P.T.). **IF AMPLIFIER (FMA-4U)** power supply and valves £13.13.0. Total Kit £16.8.0.

JUNIOR ELECTRONIC WORKSHOP, Model EW-1. 20 exciting experiments can be made. Special solderless connections. Kit £7.13.6 (inc. P.T.)

TRANSISTOR MIXER, TM-1. A must for the tape enthusiast. 4 inputs, 9 v. battery operation. Kit £11.16.0. Assembled £16.17.6.

"OXFORD" LUXURY TRANSISTOR PORTABLE, Model UXR-2. Beautiful solid leather case. LW and MW Coverage. Kit £14.18.0 (inc. P.T.)

GENERAL COVERAGE RECEIVER, Model RG-1. Freq. coverage 600 kc/s-1.5 Mc/s. 1.7-32 Mc/s in 6 switched bands. Many features incl. 1/2 lattice crystal filter. Kit £39.16.0. Assembled £53.0.0.

6W QUALITY STEREO AMPLIFIER, Model S-33H. An inexpensive stereo/mono amplifier. Ideal for use with the Decca Deram lightweight pickup. Modern attractive styling. Kit £15.17.6. Assembled £21.7.6.

STARMAKER-33 TRANSISTOR PA/Guitar AMPLIFIER. Full 20 watts (33 watts IHF) output. Four inputs on two channels. Two heavy duty speakers. Compact size. Tremolo. Elegant cabinet. Kit £44.19.0. Assembled £59.10.0, legs or castors extra.

TRANSISTOR GENERAL COVERAGE RECEIVER, Model GC-1U. Frequency coverage 580 kc/s—30 Mc/s in 5 bands. Kit £37.17.6. Assembled £45.17.6.

20 + 20W TRANSISTOR AMPLIFIER, Model AA-22U. Outstanding performance for price. Send for full spec. Kit £39.10.0, less cabinet. Beautiful cabinet £2.5.0 extra.

New! Berkeley SPEAKER SYSTEM. New construction gives faster assembly. Professionally styled walnut finished cabinet. 2 speakers cover 30 c/s—17,000 c/s. Only 7 1/2" deep x 26" h x 17" wide. Kit £18.18.0. Assembled £23.0.0.

SSU-J SPEAKER SYSTEM. A practical solution to the problem of a low-price speaker system. Two speakers. (Bookcase) £11.17.6 Kit (inc. P.T.) (With legs) £12.12.0 Kit (inc. P.T.)

See the complete Heathkit range in the FREE catalogue



HI-FI CABINETS



QUALITY STEREO and MONO AMPLIFIERS



TRANSISTOR PORTABLES



SW RECEIVERS TRANSMITTERS



FM & AM/FM RADIO TUNERS



SPEAKER SYSTEMS

RECORD PLAYERS

TAPE DECKS

CONTROL UNITS

Welcome To Our LONDON HEATHKIT CENTRE

In response to the request of many customers, we have opened a showroom and retail stores at

233 Tottenham Court Road

WHEN YOU ARE IN TOWN, WE HOPE THAT YOU WILL VISIT US THERE

To DAYSTROM LTD., DEPT. PM-3, GLOUCESTER, ENGLAND

Please send me **FREE BRITISH CATALOGUE** (Yes/No).....

Full details of model(s).....

American Catalogue 1/- p.p. (Yes/No).....

NAME (BLOCK CAPITALS) ADDRESS.....

PM-3



MINIATURE METALLIZED POLYESTER CAPACITORS

These small moulded metallized polyester capacitors are ideally suited to the applications of printed wiring panels and transistorised circuits. The use of the new dielectric material and unique construction combine the advantages of small physical size and superior electrical characteristics which meet the requirements of H.5 DEF. 5011 Specification.

CONSTRUCTION

The windings are virtually non-inductive and the wire terminations are soldered direct to the metal electrodes eliminating contact resistance and ensuring the minimum possible inductance.

Cap. Tolerance: ± 20%

Voltage Rating:
Peak ripple voltage and D.C. voltage must not exceed rated D.C. voltage.

Power Factor:
≤ 0.01 at 1 Kc/s. at + 20°C.

Temperature Rating:
Suitable for working at + 85°C. without derating.

Insulation Resistance:
10,000 megohms or 2,000 ohm farad whichever is less.

Terminations:
22 SWG solder-coated parallel wires for vertical mounting.

Finish:
Insulated—special non-cracking heat resisting thermosetting compound providing good insulation and good protection against the ingress of moisture.

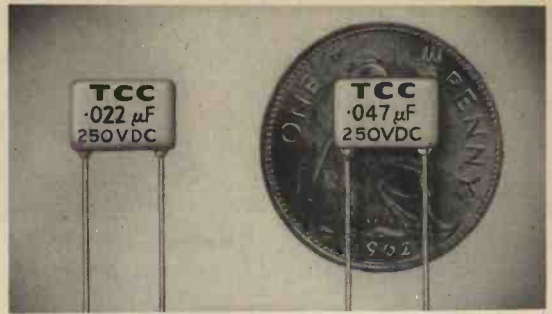
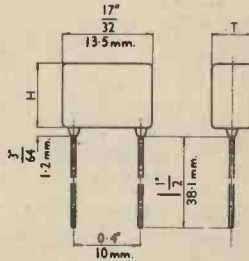

Cap. μF	Dimensions		T.C.C. Type No.
	H	T	
250 V. D.C. at 85°C working			
0.01	11/32in. 9 mm	7/32in. 5.5 mm	PMX1
0.015	11/32in. 9 mm	7/32in. 5.5 mm	PMX7
0.022	11/32in. 9 mm	7/32in. 5.5 mm	PMX2
0.033	11/32in. 9 mm	7/32in. 5.5 mm	PMX5
0.047	11/32in. 9 mm	7/32in. 5.5 mm	PMX3
0.068	7/16in. 11 mm	9/32in. 7.2 mm	PMX8
0.1	7/16in. 11 mm	9/32in. 7.2 mm	PMX4
400 V. D.C. at 85°C working			
0.01	11/32in. 9 mm	7/32in. 5.5 mm	PMX41
0.022	11/32in. 9 mm	7/32in. 5.5 mm	PMX42
0.033	7/16in. 11 mm	9/32in. 7.2 mm	PMX45
0.047	7/16in. 11 mm	9/32in. 7.2 mm	PMX43

THE TELEGRAPH CONDENSER CO. LTD.

Electronics Division · North Acton · London · W.3. · Tel. ACOrn 0061 · Telex: 261383
(also at) CHESSINGTON, SURREY & BATHGATE, SCOTLAND



For quick, easy faultless soldering

Ersin Multicore 5-core solder is easy to use and economical. It contains 5 cores of non-corrosive flux, cleaning instantly heavily oxidised surfaces. No extra flux is required. Ersin Multicore Savbit Alloy considerably reduces the wear of copper soldering iron bits.



HANDY SOLDER DISPENSER
12 ft. of 18 s.w.g. SAVBIT alloy in a continuous coil, used direct from free-standing dispenser.
2/6 each



LOW TEMPERATURE SOLDER
Size 9 pack contains 24 ft. of 60/40 high tin quality 22 s.w.g.
2/6 each
Size 10 pack 212 ft. 15/- each.



SAVBIT SIZE 1 CARTON
Contains approx. 30 ft. of 18 s.w.g. SAVBIT alloy. Also available in 14 and 16 s.w.g.
5/- each



BIB WIRE STRIPPER AND CUTTER
Strips insulation, cuts wire cleanly. Adjusts to any size.
4/- each

Available from all Electrical and Hardware shops.
If unobtainable write to:

MULTICORE SOLDERS LTD.

Multicore Works, Hemel Hempstead, Herts. Hemel Hempstead 3636 M.4/B

BLOCK CAPACITORS
New and Guaranteed. Send for List, over 2,000 in stock at a fraction of maker's price.

LATEST ARRIVALS

Maker	Mfd.	D.C.V. wkg.	Temp.	Price	Carr.
T.C.C.	10	750	60°C	10/6	2/6
T.C.C.	10	350	60°C	6/6	2/-
TCC	8	1,500	60°C	17/6	3/-
TCC	8	1,000	60°C	10/6	2/6
TCC	8	750	60°C	8/6	2/-
TCC	8	600	60°C	7/6	2/-
TCC	8	400	71°C	6/6	2/-
TCC	2	2,000	60°C	12/6	2/-
Dubilier	8	600	60°C	7/6	2/-
Dubilier	4	800	71°C	5/6	2/-
Dubilier	1	3,000	100°C	17/6	2/-
Dubilier	0.5	5,000	60°C	17/6	2/-
Dubilier	0.1 + 0.1	6,000	71°C	8/6	2/-

MULTI-TAPPED TRANSFORMERS
ALL PRIMARIES 200, 230, 250V.

Type	Sec. Taps	Amps.		
A	3.4.5.6.8.9.10.12.15.18.20.24.30V.	2	25/-	4/-
B	Ditto	4	39/6	4/6
C	Ditto	5	45/-	5/6
D	Ditto	8	59/6	7/-
E	6.7.8.10.14.15.17.19.25.31.33.40.50V.	3	45/-	5/6
F	Ditto	6	87/6	7/6
G	12.18.20.24.30V.	10	69/6	7/6

ANY 'SPECIALS' MADE TO ORDER UP TO 1500VA. DOUBLE WOUND 7-10 DAYS DELIVERY. LET US QUOTE YOU.

MOTORISED UNI-SELECTOR No. 2

8 banks 50 positions, arranged to give 4 banks 100 positions. Ex-equipment, in perfect condition. These Selector Switches have been carefully removed from a modern PABX (installed new in 1960).

£3/19/6. P.P. 4/6.



BRAND NEW ELECTRIC 30 AMP. VENNER TIME SWITCH. Type MD 1 BP.

Size 5 1/2 x 8 x 4 1/2 in. deep, 24 hr. dial. One on, one off. Beautifully finished in black bakelite case with perspex window. Packed in original cartons at fraction of maker's price. £3/19/6. P.P. 5/-.

Arms for extra switching 6/- per pair.



SAMSON'S ELECTRONICS LTD.

Tel. PAD 7851 9-10 CHAPEL STREET, LONDON, N.W.1 Tel. AMB 5125

LASKY'S RADIO

For the Finest Value and Service to the HOME CONSTRUCTOR AND THE ELECTRONICS ENTHUSIAST

We consider our construction parcels to be the finest value on the home constructor market. If on receipt you feel not content to build the set, you may return it as received within 7 days, when the sum paid will be refunded less postage.

TRANSISTOR PORTABLES

THE SKYROVER RANGE

7 transistor and 2 diode superhet portables—covering full med. plus 6 SW Bands.

The SKYROVER Mk III.

(Illustrated). Now supplied with redesigned plastic cabinet in black, grey and chrome with silverwise controls.

Controls: Waveband Selector, Volume Control with on/off switch, Tuning Control. In plastic cabinet, size 10" X 6" X 3 1/2", with metal trim and carrying handle.

Can now be built for **£8.19.6** Post 5/- extra H.P. Terms: 27/- deposit and 11 monthly payments of 15/9. Total H.P.P. £10.0s. 3d.

The SKYROVER De Luxe

Tone Circuit is incorporated, with separate Tone Control in addition to Volume Control. Tuning Control and Waveband Selector. In a wood cabinet, size 11 1/2" X 6 1/2" X 3 1/2", covered with a washable material, with plastic trim and carrying handle. Also car aerial socket fitted.

Can now be built for **£10.19.6** Post 5/- extra H.P. Terms: 33/- deposit and 11 monthly payments of 19/2. Total H.P.P. £12.3s. 10d.

Data for each receiver: 2/8 extra. Refunded if you purchase the parcel. Four U2 batteries 3/4 extra. All components available separately.

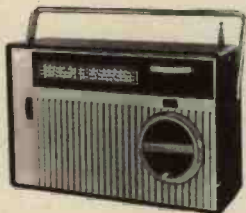

★ LONG WAVEBAND COVERAGE IS NOW AVAILABLE FOR THE SKYROVER

A simple additional circuit provides coverage of the 1100/1050M. band (including 1500 M. Light programme). This is in addition to all existing Medium and Short wavebands. All necessary components with construction data.

Only **10/-** extra Post Free. This conversion is suitable for both receivers that have already been constructed.

REALISTIC SEVEN

Fully tunable long and medium bands. Uses 7 Mullard Transistors; plus Diode OA70.

STAR features:

- 7 Transistor Superhet. 350 Milliwatt output 4in. high flux speaker. All components mounted on a single printed circuit board, size 9 1/2" X 8 1/2". In one complete assembly.
- Plastic cabinet, with carrying handle, size 7in. X 10in. X 3 1/2". In black/grey.
- Easy to read dial.
- External socket for car aerial.
- I.F. frequency 470 Kc/s.
- Ferrite rod internal aerial.
- Operates from PP9 or similar battery.
- Full comprehensive data applied with each Receiver.
- All coils and I.F.s, etc, fully wound ready for immediate assembly. An outstanding Receiver.



Can be built for

£5.19.6

P. & P. 4/6

REALISTIC SEVEN De Luxe

With the same electrical specification as standard model—PLUS A SUPERIOR WOOD CABINET IN CONTEMPORARY STYLING covered in attractive washable material, with super-chrome trim and carrying handle. Also a full vision circular dial, externally mounted to further enhance the pleasant styling. **ONLY 21 EXTRA** Both models: Battery 3/8 extra. (All components available separately.) Data and instructions separately 2/8, refunded if you purchase parcel.

SINCLAIR SUPER MINIATURES

We stock the complete range of Sinclair Super-miniatures.

THE MICRO-6 miniature radio only 1 1/2" X 1 1/2" X 1 1/2".....	42 19 6
THE SLIMLINE 2-transistor pocket radio	42 9 6
THE MICRO-FM. (tuner/receiver)	45 18 6
THE X-20 20 watt P.W.M. amplifier	87 19 6
Available ready built, tested and guaranteed	49 19 6
THE X-10 10 watt amplifier and pre-amp.	45 19 6
Available ready built, tested and guaranteed	26 19 6

VEROBOARD — Veroboard is a high grade laminated board with regular matrix of holes. Ideal for producing single items.

Boards	Accessories
42/1503 2 1/2" X 5 in.	3/8 Terminal pins — pkt. of 50
43/1504 2 1/2" X 3 1/2 in.	3/- Spot face cutter tool
46/1507 3 1/2" X 5 in.	5/2 Pin inserting tool
40/1508 3 1/2" X 3 1/2 in.	3/8 Post 6d. per item extra.
44/1505 3 1/2" X 17 in.	12/6 Orders of 10/- and over post free.

TRANSISTORS

ALL BRAND NEW AND GUARANTEED

GET 81, GET 85, GET 86 2/6; 873A, 874P 3/6; OC45, OC71, OC81D 4/6; OC 44, OC 70, OC 70, OC 81 5/6; (match pair 10/6); AF 117, OC 75, OC 200 6/6; OC 42, OC 43, OC 73, OC 82D 7/6; OC 201, OC 204 15/-; OC 205, OC 206 19/6; OC 28 24/6.

TRANSFILTERS By BRUSH CRYSTAL CO. Available from stock.

TO—01B 465 kc/s. ± 2 kc/s.	TO—02D 470 kc/s. ± 1 kc/s.	7/6 EACH
TO—01D 470 kc/s. ± 2 kc/s.	TF—01B 465 kc/s. ± 2 kc/s.	
TO—02B 465 kc/s. ± 1 kc/s.	TF—01D 470 kc/s. ± 2 kc/s.	Post 6d.

207 EDGWARE ROAD, LONDON W.2 Tel: PAD 3271
33 TOTTENHAM CT. RD., LONDON, W.1 Tel: MUS 2605

Both open all day Saturday. Early closing Thursday.

Please address all Mail Orders and Correspondence to 3-15 Cavell St., Tower Hamlets, London, E.1. Tel.: STE 4821/2

CONSTRUCTORS BARGAINS

SPECIAL PURCHASE OFFER

7 TRANSISTOR RADIO CHASSIS

Superhet chassis, fully built—by famous British manufacturer—on printed circuit. Uses 7 Newmarket transistors giving 500 mW push-pull output—3 I.F. stages; ferrite rod aerial. Covers full long and medium wavebands—200/550M and 1200/2000M and switched band spread on 308M (Luxembourg). 4 1/2in. speaker; fitted: volume control on/off switch, tuning dial and position for car aerial socket. Uses any 9V battery. Overall dimensions—7in. X 4 1/2in. X 2in. Absolutely complete except for cabinet.



LASKY'S PRICE 69/6 Post 5/-.

Recommended battery PP6 2/9 or PP7 3/8 extra.

The "Sixteen" Multirange METER KIT

This outstanding meter was featured by *Practical Wireless* in the Jan. '64 issue. Lasky's are able to offer the complete kit of parts as specified by the designer.

RANGE SPECIFICATION: D.C. volts: 0-2.5-25-50-250-500 at 20,000 Ω/V. A.C. volts: 0-25-50-250-500 at 1,000 Ω/V. D.C. current: 0-50 μA, 0-2.5-50-250mA. Resistance: 0-2,000 Ω, 0-200k Ω, 0-20 MΩ. Basic movement: 40 μA i.s.d. moving coil. With universal short full scale deflection current is 50 μA. Black plastic case—3 1/2" X 5 1/2" X 1 1/2". Controls: 12 position range switch; separate slide switch for A.C. volts—D.C. ohms; ohms zero adjustment pot. meter, meter zero. Power requirements: One 15v. and one 1.5v. batta. Complete with all parts and full construction details. H.P. Terms available.



Data and circuit available separately, 2/6; refunded if all parts bought. Pair of batteries 2/- extra.

LASKY'S PRICE £5.19.6. P. & P. 5/-

FROM PRE-AMP TO 20 WATT HI-FI STEREO ASSEMBLY WITH MARTIN AUDIOKITS

Using specially developed circuits, the very latest transistors and printed circuits—these kits are all fully checked and tested before leaving the factory. Although the kits are basically designed for use together the pre-amplifier and mixer stages may be used to great advantage with existing valve or transistor equipment.

KIT 1. 0-stage Matching Input Selector Unit.....	LASKY'S PRICE 47/6.
KIT 2. Pre-amplifier with volume control.....	LASKY'S PRICE 37/6.
KIT 3. 3-Channel Mixer with plug-in adaptors for individually matching each circuit. Adaptors 8/8 each.....	LASKY'S PRICE 79/6.
KIT 4. Pre-amplifier with tone/volume control stages.....	LASKY'S PRICE 82/6.
KIT 5. 19 and 5 watt Main Amplifier.....	LASKY'S PRICE 45/12/6.
KIT 6. Power supply converter unit.....	LASKY'S PRICE 52/6.
KIT 7. 15 ohm version of Kit 5.....	LASKY'S PRICE 26/12/6.
KIT 8. Power supply for Kit 7.....	LASKY'S PRICE 22/15/-.

SPECIAL INTEREST ITEMS!

Give a Lasky's Gift Voucher

The ideal gift for all special occasions. Any value in multiples of 10/6 (min.) upwards.

You give pleasure with a Lasky's Gift Voucher.

TEST METER ADAPTOR

Type F.E. 220—this is a fully transistorised device which enables any 50 microamp D.C. Multimeter to be used in place of a valve voltmeter. On the 1V. range an impedance of 1 megohm is offered which increases on the 1000 V. range to 100 megohms. 7 ranges: 1 to 1000 volts. Designed for immediate connection to Avo 8 and similar size meters but quite suitable for use with any other 50 microamp meter. Size 6 X 6 X 5 in. New and boxed. List Price 7 Gns.



LASKY'S PRICE 39/6

Post 2/6. Set of batteries 7/5 extra.

GORLER UT 340 FM/VHF Tuning HEART

Permeability tuned—covering 87 to 108 Mc/s. For use with one ECC85 valve. In metal case, size 3 X 2 1/2 X 1 1/2. Circuit supplied.

LASKY'S PRICE 19/11 Post 2/-.

ECC85 valve 9/- extra

U.H.F. TUNERS

Only a few available. Complete with PC86 and PC88 valves. We regret no circuit or data is available. Knobs included.

LASKY'S PRICE

69/6 Post 2/6.



LASKY'S FOR SPEEDY MAIL ORDER SERVICE

EXCEL

in

ELECTRONICS

Through this ICS 3-way Training Method:

MASTER THE THEORETICAL SIDE

From basic principles to advanced applications, you'll learn the theory of electronic engineering, quickly and easily through ICS. That's because each course is set out in easy-to-understand terms.

MASTER THE PRACTICAL SIDE

ICS show you how to develop your practical abilities in electronic engineering—alongside your theoretical studies. It's the only sure way to success. All training manuals are packed with easy-to-follow illustrations.

MASTER THE MATHEMATICAL SIDE

To many this aspect is a bitter problem. Even more so because no electronic engineer is complete without a sound working knowledge of maths. But new ICS teaching makes mathematics easier to learn.

Wide range of courses available include: Radio/T.V. Engineering and Servicing, Colour Television, Electronics, Electronics Maintenance, Instrumentation and Servomechanisms, Telemetry, Computers, etc. NEW! Programmed Course on Electronic Fundamentals

EXPERT COACHING FOR:

- INSTITUTION OF ELECTRONIC AND RADIO ENGINEERS
- CITY AND GUILDS TELECOMMUNICATION TECHNICIANS
- CITY AND GUILDS SUPPLEMENTARY STUDIES
- R.T.E.B. RADIO/T.V. SERVICING CERTIFICATE
- RADIO AMATEURS' EXAMINATION
- P.M.G. CERTIFICATES IN RADIO TELEGRAPHY

And there are practical "learn as you build" radio courses as well.

Member of the Association of British Correspondence Colleges.

FOR **FREE** HANDBOOK POST THIS COUPON TODAY

ICS, Dept. 151, INTERTEXT HOUSE,
PARKGATE ROAD, LONDON, S.W.11

NAME

ADDRESS

OCCUPATION..... AGE..... 3-66

INTERNATIONAL CORRESPONDENCE SCHOOLS

Make a wonderful range
of inexpensive devices

with DRY REED SWITCHES

Can be actuated by permanent or electromagnets to provide excellent basis for a wide range of inexpensive devices such as burglar alarms, limit switches, door bell switches, etc. Tremendous reliability factors and a working life of about 100 times that of microswitches and the uses to which they can be put is limited only by imagination. Each switch supplied complete with specification, instructions and ideas information. **SUITABLE MAGNETS 1/- extra.** **REED SWITCH COILS 4/- post free** Specially manufactured to provide

electro-magnetic operation of Dry Reed Switch described above. Coil is simply pushed on to glass tube and centrally located over switch contacts. Works from any 4-12 v. D.C. supply. Size overall $\frac{1}{2}$ in. diam. x $\frac{1}{2}$ in. long.

CHANGEVER REED SWITCH. 12/6 Post Free

Similar in construction to types listed above except that the reed is spring-loaded against one contact until actuated by a field from a permanent or electro-magnet to transfer connection to a second contact. Glass size: 1.375 in. long x 0.201 in. dia. Breakdown voltage 350 volts DC minimum. Contact rating for long life 250 mA at 250 volts AC. Amperes turns to Just Operate 70-120. Release 30-70.



Super VOLT/OHM MULTIMETER
£4-19-6 P&P 2/6

Meticulously constructed and employing heavily damped jewelled meter movement allied to first grade tolerance components and heavy

silver plated low-loss selector switch. Housed in robust plastic case with wide clear view dial. Sensitivity of 20,000 ohms per volt DC and 10,000 ohms per volt AC makes suitable for most electronic measurements. Ranges: DC: 0.5-25-50-250-500-1,000v. 50uA-5-50-500mA. AC: 0.10-50-100-500-1,000v. RESISTANCE: 0.6K-60K-600K-6meg. OUTPUT: -20 to +22db. SIZE: $3\frac{1}{2}$ x $5\frac{1}{2}$ x $1\frac{1}{2}$ in. deep. Complete with test leads, battery and full instructions.



Make simple AUTOMATIC CONTROLS with CADMIUM SULPHIDE PHOTO-CELLS

Cadmium Sulphide photocells are photo-conductive devices, i.e. they act as light sensitive resistors which become more conductive when exposed to light. They combine robust construction with great reliability, and can be readily fitted as light triggering devices into a wide range of simple control circuits. Typical uses include automatic light controls for home and car, flashing barricade or breakdown lights, exposure meters, brightness controls. They are not polarity conscious and can be used with AC or DC supplies. Spectral response covers entire visible light range.



TYPE 1



TYPE 2



TYPE 3



TYPE 4

TYPE 1—Plastic encapsulated $1\frac{1}{2}$ in. diam. x $\frac{1}{2}$ in. thick. Time response 2 megohms. Resistance 100 Lux-700 to 3,000 ohms. Max. volts 200. Max. current 10/- Post Free 250 mW.

TYPE 2—Plastic encapsulated $\frac{1}{2}$ in. diam. x $\frac{1}{2}$ in. thick. Time response 1 megohm. Resistance 100 Lux-500 to 2,000 ohms. Max. volts 150. Post 150. Max. current 7 mW. 8/6 Free

TYPE 3—Glass sealed with M.E.S. base. Glass envelope $\frac{1}{2}$ in. diam., **TYPE 3** overall length 1 in. Time response 90 megohms. Resistance 100 Lux-0.05 to 0.15 megohms. Max. volts 150. Max. current 75 mW. 6/6 Free

TYPE 4—Hermetically sealed, glass window faced. $\frac{1}{2}$ in. diam. x $\frac{1}{2}$ in. thick. Time response 1 megohm. Resistance 100 Lux-15,000 to 50,000 ohms. Max. volts 100. Max. current 5/- Post 20 mW. Free

Construct Electronics with NEW VEROBOARD Quickly, Cheaply, Professionally

VEROBOARDS supplied by Proops Brothers Limited have been specially designed to meet the needs of the amateur constructor: hole matrices have been pitched to provide the greatest utility in a wide variety of circuit layouts; purchase price has been kept low by the deliberate selection of one standard board width (22 way) which may be used with almost any circuit but permits large quantity purchase with attendant saving; specially prepared design sheets are provided with each purchase to simplify circuit layout; accessories have been kept to an essential minimum to further reduce cost.

VEROBOARD SHEETS. 12/6 each. Post Free. Board size overall: 17 in. long x $3\frac{1}{2}$ in. wide 0.0312 in. thick. Each is clad with 22 x 0.0015 in. thick copper conductors which are fully pierced in line at 0.156 in. intervals across width and 0.2 in. along length. Boards are treated with flux preservative to give protection and ensure satisfactory soldering. A design sheet is supplied with each board.

SPOT FACE CUTTER. 8/6. Post Free. Specially designed hand cutting tool with hole locating spigot. Light turning and pressure removes copper conducting strip locally to make a neat break.

TERMINAL PINS. 50 for 3/6. Post Free. Made specially for Veroboards of pre-tinned brass with a flat head to give maximum contact, and self-cutting serrations near the head to ensure a tight fit when pushed into the hole.

INTRODUCTORY VEROBOARD KIT. 24/- Post Free. Includes one sheet of Veroboard, Design Sheet, Spot Face Cutter, 50 Terminal Pins, and instruction on design method and layout procedure.

PROOPS
BROTHERS LIMITED

52 TOTTENHAM COURT ROAD, LONDON W1.
PHONE: LAMHAM 0161. HOURS: 9am-6pm
THURS: 9am-1pm. OPEN ALL DAY ON SATURDAY

Why

NOT BUILD ONE OF OUR PORTABLE TRANSISTOR RADIOS...

All components may be purchased separately if desired. Parts price lists and easy build plans available separately at prices stated. Overseas post 10/-.

BACKED BY OUR SUPER AFTER SALES SERVICE

NEW ROAMER SEVEN Mk IV

Amazing performance and specification ★ Now with PHILCO MICRO-ALLOY R.F. TRANSISTORS
FULLY TUNABLE ON ALL WAVEBANDS ● 9 stages—7 transistors and 2 diodes
 Covers Medium and Long Waves, Trawler Band and three Short Waves to approx. 15 metres. Push-pull output for room filling volume from rich toned 7" x 4" speaker. Air spaced ganged tuning condenser. Ferrite rod aerial for M & L Waves and telescopic aerial for S Waves. Real leather-look case with gilt trim and shoulder and hand straps. Size 9" x 7" x 4" approx. The perfect portable and the ideal car radio. (Uses PP7 batteries available anywhere.)
 ★ **EXTRA BAND FOR EASIER TUNING** Total cost of parts now only **£5.19.6** P. & P. 5/6
OF PIRATE STATIONS, etc.



Parts Price List and easy build plans 3/- (Free with kit)



NEW ROAMER SIX

NOW WITH PHILCO MICRO-ALLOY R.F. TRANSISTORS

● 4 WAVEBAND !!
 ● 8 stages—6 transistors and 2 diodes
 Listen to stations half a world away with this 6 waveband portable. Tunable on Medium and Long Waves, Trawler Band and two Short Waves. Sensitive Ferrite rod aerial and telescopic aerial for short waves. Top grade transistors. 3-inch speaker, handsome case with gilt fittings. Size 7½ x 5½ x 1½in. (Carrying Strap 1/6 extra.)
 ★ **EXTRA BAND FOR EASIER TUNING OF LUX, ETC.**

Total cost of all parts now only **£3.19.6** P. & P. 3/6 Parts Price List and easy build plans 2/- (Free with kit)

TRANSONA SIX

● 8 stages—6 transistors and 2 diodes

This is a top performance receiver covering full Medium and Long Waves and Trawler Band. High-grade approx. 3in. speaker makes listening a pleasure. Push-pull output. Ferrite rod aerial. Many stations listed in one evening including Luxembourg loud and clear. Attractive case in grey with red grille. Size 6½ x 4½ x 1½in. (Uses PP4 battery available anywhere.) Carrying Strap 1/- extra.
 Total cost of all parts now only **59/6** P. & P. 3/6 Parts Price List and easy build plans 1/6 (Free with kit)



NEW TRANSONA FIVE

"Home, Light, A.F.N. Lux. all at good volume"
 G.P., Durham

● 7 stages—5 transistors and 2 diodes
 Fully tunable over Medium and Long Waves and Trawler Band. Incorporates Ferrite rod aerial, tuning condenser, volume control, new type fine tone super dynamic 2½ in. speaker, etc. Attractive case. Size 6½ x 4½ x 1½in. with red speaker grille. (Uses 1289 battery available anywhere.)
 Total cost of all parts now only **42/6** P. & P. 3/6 Parts Price List and easy build plans 2/- (Free with kit)

POCKET FIVE

● 7 stages—5 transistors and 2 diodes

Covers Medium and Long Waves and Trawler Band, a feature usually found in only the most expensive radios. On test Home, Light, Luxembourg and many Continental stations were received loud and clear. Designed round supersensitive Ferrite Rod Aerial and fine tone 2½in. moving coil speaker, built into attractive black case with red speaker grille. Size 5½ x 1½ x 3½in. (Uses 1289 battery available anywhere.)
 Total cost of all parts now only **42/6** P. & P. 3/6 Parts Price List and easy build plans 2/- (Free with kit)



MELODY SIX

● 8 stages—6 transistors and 2 diodes

Our latest completely portable transistor radio covering Medium and Long Waves. Incorporates pre-tagged circuit board, 3in. heavy duty speaker, top grade transistors, volume control, tuning condenser, wave change slide switch, sensitive 6in. Ferrite rod aerial. Push-pull output. Wonderful reception of B.B.C. Home and Light, 208 and many Continental stations. Handsome leather-look pocket size case, only 6½ x 3½ x 1½in. approx. with gilt speaker grille and supplied with hand and shoulder straps.

Total cost of all parts now only **£3.9.6** P. & P. 3/6 Parts Price List and easy build plans 2/- (Free with kit)

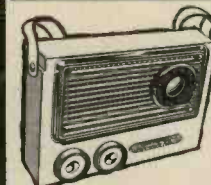

SUPER SEVEN

● 9 stages—7 transistors and 2 diodes

Covers Medium and Long Waves and Trawler Band. The ideal radio for home, car, or can be fitted with carrying strap for outdoor use. Completely portable—has built-in Ferrite rod aerial for wonderful reception. Special circuit incorporating 2 RF Stages, push-pull output, 3in. speaker (will drive large speaker). Size 7½ x 5½ x 1½in. (Uses 9v battery, available anywhere.)

Total cost of all parts now only **£3.19.6** P. & P. 3/6 Parts Price List and easy build plans 2/- (Free with kit)

BARGAIN CORNER!

A.C. ELIMINATOR. To operate 9V Radios from Mains. Also recharges 9V batteries. Complete with leads for PP3 type batteries. Leads can be adapted to suit other 9V battery types. Only 17/6. P. & P. 1/-.

CRYSTAL EARPHONE. With lead, plug, switched socket and fitting instructions. Only 6/6. P. & P. 1/-.

HEAVY DUTY CELESTION SPEAKERS. 3 ohm. Slightly soiled but in perfect working order. 7" x 4". Only 9/6. P. & P. 2/6.

SINGLE PHONES. Heavy magnet assembly. Impedance 60 ohms. Only 8/6. P. & P. 1/6.

FERRITE ROD AERIAL. Medium Wave. 4" x ½". Only 4/6. P. & P. 1/3.

THE SIG-GEN. A versatile Signal Injector. Something no constructor should be without. This ingenious device generates an audible signal through the Audio and R.F. ranges. With variable output. Telescopic Probe. Pocket size slim-line case measures 4½ x 3½ x ½in. Complete set of parts with full instructions. 19/6. P. & P. 1/6.

QUICK CHECK TRANSISTOR TESTER. Checks gain of R.F. and Audio Transistors. Also checks for noise level and duds. All parts ready to be assembled in attractive grey case with red grille, complete with Dial, Knobs, and 2½" Speaker. Simple assembly instructions free with set of parts. 39/6. P. & P. 3/6.

1200mW TRANSISTOR AUDIO AMPLIFIER. Designed to give high quality at low cost. This superb Amplifier uses 4 Transistors including a special power type operating from a 12 volt battery. Variable input impedance. Matches directly into 25 ohms—35 ohms Loudspeaker. Special gain control circuit can also reduce noise to a minimum. All parts including Transistors, Printed Circuit Board, etc. 22/6. P. & P. 2/6. Easy build plans free with sets of parts. 6" x 4" 35 ohm speaker. 12/6. P. & P. 1/6.

CYLDON PERMEABILITY TUNERS. By famous manufacturer. Full M.W. coverage. Fitted coupling coil, oscillator coil, ferrite slugs and slow motion tuning with cursor, etc. In original sealed cartons. GIVE AWAY PRICE 10/-. P. & P. 1/6.

TUNING CONDENSERS. Air spaced fine quality German manufacture with slow motion drive. 0.0005. With oscillator section. Only 5/- P. & P. 1/6.

Callers side entrance
 Barratts Shoe Shop.

RADIO EXCHANGE Ltd

Open 9—5 p.m.
 Saturdays 9—12.30 p.m.

61a HIGH STREET, BEDFORD. Phone: 52367

PUNCHIEST SALE BARGAIN EVER!

£6.19.6 MODEL



BRAND NEW
BLACK & DECKER
D500 5/16" DRILL
NOW FANTASTICALLY REDUCED
TO £4.19.6 POST FREE.

PLUS FREE PARCEL OF ACCESSORIES!

Never ever, ever has this famous Black & Decker D.500 Drill with popular 1/2" chuck been offered at such a price! To clear huge quantity, during our sale, we offer at the incredible price of only £4.19.6, with side handle, generous length

of flex and maker's guarantee AND you get our FREE KIT of twist drills and sanders, AND it's POST FREE! Brand spanking new. For drilling holes in wood, metal, brickwork, etc., sawing, sanding grinding, buffing, hole cutting, polishing, etc., this multi-purpose precision tool saves its cost on 1st or 2nd job! Even shopkeepers could buy from us at this price! Send quickly or call. Refund if not delighted. LISTS, TOOLS, WATCHES, RADIOS, etc.

De Luxe model. Transistor intercom system, originally listed at £6.6.0—Now 57/6, post 2/6. Or 10/- dep. bal. 18 finstly. pyts. of 3/3 plus post. With approx. 66ft. connecting flex, also usable for longer distances. 9-volt battery 2/6 ex. (replaceable). Every sound relayed! Hear what goes on—every sound, every movement. Two-way buzzer call and speaker system. Also usable on wall or desk, in conjunction with radio, office to office, house to garage, and many other uses. Only transistor model with new seal off infallible insulation. Send or call. Lists.

PORTABLE INTERCOM/ELECTRONIC

6 Gas MODEL 57/6
POST ETC. 2/6
OR 10/- DEP.



PREVIOUSLY CHEAPEST BATTERY/MAINS TAPE RECORDER COST £29.10.0!

NOW! our fantastic BATTERY TAPE RECORDER
'ROYAL' Plus MAINS TAPE RECORDER

AMAZING CASH PRICE
£5.19.6 POST ETC 5/-
OR LOW DEPOSIT



PRICE REALLY PULVERISED!

WHAT A GIFT! Simply send 10/- deposit, balance 18 fortnightly payments of 7/9. (Total Credit Sale Price 14/9/6), plus post. Amazing cash price £5.19.6, post 5/-. Fabulous! Fabulous! Fabulous! Check catalogues and prices in the U.K. and see for yourself! NOW "H & G" offer you the FIRST BATTERY/MAINS TAPE RECORDER FOR £5.19.6 IN HISTORY! Obtainable only from us. NOW you can record sound and music, and play back at home on A.C. mains, or record and play outdoors—anywhere using auxiliary batteries. BUILT-IN SPEAKER. WHAT TONE! WHAT VOLUME! SIMPLE FORWARD REVERSE RECORD/PLAYBACK AND VOLUME CONTROL. COMPLETE WITH SUPER SENSITIVE MICROPHONE, EARPIECE FOR PERSONAL LISTENING, FLEX AND PLUG. Truly a comprehensive set. Complete in carry case. Wonderful fun at parties, etc. Send quickly or call at any of our stores. Refund if not absolutely delighted. 2 Tapes for 2/5-. Set of standard batteries 2/6. State if required. Lists, Cameras, etc.

H EADQUARTER & G ENERAL SUPPLIES LTD.

(DEPT. PE/5) 196-200 COLDHARBOUR LANE LOUGHBOROUGH JUNCT., LONDON, S.E.5 (Wed. 1 p.m.)

ALSO 37/39 High Holborn (Thurs. 1 p.m.), and 166 North End, Croydon, and 149 High Street, Guildford (Wed. 1 p.m.). 121 High Street, Colchester (Thurs. 1 p.m.). ALL 6 p.m. SAT., 7 p.m. FRI. ALSO 267/269 Oxford St. (Wed. 1 p.m., Thurs. late night shopping 8 p.m. and Fri. 6 p.m.)

MARTIN Audiokits

FOR HI-FI AND F.M.



20 WATT INTEGRATED STEREO
ADD-ON UNIT SYSTEM
F.M. TUNER
THE EASY WAY TO BUILD AND SAVE

MARTIN AUDIOKITS comprise an ingeniously designed series of fully-transistorised units by means of which you can build up a hi-fi assembly starting with a simple mono amplifier system and adding to it to make a fully integrated 20-watt stereo installation, for well under £30. This can be used with low output as well as crystal pick-ups, radio, tape-heads, microphones, etc. Building is pleasantly easy. Quality is outstanding. Now units for making an FM Tuner are available for adding to Audiokit assemblies or using separately.

Leaflet on request.
From good stockists everywhere.

MARTIN ELECTRONICS LTD.
154-155 HIGH ST., BRENTFORD, MIDDLESEX
Martin Leaflet on Audiokits
FM Tuner , please.

Martin Electronics Ltd
154-155 High St., Brentford, Middlesex. ISLeworth H61/2

NAME.....
ADDRESS.....
Pre.3.....

D & B TELEVISION (WIMBLEDON) LTD.

131 KINGSTON ROAD, SOUTH WIMBLEDON, LONDON, S.W.19
Telephone: CHerrywood 3933

ALL BRAND NEW VALVES GUARANTEED 3 MONTHS
Postage and Packing on Valves 6d. each

AZ31	10/6	EL33	10/6	PL84	7/-	U382	13/9
DAF91	7/10	EL34	9/9	PL500	14/-	U301	13/9
DAF96	7/10	EL36	9/9	PY33	9/6	U801	15/-
DF91	6/8	EL41	8/-	PY80	6/-	UU9	8/6
DF92	6/8	EL84	6/4	PY81	7/-	6F1	9/6
DF/96	7/10	EM80	7/8	PY82	5/6	6F13	12/8
DK91	7/10	EM81	7/8	PY83	9/6	6F14	15/-
DK92	7/10	EM84	8/8	PY88	7/6	6F15	12/6
DK96	7/10	EM85	10/-	PY800	7/-	6F23	10/6
DL92	6/8	EY51	7/-	PY801	7/-	6F24	10/9
DL94	6/8	EY86	7/-	UABC80	7/-	6F25	10/9
DL96	6/8	EZ40	5/6	UBC41	7/-	6F28	9/8
DY86	7/-	EZ41	5/6	UBC81	7/-	6L1	15/6
DY87	7/-	EZ80	5/6	UBF80	7/-	6L18	12/6
EAB80	7/6	EZ81	5/6	UBF89	7/-	6/30L2	9/8
EAF42	8/6	EZ90	5/-	UCC84	8/10	10C2	12/-
EBC33	11/2	GZ32	11/-	UCC85	7/4	10F1	8/6
EB91	4/8	GZ34	11/-	UCF80	9/4	10F9	8/-
EBC41	7/2	HBC90	6/4	UCH42	9/6	10F18	8/-
EBC81	6/6	PABC80	7/6	UCH81	7/3	10P13	12/6
EBF80	7/1	PC86	8/10	UCL82	8/8	10P14	11/-
EBF89	7/1	PC88	8/10	UCL83	10/8	20F2	11/-
ECC81	7/4	PC97	7/6	UCL1	7/6	20L1	12/6
ECC82	7/4	PCC84	7/4	UF42	9/-	20P1	15/-
ECC83	7/4	PCC85	7/4	UF80	7/6	20P3	12/-
ECC84	7/8	PCC86	12/6	UF85	7/6	20P4	13/-
ECC85	7/4	PCC89	10/6	UF89	7/-	20P5	13/-
ECC80	9/6	PCC189	10/6	UL41	7/6	30C15	9/6
ECH35	13/-	PCF80	8/4	UL46	10/6	30C17	11/6
ECH42	8/6	PCF82	9/4	UL87	8/8	30C18	10/-
ECH81	7/-	PCF86	10/6	UY41	5/6	30F5	10/3
ECL80	7/4	PCF801	10/-	UY85	5/6	30FL1	10/3
ECL82	8/8	PCF802	10/-	SY3	5/6	30L15	13/6
ECL83	10/6	PCF806	10/-	SZ4	7/6	30L17	11/6
ECL86	8/8	PCL82	8/4	6Y6	7/7	30P12	9/6
EF80	7/-	PCL83	9/8	6X5	7/5	30P4	12/-
EF85	7/1	PCL84	8/8	R19	14/8	30P19	12/-
EF86	9/4	PCL85	8/8	U25	10/3	30PL1	12/6
EF89	7/1	PCL86	8/8	U26	10/6	30PL3	12/6
EF91	11/-	PL3	10/6	UY191	9/9	30PL14	11/8
EF92	9/-	PL81	8/4	UY193	7/-	30FL14	10/6
EF183	9/8	PL82	6/4	U251	11/8	30FL12	10/6
EF184	9/8	PL83	8/4	U281	13/9	30FL18	10/6

We are open 9 a.m. to 6 p.m. Monday, Tuesday, Thursday and Saturday 9 a.m. to 7 p.m. Friday. Closed all day Wednesday

SERVICE SHEETS. TELEVISION!! ALL MAKES and MODELS. 4/- each. P. & P. 4d.

MAIN LONDON AGENTS FOR CODAR EQUIPMENT



CR70A. Communication Receiver..... £18 10 0
 FR30 Preset selector..... £5 10 0
 RQ.10 "Q" Multiplier..... £8 15 0
 A.T.5 Amateur TX..... £18 10 0
 Postage extra.
 Full details on request.

OS/8B/U OSCILLOSCOPES



High quality Portable American Oscilloscope. 3" cart. 7 1/2 c/s-50 kc/s X Amp: 0-500 kc/s X Amp: 0-2 Mc/s. Power requirements 105-125v. A.C. Supplied in brand new condition, fully tested. £85. Carr. 10/- Suitable Transformer 15/6.



CLEAR PLASTIC PANEL METERS

First grade quality. Moving Coil panel meters, available ex-stock. S.A.E. for illustrated leaflet. Discounts for quantity. Available as follows: Type MR. 38P. 1 21/32in. square fronts.

50µA.....	32/6	10mA.....	22/6
100µA.....	25/6	20mA.....	22/6
200µA.....	27/6	50mA.....	22/6
500µA.....	25/-	100mA.....	22/6
50-0-50µA.....	29/6	150mA.....	22/6
100-0-100µA.....	27/6	200mA.....	22/6
500-0-500µA.....	22/6	300mA.....	22/6
1-0-1mA.....	22/6	500mA.....	22/6
1mA.....	22/6	750mA.....	22/6
2mA.....	22/6		

POST EXTRA Larger sizes available—send for lists.

TRANSISTORISED TWO-WAY TELEPHONE INTERCOM.



Operative over amazingly long distances. Separate call and press to talk buttons. 2-wire connection. 1000's of applications. Beautifully finished in ebony. Supplied complete with batteries and wall brackets. £8.10.0. Pair. P. & P. 3/6.

MAGNAVOX 363 TAPE DECKS

New 3-speed tape deck, supersedes old Collaro studio deck. 2-track £10.10.0. 4-track £13.10.0. Carr. Paid.

GARRARD RECORD PLAYERS

Brand new and guaranteed
 SRP-10 Player..... £4 17 6
 AUTOSLIM Changer..... £5 5 0
 1000 Changer..... £5 19 6
 2000 Changer..... £7 10 0
 3000 Changer—Stereo..... £8 8 0
 SP26 Player—Stereo..... £12 10 0
 DECADEC, with Deram..... £17 17 0
 A70 (less cart.)..... £22 1 0
 LAB80—Mono..... £27 0 0
 401 Transcription..... £30 0 0
 All plus P. & P. 5/-

MINE DETECTOR No. 4A

Will detect all types of metals. Fully portable. Complete with instructions. 39/6. Carr. 10/- Battery 8/6 extra.

CALLERS WELCOME!

Open 9 a.m. to 8 p.m. every day Monday to Saturday. Trade supplied.

LAFAYETTE HA-63 COMMUNICATION RECEIVER



7 valves plus Rectifier. 4 Bands. 550kc/s-31 Mc/s. "S" Meter—BFO—ANT—Bandspread Tuning. 200/250v. A.C. Brand New 24 Gns. Carr. Paid.

ERSKINE TYPE 13 DOUBLE BEAM OSCILLOSCOPE



Time base 2 c/s-750 kc/s. Calibrators at 100 kc/s and 1 Mc/s. Separate Y1 and Y2 amplifiers up to 5.5 Mc/s. Operation 110/230 volt A.C. Supplied in perfect working order. £27/10/-. Carriage 20/-.

NEW MODEL! LAFAYETTE HA-230 AMATEUR COMMUNICATIONS RECEIVER

Supersedes model HE-30. 8 valves + rectifier. Continuous coverage on 4 bands. 550 kc/s-30 Mc/s. Incorporates 1 RF & 2 IF stages. Q Multiplier, B.F.O., ANL, "S" meter, Electrical bandspread, Aerial trimmer, etc. Supplied brand new and guaranteed. £33. S.A.E. for full details. Also available in semi Kit Form. 25 gns.



NEW MODEL! LAFAYETTE HA-55 AIR-CRAFT RECEIVER

108-136 Mc/s. High selectivity and sensitivity. Incorporates 2 RF stages including 6CW4 Nuvistor, 8 tubes for 11 tube performance, solid state power supply, adjustable squelch control, slide rule dial, built in 4in. speaker and front panel phone jack. 200/240V. A.C. Supplied brand new and guaranteed. £19.7.8. Carr. 10/-.



TE-20 RF SIGNAL GENERATOR



Accurate wide range signal generator covering 120 kc/s-260 Mc/s on 6 bands. Directly calibrated. Variable B.F. attenuator. Operation 200/240 v. A.C. Brand new with instructions, £12.10.0. P. & P. 7/6. S.A.E. for details.

LAFAYETTE TE-46 RESISTANCE CAPACITY ANALYZER

2 PF-2,000 MFD. 2 ohms-200 Megohms. Also checks impedance, turns ratio, insulation. 200/250v. A.C. Brand New £15. Carr. 7/6.

LAFAYETTE NUVISTOR GRID DIP METER

Compact true one hand operation. Frequency range 1.7-180 Mc/s. 230v. AC operation. Supplied complete with all coils and instructions. £12.10.0. Carr. 5/-.



2-WAY RADIOS

Superb quality. Complete with all accessories and fully guaranteed.

3 Transistor £7.19.6 pr.
 4 Transistor £11.95 pr.
 9 Transistor £22.10.0 pr.
 10 Transistor 23 gns. pr.
 Post extra. (S.A.E. for full details).
 These cannot be operated in U.K. without licence.



VOLTAGE STABILIZER TRANSFORMERS

Input 80-120v. and 160-240v. Constant output 110v. or 240v. 250 watts. Brand New Guaranteed. £10.10.0. Carr. 7/6.



VARIABLE VOLTAGE TRANSFORMERS

Brand New Guaranteed—Fully Shrouded. Input 230v. 50/60 c/s. Output 0-260 Volts.
 1 Amp..... £4.10.0
 2.5 Amp..... £5.17.6
 5 Amp..... £9.0.0
 8 Amp..... £13.10.0
 10 Amp..... £17.0.0
 12 Amp..... £19.10.0
 20 Amp..... £32.10.0
 2.5 amp. Portable—Metal Case with Meter-Fuses, etc. £9/17/6.



MODEL PV-58 VALVE VOLTMETER

11 meg. input. 7 D.C. volt ranges. 1.5-1,500 v. 7 A.C. volt ranges 1.5-1,500 v. 4,000 Peak to Peak. Resistance 2 ohm to 1,000 megohm. Decibels -10db to +65db. Supplied brand new with instructions, leads and probe. £12/10/- P. & P. 3/6.



TS-76 20,000 O.P.V. PUSH BUTTON MULTI-TESTER

Simple operation, D.C. volts up to 1,000 v. A.C. volts up to 1,000 v. Resistance up to 10 megohm. Current up to 250 mA. Decibels -20 to +36 db. £55.5.0. P. & P. 2/-.



MODEL TE-12

20,000 O.P.V. 0/0.6/6/30/120/600/1,200/3,000/6,000 v. D.C. 0/6/30/120/600/1,200v. A.C. 0/60A 6/60/600 MA. 0/6K/600K/6 Meg. 0/6 Meg. 1/6 P.F. 3 MFD. £5/19/8. P. & P. 2/6.

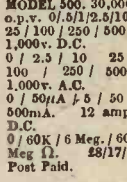

TE-51 NEW 20,000Ω/VOLT MULTIMETER

0/6/60/120/1,200v. A.C. 0/3/30/60/300/600/3,000v. D.C. 0/60µA/12/300 MA. D.C. 0/60K/6 Meg. 0/60K/6 Meg. £2/17/8 Post Paid.



G.W. SMITH & CO (RADIO) LIMITED
 Phone: GERRARD 8204/9155
 Cables: SMITHEX LESQUARE
 3-34 LISLE STREET, LONDON, W.C.2

THIS

is one of the

LEKTROKIT

pages of our
Catalogue

Designed originally by Messrs.
A.P.T. for use in their own
design shops, it was quickly
realised that here was
something that would have
immediate appeal to the
amateur constructor and
design engineer alike. Lektrokit
is a method of quickly building
up a chassis for test purposes,
yet giving that professional
look when completed.

We are the Sole Retail Stockists of Lektrokit in the Home Counties. If you are interested and would also like to examine the other thousands of items in our Catalogue please send 7/6 plus 1/6 postage with the coupon. (Each catalogue contains 5 vouchers each worth 1/- when used as directed.) If you are only interested in Lektrokit please send 6d. with coupon and a brochure will be forwarded.

For Prices see Supplement

HOME RADIO (MITCHAM) LTD.

LEKTROKIT

Introductory Kits are supplied to introduce the LEKTROKIT Chassis Construction System to the new user. Kit No. 1 contains sufficient parts to make up an open type experimental chassis. Kit No. 2 contains additional parts to enable the construction of an enclosed permanent unit.

NOTE: The lists of contents are nominal only and the makers reserve the right to vary them as circumstances dictate.

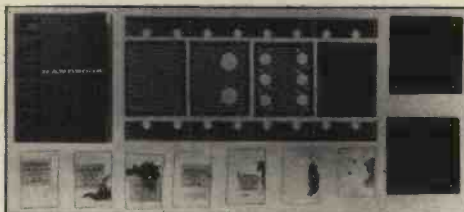

INTRODUCTORY KIT No. LK-011

Contents		Contents		Contents	
Chassis Plate No. 1	LK-111 1	Tagstrip 5-way	LK-2231 6	Pin Soldering	LK-3011 25
Chassis Plate No. 2	LK-121 1	Chassis Rail	LK-201 2	Lektrokit Handbook	1
Chassis Plate No. 3	LK-131 1	Side Plate No. 1	LK-301 2	Screws and Nuts for Assembly	
Chassis Plate No. 4	LK-141 1	Bushes Feed Through	LK-2111 12		
Insulators Lead Through	LK-2021 12				

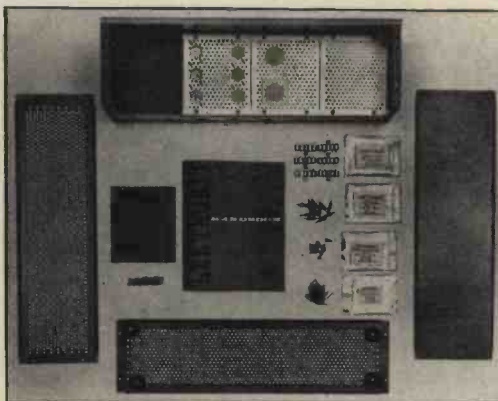

INTRODUCTORY KIT No. LK-021

Contents	
Chassis Plate No. 1	LK-111 1
Chassis Plate No. 2	LK-121 1
Chassis Plate No. 3	LK-131 1
Chassis Plate No. 4	LK-141 2
Insulators, Lead Through	
	LK-2021 12
Tagstrip 5 way	LK-2231 6
Cover	LK-501 2
Cover	LK-511 1
Chassis Rail	LK-201 2
Side Plate	LK-301 2
Front Panel No. 1	LK-401 1
Foot Rubber	LK-2411 4
Bushes Feed Through	LK-2111 12
Pin Soldering	LK-3011 25
Lektrokit Handbook	1
Assembled complete	

110

Introductory kit LK-011.....Price £1.16.6

Introductory kit LK-021.....Price £4.2.3

(Please add 2/6 p. & p.)

Please write your Name and Address in block capitals

Name

Address

.....

.....

.....

Home Radio Ltd., Dept. PE, 187 London Road, Mitcham, Surrey

YET ANOTHER VIEW

AS is now customary, the opening weeks of this year saw the publication of the ITV and the BBC annual Handbooks. This same period also witnessed a unique television occasion—one which may possibly make its mark in next year's editions of these handbooks: after many years' discussion, pay television was at last inaugurated, on a trial basis, in the Westminster and Southwark districts of London. Whether this additional television service is needed, only time will tell. It is however an interesting, and maybe significant, development in the field of home entertainment.

The competition between the two broadcasting organisations is real. ITV as a commercial enterprise is naturally concerned with making money for its shareholders, and the size of its audience has a direct bearing on the rates that can be charged for advertising time. Although a non-profit making organisation, the BBC also has every incentive for obtaining a large share of the viewing audience. This body is sensitive to the fact that all viewers, quite regardless of how they divide their viewing time, contribute to the Corporation's funds. The BBC knows it must hold a very substantial part of this audience in order to justify the existing method of raising funds, and in order to present a strong case for further increasing the cost of the broadcast receiving licence, should this be deemed necessary in the future.

In theory, this keen rivalry between the BBC and ITV should be to the viewers' advantage. In practice, we all know it is not altogether so. Certainly there have been improvements since ITV broke the BBC's monopoly 10 years ago. But the "alternative programme" is largely illusory. With both organisations fighting for the maximum number of viewers the same kind of mediocre fare is all too frequently offered on both channels in the peak viewing hours.

After a somewhat abortive start, the BBC's second television service on u.h.f. has now been reorganised. The Corporation makes a great point of the common programme junctions maintained by BBC1 and BBC2. This seems so obvious an arrangement that one is amazed it was not adopted right at the inception of BBC2.

How will pay television fit into this picture? For technical reasons this new service is limited to wired relay systems. It can therefore never become a serious rival to the two existing systems which operate on a national scale. What it can offer is an additional choice in certain centres of population. The present experiment is confined to one area in London, but later this year it will also be tried out in Sheffield. The permanent establishment of Pay TV and any future expansion will depend on the success or otherwise of these two pilot schemes.

The notion that viewers will be prepared to pay cash in advance for each programme they watch is novel; it is quite a new departure so far as broadcast entertainment in this country is concerned. It is conceivable that a successful PAY-TV network would have much influence on general viewing habits. For instance, perhaps the cultivation of a more discriminating use of the on/off switch might be beneficial all round. Not least, would it save artistes that final humiliation of being relegated to mere providers of background scenes for more pressing domestic activities.

THIS MONTH

CONSTRUCTIONAL PROJECTS

BONANZA BOARDS	180
SIMPLE PRE-AMPLIFIER AND TREBLE BOOSTER	182
DRIVER AMPLIFIER	193
WIRING BOARD HOLDER	196
A.M. RADIO TUNER	205
PORTABLE RATEMETER	208
GUITAR PRACTICE ADAPTOR	217

SPECIAL SERIES

BUILDING BLOCKS—12	189
BEGINNERS START HERE—17	202
NEON NOVELTIES—7	204

GENERAL FEATURES

PRINTED CIRCUIT TECHNIQUES	168
PRINTED CIRCUITS WITH PHOTOGRAPHIC ASSISTANCE	172
RADIO CONTROL OF MODELS	173
AUDIO DENTAL PHENOMENON	184

NEWS AND COMMENT

EDITORIAL	167
AUDIO TRENDS	187
BOOK REVIEWS	195
ELECTRONORAMA	200
MEETINGS	206
NEW PRODUCTS	207
DETACHED PARTICLES	221
READOUT	222

Our April issue will be published on Thursday, March 17

Printed Circuit

HOW TO MAKE YOUR OWN PRINTED CIRCUITS

THE days of the bulky metal chassis are now certainly numbered for the majority of exercises. Not all that long past it was general practice to commence operations on almost any electronic device—audio, radio, television and gadget—by making a chassis first. Early constructors favoured copper for this item (probably because of its good electrical conductivity!). Tin plated steel then became popular, followed by aluminium and currently die-cast alloy. This latter material is also used for enclosed boxes to considerable advantage, particularly for the housing and screening of small printed circuit assemblies.

Constructors keen on v.h.f. and u.h.f. devices found that silver-plated copper gave that little margin of increased efficiency over unplated metal, for the reason that v.h.f. and u.h.f. signal currents flow only in the first two or three microns of chassis surface. Later, however, tin-plated steel was found to be almost as good from this aspect.

TAKING OVER

However, as transistors and solid-state circuits are ousting relatively high temperature valves, so the need for the old-style chassis is diminishing and the printed circuit is taking over.

The printed circuit was originally developed as far back as 1945—in connection with a guided missile project. From the commercial aspect, it really started life as an artifice for reducing the cost of manufacturing large numbers of the same electronic assembly. Today, the situation is that almost every commercial radio and television receiver made adopts the printed circuit technique—the chassis as it was known being totally abandoned.

A printed circuit in the context considered here is a piece of insulated board (e.g. plastics laminate), upon which the complete wiring circuit of the assembly appears on one or both sides as a copper pattern. At appropriate points on the board small holes are drilled to accommodate the connecting wires of the components.

The components are thus loaded onto the board and connection to the circuit is made by soldering their shortened wire ends direct to the copper laminate. The printed circuit board therefore serves a similar function as the old-style chassis (since it is upon this that the components are mounted) and also as the wiring.

Printed circuit board assemblies of this nature can be plugged edge-wise into special, multi-contact sockets

and thus secured, or they can be supported in metal or wooden frames, depending upon the size of the board and the requirements. Both of these methods are found in commercial equipments.

Printed circuit boards lend themselves admirably, of course, to small, low temperature transistorised equipment. There are now available hosts of components specially developed for printed circuit board techniques including valve holders, controls and so on.

BASIC PRINCIPLES

For rigid-type circuits, the most usual type of board is copper-clad phenolic paper laminate. This comes in various grades and thicknesses. Of recent years, however, it has become possible to bond copper and other metals satisfactorily to other various board materials. These include flexible backings, leading to the film variety of printed circuit.

In its virgin form, the base material has securely bonded to it the copper surface—on one or both sides (Fig. 1). The copper is in the form of a foil, from about 0.0015in to 0.003in thick, and a very important part of the original process is the correct bonding of the foil to the base material to prevent the copper lifting in service.

The pattern of the required circuit is formed upon the foil by an etching process, this being first designed and drawn on paper. The design is then transferred onto the surface of the copper, in such a way that the required areas of copper appear on the copper in the form of an acid resistant ink. The whole is then placed in an etching bath containing a solution of iron perchloride, which dissolves the surplus copper and leaves only the “painted” areas of copper bonded on the laminate.

The master drawing of the circuit is usually called the “black and white” in the industry. This is drawn to scale, from full-size down to about 20 : 1, depending upon the circuit size. The “black and white” often shows all the circuit detail, including the component wire holes marked as white circles on the black circuit.

A real size photographic negative of the printed circuit is then made of the black and white original, and it is this which is used to print the circuit on to the copper board surface with an acid resistant sensitised chemical. Finally, the board is drilled at the hole positions indicated on the circuit.

The method above described is, of course, that which is employed by printed circuit board manufacturers, where large numbers of boards of the same circuit are

Techniques...

by **GORDON J. KING**

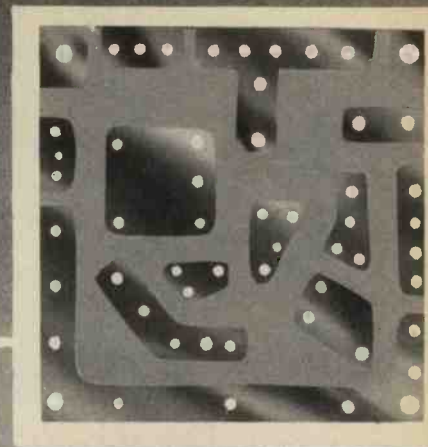

required. For the constructor, the same end result can be achieved by a less complex process, and in many cases an individual board can be processed with less trouble than by employing chassis and conventional wiring techniques.

BE CAREFUL!

Copper bonded laminate board is readily available to the constructor from firms such as those dealing in components and specialising in the needs of the constructor. Indeed, some firms advertise complete kits for the production of printed circuit boards, which include a number of copper bonded boards and all the chemicals needed for the exercise (see photograph below).

A suitable etchant can be produced by mixing 4 ounces of ferric chloride and 1 ounce of hydrochloric acid with 6 ounces of water. *This solution is poisonous and can harm the skin.* The use of rubber gloves is recommended.

IF SPLASHED INTO THE EYES, WASH THEM THOROUGHLY WITH CLEAN, WARM WATER AND CONSULT A DOCTOR OR HOSPITAL IMMEDIATELY. Better still—wear goggles.

The author has used both coloured shellac and cellulose paint as a resist. If shellac is used, about $\frac{1}{2}$ ounce of the crystals should be dissolved in 3 ounces of methylated spirits overnight, and a little dark-coloured spirit dye introduced to make the solution more visible when applied.

DEVISING A PATTERN

The first thing that the constructor has to do is to translate the circuit diagram of the piece of equipment

it is desired to build into printed circuit form. This is by no means as difficult as it may first appear. The printed wiring drawing can follow very closely the actual layout of the circuit diagram. This will be the master pattern to be transferred later on to the copper side of the board (Fig. 2).

The best plan is to make a number of rough translations, doodling with pencil, rubbing out and correcting until a printed circuit drawing which satisfies all the requirements is produced. A certain degree of allowance should be made for the sizes of components used with respect to their positions on board.

The aim should be to keep each inter-component connection as short as possible, a process which will mean orientating the components on the board (or template) until that condition can be attained. The printed wiring must, of course, have hole terminations which will suit the component dimensions, so really, before setting out on the task of translation, the components which are to be used in the equipment must be to hand; or, at least, their dimensions must be available.

Transistors, for example, have various lead-out configurations, so the holes and circuit terminations must match the electrodes in the transistor without the need to cross the wires between the transistor case and the board. Crossed transistor lead-out wires can often result in instability, particularly in v.h.f. and u.h.f. circuitry. The same reasoning applies to other components.

Printed circuit board kit left to right :

etchant, polishing powder, brush,
laminated board with copper face,
and (standing outside the box)
the resist and solvent solution



see over for
picture
sequence



1 Take a piece of copper-clad laminate and cut it 2 inches square with a fine junior hacksaw. Clean the edges

2 Trace the pattern on to the copper surface using carbon paper and drawing over the master pattern outlines

3 Remove the master pattern and "paint" the areas of copper required with the resist fluid

4 The final pattern of resist on the copper should have clean outlines. No resist should be splashed on any unwanted copper

5 Attach a rubber suction pad to the back of the board so that it can be held and agitated in the etching bath. Avoid splashing the etchant on the fingers

6 The final etched board should be clean and show only the black resist patterns. All unwanted copper has been etched away

7 Remove the resist and polish by using fine abrasive powder. Any surplus chemical left on the board can be washed off

8 Drill small holes (about no. 60 diameter) where required. Be very careful not to tear the copper or lift it

9 The finished printed circuit board drilled ready for mounting the components. This example is used in our special series of articles "Bonanza Boards"



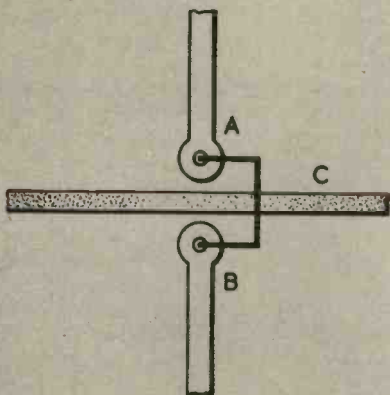

Fig. 10. Method of cross-linking

In cases where it is impossible to complete a translation without one piece of printed wiring crossing another, then the copper strip should have a "break" so that a link wire can be fitted (see Fig. 10).

The example shown here is a perfectly sound design and works quite well. However, quite a large amount of copper has had to be dissolved to leave the copper circuit. While this is not unduly difficult to achieve, it is often advantageous to retain as much copper as possible on, say, the earthed part of the circuit. That is, the parts of the circuit which are considered as being at zero signal potential.

Greater electrical stability is often possible by retaining large areas of "earthed" copper which, of course, are representative of the old-style metal chassis. Such areas are useful for the mounting of, say, transformers, chokes and other similar large components, to ensure a "common earth" throughout the design. Moreover, there is no point in dissolving more copper from the base material than absolutely necessary.

TRANSFER TO COPPER

When a scale drawing of the printed circuit pattern has been finalised, the next step is to transfer this onto the copper foil as a full-size circuit. Unless accurate photographic facilities are available, the best plan is for the constructor to draw the circuit pattern full-size to start with (Fig. 2).

Before transferring the pattern to the copper—or applying the "resist" to the copper it is desirable that the copper surface should be cleaned thoroughly. A light abrasive powder (included in the kit) is suitable for this operation, but keep some by for polishing the finished board. The copper must be clean.

Lay the master pattern on the copper surface with a piece of carbon paper between the two. A good impression will be obtained by drawing over the pattern outlines with a ball-point pen. This process is aided if the master is drawn on a good quality tracing paper. The circuit can then be easily lined up correctly on the copper side of the laminate.

Commercially, of course, the master drawing is, in effect, optically projected onto the copper sheet, and

special sensitised chemicals provide the acid resistant effect, but this is not necessary for the amateur.

RESIST

When the drawing is transferred onto the copper, the next step is to "paint" all the copper circuit elements that are required with an acid resistant ink (Fig. 3). This is sometimes called the "resist". These parts are protected against acid attack and only the exposed sections of the copper are dissolved or etched away in the acid bath.

The resist must be coloured in some way to make it visible on the copper and it should be very carefully "painted" onto the copper, taking extreme care to avoid spilling any of the resist between the required conductor sections.

The definition at the edges of the finished printed circuit will depend upon just how well the resist is applied. It is difficult to achieve an absolute straight line by hand, but good results are possible by applying the resist with a fine paint brush and employing a ruler to steady the hand and guide the brush. Too great an application of resist should be avoided, but all the required copper must be adequately covered (Fig. 4).

The resist, whatever its nature, must be allowed to dry on the copper before the board is put into the acid bath.

ETCHING

The next stage is to commence the etching process. The acid solution, often called the "etchant", *must not be put into a metallic container*; a plastics dish or box makes an ideal bath, provided it is not too deep.

The board should be placed in the solution (Fig. 5); the process can be speeded up by gently rocking the bath or board so as to agitate the solution without splashing. A rubber suction pad can be very useful if attached to the back of the board. It can then be held with the fingers and occasionally moved about so that the fluid is agitated. Lift the board out of the fluid occasionally to inspect the progress of etching.

The time it will take for the unwanted copper to dissolve will depend upon the thickness of the foil and on the strength of the etchant. The process may take a little longer than expected, and a period in excess of thirty minutes may be necessary to complete the process. Towards the end of that time small particles of copper will be seen between the "painted" conductors on the board. These must all be eliminated by the acid before the board is removed from the solution. The final etched pattern is shown in Fig. 6.

After the etchant has had the desired effect on the board, the board should be removed from the bath and washed thoroughly under running water. The resist can be cleaned off the remaining copper with a cellulose or spirit solvent and finally the copper can be polished again with a domestic abrasive (Fig. 7).

DRILLING

It is now a relatively simple matter to drill the board to take the component wires at the appropriate points on the printed circuit (Fig. 8). The copper left on the board must be sufficiently wide to take a $\frac{1}{8}$ in hole or $\frac{1}{16}$ in hole, according to the size and number of wires to be inserted in the respective holes. The finished board with all holes drilled for the "Bonanza Boards" series to follow is shown in Fig. 9.



PRINTED CIRCUITS with PHOTOGRAPHIC ASSISTANCE

by A. W. COUSINS

FOR "one-off" circuits a hand drawn pattern transferred on to the copper laminate, followed by the normal etching process, is a quick, simple and cheap method, but if several identical copies of a circuit are required, such as is shown in the "Bonanza Boards" series of articles in this issue, then photographic assistance can cut out the repetition of the drawing stages.

PRINCIPLE OF OPERATION

A pattern of the desired layout is drawn full size on white paper, using black ink to represent the copper required on the finished printed circuit.

The drawing is then photographed to produce a "black and white" negative.

The negative is projected through an ordinary photographic enlarger on to a sheet of copper laminate and the bright lines of the pattern painted over with any normal resistive paint.

The copper laminate is etched in the normal manner.

OPERATION

When drawing out the desired pattern on white card or paper there will be very few critical dimensions—perhaps an edgewise plug connection, valve base pins, or fixed component tags—these will need to be accurately reproduced. To help their accurate photographic reproduction to the correct scale, it has been found convenient to make two white marks on the original drawing (say at two corners) and note the distance between the marks. When projecting the negative later it is only necessary to adjust the picture size so that the distance between the marks is the same as previously measured, and all the other dimensions should be correct too.

Fig. 1. The original drawing on white paper — an adaptation of the Mullard 5-10 amplifier circuit

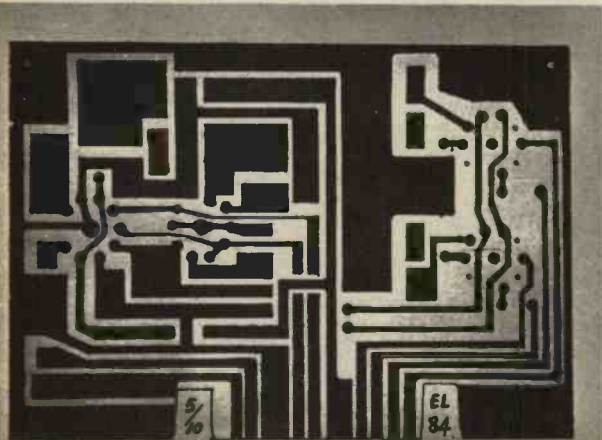

Any black and white film will provide a negative and a portrait lens or other close-up lens is usually required on an average camera. The photograph can be taken out of doors in daylight, or indoors with the aid of a flash-gun. Aim for slight under-exposure of the negative for best results.

When inking in the projected negative remember that the projector lamp will be in use much longer than for normal photographic work, so ensure it has reasonable air circulation to prevent it getting too hot.

Hold the copper laminate steady in a "masking frame" or between drawing pins on the enlarger base plate, adjust the picture focus so that the correct size is obtained. Ink over the white lines (which were black on the original drawing) until all are covered, using a paint brush or dispenser type plastics ink bottle. The process may be repeated for as many copies as required.

SERVICING

The negative has a further use—make a normal full size print on ordinary photographic paper and ink in component locations and references for future use. Under-expose the print to give a grey and white reproduction so that the ink shows clearly. ★

Fig. 2. The original drawing in the foreground with negative being projected on to the copper laminate held in a masking frame. Note paint brush and dispenser type ink bottle

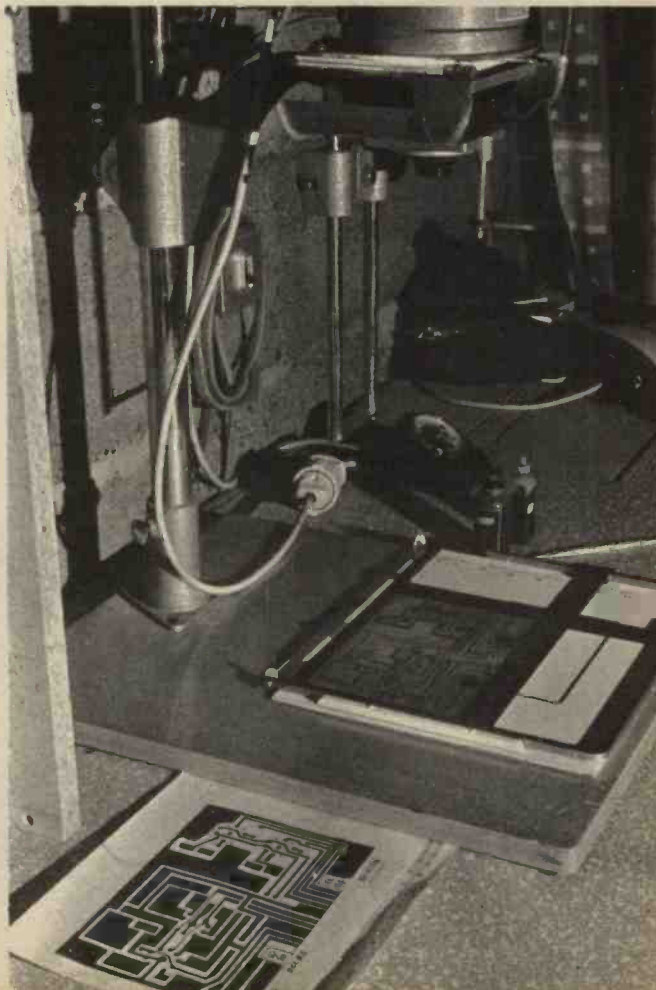

A BASIC carrier wave (c.w.) transmitter need consist only of a simple valve oscillator, suitably coupled to an aerial of definite length, a typical circuit being shown in Fig. 2. 1. The efficiency of such a circuit is generally fairly low and the tuning has to be carefully "peaked" to obtain maximum output, although with too fine a tuning the circuit may be thrown out of oscillation. Equally, the stability of such a circuit is often suspect, particularly if the air-core tuning coil is unsupported.

The tuning "peak" is readily established for, if a milliammeter is inserted in the h.t. positive line to read the anode current, this current will rise rapidly immediately the transmitter goes out of oscillation due to the loss of bias (generated by the oscillations). For "safe" operation it is necessary to back-off the tuning from this point, although this will result in some loss of signal strength. The latter can be checked with a field strength meter and it will usually be found that maximum signal (indicated by the meter) corresponds roughly with maximum anode current. Further fine tuning in one direction will result in loss of signal strength and a slight rise in anode current. Tuning in the other direction results in a sudden loss of signal and a sharp rise in anode current—e.g. typically jumping from about 15–20 milliamps to 40 milliamps or more.

Field strength will also be dependent on the efficiency of the aerial and aerial coupling. Practical resonant aerial lengths are 8–9ft and 48–50in, the former only being suitable for a ground-standing transmitter. Although this type has certain advantages

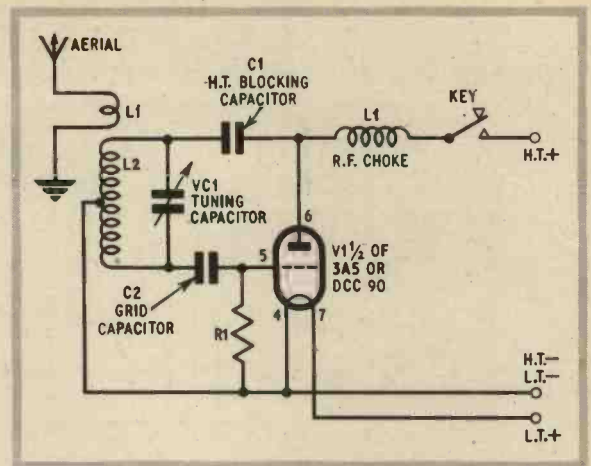

Fig. 2.1. Simple valve oscillator for c.w. transmission. Typical values of components could be as follows: VC1—3 to 30 pF; Coil L2 would have 12 turns of 16 s.w.g. enamelled copper wire, $\frac{7}{8}$ in inside diameter of coil; C1—0.01 μ F; C2—100 pF; R1—10k Ω for 90 volts h.t.

it is also particularly susceptible to detuning due to changes in position, or the dryness of the ground on which it is resting. It also limits movement of the operator to the distance which the keying lead will stretch (and the lead itself is a mechanical weakness, subject to fraying or damage).

Radio Control of Models

PART TWO

SINGLE CHANNEL TRANSMITTERS



By R.H. WARRING

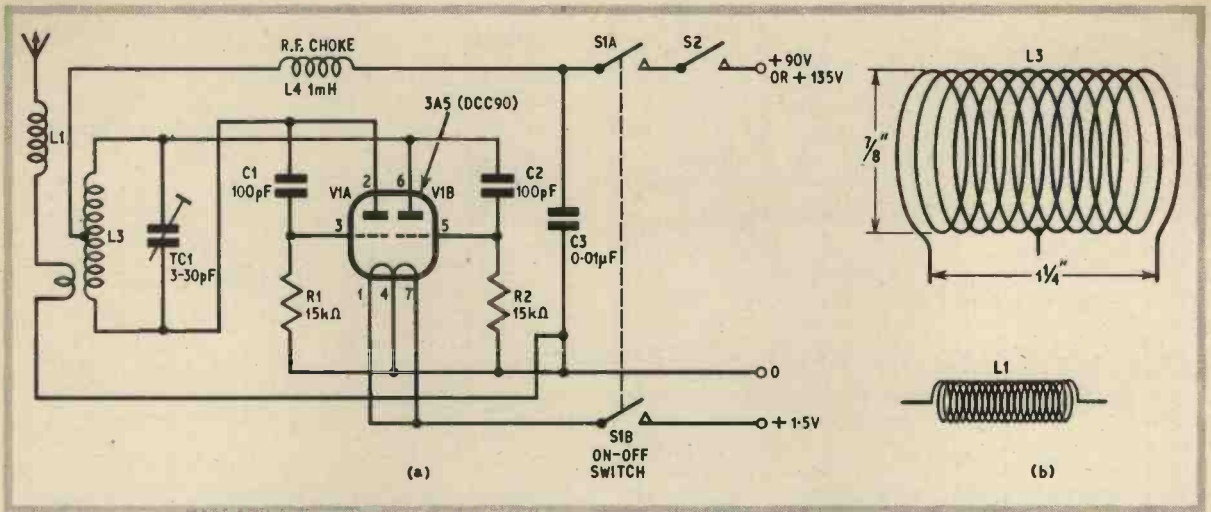

Fig. 2.2 (above). A cross-coupled transmitting circuit is shown in (a). In (b) the winding details for the coils are: L1—20 turns of 20 s.w.g. close wound enamelled copper wire. Adjust the number of turns by experiment. L3—12 turns of 16 s.w.g. enamelled copper wire close wound on $\frac{3}{8}$ in dia. former

CROSS-COUPLED

A practical and well-proven circuit design is shown in Figs. 2.2a and 2.2b, using standard and readily available components. This is also available in kit form¹.

The circuit is of cross-coupled type using a double triode valve (3A5) and can be operated on either 90V or 135V h.t. Filament current is controlled by the values of the grid resistors and, with the recommended 15 kilohm values, is of the order of 12mA and 20mA on 90V and 135V, respectively. Since the valve itself is designed for a filament current of 200mA it is possible to increase the actual filament current substantially (i.e. by reducing the value of the grid resistors) with consequent improvement in range. However, this will markedly reduce the life of the h.t. battery. The values recommended are, therefore, consistent with "optimum" battery performance from a battery of a size suitable for mounting in a hand-held transmitter. The circuit in its recommended form employs a loading coil to improve aerial efficiency, the aerial used being a standard 42in telescopic type. For a ground-standing transmitter where larger batteries can be used and larger current drain tolerated, the grid resistors can be reduced to 10 kilohms with an 8ft aerial; the aerial coupling coil would no longer be required.

Component layout is non-critical and the whole can be accommodated on an s.r.b.p. panel approximately 4in × 2in.

A considerable improvement in performance is realised by employing a master oscillator, power amplifier circuit (MOPA). This relieves the oscillator valve of having to be driven hard, so the circuit can be made that much more stable. This is rather more wasteful of power input since the power absorbed by the first valve is not fed directly to the aerial, but the amplifier stage connected to the aerial is generally more efficient than direct coupling of the oscillator to the aerial. Also, of course, the circuit gains in enabling the oscillator to draw a lower current to operate under more stable conditions, with the final output boosted by the amplifier stage. In practice both the oscillator valve and amplifier valve can be contained within a single envelope (e.g. a 3A5 or DCC 90), offering a compact and simple form of assembly and operation from a single h.t. battery.

Typical single-channel, crystal controlled transmitter with aerial loading coil. The receiver is in the foreground



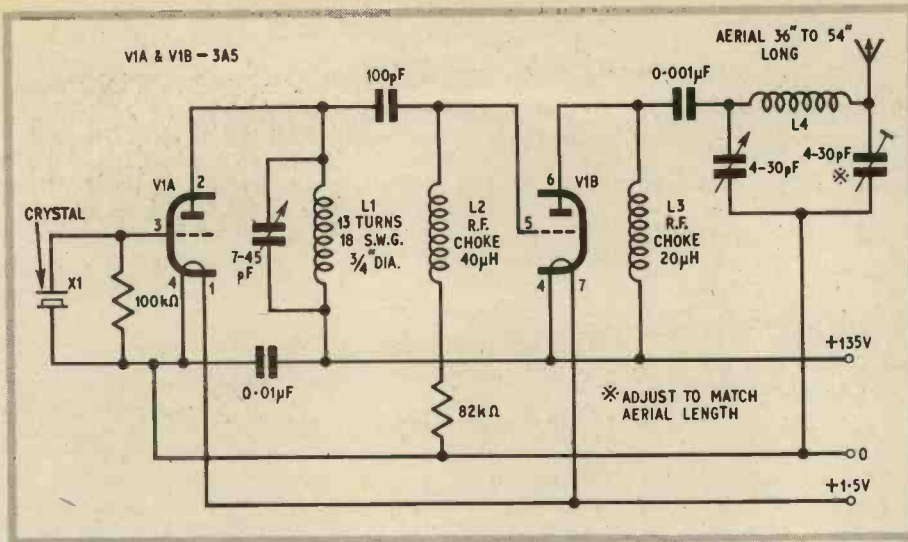

Fig. 2.3a. Two stage crystal controlled transmitter

CRYSTAL CONTROL

A typical basic circuit² is shown in Fig. 2.3a with crystal control added. Tuning is accomplished in two stages—first the oscillator circuit and then a second trimmer in the amplifier circuit for maximum signal strength as indicated by the field strength meter. This latter adjustment can be peaked out exactly for this will not affect the stability of the oscillator circuit. There may, however, be some reaction between stages calling for a repeat of tuning adjustments. Some transmitter circuits, both single-valve and MOPA,

may also have a further trimmer to adjust the aerial coupling. A somewhat more sophisticated circuit is shown in Fig. 2.3b.

For tone operation the carrier is modulated by a low frequency a.f. signal generated by a separate oscillator. This may be applied to either type of basic circuit, although the MOPA circuit is generally much easier to modulate. Because of its other advantages as well, it is the preferred type for all modern transmitters.

Choice of audio frequency is largely arbitrary and

Fig. 2.3b. A somewhat more sophisticated version of the circuit shown in Fig. 2.3a

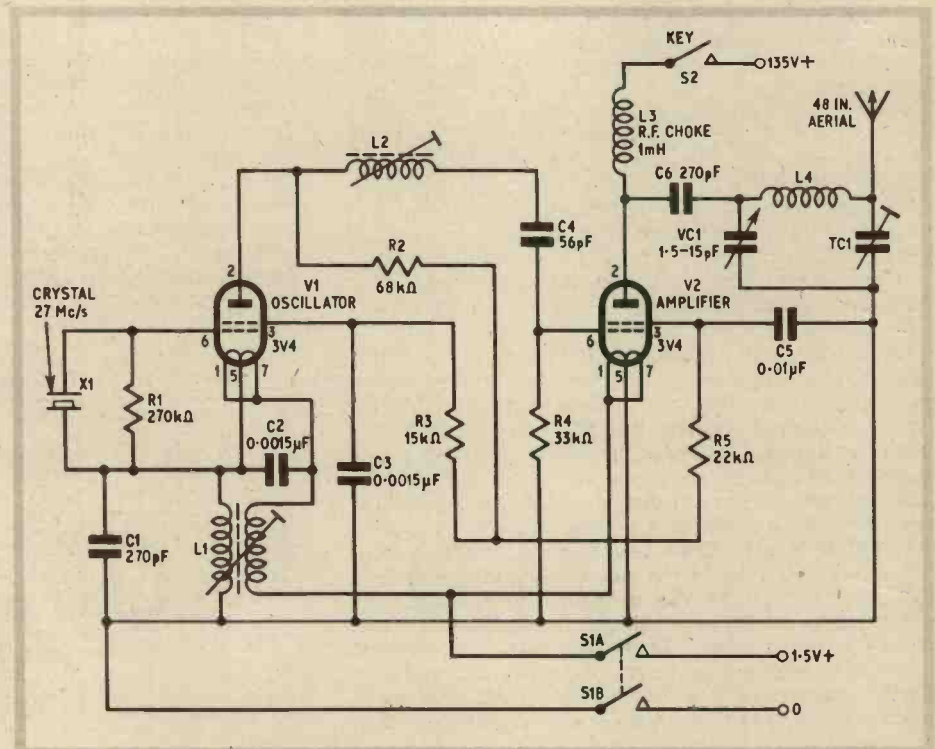

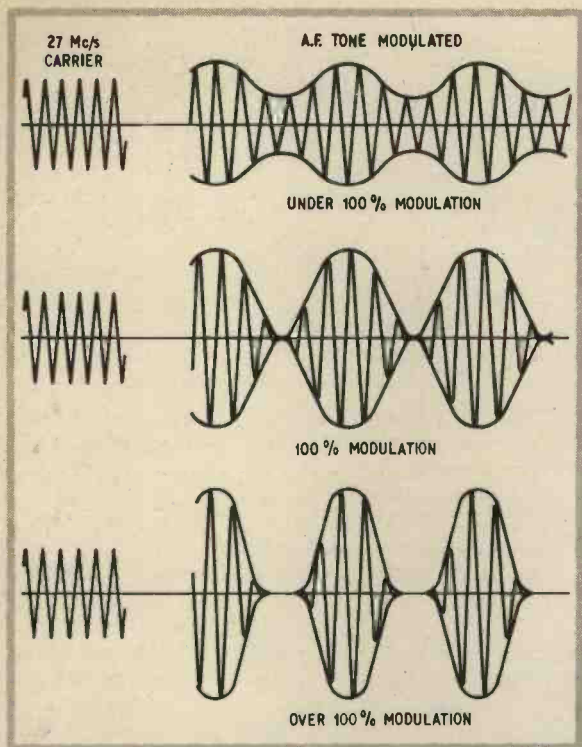

Fig. 2.4. Comparison of modulated signal waveforms

may range from as low as 100c/s to 6,000c/s or more. The range normally favoured for single-channel transmitters is anything between about 500 and 1,000c/s. The degree of modulation usually aimed at is 100 per cent, although some model transmitters produce less and some more than 100 per cent. A possible disadvantage in the latter case is that this produces definite breaks in the carrier which could cause "spatter" (see Fig. 2.4). In practice, the chief effect is that mismatching may occur between different makes of tone transmitter and tone receiver where the design modulation figures differ appreciably. This can also happen where the tone frequency also differs appreciably between the two designs.

Frequency drift can be virtually eliminated with crystal control applied to the oscillator circuit, possible arrangements being shown in Fig. 2.5. In addition to a

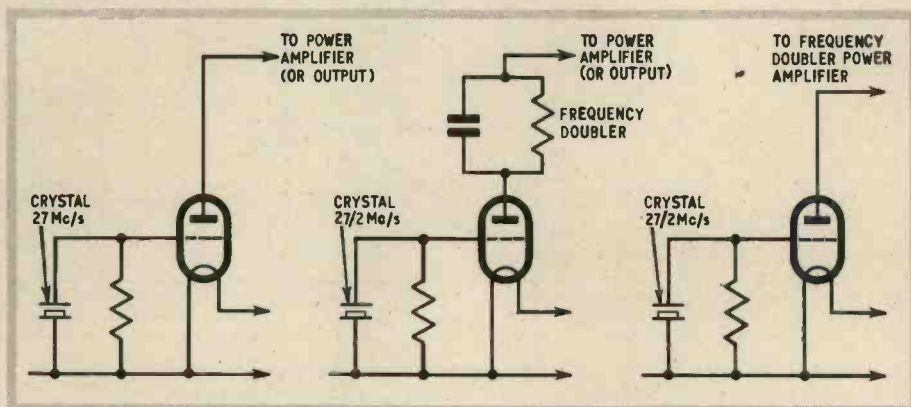

Fig. 2.5. Application of a crystal to control frequency drift using a 27 Mc/s carrier. The centre and right-hand diagrams use a 13.5 (27/2) Mc/s crystal and frequency doubler

spot frequency the crystal employed may resonate at a sub-harmonic (one half or one third of the frequency required), or a third overtone. In the latter case, although the crystal has the geometry for 9Mc/s resonance, it will also oscillate at $3 \times 9 = 27\text{Mc/s}$ in the circuit, and can thus be used directly to control the frequency of the r.f. oscillator. When the crystal frequency is a sub-harmonic equal to one-half of the required output efficiency, then frequency doubling can be introduced either in the anode circuit of the oscillator stage, or in the power amplifier stage.

LOADING COIL

A typical straightforward MOPA type single-channel tone transmitter circuit³ is shown in Fig. 2.6. employing one-half of a 3A5 (DCC 90) valve for the oscillator; the other half of the same valve for the modulator; and a second valve (3D6) for the power amplifier. In modern commercial productions of this type, printed circuit assembly is invariably employed and the aerial coils are usually accommodated on the printed circuit. In this particular example a nominal 48in telescopic aerial is used with inductive coupling and the aerial efficiency improved by the inclusion of a loading coil. This may also be accommodated on the printed circuit panel, although in some cases a wound loading coil is preferred inserted in the centre of the aerial length. In either case, exact matching of the loading coil is essential for optimum results.

A further thoroughly proven single-channel tone transmitter circuit⁴ is shown in Fig. 2.7. This employs a paralleled tone oscillator based on a 3A5 (DCC 90) valve; a second 3A5 valve is used for the master (carrier frequency) oscillator and power amplifier, with conventional crystal control of the master oscillator. Further stability is provided on the commercial production by incorporating the aerial coils on the printed circuit board.

Whilst it is readily possible for such circuits to be duplicated from basic components they are normally purchased as ready-made transmitters or kits of components including a pre-drilled printed circuit panel. The latter method is certainly the best proposition for the home constructor rather than starting from scratch both from the point of view of starting with an established circuit layout (as dictated by the printed circuit panel) and in having a complete set of components of the correct type and values. This is of considerable help in the case of inductors. There is also the point that such circuits are generally thoroughly



Amazing Kodak Quadruple Play Tape brings mains recorder playing times to battery portables!

Tiny 3¼" reel gives up to 5½ hours playing time

Now—revolutionize your battery tape recorder, add *hours* of extra playing time and enjoyment with Kodak Quadruple Play Tape, the modern miracle in sound recording. Just one tiny 3¼" reel holds 800ft. of tape—enough for up to 5½ hours playing time.* (That's over 100 'pops' with time to spare!). And a 4" reel, holding 1,200 ft. can give you up to 7½ hours playing time. There's a 3" reel, too. Sound recording pleasure has *never* been extended like this before!

THE SECRET

The secret of these phenomenally long playing times lies in the unique thinness of the tape base. The thinner the base the greater the length that can be wound on to a given reel—and the longer the playing time. Kodak Quadruple Play Tape, has a base so fantastically thin it's even thinner than the *oxide coating* on Standard Play Tape!

STRENGTH WITH LENGTH

Microscopically thin as it is, Kodak Quadruple Play Tape is no weakling. The Polyester base has been specially pre-stretched and treated to overcome distortion during use. In fact, it will stand up to every stress likely to be met with under all normal conditions, *no matter what the make of your battery tape recorder*. And if you exercise a little extra care you can even use Kodak Quadruple Play Tape on mains recorders, too.

TOTAL UNIFORMITY

Advanced techniques of emulsion coating, developed in Kodak's world-famous research laboratories, have been applied to Quadruple Play Tape with the result that its oxide coating is uniform to within *millionths* of an inch. *The combination of smoothness, sensitivity and signal-to-noise ratio that stems from this extreme coating precision cannot be equalled by any other tapes in the world.*

PLANNED FOR LOW SPEEDS

Another unique extra! Kodak Quadruple Play Tape is actually *planned* for low-speed operation and has a boosted high-frequency response at low tape speeds. This means that at the speeds you'll most likely be using with a portable you'll suffer far less of the usual drop in quality. Your battery portable will surprise even you!

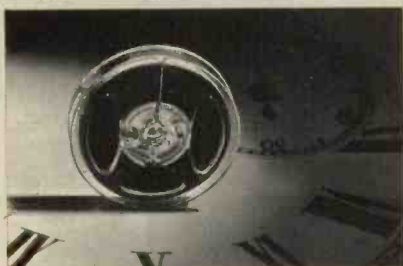

You don't miss a minute of pleasure with the tape that plays on . . . and on . . . and on!

What the magazine 'Tape Recorder' said about Kodak Quadruple Play Tape. August 1965.

"My tests show that the sensitivity at optimum bias is higher than normal, that the high-note-response is much improved over normal tapes and that the drop-out count and amplitude fluctuation are the lowest of any tape yet tested"

"Test tones and sustained musical notes showed a smoothness seldom heard at this tape speed (3¾ i.p.s.)"

Review by Alec Tutchings.

MINIMUM PRINT-THROUGH

Normally, thin tapes are highly susceptible to print-through. But Kodak Quadruple Play Tape has a remarkable resistance to this unwelcome 'echo' effect. In fact, print-through is up by only an inaudible 1.5dB on Standard Play Tape. This feature alone would be enough to set this tape apart!

ACCLAIMED BY THE EXPERTS

Britain's Sound Recording press and many independent experts have been unanimous in praising this and other Kodak Tapes. The BBC and ITV use millions of feet of Kodak tape—and so do professional recording studios the world over. Without a doubt Kodak Tapes have set totally new standards in performance and quality—standards of which you can now take advantage. Fill in the coupon below for full details—then see your Kodak dealer and give your recorder the tape it *really* deserves!

*4-track 1½ i.p.s.

Kodak Tapes—Standard, Long, Double, Triple and Quadruple Play—are available from Kodak Photo Dealers everywhere.



To Kodak Ltd., Dept. 70, Kodak House, Kingsway, London WC2

Please send me full details of all Kodak Tapes

NAME _____

ADDRESS _____

P.E.

KODAK SOUND RECORDING TAPES...the best tapes in the world



FIRST QUALITY PVC TAPE

5½" Std. 850 ft. 9/-	5" L.P. 850 ft. 10/6
7" Std. 1200 ft. 11/6	3" T.P. 600 ft. 10/6
3" L.P. 240 ft. 4/-	5" T.P. 1800 ft. 25/6
5½" L.P. 1200 ft. 11/6	5½" T.P. 2400 ft. 32/6
7" L.P. 1800 ft. 18/6	7" T.P. 3600 ft. 42/6

P. & P. on each 1/6, 4 or more post free.

GEC FLAT HEATER ELEMENT 500 w.



Can be used for wash boilers, washing machines, etc. Five or six elements can be used in parallel to give 2500/3000 watts. Sizes 5½" x 1½", copper enclosed. 2/6 each, P. & P. 1/-, 4 or more Post Paid.

3 to 4 WATT AMPLIFIER KIT

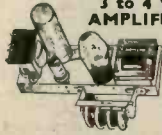

comprising chassis 8½" x 2½" x 1".

Double wound mains

transformer, output transformer, volume and tone controls, resistors, condensers, etc. 6V6, ECC81 and metal rectifier. Circuit 1/6 free with kit. 29/6 plus 4/6 P. & P.



40w. FLUORESCENT LIGHT KIT

incorporating GEC Choke size 8½" x 1½" x 1½", 2 bi-pin holders, starter and starter holder, 11/6. P. & P. 4/6.

Similar to above: 80w. Fluorescent Light Kit incorporating GEC choke size 11½" x 1½" x 1½", 2 bi-pin holders, starter and starter holder, 17/6. P. & P. 5/6.

8-watt 5-valve PUSH-PULL AMPLIFIER & METAL RECTIFIER

Size: 9 x 6 x 1½" A.C. Mains 200-250v. 5 valves. For use with Std. or L.P. records, musical instruments, all makes of pick-ups and mikes. Output 8 watts at 5 per cent total distortion. Separate bass and treble lift controls. Two inputs, with controls, for gram. and mike. Output Transformer tapped for 3 and 15 ohms speech coils. Built and tested. £3.19.6. P. & P. 8/-.

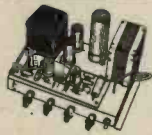

TRANSISTORISED SIGNAL GENERATOR

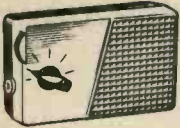

Size 5½" x 3½" x 1½". For 1F and RF alignment and AF output, 700 c/s frequency coverage 460 Kc/s to 2 Mc/s in switched frequencies. Ideal for alignment to our Elegant Seven and Musette. Built and tested. 39/6. P. & P. 3/6.

ELEGANT SEVEN Mk. II

Combined Portable and Car Radio
The Radio with the "Star" Features

- ★ 7-transistor superhet. Output 350 mW.
- ★ Wooden cabinet, fitted handle with silver-coloured fittings, size 12½ in. x 8½ in. x 3½ in.
- ★ Horizontal tuning scale, size 11½ in. x 2½ in. in silver with black lettering.
- ★ All stations clearly marked.
- ★ Ferrite-rod internal aerial.
- ★ Operated from PP9 battery.
- ★ I.F. neutralisation on each stage 460 kc/s.
- ★ D.C. coupled output stage with separate A.C. negative feed back.
- ★ All components, ferrite rod and tuning assembly mounted on printed board.
- ★ Fully comprehensive instructions and point-to-point wiring diagram.
- ★ Printed circuit board, back-printed with all component values.
- ★ Fully tunable over medium and long waveband.
- ★ Car aerial socket. ★ Full after-sales service.



ONLY **£4.4.0**

Plus 6/6 Post & Packing

POWER SUPPLY KIT to purchasers of Elegant Seven parts, incorporating mains transformer, etc. A.C. mains 200-250v. Output 9v, 50mA, 7/6d. extra.

4 in. SPEAKER. Parts list and circuit diagram 2/6. FREE with parts.
Shop Hours 9 a.m. — 6 p.m. Early Closing Wednesday
All enquiries stamped addressed envelope

RADIO & T.V. COMPONENTS (ACTON) LTD.
21D, HIGH STREET, ACTON, LONDON, W.3

Folded Horn enclosure £10.19.0

Nielsen equipment cabinet 18gns



RECORD HOUSING

Turntables, tape recorders, loudspeakers, amplifiers, tuners, records and tapes, there is a Record Housing cabinet to suit your choice. Write for illustrated catalogue of complete range, plus list of stockists. Tel. Bowes Park 7487
Record Housing, Dept 3 PE, Brook Road, London, N22



D.I.Y. with GOODMANS HIGH FIDELITY MANUAL

A new, larger and more colourful edition—revised and completely up-to-date. It contains articles of particular interest to the D.I.Y. enthusiast—including special beginners page, advice on stereo, stage-built systems and full cabinet drawings. Whether building or improving your own audio set-up or choosing a complete speaker system, you'll find it useful and interesting as well as informative. Ask your Goodmans dealer or send coupon for your FREE copy.

Please send me a free copy of the Goodmans High Fidelity Manual

Name

Address

P.E.3

GOODMANS

GOODMANS INDUSTRIES LIMITED
Axiom Works, Wembley, Middlesex
Telephone: WEMbley 1200
A Member of the Rentaset Group

Fig. 2.6. Typical MOPA single channel tone transmitter circuit

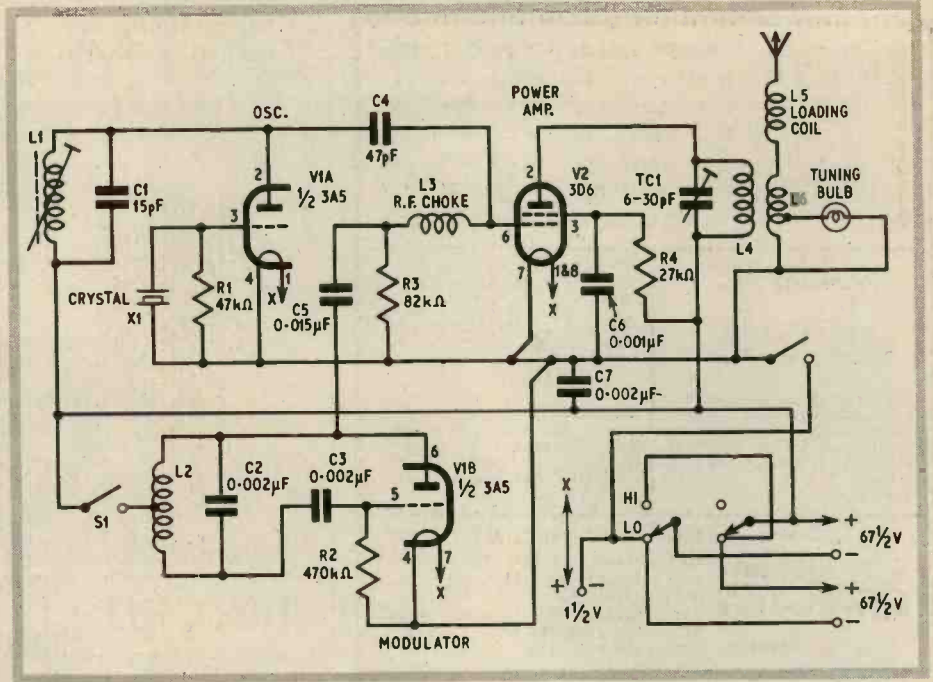

developed and proven. There is probably little further improvement and development that can be done with simple single-channel transmitters of this type, and original circuits seeking "improvements" will almost certainly show inferior results.

A high capacity h.t. battery is a characteristic of all such conventional designs of valve transmitters with a relatively high current drain. The smaller physical

sizes of batteries for reduction in weight, desirable with hand-held transmitters, makes for a relatively short battery life, even though power input may be held to the order of 1.5 to 2 watts, or well below the permitted maximum. In this respect, hand-held transmitters are at a considerable disadvantage compared with ground-standing transmitters, which are not so restricted as regards battery capacity and weight; an

continued on page 198

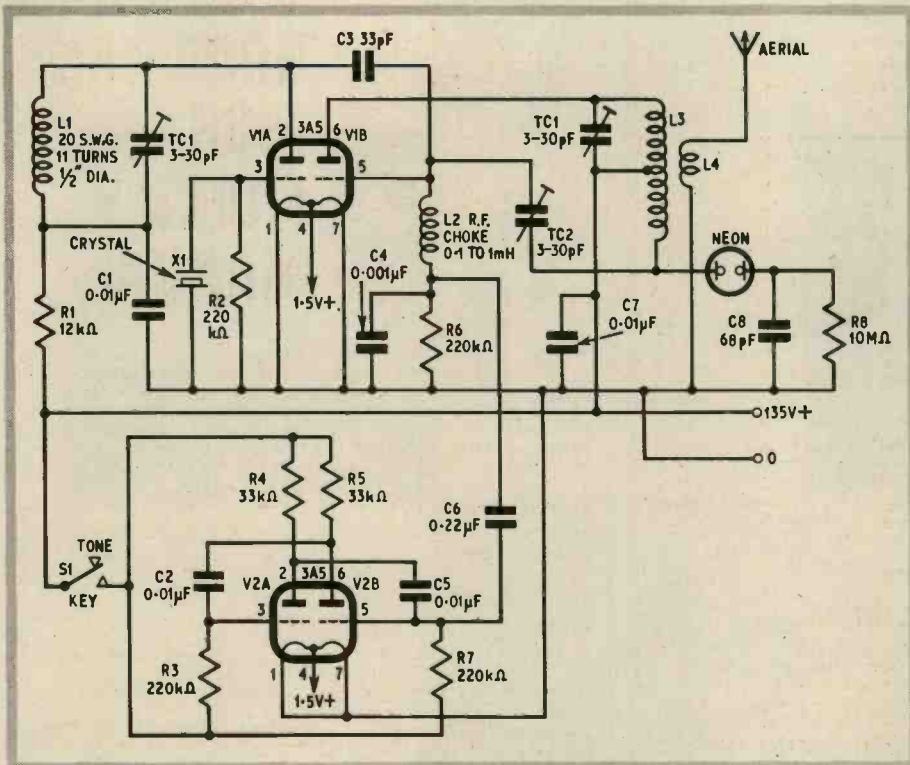
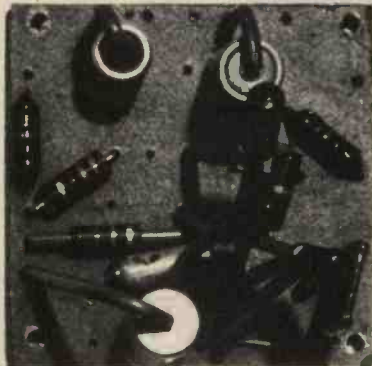

Fig. 2.7. A comprehensive crystal controlled single channel tone transmitter circuit

BONANZA



BB1
SIMPLE
PRE-AMPLIFIER



BB2
DRIVER
AMPLIFIER

BB3
A.M.
RADIO
TUNER



BB4
GUITAR
PRACTICE
ADAPTOR



BOARDS

by A.J. BASSETT

THIS is the first of a series of articles which shows how a small simple printed circuit board can be used to build any one of a number of useful circuits. If required, several of the projects can be built and suitably combined to make up a more complex electronic system, as will be seen in subsequent articles.

The projects described can form a foundation of exercises in building simple practical circuits and, as such, is ideal for the home constructor, schools and science clubs.

Each basic circuit is termed an "electronic building brick"; it is made up on a piece of printed circuit board two inches square. The basic pattern of the board in each case is similar and requires very little modification to enable the constructor to build the circuits of his choice.

This month we show how to form the basic circuit, in the article "Printed Circuit Techniques", then go on to build a radio tuner, a guitar practice adaptor, a simple pre-amplifier which can be adapted as a treble booster, and a class "A" driver amplifier.

BASIC CONFIGURATION

Many transistor circuits are based on a similar basic configuration; the components are actually selected to give the required function. Fig. 1 shows an example of this; the actual components are shown in block form but the wiring between them is *basically* the same.

The circuits to be described in this series are all based on this configuration, but in some cases certain minor deviations will become apparent when we describe individual units.

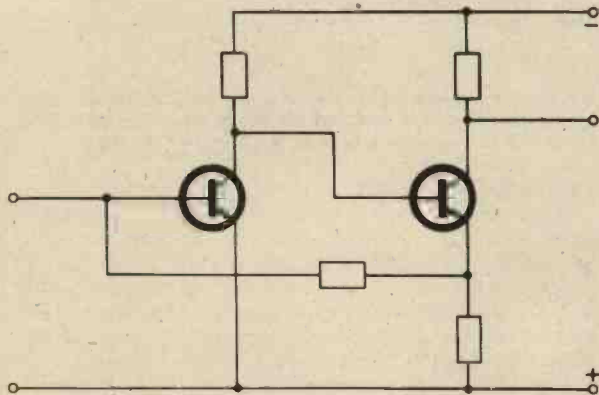

Fig. 1. Basic circuit configuration

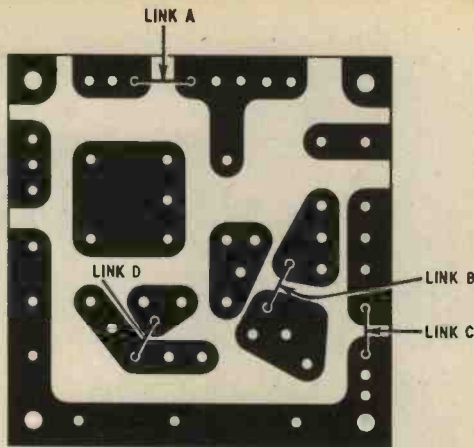

Fig. 2. Printed circuit pattern and link wire connections

PRINTED CIRCUIT BOARD

The basic units described in this series are built on printed circuit boards; a suitable design is shown in Fig. 2 which is the basis of the article showing how to make printed circuits.

A printed circuit kit can be obtained from one of the many component stockists advertising in this journal; the board and chemicals are usually supplied in the kit.

Cut a piece of the board 2in x 2in carefully, using a junior hacksaw. Make sure that you do not let the copper lift or tear as you are cutting.

The pattern of the printed board shown can be transferred direct to the copper laminate by using carbon paper.

After tracing the pattern on the board, paint the area shown in black on Fig. 2, then etch away the unwanted portions with the chemical provided in the kit. The board should then be cleaned so that all the chemical fluid and paint are removed, leaving the required pattern of copper shown in Fig. 2.

The holes to take the component wires should be drilled carefully with a no. 60 diameter drill. Some of these holes are provided to link two or more strips of copper together on some of the units. If an identical board is made for each unit the component connections can be altered to build a different circuit.

SOLDERING

Soldering the components on the board is a simple operation if a hot iron is used and is only allowed to remain in contact with the copper and the component wires for long enough to make good electrical joints.

When soldering the wires of transistors, diodes, and small components, it is best to use a heat shunt, for example a pair of pliers or a copper faced "crocodile" clip. The heat shunt is attached to the wire between the soldering iron and the actual component. This will prevent excessive heat damaging the component.

Look for these projects :

THIS MONTH

- BB1** Simple Pre-amplifier and Treble Booster, page 182
- BB2** Driver Amplifier, page 193
- BB3** A.M. Radio Tuner, page 205
- BB4** Guitar Practice Adaptor, page 217

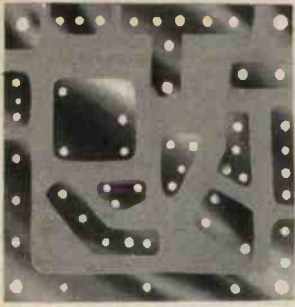

SIMPLE PRE-AMPLIFIER and TREBLE BOOSTER

BB1

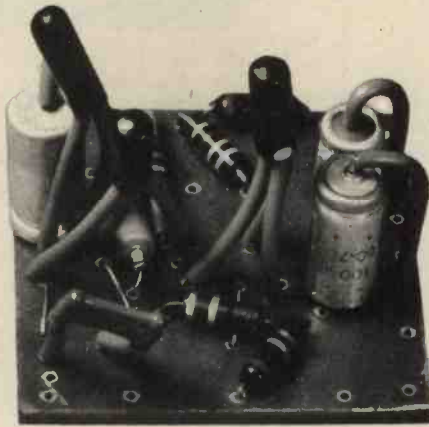

THIS is one of the most simple circuits but is extremely versatile as will be seen later. All the components are mounted on the printed circuit board with the exception of the volume control. This control is optional and can be dispensed with if the input signal is fed direct into the positive terminal of C1; the circuit is shown in Fig. 1.

The input to the pre-amplifier is medium impedance and could be fed with the signal from a low impedance pick-up. If a higher input impedance is required for connecting to a gramophone pick-up (such as a crystal or ceramic type) a resistor of about 100 kilohms should be connected in series with the input. C1 should then be made as high as possible, 50 or 100 μ F.

Assemble all components on the board as shown in Fig. 2, making sure that the electrolytic capacitors and diode are connected the right way round. Observe the connections of the transistors; the collector is the wire nearest the spot on the side of the envelope.

Links should be made by soldering short lengths of wire at positions B, C, and D (see Fig. 2).

Output 1 of the pre-amplifier can be connected to an electromagnetic earphone. Alternatively a driver transformer, whose primary impedance is between 600 ohms and 10 kilohms, can be connected between TR2 collector and the junction of R1 and R5; R3 and C5 should be removed.

If the pre-amplifier is to be used to drive a low impedance load (less than 600 ohms), an additional amplifier, such as the "Driver Amplifier" (described elsewhere in this issue) will be necessary.

The function of "Output 2" will be shown in a later article next month; it provides a low impedance output.

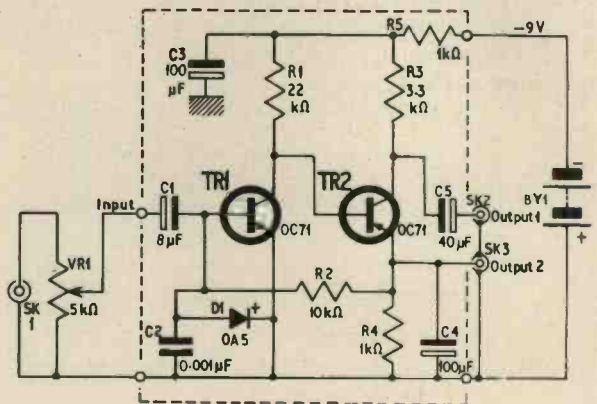

Fig. 1. Circuit of the pre-amplifier. The circuitry enclosed by the dotted line is made up on the printed circuit board. Output 2 will be used in a later article next month

TREBLE BOOSTER

It is a simple matter to convert the pre-amplifier into a treble booster. The value of C4 should be made considerably lower in order to reduce the level of the lower frequencies. A small electrolytic capacitor (8 μ F is quite suitable) should be connected between TR2 emitter and the common positive strip, in place of the 100 μ F capacitor (C4) shown in Fig. 1.

The amount of treble boost required is a matter of personal choice and can be reduced by inserting slightly larger values.

COMPONENTS . . .

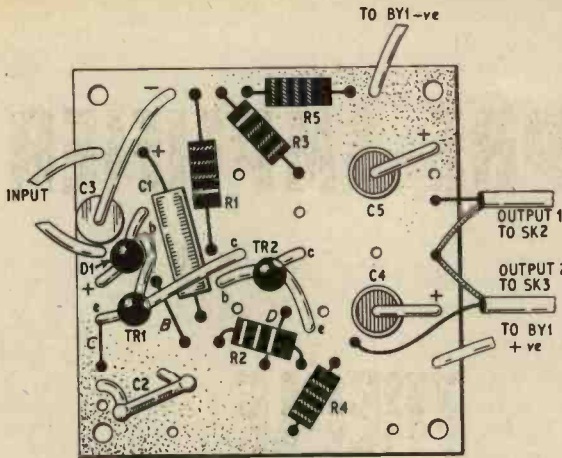

Fig. 2. Layout of components on the board. Note the link wires at B, C, and D

Some readers may prefer to incorporate a stepped variable control by using a switch. The wiper of the switch is connected to TR2 emitter and the "position" tags on the switch to the different value capacitors as shown in Fig. 3. The switch should be a "make-before-break" type otherwise some disturbing noises will be heard when changing positions.

The pre-amplifier and treble booster can be used to amplify the sounds made by the "Electronic Didgeridoo" (described in the November 1964 issue) and the "Electronic Guitar" (described in the January 1965 issue).

USING THE PRE-AMPLIFIER

Being small and at the same time a good matching unit, this pre-amplifier could replace the matching transformer in the "Guitar".

The unit can be mounted in a small box with the volume control and a leakproof battery giving between 3 and 9 volts. Coaxial sockets can be fitted for input and output connections and an on/off toggle switch in series with the battery negative lead. The "sound" lead

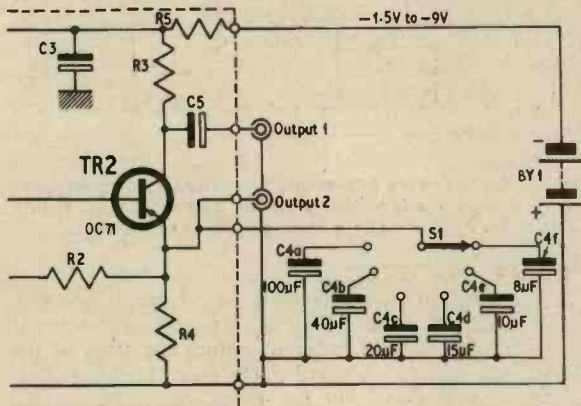

Fig. 3. For the treble booster modification, C4 is replaced by a switch S1 (single-pole, 6-ways) and six alternative capacitance values. These would not be mounted on the printed circuit board

Resistors

- R1 22k Ω
- R2 10k Ω
- R3 3.3k Ω
- R4 1k Ω
- R5 1k Ω

All 10%, $\frac{1}{4}$ watt carbon

Potentiometer

- VR1 5k Ω log. carbon

Capacitors

- C1 8 μ F elect. 15V
- C2 0.001 μ F polyester
- C3 100 μ F elect. 15V
- C4 100 μ F elect. 15V
- C5 40 μ F elect. 12V

In the "treble booster" circuit, C4 is replaced by:

- C4a 100 μ F elect. 15V
- C4b 40 μ F elect. 12V
- C4c 20 μ F elect. 12V
- C4d 15 μ F elect. 12V
- C4e 10 μ F elect. 12V
- C4f 8 μ F elect. 15V

(see text)

- S1 single-pole, 6-way rotary switch (make-before-break)

Transistors

- TR1, TR2 OC71 (2 off) (Mullard)

Diode

- D1 OA5

Battery

- BY1 9 volt light duty or leakproof

Plugs and Sockets

- PL1 and SK1 coaxial for the input
- PL2 and SK2 coaxial for output 1
- PL3 and SK3 coaxial for output 2

Miscellaneous

- Printed circuit board as described in text;
- Switch, single pole, on/off (optional) for battery;
- Battery connectors and p.v.c. covered wire.

from the guitar is plugged into the input of the pre-amplifier. Connect the output of the pre-amplifier into the input of the guitar amplifier or some other suitable power amplifier.

Before switching everything on turn all volume controls down low, otherwise extra gain provided by the pre-amplifier will result in excessive output and may lead to damage of the loudspeaker cone.

Other uses for the pre-amplifier are too numerous to mention here, but there are some which would be very popular in the home: gramophone pick-up, radio tuner, or a microphone can all be used with this unit provided that the input impedance is not more than about 5,000 ohms.



..The AUDIODENTAL PHENOMENON

by F.R. Bertrand, B.D.S.

IT HAS been known for centuries that man can hear through his teeth, but this has not been thoroughly investigated until comparatively recent times.

The phenomenon of hearing through the teeth, or more accurately hearing through the mouth, is referred to as the "audiodental phenomenon" or AD. Through AD, man can hear speech, music etc., with clarity and discrimination that exceeds that of the ears. Artificial teeth are as good, as natural teeth from the AD point of view.

Probably the most famous application of AD concerned Ludwig von Beethoven who, when stone deaf, was able to compose music by biting on a piece of wood fixed to his piano.

TRANSDUCERS

The middle ear is a natural transducer in that it changes airborne sound signals into waterborne sound signals; and deafness due to defects of the middle ear could be referred to as primary transductive deafness. The inner ear is also a natural transducer, as it changes waterborne sound signals into nerve impulses, and deafness due to defects here could be referred to as secondary transductive deafness.

A series of tests have been carried out on AD using mastoid aids, ear pieces from hearing aids and transistor radio sets. For some of these tests a mastoid aid was firmly attached or pressed against a rod, such as a dental bur. The rod transmitted sound waves to the teeth from a signal source. Such a device is referred to as a sonic probe.

FREQUENCY TESTS

Over 30 volunteers (all male) whose ages ranged from 17 to 50 years, were tested. At least ten volunteers had every single tooth tested.

The results were as follows:

(a) AD tests gave similar results to air conduction tests (AC). The frequency range was found to be 1c/s to 15,200c/s. In only a few cases the range exceeded 15,200c/s and none exceeded 20,000c/s.

(b) Different teeth gave different results, but the overall difference was small. Artificial teeth gave different results from natural teeth, but again the overall difference was small.

(c) The upper frequency limit was difficult to assess due to individual concentration limits.

(d) The sound in all cases was located in the mouth, and in fact to a tooth, by the subjects tested.

(e) Hearing was easier to obtain through the teeth when the ears were occluded. This is because reception of sound through the teeth is masked by reception of sound through the ears, at lower levels of intensity.

(f) There was a level or threshold of intensity of sound below which a subject cannot hear through his teeth.

(g) Pin point contact of the transducer with the tooth, if it is firm, is quite sufficient.

A further series of tests were carried out to compare the sensitivity of hearing through the ears and mouth. Ten volunteers (all male) whose ages ranged from 17 to 42 years were tested. Subjects were asked to determine at what frequencies the sound seemed to change from clicks to a buzz then a continuous tone. This tested the low frequency sensitivity through AD and AC.

Air Conduction

Clicks to buzz—90 to 140c/s; average 109c/s.

Buzz to continuous tone—170 to 400c/s; average 268c/s.

Audiodental Phenomenon

Clicks to buzz—50 to 80c/s; average 68c/s.

Buzz to continuous tone—80 to 210c/s; average 136c/s.

Discrimination with AD was higher than with AC.

OBSERVATIONS

Sound received by AD has the advantage of having no interference from background noise as occurs when sound is received by the ears. The sound received from AD is located to the mouth and, with a good transducer, sound can be heard and located to the mouth at the same time as it is received by the ears.

Several subjects noticed a difference in the reception of a given frequency by the anterior and the posterior teeth. For example, by placing the earpiece of a transistor radio set (connected to the radio and switched on) in the mouth on the tongue, with the lips closed and the ears occluded, sound will be heard. Now lightly holding the earpiece between the posterior teeth, the loudness of the sound will markedly increase. Holding the transducer between the anterior teeth, the quality of the sound will change, as may the loudness.

The transducers used in these tests were not designed specifically for AD, but were adapted; they were of the electro-magnetic type.

Many subjects who have been tested for AD have remarked on the quality of the sound reception, and several have referred to it as "pure" sound.

There would appear to be no reason why an AD transducer could not be plugged into a transistor radio in the same way that an earpiece is now used. One could even house a tiny radio in the bowl of a "pipe" so that mechanical sound could be transmitted to the teeth via the stem.

Such instruments may well prove of great value to many deaf people (e.g. people suffering from primary transductive deafness), as well as providing a "pure" source of sound to those of normal hearing. ★

BSR C1 CERAMIC cartridge

FOR PROFESSIONAL QUALITY

Outstanding performance and dependability make the C1 Ceramic Cartridge the natural choice of the professional because, to him, quality is absolutely essential. You, too, can buy this remarkable cartridge which has a performance comparable with designs costing twice as much.

Technical Data

Compliance	5.2 x 10 ⁻⁶ cm/dyne
Sensitivity at 1 Kc/s using Decca SXL 2057 record — 1 cm/sec.	0.110 volts ± 2 db
Stylus pressure	2-3 grammes
Equivalent capacity	600 pF
Loading	2 MΩ 100 pF
Channel difference	less than 3 db
Channel separation at 1 Kc/s	20 db



C1ST3 £2 . 6 . 5 incl. tax. Stereo cartridge with double tipped sapphire stylus.

C1ST4 £3 . 0 . 11 incl. tax. With diamond LP/S tip.



UA15 SS 3B fitted with C1ST3 £10 . 18 . 11 incl. tax.

UA15 SS 3B fitted with C1ST4 £11 . 13 . 5 incl. tax.

UA15 SS 3B 4 speed Automatic Record Changer

Tubular, low mass pick-up arm for featherweight pressure. Large turntable for stability. Manual play facilities. Wow and flutter lowest ever. The ultimate in quality performance and dependability.

Send for details of the complete range of BSR equipment and address of your nearest BSR stockist



BSR LIMITED/MONARCH WORKS/OLD HILL/STAFFS

The world's largest manufacturers of Record Changers & Tape Decks.



RANK WHARFEDALE LIMITED
IDLE, BRADFORD, YORKSHIRE
 Telephone Bradford 612552/3 · Telegrams 'Wharfdel' Bradford

BUILD A HI-FI SYSTEM WITH WHARFEDALE LOUDSPEAKERS

These Loudspeakers are the actual speakers that Wharfedale use in their world famous cabinet models. Each is fitted with roll surround for low resonance and double diaphragm assembly for extended H.F. response.

Send today for further details of these units plus free cabinet construction sheets to enable you to build a top quality Hi-Fi loudspeaker system.

SUPER 8/RS/DD

Frequency range 40 c/s — 20,000 c/s. Impedance 10/15 ohms. Power handling capacity 6 watts (12 watts peak) £7.0.0. (tax paid)

SUPER 10/RS/DD

Frequency range 30 c/s — 20,000 c/s. Impedance 10/15 ohms. Power handling capacity 10 watts (20 watts peak) £11.13.4. (tax paid)

SUPER 12/RS/DD

Frequency range 25 c/s — 20,000 c/s. Impedance 12/15 ohms. Power handling capacity 20 watts (40 watts peak) £17.10.0. (no tax)

FREE CONSTRUCTION SHEETS

Complete this coupon for 8 page booklet on Wharfedale Speaker Units plus FREE CABINET CONSTRUCTION SHEETS for your own Hi-Fi system. (Dept. PE3)

NAME

ADDRESS

TOWN..... COUNTY.....

SENSATIONAL HALF PRICE OFFER!



THE FAMOUS
 'Continental'
RADIOGRAM
 AT
HALF PRICE!

Magnificent Stereophonic Radiogram Chassis complete with two 10" elliptical loudspeakers, plus a Mono/Stereo 4-speed automatic record changer.

Only £29-19-6

- Easily fitted
- No soldering or Technical knowledge necessary
- Fits almost any cabinet with minimum trouble
- Modernises your old radiogram
- Built-in ferrite rod aerial
- Piano key switching
- Luxembourg and Caroline received at full strength
- Listen to U.S.A., Russia, Africa, Canada and even Australia
- Unique Lewis Rodio 365 day guarantee, even on all the valves
- All British make

SPECIAL terms available of £4.10.0 deposit followed by 18 monthly payments of £1.13.0 (total H.P. £34.4.0) + postage & packing 15/- extra.

INDIVIDUAL CABINETS SUPPLIED ON REQUEST

Send your cheque or P.O. today for £5.5.0 while stocks last to Dept. PE36

LEWIS radio

LEWIS RADIO, 100, CHASE SIDE, SOUTHGATE
 LONDON, N.14. Telephone: PAL 3733/9666

WORLD RADIO AND T.V. HANDBOOK 1966

Lists every B/C Station in the world, frequencies, times of operation, call signs, etc. by Johansen. 29/3

PRACTICAL TRANSISTOR SERVICING. New Revised Edition, by Caldwell. 25/-
ABC'S OF ELECTRONIC ORGANS, by Crowhurst. 17/-

ELECTRIC GUITAR AMPLIFIER HANDBOOK, by Darr. 25/-

COMPUTER CIRCUIT PROJECTS YOU CAN BUILD, by Boschen. 22/-

SOLAR CELL AND PHOTOCCELL EXPERIMENTER'S GUIDE, by Hoberman. 25/-
TRANSISTOR POCKET BOOK, by Hibberd. 26/-

HI-FI YEAR BOOK 1966. 13/6

TRANSISTOR SPECIFICATION AND SUBSTITUTION HANDBOOK, by Tech-Press. 16/-

BUILDING AND USING SOUND MIXERS, by Steele. 31/3

TROUBLESHOOTING WITH THE OSCILLOSCOPE, by Middleton. 21/-

All prices include U.K. postage

Where possible 24-hour service guaranteed

UNIVERSAL BOOK CO.

12 LITTLE NEWPORT ST., LONDON, W.C.2
 (Leicester Square Tube Station)

Audio TRENDS...

A Commentary on Sound Reproducing Equipment by Clement Brown

THERE are three main ways of adding tape to a domestic audio installation. Perhaps the most obvious is to use a portable recorder and make arrangements for a rapid and convenient hook-up to the hi-fi amplifier. The latter's facilities and controls can be employed for recording and playback. Then there is the advantage that the recorder can be disconnected and carried off for service elsewhere when required.

This approach is perfectly satisfactory (though some times untidy) provided the machine is of adequate quality. But the non-portable recorder, designed to stand on a shelf and be permanently linked to an amplifier, is also very popular nowadays. In some cases the circuits are minus an output stage, so that playback depends on the hi-fi installation. On the other hand, a few manufacturers give the "furniture look" to complete recorders by fitting them in cabinets with handsome wood finishes.

For example, Philips have introduced the EL3556 which, in its teak cabinet, will look well in its permanent living-room niche. Priced at 62 guineas, this machine has four speeds and is designed for mono recording. Stereo playback is possible, however, and there is the multiplay facility and other features demanded by enthusiasts. Output is 4 watts. A smaller model, the EL3558 (42 guineas) is superficially similar but has one speed and different facilities.

SPECIALISED APPROACH

The third approach to tape recording in the home is a more specialised one, though fairly well known to enthusiasts and all who are interested in semi-professional equipment. A tape deck—the mechanical assembly only—is the first requirement, and a separate electronic unit links the deck to the audio installation. The aim is to provide virtually tailor-made characteristics and functions, with a high standard of versatility.

A new electronic unit of this kind is the Brenell Hi-fi Tape Link, introduced at £46. It is intended for use with a stereo deck and meets the basic requirements for recording and playback: that is, the circuits include separate record and playback amplifiers plus the bias and erase oscillator. There is response correction for four speeds, and the user can monitor while he is recording.

PORTABLE RECORDERS

Returning to portable recorders, Wyndsor's latest model, the Vanguard (59 guineas) is a four-track mono machine featuring an 8in Axiote speaker in the detachable lid. With 7½in/sec as the highest of three speeds, the push-button deck has a pause control, a digital counter and three heads. There are separate recording and playback amplifiers, and it is possible to

monitor from either the tape or the input signal. Track to track recording is catered for and the output is 4 watts.

Another four-track portable, again priced at 59 guineas, is the Van der Molen model VR4, introduced by H. O. Thomas Electronics. A frequency response of 40–15,000c/s \pm 3dB and a wow and flutter figure of 0.15 per cent are quoted for the top speed of 7½in/sec. The output is 5 watts and there are controls for mixing bass, treble and track selection. A useful feature is a direct output from the head at an average level of 2mV. The machine is transistorised. As it happens, both the Wyndsor and Van der Molen recorders offer an unusual advantage—suitability for operation in a vertical position.

Price reductions are not exactly an "audio trend": at least, they are not very common. However, the Telefunken Magnetophon 203 stereo recorder climbs down from 79 guineas to 69 guineas; and a new mains and recharging unit for this firm's M300 and M301 portable recorders, though better than its predecessor, is introduced at the lower price of £9 19s 6d. By the way, the M301 is a four-track version (at 54 guineas) of the M300 twin-track machine, which was made available in the U.K. some time ago.

If the enthusiast intends to make the most of tape recording he must acquire some skill in editing his tapes. Cutting and joining are routine matters; they are not difficult but accuracy is important if strong, noise-free splices are to result.

Perhaps editing will never become a lazy man's speciality, but a new accessory known as Dry-Splice should help towards convenience and speed. It is a prepared length of splicing tape, ready for use and made up in packets of 24 pieces. The unusual feature is a peel-off backing. A card applicator, acting as a guide to tape alignment, is provided.

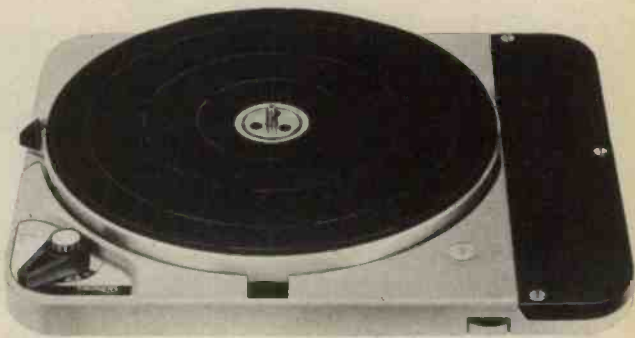

Thorens TD124 Series 2 turntable unit

DISC EQUIPMENT

A modified and improved version of the celebrated Thorens TD124 turntable, a Metrosound speciality, has been introduced at the same price as the original model. This Series 2 unit has an improved motor suspension, and several points of detail—the controls and finish, for instance—have received fresh attention.

The Thorens TD150 turntable, mentioned in an earlier article (page 955, Nov. 1965), now has a partner—the TP13 arm. This new component, available only as part of the complete turntable unit, has an in-built raising and lowering device, a plug-in head shell and a counterbalance weight arrangement which adjusts for playing weights down to 1 gm.

This arm is very much in line with modern developments in which the aim is to reduce the mass of the arm and head shell so that the lightest and most modern cartridges can be used at low pressures. When supplied for building into a cabinet the Thorens turntable and arm have the model number TD150A and the price is £82 0s 9d.

Similarly the new Transcriptor Fluid Arm is for use with modern high-compliance cartridges. This is an extra product in the firm's range, and the original Transcriptor arm continues unchanged in price and specification. Priced at £14 12s 3d, the new arm has a fluid damping arrangement in the unipivot, designed to improve stability and performance generally. Other features are a lowering and positioning device and a bias compensator to cancel side-thrust.

This arm is for playing weights up to 3gm. It is made as a universal model which accepts most cartridges, though the maximum cartridge weight is stipulated as 16gm. There are also special versions intended for Decca and E.M.I. heads. All these are nominally 9in arms but a 12in model is available to order and at an extra charge of 2 guineas.

EQUIPMENT CABINET

It was remarked on an earlier occasion that would-be cabinet constructors can learn from the experts' methods. A splendid example of a large equipment cabinet, intended to house any combination of high fidelity units, is illustrated this month. It is the Karelia De Luxe (49 guineas), the most recent in the Howland-West range. Length is 5ft and the motor-board depth is 20in. The fittings are of anodised aluminium and the standard wood finishes are rosewood and teak.

TUNER-AMPLIFIER

De-luxe tuner-amplifiers, in wood cabinets and intended for shelf mounting, continue to arrive—mostly from Continental sources. One of the most recent is the Hi-fi Studio II, a transistorised stereo tuner-amplifier from Saba.

This ambitious unit, priced at 115 guineas, includes a stereo decoder. Other special features include switchable automatic frequency control on f.m. and adjustable bandwidth on a.m. On the audio side there are transformerless output stages rated at 8 watts sine wave power per channel. Special speaker systems for this unit sell at 58 guineas a pair. Each comprises two drive units and a crossover filter in a 0.9 cu ft enclosure of the infinite baffle type. More complete details are available from Saba Electronics, Eden Grove, London, N.7.

TURNTABLE MAT

Next an accessory for the record user. This is the Colton Antistatimat which, as the name implies, is a turntable mat designed to disperse the static charges which attract dust. The manufacturer states that the introduction of suitable materials into the rubber used for the mat has the effect of conducting away the static built up on microgroove discs. The mat, which retails at 15s 8d, is 12-in diameter and will fit most turntables. It can, however, be cut if necessary.

SPEAKER UNITS

Inexpensive speaker drive units are always of interest to audio enthusiasts. Several twin-cone models, intended for use in simple reflex (vented) enclosures, have been made available by Reproducers and Amplifiers Ltd. The smallest is the 780 Mk V, an 8in unit priced at £3 18s 6d. There are also 10in and 12in models which sell at £4 13s and £4 18s 6d. A useful leaflet, incorporating guidance on the calculation of enclosure volumes, can be obtained from the firm at Frederick Street, Wolverhampton.

Tripletone's new Series 3 electronic units, offering high quality specifications at very moderate cost, so far include the Hi-fi Major amplifier and a f.m. tuner. The amplifier is a 12-watt mono unit. The mains powered tuner, at £17 15s 10d, covers the range 86–104Mc/s and has a sensitivity of 10 microvolts for 500mV output.

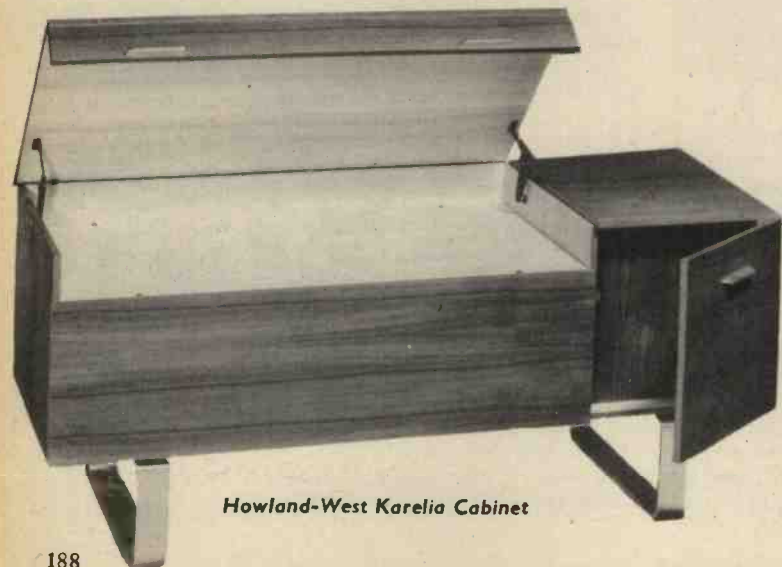

Howland-West Karelia Cabinet



R & A 780 Mark V loudspeaker

ELECTRONIC BUILDING BLOCKS

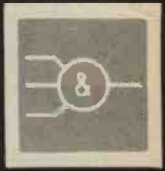
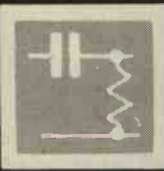

PART TWELVE

by R. A. DARLEY

FOLLOWING last month's introduction to the binary code and its application in electronics, we continue the discussion with particular reference to its application in timer/counter units.

TIMER/COUNTERS

These dual purpose instruments, which can be used for measuring frequency, counting, or measuring time periods to a high order of accuracy, are widely used in many modern laboratories. The instruments are very simple to use and give a clear direct readout of the measured quantities.

In principle, the timer/counter is a simple device, but in practice it can be quite complex. To understand the principles, it is best to consider the device in each of its individual alternative modes of operation. Fig. 12.1 shows the block diagram of a simple timer/counter set-up for frequency measurement.

Frequency is, of course, referred to in terms of a number of cycles or pulses per second. A frequency measuring instrument can be based on two basic operations: a system that will "count" the pulses, and a "gate" that will pass the input signal that is to be measured into the counter for a pre-determined time only.

The input signal is fed to the amplifier and wave shaper, which converts the input signal to a form that is suitable for the counting process, i.e. a rectangular waveform with a short rise time. This waveform is

then passed on to the "gate" circuit. The gate is normally closed, but can be opened for a pre-determined period by the "start/stop" circuit which, in turn, is driven from the timing generator. The timing generator is driven by the crystal oscillator, so the timing periods for which the gate is opened are very closely controlled and highly accurate. Thus, the input frequency can be measured to a high degree of accuracy.

Before dealing with the alternative modes of the timer/counter operation, it is necessary to explain the details of some of the "blocks" shown in Fig. 12.1.

INPUT AMPLIFIER WAVE SHAPER

This "block" usually uses a self-limiting circuit, employing two diodes as a non-linear potential divider network. The signal fed to the first transistor stage of the amplifier is virtually constant in peak value, irrespective of the magnitude of the input signal. The limiter is followed by a wide-band amplifier, the output of which is fed to a "squaring" circuit, usually a Schmitt trigger.

SCHMITT TRIGGER

An example of this circuit is shown in Fig. 12.2. Two transistors are employed, with a common emitter load R4. TR1 uses base-bias network R1 and R2, which have their values selected to ensure that TR1 is

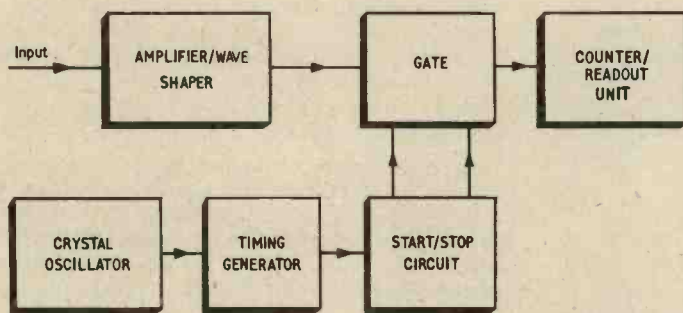

Fig. 12.1. Block diagram of equipment for frequency measurement

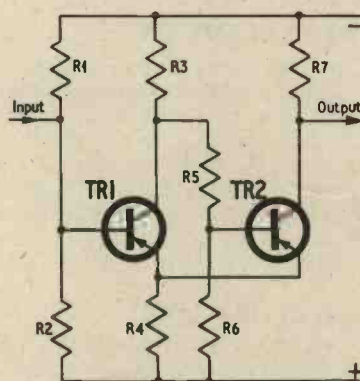

Fig. 12.2. Schmitt trigger

normally biased off. TR2 uses R5 and R6 as its base-bias network, but the top end of R5 is fed from TR1 collector; since TR1 is normally off, its collector is normally at near the full negative rail potential, and TR2 is biased hard on by suitable choice of its base-bias network. If a negative-going input signal is fed to TR1 base of sufficient magnitude to cause that transistor to begin to conduct, its collector will become less negative and so reduce the bias of TR2, thus reducing its emitter current. This results in positive feedback via the common emitter resistor R4, which further increases the emitter current of TR1; cumulative action takes place and TR1 switches hard on and TR2 switches off. When the input signal is removed the circuit reverts to its original condition. The output waveform, which can be taken from either collector, will be rectangular irrespective of the waveform of a.c. signal that is fed to the input of the circuit.

GATE AND START/STOP CIRCUITS

The gate and stop/start circuits take the same form as was shown in Fig. 10.3b in Part 10 of this series.

CRYSTAL OSCILLATOR

This block usually uses a conventional transistorised crystal oscillator, temperature controlled using an oven for the crystal to give high stability. This is followed by a wave shaping circuit, such as a Schmitt trigger, that gives an output suitable for feeding a counter stage.

TIMING GENERATOR

The timing generator consists of a series of binary "decimal" divider units of the type shown in Fig. 11.2 last month. The units are wired in cascade, the input to the generator being taken from the crystal oscillator. Thus if the crystal oscillator is working at 100kc/s, a timing cycle of 10 microseconds is available directly between pulses.

If the output is taken from the first divider stage, the timing cycle will be 100 microseconds, or if the output is taken from the fifth divider the timing cycle will be 1 second, and so on. The required timing cycle can be selected by suitable switching; typically, the following range of timing periods will be available: 10 seconds, 1 second, 100ms, 10ms, 1ms, 100 μ s, 10 μ s, and 1 μ s. A complete timing generator of this kind may use up to 80 transistors.

COUNTER/READOUT

The counter/readout unit consists of a series of divider units complete with decoding networks and readout facilities, similar to those shown in Figs. 11.3b or 11.4b last month. Usually, there are as many counter stages as there are sets of readout displays (between four and eight), and the complete "block" may contain several hundred semiconductors.

Let us now consider the alternative modes of operation of the complete instrument.

TIME MEASUREMENT

Fig. 12.3 shows how the unit is arranged for the measurement of time. In effect, the instrument is used as a precision electronic stop-watch. The timing period is started and stopped and the gate opened and closed manually via the external "start" and "stop" terminals. In this mode of operation the

input to the gate is fed from the output of the timing generator. Thus, if the timing generator is set to give pulses at 1 second intervals, and the gate is opened for 47 seconds, the counter/readout unit will register 47 seconds. Typically, the instrument can measure periods of time in the range of 1 microsecond to several days, to an accuracy of 0.0001 per cent.

SINGLE PERIOD MEASUREMENT

The repetition frequency of a signal, as well as being expressed in terms of cycles per second, can be expressed in terms of the period between individual cycles. Quite frequently, it is necessary to know the period between two individual cycles or pulses that are not repetitive; for example, when testing a delay circuit. In this case the timer/counter is set up for single period measurement, as shown in Fig. 12.4.

In this case, the input is fed to the amplifier/wave shaper and then on to the start/stop circuit, which controls the gate. The input of the gate is connected to the output of the timing generator. Thus, the counter/readout displays the period between the two input pulses.

MULTIPLE PERIOD MEASUREMENT

For some purposes it is advantageous to measure the period of, say, every one hundred input pulses, rather than between each individual pulse. In this case the circuit may be arranged as shown in Fig. 12.5. In this case, the input is fed to the amplifier/wave shaper, but is then fed to the input of the timing generator, which is in effect a decade divider unit. The output of the timing generator is then fed on to the start/stop unit, which thus opens and closes the gate for a number of input cycles, depending on the setting of the timing generator. The crystal oscillator is fed directly to the input of the gate circuit, and the counter/readout unit will give a display in terms of microseconds, if a 1Mc/s crystal oscillator is used.

COUNTING

The instrument can be used for straightforward batch counting by arranging the circuitry as shown in Fig. 12.6. The gate is opened and closed, via the start/stop circuit, by operating the external "start" and "stop" terminals manually. The input signal is fed to the amplifier/wave shaper and thence on to the counter/readout unit via the gate.

The input signal can be derived from the objects that are to be counted in a number of ways: the objects may be made to make or break a light beam that is directed to shine on a photo-cell; a metal object may be made to pass through a magnetic field and cause an electric current to be generated.

SELF-CHECK FACILITY

An outstanding attraction of timer/counter units is that a self-checking facility is generally incorporated in the design. This facility enables the functioning of the complete instrument to be checked at the turn of a switch. Fig. 12.7 shows the block diagram of the unit for this particular function.

Two outputs are made available from the timing generator, one at, say, 10kc/s, which is fed to the input of the gate, and the other at 10 seconds between pulses, which opens and closes the gate via the start/stop circuit. Thus, if the unit is operating correctly, the counter/readout unit will register a count of 100,000.

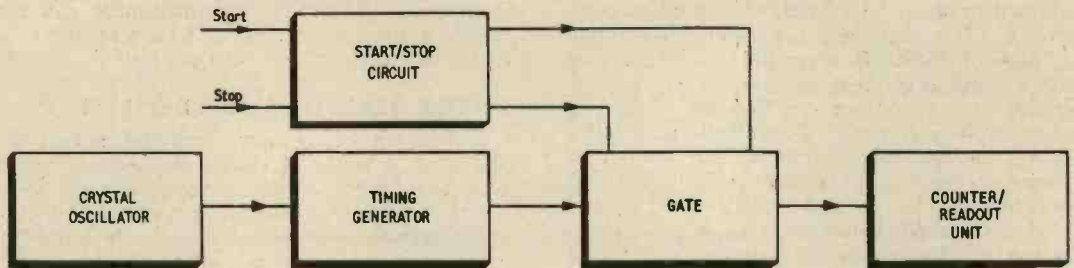

Fig. 12.3. Block diagram of equipment set up for time measurement using a counter/readout unit. Triggering is done manually through the start/stop circuit.

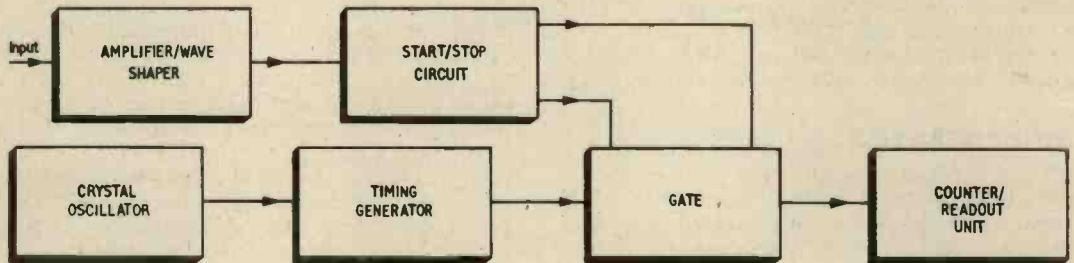

Fig. 12.4. Block diagram of single period measurement using an amplifier/wave shaper circuit

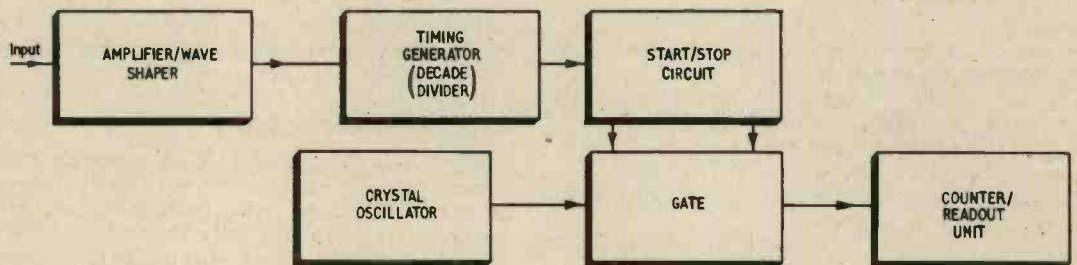

Fig. 12.5. Block diagram of multiple period measurement using a decade dividing circuit

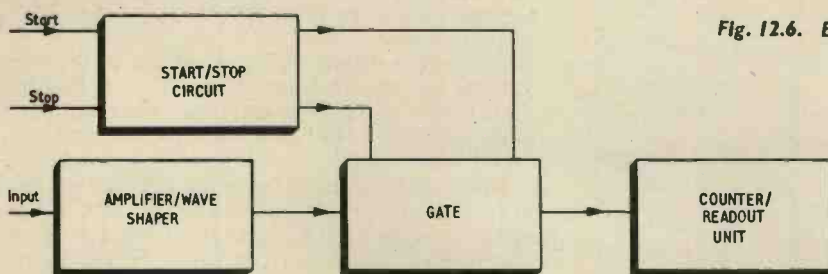

Fig. 12.6. Block diagram of a counter

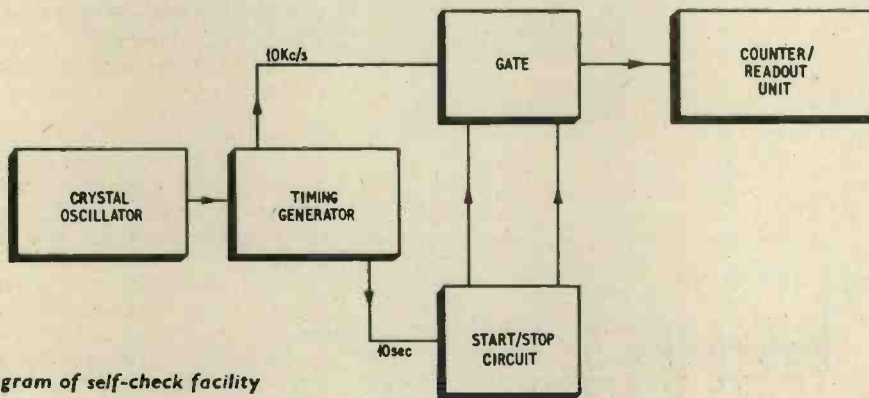

Fig. 12.7. Block diagram of self-check facility

Note that this count should be registered irrespective of the accuracy of the crystal oscillator, and that the crystal accuracy is the only detail of the instrument that is not checked automatically.

Although the impression may have been given in this article that the timer/counter requires some degree of skill to operate, needing to have its circuitry re-arranged for making different types of measurement, virtually no skill is necessary; the required mode of operation can be selected at the turn of a switch.

The instrument can be used for many applications additional to those already mentioned. It can be used to measure phase shift, speed, acceleration, distance, torque, viscosity of fluids, wind resistance, or any other properties that can be represented by an electrical signal.

READOUT METHODS

The method of readout is of considerable practical importance. One widely used system, and probably one of the easiest to read, has 10 small bulbs per readout unit, the bulbs being incorporated in a "block" with a system of lenses and numerals cut into a series of screens. Each lighted bulb projects a particular numeral onto a translucent screen on the front of the instrument.

Some instruments use a system of moving coil meters to give the readout. Each meter represents one decade and has ten calibration points, marked 0 to 9. This system is quite expensive but has the advantage that the total power consumption is considerably less than in other readout systems.

Almost all modern timer/counters have provision for feeding an output to a pen recorder, which is about the most practical system that there is for checking long term frequency drift.

Many of the old valve powered timer/counters used cold cathode tubes to give their readout displays; this system is rapidly being incorporated in transistorised equipment. Transistor inverters can be used in battery powered instruments to provide the necessary operating voltages, and the system has the great advantage that negligible power is needed to operate the tubes.

INCREASING THE FREQUENCY RANGE

Timer/counter units vary considerably in price and performance; the lower cost instruments will measure frequencies of up to 300kc/s and have only four readout units. The more expensive units may have as many as seven readout units and measure frequencies up to as high as 30Mc/s directly.

The frequency ranges of most instruments can be increased up to about 100Mc/s by the use of add-on decade divider units placed between the input signal and the timer-counter.

If frequencies greater than about 100Mc/s are to be measured, mixer type add-on units can be used, working on the "beat frequency oscillator" principle, and extending the operating frequencies up to a few thousand megacycles per second.

Next month: Mathematical circuits, both passive and active

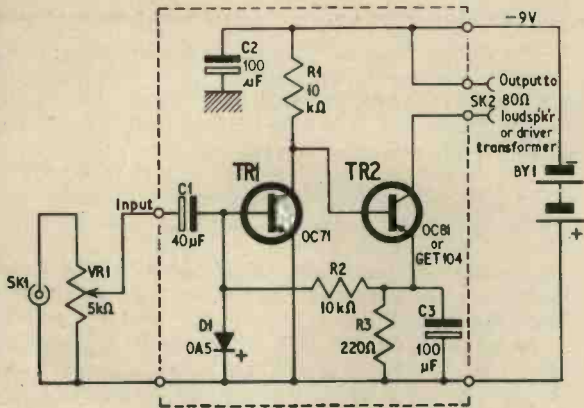

Fig. 1. Circuit of the driver amplifier. The circuitry enclosed by the dotted line is made up on the printed circuit board

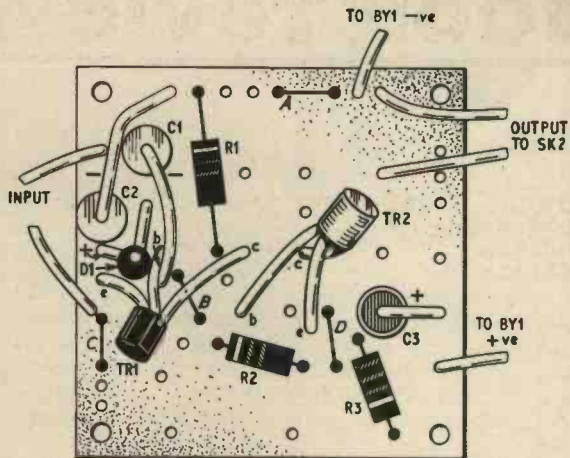

Fig. 2. Layout of components on the board. Note the link wires at A, B, C, and D

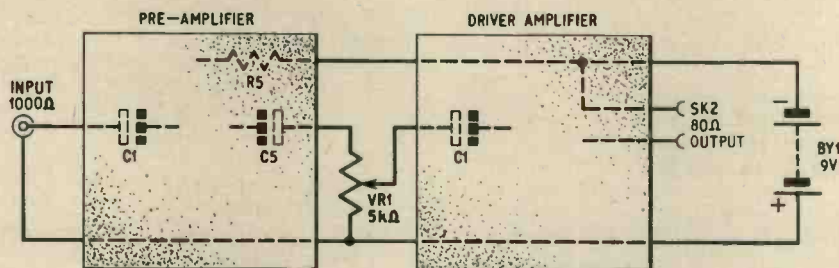

Fig. 3a. The pre-amplifier unit and the driver amplifier unit linked together to make a high gain audio amplifier with an output impedance of 80 ohms. The volume control VR1 is connected between the two boards and the input is fed direct into C1 of the pre-amplifier

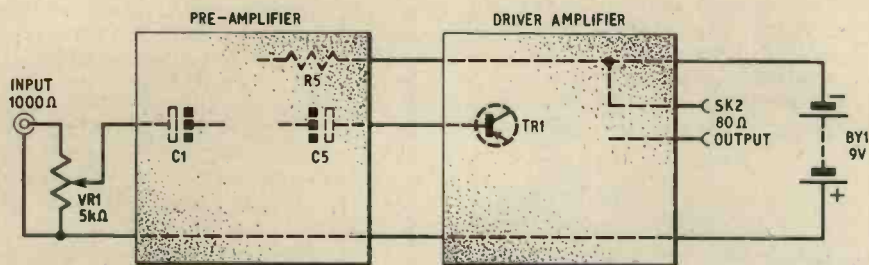

Fig. 3b. This set-up will give the same facilities as those of the circuit shown in Fig. 3a, except that VR1 is connected to the input end of the system to reduce the possibility of overloading the first stage. Notice that C5 of the pre-amplifier is connected directly to the base of the first driver stage transistor

Book reviews

MUSICAL INSTRUMENTS AND AUDIO

By G. A. Briggs

Published by Wharfedale Wireless Works Ltd.

238 pages, 8½in × 5½in. Price 32s 6d

IN this, the sixteenth Briggs-Wharfedale book, the emphasis is on musical instruments as the basis of audio. In other words it is mainly about sound production—not reproduction. It is not a text-book but a readable and liberally illustrated round-up of facts and figures about instruments and the sounds they make.

Several expert collaborators have helped with such topics as organs, pianos and formants in speech and music. Mr. K. F. Russell has acted as technical sub-editor. The result is a wide-ranging text running to 238 pages including the index.

First there are notes on basic matters such as the behaviour of vibrating strings, reeds and air columns. Contrasted with traditional “mechanical” instruments are those which employ electrical and electronic techniques.

After “Various Sounds—Cause and Effect” we come to a particularly important part of the book—two linked chapters on musical instruments (which are all illustrated) and their characteristics. Then we learn about formants in speech and music. Distortion is tackled in two parts: a very brief note on distortion of the live sound is followed by comments on distortion in reproduction.

There are chapters on pipe organs, electronic organs, pianos and tuning. A final chapter on music in schools contributes much charm—and some lovely pictures—but adds little on the subject of musical instruments.

Once or twice I thought the author's humorous touches were getting too subtle for me. The heading “psycho-acoustics” might have heralded a choice contribution from Professor Colin Cherry, but instead it concerns an American who has hidden his speakers behind a decorative screen (sensible fellow).

This is a fairly expensive publication and it is surely reasonable to expect more imaginative typographical design than is displayed here. But the book is fascinating and demands the attention of those who would like an easy-going account of a complex subject.

C.B.

ITV 1966

Published by the Independent Television Authority

224 pages, 9in. × 7in. Price 7s 6d

THIS new edition of the ITA handbook covers the whole field of Independent Television from the work of the authority and the programme companies to the advertising and the transmitters.

The major portion of the handbook is devoted to programme matters. The technically minded viewer will find some interesting reading in the chapter describing technical operations and in the particulars of the individual transmitters. Over 300 photographs are included.

PRACTICAL STEREOPHONY

By H. Burrell Hadden

Published by Iliffe Books Ltd.

155 pages, 8½in × 5½in. Price 37s 6d

“Stereophony was born out of the desire to create in the mind of a person listening to a broadcast or a recording, the illusion that he was actually present at the live performance. . . .”

THE NOTE on the jacket of this book summarises the whole essence of H. Burrell Hadden's profound description of all aspects of stereo. Yet at the same time his writing is lucid enough for amateurs to grasp the full implications of the subject.

Beginning with the theories of hearing and methods of creating a stereophonic effect, through the history of stereo development, to the techniques involved in recording, broadcasting and reproduction, practically all that one needs to know for achieving stereophonic bliss in the home is packed into these 155 pages.

Incidentally, mono enthusiasts who cannot afford stereo can learn a great deal from this book, too!

M.A.C.

THE TAPE RECORDER

By C. G. Njisen

Translated from the original Dutch book

by J. B. Wright

Published by N.V. Philips Gloeilampenfabrieken

Distributed in the U.K. by Iliffe Books Ltd.

142 pages, 8½in × 5½in. Price 13s 6d

As long ago as 500 B.C., we are told, a Greek philosopher, none other than Pythagoras, carried out investigations into the nature of sound. He produced high and low tones by causing pieces of gut to vibrate. But only in recent times has the science of sound been so intimately exploited. In fact the tape recorder, or the “telegraphon” as it was then called, was patented in 1900 by the Danish engineer Poulsen. It seems rather strange, therefore, that another 50 years should pass before the tape recorder caught the eyes and ears of domestic users on a large scale.

Today tape recording in the home, in schools and clubs is a booming hobby. Amateur, as well as professional tape recordists will find this paperback book a valuable asset and, no doubt, will find a great deal of both technical and practical advice to help with their hobby.

Explanations are included of what sound is; how it can be recorded; how the tape recorder works; its practical uses; getting the best from your recorder; about ancillary equipment; maintenance and fault finding; acoustics and their effects; stereophony in practice; choosing a recorder; practical advice on making recordings; microphone techniques; copying and editing . . . You name it, this book is very likely to explain it!

Tape recording has much to offer as a hobby; this book has much to offer the hobbyist.

M.A.C.



WIRING BOARD HOLDER

by M.E. FRANCIS

THE WIRING of the printed circuit boards and similar wiring boards by amateurs for electronic designs and equipment, presents a problem when trying to hold them in a convenient position and height whilst working on them. The clamp stand described here solves this problem and need not cost more than a few shillings. Most of the material can be found in the experimenter's odds and ends box, or in a shop dealing in second-hand articles.

The board is held by spring pressure between two s.r.b.p. strips supported on two rods, carried on an adjustable stand similar to a clamp stand used in science laboratories. It can be held at a convenient height and position by the adjustable clamps and thumb screws.

To set the board in the clamp the sliding s.r.b.p. strip is set to the width of the printed board by loosening the thumb screws on the spring retaining collars. The board is then inserted in the grooves. The spring retaining collars are slid along and tightened until the board is held firmly by pressure from the springs.

To remove the board, pull the sliding s.r.b.p. strip back against the springs and slip the board out of the grooves.

The board is placed in the clamps with the copper strips uppermost. This gives free access for soldering components to the strips. This clamp stand will hold wiring boards of any width up to about 6 inches, and any length.

HOW TO MAKE

Two pole pieces from discarded loudspeakers are used and drilled $\frac{3}{8}$ in diameter in the centre of each pole piece

to take the $\frac{3}{8}$ in diameter rods. Next drill and tap a 4B.A. hole (no. 32 or $\frac{1}{16}$ in drill) through the side of each pole-piece to take the grub and thumb screws. Use tapping grease when cutting screw threads with a tap or die. This will give a smooth clean thread.

One pole piece is used to fix the clamp to the base and uses a 4B.A. thumb screw (see detail 4). The other pole-piece will need to have its plate shaped. Alternatively this plate can be made separately and fixed to the 1in diameter boss by silver soldering, brazing, or welding (see detail 1).

YOU WILL NEED . . .

- Hard wood plate 8in \times 8in \times $\frac{3}{4}$ in
- Pole pieces from old p.m. loudspeakers (2 off)
- Steel rod $\frac{3}{8}$ in diameter—6in long (2 off)
- S.R.B.P. strip $\frac{3}{8}$ in \times $\frac{1}{2}$ in \times 5in (2 off)
- Square strip steel, brass, or duralumin, $\frac{3}{8}$ in \times $\frac{3}{8}$ in \times $1\frac{1}{2}$ in
- Collars— $\frac{3}{8}$ in o.d. \times $\frac{1}{2}$ in long with $\frac{1}{16}$ in dia. hole (2 off)
- Silver steel rod $\frac{1}{8}$ in diameter, 8in long (2 off)
- Compression springs $\frac{1}{8}$ in inside diameter 2in long (2 off)
- Screws 4B.A. $\frac{1}{2}$ in long with large knurled head (3 off)
- Screws 2B.A. $\frac{1}{2}$ in long with large knurled head (2 off)
- Lock nuts for silver steel rod, 4B.A. steel (4 off)
- Nuts and bolts 4B.A. (2 off each)
- Grub screw 4B.A. (1 off)
- Wood screws $\frac{3}{8}$ in No. 8 round head steel (3 off)

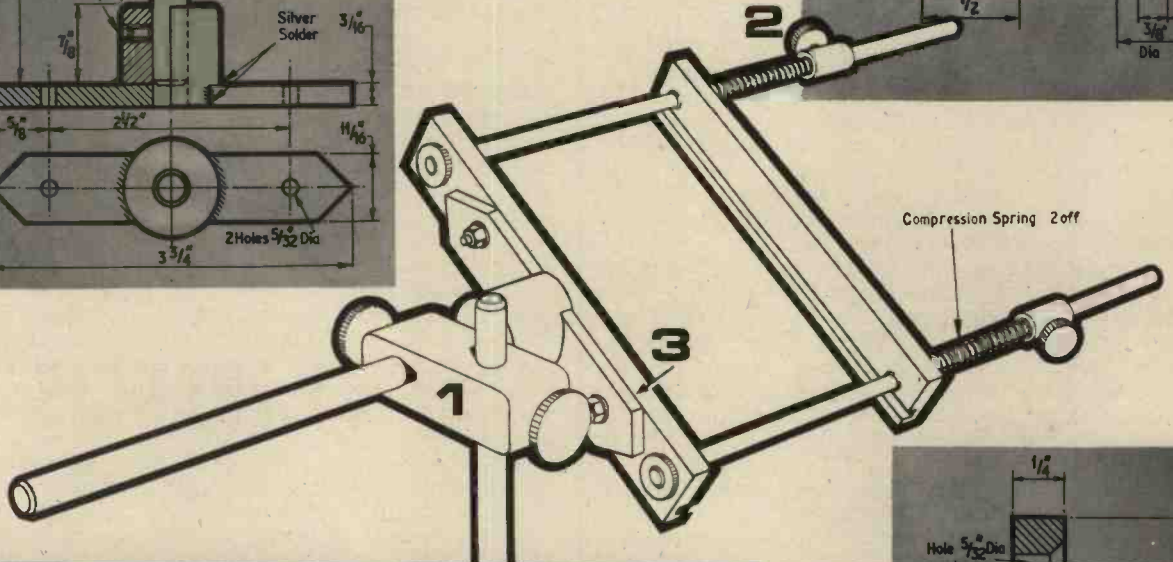
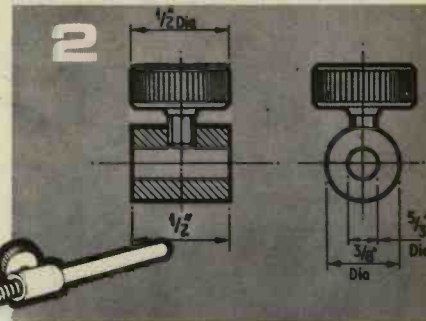
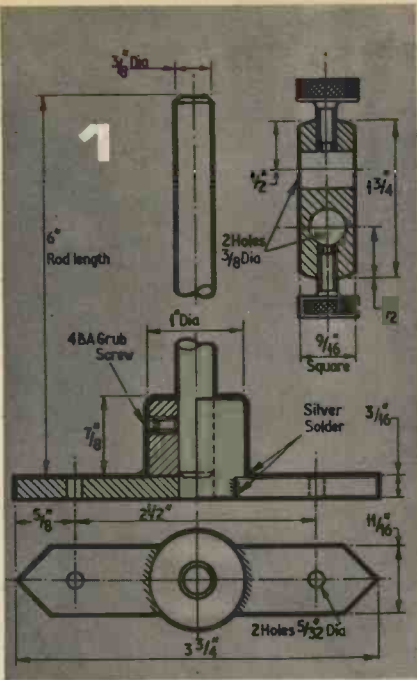

CONSTRUCTIONAL DETAILS

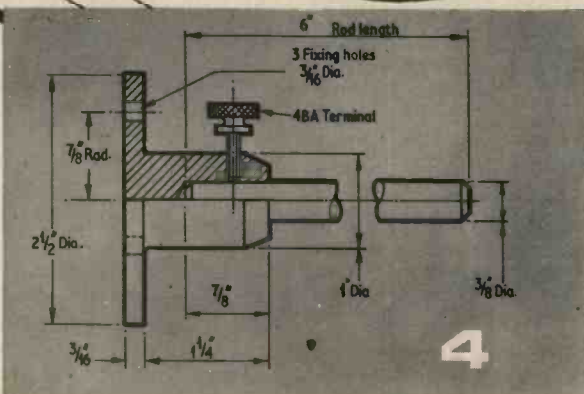
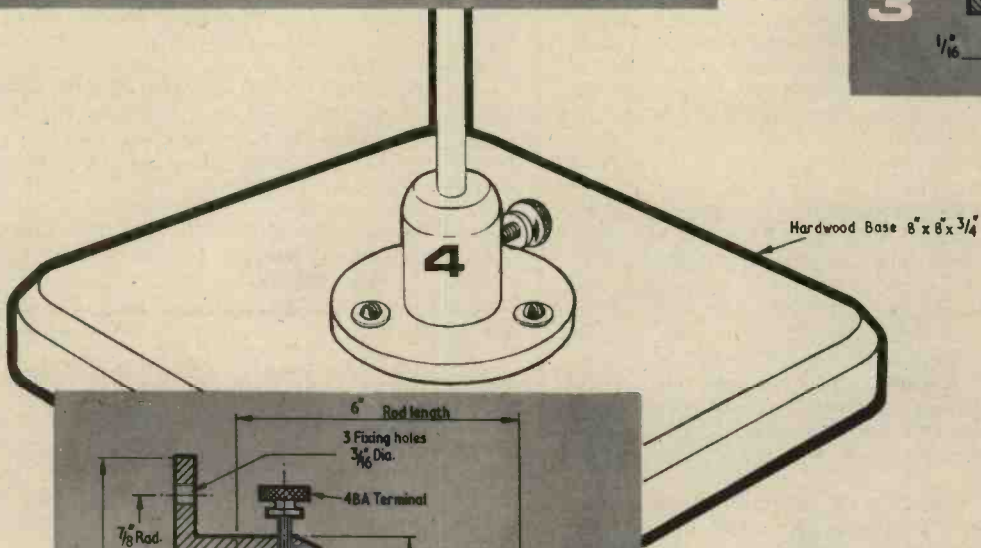
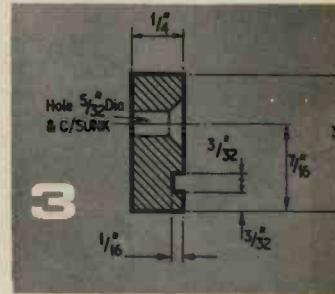

On the plate of one pole-piece two holes are drilled (across the diameter) to bolt one of the s.r.b.p. strips to it with countersunk head 4B.A. screws. One of the original holes can be used for one of them (detail 1).

A piece of $\frac{1}{2}$ in square steel, brass, or duralumin, $1\frac{1}{2}$ in long is drilled with two $\frac{1}{8}$ in diameter holes at right angles to each other (see detail 1) with a 2B.A. tapped hole (no. 24 drill) in each end for the thumb screws.

The cutting of the groove in the s.r.b.p. strip may present a little difficulty, and should be done carefully. Mark out the groove with a scriber; then clamp a piece of wood on top of the strip with the edge of the wood in line with the scribed line. With the side of a tenon saw pressed against the piece of wood, carefully saw a slot $\frac{1}{8}$ in deep in the s.r.b.p. strip. Move the wood to the other scribed line and repeat the procedure. Do the same for the other piece of s.r.b.p. strip. The small piece of s.r.b.p. left between the saw cuts can be scraped out with a small sharp chisel or knife.

Next drill the holes for the $\frac{3}{8}$ in diameter rods at the end of each s.r.b.p. strip; at the same time drill the holes in one piece for the 4B.A. bolts to hold it to the "pole-piece" plate. If the holes for the $\frac{3}{8}$ in rods are drilled in both s.r.b.p. strips while clamped together, it will ensure that they are in line when assembled.

The $\frac{3}{8}$ in rods can either be silver steel or "Meccano" axles; the spring retaining collars can be "Meccano" bosses or bored pillars (see detail 2). One end of each rod is threaded 4B.A. and bolted to the fixed s.r.b.p. strip. Place one 4B.A. nut on each rod and pass the screwed portion through the end holes in the fixed strip; lock in position with the other nuts. Bolt the s.r.b.p. strip to the pole-piece plate with the 4B.A. countersunk head screws (see detail 3).

Next place the other strip on the $\frac{3}{8}$ in rods and fit the two springs, one on each rod. Place the spring retaining collars, one on each. A 4B.A. tapping hole is drilled (no. 32 drill) and tapped through the side of each for the thumb screws. If the holes in the sliding strip are a bit too tight to allow it to slide freely they can be enlarged carefully with a small round file or reamer.

The baseplate is prepared from a piece of 8 in square hard wood about $\frac{3}{4}$ in thick; this large size gives some degree of stability. The edges can be chamfered and the corners rounded for a neat appearance. The other pole piece is screwed to the centre of this board using round head screws through the holes in the plate of the pole piece (see detail 4). ★

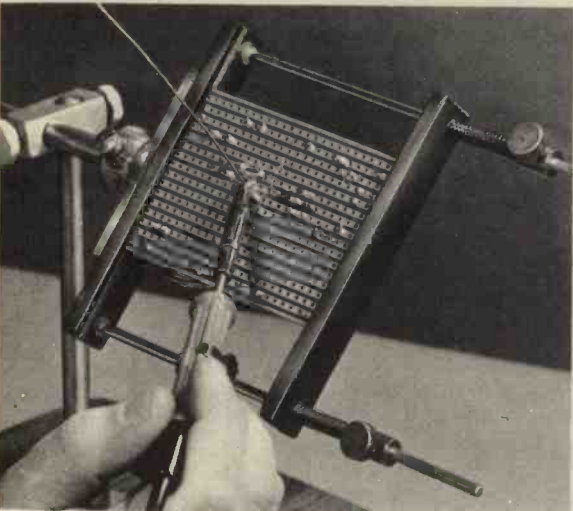

RADIO CONTROL OF MODELS

continued from page 179

additional disadvantage is that the shorter aerial (usually 48 in telescopic) further reduces overall efficiency and hence power output.

Fortunately, however, with "tone" equipment signal strength is not so important as with carrier wave operation. Thus a suitable tone transmitter-receiver combination can operate over a satisfactory range with much less signal power. The hand-held carrier wave transmitter, however, shows distinct limitations as regards range, unless particular attention is given to realising a high circuit efficiency and good aerial coupling and aerial efficiency.

USING TRANSISTORS

Restrictions on the power output available from existing transistors delayed the appearance of the satisfactory all-transistor transmitter. With types now available, however, sufficient power can be fed into the aerial for satisfactory operation at comparable ranges, although the actual power output is normally considerably lower than that realisable with valve transmitters. To compensate for the lower power into the aerial it may be necessary to increase aerial efficiency with a centre loading coil (equivalent to increasing the effective length of the aerial); with refinements in receiver circuit design increasing sensitivity without sacrificing stability and thus enabling the range to be maintained at much lower signal strengths. The superhet receiver is particularly attractive in this respect; but many conventional super-regenerative receivers may have "marginal" performances allied to an all-transistor transmitter.

Range, as such, is largely an arbitrary figure and becomes specific only when applied to a particular transmitter-receiver combination. Thus with the same transmitter, one receiver may continue to respond up to, say, two miles and another receiver only to a hundred yards or so, although both may be properly tuned, simply because of the difference in receiver sensitivities involved.

Working range is also affected by operating conditions. For model aircraft control, ground-to-air range is considerably greater than measured range ground-to-ground established by a practical check. In such cases a ground-to-ground range is usually more than adequate. With other applications it may be the ground-to-ground range which counts, and the range involved may be relatively short (e.g. 100 yards or less). In such cases transmitter power becomes even less significant and simplified transistor circuits may be satisfactory with small capacity batteries and lower power input.

The particular attraction of the all-transistor transmitter is its compactness, allied to low input voltage demands and consequently low battery costs. Circuit stability, however, may be more critical, especially in working the output transistor to its limit. In such cases a change in loading, such as produced by operating with a retracted aerial, can result in damage to the output transistor in some circuits.

REFERENCES

1. Ivy-AM transmitter, produced in kit form by Macgregor Industries
2. Kraft
3. Min-X "Powermaster" single-channel transmitter
4. Orbit single-channel transmitter

Next month: Single channel receivers

NEXT MONTH!

FREE INSIDE EVERY COPY!

CAPACITANCE & RESISTANCE CALCULATOR

For speedy evaluation of capacitances in series and resistors in parallel. Contains how-to-use instructions, with detailed examples

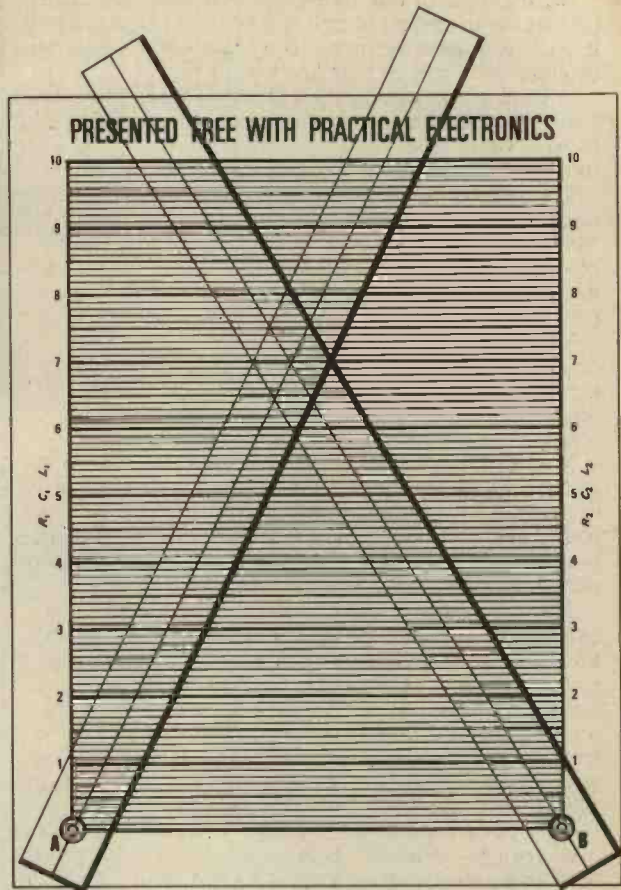

Plus *EXTRA!*

8-PAGE
SUPPLEMENT

ELECTRONIC AIDS FOR THE HOME

Includes full details of the following easy-to-make units:

- RAIN SENSOR
- BABY ALARM
- AUTO NIGHTLIGHT
- HEATER OR FIRE MONITOR

ALSO

PRIVILEGE PRICE
BOOK OFFER!

BEGINNER'S GUIDE TO ELECTRONICS

for only 6s. 6d. post free

At this greatly reduced price, written throughout in easy-to-understand language by a leading expert, this invaluable book provides a short cut for the beginner on every aspect of modern electronics. 194 pages copiously illustrated with diagrams and drawings.

APRIL ISSUE

ON SALE MARCH 17TH

2/6

Practical Electronics

BIG DEMAND! ORDER FROM YOUR NEWSAGENT NOW!

ELECTRONORAMA

HIGHLIGHTS FROM THE CONTEMPORARY SCENE

Fighting the Crime Wave

WHAT HAS a van such as this got to do with electronics? It is one of a number of vehicles armed with electronic devices aimed at out-witting the potential thief.



The Keyless Key Company of Walworth, London, is mounting a battle of brains against car thieves, pay-roll bandits, and hi-jackers by using ingenious electronic systems. The basic "Keyless Key" is designed to be fitted in addition to, or in place of, existing starter switches and operates on a combination system.

The "Securelay" has an added refinement. If a would-be thief manages to get under the bonnet and tries to start the car by bridging the coil, battery or fuses, the horn will sound and the ignition stay dead.

One device designed to beat the lorry thief is a manual alarm with diesel immobilisation. On arrival at his destination, the driver turns a key which immediately locks the fuel by an electric solenoid in the fuel line.

A special anti-hi-jacking system can be fitted to heavy vehicles. To enter the vehicle the driver operates a key switch and has 30 seconds to get into his cab. If the driver is attacked and the door opened by attackers, the alarm will sound and the engine will be immobilised. A similar condition operates when he leaves the cab.

Of course, we cannot divulge the appearance or circuitry of these units.

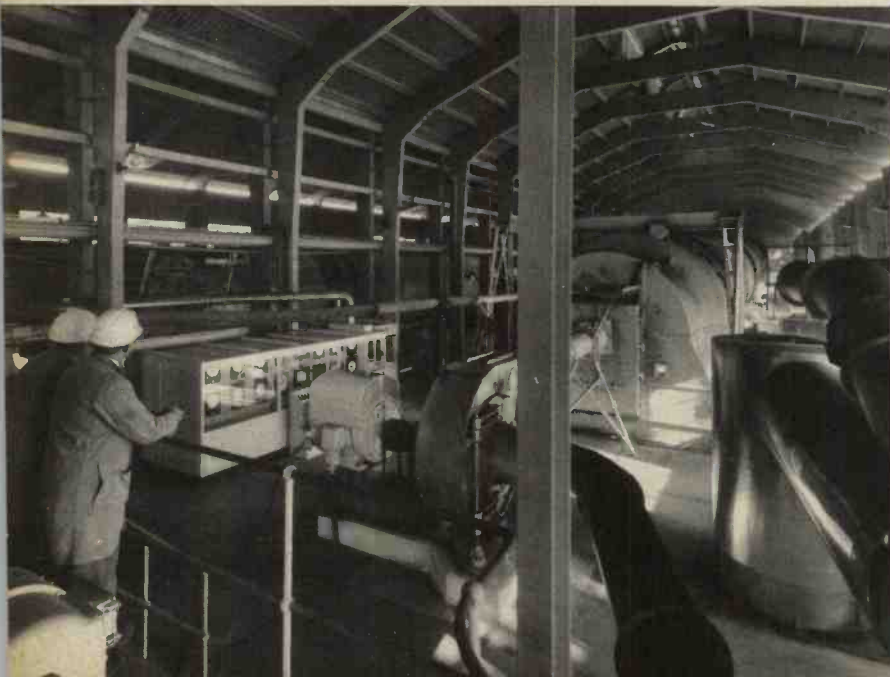

Cement Kiln

ANEW electronic controlled 500ft kiln, one of the largest in Europe, is now fully operational in the Blue Circle works of Associated Portland Cement Manufacturers Limited. Our picture shows the firing end with the electronic equipment, developed by Honeywell Controls, to provide means of recording, indicating, and controlling at optimum values, variables necessary to ensure continuous production at minimum fuel costs.



TV Pictures are Kept Clean

HAVE YOU ever stopped to think that the quality of your television picture depends to a large extent on the cleanliness of the camera tube. Here is a picture to show just how clean they have to be. A copper mesh (as used in a 4½in image orthicon tube) is being inspected by using oblique illumination from a projector.

The mesh provides a conducting surface but allows a high proportion of electrons to pass through. A dust particle on the mesh would stop some electrons and create a blemish on the television picture produced by the tube.

These particular meshes are made by E.M.I. at Hayes, Middlesex.

Microwave Repeater

THIS is one of the six repeater station towers on the Post Office microwave link between London, Birmingham, and Manchester.

It is fitted with flexible waveguide rather than the conventional rigid type to simplify installation and reduce planning time. The waveguide is manufactured by a West German firm—Hackethal-Draht-und-Kabel-Werke Aktiengesellschaft and supplied by Livingstone Laboratories.

The microwave reflectors at the top of the tower are similar to those used on the London P.O. radio tower.



Pay As You View

BRTAIN'S first pay television was inaugurated by Mrs. Harold Wilson, wife of the Prime Minister, and the Rt. Hon. Anthony Wedgwood Benn, M.P., Postmaster-General, at the Hilton Hotel, London, on 7 January.

The service is open to subscribers to Pay-TV and British Relay in Westminster and Southwark over closed circuit land lines, and is on trial for three years. The service will be extended later to Sheffield.

The master rack of equipment (above) at British Relay's London control centre shows (top to bottom) the viewer popularity gauge, the time check indicator and its controls, and the device used to set the price charged for the programme.

Each slave rack (shown below) comprises electronic calculators like this, each of which caters for 4,000 pay-television subscribers. It measures continuously the number of subscribers watching a programme and relays this information to the master rack. It also sends out the programme price pulses which operate the individual subscriber's meter.

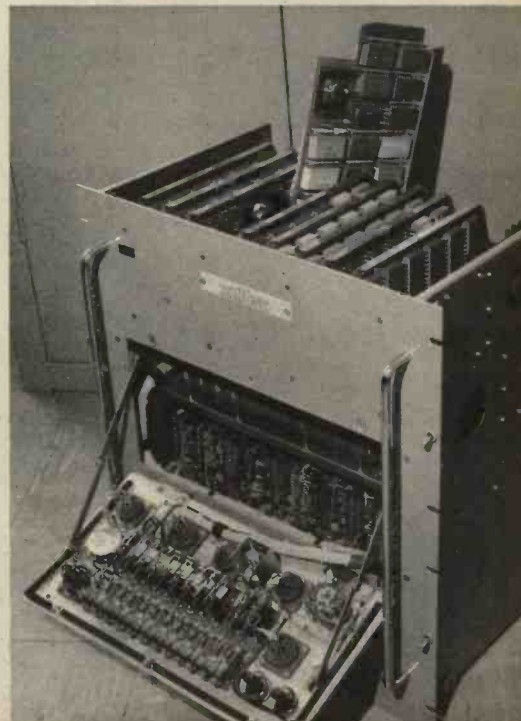
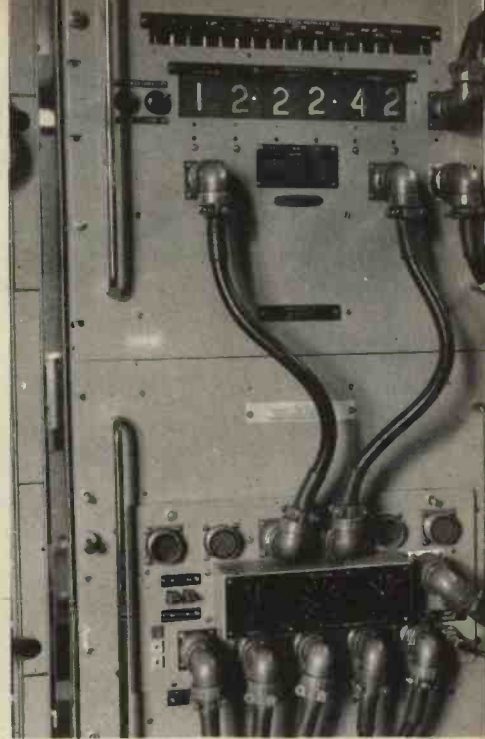

An Instructional Series for the Newcomer to Electronics

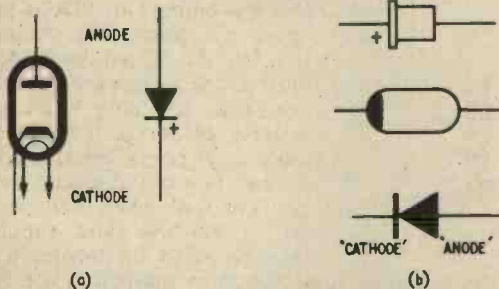

Fig. 17.1 (a). Circuit symbols for (left) a thermionic valve diode and (right) a semiconductor or "solid state" diode

Fig. 17.1 (b). The outline shapes of two types of semiconductor diode. The "cathode" (see symbol below) is usually identified by a "+" or coloured mark on the body of the component

TO follow up the two filter units described in last month's article, we now consider a pair of suitable rectifier units. But, before we discuss the construction of these units, it may be a good idea to revise what we are doing with such devices as the filters and rectifiers, and why pairs of each type of unit are required. We have really put the cart before the horse, because the filters follow the rectifier units to produce a smooth, steady d.c. supply from them. The rectifiers will produce d.c., from the a.c. coming in via the transformer, but it is pulsating d.c. The filters smooth out these pulses.

DIFFERENT REQUIREMENTS

We require two different kinds of smooth d.c. according to whether we are using valves or transistors.

COMPONENTS . . .

LOW VOLTAGE RECTIFIER

- D1-D4 Silicon diodes 200V peak inverse voltage (p.i.v.) 500mA. Lucas DD003 or Texas IS113 (Henrys Radio) 4 off.
- T1 Filament transformer. Primary tapped at 0, 210, 230 and 250V. Secondary 13V 0.5A Radiospares "Standard" type.
Wooden baseboard 5in x 3in x ½in.

HIGH VOLTAGE RECTIFIER

- D1-D4 Silicon diodes 800V peak inverse voltage (p.i.v.) 500mA. Mullard BY100 4 off.
- T1 Mains transformer. Primary tapped at 0, 200/220, and 230/250V. Secondaries: 0-250V 60mA; 6.3V 2A. R.S.C. Ltd. "Midget" type.
Wooden baseboard 6in x 4½in x ½in.

Miscellaneous Items for Both Units

Three-way terminal block. Tag-strip—four tags plus two fixing tags. Brass wood screws. Plastic covered wire. Material for cover. Three core mains lead and plug.

Valves require a high voltage, with usually small currents only. Transistors, on the other hand, draw quite heavy currents at a low voltage. We can say valves are *high impedance* devices, while transistors are *low impedance*. Hence we have a high impedance filter/rectifier supplying 200 volts at about 50 mA for small valve units, and the other (low impedance) filter/rectifier set supplies around 12 volts at up to an ampere for transistor work. These differences account for the differences in the component values in the two filters.

There are two methods of changing the mains a.c. supply into pulsating d.c. One, the *half-wave* system, allows only one half cycle of the a.c. waveform (on, say, the positive half) to reach the output. There is quite a long wait while the other half cycle is occurring before the next pulse. The other method uses *both* half cycles, and is therefore called a *full-wave* rectifier system. This method cleverly switches both half cycles appropriately to produce pulses of output with the same polarity. The pulses follow each other without any delay.

Because the full-wave method is more efficient we have used it here, and although a few more rectifiers (or diodes) are required, the investment is well worthwhile because of this efficiency. Either *valve* diodes or *semiconductor* diodes can be used. (We will discuss how these devices work at a later date.) Semiconductor diodes are much smaller than valves, they require no heating, and they are essential for the low voltage unit anyway, so we will specify them for both units. The symbols used for diodes are shown in Fig. 17.1.

HOW THE CIRCUITS OPERATE

The circuit diagram of the low voltage rectifier unit appears in Fig. 17.2. The high voltage rectifier circuit is given in Fig. 17.4.

The action of both circuits used in our units is roughly as follows. The diodes (D1-D4) offer a low resistance to current in one direction, but offer an extremely high resistance in the reverse direction. In effect, they conduct only in the direction of low resistance; this is referred to as the *forward* direction. The diodes can be considered as polarity operated switches.

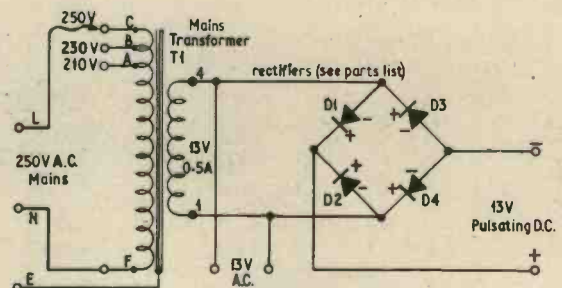

Fig. 17.2. Circuit diagram of low voltage rectifier unit

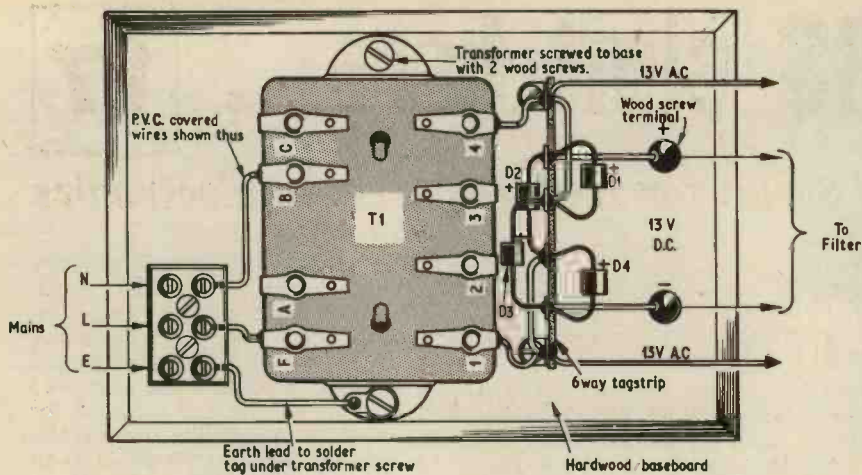

Fig. 17.3. Top view of the low voltage rectifier unit

When a.c. is applied to the diodes, they alternately switch on and off in step with the alternations of polarity of the supply voltage. For example, when the top end of the transformer secondary ("4" in Fig. 17.2) is positive, the diodes D1 and D4 conduct. When this point swings negative on the following half cycle, these two diodes cease to conduct and a path for the current is now provided via D3 and D2. In our two circuits, the four diodes form what is known as a *full-wave bridge rectifier*.

Apart from the d.c. outputs, we arrange on both units to have available a low voltage a.c. supply. This is obtained directly from the 13V secondary of T1 in Fig. 17.2. In the case of the high voltage unit, the midget mains transformer in Fig. 17.4 has an additional secondary winding which provides 6.3V.

CONSTRUCTION DETAILS

Once again, the parts are mounted onto a standard wood base as in the case of the other units in our constructional series. The a.c. mains should not be connected into the units by the "woodscrew" method, this is not really safe enough. A plastic terminal block is therefore specified for this purpose.

All wiring for the low voltage unit is clearly shown in Fig. 17.3. The arrangement of the high voltage rectifier unit is very similar, but in this case the mains transformer has flying leads, instead of tags. These leads are colour coded and should be connected up as indicated in the circuit diagram (Fig. 17.4). Also, this mains transformer is larger than the component used in Fig. 17.2 and so a larger baseboard is required.

Mount the transformer so that the side the leads emerge is adjacent to the diode tag strip.

The positive end of these diodes is marked either by red paint or by a "+". See Fig. 17.1.

A PROTECTIVE COVER

A cover should be made which will box in the bare tags which have large voltages across them. *Once again we must state the need to respect the mains and take precautions when using mains operated equipment.* Perhaps an insulating cover of hardboard or plywood could be made this time. If a perforated zinc cover is constructed as described for the filter units, then internal pieces of insulating material should be used, adjacent to high voltage points. This metal screen should be securely connected to the third (earth) lead on the mains cable. It goes without saying that a "three-pin" system should always be used with such apparatus as we are discussing.

When everything is completed, the units are ready for initial operation. Carefully check all lead positions and rectifier directions, and see that earth connections are intact, then plug in to the mains supply and switch on. A small 6 volt lamp connected across the 6.3 volt a.c. terminals of the high voltage unit will provide an indication as to whether current is available or not. Avoid the h.t. output terminals of the high voltage unit, as up to 300 volts is developed across them when the unit is operating.

Two similar lamps connected in series can be used to check the 13 volt output of the low voltage unit.

CONNECTING UP THE FILTER

Connect terminal A on the filter unit (refer back to Fig. 16.1) to the positive (+) terminal on the rectifier unit. Connect terminal B to the negative terminal on the rectifier unit.

With the appropriate filter connected in place on the rectifier output, the set of voltage supplies available to you is as follows:

- (a) 13 volts smooth d.c. and 13 volts a.c.
- (b) 250 volts smooth d.c. and 6.3 volts a.c.

Remember to avoid these two small hazards: Do not mix up the filter units, and always connect the units the correct way round regarding polarity. No switch is incorporated in either unit because the three-pin system with which these units are meant to be used has switched plug/socket units, which are also fused. If you require a switch, then one of the excellent lead switches can be fixed into the mains cable.

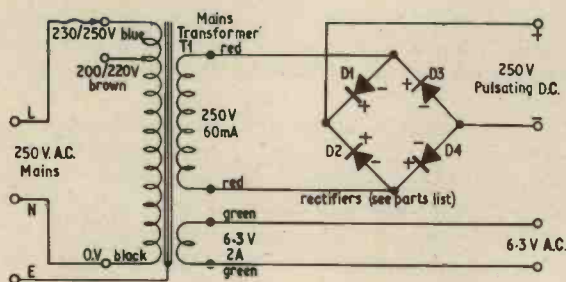
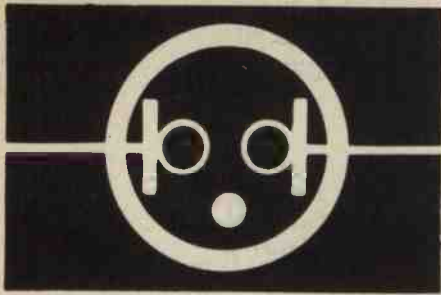
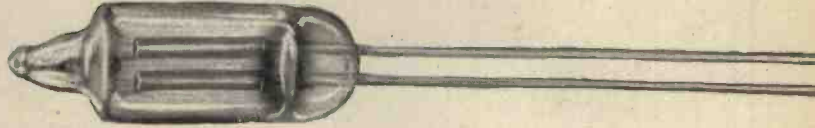

Fig. 17.4. Circuit diagram of the high voltage rectifier unit



NEON NOVELTIES



THIS is the seventh of a series of short articles illustrating some of the many uses of neon lamps. The neons employed are all miniature wire-ended types as shown above.

Two examples which are ideally suited to these applications are those supplied by Radiospares (striking voltage 65 volts), and the Hivac type 3L general purpose neons. The latter type requires a striking voltage of 80 volts and maintaining voltage of 60 volts.

Some neon indicators have a resistor wired in series with one of the neon wires to make them suitable for mains voltages. These would normally be unsuitable for the circuits described unless the resistor is removed or short-circuited.

SEVEN NEON TIMER

by **R. Bebbington**
GRAD.I.E.R.E.

THIS device is equally useful in kitchen or darkroom or wherever there is a need to measure small intervals of time. Simply select the time interval required and switch S1 to "start". When the period of time selected has elapsed the neon indicator will glow. As a refinement, an audio indication may also be obtained by connecting the output to an audio amplifier and loudspeaker.

resistance, a 2 megohm potentiometer (VR1) is used. If long time intervals are required however, a parallel network of switched capacitors may be employed.

It is an easy matter to calibrate the timing control using the seconds hand of a watch. Table 7.1 shows the time-constants for different RC combinations.

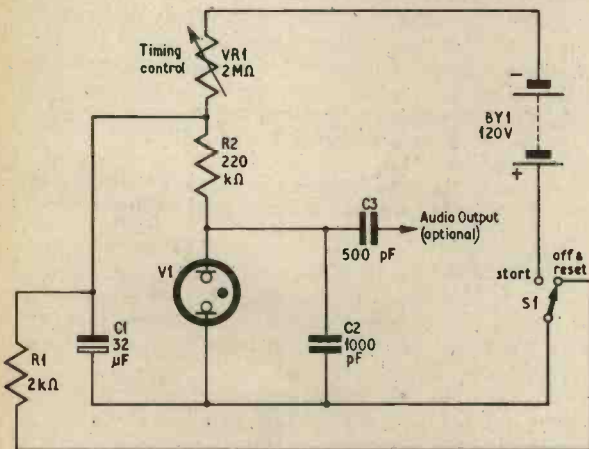

Fig. 1. Circuit diagram of the neon timer

Basically the circuit consists of a neon in parallel with an electrolytic capacitor (C1) which charges through a variable resistor VR1. The neon glows when C1 has charged to a potential in excess of the striking potential. The time taken depends upon the RC time-constant and, since it is easier to vary the

TABLE 7.1 TIME CONSTANTS

R	C	Time Interval (seconds)
220kΩ	12μF	4
220kΩ	32μF	10
1MΩ	12μF	16
1MΩ	32μF	40
2MΩ	12μF	45
2MΩ	32μF	120

For longer intervals it is more desirable to increase the capacitance of C1 rather than increase the resistance of VR1. If too high a series resistor is chosen then leakage problems may be encountered and inaccuracies result.

The reset position of the start switch S1 is also the "off" position. It is a single-pole change-over switch which disconnects the battery and discharges C1 in the "off and reset" position. In the "start" position R1 is disconnected, the battery contact is made, and the chosen time interval commences. All one has to do now is to sit back and wait for the neon to glow, indicating the required time delay.

A.M. RADIO TUNER

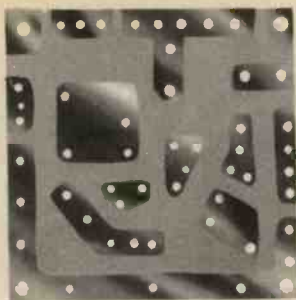

BB3

THE same printed circuit board (described in the "Bonanza Boards" article) can be used to construct a simple radio tuner for personal listening with an earphone. It can be coupled to the driver amplifier to provide a higher output for loudspeaker listening, as will be seen later.

Fig. 1 shows the circuit diagram of the tuner using a ferrite rod aerial, tuning capacitor and earpiece in addition to the printed circuit board components.

Fig. 2 shows the component layout. The only links required are C and D. If you wish to use a crystal earphone as shown in Fig. 1, C4 can be left without any connection or omitted altogether.

The ferrite rod aerial and tuning capacitor VC1 are types which are commonly used for medium and long waves. Those who wish to make their own tuning coils can use a piece of $\frac{1}{8}$ in diameter ferrite rod and wind 50 turns of 28 s.w.g. enamelled copper wire in a single layer for L1. This will tune with VC1 for medium wave stations. If long wave stations are required L1 should have 160 turns of the same wire layer wound. L2 is wound either on top of or close to L1 and consists of 5 turns of 28 s.w.g. enamelled copper wire.

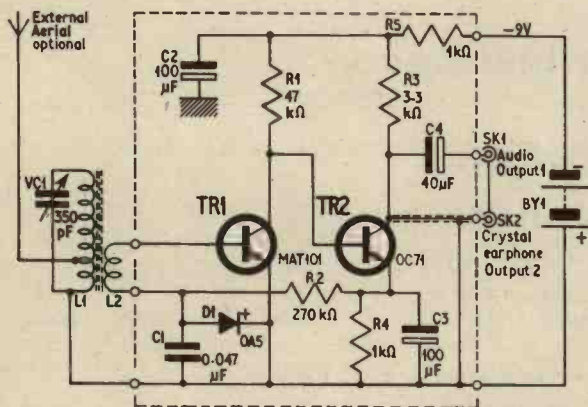
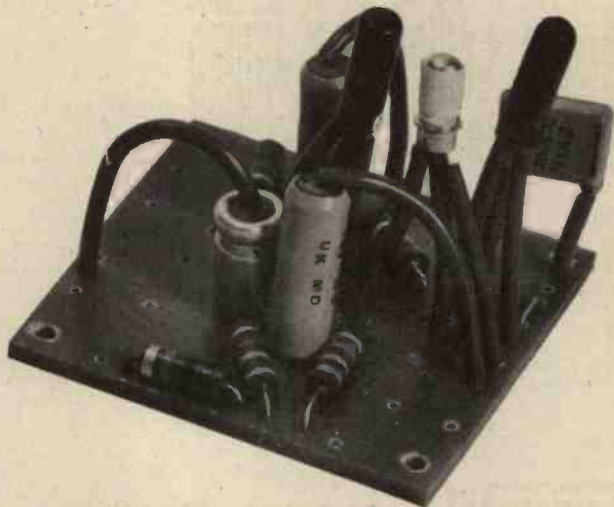

Fig. 1. Circuit of the a.m. radio tuner. The components outside the dotted line are mounted on a suitable metal box which houses the whole tuner (see text). Components inside the dotted line are assembled on the printed circuit board



It is a desirable precaution, although not strictly necessary, to wrap a thin sheet of paper round the ferrite rod before winding. This will help to prevent short-circuited turns, which could arise if the enamel is chafed.

The tuning capacitor is 350pF; a mica dielectric type is suitable here. If reception is difficult by reason of locality or screening when used in a car, L1 can be "tapped" one-third of the number turns from the "earthy" end and an aerial wire attached. Alternatively an extra coil with one-third of the number of turns as on L1 can be wound on the same ferrite rod. One end of this winding is earthed; the other end is connected to the external aerial.

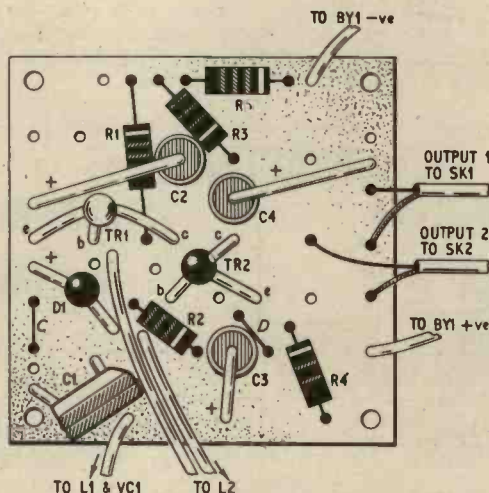

Fig. 2. Layout of components on the board. Notice the link wires C and D and the leads to the coils L1 and L2. Output 1 can be fed into an audio amplifier such as the driver amplifier described elsewhere in this issue. Output 2 will provide a low level signal for a crystal earpiece.

COMPONENTS . . .

Resistors

R1 47k Ω R3 3.3k Ω
 R2 270k Ω R4 1k Ω
 All $\pm 10\%$, $\frac{1}{2}$ watt carbon

Capacitors

C1 0.047 μ F mica
 C2 100 μ F elect. 15V
 C3 100 μ F elect. 15V
 C4 40 μ F elect. 12V
 VC1 350pF mica or air dielectric, variable

Transistors

TR1 MAT101 (Sinclair)
 TR2 OC71 (Mullard)

Diode

DI OA5

Inductors

L1 and L2 made by winding 28 s.w.g. enamelled copper wire on $\frac{3}{8}$ in diameter ferrite rod (see text)

Battery

BY1 9 volt light duty

Plugs and sockets

PL1 and SK1 coaxial for output 1
 PL2 and SK2 coaxial for output 2

Miscellaneous

Printed circuit board (see text)
 Switch, single pole, on/off (optional) for battery
 Battery connectors and p.v.c. covered wire
 Crystal earphone (if required)

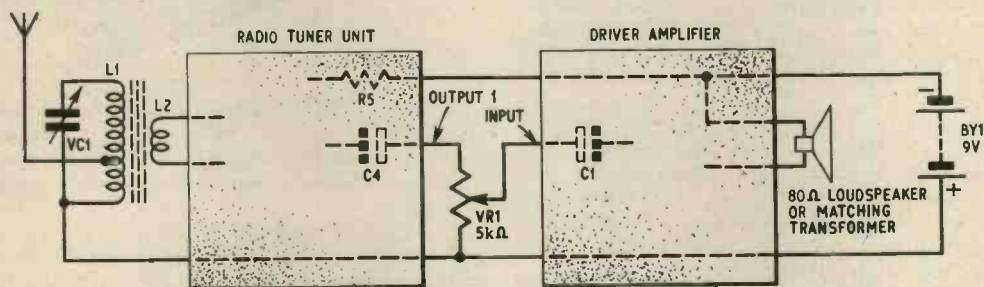

Fig. 3. The radio tuner can be combined with the Driver Amplifier to form a small pocket receiver using an 80 ohm output to a small loudspeaker or phone (not crystal). The dotted components refer to those described in the "Radio Tuner" and "Driver Amplifier" articles respectively.

POCKET RECEIVER

It is possible to combine the radio tuner unit with the "Driver Amplifier", described elsewhere in this issue, to provide a personal pocket receiver. Fig. 3 shows how the two units should be linked together.

Only one battery is needed; the common positive strips should be joined together, and the battery end of R5 on the tuner should be connected to the junction of R1, C2, and SK2 on the driver amplifier. SK1 on the tuner is linked with SK1 on the driver; the plugs and sockets can be eliminated if desired.

PRACTICAL

**WIRELESS
MARCH**

**MOBILE
TRANSMITTER**

**SWITCH TUNED
SUPERHET**

ALSO:
PROXIMITY ALARM

On Sale Now
Price 2/-

**TELEVISION
MARCH**

**INTEGRATED
TUNERS**

**SOUND CHANNEL
PROBLEMS**

ALSO:
FAULTY RESISTORS

On Sale Feb. 24th
Price 2/-

Meetings . . .

SOCIETY OF ELECTRONIC & RADIO TECHNICIANS

SOUTHAMPTON

Date: February 23
 Title: Flight Simulation (General Precision Systems)
 Time: 7.30 p.m.
 Address: College of Technology, East Park Terrace,
 Southampton.

STOKE-ON-TRENT

Date: February 22
 Title: Television Studio Equipment
 B. Yates A.S.E.R.T.
 (ATV (Birmingham) Ltd.)
 Time: 7.30 p.m.
 Address: Room 215, Physics Block, College of Tech-
 nology, Stoke-on-Trent.

"Bighead" Bonding Fastener

Metal Ventures Ltd., Southern Road, Aylesbury, Bucks.

These new fasteners enable thermal and acoustic insulation materials to be fixed quickly to laminates of all kinds. They are particularly suitable for fixing linings to loudspeaker enclosures.

The lagging studs can also be bonded on to surfaces such as acrylic sheet, plywood, steel, decorative laminates and chip-board. They can be hot pressed into polythene.

Once the perforated portion of the fastener has been fixed, the insulant can be easily impaled on the protruding studs and firmly secured with the barbed cap supplied.

Five standard lagging studs are produced, $\frac{1}{2}$ in, $\frac{3}{4}$ in, 1in, $1\frac{1}{4}$ in and $1\frac{1}{2}$ in in length, to suit various thicknesses of insulants.



Sine/Square Wave Generator

Daystrom Ltd., Gloucester, England.

The Heathkit Model IG-82U sine/square wave generator is designed for servicing and testing audio, radio, television, and recording equipment.

The sine wave frequency range extends from 20c/s to 1Mc/s ± 1.5 dB into a high impedance load. Distortion is better than 0.5 per cent from 20 to 20,000c/s. The output voltage, peak-to-peak, is available in four ranges: 0-0.01, 0-0.1, 0-1, and 0-10.

The square wave frequency coverage is 20c/s to 1Mc/s. The output voltage peak-to-peak is in three ranges: 0-0.1, 0-1 and 0-10. The rise time is less than 0.15 microsecond.

Both the sine and square wave outputs can be used simultaneously, as well as independently. The frequency of these two output signals is identical but the output signal levels are individually variable.

The generator has many applications which include the design and development of filter or compensating/equalisation networks, checking loudspeakers and enclosures, and square wave tests for high and low frequency attenuation, phase shift, ringing, etc.

The model IG-82U weighs 16lb and is available in kit form for £24 10s, with constructional and operating manual. The generator assembled and tested costs £36 10s.

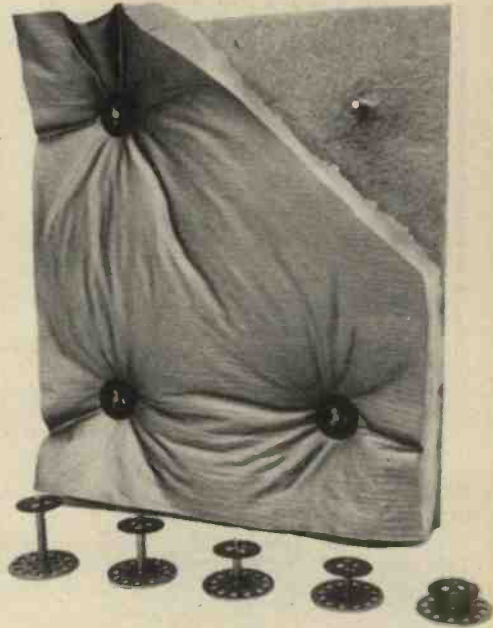

New Workbench Tool Rack

Henri Picard & Frere Ltd., 34/35, Fournival Street, London, E.C.4.

Our photograph below shows a new workbench tool rack, which holds 26 miniature hand tools. The tools are held in position by rubber grommets arranged in three stepped rows at the back of the rack. These grommets are easily replaceable and there are 34 different sizes for holding tools with body diameters ranging from 1mm to 10mm. By mounting in this method the workbench is kept clear and the working ends of the tools are protected from damage. The risk of loss is also minimised.

There are two shallow troughs below the first row of grommets and deeper storage trays, divided into 10 compartments, project from the front. These compartments have transparent lids and are ideal for storing small components. The price of the tool rack is 95s 8d.



PORTABLE RATEMETER

By D.V. SMITH

Part Two

It was stated in last month's article that the sub-units of the ratemeter may be used in various combinations to suit individual requirements. As such arrangements are identical to the internally switched facilities in the complete instrument, it is felt that some further descriptions of the possible "set-ups" would be useful to those intending to construct either the complete comprehensive instrument or only certain sections.

G.M. TUBE ALONE

The first of these arrangements for using the G.M. tube only is shown in Fig. 7. (Note: in this and the following "set-up" descriptions the choice of either battery or mains power is taken for granted.)

The circuits needed are the G.M. amplifier (Fig. 2), the ratemeter (Fig. 5), and the e.h.t. generator (Fig. 6). This set-up will enable an experimenter to explore the characteristics of a large number of G.M. tubes whose operating voltages fall within the range of the e.h.t. generator (0-800V). In addition, the various well-known radiation experiments included in most modern physics syllabi are within the capabilities of the circuits.

To the newcomer, the range of G.M. tubes available is a good indication of the specialised nature of most types and careful consideration of the application one has in mind is, of course, a basic step towards achieving the best results with a given instrument.

The physical layout of the above arrangement as used on its own is not critical and could be tailored to meet most requirements.

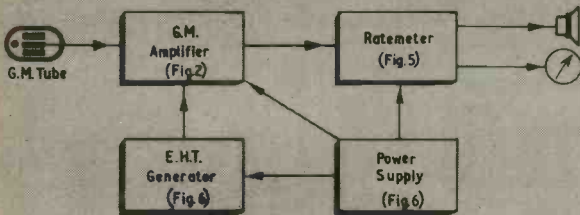

Fig. 7. Arrangement of units when using G.M. tube alone

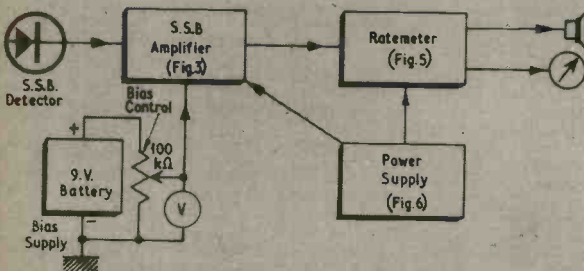

Fig. 8. Set-up for the detection of alpha particles using the s.s.b. detector. Output link on s.s.b. amplifier (Fig. 3) to be connected between B and C

S.S.B. DETECTOR FOR ALPHA PARTICLES

The simplest arrangement for using the s.s.b. detector is shown in Fig. 8 and will make possible the detection of alpha particles.

This amplifier is also capable of being used in conjunction with pulse height analysers for energy spectrometry of alpha particles.

The circuits indicated are the s.s.b. amplifier (Fig. 3) and the ratemeter (Fig. 5). A nine volt battery is all that is needed to provide sufficient detector bias. This should be possible, with the variable metered supply, to demonstrate the ability of the device to detect alpha particles at bias levels down to zero and the effect of various bias levels on the count rate observed.

At this point it might be prudent to look at one of the few problems involved with the s.s.b. detector. This is associated with the measurement of the actual bias appearing across the device.

Due to the finite reverse resistance, some leakage current will flow and its magnitude will vary from unit to unit within the manufacturer's limits. The leakage characteristic for all these devices will be approximately of the form shown in Fig. 9 where it can be seen that for most values of bias the leakage is fairly constant.

Some figures for high grade 20th Century units are given in the table below.

TABLE I

Detector type	Working voltage	Leakage at w. voltage
SSNO3K	25	$< \frac{1}{2} \mu A$
SSNO5K	25	$< 1 \mu A$
SSNO3K	300	$< 1 \mu A$
SSNO5K	100	$< 2 \mu A$

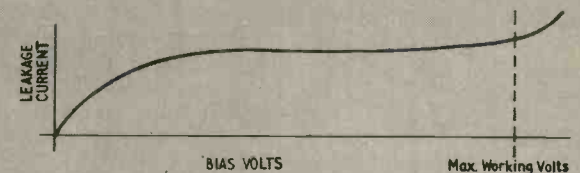

Fig. 9. Leakage current characteristic of the s.s.b. detector

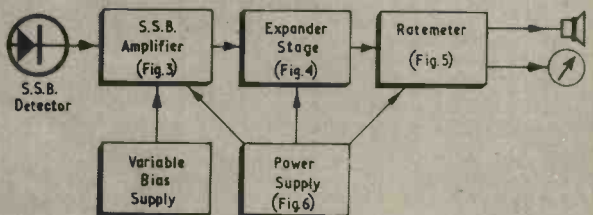

Fig. 10. Set-up for the detection of beta and gamma radiation. Output link on s.s.b. amplifier (Fig. 3) to be connected between A and B

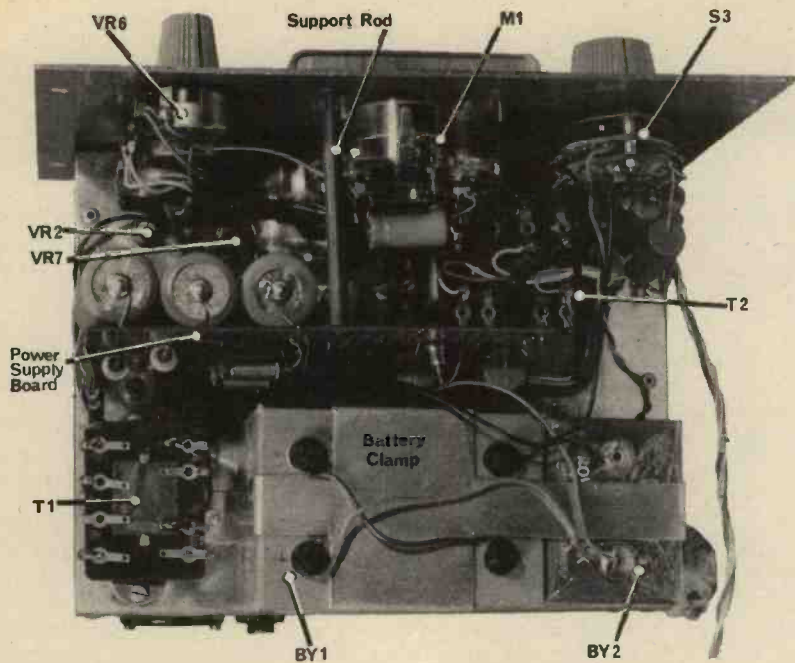

Fig. 11. Top view of the completed ratemeter

the most commonly used (and cheapest), while at the other end of the scale (and more expensive) 300 volts is the present limit.

As a general rule only low voltage working detectors are required for alpha particle detection while for beta and gamma detection better results are obtained at higher voltages.

The problems with the complete instrument in this respect was how best to portray the s.s.b. detector facility and in fact the most awkward case was chosen, this being for the 300 volt variety where use of the e.h.t. generator rather than batteries was called for.

S.S.B. BIAS PROBLEMS

Here again the problem of the bias calibration arises. At first sight it might only appear necessary to arrange the bias supply in much the same way as in Fig. 7 and use the calibrated e.h.t. control as the means of obtaining variation.

This will work to a certain extent but it has one serious drawback in that the e.h.t. generator will cease to function at outputs of about 10 volts or lower.

While this is of no consequence as far as the G.M. tube is concerned, because no operation of the tube is to be expected at this voltage, from zero to 10 volts is a region of great interest in the case of the s.s.b. detector regardless of its maximum voltage.

The answer was to operate the e.h.t. generator at a fixed voltage using a preset control and to "pot" down the output to a variable potentiometer from which the bias voltage was obtained. It was also necessary to ensure that the total resistance of the potentiometer chain was sufficiently high enough not to over-load the

The problem is, of course, to ascertain by how much the bias is reduced by the leakage current flowing through the load. Probably the most practical approach is to plot leakage versus bias for the particular detector and make allowance for the voltage drop in the megohm load resistor at the various bias levels.

Too great a stress ought not to be laid on this aspect for, as can be seen, the difference made by the leakage is unlikely to create great difficulty.

A suitable source of alpha particles is a luminous dial, but care should be taken to avoid fingering the characters for any deposit will reduce by absorption the available counts. Most important, however, is the presence in the luminous paint of radio-active materials which are selectively accumulated *permanently* in various sites in the body, particularly in this case the bones, and any risk of bodily uptake, however small, should be avoided.

S.S.B. FOR BETA & GAMMA

Detection of beta and gamma in addition to alpha radiations is made possible with the arrangement of Fig. 10 to which the addition of the expander stage (Fig. 4) gives the added gain required together with the necessary facility to discriminate against unwanted noise. Some care should be taken with layout and screening of circuits to avoid both noise pick-up and oscillation.

The bias supply is not specified in this case because the maximum voltage which can be applied to the device will depend on its rated voltage and this will vary from unit to unit.

The 25 volt working detector is

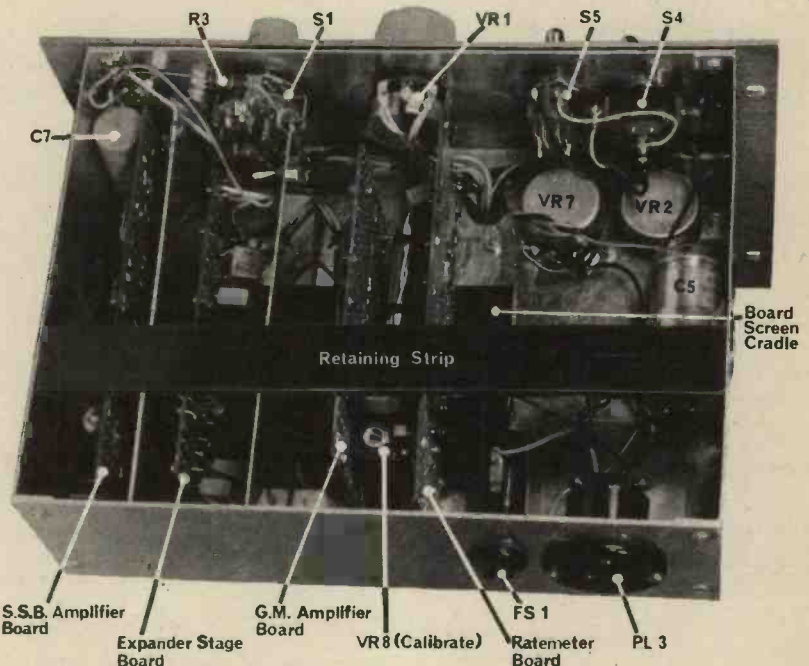

Fig. 12. Underside view of the ratemeter chassis

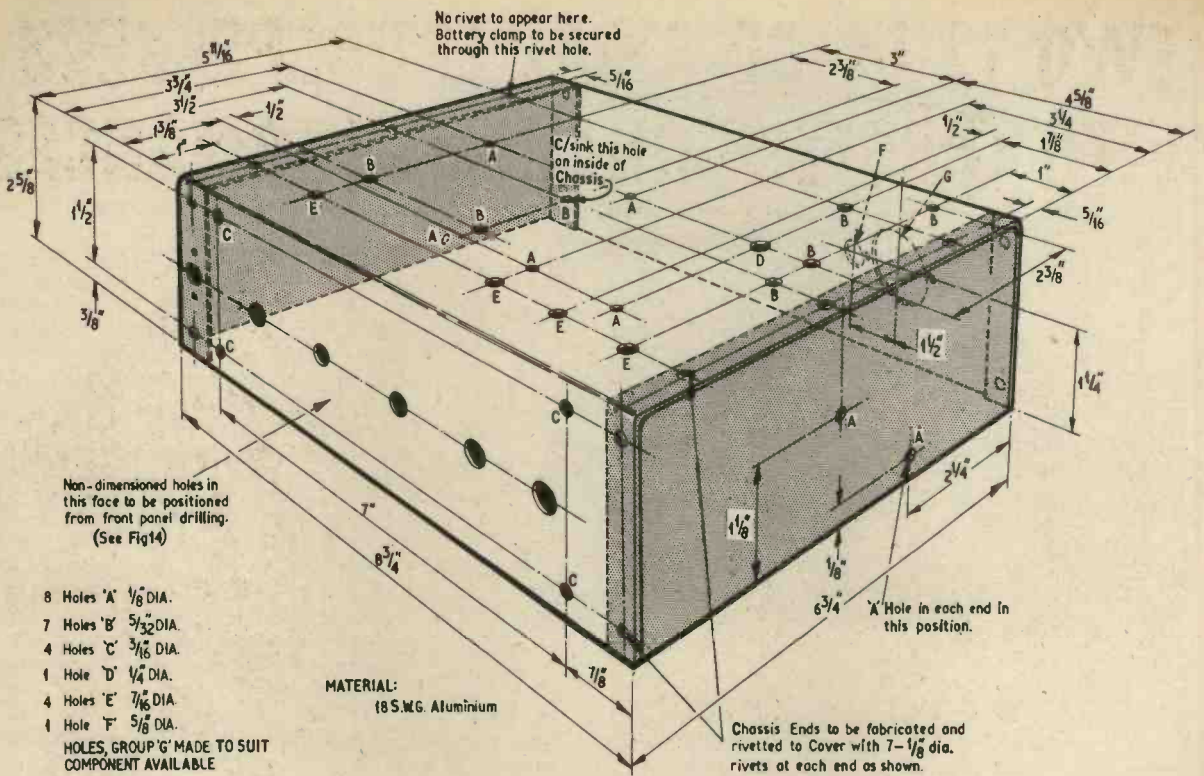

Fig. 13. Dimensions and drilling details for the chassis

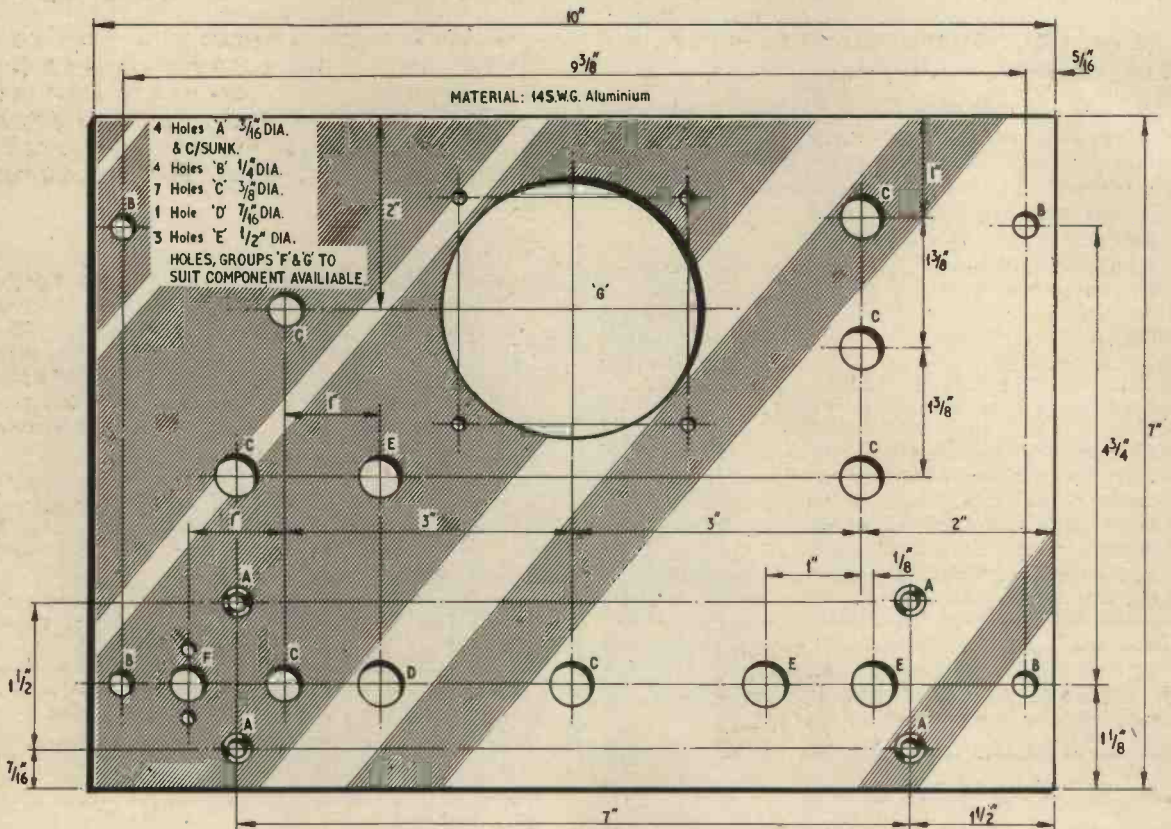
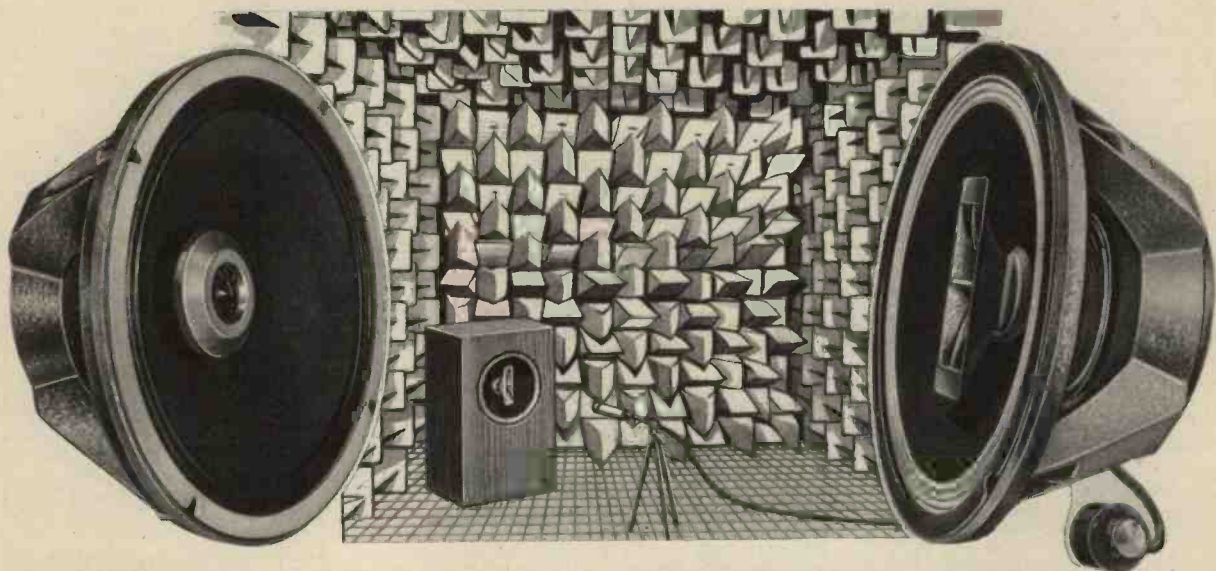

Fig. 14. Dimensions and drilling details for the front panel

TWO 12 in. CO-AXIAL LOUDSPEAKERS WITH **PROFESSIONAL** PERFORMANCES



CX 1512

£11. 10. 0

* PLASTAFLEX SURROUND * COMPRESSION TREBLE UNIT * TWO VOICE COILS * HIGH FLUX CERAMIC MAGNETS * RIGID DIE CAST CHASSIS * PURE ELECTRICAL CROSSOVER

Specification

Overall Frequency Response	30-15,000 c/s
Power Handling Capacity	15 Watts
Fundamental Resonance Frequency	35 c/s
Crossover Frequency	4 kc/s
Impedance	15/16 ohms
Flux Density	13,000 gauss
Total Flux	88,000 Maxwells

SMALLER ENCLOSURES

The research and development department of Celestion has now evolved two new enclosure designs for these Co-axial loudspeakers based on a cabinet volume of only 2.5 cu. ft. and measuring 30½" x 17½" x 11½". Full dimensional details are included with the general colour brochure.

Celestion

Studio Series

CELESTION LTD

Ferry Works, Thames Ditton, Surrey.
Telephone: EMBerbrook 3402/6

CX 2012

£16. 10. 0

* HI-FLEX 'FREE' SURROUND * TWO VOICE COILS * COMPRESSION HORN LOADED TREBLE UNIT * SEPARATE HIGH FLUX CERAMIC MAGNETS FOR BASS AND TREBLE UNITS * PURE ELECTRICAL CROSSOVER * RIGID DIE CAST CHASSIS * HIGH FREQUENCY LEVEL CONTROL

Specification

Overall Frequency Response	30-18,000 c/s
Power Handling Capacity	20 Watts
Fundamental Resonance Frequency	35 c/s
Crossover Frequency	4 kc/s
Impedance	15/16 ohms
Flux Density	17,000 gauss
Total Flux	180,000 Maxwells

Typical response curve of CX 1512

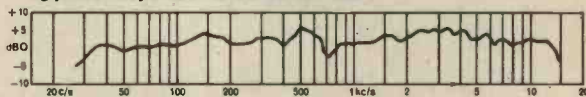

Typical response curve of CX 2012



Celestion Ltd., Ferry Works, Thames Ditton, Surrey
Please send me details of the 'STUDIO' Series Loudspeakers

Name.....

Address.....

GD 392

TYGAM FBET (Contem. pat.), 12 x 12in. 8 1/2, 12, 18in. 3/4, 12 x 24in. 4, etc.
EXPANDED ANODISED METAL—Attractive gilt finish 1/4in. x 1/4in. diamond mesh 4/8 sq. ft. Multiples of 6in. cut. Max. size 4ft. x 3ft., 47/8 plus carr.
BOMBAFOUST Speaker Cabinet Acoustic Wadding (1in. thick approx.) 18in. wide, any length cut, 6/- yd.

Volume Controls—5K-2 Meg. ohms, 3in. spindles, Morganite Midget Type 1 1/2in. diam. (dur. 1 year, LOG or LIN ratios less 8/- 3/4). DP. Hw. 4/8. Twin Stereo less 8w. 7/8. 100 K to 2 M/ohms with DP. Sw. 9/6.

WAVECHANGE SWITCHES 1 p. 12-way, 2 p. 2-way, 2 p. 6-way, 3 p. 4-way, 4 p. 2-way, 4 p. 3-way, long spindle, 3/6 ea.

ENAMELLED COPPER WIRE—1lb. reels 14g-20g, 3/-; 22g-28g, 3/6; 30g-34g, 4/8; 36g-38g, 4/8; 39g-40g, 5/-, etc.

TINNED COPPER WIRE, 16-22g, 4/- 1/2lb.

RESIN MULTICORE SOLDER, 60/40 6d. per yard. Cartons 6d. 1/-, 2/8, etc.

New Boxed VALVES Reduced Bargain Prices

1T4	3/8	EF86	8/8	PCL83	10/8
1R5, 1R5 8/		EL33	12/8	PCL84	10/-
3R4, 3V4 7/-		EL24	12/8	PCL85	11/8
ECC81	7/-	EL94	7/-	PL36	10/8
ECC82	7/-	EY51	9/-	PL81	9/8
ECC83		EY86	9/-	PL83	8/-
ECL80	9/-	EZ81	7/-	PY33	10/8
ECL82	10/-	U232	9/8	PY82	7/-
ECL86	10/8	PCX894	8/-	U25	10/8
EF80	7/8	PCY80	8/-	U34	9/-

CO-AX 80 ohm CABLE
 High grade low loss Cellular Air Spaced Polythene—1/4in. diam. Stranded Concl.
 Now only 6d. yard

BARGAIN PRICES—SPECIAL LENGTHS
 20 yds. 9/- carr. 2/-; 40 yds. 17/6 carr. 3/-; 60 yds. 25/- carr. 3/6; Coax. Plugs 1/-; Sockets 1/-; Couplers 1/8.

7 VALVE AM/FM RADIOGRAM CHASSIS

New 1965 Model Now Available

Three Waveband and Switched Gram positions. Med. 200-550m. Long 1,000-2,000m. VHF/FM 88-95 Mc/s. Philips Continental Tuning insert with permeability tuning on FM and combined AM/FM IF transformers. 460 kc/s and 10.7 Mc/s. Dust core tuning all coils. Latest circuitry including AVC and Neg. Feedback. 3 watt output. Sensitivity and reproduction of a very high standard. Chassis size 13 1/2" x 6 1/2". Height 7 1/2". Edge illuminated glass dial 11 1/2" x 3 1/4". Vert. pointer. Horiz. station names. Gold on brown background. A.C. 200/250V operation. Magic-eye tuning. Circuit diag. now available. Comp. with Tape, O/P socket, ext. spk'r and P/U sockets and indoor FM aerial, and 4 knobs—walnut or ivory to choice. 3Ω P.M. Speaker only required. Recommended Quality Speakers 10" Elac. 27/6. 13 1/2" x 8" E.M.I. Fidelity, 37/6. 12" R.A. with conc. Tweeter, 42/6. Carr. 2/6.

Valves ECC85, ECH81, EF89, EABC80, EL84 EM81, EZ80



Aligned and tested ready for £13.19.6 Carr. & Ins. 7/6 use.

L.P. RECORDING TAPE BARGAIN OFFER!

By leading British manufacturers—**PROFESSIONAL GRADE—DOUBLE-SIDED** (each side coated) 5 1/2" reels only

Special Price Offer 1,450 feet 20/- post free (2 reels)

Ideal for the experimenter who wants to record both sides, and a good L.P. Tape for the enthusiast who wishes to record single side only.

SPECIAL OFFER 3" Message tape 150', 3/8; 3" L.P. 225', 4/8; 3" D.P. 300', 8/8. P. & F. per reel 6d.

TAPE REELS Mutra surplus 7", 2/8; 6", 2/-; 5", 2/-; 3", 1/8; Plastics spool containers, 5", 1/8; 6", 2/-; 7", 2/8.

Speakers P.M.—3 ohms 2 1/2" E.M.I. 16/8. Goodmans 3 1/2" 18/8. 5" Rola 15/8. 6" Elac 18/8. 7" x 4" Goodmans 15/8. 8" Rola 19/8. 10" R. A. 25/-.

9" x 6" Goodmans 22/8. E.M.I. Ceramic Magnet 37/8. Tweeter 22/8. Jack Plugs Mandari 2 1/2" Igranite Type, 2/8. Screened ditto, 3/8. Miniature ser. 1 1/2", 2/8. Sub-min. 1/3.

TRIS
 Est. 1949

RADIO COMPONENT SPECIALISTS
 70 Bristol Rd., Thornton Heath, Surrey. TH2 2188. Terms C.W.O. or C.O.D. Post and Packing up to 1 lb. 1/8; 1 lb. 1/8; 3 lb. 3/-; 5 lb. 3/9; 8 lb. 4/6.

Hours: 9 a.m.-6 p.m., 1 p.m. Wed.

TRANSISTOR COMPONENTS

Midget I.F.F.s—460 Kc/s 1/4 in. diam. first, second or third. 5/6
 Osc. Coil M. & L.W. 1/4 in. diam. 2/-
 Midget Driver Trans. 9/11
 Midget Output Trans. Push-Pull—3 ohms 6/-
 Elect. Condensers—Midget Type 1 mid.-0.01 mid. ea. 1/8, 10 mid. 2/8, 12V. Condensers 150 V. working—.01 mid., .02 mid., .03 mid., .04 mid. 9d.; .05 mid., .1 mid., 1/-; .25 mid., 1/8; .5 mid., 1/8, etc. Midget Tuning Condensers. J.B. "OO" 208 pF and 176pF, 3/8; ditto with trimmers, 9/8. J.B. 220pF and 105pF conc. slow motion 10/8. 365pF angle 7/8.

Condensers—Silver Mica. All values 2pF to 1,000pF, 6d. each. Dittos Ceramics 9d. Tub. 450V T.C.C. etc. 0.001 mFd to 0.01 and 0.1 350V, 9d. 0.0-0.1 500V, 1/-, 0.25 Hmkt. 1/8. 0.25 T.C.C. 1/8, etc. Glass Tol. 8/Micas—10% 5pF-500pF, 6d. 600-5,000pF, 1/-, 1% 2pF-100pF, 9d. 100pF-500pF, 11d. 575pF-5,000pF, 1/6. Resistors—Full Range 10 ohms-10 meg. ohms 20% 1/2 and 1W, 3d. 1W. 6d. (Midget type modern rating) 1W. 6d., 2W. 6d. HI-50k, 6% 1W, 1W, 6d. (100 ohms-1 meg.). Other values 9d. 1% 1W, 1/8, etc., etc.

TRIMMERS, Ceramic (Compression Type)—30pF, 50pF, 70pF, 9d.; 100 pF, 150pF, 1/8; 250pF, 1/8; 600pF, 1/8.

PHILIPS, Bee Hive Types (conc. air spaced) —2.5pF, 1/-; 3.50pF, 1/-.

KNOBBS—Modern Continental types. Brown or Ivory with Gold centre; 1" dia., 9d. each; 1 1/2", 1/3 each. Conc. knobs Ivory with gold centre 1 1/2" dia. 2/9 p. Matching ditto 2/8 ea. **LARGE SELECTION AVAILABLE.**

METAL RECTIFIERS, STC Types—RM1, 4/8; RM2, 6/8; RM3, 7/8; RM4, 10/-; RM6, 21/-; RM4B, 17/8; Mullard BY100, 8/8.

TUB-ELECTROLYTICS—CAN
 25/25 v. 50/12v. 1/9; 8+8/450v. 4/8; 50/50v. 100/125v. 2/-; 32+32/275v. 4/8; 8/450v. 4/850v. 2/8; 60/50/350v. 6/8; 18+18/450v. 5/8; 60/250/275v. 12/8; 32+32/450v. 6/8. 100+250/275v. 12/8.

4-STATION INTERCOM



£27/19/0

Solve your communication problems with this latest 4-Station Transistor Intercom system (1 master and 3 Subs) in de-luxe plastic cabinets for desk or wall mounting. Call/talk/listen from Master to Subs and Subs to Master. Operates on one 9V battery. On/off switch. Volume control. Ideally suitable to modernize Office, Factory, Workshop, Warehouse, Hospital, Shop, etc. to keep instant inter-departmental contacts. Complete with 3 connecting wires, each 66 ft. & other accessories. Nothing else to buy. Post Free



Usually ~~£6.95~~ Our Price ONLY **57/6**

Modernize your Office, Shop, Warehouse, Workshop, Surgery, Nursery, and home with this latest two-way Transistor Intercom, consisting of two units, Master and Sub, in strong plastic cabinets with chromium stands. Elegantly designed to use as two-way instant communication system—Call/talk/listen—between two persons anywhere indoors or outdoors. Both units operate on one 9V battery. Complete with 60 ft. wire. Battery 2/- P. & F. 2/6.

BATTERY ELIMINATOR AND CHARGER 27/6

Use your Transistor Radio or Intercom from domestic A.C. mains and charge dry battery PPS 9V to boost battery's life many times. Unbeatable value. Save your pounds on batteries. P. & F. 1/6. Complete with Plug, Lead and Snap cord.

Full price refunded if returned in seven days.

WEST LONDON DIRECT SUPPLIES (PE/1)
 6 Chiswell Place, West Ealing, London, W.13

TRANSISTOR RECEIVERS AND AMPLIFIERS

This book describes the best and most popular working circuits for radios, record players and public-address systems.

by F. G. Rayer
 30/- Postage 1/-

TRANSISTOR ELECTRONIC ORGANS FOR THE AMATEUR by A. Douglas & S. Astley. 18/-. Postage 1/-.

UNDERSTANDING LASERS AND MASERS by S. Leinwoll. 13/6. Postage 9d.

ELEMENTS OF TRANSISTOR PULSE CIRCUITS by T. D. Towers. 35/-. Postage 1/-.

MOTOROLA SEMICONDUCTOR CIRCUITS MANUAL 16/-. Postage 1/-.

NETWORK ANALYSIS FOR TELECOMMUNICATIONS AND ELECTRONICS by R. A. Lampitt. 63/-. Postage 2/-.

BUILDING AND USING SOUND MIXERS by R. E. Steele. 30/-. Postage 1/-.

HI-FI YEAR BOOK 1965/6 by M. Henslow. 12/6. Postage 1/-.

COMPLETE CATALOGUE 1/-.

THE MODERN BOOK CO.
 19-21 PRAED STREET
 LONDON, W.2
 Phone: PADdington 4185
 Open 6 days 9-6 p.m.

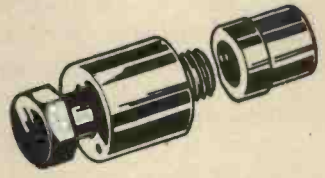

The PUNCH you need!

HOLE PUNCHES

Instant Type					
1 1/2" diameter	6/10 ea.
Screw-up Type					
1 1/2" diameter Toggle switch	8/6 ..
" " " " " "	8/6 ..
" " B7G	9/6 ..
" " B8A, B9A	10/2 ..
" " " " " "	10/8 ..
" " " " " "	11/8 ..
1 1/2" diameter Int. Octal	13/4 ..
1 1/2" " " " " "	16/2 ..
1 1/2" " " " " "	18/10 ..
1 1/2" " " B9G	21/8 ..
1 1/2" " " " " "	24/4 ..
2 1/2" " " Meter	33/2 ..

Complete Set £9.3.6

No extra charge for postage and packing in the U.K.

Now supplied by:
TOMPKINS & LONGMAN LTD.
 237 GIPSY ROAD
 WEST NORWOOD, S.E.27
 Tel.: Gipsy Hill 5000

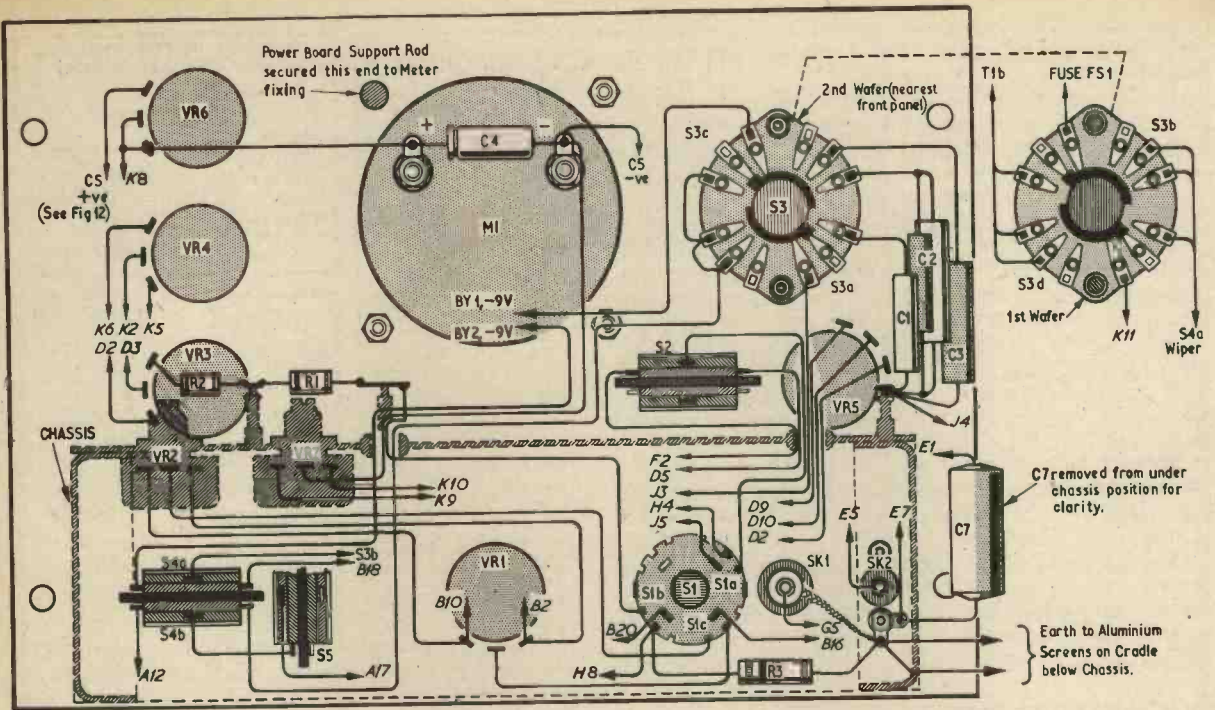

Fig. 15. Front panel components and wiring. Key to the coding of the external connections is given in Fig. 1. (last month)

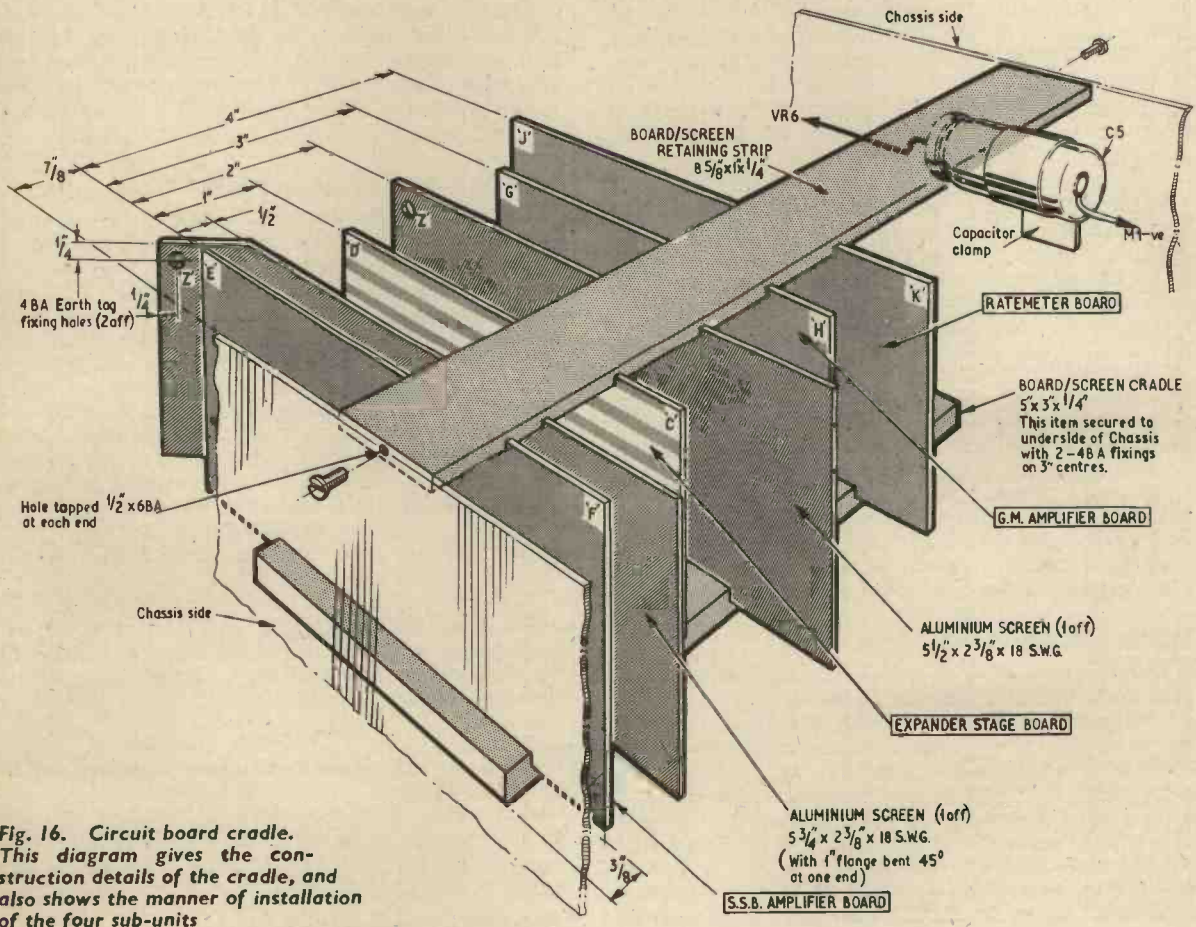

Fig. 16. Circuit board cradle. This diagram gives the construction details of the cradle, and also shows the manner of installation of the four sub-units

e.h.t. generator. A value of 20 megohms was used in the prototype.

It is necessary, therefore, to take into account the impedance of the supply when calibrating the "s.s.b. volts" (VR3) for a particular detector whose leakage is known.

To put the problem in its proper perspective it should be said that not many experimenters are likely to need 300 volts bias for, in practice, 9 volts bias will still enable one to detect even quite low energy beta and gamma radiations with a good 25 volt working detector using the circuits of Fig. 10. The described arrangement using the e.h.t. generator was incorporated in the instrument to show that it could be done if needed and this should be borne in mind when choosing the bias supply, as obviously a 25 volt working detector can be very easily operated from a small battery.

Once again a source of beta and gamma radiations is the luminous dial—provided that the alpha particles are absorbed by a thin sheet of paper placed between the source and the detector.

The luminous watch face may not be the most perfect source by laboratory standards, but it is undeniably the most easily obtainable and can readily be used in a number of experiments involving the three types of radiation discussed.

MECHANICAL DESIGN

The mechanical design of the prototype instrument naturally raised questions regarding the best method of arrangement, the Veroboard sub-units being the foremost consideration in this respect. A commercial instrument built for the same applications would almost certainly employ plug-in circuit boards making a very convenient unit. It was felt however that this sort of refinement would unnecessarily add to the cost and be of little or no benefit to the constructor building this instrument as described.

The top and underside views of the finished ratemeter (see Fig. 11 and Fig. 12) show the compromise method by which the sub-unit boards can be mounted in a roughly similar manner to the conventional plug-in modular form of construction. The important difference in this case is that although the boards are moveable they are not strictly removeable unless the wire connections are broken.

Adherence to this "modular" system was considered necessary as far as the complete instrument was concerned in order to keep it as small as possible while, at the same time, still clearly made up of separately useable sub-units.

Of course there is no reason why individual constructors should not employ good alternative systems better tailored to their own requirements, if they prefer. This is particularly so if only sections of the instrument are required and space is not at a premium.

MAIN CHASSIS ASSEMBLY

Details now follow of the construction of the comprehensive instrument shown in the illustrations.

Construction commences with preparation of the metal work for the main chassis assembly. This consists of the chassis proper, Fig. 13, and the front panel, Fig. 14. Both these items are made from 18 s.w.g. sheet aluminium. Drilling positions on the front edge of the chassis should be obtained by offering up the completed front panel to the chassis.

When the front panel has been bolted to the chassis, the main assembly circuit components should be

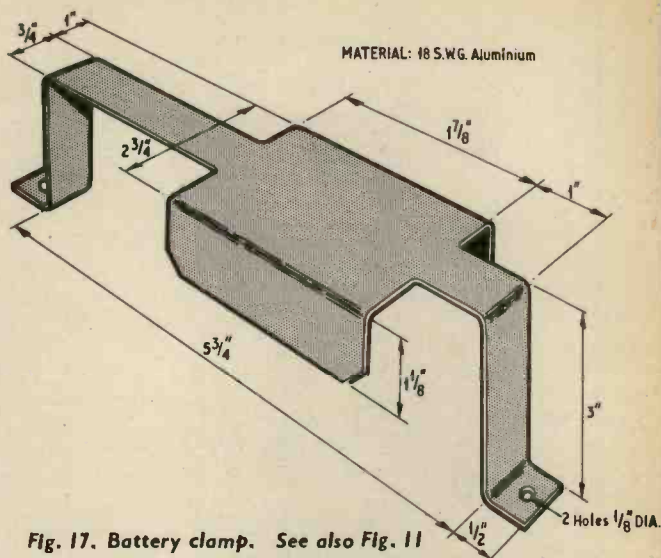

Fig. 17. Battery clamp. See also Fig. 11

mounted in position and the wiring completed so far as is practical at this stage. Fig. 15 shows all the front panel components *in situ*; also included in this diagram are two potentiometers (VR2, VR7) which are mounted on the deck of the chassis, close to the front panel. The "external" wiring, i.e. the flying leads A12, H4, etc. are best omitted at this stage; they can be added when the sub-units have been incorporated in the chassis.

The two transformers (T1, T2) are bolted to the top of the chassis as shown in the photograph, Fig. 11. The mains connector PL1 and the fuseholder are fitted to the rear edge of the chassis. The capacitor C5 is clamped to the side of the chassis, see Fig. 12. Fixing holes for all these items are included in Fig. 13.

CRADLE FOR CIRCUIT BOARDS

The cradle which holds four sub-unit boards can be seen in the underside view of the chassis, Fig. 12. Constructional details are given in Fig. 16. The cradle is made from $\frac{1}{2}$ in thick \times 3 in wide s.r.p.b. with $\frac{1}{2}$ in deep slots cut crosswise. Two hacksaw blades mounted side-by-side in the saw will cut slots of the correct width for the Veroboards. A 1 in wide strip of the same material with corresponding slots and fixed at each end to the chassis forms the board retaining strip. (If an extra conductor is left at both edges of the eleven-way Veroboards, making a total of thirteen ways in all, this will allow them to be mounted in the slots without fouling the components wires on the "I" and "J" conductors—see Part Three).

Two holes are drilled in the cradle for fixing this to the chassis as mentioned in Fig. 16.

Details of the battery clamp are given in Fig. 17.

The third and concluding part of this article will cover the construction of the individual circuit boards, the final assembly and wiring, and the setting up and operation of the ratemeter.

ERRATA

The following small amendments should be made to diagrams included in Part I.

- Fig. 1. Value of C5 should be 5,000 μ F. Common side C1, C2 and C3 goes to J4.
- Fig. 3. Output to ratemeter at F2 is NEGATIVE (link between B and C).
- Fig. 5. Input at J5 is NEGATIVE.

take your pick!



WORLD'S TOP SEMICONDUCTORS now available to everyone at IR SEMICONDUCTOR CENTERS

**TRANSISTORS · ZENER DIODES · SILICON CONTROLLED RECTIFIERS · GERMANIUM DIODES · SOLAR CELLS
SILICON RECTIFIERS · SELENIUM STACKS · BRIDGE RECTIFIERS · PHOTO CELLS · INSTRUMENT RECTIFIERS
DUAL DIODES · AUTOMOTIVE RECTIFIERS · MOUNTING ACCESSORIES · PROJECT KITS · MANUALS**

Over 100 items available, prepacked and prepriced, many with free instruction manual and project and experiment details. Send to your nearest IR Semiconductor Center for the full illustrated catalogue and price list.

Co. Durham: Red Radio Shop, 31 Crotree Rd. Sunderland, Tel: 72087 · Kent: B. W. Cursons, 78 Broad St. Canterbury, Tel: 65442 · Lancashire: P. Kirkland Engineering Ltd., 16-18 Albion St., Manchester 1, Tel: CEN 1226 · R.S.C. (Manchester) Ltd., 60A-60B Oldham St. Manchester, Central 2778 · London: Henry's Radio Ltd., 303 Edgware Rd. London W2, PAD 1008 · G. W. Smith & Co. Ltd., 3 Lisle St. London WC2, GER 8204 & 9155 · Sterne-Clyne Ltd., 162 Holloway Rd. London N7, NOR 8161 · Lasky's (Harrow Road) Ltd., 42 & 43 Tottenham Court Rd. London W1, MUS 2605 · Middlesex: Odeon Radio Ltd., 146 College Rd. Harrow, HAR 5778 · South Supplies Electrical Ltd., 90 High St. Edgware, EDG 6751 · Northumberland: Aitken Bros. & Co., 48 Pudding Chare, Newcastle upon Tyne 1, Tel: 26729 · Ritchley & Freeman Ltd., 100 Percy St. Newcastle upon Tyne 1, Tel: 23285 · Scotland: R.S.C. (Manchester) Ltd., 326 Argyle St. Glasgow, City 4158 · F. Brown & Co., 45 George IV Bridge, Edinburgh 1, Caledonian 3461 · RME Surplus Supplies, 143 Stockwell St. Glasgow C1, Bell 2634 · Surrey: Home Radio (Mitcham) Ltd., 187 London Rd. Mitcham, MIT 3282 · Warwickshire: Regency Electronics, 29 Regent St., Leamington Spa, Tel. 22590 · Yorkshire: R.S.C. (Manchester) Ltd., 106 Newport Rd., Middlesbrough, Tel: 47096 · R.S.C. (Manchester) Ltd., 10 North Parade, Bradford 1, Tel: 25349.

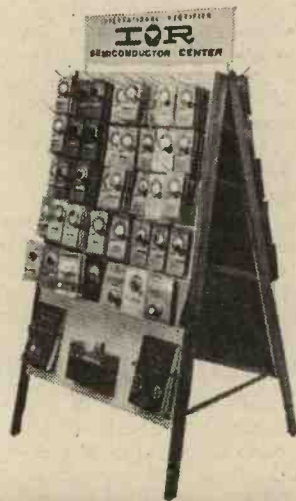

Fully displayed and described. Take your pick! ▶



INTERNATIONAL RECTIFIER CO. (GREAT BRITAIN) LTD., HURST GREEN, OXTED, SURREY. PHONE OXTED 3215. TELEX RECTIFIER OXTED 8819

SERVISCOPE MINOR



£23.10.0

Extend the range of your present test instrumentation with this versatile Teleequipment oscilloscope. Simplified operation—minimum controls, automatic time base synchronisation—but top quality construction.

2.75" tube with graticule, contrast filter and rubber light hood. Bandwidth 30Kc/s (-3dB); maximum sensitivity 100mV/0.5cm division. Time base continuously variable from 100usecs to 100msecs per 0.5cm division. Mains operated, fully portable. Instruction manual supplied. Descriptive leaflet on request.

Obtainable only direct from the country's largest specialist manufacturer of portable oscilloscopes for science and industry.

Serviscope is a registered trademark

TELE-EQUIPMENT

Teleequipment Ltd., 313 Chase Rd., Southgate, London N.14
Tel: Fox Lane 1166

Please send me, without obligation, the descriptive leaflet on the Serviscope Minor.

NAME

ADDRESS

PE/3

The SUPER 6 LONG AND MEDIUM WAVE TRANSISTOR RADIO



★ 6 transistors and diode. ★ 350mW. ★ Superhet, Ferrite rod aerial.
★ Component positions and references printed on back of board. ★ Wooden cabinet, 11x7 1/4 x 3 1/2 in. ★ Vinyl covered. ★ 6x4 in. speaker. ★ Booklet 2/-, Free with kit. ★ Lining up service. ★ All parts supplied separately.
Write for list. B.A.E. please. VT9 or F.P.S. (3/9 with kit).

COMPLETE SET OF PARTS ONLY £4.0.0.

PLUS 5/- POST
OR FULLY BUILT £6.7.6 Tax & Carr. Paid

AM/FM (V.H.F.) RADIO GRAM CHASSIS £13.13.0



Chassis size 16 x 6 1/2 x 5 1/2 in. high. New manufacture. Dial 1 1/2 x 4 in. in cream and red. 200-250v. A.C. only.

Pick-up. Ext. Speaker. Ac. E. and Dipole Sockets. Five pushbuttons—OFF, L.W., M.W., F.M., and Gram. Aligned and tested. Tone control. 1000-1900 M.: 200-500 Mc/s; 88-98 Mc/s. EZ30, ECH81, EF89, EABC80, EL84, ECC85, 3-ohm speaker required.

9 x 6 in. ELLIPTICAL SPEAKER 25/-.

TERMS: £3.10.0 down and 5 monthly payments of £2.4.0, total £14.10.0.

V.H.F. Dipole 12/6. Feeder 6d. yd.
ALTERNATIVE DESIGN. Similar to above chassis. With addition of S.W. 6-17 Mc/s. £16.15.0. TERMS: £3.10.0 down and 6 monthly payments of £2.4.0. Total H.P. price £16.14.0. Circuit diagram 2/6.

NEW 6 PUSHBUTTON STEREOGRAM CHASSIS

M.W.; S.W.1; S.W.2; VHF; Gram; Stereo Gram. Two separate channels for Stereo Gram with balance control. Also operates with two speakers on Radio. Chassis size 15" x 7" x 6 1/2" high. Dial cream and red 16" x 3". Price £17.17.0 carr. paid or £4.0.0 deposit and 6 monthly payments of 50/-. Total H.P. price £19.0.0. Cream moulded escutcheon for dial 7/6 extra.

GLADSTONE RADIO

66 ELMS ROAD, ALDERSHOT, Hants.

(2 mins. from Station and Busen.)

Aldershot 22240

CLOSED WEDNESDAY AFTERNOON

CATALOGUE 6d.

Eddystone



DIE CAST INSTRUMENT BOXES

The largest of the range—Cat. No. 903—is illustrated above. Made of aluminium alloy, it has internal dimensions of 7 1/2 in. x 4 1/2 in. x 3 in., and weighs 21 oz. Details of the other boxes are as follows:

Catalogue Number	dimensions	weight
896	4 1/2 in. x 2 1/2 in. x 1 in.	11 1/2 oz.
650	4 1/2 in. x 3 1/2 in. x 2 in.	18 oz.
845	7 1/2 in. x 4 1/2 in. x 2 in.	32 oz.
6827P	7 1/2 in. x 4 1/2 in. x 2 in.	16 oz.

Cat. No. 6827P is of aluminium alloy, the others of Mazak alloy. All are complete with close-fitting flange lids and are supplied in natural metal. Data sheets on request.

Eddystone Radio Limited

Eddystone Works, Alvechurch Road, Birmingham 31
Telephone: Priory 2231. Cables: Eddystone Birmingham.
Telex: 33708

LTD/ED9

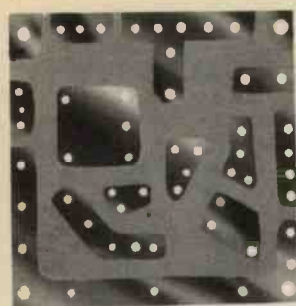

BB4

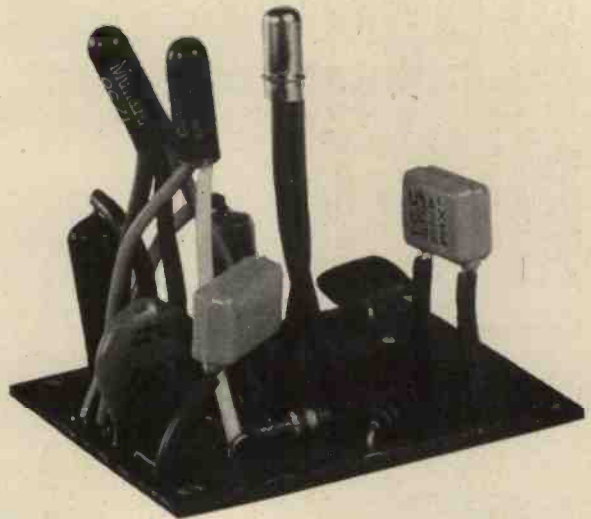

Use this simple device to play an electric guitar or a microphone through your radio

GUITAR PRACTICE ADAPTOR

THIS adaptor is a simple device to enable an electric guitar to be used with a domestic a.m. radio-receiver. The guitar output leads are connected to the input of this unit; the output of the adaptor is connected to the "aerial" and "earth" input sockets of a medium or long wave receiver according to the type of coil used.

The signal from the guitar (or microphone) modulates an r.f. signal produced by the oscillator circuit tuned by L1, L2 and VC1. The circuit diagram is shown in Fig. 1. These tuning components are the same as those

described in the "A.M. Radio Tuner" article elsewhere in this issue. The output is taken from the collector of TR2 via a 2.2pF capacitor.

This capacitor can be replaced by a home-made capacitance consisting of two short lengths of wire (about 2in) with thin insulation, which are twisted together. The collector of TR2 is connected to one wire and the output terminal to the other. The two wires must not touch each other (electrically) but must be close together.

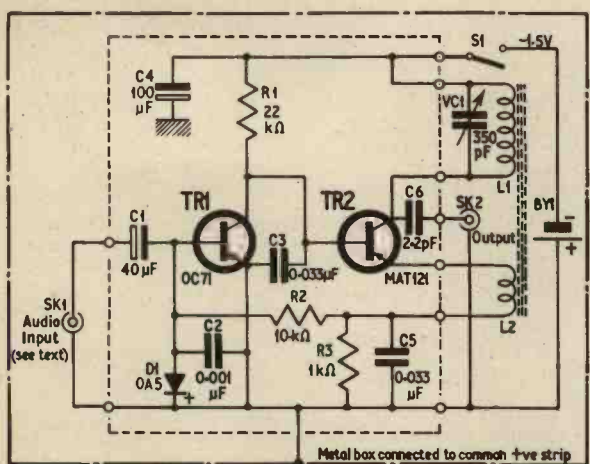

Fig. 1. Circuit diagram of the adaptor. The circuitry within the inner dotted line is made up on the printed circuit board. The outer chain dotted line indicates a metallic screen, such as an aluminium box, in which the complete circuit is assembled

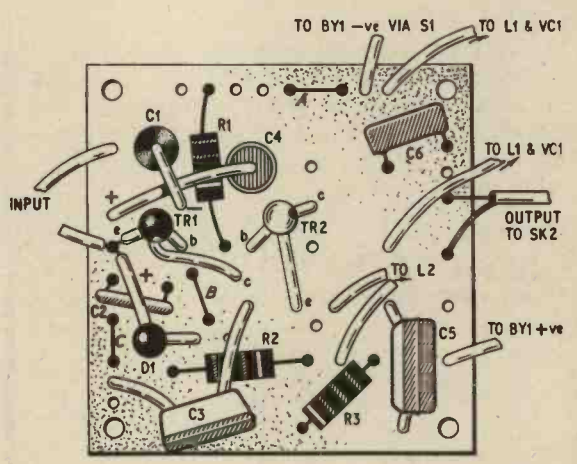

Fig. 2. Layout of components on the board. The coils L1 and L2 and tuning capacitor TC1 are the same as those used in the a.m. radio tuner described elsewhere in this issue. Notice the 11n wires at A, B, and C

Yet another method of coupling the output is by means of an extra winding on the ferrite rod. Only one complete turn of wire is needed and should not be too close to either of the other two windings. One end of this winding is connected to the metal screen round the whole unit; the other end is connected to the r.f. output terminal (SK2) for subsequent connection to the radio receiver.

METAL SCREEN

The metal screen is advised to prevent interference or interaction with nearby receivers. The simplest is a small tin, aluminium, or copper box with the input and output sockets SK1 and SK2 (coaxial types) screwed to the box on opposite sides. Although the r.f. output may be only a few millionths of a watt (a small fraction of a milliwatt), without the screen the interaction (possibly via nearby metallic objects) can be most disturbing.

COMPONENTS . . .

Resistors

R1 22k Ω
R2 10k Ω
R3 1k Ω } All resistors 10% $\frac{1}{2}$ watt carbon

Capacitors

C1 40 μ F elect. 12V
C2 0.001 μ F mica or polyester
C3 0.033 μ F mica or polyester
C4 100 μ F elect. 15V
C5 0.033 μ F mica or ceramic
C6 2.2pF ceramic (see text)
VC1 350pF mica or air dielectric, variable

Transistors

TR1 OC71 (Mullard)
TR2 MAT121 (Sinclair)

Diode

DI OA5

Inductors

L1 and L2 made by winding 28 s.w.g. enamelled copper wire on $\frac{3}{8}$ in diameter ferrite rod (details as in "Radio Tuner")

Battery

BY1 $1\frac{1}{2}$ volt cell, leakproof

Switch

S1 Single pole on/off

Plugs and sockets

PL1 and SK1 coaxial for the input
PL2 and SK2 coaxial for the output

Miscellaneous

Printed circuit board (see text)
Insulating board 2in \times 2in (see text)
Battery connectors (if required)
Metal box to house whole unit

The layout of components, using the same printed circuit board pattern as before, is shown in Fig. 2. Link wires are required at A, B, and C (see Fig. 2).

A backing plate of thin plain s.r.b.p. or other insulating material can be attached to the underside of the board to insulate the copper strips from the metal box. This plate can be cut 2in square with four $\frac{1}{8}$ in diameter holes drilled to match the fixing holes in the four corners of the printed circuit board. Alternatively, it can be made a bit larger according to the size of the metal box, so that both the printed circuit board and the ferrite rod can be mounted on it.

The two boards are screwed together on wooden mounting blocks glued to the inside of the metal box. Allow sufficient space to house the tuning capacitor VC1, the leakproof battery BY1, the on/off switch S1, and the two sockets SK1 and SK2. The box should be connected to the common "positive" copper strip from BY1.

TEST THE ADAPTOR

When the complete adaptor has been constructed and wiring checked, it can be tested. Connect the output from SK2 to the aerial and earth sockets of a domestic a.m. radio, making sure that the screen is connected to the "earth" terminal and the centre conductor to the "aerial" terminal. If the receiver has no "aerial" and "earth" sockets (it may use a ferrite rod or frame aerial), a single loop of wire round the internal aerial may be connected to the adaptor. A.C./D.C. receivers should not be used.

Switch on the receiver and tune to a "quiet" spot. Switch on the adaptor and rotate the tuning capacitor knob. This should produce a series of whistles from the receiver due to passing heterodynes and will indicate that the adaptor is oscillating correctly. If these heterodyne whistles are not heard, even with the receiver volume control turned up, the connections to L2 in the adaptor should be interchanged. The adaptor may fail to oscillate if these connections are incorrect.

Now connect an electric guitar, or other low level audio signal source, to the input socket SK1. Tune the adaptor with VC1 until the audio signal can be heard through the receiver loudspeaker.

NEXT MONTH

BB5 Wide Range Harmonic Oscillator and Metronome

BB6 Bistable Trigger Circuit

BB7 Regenerative Coincidence Detector

BB8 Ultrasonic Sawtooth Generator

BB9 Envelope Amplifier

PLUS Vocal Sound Effects Unit
Guitar Sound Effects Unit

BUILD OVER 40 CIRCUIT/EXPERIMENTS

and master electronics the LERNAKIT way



- No maths — No unnecessary theory
- NO PREVIOUS KNOWLEDGE NEEDED
- BUILD A PROFESSIONAL
CATHODE RAY OSCILLOSCOPE

Learn how to

- READ AND DRAW CIRCUIT DIAGRAMS
- RECOGNISE, HANDLE AND UNDERSTAND
every type of modern **ELECTRONIC COMPONENT**

OVER 40 EXPERIMENTS — including:-

- | | |
|--------------------------------|--------------------------|
| ● Valve Experiments | ● Square Wave Generator |
| ● Transistor Experiments | ● Morse Code Oscillator |
| ● Electro-magnetic Experiments | ● Simple Transmitter |
| ● Basic Amplifier | ● Electronic Switch |
| ● Basic Oscillator | ● Photo-electric Circuit |
| ● Basic Rectifier | ● Basic Computer Circuit |
| ● Signal Tracer | ● Basic Radio Receiver |
| ● Simple Counter | ● A.C. Experiments |
| ● Time Delay Circuits | ● D.C. Experiments |

This complete practical course will teach you all the basic principles of electronics by carrying out experiments and building operational apparatus. You will learn how to recognise and handle all types of modern components, their symbols and how to read a complete circuit or schematic diagram. The course then shows how all the basic electronic circuits are constructed and used and **HOW THEY ACTUALLY WORK BY USING THE OSCILLOSCOPE PROVIDED**. An application is given in all the main fields of electronics, i.e. Radio; control circuits; computers and automation; photoelectrics; counters, etc., together with rules and procedure for fault finding and servicing of all types of electronic equipment. For a new and exciting approach which gives a real understanding of electronics in an entirely practical way—this course has no equal anywhere to-day.

POST NOW FOR FREE COLOUR BROCHURE

To: **BRITISH NATIONAL RADIO SCHOOL, READING, BERKSHIRE**

Please send free Brochure, describing your LERNAKIT Oscilloscope Course without obligation, to:

NAME

ADDRESS

BLOCK CAPITALS PLEASE

OR WRITE IF YOU PREFER NOT TO CUT COUPON

(No representatives employed)

P.E.3.66

British National Radio School

Cabinet snip

This fine cabinet as illustrated but less control knobs is available this month at a special snip price of 12/6, plus 3/6 post and insurance. Size is 3 1/2 in. x 9 in. x 4 in. and it is nicely covered in two-tone I.C.I. fabric.



SELF-ENERGISED TELEPHONES



These require no batteries, in fact they have only to be connected by a pair of wires. They can thus be fitted into existing bell circuits. Results are extremely good and maintenance costs are nothing. Handsets complete uncut and tested, 15/- each, 2/6 post. Two post free.

SHEET PAXOLIN

Ideal for transistor projects.
Special offer 12 panels 5 x 8 in. 5/-



Waterproof Heater Wire

16 yds. length 70 watts, self regulating temperature control, 10%, post free.



Siemens High Speed Relay

Twin coils adjustable tension change over contact—pink points. Very sensitive. 1,000Ω + 100Ω 7/6. 1,000Ω + 1,000Ω 10/-. 1,750Ω + 1,750Ω 12/6.

SPEAKER BARGAIN

12 in. High fidelity loudspeaker. High flux permanent magnet type with either 3 or 15 ohm speech coil. Will handle up to 10 watts. Brand new, by famous nuker.



Price 29/6 plus 3/6 post and insurance.

THERMOSTATS

Type "A" 15 amp. for controlling room heaters, greenhouse, airing cupboard. Has spindle for pointer knob quickly adjustable from 30-80°F. 9/6 plus 1/- post. Suitable box for wall mounting, 5/- P. & P. 1/1.
Type "B" 15 amp. This is a 17 in. long rod type made by the famous Ruvic Co. Spindle adjusts this from 50-350°F. Internal screw alters the setting so this could be adjustable over 30° to 1000°F. Suitable for controlling furnace, oven kiln, immersion heater or to make flame-start or fire alarm. 8/6 plus 2/6 post and insurance.
Type "C" is a small porcelain thermostat as fitted to electric blankets, etc. 1/1 amp setting adjustable by screw through side, 3/6 P. & P. 6/1.
Type "D" We call this the Ice-ant as it cuts in and out at around freezing point. 2/5 amps. Has many uses, one of which would be to keep the loft pipes from freezing, if a length of our blanket wire (16 yds. 10/-) is wound round the pipes, 7/6 P. & P. 1/1.
Type "E" This is a standard refrigerator thermostat. Spindle adjustments cover normal refrigerator temperature, 7/6 plus 1/- post.

WALL MOUNTING THERMOSTAT

By Selchwell, intended for use to control tubular or any type of space heaters indoors or in a greenhouse—adjustable over 40/80 complete with mounting screws. 29/6 plus post 2/9 (normal price is at least twice this).

THREE UNUSUAL ITEMS

OZONE OUTFIT—for removing smells and generally improving any oppressive atmosphere. Kit consists of Philips ozone lamp and mains unit, only needs box. 19/6 plus 3/6 postage and insurance.
BLACK LIGHT UNIT. 40 watt intensity, comprises lamp, lamp holder and 40-watt choke. Only 19/6 plus 6/6 curr. and ins.
TIMEE KIT. Special offer of all components except metal box to make mains operating interval timer for photography, etc. 12/6 plus 2/6 post.

When postage is not definitely stated as an extra then orders over £3 are post free. Below £3 add 2/9.

INFRA-RED HEATERS

Make up one of these latest type heaters. Ideal for bathroom, etc. They are simple to make from our easy-to-follow instructions—uses silica enclosed elements designed for the correct infra-red wavelength (3 microns). Price for 750 watts element, all parts, metal casing as illustrated, 21/6 plus 3/6 post and ins. Full switch 3/- extra.



750 mW TRANSISTOR AMPLIFIER

4 transistors including two in push-pull-input for crystal or magnetic microphone or pick-up—feedback loops—sensitivity 5 mV. Price 19/6. Post and ins. 2/6. Speakers 3 in. 12/6; 5 in. 13/6; 6 in. x 4 in. 14/6.

B.S.R. UA16 RECORD PLAYER only 44-19-6



WHICH IS THE BEST RECORD CHANGER TO BUY? If you want a "pretty" unit which will give next to perfect results and years of trouble-free service even though it may not always get the most careful treatment then the unit for you is the B.S.R. UA16. It operates at usual four speeds off standard A.C. mains, takes one to ten records (mixed sizes if you like), is super slim and fitted with famous "Full-Fi" head for 33 or 78 records.

You can have one of these brand new in perfect order, guaranteed and sent by insured transport for only 44/19/6 plus 6/6 carriage and insurance.

THIS MONTH'S SNIP

Complete set of parts to build this famous 6 transistor, 2 wave band, superhet receiver until recently retailing at almost £10. It's yours if you act quickly for only 39/6 plus 3/6 post & ins.



PRINCESS 2 wave

Its circuit features all the latest refinements:—A.V.C. Push-pull output. Feedback, etc., etc., includes efficient reedy wound aerial and 2 1/2 in. P.M. speaker. Transistors—case—everything supplied except battery. Instructions supplied but if required separately 1/6.

TRANSISTOR BARGAIN

Transistor set case with carrying handle size 10 x 8 x 3 in. Strongly made from best plywood and covered two tone fabric—looks very smart—suitable for receiver—amplifier—extension speaker, etc. Originally listed at 29/6 but offered this month at only 18/- plus 5/- post and insurance also given free with it is a printed circuit board to suit it and building instructions for the two wave radios.—Don't miss this grand offer.



CAPTAIN DRIVEN TAPE RECORDER

Although some well made opol driven machines give remarkably good results, there is no doubt that to achieve anything like perfection and to have versatility a Captain Driven Tape is essential. Now at last we can offer you a Captain Driven, completely portable battery operated instrument at a remarkably low price. So low in fact that you can easily afford to have a second machine for use in your car, office, home, etc., or to give to reps. or relations to exchange tapes.



SPECIFICATION—200/7000 c.p.s.—400 mW. output—double track—twin speed (31 and 7 1/2) fast rewind line—3 in. spool gives one hour playing with standard tape, weight 7 lb. Size 8 1/2 x 11 x 3 1/2. Complete with batteries, microphone—tape spool and instruction manual. Nothing to go wrong if you use a good tape and keep heads clean. Demonstration gladly given at our Croydon shop.
Special Snip Price This Month, 81/11/0, post and insurance 6/6.

See in the Dark INFRA-RED BINOCULARS

These infra red from a high-voltage source will enable objects to be seen in the dark, providing the objects are in the rays of an infra-red beam. Each eye tube contains a complete optical lens system as well as the infra-red cell. These optical systems can be used as lens for T.V. cameras—light cell, etc. (details supplied). The binoculars form part of the Army night driving (Tabby) equipment. They are unused and believed to be in good working order, but sold without a guarantee. Price 82/17/6 plus 10/- carriage and insurance. Handbook 2/6.



MAINS POWER PACK

MAINS POWER PACK designed to operate transistor sets and amplifiers. Adjustable output 6 v.-9 to 12 volts for up to 500 mA (class B working). Takes the place of any of the following batteries: PR1, PP3, PP4, PP6, PP7, PP9, and others. Kit comprises mains transformer-rectifier, smoothing and load resistor, 5,000 and 500 mfd. Condenser, Zener diode and instructions. Real snip at only 14/6 plus 3/- post.

BATTERY ELIMINATOR



With this you can operate your pocket radio from the mains. You can also recharge PP3 batteries five or six times. Only 18/6 plus 3/- post and insurance. Will save its cost in no time

TWO-WAY RADIOS

Give communication over 1 mile. FULLY transistorised—crystal controlled, built-in telescopic aerial—press button operation—PP3 batteries—pair instruments complete and ready to use. 47/9/6 plus 5/- post and insurance. G.P.O. licence required



FOUR-STATION INTERCOM.

Will save time and improve efficiency. Ideal in home—office—shop—surgery, etc. Complete outfit comprises Master unit and three substations each of which can call the master and have full two-way working. No wiring problems as sub fitted with 60 ft. twin flex and they plug into sockets. Also included is packet of staples—and battery. Nothing else to buy—47/15/- plus 4/6 post and insurance.



13 AMP. SOCKETS

Change all those old-fashioned ones to these modern fused types or install a new ring main. White sockets for surface mounting or for letting into wall or skirting—best make (Q.E.C.), 5/6 with switch or 3/9 less switch. Six or more post free, otherwise add 2/-.
13 AMP. SOCKET

HEAT AND LIGHT UNIT

Gives 300 watts of heat with approx. 150 watts of light and simply fits in place of lamp, 29/6 plus 3/6 carriage and insurance.



SEED & PLANT RAISING

Hot heating wire and transformer. Suitable for standard size garden frame, 12/6 plus 2/6 post and insurance.



TURRET TUNERS

By the famous Cydon or Brayhead firm complete with coils, but less coil cover, valves and knobs—all 35 Mc/a—wonderful bargain at 6/6 each plus 2/9 post.



FINE TUNERS

50 pf with long spindle as illustrated, 1/6 or 12/- doz. Twin 50 pf not quite such long spindle, 3/6 or 24/- doz.



WINTER HEATER REGULATOR Suitable to control elements, heater, soldering iron and boiling rings up to 2,500 watts. Complete, adjustable, normal price 55/- each, special snip price 12/6 plus 2/- postage and insurance.

NOUGHTS & CROSSES MACHINE—an opportunity to make this very amusing item—described in Practical Electronics. Kit of 19 switches only 40/- post paid.

NEONS FOR PANEL GAME SWITCH, ETC.—not the midget type but possibly more suitable. 12 for 10/6 post paid.

Midget wire ended type 1/3 (Ex. equip.) or 1/9 new.

FIVE CORE CABLE

Ideal for switching circuits, intercom. F.A. runs, etc., each core flex copper with rubber insulation cores, covered overall in tough rubber or P.V.C. 9d. per yd. or 30 yds. length 15/- plus 5/- post.

ANOTHER BRANCH FOR CALLERS
103/4 TAMWORTH ROAD, CROYDON
Opp. West Croydon Station

ELECTRONICS (CROYDON) LIMITED

266 LONDON ROAD, WEST CROYDON, SURREY
post orders to: Dept. PE.4, SPRINGFIELD ROAD, EASTBOURNE, SUSSEX

detached particles

JOHN VALENCE

THE WRECKERS

During the last few weeks it has been impossible to open a newspaper without reading of telephone vandalism. Each day it seems there are further reports of damage to public telephone kiosks up and down the country. This plague of senseless destruction is alas just another sign of these lawless times. There appear to be two quite different categories of wreckers: the petty crooks who raid the coin boxes for greed, and the young irresponsibles with time on their hands and nothing in their heads who get "kicks" from wrecking other people's property.

It is appalling that these individuals are so completely lacking in feeling for their fellows. Do they never come in contact with people who have to use the telephone for urgent business — perhaps life or death matters? Is thought for other people altogether beyond their capabilities, or are they just downright callous?

The G.P.O. is trying out a number of secret devices in an effort to trap these vandals. What a pity all this engineering effort has to be diverted from normal work of catching up on the backlog of telephone installations.

The introduction of the "dial-a-disc" service may be seen as another but quite different and clever method of discouraging some vandalism. What irony if, in the future, public telephone call boxes owe their continued existence to the fact that pop records are an important amenity. Strange world.

I wish the G.P.O. luck, but feel that the remedy rests largely with the police.

ON THE BEAT

The equipping of police officers with two-way radios seems an obvious and urgent task. We hear a lot about new types of radio equipment being designed for the man-on-the-beat and enthusiastic re-

marks about this soon replacing the P.C.'s whistle. But all this has been going on for such a long time that it sounds like ancient history. Two-way walkie-talkies are not a startling new discovery, heaven knows. It makes one wonder who has been dragging their feet over this matter: is it the equipment manufacturers, or is it the authorities responsible for running the police?

It might be significant that the first police forces to be operatively equipped with specially designed individual radios are run by county authorities. The metropolitan force is of course run directly by the Home Office.

With a new boss in this government department, perhaps things will start moving. The new Home Secretary Roy Jenkins seems to be in sync with these times. Some little while ago I remember hearing him in his then capacity as Aviation Minister pointing out the impressive part electronics plays in aeronautics. About one third of the total cost of a modern aircraft is accounted for in installed electronic equipment, he said.

Coming from this kind of environment where all the latest technological aids are exploited, the minister surely can but be staggered by the inadequacy of electronic aids employed in the detection and prevention of crime. Let us hope he will rapidly redress this deficiency. If successful in his war on crime, I am sure his hard pressed colleague the P.M.G. will be at the top of the queue of those offering their grateful thanks.

HOLIDAY HOUR

Now to a more pleasant topic:

A popular pastime in the winter time is the study of holiday advertisements. And what better way of dispelling the wintry gloom than to indulge in flights of fancy from your own armchair? The alluring descriptions of sun drenched holiday

resorts do indeed provide a temporary balm to our more immediate surroundings.

This large and ever-growing holiday industry has now attracted the attention of the computer makers. It has been suggested that hotels using computers instead of clerical staff to reserve rooms, write guests' bills, and keep accounts, could show a handsome profit over and above the initial cost of the computer.



Well, everyone likes to make money, and I have no doubt that the managers of the more progressive hotels are already poring over computer specifications and measuring up the available space behind the reception desk with an eye on vital statistics—technical ones, naturally.

Bearing in mind the not infrequent news of rebellious computers at work in breweries, rating offices, etc., I admit to being a trifle apprehensive about this latest venture. Just imagine; hot, dusty, and tired on arrival—how do you argue with a computer about a disputed booking? And whom do you demand to see, the manager or the electrician?

Readout—

A SELECTION FROM OUR POSTBAG

Crookes radiometer

Sir—Please could you publish or pass on this letter with reference to Mr. M. J. Bunce's enquiry about where he could acquire a "Crookes Radiometer": Proops Bros. Ltd., of 52 Tottenham Court Road, London, W.1. can help. In their catalogue it is called a "Solar Engine" and is numbered—Cat S-168. It is five inches high and three inches in diameter and costs 12s 6d plus 1s 6d postage and packing.

C. Fosbury,
Hove, 3,
Sussex.

Many thanks to all those readers who have kindly sent similar information.

More power please!

Sir—I have been most interested in the "S.C.R. Light Dimmer" described on page 987 (December issue). Can you tell me if any changes would be necessary to the circuit to enable it to control a 300 watt lamp?

I have in mind using such a dimmer on a transparency projector to control the brilliance of the lamp relative to the density of any particular transparency, and to prevent surge current in the lamp when first switching on the projector.

J. Cannam, B.Sc., A.R.P.S.
Chesterfield,
Derbys.

Sir—Would it be possible, by substituting larger diodes for D1-D4 and/or using a larger s.c.r. (or more than one in parallel) to increase the load carrying capacity of the bridge circuit from 120 watts to say, 2kW (240V a.c. Unity Power factor)?

C. J. Knight,
Great Barr,
Birmingham, 22a.

In the actual power circuit, the s.c.r. is well capable of handling greater currents than those demanded by the load specified in the article. The diodes, however, are capable of passing only 0.5 ampere and would need replacement.

Naturally the larger the diodes used, the greater the space required. Also, as the desired current rating approaches the maximum limits of the s.c.r. and diode consideration must be paid to heatsink dimensions. Another limit to be observed to increase power is the type of load to be supplied. Reactive loads such as inductors and capacitors automatically limit the maximum ratings quite severely according to the amount of reactance present in relation to the resistance of the load. Inductive loads such as motors are fitted with capacitive power factor correction but even so, careful consideration must be paid to the rating of the s.c.r. and diodes used:

The trigger circuit is relatively independent of the power rating of the power control circuit, and should require little alteration for increased power. Any alteration for increased trigger voltage would be carried out by either increasing the emitter resistance of TR2 or decreasing the resistance of the 68 kilohm resistor. But these can only be varied within narrow limits.

To increase the power to some high value (above 2kW) then careful design is required according to the load requirements and this is going further than just altering the circuit in the published article. —E. Barnett.

"Light" amplifier

Sir—I am constructing a fairly sensitive counting device using a 2.5V lens ended bulb and an OCP71 phototransistor. I find that a single stage amplifier circuit (which I took from your article on "Light Operated Switches" in the December 1964 issue) does not give sufficient light-to-dark current ratio. I wish to increase the amplification stages to possibly four. I would be grateful if you could advise me where I could obtain such a circuit. The output is required to operate a relay which in turn operates a simple electro-magnetic counter.

J. M. Scott,
Isle of Cumbrae,
Scotland.

A second transistor (also OC72) d.c. coupled would give a considerable rise in sensitivity. —G.J.K.

What's all the "fuzz"!

Sir—I am a keen guitarist interested in sound effects. I wondered if you could supply me with a circuit diagram of a "Fuzz Box" or "Tone Bender"?

C. J. Gatton,
Crawley,
Sussex.

Can you help?

Sir—Could any of your readers sell, lend or give me a circuit diagram for an oscilloscope using a G.E.C. type E4504/B/16 tube or its equivalent, any information on this tube would be appreciated.

Further to this, could anyone sell me the first five copies of PRACTICAL ELECTRONICS, which are missing from my collection.

G. M. Davis,
St. Helens,
Lancs.

Sir—I should be obliged if you could insert an enquiry in P.E. for a loan of the January 1965 issue or to purchase a copy. The article I am interested in is the article on the "Darkroom Timer".

A. Whitefield,
Glasgow, W.3.

New recruits welcome

Sir—I am sure that readers in this neighbourhood will be interested to know that the St. Cyres Electronic Group will be showing Mullard films on February 18 and 25 at the County Secondary School, St. Cyres Road (off Redlands Road), Penarth, Glam., starting at approximately 7.15 p.m. Anyone interested in joining the Group should contact me as soon as possible, as numbers must be limited.

I organised this Group so that others like me who are interested in electronics as a hobby could get together and discuss and, I hope, make, various electronic projects of general interest and, in particular, those which are normally considered "not practical" for amateurs. I am hoping that regular meetings will be arranged for discussions and the organisation of projects and visits to places of interest.

Members include engineers from the BBC, ITA and IBM at present. I also hope that those members who know very little about electronics but are interested in the subject will join.

C. Bogod,
"Dickens",
26 Forrest Road,
Penarth, Glam.

USERS ACCLAIM *Kedoco* PRODUCTS

KEDOCO CLASSIC SS20/7 20 WATTS

£9-19-6

READY BUILT

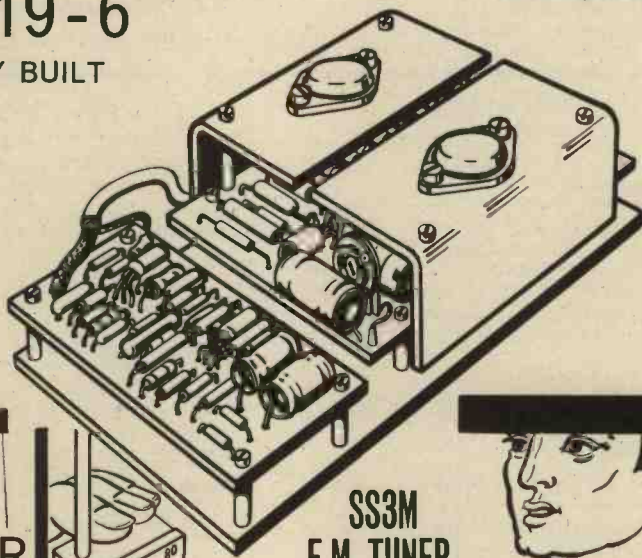

Believe it or not we have actually produced an all transistor integrated HIFI amplifier complete with pre-amp and tone controls giving 20 watts power output and ready to operate for only £9 19s. 6d. The KEDOCO CLASSIC SS20/7 is the result of several years of research and investigation into the various approaches to solid state amplification. The end product, Kedoco engineers claim, with complete confidence, is the finest power amplifier available today and stands above all others for quality in a class of its own. The CLASSIC requires a 30 volt power supply but consumes only 20mA*. It will operate into most speakers but the best results are obtained with 3 ohms. We are confident you find this amplifier excels others costing many times its price.

SPECIFICATION—

20 watts output max. Distortion less than 0.1%. Frequency response flat from 16c/s to 20kc/s. Noise 80dB down on max. output.

* quiescent

POWER SUPPLY

30 volt
3 amps
Ready built and ideal for your Kedoco Classic and will power 2 of them

69/6

Quantity discounts on application for all semi-conductors

ZENER DIODE

Silicon planar diffused units featuring very sharp knee. Type No. specifies voltage. KZ5.1 Types KZ7.5, KZ5.6 KZ8.2, KZ6.2 KZ9.1, KZ6.8

10% tolerance. Slope resistance nominally 10 ohm at 5mA. Dissipation 250mW Temperature coefficient 0.01% per degree C.

3/11 EACH

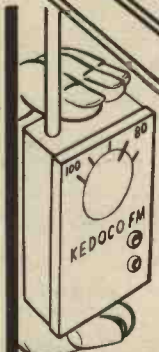

SS3M F.M. TUNER

80—100 mc/s

The smallest 7 transistor FM Tuner. Tunable through the whole broadcast V.H.F. band housed in case measuring only 84mm. by 42mm. by 20mm. unbeatable value at 119/-

Kit with full Instructions



MINICLASSIC SS3/9

69/-

READY BUILT

3 watts output. 6 silicon planar epitaxial transistors. 2 diodes and one zener. All mounted on precision printed circuit board. HIFI at its cheapest—16 c/s to 30 kc/s flat response. Many other uses. Requires 18 volt power supply. Will operate directly from crystal pick-up. Used with tape Pre-amp it makes a complete Tape Amplifier. Also tone controlled HIFI Pre-amp available at 39/-.

PLANAR EPITAXIAL SILICON TRANSISTOR

Double diffused npn. Suitable from audio to RF power applications. I_{co} less than 100nA. B_{vbe} greater than 30 volts. Power output at 28mc/s typically 300mW. Emitter/base breakdown voltage greater than 5 volts. Typical f_t 300mc/s. h_{fe} KPS 24 min h_{fe} 20 KPS 25 min 50

KPS 24
7/11
KPS 25
9/11

UNIQUE FRONT PANEL SYSTEM

In a choice of three hardwood finishes, mahogany, oak, or walnut, with superb high gloss polish and beautifully engraved. This unique idea offers you the facility of putting your whole system speedily into your own cabinet.

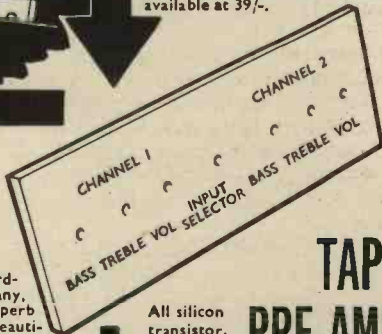

All silicon transistor. Zero hum.

TAPE PRE-AMP

29/6

High gain fully compensated to give flat response output. Suitable for medium impedance heads such as Collaro, Truvox, B.S.R., equalised for 3 1/2 inches/second. Simple mod. allows equalisation at any speed.

MONO 9/6
12" x 6"

STEREO 19/6
24" x 6"

NEW BOOK

3/11

Theory and applications of planar epitaxial transistors. Explains significance of these new transistors and gives many interesting circuits.

ORDER FORM: To KEDOCO ELECTRONICS, BEVERSTONE WORKS, TETBURY, GLOS.

PLEASE SUPPLY _____

ADDRESS _____

Enclose Cheque/P.O. for _____ Postage 2/6 extra for all orders under £1

All KEDOCO products are fully guaranteed and should you not be completely satisfied with your purchase we will gladly refund your money.

Practical Electronics Classified Advertisements

The pre-paid rate for classified advertisements is 1/- per word (minimum order 12/-), box number 1/6 extra. Semi-displayed setting £3.5.0 per single column inch. All cheques, postal orders, etc., to be made payable to PRACTICAL ELECTRONICS and crossed "Lloyds Bank Ltd." Treasury notes should always be sent *registered post*. Advertisements, together with remittance, should be sent to the Advertisement Manager, PRACTICAL ELECTRONICS, George Newnes Ltd., Tower House, Southampton Street, London, WC2, for insertion in the next available issue.

SERVICE SHEETS

SERVICE SHEETS for all makes of Radio and TV 1925-1966. Prices from 1/- with free fault-finding guide. S.A.E. inquiries. Catalogue of 6,000 models, 1/6, Valves, modern and obsolete. Radio/TV Books. S.A.E. lists, HAMILTON RADIO, Western Road, St. Leonards, Sussex.

TRADE SERVICE SHEETS. Radio, TV, etc. Mixed dozen @ 4/-, 100—22/6d. p.p. TELRAY, Maudland Bank, Preston.

STATE MODEL NO. Radio 2/-. TV 2/6. S.A.E. DARWIN, 19 George Street, St. Helens, Lancs.

SERVICE SHEETS

4/- each, plus postage.

We have the largest supply of Service Sheets for all makes and types of Radios and Televisions, etc. in the country. Speedy Service.

To obtain the Service Sheet you require, please complete the attached coupon:

From:

Name:

Address:

To: **S.P. DISTRIBUTORS**
44 Old Bond St., London, W.1
Please supply Service Sheets for the following:

Make:

Model No.: Radio/TV

Make:

Model No.: Radio/TV

Make:

Model No.: Radio/TV

New 1966 List now available.

I also require list of Service Sheets

at 1/6 plus postage.

(please delete items not applicable)

I enclose remittance of

MAIL ORDERS ONLY Mar. PE

MISCELLANEOUS

CONVERT ANY TV SET into an Oscilloscope. Diagrams and Instructions, 12/6. REDMOND, 42 Dean Close, Portslade, Sussex.

TRANSFORMERS Rewound. Output or mains. Specials made to order. Reasonable prices. S.A.E. enquiries. RATCLIFFE, 27 Station Road, Holmfirth, Yorks.

MISCELLANEOUS

(continued)

"P.E." Pipe and Cable Locator. Electronic Candle. Servo System. Miniprobe Signal Generator. Simple Digital Computer. Fire Alarm System. Neon Novelties. Doorphone. Audio Oscillator and Valve Voltmeter. Water Level Alarm. New Look Tape Recorder. General Purpose Scaler. Echo Unit. Noughts and Crosses Machine. Transistor and Diode Tester. Simple Analogue Computer. Stereo Record Player. Integrated Transistor Amplifier. Two Band Radio Tuner. Intercomm. Unit. V.H.F. Broadcast Receiver. R/C Bridge. Inexpensive Oscilloscope. Mullard Miniature Electrolytics and Hi-stab Resistors. S.A.E. for itemised price lists. AJAX ELECTRONICS, 18A, Rumbold Rd., Fulham, London, S.W.6.

FOR SALE

VENNER TIME SWITCHES. Reconditioned, 14 day clock, once on once off every 24 hrs. jewelled movement, fully guaranteed. 1 amp 25/-, 5 amp 32/6d., 15 amp 39/6d. Post etc. 2/6d. Cast Aluminium Cases 7/6d. A. R. BATCHELOR, P.E. Dept. 4 Park Road, Bromley, Kent.

HAMMERITE

HAMMER PATTERN BRUSH PAINT FOR PANELS AND BOXES

★ THE PATTERN IS IN THE TIN ★
ALL YOU DO IS BRUSH IT ON!

2 1/2 oz. tins	3/6	1 gallon	35/-*
1 pint	7/6	1 gallon	58/-*
1 pint	15/-		(* sent by road)

Carriage: Orders up to 5/-, 9d.; up to 10/-, 1/9; over 10/-, 2/9. Colours: Blue, Silver or Metallic Black. Return of post service, Monday to Friday. From your component shop or direct from the manufacturer.

FINNIGAN SPECIALITY PAINTS (PE)
Mickleby Square, Stocksfield, Northumberland
Tel. Stocksfield 2280

A.C. STANDARD. Mains Motors Fractional H.P. 3 1/4 in dia x 4 in long with 1/4 in spindle. Many uses. Brand new, 25/- each. P. & P. 2/6d. Small Battery Motors 1 1/4 in dia x 2 1/2 in long—4 1/2 to 9 volts. Heavy construction; only 7/6d. each. P. & P. 1/-. **WALTONS WIRELESS STORES,** 15 Church Street, Wolverhampton.

ELECTRIC SOLDERING IRON



FANTASTIC BARGAIN OFFER

Lightweight Pistol Grip handle. 40 watt, 240 - 250v. A.C. Solid copper bit, detachable handle forms cover for iron when not in use. With 4ft. Safety 3-core flex. Indispensable for every home handyman. A boon to model makers and a necessity for every electronics enthusiast. Offered to you at this new amazing price.

C. H. SERVICE (Dept. P.E.1)
Lusted Hall Lane, Tatsfield, Kent.

FOR SALE

(continued)

ANOMETER Model 8, Mark 2, as new. Two months' use, £14. 14, Hayfield Rd., Salford 6.

CRACKLE PAINT. Black or Grey, 1 pint tins 4/-, post 6d. from the component specialists. **SERVIO RADIO,** 156-8 Merton Road, Wimbledon, London, S.W.19.

TRANSISTORS UNMARKED UNTESTED. 40 for 10/-. P. & P. 1/-. 4 packets post free. Relays, thousands of types, special catalogue free. General Catalogue of Mechanical & Electrical Gear, Tools, etc., 5,000 items, free. K. B. WHISTON (Dept. PET), New Mills, Stockport.

TRANSCIVERS

W.8. 38 A.F.V. New condition. Complete set valves, 17/6, p. & p. 4/-; 30/- pair, p. & p. 7/6. G.P.O. Licence required.

RELAYS. 12 assorted 12-24 volt Ex-Equipment, 20/-, p. & p. 4/-.

GOVERNMENT SURPLUS. Electrical and Radio Equipment. Our new catalogue No. 16 now ready, 2/8 Post Free, cost refunded on purchase of goods over £2. **ARTHUR SALLIS,** Radio Control Ltd., 93, North Road, Brighton.

EDUCATIONAL

B.Sc.(ENG.), A.M.I.Mech.E., A.M.I.E.R.E. City & Guilds, etc., on "Satisfaction or Refund of Fee" terms. Wide range of expert Home Study Courses in Electronics, Computers, Radio, T.V., etc. 166-page Guide—FREE. Please state subject of interest. **BRITISH INSTITUTE OF ENGINEERING TECHNOLOGY,** 124k College House, Wright's Lane, London, W.8.

Full-time courses in **RADAR and RADIO-TELEGRAPHY** for prospective marine Radio Officers. Govt. approved exam. centre.

Also courses in basic **ELECTRONICS, RADIO, TELEVISION and COMPUTERS.**

Apply:—Director, British School of Telegraphy, 20 Penywern Road, Earls Court, London, S.W.5

STUDY RADIO, TELEVISION and ELECTRONICS with the world's largest home study organisation. I.E.R.E., City & Guilds, R.T.E.B., etc. Also Practical Courses with equipment. All books supplied. Write for FREE Prospectus stating subject to I.C.S. (Dept. 577), Intertext House, Parkgate Road, London, S.W.11.

HOME STUDY COURSES in Practical Electronics. Free Brochure without obligation from: **BRITISH NATIONAL RADIO SCHOOL,** Reading, Berks.

A.M.I.Mech.E., A.M.I.E.R.E. City & Guilds, G.C.E., etc. Become a Technician or Technologist for high pay and security. Thousands of passes. For details of Exams and Courses in all branches of Engineering, Building, Electronics, etc., write for 156-page handbook—FREE. **B.I.E.T.** (Dept. 125k), London, W.8.

WANTED

WANTED

THIS TYPE OF RELAY CONTACT MARKED WITH "V" NOTCHES
112 Groby Rd., Glenfield, Leicester

SEND
S.A.E.
FOR
DETAILS

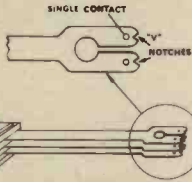

G.P.O. TYPE RELAY CONTACT SPRINGS

BOOKS AND PUBLICATIONS

VISATECHNICA. The up-to-date **TECHNICAL** language course French—German—English on records or tape. Three-language illustrated book covering 260 technical subjects. Send 4d. stamp for descriptive leaflet to **VISAPHONE CO. LTD.**, 17 Middleton Rd., London, N.W.11.

SURPLUS HANDBOOKS

- 19 set Instruction Handbook ... 3/6 P.P. 6d
 - 1135 Instruction Handbook ... 3/6 P.P. 6d
 - H.R.O. Instruction Handbook ... 3/6 P.P. 6d
 - 38 set Instruction Handbook ... 3/6 P.P. 6d
 - 46 set Walkie-talkie circuit & notes ... 3/6 P.P. 6d
 - 88 set Walkie-talkie Instruction Handbook ... 5/- P.P. 6d
 - Frequency Meter BC221 Instruction Handbook ... 3/6 P.P. 6d
 - Wavemeter Class D Handbook Mk. I, II, III ... 3/6 P.P. 6d
 - 18 set Circuit Details & Notes ... 3/6 P.P. 6d
 - A.R.88D Instruction Handbook 15/- P.P. 1/6d
 - R.107 Instruction Handbook ... 5/- P.P. 6d
 - CR.100/B.28 Receiver Handbook 8/6 P.P. 9d
 - R1116/A Circuit Diagram & Details 1/9 P.P. 6d
 - R1224/A Circuit Diagram & Details 1/6 P.P. 6d
 - R1335 Circuit Diagram & Details 1/6 P.P. 6d
 - RF Unit 24 Circuit Diagram & Details 1/6 P.P. 6d
 - RF Unit 25 Circ. Diag. & Details 1/6 P.P. 6d
 - RF Unit 26 Circ. Diag. & Details 1/6 P.P. 6d
 - Amplifier A1134 Circuit Diagram & Details 1/9 P.P. 6d
 - Transmitter T1154 Circuit Diagram & Details (all models) ... 2/- P.P. 6d
 - Resistor Colour Code Indicators. Indicates the value of a resistor at a glance ... 1/6 P.P. 6d
- All mail orders to:
Instructional Handbook Supplies
Depl. P.E. Talbot House, 28 Talbot Gardens
Roundhay, Leeds, 8

SITUATIONS VACANT

A FULL TIME TECHNICAL EXPERIENCED SALESMAN required for Retail sales. Write giving full details of age, previous experience, and salary required to: **The Manager, HENRY'S RADIO LTD.**, 303 Edgware Road, London, W.2.

MINISTRY OF DEFENCE (AD), London requires **Technician** for collection and evaluation of data relating to wide field of electrical or mechanical engineering subjects with a view to preparation of Standards. **Quals.**: Recognised apprenticeship in electrical or mechanical engineering; good general experience of engineering practices and manufacturing processes; capable of clear and concise expression in correspondence and preparation of technical reports; knowledge of service stores and experience in preparation of spares schedules an advantage. **O.N.C.** or equivalent. **Salary**: £1,204-£1,363 p.a. (Inner London). **Application**: Form from **THE MANAGER (P.E.8342)**, Ministry of Labour, Professional and Executive Register, Atlantic House, Farringdon Street, London, E.C.4.

TWO SKILLED ELECTRONIC WIREMEN require part time assembly work; printed circuit, chassis wiring etc. All reasonable offers considered. **BOX NO. 8.**

SITUATIONS VACANT (continued)

RADIO TECHNICIANS

A number of suitably qualified candidates will be required for training, leading to permanent and pensionable employment. (Normally at Cheltenham but with opportunities for service abroad or appointment to other U.K. establishments including London).

Applicants must be 19 or over and be familiar with the use of Test Gear and have had Radio/Electronic workshop experience. They must offer at least "O" level GCE passes in English Language, Maths and/or Physics, or hold the City and Guilds Telecommunications Technician Intermediate Certificate or equivalent technical qualifications.

Pay according to age, e.g. at 19 £747, at 25 £962 (highest age pay on entry) rising by four annual increments to £1,104.

Prospects of promotion to grades in salary range £1,032-£1,691.

Annual Leave allowance of 3 weeks 3 days, rising to 4 weeks 2 days.

Normal Civil Service sick leave regulations apply.

Apply
Recruitment Officer (RT/54)
Government Communications Headquarters
Oakley
Priors Road
CHELTENHAM, Glos.

SITUATIONS VACANT (continued)

**A CAREER
IN AUTOMATION
JUNIOR
INSTRUMENT
TESTERS**

Just a few vacancies remain in our Test Department for Technically minded boys.

These openings form first-class introductions to the growing field of automatic electrical control and will interest any boy who is learning at technical or grammar school. The work demands an enquiring and methodical mind—reliability, accuracy and integrity are more important than speed.

Those appointed will be encouraged to study for recognised qualifications and a paid day release scheme to technical college is in operation. Working conditions in an entirely new building are excellent and there are ample opportunities for promotion—many of our senior executives entered the Company through the Test Department.

Apply to:
Mr. G. W. Hanson
Head of Test Department
Londex Limited
15 Howard Road, London, S.E.20
Telephone: SYDenham 6258

A Member of the Elliott-Automation Group

**TECHNICAL TRAINING by
ICS
IN RADIO, TELEVISION AND
ELECTRONIC ENGINEERING**

First-class opportunities in Radio and Electronics await the ICS trained man. Let ICS train YOU for a well-paid post in this expanding field.

ICS courses offer the keen, ambitious man the opportunity to acquire, quickly and easily, the specialized-training so essential to success. Diploma courses in Radio/TV Engineering and Servicing, Electronics, Computers, etc. Expert coaching for:

- INSTITUTION OF ELECTRONIC AND RADIO ENGINEERS
- C. & G. TELECOMMUNICATION TECHNICIANS' CERTS.
- C. & G. SUPPLEMENTARY STUDIES.
- R.T.E.B. RADIO AND TV SERVICING CERTIFICATE.
- RADIO AMATEURS' EXAMINATION.
- P.M.G. CERTIFICATES IN RADIOTELEGRAPHY.

Examination Students Coached until Successful.

NEW SELF-BUILD RADIO COURSES.

Build your own 5-valve receiver, transistor portable, signal generator and multi-test meter—all under expert tuition.

POST THIS COUPON TODAY and find out how ICS can help YOU in your career. Full details of ICS courses in Radio, Television and Electronics will be sent to you by return mail.

MEMBER OF THE ASSOCIATION OF BRITISH CORRESPONDENCE COLLEGES.

**INTERNATIONAL
CORRESPONDENCE
SCHOOLS**

**A WHOLE WORLD
OF KNOWLEDGE
AWAITS YOU!**

International Correspondence Schools
(Dept. 152), Intertext House, Parkgate Road,
London, S.W.11.

NAME

ADDRESS
Block Capitals Please

3.66

PUBLIC APPOINTMENTS

MINISTRY OF DEFENCE (AD), Bromley, Kent, requires technicians to assist in control of section documenting to NATO system electronic and electrical equipments. Work involves supervision of staff engaged on codification tasks, maintenance of accuracy of technical records produced both internally and by civilian contractors, attendance at meetings in connection with cataloguing of equipment and maintenance spares. **Quals.:** Recognised engineering apprenticeship; good knowledge of electronics and some knowledge of NATO cataloguing techniques; O.N.C. or equivalent. **Salary:** £1,170-£1,343 p.a. (Outer London). **Application:** Form from THE MANAGER (P.E. 6367), Ministry of Labour, Professional and Executive Register, Atlantic House, Farringdon Street, London, E.C.4.

MINISTRY OF DEFENCE (Army Department), UK Central Codification Authority, requires Technicians (1) to be responsible for the examination of technical content and presentation of codification data compiled by agencies and specialist contractors (V.4268A Strand, W.C.2) or (2) to assist in codification of electrical and electronic equipments and components by enumeration of technical characteristics to facilitate comparison. (V.4268B Bromley, Kent and Malvern, Worcs.). **Quals.:** Recognised engineering apprenticeship or equivalent training; O.N.C. or equivalent. For (2) above good general knowledge of electronic equipment as used by Services. Ex-Artificers from Armed Forces considered. Service No. must be given. **Salary:** £945 (age 26)-£1,129 p.a. National plus London Weighting—Strand and Bromley. **Application:** Form from THE MANAGER (P.E. 6365), Ministry of Labour, Professional and Executive Register, Atlantic House, Farringdon Street, London, E.C.4.

TAPE RECORDERS, TAPES, ETC.

TAPES TO DISC—using finest professional equipment—45 r.p.m. 18/- . S.A.E. leaflet. DEROY, 52 Hest Bank Lane, Lancaster.

RECEIVERS AND COMPONENTS

SILICON PLANAR TRANSISTORS

Type	V _{max}	I _{c max}	β	Price
2N2926 (NPN)	18	100mA	150-300	5/6
2N3711 (NPN)	30	30mA	180-660	7/-
2N5390 (NPN)	25	100mA	400-800	15/6
2N3702 (PNP)	25	200mA	60-150	5/-
2N3685 (NPN)	30	20mA	75 typ	17/-
2N3685 ft 1200 Mc/s, 19dB typ. gain @ 200 Mc/s				

Complementary matched pairs, minimum β=50, 10/- pr.

ELECTROVALVE

6 MANSFIELD PLACE · ASCOT · BERKS

MOBILE POWER—60 WATT transformers for D.C.—D.C. transistor converters, 12V input, 300V, 200mA output, high efficiency, with full data, 35/- . B. M. SANDALL, 21, Dale View, Ilkeston, Derbyshire.

L.S.T. COMPONENTS

23 New Road, Brentwood, Essex

Special March Bargain offers; All Brand New Transistors and Diodes.

XA702 (2N2190 NPN) 4/- . XB104 (OC70) 1/- . OC76 2/- . GET105 with heat sink 4/6 . OC170 3/9 . MAT393 3/- . Power transistors: OC29 12/- . OC30 7/- . Diodes CGE 1/3 . G5D 2/- . GEX45/1 and CG63H both 1/3 each. All post free over 5/- order, or add 6d. Many other bargains in our stocklist, send 6d. stamp for details.

Experimenters: If you haven't tried our famous 25 transistors for 10/- offer we will send, this month only, FREE SAMPLES with any order from this advertisement over 10/- value.

ZENER SALE 5 watt stud mounted zeners, any voltage 14-65 volts at only 3/- each.

SCHOOLS: Special terms for Schools and Clubs buying in reasonable quantities. Send for special price list.

PLANAR SPECIAL: Genuine 2N706 300 mc/s Silicon Planar switch 4/9.

RECEIVERS AND COMPONENTS

(continued)

R. & R. RADIO & TV SERVICE

Dept: P.E.

44 Market Street, BACUP. Tel. 465

Salvage Valves

6F13	4/6	PCF80	4/-
6F15	5/-	PCL83	5/-
6L18	4/6	PL81	5/-
6K25	10/-	PL82	4/-
6U4GT	5/-	PL83	4/-
6BW6	5/-	PY81	3/6
6/30L2	5/-	PZ30	5/-
EB91	1/-	U801	7/6
6F1	2/6	U301	6/-
EBF80	5/-	U329	5/-
EF80	1/6	10F1	1/-
EF91	2/6	10LD11	5/-
EF85	5/-	10P13	5/6
ECC82	4/-	10P14	5/-
EY86	4/-	PY800	5/-
ECL80	4/-	20F2	5/6
20P3	5/-	20D1	2/-
20P4	7/6	20P1	6/6
30F5	5/-	20P5	6/6
30PL1	5/-	30FL1	6/6
EF37A	7/6	30P12	5/-
PL36	7/6	30P4	7/6
PY33	7/6	PY32	6/-
PCC84	4/-	PY82	5/-

Postage on valves 6d.—3 or more post free.

1 Pole 8-way switch, complete with 8 resistors 2 @ 1K, 2 @ 15K, one each of 22K, 15K, 18K, 6.8K. 3/6 incl. post.

Fireball Tuners as removed 14/9. Selected Tuners 18/9. Speakers ex T.V. 6 × 4 inch 3/6. 8 inch rnd 6/- . Resistors New: ½ watt 3½d., 1 watt 5d., 2 watt 9d. all 10%.

Postage on Tuners and Speakers 2/6.

S.A.E. with all enquiries. All goods subject to satisfaction or money refunded.

TRANSISTORS AND COMPONENTS

MULLARD TRANSISTORS

OC71, OC44, OC45, OC72, OC81, OC81D—3/- each. OC83 6/4 each. AF116, AF117, OC171—3/6 each. AF114, AF115—4/- each.

BY100 Mullard Branded 250V 550 M/A—5/- each. Westinghouse 1,000V P.I.V. 1 Amp.—6/6 each.

BYZ15 200V P.I.V. at 40 Amps.—£2.17. 0.

ORP12—7/9 each. BYZ15 200V P.I.V. at 40 Amps.—£2.17. 0.

AC126—8/- each. ASY28—8/6 each. AF186 cut. of FREQ 800 Mc/s—27/6.

STC Silicon Rectifiers, P.I.V. 200 3 Amps.—3/6 each.

M.A.T. TRANSISTORS

MAT 100 7/9.
MAT 101 8/6.
MAT 120 7/9.
MAT 121 8/6.
ADT 140 15/-.

Acos Record Player Cartridge Replacements for Collaro, Garrard, B.S.R., etc.—12/6 each.

3 Transistor Walkie Talkies £7.10. 0. pr. Xtal Controlled.

TEXAS TRANSISTORS
2N1302—ASY28 6/6 each.
GM290—AF139 19/6.
2G302—GET872 7/6.
2G301—GET873 6/6.

Other types available on request.

MULLARD ZENERS
OAZ 200 4-7 volts 260 M/W 12/6
OAZ 201 5-1 volts 260 M/W 10/6
OAZ 202 5-6 volts 260 M/W 9/6
OAZ 203 6-2 volts 260 M/W 9/6
OAZ 204 6-8 volts 260 M/W 9/6
OAZ 205 7-5 volts 260 M/W 9/6
OAZ 206 8-2 volts 260 M/W 9/6
OAZ 207 9-1 volts 260 M/W 10/6

Denco Technical Bulletin and Transistor List. Please send P.O. for 2/6.

S.A.E. all enquiries.
All Above Post Paid

Mail Order Only:
J. ROBINSON
(Radio & T.V.)

4 Highcliff Road, Blackley, Manchester 9

RECEIVERS AND COMPONENTS

(continued)

A.1 POST FREE BARGAINS. 25k or 50k 3watt w/wound pots with S.P. switch new and boxed 5/- ea. Guaranteed reclaimed valves. S.A.E. for list. **A.1 RADIO COMPONENTS**, 14 The Borough, Canterbury, Kent.

SHOEBURYNNESS ELECTRONICS

We offer the greatest ever parcel of all new components.

Over 350 mixed new electronic components.

Each parcel will include:

Condensers, Resistors, Diodes, Transistors, Silicon Rectifiers, Potentiometers, IFT's, Valve Bases, Tuning Condensers, Transformers, Printed Circuits, Coils, etc.

The Price: 10/- plus 3/6 P.P.

90 BUNTERS AVENUE, SHOEBURYNNESS, ESSEX

PI-PAN PRINTED CIRCUIT BOARD makes any circuit by soldering connections only. S.a.e. to M.E.D.S., 20 Knolls View, Totterhoe, Bedfordshire, for leaflet.

SPECIAL OFFER

1 Watt S.T.C. 300 MC/S N.P.N. Silicon Planer. 100% Transistors. Limited Stocks. £1 for 6.

3/- each. OC44, OC45, OC70, OC71, OC81, OC81D, OC200, Get 16, Get 20.

4/- each. AF114, AF115, AF116, AF117, OC170, OC171.

5/- each. OC139, OC140, Get 7, Get 8, Get 9, XC141, BY100, OA211.

SUN SOLAR CELL KITS

24 Page Booklet on Experiments Inc. 4 Solar Cells II/- Set.

G.P.O. DIAL TELEPHONES

20/- each. 35/- pair.

Send 6d. for full lists: inc. S.C.R. Zeners.

Cursons

78 Broad Street
Canterbury
Kent

WITWORTH TRANSFORMERS LTD.

26 ALL SAINTS ROAD, LONDON, W.11

Tel.: BAY9071

250-0-250v. 80mA, 6.3v. 2a, 0-5-6.3v. 1a 30/-
250-0-250v. 150mA, 6.3v. 4a, 0-5-6.3v. 1a 42/-
300-0-300v. 60mA, 6.3v. 1a, 0-5-6.3v. 1a 30/-
300-0-300v. 100mA, 6.3v. 2a, 0-5-6.3v. 2.5a 40/-
410-0-410v. 180mA, 6.3v. 4a, C.T. 6.3v. 2.5a 80/-

ISOLATING TRANSFORMERS, II:1 Ratio
150 Watt, 200-250v. Range ... 75/-
200 Watt, 200-250v. Range ... 90/-

We Manufacture all types of Transformers small or large quantities at competitive prices

12 Months' Guarantee. S.A.E. All Enquiries
Postage and Packing 3/- C.O.D. 5/-

CONTINUED FACING PAGE

RECEIVERS AND COMPONENTS

(continued)

SLASHED PRICES. Autochangers, turntables, stereo and mono cartridges. All popular models new and boxed. Send S.A.E. for details. **PRACTICAL ELECTRONICS (ENGINEERING)**, DEPT. (7), Pecked Lane, Bishops Cleeve, nr. Cheltenham, Glos.

CASH BUYING DISCOUNT!

HI-FI AMPLIFIERS, TUNERS, SPEAKERS, TURNTABLE UNITS, Etc. Any make supplied with a **DISCOUNT**

S.A.E. with enquiries please to:

HIGH FIDELITY CENTRE

61 West Street · DORKING · Surrey

EX-RENTAL TELEVISIONS

14 in.
£7.10.0

17 in.
£11.0.0

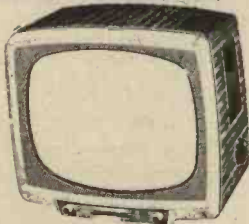

12 months' 3 Star Guarantee

★ Tube ★ Valves ★ Components
COLOURED FREE LIST
Channels for all areas

Demonstrations daily from Large Selection
Personal collection or Insured Carriage 14in. 20/-; 17in. 30/-.

2 years' GUARANTEE
NOW ON ALL SLIM-LINE TV's

VALVES £1 per 100. Assorted TV and Radio. Surplus ex-rental dismantled receivers. Post 4/6.
CONDENSERS 10/- per 100. New Assorted Electrolytics and p.F.s. P. & P. 2/6.
RESISTORS 5/- per 100. New. Mostly High Stabs. Assorted. P. & P. 2/-. Overseas 3/6.
SPEAKERS 7/8. 6in., 8in., 7 x 4in., 8 x 3in. Ex-mtd. Salvage. P. & P. 2/3. Overseas 4/-.

DUKE & CO. (LONDON) LTD.
621/3 Romford Road · Manor Park · E.12
Liverpool Street — Manor Park — 10 mins.
Phone: ILFord 6001/2/3 Stamp for Free List

BBC2 (625 LINE) TV AERIALS

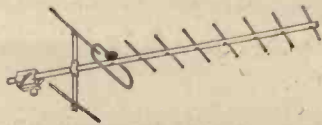

MAST MOUNTING ARRAYS, 9 element 45/-; wide spaced high gain, 11 element 55/-; 14 element 62/6. **WALL MOUNTING WITH CRANKED ARM**, 9 element 60/-; wide spaced high gain, 11 element 67/6; 14 element 75/-. **CHIMNEY ARRAYS COMPLETE**, 9 element 72/-; wide spaced high gain, 11 element 80/-; 14 element 87/6. **LOFT ARRAYS**, 7 element 32/6; wide spaced high gain, 11 element, WITH TILTING ARM 62/6; 14 element 70/-. **ALL HIGH GAIN UNITS HAVE SPECIAL MULTI-ROD REFLECTOR. LOW LOSS CO-AXIAL CABLE** 1/6 yd. **UHF transistor pre-amps** from 75/-.

BBC + ITV + F.M. AERIALS



B.B.C. (BAND 1), Telescopic, loft 21/-. External S/D 30/-.

I.T.V. (BAND 3), 3 Element, loft array, 25/-; 5 element 35/-. Wall mounting, 3 element 35/-. 5 element 45/-.

COMBINED B.B.C./I.T.V. Loft 1+3, 41/3; 1+5, 48/9. Wall mounting 1+3, 56/3; 1+5, 63/9. Chimney 1+3, 63/9; 1+5, 71/3.

VHF transistor pre-amps from 75/-.

F.M. (BAND 2), Loft S/D 12/6. "H" 30/-; 3 element 52/6. External units available. Co-ax. cable 8d. yd. Co-ax. plugs 1/3. Outlet boxes 4/6. Diplexer Crossover Boxes 12/6. C.W.O. or C.O.D. P. & P. 4/6. Send 6d. stamps for illustrated lists.

K.V.A. ELECTRONICS (Dept. P.E.)
27 Central Parade, New Addington, Surrey
LOD 2266

BATTERY ELIMINATORS

The ideal way of running your **TRANSISTOR RADIO, RECORD PLAYER, TAPE RECORDER, AMPLIFIER**, etc. Types available: 9v; 6v; 41v (single output) 39/6 each. P. & P. 2/9. 9v + 9v; 6v + 6v; or 41v + 41v (two separate outputs) 42/6 each. P. & P. 2/9. Please state output required. All the above units are completely isolated from mains by double wound transformer ensuring 100% safety.

R.C.S. PRODUCTS (RADIO) LTD.
(Dept. P.E.), 11 Oliver Road, London, E.17

"PRACTICAL ELECTRONICS"

CONSTRUCTIONAL DESIGNS

All specified 1st grade Components, complete Metalwork, full range of Materials, engraved Panel Plates, Ancillary Equipment and Assembled Units. Comprehensive lists available for each "P.E." Constructional Article.

Please send 6d. in stamps for each design
MALVYN ENGINEERING WORKS
Engineers to the Radio and Electronic Industries
7 CURRIE STREET, HERTFORD, HERTS
TELEPHONE: HERTFORD 2264

Please mention

PRACTICAL ELECTRONICS

when replying to

Advertisements

ANNOUNCING COMPONENTS AT PRICES YOU CAN AFFORD

BELOW ARE JUST A FEW OF OUR MANY BARGAINS THAT CAN BE SEEN ALONG WITH HUNDREDS OF OTHERS AT OUR RETAIL SHOP

RED SPOT	9d.	WHITE SPOT	9d.
AF117	2/6	OC76	2/6
OC44	2/6	OC45	2/6
OC71	2/6	OC72	2/6
OC81D	2/6	OC81	2/6
OC26	10/-	AD140	10/-
OC35	10/-	OC26	10/-

BARGAIN OF THE MONTH

Set of Six Transistors
OC44 OC45 OC45
OC81D OC81 OC81
12/6 P. & P. 6d.
Sets with
OC71, OC72, OC72 AF Output
are available

1/2-1W RESISTORS
10Ω-22M 2d.
GERAMICS 4d.
SILVER MICA 6d.
HI-STABS 1% 1/- OAB1 1/-
MAGNETIC EARPIECES 3/-
CRYSTAL EARPIECES 4/4
MIN TRANSISTOR
ELECTROLYTICS 1/2

SET OF I.F. AND OSC COILS, FERRITE ROD AERIAL, TUNING CONDENSER AND DIAL. SUITABLE FOR ABOVE TRANSISTOR SET 24/6.

We welcome enquiries for all types of components. Lists. S.A.E. Terms, cash with order, P.I.P. add 9d. for orders under £2.

WENTWORTH RADIO, 1a, Wentworth Court, Alston Rd., Barnet. Tel.: BAR 3087

INCREASE YOUR EARNING POWER AND JOB SECURITY WITH ONE OF THESE LOW COST COURSES

NEW. No. 500. RADIO AND TELEVISION COURSE, 75/-. Here at last is your opportunity to own a most complete course at a very modest cost! This expanded course which now includes television as well as radio repair training could get you started on a whole new career!

The Radio Section of the course was **ORIGINALLY DEVELOPED BY THE RADIO TECHNICAL INSTITUTE**, while the Television Servicing Course has formed the basis of instruction provided by one of the world's largest television and electronics firms!

Compare lesson by lesson with some courses costing ten times as much! You save because you receive all the lessons at one time and are not required to purchase equipment you may not need.

The lessons are crystal clear, practical, easy to master and use. Early lessons make fundamentals clear even to the beginner, while other lessons will give you the practical know-how of an expert!

The new 500 Radio and Television Course consists of 352 large quarto size pages of instruction, hundreds of illustrations. We positively guarantee that you will be delighted or your money refunded!

NEW. No. 800. RADIO-TELEVISION-ELECTRONICS COURSE, 85/-. This is really big value in home training. Similar in details to the above course excepting that you get an extra 56 pages of instruction making a total of 409 quarto size pages. Hundreds of illustrations. Includes all the usual subjects plus Radio Transmitter Circuits, Electronic Test Equipment, Thyatron Tubes, Inter-Communicators, Sound Level Meters, Servicing Printed Circuits and many more similar items. This course could be your first step into the fascinating world of electronics!

No. 400. ELECTRONICS COURSE, 45/-. A complete home-study course of 35 lessons. Consists of 216 large quarto size pages of instruction. Comes complete with instructor's notes and test questions. This is a modern course that teaches without resorting to comic strip methods... Thousands of readers of this magazine have taken this course and enjoyed every minute of it... Way not you? Clip the coupon for your free trial offer now!

UNCONDITIONALLY GUARANTEED TO GIVE COMPLETE SATISFACTION! Any course not satisfactory may be returned within 10 days post-paid for full refund or credit of the purchase price.

IF YOU SEND CASH WITH ORDER WE WILL INCLUDE A FREE BOOK worth 4/8 to 6/- if bought separately. By sending cash you reduce book-keeping and other costs which we pass back to you. But you must include cash at the time of order to get this special offer!

★ ★ FREE TRIAL OFFER ★ ★

PAY ONLY 5/- per week if you wish.

To Slim-Tech Technical Books, Dept. H4, Gater's Mill, West End, Southampton, Hants.

Please send the courses I have circled.

No. 500 No. 600 No. 400

If not delighted I may return any book post-paid without further obligation on my part, otherwise I will pay cash price or 5/- weekly (10/- fortnightly) commencing not later than 10 days after delivery. I am over 21 years of age. (If under 21 parents should place order.)

I enclose cash to the sum of £
I understand you will refund this money if I am not 100% satisfied and I return the book within 10 days.

Please send me the free book(s) I have ticked.

- Oscilloscope Book.
- Electronic Gadgets Book.
- Transistor Book.
- Radio Instruments Book.

Name

Address

VARIABLE VOLTAGE TRANSFORMERS



50 AMPS

1/2 AMP

INPUT 230/240v. A.C. 50/60—
OUTPUT VARIABLE 0-260v.
BRAND NEW Carriage Paid.
Buy direct from the importer,
keenest prices in the country.
All Types (and Spares) from
1/2 to 50 amp. from stock.

OPEN TYPE (Panel Mounting)
1/2 amp, £3. 3. 0. 1 amp, £4. 17. 6.
2 1/2 amps, £5. 12. 6.

SHROUDED TYPE
1 amp, £4. 10. 0. 2.5 amps,
£5. 17. 0. 4 amps, £8. 7. 6.
5 amps, £9. 0. 0. 8 amps,
£13. 10. 0. 10 amps, £17. 0. 0.
12 amps, £19. 10. 0. 15 amps,
£22. 0. 0. 20 amps, £32. 10. 0.
37.5 amps, £65. 0. 0. 50 amps,
£85. 0. 0.

PORTABLE TYPE
2.5 amps, Portable £9. 17. 6.

ULTRA VIOLET BULBS

Easy to use source of U.V. for dozens of
practical and experimental uses.

12 volt 36 watt A.C./D.C. SBC 6/6.
P. & P. 1/-.
12 volt 60 watt A.C./D.C. SBC 8/6.
P. & P. 1/-.

Transformer to suit the above, Input 200-
240 v. A.C., 12 volt 36 watts, 16/6; P. & P.
2/6. Input 200-240 v. A.C. 12 volt 60 watt,
22/6. P. & P. 3/6.

Set of 4 Colours FLUORESCENT
PAINT. Red, yellow, green and cerise. In
1/2 oz. tins. Ideal for use with the above
Ultra Violet Bulbs. 9/6, plus 1/6 P. & P.

NICKEL CADMIUM BATTERY.
Sintered Cadmium Type, 1.2 v. 7AH. Size:
height 3 3/8", width 2 1/8" x 1 1/8". Weight:
Approx 13 ozs. Ex-R.A.F., Tested, 12/6.
P. & P. 2/6.

SANGAMO WESTON

Type S32 2 1/2 Edgewise Meter
250 Micro-amp., scaled in dB's. New
29/6. P. & P. 1/-.



100 WATT POWER RHEOSTATS (NEW)

AVAILABLE IN THE
FOLLOWING 9 VALUES

10 ohm, 3 a.; 25 ohm, 2 a.; 50 ohm,
1.4 a.; 100 ohm, 1 a.; 250 ohm, .7 a.;

500 ohm, .45 a.; 1,000 ohm, 280 mA;

1,500 ohm, 230 mA; 2,500 ohm, .2 a.

Diameter 3 1/2 in. Shaft length 3 in.,
dia. 3/8 in. All at 27/6 each. P. & P. 1/6.



230V. A.C. MOTOR AND REDUCTION GEAR BOX



Reversible 1/2
h.p. 1,450
r.p.m. 3/8" dia. 1" long shaft. Mounted
in anti-vibration cradle.

Supplied complete with precision
20-1 reduction gear box and
pulleys.

Made to highest standard for com-
puter work. Ex equip. First class
condition. Price £35.0. P. & P. 7/6.

230 v. A.C. RELAY

Type 1.2 c/o. 2 amp. contacts, 9/6.
Type 2.2 x 15 amp. break, 2 x 2 amp.
make, 1 x 2 amp. break, 11/6. Both
types, ex new equip. P. & P. 1/6 each.

"CABY" MULTI-RANGE TEST METER

Model B40. D.C. volt.
0.5 v., 2.5 v., at 10,000
ohm per volt. Ideal for
transistor circuit test-
ing. A.C. and D.C.
volt, 10 v., 50 v., 250 v.,
500 v., 1,000 v., at 4,000
ohm per volt. Resistance,
2K ohm, 200 K
ohm. 2 megohm, 20
megohm. Fully guaranteed, complete
range of spares available from stock.
Price includes Test Leads, Battery,
Instruction book. Packing and Post
(U.K.), £6/2/6. 3 additional models
available from 5/- to £14/14/-.
Leaflet gladly sent on request.



14,000 OHM SEALED RELAY

High Speed single c/o, Platinum contacts.
Super-sensitive, ideal for transistor cir-
cuitry. Will operate on 1 milliamp,
25/- P. & P. 1/-.

230 VOLT A.C. GEARED MOTORS

5 r.p.m. 1.71b inch £2/9/6. P. & P. 2/6
13 r.p.m. 1.451b. inch £2/12/6. P. & P. 2/6

ELECTRIC CHECK METER (Sangamo Weston) 200/240 volt, A.C., 40 amp. As new 35/- plus 3/6 P. & P.

LATEST HIGH SPEED MAGNETIC COUNTERS

4 figure 10 impulses per second. Type 100D, 4.1 ohm
coil, 3-6 v. D.C. operation, Type 100A, 500 ohm coil,
18-24 v. D.C. operation. Type 100B, 2,300 ohm coil,
36-48 v. D.C. operation. Any type, 15/- each, plus
1/6 P. & P.

L.T. TRANSFORMERS All primaries 220-240 volts.

Type No.	Sec. Taps	Price Carr.
1	30, 32, 34, 36 v. at 5 amps.	£2/19/6 6/-
2	30, 40, 50 v. at 5 amps.	£4/15/0 6/-
3	10, 17, 18 v. at 10 amps.	£3/2/6 4/6
4	6, 12 v. at 20 amps.	£3/12/6 6/6
5	17, 18, 20 v. at 20 amps.	£5/2/6 6/6
6	6, 12, 20 v. at 20 amps.	£4/15/0 7/6
7	24 v. at 10 amps.	£3/9/6 5/6
8	28, 29, 30, 31 v. at 21 amps.	£6/15/0 10/-

VEROBOARD

The perforated
Copper Board for
Modern Circuitry

.15 x .15 pitch,
2.5 x 3.75.....3/6-

2.5 x 5.....3/8

3.75 x 3.75.....3/8

3.75 x 5.....5/6-

Spot face cutter, 9/-

Special Veropins,
Pkts. 200.....14/-

p.&p. on all items 1/-

METERS

2 1/2" Flush Round

A.C. AMMETERS

0-1, 0-5, 0-10, 0-15,

0-20 Amp. All 21/-

each, p. & p. extra.

A.C. VOLTMETERS

0-25, 0-50, 0-150 V.

All 21/- each, p. &

p. extra.

0-300 V. A.C. m/c

Rectifier £19.0.

BUILD AN EFFICIENT STROBE UNIT FOR ONLY 37/6.

We supply a simple circuit diagram and
all electrical parts including the
NSP2 Strobe tube which will enable
you to easily and quickly construct a
unit for infinite variety of speeds,
from 1 flash in several seconds to
several thousands per minute. 37/6
plus 3/- P. & P.

NSP2 TUBE brand new. I.O. base.
Price 15/- P. & P. 1/6.

UNIVERSAL DEMONSTRATION TRANSFORMER

Stenzyl Type



A complete composite
apparatus, comprising a
Transformer and
electro-magnet with
removable coils and pole
pieces. Coil tapped for
230 v, 220 v, 110 v,
115 v, 6, 12, 36, 110 v. A.C.
These coils are also used
for D.C. experiments.

Complete with all acces-
sories as shown. £17 + 10/- carriage. Leaflet on request.

12 VOLT D.C. RELAY

Single c/o, 600 ohm coil, New. 2 for 10/- plus
1/6 P. & P.

12-18 VOLT D.C. RELAY

168 ohm coil, 3 x 5 amp. N.I. c/o contacts.
New. 16/6 plus 1/- P. & P.

LIGHT SENSITIVE SWITCH. Kit of
parts, including ORP12 Cadmium Sulphide
Photocell, Relay, Transistor and Circuit, etc.,
price 25/- plus 2/6 P. & P. ORP 12 including
circuit, 10/6 each, plus 1/- P. & P.

A.C. MAINS MODEL

Incorporates Mains Transformer, Rectifier and
special relay with 3.5 amp mains c/o contacts.
Price inc. circuit 47/6 plus 2/6 p. & p.

INTERNATIONALLY FAMOUS NATIONAL RECEIVER



NC190—10 valves, 540 kc/s to 30 Mc/s,
5-meter, noise limiters, product detector,
bandspread, double conversion. £97. 4. 2.

EAGLE VALVE VOLTMETER K-142
Large 6" x 4" 200 microamp meter. 11
megohm, 2pF input. 0-1.5/5/15/50/150/500/
1500v. AC also 0-4000v. peak-to-peak in
7 ranges.

Decibels:—20 to +5/16/25/36/45/56/65 db.
0-1.5/5/15/50/150/500/1500v. DC.
Resistance: 0.2 ohm to 100 megohm.

240 volts, 50/60 c/s. 7 1/2 x 6 1/2 x 4 1/2 lbs.
Complete with DC probe, test leads &
instruction manual. 16 gns. post free.
S.A.E. for leaflet.

HAYATO PRINTED CIRCUIT ETCHING KIT PK-1

Complete with polisher, paint, etching
liquid, paint eraser, flux, 6" x 4" copper
laminates, knife, spatula, etc. etc. Satisfac-
tion guaranteed. Fantastic value at
19/6. P.P. 2/- S.A.E. for illustrated leaflet.

WESTINGHOUSE SILICON REC- TIFIER SI0AR2

1000 v. P.I.V. 750 mA. 9/6. each P.P. 6d.
2 for 17/6. P.P. 9d.

BRIAN J. AYRES & CO.

Dept. DY, 8 Hartfield Road
Wimbledon, London, S.W.19

Telephone: Wimbledon 6063

DIGITAL COMPUTER

A simple digital Adder/Subtractor using switches
and lamps only. A fascinating demonstration of
Binary arithmetic. Full circuit, wiring diagram
and notes on the Binary system, 3/6d.

NOUGHTS AND CROSSES MACHINE

Uses standard miniature switches and lamps
only. This machine cannot be beaten. Full
circuit, wiring diagram and instructions, 3/6d.

1% High Stability Resistors

1/2 watt 1%, 2/- each. Full range 10 ohms to 10
Meg. Many special values for meter multipliers,
etc. in stock.

1% Wirewound Resistors

1% 1 watt, 1 ohm to 5K, 3/-; to 20K, 4/3. 1%
add 3d. Your value would to order. Shunts
down to 0.1 ohm.

High Resistance Phones 10/-, post 1/-.
100 Resistors 1, 2 and 5% assorted 9/6d.
Signal Injector Kit 10/-, post 1/-.

PLANET INSTRUMENT CO.

25 (E), DOMINION AVE., LEEDS 7

Packed with concise servicing data
and facts for day-to-day use ...

TAPE RECORDER SERVICING MANUAL

by H. VV. Hellyer, A.M.T.S., A.I.P.R.E.,
A.M.I.S.M.

This book provides concise service data,
including circuit diagrams and numerous
layout diagrams and views of mechanisms
and adjustments, for the majority of tape
recorders and decks that have been released
in this country.

Covers 282 models in 344 pages
supported by over 345 drawings

3s from all booksellers

or, in case of difficulty, post free from
George Newnes, Tower House,
Southampton Street, London, W.C.2

NEWNES

SERVICE TRADING CO

All Mail Orders—Also callers:
47/49 HIGH STREET, KINGSTON ON THAMES
Telephone: KINGSTON 9450

Personal callers only
9 LITTLE NEWPORT STREET
LONDON, W.C.2 Tel.: GERrard 0576

TRANSISTOR ELECTROLYTICS

COMPARE THESE PRICES!

32uf ... 1.5Volt	3.2uf ... 6Volt	3uf ... 12Volt	16uf ... 15Volt
25uf ... 3Volt	4uf ... 6Volt	4uf ... 12Volt	32uf ... 15Volt
2uf ... 3Volt	8uf ... 6Volt	10uf ... 12Volt	50uf ... 15Volt
3uf ... 3Volt	10uf ... 6Volt	20uf ... 12Volt	64uf ... 15Volt
8uf ... 3Volt	25uf ... 6Volt	25uf ... 12Volt	2.5uf ... 25Volt
10uf ... 3Volt	30uf ... 6Volt	30uf ... 12Volt	16uf ... 25Volt
12uf ... 3Volt	50uf ... 6Volt	1uf ... 15Volt	32uf ... 25Volt
20uf ... 3Volt	100uf ... 6Volt	2uf ... 15Volt	2uf ... 30Volt
30uf ... 3Volt	2uf ... 9Volt	4uf ... 15Volt	16uf ... 30Volt
40uf ... 3Volt	10uf ... 9Volt	5uf ... 15Volt	25uf ... 30Volt
25uf ... 6Volt	20uf ... 9Volt	6uf ... 15Volt	1uf ... 40Volt
2uf ... 6Volt	2uf ... 12Volt	8uf ... 15Volt	5uf ... 70Volt

All the above at 1/2 each

320uf ... 2.5Volt	250uf ... 15Volt	150uf ... 25Volt	} All at 1/6
200uf ... 3Volt	500uf ... 15Volt	100uf ... 30Volt	
250uf ... 6Volt	100uf ... 18Volt	200uf ... 30Volt	
400uf ... 6Volt	64uf ... 25Volt	50uf ... 150Volt	} All at 2/-
1,000uf ... 6Volt	500uf ... 25Volt		
1,000uf ... 12Volt	500uf ... 50Volt		
4,000uf ... 12Volt	1,000uf ... 50Volt		
750uf ... 15Volt			
1,000uf ... 15Volt			

200/100uf ... 275Volt or 200/200uf ... 275Volt ... 6/6 each

CONDENSERS

Silver Mica 3.3pf to 6,800pf. Including High Voltage
 Disc Ceramics. (Normally 3/- each) ... 10/- 100
 Paper Condensers .0001uf, .001uf, .002uf, .005uf and .04uf
 all at 7/6 per 100. £3 per 1,000
 .1uf, .25uf, .5uf ... 10/- per 100

RESISTORS

1/10th 1/6th 1/4Watt ... Assorted Values 10/- per 100

Mixed wattages 1/4Watt to 3Watt. Close Tolerance. Assorted Values.
 Polythene wrapped on cards of 10. Give-away price 50/- per 1,000 plus
 5/- post and packing.

TRANSISTORS

Special offer. Unmarked. 6/- doz.
 State R.F. or A.F. £1 100

(At a price you can afford)

OC71 equivalent, 1/- each, 25 for £1, 100 for £3. NKT124 or NKT 125,
 Switching transistors, 2/- each, 6 for 10/-. Large Car Radio type Output
 Transistors OC25, OC35, NKT405, 10/- each. Packet containing:
 3 2G417, 2 2G371, 1 2G381, 1 2G339, 1 diode (for making superhet with
 complementary symmetry transformerless output stage), £1 complete.
 Diodes, 1/- each. Zener Diodes, ZE12, ZB4-3, 5/- each. BY100 Mains
 Rectifiers for TV Sets, 7/6 each.

SIGNAL INJECTOR

R.F./I.F./A.F. Transistors, components and circuit to make, only 10/-
 complete.

LOUDSPEAKERS

Brand-new 4in. Excellent reproduction, 10/- each

Midget Earpieces complete with plug and lead	...	5/- each
Magnetic Lapel Microphone with plug and lead	...	10/- each
Transistor Holders	...	1/- each
Miniature Soldering Irons complete with Bit	...	30/- each
Set of 5 assorted Bits to suit any job	...	20/- set
Crystal Set kits	...	15/- each
POCKET-SIZE MULTIMETERS, AC/DC/OHMS	...	£3
Transistor Intercomm. Units	...	55/- pair
5ft. FLUORESCENT FITTINGS. With choke and starter	...	39/6*
4ft. ditto	...	32/6*

* Carriage 10/- per fitting

ACOS PICK-UP HEADS. Complete with needles

This is the price you would expect to pay for the Needles only!
 Monaural ... 14/-
 Stereo ... 21/-
 Diamond Stereo... 28/9
 Will fit most record changers. Can be very profitable!

RELAYS, Miniature, 1 1/2" x 1" x 3/4"

700 ohm or 2,500 ohm coil. Transparent dust cover. Two
 pairs of change-over contacts. PLUG-IN TYPE. Base
 included in price ... 25/- each

For orders less than 10/- please add 6d. towards postage.

G. F. MILWARD
17 PEEL CLOSE, DRAYTON BASSETT
Nr. TAMWORTH, STAFFS
 Telephone: TAMWORTH 2321 **POST ONLY**

HIGH QUALITY



LOWER COST

Combine an Armstrong Tuner and Amplifier and you have
 a compact item with all the advantages of the separate
 units, plus easier installation, and equivalent performance
 at a lower price.

Stereo model 127, above, is derived from the more
 expensive 227, and has an identical AM-FM tuner
 section, but with an amplifier section designed for those
 whose power requirements are more modest.
 It has a more modest price too, as does the mono version
 model 127M.

Each Armstrong Tuner-Amplifier is ideal as the basis of a
 high fidelity system for radio and record reproduction,
 tape recording and playback, and each unit may be built
 into your own cabinet or used in our optional case,
 of teak and vinyl hide, as shown.

For full details and technical specifications of all models, plus
 list of over 300 stockists, post coupon or write mentioning
 3/PE/66

model 127 STEREO TUNER AMPLIFIER	...	£37.10.0
model 127M MONO TUNER AMPLIFIER	...	£26.10.0

optional case for each model £3.10.0

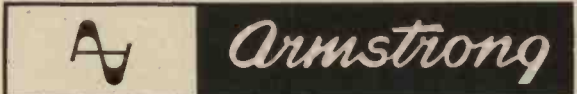

ARMSTRONG AUDIO LTD - WARLTERS ROAD - N.7
 Telephone: NORTH 3213

Name

Address

3/PE/66

Brand new individually checked and guaranteed VALVES

AC/HL	4/6	EB34	1/6	EL30	5/6
ACP4	6/8	EB91	3/8	EL37	1/6
AC6PEN	5/8	EB33	6/8	EL38	17/8
AL60	5/8	EB04	1/8	EL41	7/8
AR6	8/8	EB30	8/8	EL42	8/8
ARF9	9/8	EB70	8/8	EL43	8/8
ARF12	2/6	EBF83	7/8	EL44	8/8
ARF24	3/8	EBF89	6/8	EL83	6/3
ATP4	6/8	EC52	4/8	EL84	5/8
ATP4	2/3	EC33	12/8	EL85	8/8
ATP7	5/8	EC70	4/8	EL81	4/8
AU7	55/8	EC90	2/8	EL85	5/8
AE31	9/8	EC91	3/8	EM80	6/8
BH	15/8	EC81	4/8	EM81	7/8
BD78	40/8	EC82	5/8	EM84	6/3
BL63	10/8	EC83	6/8	EN31	10/8
B84	8/8	EC84	5/8	ESU74	80/8
B85	20/8	EC85	6/8	ESU208	8/8
B884	47/8	EC91	4/8	EY51	5/8
B2134	16/8	EC92	8/8	EY80	8/8
CC32	2/8	ECH42	8/8	EY91	3/8
CL33	9/8	ECH81	5/8	EZ40	6/8
CY31	6/8	EC83	7/8	EZ41	6/8
D1	1/6	ECL80	6/8	EZ80	5/8
D41	3/3	ECL82	7/8	EZ81	3/8
D61	6/8	ECL83	10/8	FY603	7/8
D77	3/8	ECL86	10/8	FY604	5/8
DA30	12/8	EF36	3/6	FY603	5/8
DAP96	6/8	EF34	7/8	FW4500	6/8
DD41	4/8	EF40	8/8	FW4800	8/8
DF73	5/8	EF41	6/8	GI/2360	9/8
DF91	3/8	EF50	2/6	GM20	8/8
DF92	3/8	EF52	6/8	GM4	4/8
DF96	3/8	EF53	4/8	GZ32	10/8
DE63	6/8	EF55	8/8	GZ34	10/8
DK96	5/8	EF71	7/8	H63	7/8
DL92	5/8	EF72	5/8	HK54	22/8
DL93	6/8	EF73	5/8	HL2K	2/8
DL94	5/8	EF80	5/8	HL23	6/8
DL86	6/8	EF85	4/8	HL23DD	5/8
DL10	8/8	EF86	6/8	HL41	4/8
DL19	15/8	EF89	5/8	HK54	30/8
EB0F	22/8	EF91	2/8	KT32	8/8
EB8CC	12/8	EF92	2/8	KT33C	9/8
ES90C	10/8	EF95	5/8	KT44	5/8
EA50	1/8	EF96	5/8	KT43	5/8
EA73	7/8	EF183	8/8	KT66	16/8
EABC80	5/8	EF184	8/8	KT67	15/8
EAC91	3/8	EL32	3/8	KT76	8/8
EAP42	6/8	EL34	10/8	KT88	22/8

KTW61	4/6	Q81202	8/8	UY21	7/8	2C34	2/6	6AL5W	7/8	6J7M	8/8	12AH7	8/8	69	6/8	5704	9/8		
KTW63	2/8	QV047	8/8	UY85	5/8	2C45	22/8	6AM6	2/8	6K6GT	5/8	12AH8	11/8	75	5/6	6064	7/8		
KT21	6/8	RE	8/8	VMP40	12/8	2C48	30/8	6AM6	4/8	6K70	4/8	12AT7	4/8	76	5/8	6083	6/8		
KT263	5/8	RG4/1230	8/8	VP23	3/8	2C51	12/8	6AQ5	7/8	6K80	3/8	12AU7	5/8	77	6/8	6088	22/8		
MH4	5/8		60/8	VE133	9/8	2D21	5/8	6AQ5W	9/8	6K8G	3/8	12AX7	6/8	78	5/8	7193	1/8		
MHL16	10/8		60/8	VR99	5/8	2X2	3/8	6A86	4/8	6K8GT	5/8	12AX7	10/8	80	5/6	7475	2/8		
				VR105/30	3/8	3A4	4/8	6A86W	9/8	6K8M	8/8	12BA6	5/8	81	9/8	8013A	25/8		
ML6	6/8			8130P	15/8	3D6	4/8	6A87G	20/8	6L5G	6/8	12BE6	7/8	82	5/8	8020	8/8		
N78	15/8			8130	15/8	3E7	5/8	6A87G	20/8	6L6B	7/8	12BT7	4/8	83	8/8	8020	3/8		
NE17	7/8			8P2	8/8	3F24	5/8	6A06	7/8	6L7G	4/8	12C3	3/8	85A3	3/8	8022	4/8		
OA2	6/8			8P41	1/8	3E29	50/8	6AX4	4/8	6L34	4/8	12H6	2/8	25A5U	9/8	9003	6/8		
OB2	6/8			8P61	1/8	3Q4	6/8	6B7	6/8	6LD20	5/8	12J5GT	2/8	307A	5/8	9004	2/8		
OB3	7/8			8P120	3/8	W21	5/8	3Q5GT	7/8	6B8G	2/8	12J7GT	6/8	313C	25/8	9006	2/8		
OC3	5/8			T41	6/8	W118	8/8	3M4	4/8	6BA6	4/8	6N70	5/8	320	8/8	G.R. Tubes			
OD3	5/8			TP22	9/8	W119	8/8	3V4	5/8	6B7	5/8	6P26	12/8	357A	70/8	CV1596			
OE3	5/8			TP25	15/8	X66	7/8	4C97	3/8	6B66	4/8	6Q7G	6/8	368A	15/8	1043	55/8		
OZAA	5/8			TT11	5/8	X118	8/8	4D1	4/8	6B77	7/8	6R7	5/8	393A	15/8	VC87	28/8		
PC84	5/8			TT15	35/8	X145	8/8	5A173G	5/8	6BR7	9/8	68A7	7/8	428C7	4/8	VC8133	30/8		
PC89	10/8			TR31	45/8	YF	1/8	5A174G	5/8	6BW6	9/8	68A7GT	6/8	428G7	3/8	703A	30/8		
PC80	8/8			TZ20	16/8	Y63	5/8	5B325M	6/8	6C4	2/8	68H7	3/8	705A	10/8	VC817B			
PC82	6/8			U81	8/8	Y66	4/8	25/8	6C6G	2/8	68C7	7/8	128J7	5/8	715B	60/8	40/8		
PCF84	6/8			U121	8/8	Y66	8/8	5B263M	6C6GT	6/8	68C7GT	5/8	128K7GT	3/8	717A	3/8	VC817C		
PC85	8/8			U17	15/8	Z800	20/8	15/8	6C6G	3/8	68H7	3/8	128L7	5/8	724A	16/8	40/8		
PC82	7/8			U18	6/8	Z801U	10/8	5B254M	6C6G	3/8	68J7	5/8	12Y2	2/8	801	6/8	3FF7	45/8	
PC83	8/3			U22	11/8	1A5GT	5/8	5B255M	6C6H	4/8	68J7	5/8	14L7	7/8	807	8/8	5CP1	30/8	
PC84	7/8			U26	11/8	1B22	30/8	35/8	6C21	80/8	68J7Y	6/8	15D2	6/8	808	9/8	5FP7	12/8	
PC85	8/8			U28	4/8	1C6GT	6/8	3R4Y	9/8	6C16	9/8	68K7	4/8	20P4	13/8	88D	40/8		
PC86	9/8			U30	4/8	1D6GT	6/8	5J7	7/8	6D8	3/8	68L7GT	5/8	21B6	8/8	1178	6/8	Photo Tubes	
PC87	9/8			U32	4/8	1E7G	7/8	5U4G	4/8	6E5	8/8	68M7	3/8	23L6GT	8/8	813	60/8	800	40/8
PC88	9/8			U191	11/8	1F2	3/8	5V4G	8/8	6F5G	5/3	68N7	3/8	25Y6	6/8	815	35/8	816	12/8
PEN220A	3/8			U801	18/8	1P2	3/8	5X4G	8/8	6F6GT	5/8	68P7	2/8	25Z4G	6/8	820B	5/8	91A	55/8
				UABC80	6/8	1Q6GT	6/8	5Y3G	4/8	6F6G	4/8	6U6GT	9/8	25Z6	7/8	830B	4/8	6097C	350/8
				UAF42	9/8	1L4	2/8	5Y3GT	5/8	6F7	6/8	6V6G	5/8	25Z6GT	8/8	832	15/8	Transistors	
				UAC41	6/8	1L6	6/8	5Y3GT	5/8	6P17	6/8	6V6GT	7/8	28D7	6/8	843	5/8	OC16	29/8
				UBF80	5/8	1L6C	7/8	5Y3GT	5/8	6P17	6/8	6V6M	8/8	30	5/8	866A	14/8	OC22	23/8
				UBF89	6/8	1LH4	4/8	5Z4G	6/8	6F12	4/8	6X4	3/8	30C15	5/8	884	10/8	OC25	18/8
				UBL21	11/8	1N21B	5/8	5Z4G	6/8	6F12	4/8	6X6G	5/8	30P5	8/8	884	10/8	OC44	6/8
				UC85	6/8	1N43	4/8	5Z4GT	6/8	6F13	5/8	6X6GT	5/8	30PL1	10/8	954	4/8	OC45	6/8
				UC82	8/8	1N70	4/8	6AB7	4/8	6F32	4/8	6Y6G	6/8	30P12	10/8	955	2/8	OC71	4/8
				UC81	6/8	1R4	5/8	6AC7	2/8	6F33	3/8	6Y6M	8/8	30P19	18/8	956	2/8	OC72	6/8
				UL2	3/8	1R5	3/8	6AG5	2/8	6G8G	2/8	6Z4	5/8	30P15	8/8	958A	4/8	OC73	10/8
				UL3	10/8	1R6	4/8	6AG7	8/8	6H6M	1/6	7B7	7/8	35L6GT	7/8	958B	4/8	OC81M	7/8
				UL4	8/8	1R6	4/8	6AH6	10/8	6J4WA	10/8	7B7	7/8	35T	17/8	1612	5/8	OC82	10/8
				UL5	7/8	2A3	6/8	6AJ7	3/8	6J5	10/8	7C7	7/8	35W4	5/8	1616	3/8	OC122	18/8
				UL41	7/8	2A3	6/8	6AK5	5/8	6J6G	2/8	7C7	6/8	35Z3	8/8	1619	5/8	OC200	10/8
				UL84	5/8	2B28	8/8	6AK6	6/8	6J6G	3/8	7H7	7/3	35Z4GT	6/8	1625	3/8	XC141	10/8
				U19	7/8	2C26	7/8	6AK7	6/8	6J6G	6/8	7H7	7/3	35Z6GT	6/8	1626	3/8	XC142	15/8
				U05	8/8	2C26A	3/8	6AL5	3/8	6J7G	6/8	7V7	6/8	37	4/8	1629	4/8	XC156	20/8
				Q895/10	5/8							7Z4	4/8	38	4/8	2061	5/8	XC156	22/8
												8D2	2/8	2168G	6/8	4043C	3/8	2N247	9/8
												986	3/8	50L6GT	8/8	4063	3/8	2N502	47/8
												9D2	3/8	53A	7/8	4313C	30/8	2N588	10/8
												10F9	9/8	57	6/8	5704	9/8	2N1090	20/8
												12A6	2/8	68	6/8	5726	6/8	2N1091	29/8

P.C. RADIO LTD

170 GOLDHAWK ROAD, W.12
Shepherd's Bush 4946
Open 9-5.30 p.m. Thursday 9-1 p.m.

MANY OTHERS IN STOCK include Cathode Ray Tubes and Special Valves. U.K. Orders below £1 P. & P. 1/; over £1, 2/; over £3, P. & P. free. C.O.D. 2/6 extra. Overseas Postage extra at cost.

ASTONISHING LOW PRICED RADIO KITS (all Guaranteed) FROM CONCORD

MAKE 5 DIFFERENT TRANSISTOR RADIOS for 35/-

Amazing Radio Construction Set! Become a radio expert for 35/-. A complete Home Radio Course. No experience necessary. Parts include instructions for each design, Step-by-Step plan, all Transistors, loudspeaker, personal phone, knobs, screws, etc., all you need. Box size 14" x 10" x 2" (parts available separate). Originally 25, NOW 35/- plus 3/6 p. & p.

New RADIO Anyone CAN BUILD in 2-3 hours! Only 10/6!

EVENTHE CHILDREN BUILD THEM!

No soldering—only 10 connections! Then hear it reach out bringing in station after station.

4 1/2" x 2 1/2" x 1 1/2". Many Testimonials!—M.H. of Bradford, writes: "... I have just completed one of your sets successfully. It is the first time I have ever tackled anything like a radio and I must state here and now, I am amazed how easy it is to no longer like me. Your instructions and plans have obviously been very carefully thought out so that even the most dim can follow them..."

10/6 plus 2/6 post, etc.

(Mail Order Only)

The President 4 is a pocket size medium wave radio—only 3 1/2" x 2 1/2" x 4". Specially designed case, ferrite rod, 4 new Mullard semiconductor, proper tuning condenser, proper plug-in battery. Special reflex pin regeneration circuit gives performance equal to 6 transistor Radio (even operates a speaker).

Amazing power, superb tone—tunes into station after station, home and abroad. No aerial or earth needed—works beautifully anywhere at all!

Only 39/6 plus 2/6 p. & p. Everything—including 4 Mullard semiconductor, OC44, OA70, OC71 and OA70, personal earpiece, etc.

ASTONISHING CIGARETTE RADIO!

ONLY 18/6

Yes a perfectly ordinary packet of cigarettes—but it fetches in station after station, holds it clear! Holds 10 Cigarettes—yet cleverly conceals highly sensitive, fully transistorised circuit (incl. tiny battery). Even a young boy can assemble it in under 2 hours. No soldering. No experience necessary. Only 16 Connections. From our bulging testimonial file, Mr. D. B. of Huddersfield writes: "... I have fitted the parts in and it is working wonderfully..."

ALL PARTS including Semi-Conductors, A.B.C. Plans, etc. ONLY 18/6 plus 2/6 post, etc.

CRESCENT RADIO LTD.

40 MAYES ROAD
WOOD GREEN, N.22

LONDON'S ELECTRONIC COMPONENT CENTRE

BEST QUALITY • KEEN PRICES

VALVES • TRANSISTORS • MIKES • AERIALS
DIODES • CONDENSERS • AMPS • PLUGS
SPEAKERS • RESISTORS • CABLES • SOCKETS
CHASSIS • TRANSFORMERS • TAPES • BOOKS
RECTIFIERS • VALVE HOLDERS • COILS • METERS

Everything you want in a friendly atmosphere

A book for every electronics engineer . . .

TRANSISTOR POCKET BOOK

by R. G. Hibberd, B.Sc., M.I.E.E., Sen.M.I.E.E.E.

A comprehensive guide to the characteristics and use of the various types of transistor now available. The manufacture of the various types of transistor, up to and including the latest epitaxial planar, field of effect and metal-oxide silicon transistors, is described in detail in order to make clear the different characteristics

R.S.C.

(MANCHESTER) LTD.

MAIL ORDERS TO:
DEPT. P
102 HENCONNER LANE
LEEDS 13

Terms: C.W.O. or C.O.D. No C.O.D. under £1. Postage 2/9 extra under £2. 4/6 extra under £5. Trade Supplied. S.A.E. with all enquiries please. Personal shoppers welcome at any of the branches below.

All branches open all day Saturday.

BRADFORD:

10 North Parade.
(Half-day Wednesday)
Tel: 25349

BRISTOL:

14 Lower Castle Street.
(Half-day Wednesday)
Tel: 22904

BIRMINGHAM:

30/31 Ge. Western Arcade,
opp. Snow Mill Station.
CENTRAL 1279 No half-day

DERBY:

26 Osmaston Rd. The Spot.
(Half-day Wed.) Tel: 41361

DARLINGTON:

13 Post House, Wynd.
(Half-day Wed.) Tel: 68043

EDINBURGH:

133 Leith Street.
(Half-day Wednesday)

GLASGOW:

326 Argyle St. (No Half-day)
Tel: CITY 4158

HULL:

51 Saville Street. (Half-day
Thursday) Tel: 20505

LEICESTER:

32 High Street. (Half-day
Thursday) Tel: 56420

LEEDS:

5-7 County (Mecca) Arcade
(No Half-day) Tel: 28252

LIVERPOOL:

73 Dale St. (No Half-day)
Tel: CENTRAL 3573

LONDON:

238 Edgware Road, W.2.
(Half-day Thursday)
Tel: PADINGTON 1629

MANCHESTER:

60A-60B Oldham St.
Tel: CENTRAL 2778. (No
Half-day) New large store

MIDDLESBROUGH

106 Newport Rd. (Half-day
Wednesday) Tel: 47096

SHEFFIELD:

13 Exchange Street, Castle
Market Bldgs. (Half-day
Thursday) Tel: 20716

R.S.C. TRANSFORMERS

Fully Guaranteed. Interleaved and Impregnated. Primaries 200-230-250v. 50 c/s. Screened.

TOP SHROUDED DROP THROUGH	
250-0-250v. 70mA. 6.3v. 2a. 0-5-6.3v. 2a	17/9
250-0-250v. 80mA. 6.3v. 2a. 0-5-6.3v. 2a	21/9
250-0-250v. 100mA. 6.3v. 2a. 6.3v. 1a	21/9
250-0-250v. 100mA. 6.3v. 3.5a. C.T.	19/9
250-0-250v. 100mA. 6.3v. 4a. 0-5-6.3v. 3a	28/9
300-0-300v. 130mA. 6.3v. 4a. 6.3v. 1a for Mullard 510 Amplifier	35/9
300-0-300v. 100mA. 6.3v. 4a. 0-5-6.3v. 3a	28/9
350-0-350v. 100mA. 6.3v. 2a. 0-5-6.3v. 3a	28/9
350-0-350v. 150mA. 6.3v. 4a. 0-5-6.3v. 3a	37/9
FULLY SHROUDED UPRIGHT MOUNTING	
250-0-250v. 60mA. 6.3v. 2a. 0-5-6.3v. 2a	18/9
Midget type 2 1/2 x 3 1/2 in.	29/9
250-0-250v. 100mA. 6.3v. 4a. 0-5-6.3v. 3a	29/9
300-0-300v. 100mA. 6.3v. 4a. 5v. 3a	29/9
300-0-300v. 130mA. 6.3v. 4a. C.T. 6.3v. 1a for Mullard Amplifier	36/9
350-0-350v. 100mA. 6.3v. 4a. 0-5-6.3v. 3a	29/9
350-0-350v. 150mA. 6.3v. 4a. 0-5-6.3v. 3a	38/9
425-0-425v. 200mA. 6.3v. 4a. C.T. 5v. 3a	59/9
425-0-425v. 200mA. (6.3v. 4a Twice), 5v. 3a	59/9
450-0-450v. 250mA. 6.3v. 4a. C.T. 5v. 3a	69/9
FILAMENT TYPES	
6.3v. 1.5a. 5/9; 6.3v. 2a. 7/6; 12v. 1a. 7/11; 6.3v. 3a. 8/11; 6.3v. 6a. 17/6; 12v. 1.5a. twice 17/6.	

OUTPUT TRANSFORMERS

Push-Pull 8 watts, EL84 or 6V6 to 3 Ω or matched to 15 Ω 9/9
Push-Pull 10-12 watts to match 6V6 or EL84 to 3-5-8 to 15 Ω 19/9
Following types for 3 and 15 Ω speakers—
Push-Pull 10-12 watts to match 6V6 or EL84—18/9
Push-Pull 15-18 watts. 6L6, KT66 22/9
Push-Pull Mullard 510 Ultra Linear 29/9
Push-Pull 20 watts, sectionally wound 6L6, KT66, EL34, etc. 49/9
MIDGET (Clamped type) 21" x 21" x 21"
50 c/s. 250v. 60mA. 6.3v. 2a 13/9
250-0-250v. 60mA. 6.3v. 2a 14/9
CHARGER TYPES, 0-9-15v. 1 1/2a, 12/9; 0-9-15v. 2a, 16/9; 0-9-15v. 5a, 19/9;
0-9-15v. 6a 23/9; 0-9-15v. 8a, 28/9
AUTO (Step up/Step down) TRANS.
0-10-110-230/250v. 50-80 watts. 13/9; 150 watts. 27/9; 250 watts. 49/9; 500 watts. 99/9

AUDIOTRINE HF100D HIGH FIDELITY LOUDSPEAKER. Really exceptional value and performance. Heavy cast 10" diam. frame. Huge pole pieces for high sensitivity. Special rubber cone surround giving extremely low fundamental resonance. Dual cone for full frequency range of 20-20,000 c.p.s. Rating 15 watts, impedance 3 ohms or 15 ohms. Only £5.15.0. Carr. 5/-.

R.S.C. A10 30 WATT ULTRA LINEAR HIGH FIDELITY AMPLIFIER

A highly sensitive Push-Pull high output unit with self-contained Pre-amp. Tone Control Stages. Certified performance figures compare equally with most expensive amplifiers available. Hum level—70dB. Frequency response ±3dB 30-20,000 c/s. A specially designed sectionally wound ultra linear output transformer is used with 807 output valves. All high grade components. Six valves: EF86, EF86, ECC83, 807, 807, GZ34. Separate Bass and Treble Controls. Minimum input required for full output is only 12 millivolts so that ANY KIND OF MICROPHONE OR PICK-UP IS SUITABLE. The unit is designed for CLUBS, SCHOOLS, THEATRES, DANCE HALLS or OUTDOOR FUNCTIONS, etc. For VOCALISTS, Electronic ORGAN, BASS, LEAD OR RHYTHM GUITAR, STRING BASS, etc. OUTPUT SOCKET PROVIDES L.T. and H.T. for RADIO TUNER. Two separately controlled inputs for mixing purposes, 200-250v. 50 c/s. A.C. Mains output for 3 and 15 ohm speakers. Complete kit of parts with fully punched chassis and instructions. Supplied factory built with 807 output handles can be supplied for 21/-. Send S.A.E. for leaflet, also speaker. Terms: DEPOSIT 12 Gns. Carr. 10/-

point-to-point wiring diagrams and Instructions. If required perforated cover with carrying handles can be supplied for 21/-. Send S.A.E. for leaflet, also speaker. Terms: DEPOSIT 12 Gns. Carr. 10/-

R.S.C. A11-HIGH FIDELITY 12-14 WATT AMPLIFIER

PUSH-PULL ULTRA LINEAR OUTPUT "BUILT-IN" TONE CONTROL PRE-AMP STAGES
Two input sockets with associated controls allow mixing of "mike" and gram., as in A10. High sensitivity. Includes 5 valves, ECC83, ECC83, EL84, EL84, EZ81. High Quality sectionally wound output transformer specially designed for Ultra Linear operation and reliable small condenser of current manufacture. INDIVIDUAL CONTROLS FOR BASS AND TREBLE "Life" and "Cut". Frequency response ±3 dB 30-20,000 c/s. Six negative feedback loops. Hum level 60 dB down. ONLY 23 millivolts input required for FULL OUTPUT. Suitable for use with all makes and types of pick-ups and microphones. Comparable with the very best designs. For GRAM, RADIO or TAPE. For VOCALISTS or MUSICAL INSTRUMENTS such as STRING BASS, LEAD or RHYTHM GUITARS, etc. OUTPUT SOCKET with plug provides 300v, 30mA, and 6.3v. 1.5a for supply of a RADIO TUNER. Size approx. 12 x 9 x 7in. For A.C. mains 200-250v. 50 c.p.s. Output for 3 and 15 ohms speaker. Kit is complete to last nut. Chassis is fully punched. Full instructions and point-to-point wiring diagrams supplied. (Or factory built 51/6 extra). If required perforated metal covers with 2 carrying handles can be supplied for 19/9. TERMS ON ASSEMBLED UNITS: DEPOSIT 33/3 and 9 monthly payments of 24/1 (Total £12.10.0). Send S.A.E. for illustrated leaflet detailing Cabinets, Speakers, Mikes, etc.

E.M.I. 4 SPEED RECORD PLAYING UNITS

with Crystal pick-up, fitted turn-over cartridge. Limited quantity. Carr. 5/- at only **79/6**

AUDIOTRINE HI-FI TAPE RECORDER KIT

REALISM AT INCREDIBLY LOW COST, CAN BE ASSEMBLED 25! GNS. Carr. 10/-
TIN AND TUBE. Incorporating the latest Magnavox Tape Deck. The Audiotrine High Quality Tape Amplifier with negative feedback equalizer. 2 1/76 ton for each of 3 speeds. High Flux P.M. Speaker, empty Tape Spool, a Reel of Best Quality Tape and a Handsome Portable Carrying Cabinet covered in attractive leathercloth, chrome fittings and trimmings. Size 14 1/2 x 17 1/2 x 8 1/2 in. high and circuit. Total cost if purchased individually approx. £40. Performance equal to units in the £50-£70 class. S.A.E. for leaflets. TERMS—4 gns. deposit and 9 monthly payments of 42/- (Total 28 gns.) ONLY 3 PAIRS OF SOLDERED JOINTS PLUS MAINS.



TRANSISTOR SALE Mullard OC71 2/11, OC45 3/11, OC44 3/11, OC72 3/11, OC81 2/11, OC171 8/9, Ediswan XA101 3/9, XA112 3/9, XC101A 3/9, AF117 8/9. Postage 6d. for up to 3 transistors.

SELENIUM RECTIFIERS F.W. (BRIDGED) TYPES

6/12v. 1a 3/11 6/12v. 3a 9/9 6/12v. 6a 15/3
6/12v. 2a 6/11 6/12v. 4a 12/3 6/12v. 10a 26/9

COMPLETE POWER PACK KIT

Consisting of Mains, Trans., Metal Rectifier, Double electrolytic, smoothing choke chassis and circuit. For 200/250v. A.C. mains. Output 250v., 60mA, 6.3v., 2a. **19/11**

FANE I22/10 20 WATT HEAVY DUTY LOUDSPEAKER

12in. 15 ohm. With exceptionally robust 2 in. diameter voice coil assembly. Post 3/6 **5 gns.**

AUDIO FIDELITY HF 100D. 10" 15 WATT HI-FI SPEAKER.

Heavy cast construction, dual cone, smooth frequency response. 40-15,000 c.p.s. Speech coil 3 ohm or 15 ohm. Exceptional value at **£5.15.0**

NOMBREX SIGNAL GENERATOR Model 27.

Covers 150 Kcs. to 350 Mc/s. in 8 ranges. Accuracy ± 2% or better. R.F. Modulated or unmodulated average 50 Mw. Separate A.C. output at 400 c/s. 3 volts peak. £9. 10. 0

R.S.C. GRAM AMPLIFIER KIT

3 watts. output. Negative feedback. Controls Vol., Tone and Switch. Mains operation 200-250v. A.C. Fully isolated chassis. Circuit, etc. supplied. Only **39/9** Carr. 3/9

R.S.C. Battery to Mains Conversion Units

Type BM1. An all-dry battery eliminator. Size 5 1/2 x 4 x 2in. approx. Completely replaces batteries supply 1.4v. and 90v. wires. For A.C. mains 200-250v. 50 c/s. available. Suitable for all battery portable receivers requiring 1.4v. and 90v. Com-plete kit with diagram 39/9 or ready for use 49/9

AUDIOTRINE HI-FI SPEAKER SYSTEMS

Consisting of matched 12in. 12,000 line, 15 ohm high quality speaker; crossover unit (consisting of choke, condenser, etc.) and Tweeter. The smooth response and extended frequency range ensure surprisingly realistic reproduction. Standard 10 watt rating. £4.19.9. Carr. 3/-. Or Senior 20 watt Model £6.19.6. Carr. 7/6

R.S.C. BABY ALARM or INTER-COMM

R.S.C. KIT. Complete set of parts with diagrams, etc. Housed in two polished walnut finished cabinets of pleasing design. High sensitivity Output 3 Watts. For 200-250v. A.C. mains. Fully isolated. Controllable at both units. An inter-comm. of this class would normally cost £20-£30. Only 89/6. Carr. 3/-. Ready for use, 6 gns.

R.S.C. COLUMN SPEAKERS

Covered in two-tone Rexine/Vynair. Ideal for vocalists and Public Address. Normally supplied for 15 ohm matching but can be supplied for 100v. line for 35/- extra.
Type C58. 15-20 watts. Fitted five 8in. high flux speakers. Overall size approx. 42 x 10 x 5in.
12 1/2 Gns. 10/- Or deposit 42 and 9 monthly payments of 27/9 (Total 14.9.9.)
Type C412. 40 watts. Fitted four 12in. 12,000 line 10 watt speakers. Overall size 56 x 14 x 9in. approx. Carr. 15/- **19 1/2 Gns.**
Or deposit of 3 gns. and 9 monthly payments of 43/2 (Total 21 gns.)

12 in. 10 WATT HIGH QUALITY LOUDSPEAKER

In walnut veneered cabinets. Gains 12,000 line. Speech coil 3 ohms or 15 ohms. Only **£4.19.6**
Carr. 5/6
Terms: Deposit 11/3 and 9 monthly payments of 11/3 (Total £5.12.6). 12 1/2 Gns.
HI-FI LOUD-SPEAKERS IN CABINETS. **£7.19.6**
Size 18 x 18 x 10in. Finish as above. Terms: Deposit 17/9 and 9 monthly payments of 17/9 (Total £8.17.6). Carr. 8/6

NOMBREX RESISTANCE — CAPACITY BRIDGE Model 62.

Transistorised 1 ohm-1000 M ohms and 1 pf.-100 mfd. in six ranges. Accuracy 21% or better at mid-scale. Balance by luminescent indicator tube. Separate resistance and capacity scales. Power factor check for electrolytics. **£8.5.0** Leakage check by neon indicator.

STEREO AMPLIFIER

Incorporating 2 ECL82s and 1 E280, heavy duty, double wound mains transformer. Output 4 watts per channel. Full tone and volume controls. Absolutely complete.

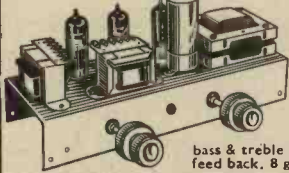

ONLY £4.19.6

P. & P. 6/6

Super Deluxe version with ECL86 valves, sep. bass & treble controls, full feedback. 8 gns. P. & P. 6/6

HSL 'FOUR' AMPLIFIER KIT.

A.C. Mains 200/250v., 4 watt, using ECC83, EL84, EZ80 valves.



★ Heavy duty double-wound mains transformer with electrostatic screen. ★ Separate Bass, Treble and Volume controls, giving fully variable boost and cut with minimum insertion loss. ★ Heavy negative feedback loop over 2 stages ensures high output at excellent quality with very low distortion factor. ★ Suitable for use with guitar, microphone or record player. ★ Provision for remote mounting of controls or direct on chassis. ★ Chassis size only 7 1/2" wide x 4 1/2" deep. Overall height, 4 1/2". All components and valves are brand new. ★ Very clear and concise instructions enable even the inexperienced amateur to construct with 100% success. ★ Supplied complete with valves, output transformer (3 ohm only), screened lead, wire, nuts, bolts, solder, etc. (No extras to buy). PRICE 7/6. P. & P. 6/6. Comprehensive circuit diagram, practical layout and parts list 2/6 (free with kit). This kit although similar in appearance to HA34 it employs entirely different and advanced circuitry.

MAINS TRANSFORMERS

Semi shrouded drop thro' type. Pri. 200, 220, 240v. Sec. 250v. 1 wave at 70mA and 6.3v. at 2 amp. c/t. Stack size 3" x 2 1/2" x 1 1/2". PRICE 11/-. P. & P. 3/-.

BRAND NEW 3 OHM LOUDSPEAKERS

5 in., 12/6; 6 1/2 in., 15/-; 8 in., 21/-; 10 in., 25/-; 12 in., 27/6; (12 in., 15 ohm, 30/-); 10 in. x 6 in., 26/-. E.M.I. 13 1/2 x 8 in. with high flux ceramic magnet, 42/- (15 ohm, 45/-). P. & P. 4" & 5" 2/6, 6 1/2" & 8" 2/6, 10" & 12" 3/6 per speaker.

ACOS CRYSTAL MIKES. High imp. For desk or hand use. High sensitivity, 18/6. P. & P. 1/6.

TSL CRYSTAL STICK MIKE. Listed at 45/-. Our price, 18/6. P. & P. 1/6.

BRAND NEW. 12" 15w. H/D Speakers. 3 or 15 ohm. Current production by well-known British maker. Offered below list price at 89/6. P. & P. 5/-. (25w. guitar model £5.5.0). (35w. guitar model £8.0.0).

MATCHED PAIR OF 2 WATT TRANSISTOR DRIVER AND OUTPUT TRANSFORMERS. Stack size 1 1/2 x 1 1/2 in. Output trans. tapped for 3 ohm and 15 ohm output. 10/- pair plus 2/- P. & P.

BRAND NEW PLESSEY 12 v. 4 pin non-syn. vibrators. Type 12 1.4SD. ONLY 8/6. P. & P. 1/6

4-WAY NON-TANGLE TELEPHONE CABLE Latest spring-back coil type; extends 12 in. to 5ft. Complete with rubber bushes. 4/6 each. P. & P. 1/6.

YVNAIR ANDREXINE SPEAKER AND CABINET FABRICS app. 54 in. wide. Usually 35/- yd., our price 13/6 per yd. length (min. 1yd.) P. & P. 2/6. S.A.E. for samples.

QUALITY RECORD PLAYER AMPLIFIER

A top-quality record player amplifier. This amplifier (which is used in a 29 gn. record player) employs heavy duty double wound mains transformer, ECC83, EL84, EZ80 valves. Separate Bass, Treble and Volume controls. Complete with output transformer matched for 3 ohm speaker. Size 7 1/2" w. x 2 1/2" d. x 5 1/2" h. Ready built and tested. PRICE 69/6. P. & P. 4/9.

ALSO AVAILABLE mounted on board with output transformer and 6in. speaker ready to fit into cabinet below. PRICE 89/6. P. & P. 5/9.

QUALITY PORTABLE R/P CABINET

Uncut motor board. Will take above amplifier and B.S.R. or GARRARD Autochanger or Single Record Player Unit. Size 18 x 14 x 8 1/2 in. PRICE £39/6. Carr. 7/6.

4-SPEED PLAYER UNIT BARGAINS

All brand new in maker's original packing.

SINGLE PLAYERS
B.S.R. TU12 £39/6. Carr. 5/6.
GARRARD SP25 De Luxe... £12/10/6. Carr. 5/6.
B.S.R. GU7 with unit mounted pickup arm. £4/10/8. Carr. 5/6.

AUTO. CHANGERS
B.S.R. UA15 £6/19/6. B.S.R. UA16..... £6 19 6
Latest B.S.R. UA25 Super slim £6 2 6
GARRARD AT5 £9 10 0
GARRARD Auto Slim £3.10. Carr. 6/6 on each.
All the above units are complete with t/c motor head and sapphire styli or can be supplied with compatible stereo head for 12/6 extra.

BRAND NEW CARTRIDGE BARGAINS

RONETTE STEREO 105 CARTRIDGE. Stereo/L. R. L. complete with two spools. Original list price 67/9. Our price 24/-. P. & P. 1/-.
ACOS GP67-1. Mono complete. List price 21/-. Our price 13/6. P. & P. 1/-.

PORTABLE TAPE RECORDER CASE

Beautifully made and expensively finished in dark grey heavy grade resin. Satin Chrome metal grille front and chrome fitting. Speaker aperture 9" x 4". Overall size 15 1/2" w. x 15" d. x 7 1/2" h. Will take any standard tape deck or single record player. Limited number only. Worth at least £5. OUR PRICE 49/6. P. & P. 5/-. Brand new and unused.

TAPE DECKS

B.S.R. MONARDECK (Single speed) 3 1/2 in. per sec., simple control, uses 5 1/2 in. spools, £6/15/- plus 7/6 carr. and ins. (Tapes extra.)

10/14 WATT HI-FI AMPLIFIER KIT

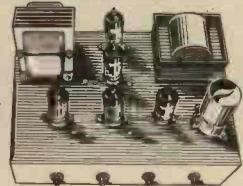

A stylishly finished monaural amplifier with an output of 14 watts from 2 EL84s in push-pull. Super reproduction of both music and speech, with negligible hum. Separate inputs for mike and gram allow records and announcements to follow each other. Fully shrouded section wound output transformer to match 3-15Ω speaker and 2 independent volume controls, and separate bass and treble controls are provided giving good lift and cut. Valve line-up 2 EL84s, ECC83, EF86, and EZ80 rectifier. Simple instruction booklet 1/6. (Free with parts.) All parts sold separately. ONLY £6/19/6. P. & P. 8/6. Also available ready built and tested complete with std. input sockets. £8/15/- P. & P. 8/6.

HARVERSON SURPLUS CO. LTD.

170 HIGH ST., MERTON, S.W.19. CHERRYWOOD 3985

Open all day Saturday Early closing Wed., 1 p.m.

A few minutes from South Wimbledon Tube Station. (Please write clearly) OVERSEAS P. & P. CHARGED EXTRA. S.A.E. with all enquiries.

3-VALVE AUDIO AMPLIFIER

MODEL HA34



Designed for Hi-Fi reproduction of records. A.C. Mains operation. Ready built on plated heavy gauge metal chassis, size 7 1/2 in. w. x 4 in. d. x 4 1/2 in. h. Incorporates ECC83, EL84, EZ80 valves. Heavy duty, double wound mains transformer

and output transformer matched for 3 ohm speaker, separate Bass, Treble and volume controls. Negative feedback line. Output 4 1/2 watts. Front panel can be detached and leads extended for remote mounting of controls. The HA34 is being specially designed for us and our quantity order enables us to offer them complete with knobs, valves, etc., wired and tested for only **£4.50** P. & P. 6/-.

HIGH GAIN 4 TRANSISTOR PRINTED CIRCUIT AMPLIFIER KIT

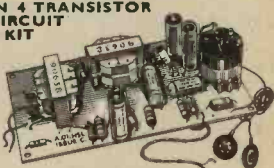

Type TAI
● P e a k output in excess of 1 1/2 watts.
● All standard British components.
● Built on printed circuit panel, size 6 x 3 in.

● Generous size Driver and Output Transformers.
● Output transformer tapped for 3 ohm and 15 ohm speakers. ● Transistors (GET 114 or SI Mullard OC81D and matched pair of OC81 o/p).
● 9 volt operation. ● Everything supplied, wire, battery clips, solder, etc. ● Comprehensive easy to follow instructions and circuit diagram 1/6 (Free with Kit). All parts sold separately. SPECIAL PRICE 45/-. P. & P. 3/-. Also ready built and tested, 52/6. P. & P. 3/-. A pair of TAIs are ideal for stereo.

HARVERSON'S F.M. TUNER Mk. I

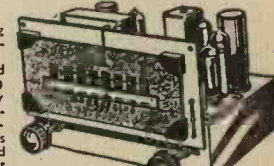

● F.M. tuning head by famous maker.
● Guaranteed non-drift. ● Permeability tuning ● Frequency coverage 88-100Mc/s ● Balanced diode output
● Two I.F. stages and discriminator. ● Attractive maroon and solid dial (7 x 3 in. glass). ● Self powered, using a good quality mains transformer and valve rectifier.
● Valves used ECC85, two EF80s, and EZ80 (rectifier). ● Fully drilled chassis. ● Size of completed tuner 8 x 6 x 5 1/2 in. ● All parts sold separately. Set of parts if purchased at one time £5/19/6, plus 8/6 P.P. and ins. Circuit diagram and instructions 1/6 post free. Mark II version as above but complete with magic eye, front panel and brackets, £5/12/6. P. & P. 1/6.
Mark III version as Mark I but with output stage (ECL82) and tone control, £7/7/-. P. & P. 8/6.

SPECIAL PURCHASE!

from LEADING HI FI MANUFACTURER
7-10 watt OUTPUT TRANSFORMERS to match pair of ECL 86's in push-pull to 3 ohm output. ONLY 11/-. P. & P. 2/6.
7-10 watt ULTRA LINEAR OUTPUT TRANSFORMERS to match pair of ECL 82's in push-pull to 3 ohm output. ONLY 15/-. P. & P. 2/6.
SPECIAL MAINS TRANSFORMERS to match either of the above. Tapped primary. Secondary 250v. 80mA. half wave and 6.3v. 2 amp. ONLY 12/6. P. & P. 3/6.

YUKAN SELF-SPRAY

Get this AIR DRYING HAMMER FINISH NOW!

SO PROFESSIONAL... THE YUKAN AEROSOL WAY!

YUKAN Aerosol spraykit contains 16 ozs. fine quality durable easy instant spray. No stove baking required. Available in Grey, Blue, Gold, Bronze at 14/11 at our counter or 15/11, Carr. paid, per pushbutton self-spray can. SPECIAL OFFER: I can plus optional transferable snap-on trigger handle (value 5/-) for 18/11.



Choice of 13 self-spray plain colours and primer (Motor car quality) also available

Please enclose cheque or P.O. for total amount to:

YUKAN

Dept. PE/3, 307a EDGWARE ROAD, LONDON, W.2

SILICON PLANAR EPITAXIAL 200 MC/S

5/- 5/- 5/- 5/-

At last! Truly general-purpose silicon transistors at germanium prices. These tiny epoxy-encapsulated NPN devices are suitable for practically every low-power application — low-noise audio, r.f. amplifiers and mixers up to the edge of the v.h.f. band, d.c. amplifiers, low-power output stages...

- ★ Selected 2N2926
- ★ Current gain (h_{fe}) 55-300 at 2 mA
- ★ Collector dissipation 200 mW
- ★ Cut-off frequency (f_T) 200 Mc/s
- ★ A.f. noise figure 2.8 dB at 10 kc/s
- ★ First grade. Data supplied

Price includes U.K. postage. Cash with order, Mail order only. AMATRONIX LTD., 396 SELSDON RD., CROYDON, SURREY

Closed Thurs. afternoons

Open all day Saturday

VALUABLE NEW HANDBOOK FREE TO AMBITIOUS ENGINEERS

Have you had your copy of "Engineering Opportunities"?

The new edition of "ENGINEERING OPPORTUNITIES" is now available—without charge—to all who are anxious for a worthwhile post in Engineering. Frank, informative and completely up to date, the new "ENGINEERING OPPORTUNITIES" should be in the hands of every person engaged in any branch of the Engineering industry, irrespective of age, experience or training.

On 'SATISFACTION OR REFUND OF FEE' terms

This remarkable book gives details of examinations and courses in every branch of Engineering, Building, etc., outlines the openings available and describes our Special Appointments Department.

WHICH OF THESE IS YOUR PET SUBJECT?

MECH. ENGINEERING
Gen. Mech. Eng.—Maintenance Eng.—Diesel Eng.—Press Tool Design—Sheet Metal Work—Welding—Eng. Pattern Making—Inspection—Draughtsmanship—Metallurgy—Production Eng.

RADIO ENGINEERING
General Radio—Radio & TV Servicing—TV Eng.—Telecommunications—Electronics—Sound Recording—Automation—Practical Radio—Radio Amateurs' Exam.

CIVIL ENGINEERING
General Civil Eng.—Municipal Eng.—Structural Eng. Sanitary Eng.—Road Eng. Hydraulics—Mining—Water Supply—Petrol Tech.

FLEC. ENGINEERING
General Electrical Eng.—Installations—Draughtsmanship—Illuminating Eng.—Refrigeration—Elem. Elec. Science—Elec. Supply—Mining Elec. Eng.

AUTO ENGINEERING
General Auto Eng.—Auto. Maintenance—Repair—Auto. Diesel Maintenance—Auto. Electrical Equipment—Garage Management.

BUILDING
General Building—Heating & Ventilation—Plumbing—Architecture—Carpentry—Painting—Decorating—Specifications & Quantities—Surveying—Architectural Draughtsmanship.

WE HAVE A WIDE RANGE OF COURSES IN OTHER SUBJECTS INCLUDING CHEMICAL ENG., AERO ENG., MANAGEMENT, INSTRUMENT TECHNOLOGY, WORKS STUDY, MATHEMATICS, ETC.

Which qualification would increase your earning power?
A.M.I.Mech.E., A.M.S.E., A.M.I.C.E., A.M.I.E.R.E., B.Sc.,
A.M.I.P.E., A.M.I.M.I., A.R.I.B.A., A.I.O.B., A.M.I.Chem.E., A.R.I.C.S.,
M.R.S.H., A.M.I.E.D., A.M.I.Mun.E., CITY & GUILDS, GEN. CERT. OF
EDUCATION, ETC.

BRITISH INSTITUTE OF ENGINEERING TECHNOLOGY
316A COLLEGE HOUSE, 29-31 WRIGHT'S LANE, W.8

THIS BOOK TELLS YOU

- ★ HOW to get a better paid, more interesting job.
- ★ HOW to qualify for rapid promotion.
- ★ HOW to put some letters after your name and become a key man . . . quickly and easily.
- ★ HOW to benefit from our free Advisory and Appointments Depts.
- ★ HOW you can take advantage of the chances you are now missing.
- ★ HOW, irrespective of your age, education or experience, YOU can succeed in any branch of Engineering.

156 PAGES OF EXPERT CAREER - GUIDANCE

PRACTICAL EQUIPMENT

Basic Practical and Theoretic Courses for beginners in Radio, T.V., Electronics, Etc., A.M.I.E.R.E. City & Guilds Radio Amateurs' Exam. R.T.E.B. Certificate P.M.G. Certificate Practical Radio Radio & Television Servicing Practical Electronics Electronics Engineering Automation

INCLUDING TOOLS

The specialist Electronics Division of B.I.E.T. NOW offers you a real laboratory training at home with practical equipment. Ask for details.

B.I.E.T.

You are bound to benefit from reading "ENGINEERING OPPORTUNITIES", and if you are earning less than £30 a week you should send for your copy now—FREE and without obligation.



POST NOW!

TO B.I.E.T., 316A COLLEGE HOUSE,
29-31 WRIGHT'S LANE, W.8.

3d. stamp if posted in an unsealed envelope.

Please send me a FREE copy of "ENGINEERING OPPORTUNITIES." I am interested in (state subject, exam., or career).

NAME

ADDRESS

WRITE IF YOU PREFER NOT TO CUT THIS PAGE

THE B.I.E.T. IS THE LEADING INSTITUTE OF ITS KIND IN THE WORLD



(8)



(10)



(4)



(6)



(5)

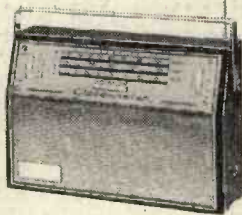

(1)

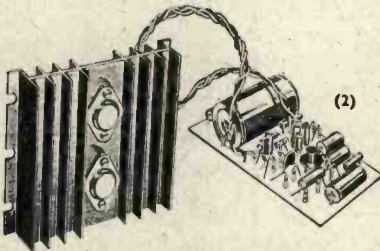

(2)



(3)



(7)

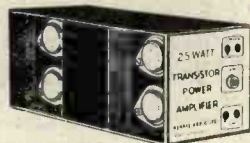

(9)



(11)



(13)



(12)

NEW 1966 CATALOGUE 150 PAGES

Fully detailed and illustrated components, equipment and Hi-Fi. All types and makes. 5000 Stock lines. 500 Transistors and Devices. 1000 Quartz Frequencies. 800 Valves and Tubes. The Finest Range available. A mine of information.

Price 6/- post paid

FREE with Catalogue, 6/- Discount vouchers gives 2/- in pound discount on purchases.

CATALOGUE COSTS NOTHING AFTER USING VOUCHERS



(1) GLOBEMASTER MW/LW/SW PORTABLE

Full 3-waveband tuning. Pushbutton wavechange. Superhet printed circuit. Black-chromed cabinet 11 x 7½ x 3½ in. (SW 17-50 metres). Ear/Record sockets. **TOTAL COST TO BUILD £8.19.6** P.P. 3/6.

(6) VHF FM TUNER

87/105 Mc/s Transistor Superhet. Geared tuning. Terrific quality and sensitivity. For valve or transistor amplifiers. 4 x 3½ x 2½ in. **TOTAL COST TO BUILD £6.19.6** P.P. 2/6. (Cabinet Assembly 20/- extra)

10 AND 20 WATT TRANSISTOR MONO AND STEREO HI-FI UNITS

(2) **POWER AMPLIFIERS.** 10 watts RMS output. 100mV input. 30 c/s to 20kc/s ± 1dB. 6-Transistor Push-pull. Panel size 4 x 2½ x 1½ in. H/S 4 x 4 in. TPA10/3 3-5 ohm spkr. £5.10.0, pp. 2/6 TPA10/15 12-16 ohm spkr. £5.19.6, p.p. 2/6 (Mains unit for 1 or 2 amplifiers, 5/9, p.p. 2/6)

(3) **PREAMPLIFIERS.** 8 input selector. Treble, bass, volume, filter controls. 1½mV to 300mV inputs. Battery operated or from Mains Unit. Output up to 150mV RMS.

MP2 Mono 9½ x 2½ x 2½ in. £5.10.0, p.p. 2/6 (brown and gold front panel 8/6)

SP4 Mono/Stereo, 9 x 3½ x 1½ in., £10.19.6, p.p. 3/6 (front panel plate 12/6)

The Finest High Fidelity at Unbeatable Prices

● ALL UNITS BUILT AND TESTED

(5) BUILD A TAPE RECORDER

Three speeds—3 watts. Complete kits with new "363" decks. Supplied as preassembled sections. Complete with portable cabinets and Speaker—excellent quality. 1,200ft. tape and spool.

★ TWO TRACK P.P. £26 8/6 ★ FOUR TRACK P.P. £30 8/6

(7) 5 WATT AMPLIFIER

6-Transistor Push-pull, 3 ohms. 6mV into 1K. 12/18V supply. 2½ x 2 x 1½ in. **BUILT AND TESTED 79/6** P.P. (optional mains units, 54/- 2/- p.p. 2/-)

New matching Preamplifier, 6 inputs, treble/bass/selector/volume controls. 6-10mV o/put. 9-18V supply. 79/6, p.p. 2/-

(8) REGENT-6 MW/LW POCKET RADIO

6-Transistor superhet. Geared tuning. Push-pull output. Moulded cabinet 5 x 3 x 1½ in. Phone socket. **TOTAL COST TO BUILD 85/-** P.P. 2/-

(4) MULTI-METERS

PT34 1kV	39/6	TP55 20kV	£5.19.6
M1 2kV	49/6	EP30k 30kV	£6.10.0
TP10 2kV	75/-	EP50k 50kV	£6.15.0
EP10k 10kV	79/6	500 30kV	£8.17.6
ITI-2 20kV	89/6	EP100k 100kV	£10.10.0
EP20k 10kV	99/6		

(9) 25 WATT AMPLIFIER

New 8-Transistor design. Push-pull output for 7½ to 16ohm speaker. 150mV input. 30c/s to 20kc/s ± 1dB. For use with valve or transistor preamplifiers as item (3) above. Size 2½ x 2½ x 6½ in. **PRICE BUILT AND TESTED £8.19.6** P.P. 3/6 (Mains unit 79/6, p.p. 2/6)

(10) ROADSTER MW/LW CAR RADIO

Supplied as Preassembled Panels. Permeability tuned superhet. Push-button wave-changer. Push-pull output. Fits any car. 7 x 4 x 2 in. 12 volt (+) earth. **ASSEMBLY TOTAL COST £8.19.6** P.P. 3/6 (Speaker/Baffle/Car Fixing Kit, 20/-)

(11) GARRARD DECKS

(p.p. 5/- any type)
1000 mono £6.10.0, stereo £6.19.6
2000 mono £6.19.6, stereo £7.10.0
*SP25 mono £10.19.6, stereo £11.10.0
Autoslim mono £5.19.6, stereo £6.10.0
*AT6 mono £8.19.6, stereo £9.10.0
*AT60 mono £11.19.6, stereo £11.19.6
3000LM stereo £8.19.6
*Deram cartridge add 60/- to mono price). All autochange (except SP25), complete with cartridge. Brand new.

(12) TRANSMITTER/RECEIVERS

*Up to ½ mile range. Price per pair £7.19.6, p.p. 2/6.
*Up to 5 miles range. Price per pair £22.10.0, p.p. 3/6.
*FM wireless microphone £16.
G.P.O. Licence required

(13) VHF FM TUNER

Supplied as 2 Preassembled Panels, plus metal work Superhet design, 88-108 Mc/s, 9 volt operated. Total cost £12.17.6, p.p. 2/6.

(14) NEW MW/LW TUNER TO BUILD

Fully tunable superhet with excellent sensitivity and selectivity. Output up to ½ volt peak. Complete with front panel, etc. 9 volt operated. **TOTAL COST TO BUILD 79/6** P.P. 2/6



HENRY'S RADIO LTD.
303 EDGWARE RD., LONDON, W.2
PADdington 1008/9
Open Mon. to Sat. 9-6. Thurs. 1 p.m.
Open all day Saturday.

PROVED AND TESTED DESIGNS AND UNITS

SEE NEW CATALOGUE FOR FULL STOCK RANGE AVAIL-

ABLE. LET US QUOTE FOR COMPONENTS AND ACCESSORIES FOR YOUR CIRCUIT. SEND A LIST FOR QUICK REPLY. QUALITY COMPONENTS AT REALISTIC PRICES