

Practical Electronics

SEPTEMBER 1965

PRICE 2'6

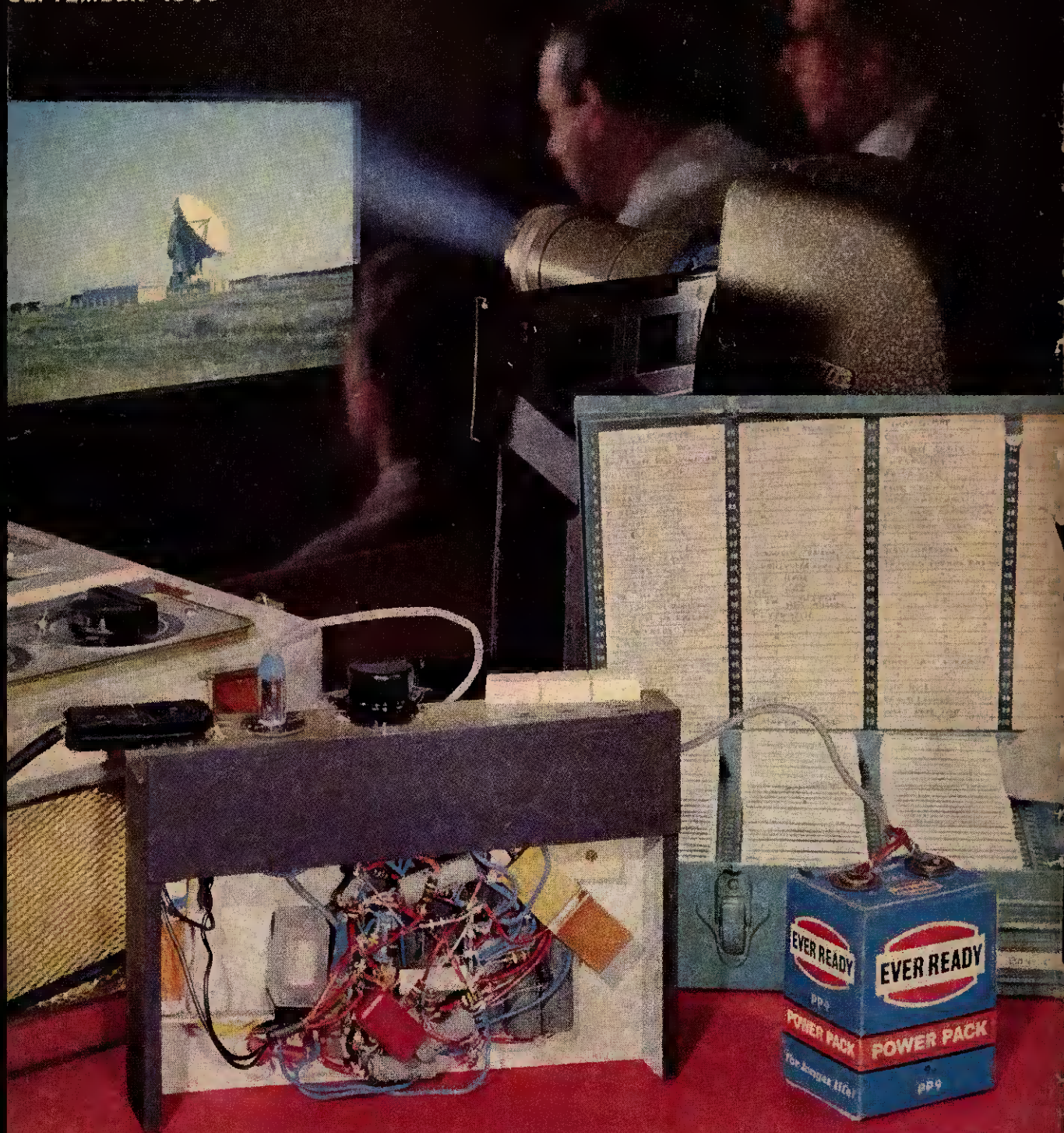

COMMENTARY SYNCHRONISER FOR AUTO PROJECTORS

Why

NOT BUILD ONE OF OUR PORTABLE TRANSISTOR RADIOS...

BACKED BY OUR SUPER AFTER SALES SERVICE

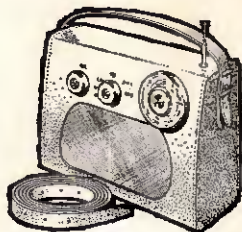

ROAMER SEVEN Mk III

5 WAVEBAND PORTABLE OR CAR RADIO

Amazing performance and specification ★ Now with PHILCO MICRO-ALLOY R.F. TRANSISTORS

● 9 stages—7 transistors and 2 diodes
Covers Medium and Long Waves, Trawler Band and two Short Waves to approx. 15 metres. Push-pull output for room filling volume from rich toned heavy duty "Celestion" speaker. Air spaced ganged tuning condenser. Ferrite rod aerial for M & L Waves and telescopic aerial for S Waves. Real leather-look case with gilt trim and shoulder and hand straps. Size 9 × 7 × 4in. approx. The perfect portable and the ideal car radio. (Uses PP7 battery available anywhere.)

Total cost of parts now only **£5.19.6** P. & P.
Parts Price List and easy build plans 3/- 5/6

NEW TRANSONA FIVE

Home, Light, A.F.N., Lux, all at good volume.

G.P. Durham

● 7 stages—5 transistors and 2 diodes
Fully tunable over Medium and Long Waves and Trawler Band. Incorporates Ferrite rod aerial, tuning condenser, volume control, new type fine tone super dynamic 2 1/2in. speaker, etc. Attractive case. Size 6 1/2 × 4 1/2 × 1 1/2in. (Uses 1289 battery available anywhere.)



Total cost of all parts now only **42/6** P. & P. Parts Price List and easy build plans 2/-

POCKET FIVE

● 7 stages—5 transistors and 2 diodes

Covers Medium and Long Waves and Trawler Band, a feature usually found in only the most expensive radios. On test Home, Light, Luxenbourg and many Continental stations were received loud and clear. Designed round supersensitive Ferrite rod aerial and fine tone 2 1/2in. moving coil speaker, built into attractive black case with red speaker grille. Size 5 1/2 × 1 1/2 × 3 1/2in. (Uses 1289 battery available anywhere.)

Parts Price List and easy build plans 1/6 Total cost of all parts now only **42/6** P. & P. 3/-

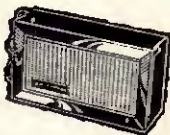

SUPER SEVEN

● 9 stages—7 transistors and 2 diodes

Covers Medium and Long Waves and Trawler Band. The ideal radio for home, car, or can be fitted with carrying strap for outdoor use. Completely portable—has built-in Ferrite rod aerial for wonderful reception. Special circuit incorporating 2 R.F. Stages, push-pull output, 3in. speaker (will drive large speaker). Size 7 1/2 × 5 1/2 × 1 1/2in. (Uses 9v battery, available anywhere.)

Total cost of all parts now only **£3.19.6** P. & P. Parts Price List and easy build plans 2/-

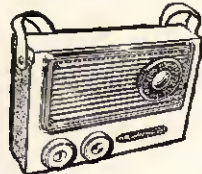

MELODY SIX

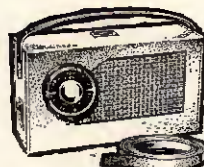

speaker grille and supplied with hand and shoulder straps. Parts Price List and Total cost of all easy build plans 2/- parts now only **£3.9.6** P. & P. 3/6

"... amazed at volume and performance, has really come up to my expectations". S.G., Stockton-on-Tees.

● 8 stages—6 transistors and 2 diodes

Our latest completely portable transistor radio covering Medium and Long Waves. Incorporates pre-tagged circuit board, 3in. heavy duty speaker, top grade transistors, volume control, tuning condenser, wave change slide switch, sensitive 6in. Ferrite rod aerial. Push-pull output. Wonderful reception of B.B.C. Home and Light, 208 and many Continental stations. Handsome leather-look pocket size case, only 6 1/2 × 3 1/2 × 1 1/2in. approx. with gilt

TRANSONA SIX

● 8 stages—6 transistors and 2 diodes

This is a top performance receiver covering full Medium and Long Waves and Trawler Band. Push pull output. High-grade speaker makes listening a pleasure. Ferrite rod aerial. Many stations listed in one evening including Luxenbourg loud and clear. Attractive case in grey with red grille. Size 6 1/2 × 4 1/2 × 1 1/2in. (Uses PP4 battery available anywhere.) Carrying Strap 1/- extra.

Total cost of all parts now only **59/6** P. & P. Parts Price List and easy build plans 1/6

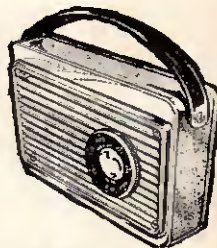

ROAMER SIX NEW!!

NOW WITH PHILCO MICRO-ALLOY R.F. TRANSISTORS

● 6 WAVEBAND!!

● 8 stages—6 transistors and 2 diodes

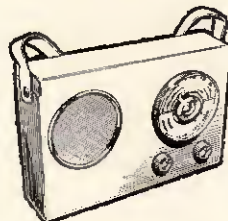

Listen to stations half a world away with this 6 waveband portable. Tunable on Medium and Long Waves, Trawler band and three Short Waves. Push pull output. Sensitive Ferrite rod aerial and telescopic aerial for short waves. Top grade transistors, 3-inch speaker, handsome case with gilt fittings. Size 7 1/2 × 5 1/2 × 1 1/2in.

★ Extra band for easier tuning of LUX., etc.

Parts Price List and Total cost of all easy build plans 2/- parts now only **£3.19.6** P. & P. 3/6 (Carrying Strap 1/6 extra.)

All components used in our receivers may be purchased separately if desired. Parts price lists and easy build plans available separately at fixed prices stated.

COMPONENT BARGAINS

TRANSISTORS

PHILCO MADT Type 2N1727
Maximum frequency of oscillation 150 Mc/s ... 8/6
PHILCO MADT Type 2N1728
Maximum frequency of oscillation 150 Mc/s ... 9/6
PHILCO MADT (Micro Alloy Diffused) Type 2N503
Maximum frequency of oscillation over 500 Mc/s ... 15/-

TUNING CONDENSERS

Air spaced fine quality German manufacture with slow motion drive. 0.0005" with oscillator section ... 5/6 Post 1/-

HEADPHONES

High Fidelity miniature magnetic earpieces (2) on slim band with lead and plug. Easily converted to stereo. American manufacture. 100 ohms impedance. Transformers supplied free for higher impedances ... 13/6 P & P 1/6

CYLDON PERMEABILITY TUNERS

Full M.W. coverage. Fitted coupling coil, oscillator coil, ferrite slugs and slow motion tuning with cursor, etc. GIVE AWAY PRICE ... 10/- P & P 1/-

RADIO EXCHANGE Ltd.

61a, HIGH STREET, BEDFORD. Phone: 2367

Callers side entrance
Barratts Shoe Shop
Open 9—5 p.m.
Sats. 9—12.30 p.m.

The NEW Stern-Clyne ELECTRONIC CONCERT ORGAN TO BUILD YOURSELF.

DESIGNED —

- For the Electronic amateur seeking the most fascinating project.
- For the discriminating organist seeking an instrument which DOES sound like a pipe organ.

NEW —

- Constructional methods introducing "sectional complete instrument" building.
- Extended range of tone colours. Without unrealistic "Gimmick" effects.

THE MOST COMPREHENSIVE KIT OF PARTS AVAILABLE IN THIS COUNTRY

**START BUILDING FOR AS LITTLE AS
£75.15.0 approx. (H.P. Terms Available)**

Send 2/6 for data and information booklet (credited on initial purchase) to: **Electronic Organ Dept., 162 Holloway Road, London, N.7.**

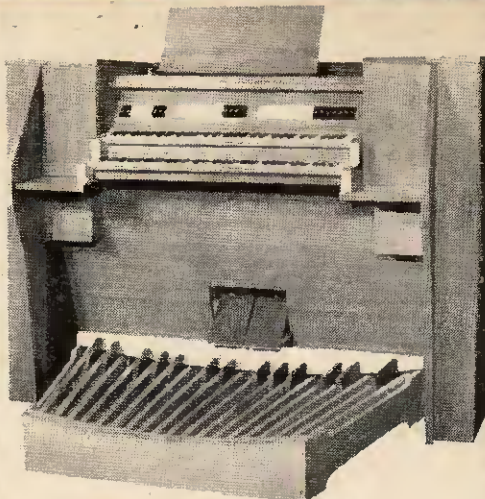

VISIT US AT
162 HOLLOWAY ROAD, LONDON, N.7
and hear this fabulous new Electronic Concert
Organ demonstrated.

STERN-CLYNE

GREAT BRITAIN'S GREATEST ELECTRONIC HOBBIES ORGANISATION

HERE'S WHY THOUSANDS OF
ELECTRONICS ENTHUSIASTS
BUY WITH CONFIDENCE
FROM STERN-CLYNE —

- A wide range of exclusive equipment available including our own speciality — MULLARD DESIGNS — for the home constructor or ready assembled.
- The finest selection of Hi-Fi and Audio equipment by all leading manufacturers.
- A comprehensive range of electronic components for the build it yourself enthusiast available at all branches.
- Retail shops, showrooms and demonstration rooms throughout London and the provinces all carry extensive stocks.
- Finest Mail Order Service—geared to give prompt and efficient attention.
- Hire Purchase facilities available on orders of £11 10. 0 and over.
- Hi-Fi advisory service to help you in choosing the right equipment.
- After sales service — complete satisfaction guaranteed.

VISIT YOUR NEAREST
STERN-CLYNE ELECTRONICS CENTRE

LONDON

18 Tottenham Court Rd., W.1. MUSEum 5929-0095. *Half Day Sat.*
23 Tottenham Court Rd., W.1. MUSEum 3451-2. *Half Day Thurs.*
309 Edgware Rd., W.2. PADDington 6963. *Half Day Thurs.*
109 Fleet St., E.C.4. FLEet St. 5812-3. *Half Day Sat.*
162 Holloway Road, N.7. NORTH 7941. *Half Day Thurs.*
9 Camberwell Church St., S.E.5. RODney 2875. *Half Day Thurs.*

BRISTOL

26 Merchant Street, Bristol 1. Bristol 20261.
Now open 6 days a week.

CROYDON

12 Suffolk House, George St. MUNICIPAL 3250. *Half Day Wed.*

LIVERPOOL

52 Lord Street, Liverpool. Royal 7450. *Open 6 days a week.*

MANCHESTER

20-22 Withy Grove, Manchester 4. BLAckfriars 5379-5246.
Open 6 days a week.

SHEFFIELD

125 The Moor, Sheffield. Sheffield 29993. *Half Day Thurs.*

MAIL ORDERS AND ENQUIRIES TO:

Dept. P.E., 3-5 Eden Grove, Holloway, London, N.7. NORTH 8161-5.

UNUSUAL SINGLE SPEAKER SYSTEM

A CONCRETE COLUMN

An inexpensive column speaker constructed from a concrete pipe and fitted with a good 8" or 10" unit, has attracted much interest and admiration because of its clean, open sound.

Complete kits of wooden fixtures are available, including absorbent wadding and diffusing cone.

Price **£3.15.0** for 8" model. Recommended 8" unit—Super 8/RS/DD **£6.14.2** including purchase tax. Price **£4.18.0** for 10" model. Recommended 10" units—Super 10/RS/DD **£10.18.8**; Golden 10/RS/DD **£7.17.5**; 10" Bronze/RS/DD **£4.12.9**. Prices include purchase tax.

Suitable concrete pipes can be purchased from builders' merchants at about 12/6 and 17/6.

Descriptive leaflet free on request from:



WHARFEDALE WIRELESS WORKS LTD.
Dept. E
IDLE, BRADFORD, YORKSHIRE
Grams: "Wharfedel" Bradford
Telephone: Bradford 612552/3

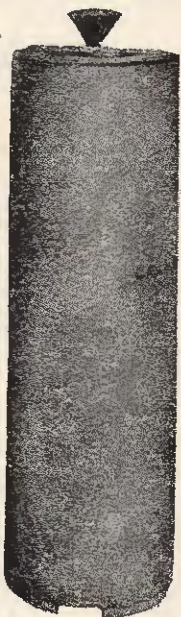

BARGAINS

for **C.C.T.V.**
Enthusiasts

ALL BRAND NEW!

A FURTHER PURCHASE
**E.M.I. 1" VIDICON
TUBES**



FOR ALL
C.C.T.V. VIDICON
CAMERAS

Excellent for all Industrial, Commercial, Entertainment, Experimental & Research applications

OUR PRICE ONLY **£8.10**
(USUALLY £15) P. & Ins. 16/-

'COSMICAR' 1" f/1.9 LENS

"Click" stop aperture to 1/22. C mount (16mm. cine fitting). Full focusing adjustment. Fully bloomed. Complete with lens cap
USUALLY **£23** **£9.19.6** P. & Ins. 5/6



HERE'S A BARGAIN — 3 ONLY

'CYCLOP' C.C.T.V. CAMERAS

Mk. III 405 line R.F.
Normally selling at £91.5
Genuine Buy at Only...

£43

not including
Vidicon Tube and Lens
(Available as above)

EXPECTED SHORTLY FROM JAPAN!

Semi-Professional 'VIDEO-TAPE RECORDER' AT A PRICE ALL CAN AFFORD! Details will be available shortly—Are You on Our Mailing List?

★ SPECIAL OFFER! 'CIRCUIT DIAGRAMS' of N.E.V. 'Icon' R.F. C.C.T.V. Transistor Cameras—only 24/- inc. p. & p.

HORNTONS ELECTRONICS LTD.

(Next to Pan American Airways)

145 GREAT CHARLES STREET, BIRMINGHAM 3

Tel. MID. 0972 or CEN. 6283

ERSIN

Multicore
SOLDER

SAVBIT ALLOY
*saves wear on
soldering iron bits*

The world-famous copper loaded alloy containing 5 cores of non-corrosive flux, that saves the soldering iron bit. Ersin Multicore Solder is also available in high tin quality alloys. 60/40. in 22 s.w.g. for printed circuits, transistors, etc.

SAVBIT SIZE 1 CARTON

Contains approximately 30 feet of 18 s.w.g. SAVBIT. It is also supplied in 14 s.w.g. and 16 s.w.g. Obtainable from radio and electrical stores.

5/- each



THE HANDY DISPENSER



Easy to find in the tool box—simple to use. Virtually a third hand for tricky soldering jobs. 12 feet 5 core 18 s.w.g. ERSIN MULTICORE SAVBIT alloy in a continuous coil used direct from free-standing dispenser.
2/6 each

BIB WIRE STRIPPER
AND CUTTER

Strips insulation without nicking wire, cuts wire cleanly, adjustable to most thicknesses. Splits extruded plastic twin flex.
3/6 each



MULTICORE SOLDERS LTD.

MULTICORE WORKS • HEMEL HEMPSTEAD • HERTS • HEMEL HEMPSTEAD 3636

GUITAR AMPLIFIERS WITH TREMOLO

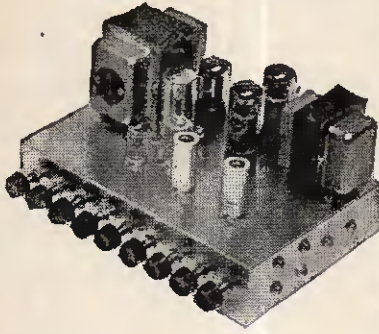

Five jack socket inputs, four with separate mixing volume controls, and one input "straight through". All inputs are of very high sensitivity only 10 millivolts input is required for full output, making them suitable for all types of guitars and microphones. Separate Bass and Treble controls, giving a wide range of lift and out. Separate master gain control. Tremolo speed and depth controls. Jack socket for remote tremolo switching.

Outputs for 3 and 15 ohms speakers. Valves used in the 30 watt and 50 watt amplifier ECC83, ECC83, EL34, EL34, GZ34. In the 15 watt amplifier ECC83, ECC83, EL34, EL34, E781. An extra valve ECC83 is used in the tremolo circuit. The chassis is complete with baseplate and is solidly made of 18 gauge steel, finished silver grey hammer. Size 12 x 8 x 6 1/2 inches high.

PRICES—	
50 watt with tremolo	£20.10.0
50 watt less tremolo	£19.10.0
30 watt with tremolo	£15.10.0
30 watt less tremolo	£14.10.0
15 watt with tremolo	£12.10.0
15 watt less tremolo	£11.10.0

Add carriage 10/- any amplifier. Send S.A.E. for free descriptive leaflet.

CREDIT TERMS ARRANGED

EXPORT ENQUIRIES INVITED

STROUD AUDIO

CASHES GREEN ROAD, STROUD, GLOS.



D.I.Y. with GOODMAN'S HIGH FIDELITY MANUAL

A new, larger and more colourful edition—revised and completely up-to-date. It contains articles of particular interest to the D.I.Y. enthusiast—including special beginners page, advice on stereo, stage-built systems and full cabinet drawings. Whether building or improving your own audio set-up or choosing a complete speaker system, you'll find it useful and interesting as well as informative. Ask your Goodman's dealer or send coupon for your FREE copy.

Please send me a free copy of the Goodman's High Fidelity Manual

Name _____

Address _____

P.E.9

GOODMANS

GOODMANS INDUSTRIES LIMITED
Axiom Works, Wembley, Middlesex
Telephone: WEMBLEY 1200
A Member of the Rentaset Group

BRAND NEW AM/FM (V.H.F.) RADIO GRAM CHASSIS AT £13.13.0 (Carriage Paid)

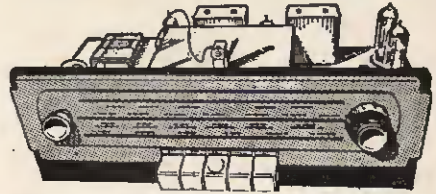

Chassis size 16 x 6 1/2 x 5 1/2 in. high. New manufacture. Dial 1 1/2 x 4 in. in 2 colours, predominantly cream. 200-250v. A.C. only. Pick-up, Ext. Speaker, As., E., and Dipole Sockets. Five pushbuttons—OFF, L.W., M.W., F.M., and Gram. Aligned and tested O.P. Transformer. Tone control 1000-1900 Mc.; 200-650 Mc.; 88-98 Mc/s. Valves E220 rect.; ECC83, EF89, EAF200, EL84, ECC85, 3-ohm speaker required. 10 x 6 in. ELLIPTICAL SPEAKER 2 1/2" to purchasers of this chassis. **TERMS:** (Chassis) £3.10.0 down and 6 monthly payments of £2.4.0. Cheap Room Dipole for V.H.F., 12/6. Feeder 6d. per yard. **ALTERNATIVE DESIGN.** L.W. 1000-1900 Mc.; S.W. (9-15 Mc/s); M.W. 190-370 Mc.; V.H.F. 87-100 Mc/s.; Gram position. Otherwise similar to above chassis. Price £15.15.0 (curr. paid). **TERMS:** £3.10.0 down and 6 monthly payments of £2.4.0. Total H.P. price £16.14.0. Circuit diagram 2/6.

2-VALVE GRAMOPHONE AMPLIFIER

Price 37/6 (P. & P. 2/6)

Overall size 4" wide x 5" high x 2 1/2". Volume and tone controls. Mains lead. Screened lead input. With output transformer for 3-ohm. For series connection to Garrard and B.B.R. Autochangers and Players, having 90v. tapping. Can also be supplied on fabric covered board with mains transformer and 6" x 4" speaker at 55/-. (P. & P. 5/-).

BATTERY ELIMINATOR

For 4 low consumption valves (96 range) 90v. 16mA and 1.4v. 126mA, 42/6. (4/- post), 200-250v. A.C. Also for 200 mA, 1.4v. and 90v. 15 mA at same price. Two units to replace existing batteries.

SELF-POWERED V.H.F. TUNER CHASSIS.

Covering 88-95 Mc/s. Mullard permeability tuner. Dims. 8 x 6 x 6 in. high. Valves ECC85 and 2-EP89's plus 2 diodes with E220 rectifier. Mains transformer. Fully wired and tested ONLY £3.17.8 (curr. paid). Room dipole 12/6. Feeder 6d. per yard.

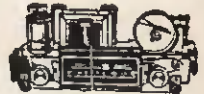

HIGH GAIN PUSH-PULL OUTPUT AMPLIFIER £5.4.6 (6/- post).

Valves E220, ECC83 and 2-EG132 giving 8 watts. Chassis 12 x 8 1/2 x 3 1/2 in. With O.P. Trans. for 3 and 16-ohm speaker. Isolated chassis. Bass and treble out. Mike, guitar, radio and crystal pick-up input. Facilities for mixing mike and radio, etc. Front panel fixed. Also available as straight 10-watt amplifier with bass, treble and volume controls at £5.5.0. (6/- post). Front panel may be removed on this amp.



4 TRANSISTOR MINIATURE PUSH-PULL AUDIO AMPLIFIER HIGH IMPEDANCE

PRINTED CIRCUIT, 4 in. x 2 1/2 in. x 1 1/2 in. over transformers. Output for 3-ohm speaker. Suitable for microphone, record player and intercom. 9 volt battery required. Frequency range 100 cps. to 25 Kcps. Push-pull output class B. Instruction sheet provided. Fully wired ready for use. Three types, 200mW 25/-; 500mW 41/-; 1.2W 57/6. (P. & P. 2/6 each).

CM21 CRYSTAL MICROPHONE

With 3.5 mm. Jack plug, 12/6 (Post 1/6.)

4 TRANSISTOR BARY ALARM. Attractive walnut veneer speaker cabinet 13 1/2" x 8" front. Ear piece as mike sensitive at 20ft. x 60ft. Ext. Lead. (P.P. 6 battery required)—will last for hundreds of hours. Volume Control and On/Off. Price £3.18.6. (P. & P. 5/-).

GLADSTONE RADIO

66 ELMS ROAD, ALDRSHOT, Hants.

(2 mins. from Station and Buses.)

Aldershot 22240

CLOSED WEDNESDAY AFTERNOON

CATALOGUE 6d.

Regret overseas orders cannot be executed

in step with the

SINCLAIR X-20

In kit form or ready built

**20 WATT R.M.S. INTEGRATED PULSE
WIDTH MODULATED AMPLIFIER AND
PRE-AMP — SIZE 8 $\frac{1}{4}$ " x 3 $\frac{1}{4}$ " x 1"**

By the use of Pulse Width Modulation in circuitry developed exclusively by Sinclair Radionics, the unique X-20 achieves standards never before reached by any audio amplifier in the world. From the input of the integrated pre-amp through to the power output stage, this amazing amplifier gives quality and power far ahead of anything in its class to make it the most original and interesting design in years. You use your X-20 like any conventional quality amplifier, but it occupies far less space, costs less, behaves perfectly and brings a refreshingly new approach to audio that is setting the standard for the whole industry.

AN X-20 USER WRITES

"Please send me another X-20 amplifier. I received one last week and it works very well." (Signed) J. B., Ellesmere.

ONLY THE SINCLAIR X-20 GIVES YOU THESE FEATURES

- ★ Easily built in an evening
 - ★ No. of transistors—12
 - ★ Silicon epitaxial planar output transistors
 - ★ Response—20 to 20,000 c/s \pm 1dB
 - ★ Total harmonic distortion at 10 watts R.M.S.—0.1%
 - ★ Input sensitivity—1 mV into 5-K ohms
 - ★ Signal-to-noise ratio—better than 70dB
 - ★ 20 WATTS R.M.S. MUSIC POWER OR 15 WATTS R.M.S. CONTINUOUS INTO 7.5 OHMS
 - ★ 15 WATTS R.M.S. MUSIC POWER OR 12 WATTS R.M.S. CONTINUOUS INTO 15 OHMS
 - ★ For any available pick-up, microphone, radio tuner, tape pre-amp, etc.
 - ★ Ideal for guitar or other forms of P.A.
 - ★ Widely tolerant of the load at the output
 - ★ Power required—36 V dc at 700 mA
 - ★ 95% ENERGY CONVERSION FACTOR AT OUTPUT
 - ★ SUPERB QUALITY AND RELIABILITY
 - ★ The simplest ever system of installation for mono or stereo
 - ★ Connect the tone and control system of your choice
- QUALITY AND POWER FOR SUCH VERY SMALL OUTLAY**

Complete kit of parts including transistors and X-20 manual in sealed carton

£1-19-6

Built and tested with X-20 manual in sealed carton **£9-19-6**

X-20 Power Pack sufficient to drive two X-20's **£4-19-6**

THE X-20 MANUAL gives full details of tone and volume control systems for adding to your X-20 according to the equipment to be used with it. Includes circuits for STEREO, INPUT SWITCHING, STEREO BALANCE, etc. **FREE WITH EVERY X-20.** Available separately—2/- post free.

FULL SERVICE FACILITIES AVAILABLE TO ALL SINCLAIR CUSTOMERS

SINCLAIR RADIONICS LTD., COMBERTON, CAMBRIDGE

Telephone
COMBERTON
688

SPACE AGE!

SINCLAIR

P.W.M. AMPLIFIERS
MICRO-RECEIVERS
MICRO-DESIGNS

THE SMALLEST SET ON EARTH!

$1\frac{4}{5}'' \times 1\frac{3}{10}'' \times \frac{1}{2}''$

Weighs under 1 oz.

Fantastic power
and range

Plays in cars, trains,
buses and difficult
areas

**SINCLAIR
MICRO-6
6-STAGE RECEIVER**

Build it in an evening!

No transistor set has ever yet compared with the Micro-6 for size, power, performance and design. Thousands upon thousands have been built by enthusiasts from electronic engineers to beginners in transistor construction and are now in use throughout the world. Everything except the lightweight earpiece is contained within the smart minute white gold and black case. With batteries and self-contained aerial, the Micro-6 weighs under one ounce! Unique features which make such wonderful performance possible include bandspread over the higher frequency end of the medium waveband for easy reception of Luxembourg, powerful A.G.C. to counteract fading of distant stations, and vernier type tuning. Quality of reproduction is outstandingly good, so that you derive real pleasure from using this fantastic set. Order your Micro-6 now and prove for yourself why it cannot be too highly recommended as an intriguing design to build and a most practical radio to use. You can build it in an evening and when you have built your first, be certain others are going to want one too, when they see and hear the Micro-6.

All parts including M.A.T.s, case, dial, lightweight earpiece and beautifully detailed easy-to-follow instructions come to MALLORY MERCURY CELL Type ZM.312 (2 required) each 1/11. Pack of 6 10/6

"Transista" Black nylon strap for wearing Micro-6 on your wrist 7/6

59/6

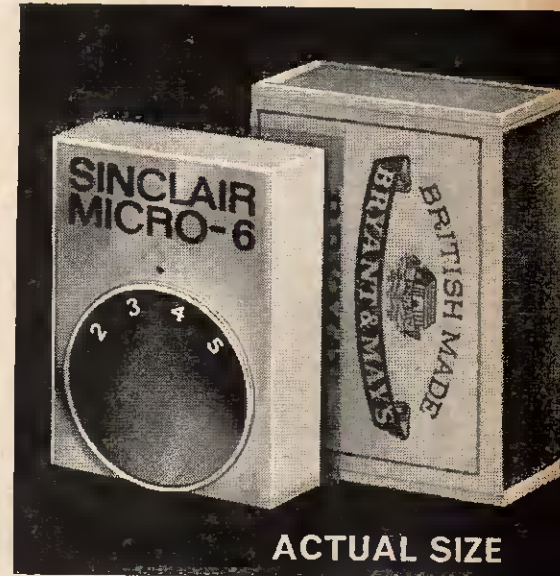

ACTUAL SIZE

Amazing circuitry

In the Micro-6, a six stage circuit using 3 special Micro-alloy transistors (Sinclair M.A.T.s) provides two stages of R.F. amplification, double diode detector and high gain 3-stage A.F. amplifier plus A.G.C. and bandspread over the higher frequency end of the tuning to bring in Luxembourg like a local station. Inserting the plug of the earpiece switches the Micro-6 ON; withdrawing switches it OFF. Tuning is by vernier-type dial over the medium wave band. Two self-contained batteries give about 70 hours working life.

**A POWERFUL AMPLIFIER
FOR YOUR MICRO-6**

TR750

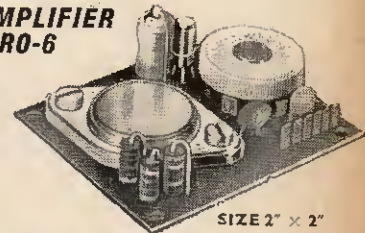

SIZE 2" x 2"

This highly original Sinclair amplifier makes a powerful car, portable or domestic loud-speaker radio used with the Micro-6. Can also be used for record reproduction, baby alarm, intercom, etc. 750 milliwatts output for feeding into a standard 25-30Ω 1/speaker. Input, 10mV. Response, 30-20,000 c/s ± 1dB. With built-in switch and volume control. For 9V d.c. operation.

Parts and instructions **39/6** Ready built and tested **45/-**

SINCLAIR MICRO-INJECTOR

Simple to build and use for fault tracing. Ready built **32/6** Set of parts **27/6**

SINCLAIR X-10 P.W.M. AMPLIFIER AND PRE-AMP

Recommended for use where a less powerful amplifier than the X-20 is required. The X-10 offers similar advantages of quality, compactness and price, and it can be battery operated if desired. Tone control system added to choice. For 12.15 volt operation. **FREE X-10 Manual** with every amplifier.

Complete kit and instructions **£5. 19. 6**

Ready built and tested **£6. 19. 6**

X-10 power supply unit **£2. 14. 0**

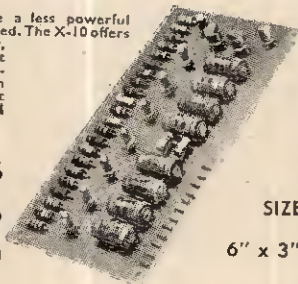

SIZE

6" x 3"

ANOTHER SINCLAIR SPECIAL

MICRO AMPLIFIER

Smaller than a 3d. piece!

Frequency response — 30-50,000 c/s ± 1dB; gain — 60dB (1,000,000 times).

The instructions supplied with the set of parts, show how to use this amazing design in many ways including an A.F. amplifier, broadband R.F. amplifier, in a F.M. transmitter, etc., etc. Ideal for modellers and experimenters. Easy to build.

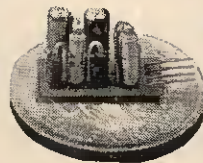

28/-

GUARANTEE ORDER FORM

Please send me

NAME.....

ADDRESS.....

For which I enclose Cash/Cheque/Money Order value

£.....s.....d.

Guarantee

Should you not be completely satisfied with your purchase when you receive it from us, your money will be refunded in full and at once without question. It is important to quote Pr.E 9 should you prefer to write your order instead of cutting out this coupon.

Famous British P.V.O. Recording Tapes

7in. L.P. 1,800ft. 19/6 7in. D.P. 2,400ft. 29/6
 5 1/2in. L.P. 1,200ft. 14/6 5 1/2in. D.P. 1,800ft. 24/6
 5in. L.P. 900ft. 11/6 5in. D.P. 1,200ft. 18/6

FULL WAVE BRIDGE SELENIUM RECTIFIERS:

2, 6 or 12 v. outputs, 1 1/2 amp., 8/0; 2 a. 11/3; 4 a., 17/6.

CHARGER TRANSFORMERS. Tapped input 200/250 v. for charging at 2, 6 or 12 v., 1 1/2 amp., 15/6; 2 amps., 17/6; 4 amp., 22/6. Circuit included. Amp meter 5 amp. 17/6.

MOVING COIL MULTIMETER TK20A. 0-1,000 v. A.C./D.C. ohms. 0 to 100 K., 0-150 mA. Pocket size 2in. scale, 49/6.

EP10K (10K Ω per v.) 1,000 v., 300 K., 250 mA. 79/6

NEW MULLARD TRANSISTORS

OC71 6/-; OC72 7/6; OC81D 7/6; OC81 7/1; AP115 10/6; AP114 11/-; OC24 3/-; OC45 8/-; OC171 9/-; OC170 8/6; AP17 9/6. OC28 12/6; Transistor Holders 1/3. Sub Miniature Condensers. 0.1 mFd., 30 v. 1/3; 1, 2, 4, 5, 8, 16, 25, 30, 50, 100 mFd., 15 volt 2/6. Diode OA81 3/6.

VALVE HOLDERS. EA50 6d. MOULDED Int. Oct. 6d. Mazda Oct. 6d.; B70, B8A, B86, B9A, 9d.; B76 with can 1/3. B9A with can 1/9. Ceramic Oct. EF50, B76, B9A, 1/-; Valve base plugs B70, B9A, Int. Oct., 2/3.

1965 RADIOGRAM CHASSIS

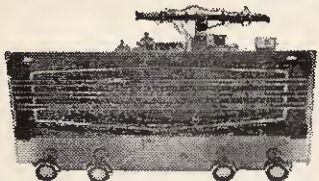

Three Wavebands Five Valves: ECH81, Long, Med., Short. EF80, EB931, EL83, E220, 12-month guarantee, A.C. 200-250 v. Ferrite Aerial A.V.C. Negative Feedback. 5 watts 3 ohm. Chassis 13 1/2in. x 7in. high x 5in. deep. Glass dial size 1 1/2in. x 4in. horizontal winding. Two Pilot Lamps. Four Knobs. Aligned calibrated. Chassis isolated from mains.

BRAND NEW £9.15.6

Carr. 4/8.

ARMSTRONG 'GRAM CHASSIS V.H.F. MODEL 127M. MED. and F.M. 226.10, Stereo 237.10.

GRAM AMPLIFIERS

Valves: UY85 Rectifier and UCL82 Triode/Pentode 3 1/2 watts output. Size (inc. valves) 5 x 5 1/2 x 2in. deep. New and Tested complete 3 ohm output tone and volume. **ONLY 37/6 P. & P. 2/6** on/off controls.

Ready for use 200-250 v. A.C.

BARGAIN XTAL PICK-UP ARM

Complete with ACOS LP-78 Turnover Head 20/- Stereo 30/-

TRANSISTOR MAINS ELIMINATORS 29/6

PP1-6 volt. PP9-9 volt. (All same sizes as batteries) **DOUBLES 42/6. PP1+PP1, PP9+PP9, PP11-41+41.**

WEYRAD P50 - Transistor Coils

EA9W 8 in. Ferrite Aerial with car aerial coil.....12/6
 Oct. P50/IAC.....5/4
 1st and 2nd I.F. P50/2CC 470 kcs.....each 5/7
 3rd I.F. P50/3CC.....6/-

Volume Controls

Long spindles. Midget Size 5 K. ohms to 2 Meg. LOG or LIN. 1/8 3/4. D.P. 4/6; Stereo L/S 10/6, D.P. 14/6. Linear or Log Tracks.

80 Ohm Coax

Semi-air spaced 6d. yd. 40 yd. 17/6, 80 yd. 25/-; Low loss 5d/8. per 100ft. at 800 mc/s. Ideal 625 lines 1/8 yd.

COAXIAL PLUG 1/2. PANEL SOCKETS 1/2. LINE SOCKETS 2/2. OUTLET BOXES, SURFACE OR FLUSH 4/-; BALANCED TWIN FEEDERS 6d. yd. 80 or 300 ohms. TWIN SCREENED FEEDER 1/- yd. 80 ohms. TELESCOPIC CHROME AERIALS. 12in. extends to 33in. 6/6 each. CAR AERIAL PLUGS 1/6. Sockets 1/3.

THE "INSTANT" BULK TAPE ERASER AND RECORDING HEAD DEMAGNETIZER, 200/250 v. A.C. 35/-

GARRARD Auto Slim changers £6.10.
 GARRARD AT5 Auto changers £8.10.
 GARRARD AT4 Auto changers £10.10.

C.R.T. BOOSTER TRANSFORMERS

for heater cathode short circuit or tubes with failing emission. Full instructions supplied, mains input. Optional 25% and 50% boost 2v. or 6.3v. or 12.6v. State voltage required. **PRICE 15/6**

BOOKS (Please Add Postage)

"W.W." Radio Valve Data	7/6
High Fidelity Speaker Enclosures	5/-
Transistor Communication Sets	6/-
TV Fault Finding	6/-
Mullard Audio Amplifier Manual	8/6
Radio Valve Guide, Books 1, 2, 3, 4 or 5	3/6
Practical Radio Inside Out	3/6
Transistor Audio Amplifier Manual	6/-
Shortwave Transistor Receivers	5/-
International Radio Stations List	2/6
Modern Transistor Circuits, Beginners... ..	7/6
Sub-Miniature Transistor Receivers	5/-
How to Receive Foreign T.V.	5/-

JACKS. Lead 6/-, Std. open-circuit 2/6, closed-circuit 4/6. Grundig type 3-pin 1/3; Grundig Lead Type 3/8.

Phono Plugs 1/2. Socket 1/2. Banana Plugs 1/2. Sockets 1/2. JACK PLUGS STANDARD. Screened 3/6. Grundig 3-pin 3/8.

BULGIN NON-REV PLUGS and SOCKETS. P74 2-pin 4/3; P73 3-pin 4/6; P194 8-pin 6/6; 2488 8-pin 12/6; P300 4/-.

RESISTORS. Preferred values, 10 ohms to 10 meg. 1 w. 1 w., 1 w., 20% 4d.; 1 w. 8d.; 2 w. 1/-; 1 w. 10% 6d. HIGH STABILITY. 1 w. 1% 2/-. Preferred values, 10 ohms to 10 meg. Ditto 5%, 10 ohms to 22 meg., 8d.

6 watt } 0.5 to 8.2 ohm 3 w. 1/6
 10 watt } WIRE-WOUND RESISTORS 1/8
 15 watt } 10 ohms to 6,875 ohm 2/-

10K, 15K, 20K, 25K, 10W MAINS DROPPERS. Midgast. With sliders. 0.3 a., 1K., 0.2 a., 1.2 K., 0.15 a., 1.5 K., 0.1 a., 2 K., 6/- each.

LINE CORD 100 ohms It. 3-way 1/2. WIRE-WOUND 4-WATT WATT Pre-set Min. T.V. STANDARD SIZE POTS

T.V. All values 10 ohms LONG SPINDLE VALUES to 25 K. 3/- ea.; 30 K. 4/-; 50 OHMS to 50 K. 6/6; Carbon 30 K. to 2 meg., 3/-; 100 K. 7/6.

SPEAKER-FRET. Tygan various colours, 52in. wide from 10/- to 28in. wide from 6/- to 11. Samples, large, S.A.E.

EXPANDED METAL. Gold 12 x 12in. 6/-. ARDENNE TRANSISTOR TRANSFORMERS

D3085, 7.3 CT. 1 Push Pull to 3 ohms for OC72, OC81 .. 11/-
 D3084, 1.75 : 1 CT. Push Pull Driver for OC72, OC81 .. 11/-
 D3088, 11.5 : 1 Output to 3 ohms for OC72, OC81 .. 11/-

D238, 4.5 : 1 Driver; D240, 8.5 : 1 Driver ea. 11/6
 ARDENNE TRANSISTOR POT. 6 K. switched YC1545 6/3

Anti-Parasitic beads (various) dot. 3/8. BLANK ALUMINIUM CHASSIS. 18 a.w.g. 4 sides, riveted corners, lattice sizing holes, 2 1/2in. sides, 7 x 4in., 6/6; 9 x 7in., 6/6; 11 x 3in. 6/6; 11 x 7in. 7/6; 13 x 9in. 8/6; 14 x 11in. 12/6; 15 x 14in., 15/-.

ALUMINIUM PANELS 18 a.w.g. 12 x 12in. 5/6; 14 x 9in. 4/6; 12 x 8in. 8/6; 10 x 7in. 2/9; 8 x 6in. 2/-; 8 x 4in. 1/6.

B.T.H. TAPE MOTORS 115 v. A.C. 28 w. 12/6 pair, for 200/250 v. (in series)
 COLLARO TAPE HEADS 35/- pair

RETURN OF POST DESPATCH Post 1/6, List 1/-, C.O.D. 2/6 extra. (Export. Send remittance and extra postage, no C.O.D.) CALLERS WELCOME

RADIO COMPONENT SPECIALISTS

337 WHITEHORSE ROAD, Telephone THO 1665
 WEST CROYDON

The

SUPER 6
 LONG & MEDIUM WAVE
 TRANSISTOR RADIO

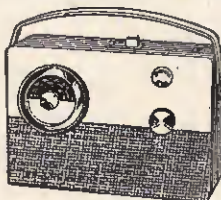

A quality radio available as a kit or ready built. The sparkling performance and superb finish of the completed receiver give you value equivalent to a £12. 12. 0 commercial model.

- ★ All new parts. ★ 6 transistors and diode. ★ 350mW output.
- ★ Superhet circuit, Ferrite rod aerial. ★ Weymouth Radio printed circuit board. ★ Component positions and references printed on back of board. ★ Nicely styled wooden cabinet, 11 x 7 1/2 x 3 1/2 in.
- ★ Vinyl covered in various colours. ★ 6 x 4in. speaker giving good bass and treble response. ★ Full instruction booklet 2/-. Free with kit. ★ I.F. frequency 470 kc/s. ★ Lining up service if required. ★ All parts supplied separately. Write for list, S.A.E. please. ★ 9v. battery required, VT9 or P.P.9. (3/9 with kit).

COMPLETE KIT ONLY

PLUS 5/- POST

£4.17.6

OR FULLY BUILT £6.17.6 Tax & Carr. Paid

V.H.F. Pre-amplifier with high signal-noise ratio and gain of at least 3:1 under average fringe area conditions. Metal container 3 1/2 x 3 1/2 x 1 1/2 in. high, with strap for eaves, loft or skirting fixing. 9 volt battery operated, using transistor AF114. Covers all British and some Continental stations. 88 to 108-M/cs. Order with confidence of improved reception.

29/6 (2/16 p. & p.)

ELECTRONICS (Camberley) LTD.

15 VICTORIA AVENUE, CAMBERLEY, SURREY
 Post Orders Only Please

The foremost name
 in microphones and sound
 accessories

LUSTRAPHONE

The many Public Authority and Service users of Lustraphone equipment appreciate the quality and reliability resulting from our extensive experience as specialists in the design and manufacture of microphones and associated equipment.

Microphones for all purposes incorporating the newest techniques • portable P/A systems for indoor and outdoor use • noise cancelling intercom systems • audio equipment accessories and components.

LUSTRAPHONE LIMITED

St. George's Works
 Regents Park Road • London, N.W.1
 PR1mrose 8844

Here's time-saving data to earn money for you!



**NEARLY 1,200
CIRCUITS!**



**HUNDREDS OF
DIAGRAMS!**

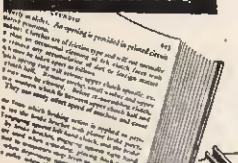

**PACKED WITH
REPAIR HINTS!**

Given with every set
Newnes TV ENGINEERS POCKET BOOK
(Value 12/6)

An invaluable companion to your set for on-the-spot repairs. 272 pages of reference data on installing, fault-tracing and repairing, servicing equipment, etc.

PROVE IT BY EXAMINING NEWNES RADIO & TV SERVICING — FREE

See for yourself the wealth of time-saving and money-making information contained in Newnes RADIO & TV SERVICING. Produced by a team of expert technicians this 12th Edition provides all the CIRCUITS—DIAGRAMS—AND REPAIR DATA you need for servicing nearly 2,300 [models—television, radio, car radios, tape recorders, and radiograms. Complete in six sturdily-bound volumes it is essential equipment that will repay you over and over again. Nearly 60,000 sets of previous editions have been sold... solid proof of its importance to you—the engineer in Radio and TV. Use this new edition for a week free.

**3,500 PAGES OF DATA FOR NEARLY
2,300 Models!**

TELEVISION • RADIO • RADIOGRAMS • TAPE
RECORDERS • RECORD REPRODUCERS • CAR RADIOS

Data for over 90 makes,

Acc, Aerodyne, Ajax, Alba, Argosy, Baird, Beethoven, Berec, B.R.C., B.S.R., Bush, Capitol, Champion, Channel, Collaro, Cossor, Cydon, Dansette, Decca, Defiant, Doric, Dynatron, E.A.R., Eddystone, Ekco, Elizabethan, Elpico, E.M.I., Emerson, Emisonic, Emuig, Ever Ready, Ferguson, Ferranti, Fidelity, Ford Motor Co., Garrard, G.B.E., G.E.C., Gramdeck, Grundig, H.M.V., Invicta, K-B., Magnavox, Marconiphone, Masteradio, McMichael, Motorola, Murphy, National, Neomatic, Pageant, Pam, Perdio, Peto Scott, Philco, Philips, Pilot, Playmate, Portadyne, Portogram, Pye, Pye Telecommunications, Radiomobile, Raymond, Recording Devices, Rediffusion, Regentone, Retra, Revelation, R.G.D., Roberts' Radio, Sobell, Sonolor, Sony, Sound, Spencer-West, Standard, Stella, Stereosound, Stuzzi, Thorn, Trans Arena, U.K.W., Ultra, Vidor, Volmar, Walter, Waltham-Standard, Zenith.

Post coupon Now for
FREE TRIAL

EASY NO-INTEREST TERMS IF KEPT AFTER FREE TRIAL

To: George Newnes Ltd., 15-17 Long Acre, London, W.C.2

Please send Newnes RADIO & TELEVISION SERVICING and TV ENGINEERS POCKET BOOK without obligation to buy. If you accept this application I will post 16/- deposit 8 days after receipt of books, then 20/- monthly for 16 months, paying £16.16s. in all—or return the books. Cash in 8 days £16.16s.

If under 21 your father must fill up coupon

Full Name..... (BLOCK LETTERS) (Mr., Mrs., Miss) Tick where applicable

Address..... The address on left is

Occupation..... My Property

Signature..... Rented unfurnished

(Mr., Mrs., Miss) Parents' Home

(RV)41/1378 Furnished Accom.

Temporary Address



THINKING TAPE? THINK Brenell

If you're thinking in terms of tape recording, then the Brenell deck and complete recorders should be uppermost in your mind. The reliability, the versatility and the quality of manufacture are seldom equalled in other tape recorders (even in those costing much more).



How many can equal or better this specification?

4 record/playback speeds 1 7/8, 3 3/4, 7 1/2 and 15 ips • 3 motors (capstan motor-hysteresis synchronous) • low 'wow and flutter' content (0.05% at 15 ips, 0.1% at 7 1/2 ips, 0.15% at 3 3/4 ips and 0.25% at 1 7/8 ips) • double-gapped ferrite erase head to minimise erase noise • narrow-gapped record/playback head to give extended frequency response • pause control • superimpose control • 8 1/2" dia. reels (to take 10 1/2" dia. N.A.B. reels at extra cost) • fast rewind • digital rev. counter.

Mark 5
Series 3
Deck

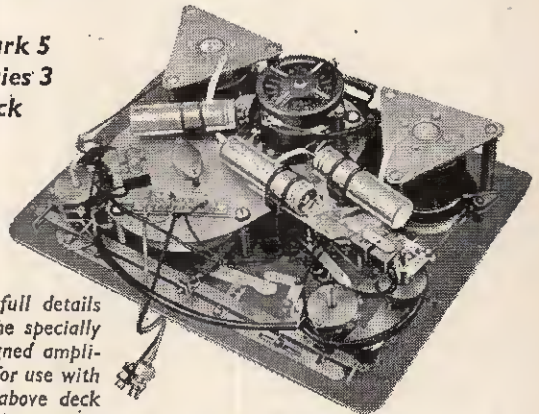

For full details of the specially designed amplifier for use with the above deck and the range of mono and stereo recorders, write or telephone the sole manufacturers:



BRENELL ENGINEERING CO. LTD.
231-5 LIVERPOOL ROAD, LONDON, N.1
Telephone: NORTH 8271 (5 lines)

EXCEL

in

ELECTRONICS

Through this ICS 3-way Training Method:

MASTER THE THEORETICAL SIDE

1 From basic principles to advanced applications, you'll learn the theory of electronic engineering, quickly and easily through ICS. That's because each course is set out in easy-to-understand terms.

MASTER THE PRACTICAL SIDE

2 ICS show you how to develop your practical abilities in electronic engineering—alongside your theoretical studies. It's the only sure way to success. All training manuals are packed with easy-to-follow illustrations.

MASTER THE MATHEMATICAL SIDE

3 To many this aspect is a bitter problem. Even more so because no electronic engineer is complete without a sound working knowledge of maths. But new ICS teaching makes mathematics easier to learn.

Wide range of courses available include:

Radio/T.V. Engineering and Servicing, Colour Television, Electronics, Electronics Maintenance, Instrumentation and Servomechanisms, Telemetry, Computers, etc.
NEW! Programmed Course on Electronic Fundamentals

EXPERT COACHING FOR:

INSTITUTION OF ELECTRONIC AND RADIO ENGINEERS
CITY AND GUILDS TELECOMMUNICATION TECHNICIANS
CITY AND GUILDS SUPPLEMENTARY STUDIES
R.T.E.B. RADIO/T.V. SERVICING CERTIFICATE
RADIO AMATEURS' EXAMINATION
P.M.G. CERTIFICATES IN RADIOTELEGRAPHY

And there are practical "learn as you build" radio courses as well.

Member of the Association of British Correspondence Colleges.

FOR FREE HANDBOOK POST THIS COUPON TODAY

I.C.S., Dept. 151, INTERTEXT HOUSE,
PARKGATE ROAD, LONDON, S.W.11

NAME

ADDRESS

OCCUPATION

AGE 9.65

INTERNATIONAL CORRESPONDENCE SCHOOLS

Construct Electronics with New VEROBOARD

Quickly, Cheaply, Professionally

VEROBOARDS supplied by Proops Brothers Limited have been specially designed to meet the needs of the amateur constructor; hole matrices have been pitched to provide the greatest utility in a wide variety of circuit layouts; purchase price has been kept low by the deliberate selection of one standard board width (22 way) which may be used with almost any circuit but permits large quantity purchase with attendant saving; specially prepared design sheets are provided with each purchase, to simplify circuit layout; accessories have been kept to an essential minimum to further reduce cost.

VEROBOARD SHEETS. 12/6 each. Post Free.
Board size overall: 17 in. long × 3½ in. wide 0.0312 in. thick. Each is clad with 22 × 0.0015 in. thick copper conductors which are fully pierced in line at 0.156 in. intervals across width and 0.2 in. along length. Boards are treated with flux preservative to give protection and ensure satisfactory soldering. A design sheet is supplied with each board.

SPOT FACE CUTTER. 8/6. Post Free.
Specially designed hand cutting tool with hole locating spigot. Light turning and pressure removes copper conducting strip locally to make a neat break.

TERMINAL PINS. 50 for 3/6. Post Free.
Made specially for Veroboards of pre-tinned brass with a flat head to give maximum contact, and self-cutting serrations near the head to ensure a tight fit when pushed into the hole.

INTRODUCTORY VEROBOARD KIT. 24/- Post Free.
Includes one sheet of Veroboard, Design Sheet, Spot Face Cutter, 50 Terminal Pins, and instruction on design method and layout procedure.

Make simple
AUTOMATIC CONTROLS
with
CADMIUM SULPHIDE PHOTO-CELLS

New, inexpensive photo-conductive cells act as light sensitive resistors that increase conductivity with increased light. 1,000 times more sensitive than selenium cells with greater reliability, and can easily be built into a wide range of simple circuits. Typical uses include: automatic light controls, exposure meters and many other devices. Requires simple low power source from battery or mains transformer. Two types available: Type 1: Max voltage 200 v. Output 0.5 watt. Sens. range 400-800 mu. 10/- post free. Type 2: Max. voltage 150 v. Output 0.15 watt. 8/6d. post free. Both types have a resistance range of 5 megohms at zero to 500 ohms at 1,000 lux. Sensitive range is 400-800 mu. Supplied with specification, instructions and typical circuits.

Make a wonderful range of inexpensive devices

with DRY REED SWITCHES

Can be actuated by permanent or electromagnets to provide excellent basis for a wide range of inexpensive devices such as burglar alarms, limit switches, door bell switches, etc. Tremendous reliability factors and a working life of about 100 times that of microswitches and the uses to which they can be put is limited only by imagination. Each switch supplied complete with specification, instructions and ideas information. **SUITABLE MAGNETS 1/- extra.**
REED SWITCH COILS 4/- post free
Specially manufactured to provide electro-magnetic operation of Dry Reed Switch described above. Coil is simply pushed on to glass tube and centrally located over switch contacts. Works from any 4-12 v. D.C. supply. Size overall ½ in. diam. × ½ in. long.

CHANGEVER REED SWITCH. 12/6 Post Free.
Similar in construction to types listed above except that the reed is spring-loaded against one contact until actuated by a field from a permanent or electromagnet to transfer connection to a second contact. Glass size: 1.975 in. long × 0.201 in. dia. Breakdown voltage 350 volts DC minimum. Contact rating for long life 250 mA at 250 volts AC. Ampere turns to Just Operate 70-120. Release 30-70.

STANDARD SOLENOIDS

Specially made, high-grade Solenoids in four basic frame sizes and for 12v. DC or 240v. AC, pull or push operation. State requirements.
Type 1: Max. pull 9oz., 1¼" to 2". Size 2" long. Bolt diam. ⅜". 12/6. P. & P. 1/-
Type 2: Max. pull 18oz. Stroke ½" to 1". Size 2 ½" long. Bolt diam. ⅜". 14/6. P. & P. 1/-
Type 3: Max. pull 26oz. Stroke 1" to 2". Size 2 ½" long (bolt in) × 1 ½" wide × 1 ½" high. Bolt diam. ½". 27/6.
Type 4: Max. pull 26 oz. Stroke 1" to 1 ½". Size 3 ½" long (bolt in) × 1 ½" wide × 1 ½" high. Bolt diam. ½". 32/6. P. & P. 1/6.
SEND FOR SOLENOID LIST.

MINIATURE MERCURY SWITCH

2
1/6
for
Post free

Almost indestructible Featherlight operation
Encapsulated in copper-plated steel tube only ⅜" diam. × ½" long (incl. flange). Tube provides one contact and other contact is ½" long wire fused into glass centre of tube base. 20° movement makes or breaks contact; vacuum sealing ensures unchanged contact resistance throughout life. Can be simply clipped into position. Rating 240v. AC mains operation at 1 amp., may also be used with DC current from small torch battery. Can be installed almost anywhere to operate lights automatically or to provide simple warning or safety devices.

PROOPS BROTHERS LIMITED

52 TOTTENHAM COURT ROAD, LONDON W.1.
PHONE: LANGHAM 0141. HOURS: 9am-6pm
THURS. 9am-1pm. - OPEN ALL DAY ON SATURDAY



LAFAYETTE HA-63 COMMUNICATION RECEIVER
7 valves plus Rectifier. 4 Bands. 550 kc/s-31 Mc/s. "8" Meter—BFO—ANL—Band Spread Tuning. 200/250v. A.C. Brand New 24 Gns. Carr. Paid.

STAR SR-40 COMMUNICATION RECEIVER
4 Bands. 550 kc/s-30 Mc/s. "8" Meter—BFO—ANL—Bandspread Tuning—Built-in speaker 200/250v. A.C. Brand New. 18½ Gns. Carr. 10/-.



NEW MODEL! LAFAYETTE HA-230 AMATEUR COMMUNICATIONS RECEIVER

Supersedes model HE-30. 8 valves + rectifier. Continuous coverage on 4 bands. 450 Kc/s-30 Mc/s. Incorporates 1 RF & 2 IF stages, Q Multiplier, B.F.O., ANL, "8" meter. Electrical handspread, Aerial trimmer etc. Supplied brand new and guaranteed. 29 gns. S.A.E. for full details.



NEW MODEL! LAFAYETTE HA-55 AIR-CRAFT RECEIVER

108-130 Mc/s. High selectivity and sensitivity. Incorporates 2 RF stages including 6CW4 Nuristor, 8 tubes for 11 tube performance, solid state power supply, adjustable squelch control, slide rule dial, built in 4in. speaker and front panel phone jack. 220/240v. A.C. Supplied brand new and guaranteed. 19 gns. Carr. 10/-.

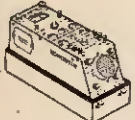
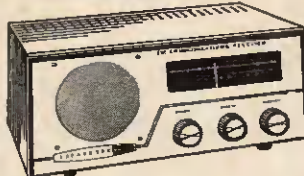

OS/88/U OSCILLOSCOPES

High quality Portable American Oscilloscope. 3" c.r.t. T/B 2 c/s-50 kc/s X Amp: 0-500 kc/s Y Amp: 0-2 Mc/s. Power requirements 105-120v. A.C. Supplied in brand new condition, fully tested. £25. Carr. 10/-.



ERSKINE TYPE 13 DOUBLE BEAM OSCILLOSCOPE

Time base 2 c/s-750 kc/s. Calibrators at 100 kc/s and 1 Mc/s. Separate Y1 and Y2 amplifiers up to 5.5 Mc/s. Operation 110/230 volt A.C. Supplied in perfect working order. £27/10/-.



CLEAR PLASTIC PANEL METERS

First grade quality. Moving Coil panel meters, available ex-stock. S.A.E. for illustrated leaflet. Discounts for quantity. Available as follows: Type MR. 38P. 1 1/2"/32in. square fronts.

5mA.....	22/6	1A D.C.....	22/6	300V D.C.....	22/6
10mA.....	22/6	2A D.C.....	22/6	500V D.C.....	22/6
100mA.....	22/6	5A D.C.....	22/6	750V D.C.....	22/6
50mA.....	22/6	8V D.C.....	22/6	15V A.C.....	22/6
100mA.....	22/6	10V D.C.....	22/6	50V A.C.....	22/6
200mA.....	22/6	20V D.C.....	22/6	150V A.C.....	22/6
500mA.....	22/6	50V D.C.....	22/6	300V A.C.....	22/6
1000mA.....	22/6	100V D.C.....	22/6	500V A.C.....	22/6
500-1000mA.....	22/6	150V D.C.....	22/6	"8" Meter in A.....	22/6

POST EXTRA Larger sizes available—send for lists. ILLUMINATED "8" METER. 1 1/2in. square front. Cal. in 5 units. 6V. lamp. 22/6. P. & P. 1/-.

COLLIN'S R-278/GR RADIO RECEIVERS

High quality military UHF crystal controlled receiver providing reception of AM and CW signals on any one of 1,750 Channels in the frequency range of 225-399.9 Mc/s. Power requirements 115-230V. A.C. size 13in. x 19in. x 2 1/2in. Output 3 watts into 600 ohms. Original cost, hundreds of £££s. Available in "as new" condition fully tested. Complete with all crystals £60. Carriage 50/-.

MAGNAVOX 363 TAPE DECKS

New 3-speed tape deck, supersedes old Colliaro studio deck. 2-track £10.10. 4-track £13.10. Carr. Paid.

AVO METERS

Supplied reconditioned, guaranteed perfect. Model D £8.15. Model 7 £12.10. Post and Ins. 5/-

MINE DETECTOR No. 4A

Will detect all types of metals. Fully portable. Complete with instructions. 39/6. Carr. 10/-.

BEST BUY!

Send 1/- P.O. for full Catalogue and Lists. Open 9 a.m. to 6 p.m. every day Monday to Saturday. Trade supplied.

MODEL ZQM TRANSISTOR CHECKER

It has the full test capacity for checking on A, B and Ico. Equally adaptable for checking diodes, etc. Spec.: A: 0-7.0-9967, B: 0-200. Ico: 0-50 microamps, 0-5 mA. Resistance for diode 200 Ω - 1 MEG. Supplied complete with instructions, battery and leads. £8/19/6. P. & P. 2/6.



SILICON RECTIFIERS

200 v. P.I.V. 200mA.....	2/6
480 v. P.I.V. 8 amp.....	7/6
240 v. P.I.V. 6 amp.....	5/6
1,000 v. P.I.V. 650 mA.....	7/6
800 v. P.I.V. 500mA.....	5/6
400 v. P.I.V. 500mA.....	3/6
95 v. P.I.V. 3 amp.....	5/6
70 v. P.I.V. 1 amp.....	3/6
150 v. P.I.V. 150mA.....	1/-

Discounts for quantities. Post extra.

AMERICAN TAPE

First grade quality American tapes. Brand new and guaranteed. Discounts for quantities.

3in. 235ft. L.P. acetate.....	4/-
5in. 300ft. T.P. mylar.....	10/-
5in. 600ft. std. plastic.....	8/6
5in. 900ft. L.P. acetate.....	15/-
5in. 1,200ft. D.P. mylar.....	15/-
5in. 1,800ft. T.P. mylar.....	35/-
5in. 1,900ft. L.P. acetate.....	12/6
5in. 2,400ft. D.P. mylar.....	22/6
5in. 2,400ft. T.P. mylar.....	45/-
7in. 1,200ft. std. mylar.....	12/6
7in. 1,800ft. L.P. acetate.....	15/-
7in. 1,800ft. L.P. mylar.....	20/-
7in. 2,400ft. D.P. mylar.....	25/-
7in. 2,400ft. T.P. mylar.....	58/6

Postage 2/- Over 23 post paid.

TE22 SINE SQUARE WAVE AUDIO GENERATORS

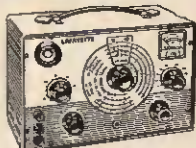

Sine: 20 cps to 200 kc/s on 4 bands. Square: 20 cps to 20 kc/s. Output impedance 5,000 ohms. 200/240v. A.C. operation. Supplied Brand New and Guaranteed with instruction manual and leads. £15. Carr. 7/6.

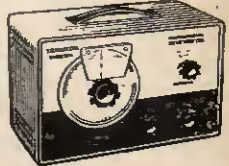

LAFAYETTE TE-46 RESISTANCE CAPACITY ANALYZER

2 PF-2,000 MFD. 2 ohms-200 Megohms. Also checks impedance, turns ratio, insulation 200/250v. A.C. Brand New £15. Carr. 7/6.



LAFAYETTE TE-20A R.F. SIGNAL GENERATOR

120 kc/s-300 Mc/s on 6 ranges. Variable R.F. and A.P. outputs. Large clear scale. Size 7 1/2" x 10 1/2" x 4 1/2". 220/250v. A.C. Operation. Brand New £12/19/6. Carr. 7/6.



2-WAY RADIOS

3 transistor. Range up to 1 MILE. £9/19/6 per pair. Post extra. 9 transistor. Range up to 5 miles. £25 per pair. Post extra. S.A.E. for full details.

TS-76 20,000 O.P.V. PUSH BUTTON MULTI-TESTER

Simple operation, D.C. volts up to 1,000 v. A.C. volts up to 1,000 v. Resistance up to 10 megohm. Current up to 250 mA. Decibels -20 to +34 db. 85/-.



VOLTAGE STABILIZER TRANSFORMERS

Input 50-120v. and 160-240v. Constant output 110v. or 240v. 250 watts. Brand New Guaranteed. £10.10. Carr. 7/6.



VARIABLE VOLTAGE TRANSFORMERS

Brand New Guaranteed—Fully Shrouded. Input 230v. 50/60 c/s. Output 0-250 Volts. 1 Amp..... £4.10. 2.5 Amp..... £5.17.6. 5 Amp..... £8.0. 8 Amp..... £13.10. 10 Amp..... £17.0. 12 Amp..... £19.10. 20 Amp..... £28.10. 2.5 Amp Portable—Metal Case with Meter-Fuses, etc. £9/17/6.

MODEL PV-58 VALVE VOLTMETER

11 meg. input. 7 D.C. volt ranges. 1.5-1,500 v. 7 A.C. volt ranges 1.5-1,500 v. 4,000 Peak to Peak. Resistance 2 ohm to 1,000 megohm. Decibels -10db to +65db. Supplied brand new with instructions, leads and probe. £12/10/- P. & P. 3/6.



MODEL TE-12 20,000 O.P.V. 0/0/6/30/120/600/1,200/3,000/5,000 v. D.C. 0/5/30/120/600/1,200v. A.C. 0/500mA 5/60/600 M.A. 0/5K/500K/5 Meg. 0/6 Meg. Ω. P.P. £2 MERD. £5/19/6. P. & P. 2/6.



MODEL 500 30,000 o.p.v. 0/5/12.5/10/25/100/250/600/1,000v. D.C. 0/2.5/10/25/100/250/600/1,000v. A.C. 0/500mA/5/50/500mA. 12 amp. D.C. 0/60K/6 Meg. 0/6 Meg. Ω. 28/17/6. Post Paid.



TE-51 NEW 20,000 VOLT MULTIMETER

0/5/60/120/1,200v. A.C. 0/5/30/60/300/600/3,000v. D.C. 0/600mA/12/300 M.A. D.C. 0/60K/6 Meg. Ω 85/- P. & P. 2/6.



G.W. SMITH & CO (RADIO) LIMITED
Phone: GERRARD 8204/9155
Cables: SMITHEX LESQUARE
3-34 LISLE STREET, LONDON, W.C2

HOME RADIO LTD. Dept. PE, 187 LONDON ROAD, MITCHAM, SURREY. Telephone: MITcham 3282

TO CELEBRATE the arrival of our NEW CATALOGUE

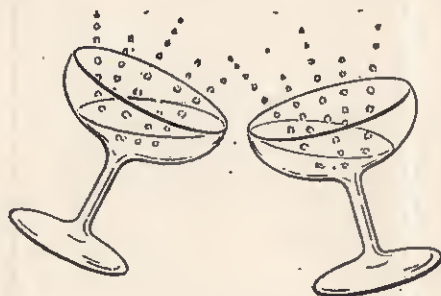

we are offering our giant Bargain Resistor Packs at a special low price. Each pack contains 60 standard resistors, of at least 30 different preferred values, and all well known makes. We estimate the value of this Resistor Pack to be over 25/-. While stocks last we are offering them at 10/6 each, post free! Don't delay . . . stocks are limited! Every customer purchasing a Resistor Pack will receive free of charge a Colour Code Calculator as illustrated.



And now to our NEW CATALOGUE

The vital statistics are (no, not 36-24-36) but 210 pages, plus a separate supplement of prices, valves and transistors, over 5,800 items accurately indexed and priced — 900 of them illustrated. With each catalogue we give a free brochure, value 6d, of items available from the new Semi Conductor Centres, of which Home Radio is one. In the brochure you will find some exciting new components from America, such as Solar Drive Motors and Silicon Light Cells which operate the motors direct off the sun's rays!

The Home Radio Components Catalogue costs 7/6, plus 1/- postage and packing, and every copy contains 5 coupons, each worth 1/- when used as directed. Note too that because of the separate price supplement we can keep your catalogue up to date, from the point of view of prices, for as long as you wish to continue using it. Send off the attached coupon with your cheque or P.O. for 8/6. Why delay? Post today!

Please write your Name and Address in block capitals

Name.....

Address.....

Home Radio Ltd., Dept. PE, 187 London Road, Mitcham, Surrey

ANOTHER ASPECT

There is an increasing awareness among electronic equipment manufacturers of the importance of good styling and external appearance, whether their products be hi-fi equipments for the home or test instruments for professional engineers. No matter how excellent the basic technical design, the quality of the components, and the craftsmanship embodied in the final product, the visual appeal of the equipment is a key factor in influencing a potential buyer.

★ ★ ★

The amateur designer/builder has (as a general rule) no customer to win and has therefore no compulsion to emulate the professional in matters of external appearance and styling—except only the compulsion engendered by personal pride and taste. We suspect that all too frequently, so far as amateurs are concerned, the technical design is considered the beginning and the end, the physical arrangement of components being somewhat casually evolved during the processes of circuit development. When the circuit is finally completed and functioning satisfactorily, there is a reluctance to interfere with the existing lash-up: the intended "rebuild" is deferred until a more opportune moment—which seldom if ever, materialises.

All this is based on our own experience. It is not therefore in any "holier than thou" attitude that we address our readers on this subject. Rather it is our aim to give those who have yet to get their feet wet the benefit of such experiences.

★ ★ ★

Mechanical design is really quite as important as electronic circuit design. This may not always seem apparent but second thoughts (or regrets) often arise after a piece of equipment has been built!

Such mechanical or physical layout design is especially important where the equipment will be manually operated and a number of controls are involved. Careful attention to the arrangement of controls, meters, sockets and other front panel components is an essential part of good design. There are two major considerations: ergonomics—the best location of controls for ease of operating; and aesthetics—the most pleasing visual effect. Sometimes these two conflict.

In the case of radio, audio, or similar user equipment that is normally on view in domestic surroundings, aesthetics will usually have prior claim to attention. Stylish control knobs to suit practically all tastes and requirements are readily available and these contribute towards that professional finish. Ergonomics is of great significance in the design of test instruments, particularly those having a large number of controls—as for example, an oscilloscope. A well planned front panel will prevent such hazards as confusion between controls or the masking of a meter or such like by the arm when making an adjustment to a knob.

THIS MONTH

CONSTRUCTIONAL PROJECTS

ECHO UNIT	769
AUDIBLE WARNING FOR YOUR CAR	776
AERIALS FOR U.H.F.	782
SLIDE SYNCHRONISER	790
NOUGHTS AND CROSSES MACHINE	806

SPECIAL SERIES

NEON NOVELTIES—I	781
BEGINNERS START HERE—II	796
BUILDING BLOCKS—6	802

GENERAL FEATURES

ELECTRONICS AT GOONHILLY	764
-----------------------------	-----

NEWS AND COMMENT

EDITORIAL	763
AUDIO TRENDS	788
ELECTRONORAMA	794
DETACHED PARTICLES	798
NEW PRODUCTS	799
NEWS BRIEFS	815
READOUT	816

*Our October issue will be published on
Thursday, September 16*



electronics at GOONHILLY

by D. Wray

Post Office Engineering Department

THE Post Office satellite communications earth station at Goonhilly Downs, in Cornwall, first came into prominence just over three years ago when it took part in the first live transatlantic transmissions of television via the "Telstar" satellite. In December 1962, a second communications satellite, "Relay", was launched and this, too, was used in many technical experiments and for long-distance television transmissions. Further models of both "Telstar" and "Relay" were launched in 1963. For 2½ years hundreds of experiments were carried out over these satellites to amass the statistics needed for moving from a purely experimental phase to a system that can give worldwide continuous commercial communications.

A major step towards the attainment of such a commercial system was taken in April of this year with the launching of the "Early Bird" satellite. "Early Bird" differs from its predecessors in that it was placed into an orbit having a 24-hour period and so appears to hover over one place on the earth's surface—in this case, over the mid-Atlantic. For the first time *continuous* transmission by satellite between Europe and the United States was possible.

EARTH STATION REQUIREMENTS

Although the earth stations taking part in this project (Andover, in U.S.A.; Plumeur Bodou, in France; Raisting, in Germany; Fucino, in Italy; and Goonhilly, in Britain) differ considerably in their details, the basic requirements of these earth stations must be common to all—as shown in outline in Fig. 1.

The most obvious feature of any earth station is a large steerable aerial. The aerial must necessarily be very large because the received power from the satellite is so small—a fraction of a billionth of a watt—so the aerial must have a large collecting area; in other words, the aerial has a high gain and its radiation pattern evinces a very narrow main beam.

Another factor that must be considered is that the frequencies of transmission between the satellite and the ground must be chosen so that there is as little degradation of the signal as possible by galactic noise (radio noise originating in space) or by absorption in the atmosphere. The frequencies selected as optimum at present are in the region of 4,000 Mc/s for the satellite-to-ground direction, and about 6,000 Mc/s for the reverse direction. As the beam width of a large aerial is not likely to be more than one-sixth of a degree at 6,000 Mc/s, the aerial must be steered towards the satellite with an accuracy of a small fraction of a degree or contact with the satellite will be lost.

The three electronic chains that must meet at the aerial are, therefore, a control system for steering the aerial's movements with considerable accuracy; a transmission chain that will accept either a television signal or multi-channel telephony and convert this into a high-powered radiation at 6,000 Mc/s for transmission to the satellite; and a reception chain to receive the 4,000 Mc/s radio signal from the satellite and reduce it to a television or telephony output. For telephony, of course, transmission and reception must take place simultaneously.

THE PARABOLIC AERIAL

The parabola has the geometric property that straight lines drawn from the focus to the line of the parabola, and then reflected back with equal angles of incidence and reflection, are all reflected in parallel (see Fig. 2). Moreover, the total distance from the focus to any plane drawn at right angles to these reflected lines is always the same no matter what path

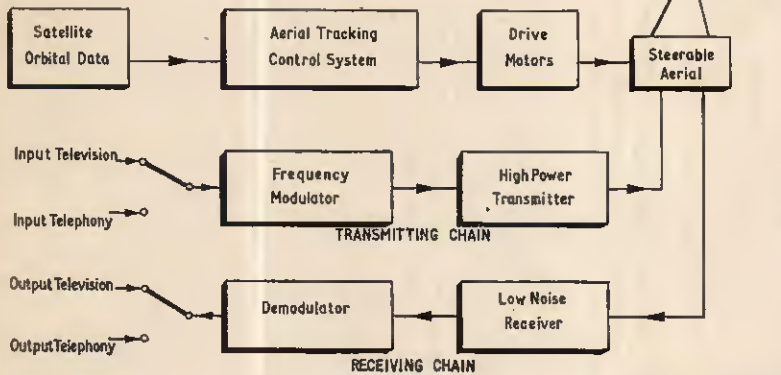

the incident and reflected paths travel. Thus, if the parabola is rotated about its longitudinal axis to make a paraboloid, and waves emanate from the focus to the paraboloidal surface, they are reflected in phase in a parallel beam. Searchlights and car headlights work on this principle, and so do most of the large aerials used at high frequencies. The Goonhilly aerial is a paraboloid 85ft in diameter with a radio feed unit supported at its focus on a slender, but rigid, mechanical tripod.

Referring back to Fig. 2 we can see that if the paraboloid is not geometrically perfect, but has imperfections or discontinuities, then the path lengths to the reference plane will not all be the same; for a radio aerial this means that the reflected beam will not be perfectly parallel, and so the gain of the aerial will not be as high as it could be and some energy will be scattered in unwanted directions. A very high standard of constructional perfection is therefore necessary, for the tolerable imperfections must be related, not to the size of the aerial, but to the radio wavelength being used. The Goonhilly aerial, although 85ft in diameter, is so accurately made that 99 per cent of its area lies within 85 thousandths of an inch of the geometrically ideal.

Since the Goonhilly station is part of an international telecommunications service, it must aim at a very high standard of reliability; the aerial must therefore always track the satellites with an accuracy of at least one-fifteenth of a degree even for the few hours a year in which the mean wind speed is 60 m.p.h. with gusts as high as 85 m.p.h.

PROGRAMMED CONTROL

The method of tracking employed at Goonhilly is that of programmed control with additional automatic correction; the process is shown in Fig. 3. Predictions of the position of the satellite are received from computing centres in the U.S.A. several days in advance of the orbit to which they refer. For "Telstar" and "Relay" these predictions are at one minute

Fig. 1. Essentials of earth station for satellite communications

intervals in time, and a computer at Goonhilly analyses the way in which these positions vary with time and makes further interpolations to one-second intervals. The predictions are punched out in a 5-unit code into a control tape in which the required angle for both aerial station and elevation are given for each second in time. Before any particular orbit is due, the appropriate control tape is placed into a high-speed tape reader connected to special-purpose digital control equipment.

The digital equipment carries out further interpolations until the aerial is finally receiving no less than 50 instructions per second in both the azimuth and elevation angles. These digital instructions are converted into a corresponding smoothly-varying voltage in the digital-to-analogue converter, and it is this voltage that controls the speed of a variable-speed motor-generator set. Each direction of motion—azimuth and elevation—has a 100 h.p. electric motor for motive power, so the control chain starts with a paper tape and finishes with the motion of 1,000 tons of steel and concrete!

However, gusts of wind may tend to deflect the aerial from its course, so both axes of rotation of the aerial have digital position encoders. These are glass discs on which 16 tracks are printed photographically; they are scanned photo-electrically to give an angular position indication to an accuracy of one two-hundredth of a degree. This information is sent back to the digital control equipment so that the demanded angle and the actual angle can be compared; if there is any difference between them, an error signal is added to the drive voltage to the aerial's motors, and the aerial is driven back on to course again. In other words there is a complete servo loop.

The timing sequence mentioned—one-minute predictions reduced to one-second intervals—applies to

Central Control Console at Goonhilly. Photograph by courtesy of H.M. Postmaster-General

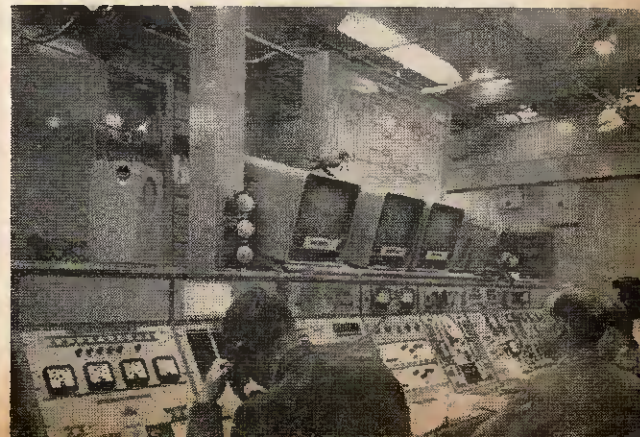

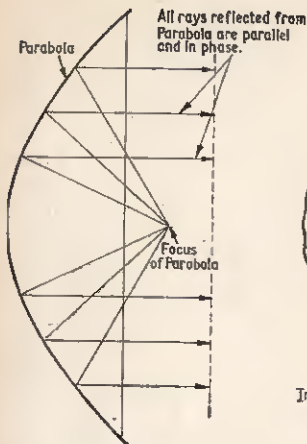

Fig. 2a. Reflection from a perfect parabola

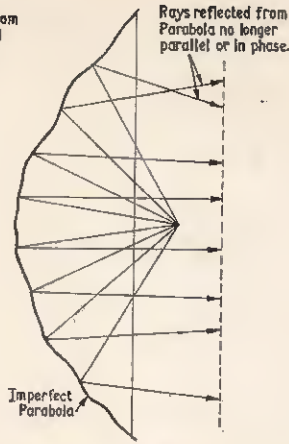

Fig. 2b. Reflection from imperfect parabola

comparatively fast-moving satellites such as "Telstar" and "Relay". For much slower-moving satellites, such as "Early Bird", the predictions are at 10-minute intervals and are reduced to one-minute periods by the computer. In fact, "Early Bird" has been positioned so accurately that once the aerial has been set into position at the beginning of the day there is no need for any further movement during the next 24 hours.

BEACON SIGNAL

But there might be slight errors in the original predictions, or the satellite itself may wobble a little about the geometrically perfect orbit due to the per-

turbing influence of other planets. Fortunately, the satellites transmit an unmodulated beacon signal and this can help to improve the tracking of the aerial.

At Goonhilly this is accomplished by rapidly moving the radio feed at the focus of the aerial through a circular displacement of very small angle. If the beacon signal picked up by the aerial is strongest when the feed is not along the centre line, then this is an indication that the aerial is not pointing precisely at the satellite. If the error is small or transitory, the feed unit can be moved bodily to counteract it; if the error is persistent, instructions can be fed back with the main aerial control system to bring the aerial back on to course.

With this combination of predicted movement, servo loop correction, the natural stiffness and heaviness of the aerial itself, and the automatic fine trimming action of the aerial feed, satellites can be tracked with an accuracy of two minutes of arc in spite of high winds and rapid acceleration of the aerial.

THE TRANSMITTING CHAIN

Wide deviation frequency modulation has been used by all the active communication satellites that have been launched to date. A wide deviation is necessary to obtain an adequate signal/noise ratio in the received signal when the great losses of the transmission path are taken into account; as a consequence a wide bandwidth is necessary in all the equipment in the transmission chain.

The transmitting (or "up-direction") path is shown in block schematic form in Fig. 4. The input signal—either a television waveform or several hundred telephone channels assembled side by side into a continuous bandwidth—is presented to a modulator which produced a frequency modulated output centred on 70 Mc/s. This is amplified in further amplifiers and

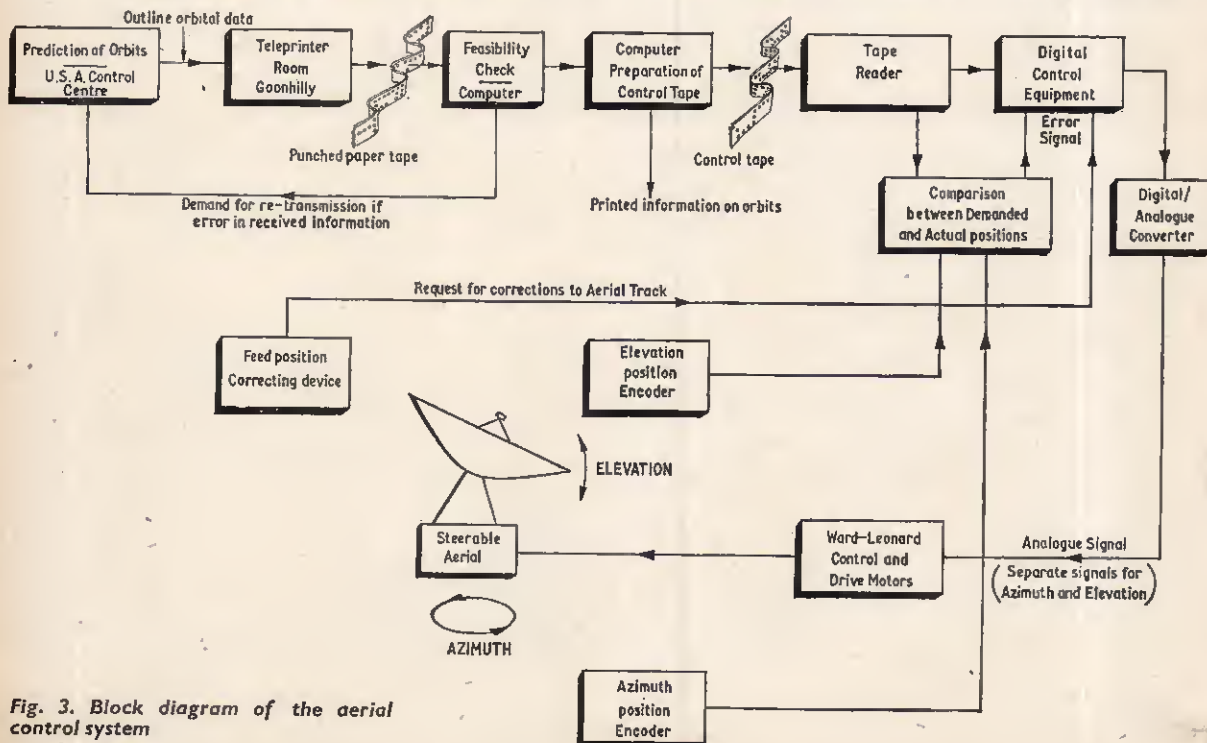

Fig. 3. Block diagram of the aerial control system

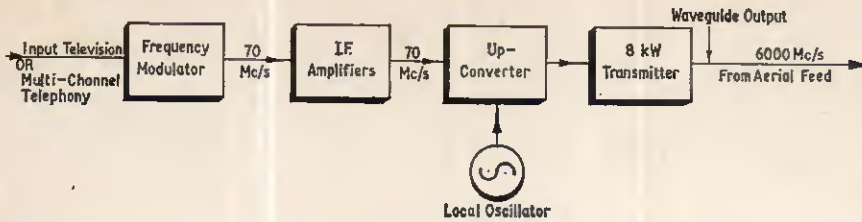

Fig. 4. Block diagram of the transmitting chain

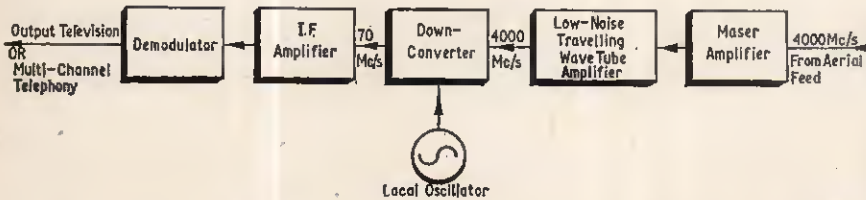

Fig. 5. Block diagram of the receiving chain

applied to the drive stages of a transmitter in which the frequency-modulated 70 Mc/s signal is mixed with a local oscillator to move it up into the 6,000 Mc/s region.

So far, this is all fairly conventional practice. The unique step is in the output stage, which is a specially-developed travelling wave tube. In normal microwave radio systems, a travelling wave tube can be expected to deliver a few watts; at Goonhilly, the output tube delivers 8kW. This is the highest power produced by any earth station in the world.

At these high frequencies, normal cables cannot be used—they are far too lossy; the output from the transmitter is therefore carried to the feed at the focus of the aerial along waveguides—rectangular tubes of copper and brass that carry the radio waves inside them.

Here again, problems arise at Goonhilly that are not encountered in normal microwave radio transmission, because the powers carried by the waveguides are so high that there is real danger of arcs forming if there is the slightest discontinuity or dirt inside the waveguides. It is essential, therefore, for the transmitter to be protected by an arc-detector, for arcs forming in the output waveguide would act as virtual short-circuits across the valuable output tube.

THE RECEIVING CHAIN

One of the fascinating contrasts of a satellite communications earth station is the tremendous difference in power between that transmitted to the satellite and that received from it—a ratio of about one thousand billion to one.

The very low received power is a consequence of the small output power from the satellite itself (usually just a few watts, itself limited by the small battery power supplies charged by solar cells) and the very high path propagation loss entailed in the enormous distance between the satellite and earth. Normal receiving techniques are quite useless when dealing with powers of less than a billionth of a watt; thermal noise produced by the earth, the aerial, and even the sky itself, is comparable with the radio signal that must be snatched from the air.

The first receiving stage must therefore be extremely sensitive, contribute an extremely low noise level, and be able to receive frequencies in the 4,000 Mc/s region with an adequate bandwidth (25-30 Mc/s). All these conditions are met by the maser.

MASER AMPLIFIER

The maser consists, essentially, of a rod of ruby in a waveguide. The atomic structure of ruby is such that its electrons can exist at three different energy levels. By pumping radio power into the ruby at a frequency well above that to be amplified, a substantial proportion of the electrons are lifted to the highest energy level. When a radio signal is received it triggers some of the electrons from the higher energy levels to the lower, and, in doing so, releases energy that represents an amplified version of the input signal. In this way, radio signals of a billionth of a watt or less in power can be amplified by 2,000 times or so. But for this to happen, it is essential that the high energy level electrons should not be dislodged by the normal thermal molecular agitation of the ruby material; the maser must therefore be maintained at an extremely low temperature—about 2 degrees above absolute zero (–271 degrees C).

This fantastically low temperature is only attained by immersing the ruby in liquid helium, and one of the most formidable operational problems at Goonhilly is to ensure that constant supplies of liquid helium are available and that the masers are kept immersed as the helium boils off. Masers are tuned to a particular frequency band by varying an external magnetic field, and the presence of the liquid helium coolant is exploited at Goonhilly by obtaining this magnetic field from a superconducting coil.

The received signal level is still very low at the output of the maser and must be further amplified by a low-noise travelling wave tube. A frequency-changer converts the signal down from the microwave region to a 70 Mc/s intermediate frequency, and it is this that is finally demodulated in a f.m. demodulator. A block diagram of the arrangement is shown in Fig. 6.

F.M. NEGATIVE FEEDBACK DEMODULATOR

Even after all these precautions of low-noise amplification, the final i.f. signal that reaches the demodulator can have such a poor signal/noise ratio that the normal type of Foster-Seeley frequency discriminator becomes unusable. To meet this situation, a special device called a frequency-modulated negative-feedback demodulator (often referred to as an f.m.f.b.) is used. This was invented as far back as 1938, but it did not find an application until the coming of satellite communication in the 1960's.

Fig. 6. Block diagram of the frequency-modulated negative-feedback demodulator

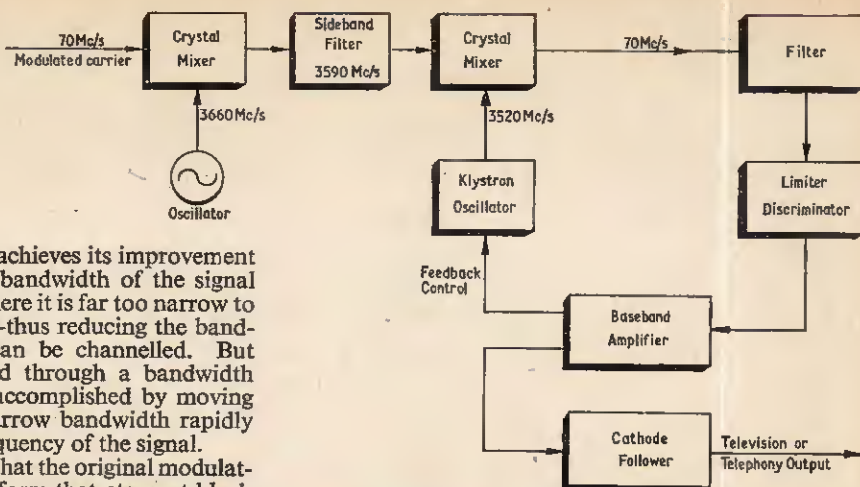

Making a "print-out" in the control room. Photograph by courtesy of H.M. Postmaster-General

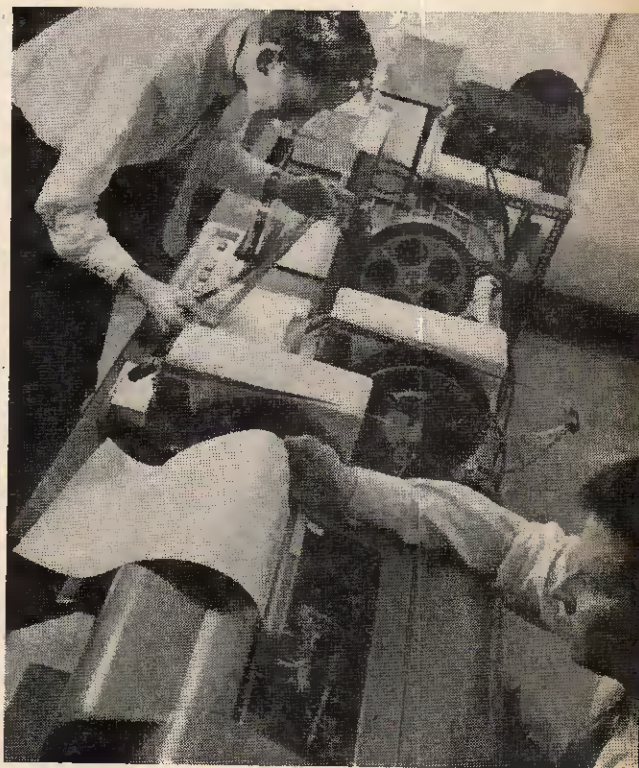

Fundamentally, the f.m.f.b. achieves its improvement by substantially reducing the bandwidth of the signal path—apparently to a point where it is far too narrow to carry the wide deviation f.m.—thus reducing the bandwidth through which noise can be channelled. But how can the signal be carried through a bandwidth that is too narrow? This is accomplished by moving the centre frequency of the narrow bandwidth rapidly to follow the instantaneous frequency of the signal.

Let us imagine, for instance, that the original modulating signal is a television waveform that stays at black level for half the line and then moves up to peak white for the other half; after frequency modulation, this will appear as a certain frequency corresponding to the black level which then swings to another frequency that is equivalent to the white level. Thus, although the television picture needs a wide frequency swing, the instantaneous frequency band requirements are quite modest.

Reference to Fig. 6 shows that the received wide deviation 70 Mc/s f.m. signal is applied to a crystal mixer driven by a 3,660 Mc/s oscillator. The lower sideband, centred on 3,590 Mc/s, is filtered off and applied to a down-converter mixer. This second local oscillator, however, is not fixed but comes from a klystron oscillator, the frequency of which can be shifted by varying the reflector potential. This potential is derived from a discriminator and detector, the discriminator being fed by the down-converted 70 Mc/s signal. Thus the down-converter local oscillator is constantly shifting in frequency according to the instantaneous frequency of the signal and the effective pass-band is moving in sympathy. The f.m.f.b. therefore can demodulate a wide deviation f.m. signal whilst still having a small noise band-width.

This article has described just a few of the novel aspects of the Goonhilly radio station. In addition, there are very many more items of transmission and test equipment that there is no space here to mention. All of these combine to make one of the most fascinating centres of electronic engineering in the country. ★

The down lead assembly with its superconducting magnet alongside one of a pair of travelling masers, designed and built by scientists at the Mullard Research Laboratories, England, for the Goonhilly Earth Station. The masers operate at the temperature of liquid helium. (— 217 degrees C) and are capable of amplifying signals of 10^{-13} watts or even less at a frequency of 4,160 Mc/s.

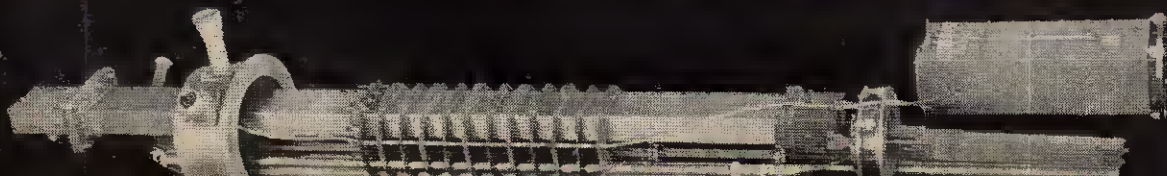

ECHO UNIT

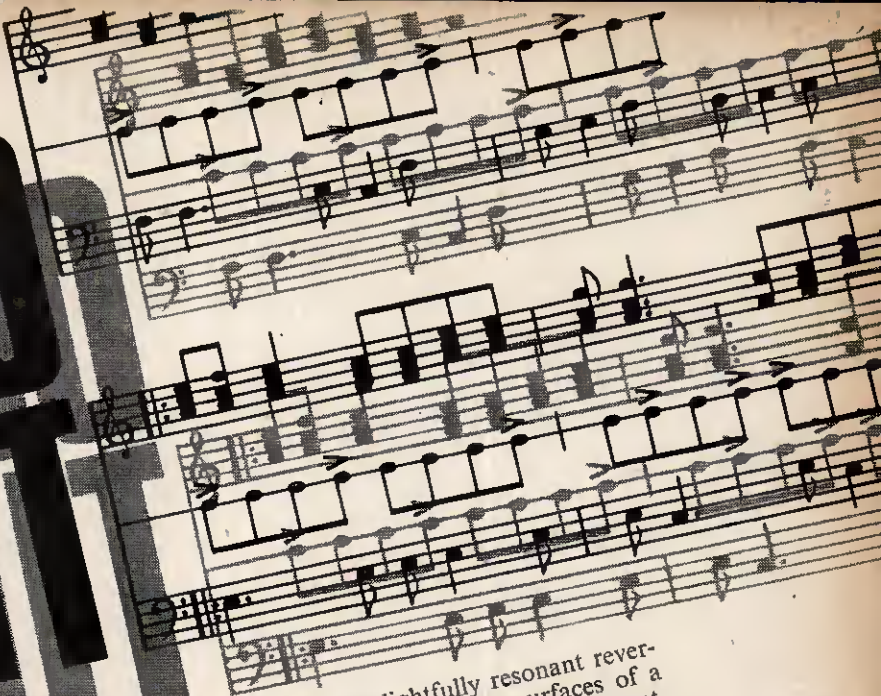

We have all experienced the "Bathroom Effect", that delightfully resonant reverberation added to the voice or an instrument by the hard reflecting surfaces of a sparsely furnished room such as a bathroom. The apparent improvement, occurring a small but definite time interval after the original sound. Such echoes have of course been from time immemorial a source of fascination and pleasure to man.

Controlled echoes, which can be produced in a variety of ways, can be put to many uses; for example, adding a new dimension to a solo instrument such as a guitar or saxophone, creating "Radiophonic" or electronic music, adding dramatic sound effects to plays and film sound tracks, or even improving the musical efforts of pop or beat groups.

Since it is hardly practicable to carry around a portable bathroom or echo chamber, the author designed and constructed the instrument to be described, by means of which a controlled echo or series of echoes can be added to any audio signal. Emphasis in the design was given to reliability and mechanical simplicity, and ease of construction, and as can be seen from the accompanying photograph the instrument is very compact and easily portable.

by A. J. Carrington

This is the completed echo unit. The side and bottom panels can be detached leaving the electronic—mechanical assembly fully exposed.

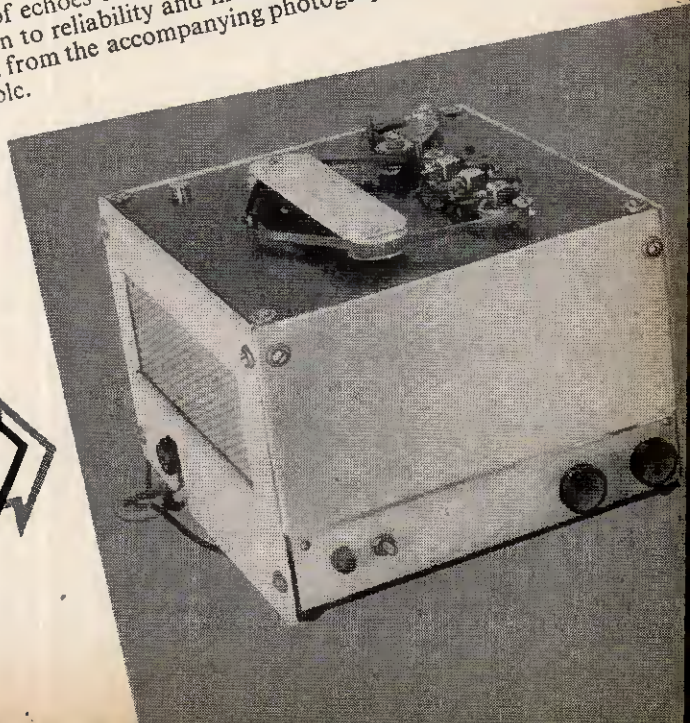

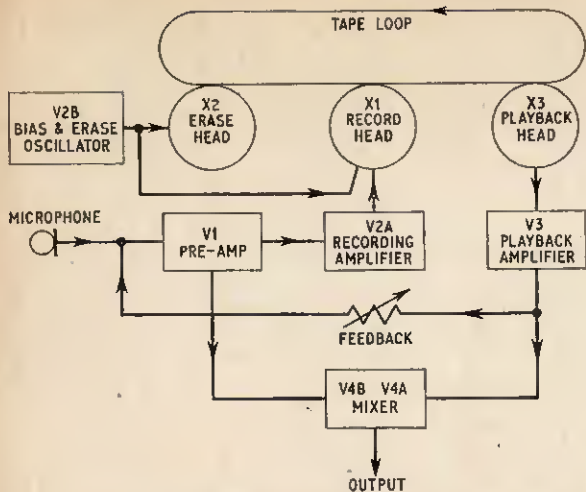

Fig. 1. This block diagram makes clear the system used in the echo unit

THIS instrument uses the endless tape loop method of producing echoes, and in effect is a specialised form of tape recorder. Reference to Fig. 1 should make the operating principles clear.

The signal, from a microphone or other source, is fed to the pre-amplifier, stage V1, the output from which is split into two parts. Part of the signal is fed to the recording amplifier, V2A and thence to the recording head X1 where it is recorded on the tape loop. The other part of the signal from V1 is fed to a mixer stage, V4B, and thence to the output socket of the unit, so the original signal is amplified and passed straight through the unit and can be applied to the equipment desired.

The recorded signal on the tape is picked up by the playback head X3 and fed into the playback amplifier V3, and thence to the mixer V4A, where it is mixed with the original signal, both signals appearing at the output.

So we now have the original signal plus a single echo, the time lag being dependent on the speed of the tape loop and the distance between the heads. A single echo is not very effective however, and so if we feed back part of the amplified echo from the playback amplifier V3 to the first amplifier V1 the *echo* will go through the whole process again and again and so we will end up with the original signal plus a whole series of echoes, which can, by suitable adjustment of the feedback control, be made to gradually fade away into silence, considerably enhancing the effect.

THE CIRCUIT

Fig. 2 shows the complete circuit diagram of the echo unit.

V1, an EF86 low noise pentode, is the pre-amplifier. Part of the output from V1 anode is fed via C4 and R8 to the preset recording level control VR1 which determines the level of signal fed to the triode grid of V2. The triode section of this valve (V2A) is the recording amplifier, and the pentode section (V2B) is used as the bias and erase oscillator.

V3, another EF86, is the playback amplifier, and the output from this stage is fed via C16 and the playback gain control VR3 to the grid of V4A.

The second triode section of this valve (V4B) is fed from V1 anode via C5, R7 and VR4, gain being adjusted by the latter preset control. The echo feedback is applied via VR2, which controls the amplitude of the amplified echoes from V3 that are fed back to the grid of V1.

The full wave rectifier V5 provides h.t. which is well smoothed and decoupled by C1, C14, C18, C12 and C13 in conjunction with the associated resistors.

TAPE TRANSPORT MECHANISM

As was mentioned before, emphasis was given to simplicity of construction, and the tape transport mechanism consists simply of a square mild steel plate on which are mounted the three heads (erase, record and playback), the tape guides, and a motor.

The motor is an induction type similar to those used in record players. The shaft of this motor forms the capstan which in conjunction with a rubber faced pinch wheel draws the tape past the heads at a speed of approximately 12.5in/sec. In this way, no pulleys, belts or other mechanical parts are required, and the author found this method entirely satisfactory, wow and flutter being well within tolerable limits. Two spring loaded pressure pads are also mounted to keep the tape in intimate contact with the heads.

AMPLIFIER CONSTRUCTION

The electronics were mounted by conventional methods on an aluminium chassis measuring 10in x 10in x 2.5in, components being mounted directly onto valveholders with insulated anchor tags being used where necessary. The arrangement of the larger components is shown in Fig. 3. Layout is not critical but care must be taken to screen the oscillator stage; this was done in the prototype by making a rectangular box from strip aluminium and bolting this to the chassis, the oscillator components being mounted in the box.

The mains transformer should be mounted as far away from the playback head as possible, but owing to the shielding effect of the mild steel baseplate, the author was not troubled by any problems of induced mains hum.

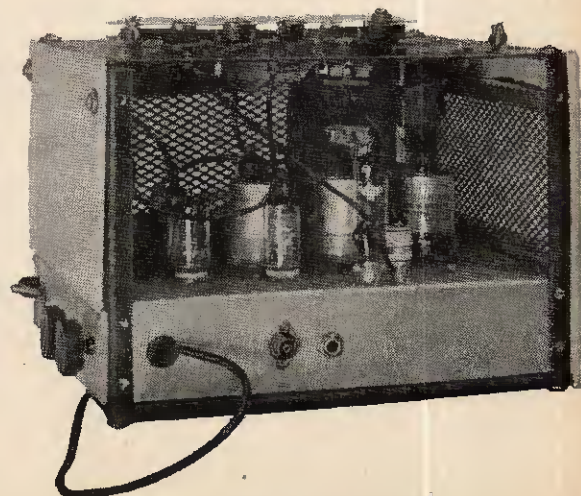

Interior of the echo unit



Home Construction made easy by Building Heathkit models

A wide range of well designed quality kit sets to choose from

Ease of assembly is guaranteed

Even for those without previous experience—by the comprehensive, yet simple step-by-step construction manuals supplied with every Heathkit model.

Save £ £'s building the models

Heathkit units cost considerably less than comparable pre-assembled equipment. You cannot buy the parts any other way as cheaply.

Guaranteed performance

Every Heathkit product—assembled in accordance with our comprehensive construction manuals is guaranteed to meet published performance specifications, or your money will be cheerfully refunded.

Convenient credit terms

By taking advantage of our credit terms—you can enjoy your model right away—and pay for it in easy monthly instalments. Deferred terms available over £10 in U.K.

AUDIO

Cabinets, Turntable units, Mono and Stereo Amplifiers, Pick-ups, Speakers, Speaker Systems, Mono and Stereo Control Units, Tape Pre-amplifiers, Tape Decks, Transistor Mixer.

RADIO

AM/FM and FM Tuners, Transistor Radios, SW and Communication Receivers.

TEST INSTRUMENTS

A wide range of Audio Test, Home Workshop, Service and Laboratory Instruments.

AMATEUR GEAR

A wide range of equipment.

MISCELLANEOUS

Hobby kits for the youngster, Tool kits, Intercoms, Electronic Organs, Transistor Gram Amplifier, etc.

See the complete Heathkit range in the FREE catalogue



HI-FI CABINETS

RECORD PLAYERS



FM & AM/FM RADIO TUNERS



TRANSISTOR PORTABLES



SW RECEIVERS TRANSMITTERS



QUALITY STEREO and MONO AMPLIFIERS



SPEAKER SYSTEMS

TAPE DECKS

CONTROL UNITS

"MALVERN" HI-FI EQUIPMENT CABINET.

Will house all your Hi-fi equipment. Lefe "in the white." Size: 39½ x 32 x 21½ in.

Kit £18.1.0 (inc. P.T.)

A wide range of other cabinets.

HI-FI FM TUNER. Range 88-108 Mc/s. Available in two units, sold separately. **TUNER (FMT-4U)** 10.7 Mc/s IF £2.15.0 (inc. P.T.). **IF AMPLIFIER (FMA-4U)** power supply and valves £13.13.0. Total Kit £16.8.0.

JUNIOR ELECTRONIC WORKSHOP. Model EW-1. 20 exciting experiments can be made. Special solderless connections. Kit £7.13.6 (inc. P.T.)

TRANSISTOR MIXER. TM-1. A must for the tape enthusiast. 4 inputs, 9 v. battery operation. Kit £11.6.0. Assembled £16.17.6.

"OXFORD" LUXURY TRANSISTOR PORTABLE, Model UXR-2.

Beautiful solid leather case, LW and MW Coverage. Kit £14.8.0 (inc. P.T.)

GENERAL COVERAGE RECEIVER, Model RG-1. Freq. coverage 600 kc/s-1.5 Mc/s. 1.7-32 Mc/s in 6 switched bands. Many features incl. ½ lattice crystal filter. Kit £39.16.0, Assembled £53.0.0.

6W QUALITY STEREO AMPLIFIER, Model S-33H. An inexpensive stereo/mono amplifier. Ideal for use with the Decca Deram lightweight pickup. Modern attractive styling. Kit £15.17.6, Assembled £21.7.6.

50W PA/GUITAR AMPLIFIER, Model PA-1. A multi-purpose unit, suitable for vocal and instrumental groups. 4 inputs for guitars, mics, etc. 2 heavy duty speakers, vol. indicator, variable tremolo, modern cabinet. Kit £34.15.0, Assembled £74.0.0. Legs optional extra, 17/6.

TRANSISTOR GEN. COVERAGE RECEIVER, Model GC-1U.

Frequency coverage 580 kc/s-30 Mc/s in 5 bands. Kit £37.17.6, Assembled £45.17.6.

TRANSISTOR INTERCOM.

Master Unit. Kit £10.19.6, Assembled £16.19.6. Remote. Kit £4.7.6, Assembled £5.16.0. Will operate up to 5 remotes.

"COTSWOLD" HI-FI SPEAKER SYSTEMS.

Std. model. Size: 26 x 23 x 14 in. Kit £25.12.0.

MF5 "Cotswold" for the smaller room. Size: 36 x 16½ x 14 in. Kit £25.12.0

SSU-1 SPEAKER SYSTEM. A practical solution to the problem of a low-price speaker system. Two speakers. (Bookcase) £11.17.6 Kit (inc. P.T.) (With legs) £12.12.0 Kit (inc. P.T.)

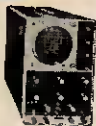

'SCOPES



POWER SUPPLIES



TRANSISTOR TESTER



SIGNAL GENERATORS



VALVE VOLTMETERS



TV ALIGN GENERATOR

5 in. FLAT-FACE GENERAL PURPOSE OSCILLOSCOPE, Model 10-12U. An outstanding scope. "W" sensitivity, 10 Mc/s per cm at 1 kc/s; Bandwidth 3 c/s to 4.5 Mc/s. T/B 10 c/s to 500 kc/s in 5 steps. Kit £35.17.6, Assembled £45.15.0.

MULTIMETER, Model MM-1U. Ranges 0-1.5 v to 1,500 v A.C. and D.C. 150 µA to 15A D.C.; 0.2 to 20 MΩ. 4½ in. 50µA meter. Kit £12.18.0 Assembled £18.17.6.

REGULATED POWER SUPPLY, Model IP-20U. Transistorised, compact unit. Current range: from 50 mA to 1.5 A f.s.d. Voltage ranges: from 5 to 50 volts f.s.d. Kit £35.8.0, Assembled £47.8.0.

TRANSISTOR TESTER, Model IM-30U. Unmatched in quality, performance and price. Provides complete d.c. analysis of PNP, NPN transistors and diodes. Internal battery for tests up to 9 v. Kit £24.18.0, Assembled £35.10.0.

R.F. SIGNAL GENERATOR, Model RF-1U. Freq. coverage from 100 kc/s-100 Mc/s or six bands, on fundamentals and up to 200 Mc/s on calibrated harmonics. Kit £13.8.0, Assembled £19.18.0.

6 in. DE LUXE VALVE VOLTMETER, Model IM-13U. Measures ac and dc volts 0-1.5 to 1,500 V in 7 ranges. Res. to 1,000 MΩ in 7 ranges. Modern styling, with gimbal mount. Kit £18.18.0, Assembled £26.18.0.

TV ALIGNMENT GENERATOR, Model HFV-1. 3.6 to 220 Mc/s on fundamentals. Unique electronic sweep oscillator. Built-in fixed and variable marker generators (5 Mc/s crystal). Kit £37.18.0, Assembled £47.10.0.

DECADE RESISTANCE, Model DR-1U. Range 1-99,999Ω in 1Ω steps. Kit £10.8.0, Assembled £14.8.0.

DECADE CAPACITOR, Model DC-1U. range, 100µF to 0.111 µF in 100 µF steps. Kit £7.5.0, Assembled £10.8.0.

INTERNATIONAL MAIL ORDER SCHEME covering the American Heathkit range of 250 models. Illustrated American catalogue and full details can be obtained from us for 1/- post paid.

MANY OTHER MODELS
For the home, Hi-Fi enthusiast, Home workshop, Service and Test bench, Laboratory.

FULL RANGE OF MODELS IN FREE CATALOGUE

SIMPLY SEND COUPON TO:—

To **DAYSTROM LTD., DEPT. PM-9, GLOUCESTER, ENGLAND**

Please send me **FREE BRITISH CATALOGUE (Yes/No)**.....

Full details of model(s).....

American NAME (BLOCK CAPITALS).....

Catalogue ADDRESS.....

(Yes/No).....

PM-9



FIRST QUALITY PVC TAPE

5 1/2" Std. 850 ft. 9/- 5" L.P. 850 ft. 10/6
 7" Std. 1200 ft. 11/6 3" T.P. 600 ft. 8/-
 3" L.P. 240 ft. 4/- 5" T.P. 1800 ft. 20/6
 5 1/2" L.P. 1200 ft. 11/6 5 1/2" T.P. 2400 ft. 27/6
 7" L.P. 1800 ft. 18/6 7" T.P. 3600 ft. 37/6
 P. & P. on each 1/6, 4 or more post free.

Complete with McLaren Variable Thermostat 90° to 180°F, 20 amp. A.C. and GEC double pole 20 amp. mains switch, 18", 30" and 36". State length required. £2.0.0 plus 5/- P. & P.

3 kW IMMERSION HEATER



"PREMIER" KETTLE ELEMENT

1000 w., 8/6 + 3/- P. & P. Retaining nut and flange 2/6, switch plug to suit 2/6.

A.C. MAINS MOTOR



Can be used for a variety of purposes, silent running, satisfactory in every way. 230/250 v. A.C. 9/6. P. & P. 3/-.

3 to 4 WATT AMPLIFIER KIT



comprising chassis 8 1/2" x 2 1/2" x 1". Double wound mains transformer, output transformer, volume and tone controls, resistors, condensers, etc. 6V6, ECC81 and metal rectifier. Circuit 1/6 free with kit. 29/6 plus 4/6 P. & P.

40w. FLUORESCENT LIGHT KIT



incorporating GEC Choke size 8 1/2" x 1 1/2" x 1 3/4", 2 bi-pin holders, starter and starter holder, 11/6. P. & P. 4/6.

Similar to above: 80w. Fluorescent Light Kit incorporating GEC choke size 11 1/2" x 1 1/2" x 1 3/4", 2 bi-pin holders, starter and starter holder, 17/6. P. & P. 5/6.

8-watt 5-valve PUSH-PULL AMPLIFIER & METAL RECTIFIER

Size: 9 x 6 x 1 1/2" A.C. Mains 200-250v. 5 valves. For use with Std. or L.P. records, musical instruments, all makes of pick-ups and mikes. Output 8 watts at 5 per cent total distortion. Separate bass and treble lift controls. Two inputs, with controls, for gram. and mike. Output Transformer tapped for 3 and 15 ohms speech coils. Built and tested. £3.19.6. P. & P. 8/-.

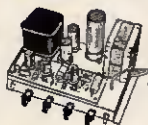

SPECIAL OFFER!

ELEGANT SEVEN Mk. II

Combined Portable and Car Radio
 The Radio with the "Star" Features

- ★ 7-transistor superhet. Output: 350 mW.
- ★ Gray wooden cabinet, fitted handle with silver-coloured fittings, size 12 1/2 in. x 8 1/2 in. x 3 1/2 in.
- ★ Horizontal tuning scale, size 1 1/2 in. x 2 1/2 in. in silver with black lettering.
- ★ All stations clearly marked.
- ★ Ferrite-rod internal aerial.
- ★ Operated from PP9 battery.
- ★ I.F. neutralisation on each stage 460 kc/s.
- ★ D.C. coupled output stage with separate A.C. negative feed back.
- ★ All components, ferrite rod and tuning assembly mounted on printed board.
- ★ Fully comprehensive instructions and point-to-point wiring diagram.
- ★ Printed circuit board, back-printed with all component values.
- ★ Fully tunable over medium and long waveband.
- ★ Car aerial socket.

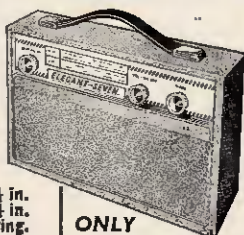

ONLY
£4.4.0

Plus 6/6 Post & Packing

SPECIAL OFFER—

POWER SUPPLY KIT to purchasers of Elegant Seven parts, incorporating mains transformer, etc. A.C. mains 200-250v. Output 9v. 100mA. 7/6.

4 in. SPEAKER. Parts list and circuit diagram 2/6. FREE with parts.

Shop Hours 9 a.m. — 6 p.m. Early Closing Wednesday

RADIO & T.V. COMPONENTS (ACTON) LTD.
 21D, HIGH STREET, ACTON, LONDON, W.3

The finest in the World

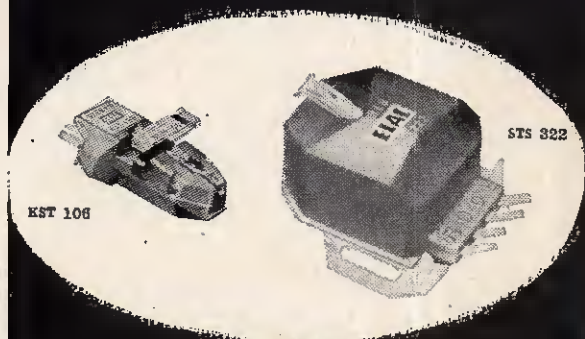

ELAC Cartridges

KIEL-GERMANY

THE ELAC CARTRIDGES MENTIONED IN THE "AUDIO TRENDS" FEATURE WHICH APPEARED IN THE JULY 1965 ISSUE OF PRACTICAL ELECTRONICS, ARE PART OF THE COMPLETE RANGE OF ELAC TRANSCRIPTION QUALITY EQUIPMENT AVAILABLE FROM: THE BRITISH AGENTS

MITCHELL ENTERPRISES LTD.

61 WEST STREET • DORKING • SURREY Telephone 4229

TAPE RECORDER COVERS



Smart waterproof cover to give complete protection to your tape recorder. Made from rubberised canvas in navy, wine, tan, grey and bottle green with white contrasting pipings, reinforced base, handy zip microphone pocket and name panel.

Grundig	TK 1	49/6	Grundig Cub	35/-*	Cossor 1601	63/-
	TK 5	55/-	Telefunken 85	65/-	" 1604	79/-
	TK 6	67/6	" 75/15	55/-	" 1605	84/-
	TK 8	63/-	" 76K	69/6	Stella ST455	63/-
	TK 14, 18	59/6	" 95	57/6	" ST454	57/6
	& 23	59/6	Philips 8108	79/6	" ST458	79/-
	TK14L, 17L,	67/6	" 3548	69/6	" ST459	84/-
	18L & 23L	67/6	" 3459	77/6	Saba 2305	63/-
	TK 20	52/6	" 3459	87/-	Elizabethan LZ29	75/-
	TK 24	55/-	EL3538	63/-	Brenell Mk. 5	77/-
	TK 25	55/-	EL3542	63/-	" 3 star	69/-
	TK 30	60/-	EL3536	70/-	Truvox R92 and 94	99/-
	TK 35	63/-	EL3515	57/6	Robuk RK3	67/6
	TK 40 & 41	66/-	EL3541/15	57/6	Ferrograph	88/-
	TK 46	82/-	" 3541/H	72/-	Sony S21	90/-
	TK 55	63/-*	Starmaker	66/-	Revox	84/-
	TK 60	75/-*	Cossor 1602	57/6	Optacord 414—412	63/-

* Without pocket

A. BROWN & SONS LTD.

24-28 GEORGE STREET, HULL. TEL.: 25413, 25412

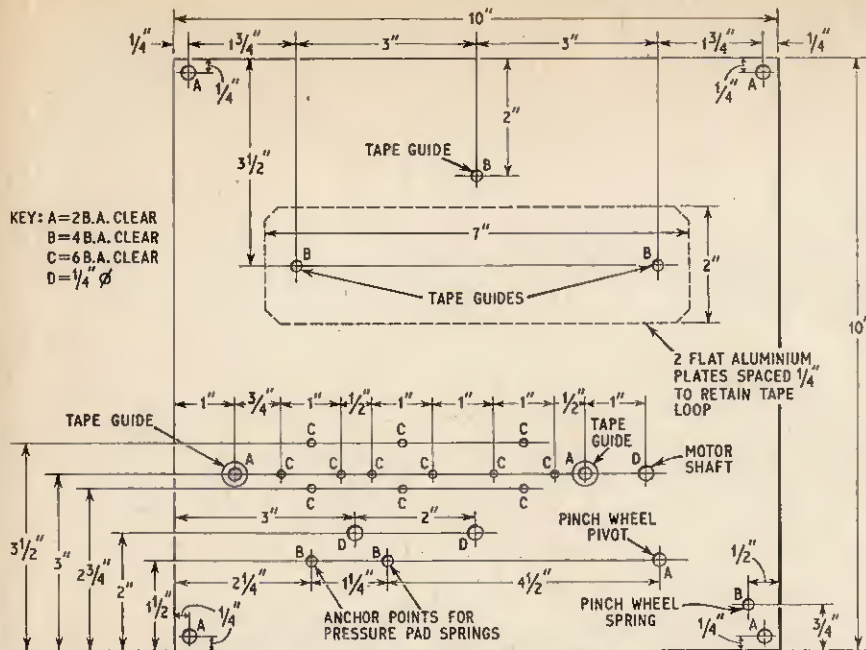
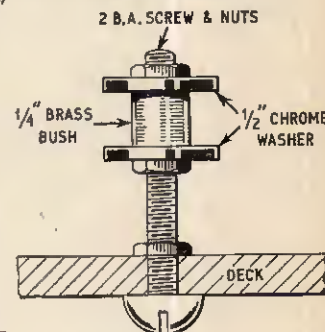

Fig. 4 (left). A plan view of the tape deck showing drilling dimensions

Fig. 5. Details of the tape guides. Five of these are required



The motor was bolted directly to the underside of the plate, the shaft projecting through a hole drilled for the purpose. The three heads, all high impedance, were of the Mariott type as used in the B.S.R. Monardeck, and were mounted on wedge shaped bases so that they could be individually adjusted for azimuth alignment. The distance between the erase and record heads is unimportant, but the playback head should be approximately 2in from the record head in the direction of tape travel.

The tape guides were made from 1/4in brass bushes with a chrome washer top and bottom mounted on a 2B.A. stud. See Fig. 5. These guides were screwed into tapped holes in the deck and secured with a locking nut being adjusted so that the tape ran parallel to the deck.

The pinch wheel, which can be of any diameter, was mounted on a pivoted mild steel arm, held firmly against the motor shaft by a 2in x 1/4in steel spring. This spring is removed when the instrument is not in use, to prevent "flats" forming on the pinch wheel. Details of the pinch wheel appear in Fig. 6.

The two pressure pads each consist of a piece of thick felt cemented to a piece of 1/4in brass strip, the latter being soldered to a 3/8in shaft which passes through a bush in the deck, see Fig. 7. To the lower end of the shaft is soldered a 2B.A. tag which carries a light tension spring. The other end of this spring is anchored to a 6B.A. bolt in the deck plate. The tension of each spring should be adjusted so that the tape is kept snugly against the heads. Too much tension will cause excessive tape head wear. The erase head, having a much wider gap, needs no pressure pad as long as the tape is in contact with the head.

The tape loop itself was about 20in long but this is not at all critical. In order to keep the loop in position, two flat aluminium plates separated by 1/4in bushes were mounted on the deck so that the loop was kept in slight tension. Incidentally, the loop wears extremely well—the author is still using the original, eighteen months after constructing the instrument!

CABINET

The author, not being a particularly good joiner, evolved the following method of housing the instrument. A double decker form of construction was used, the chassis being bolted to four uprights, each 7.5in long and made from 1/2in angle iron. The top and bottom of each upright were bent over and drilled and tapped to take 2B.A. screws (see Fig. 8).

The tape deck was then screwed to the top of the uprights and a plywood base with four rubber feet fixed to the bottom of the uprights.

The sides of the uprights were again drilled and tapped 2B.A. and hardboard panels covered in white vinyl cloth with a cutout covered by gold anodized fret were screwed to the uprights. This resulted in a neat cabinet with side panels and bottom being easily detached for easy access to the interior. A lid was constructed from hardboard cemented to four 1 1/2in x 1 1/2in battens, the whole being covered with white vinyl.

SETTING UP AND TESTING

The setting up process is made easier by virtue of the fact that the result of any adjustment is immediately audible via the playback amplifier.

First of all it is necessary to adjust the tape guides so that the tape is drawn easily past and parallel with the tape heads. The author used a commercial test tape to make the head azimuth adjustment, but it is quite easy to line them up without. To do this, first align the record head visually so that the head gap is as nearly as possible at right angles to the tape; do this by slackening one screw and tightening the other so the head rocks about the wedge shaped base.

The erase and playback heads cannot be adjusted until the amplifier has been set up. Start by setting all preset controls and the echo feedback control to minimum. Advance the playback control about three quarters towards maximum, and feed a suitable signal into the input socket.

Components . . .

Resistors

R1 1M Ω	R10 47k Ω	R19 27k Ω
R2 1M Ω	R11 1.5k Ω	R20 470k Ω
R3 3.3M Ω	R12 330 Ω 1W	R21 3.9k Ω
R4 27k Ω	R13 470 Ω	R22 100k Ω
R5 470k Ω	R14 470k Ω	R23 4.7k Ω
R6 3.9k Ω	R15 5k 5W	R24 220k Ω 1W
R7 100k Ω	R16 5k Ω 10W	R25 2.2k Ω
R8 100k Ω	R17 1M Ω	R26 2.2k Ω
R9 150k Ω	R18 3.3M Ω	

All $\pm 10\%$, $\frac{1}{2}$ W carbon, unless otherwise stated.

Valves

V1 EF86	V3 EF86
V2 ECL82	V4 ECC82
V5 EZ81	

Inductors

- L1 Oscillator coil, 45kc/s.
- T1 Mains transformer. Secondaries: 250-0-25V 70mA; 6.5V 2A; 6.3V 1A (Radiospares "Economy" type)

Switch

- S1 Double pole on/off switch

Sockets

- SK1-5 Coaxial socket, chassis mounting (5 off)

Lamp

- LPI 6V lamp

Capacitors

C 1 50 μ F elect. 350V	C12 50 μ F elect. 350V
C 2 0.25 μ F paper 500V	C13 50 μ F elect. 350V
C 3 25 μ F elect. 25V	C14 50 μ F elect. 350V
C 4 0.01 μ F paper 500V	C15 0.25 μ F paper 500V
C 5 0.01 μ F paper 500V	C16 0.01 μ F paper 500V
C 6 2,000pF ceramic	C17 25 μ F elect. 25V
C 7 1,000pF ceramic 500V	C18 50 μ F elect. 350V
C 8 25 μ F elect. 25V	C19 25 μ F elect. 25V
C 9 25 μ F elect. 25V	C20 25 μ F elect. 25V
C10 500pF silver	C21 0.01 μ F paper 500V
C11 1,000pF ceramic 500V	TC 1 0-100pF preset trimmer

Potentiometers

VR1 500k Ω carbon, preset	VR4 500k Ω carbon, preset
VR2 500k Ω carbon, log	VR5 200 Ω wirewound, preset
VR3 500k Ω carbon, log	

TAPE DECK

Record/Playback Head with mounting plate	A102874
Erase Head with mounting plate	A102875
Pinch Wheel Assembly	A102821

The above items are as used in the B.S.R. Monardeck and are obtainable (via retailer) from:

Elstone Electronics, Edward St., Templer St., Leeds 2.

Mo.I. A.C. Induction Motor, obtainable from:
Radio and T.V. Components (Acton) Ltd.,
21A High St., Acton, London W.3.

Other parts of the deck are made as described in the text.

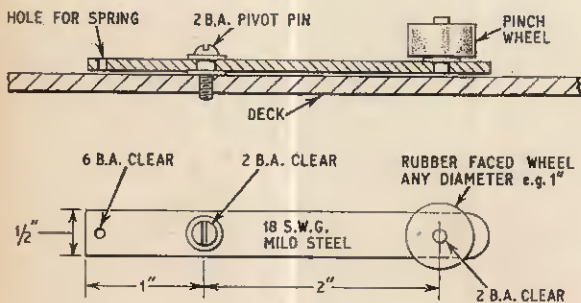

Fig. 6 (left). The pinch wheel mechanism, side and plan views

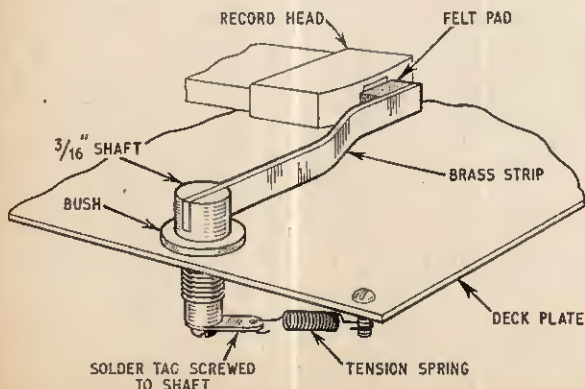

Fig. 7 (left). Detail of the pressure pad assemblies. Two of these are required

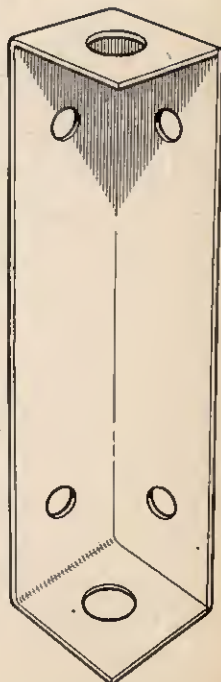
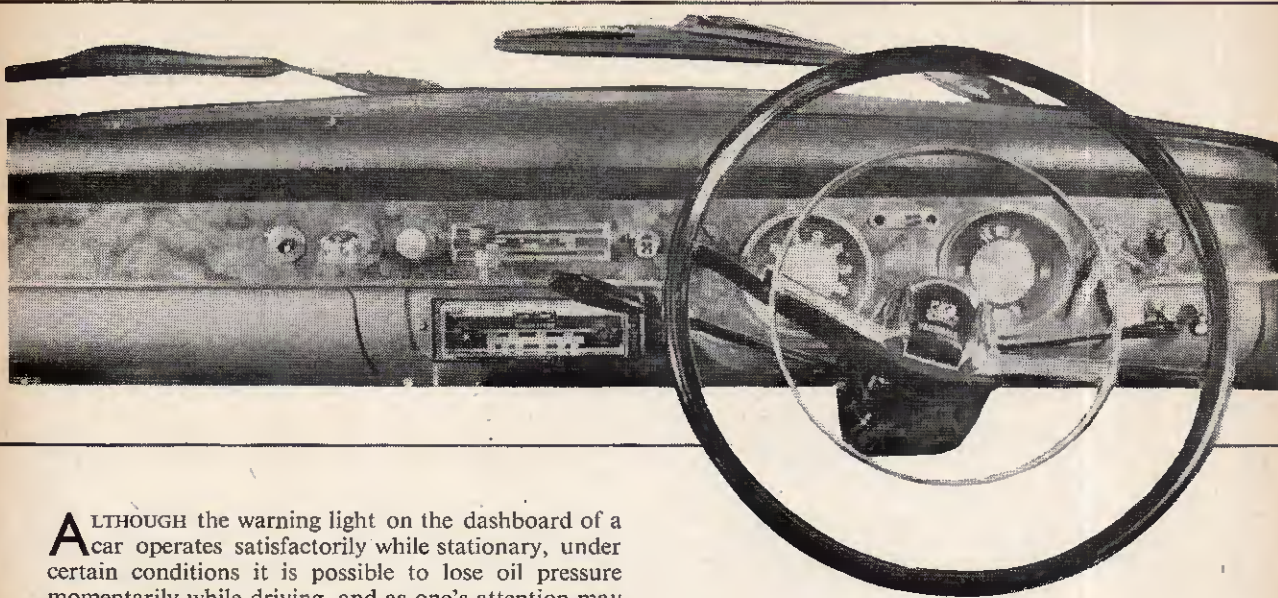

Fig. 8 (right). Detail of cabinet supports. Four are required

continued on page 793



ALTHOUGH the warning light on the dashboard of a car operates satisfactorily while stationary, under certain conditions it is possible to lose oil pressure momentarily while driving, and as one's attention may be otherwise engaged, this may pass unnoticed. The simple unit described in this article will overcome this problem at a very low cost by emitting an audible tone whenever the oil pressure switch operates.

Moreover, the system can be extended, as will be seen later, to give a similar warning when the headlamps and other lamps are left on after the ignition has been switched off. No doubt readers will be able to adapt the unit to give other warnings to suit his own requirements, for example a theft alarm.

OSCILLATOR

The circuit for providing the audible signal is in the form of a modified Hartley oscillator as shown in Fig. 1. A single transistor is connected to a push-pull

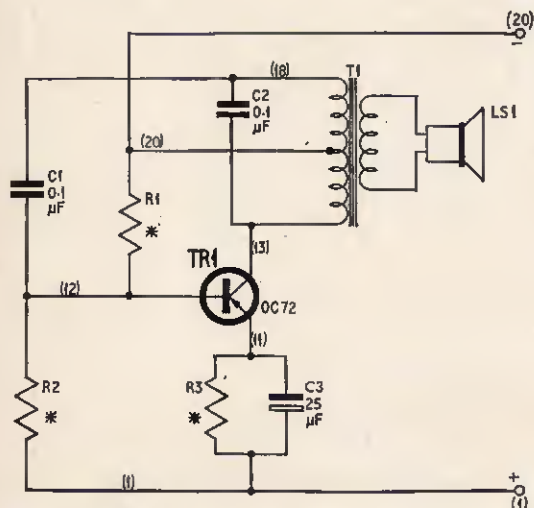

Fig. 1. Circuit diagram of the oscillator. The values of R1, R2, and R3 depend on the car battery used (see the components list.) The reference numbers on Figs. 1 to 5 correspond to the copper strips in Figs. 6 and 7 only

type output transformer (T1). The resulting fluctuations in collector current produce an oscillatory action which is controlled by the stabilising network, R1 and R2.

The frequency of oscillation is determined by the inductance of the primary winding and the value of C2. Since the transformer remains at constant inductance, the easiest way to alter the frequency would be by changing the value of C2.

The power supply for the oscillator is provided by the car battery; the values of R1, R2, and R3 should be of such a value to suit the battery voltage (see components list). Note that the battery connections to the oscillator should be arranged according to which version is required (see Figs. 2 to 5).

If the comprehensive system (shown in Fig. 5) is used the connector can be wired to provide any of the warnings shown by Figs. 2 to 5 or a combination of any two or more of these. The positive side of the oscillator is earthed to the car body through the multi-way connector only if the car battery positive terminal is "earthed". The device may be used on any car, irrespective of the supply polarity, provided that the oscillator is connected the right way round, i.e. positive to positive.

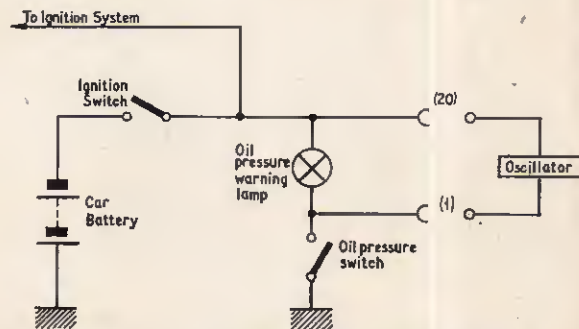
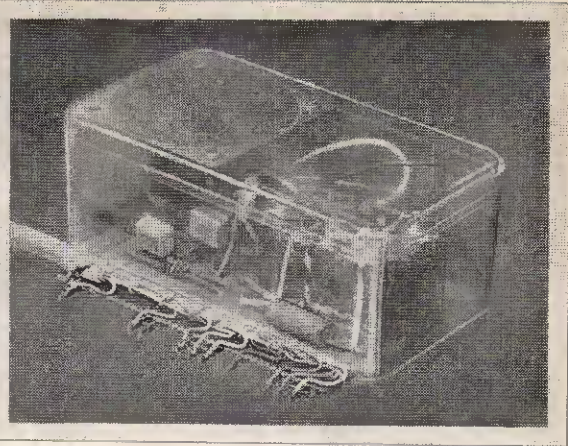

Fig. 2. Basic circuit for giving an audible warning of low oil pressure with the ignition switched on

AUDIBLE WARNING FOR YOUR CAR

BY A. J. HOLMES



OIL PRESSURE

Fig. 2 shows the basic circuit for indicating that the oil pressure is low. The oscillator is connected directly across the oil pressure warning lamp, so that the audible tone can only be switched by the automatic oil pressure switch after the ignition is turned on.

HEADLAMPS

If the driver leaves his car after the ignition is switched off, the circuit shown in Fig. 3 will let him know if he has left the headlamps on.

In this case a relay is used to disconnect the oscillator from the headlamp circuit when the ignition is switched on. When switched off the relay returns to connect the oscillator to the headlamps switch and chassis. The relay should be a type which can be operated on the car battery supply. The type MH2 relay having a resistance of 700Ω as used in the prototype will operate on 12 volts, but for 6 volts a 185 ohm version is necessary.

The dotted lines shown in Fig. 3 indicate wires used in the comprehensive system (see Fig. 5).

OIL PRESSURE AND HEADLAMPS

Fig. 4 shows the circuit combining the functions of oil pressure and headlamp warnings. Two relays are used, and an extra set of contacts (RLB1) are brought into the circuit. Either a direct "chassis" connection to the oscillator for headlamp warning,

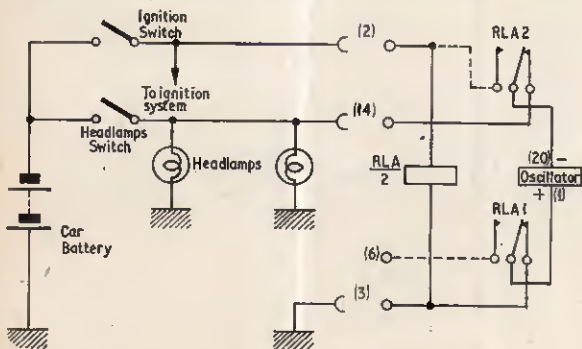

Fig. 3. Basic circuit for giving an audible warning when the headlamps have been left on after the ignition is switched off

or connection via the oil pressure switch for oil pressure warning is achieved. The "normal open" contact of RLA2 is connected to the ignition switch via the multi-way connector to supply the battery negative to the oscillator in the "oil pressure" warning system. The "normal open" contact of RLA1 is connected to the oil pressure switch and lamp.

COMPREHENSIVE SYSTEM

The two systems previously described can be combined with any number of extra systems to form an extremely flexible warning system, while the cost is still kept low. The circuit in Fig. 5 and the photograph in the heading to this article shows the prototype unit which was designed on the principles already described.

This unit can be used on comprehensive lines or may be connected to perform any of the previous functions without altering the wiring in the unit. Only the multi-way connector should be wired, according to the reader's requirements from either Figs. 3, 4, or 5.

The circuit shown in Fig. 5a enables three systems to be used to give warnings with two relays additional to the oil pressure system relay. A spare switch and relay can also be incorporated, as shown.

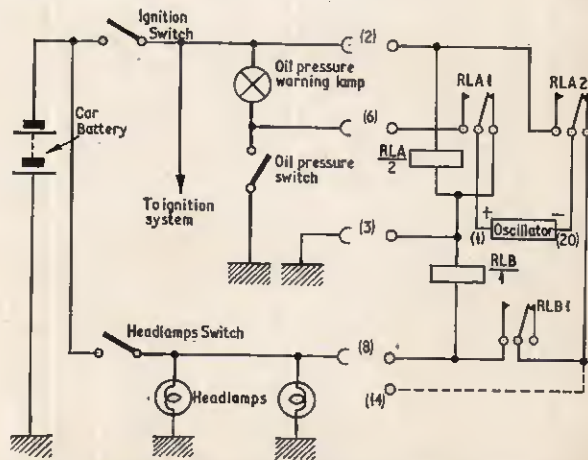

Fig. 4. Combined circuit for low oil pressure and headlamps

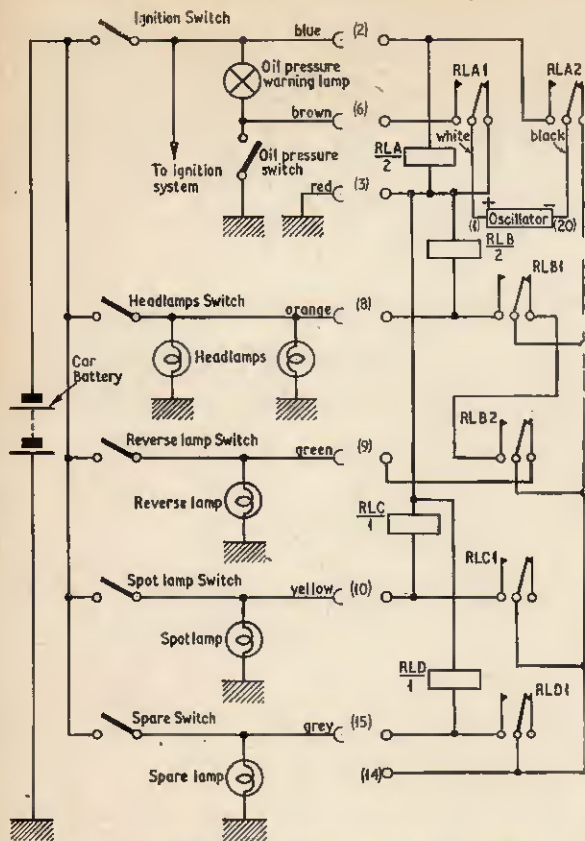

Fig. 5a. Comprehensive system incorporating additional alarms for indicating when either headlamps, reverse lamp or spot lamp are left on after the ignition is switched off. The reference numbers correspond to the copper strip numbers in Figs. 6 and 7 only

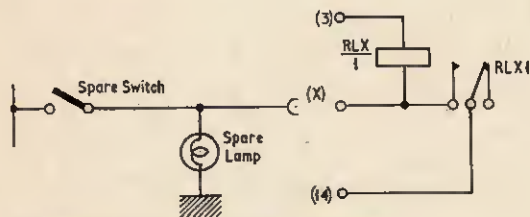

Fig. 5b. Basic circuit of an "add-on" system

The oscillator is switched either to the ignition and oil warning system or the lamps on the car, so that while the ignition is switched on no "warning" sounds can be obtained if the lamps are used in the normal way. However, if any of the lamp switches are left on when the ignition is switched off, the driver is immediately informed.

Provision is made for any extra warning system to be applied by using the lowest part of the circuit where the "spare" position is connected to terminal 15 on the multi-way connector. This can be used, for example, as an anti-theft device. The spare switch can be a microswitch attached to the door, and the spare lamp can be a flashing lamp which is conspicuous to passers-by.

Additional systems can be attached by connecting the basic circuit of Fig. 5b to terminals 3 and 14; the "x" terminal can be one of the spare unused strips on the board or connected direct to an extra switch and lamp.

CONSTRUCTION

The oscillator can be assembled on either a piece of printed wiring board as in the prototype, a piece of Paxolin sheet $\frac{1}{16}$ in thick, or on a printed circuit. Details for each method will be given in turn. It would also be possible to assemble it on a circular board to fit closely around the loudspeaker magnet, thus making the oscillator very small and virtually self-contained. The relays would need to be mounted separately if required.

PRINTED WIRING BOARD

The prototype version of the comprehensive system was built on a printed wiring board (available from West Hyde Developments Limited). The complete circuit including the relays can be accommodated on the board, then housed in a suitable case, for example a clear plastics sandwich box $5\frac{1}{2}$ in \times 3in \times 2 $\frac{1}{2}$ in deep. In this way the versatile unit can be used on any of the systems described previously.

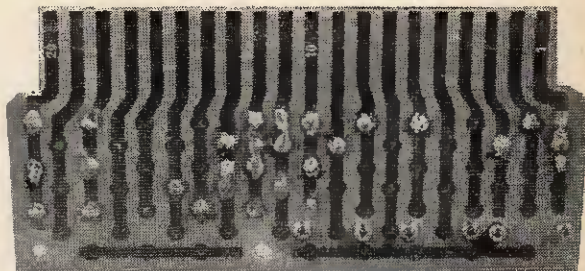

Fig. 6. Underside view of the printed wiring board showing the breaks in the copper strips and additional holes to be drilled. The reference numbers on the strips apply to those in Figs. 1 to 5 inclusive

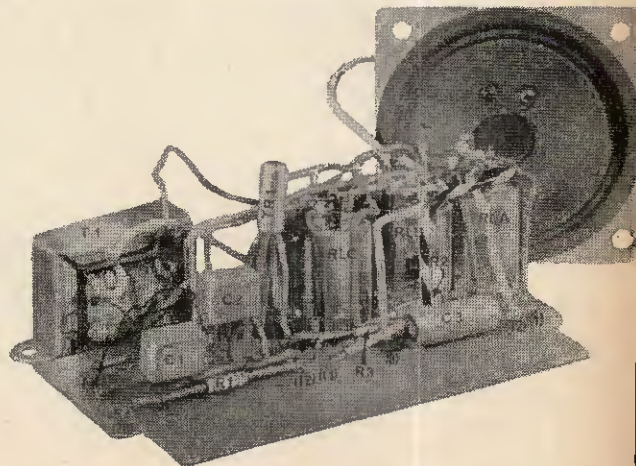

Fig. 7. Top view of the printed wiring board showing the component layout and connections. The transformer can be mounted on the board or in the plastic box

Fig. 6 shows the underside view of the board. It is necessary to drill the board as shown and cut away parts of some strips so that the relays can be mounted on the board. Some additional holes are drilled through the copper strips to take component wires; all soldered connections are shown.

It is probably best to start wiring the components for the oscillator first. The layout of components is shown in Fig. 7. The reference numbers on the strips correspond with those on the circuit diagrams in Figs. 1 to 5, so that any system can be built on this board; conversely the comprehensive system in Fig. 5 can be built for use on any other system required from Figs. 2 to 4. If the diagrams are followed carefully no difficulty should be experienced.

The transformer can be mounted on the board or if housed in the plastics box, it can be fixed to the box as shown in the photograph, so that the loud-speaker will fit in the lid.



Fig. 8. Wiring the connector using multi-way cable

When complete the oscillator can be tested by temporarily connecting a dry battery (6V or 12V according to the circuit values used); positive to strip number 1 and negative to 20. If satisfactory the connector can be wired, as shown in Fig. 8, using multi-way cable with at least eight wires. To avoid undue strain on the wires the cable can be laced and anchored to the connector strip as shown.

The board is mounted in the plastics box using the two holes "A" which were drilled for the transformer. It will be necessary to cut a slot in the side of the box about $\frac{1}{2}$ in wide and 4in long so that the copper strip ends protrude.

It is most important to prevent the unit coming into contact with moisture, otherwise serious damage can occur if the copper strips are short-circuited.

PINBOARD VERSION

Cut a piece of s.r.b.p. sheet $\frac{1}{8}$ in thick, 2in square, and drill the holes as detailed in the diagram (Fig. 9). The two large holes are made with a number 34 or $\frac{7}{8}$ in drill; the other thirteen holes are drilled with a number 56 drill to take short pieces of 18 s.w.g. copper wire. This size of wire will be found to be a fairly tight fit in the holes. It will be necessary to use a pair of pliers to insert the pieces of wire.

The pinholes are numbered in Fig. 10 for reference in the following description of wiring only and do not correspond with those on the circuit diagrams. The side of the board marked out for drilling will be referred to as the front. Cut a number of lengths of the 18 s.w.g. wire about $\frac{1}{2}$ in long and push these into place so that about half the wire protrudes from each side of the board; any surplus wire will be trimmed off later. Turning to the back of the board, connect pins 3, 4 and 5 together with thin wire and solder in position. Now connect pins 6 and 7, 8 and 9, and 12 and 13, as shown in Fig. 10. See the photograph in Fig. 11 for appearance at this stage.

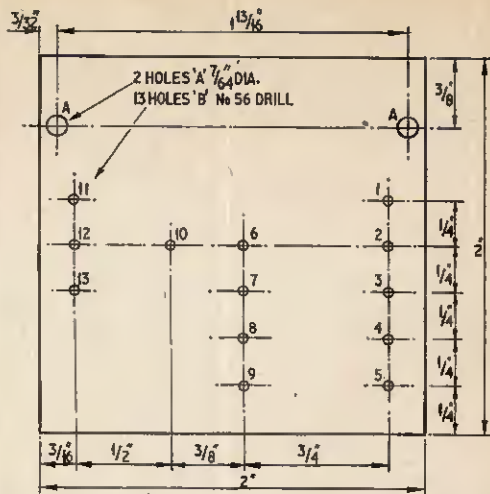

Fig. 9. The oscillator can be built on s.r.b.p. sheet. This drawing shows the drilling details of the sheet. Holes "A" number 34 drill, all others number 56 drill. The hole numbers do not correspond with those in the circuit diagrams, but are only given for the appropriate construction description

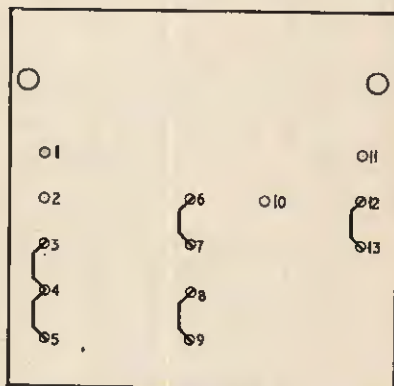

Fig. 10. Wiring the pins on the back of the s.r.b.p. board shown in Fig. 9

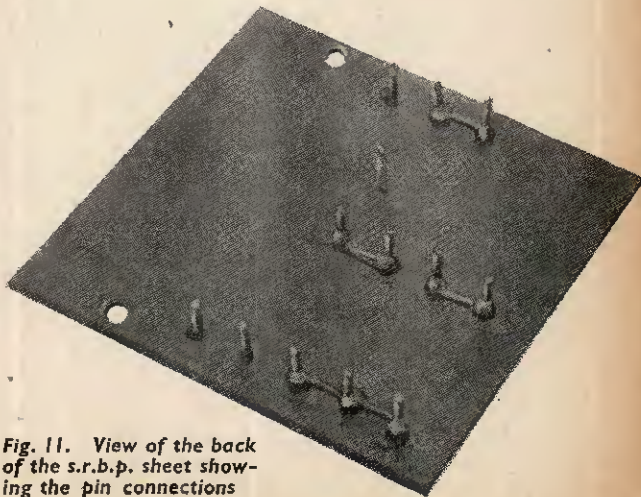

Fig. 11. View of the back of the s.r.b.p. sheet showing the pin connections

COMPONENTS . . .

Turn the board over to the front side. Fit the transformer in position using holes A-A (see Fig. 9), with the leads on the side nearest to the pins. Solder the leads into place: the loudspeaker winding of the transformer (identified as the pair of thick enamelled wires) to pins 1 and 11; the black flexible wire is connected to pin number 2; the red wire to 10 and the blue wire to 12. These wires should be pushed well down close to the board and soldered to the pins.

Fit the resistors next, R1 to pins 2 and 6, R2 to 3 and 7, and R3 to 4 and 8. Now fit the capacitors; C1 to 10 and 12; C2 to 7 and 13; C3 positive to 5 and negative to 9. Check the circuit over very carefully for any doubtful connections before fitting the transistor. Now fit p.v.c. sleeving to the transistor wires and connect the collector to pin 10, base to 7, and emitter to 8, using a heat shunt on the leads while soldering it in position. The collector lead is the wire nearest the spot on the side of the transistor. The loudspeaker leads are connected to pins 1 and 11 on the back of the board; the battery supply leads—red for positive to 5, and black for negative to 2. Now trim off the surplus wire on the pins. Connect to the supply and check that the oscillator works (6 or 12 volt supply according to the resistors used).

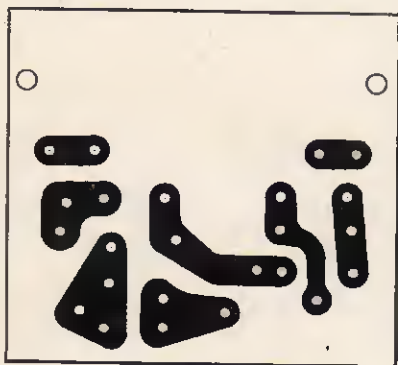

Fig. 12. Pattern for the etched printed circuit which can be used for building the oscillator only

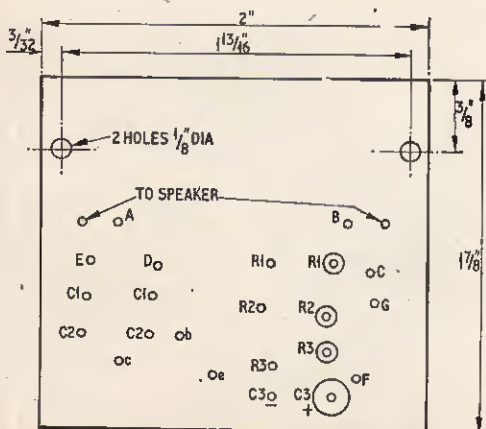

Fig. 13. Connections of the components on the etched printed circuit

Resistors

(6 volt version)

R1 3.3k Ω

R2 1k Ω

R3 68 Ω

All $\frac{1}{2}$ watt 10% carbon

Resistors

(12 volt version)

R1 18k Ω

R2 4.7k Ω

R3 270 Ω

Capacitors (Both versions)

C1 and C2 0.1 μ F plastic 250V (T.C.C. type PMX4)

C3 25 μ F elect. 25V (T.C.C. Elkomold type)

Transformer

T1 Push-pull output type TT5 (Repanco)

Transistor

TR1 OC72 or NKT 271

Loudspeaker

LS1 3 ohms 2 $\frac{1}{2}$ in (E.M.I. "square" type or similar)

Relays

(6 volt version)

RLA, RLB, RLC,

Type MH2 185 Ω

(All relays from Keyswitch Relays Ltd., 120-132 Cricklewood Lane, London, N.W.2)

Relays

(12 volt version)

Type MH2 700 Ω

Component Wiring Board Assemblies

Only one of the following assemblies is needed according to which method of wiring is adopted.

(a) Printed Wiring Board type B (West Hyde Developments Ltd., 30 High Street, Northwood, Middlesex.)

Multi-way connector, with ten clips (Cinch) (available from West Hyde Developments Ltd.)

Multi-core cable "standard" type 8-way (Radio-spares)

(b) S.R.B.P. panel, 2in \times 2in \times $\frac{1}{8}$ in thick and 18 s.w.g. tinned copper wire.

(c) Printed circuit etching kit (Proops Bros.)

ETCHED PRINTED CIRCUIT

While many constructors will have already had some experience in producing small printed circuits, there are, no doubt, others who perhaps would like to try their hand at it.

A kit containing everything that is needed for the oscillator can be obtained from one of the many advertisers in this journal, for example Proops Bros. of Tottenham Court Road, London. In the kit you will find a piece of copper clad board, some abrasive powder, some paint for covering the areas you wish to keep, and some thinners for cleaning the board when you have finished.

Cut a piece of printed circuit board 2in by 1 $\frac{7}{8}$ in, and clean the copper thoroughly with the abrasive powder. Copy the printed circuit diagram given in Fig. 12 by placing carbon paper between the diagram and the copper. Trace the lines through direct from the page. Alternatively trace the diagram on to a piece of tracing paper and then transfer this to the copper. Paint the black areas that you are to keep with the paint supplied, wait until this has dried, and immerse the whole board

in the etching fluid. When the etching is completed, and the areas which should be clear are completely free of copper, remove from the etching fluid and wash under running water. Do not let *concentrated* etching fluid go down the sink if you have copper plumbing, or you may find expensive leaks in the waste pipe later on. Clean off the paint with the thinners supplied.

Drill the holes where indicated. The two larger holes are drilled with a number 34 drill to take the 6 B.A. screws for the transformer.

Fit the transformer into position on the plain side of the board, making sure that it is the right way round. Push the leads into the holes in the board; the loud-

speaker winding is connected to the holes marked A and B; the black wire into hole C; the red wire into hole D; the blue wire into hole E.

Insert the other components as indicated in Fig. 13, putting the transistor in last. Use a heat shunt on the leads while soldering it into position.

Examine the board carefully to ensure that there are no doubtful joints or pieces of solder bridging the gaps between the copper strips. Fix the loudspeaker leads into their respective holes, as indicated, and fit the supply leads, red for positive to hole F, and black for negative to hole G. Connect to the battery supply, (6 or 12 volts according to the components used). ★



NEON NOVELTIES

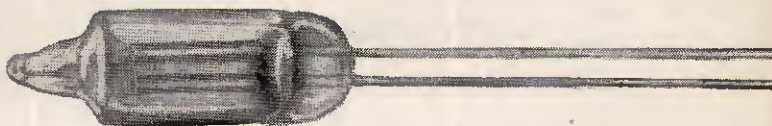

THIS is the first of a series of short articles illustrating some of the many uses of neon lamps. The neons employed are all miniature wire-ended types as shown above.

Two examples which are ideally suited to these applications are those supplied by Radiospares (striking voltage 65 volts), and the Hivac type 3L general purpose neons. The latter type requires a striking voltage of 80 volts and maintaining voltage of 60 volts.

Some neon indicators have a resistor wired in series with one of the neon wires to make them suitable for mains voltages. These would normally be unsuitable for the circuits described unless the resistor is removed or short-circuited.

The series is to be divided into groups, the first group dealing with "games"; there will be three of these. Later groups will describe musical devices and instrument applications.

All circuits are simple and require only the minimum of components and technical knowledge in order to make them. Construction is left to the discretion of the readers as this will depend on their individual applications.

ONE

PANEL GAME SWITCH by R. Bebbington

GRAD.I.E.R.E.

READERS will no doubt be familiar with the device used on television panel games to ensure that the first player ready with the answer is identified. Each member of the panel has a switch and an associated light at his disposal which will glow if he is lucky enough to operate his switch before the other contestants. This can be done with relays but a simpler circuit using miniature neons is described.

The first player to press a switch will cause his neon lamp to glow as it draws current from the battery through the limiting resistor. Any other switch that is "made" even fractionally after this will have no effect because the voltage across the neons is now the maintaining potential of the neon that is struck. For a gas-discharge tube that has a striking voltage of say, 65 volts, this running potential may be around 55 volts, which would be too low for the others to strike. The player must of course release his switch or push-button before the quiz-master poses the next question.

Any number of neons may be used, each of these requiring its own individual switch, which can either be adjacent to it, or identified on a remote display panel.

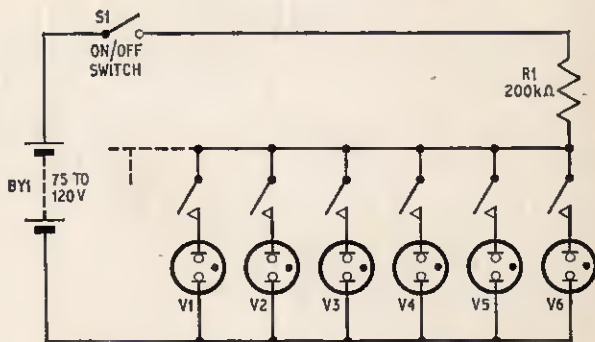

Several alternative uses for this circuit will probably spring to mind. In miniature car racing a contact situated at the end of each track could be linked up to this circuit and would prove most useful in the event of a close finish. The result could not be in dispute with a neon lit. Perhaps not a photo-finish, but a neon-finish!

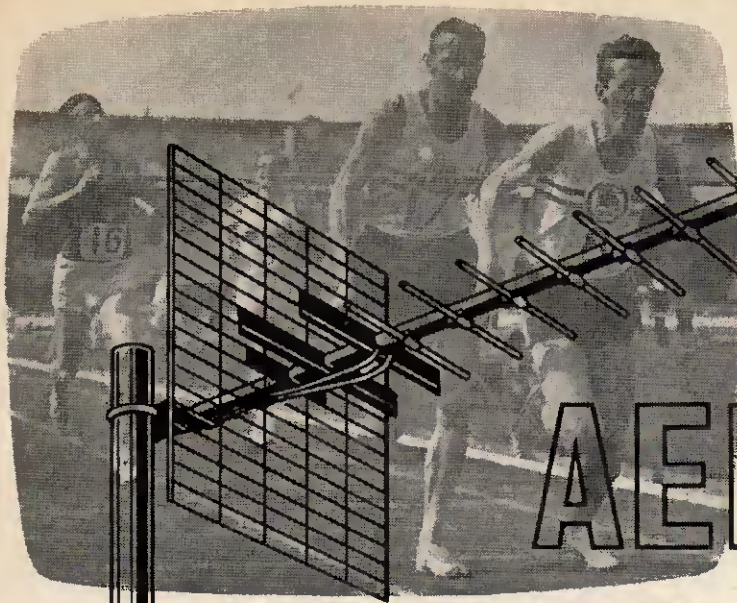

AERIALS

FOR UHF

By J. D. Benson

IN LAST month's article we discussed the properties of radio waves when transmitted at different frequencies and in particular some of the conditions which must be observed when attempting to receive u.h.f. transmissions. In this article, practical information is given for the construction of aerials for receiving BBC2 within the service area and for more distant reception.

To join the aerial to the receiver, coaxial cable must be used and for u.h.f. reception low-loss cable is a must. The use of inferior cable can completely negate the effectiveness of the signal induced in the aerial.

The construction of three types of aerial will be considered. One is a loft type for use in areas of strong signal and a further two outdoor arrays to cover medium and long distance will be discussed.

The reception of u.h.f. signals is largely conditioned by the position of the aerial relative to the transmitter, i.e. an aerial at long range but situated on a hilltop may give better results than an aerial within the service area, but which is overshadowed by tall buildings.

In weak signal areas little can be gained by increasing the size of the aerial beyond certain limits, but it is possible to amplify weak u.h.f. signals successfully by the use of transistor pre-amplifiers, mainly because man-made interference is almost non-existent in Bands IV and V. Band I signals are very prone to electrical interference. Therefore, if a weak signal is amplified the interference is also amplified, which generally results in a picture covered in "snow" (patterns of white flecks).

OTHER AREAS

The aerial designs, dealt with in this article are specifically designed for Channel 33 which transmits on the frequencies of 567.25Mc/s for vision and 573.25Mc/s for sound. It was felt that in view of the author's location, i.e. some 60 miles from the transmitter, that

maximum results should be aimed at from the one channel in operation instead of designing an aerial to cover the four channels allocated to the area.

Many experimenters and constructors may, however, wish to construct aerials which will cover all channels allocated for their areas, or to design an aerial for the particular transmitter currently working. The following design information will enable constructors to build aerials both loft and outdoor, to meet their own specific requirements. The author does not claim that the information given is based on purely theoretical calculations, but it is based mainly on practical results.

LOFT AERIAL

Dealing first with the loft aerial, the reflecting elements are approximately three wavelengths long by one wavelength wide. The "bow tie" overall measurement ($4\frac{1}{2}$ in \times 2in, Fig. 2b) is half a wavelength calculated on the mean of the vision and sound frequencies for Channel 33.

$$\text{Half a wavelength } \frac{\lambda}{2} = \frac{300 \times 10^6}{2f}$$

If it is required to cover the four channels allocated (i.e. Channels 23, 26, 30, and 33), then the "bow tie" measurement will be based on the mean of the sum of all the four channels vision and sound frequencies. For the London channels this works out at approximately 530Mc/s (see Table 1). The shape of the "bow tie" elements is important as it provides for the correct impedance transfer to the coaxial cable. If the constructor keeps to the proper proportions shown, a very fair match will be obtained.

The distance of the "bow tie" from the apex of the reflectors is also important, with regard to matching; this should be half a wavelength measured from the apex of the "bow tie" triangle.

Fig. 1 (right). The complete loft aerial with the "bow tie" inside the 60 degree reflector

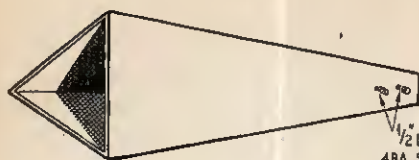

1/2 LONG X
4BA SCREWS
SOLDERED IN
PLACE

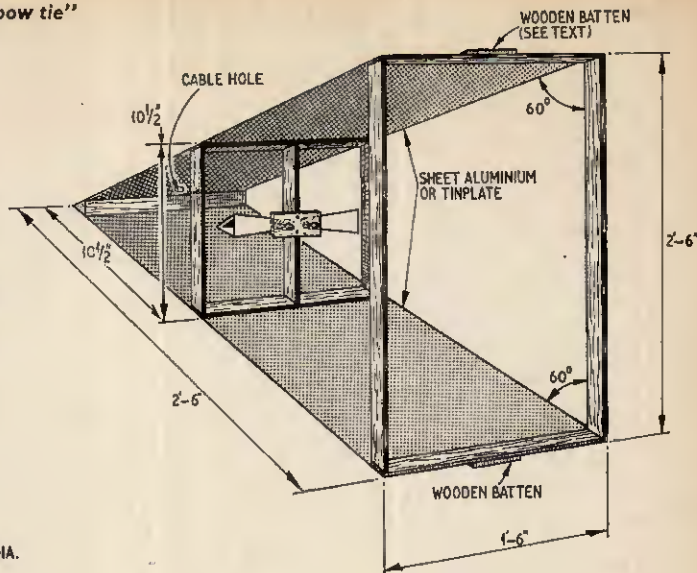

Fig. 2a. Half of the "bow tie" element for the loft aerial. The soldered join is along the back edge or "apex".

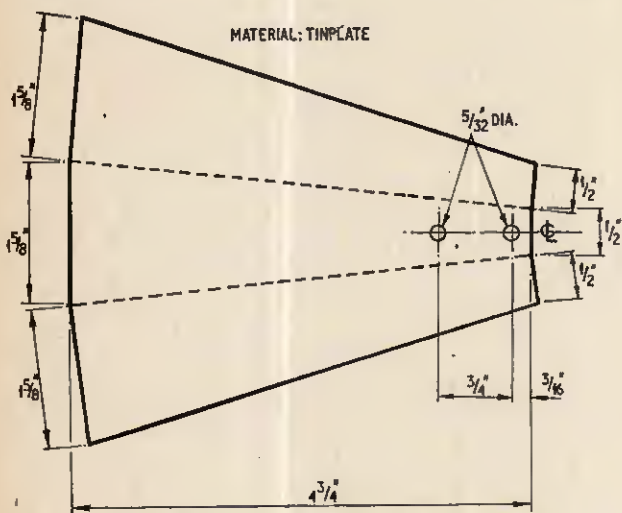

Fig. 2b. Constructional details of the "bow tie". Two are required to be made from sheet tinplate

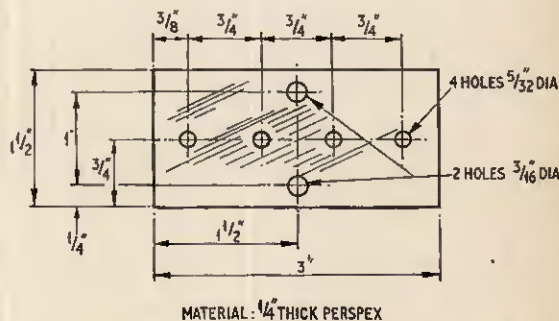

Fig. 2c. Perspex insulator for joining the two halves of the "bow tie" leaving a small air gap between them

The loft type aerial shown in Fig. 1 is of simple construction and has been designed to give best results on Channel 33. The measurements must be adhered to. Wood sizes have been left to the constructor, but the angle of 60 degrees should be accurate, as this contributes largely to the matching of the dipole to cable.

The "bow-tie" dipole elements (Fig. 2) can be made from tinplate and, before bending into shape (Fig. 2a), the 4 B.A. fixing bolts should be soldered in position to prevent turning when mounting on the perspex insulator shown in Fig. 2c. The aerial can be supported by cords attached to the wooden batten which runs along the middle of the reflector surfaces. The "mouth" of the aerial should be directed towards the transmitter and the aerial should be positioned as far away as possible from all metal fixtures (for example, pipes and tanks), which may be in the roof loft.

The gain from this type of aerial is high; it has been successfully used at distances of up to 20 miles from the transmitter. Positioning of the aerial is best carried out by two persons, one moving the aerial in the loft and the other at the receiver to note when best results are obtained.

OUTDOOR YAGI

The construction of the Yagi array calls for careful calculations and measurements. The dipole is half a wavelength overall and is calculated by using the following formula:

$$\text{Length} = \frac{300 \times 10^8}{2 \times 530 \times 10^6} \text{ metres, which resolves to}$$

approximately 28.5 centimetres, which in British units is 11.5 inches. The figure 530 is arrived at by taking the mean of the sum of the vision and sound frequencies of all four channels. In using this formula a correction factor relating to the diameter of the dipole elements should be included, but in practice no ill effects could be observed by its omission. The parasitic element in the centre of the folded dipole is made approximately 15 per cent shorter than the dipole, i.e. approx. 9.5 inches.

The spacing of the Yagi elements from the folded dipole has been based on 0.25 wavelength which gives high gain and good matching. The reflector, which is generally designed at 10 per cent longer than the dipole, is in this case 40 per cent longer to improve the front to back ratio. The vertical overall measurements of the reflector is half a wavelength plus 10 per cent.

Table 1: ALLOCATION OF U.H.F. CHANNELS FOR BBC2

Station	Channels	Frequencies (Mc/s)		Mean channel frequency (Mc/s)	Mean Station frequency (Mc/s)	in operation
		Vision	Sound			
Crystal Palace, London	33	567.25	573.25	570.25	} 530.25	now
	23	487.25	493.25	490.25		
	26	511.25	517.25	514.25		
	30	543.25	549.25	546.25		
*Sutton Coldfield, Warwickshire	40	623.25	629.25	626.25	} 664.25	now
	43	647.25	653.25	650.25		
	46	671.25	677.25	674.25		
	50	703.25	709.25	706.25		
Wenvoe, South Wales	44	655.25	661.25	658.25	} 672.25	12 Sept. 1965
	41	631.25	637.25	634.25		
	47	679.25	685.25	682.25		
	51	711.25	717.25	714.25		
Winter Hill, Lancashire	62	799.25	805.25	802.25	} 788.25	17 Oct. 1965
	55	743.25	749.25	746.25		
	59	775.25	781.25	778.25		
	65	823.25	829.25	826.25		
Emley Moor, Yorkshire	51	711.25	717.25	714.25	} 672.25	17 Oct. 1965
	41	631.25	637.25	634.25		
	44	655.25	661.25	658.25		
	47	679.25	685.25	682.25		
Rowridge, I.O.W.	24	495.25	501.25	498.25	} 540.25	14 Nov. 1965
	21	471.25	477.25	474.25		
	31	551.25	557.25	554.25		
	41	631.25	637.25	634.25		
Black Hill, Lanarkshire	46	671.25	677.25	674.25	} 664.25	12 Dec. 1965
	40	623.25	629.25	626.25		
	43	647.25	653.25	650.25		
	50	703.25	709.25	706.25		

All of the above stations are horizontally polarised.

The first named channel for each station is, or will be, used initially. The other three channels in each case are for possible future services.

* Sutton Coldfield is, at present, in operation temporarily on low power and becomes permanent on full power 4 October 1965.

Table 2: BBC2 FILL-IN STATIONS FOR THE LONDON REGION

Due to hills obstructing the path of u.h.f. signals to aerials in valley areas, the following fill-in stations are to be brought into service in the near future in the London Region.

Station	Channel	Frequencies (Mc/s)		Mean channel frequency (Mc/s)	Polarisation
		Vision	Sound		
Hertford	64	815.25	821.25	818.25	} All these stations will be vertically polarised
Tunbridge Wells	44	655.25	661.25	658.25	
Reigate	63	807.25	813.25	810.25	
Guildford	46	671.25	677.25	674.25	

The director elements are spaced 0.25 wavelength from the folded dipole and from each other. The director nearest the dipole is 10 per cent shorter than the dipole and 10 per cent longer than the next one in front. This can be continued for all the directors. In the aerial design given the last five directors were made the same length; no deterioration could be detected.

The design of u.h.f. aeriels is a difficult problem and one that even manufacturers differ on. The problems which confront the aerial designer are many and whilst no claim is made that the design figures given are optimum, a very serviceable aerial can be constructed if they are carefully adhered to.

As an outdoor aerial is subjected to wind and rain the construction must be rugged but light in weight and rust resistant. The design is the result of a great deal of experimental work and gives excellent gain under adverse conditions. Used at 50 miles range with a single stage transistor pre-amplifier, excellent results can be obtained. The construction is straight-forward and well within the average experimenter's resources.

Since light weight is essential, aluminium has been used throughout with the exception of the securing clamps which are of steel, plated to prevent rust. Well painted brass or sheet iron clamps would do equally well.

Most of the metal sections used can be obtained from ironmongers or "do-it-yourself" shops, but in case of difficulty all necessary parts cut to size and drilled,

can be obtained from Messrs. George Morton (Aerials) Ltd., Shuttleworth Road, Goldington, Bedford, who state that parts or complete sets of parts can be supplied for constructing these outdoor aeriels—but not the loft array.

The main boom of the aerial is made of $\frac{1}{2}$ in square section aluminium tube. The nine directors are $\frac{7}{8}$ in half round section aluminium; each one is held in position by a 4 B.A. screw and clip which is fitted to each director to prevent it twisting out of alignment. Note the differing lengths of these directors in Fig. 3a and clip in Fig. 3b.

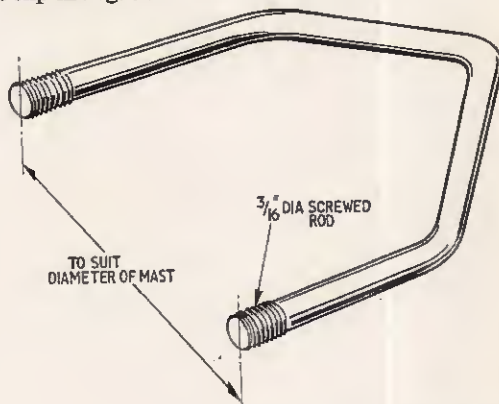

Fig. 5a. This 'U'-shaped cleat is fixed to the upper holes in the bracket (see below) to hold this bracket firmly to a vertical pole

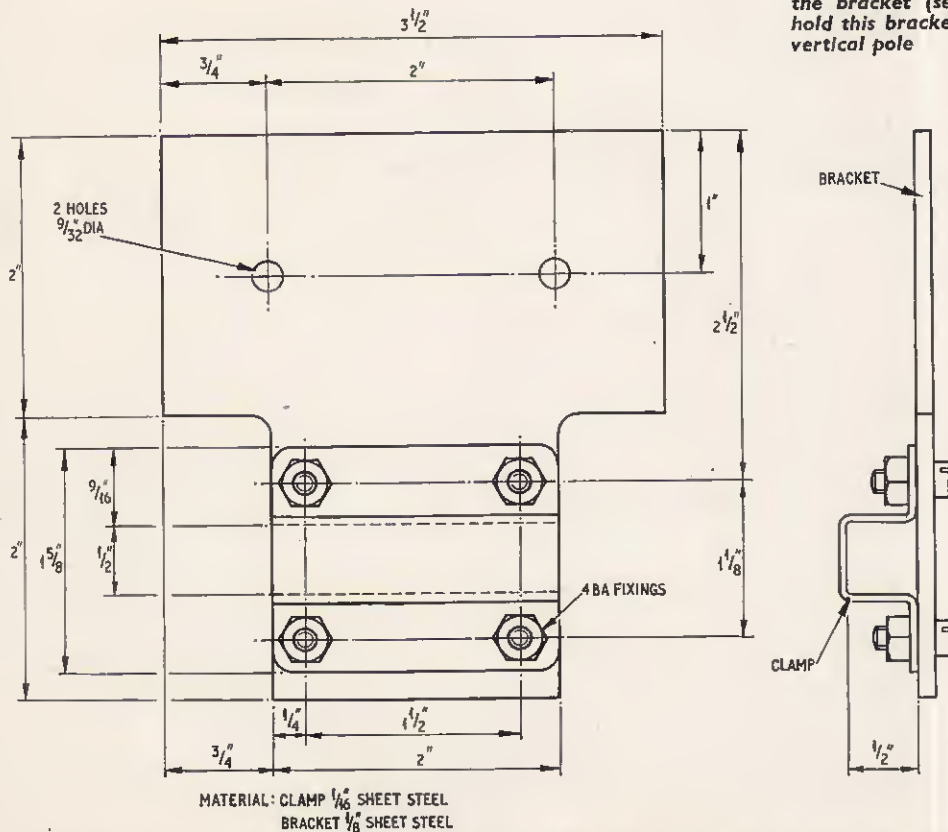

Fig. 5b. Details of the clamping plate and bracket. All parts should be well protected by painting with a primer, undercoat and gloss finish before assembly

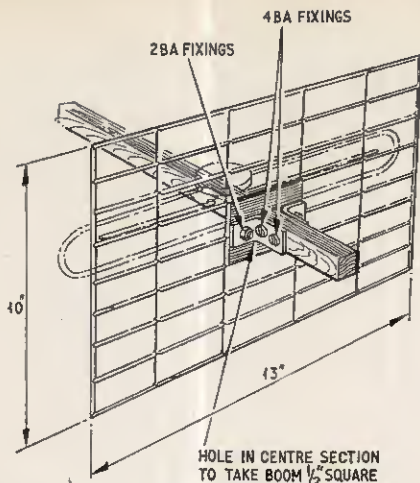

Fig. 6. Constructional details of the reflector fixed to the $\frac{1}{2}$ inch square aluminium boom

The folded dipole is made from a piece of $\frac{1}{4}$ inch solid aluminium (this facilitates bending) and the centre element is of the same material (see Fig. 4a). It will be noted that an extra element is positioned in the centre of the dipole. This extra element is of the highest importance and is responsible for matching the dipole to the feeder cable.

The folded dipole calls for special attention. A special insulator (Fig. 4b) and connection has been used which protects the cable joints from the weather. The use of this special insulator is advised but readers may be able to improve on it and devise an alternative. One method of mounting the dipole and central element

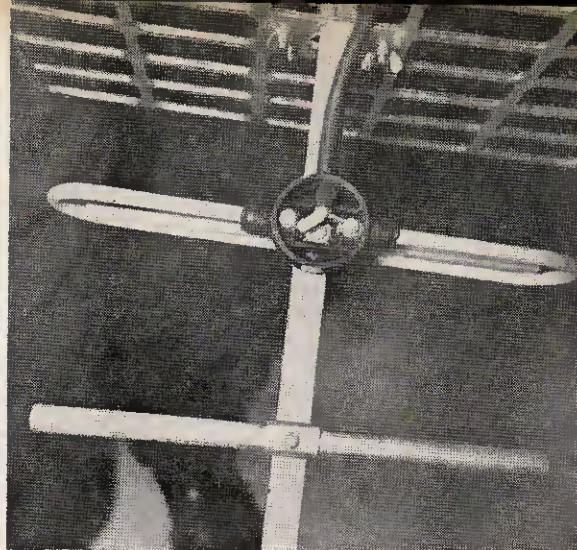

Fig. 7. Close-up view of the dipole showing the coaxial cable connections inside a moulded plastics insulator

ERECTION

The completed aerial should be erected in the highest position possible, consistent with the position of surrounding buildings, and accurately aligned on the transmitter with the help of a friend who can report on results from the receiver below. (Note the coaxial cable connections in Figs. 7 and 8b). U.H.F. aerials must be kept in strict alignment with the transmitter for constant results.

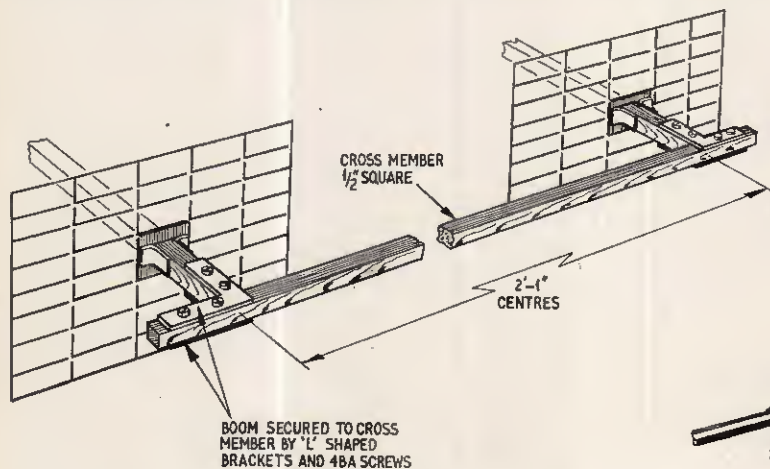
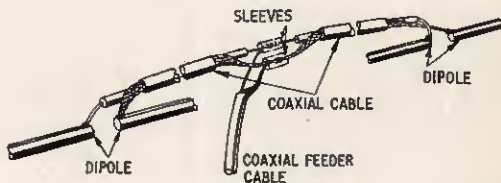

Fig. 8a (left). Details of a twin Yagi arrangement, showing the method of erecting the two arrays on a $\frac{1}{2}$ inch square aluminium cross boom

Fig. 8b (below). The connections of the coaxial feeder cable to the two dipoles so that they are arranged "core, screen, core, screen"



is shown in detail. A block of perspex or hard wood impregnated with paraffin wax can be used. If this method of construction is used the terminal screws should be varnished or painted to prevent corrosion.

The reflector, behind the dipole, is of cast aluminium or it can be fabricated from stout galvanised wire as in Fig. 6. An alternative would be to cut the grid from hardboard and cover with foil.

Throughout the construction, spring washers should be used to prevent the elements becoming loose through vibration in the wind.

Wooden poles should *not* be used for supporting the aerial, as they have been known to twist by as much as 15 degrees due to wet weather conditions.

For distance up to 20 miles, one array is sufficient, provided the site is not overshadowed by tall buildings. Under such conditions two arrays in tandem may be necessary (see Fig. 8 above). For long distance reception two arrays in tandem with a transistor pre-amplifier, preferably mounted at the mast head, will give reliable results.

★

Audio TRENDS...

A Commentary on Sound Reproducing Equipment by Clement Brown

THE SUMMER months are usually rather quiet as far as new audio products are concerned. Therefore it is especially heartening to be able to note that a whole range of high-quality disc equipment, designed and made in the U.K., has been announced by a London firm. Transcriptors Ltd. evidently know how to cater for the increasing numbers of enthusiasts who seek advanced technical features at a less than professional price.

First item on the list is the Transcriptor Arm which, as the illustration shows, is attractive by virtue of its "technical" appearance. There are 10-in and 12-in versions, both of which can be supplied with a head-shell to accept cartridges of normal design. Moreover there are alternative versions with plug-in fittings for E.M.I., Decca Deram and Decca "FFSS" heads.

Technical features include a unipivot bearing reckoned to give bearing friction not exceeding 0.08 grammes; a special counterweight system for both planes of movement; and a lifting device for both lateral and vertical positioning of the stylus on the record. A most comprehensive specification is offered in view of the moderate price of £9 7s which applies to all versions. One version of the arm will be converted to another at the works for a charge of £1 9s 3d.

RECORD CARE

Other items in this new range of disc equipment include the Transcriptor Sweep Arm (£2 9s 10d), a cleaning brush which tracks the record; and a stylus brush costing £1 9s 3d. Then there are the Transcriptor Stylus Scales, priced at £2 8s 10d; this gadget is claimed to measure playing weight much more accurately than any competitive device. Full des-

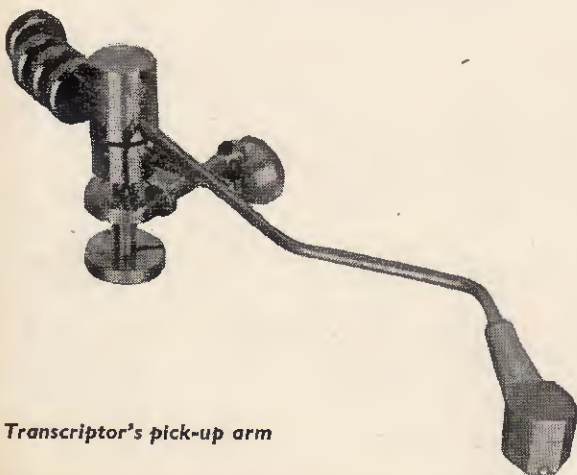

Transcriptor's pick-up arm

criptions of these items are available and should prove of special value to those investigating disc equipment for the first time. Write to the firm at 26 Bloomsbury Way, London, W.C.1.

Of course, the availability of cleaning brushes and other "record care" accessories reflects the increased interest in obtaining optimum performance from the more advanced pick-ups. Now that the most costly models track at a gramme in suitable arms, or even less under the most carefully controlled conditions, there must be painstaking care over removal of dust from the record groove. Again, many users wish to clean sticky deposits and fluff from the stylus tip.

Flicking the stylus with a finger does *not* clean it, and one can quite easily damage the stylus-bar or the compliant pivot in the cartridge. A few months ago Metro-Sound introduced a cleaning kit comprising a small brush and a bottle of cleaning fluid, and at the same time they made available an antistatic turntable mat. It is just as important—though for different reasons—to clean tape recorder heads, and Metro-Sound have a kit for this also.

TAPE RECORDERS

And so from disc to tape. Although British engineering in this field would take some beating—at least at the professional end of the range—the increasingly international nature of tape recording undoubtedly adds a great deal of interest and variety for the hobbyist and serious amateur. The most notable sources of these machines—specialised heavyweights as well as transistor portables—are Germany and Japan.

Indeed, the Japanese industry offers much to attract the serious enthusiast in the U.K. For instance, there are the Akai machines, marketed here by Pullin Photographic, part of the Rank Organisation. One of the latest models is the ST-1, a two-speed stereo recorder with many advanced features and priced at £129 3s. The frequency response is quoted as 40–15,000 c/s ± 3 dB, at $7\frac{1}{2}$ inches per second.

There are 3-watt output stages and transistorised pre-amplifier circuits. The ST-1 provides such facilities—now much in demand—as twin VU meters and "sound-on-sound" recording. It weighs nearly 42 lb—a fair guide to the kind of engineering that goes into a recorder of semi-professional calibre. And this is a portable machine: weights of 60 lb or more are common in non-portable models.

FIXED INSTALLATION

Sony recorders are of course among the best known of Japanese designs. It is perhaps less widely realised that the U.K. distributors include in their catalogue a two-speed stereo tape deck, suitable for building into fixed audio installations. Known as the TC-263D, the

deck has admirably simple controls; it employs the four-track system and has three heads. It is basically the same as the mechanism used in the Sony TC-200 portable recorder, an excellent stereo model of medium price.

With this deck one can use the SRA-3 stereo pre-amplifier, which provides control facilities and recording and playback circuits intended for linking with the main amplifier of a hi fi system. This is one way to add tape: the other obvious solution is a tape unit, in which mechanical and electronic parts are integrated. The enthusiast's approach must depend on the nature of the audio installation.

Prominent among West German tape specialists are Telefunken and Grundig. Additions to the Telefunken range include the M203 four-track stereo machine. It has a built-in power amplifier and speaker for one channel, and it is intended that the other playback channel for stereo will be provided by an external amplifier or radio set. There are such up-to-date facilities as track-to-track transcription, multiplay recording, and the parallel track feature which enables material on one track to form an accompaniment to a programme on the other track. Price is 79 gns.

In the new Grundig TK400 the recording level is adjusted automatically. This mono recorder, which is in the medium-price category (47 gns.), has the 7½ and 3½ in./sec. speeds and accepts 7-inch spools. Two of the four tracks can be played back simultaneously, head-phone monitoring is possible, and synchronised recordings can be made with appropriate accessories.

TRANSISTOR AMPLIFIERS

Tuner-amplifiers, with radio and amplifier sections integrated in one housing, are now seen more often. They are of special interest to those who seek to minimise expenditure on cabinet work by assembling a relatively simple and compact shelf mounted outfit. That this trend has emerged is largely due to increased imports from European and Japanese sources. One of the more elaborate Continental examples, the Dualtone Electra 2000, has transistorised input circuits and is rated at 15 watts per channel. The tuner section, adaptable to stereo, covers f.m. and medium-wave bands.

A fully transistorised amplifier for stereo is the MST-15 by Metro-Sound. Again the specification is elaborate and the output is 15 watts per channel. Pick-up input sensitivity is high at 2mV, so that the most advanced types of magnetic pick-up can be used. The controls include one for tape monitoring as well as switched rumble and low-pass filters.

However, at present the majority of high performance amplifiers, especially those rated higher than 10 watts per channel, depend on valves—at least in the output stages. In general, valve output stages give top-quality results at somewhat lower cost. A very nice example is the new Mk 3 version of the Rogers HG88 amplifier. We are, of course, seeing gradual changes in audio electronics, and we can expect a steady though slow fall in the cost of the more elaborate transistor circuits and techniques.

Those who devise their own cabinet-work hardly need reminding to keep an eye on what is done commercially. Pye always come up with pleasing designs for their audio units, and a recent example is model HF1000—the Peri. As the illustration shows, access to controls and pickup is by way of transparent sliding panels. Pye have added a bigger cabinet outfit, the Pammelia, incorporating their transistor amplifier and tuner units.



Rogers HG88 Mk 33 amplifier

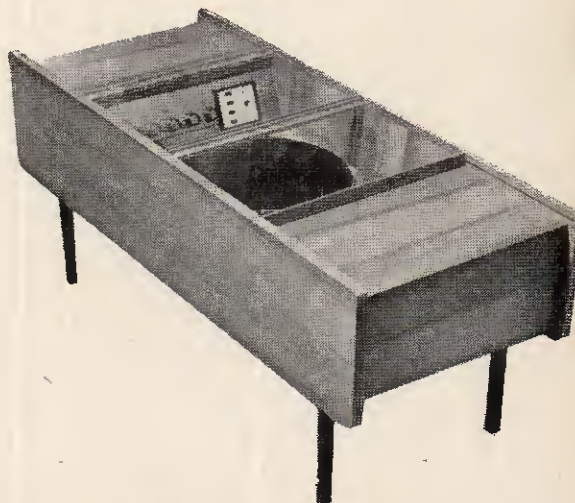

Pye Peri HF 1000

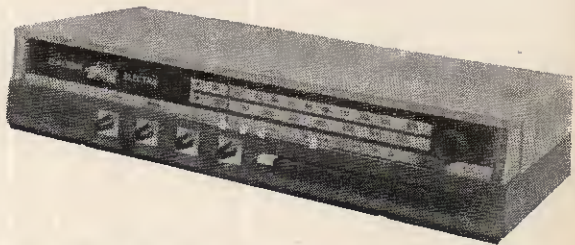

Dualtone Electra tuner-amplifier

SLIDE Synchroniser



by E. G. Prentice

No doubt many readers will have taken photographs while on holiday and wish to show them to their friends. Those who take some pride in showing transparencies with a projector may like to add a professional touch to the show by giving a tape recorded commentary.

The adaptor unit described in this article provides a useful link between the tape recorder and projector to synchronise the commentary with the slides. This facility is extremely useful when automatic "slide change" facilities are provided on the projector. The owner can sit back and relax with his audience while the show proceeds automatically.

Some projectors have a remote control socket with which the synchroniser can be linked to change the slides for you.

During playback the tape recorder reproduces the accompanying programme. The synchroniser amplifies the signals produced by an oscillator, converts them to d.c. pulses and operates a relay, which completes the remote control circuit of the automatic projector.

LOWER TRACK HEAD

The synchroniser was designed to be used with a two-track tape recorder, the upper track being used for the programme and the lower track for the pulses. The head is a lower-track Collaro head having an approximate resistance of 130 ohms. The tape, of course, is non-reversible.

A four-track recorder could be used, provided that a suitable four-track head is used on the synchroniser. Tracks four or one would be used for the pulses and track two or three for the programme. The tape would then be invertable.

If a lower-track head is not available an upper-track head may be used, but it must be mounted upside down.

The original model, shown in the photographs, was made to fit into the microphone compartment of a "Fidelity" tape recorder, but it could be attached to the side of the recorder with suitable brackets. This is obviously left to the discretion of the constructor. The important point to remember is that it should be firmly held in position so that the tape passes evenly round the head on the synchroniser without upsetting the smooth running of the recorder mechanism. The head should be positioned so that the tape passes it after leaving the capstan and before going on to the take-up spool of the recorder. An even tension is necessary to maintain good contact between head and tape.

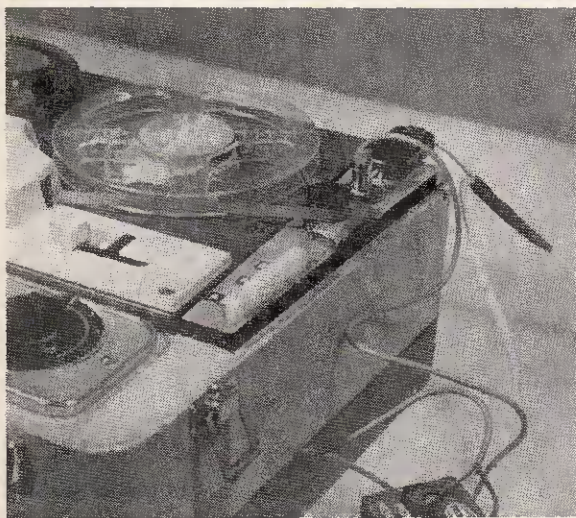

The prototype synchroniser was made to fit a "Fidelity" tape recorder and is shown here fitted into the microphone compartment

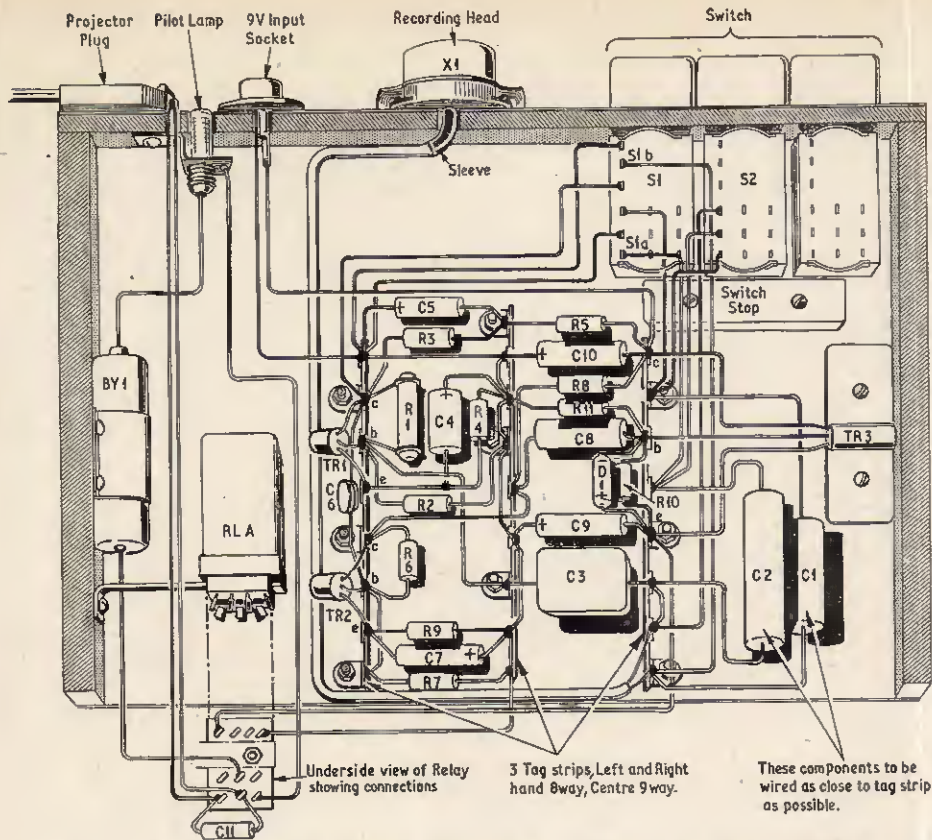

Fig. 2. Layout of components in the synchroniser. The size and shape of individual constructors' units will be determined by the types of tape recorder used

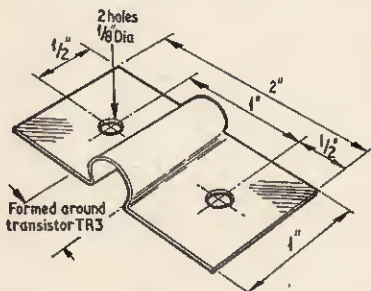

Fig. 3a. Heatsink for TR3. Material can be 20 s.w.g. copper or brass sheet

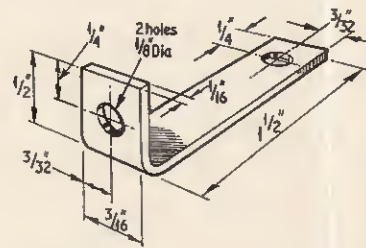

Fig. 3c. Bracket for mounting the relay. The final dimensions depend on the relay used (see text)

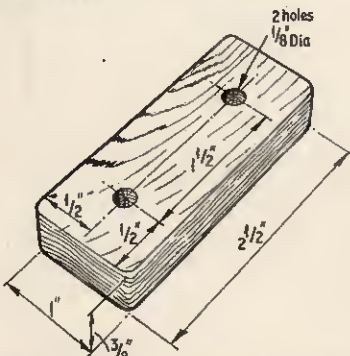

Fig. 3b. Wooden stop block mounted below the push button switches

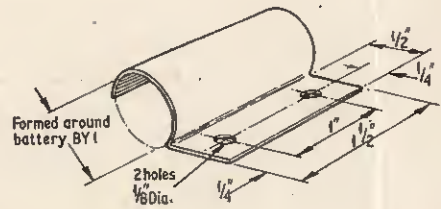

Fig. 3d. Metal clamp for the 1.5 volt cell BY1

two sets of changeover switches. Otherwise the type of switch used is not critical and can even be a rotary type. Fig. 3b shows a wooden stop which is fitted underneath the switch assembly (see Fig. 2).

The relay was mounted on a bracket fixed to the side of the box (see Fig. 3c). The remainder of the components were mounted on tag strips as shown in Fig. 2; the layout is not critical. The small pilot lamp, powered by a 1.5 volt cell clamped to the side of the box (Figs. 2 and 3d), indicates when the relay contacts are closed due to the pulses. This relay has two sets of changeover contacts; the actual type is not important provided the coil resistance is as close to 280 ohms as possible.

COMPONENTS . . .

Resistors

R1	150k Ω
R2	680k Ω
R3	5.1k Ω
R4	1k Ω
R5	270 Ω
R6	1M Ω
R7	100k Ω
R8	6.8k Ω
R9	820 Ω
R10	150k Ω
R11	6.8k Ω

All 10%, $\frac{1}{2}$ W carbon

Capacitors

C1	0.05 μ F	paper	150V
C2	0.2 μ F	paper	150V
C3	0.22 μ F	paper	150V
C4	100 μ F	elect.	12V
C5	16 μ F	elect.	12V
C6	0.047 μ F	paper	150V
C7	32 μ F	elect.	12V
C8	0.1 μ F	paper	150V
C9	32 μ F	elect.	12V
C10	100 μ F	elect.	12V
C11	0.01 μ F	paper	500V

Transistors

TR1, TR2	OC71
TR3	OC81

Diode

DI	OA85 or OA81
----	--------------

Relay

RLA	280 Ω two-pole changeover (S.T.C. type 24)
-----	---

Recording Head

XI	130 Ω Collaro or similar for lower-track recording (see text)
----	--

CONSUMPTION

The battery consumption is very low except when the relay is operated. The following are guides to the currents which you can expect to be drawn under certain conditions:

- Playback—0.5mA
- Erase—2.0mA
- Pulse (relay operated)—35mA

As conditions (b) and (c) are only in operation for very short periods the life of the battery is very good. In fact, it was found that, after 2,000 operations of the slide changer, the battery voltage had dropped only about $\frac{1}{2}$ volt. ★

IT'S A BINDER

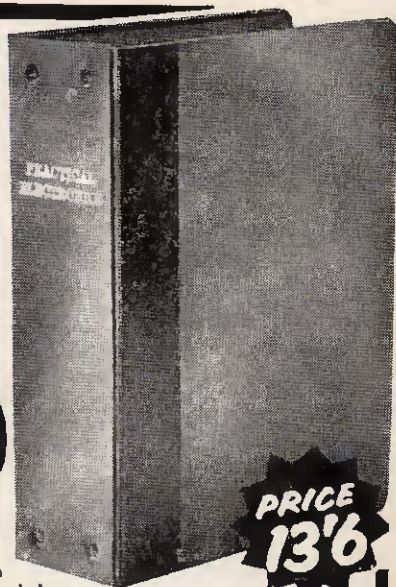

when copies of magazines become misplaced just when they are most needed.

Start off on the right foot and avoid any future frustration by inserting each copy of Practical Electronics, as it is received, into this Easi-Binder.

Handsomely finished in maroon waterproof and grease-proof cloth with gold lettering on the spine, each binder will hold twelve issues of Practical Electronics.

Obtain your binder from: Binding Department, George Newnes Ltd., Tower House, Southampton Street, W.C.2. The price is 13s. 6d., including postage.

ELECTRONORAMA

HIGHLIGHTS FROM THE CONTEMPORARY SCENE

FIRST!

Car-to-Car Phone Call Across the Atlantic

THE first car-to-car telephone call was made on 5 July between London and Montreal. The link was made from a car installed with the new G.P.O. Radiophone manufactured by Pye Telecommunications Limited. Managing Director Mr. John Brinkley spoke to Pye's Canadian Managing Director in a taxi cab in Montreal, via the Bell Telephone Network. The handset was then passed to a reporter who chatted to the taxi driver, Mr. Marx Kaufman.

A few minutes earlier, the Postmaster-General, Mr. Anthony Wedgwood Benn, M.P., declared the Radiophone Service open to London subscribers by telephoning from the G.P.O. Headquarters in London to Richard Dimpleby in a car on Vauxhall Bridge.

Brrr!

D.C. MOTORS, manufactured by Rank Pullin Controls, have to undertake vigorous testing for twelve months before being certified by the Ministry of Aviation.

The photograph below shows the mounting frame, with the motors attached, being withdrawn from a refrigerator after ten days of environmental tests, during which the temperature was varied between -65 degrees and $+85$ degrees centigrade. They are further subjected to changes in pressure and humidity.

Later, the motors are placed in close proximity with tropical fungi to ensure that they would not support fungi growths.

They also have acceleration tests up to 100g and vibrations tests at frequencies up to 500 cycles per second at 30g. During vibration testing the motors complete 22½ million cycles.

The motors are expected to have a life of 1,000 hours of continuous running on full rated load. They are used in aircraft flight systems, missiles and industrial control systems.

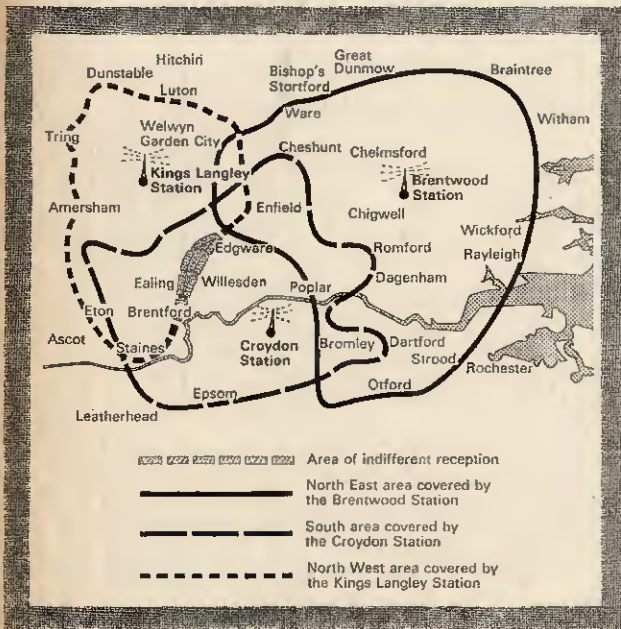

The new service covers an area of up to 30 miles in a rough circle round the centre of London and will, at the start, cater for about 350 subscribers. Provided they are in the service area, subscribers can make and receive calls to any part of the country and to other cars connected to the service. The service area is divided into three sectors, each of which is served by a radio station. These are at Beulah Hill, near Croydon; Kelvedon Hatch, near Brentwood; and Bedmond, near King's Langley. Calls are centrally controlled by operators at the Tate Gallery Exchange, Victoria.

Storno Limited are also manufacturing the radio transmitting-receiving equipment for installation in cars.

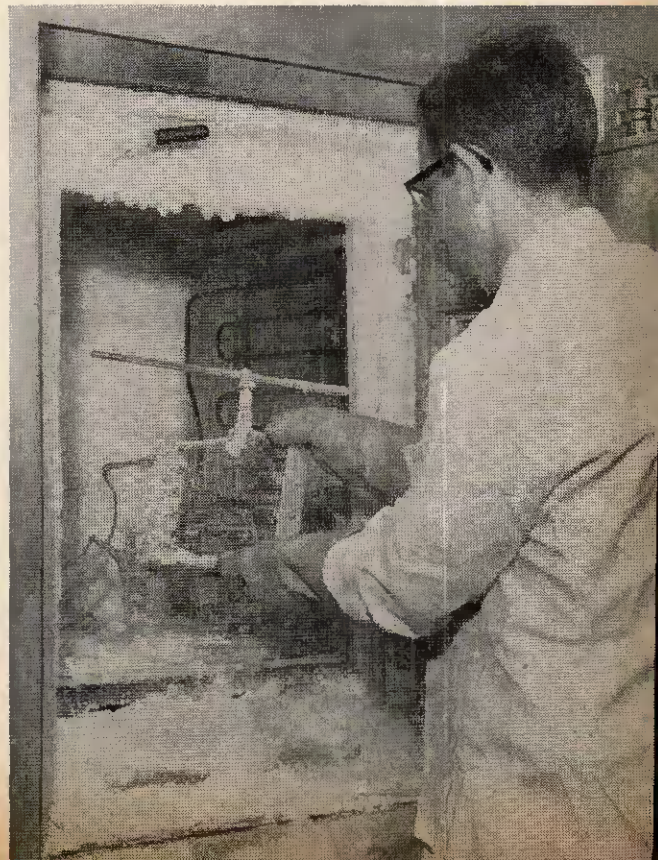



FIRST AGAIN!

Electronic Controlled Colliery

BEVERCOTES COLLIERY in Nottinghamshire is the "Mine of the Future". Equipped with an extensive electronic control scheme, this is the most advanced colliery in the world.

Electronic control is provided for the mechanised longwall faces (coal cutting machinery), all underground transport, shaft winding, and for the coal preparation plant on the surface. The consoles which control these operations are linked to a central control room at the pithead from where they receive information and instructions. The comprehensive communications system includes closed circuit television with cameras located at vital positions below ground. It is expected that a computer will be added shortly, so that the mine can be run entirely automatically, producing a pre-determined coal output programmed at the commencement of each shift.

Coal production will start later this year. It is anticipated that by 1968 1.5 million tons of power station coal will be produced from five remotely operated coal faces with a labour force of only 770 men, compared with a force of 2,000 men required for a similar mine using conventional mechanisation.

The photograph on the left shows part of the underground control room. Cendrex ash analysis in the coal preparation plant is undertaken by the x-ray equipment shown below.

All this . . .

THE new Honeywell Series 9300 Analysis System shown below can compute and plot amplitude versus frequency, power spectral density, peak versus frequency, amplitude ratio versus frequency, cross power spectra, complex transfer function, and amplitude or amplitude-squared versus time.

The output can be presented as an X - Y plot in which the r.m.s. value, or mean square value, is plotted against the log. frequency. It is also available for digitising.

Now we can get down to work!

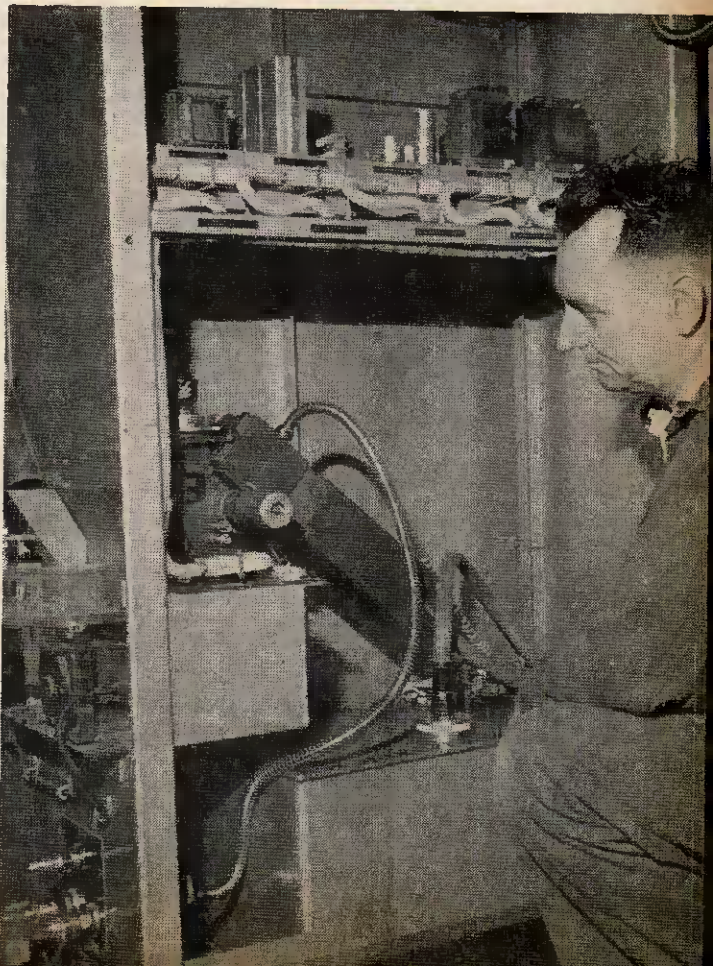
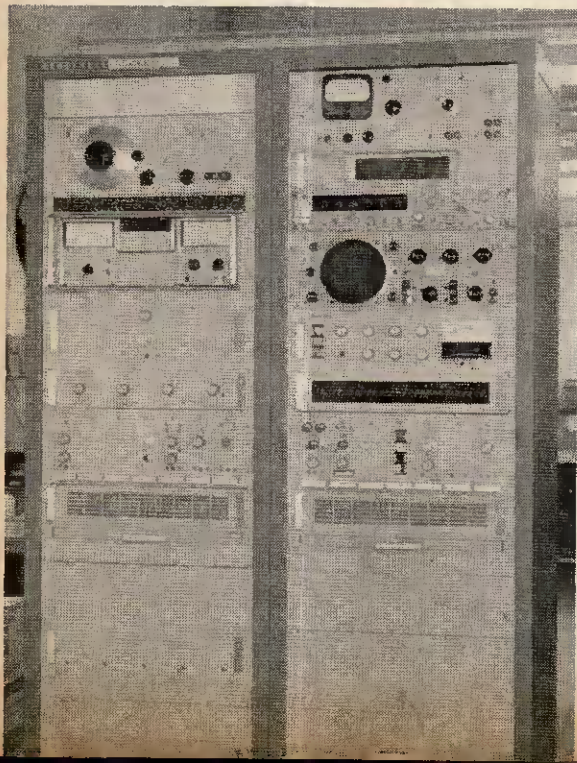

BEGINNERS start here...

11

An Instructional Series for the Newcomer to Electronics

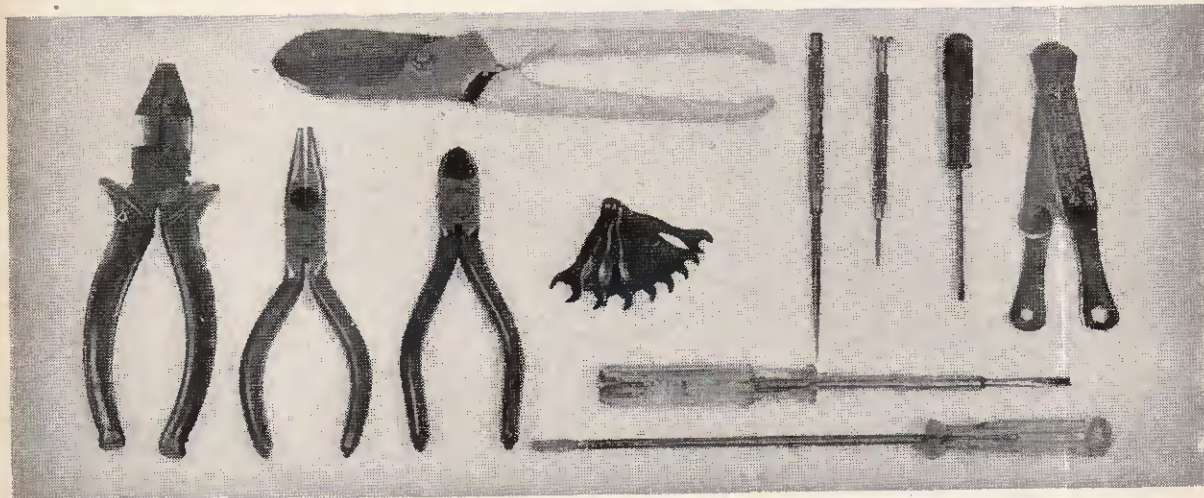

Here are displayed the essential tools for general constructional work. Other more specialised items can be added as the demand arises. In our photograph we show (left to right) square nosed ("electricians") pliers with insulated grips; long nose, side cutting pliers; round nose ("diagonal") wire cutters; set of B.A. spanners (0 to 8); scriber; watchmaker's screwdriver; grub screwdriver; "Bib" wire cutters and strippers. In the top centre is a pair of tinsnips. Finally, the picture is completed with a medium and large screwdriver—one having an insulated shank

WHEN we launched our present series of articles for the newcomer to electronics, we made it clear that both the theoretical and the practical aspects of this hobby would be dealt with. Some of our readers may be thinking, perhaps ruefully, that theory has stolen the stage in our last few instalments. But they may rest assured that the balance will be restored!

Before tackling a.c. theory, we will direct our attention to the other side and talk about materials, tools and workshop practice.

IN YOUR WORKSHOP

If you are a regular reader of our series, there is probably a corner somewhere which is already serving as the "centre of operations" for your constructional work. Our young readers might have a drawer and tabletop in the bedroom (with mum grumbling now and then about "all those bits of wire!"), or perhaps the kitchen table serves as a workbench when the domestic situation permits. Some readers may be fortunate enough to have a separate room or out-building already equipped with workbenches and tools.

Like any practical subject, electronics has certain techniques attached to the constructional work enabling successful results to be obtained with the minimum effort. How about the tool kit for this work in our subject? There are many opinions possible concerning the kind of tools needed. In spite of this, however, the following ideas are probably universal, and should help you to see the way.

CONSTRUCTIONAL METHODS

The methods of construction are now more or less governed by the component makers, whose parts generally have become standardised. Thus an international octal valveholder has a diameter of $1\frac{1}{8}$ in and the fixing holes are $1\frac{1}{4}$ in apart.

Most valve apparatus is built on metal plates (usually aluminium) with side panels, this kind of assembly being called a *chassis*. Very early in the radio construction art, wooden baseboards were used, the components being fixed down with woodscrews. This method is still sometimes used for experimental *lash-ups* and is called, naturally enough, the *breadboard method*.

There has been a rapid development of special techniques to fit in with the modern trend towards miniaturisation, especially in the case of circuits employing transistors and other semiconductors.

The most obvious and well-known of these techniques is the *printed wiring board*. Here one starts with a piece of laminated plastics board which is clad with copper on one side. A special etching process is used to produce a suitable pattern of copper, the unwanted portion of the copper skin being dissolved away by chemicals. This method is best suited for fairly complex circuit designs, and has most definite advantages when a number of identical units have to be made.

Another form of "printed wiring" is available pre-made in a standardised style. One well-known brand is called *Veroboard* and consists of a perforated plastics board with strips of copper attached to one side. This material has figured prominently in *PRACTICAL ELECTRONICS* designs, and can be used for a great variety of projects. And of course, there is no need for chemicals and the somewhat involved preparation required when making an orthodox printed wiring board.

Ordinary, plain plastics board ("Paxolin") can also be used for mounting components, the connections being made by pieces of wire running along the reverse side of the board. To save the labour of drilling holes, the perforated type of board can be purchased. Terminal posts for securing the components can be improvised from short lengths of fairly thick tinned copper wire (16 or 18 s.w.g.). Alternatively, it is possible to buy packets of prepared terminal pins. These are tapered and are of a suitable diameter for the standard type perforated board.

In the course of your practical work in electronics, it is likely that you will make use of all these methods—plus other variations! Plenty of scope here for private enterprise. And after all, part of the fun of a hobby is making good use of seemingly worthless odds and ends.

BASIC TOOL KIT

Before we get down to discussing the above mentioned constructional methods in detail, we must deal with the question of tools. All constructional methods involve soldering, so some skill in this art is a necessity. So important in fact that we will be devoting the major part of our next article to soldering.

In the meanwhile, all methods except printed circuitry require work with wire—and even with printed wiring methods the component leads still have to be trimmed to the correct length. All this indicates that a pair of wire snippers is a "must". The most convenient type are round nose cutters (diagonal cutters). Wire strippers are also useful, but the insulation, usually plastic these days, can be stripped with the cutters, if it is knicked each side of the point required, then pulled off—but it requires some skill not to cut the wire!

A couple of screwdrivers are needed: one to fit the 2, 4, and 6 B.A. screws so common in our work; the

This illustrates the method of bending sheet metal

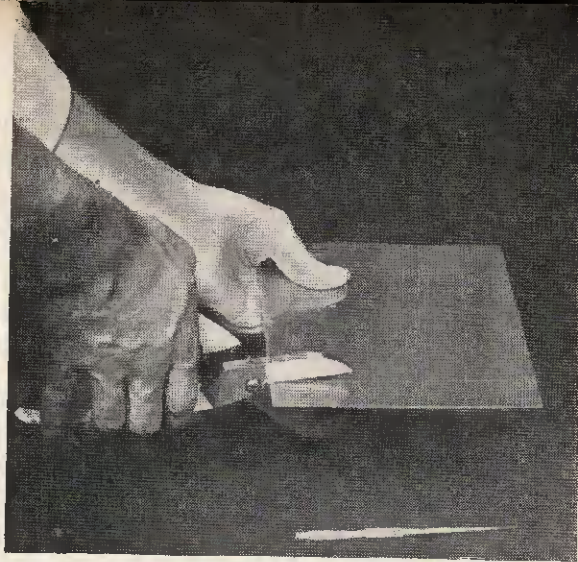
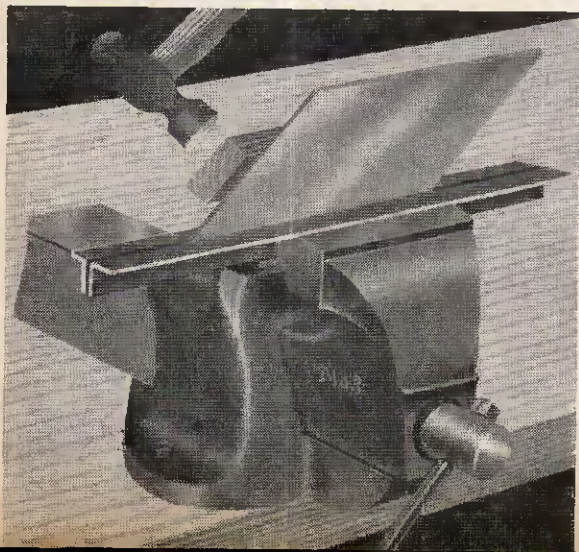

Cutting a piece of aluminium. The scribe is in the foreground

other, smaller, and often called a grubdriver, to fix control knobs onto their spindles.

Closely following on the screwdrivers are pliers. A long nose, side cutting pair of pliers is indispensable. A useful size for general work is $5\frac{1}{2}$ or 6in. Longer, and more finely tapered pliers are most desirable tools—but they are more expensive. A pair of round nose pliers will come in very handy if loops and bends are to be made in wires.

PREPARING THE MATERIAL

Of course, for accurate and neat jobs, the parts involved should be carefully laid out before the cutting and drilling starts. In fact, a simple drawing helps greatly at this stage. It doesn't have to be an honours' grade technical drawing effort, but just a sketch showing dimensions, hole positions, and so on. With a preliminary sketch, perhaps drawn up from juggling around the actual components relative to each other on a piece of wood or paper, any fouling of parts is usually noticed straight away. It is most annoying to find a valve won't plug into its holder because a mains transformer is in the way!

Now the cutting out. The metal or plastics sheet should be marked out carefully along the line of cut: for this operation a scribe is needed. You can obtain one of the proper ones, or sharpen a point onto the blade of a broken screwdriver or steel knitting needle.

When cutting, keep the progress of the hacksaw blade or tinsnips slightly on the waste side of the line, then you will have a tiny excess which can be filed down to smooth off the edge.

BENDING SHEET METAL

Bending sheet metal presents a bit of a problem without a vice, so if you are thinking of some fairly ambitious cabinet or chassis work it might be an idea to fix yourself up with one somewhere. Even then, a vice alone isn't much use—the jaws are too short, and have serrations on them which will make ugly marks on soft metals like aluminium.

For fairly long bends, a pair of angle irons are useful. These can be clamped in the vice and the work gripped between them so that the bend can be made along the whole length. The bend can be started by hand, then finished by means of a hammer and a block of wood: to hit the metal directly would, of course, result in serious dents and marks.

DETACHED PARTICLES

By John Valence

TRIGGER PULSE

IT is quite fascinating how an odd item of news can act as a trigger pulse and set up a train of thought or revive memories of some happening or experience of long long ago.

Take that exciting (or to the insularly minded, disturbing) project the Channel Tunnel, which has been in the news again just recently. Mention of this subject always evokes memories of one of my earliest visits to the cinema, and in particular of a (then) greatly imaginative and futuristic film dealing with international skullduggery. Most details of the plot escape me, but two things remain as vivid impressions: a highly dramatic episode when a time bomb planted on a cross channel train explodes in mid tunnel (or mid channel, as you will); and the appearance of the television phone which seemed to be part of the normal domestic scene. As I recall, images of callers appeared on a picture frame type of screen which retracted into a cabinet when not in use. The script writer had unconsciously leapfrogged the cathode ray tube era and transported us even further ahead into the world of the solid state screen!

Spectacular progress notwithstanding, it is going to take us quite a while yet to catch up with this! Seems a safe bet that the Channel Tunnel will be in existence before the c.r.t. is pensioned off, or even, for that matter, before vision is added to our public telephone service.

By the way, maybe someone will recognise this old film (*circa* 1930) and remember the title. Needn't be afraid of thus revealing your age—you can always say you saw it on B.B.C. television (1965 variety).

NEW BROOMS

YOUNG members of Parliament are reported to be chaffing at the bit and impatient of the traditional ways of the Mother of Parliaments. And who can blame them? Typical and yet pathetic, I thought, was the off-handed manner in which one older MP dismissed all this agitation in a television interview: "always happens with new members—want to have a clean sweep—but soon will settle

down to the traditional ways"—or words of a similar kind.

What a dreadful thought! Let's hope some of the new blood will not succumb too rapidly to the cosy pedestrian ways of the "best club in the country". It is just this fresh outlook that is required and a new wind to blow some of the dust from the multitudinous nooks and crannies down Westminster way.

Seemingly, one of the revolutionary ideas being put forward concerns the use of electronic apparatus for counting and recording votes in the House. Gad, Sir! What will they think of next?

BLAST OFF

THERE are of course good and bad traditions. I will not be alone in regretting that the jet aircraft's ability to blast the eardrums of all those within a mile or two of a major airport seems to be accepted by the authorities as a traditional right. While the aircraft industry is strangely enough absolved from responsibility in this matter, it falls to the lot of other technologies to provide a palliative to this sometimes quite unendurable racket.



"Jones Minor will relieve you after second period of maths..."

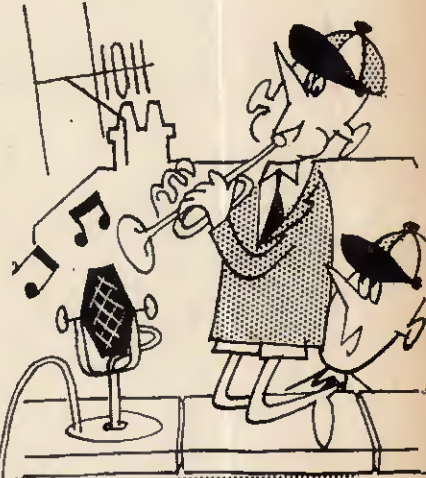

Soundproofing of buildings is a very expensive business. Apart from the additional structural materials needed, the use of double glazed windows makes an air-conditioning system mandatory if the desired result is to be achieved.

An interesting way around this dilemma has been tried out in a school close to London Airport. Instead of a costly air conditioning system, certain windows are allowed to be opened for normal ventilation purposes. These windows are coupled to an automatic device which in turn is connected to a sound detector mounted on the roof. When the sound picked up (as from an approaching jet) exceeds a pre-determined level, this amplified sound operates a solenoid and the window is quickly closed. Subsidence of the noise results in the reopening of the window.

One possible snag I can see arises from the fact that the warmer days coincide with peak holiday traffic on the airlines. With a steady stream of aircraft passing overhead at one minute intervals, I feel the atmosphere inside the classrooms will become a trifle heavy—if quiet. *Wake up there, Jones!*

NEW PRODUCTS

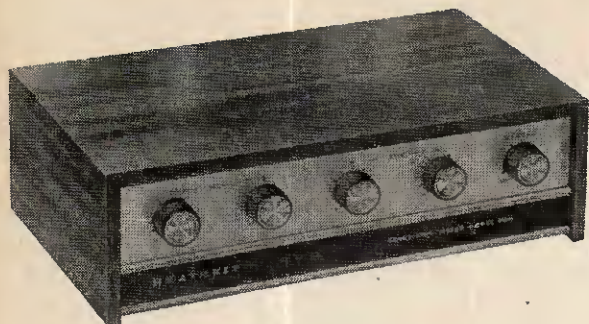

Audio Mixer Kit

Daystrom Ltd., Gloucester, England.

The mixer type TM-1 in our photograph is designed for use with a variety of amplifiers, radio tuners, tape recorders, and dynamic and crystal microphones. Four channels are provided, two of high sensitivity and high impedance and two channels of lower sensitivity and impedance. Each channel is controlled by its own volume control and is automatically earthed when the input plugs are removed.

The technical specifications are as follows: sensitivities (for an output of 200mV r.m.s.), channel one 1.5mV (1 megohm nominal input impedance in "High Z" position); 4.5mV (2.5 megohm nominal input in "Xtal" position); channel two 1.5mV (1 megohm nominal input impedance); channel three and four 180mV (250 kilohm nominal input impedance). The output (for rated input in one channel) is 200mV (600 ohm nominal output impedance). The noise (referred to 200mV r.m.s. output) is -50dB (all channels) in "High Z" position.

The frequency response (ref. 1 kilocycle at full output) is 15 cycles per second to 30 kilocycles per second at ± 3 dB, with a distortion of less than 0.2 per cent at full output. The mixer is powered by a 9 volt battery at 6mA current consumption and has seven transistors mounted on a roller-tinned printed circuit board.

The mixer has individual volume controls for each channel, a master volume control, and on/off switch. A useful facility in the TM-1 is the inclusion of a "music/speech" switch which in the music position gives a linear response. In the "speech" position the response is cut by 3dB at frequencies below 150 cycles per second. By attenuating the low speech frequencies it is possible to minimise the boom effect particularly noticeable in public address systems.

The TM-1 is housed in an attractive oil-finished walnut cabinet which is supplied factory assembled. The front panel is extruded aluminium with a brushed, gold anodised finish. The matching knobs have spungold inlays. The "High Z/Xtal" and "Music/Speech" switches are concealed behind the hinged lower front panel. The TM-1 mixer is available in kit form with full constructional details for £11 16s 6d or assembled and tested for £16 17s 6d.

Stereo Amplifier and F.M. Tuner

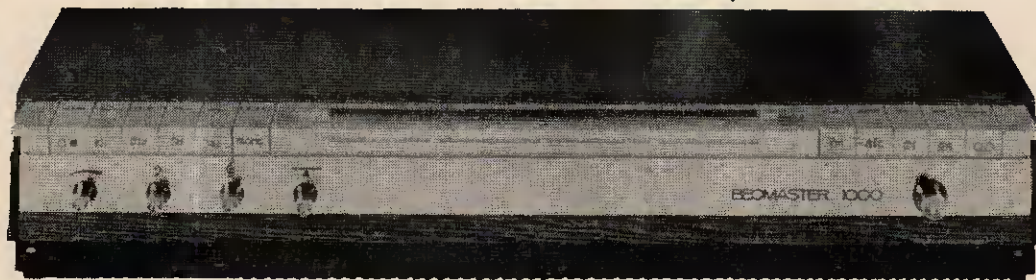

Bang & Olufsen U.K. Sales Division, Eastbrook Road, Gloucester.

Bang & Olufsen announce the U.K. introduction of the all-transistor Beomaster 1,000 stereo amplifier and f.m. tuner. The amplifier gives an output of 15 watts per channel. The f.m. band is extended up to 108Mc/s and incorporates an automatic frequency control circuit.

Other features include: push-button speaker change-over switches which control two sets of stereophonic speaker systems; separate bass and treble controls; balance control for correct stereo sound distribution; separate treble and rumble filters; push-button switching between monaural and stereophonic reproduction, and push-button function selector for switching between f.m., tape recorder, "gram 1" and "gram 2".

The Beomaster 1,000 is styled in a teak or Brazilian rosewood "slim line" cabinet $3\frac{1}{8}$ in high by $19\frac{1}{2}$ in wide by 10in deep with stainless steel control knobs, and "piano-key" selector switches. It retails at 79 guineas.

Miniature Jack Socket

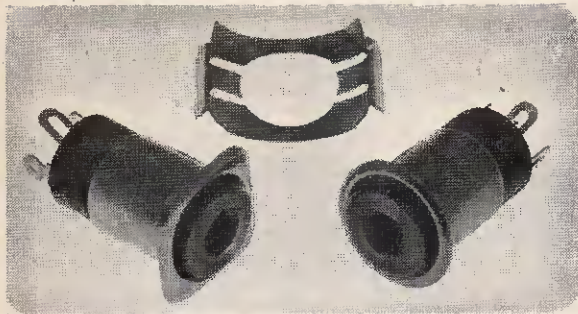

Carr Fastener Co. Ltd., Stapleford, Nottingham.

A new moulded miniature jack socket designed to accept all miniature jack plugs has just been announced by Carr Fasteners Co. Ltd.

The sockets are designed for insertion into a pre-punched or drilled hole of 0.438in ($\frac{7}{16}$ in) diameter where they are secured firmly by a ratchet plate. Two types of nickel plated bezels are available presenting either a circular or square face.

The contacts which have a tinned finish for easy soldering and long storage life, are fully enclosed within the moulding thus protecting them from damage in handling.

High Intensity Neons

West Hyde Developments Ltd., 30 High Street, Northwood, Middlesex.

The above firm have recently increased their range of high intensity neons from two to twenty. They now include 115 volt and 400 volt versions.

Marketed under the trade name of "Brightlife" the neons give greater brightness than their existing models and have 25,000 hours average life. They can be operated at 120 degrees centigrade (panel temperature) and 75 degrees centigrade at the leads.

The neons come in two fixing sizes $\frac{1}{2}$ in diameter and $\frac{3}{8}$ in diameter with one hole fixing; a thin protrusion prevents rotation. The $\frac{1}{2}$ in diameter types are moulded in polypropylene which diffuses the light and are available in white or red housings. The high density polythene bases, with the leads moulded in them, have a high resistance to splashes from chemicals.

The $\frac{3}{8}$ in diameter type are moulded in polycarbonate which gives higher light transmission; these are available in three cap shapes and three colours, red, amber, or clear, dome, top-hat, or square.

Both types give a glow behind the panel which serves as a warning when any servicing is carried out with the apparatus switched on.

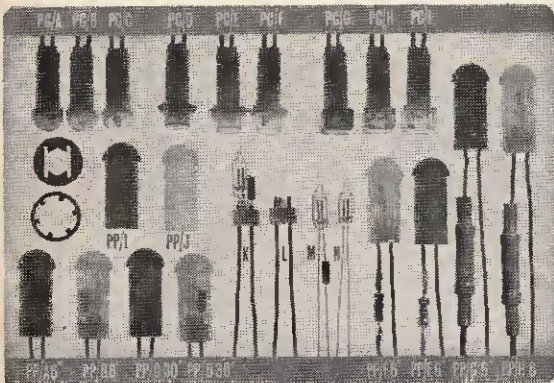

M4 Labelmaker

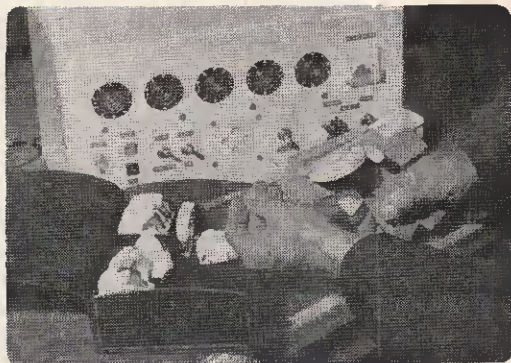

Dymo Ltd., Browells Lane, Feltham, Middlesex.

The unit in our photograph is the Dymo M4 Labelmarker which is proving a very useful gadget in our workshop. The photograph shows the added professional appearance obtained by using the labels on the General Purpose Counter or Scaler to be described in next month's PRACTICAL ELECTRONICS.

The labels are produced by "dialling" the required letter or number on the gun and squeezing the large embossing trigger. Once the label is completed the tape is cut by squeezing the small cut-off trigger.

The tapes for the M4 are available in nine different colours and one transparent version. The self-adhesive tape is $\frac{1}{4}$ in wide and is prepacked in a plastics magazine, which provides easy loading and quick change of colours. The range of colours enables any equipment to be labelled under a coding system.

The M4 Labelmarker costs £3 19s 6d supplied with one roll of tape free. Tape for the M4 is available at 6s 3d per magazine and the colour required must be given when ordering.

FREE *INSIDE
NEXT
MONTH'S* Practical Electronics

2 FULL SIZE BLUEPRINTS TO BUILD

* TRANSISTORISED TAPE RECORDER

Using a commercial tape deck

* CAR ENGINE REVOLUTION COUNTER

Calibrated up to 10,000 r.p.m.

WITH

* WALL DATA CHARTS

For

TRANSISTORS Essential do's and don'ts when using transistors, with lists of equivalents.

BASIC R, C, and L THEORY Handy reference to fundamentals used in electronic circuit design.



MAKE SURE OF YOUR COPY!

COMPLETE AND HAND THIS FORM TO YOUR NEWSAGENT

To _____ (Name of Newsagent)

Please reserve/deliver the October issue of PRACTICAL ELECTRONICS (2/6d.), on sale Sept. 16th, and continue every month until further notice.

NAME _____

ADDRESS _____

ELECTRONIC BUILDING BLOCKS

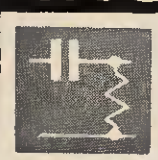

PART SIX

by R. A. DARLEY

LAST MONTH we discussed a simplified method of designing basic stages of a transistor amplifier and described its use in providing phase-splitting circuits. Before going on to the various impedance matching devices, it is probably worth looking at two basic circuits for providing feedback equalisation.

INTEGRATORS AND DIFFERENTIATORS

The circuit of the integrator is shown in Fig. 6.1a, together with its block diagram in Fig. 6.1b. A resistor (R_s) is connected in series with the input and a capacitor (C_f) provides feedback between collector and base. A time constant is thus deliberately introduced in the circuit, so that the degree of feedback that is applied over the complete circuit is made a function of frequency.

If a square-wave is fed into the input, the output will be as shown in the Fig. 6.1c, the degree of change in wave shape being dictated by the effective time constant of R_s and C_f . The effective value of C_f is increased over the nominal value by a factor β (the current gain of the circuit), i.e. $C_{\text{effective}} = \beta \times C_f$.

The capacitive coupling between collector and base results in a substantial reduction in the input impedance at operational frequencies.

The circuit of the differentiator is shown in Fig. 6.2a, together with its block diagram in Fig. 6.2b. In this case a capacitor, C_s , is in series with the input, and feedback between collector and base is obtained via resistor R_f . A time constant is again introduced, and the output amplitude again depends on frequency. The effect of the circuit on a square-wave is shown in Fig. 6.2c.

These two circuits are often used in applications where a non-linear frequency response is required, such as in equalisation networks.

IMPEDANCE AND CURRENT TRANSFER

The main part of this article will discuss the inherent impedance characteristics of transistors and their application to practical circuits.

Certain basic details should be remembered in order to understand these characteristics. The transistors can be used in any one of three configurations, each one making use of the current transfer characteristics in a different way. These three configurations were mentioned in last month's article and are expanded here to show the different ways in which an impedance match may be obtained between two other circuits.

It should be realised that both α and β represent current gains in the transistor, but they are the gains between different parts of the semiconductor. Either term may be used to indicate current gain, as the values of the two gains are interdependent. β denotes the current gain from base to collector while α denotes the current gain from emitter to collector. For example, if the value of α is known then β can be calculated from the following formula:

$$\beta = \frac{1}{1 - \alpha}$$

It will be noted that α can never be greater than 1, but that the nearer it approaches to 1 the greater will be the value of β .

COMMON EMITTER CONFIGURATION

The practical circuit diagram of a common emitter amplifier is shown in Fig. 6.3. The input impedance of this circuit is generally fairly low, in the order of 1,000 ohms, and is not greatly effected by variations in the collector load. Typical values of input impedance with collector loads of zero and infinity, for example, are 750 ohms and 1,500 ohms respectively.

The output impedance is of medium value and likewise is not subject to undue variation of collector load values. With loads of zero and infinity, the output impedance can be expected to be in the order of 25,000 ohms and 50,000 ohms respectively. Ratios of input to output impedances are typically in the order of 35:1.

High orders of current, voltage and power gain are obtained with this configuration although the frequency response of the circuit is not very good; in an amplifier using an OC71, for example, the upper 3dB-down point will normally be at about 11kc/s. The output of the amplifier is 180 degrees out of phase with the input.

COMMON BASE CONFIGURATION

The circuit diagram of a typical common base circuit is shown in Fig. 6.4. The input impedance in this mode of operation is generally low, typically in the order of 35 to 700 ohms, depending on the collector load. It should be noted that the input impedance is greatly effected by variations in the collector load.

The output impedance is generally high, in the order of hundreds of thousands of ohms. Ratios of input to output impedance are very high, frequently in the order of 1,500:1.

The circuit gives high voltage gains, but only medium power gains, while the current gain is invariably very nearly 1.

The frequency response of the circuit is very good; in an amplifier using an OC71, for example, the upper 3dB-down point will be at about 600kc/s.

The output of the amplifier is in phase with the input.

The low input and high output impedances of this circuit make it ideal for matching a low impedance circuit or component into a high impedance one; in this type of application, the circuit is used like a step-down impedance matching transformer. The circuit may also be used purely to take advantage of its very good frequency response characteristics.

COMMON COLLECTOR CONFIGURATION

The input impedance of the common collector circuit, (see Fig. 6.5), is generally high, values of 500 kilohms being obtained with little difficulty.

Output impedances are low, typically in the order of 500 to 1,000 ohms.

The current gain of the circuit is high, but the power gain is low, while the voltage gain is always slightly less than one.

The frequency response of the circuit depends to a large degree on the value of the emitter load, but can, for general purposes, be considered to be about the same as is obtained with a common emitter circuit.

The output of the amplifier, taken from the emitter, is in phase with the input. Thus, the emitter "follows" the base signal and, for this reason, the circuit is generally referred to as the "emitter follower". This is a very important circuit in electronics.

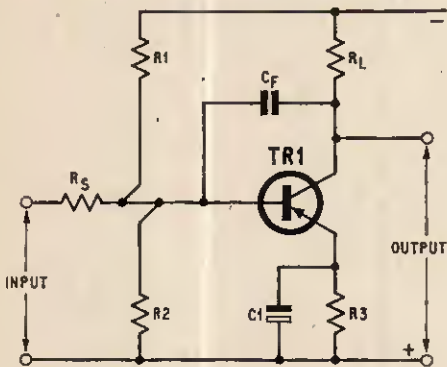

(a) Circuit diagram showing the feedback component C_F

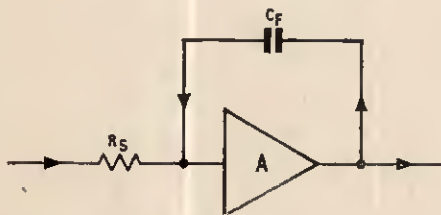

(b) Block diagram

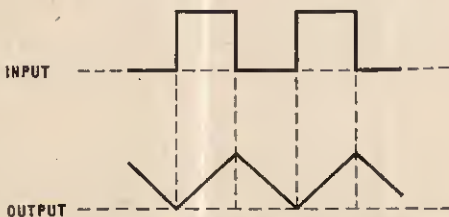

(c) Output waveform from a square wave input.

Fig. 6.1. Single stage integrator

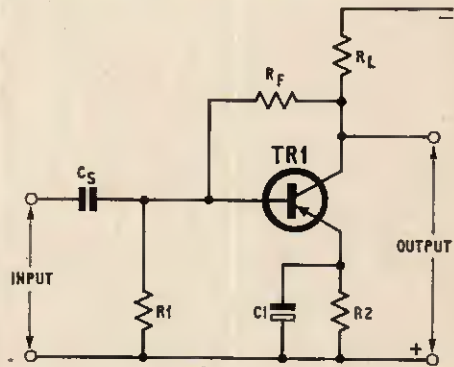

(a) Circuit diagram showing the feedback component R_F

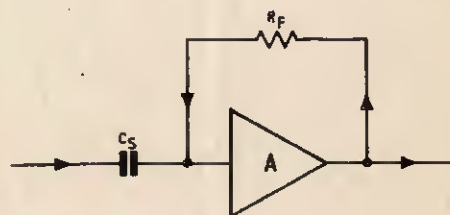

(b) Block diagram

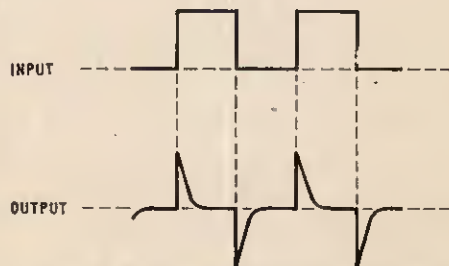

(c) Output waveform from a square wave input.

Fig. 6.2. Single stage differentiator.

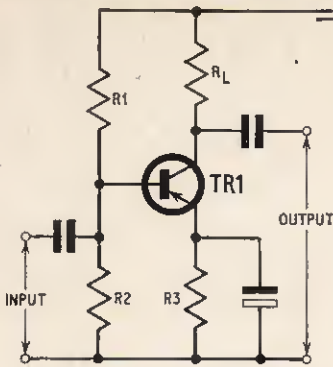

Fig. 6.3. Common emitter circuit giving medium impedance input and output

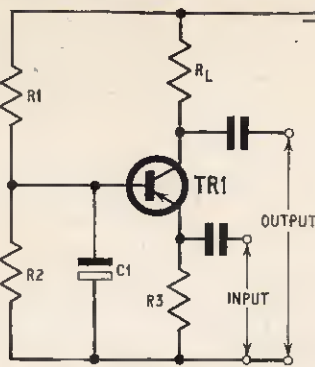

Fig. 6.4. Common base circuit giving low impedance input and high impedance output

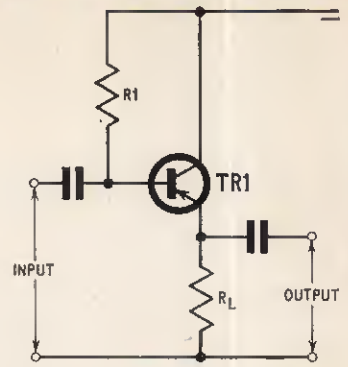

Fig. 6.5. Common collector circuit giving high impedance input and low impedance output

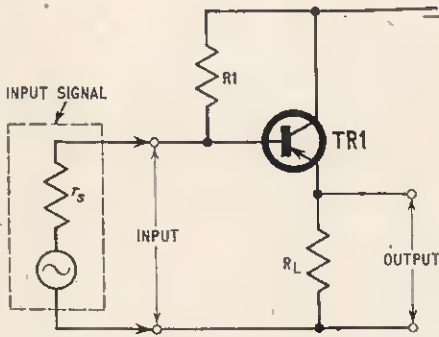

Fig. 6.6. Emitter follower circuit where $Z_{in} \approx \beta R_L$ and $Z_{out} \approx r_s/\beta$

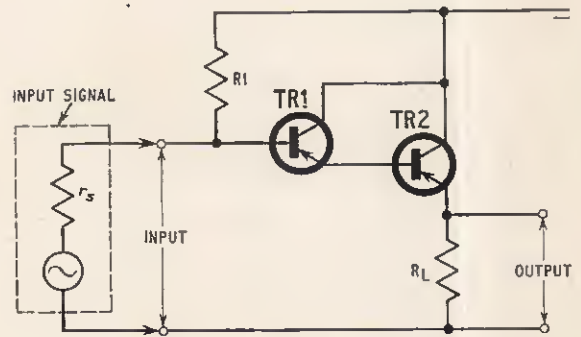
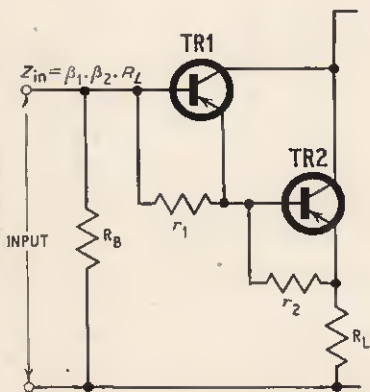
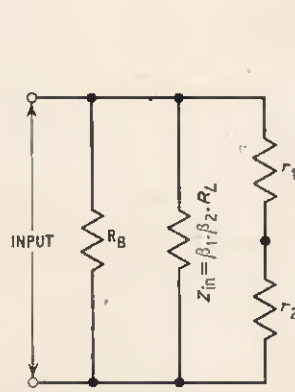

Fig. 6.7. Darlington or super-alpha pair provides a higher input impedance. $Z_{in} \approx \beta_1 \beta_2 R_L$, and lower output impedance $Z_{out} \approx r_s/\beta_1 \beta_2$



(a)



(b)

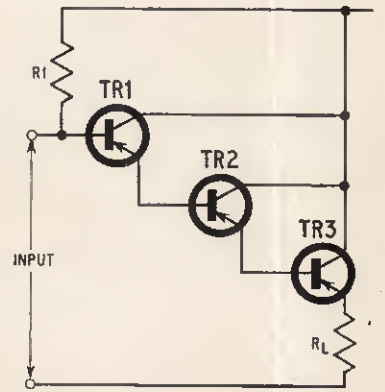

Fig. 6.8. Theoretical circuits of the Darlington pair. (a) and (b) Resistances r_1 and r_2 represent the internal resistances between base and emitter of each transistor

Fig. 6.8c. Darlington pair type of circuit using three transistors. $Z_{in} \approx \beta_1 \beta_2 \beta_3 R_L$

EMITTER FOLLOWER CIRCUIT

The input impedance of the emitter follower circuit can be calculated approximately as the product of the emitter load resistor, R_L , and the β of the transistor. Thus, if an OC71 transistor, which has a typical β of 50, is connected as an emitter follower with an R_L of 5,000 ohms, the input impedance of the circuit will be $50 \times 5,000 = 250$ kilohms.

The output impedance of the emitter follower circuit is given approximately as the source impedance of the input signal divided by the β of the transistor. This is made a little clearer from Fig. 6.6, where the input signal is shown as coming from a signal generator with an internal source resistance, r_s . This internal resistance is effectively in parallel with the input impedance (Z_{in}) of the transistor. It follows, therefore, that if the source impedance of the input signal is infinitely high, the effective source resistance of the input signal will be the same as the input impedance of the emitter follower, and the output impedance of the emitter follower will therefore equal R_L .

It can be seen that, within reason, any desired combination of input and output impedances can be obtained using the emitter follower circuit. The circuit is thus ideal for use as a "buffer" or matching stage in an amplifier circuit.

The voltage gain of the emitter follower circuit is always less than 1. Generally speaking, however, the higher the output impedance of the circuit, the nearer will the voltage gain approach to unity. In practice, the voltage gain of a conventional emitter follower circuit will be in the order of 0.9.

"DARLINGTON" OR "SUPER-ALPHA" PAIR CIRCUIT

One of the main disadvantages of the transistor compared with the valve is that comparatively low input impedances are involved. For many applications this low impedance is of little importance, but occasions do arise when a very high input impedance, in the order of megohms, is necessary for satisfactory operation, a typical example being matching a high-impedance crystal pick-up into a fairly low impedance common emitter amplifier, without appreciably loading the crystal.

Let us suppose, for example, that an input impedance of 2 megohms is required. If an attempt is made to use an emitter follower circuit to obtain this impedance it is found that, using a transistor with a β of 50, the emitter load resistance (R_L) has to be in the order of 40 kilohms. If a transistor such as an OC71 is to be used in this circuit, such a high value of R_L will necessitate a supply voltage of at least 45 volts, remembering that this transistor is required to operate at a mean collector current of about 1mA if excessive distortion is to be avoided. Even ignoring this fact, the 40kilohm emitter resistor will give too high an output impedance for feeding into the common emitter amplifier circuit.

To overcome this problem the effective current gain can be increased, rather than increasing the value of R_L . A circuit that does this is shown in Fig. 6.7, and is known as the "Darlington" or "Super-alpha" pair.

Transistor TR2 is connected as a conventional emitter follower circuit, with a β of (say) 50; R_L is the emitter load. An amplifier (TR1) precedes the emitter follower, but is connected so that the emitter current of TR1 flows directly in the base of TR2.

If the current gain of TR1 is also 50, the current flowing in the emitter of TR1, and therefore in the base of TR2, will be 50 times greater than that in the base of TR1, and the current flowing in the emitter of TR2 will be 50 times greater again. If we call the current gains of TR1 and TR2 β_1 and β_2 respectively, the overall gain between the base of TR1 and the emitter of TR2 can be seen to be $\beta_1 \times \beta_2$; the input impedance of the circuit is therefore $\beta_1 \times \beta_2 \times R_L$, which in this case gives $2,500 \times R_L$.

The output impedance of this circuit is given approximately as the source impedance of the input signal divided by ($\beta_1 \times \beta_2$).

Returning to the case in which an input impedance of 2 megohms is required, using transistors having a β of 50, it can be seen that if a Darlington pair is used, the required value of R_L is given from the simple formula

$$R_L = \frac{Z_{in}}{\beta_1 \beta_2} = \frac{2,000,000}{2,500} = 800 \text{ ohms}$$

In practice, it is unlikely that this value of R_L will suffice to give the value of input impedance required. The reason for this is explained by referring to Fig. 6.8.

Fig. 6.8a shows a conventional Darlington pair circuit redrawn to show the true effective circuit. R_B represents the base bias resistors of the circuit and, remembering that the negative supply line is effectively shorted to chassis as far as a.c. is concerned, can represent either the single resistor (R_1) shown in Fig. 6.7, or the two resistors of a voltage divider network in parallel, depending on the type of base bias circuit that is used. R_B is in parallel with the input impedance (Z_{in}) of the main circuit.

In a transistor, leakage currents flow between base and emitter, base and collector, and emitter and collector. For our present theoretical purpose, these leakage paths can be represented as a single resistance between the base and emitter, external to the actual transistor. In a germanium transistor this leakage resistance has a value of about 2 megohms, while a silicon transistor has one of about 10 megohms. Thus, in all normal transistor circuits, this leakage resistance is in parallel with the input; in the Darlington pair, however, the leakage resistances of the two transistors are effectively in series with each other, and the combination is in parallel with the input circuit. These two resistances are shown as r_1 and r_2 in the circuit diagram (Fig. 6.8a).

Fig. 6.8b shows the effective input circuit that results from the above. The maximum input impedance that can be obtained with this circuit is limited by the values of leakage and bias resistance.

In practice, the maximum value of input impedance that can be obtained using germanium transistors is in the order of 2 megohms, using the Darlington pair circuit.

If an additional transistor stage is wired in front of TR1 in Fig. 6.8a, the input impedance will be raised and can be determined by $Z_{in} = \beta_1 \times \beta_2 \times \beta_3 \times R_L$. The new circuit is shown in Fig. 6.8c. The same limitations are still imposed by the leakage and base bias resistances. It is not practical to use more than three transistors in the Darlington pair type of circuit.

Next month: Applications of the Darlington pair, the "bootstrap" amplifier, and ultra high impedance amplifiers.

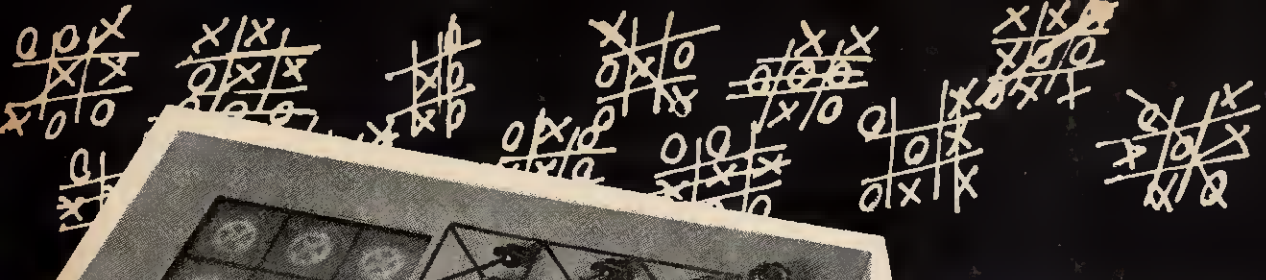

BY G. E. DUNNING

NOUGHTS and CROSSES MACHINE

For a modest outlay the Noughts and Crosses Electroponent Machine provides an item of considerable attraction for a Fete, Club or small Exhibition, etc. It is also of some educational value in the sense of logical acuteness, and no doubt could be developed much further into a game of greater depth and sophistication.

NOUGHTS and Crosses is a "perfect information" game because no simultaneous moves are made and every previous move is at all times during play known to both players. According to the theory of games¹ this form of game is always "strictly determined"—which means that if the best strategy is employed by both players then the game will inevitably result in a draw.

Incidentally, Draughts and Chess are also "perfect information" games. In practice, however, because of the enormously large scope of possible strategy which may be employed in these games, one or both players is very likely to make an error of judgement and then chance enters the game, often allowing one player to beat the other.

Unfortunately in the game of Noughts and Crosses the scope for strategy is very limited and moves are easily anticipated by opponents so that the game invariably ends in a draw. The Noughts and Crosses Machine may be arranged to illustrate this fact, causing the best strategy of all contestants always resulting in a draw.

Under these conditions the game becomes trivial, resulting as the machine proves, in no win to any player; so in order to remedy this state of affairs it has been decided to introduce an element of chance into the working of the machine. This element may be introduced at will and just how this is applied will be described later in the text.

STRATEGY OF THE GAME

The nine possible positions of Noughts and Crosses shown in Fig. 1 may be considered as being: Corner, Middle or Centre. Of these three the middle positions are strategically the weakest.

1	2	3	crn	mid	crn
4	5	6	mid	ctr	mid
7	8	9	crn	mid	crn

Fig. 1

The main strategy of Noughts and Crosses may be considered as being divided into two classes as follows:

(a) Primary Strategy

The player's objective here being simply to produce a pair of, say, Xs whenever and wherever possible. For example:

X	X	

Fig. 2

b) Secondary Strategy

Here the player's objective is to position his preliminary moves so that a subsequent move will yield two alternative pairs. For example:

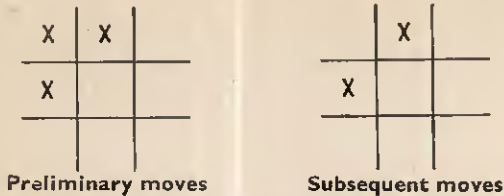

Fig. 3

(c) Combined Primary and Secondary Strategy

This is a more subtle strategy in which two apparent moves of primary strategy result in a second strategy position yielding three alternative pairs.

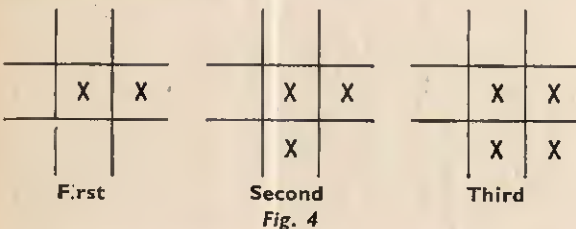

Fig. 4

In designing the Noughts and Crosses Machine the significance of these points was taken into consideration. First of all it was decided that if either the middle or corner positions were taken in the opening move, then the machine would reply by taking the centre position. Alternatively, if the centre position was taken in the opening move then the machine would take a corner position (actually the No. 3 position).

Obviously the machine must defeat primary strategy by causing any adjacent pair of Xs to be automatically blocked by a 0. But clearly this leads to cheating through moving twice in a turn, on the part of the machine, when it is dealing with secondary strategy. Therefore in such cases it was decided that the switching should be so arranged that one of the two or three alternatives, when blocked by a nought, should always result in a winning line for the machine. In practice it is found that the contestant foresees this outcome and detracts from his strategy in an effort to prevent the machine from winning.

AN EXTRA VARIABLE

In order to economise in switch contacts and also to introduce a certain amount of randomness into the game, if so desired, an extra switch is included.

This switch (S19) will provide a nought in any of the nine positions, unless that position is already occupied by a cross, and it is turned by the contestant to cause the machine to make its move whenever the machine fails to respond automatically. Such a condition arises when the opposition is of a non-strategic nature; moreover the order of the numerical positions around this switch are arranged so as to cause a possible win for the machine by means of secondary strategy.

As a further economy in switch contacts, S19 is utilised by the machine in defence against secondary strategy involving the No. 1 position.

S19 has three symmetrically arranged blank positions.

If it is originally positioned so that on rotation in a clockwise direction the No. 1 position will be the first taken, then it is impossible to beat the machine (provided the extra switch knob is rotated in a clockwise direction).

If S19 is positioned originally on either of the remaining blank positions or is rotated anticlockwise, then it is possible to beat the machine (by secondary strategy). No coding is provided on the top panel and the contestant cannot tell upon which blank S19 is originally positioned. This switch may also be used to cause the machine to start the game.

CONSTRUCTION

The actual noughts and crosses are displayed upon a ground-glass screen. The ground-glass side is placed uppermost and the plain side is blacked out with black self-adhesive plastic, such as *Fablon*. Nine cut-outs are made in the plastic, each consisting of an X surrounded by an exposed 0 as shown in Fig. 5.

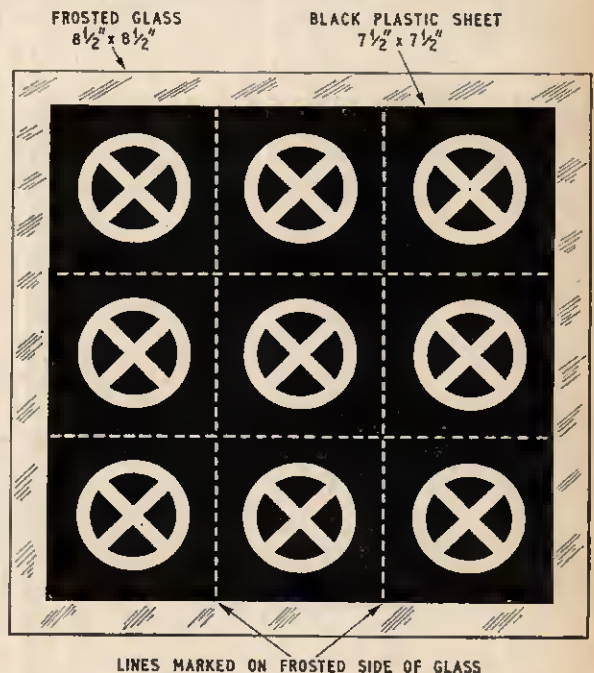

Fig. 5. Rear view of ground-glass screen with plastics material in position.

COMPONENTS . . .

- S1-18 Single wafer 4-pole 2-way switch (18 off)
- S19 Two wafers, each 1 pole 12-way.
Make-switch assembly (Radiospares)
- LPI-18 Pilot lamps bulbs (MES) 6V 0.06A (18 off)
- T1 Heater transformer 6.3V 1.5A secondary

Eighteen pointer knobs. Nine batten lampholders. Nine clip-on lamp holders.
Material for case (see text).

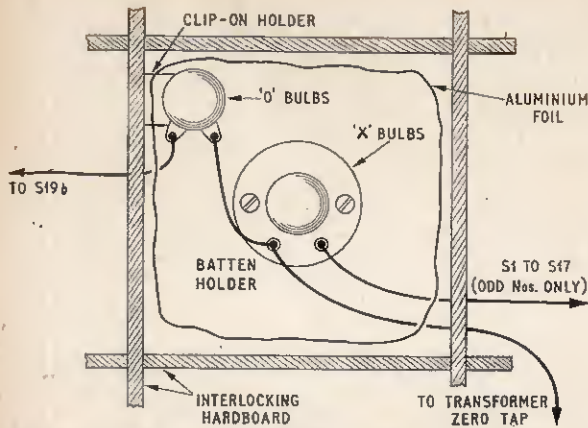

Fig. 6. Detailed view of lamps installed in hardboard "square"

The positions of the Os is first marked out on the paper backing of the *Fablon*. These are cut out and then the plastic is stuck onto the glass. Small squares of plastic are then stuck inside these Os and these are trimmed by a razor blade around a suitable round object such as a halfpenny. The cross is then marked using a rule and razor blade and the centre strips lifted out.

The nine squares are fabricated from four interlocking strips of hardboard, the outer squares being open on one side. These noughts and crosses are lit by separate pilot lamps, the light from the nought bulb being separated from that of the cross bulb by a thin cardboard tube which is stuck to the plain side of the glass in a position which forms the inner circle of the nought. Light from the nought bulb is reflected around this cardboard tube by means of a surrounding lining of aluminium foil.

The "squares" are fitted inside the case as shown in Fig. 7. A detailed drawing showing the lamps and their wiring connections is given in Fig. 6.

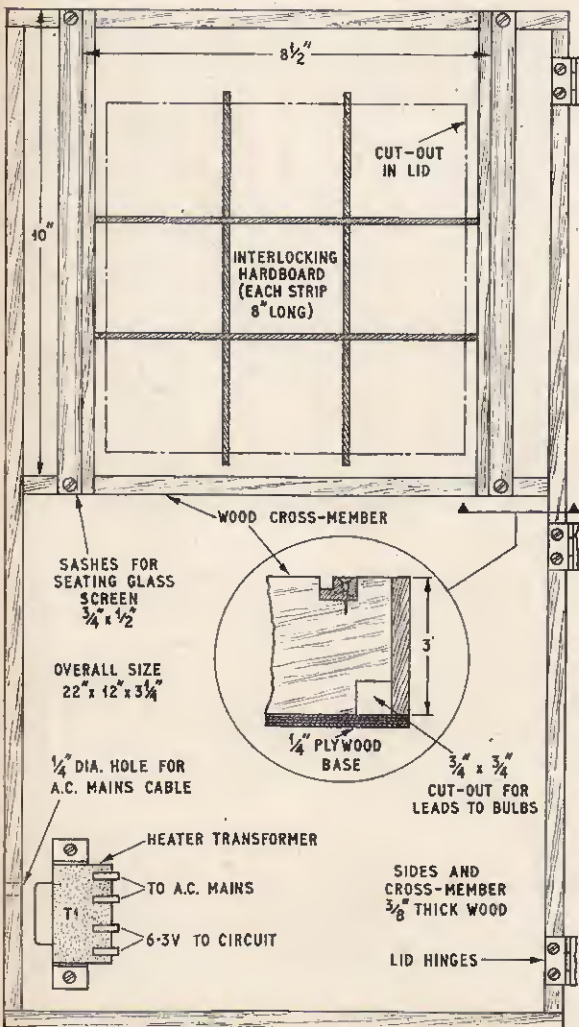

Fig. 7. Construction of the case

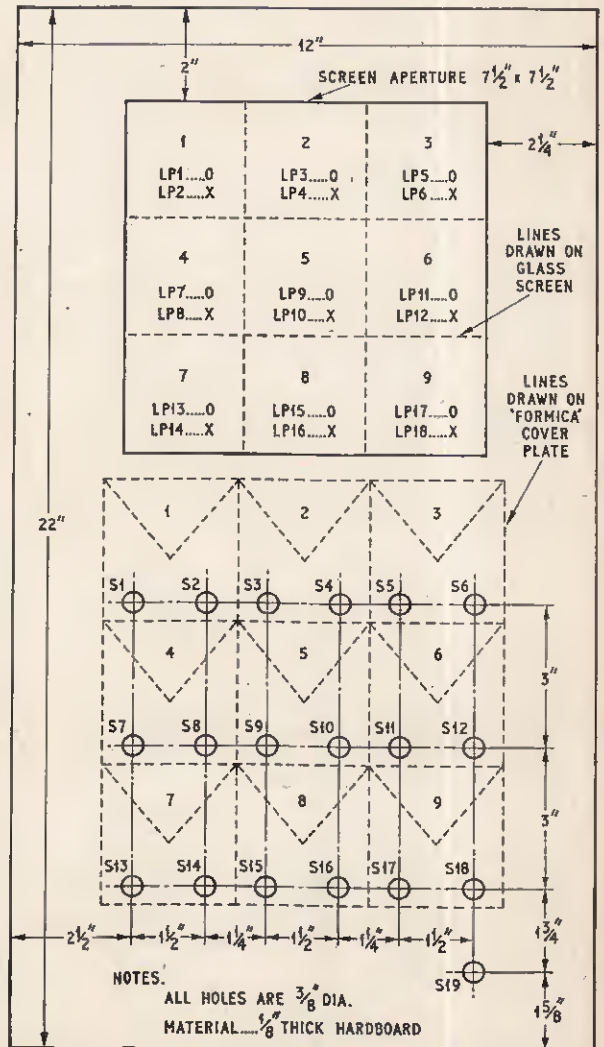
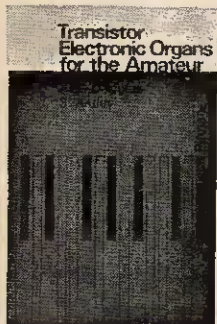

Fig. 8. The lid and control panel

Two valuable new Pitman books for the Electronics enthusiast

Making music the hard way!



Transistor Electronic Organs for the Amateur

By Alan Douglas and S. Astley

There are undoubtedly easier ways of making music than by first constructing an electronic organ—but to the enthusiast there can be no other way. This is the fourth book by Alan Douglas, who is probably the country's leading writer on this type of equipment. It presents not only a detailed design for a full scale organ, but a complete explanation of everything to do with transistorised organs. It is written in a simple style especially for the amateur constructor, and profusely illustrated with clear diagrams.

eighteen shillings net

Dispelling an old theory



Pick-Ups (The Key to Hi-Fi)

By J. Walton

For many years it has been the assumption that the loudspeaker is the weakest link in the record reproducing chain. This book challenges that theory. The author, after many years of research into the subject, concludes that it is the pick-up that causes most distortion. It is no exaggeration to say that, by following its advice, the owner of an ordinary gramophone or record player or the hi-fi enthusiast will not only achieve a superior standard of record reproduction, but will ensure that his records will last many times as long.

ten shillings net

FREE

If you want to know more about the three other books by Alan Douglas, or the whole range of Pitman books on electronics write to: Dept. PE, Sir Isaac Pitman & Sons Ltd., 39 Parker Street, London, W.C.2

VARIABLE VOLTAGE TRANSFORMERS

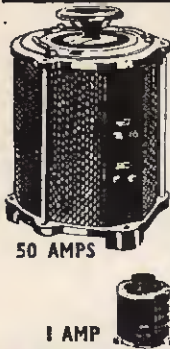

INPUT 230 v. A.C. 50/60—
BRAND NEW Carriage Paid.
 Buy direct from the importer, keenest prices in the country. All Types (and Spares) from 1/2 to 50 amp. available from stock.

0-260v at 1/2 amp	£3 3 0
*0-260v at 1 amp	£4 10 0
*0-260v at 2.5 amps	£5 17 0
2.5 amps Portable	£9 17 6
*0-260v at 4 amps	£8 7 6
*0-260v at 5 amps	£9 0 0
*0-260v at 8 amps	£13 10 0
*0-260v at 10 amps	£17 0 0
*0-260v at 12 amps	£19 10 0
*0-260v at 20 amps	£32 10 0
*0-260v at 37.5 amps	£65 0 0
*0-260v at 50 amps	£85 0 0

*These instruments are fully shrouded.

NEW 1/2 AMP FULL RANGE VARIABLE VOLTAGE TRANSFORMER



Input 230v. a.c. Output continuously variable from 0 to 260v. at 1/2 amp. Size: dia. 3in., depth 3 1/2in. including shaft, single hole fixing. Easily built into equipment. Ideal for manufacturers or Lab. use. £3/3/0.

1 AMP. OPEN TYPE (Type 1A).

Designed for building into equipment. Complete with voltage panel and knob. Output variable 0-260v. Price £4/17/6 post paid.

CRATOR 4 Way 16 Amp 250V A.C. SWITCH 3 on, 1 off position, complete with knob. 7/6 p. & p. 1/6.

100 WATT POWER RHEOSTATS (NEW)



AVAILABLE IN THE FOLLOWING 9 VALUES

10 ohm, 3 a.; 25 ohm, 2 a.; 50 ohm, 1.4 a.; 100 ohm, 1 a.; 250 ohm, .7 a.; 500 ohm, .45 a.; 1,000 ohm, 280 mA; 1,500 ohm, 230 mA; 2,500 ohm, .2 a. Diameter 3 1/2in. Shaft length 3 1/2in. dia. 1/4in. All at 27/6 each. P. & P. 1/6.

INSULATION TESTERS (NEW)

Test to I.E.E. Spec. Rugged metal construction, 500 volt, 500 megohms. Price £22. 1,000 volts, 1,000 megohms, £28.

TYPE 34R SILICON SOLAR CELL



Four .5 volt units series connected in high impact polystyrene case, flying lead connections. Specially designed diffusing lens system to ensure maximum light pickup. Output up to 2v. at 10 to 16 mA in bright sunlight. Wider spectral response, and thirty times the efficiency of selenium cells. As used to power earth satellites! 37/6, and 1/- P. & P.

SLIDER RESISTANCES

1 ohm., 12 amp, 17/6; 1.2 ohm, 14 amp, 27/6; 75 ohm, 2 amp, 37/6; 200 ohm, 1.25 amp., 37/6; 36 ohm, 6.5 to 2.8 amp., tapered winding, geared drive (less knob), 37/6. P. & P. 3/6.

available in black, red, white, yellow, blue and green. New, 15/- per doz. P. & P. 1/-.

VAN DE GRAAFF ELECTROSTATIC GENERATOR



Fitted with motor drive for 230 v. A.C. giving a potential of approx. 50,000 volts. Supplied absolutely complete, including accessories for carrying out a number of interesting experiments, and full instructions. This instrument is completely safe, and ideally suited for School demonstrations. Price £6/6/- plus 4/- P. & P. Leaflet on request.

INSULATED TERMINALS

The perforated Copper Board for Modern Circuitry.

15 x 15 pitch, 2.5 x 3.75.....3/-
2.5 x 5.....3/8
3.75 x 3.75.....3/8
3.75 x 5.....3/8

Spot face cutter, 9/-
 Special Veropins, Pkts. 200.....14/-
 p.&p. on all items 1/-

BUILD AN EFFICIENT STROBE UNIT FOR ONLY 37/6.

We supply a simple circuit diagram and all electrical parts including the NSP2 Strobe tube which will enable you to easily and quickly construct a unit for infinite variety of speeds, from 1 flash in several seconds to several thousands per minute. 37/6 plus 3/- P. & P.
 NSP2 TUBE brand new. I.O. base. Price 15/-. P. & P. 1/6.

METERS

2 1/2" Flush Round

A.C. AMMETERS
 0-1, 0-5, 0-10, 0-15, 0-20 Amp. All 21/- each, p. & p. extra.

A.C. VOLTMETERS
 0-25, 0-50, 0-150 V. All 21/- each, p. & p. extra.

0-300 V. A.C. m/c Rectifier £19.0.

TRANSISTORS

1st grade.	Brand new
OC28 ... 17/-	OC76 ... 6/-
OC29* ... 18/-	OC81* ... 8/-
OC41 ... 7/-	OC83* ... 12/-
OC44 ... 6/-	OC139 ... 6/-
OC45 ... 5/-	OC140 ... 8/-
OC71 ... 5/-	OC170 ... 9/-
OC72 ... 7/-	OC200 ... 10/6
OC73 ... 7/-	OC203 ... 14/-
OC75 ... 7/-	Get 105 ... 10/-

*Available in Matched Pairs.

ULTRA VIOLET BULBS

Easy to use source of U.V. for dozens of practical and experimental uses.

12 volt 36 watt A.C./D.C. SBC 6/6. P. & P. 1/-.
12 volt 60 watt A.C./D.C. SBC 8/6. P. & P. 1/-.

Transformer to suit the above. Input 200-240 v. A.C., 12 volt 36 watts, 1/6; P. & P. 2/6. Input 200-240 v. A.C. 12 volt 60 watt, 22/6. P. & P. 3/6.

Set of 4 Colours FLUORESCENT PAINT. Red, yellow, green and cerise. In 1/2 oz. tins. Ideal for use with the above Ultra Violet Bulbs. 9/6, plus 1/6 P. & P.

0-4 MINUTE MECHANICAL TIME SWITCH

16 Amp D.P. Switch complete with knob. Will switch off any setting between 0-4 minutes. As New, fraction of makers' price. 10/- plus 2/6 p. & p.

SOLENOID. Overall length 3 1/2in., stroke 1/2in. to 3/4in. Maximum push 8 oz. 12-24 v. D.C. operation. D.C. resistance 35 ohm. Price 8/6. P. & P. 1/6.

SOLENOID. Heavy Duty 230 v. A.C. Approx. 3lb. pull. 15/- P. & P. 1/6.

SOLENOID OPERATED MAGNETIC RELAY. Type Sc/3944, 4 Pole c/o., 10 amp. Contacts, 24 volt D.C. operation, 12/6 each. P. & P. 1/6.

230 v. A.C. RELAY. Type 1, 2 c/o; 2 amp. contacts, 9/6. Type 2, 2 x 15 amp. break, 2 x 2 amp. make, 1 x 2 amp. break, 11/6. Both types ex new equip. P. & P. 1/6 each.

LIGHT SENSITIVE SWITCH. Kit of parts, including ORP12 Cadmium Sulphide Photocell, Relay, Transistor and Circuit, etc., price 25/- plus 2/6 P. & P. ORP 12 including circuit, 10/6 each, plus 1/- P. & P.

A.C. MAINS MODEL

Incorporates Mains Transformer, Rectifier and special relay with 3, 5 amp mains c/o contacts. Price inc. circuit 47/6 plus 2/6 p. & p.

RADIO AND ELECTRONICS BOOKS ON FREE TRIAL

Then only 5/- weekly for those you keep!

No. 90. PIN-POINT TRANSISTOR TROUBLES IN 15 MINUTES. By Louis E. Garner, Jr. 486 pages. Companion manual to the well-known 'Pin-Point T.V. Troubles in 10 Minutes' using the famous Coyns Check Chart Trouble Shooting Method. Covers all kinds of equipment including radios, T.V.s, audio amplifiers, pre-amplifiers and just about everything. There are hundreds of photos, illustrations, diagrams and check charts; valuable reference sections. Supplies are limited so order your copy now and avoid disappointment. Price, 49/6 including postage.

No. 18M. RADIO SERVICING. 351 pages (hard covers), with hundreds of illustrations, circuits and diagrams. By G. B. Patchett and B. Fozard. Price 26/6, including postage. A very thorough approach to learning radio servicing, starts with simple explanations and goes on to more advanced radio theory. Doesn't miss a single point. One of the most complete radio manuals ever published. A book you will use for years to come. This is the first time this book has ever been offered on a free trial basis. Order your copy now, see coupon below.

No. 15N. TELEVISION SERVICING. 520 pages, hard covers, 296 diagrams. Price, 26/- including postage. As described above, but teaches television repair.

No. 39. RADIO & ELECTRONICS COURSE. 216 pages, quarto size, 35 complete lessons. You will find this course easy to understand. The lessons are CRYSTAL CLEAR, PRACTICAL, EASY TO MASTER AND USE. Early lessons make fundamentals clear even to the beginner while other lessons will give you the practical knowledge of an expert! This is a modern course, that teaches without resorting to comic strip methods... Thousands of PRACTICAL ELECTRONICS and PRACTICAL WIRELESS readers have taken this course and enjoyed every minute of it... Why not you? Price for the complete course, 41/- including postage.

No. 22. PIN-POINT COLOUR T.V. TROUBLES IN 15 MINUTES. By Robert G. Middleton. 548 pages. 352 check charts. Just about the biggest and most useful manual on Colour T.V. available anywhere. Now is the time to get the complete information on this important new subject. Price, 49/6 including postage.

No. 8. PIN-POINT T.V. TROUBLES IN 10 MINUTES. Over 340 cross indexed pages, covers 70 symptoms, 700 trouble spots, has 80 time saving check charts, 280 diagrams. Over 30,000 copies now used in the U.K. alone!

NOW REPRINTING. Orders accepted for delivery in four weeks' time. One of the best manuals we have ever handled, well worth waiting for! Price, 41/- including postage. Send coupon today for excellent delivery.

IRONCLAD GUARANTEE

Any book not satisfactory may be returned within 10 days post-paid for full refund of the purchase price.

FREE BOOK OFFER!

Send cash with order and qualify for any free book listed on the coupon as follows. Minimum 40/- One book. 80/- or more Two books. 120/- Three books.

NOTE. These books are authoritative and loaded with useful information, cost from 9/6 to 5/- each in book stores.

FREE TRIAL OFFER!

To Sim-Tech Technical Books, Dept. EI, Gater's Mill, West End, Southampton, Hants.

Please send the following books I have circled.

- 90 22N 18N 39

If not delighted I may return any book post-paid without further obligation on my part, otherwise I will pay cash price or 5/- weekly (10/- fortnightly) commencing not later than 10 days after delivery. I am over 21 years of age. (If under 21 parents should place order).

I enclose cash to the sum of £
 I understand you will refund this money if I am not 100% satisfied (provided I return the book in good condition within 10 days).

Please send me the free book(s) I have ticked.

- Oscilloscope Book.
- Electronics Gadgets Book.
- Transistor Book.
- Radio Instruments Book.

Name

Address

SERVICE TRADING CO

All Mail Orders—Also callers:
 47/49 HIGH STREET, KINGSTON ON THAMES
 Telephone: KINGston 9450

Personal callers only
 9 LITTLE NEWPORT STREET
 LONDON, W.C.2 Tel.: GERnard 0576

The case dimensions are 22in x 12in x 3in. The sides are built up from 3in x 3/4in timber and the base is a piece of 1/2in plywood. See Fig. 7.

Within the case is a cross member of 3in x 3/4in; this is pinned to the sides and supports the two sashes which hold the glass screen in place. The bottom corners of the cross member are cut away to allow connecting wires to pass through.

The size of the piece of ground-glass is 8 1/2in x 8 1/2in, but the size of the seen screen is 7 1/2in x 7 1/2in.

THE CONTROL PANEL

Below this screen is positioned the control panel. This consists of eighteen 4-pole 2-way switches grouped in pairs within a noughts and crosses former. The remaining control, S19, which is a 1-pole 12-way rotary switch is located below the lower right hand corner.

It would, of course, be possible to employ just one switch in each of the nine positions. However, this would necessitate the case of double wafer switches, which are not always easy to obtain and, furthermore, would undoubtedly prove far more costly than the present arrangement.

The switches are located in position on a sheet of hardboard of slightly larger overall dimensions than that of the case. This board is hinged to the case and its top surface covered by a sheet of Formica laminated plastic. This plastic surface can be marked in the

manner shown in Fig. 8 by means of a felt tipped marking pen which can also be used to mark the noughts and crosses former on the top surface of the ground-glass screen.

The switches are positioned within a rectangle 9in x 8 1/2in; it was found necessary to lengthen the side so as to narrow the shape of the X formed by the switches when turned inwards, as the switches used only turned through an angle of 30 degrees.

WIRING UP THE SWITCHES

The switch wiring is fairly complex, and is best performed in two distinct stages as indicated in Fig. 9 and Fig. 10.

First complete all the wiring shown in Fig. 9. This comprises most of the interconnections between the switches S1 to S18. It will be noticed that one pair of switches is associated with each of the nine squares.

These switches should be mounted so that the knob is pointing upwards when the rotors are against contact number 1. The odd numbered switches (i.e. left handed as viewed from front of machine) will then rotate clockwise to the second position, while the right hand switches will rotate anticlockwise.

Next, proceed to add the additional wiring shown in Fig. 10. This second stage brings in the extra switch S19.

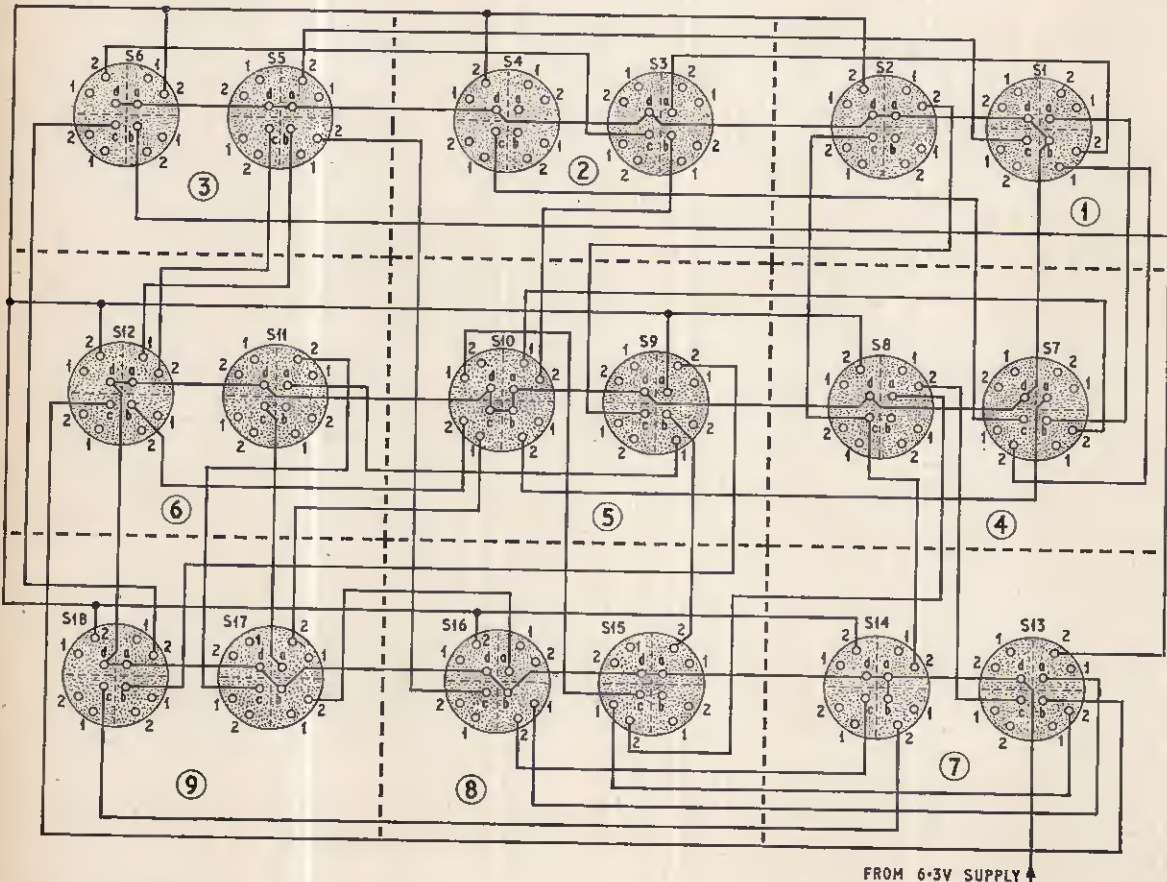

FROM 6.3V SUPPLY

Fig. 9. First stage wiring

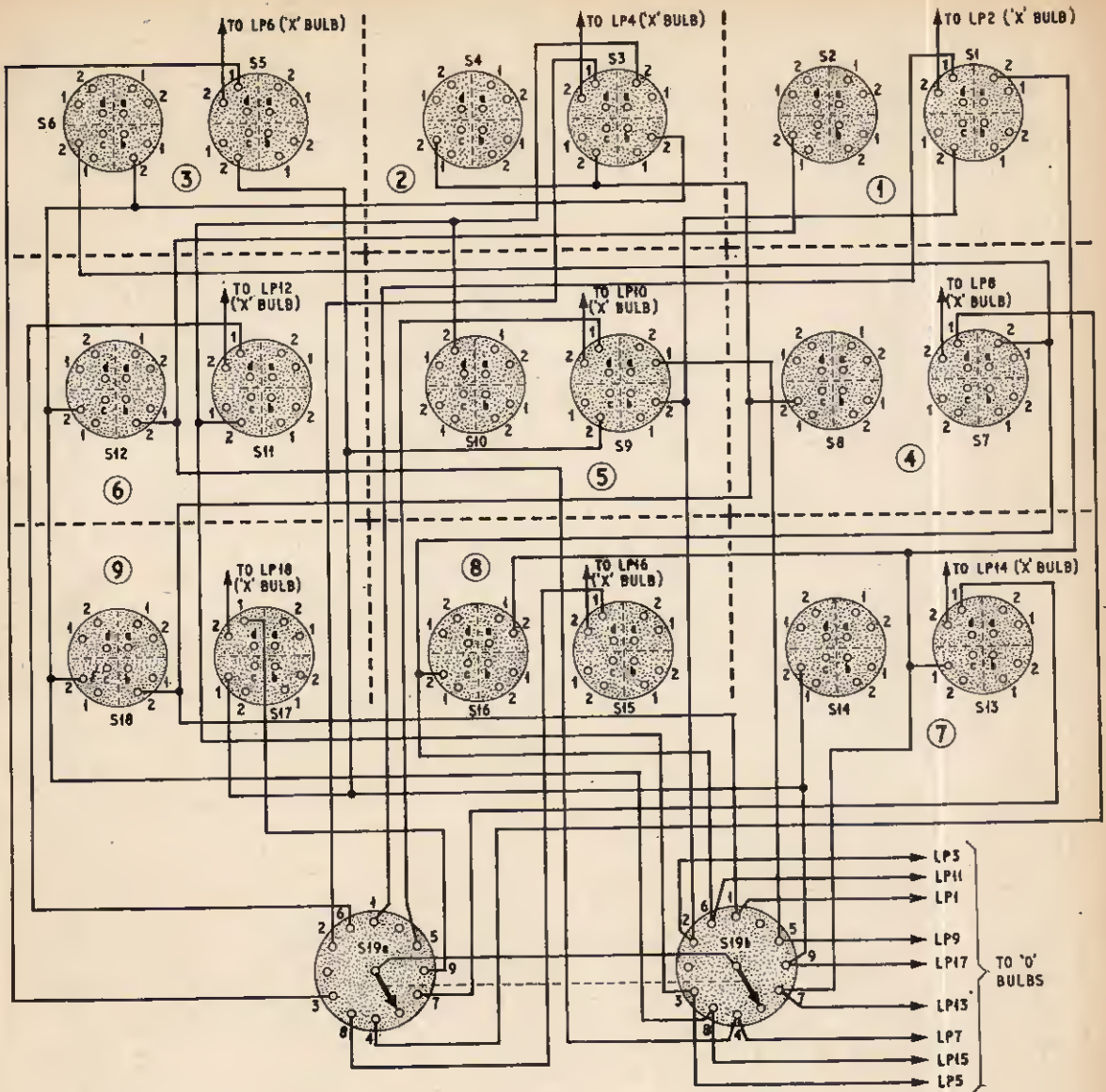

Fig. 10. Second stage wiring

POWER SUPPLY

The power supply is provided by a 6.3V heater transformer. It is, however, quite practical to use a bell battery in place of the transformer if similar low rating bulbs are used.

PLAYING THE GAME

The contestant is intended to turn each of the pairs of pointer knobs in the square desired, as seen on the screen. The position of the pointer knobs then forms the bottom half of an X, which is lit upon the screen in the corresponding position.

Turning the left hand pointer knob inwards in the desired square will light the players X and turning the right hand pointer knob of the pair inwards will usually

provide the machines answering 0. If, however, on turning the left hand knob inwards the machine answers immediately then there is no need to turn the right hand pointer knob inwards also.

If on turning both pointer knobs inwards the machine fails to answer, then the extra knob (S19) must be rotated until the machine does answer. The machine will always play a rational game, provided these instructions are complied with and the switches are wired as shown in Figs. 9 and 10.

REFERENCE

1. Vatsda, S. An introduction to linear programming and theory of games. ★

LEARN ELECTRONICS — AS YOU BUILD

over **25** **CIRCUITS**
EXPERIMENTS
TEST GEAR



including . . .

● CATHODE RAY OSCILLOSCOPE

- | | |
|--------------------------------|--------------------------|
| ● Valve Experiments | ● Square Wave generator |
| ● Transistor Experiments | ● Morse Code Oscillator |
| ● Electro-magnetic Experiments | ● Simple Transmitter |
| ● Basic Amplifier | ● Electronic Switch |
| ● Basic Oscillator | ● Photo-electric circuit |
| ● Basic Rectifier | ● Basic Computer Circuit |
| ● Signal Tracer | ● Basic radio receiver |
| ● Simple Counter | ● A.C. Experiments |
| ● Time Delay Circuits | ● D.C. Experiments |

The full equipment supplied comprises: valves, transistors, photo-tube, modern type chassis board; printed circuit board; full range resistors, capacitors and inductors; transformers; potentiometers; switches; transistors; valves; all hardware, wiring and every detail required for all practical work plus CATHODE RAY OSCILLOSCOPE for demonstrating results of all experiments carried out. All practical work fully described in comprehensive PRACTICAL MANUALS. Tutor service and advice if needed.

This complete practical course will teach you all the basic principles of electronics by carrying out experiments and building operational apparatus. You will learn how to recognise and handle all types of modern components; their symbols and how to read a completed circuit or schematic diagram. The course then shows how all the basic electronic circuits are constructed and used, and HOW THEY ACTUALLY WORK BY USING THE OSCILLOSCOPE PROVIDED. An application is given in all the main fields of electronics, i.e. Radio; control circuits; computers and automation; photoelectrics; counters, etc., and rules and procedure for fault finding and servicing of all types of electronic equipment:

- | | | |
|--------------------------------|---------------------------|--|
| ● NO PREVIOUS KNOWLEDGE NEEDED | ● NO MATHS USED OR NEEDED | ● REASONABLE FEE—NO EXTRAS REQUIRED |
| ● SENT IN ATTRACTIVE BOX | ● COMPLETE ADVICE SERVICE | ● EVERYTHING REMAINS YOUR OWN PROPERTY |

A completely **NEW** up-to-date home study experimental course by
BRITISH NATIONAL RADIO SCHOOL —
Britain's Leading Electronic Training Organisation.

POST NOW FOR FREE BROCHURE

To: BRITISH NATIONAL RADIO SCHOOL, READING, BERKSHIRE. Please send free Brochure, without obligation, to:

NAME.....

ADDRESS

.....
Block Capitals Please
OR WRITE IF YOU PREFER NOT TO CUT COUPON PE 9.65.



INTERCOM/BABY ALARM

Usually ~~50/-~~
Our Price ONLY

59/6

Modernize your Office, Shop, Warehouse, Workshop, Surgery, Nursery and Home with this latest two-way TRANSISTOR INTERCOM. Consists of two units MASTER and SUB, in strong plastic cabinets with chromium stands. Specially designed for instant communications (Call/Talk), between two persons anywhere indoors or outdoors. Ideal as baby alarm. Operates on one 9V battery. Complete with accessories. Ready to operate. P. & P. 2/6 Outstanding value.

TRANSISTORISED MICROPHONE MIXER



Usually ~~55/-~~
Our Price ONLY **49/6**

This 4-CHANNEL MIC. MIXER permits to mix 4 signals; Tape, Mic., Tuner and Records into a single output. Delightful to amateur and professional recorders alike. Outstanding value. Post free.

Transistor BATTERY CHARGER



Usually ~~30/-~~
Our Price ONLY **27/6**

Use your TRANSISTOR RADIO or INTERCOM from domestic A.C. mains, and charge 9-volt dry battery FP3, VD3, VT3, or 216 thus boost battery's life many times. Unbeatable value. Immense saving on batteries. Complete with Plug, Lead and Snap cord. P. & P. 1/6.
Full price refunded if not satisfied in seven days.

WEST LONDON DIRECT SUPPLIES (PE/1)
6 CHIGNELL PLACE, WEST EALING, LONDON, W.13

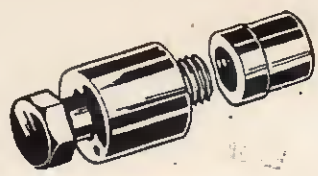

The **PUNCH** you need!

HOLE PUNCHES

Instant Type		
3/8" diameter	...	6/10 ea.
Screw-up Type		
3/8" diameter Toggle switch	...	8/6 "
" " B7G	...	8/6 "
" " B8A, B9A	...	9/- "
" " " " " "	...	9/6 "
" " " " " "	...	10/2 "
" " " " " "	...	10/8 "
" " " " " "	...	11/8 "
1" diameter Int. Octal	...	13/4 "
" " " " " "	...	16/2 "
" " " " " "	...	18/10 "
" " B9G	...	21/8 "
" " " " " "	...	24/4 "
2 3/8" " Meter	...	33/2 "

Complete Set £9.3.6.

No extra charge for postage and packing in the U.K.

Now supplied by:

TOMPKINS & LONGMAN LTD.
237 GIPSY ROAD
WEST NORWOOD, S.E.27
Tel.: Gipsy Hill 5000

NOW ANYONE CAN AFFORD TO TRAIN TO BE AN EXPERT IN RADIO and ELECTRONICS

It's the most exciting news of the year! Just imagine. You can get 35 large, fact-packed lessons for little more than 1/- per lesson! The lessons are crystal clear, practical, easy to master and use. Early lessons make fundamentals clear even to the beginner, while other lessons will give you the practical "know-how" of an expert.

Compares favourably with some courses costing ten times as much. You save because you receive all the lessons at one time and are not required to purchase equipment you do not need.

This is a real home-study course that has been bound into one giant 8 x 11in. 216 page manual. Each page is divided into two columns. A wide column features the text, while a narrow column at the side has the instructor's comments, helpful suggestions and additional pictures to simplify the difficult parts.

Everyone can benefit from this practical course. No old fashioned (or pseudo modern) methods used here, just straight forward, easy to understand explanations to help you make more money in electronics.

The price! Only 39/6 plus postage 1/6.
Terms? Why of course! See Coupon.

OTHER COURSES AVAILABLE
RADIO COURSE (22 lessons, price 36/-)
TELEVISION COURSE (price 38/-)

UNCONDITIONALLY GUARANTEED TO GIVE COMPLETE SATISFACTION

You must be convinced that this is the best value you have ever seen in Electronics, Radio or T.V. Training, otherwise you can return the course (or have your money refunded if sent with order) after you have examined it in your own home for a full seven days.

IF YOU SEND CASH WITH ORDER WE WILL INCLUDE A FREE BOOK VALUED 5/-. Tick on the coupon one book for each course ordered with full cash. These free books are authoritative, and loaded with information. Would cost at least 5/- each if bought separately—by sending cash you reduce book-keeping and other costs which savings we pass back to you.

--- FREE TRIAL OFFER ---

Pay only 5/- per week if you wish. Clip coupon right now for this special offer.

To: Sim-Tech Technical Books, Dept. ETV10, Gater's Mill, West End, Southampton, Hants.

Please send the following courses for a full seven days' trial.

- No. 1. RADIO COURSE, 37/6, incl. postage.
- No. 2. RADIO & ELECTRONICS COURSE, 41/-, incl. postage.
- No. 3. TELEVISION COURSE, 37/6, incl. postage.

(Free trial customers tick one only please.)

If not delighted, I may return the course post-paid without further obligation on my part. Otherwise I will pay cash price or 5/- weekly until paid.

- Tick here if enclosing full purchase price.
- Please send me
- FREE TRANSISTOR CIRCUITS BOOK.
- FREE OSCILLOSCOPE BOOK.

Amount enclosed £.....

I understand that you will refund this money in full if I am not 100% satisfied. Overseas customers please send full amount (including Ireland).

NAME.....
ADDRESS.....
City..... County.....

JUST PUBLISHED

ADVANCED RADIO CONTROL

by E. L. Safford

25/- Postage 1/-

DESIGN & CONSTRUCTION OF TRANSISTOR SUPERHETS, by R. H. Warring. 17/6. Postage 1/-.

PROBLEMS IN ELECTRONICS WITH SOLUTIONS, by F. A. Benson. 22/6. Postage 1/-.

ELECTRONIC MOTOR CONTROL, by A. Lytel. 30/- Postage 1/-.

BASIC THEORY & APPLICATION OF TRANSISTORS, by U.S. Army. 10/- Postage 1/-.

INTRODUCTION TO ELECTRONICS, by U.S. Navy. 8/- Postage 1/-.

AMATEUR RADIO MOBILE HAND-BOOK, by C. Caringella. 24/- Postage 1/-.

DIGITAL INSTRUMENTS, by K. J. Dean. 25/- Postage 1/-.

PICK UPS. The Key to HI-FI, by J. Walton. 10/- Postage 6d.

ELECTRONICS POCKET BOOK, by J. P. Hawker and J. A. Reddihough. 21/- Postage 1/-.

COMPLETE CATALOGUE 1/-

THE MODERN BOOK CO.
19-21 PRAED STREET
LONDON, W.2
Phone: PADdington 4185
Open 6 days 9-6 p.m.

COMMUNICATIONS RECEIVERS

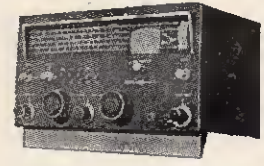

NATIONAL NC190X

INTERNATIONALLY FAMOUS NATIONAL RECEIVERS

HRO-500—completely solid state professional receiver, 5 kc/s to 30 Mc/s in sixty 500 kc/s bands. £700.

NC190X—10 valves, 540 kc/s to 30 Mc/s, S-meter, noise limiters, product detector, bandspread, double conversion. £99.0.0.

NC77X—beginner's receiver, 5 valves, 540 kc/s, to 30 Mc/s, built-in speaker. £32.8.9.

Write for illustrated leaflets

WE HAVE A LARGE STOCK OF NEW AND SECONDHAND RECEIVERS — MANY SECONDHAND BARGAINS IN MINT CONDITION
Just write or phone for full details

BRIAN J. AYRES & CO.
Dept. DW, 21 Victoria Road
Surbiton, Surrey
Telephone: Elmbridge 2833

NEWS BRIEFS

Early Bird Now Commercial

THE WORLD'S first satellite for public telephone service is now fulfilling its intended task of supplementing existing cable circuits between the U.K. and North America.

Individuals making Transatlantic telephone calls will be unaware of the type of circuit over which they are speaking, since it is Post Office policy not to divulge this. Speech transmission by satellite does not seem to be at all distinguishable from similar transmissions made by cable.

This latter point was confirmed by the Editor of PRACTICAL ELECTRONICS, who through the courtesy of the G.P.O., spoke to the Editor of *Radio-TV Experimenter* in New York via "Early Bird" shortly after the International Inaugural Ceremony on 28 June. No delay in speech transmission was detectable at either end of the circuit during this two minute conversation.

Guest of Honour

ADMIRAL of the Fleet the Earl Mountbatten of Burma, K.G., was the Guest of Honour at a Dinner held in June to mark the 40th Anniversary of the founding of the Institution of Electronic and Radio Engineers.

Lord Mountbatten has played a significant part in the promotion of electronics research. Only a year ago, his desirability to co-ordinate electronics research programmes culminated in the founding of the National Electronics Research Council, of which he is Chairman.

New International Telephone Exchange

A NEW EXCHANGE, standing in the shadows of St. Paul's Cathedral, London, and aptly named Wren House, was opened by the Postmaster-General, the Rt. Hon. Anthony Wedgewood Benn, M.P., on 29 June. The opening of this exchange is but one step in the tremendous task of coping with the ever increasing demand for overseas telephone services. Mechanised processes, expanding operator and subscriber dialling and the provision of more submarine cables—and of course "Early Bird"—will help in dealing with this traffic.

There are 198 manual switchboards in this new building. Outgoing services to North America will operate from Wren House together with most of the radio telephone services from London including those to India, Pakistan and South America, and many of the services to Africa and the Middle East. The service to ships at sea will also operate from this new exchange.

Automatic Shopping

PUNCHED-CARD shopping has arrived at Wallasey, Cheshire. Britain's first automated supermarket provides a wide range of goods, from which the shopper selects her choice by picking up the appropriate punched card. She then presents the cards to the checkout desk where a tabulator prints the bill. The bill is passed to the stock room where the order is packed.

The system, which was installed by De La Rue Bull Machines Ltd., is similar to one used in Caen, France.

Computer Research at Stevenage

THE Minister of Technology, Mr Frank Cousins, M.P., recently opened the new Research and Development Laboratories of International Computers and Tabulators, at Stevenage, Hertfordshire.

Mr Cousins is seen here looking at a new punched card reader which will be used with small computer installations of the 1900 series.

Meanwhile in the September Practical Television

- THERMOPLASTIC VIDEO RECORDING
- GETTING THE BEST FROM TV AERIALS
- PRACTICAL OSCILLOSCOPY

On sale August 19

. . . and in the September Practical Wireless

- BUILT-IN TUNER FOR TAPE RECORDERS
- VARIABLE VOLTAGE TRANSFORMER
- BAND EDGE MARKER

On sale NOW

Both only 2/- each



Readout —

A SELECTION FROM OUR POSTBAG

Whatever the "correct" usage of aural and phonic, the fact of the matter is that many engineers (as I) tend nowadays to use the terms as completely interchangeable.—D. J. R. Bowers.

Transistor quality

Sir—Are transistor amplifiers, as described in the first issue of PRACTICAL ELECTRONICS as clear in tone as valve amplifiers?

The reason I ask is that if you compare a transistor radio with a valve one, the latter always sounds clearer and is not "tinny" as is the case with transistors.

T. Crisp,
London, E.17.

Modern transistors are capable of providing high quality reproduction—equal to the performance obtained from valves.

The reason why transistor radios often sound tinny is the fact that they are built on a very small scale and use miniature loudspeakers. You will notice that amongst the high-class commercial equipment, transistors are coming more and more into favour.

Semiconductor coding

Sir—I cannot agree with your view in your July editorial that British semiconductor firms had "a perfect model to follow in the American Numbering System."

The American system tells only one thing, whether a device is a transistor or a diode and the resulting mess in America is one to be pitied. They have a system in which devices are referred to purely by numbers, which by themselves are meaningless.

In this country however, the big firms like S.T.C., S.G.S.-Fairchild, and Mullard are now adopting the standard European code for their non-military devices, such as the ASY67 or BSX28.

Thus I feel sure that in a few years' time, the Americans, of whom you spoke so highly, will be looking to Europe for the "perfect model of the numbering system."

D. J. Taylor,
Dudley,
Worcs.

The American numbering system was not put forward as being an ideal model in all respects—but as an illustration of the fact that a large number of manufacturers in one country could get together and agree to use a unified system.

That this is possible is further demonstrated by the British Services and governmental departments who use a CV system; there are also several other "standard systems" in use in various parts of the world.

Our criticism was aimed at the many house numbering systems created by individual manufacturers of transistors.

Listen here!

Sir—I note with despair, the perpetration in your columns of a hopelessly incorrect nomenclature (and this in an issue in which the editorial is concerned with nomenclature—admittedly of a somewhat different type). I refer of course to the use of the term "monaural" in the Portable Stereo Record Player article.

The tag *monaural* may be applied only where a single ear is concerned, as, for instance, when using a normal telephone handset. I quote the following interesting sentence from the article: "When using the two amplifiers for monaural (one-ear) listening an interesting *pseudo-stereo* effect is obtained by switching one earpiece out of phase". Which is a bit pointless since it's only necessary to use *one* amplifier and *one* earpiece for *monaural* listening. Let's get it right, 99 times out of 100, the word to use is MONOPHONIC.

R. McC arson,
London, N.W.10.

The rigorous definitions accepted by the professional engineers who look into the matter closely are those given by the famous American musical engineer, Mr. H. F. Olsen, in an article "Sound Reproducing Systems" in the American Journal Audio, September, 1959. p. 28. In effect his definitions restrict aural to headphone systems and phonic to loud-speaker systems.

Novice licences

Sir—I am in complete accordance with the views set out by your correspondent, Mr. Kirk, G3JDK (July issue), except that I feel the issue of an Amateur licence should be taken a step further.

I would like to see the *nouveau* licensee serve a probationary period for the first six months. He would have a distinguishing prefix to his call-sign, and would only be allowed to operate in selected segments of certain bands. At the end of this period, the G.P.O. monitoring stations (or an R.S.G.B. Committee set up for this purpose) could weed out the poor transmissions and bad operators, convene a meeting, and gently read them the "riot act". They would then continue for another six months and if they failed to reach a normal standard at the end of the year, the renewal of their licence could be declined.

Rex J. Toby, G2CDN, EI5B,
SUICX, etc.,
Isleworth,
Middlesex.

Pulse counter

Sir—With reference to your April issue, I would like to build the pulse counter which you describe. The counter would be used on my motor cycle and another on my friend's car; however, both use magneto ignition.

We imagine that the output would simply connect to the contact breaker, the negative line to the battery and the positive to earth, as we both use 6 volt and earth systems.

Also, could I use an illuminated "S" type meter if one was available in the correct impedance?

G. Ball,
Harrow,
Middlesex.

The transistor limiter should be run from the motor cycle battery and the pulses occurring across the contact breaker should be fed into the limiter, as you suggest. There is no reason why an illuminated "S-meter" could not be used as the indicator, provided it has a suitable sensitivity. This type of meter, of course, is really nothing more than a milliammeter, anyway.—G.J.K.

RADIONIC

RADIO & ELECTRONIC CONSTRUCTION SYSTEM

YOU NEED RADIONIC

IF YOU ARE A BEGINNER
YOU WISH TO EXPERIMENT
YOU TEACH RADIO OR ELECTRONICS

Unique and brilliantly simple. Hundreds of educational establishments—Universities, Technical Colleges, Schools, the Armed Forces—are already using Radionic for electronic instruction. Enthusiastic owners range from 9 to 82 years of age. Selected by the Council of Industrial Design for all British Design Centres. Featured in Sound and Television broadcasts.

The system is beautifully engineered from top quality British components. No soldering. No mains. No prior knowledge needed. Simply arrange components on perforated transparent panel, position brass connecting strip underneath, fix with 6BA nuts and circuit works with full efficiency. You can then dismantle and build another circuit. Your results are guaranteed by our Technical Department and News Letter Service. All parts available separately for conversion or expansion of sets.

No. 1 Set	£5.18.6.	14 Circuits (Earphone)
No. 2 Set	£6.19.6.	20 Circuits (Earphone)
No. 3 Set	£10.19.6.	22 Circuits (7 x 4in. Loudspeaker output)
No. 4 Set	£14.19.6.	26 Circuits (include 6 Transistor and reflex superhets)

Prices (Post Free)

Full details from:

RADIONIC PRODUCTS LIMITED
STEPHENSON WAY, THREE BRIDGES
CRAWLEY, SUSSEX

Tel.: CRAWLEY 28700

Trade Enquiries Invited

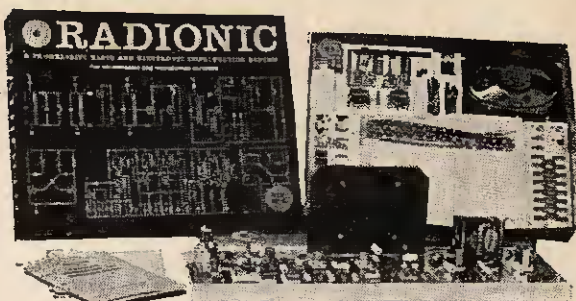

A No. 4 SET and 6-TRANSISTOR SUPERHET

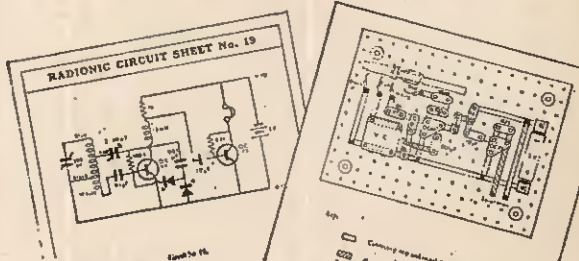

Theoretical Circuit

Practical Layout

Our new 'E' Series of basic electronic circuits is also available separately.

THE TECHNICAL PRESS LTD.

Announce an Important New Title in

The **COMMON-CORE** Series

BASIC INDUSTRIAL ELECTRICITY — 2 parts

About 18/- net per part. Each part has about 144 pp. and 150 illus.

Featuring a New Patented Programming Device: The **TRAINER-TESTER**

Student Response Sheet With Auto-Instructional Feedback

The following Titles in the series are also available:

BASIC ELECTRICITY (5 parts) BASIC ELECTRONICS (6 parts)

BASIC SYNCHROS & SERVOMECHANISMS (2 parts)

BASIC ELECTRONIC CIRCUITS (2 parts)

COUPON - SEND NOW!

OR ASK YOUR BOOKSELLER

To THE TECHNICAL PRESS LTD.
112 Westbourne Grove, London, W.2.

Name.....

Address.....

Please send me your FREE prospectus describing
THE COMMON-CORE SERIES

PE

Practical Electronics Classified Advertisements

The pre-paid rate for classified advertisements is 1/- per word (minimum order 12/-), box number 1/6 extra. Semi-displayed setting £3.5.0 per single column inch. All cheques, postal orders, etc., to be made payable to PRACTICAL ELECTRONICS and crossed "Lloyds Bank Ltd." Treasury notes should always be sent *registered post*. Advertisements, together with remittance, should be sent to the Advertisement Manager, PRACTICAL ELECTRONICS, George Newnes Ltd., Tower House, Southampton Street, London, WC2, for insertion in the next available issue.

TAPE RECORDERS, TAPES, ETC.

TAPE TO DISC. New High-level Cutters 45 p.p.m. 21/- S.E.A. Leaflet. DEROY, 52 West Bank Lane, Lancaster.

MISCELLANEOUS

GOVERNMENT SURPLUS Electrical and Radio Equipment. Our new catalogue No. 16 now ready, 2/6 Post Free, cost refunded on purchase of goods over £2. **ARTHUR SALLIS RADIO CONTROL LTD.**, 93 North Road, Brighton.

HAMMER FINISH PAINT. The modern finish for electronics. Can be BRUSHED or sprayed. Blue or silver. 2oz tins 3/6, post 8d., 1/2 pint 7/6, post 1/9, 1 pint 15/-. post 2/9. Retailers supplied, write for details. Amazing results! Return of post service. Orders over 30/- post free. **FINNIGAN SPECIALTY PAINTS, (P)E**, Mickley Square, Stockfield, Northumberland.

CONVERT ANY TV SET into an Oscilloscope. Diagrams and Instructions, 12/6. **REDMOND**, 42 Dean Close, Portslade, Sussex.

ARMATURE REWINDS. All Small Types, 32/-. Fields 17/6, P. & P. 2/6. A. B. TAYLOR, 22 Forester Street, Netherfield, Nottingham.

SUNNY QUEENSLAND, AUSTRALIA. Long-established lucrative T.V. Radio Hire, Sales, Service Business. Seaside resort close Brisbane. Particulars S. McCULLOUGH, Noosaville.

TELEVISION SETS from 35/-. 20 for 25/- each, not working, callers only, 20 Palmerstoune Road, Earley, Reading.

TRANSFORMERS REWOUND. Output or Mains. Specials made to order. Reasonable prices. **RATCLIFFE**, 27 Station Road, Holmfirth, Yorks.

RECEIVERS AND COMPONENTS

A.1 POST FREE BARGAINS. Guaranteed reclaimed valves. Send for full list to Dept. MO/E, A.1 RADIO COMPONENTS, 14 The Borough, Canterbury, Kent.

20% OFF!!

RECORD PLAYER AND TRANSCRIPTION UNITS ALL MAKES 20% BELOW LIST PRICES
Terms C.W.O. only — Postage extra
Send S.A.E. with enquiries please
HIGH FIDELITY CENTRE
61 West Street, Dorking, Surrey Tel. 4229

RECEIVERS AND COMPONENTS (continued)

L.S.T. COMPONENTS

182B HIGH ROAD, BENFLEET, ESSEX

More bargains from our new list:

Silicon Power 2S012 10/-. HF Power Mesa 2S025 100 watt 10 mc/s 30/-. Red spot NPN transistors 1/- OC71 equivalents 9d. Still available: Our famous 25 for 10/- offer, state 2G371/81 series (AF) or 2G4147 series (RF).
100 Diodes for 12/-. Post paid over 5/- order. send 6d. stamp for our latest list.

TRANSISTORISED SIGNAL INJECTOR. Complete kit of components and circuit of injector for testing amplifier or radio, 10/- only. Post free. **G. F. MILLWARD**, 17 Peel Close Drayton Bassett, Staffs.

TELEVISION TUBE SHOP

FOR

Unused, Guaranteed Tubes
OVER 2,000 IN STOCK

At prices from 50% to 75% of
normal List Price

All tubes tested before despatch
and Guaranteed for 12 months

**CARRIAGE 10/- via B.R.S. or
15/- via passenger train**

**TERMS £2 down (plus
carriage) and balance at £1
per month**

See our advertisement in
PRACTICAL TELEVISION for exact
prices, or write for details

TELEVISION TUBE SHOP

48 BATTERSEA BRIDGE ROAD
LONDON, S.W.11. BAT 6859
OPEN ALL WEEK AND SATS. UNTIL 4 p.m.

RECEIVERS AND COMPONENTS (continued)

HIGH STABILITY RESISTORS 1% cracked carbon 1 watt 100 mixed values 17/6d. **LST COMPONENTS**, 182B High Road, Benfleet, Essex.

GENUINE MULLARD TRANSISTORS & DIODES

OC45, OC76, OC71, OC81, OC81d, OC84—3/-
OC44, OC75, OC170, AF15—3/6d. OC81,
OC84 pairs—6/-. OC28, OC35—7/6d. OA70,
OA79, OA81—1/6d. TEXAS 2G344a—3/-
2G339a (=AC127)—4/-. IS100—2/3d.
8TH G5-D—2/3d. SEMICS MA393—3/6d.
STC Silicon 800 PIV, 500mA—1/6d.
N.K.T. V30/30—6/-. FERRANTI ZT20—6/-.

ALL POST FREE
All amateur requirements supplied
Trade enquiries invited

THE RADIO CONSTRUCTORS CENTRE

363 Westborough Road
Westcliff-on-Sea, Essex
Phone: Southend 49686

PHOTOTRANSISTOR OC6P71 9/6 EACH.
Another special from LST COMPONENTS,
182B High Road, Benfleet, Essex.

"P.E." ELECTRONIC FLASH GUN. Portable Stereo Record Player. I/C Bridge. V.H.F. Broadcast Receiver. Integrated Transistor Amplifier. Two Band Radio Tuner. Inexpensive Oscilloscope. Mullard Electrolytic & Polyester Capacitors and High Stability Resistors. S.A.E. for itemised price lists. **AJAX ELECTRONICS**, 18A Rumbold Road, Fulham, London, S.W.6.

WITWORTH TRANSFORMERS LTD.

26 ALL SAINTS ROAD, LONDON, W.11

Tel.: BAY 9071

260-0-260V. 80mA, 6.3v.2a, 0-5-6. 3v.2a 18/-
250-0-250V. 160mA, 6.3v.4a, 0-5-6. 3v.2a 27/-
260-0-260V. 180mA, 6.3v.4a, 0-5-6. 3v.2a 28/-
400-0-400V. 200mA, 6.3v.4a, C.T.05-6. 3v.3a. 50/-

ISOLATING TRANSFORMER, 150 Watt.
1:1 Ratio. 200-250V. Range ... 50/-

All Transformers have Standard Primaries.
Screened and are Fully Varnish Impregnated
We manufacture all types of Transformers small or large... quantities at competitive prices

12 Months' Guarantee. S.A.E. All Enquiries
Postage and Packing 3/- C.O.D. 5/-

OVER 300 ELECTRONIC COMPONENTS in one great parcel including printed circuit panel with condensers, resistors, coils, diodes, transistors, silicon rectifiers, potentiometers 1F's, valve base's, tuning condensers, transformers, etc. You can't afford to miss this great bargain offer. Send 10/- plus P. & P. 2/6 to D. & W. LTD., 224 West Road, Westcliff-on-Sea, Essex.

50 TRANSISTORS all tested, marked and guaranteed. A.T.R.P. Silicon and P.N.P. Unobtainable elsewhere at this low price of 35/- plus P. & P. 1/-. D & W LTD., 224 West Road, Westcliff-on-Sea, Essex.

RECEIVERS AND COMPONENTS

(continued)

TRANSISTORS AND COMPONENTS

OC71—2/9d. each. OC44, OC45, OC72, OC81, OC81D—3/10d. each. OC42—2/6d. each. OC26, ORP12, GET57—7/9d. each. AF116, AF117, OC170, OC171—3/6d. each. OC82, GET8, BY100—5/10d. each.
 Latest Mullard types AC126—8/10d. each. ACY18—7/6d. each. ASY28—9/6d. each. AF186 cut of FREQ 800 Mc/s—28/-.
 Branded Mazda ECC85 valves—4/6d. each. 10 watt Transistor driver and output transformers—22/6d. each.

Acos Record Player cartridge, suits Collaro, Garrard, B.S.R., etc.—12/6d. each.

Latest Mini 2 Motor Transistor Tape Recorder £6. 15. 0d. post paid.

Ivelec Signal Injector—22/6d.

Transistor Walkie Talkies 1/2 mile range—9 Gns. pr. Caby A10 Multi Meter 2000 O.P.V.—£4.17.6d. Baby B40 Multi Meter 4000 O.P.V.—£5.15.0d. S.E.—200 Min Lab Incorporating A/C D/C Volt Meter, Resistance Measurement, RF Sig. Gen., AF Sig. Gen. R.F. Field Strength, Condenser Check—£8.5.0d. complete.

M.A.T. TRANSISTORS

MAT 100 7/9.

MAT 101 8/6.

MAT 120 7/9.

MAT 121 8/6.

ADT 140 15/-.
 Transistor Walkie Talkies 5 mile range—£25 pr. Guitar Pickup—£3.5.0.

4 Transistor 250 M/Watt Amplifier.—47/6.

4 Transistor 1 Watt Output.—£3.3.0.

All types Valves in Stock.

S.A.E., all enquiries.

All Above Post Paid

Mail Order Only:

J. ROBINSON

(Radio & T.V.)

4 Highcliffe Road, Blackley, Manchester 9

RECEIVERS AND COMPONENTS

(continued)

COMPASS AMPLIFIERS. New Unit containing 5 B7G valves, Silicon and Metal Rectifiers, etc. 25/- post paid. G. DOWNIE, Kirkpatrick-Fleming, Lockerbie, Dumfriesshire.

TRANSISTORS. PNP from 7d., NPN high gain from 6/-, power types, 20 watt from 7/6, diodes 6d., All guaranteed. SAE lists, LONGLANDS, 6 Mansfield Place, Ascot, Berks.

GUARANTEED NEW & TESTED TRANSISTORS Money returned if not satisfied. XA101, 102, 103, 111, 112, XB103, 1/9 each. XA116, XB102, XC121, 1/81, 3/8 each. XA191, 1/93, XB113, 5/8 each. XA701, 7/02, 7/03, GET 8, 4/9 each. XB104, XC101, 1/01A, OC109, 3/4 each. OC43, 43, 44, 45, 71, 2/8 each. OC81, 81D, 2/8 each. OC26, 8/- each. General purpose diode, 6d. each. Germanium rectifier GJM 3/- each. All previous lists withdrawn. Add 6d. P. & P. on orders under £1. Transistor Sundries. 6 transistor printed circuit 1/8. 2 1/2 in. speaker 4/6. Ferrite block 1/-. Edge volume control D.P.S.K. 1/8. T. P. and Osc. coils (set of 4) 5/8 set. Slide switch D.P.D.T. 1/-. Ganged condenser 5/-. P.P. output transformer 7/6. Driver transformer 7/8. Circuit 1/8.

All the above made specially and ready for assembly 37/8 post free. Any item supplied separately.

Add 1/6 P. & P. when order less than 10/-.

CLEYELEY ELECTRICAL ENGINEERING CO.

Bank Chambers, Foulton le Fyde, Lancs.

TRANSISTORS AT GIVE-AWAY PRICE! NKT 124/5 switching transistors. Also capable of being used in all stages of a superhet. 6 for 10/-. Newmarket 405 10/- each. Miniature earphones with plug and lead 6/-. Transistor electrolytics 1/6d. each. Brand-new 4in speakers 10/-. Goods under 10/- add 6d. postage please. G. F. MILLWARD, 17 Peel Close, Drayton Bassett, Staffs.

RESISTORS! You can't resist these 1,000 assorted wattage and value. Cannot be repeated at 22/10/- per 1,000. G. F. MILLWARD, 17 Peel Close, Drayton Bassett, Staffs.

RECEIVERS AND COMPONENTS

(continued)

POTENTIOMETERS

250Ω 1W, 500Ω 1W, 500Ω 1W, 5K1W, 50K1W, 50K1W, 100K1W, 100K1W, 150K1W, 400K1W, 500K1W, 1 Meg 1W, 1 Meg 1W, 1.5 Meg 1W. 15/- per dozen your selection.

ELECTROLYTIC CAPACITORS

100 mfd 6V, 10 mfd 25V, 50 mfd 50V, 8 mfd 50V. All at 9d. each. 500 mfd 50V 2/8d, 1000 mfd 50V 3/6, 100/200 mfd 275V 6/4d.

SILVER MICA CAPACITORS

A packet of 100 assorted values up to 10000 PF 15/-.

RESISTORS

A packet containing 100 assorted values 1W to 3W 1% to 10% 6/-.

METAL RECTIFIERS

400V Max RMS 150 MA 2/-.

VALVE HOLDERS

B7G 3/- per doz. State chassis or P.C. Mounting.

TUBULAR CAPACITORS

.5 mfd 250V, .01 mfd 1000V, .1 mfd 150V, .01 mfd 200V, .02 mfd 250V, .005 mfd 200V, .1 mfd 350V 6/6 per dozen, you select.

I2P IN PAINTON PLUGS AND SOCKETS

Type 500685 9/- per pair.

PLESSEY WAFER SWITCHES

4 pole 6 way Type GA2 4/6 each.

DIODES

ED400, SD92, SD94, 2/6 each, OA81 and GEX34 2/- each.

ZENER DIODES

VR475F 6/6, ZL18 12/6, IN2048/1 14/6, KR60 20/-.

NEON INDICATORS

Red or Amber Type SL78 5/-.

Postage and Packing for orders under £1, 1/-, under £5, 2/-, above £5 free.

TRANSUNITS LTD.

79 High St., Walton-on-Thames

Telephone: Walton-on-Thames 21361

R. & R. RADIO & TV SERVICE

Dept. P.E.

32 Market Street, BACUP. Tel. 465

Salvage Valves

6F13	4/6	PCF80	4/-
6F15	5/-	PCL83	5/-
6L18	4/6	PL81	5/-
6K25	10/-	PL82	4/-
6U4GT	5/-	PL83	4/-
6BW6	5/-	PY81	3/6
6/30L2	5/-	PZ30	5/-
EB91	1/-	U801	7/6
6F1	2/6	U301	6/-
EBF80	5/-	U329	5/-
EF80	1/6	10F1	1/-
EF91	2/6	10LD1	5/-
EF85	5/-	10P13	5/6
ECC82	4/-	10P14	5/-
EY86	4/-	20L1	5/-
ECL80	4/-	20F2	5/6
20P3	5/-	20D1	2/-
20P4	7/6	20P1	6/6
30F5	5/-	20P5	6/6
30PL1	5/-	30FL1	6/6
PL38	6/-	30P12	5/-
PL36	7/6	30P4	7/6
PY33	7/6	PY32	6/-
PCC84	4/-	PY82	5/-

Postage on valves 6d.—3 or more post free.

1 Pole 8-way switch, complete with 8 resistors 2 @ 1K, 2 @ 15K, one each of 22K, 15K, 18K, 6.8K. 3/6 incl. post.

Fireball Tuners as removed 14/9. Selected Tuners 18/9. Speakers ex T.V. 6 x 4 inch 3/6. 8 inch rad 6/- Resistors New: 1/2 watt 3 1/2d., 1 watt 5d., 2 watt 9d. all 10%.

S.A.E. with all enquiries. All goods subject to satisfaction or money refunded.

NOW READY!

A modern way of instrument case assembly using our "Die Strip". The strip has been specially made for us at Birmingham on qty. production, for low price to the public. It is made of high strength alloy and will enable anyone to assemble an instrument case or cabinet in minutes. Full details of these products will be sent free. Please send large envelope self addressed.

88 set transmitter receiver. Chassis less valves 20/- each. Post paid.

Copper Laminate Board, single or double sided, 5/- per square foot panels, either type 3ft. by 4ft. 33/-.

High Stab Resistors, 5% 6d.; 2% 9d.; 1% 1/- Every six packed in 7-compartment linen finish component box.

Speakers, 3 ohm P.M. 5in., 5/-, 6in., 6/-, 7 x 4in., 7/-, 8in., 8/-, 10in., 12/6.

Please send S.A.E. for full Lists of other goods on offer.

U.K. ONLY

E. R. NICHOLLS

Mail Order and Retail Shop

46 LOWFIELD ROAD

off SHAW HEATH, STOCKPORT

CHESHIRE

TESTED TRANSISTORS

1/- each, Red or White Spots.

2/- each, XA101, XA102, XB103, OA90, XA111, XA112, OC430, V10/1S.

3/- each, OC44, OC45, OC70, OC71, OC81, OC81D, XA151, XB104, XC101, XC101A, OC169, OC200.

4/- each, AF114, AF115, AF116, AF117, OC170, OC171, XA103, XA116, XB102, XB105, XC121, XU611.

5/- each, OC139, OC140, OC204, ORP60, XA701, XA703, GET7, GET8, GET9, XC141, BY100, OA211.

10/- each, OC19, OC22, OC25, OC26, OC28, OC35, 2SO13.

ZENER DIODES 4.7 v. to 30 v. 1/2 watt, 3/6, 1.5 watt, 5/-, 7 watt, 6/- each.

Plus many more, send 6d. in stamps for Full List and Equivalent Chart.

B. W. CURSONS

78 BROAD STREET

CANTERBURY, KENT

TRANSFORMERS

TELEVISION:!
From your OWN Car Battery

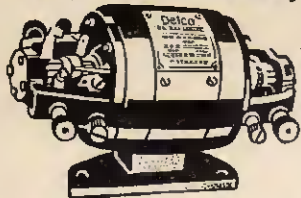

Famous **DELCO TRANSFORMER** transforms 12 or 24v. supply to mains Power for TV, 3" drills, etc. **NOW ONLY 65/-**. C.O.D. 2/8 extra. Carr. Paid.
VIBRATOR POWER-PAK. Step 12v. up to MAINS output. For Universal AC/DC razors, small fluorescent fittings, radios, etc. Only **32/6**
HOOVER ROTARY TRANSFORMERS. 6v. input, 250v. output. 12v. input, 490v. output, 32 watts. **Brand New 25/-**
GENERATING SETS. Brand New. **TINY TIM.** 12v. 300 watts. In packing case. **SELF STARTING.** Normal List Price **£76.** Price Delivered **£35**

Send NOW—Delivery by return
JAMES WALKER, ELECTRONICS DIVISION
36 Alexandra Street, Thurmarston, Leicester

FOR SALE

FOR SALE. Radio Control 8 channel Tx/Rx, 3-5cc engine, 12V Boat Motor. **£15.** Heathkit 5in. 10-12" oscilloscope **£30.** Jason FMT3 Tuner **£15.** B. STATION, 97 Edward Wilson House, Hesters Way, Chettenham.

CONSTRUCTORS parcel containing useful assortment of radió and electronic spares. Relays, Switches, Resistors, Condensers; 30/-. Ten times value guaranteed. **AUDIOCRAFT,** 20 Kettering Road, Northampton, 36291.

CONDENSER BARGAIN! Miniature paper condensers, 1/4in x 1/4in. Ideal for transistor sets. .0001, .001, .002, .005, .02, .04µF; also small. 500µµF and 2.2µµF condensers. All 7/6d. per 100. **£3** per 1,000. G. F. MILWARD, 17 Peel Close; Drayton Bassett, Staffs.

DID YOU KNOW that Suffolk Tubes, still the largest independent tube rebuilders, give a free delivery service by van or passenger train to all parts of the U.K. Each tube is guaranteed 12 months and all types are always available off the shelf at keenest prices. 1-3 Upper Richmond Road, Putney, London, S.W.15. Telephone Vandyke 4304/5267.

VENNER TIME SWITCHES. Reconditioned, 14 day clock, once on once off every 24 hrs. jewelled movement, fully guaranteed. 1 amp 25/-, 5 amp 32/6d., 15 amp 39/6d. Post etc. 2/6d. Cast Aluminium Cases 7/6d. A. B. BATCHELOR, P.E. Dept. 4 Park Road, Bromley, Kent.

ELECTRIC SOLDERING IRON



FANTASTIC BARGAIN OFFER ONLY

Lightweight Pistol Grip handle, 40 watt, 240 - 250v. A.C. Solid copper bit, detachable handle forms cover for iron when not in use. With 41ft. Safety 3-core flex. Indispensable for every home handyman. A boon to model makers and a necessity for every electronics enthusiast. Offered to you at this new amazing price.

C. H. SERVICE (Dept. P.E.1)
Lusted Hall Lane, Tatsfield, Kent.

FOR SALE

(continued)

MAINS TRANSFORMERS

MARCONI CANADIAN RECEIVER No. 52. Shipping, Amateur and Broadcast. 10 valves receiver, three switched wave-bands covering 1.75-16 Mc/s (19-170 metres), plus 3 valve crystal calibrator to provide marker checks at 10-100-1000 kc/s. One R.F. and two I.F. stages. Other refinements: valve, H.T. and Signal check meter. Internal 3 in. speaker and two H/Phone outputs with switched control. RF-AF Gain, Noise Limiter, Filter, BFO, Heterodyne pitch control. Wide and Narrow Bandwidth, Man or AVC on CW and RT. Past and Slow tuning with lock. Additional OSC Tuning (plus and minus) Power requirements HT 160v. 60 mA; I/T 12v. 1 1/2 amps. Brand new with circuit and cover. Price **£9/17/6**, plus 12/6 carriage.

R F 25 UNITS. Switch tuned over the band 40 to 50 Mc/s. Valves VR65x3, 1F-O/P 7 Mc/s, in good condition with circuit. Requires 250v. and 6v. Price **25/-**, plus 5/- post.

Class D WAVE METER. Frequency 1.9 to 8 Mc/s in two bands, 1.9 to 4 and 4 to 8 also 1 Mc/s Harmonics up to 25 Mc/s. These are supplied complete in transit case with headphones, spare valve vibrator, instruction book and circuit diagram. These units are intended to work off 6v. D.C., but are easily converted to mains operation, simple conversion details supplied. They are supplied in new condition and are ideal for use with types 19, 38 and similar Trans. receivers. Price **£3/7/6**, plus 7/6 carriage. 230 to 6v. transformers for mains conversion 0/6.

P.O. SUPPLIES Enclosed Prim: 110-230v., Sec.: 6v. 3a or 12v. 1.5a. This is a totally enclosed transformer with terminal block connections on I/P & O/P. Will work as a 110v. 40 watt Auto Transformer. Price **10/-**, plus 3/- post. **BRAND NEW.**

POWER UNIT 311. I/P 200-250v. 50 c/s, O/P's +300v. 250 Ma-130v. 40 Ma and 12v. D.C. smoothed at 4 amps. Valves 6u4 or 5v4x2, 6x5. The O/P's are all fused and can be switched remotely by relays in the Power Unit. H.T. circuits employ choke I/P filters. Some increase in the H.T. O/P can be obtained by using Condenser Filters. The unit is complete with outer cover and circuit in new condition and crated. Price **£5/10**, plus £1 carriage.

METERS 5Q/171. 500UA scaled 0 to 5. Marconi type single hole fixing 2 1/2 in. OSD 90 ohms. New ex-equipment. Price **15/-**, plus 2/- post.

R.F. 26 UNITS. This unit covers the band 60 to 65 Mc/s. Manual tuned (no XTALS required), giving a I.F. O/P of 7 Mc/s. Valves EF54 RF Amp, BF 54 Mix, EC52 L.O. A Multhead slow motion drive is fitted, also Aerial Trimmer. These units are easily converted to the band 80 to 100 Mc/s. Power requirements 250v. 25 Ma and 6.3 v. 1a. The I.F. O/P from these can be fed into a R.X., or 1 F amp tuned to 7 Mc/s. Circuit diagram and connections supplied. These units are complete new and boxed. Price **37/6**, plus 5/6 carriage.

TEST SET Type 502. Contains meter 2.5 MA scaled 0 to 25 2 1/2 in., 3 rotary switches 2x11 way and 9 way, 3 terminals, neon Ind, 20 2%, and 5% Resistors, Meter rectifier, etc. Complete with outer cover size 8 in. x 10 in. x 3 1/2 in. deep. Modern style unit. Price **30/-**, plus 5/- post. Lend with plug to fit P.S. 502 7/6.

SELENIUM RECTIFIERS. Half wave type I/P 300 v. A.C., O/P current 100 Ma, with mounting brackets. Made by FEDERAL TELEPHONE CO., U.S.A. New and boxed. Price 2/6 each, plus 6d. post or 4 for 10/- post paid.

B. SLATER

34 Lifford Street, Sheffield 9

(Dept. ES65)

FOR SALE

(continued)

A.C. STANDARD. Mains Motors Fractional H.P. 3 1/2 in dia x 4 in long with 1/4 in spindle. Many uses. Brand new, 25/- each. P. & P. 2/6d. Small Battery Motors 1 1/4 in dia x 2 in long—4 1/2 to 9 volts. Heavy construction; only 7/6d. each. P. & P. 1/-. **WATSONS WIRELESS STORES,** 15 Church Street, Wolverhampton.

CRACKLE PAINT. Black or Grey, 1/2 pint tins 4/-, post 6d. from the component specialists. **SERVIO RADIO,** 158-8 Merton Road, Wimbledon, London, S.W.19.

TRANSISTORS UNMARKED UNTESTED. 40 for 10/-, P. & P. 1/- 4 packets post free. Relays, thousands of types, special catalogue free. General Catalogue of Mechanical & Electrical Gear, Tools, etc., 5,000 items, free. **K. R. WHISTON (Dept. PET),** New Mills, Stockport.

SERVICE SHEETS

SERVICE SHEETS for all makes of Radio and TV 1925-1965. Prices from 1/- with free fault-finding guide. S.A.E. inquiries. Catalogue of 6,000 models, 1/6. Valves, modern and obsolete. Radio/TV Books. S.A.E. lists, **HAMILTON RADIO,** Western Road, St. Leonards, Sussex.

TRADE SERVICE SHEETS. Radio, TV, etc. Mixed dozen @ 4/-, 100-22/6d. p.p. **TELRAY,** Maudland Bank, Preston.

STATE MODEL NO. Radio 2/-, TV 2/6. S.A.E. **DARWIN,** 10 George Street, St. Helens, Lancs.

SHEETS for all Radios and Televisions from 1924-4/- each plus S.A.E. From **GRIMSDYKE RADIO,** 77 Merrion Avenue, Stanmore, Middlesex.

SERVICE SHEETS

4/- each, plus postage.

We have the largest supply of Service Sheets for all makes and types of Radios, Televisions, Tape Recorders, etc. in the country. Speedy Service.

To obtain the Service Sheet you require, please complete the attached coupon:

From:

Name:

Address:

.....

.....

To: **S.P. DISTRIBUTORS**

44 Old Bond St., London, W.1

Please supply Service Sheets for the following:

Make:

Model No.: Radio/TV

Make:

Model No.: Radio/TV

Make:

Model No.:

New 1965 List now available.

I also require list of Service Sheets at 1/6.

(please delete items not applicable)

I enclose remittance of

MAIL ORDERS ONLY Sept. PE

SITUATIONS VACANT



AVIATION SERVICE AND REPAIR DIVISION

Aviation Service and Repair Division at Airport Works, Rochester, provides unique servicing facilities for the airlines of the world. It services aircraft instruments, autopilots and complete control systems involving electronic assembly to the very highest standards. Because of the need for reliability the work is carried out in first class working conditions.

Owing to our expansion programme, we now have immediate vacancies for:—

ELECTRONIC INSTRUMENT MECHANICS

Capable of complex fault diagnosis on electronic airborne equipment (radio and television servicing or H.M. Forces experience would be an advantage).

INSTRUMENT MECHANICS (GYROSCOPIC)

Previous experience in the overhaul of gyroscopic equipment is considered necessary.

Applications should be made in writing, quoting reference number ASR/2, and giving brief details of previous experience to:

M. J. Moran, Personnel Officer
ELLIOTT BROTHERS (LONDON) LIMITED

Airport Works, Maidstone Road
Rochester, Kent

All applications will be answered within seven days.

A member of the Elliott-Automation Group

EDUCATIONAL

HOME STUDY COURSES in Practical Electronics. Free Brochure without obligation from: **BRITISH NATIONAL RADIO SCHOOL**, Reading, Berks.

STUDY RADIO, TELEVISION AND ELECTRONICS with the world's largest home study organisation. I.E.R.E., City & Guilds, R.T.E.B., etc. Also Practical Courses with equipment. All books supplied. Write for **FREE** Prospectus stating subject to I.C.S. (Dept. 577), Intertext House, Parkgate Road, London, S.W.11.

Full-time courses in **RADAR** and **RADIO-TELEGRAPHY** for prospective marine Radio Officers. Govt. approved exam. centre.

Also courses in basic **ELECTRONICS, RADIO, TELEVISION** and **PRACTICAL SERVICING**.

Apply:—**Director, British School of Telegraphy**, 20 Penywern Road, Earls Court, London, S.W.5

A.M.I.Mech.E., A.M.I.E.R.E. City & Guilds, G.E.C., etc. Become a Technician or Technologist for high pay and security. Thousands of passes. For details of Exams. and Courses in all branches of Engineering, Building, Electronics, etc., write for 156-page handbook—**FREE**. B.I.E.T. (Dept. 152), London, W.8.

EDUCATIONAL

(continued)

B.Sc.(ENG.), A.M.I.Mech.E., A.M.I.E.R.E. City & Guilds, etc., on "Satisfaction or Refund of Fee" terms. Wide range of expert Home Study Courses in Electronics, Computers, Radio, T.V., etc. 156-page Guide—**FREE**. Please state subject of interest. **BRITISH INSTITUTE OF ENGINEERING TECHNOLOGY**, 151a College House, Wright's Lane, London, W.8.

THE INCORPORATED PRACTITIONERS in Radio & Electronics (I.P.R.E.) Ltd., Membership Conditions booklet 1/-, Sample copy of I.P.R.E. Official Journal 2/-, post free. Secretary, Dept F, 32 Kidmore Road, Caversham, Reading, Berks.

METAL WORK

CABINETS • CASES CHASSIS

Anything in metal, "One-offs" a pleasure
Send your drawing for quote
Stove enamelled in any professional finish

MOSS, WATSON P.E.
40 Mount Pleasant Street, Oldham
Lancs. MAIN 9400

AMPLIFIERS AND SPEAKERS
NORTHCOURT "FIVE" AMPLIFIER

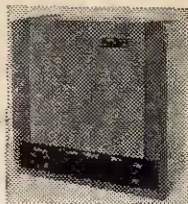

Suitable for guitars, gramms and radios. The 5 watt output amplifier incorporates separate volume, treble and bass controls. Two jack socket inputs are fitted. Twin speakers give exceptionally realistic reproduction and are built into an attractive cabinet. Size: Length 11 1/2 in. Height 11 1/2 in. Depth 5 1/2 in. Finished in mottled grey with the front covered in VYNAIR. Mains Voltage 200/250, 50 K/c. Ideal for home use with any guitar. Retail £9.17.6.

As above fitted with volume control, 35/9 Retail.

P.A. EXTENSION SPEAKER



Suitable for radio and Record Players. Size: Length 10 in. Height 7 in. Depth 5 in. Fitted in wood cabinet. Attractively finished in industrial mottled grey with speaker front covered in VYNAIR. Price 29/9 Retail. Twin Speaker 39/6.

As above fitted with volume control, 35/9 Retail.

All products guaranteed 12 months. Trade supplied. For name of nearest stockist and full accessory brochure, write to:

Northcourt (Electrical Bfd.) Limited

Transformer and Coil Manufacturers
Dept. P.W. SOUTH PARK MILLS
PUDSEY, Yorks.

BBC2 (625 LINE) TV AERIALS



MAST MOUNTING ARRAYS, 9 element 45/-; wide spaced high gain, 11 element 55/-; 14 element 62/6. **WALL MOUNTING WITH CRANKED ARM**, 9 element 60/-; wide spaced high gain, 11 element 67/6; 14 element 75/-. **CHIMNEY ARRAYS COMPLETE**, 9 element 72/-; wide spaced high gain, 11 element 80/-; 14 element 87/6. **LOFT ARRAYS**, 7 element 32/6; wide spaced high gain, 11 element, **WITH TILTING ARM** 62/6; 14 element 70/-. **ALL HIGH GAIN UNITS HAVE SPECIAL MULTI-ROD REFLECTOR, LOW LOSS CO-AXIAL CABLE** 1/6 yd. **VHF transistor pre-amps** from 75/-.

BBC + ITV + F.M. AERIALS



B.B.C. (BAND 1), Telescopic, loft 21/-. External S/D 30/-.

I.T.V. (BAND 3), 3 Element loft array, 25/-. 5 element 35/-. Wall mounting, 3 element 35/-. 5 element 45/-.

COMBINED B.B.C./I.T.V. Loft 1+3, 41/3; 1+5, 48/9; Wall mounting 1+3, 56/3; 1+5, 63/9; Chimney 1+3, 63/9; 1+5, 71/3.

VHF transistor pre-amps from 75/-.

F.M. (BAND 2), Loft S/D, 12/6. "H", 30/-. 3 element, 52/6. External units available. Co-ax. cable 8d. yd. Co-ax. plug, 1/3. Outlet boxes, 4/6. Diplexer Crossover Boxes 12/6. C.W.O. or C.O.D. P. & P. 3/6. Send 6d. stamps for illustrated lists.

K.V.A. ELECTRONICS (Dept. 2)
3b, Godstone Road, Kenley, Surrey.
CRO 2527

LASKY'S RADIO

For the Finest Value and Service to THE ELECTRONICS ENTHUSIAST

We consider our construction parcels to be the finest value on the home constructor market. If on receipt you feel not competent to build the set, you may return it as received within 7 days when the sum paid will be refunded less postage.

TRANSISTOR PORTABLES

THE SKYROVER RANGE

7 transistor and 2 diode superhet portables—covering full med, plus 6 SW Bands.

The SKYROVER Mk III.

(Illustrated). Now supplied with redesigned plastic cabinet in black, grey and chrome with edgewise controls.

Controls: Waveband Selector, Volume Control with on/off Switch, Tuning Control. In plastic cabinet, size 10 x 8 1/2 x 3 1/2 in., with metal trim and carrying handle.

Can now be built for **£8.19.6** Post 6/- extra. H.P. Terms: 27/- deposit and 11 monthly payments of 15/9. Total H.P.P. £10.0s.3d.

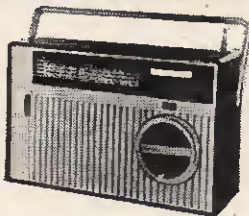

The SKYROVER De Luxe

Tone Circuit is incorporated, with separate Tone Control in addition to Volume Control. Tuning Control and Waveband Selector. In a wood cabinet, size 11 1/2 x 8 1/2 x 3 1/2 in., covered with a washable material, with plastic trim and carrying handle. Also car aerial socket fitted.

Can now be built for **£10.19.6** Post 6/- extra. H.P. Terms: 33/- deposit and 11 monthly payments of 19/2. Total H.P.P. £12.3s.10d.

Data for each receiver: 2/6 extra. Refunded if you purchase the parcel. Four U2 batteries 3/4 extra. All components available separately.

* LONG WAVEBAND COVERAGE IS NOW AVAILABLE FOR THE SKYROVER

A simple additional circuit provides coverage of the 1100/1500Kc. band (including 1500 M. Light programme). This is in addition to all existing Medium and Short wavebands. All necessary components with construction data.

Only **10/-** extra Post Free. This conversion is suitable for both receivers that have already been constructed.

THE "HARROW" POWER PACK

Battery eliminator for portable radios, etc. Converts your battery radio to A.C. mains. Replaces 4 1/2 v. 6 v. and 9 v. batts. Size only 5 1/2 x 3 1/2 in. State voltage required when ordering.

LASKY'S PRICE 29/6 Post 2/-

SPECIAL INTEREST ITEMS!

TEST METER ADAPTOR

Type P.E. 220—this is a fully transistorised device which enables any 50 microamp D.C. Multimeter to be used in place of a valve volt meter. On the 1V, range an impedance of 1 megohm is offered which increases on the 1000 V. range to 100 megohms. 7 ranges: 1 to 1000 Volts. Designed for immediate connection to Avo 7, 8 and similar size meters but quite suitable for use with any other 50 microamp meter. Size 8 x 6 x 3 in. New and boxed. List Price 7 Gu.

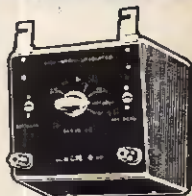

LASKY'S PRICE 39/6

Post 2/6. Set of batteries 7/6 extra.

VERBOBOARD — NOW IN STOCK

A really remarkable time saver in setting out complicated experimental circuits, with a regular matrix of holes. Ideal for producing single items.

As featured in "Practical Electronics" April '65 issue.

Boards	Accessories
42/1503 2 1/2 x 4 in.	3/8 Terminal pins - pkt. of 30
43/1604 2 1/2 x 3 1/2 in.	3/8 Spot face cutter tool
43/1607 3 1/2 x 5 in.	3/2 Pin inserting tool
44/1608 3 1/2 x 3 1/2 in.	3/8
44/1605 3 1/2 x 17 in.	13/8 Post 6d. per item extra.

TRANSISTORS

ALL BRAND NEW AND GUARANTEED
GET 81, GET 85, GET 86 2/8; 873A, 874P 3/8; OC45, OC71, OC81D 4/8; OC 44, OC 70, OC 76, OC 81 5/8; (match pair 10/8); AF 117, OC 75, OC 200 6/8; OC 42, OC 43, OC 73, OC 82D 7/8; OC 201, OC 204 16/-; OC 208, OC 200 18/8; OC 28 24/8.

TRANSFILTERS By BRUSH CRYSTAL CO. Available from stock.

TO—01D 465 kc/s. ± 2 kc/s.	TO—02D 470 kc/s. ± 1 kc/s.	7/6 EACH
TO—01D 470 kc/s. ± 2 kc/s.	TF—01B 465 kc/s. ± 2 kc/s.	P. & P. 6d.
TO—02B 465 kc/s. ± 1 kc/s.	TF—01D 470 kc/s. ± 2 kc/s.	

207 EDGWARE ROAD, LONDON, W.2.

Near Praed St. PADDINGTON 3271/2

Open All Day Sat. Erl. Closing Thurs. (42 Toll. Ct. Rd. Erl. Close Sat), Mail Orders to Dept. P.E., 207 Edgware Rd., W.2

33 & 42 TOTTENHAM COURT ROAD, W.1.

Nearest Stn.; Goodge St. MUSEUM 2605

152/3 FLEET STREET, LONDON, E.C.4.

Telephone: FLEET Street 2833

OPEN ALL DAY THURSDAY., Early Closing Sat.



MAKING or BUYING?

DEAL WITH LIVERPOOL'S LEADING
— MUSICAL INSTRUMENT DEALER —

FRANK HESSY LIMITED (Liverpool)

27/29 STANLEY STREET, LIVERPOOL 1 + Central 1418/9

Suppliers to all the leading groups

GUITAR ACCESSORIES

Vox solid guitar pickup	39/6
Hofner Electric pickup	43/6
Plato Electric pickup solid type	63/-
Plato Electric pickup Bass	66/-
Stanley pickup c/w vol. and tone control (suitable for Spanish or cello, state which)	75/-
Framus 2 pickup unit mounted on chrome scratch plate, 4 controls	111
Kent adjustable bridge with built in pickup and vol. control	75/-
Adjustable Bridge (solid or cello, state which)	8/-, 12/6 and 15/-
Machine heads (single)	4/-
Machine heads (set 3 on each side)	14/6
Bass guitar machine head (heavy duty)	15/-
Guitar string sets, electric Hofner	per set 6/-, 6/6, 7/6
Guitar string sets, electric Monopole	per set 20/-
Guitar string sets, Cathedral	per set 21/6
Guitar string sets, Stanley	per set 12/-
Bass Guitar strings (Stanley)	per set 47/6
Bass Guitar strings (Monopole)	per set 56/-
Plectrums—5 assorted	9/-
Hawaiian Steels	9/-
Fretwire per yard	4/6
Top Nuts each	1/6
Endpins for guitar straps	1/6
Capoastars	8/-
Quick release type	48/6
Guitar straps	7/6, 12/6, 17/6
Tailpiece (state type) from	8/9, 15/-
Tuning Pitch Pipes	7/3
Guitar Tutor Books—Play in a Day, Bert Weedon	5/-
A Tune a Day	3/-
Others	3/-
Stanley single pickup guitar (c/w lead) Cash	£11/19/6
Stanley 3 pickup with tremolo solid guitar	24 gns.
Assorted Second-Hand part exchange solid guitars, from	£10
Selmer 6 watt amplifier (c/w speaker)	£12/12/0
Fenton Weill amplifier (c/w speaker)	£14/14/0
Stanley Treble boosters	25/5/0

Microphones by RESLO, GRAMPIAN, SHURE & BEYER

We can supply any type of musical instrument. Let us know your requirements and it will receive our immediate attention. Send cash with your order now!! We pay all postal charges—goods despatched by return post

PRINTED CIRCUIT BOARDS

Available for GULTON ultrasonics remote control system. Mullard 10 Watts Transistor Amplifier. Write for details to: TATES ELECTRONIC SERVICES LTD. 3 WATERLOO ROAD, STOCKPORT, CHESHIRE

BATTERY ELIMINATORS

The ideal way of running your TRANSISTOR RADIO, RECORD PLAYER, TAPE RECORDER, AMPLIFIER, etc. Types available: 6v; 6v-4 1/2v (single output) 39/6 each. P. & P. 2/9. 9v + 9v; 6v + 6v; or 4 1/2v + 4 1/2v (two separate outputs) 42/6 each. P. & P. 2/9. Please state output required. All the above units are completely isolated from mains by double wound transformer ensuring 100% safety.

R.C.S. PRODUCTS (RADIO) LTD. (Dept. P.E.), 11 Oliver Road, London, E.17

Please mention

PRACTICAL ELECTRONICS

when replying to

Advertisements

QUALITY RECORD PLAYER AMPLIFIER
A top quality record player amplifier. This amplifier (which is used in a 29 gm. record player) employs heavy duty double wound mains transformer, ECC83, EL84, EZ80 valves. Separate Bass, Treble and Volume controls. Complete with output transformer matched for 3 ohm speaker. Size 7in. w. x 2 1/2in. d. x 5 1/2in. h. Ready built and tested. PRICE 69/6. P. & P. 4/9.

ALSO AVAILABLE mounted on board with output transformer and 6in. speaker ready to fit into cabinet below. PRICE 89/6. P. & P. 3/9.

QUALITY PORTABLE R/P CABINET
Uncut motor board. Will take above amplifier and B.S.R. or GARRARD Autochanger or Single Record Player Unit. Size 11 1/4 x 14 x 8 1/2 in. PRICE £19/6. Carr. 7/6.

4-SPEED PLAYER UNIT BARGAINS
All brand new in maker's original packaging.

SINGLE PLAYERS
B.S.R. TU/12 £18/6 Carr. 5/6
GARRARD SRP10 £5/9/11 Carr. 5/6
B.S.R. GUT with unit mounted pickup arm £4/18/8 Carr. 5/6

AUTO. CHANGERS
B.S.R. UA15 £6/19/6, B.S.R. UA16 £6 19 6
Latest B.S.R. UA25 Super slim £6 2 6
Latest GARRARD AT5 £5 10 0
GARRARD AT6 £10 10 0
GARRARD Auto-Slim £6.10.0. Carr. 6/6 on each.

All the above units are complete with t/o mono head and sapphire styl or can be supplied with compatible stereo head for 12/6 extra.

BRAND NEW CARTRIDGE BARGAINS!
ACOS 71-5. Single sided Crystal Cartridge for Stereo and L.P. records. Complete with diamond styl and universal mounting bracket. List price £26/4. Our price 18/6. P. & P. 1/6.

GARRARD GC2 MONO complete. List price 24/11. Our price 12/6. P. & P. 1/6.
RONETTE STEREO 105 CARTRIDGE Stereo/LP/78 complete with two sapphires. Original list price 67/9. Our price 24/-. P. & P. 1/6.

MAINS TRANSFORMERS
Fully shrouded, can be mounted upright or drop through. Tapped pri. 110, 200, 220, 240v. Sec. 250v. 1 1/2 wave at 85mA and 6-3v. 2 amps. ctc. Stack size 3" x 2 1/2" x 1 1/2". PRICE 12/6. P. & P. 3/6. ALSO Semi shrouded draught type. Pri. 200, 220, 240v. Sec. 250v. 1 1/2 wave at 70mA and 6-3v. at 2 amp. ctc. Stack size 3" x 2 1/2" x 1 1/2". PRICE 11/-. P. & P. 3/6.

BRAND NEW 3 OHM LOUDSPEAKERS
5in., 12/6; 6in., 15/-; 8in., 21/-; 10in., 25/-; 12in., 27/6; (12in. 15 ohm, 30/-). 10in. x 6in. 26/-. E.M.I. 133 x 8 in. with high flux ceramic magnet, 42-1 (15 ohm, 45/-). 4in. HIGH FLUX TWEETER. 3 ohm and 15 ohm imp. Famous British make. Few only 12/-. P. & P. 4/- 5" 2/-, 6" 2/6, 8" 2/6, 10" 3/6 per speaker.

ROLA CELESTION. Approx. 9in. x 6in. x 3ohm. Middle register speaker, 10/6. P. & P. 3/6.
ACOS CRYSTAL MIKES. High imp. For desk or hand use. High sensitivity, 18/6. P. & P. 1/6.

TSI CRYSTAL STICK MIKE. Listed at 45/-. Our price, 18/6. P. & P. 1/6.

BRAND NEW. 12" 15W. H/D Speakers, 3 or 15 ohm. Current production by well-known British maker. Offered below list price at 89/6. P. & P. 5/-. (25w. guitar model £5.5.0). (35w. guitar model £8.8.0).

MATCHED PAIR OF 2 WATT TRANSISTOR DRIVER AND OUTPUT TRANSFORMERS. Stack size 1 1/2 x 1 1/2 x 1 in. Output trans. tapped for 3 ohm and 15 ohm output. 10/- pair plus 2/- P. & P.

BRAND NEW PLESSEY 12 v. 4 pin non-synch. vibrators. Type 121.45D. ONLY 8/6. P. & P. 1/6

4-WAY NON-TANGLE TELEPHONE CABLE
Latest spring-back coil type, extends 12 in. to 5ft. Complete with rubber bushes, 4/6 each. P. & P. 1/6.
VYNAIR AND REKINE SPEAKER AND CABINET FABRICS app. 54 in. wide. Usually 35/- yd., our price 13/6 per yd. length (min. 1yd.) P. & P. 2/6. S.A.E. for samples.

STEREO AMPLIFIER
Incorporating 2 ECL82s and 1 EZ80, heavy duty, double wound mains transformer. Output 4 watts per channel. Full tone and volume controls. Absolutely complete.

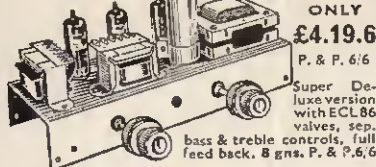

ONLY £4.19.6
P. & P. 6/6

Super Deluxe version with ECL86 valves, sep. bass & treble controls, full feedback. 8 gns. P. & P. 6/6

HIGH GAIN 4 TRANSISTOR PRINTED CIRCUIT AMPLIFIER KIT Type TAI

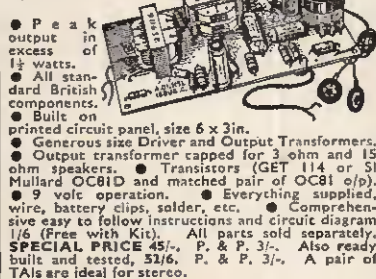

- Peak output in excess of 1 1/2 watts.
- All standard British components.
- Built on printed circuit panel, size 6 x 3in.
- Generous size Driver and Output Transformers.
- Output transformer capped for 3 ohm and 15 ohm speakers.
- Transistors (GET 114 or 51 Mullard OC81D and matched pair of OC81 o/p).
- 9 volt operation.
- Everything supplied, screws, battery clips, solder, etc.
- Comprehensive size easy to follow instructions and circuit diagram 1/6 (Free with Kit). All parts sold separately. SPECIAL PRICE 45/-. P. & P. 3/-. Also ready built and tested, 51/6. P. & P. 3/-. A pair of TAIs are ideal for stereo.

TAPE DECKS
B.S.R. MONARDECK (Single speed) 3 1/2in. per sec., simple control, uses 52in. spools, £6/15/- plus 7/6 carr. and ins.
COLLARO STUDIO DECK 3 motors, 3 speeds push button control. Up to 7in. spools £10/10/- P. & P. 7/6. (Tapes extra on both.)

10/14 WATT HI-FI AMPLIFIER KIT

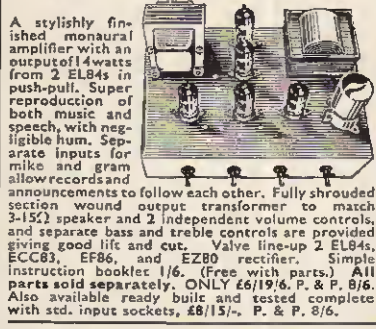

A stylishly finished monaural amplifier with an output of 4 watts from 2 EL84s in push-pull. Super reproduction of both music and speech, with negligible hum. Separate inputs for mike and gram allow records and announcements to follow each other. Fully shrouded section wound output transformer to match 3-15Ω speaker and 2 independent volume controls, and separate bass and treble controls are provided giving good life and cut. Valve line-up 2 EL84s, ECC83, EF86, and EZ80 rectifier. Simple instruction booklet 1/6. (Free with parts.) All parts sold separately. ONLY £6/19/6. P. & P. 8/6. Also available ready built and tested complete with std. input sockets, £8/15/-. P. & P. 8/6.

HARVERSON SURPLUS CO. LTD.

170 HIGH ST., MERTON, S.W.19. CHERRYWOOD 3985

Open all day Saturday Early closing Wed., 1 p.m.

A few minutes from South Wimbledon Tube Station. (Please write clearly)

OVERSEAS P. & P. CHARGED EXTRA. S.A.E. with all enquiries.

3-VALVE AUDIO AMPLIFIER MODEL HA34

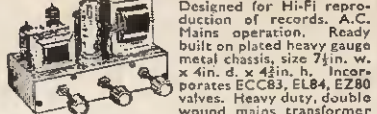

Designed for Hi-Fi reproduction of records. A.C. Mains operation. Ready built on plated heavy gauge metal chassis, size 7 1/2in. w. x 4in. d. x 4 1/2in. h. Incorporates ECC83, EL84, EZ80 valves. Heavy duty, double wound mains transformer and output transformer matched for 3 ohm speaker, separate Bass, Treble and volume controls. Negative feedback line. Output 4 1/2 watts. Front panel can be detached and leads extended for remote mounting of controls.

The HA34 has been specially designed for us and our quantity order enables us to offer them complete with knobs, valves, £4.5.0 etc., wired and tested for only P. & P. 6/-.
HSL 'FOUR' AMPLIFIER KIT. A.C. Mains 200/250v., 4 watt, using ECC83, EL84, EZ80 valves.



★ Heavy duty double-wound mains transformer with electrostatic screen.
★ Separate Bass, Treble and Volume controls, giving fully variable boost and cut with minimum insertion loss.
★ Heavy negative feedback loop over 2 stages ensures high output at excellent quality with very low distortion factor.
★ Suitable for use with guitar, microphone or record player.
★ Provision for remote mounting of controls or direct on chassis.
★ Chassis size only 7 1/2in. wide x 4in. deep. Overall height 4 1/2in. ★ All components and valves are brand new.
★ Very clear and concise instructions enable even the inexperienced amateur to construct with 100% success.
★ Supplied complete with valves, output transformer (3 ohms only), screened lead, wire, nuts, bolts, solder, etc. (No extras to buy.) PRICE 79/6. P. & P. 6/-.
Comprehensive circuit diagram, practical layout and parts list 2/6 (free with kit).

HARVERSON'S F.M. TUNER Mk. I

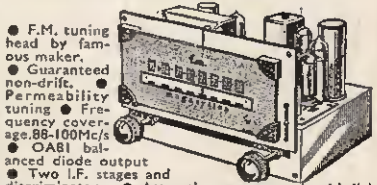

● F.M. tuning head by famous maker.
● Guaranteed non-drift.
● Permeability tuning.
● Frequency coverage 85-100 Mc/s.
● O.A.B. balanced diode output.
● Two I.F. stages and discriminator.
● Attractive maroon and gold dial (7 x 3in. glass).
● Self powered, using a good quality mains transformer and valve rectifier.
● Valves used ECC85, two EF86s and EZ80 (rectifier).
● Fully drilled chassis.
● Size of completed tuner 8 x 6 x 5 1/2in. ● All parts sold separately. Set of parts if purchased at one time £5/19/6, plus 8/6 P.P. and ins. Circuit diagram and instructions 1/6 post free.
Mark II Version as above but complete with maze eye, front panel and brackets, £6/12/6. P. & P. 8/6.
Mark III Version as Mark I but with output stage (ECL82) and tone control, £7/7/-. P. & P. 8/6.
Handsome Metal Cabinets. Choice of Black, or Green. For Mark I, 25/-. P. & P. 3/-. To fit Mark II, 17/6. P. & P. 3/-.
SPECIAL PURCHASE TURRET TUNERS
By famous maker. Brand new and unused. Complete with PCC84 and PCF80 valves, 34-38 Mc/s I.F. Biscuits for Channels 1 to 5 and 8 and 9. Circuit diagram supplied. ONLY 25/- each. P. & P. 3/9.

O/X Your move!

No doubt you will put your X between the two O's. The machine will then play O in the bottom right hand corner. Play what you will, the machine wins at the next move. This is just one of the games played on our Noughts and Crosses machine. As Brian Treuman of Granada TV said, after demonstrating the machine on television on April 12th, "I'm glad I wasn't playing it for money".

One machine that was playing for money, at 3d. a go, refunded for a drawn game, raised £3 in three hours for charity.

Full circuit, wiring diagram, and instructions, 3/6d. post free.

PLANET INSTRUMENT CO.
25 (E) DOMINION AVE., LEEDS 7

DUKE & CO. (LONDON) LTD.
61/3 Romford Road
Manor Park, E12
1L Ford 6001-2-3

T.V. TUBES
14in.—15/-
17in.—35/-

Most makes and types available. Set Tested. Guaranteed good picture. Ex Rental Service Depts. Stock. Carriage 5/- extra Stamp for list

"PRACTICAL ELECTRONICS" CONSTRUCTIONAL DESIGNS

All specified 1st grade Components, complete Metalwork, full range of Materials, engraved Panel Plates, Ancillary Equipment and Assembled Units. Comprehensive lists available for each "P.E." Constructional Article.

Please send 6d. in stamps for each design

MALVYN ENGINEERING WORKS
Engineers to the Radio and Electronic Industries
7 CURRIE STREET, HERTFORD, HERTS
TELEPHONE: HERTFORD 2264

GEA
FIRST QUALITY TAPE FACTORY FRESH

LOWEST EVER PRICES

5in.	Std.	600ft.	8/6
7in.	Std.	1,200ft.	12/6
5in.	L.P.	900ft.	10/0
5 1/2in.	L.P.	1,200ft.	12/6
7in.	L.P.	1,800ft.	15/0
4in.	D.P.	600ft.	9/0
5in.	D.P.	1,200ft.	15/0
5 1/2in.	D.P.	1,800ft.	22/6
7in.	D.P.	2,400ft.	25/0

P. & P. 2/- per order (Over £3 Post Free)

Attractively boxed, guaranteed. Brand New. Obtainable at these low prices ONLY from: **GEE BROS. (RADIO) Ltd. (Dept. P.E.)**, 15 Little Newport St., W.C.2. Ger. 6794 Adjoining Leicester Square Tube Station

ASTONISHING LOW PRICED RADIO KITS (all Guaranteed) FROM CONCORD



MAKE 5 DIFFERENT TRANSISTOR RADIOS for 35/-

New RADIO Anyone CAN BUILD in 2-3 hours. Only 16/8! **EVERY CHILDREN BUILD THEM!** ... no soldering - only 16 connections! Then hear it reach out bringing in station after station. 4 1/2" x 2 1/4" x 1 1/2".



TRANSISTOR RADIO KITS

Sold in Department Stores at £5.8.0

OUR PRICE 37/6 P. & P. 3/6 extra



ASTONISHING CIGARETTE RADIO! ONLY 18/6

Yes a perfectly ordinary packet of cigarettes - but it fetches in station, after station, loud and clear! Holds 10 Cigarettes - yet cleverly conceals highly sensitive, fully transistorised circuit (incl. tiny battery). Even a young boy can assemble it in under 2 hours. No soldering. No experience necessary. Only 18 Connections. From our bulging testimonial file, Mr. D. B. of Hindersfield writes: "... I have fitted the parts in and fit it working wonderfully..." ALL PARTS including Semi-Conductors, A.B.O. Plans, etc. ONLY 18/6 plus 2/6 post, etc.



Amazing Radio Construction Set! Become a radio expert for 35/-. A complete Home Radio Course. No experience needed. Parts include instructions for each design, Step-by-Step plan, all Transistors, loudspeaker, personal phone, knobs, screws, etc., all you need. Box size 14" x 10" x 2" (parts available separate). Originally £6. **NOW 35/- plus 3/6 p. & p.**

Many Testimonials - M.H. of Bradford, writes: "... I have just completed one of your sets successfully, it is the first time I have ever tackled anything like a radio and I must state here and now, I am amazed how easy it is to a layman like me. Your instructions and plan have obviously been very carefully thought out so that even the most dim can follow them..." 19/8 plus 2/6 post, etc.

Well-known brand Transistor Radio Kits - **YOU SAVE £3.35.8.** Covering all medium long wave with parts including Mullard Semi-Conductors. 48 page instruction manual. Entertaining & educational. **No soldering,** just plug in, making many different Radios in a few mins. **Money back if not delighted.**

CONCORD ELECTRONICS LTD (Dept. PE21) 9 Western Road, Hove, Sussex

STOCK TAKING CLEARANCE!

We have many items which we are clearing at special prices. A list is now available and will be sent upon request. Please enclose 4d. stamp for postage.

WATTS RADIO (Mail Order) LTD
54 CHURCH STREET, WEYBRIDGE, SURREY

PLEASE NOTE: Postal business only

YUKAN SELF-SPRAY

Get this Air Drying Grey HAMMER FINISH Now -

IT'S SUPERB... THE PUSHBUTTON WAY!

YUKAN Aerosol spraykit contains 16 ozs. fine quality durable easy instant spray. No stove baking required. Available in Grey Hammer at 14/11 at our counter or 15/11, Carr. paid, per pushbutton self-spray can. **SPECIAL OFFER:** I can plus optional transferable snap-on trigger handle (value 5/-) for 18/11.



Please enclose cheque or P.O. for total amount to:

YUKAN

Dept. PE, 9, 307a EDGWARE ROAD, LONDON, W.2

(Closed Thursday afternoons, open all day Saturday)

Choice of 13 self-spray paint colours and primer (Motor car quality) also available

Z & I AERO SERVICES LTD.

Head Office and Warehouse: 44A WESTBOURNE GROVE, LONDON, W.2.

Retail Shop: 85 TOTTENHAM COURT ROAD, LONDON, W.1
Tel.: LANgham 8408
Tel.: PARK 5641/2/3

OA2 6/-	6/30L2 10/6	6CD0GAL17/-	6X5GT 5/6	198G7 4/-	EC00 2/6	EP184 8/-	GZ37 12/-	PEN40DD 12/-	UR01 12/-
OB2 6/-	6A8 8/-	6CL6 9/-	6V6G 7/0	128J7 4/-	EC01 5/-	EPF60 10/-	HAB50 8/-	PL36 12/-	C403 13/-
OB3 6/-	6AB4 6/6	60W4 12/-	7B6 11/-	128K7 5/-	EC02 6/6	EH90 7/6	HL33DD 10/-	PL38 16/-	U601 13/-
OC2 6/-	6AB7 4/-	6D3 7/8	7B7 8/-	128Y7 6/-	EC03 5/-	EL24 10/-	KT20 20/-	PL81 8/-	U4020 7/8
OC3 6/-	6AG7 8/-	6D4 15/-	7C5 10/-	19A05 5/-	EC032 4/-	EL25 5/-	KT20 20/-	PL82 7/-	UAC50 6/8
1ASGT 5/-	6AG7 10/-	6D4 15/-	7C5 10/-	20P1 15/-	EC033 8/-	EL27 5/8	KT20 20/-	PL83 7/-	UB421 9/8
1A7GT 8/-	6AK5 8/8	6D8A 15/-	787 18/-	20L1 14/-	EC035 7/-	EL28 17/8	KT20 20/-	PL84 7/-	UBC81 7/8
1B3GT 7/-	6AK6 7/-	6EAS 10/-	7Y4 8/-	20P1 14/-	EC040 9/-	EL28 17/8	KT20 20/-	PL84 7/-	UBC81 7/8
1D6 8/-	6AL6 8/-	6F6 2/-	7Z2 6/-	20F3 13/-	EC041 4/-	EL21 9/-	KT20 20/-	PL600 15/-	UBR50 6/8
1G6GT 7/-	6AM3 2/6	6F8G 3/-	8B7 7/-	20P4 14/-	EC042 5/-	EL42 9/-	KT20 20/-	PY33 9/6	UBR59 7/8
1H4GT 10/6	6AM6 4/-	6F11 6/-	10F3 8/-	20F5 12/-	EC043 8/-	EL81 9/-	KT20 20/-	PY81 6/6	UBC21 11/-
1H5GT 7/-	6AN5 10/6	6F13 8/-	10F18 9/-	25AGG 5/-	EC045 8/-	EL83 7/6	KT20 20/-	PY82 6/6	UC32 4/8
114 2/6	6AN8 10/6	6F17 6/-	10P13 12/6	25LGGT 8/-	EC046 9/-	EL85 8/-	KT20 20/-	PY83 7/-	UC84 7/8
116 17/-	6AQ6 6/-	6J4 9/-	10P14 12/6	28Z4G 5/8	DF91 9/-	EL85 8/-	MU17/14 8/-	PY88 8/6	UC85 7/8
1N5GT 8/-	6AQ6 2/6	6J6G 4/-	11D3 7/-	28Z4G 5/8	DF92 2/6	EL86 7/8	N78 15/8	PY900 8/6	UC90 10/6
1Q6GT 8/-	6AR6 8/-	6J6 3/8	11D6 7/-	28Z4G 5/8	DF96 7/-	EL96 6/-	NF81 25/6	PX25 10/6	UC921 9/6
1R4 6/-	6AR6 8/-	6J6 3/8	11D6 7/-	28Z4G 5/8	DK92 9/-	EL91 2/6	NR2 22/6	QV03/10 10/6	UC942 9/6
1R3 5/-	6AR6 8/-	6J6 3/8	11D6 7/-	28Z4G 5/8	DK92 9/-	EL91 2/6	ORP12 12/6	UC981 7/-	UC981 7/-
1R4 5/-	6AR6 8/-	6J6 3/8	11D6 7/-	28Z4G 5/8	DK92 9/-	EL91 2/6	ORP12 12/6	R2 3/6	UC982 8/6
1R5 4/6	6AR6 8/-	6J6 3/8	11D6 7/-	28Z4G 5/8	DK92 9/-	EL91 2/6	ORP12 12/6	R10 10/6	UC983 10/6
1R6 4/6	6AR6 8/-	6J6 3/8	11D6 7/-	28Z4G 5/8	DK92 9/-	EL91 2/6	ORP12 12/6	R17 8/6	UC984 9/6
1R7 3/6	6AR6 8/-	6J6 3/8	11D6 7/-	28Z4G 5/8	DK92 9/-	EL91 2/6	ORP12 12/6	R19 7/6	UC985 9/6
1R8 3/6	6AR6 8/-	6J6 3/8	11D6 7/-	28Z4G 5/8	DK92 9/-	EL91 2/6	ORP12 12/6	R19 7/6	UC985 9/6
1R9 3/6	6AR6 8/-	6J6 3/8	11D6 7/-	28Z4G 5/8	DK92 9/-	EL91 2/6	ORP12 12/6	R19 7/6	UC985 9/6
1R10 3/6	6AR6 8/-	6J6 3/8	11D6 7/-	28Z4G 5/8	DK92 9/-	EL91 2/6	ORP12 12/6	R19 7/6	UC985 9/6
1R11 3/6	6AR6 8/-	6J6 3/8	11D6 7/-	28Z4G 5/8	DK92 9/-	EL91 2/6	ORP12 12/6	R19 7/6	UC985 9/6
1R12 3/6	6AR6 8/-	6J6 3/8	11D6 7/-	28Z4G 5/8	DK92 9/-	EL91 2/6	ORP12 12/6	R19 7/6	UC985 9/6
1R13 3/6	6AR6 8/-	6J6 3/8	11D6 7/-	28Z4G 5/8	DK92 9/-	EL91 2/6	ORP12 12/6	R19 7/6	UC985 9/6
1R14 3/6	6AR6 8/-	6J6 3/8	11D6 7/-	28Z4G 5/8	DK92 9/-	EL91 2/6	ORP12 12/6	R19 7/6	UC985 9/6
1R15 3/6	6AR6 8/-	6J6 3/8	11D6 7/-	28Z4G 5/8	DK92 9/-	EL91 2/6	ORP12 12/6	R19 7/6	UC985 9/6
1R16 3/6	6AR6 8/-	6J6 3/8	11D6 7/-	28Z4G 5/8	DK92 9/-	EL91 2/6	ORP12 12/6	R19 7/6	UC985 9/6
1R17 3/6	6AR6 8/-	6J6 3/8	11D6 7/-	28Z4G 5/8	DK92 9/-	EL91 2/6	ORP12 12/6	R19 7/6	UC985 9/6
1R18 3/6	6AR6 8/-	6J6 3/8	11D6 7/-	28Z4G 5/8	DK92 9/-	EL91 2/6	ORP12 12/6	R19 7/6	UC985 9/6
1R19 3/6	6AR6 8/-	6J6 3/8	11D6 7/-	28Z4G 5/8	DK92 9/-	EL91 2/6	ORP12 12/6	R19 7/6	UC985 9/6
1R20 3/6	6AR6 8/-	6J6 3/8	11D6 7/-	28Z4G 5/8	DK92 9/-	EL91 2/6	ORP12 12/6	R19 7/6	UC985 9/6
1R21 3/6	6AR6 8/-	6J6 3/8	11D6 7/-	28Z4G 5/8	DK92 9/-	EL91 2/6	ORP12 12/6	R19 7/6	UC985 9/6
1R22 3/6	6AR6 8/-	6J6 3/8	11D6 7/-	28Z4G 5/8	DK92 9/-	EL91 2/6	ORP12 12/6	R19 7/6	UC985 9/6
1R23 3/6	6AR6 8/-	6J6 3/8	11D6 7/-	28Z4G 5/8	DK92 9/-	EL91 2/6	ORP12 12/6	R19 7/6	UC985 9/6
1R24 3/6	6AR6 8/-	6J6 3/8	11D6 7/-	28Z4G 5/8	DK92 9/-	EL91 2/6	ORP12 12/6	R19 7/6	UC985 9/6
1R25 3/6	6AR6 8/-	6J6 3/8	11D6 7/-	28Z4G 5/8	DK92 9/-	EL91 2/6	ORP12 12/6	R19 7/6	UC985 9/6
1R26 3/6	6AR6 8/-	6J6 3/8	11D6 7/-	28Z4G 5/8	DK92 9/-	EL91 2/6	ORP12 12/6	R19 7/6	UC985 9/6
1R27 3/6	6AR6 8/-	6J6 3/8	11D6 7/-	28Z4G 5/8	DK92 9/-	EL91 2/6	ORP12 12/6	R19 7/6	UC985 9/6
1R28 3/6	6AR6 8/-	6J6 3/8	11D6 7/-	28Z4G 5/8	DK92 9/-	EL91 2/6	ORP12 12/6	R19 7/6	UC985 9/6
1R29 3/6	6AR6 8/-	6J6 3/8	11D6 7/-	28Z4G 5/8	DK92 9/-	EL91 2/6	ORP12 12/6	R19 7/6	UC985 9/6
1R30 3/6	6AR6 8/-	6J6 3/8	11D6 7/-	28Z4G 5/8	DK92 9/-	EL91 2/6	ORP12 12/6	R19 7/6	UC985 9/6
1R31 3/6	6AR6 8/-	6J6 3/8	11D6 7/-	28Z4G 5/8	DK92 9/-	EL91 2/6	ORP12 12/6	R19 7/6	UC985 9/6
1R32 3/6	6AR6 8/-	6J6 3/8	11D6 7/-	28Z4G 5/8	DK92 9/-	EL91 2/6	ORP12 12/6	R19 7/6	UC985 9/6
1R33 3/6	6AR6 8/-	6J6 3/8	11D6 7/-	28Z4G 5/8	DK92 9/-	EL91 2/6	ORP12 12/6	R19 7/6	UC985 9/6
1R34 3/6	6AR6 8/-	6J6 3/8	11D6 7/-	28Z4G 5/8	DK92 9/-	EL91 2/6	ORP12 12/6	R19 7/6	UC985 9/6
1R35 3/6	6AR6 8/-	6J6 3/8	11D6 7/-	28Z4G 5/8	DK92 9/-	EL91 2/6	ORP12 12/6	R19 7/6	UC985 9/6
1R36 3/6	6AR6 8/-	6J6 3/8	11D6 7/-	28Z4G 5/8	DK92 9/-	EL91 2/6	ORP12 12/6	R19 7/6	UC985 9/6
1R37 3/6	6AR6 8/-	6J6 3/8	11D6 7/-	28Z4G 5/8	DK92 9/-	EL91 2/6	ORP12 12/6	R19 7/6	UC985 9/6
1R38 3/6	6AR6 8/-	6J6 3/8	11D6 7/-	28Z4G 5/8	DK92 9/-	EL91 2/6	ORP12 12/6	R19 7/6	UC985 9/6
1R39 3/6	6AR6 8/-	6J6 3/8	11D6 7/-	28Z4G 5/8	DK92 9/-	EL91 2/6	ORP12 12/6	R19 7/6	UC985 9/6
1R40 3/6	6AR6 8/-	6J6 3/8	11D6 7/-	28Z4G 5/8	DK92 9/-	EL91 2/6	ORP12 12/6	R19 7/6	UC985 9/6
1R41 3/6	6AR6 8/-	6J6 3/8	11D6 7/-	28Z4G 5/8	DK92 9/-	EL91 2/6	ORP12 12/6	R19 7/6	UC985 9/6
1R42 3/6	6AR6 8/-	6J6 3/8	11D6 7/-	28Z4G 5/8	DK92 9/-	EL91 2/6	ORP12 12/6	R19 7/6	UC985 9/6
1R43 3/6	6AR6 8/-	6J6 3/8	11D6 7/-	28Z4G 5/8	DK92 9/-	EL91 2/6	ORP12 12/6	R19 7/6	UC985 9/6
1R44 3/6	6AR6 8/-	6J6 3/8	11D6 7/-	28Z4G 5/8	DK92 9/-	EL91 2/6	ORP12 12/6	R19 7/6	UC985 9/6
1R45 3/6	6AR6 8/-	6J6 3/8	11D6 7/-	28Z4G 5/8	DK92 9/-	EL91 2/6	ORP12 12/6	R19 7/6	UC985 9/6
1R46 3/6	6AR6 8/-	6J6 3/8	11D6 7/-	28Z4G 5/8	DK92 9/-	EL91 2/6	ORP12 12/6	R19 7/6	UC985 9/6
1R47 3/6	6AR6 8/-	6J6 3/8	11D6 7/-	28Z4G 5/8	DK92 9/-	EL91 2/6	ORP12 12/6	R19 7/6	UC985 9/6
1R48 3/6	6AR6 8/-	6J6 3/8	11D6 7/-	28Z4G 5/8	DK92 9/-	EL91 2/6	ORP12 12/6	R19 7/6	UC985 9/6
1R49 3/6	6AR6 8/-	6J6 3/8	11D6 7/-	28Z4G 5/8	DK92 9/-	EL91 2/6	ORP12 12/6	R19 7/6	UC985 9/6
1R50 3/6	6AR6 8/-	6J6 3/8	11D6 7/-	28Z4G 5/8	DK92 9/-	EL91 2/6	ORP12 12/6	R19 7/6	UC985 9/6
1R51 3/6	6AR6 8/-	6J6 3/8	11D6 7/-	28Z4G 5/8	DK92 9/-	EL91 2/6	ORP12 12/6	R19 7/6	UC985 9/6
1R52 3/6	6AR6 8/-	6J6 3/8	11D6 7/-	28Z4G 5/8	DK92 9/-	EL91 2/6	ORP12 12/6	R19 7/6	UC985 9/6
1R53 3/6	6AR6 8/-	6J6 3/8	11D6 7/-	28Z4G 5/8	DK92 9/-	EL91 2/6	ORP12 12/6	R19 7/6	UC985 9/6
1R54 3/6	6AR6 8/-	6J6 3/8	11D6 7/-	28Z4G 5/8	DK92 9/-	EL91 2/6	ORP12 12/6	R19 7/6	UC985 9/6
1R55 3/6	6AR6 8/-	6J6 3/8	11D6 7/-	28Z4G 5/8	DK92 9/-	EL91 2/6	ORP12 12/6	R19 7/6	UC985 9/6
1R56 3/6	6AR6 8/-	6J6 3/8	11D6 7/-	28Z4G 5/8	DK92 9/-	EL91 2/6	ORP12 12/6	R19 7/6	UC985 9/6
1R57 3/6	6AR6 8/-	6J6 3/8	11D6 7/-	28Z4G 5/8	DK92 9/-	EL91 2/6	ORP12 12/6	R19 7/6	UC985 9/6
1R58 3/6	6AR6 8/-	6J6 3/8	11D6 7/-	28Z4G 5/8	DK92 9/-	EL9			

VALUABLE NEW HANDBOOK FREE TO AMBITIOUS ENGINEERS

Have you had your copy of "Engineering Opportunities"?

The new edition of "ENGINEERING OPPORTUNITIES" is now available—without charge—to all who are anxious for a worthwhile post in Engineering. Frank, informative and completely up to date, the new "ENGINEERING OPPORTUNITIES" should be in the hands of every person engaged in any branch of the Engineering industry, irrespective of age, experience or training.

On 'SATISFACTION OR REFUND OF FEE' terms

This remarkable book gives details of examinations and courses in every branch of Engineering, Building, etc., outlines the openings available and describes our Special Appointments Department.

WHICH OF THESE IS YOUR PET SUBJECT?

MECH. ENGINEERING
Gen. Mech. Eng.—Maintenance Eng.—Diesel Eng.—Press Tool Design—Sheet Metal Work—Welding—Eng. Pattern Making—Inspection—Draughtsmanship—Metallurgy—Production Eng.

ELEC. ENGINEERING
General Electrical Eng.—Installations—Draughtsmanship—Illuminating Eng.—Refrigeration—Elem. Elec. Science—Elec. Supply—Mining Elec. Eng.

RADIO ENGINEERING
General Radio—Radio & TV Servicing—TV Eng.—Telecommunications—Electronics—Sound Recording—Automation—Practical Radio—Radio Amateurs' Exam.

AUTO ENGINEERING
General Auto Eng.—Auto. Maintenance—Repair—Auto. Diesel Maintenance—Auto. Electrical Equipment—Garage Management.

CIVIL ENGINEERING
General Civil Eng.—Municipal Eng.—Structural Eng.—Sanitary Eng.—Road Eng.—Hydraulics—Mining—Water Supply—Petrol Tech.

BUILDING
General Building—Heating & Ventilation—Plumbing—Architecture—Carpentry—Painting—Decorating—Specifications & Quantities—Surveying—Architectural Draughtsmanship.

WE HAVE A WIDE RANGE OF COURSES IN OTHER SUBJECTS INCLUDING CHEMICAL ENG., AERO ENG., MANAGEMENT, INSTRUMENT TECHNOLOGY, WORKS STUDY, MATHEMATICS, ETC.

Which qualification would increase your earning power?
A.M.I.Mech.E., A.M.S.E., A.M.I.C.E., A.M.I.E.R.E., B.Sc., A.M.I.P.E., A.M.I.M.I., A.R.I.B.A., A.I.O.B., A.M.I.Chem.E., A.R.I.C.S., M.R.S.H., A.M.I.E.D., A.M.I.Man.E., CITY & GUILDS, GEN. CERT. OF EDUCATION, ETC.

BRITISH INSTITUTE OF ENGINEERING TECHNOLOGY
155 COLLEGE HOUSE, 29-31 WRIGHT'S LANE, W.8

THIS BOOK TELLS YOU

- ★ HOW to get a better paid, more interesting job.
- ★ HOW to qualify for rapid promotion.
- ★ HOW to put some letters after your name and become a key man . . . quickly and easily.
- ★ HOW to benefit from our free Advisory and Appointments Depts.
- ★ HOW you can take advantage of the chances you are now missing.
- ★ HOW, irrespective of your age, education or experience, YOU can succeed in any branch of Engineering.

156 PAGES OF EXPERT CAREER - GUIDANCE

PRACTICAL EQUIPMENT

Basic Practical and Theoretic Courses for beginners in Radio, T.V., Electronics, Etc., A.M.I.E.R.E. City & Guilds Radio Amateurs' Exam. R.T.E.B. Certificate P.M.G. Certificate Radio & Television Servicing Practical Electronics Electronics Engineering Automation

INCLUDING TOOLS

The specialist Electronics Division of B.I.E.T. NOW offers you a real laboratory training at home with practical equipment. Ask for details.

B.I.E.T.

You are bound to benefit from reading "ENGINEERING OPPORTUNITIES", and if you are earning less than £30 a week you should send for your copy now—FREE and without obligation.



POST NOW!

TO B.I.E.T., 155 COLLEGE HOUSE,
29-31 WRIGHT'S LANE, W.8.

3d. stamp if posted in an unsealed envelope.

Please send me a FREE copy of "ENGINEERING OPPORTUNITIES." I am interested in (state subject, exam., or career).

NAME

ADDRESS

WRITE IF YOU PREFER NOT TO CUT THIS PAGE

THE B.I.E.T. IS THE LEADING INSTITUTE OF ITS KIND IN THE WORLD

FULLY DETAILED AND ILLUSTRATED
CATALOGUE

Now 96 big pages. The largest PRICE range available in the country. 2/6
All types of components and (post paid) equipment at competitive prices.

PROVED AND TESTED DESIGNS
FULL AFTER SALES SERVICE AND GUARANTEE

★ **CALL IN FOR DEMONSTRATIONS** ★
DETAILED LEAFLETS FREE ON REQUEST



MW/LW POCKET SUPERHET RADIO

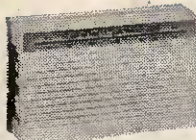

TOTAL COST TO BUILD

85/- P.P.
(Battery 2/6
Phone 5/-)

★ All parts sold separately.

- ★ 6-Transistor design. Push-pull output.
- ★ 2 1/2 in. Cleartone speaker. Printed circuit.
- ★ Attractive moulded cabinet.
- ★ Slow motion tuning.
- ★ Full med. and long waves.
- ★ Size: 5 x 3 x 1 1/2 in.

● **AMAZING SENSITIVITY & SELECTIVITY** ●

- ★ 6-Transistor push-pull design.
- ★ Uses factory built panels.
- ★ Permeability geared tuning.
- ★ Full med./long wave tuning with push-button wave change.
- ★ Double tuned IFT's.
- ★ Chromed front panel plate.
- ★ Size: 7 x 4 x 2 in. Fits any car.
- ★ Pre-built units sold separately.

TOTAL COST TO BUILD

£8.19.6 P.P.
3/6

(7 in. x 4 in. speaker with car fixing kit and baffle board 20/- extra).

TWO WAVEBAND ALL TRANSISTOR CAR RADIO TO ASSEMBLE
● **HIGH PERFORMANCE SUPERHET** ●



2- AND 4-TRACK TAPE RECORDERS TO ASSEMBLE

Pre-built Equipment—6 Valves—Collaro Studio Decks—Portable Cabinets with Speakers. Complete record and playback.



★ 2-track deck 10 gns. P.P. 5/- Amplifier 11 gns. Cabinet with speaker 5 gns.
OR SPECIAL PRICE £26 P.P. **TWO TRACK** 8/6

★ 4-track deck £13. 19.6. P.P. 5/- Amplifier 12 gns. Cabinet with speaker 5 gns.
OR SPECIAL PRICE £30 P.P. **FOUR TRACK** 8/6

Prebuilt and tested units. Low distortion, low noise.

10 Watt & 20 Watt HI-FI AMPLIFIERS

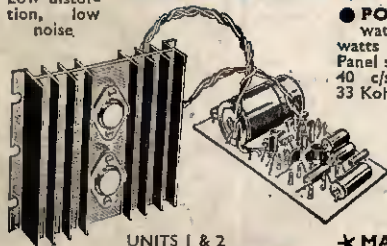

UNITS 1 & 2



UNIT 5

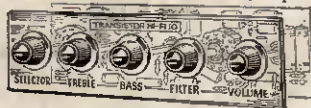

UNIT 3

THE FINEST QUALITY HI-FI AT UNBEATABLE PRICES

● **POWER AMPLIFIERS.** 10 watts R.M.S. music power. 20 watts peak. 6-Transistor design. Panel size 4 x 2 1/2 x 3 in. Response 40 c/s to 20 kc/s. 100mV into 33 Kohm input.

UNIT 1. For 12/15 ohm speakers. 40 volt supply. PRICE **£5.19.0** P.P. 2/6
BUILT

UNIT 2. For 3 to 5 ohm speakers. 24/28 volt supply. PRICE **£5.10.0** P.P. 2/6
BUILT

★ **MAINS UNITS.** 59/6. To power one amplifier or 69/6 to power two amplifiers (State 24 or 40 volt version).

PREAMPLIFIERS. Mono and stereo versions, 8 inputs, 1 1/2 to 300mV at 1k to 500k. Response 30 c/s to 20 kc/s. Complete range of controls. Mains unit or battery operated. For pickups, tuners, tape, microphones, etc.

UNIT 3. Mono full-function pre-amplifier. Size: 9 1/2 x 2 1/2 x 2 in. PRICE **£5.10.0** P.P. (Brown/Gold front panel plate 8/6)
BUILT

UNIT 4. Simplified version of Unit 3. Price 65/-. P.P. 1/6. Panel plate 6/6.

UNIT 5. Stereo preamplifier for use with two units 1 or 2. Size 9 x 3 1/2 x 1 1/2 in.

PRICE **£10.19.6** P.P. 3/6.
BUILT (Front panel plate 12/6)

- We stock:
- TRANSISTORS
 - RECTIFIERS
 - VALVES
 - CRYSTALS
 - MICROPHONES
 - TEST GEAR
 - TAPE DECKS
 - SPEAKERS
 - MULTI-METERS
 - RADIO
 - CONTROL
 - AMPLIFIERS
 - RECORDERS
 - TUNERS
 - RECORD DECKS
 - TWEETERS
 - RECEIVERS
 - GENERATORS
 - COMPONENTS
 - AND
 - ACCESSORIES

SINCLAIR DESIGNS

- ★ Micro-6 MW/ radio 59/6
- ★ TR750 "Addon" power amp. 39/6
- ★ Micro injector 27/6
- ★ Micro amp. 28/6
- ★ X10 Amp. kit £5.19.6



4 WATT AND 1 1/2 WATT PACKAGED AMPLIFIERS

- ★ 6-Transistor push-pull printed circuit designs.
- ★ Size only 2 1/2 x 2 x 1 1/2 in.
- ★ 4 watt 12/18 volt, 1 1/2 watt 9/12 volt
- ★ For 3 to 5 ohm speakers
- ★ 7mV into 1 Kohm. 40 c/s. to 15 kc/s.

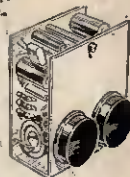

PRICES **£1.75.0** P.P. 1/6
BUILT 4w. 79/6 P.P. 1/6

4-CHANNEL MICROPHONE MIXER

Transistorised, 4 inputs up to 100 Kohm. Full mixing. PRICE **49/6** P.P. 1/6



Let us quote for parts for your circuit. Send a list for quick reply. Quality components at realistic prices.



TRANSISTOR PORTABLE TEST EQUIPMENT

All units size 6 1/2 x 4 1/2 x 2 1/2 in.
★ RF generator, 150 kc/s to 350 mc/s in 8 ranges. RF. Mod. RF. AF outputs.
PRICE **£9.10.0** P.P. 2/6
Resistance/capacitance bridge. **£8.5.0.**

★ Audio generator 10 c/s—100 kc/s. 4 ranges. **£16.15.0.** P.P. 2/6

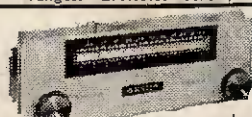

VHF/FM TUNER TO ASSEMBLE

★ Two pre-built units plus metal work and front panel
Total Cost **£12.17.6** P.P. 2/6
★ Size: 9 1/2 x 3 1/2 x 4 in
★ 88 to 108 mc/s tuning
★ 100mV to 100Kohm output
★ 6-Transistor printed cct. superhet design (All units available separately)

NEW 3-WAVEBAND PUSH-BUTTON PORTABLE TO BUILD

- ★ SHORT WAVES (17-50m)
- ★ MED. WAVES
- ★ LONG WAVES

TOTAL COST TO BUILD **£8.19.6** P.P. 3/6



6 Transistors. 1 watt push-pull output. Special circuit for car aerial. Car and tape sockets. Telescopic and ferrite aerials. Full tuning on all wavebands. Push-button coil pack. Cabinet size 11 x 7 1/2 x 3 1/2 in. Black fabric with chromed handle and fittings. **THE ONLY FULLY TUNABLE MW/LW/SW RADIO AVAILABLE FOR HOME CONSTRUCTION.**

(2-waveband version as previously advertised still available at **£7.19.6** p.p. 3/6. Batteries 6/-)

VHF/FM TRANSISTOR TUNER TO BUILD

TOTAL COST **£6.19.6**

P.P. 2/6 (complete with frontplate)
(Gold sprayed cabinet 20/- extra).

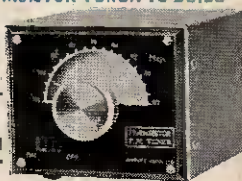

- ★ 5-Transistor 4 diodes
- ★ Printed circuit superhet
- ★ Geared tuning 87 to 105 mc/s FM
- ★ RF stage and double tuned IFT's
- ★ Output up to 1 volt peak up to 100 Kohm
- ★ 9-volt 9mA supply
- ★ Size in cabinet 4 x 3 1/2 x 2 1/2 in.
- ★ All parts sold separately

HENRY'S RADIO LTD.

303 EDGWARE RD., LONDON W2
PADddington 1008/9

Open Mon. to Sat. 9-6. Thurs; 1 p.m.
Open all day Saturday