

THE No.1 MAGAZINE FOR ELECTRONICS TECHNOLOGY & COMPUTER PROJECTS

EVERYDAY

JANUARY 2005

PRACTICAL

ELECTRONICS

£3.10

SPEED CAMERA WATCH

An early warning system



GATE ALARM

Simple versatile project



LIGHT DETECTOR

An I.e.d. as sensor and indicator

PLUS

32-BIT MATHS FOR PICs

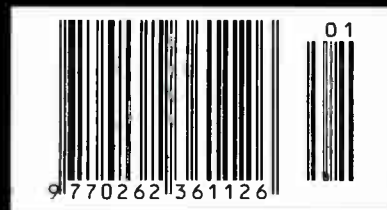

www.epemag.co.uk

World Radio History

Colour CCTV camera, 8mm lens, 12vdc200m a 582X628 Res 380 lines Automatic aperture lens Mirror function PAL Back Light Comp MLR, 100x40x40mm ref EE2.£75.90

Built in Audio .15lux CCD camera 12vdc 200ma 480 lines s/n ratio >48 db 1v P-P output 110x60x50mm ref EE1.£108.90

Metal CCTV camera housings for internal or external use. Made from aluminium and plastic they are suitable for mounting body cameras in. Available in two sizes 1-100x70x170mm and 2-100x70x280mm Ref EE6.£22 EE7.£26 Multi position brackets Ref EE8.£8.80

Excellent quality multi purpose TV/TFT screen, works as just a LCD colour monitor with any of our CCTV cameras or as a conventional TV ideal for use in boats and caravans 49.75mhz-91.75mhz VHF channels 1-5, 168.25mhz-222.75mhz VHF channels 6-12, 471.25mhz-869.75mhz, Cable channels 112.325mhz-166.75mhz Z1-Z7, Cable channels 224.25mhz-446.75mhz Z8-Z35 5" colour screen, Audio output 150mW, Connections, external aerial, earphone jack, audio/video input, 12vdc or mains, Accessories supplied Power supply Remote control Cigar lead power supply Headphone Stand/bracket, 5" model £139 Ref EE9.

Self cocking pistol picr002 crossbow with metal body. Selfcocking for precise string alignment Aluminium alloy construction High tec fibre glass limbs Automatic safety catch Supplied with three bolts Track style for greater accuracy Adjustable rear sight 50lb draw weight 150ft sec velocity Break action 17" string 30m range £23.84 Ref PLCR002

Fully cased IR light source suitable for CCTV applications. The unit measures 10x10x150mm, is mains operated and contains 54 infra red LEDs. Designed to mount on a standard CCTV camera bracket. The unit also contains a daylight sensor that will only activate the infra red lamp when the light level drops below a preset level. The infrared lamp is suitable for indoor or exterior use, typical usage would be to provide additional IR illumination for CCTV cameras. £53.90 ref FF11

Colour CCTV Camera measures 60x45mm and has a built in light level detector and 12 IR leds 2 lux 12 IR leds 12vdc Bracket Easy connect leads £75.90 Ref EE15

A high quality external colour CCTV camera with built in infra red LEDs measuring 80x60x80mm Easy connect leads colour Waterproof PAL 1/4" CCD542x588 pixels 420 lines .05lux 3.8mm F2.78 deg lens 12vdc 400ma Built in light level sensor. £108.90 Ref EE13

A small colour CCTV camera just 35x28x30mm Supplied with bracket, easy connect leads. Built in audio. Colour 380 line res, PAL 0.2lux +18db sensitivity Effective pixels 628x582 6-12vdc Power 200mw £39.60 Ref EE18

Pettier module. Each module is supplied with a comprehensive 18 page Pettier design manual featuring circuit designs, design information etc etc. The Pettier manual is also available separately Maximum watts 56.2 40x40mm I max 5.5A Vmax 16.7 T max (c-dry N2) 72 £32.95 (inc manual) REF PELT1, just manual £4.40 ref PELT2

COMPAQ 1000mA 12vdc power supplies, new and boxed. 2 metre lead DC power plug 2.4mmx10mm £5.25 each, 25+ £3.50 100+£2.50

1.2ghz wireless receiver Fully cased audio and video 1.2ghz wireless receiver 190x140x30mm metal case, 4 channel, 12vdc Adjustable time delay, 4s, 8s, 12s 16s. £49.50 Ref EE20

The smallest PMR446 radios currently available (54x87x37mm). These tiny handheld PMR radios look great, user friendly & packed with features including VOX, Scan & Dual Watch. Priced at £59.99 PER PAIR they are excellent value for money. Our new favourite PMR radios! Standby - 35 hours Includes: 2 x Radios, 2x Belt Clips & 2 x Carry Strap £59.95 Ref ALAN1 Or supplied with 2 sets of rechargeable batteries and two mains chargers £93.49 Ref Alan2

The TENS mini Microprocessors offer six types of automatic programme for shoulder pain, back/neck pain, aching joints, Rheumatic pain, migraines headaches, sports injuries, period pain. In fact all over body treatment. Will not interfere with existing medication. Not suitable for anyone with a heart pacemaker. Batteries supplied. £21.95 Ref TEN327 Spare pack of electrodes £6.59 Ref TEN327X

Dummy CCTV cameras These motorised cameras will work either on 2 AA batteries or with a standard DC adapter (not supplied) They have a built in movement detector that will activate the camera if movement is detected causing the camera to 'pan' Good deterrent. Camera measures 20cm high, supplied with fixing screws. Camera also has a flashing red led. £10.95 Ref CAMERAB

INFRARED FILM 6" square piece of flexible infra red film that will only allow IR light through Perfect for converting ordinary torches, lights headlights etc to infrared output using standard light bulbs Easily cut to shape. 6" square £16.50 ref IRF2 or a 12" sq for £34.07 IRF2A

THE TIDE CLOCK These clocks indicate the state of the tide. Most areas in the world have two high tides and two low tides a day, so the tide clock has been specially designed to rotate twice each lunar day (every 12 hours and 25 minutes) giving you a quick and easy indication of high and low water. The Quartz tide clock will always stay calibrated to the moon. £23.10 REF TIDEC

LINEAR ACTUATORS 12-36VDC BUILT IN ADJUSTABLE LIMIT SWITCHES POWDER COATED 18" THROW UP TO 1,000 LB THRUST (400LB RECOMMENDED LOAD) SUPPLIED WITH MOUNTING BRACKETS DESIGNED FOR OUTDOOR USE These brackets originally made for moving very large satellite dishes are possibly more suitable for closing gates, mechanical machinery, robot wars etc. Our first sale was to a company building solar panels that track the sun! Two sizes available, 12" and 18" throw. £32.95 REF ACT12.

Samarium magnets are 57mm x 20mm and have a hole (5/16th UNF) in the centre and a magnetic strength of 2.2 gauss. We have tested these on a steel beam running through the offices and found that they will take more than 170lbs (77kgs) in weight before being pulled off. With keeper. £21.95 REF MAG77

New transmitter, receiver and camera kit. £69.00 Kit contains four channel switchable camera with built in audio, six IR leds and transmitter, four channel switchable receiver, 2 power supplies, cables, connectors and mounting bracket. £69.00 Wireless Transmitter Black and white camera (75x50x55mm) Built in 4 channel transmitter (switchable) Audio built in 8 IR Leds Bracket/stand Power supply 30 m range Wireless Receiver 4 channel (switchable) Audio/video leads and scart adapter Power supply and Manual £69.00 ref COP24

This miniature Stirling Cycle Engine measures 7" x 4-1/4" and comes complete with built-in alcohol burner. Red flywheels and chassis mounted on a green base, these all-metal beauties silently running at speeds in excess of 1,000 RPM attract attention and create awe wherever displayed. This model comes completely assembled and ready to run. £108.70 REF SOL1

High-power modules using 125mm square multi-crystal silicon solar cells with bypass diode Anti reflection coating and BSF structure to improve cell conversion efficiency: 14%. Using white tempered glass, EVA resin, and a weatherproof film along with an aluminum frame for extended outdoor use. system Lead wire with waterproof connector. 80 watt 12v 500x1200 £315.17, 123w 12vdc 1499x662x46 £482.90 165 w 24v 1575x826x46mm £652.30

BULL GROUP LTD
UNIT D HENFIELD BUSINESS PARK
HENFIELD SUSSEX BN5 9SL
TERMS: CASH, PO, CHEQUE PRICES+VAT
WITH ORDER PLUS £5.50 P&P (UK) PLUS VAT.
24 HOUR SERVICE £7.50 (UK) PLUS VAT.
OVERSEAS ORDERS AT COST PLUS £3.50
Tel: 0870 7707520 Fax 01273491813
Sales@bullnet.co.uk
www.bullnet.co.uk



Ultra-compact, lightweight, easy to use and comfortable to hold, the new NVMT is unique for a night scope in offering a tactile, suregrip plastic bodyshell and, for extra protection/grip, partial rubber armouring. Currently the top of the range model, the NVMT G2+ features a 'commercial grade' Gen 2+ Image Intensifier Tube (IIT). The NVMT has a built-in, powerful Infrared (IR) Illuminator for use in very low light/total darkness. Powered for the scope and IR is provided by 1 x 3V Lithium CR123A battery (not supplied). A green LED next to the viewfinder indicates when the Image Intensifier Tube is switched on while a red LED indicates when the IR Illuminator is switched on. Type Gen Weight Size Lens Mag 2x, Weight 400g, 125x82x35mm angle of view 30 deg, built in infra red, rang 3 - 400m, supplied with batteries £849 ref COB24023.

55 - 200 WATT INFRA RED TORCHES
 Search guard 1 infrared torch Plastic bodied waterproof Infrared rechargeable lamp, 100mm diameter lens, 200mm body length, 55 watt bulb, 1,000,000 candle power (used as an indication of relative power) Supplied complete with a 12v car lighter socket lead/charger and a 240v mains plug in charger. £49 REF sgward 1. Also available, 70watt £59, 100 watt £79, 200watt £99.



AIR RIFLES FROM £24.70
 B2 AIR RIFLE Available in .177 and .22+19" Tapered Rifled Barrel Adjustable Rear Sight+ Full Length Wooden Stock+ Overall Length 43" approx Barrel Locking Lever + Also available in CARBINE Grooved for Telescopic Sight model with 14" barrel - no front sight for use with scope. Weight approximately 6lbs Extremely Powerful .22 £28.90, .177 £24.70, pellets (500) £2.55, sights 4x20 £6.80, 4x28 £15.32 Other models available up to £250 www.airpistol.co.uk

12V SOLAR PANELS AND REGULATORS
9 WATT £58.75
15 WATT £84.25
22 WATT £128.70
 Regulator up to 60 watt £21.25
 Regulators up to 135 watt £38.25

The combination of multi-crystal cells and a high-reliability module structure make this series of solar panels the ideal solar module. For large-scale power generation hundreds or even thousands of modules can be connected in series to meet the desired electric power requirements. They have a high output, and highly efficient, extremely reliable and designed for ease of maintenance. Separate positive negative junction boxes and dual by-pass diodes are a few examples of some of its outstanding features. Supplied with an 8 metre cable. Perfect for caravans, boats, etc. Toughened glass.



LOCK PICK SETS 16, 32 AND 60 PIECE SETS
 This set is deluxe in every way! It includes a nice assortment of balls, rakes, hooks, diamonds, two double ended picks, a broken key extractor, and three tension wrenches. And just how do you top off a set like this? Package it in a top grain leather zippered case. Part: LP005 - Price £45.00
 This 32 piece set includes a variety of hooks, rakes, diamonds, balls, extractors, tension tools ... and comes housed in a zippered top grain leather case. If you like choices, go for this one! Part: LP006 - Price £65.00
 If you want to run toward the biggest pick set you can find, here it is. This sixty piece set includes an array of hooks, rakes, diamonds, balls, broken key extractors, tension wrenches, and even includes a warded pick set! And the zippered case is made, of course, of the finest top grain leather. First Class! Part: LP007 - Price £99.00

Mamod steam roller, supplied with fuel and everything you need (apart from water and a match!) £85 REF 1312 more models at www.mamodspares.co.uk

Mamod steam roller, supplied with fuel and everything you need (apart from water and a match!) £130 REF 1318 more models at www.mamodspares.co.uk

PEANUT RIDER STIRLING ENGINE This all metal, black and brass engine with red flywheel is mounted on a solid hardwood platform. comes complete with an alcohol fuel cell, extra wick, allen wrenches, and Owner's Manual. Specifications: Base is 5-1/4" x 5-1/4", 4" width x 9" height, 3/4" stroke, 3-1/2" flywheel £141.90

SHOP ONLINE
WWW.BULLNET.CO.UK

ISSN 0262 3617

PROJECTS ... THEORY ... NEWS ...
COMMENTS ... POPULAR FEATURES ...

VOL. 34. No. 1 JANUARY 2005

Cover illustration: Martyn F. Chillmaid/Science Photo Library

EVERYDAY
**PRACTICAL
ELECTRONICS**
INCORPORATING **ELECTRONICS TODAY INTERNATIONAL**

www.epemag.co.uk

EPE Online: www.epemag.com

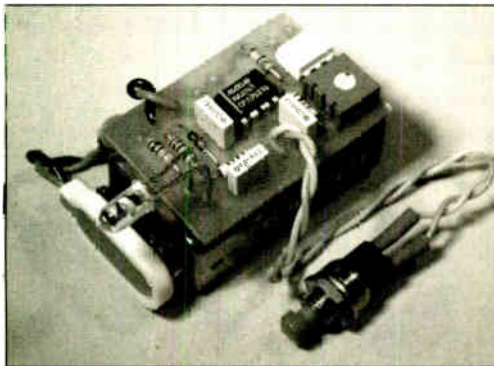
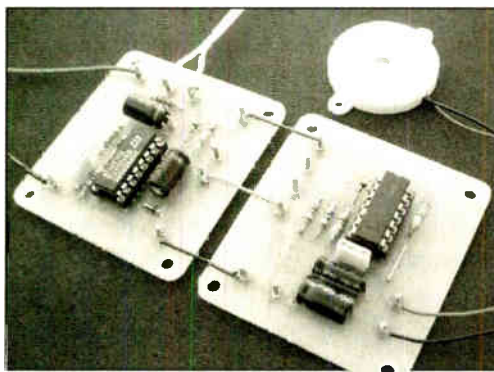

*Seasons
Greetings*
To all our readers.

© Wimborne Publishing Ltd 2004. Copyright in all drawings, photographs and articles published in **EVERYDAY PRACTICAL ELECTRONICS** is fully protected, and reproduction or imitations in whole or in part are expressly forbidden.

Our February 2005 issue will be published on Thursday, 13 January 2005. See page 3 for details

Everyday Practical Electronics, January 2005

Projects and Circuits

- SPEED CAMERA WATCH** by Mike Hibbett 12
Be forewarned about known hazards while you're driving
- LIGHT DETECTOR** by Anthony H. Smith B.Sc. (Hons) 22
An unusual design which uses an l.e.d. both as the light sensor and indicator
- GATE ALARM** by Thomas Scarborough 36
Baffle callers to your home with this low-cost, delayed action versatile alarm
- SMART KARTS – 4 Software development for the SK2-mobile robot** 56
by Owen Bishop
Discussing the second set of software routines for our PIC-based buggy
- INGENUITY UNLIMITED – Sharing your Ideas with others** 66
Tri-State Logic Probe; 64 L.E.D. Sequencer; L.E.D. Charging Indicator

Series and Features

- TECHNO TALK** by Andy Emmerson 28
Trust Misplaced – Are you in danger of unwittingly giving away highly personal information about yourself?
- CIRCUIT SURGERY** by Alan Winstanley and Ian Bell 30
Continuing our short series on the Universal Serial Bus (USB)
- PRACTICALLY SPEAKING** by Robert Penfold 40
A novice's guide to connector types
- PIC N' MIX** by Andrew Jarvis 42
PIC12F629/75 – programming from a 16F perspective
- PICOSCOPE 3205 REVIEW** by Robert Penfold 46
Putting Pico Technology's dual-trace PC oscilloscope through its superb paces
- NET WORK – THE INTERNET PAGE** surfed by Alan Winstanley 50
More about domain names and possible pitfalls
- 32-BIT SIGNED INTEGER MATHS FOR PICS** by Peter Hemsley 60
An excellent suite of maths routines to simplify your PIC programming ambitions

Regulars and Services

- PIC PROJECTS VOL. 1 CD-ROM** 6
A plethora of 20 "hand PICked" EPE past projects
- EDITORIAL** 11
- NEWS** – Barry Fox highlights technology's leading edge 18
Plus everyday news from the world of electronics
- READOUT** John Becker addresses general points arising 34
- BACK ISSUES** Did you miss these? 44
- BACK ISSUE CD-ROMS** single-source shopping for issues you've missed 45
- SHOPTALK** with David Barrington 48
The *essential* guide to component buying for *EPE* projects
- CD-ROMS FOR ELECTRONICS** 52
A wide range of CD-ROMs for hobbyists, students and engineers
- DIRECT BOOK SERVICE** 63
A wide range of technical books available by mail order, plus more CD-ROMs
- ELECTRONICS MANUALS** 68
Essential CD-ROM reference works for hobbyists, students and service engineers
- PRINTED CIRCUIT BOARD AND SOFTWARE SERVICE** 69
PCBs for *EPE* projects. Plus *EPE* project software
- ADVERTISERS INDEX** 72

Readers Services • Editorial and Advertisement Departments 11

NEW FROM FED – FEDPIC Key - USB In Circuit Programmer / Debugger

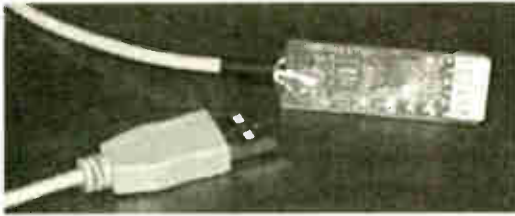

FEDPIC Key – Ultra-Miniature USB In Circuit Serial Programmer and Debugger

Pricing £60.00

Description : Our new in-circuit programmer/debugger for PIC's operates on the PC USB port, requires no additional power supply and the programmer application runs under Windows '98, ME, 2000 or XP.

Programs : 12Cxxx, 12Fxxx, 16Fxxx, 18Cxxx and 18Fxxx devices and flash upgradeable for future devices.

Operates on a simple 6 pin SIL connector and includes the FED In Circuit Debugger. FEDPIC Key Debugger has the same functionality as our standard ICD described below, but runs 3 times faster !

FED – PIC and AVR – ANSI C Compiler products

Visual Development for the FED C Compilers WIZ-C for PIC, AVIDICY for AVR

- An application designer for the FED PIC or AVR C Compilers FULLY including the PIC or AVR C Compiler
- Drag a software component on to your design & set up the parameters using check boxes, drop down boxes and edit boxes (see shot below)
- Connect the component to the device pins using the mouse
- Select your own C functions to be triggered when events occur (e.g. Byte received, timer overflow etc.)
- Simulate, Trace at up to 10x the speed of other simulators
- Generate the base application automatically and then add your own functional code in C or assembler
- WIZ-C supports over 80 PICS - 16F87x, 16F627/8, 16C55x, 16C6x, 16F8x, 16C7xx 18Cxx, 18Fxxx, 12F629/675 etc.
- AVIDICY supports normal and Mega range devices
- Demonstration download available :

www.fored.co.uk/CDemo.htm

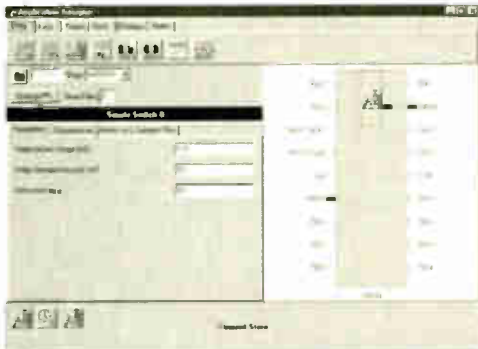

Screen shot (left) shows push button element connected to a PIC, Parameters may be set to control debounce and repeat. C function may be specified to call when the button is pressed

FED ANSI C Compiler for PIC and AVR

- C Compiler designed to ANSI standards
- Supplied with library routines for C standard functions and many interface applications including I2C, LCD, LED's, timers, EEPROM, IRDA, Dallas 1 Wire, Hex Keypad, Maths, asynchronous serial interfacing, clocked data etc.
- With complete development/simulation environment including LCD/Keypad/LED/RS232 terminal
- View your simulation on a logic analyser application showing waveforms, timing or analogue results
- Profiler shows execution count, execution time and average time for functions and code blocks
- Smart linker – efficiently tiles routines throughout memory to minimise long jumps and page setting bits
- Supports the FEDPIC Key and FED In Circuit Debugger for PIC devices 16F87x and 18Fxx devices – See web site for more details.

WIZ-C and C Compiler Pricing :

AVR or PIC C Compiler	£60.00
AVR or PIC C Compiler Professional	£90.00
AVIDICY or WIZ-C	£70.00
AVIDICY or WIZ-C Professional	£100.00

WIZ-C products are provided with introductory tutorial, full extensive manuals provided on CD.

All prices may be **reduced by £20.00** if the product is purchased at the same times as WIZ-ASM, serial or USB programmer, or our Development board.

In Circuit Debugger board (or use the new FEDPIC Key)

Supports 16F87x and 18Fxxx

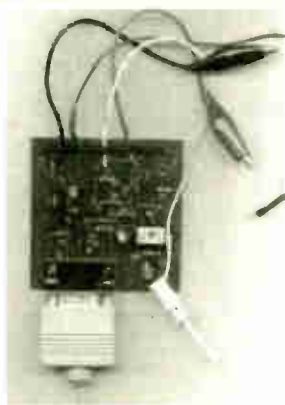

- ICD and FEDPIC Key, allow real hardware to be examined & programs to be debugged and to be run in real time on your application
- The FED ICD requires only one data I/O pin on the PIC which can be chosen from any of ports B, C or D.
- Can program and re-program applications in circuit
- Up to 13 breakpoints (18F version)
- Run, Animate, single step and step over, run to cursor line, set PC to any value in the program
- Trace execution in the original C or Assembler source files
- View and change values of PIC special function registers, W and the ports.
- Standard serial interface to PC

Programmiers and Development Board (See web pages)

USB Programmer - 40 pin multi-width ZIF socket. Same range of devices as our serial programmer (below).

Price : £90/kit

PIC Programmer - Handles serially programmed PIC devices in a 40 pin multi-width ZIF socket. 16C55X, 16C6X, 16C7X, 16C8x, 16F62x, 16F8X, 12C508, 12C509, 16C72XPIC 14000, 16F87X, 18Cxxx, 18Fxxx, 12F6xx etc.

Also In-Circuit programming.

Operates on PC serial port

Price : £45/kit, £50/built & tested

Development Board – For ALL 40 pin PICS from 16cxxx, 16Fxxx and 18C/Fxxx. Includes In-Circuit Programmer – NO separate programmer required. LCD interface, hex keypad, LED's and Driver, 32 I/O pins on header, I2C EEPROM, 2 Serial Interfaces, Will run FED PIC BASIC (supplied free on CD ROM), 1A 5V regulator etc.

The CD-ROM is supplied with FED PIC BASIC and Compiler

Price : £35/kit, £45/built & tested, CD - £5.00.

Manual on CD-ROM or download free from our web site

Forest Electronic Developments
12 Buldowne Walk, Sway,
LYMINGTON Hampshire, SO41 6DU
Email – info@fored.co.uk
Web Site – <http://www.fored.co.uk>
01590-681511 (Voice/Fax)



Prices - Please add £3.00 for P&P and handling to each order. and then EU residents add VAT at 17.5%. Cheques/POs payable to Forest Electronic Developments. phone with credit card details. or order using Credit card or Switch from our secure web site

NEXT MONTH

PIC-ELECTRIC Mk2

PIC-Electric Mk2 is a considerably more sophisticated version of a design published in EPE about nine years ago. Whereas the original basically monitored the cost of running a single mains a.c. electrical appliance in real-time, the Mk2 provides data logging facilities for two appliances, each independently connected to its own logging path.

It has the following features:

- PIC16F876 microcontrolled
- 230V/110V 50Hz/60Hz compatible
- 2-channel monitoring – second channel optional
- L.C.D. display of real-time values for:
 - Mains a.c. voltage, up to 250V a.c., including 110V a.c.
 - Appliance load current, up to 25A per channel
 - Appliance power consumption, up to 6kW per channel
 - Cumulative cost since start of monitoring, to 999.99 units
 - User selected cost per kWh value, any decimal currency
 - Elapsed time since unit's power-up
- Optional on-board serial logging memory for:
 - Mains a.c. voltage
 - Appliance load current, 2 channels
- Logging capacity approximately 68 hours at 1-minute sampling rate
- Cyclic recording, 0 to maximum memory, roll-over to 0, continue, etc
- Output of recorded data to PC-compatible computer, Windows 95 upwards
- Specially written PC program for data storage to disk for subsequent display and analysis
- Stand-alone program, written in Visual Basic 6, but does not need VB6 to be installed on PC
- Data files compatible with Windows Excel graphing and analysis software

SNEAKY

Sneaky is a "magicians assistant" – a system to remotely signal items selected by a member of an audience. It has been designed to be completely undetectable in use and has proved itself in a number of "performances". Using 433MHz low power RF modules Sneaky enables basic covert communication between two people. The article describes how it is used to confound an audience with a "magic" trick.

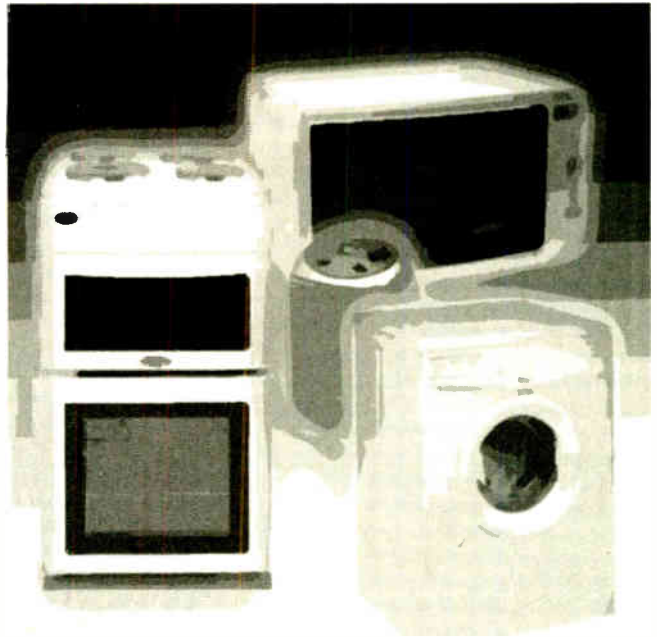

SOUND CARD MIXER

Have you ever used your computer's sound card to make a live recording? Did you plug a microphone into the "microphone input" socket and were disappointed with the results? The most common complaints from people doing this are of weak or distorted sound.

The circuit described here will help to bring "life" to your live PC recordings! It basically provides the boost necessary to bring the microphone output to Line level, but also provides additional inputs for two stereo microphones (or four mono ones) plus a stereo line input. The latter allows a high-level device such as a CD player, tape deck or musical instrument to be connected. Panel controls allow the left and right channels of all inputs to be adjusted and mixed independently to provide a single pair of stereo outputs.

The design takes the form of a desktop unit which is connected to the computer's sound card through a short length of cable.

NO ONE DOES IT BETTER

EVERYDAY
PRACTICAL
ELECTRONICS

**DON'T MISS AN
ISSUE – PLACE YOUR
ORDER NOW!**
Demand is bound to be high

FEBRUARY 2005 ISSUE ON SALE THURSDAY, JANUARY 13



Quasar Electronics Limited
 PO Box 6935, Bishops Cleeve, Nottingham, NG5 2EP
 CM23 4WP
 Tel: 0870 246 1826
 Fax: 0870 460 1045
 E-mail: sales@quasarelectronics.com

Add £2.95 P&P to all UK orders or 1st Class Recorded – £4.95.
 Next day (Insured £250) – £7.95. Europe – £6.95. Rest of World – £9.95
 (order online for reduced price UK Postage).
 We accept all major credit/debit cards. Make cheques/POs
 payable to Quasar Electronics Limited.
 Prices include 17.5% VAT. MAIL ORDER ONLY.
 Call now for our FREE CATALOGUE with details of over 300
 high quality kits, projects, modules and publications.



QUASAR 0871 CREDIT CARD SALES 717 7168 electronics

Helping you make the right connections!

PIC & ATMEL Programmers

We have a wide range of low cost PIC and ATMEL Programmers. Complete range and documentation available from our web site.

Programmer Accessories:

40-pin Wide ZIF socket (ZIF40W) £15.00
 18VDC Power supply (PSU010) £19.95
 Leads: Parallel (LDC136) £4.95 / Serial (LDC441) £4.95 / USB (LDC644) £2.95

NEW! USB 'All-Flash' PIC Programmer

USB PIC programmer for all 'Flash' devices. No external power supply making it truly portable. Supplied with box and Windows Software. ZIF Socket and USB Plug A-B lead not incl.



Kit Order Code: 3128KT – £34.95

Assembled Order Code: AS3128 – £44.95

Enhanced "PICALL" ISP PIC Programmer

Will program virtually ALL 8 to 40 pin PICs plus certain ATMEL AVR, SCENIX SX and EEPROM 24C devices. Also supports In System Programming (ISP) for PIC and ATMEL AVRs. Free software. Blank chip auto detect for super fast bulk programming. Requires a 40-pin wide ZIF socket (not included)

Assembled Order Code: AS3144 – £54.95

ATMEL 89xxx Programmer

Uses serial port and any standard terminal comms program. 4 LEDs display the status. ZIF sockets not included. Supply: 16VDC.



Kit Order Code: 3123KT – £29.95

Assembled Order Code: AS3123 – £34.95

NEW! USB & Serial Port PIC Programmer

USB/Serial connection. Header cable for ICSP. Free Windows software. See website for PICs supported. ZIF Socket and USB Plug A-B lead extra. 18VDC.

Kit Order Code: 3149KT – £34.95

Assembled Order Code: AS3149 – £49.95

Introduction to PIC Programming

Go from a complete PIC beginner to burning your first PIC and writing your own code in no time! Includes a 49-page step-by-step Tutorial Manual, Programming Hardware (with LED bench testing section), Win 3.11-XP Programming Software (will Program, Read, Verify & Erase), and a rewritable PIC16F84A that you can use with different code (4 detailed examples provided for you to learn from). Connects to PC parallel port.



Kit Order Code: 3081KT – £14.95

Assembled Order Code: AS3081 – £24.95

ABC Maxi AVR Development Board

The ABC Maxi board has an open architecture design based on Atmel's AVR AT90S8535 RISC microcontroller and is ideal for developing new designs.



Features:

8Kb of In-System Programmable Flash (1000 write/erase cycles) • 512 bytes internal SRAM • 512 bytes EEPROM
 • 8 analogue inputs (range 0-5V)
 • 4 Opto-isolated Inputs (I/Os are bi-directional with internal pull-up resistors)
 • Output buffers can sink 20mA current (direct i.e.d. drive) • 4 x 12A open drain MOSFET outputs • RS485 network connector • 2-16 LCD Connector
 • 3-5mm Speaker Phone Jack
 • Supply: 9-12VDC.

The ABC Maxi STARTER PACK includes one assembled Maxi Board, parallel and serial cables, and Windows software CD-ROM featuring an Assembler, BASIC compiler and in-system programmer.

Order Code ABCMAXISP – £79.95

The ABC Maxi boards only can also be purchased separately at £59.95 each.

Controllers & Loggers

Here are just a few of the controller and data acquisition and control units we have. See website for full details. Suitable PSU for all units: Order Code PSU445 – £8.95

Rolling Code 4-Channel UHF Remote

State-of-the-Art. High security.

4 channels. Momentary or latching relay output. Range up to 40m. Up to 15 TXs can be learned by one Rx (kit includes one Tx but more available separately). 4 indicator LEDs.

Rx: PCB 77x85mm, 12VDC/6mA (standby).

Two & Ten Channel versions also available.

Kit Order Code: 3180KIT – £41.95

Assembled Order Code: AS3180 – £49.95



Computer Temperature Data Logger

Serial port 4-channel temperature logger. °C or °F. Continuously logs up to 4 separate sensors located 200m+ from board. Wide range of free software applications for storing/using data. PCB just 38x38mm. Powered

by PC. Includes one DS1820 sensor and four header cables.

Kit Order Code: 3145KT – £19.95

Assembled Order Code: AS3145 – £26.95

Additional DS1820 Sensors – £3.95 each



NEW! DTMF Telephone Relay Switcher

Call your phone number using a DTMF phone from anywhere in the world and remotely turn on/off any of the 4 relays as desired. User settable Security Password, Anti-Tamper, Rings to Answer, Auto Hang-up and Lockout. Includes plastic case. 130 x 110 x 30mm. Power: 12VDC.



Kit Order Code: 3140KT – £39.95

Assembled Order Code: AS3140 – £49.95

Serial Port Isolated I/O Module

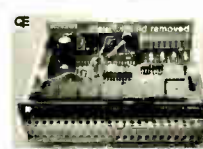

Computer controlled 8-channel relay board. 5A mains rated relay outputs and 4 opto-isolated digital inputs (for monitoring switch

states, etc). Useful in a variety of control and sensing applications. Programmed via serial port (use our new Windows interface, terminal emulator or batch files). Serial cable can be up to 35m long. Includes plastic case 130 x 100 x 30mm. Power: 12VDC/500mA.

Kit Order Code: 3108KT – £54.95

Assembled Order Code: AS3108 – £64.95

Infra-red RC 12-Channel Relay Board



Control 12 on-board relays with included infra-red remote control unit. Toggle or momentary. 15m+ range. 112 x 122mm.

Supply: 12VDC/0.5A.

Kit Order Code: 3142KT – £41.95

Assembled Order Code: AS3142 – £51.95

PC Data Acquisition & Control Unit

Monitor and log a mixture of analogue and digital inputs and control external devices via the analogue and digital outputs. Monitor pressure, temperature, light intensity, weight, switch state, movement, relays, etc. with the appropriate sensors (not supplied). Data can be processed, stored and the results used to control devices such as motors, sirens, relays, servo motors (up to 11) and two stepper motors.



Features

- 11 Analogue Inputs – 0-5V, 10 bit (5mV/step)
- 16 Digital Inputs – 20V max. Protection 1K in series, 5-1V Zener
- 1 Analogue Output – 0-2.5V or 0-10V. 8 bit (20mV/step)
- 8 Digital Outputs – Open collector, 500mA, 33V max
- Custom box (140 x 110 x 35mm) with printed front & rear panels
- Windows software utilities (3-1 to XP) and programming examples
- Supply: 12V DC (Order Code PSU203)

Kit Order Code: 3093KT – £69.95

Assembled Order Code: AS3093 – £99.95

Most items are available in kit form (KT suffix) or pre-assembled and ready for use (AS prefix).

Hot New Kits This Summer!

Here are a few of the most recent kits added to our range. See website or join our email Newsletter for all the latest news.

NEW! EPE Ultrasonic Wind Speed Meter

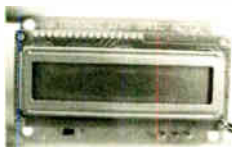

Solid-state design wind speed meter (anemometer) that uses ultrasonic techniques and has no moving parts and does not need

calibrating. It is intended for sports-type activities, such as track events, sailing, hang-gliding, kites and model aircraft flying, to name but a few. It can even be used to monitor conditions in your garden. The probe is pointed in the direction from which the wind is blowing and the speed is displayed on an LCD display.

Specifications

- Units of display: metres per second, feet per second, kilometres per hour and miles per hour
- Resolution: Nearest tenth of a metre
- Range: Zero to 50mph approx.

Based on the project published in *Everyday Practical Electronics*, Jan 2003. We have made a few minor design changes (see web site for full details). Power: 9VDC (PP3 battery or Order Code PSU345).

Main PCB: 50 x 83mm.

Kit Order Code: 3168KT – £34.95

NEW! Audio DTMF Decoder and Display



Detects DTMF tones via an on-board electret microphone or direct from the phone lines through the onboard audio transformer. The

numbers are displayed on a 16-character, single line display as they are received. Up to 32 numbers can be displayed by scrolling the display left and right. There is also a serial output for sending the detected tones to a PC via the serial port. The unit will not detect numbers dialled using pulse dialling. Circuit is microcontroller based.

Supply: 9-12V DC (Order Code PSU345). Main PCB: 55 x 95mm.

Kit Order Code: 3153KT – £17.95

Assembled Order Code: AS3153 – £29.95

NEW! EPE PIC Controlled LED Flasher

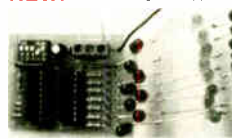

This versatile PIC-based LED or filament bulb flasher can be used to flash from 1 to 160

LEDs. The user arranges the LEDs in any pattern they wish. The kit comes with 8 superbright red LEDs and 8 green LEDs.

Based on the *Versatile PIC Flasher* by Steve Challinor, *EPE Magazine* Dec '02. See website for full details. Board Supply: 9-12V DC. LED supply: 9-45V DC (depending on number of LED used). PCB: 43 x 54mm. Kit Order Code: 3169KT – £10.95

Most items are available in kit form (KT suffix) or assembled and ready for use (AS prefix)

FM Bugs & Transmitters

Our extensive range goes from discreet surveillance bugs to powerful FM broadcast transmitters. Here are a few examples. All can be received on a standard FM radio and have adjustable transmitting frequency.

MMTX' Micro-Miniature 9V FM Room Bug



Our best selling bug! Good performance. Just 25 x 15mm. Sold to detective agencies worldwide. Small enough to hide just about anywhere.

Operates at the 'less busy' top

end of the commercial FM waveband and also up into the more private Air band.

Range: 500m. Supply: PP3 battery.

Kit Order Code: 3051KT – £8.95

Assembled Order Code: AS3051 – £14.95

HPTX' High Power FM Room Bug

Our most powerful room bug.

Very impressive

performance. Clear and stable output signal thanks to the extra circuitry employed.

Range: 1000m @ 9V. Supply: 6-12V DC (9V PP3 battery clip supplied). 70 x 15mm.

Kit Order Code: 3032KT – £9.95

Assembled Order Code: AS3032 – £17.95

MTTX' Miniature Telephone Transmitter



Attach anywhere along phone line. Tune a radio into the signal and hear

exactly what both parties are saying.

Transmits only when phone is used. Clear, stable signal. Powered from phone line so completely maintenance free once installed. Requires no aerial wire – uses phone line as antenna. Suitable for any phone system worldwide. Range: 300m. 20 x 45mm.

Kit Order Code: 3016KT – £7.95

Assembled Order Code: AS3016 – £13.95

3 Watt FM Transmitter



Small, powerful FM transmitter. Audio preamp stage and three RF stages deliver 3 watts of RF power. Can be used with the electret

microphone supplied or any line level audio source (e.g. CD or tape OUT, mixer, sound card, etc). Aerial can be an open dipole or

Ground Plane. Ideal project for the novice wishing to get started in the fascinating world of FM broadcasting. 45 x 145mm.

Kit Order Code: 1028KT – £22.95

Assembled Order Code: AS1028 – £34.95

25 Watt FM Transmitter

Four transistor based stages with a Philips BLY89 (or equivalent) in the final stage. Delivers a mighty 25 Watts of RF power. Accepts any line level audio source (input sensitivity is adjustable). Antenna can be an open dipole, ground plane, 5/8, J, or YAGI configuration. Supply 12-14V DC, 5A.

Supplied fully assembled and aligned – just connect the aerial, power and audio input. 70 x 220mm.

Order Code: 1031M – £124.95



QUASAR
electronics

Helping you make the right connections!

**CREDIT
CARD
SALES
0871
717
7168**

Electronic Project Labs

Great introduction to the world of electronics. Ideal gift for budding electronics expert!

500-in-1 Electronic Project Lab

This is the top of the range and is a complete electronics course taking you from beginner to 'A' level standard and beyond! It contains all the parts and instructions to assemble 500 projects. You get three comprehensive course books (total 368 pages) – *Hardware Entry Course*, *Hardware Advanced Course* and a micro-computer based *Software Programming Course*. Each book has individual circuit explanations, schematic and assembly diagrams. Suitable for age 12 and above. Order Code EPL500 – £149.95

30, 130, 200 and 300-in-1 project labs also available – see website for details.



Number 1 for Kits!

With over 300 projects in our range we are the UK's number 1 electronic kit specialist. Here are a few other kits from our range.

- 1046KT – 25W Stereo Car Booster £29.95
- 3087KT – 1W Stereo Amplifier £4.95
- 3105KT – 18W BTL mono Amplifier £9.95
- 3106KT – 50W Mono Hi-fi Amplifier £19.95
- 3143KT – 10W Stereo Amplifier £10.95
- 1011-12KT – Motorbike Alarm £12.95
- 1019KT – Car Alarm System £11.95
- 1048KT – Electronic Thermostat £9.95
- 1080KT – Liquid Level Sensor £6.95
- 3003KT – LED Dice with Box £7.95
- 3006KT – LED Roulette Wheel £8.95
- 3074KT – 8-Ch PC Relay Board £29.95
- 3082KT – 2-Ch UHF Relay £26.95
- 3126KT – Sound-Activated Relay £7.95
- 3063KT – One Chip AM Radio £10.95
- 3102KT – 4-Ch Servo Motor Driver £15.95
- 3155KT – Stereo Tone Controls £8.95
- 1096KT – 3-30V, 5A Stabilised PSU £32.95
- 3029KT – Combination Lock £6.95
- 3049KT – Ultrasonic Detector £13.95
- 3130KT – Infra-red Security Beam £12.95
- SG01MKT – Train Sounds £6.95
- SG10 MKT – Animal Sounds £5.95
- 1131KT – Robot Voice Effect £9.95
- 3007KT – 3V FM Room Bug £6.95
- 3028KT – Voice-Activated FM Bug £12.95
- 3033KT – Telephone Recording Adpt £9.95
- 3112KT – PC Data Logger/Sampler £18.95
- 3118KT – 12-bit Data Acquisition Unit £52.95
- 3101KT – 20MHz Function Generator £69.95

www.quasarelectronics.com

Secure Online Ordering Facilities • Full Product Listing, Descriptions & Photos • Kit Documentation & Software Downloads

**No.1
FOR
KITS**

EPE PIC PROJECTS VOLUME 1 MINI CD-ROM

A plethora of 20 "hand-PICked" PIC Projects from selected past issues of EPE

Together with the PIC programming software for each project plus bonus articles

The projects are:

PIC-Based Ultrasonic Tape Measure

You've got it taped if you PIC this ultrasonic distance measuring calculator

EPE Mind PICKler

Want seven ways to relax? Try our PIC-controlled mind machine!

PIC MIDI Sustain Pedal

Add sustain and glissando to your MIDI line-up with this inexpensive PIC-controlled effects unit

PIC-based MIDI Handbells

Ring out thy bells with merry tolling – plus a MIDI PIC-up, of course!

EPE Mood PICKer

Oh for a good night's sleep! Insomniacs rejoice – your wakeful nights could soon be over with this mini-micro under the pillow!

PIC Micro-Probe

A hardware tool to help debug your PIC software

PIC Video Cleaner

Improving video viewing on poorly maintained TVs and VCRs

PIC Graphics LCD Scope

A PIC and graphics LCD signal monitor for your workshop

PIC to Printer Interface

How to use dot-matrix printers as data loggers with PIC microcontrollers

PIC Polywhatsit

A novel compendium of musical effects to delight the creative musician

PIC Magick Musick

Conjure music from thin air at the mere untouching gesture of a fingertip

PIC Mini-Enigma

Share encrypted messages with your friends — true spymaster entertainment

PIC Virus Zapper

Can disease be cured electronically? Investigate this controversial subject for yourself

PIC Controlled Intruder Alarm

A sophisticated multi-zone intruder detection system that offers a variety of monitoring facilities

PIC Big-Digit Display

Control the giant ex-British Rail platform clock 7-segment digits that are now available on the surplus market

PIC Freezer Alarm

How to prevent your food from defrosting unexpectedly

PIC World Clock

Graphically displays world map, calendar, clock and global time-zone data

PICAXE Projects

A 3-part series using PICAXE devices – PIC microcontrollers that do not need specialist knowledge or programming equipment

PIC-based Tuning Fork and Metronome

Thrill everyone by at long last getting your instrument properly tuned!

Versatile PIC Flasher

An attractive display to enhance your Christmas decorations or your child's ceiling



**ONLY
£14.45**

**INCLUDING
VAT and P&P**

Order on-line from

www.epemag.wimborne.co.uk/shopdoor.htm

or www.epemag.com (USA \$ prices)

or by Phone, Fax, Email or Post.

NOTE: The PDF files on this CD-ROM are suitable to use on any PC with a CD-ROM drive. They require Adobe Acrobat Reader.

EPE PIC PROJECTS CD-ROM ORDER FORM

Please send me (quantity) EPE PIC PROJECTS VOL 1 CD-ROM

Price £14.45 each – includes postage to anywhere in the world.

Name

Address

.....

.....

..... Post Code

I enclose cheque/P.O./bank draft to the value of £

Please charge my Visa/Mastercard/Amex/Diners Club/Switch

£

Card No.

Card Security Code (The last 3 digits on or just under the signature strip)

Start Date Expiry Date Switch Issue No.

**SEND TO: Everyday Practical Electronics,
Wimborne Publishing Ltd.,**

408 Wimborne Road East, Ferndown, Dorset BH22 9ND.

Tel: 01202 873872. Fax: 01202 874562.

Email: orders@epemag.wimborne.co.uk

Payments must be by card or in £ Sterling – cheque or bank draft drawn on a UK bank.

Normally supplied within seven days of receipt of order.

Send a copy of this form, or order by letter if you do not wish to cut your issue.

BECOME A PIC PROJECT BUILDER WITH THE HELP OF EPE!

Learn About Microcontrollers

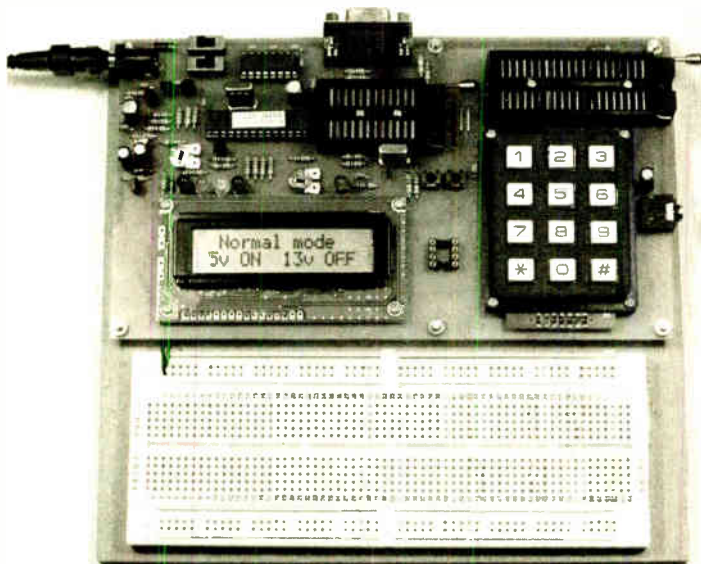

PIC Training & Development System

The best place to start learning about microcontrollers is the PIC16F84. This is easy to understand and very popular with construction projects. Then continue on using the more sophisticated PIC16F877 family.

The heart of our system is two real books which lie open on your desk while you use your computer to type in the programme and control the hardware. Start with four very simple programmes. Run the simulator to see how they work. Test them with real hardware. Follow on with a little theory....

Our complete PIC training and development system consists of our universal mid range PIC programmer, a 306 page book covering the PIC16F84, a 262 page book introducing the PIC16F877 family, and a suite of programmes to run on a PC. The module is an advanced design using a 28 pin PIC16F870 to handle the timing, programming and voltage switching requirements. The module has two ZIF sockets and an 8 pin socket which between them allow most mid range 8, 18, 28 and 40 pin PICs to be programmed. The plugboard is wired with a 5 volt supply. The software is an integrated system comprising a text editor, assembler disassembler, simulator and programming software. The programming is performed at 5 volts, verified with 2 volts or 3 volts applied and verified again with 5.5 volts applied to ensure that the PIC is programmed correctly over its full operating voltage. DC version for UK, battery version for overseas. UK orders include a plugtop power supply.

- Universal mid range PIC programmer module
 - + Book *Experimenting with PIC Microcontrollers*
 - + Book *Experimenting with the PIC16F877 (2nd edition)*
 - + Universal mid range PIC software suite
 - + PIC16F84 and PIC16F870 test PICs. £159.00
- (Postage & insurance UK £10, Europe £15, Rest of world £25)

Experimenting with PIC Microcontrollers

This book introduces the PIC16F84 and PIC16C711, and is the easy way to get started for anyone who is new to PIC programming. We begin with four simple experiments, the first of which is explained over ten and half a pages assuming no starting knowledge except the ability to operate a PC. Then having gained some practical experience we study the basic principles of PIC programming, learn about the 8 bit timer, how to drive the liquid crystal display, create a real time clock, experiment with the watchdog timer, sleep mode, beeps and music, including a rendition of Beethoven's *Für Elise*. Finally there are two projects to work through, using the PIC16F84 to create a sinewave generator and investigating the power taken by domestic appliances. In the space of 24 experiments, two projects and 56 exercises the book works through from absolute beginner to experienced engineer level.

Hardware & Ordering Information

Our latest programmer module connects to the serial port of your PC (COM1 or COM2), which enables our PIC software to operate directly within Windows 98, XP, NT, 2000 etc.

Telephone with Visa, Mastercard or Switch, or send cheque/PO for immediate despatch. All prices include VAT if applicable.

Web site:- www.brunningsoftware.co.uk

NEW 32 bit PC Assembler

Experimenting with PC Computers with its kit is the easiest way ever to learn assembly language programming. If you have enough intelligence to understand the English language and you can operate a PC computer then you have all the necessary background knowledge. Flashing LEDs, digital to analogue converters, simple oscilloscope, charging curves, temperature graphs and audio digitising.

Kit now supplied with our 32 bit assembler with 84 page supplement detailing the new features and including 7 experiments PC to PIC communication. Flashing LEDs, writing to LCD and two way data using 3 wires from PC's parallel port to PIC16F84.

- Book + made up kit 1a + software..... £73.50
 - Book + unmade kit 1u + software..... £66.50
- (PP UK £4, Europe £10, Rest of world £14)

C & C++ for the PC

Experimenting with C & C++ Programmes teaches us to programme by using C to drive the simple hardware circuits built using the materials supplied in the kit. The circuits build up to a storage oscilloscope using relatively simple C techniques to construct a programme that is by no means simple. When approached in this way C is only marginally more difficult than BASIC and infinitely more powerful. C programmers are always in demand. Ideal for absolute beginners and experienced programmers.

- Book + made up kit 2a + software £57.50
 - Book + unmade kit 2u + software £51.50
 - Book + top up kit 2t + software £37.98
- (PP UK £4, Europe £10, Rest of world £14)

The Kits

The assembler and C & C++ kits contain the prototyping board, lead assemblies, components and programming software to do all the experiments. The 'made up' kits are supplied ready to start. The 'top up' kit is for readers who have already purchased kit 1a or 1u.

Assembler and C & C++

Click on 'Special Offers' on our website for details of how to save by buying a combined kit for assembler and C & C++.

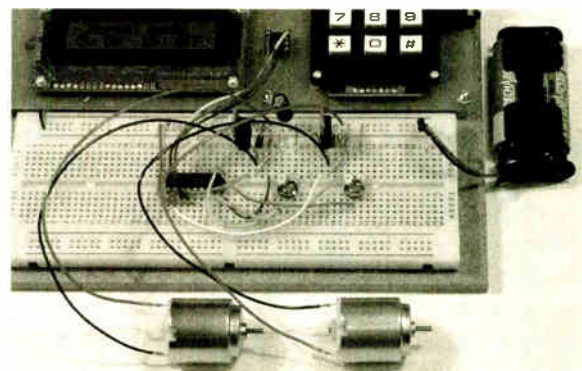

Experimenting with the PIC16F877

The second PIC book starts with the simplest of experiments to give us a basic understanding of the PIC16F877 family. Then we look at the 16 bit timer, efficient storage and display of text messages, simple frequency counter, use a keypad for numbers, letters and security codes, and examine the 10 bit A/D converter.

The PIC16F627 is then introduced as a low cost PIC16F84. We use the PIC16F627 as a step up switching regulator, and to control the speed of a DC motor with maximum torque still available. We study how to use a PIC to switch mains power using an optoisolated triac driving a high current triac. Finally we study how to use the PICs USART for serial communication to a PC.

Mail order address:

Brunning Software 138 The Street, Little Clacton, Clacton-on-sea,
Essex, CO16 9LS. Tel 01255 862308

MAIL ORDER ONLY • CALLERS BY APPOINTMENT

EPE PROJECT PICS

Programmed PICs for *EPE Projects

12C508/9 - £3.90; 16F627/8 - £4.90
 16C84/16F84/16C71 - £5.90
 16F876/877 - £10.00
 All inc. VAT and Postage
 (*Some projects are copyright)

**EPE MICROCONTROLLER
 P.I. TREASURE HUNTER**

The latest MAGENTA DESIGN - highly stable & sensitive - with I.C. control of all timing functions and advanced pulse separation techniques.

- High stability drift cancelling
- Easy to build & use
- No ground effect, works in seawater



- Detects gold, silver, ferrous & non-ferrous metals

- Efficient quartz controlled microcontroller pulse generation.
- Full kit with headphones & all hardware

KIT 847 £63.95

PIC PIPE DESCALER

- SIMPLE TO BUILD
- HIGH POWER OUTPUT
- AUDIO & VISUAL MONITORING
- SWEPT FREQUENCY

An affordable circuit which sweeps the incoming water supply with variable frequency electromagnetic signals. May reduce scale formation, dissolve existing scale and improve lathering ability by altering the way salts in the water behave. Kit includes case, P.C.B., coupling coil and all components. High coil current ensures maximum effect. L.E.D. monitor.



KIT 868 £22.95 POWER UNIT.....£3.99

MICRO PEST SCARER

Our latest design - The ultimate scarer for the garden. Uses special microchip to give random delay and pulse time. Easy to build reliable circuit. Keeps pets/pests away from newly sown areas, play areas, etc. uses power source from 9 to 24 volts.

- RANDOM PULSES
- HIGH POWER
- DUAL OPTION



Plug-in power supply £4.99

KIT 867.....£19.99

KIT + SLAVE UNIT.....£32.50

WINDICATOR

A novel wind speed indicator with LED readout. Kit comes complete with sensor cups, and weatherproof sensing head. Mains power unit £5.99 extra.

KIT 856.....£28.00

★ TENS UNIT ★

DUAL OUTPUT TENS UNIT

As featured in March '97 issue.

Magenta have prepared a FULL KIT for this excellent new project. All components, PCB, hardware and electrodes are included. Designed for simple assembly and testing and providing high level dual output drive.

KIT 866. . Full kit including four electrodes £32.90

Set of 4 spare electrodes £6.50

1000V & 500V INSULATION

TESTER

Superb new design. Regulated output, efficient circuit. Dual-scale meter, compact case. Reads up to 200 Megohms.

Kit includes wound coil, cut-out case, meter scale, PCB & ALL components.

KIT 848..... £32.95



EPE TEACH-IN 2000

Full set of top quality NEW components for this educational series. All parts as specified by EPE. Kit includes breadboard, wire, croc clips, pins and all components for experiments, as listed in introduction to Part 1.

*Batteries and tools not included.

TEACH-IN 2000 -

KIT 879 £44.95
MULTIMETER £14.45

SPACEWRITER

An innovative and exciting project. Wave the wand through the air and your message appears. Programable to hold any message up to 16 digits long. Comes pre-loaded with "MERRY XMAS". Kit includes PCB, all components & tube plus instructions for message loading.

KIT 849£16.99



12V EPROM ERASER

A safe low cost eraser for up to 4 EPROMs at a time in less than 20 minutes. Operates from a 12V supply (400mA). Used extensively for mobile work - updating equipment in the field etc. Also in educational situations where mains supplies are not allowed. Safety interlock prevents contact with UV.

KIT 790£29.90

SUPER BAT DETECTOR

1 WATT O/P, BUILT IN SPEAKER, COMPACT CASE 20kHz-140kHz NEW DESIGN WITH 40kHz MIC.

A new circuit using a 'full-bridge' audio amplifier i.c., internal speaker, and headphone/tape socket. The latest sensitive transducer, and 'double balanced mixer' give a stable, high performance superheterodyne design.

KIT 861£34.99

ALSO AVAILABLE Built & Tested... £48.99



68000 DEVELOPMENT TRAINING KIT

- NEW PCB DESIGN
- 8MHz 68000 16-BIT BUS
- MANUAL AND SOFTWARE
- 2 SERIAL PORTS
- PIT AND I/O PORT OPTIONS
- 12C PORT OPTIONS

KIT 621

£99.95

- ON BOARD 5V REGULATOR
- PSU £6.99
- SERIAL LEAD £3.99

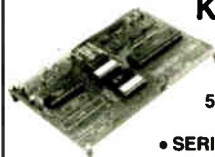

Stepping Motors

MD100...Std 100 step...£9.99
 MD200...200 step...£12.99
 MD24...Large 200 step...£22.95



MOSFET MkII VARIABLE BENCH POWER SUPPLY 0-25V 2-5A

Based on our Mk1 design and preserving all the features, but now with switching pre-regulator for much higher efficiency. Panel meters indicate Volts and Amps. Fully variable down to zero. Toroidal mains transformer. Kit includes punched and printed case and all parts. As featured in April 1994 EPE. An essential piece of equipment.



Kit No. 845 £64.95

ULTRASONIC PEST SCARER

Keep pets/pests away from newly sown areas, fruit, vegetable and flower beds, children's play areas, patios etc. This project produces intense pulses of ultrasound which deter visiting animals.

- KIT INCLUDES ALL COMPONENTS, PCB & CASE
- EFFICIENT 100V TRANSDUCER OUTPUT
- COMPLETELY INAUDIBLE TO HUMANS



- UP TO 4 METRES RANGE
- LOW CURRENT DRAIN

KIT 812..... £15.00

SIMPLE PIC PROGRAMMER

KIT 857... £12.99

Includes PIC16F84 chip disk, lead, plug, p.c.b., all components and instructions

Extra 16F84 chips £3.84
 Power Supply £3.99

PIC LCD DISPLAY DRIVER

16 Character x 2 Line display, pcb, programmed PIC16F84, software disk and all components to experiment with standard intelligent alphanumeric displays. Includes full PIC source code which can be changed to match your application.

KIT 860.....£19.99

- Learn how to drive the display and write your own code.
- Ideal development base for meters, calculators, counters, timers — just waiting for your application!
- **Top quality display** with industry standard driver, data and instructions

PIC STEPPING MOTOR DRIVER

PCB with components and PIC16F84 programmed with demonstration software to drive any 4 phase unipolar motor up to 24 Volts at 1 Amp. **Kit includes 100 Step Hybrid Stepping Motor** Full software source code supplied on disc.

Use this project to develop your own applications. PCB allows 'simple PIC programmer' 'SEND' software to be used to reprogram chip.

KIT 863.....£18.99

8 CHANNEL DATA LOGGER

From Aug/Sept.'99 *EPE*. Featuring 8 analogue inputs and serial data transfer to PC. Magenta redesigned PCB - LCD plugs directly onto board. Use as Data Logger or as a test bed for developing other PIC16F877 projects. Kit includes lcd, prog. chip, PCB, Case, all parts and 8 x 256k EEPROMs

KIT 877.....£49.95

PIC16F84 MAINS POWER CONTROLLER & 4 CHANNEL LIGHT CHASER / DIMMER

- Zero Volt Switching
- Opto-Isolated 5 Amp **HARD FIRED TRIACS**
- 12 Way keypad Control

- With program source code disk.
- Chase Speed and dimming potentiometer controls.
- Reprogram for other applications

KIT 855.....£39.95

PIC TUTOR 1 EPE MARCH APRIL MAY '98 PIC16F84 STARTER SERIES

The original PIC16F84 series by John Becker. Magenta's Tutor board has individual switches and leds on all portA and PortB lines, plus connectors for optional 4 digit seven segment led display, and 16 x 2 intelligent lcd. Written for newcomers to PICs this series. Disk has over 20 tutorial programs. Connect to a PC parallel port, send, run, and experiment by modifying test programs - Then Write and Program your Own

KIT 870... £27.95, Built...£42.95

16x2 LCD..£7.99. LED display..£6.99. 12VPSU..£3.99

SUPER PIC PROGRAMMER

Magenta's original parallel port programmer. Complete with WINDOWS 95 - 2K software. Use standard Microchip .HEX files. Includes Disassembler. Read/Prog/Verify 18,28, and 40 pin PICs. 16F84/876/877, 627/8, + 16xx OTPs.

KIT 862... £29.99 Power Supply £3.99

ICEBREAKER

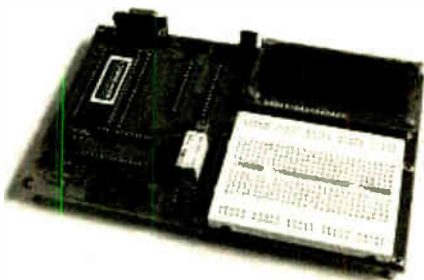

PIC Real Time In-Circuit Emulator

- ICEbreaker uses PIC16F877 in-circuit debugger.
- Links to standard PC Serial port (lead supplied).
- Windows (95 to XP) Software included
- Works with MPASM assembler
- 16 x 2 LCD display, Breadboard, Relay, I/O devices and patch leads.

Featured in *EPE Mar'00* Ideal for beginners & experienced users.

KIT 900...£34.99 With serial lead & software disk, PCB, Breadboard, PIC16F877, LCD, all components and patch leads.
POWER SUPPLY - £3.99 STEPPING MOTOR 100 Step £9.99

Programs can be written, downloaded, and then tested by single-stepping, running to breakpoints, or free run at up to 20Mhz.
Full emulation means that all ports respond immediately - reading and driving external hardware.
Features include: Run; set Breakpoint; View & change registers, EEPROM, and program memory; load program; 'watch window' registers.

Introducing: BrainiBorg!

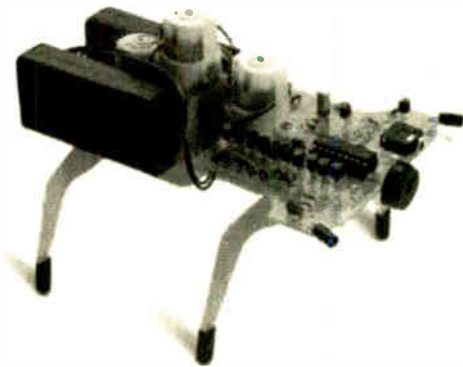

A super walking programmable robot with eyes that sense obstacles and daylight: **BrainiBorg** comes with superb PC software CD (*WIN95+ & XP*) and can be programmed to walk and respond to light and obstacles on any smooth surface.

CD contains illustrated constructional details, operating principles, circuits and a superb **Educational Programming Tutorial**.

Test routines give real-time 'scope traces of sensor and motor signals. Connects to PC via **SERIAL** port with the lead supplied.

Kit includes all hardware, components, 3 motor/gearboxes. Uses 4 AA batteries (*not supplied*). *An Ideal Present!*

KIT 912 Complete Kit with CD rom & serial lead **£49.99**

KIT 913 As 912 but built & tested circuit board **£58.95**

EPE PIC Tutorial

EPE Apr/May/June '03 and PIC Resources CD

- Follow John Becker's excellent PIC toolkit 3 series.
- Magenta Designed Toolkit 3 board with printed component layout, green solder mask, places for 8, 18, 28 (wide and slim), and 40 pin PICs. and Magenta extras.
- 16 x 2 LCD, PIC chip all components and sockets included.

KIT 880 (with 16F84) **£34.99**, built & tested **£49.99**

KIT 880 (with 16F877) **£39.99**, built & tested **£55.99**

EPE TEACH-IN 2004

THE LATEST NOV 03 SERIES
All parts to follow this new Educational Electronics Course.
Inc. Breadboard, and wire, as listed on p752 Nov. Issue.

Additional Parts as listed in 'misc.' Section (less RF modules, Lock, and Motor/g.box)

Reprints: **£1.00 per part.**

KIT 920.....£29.99

KIT921.....£12.99

MAGENTA BRAINIBOT I & II

- Full kit with ALL hardware and electronics.
- As featured in *EPE Feb '03* (KIT 910)
- Seeks light, beeps, and avoids obstacles
- Spins and reverses when 'cornered'
- Uses 8 pin PIC chip
- ALSO KIT 911 - As 910 PLUS programmable from PC serial port leads and software CD included.



KIT 910....£16.99 **KIT 911....£24.99**

MAGENTA

All prices include VAT. Add £3.00 p&p. Next day £6.99

Tel: 01283 565435 Fax: 01283 546932 email: sales@magenta2000.co.uk

122004



Station Road, Cullercoats, Tyne & Wear, NE30 4PQ

Prices Exclude Vat @17.5%.
UK Carriage £2.50 (less than 1kg)
£5.50 greater than 1kg
Cheques / Postal orders payable to
ESR Electronic Components.
PLEASE ADD CARRIAGE & VAT TO ALL ORDERS



See Next / Last Months Ad. for ELECTRONIC COMPONENTS

PCB Production - Development

0.1" Copper Striplate

Size	Tracks/Holes	£0.24
25 x 64mm	9T / 25H	£0.24
64 x 75mm	24T / 37H	£0.87
95 x 127mm	36T / 50H	£1.41
95 x 132mm	36T / 170H	£1.39
100 x 100mm	39T / 38H	£4.40
100 x 500mm	39T / 199H	£6.20
119 x 455mm	46T / 179H	£5.40

Stripboard track cutter £1.99



Solderless Breadboard

Tie Points & Size Power Rails
390 81 x 60mm 2 £2.75
840 175 x 67mm 2 £4.86
740 175 x 55mm 1 £4.03
640 175 x 42mm 0 £3.08
Many other sizes available,
also jump wires & matrix board.



PCB Production - Drafting Materials

A4 Artwork Film (per 10 sheets)

Clear Manual Film £1.25
Clear Laser Film £1.75
White HiG Laser Film £4.62

Eth Resist Pens

"Dolo" Pen £2.98
"Sloedler" Fine Pen £0.88

Eth Resist Transfers

Sena mixed DIL pads £2.24
Sena mixed Rnd pads £2.24
Alfac mixed pads £1.84
Transfer Spatular £1.25



We carry the full range of Sena & Alfac PCB transfers, see our catalogue for full details.

Soldering Irons

We carry a stock a wide range of soldering iron and soldering accessories. Irons from 12 to 100 Watts.

20W 240V Basic £3.74
25W 240V Ceramic £14.05
30W 240V Basic £4.68



Desolder Pumps

Basic 165 x 18mm £2.85
Antistatic 125mm £3.92
Antex Mini 198mm £6.02
Antex Pro 210mm £10.26



Digital Multimeter

Model: 121-120
Price: £11.47

A highly featured digital multimeter for professional use. Offers 30 ranges and 8 functions including temperature, capacitance, diode, continuity and hFE measurement. Large 3.5 digit LCD display with automatic polarity indicator. Supplied with shrouded test leads, K type temperature probe and shock proof rubber holster.



Technical Specifications

DC voltage 200mV - 1000V (±0.5%)
AC volts 2V - 700V (±0.8%)
DC current 2mA - 20A (±1.2%)
AC current 200mA - 20A (±1.8%)
Resistance 200 Ohms - 20M Ohms (±0.8%)
Capacitance 2000pF - 20 F (±2.5%)
Temperature 0 C - 1000 C (±1.5%)
Frequency 20kHz (±1%)
Max display 1999
Power supply 9V (PP3 battery)
Dimens ons 88 x 173 x 40 mm

CCTV - Complete Systems

We carry the full range of Micromark Black & White and Colour CCTV systems for the home or office.

These complete easy install systems are supplied complete with power supply, cables and all fixings. Simple plug-in connections, for use with any TV or Video with a scart socket.



Black & White Systems from £22.97

CCTV - Black & White Module

A miniature CMOS camera module with a 3.6mm F2 Lens, video output & power v.a connectors provided.

Specs (660-800)
Power: 1.2Vdc 50mA
Video System: CCIR
Pixels: 352 x 288
Min Illumination: 0.5Lux
Video Output: 1 Vpp, 75Ω
Dims: 35 x 35 x 28mm 20g **£17.93**



PCB Production - Processing Equipment

We carry a large range of the photographic & chemical processing equipment for PCB production, a full list with full technical specifications is available in our catalogue or visit our web site.

UV Exposure units
2 x 8W Tubes, 6 min timer
229 x 159mm working area
Model 332-002 £88.78
4 x 15W Tubes, 7 1/2 min timer
330 x 260mm working area
Model 332 004 £194.51



Chemical Processing

Low cost plastic tray £1.80
Process tanks feature electrically operated pumps and/or heaters with thermostat control, suitable for boards upto 320 x 260mm.

Universal Tank with heater
Model 333-007 £161.60
Bubble etch Tank with heater & bubble pump.
Model 333-004 £198.50

PCB Production - Tools

Drill Bits
HSS parallel shank bits available in sizes from 0.3mm to 2.0mm

0.3-0.95mm in 0.05mm steps £0.60ea £4.00/10
1.0-2.0mm in 0.1mm steps £0.40ea £3.60/10

HSS Reduced shank (2.35mm) bit available in sizes from 0.6mm to 1.7mm in 0.1mm steps £0.84ea £7.60/10

Reground Tungsten carbide reduced shank (3.2mm) available in sizes from 0.6 to 1.6mm in 0.1mm steps £1.90

Drilling Machines
Expo rehand 12V drill, 3.8mm capacity, 8400rpm £12.78

Minicraft MX1 230V, 8000 - 21000rpm with chuck & collet.
Model EPE270-390
Normal price £48.51



**** SPECIAL OFFER PRICE £31.02 ****

Servisol Products

Aerosols

200ml Switch Cleaner £1.96
200ml Freezer £3.97
400ml Foam Cleanser £2.13
400ml Cleaner / lubricant £2.79
75ml Vide Head Cleaner £1.94
200ml Aero Klene £2.85
200ml Aero Duster £4.66
250ml Cold Clean £3.14
200ml Label remover £3.52
400ml Isopropyl alcohol £3.36

Tubes

25g Heatsink Compound £2.60
50g Silicone grease £2.50



NEW CATALOGUE OUT NOW

available from www.esr.co.uk

Educational Kits

These kits are an ideal way to start your interest in electronics. They feature re-usable components which are attached via springs & wires and easy step by step guides to make a range of exciting projects. The 300+ features a breadboard for more complex circuits.



Panel Meters

High quality analogue panel meters, class 2 zero point correction, mirror scale and prewired for panel illumination. Meter size 46 x 60mm, Cutout size: 38mmØ.

Range	Int Ω	All meters £5.89 each
0-50 A	6k5	6V Lamps £1.23 /pair
0-100 A	1k0	
0-500 A	430Ω	
0-1mA	200Ω	
0-10mA	2k6	
0-50mA	1Ω2	
0-100mA	0Ω65	
0-500mA	0Ω12	
0-1A	60mΩ	
0-3A	20mΩ	
0-5A	12mΩ	
0-15A	4mΩ	
0-10V	10k	
0-15V	15k	
0-30V	30k	
±50 A	1k9	



CCTV - Colour Module

A miniature colour CMOS camera module with a 3.6mm F2 Lens, video output & power v.a connectors provided.

Specs (660-842)
Power: 1.2Vdc 150mA
Video System: PAL
Pixels: 628 x 582
Min Illumination: 3Lux
Video Output: 1 Vpp, 75Ω
Dims: 28 x 28 x 28mm 20g **£36.33**



PCB Production - Laminates

Copper clad - paper
Single sided low cost paper composite board

100 x 160mm Board £0.44
100 x 220mm Board £0.62
160 x 233mm Board £1.02
220 x 233mm Board £1.40
8" x 12" Board £1.70

Copper clad - glass fibre
Single & Double 1.6mm 305g/m²

100 x 160mm Single £0.85
100 x 220mm Single £1.25
160 x 233mm Single £2.29
220 x 233mm Single £2.88
8" x 12" Single £3.44
100 x 160mm Double £0.88
100 x 220mm Double £1.25
160 x 233mm Double £2.30
220 x 233mm Double £2.90
8" x 12" Double £3.50



Photoresist Coated

1.6mm 35 micron Pre-coated with a high quality photoresist layer. Available in low cost paper composite or Glass fibre, Single & Double sided. Other sizes also available.

Size	Paper		Glass Fibre	
	Single	Double	Single	Double
4 x 6"	£1.47	£1.82	£1.89	£2.17
6 x 12"	£4.20	£5.04	£5.60	£6.23
9 x 12"	£6.30	£7.70	£8.40	£9.38
10 x 12"	£8.19	£10.01	£10.78	£11.83
12 x 12"	£8.26	£10.08	£10.99	£12.25
100 x 160mm			£2.38	£2.66
203 x 114mm			£3.01	£3.43
220 x 100mm			£3.08	£3.71
233 x 160mm			£4.83	£5.32
233 x 220mm			£6.83	£7.70

PCB Production - Chemicals

100ml Aerosol Photoresist spray, covers 2m² £4.25
50g Powder developer, makes 1lt £1.09
500g Powder developer, makes 10lt £7.08
250g Ferric Chloride Pellets, makes 500ml £1.68
500g Ferric Chloride Pellets, makes 1lt £3.04
2.5kg Ferric Chloride Pellets, makes 5lt £17.84
1kg Clear Fine etch crystals, makes 5lt £17.58
90g Tin Plating Powder, makes 1lt £11.58
200ml Aerosol Flux spray, makes 1lt £3.41
110ml Aerosol PCB Laquer spray £3.63

Magnifying Desk Lamp

A high quality scratch resistant magnifying glass fitted to a balanced swivel arm and desk mount. An integral fluorescent tube provides illumination

Magnification: 3x Lens: 120mmØ
Tube: 22W Daylight simulation.



Model: 028-205 £28.80

Tools - Cutters & Strippers

We carry a wide range of specialist tools for the electronics industry including:

Side Cutters

130mm Low cost £1.99
115mm Draper £2.38
115mm Box Jointed £4.26
145mm Long reach £3.40

Wire Strippers

130mm Low cost £2.30
150mm Draper 5mmØ £5.86



Tools - Ratchet Crimping Pliers

High quality ratchet crimping pliers for various terminals including Automotive, Data, Power and Data connections.

Red / Blue / Yellow £15.80
BNC / TNC RF Series £15.19
RJ11/12 Data Series £22.32
RJ45 Data Series £20.43
RJ11/12 & 45 Series £12.64

CK® Tools Crimp Pliers

Green/Red/Blue £24.38
Red/Blue/Yellow £21.83
0.24-2.5mm crimps £24.35
0.5-6.0mm crimps £24.77
Non insulated crimps £24.38



Cable - Ribbon

7/0.127mm Grey ribbon cable on a 0.05" 1.27mm pitch with a red identifying stripe. Supplied by 305mm (1ft) or on full 30.5m (100ft) reels.

Size	per 305mm	per Reel
10 Way	£0.10	£2.26
14 Way	£0.14	£2.50
16 Way	£0.16	£8.58
20 Way	£0.20	£10.72
26 Way	£0.26	£13.94
34 Way	£0.34	£18.22
40 Way	£0.40	£21.44
50 Way	£0.50	£26.80
60 Way	£0.64	£33.92
IDC Crimp tool		£11.80



CAT5e Networking

11TP Cable
305m Box conforms to CAT5e 100MHz standard, ETA verified TIA/EIA 568-B.2

Only £23.99 per box exc carriage.

RJ45 Outlet Kit
Backing Box
2 Gang Plate
RJ45 Module
Blank Module
Colour coded id inserts.

special price £3.14



Tools
Plastic punch down tool £1.42
& cable stripper £1.42
Professional punch down IDC & trim tool £7.38



NOW IN Stock

Patch & Cross-over leads from £0.50, Full range of outlet modules/keystone outlets, switches & accessories.

Tel: 0191 2514363 Fax: 0191 2522296 Email: sales@esr.co.uk <http://www.esr.co.uk>

EVERYDAY PRACTICAL ELECTRONICS

THE No.1 MAGAZINE FOR ELECTRONICS TECHNOLOGY & COMPUTER PROJECTS

VOL. 34 No. 1 JANUARY 2005

Pulse

Recent correspondence in our sister magazine *Radio Bygones* has triggered off some thoughts regarding the present susceptibility of all forms of semiconductor electronics to electromagnetic pulses. As most readers will no doubt be aware semiconductors can be damaged by a large electromagnetic pulse that could be generated by a nuclear bomb. Old valve equipment was not susceptible to this which may have been the reason that some countries retained valve communications equipment in their armed forces long after it had been superseded by solid-state sets.

Just think of the impact on modern life if a major city was exposed to a massive electromagnetic pulse – virtually everything we use relies on semiconductor technology to operate, from phones, watches and cars to computers, aeroplanes and missiles.

Avoidance

Whilst we have been aware of this potential vulnerability – which could obviously cripple government and financial operations of virtually the whole country – for many years now we are not aware that much, if anything, has been done to counter this major threat. I guess that particularly with any form of communications equipment, that protection is no easy matter. Presumably with some products the whole thing could be enclosed in a metal box which might protect it, but it would not be easy to provide full protection of every system etc.

So what has been done or what is being proposed? It would be interesting to hear from anyone who has knowledge of this subject – presuming it is not covered by the Official Secrets Act of course.

Detonation of a high level nuclear device could destroy sensitive equipment over an area of up to 1000 miles in diameter, which would obviously increase the problems resulting from the actual blast and that of defending any further attacks. But what if an electromagnetic pulse could be generated without a nuclear explosion then the potential for crippling a country without massive loss of life would be a possibility. In these troubled times it does need to be considered, and hopefully someone, somewhere is protecting our defence electronics and communications systems from just such a possibility.

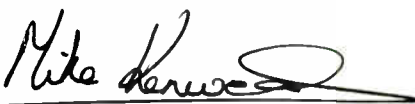

AVAILABILITY

Copies of *EPE* are available on subscription anywhere in the world (see opposite), from all UK newsagents (distributed by COMAG) and from the following electronic component retailers: Omni Electronics and Yebo Electronics (S. Africa). *EPE* can also be purchased from retail magazine outlets around the world. An Internet on-line version can be purchased and downloaded for just \$10.99US (approx £7) per year available from www.epemag.com

SUBSCRIPTIONS

Subscriptions for delivery direct to any address in the UK: 6 months £16.50, 12 months £31, two years £57; Overseas: 6 months £19.50 standard air service or £28.50 express airmail, 12 months £37 standard air service or £55 express airmail, 24 months £69 standard air service or £105 express airmail. To subscribe from the USA or Canada see the last magazine page. Online subscriptions, for downloading the magazine via the Internet, \$10.99US (approx £7) for one year available from www.epemag.com. Cheques or bank drafts (in £ sterling only) payable to *Everyday Practical Electronics* and sent to EPE Subs. Dept., Wimborne Publishing Ltd, 408 Wimborne Road East, Ferndown, Dorset BH22 9ND. Tel: 01202 873872. Fax: 01202 874562. Email: subs@epemag.wimborne.co.uk. Also via the Web at: <http://www.epemag.wimborne.co.uk>. Subscriptions start with the next available issue. We accept MasterCard, Amex, Diners Club, Maestro or Visa. (For past issues see the *Back Issues* page.)

BINDERS

Binders to hold one volume (12 issues) are available from the above address. These are finished in blue p.v.c., printed with the magazine logo in gold on the spine. Price £6.95 plus £3.50 p&p (for overseas readers the postage is £6.00 to everywhere except Australia and Papua New Guinea which cost £10.50). Normally sent within seven days but please allow 28 days for delivery – more for overseas.

Payment in £ sterling only please. Visa, Amex, Diners Club, Maestro and MasterCard accepted. Send, fax or phone your card number, card expiry date and card security code (the last 3 digits on or just under the signature strip), with your name, address etc. Or order on our secure server via our UK web site. Overseas customers – your credit card will be charged by the card provider in your local currency at the existing exchange rate.

Editorial Offices:

EVERYDAY PRACTICAL ELECTRONICS EDITORIAL
WIMBORNE PUBLISHING LTD., 408 WIMBORNE ROAD EAST,
FERNDOWN, DORSET BH22 9ND
Phone: (01202) 873872. Fax: (01202) 874562.

Email: enquiries@epemag.wimborne.co.uk

Web Site: www.epemag.wimborne.co.uk

EPE Online (downloadable version of *EPE*): www.epemag.com

EPE Online Shop: www.epemag.wimborne.co.uk/shopdoor.htm

See notes on *Readers' Technical Enquiries* below – we regret lengthy technical enquiries cannot be answered over the telephone.

Advertisement Offices:

EVERYDAY PRACTICAL ELECTRONICS ADVERTISEMENTS
MILL LODGE, MILL LANE,
THORPE-LE-SOKEN, ESSEX CO16 0ED
Phone/Fax: (01255) 861161 Email: epeads@aol.com

Editor: MIKE KENWARD

Deputy Editor: DAVID BARRINGTON

Technical Editor: JOHN BECKER

Business Manager: DAVID J. LEAVER

Subscriptions: MARILYN GOLDBERG

Administration: FAY KENWARD

Editorial/Admin: (01202) 873872

Advertisement Manager:

PETER J. MEW, (01255) 861161

On-Line Editor: ALAN WINSTANLEY

EPE Online (Internet version) Editors:

CLIVE (MAX) MAXFIELD and ALVIN BROWN

READERS' TECHNICAL ENQUIRIES

E-mail: techdept@epemag.wimborne.co.uk
We are unable to offer any advice on the use, purchase, repair or modification of commercial equipment or the incorporation or modification of designs published in the magazine. We regret that we cannot provide data or answer queries on articles or projects that are more than five years old. Letters requiring a personal reply *must* be accompanied by a stamped self-addressed envelope or a self-addressed envelope and international reply coupons.

PROJECTS AND CIRCUITS

All reasonable precautions are taken to ensure that the advice and data given to readers is reliable. We cannot, however, guarantee it and we cannot accept legal responsibility for it.

A number of projects and circuits published in *EPE* employ voltages than can be lethal. You should not build, test, modify or renovate any item of mains powered equipment unless you fully understand the safety aspects involved and you use an RCD adaptor.

COMPONENT SUPPLIES

We do not supply electronic components or kits for building the projects featured, these can be supplied by advertisers (see *Shoptalk*). We advise readers to check that all parts are still available before commencing any project in a back-dated issue.

ADVERTISEMENTS

Although the proprietors and staff of EVERYDAY PRACTICAL ELECTRONICS take reasonable precautions to protect the interests of readers by ensuring as far as practicable that advertisements are *bona fide*, the magazine and its Publishers cannot give any undertakings in respect of statements or claims made by advertisers, whether these advertisements are printed as part of the magazine, or in inserts.

The Publishers regret that under no circumstances will the magazine accept liability for non-receipt of goods ordered, or for late delivery, or for faults in manufacture.

TRANSMITTERS/BUGS/TELEPHONE EQUIPMENT

We advise readers that certain items of radio transmitting and telephone equipment which may be advertised in our pages cannot be legally used in the UK. Readers should check the law before buying any transmitting or telephone equipment as a fine, confiscation of equipment and/or imprisonment can result from illegal use or ownership. The laws vary from country to country; readers should check local laws.



Speed Camera Watch

by Mike Hibbett

Be forewarned about known hazards while you're driving

HOW often have you found yourself surprised by the presence of a speed camera while driving, your attention distracted while you double-check your speed? Or come across a sharp bend in the road and had to break sharply? Too often in the author's case, many times at the same spot. Wouldn't it be great if you could have a simple device that would gently warn you of these oncoming "black spots"?

Although speed cameras are controversial they are (in the main) located where speed control is important, so having a device that can remind you to take extra care has its merits.

The purpose of this project is to produce a device that can advise you of places that require attention to speed, not to help you avoid prosecution for speeding!

GPS Location Monitoring

This design monitors its own precise location using an embedded GPS (Global Positioning System) receiver, and alerts you to oncoming pre-recorded blackspots. As you drive past a speed camera or blackspot to which you want to be alerted on a future occasion, you press a Record switch on the unit. This stores the current location into the device's memory, a non-volatile EEPROM (electrically erasable read only memory).

The EEPROM can store up to 1000 locations, and once every second the

PIC16F873 microcontroller scans all of the stored locations, comparing them to the current position. When it has found the closest blackspot it displays your distance from it on an l.e.d. bargraph. When you get very close, a low level beep is emitted. A second button is used to cancel the beep, and it also functions as a delete key to remove unwanted locations from the EEPROM.

This all sounds like a nice and straight forward design but it conceals some complex maths, an interesting limitation of computers in general and some devious mathematical simplifications. Normal fare for an embedded micro project!

How It Works

At the heart of the device is a small embedded GPS receiver. These tiny units can now be purchased relatively cheaply – cheap when you consider what they are doing; picking up transmissions from multiple satellites above our heads, and pinpointing your position to a few feet. Of the several units available this one was chosen as it was small, cheap, available in "one off" quantities and has a built in antenna.

All you need to do is apply a 5V supply and you get NMEA data output in both RS232 and TTL levels. NMEA stands for National Marine Electronics Association, the body which defines the minimum protocol standards to which GPS receivers should adhere.

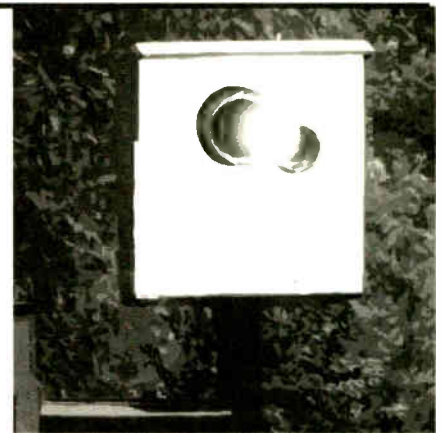

Data from the GPS module is output as a series of NMEA messages emitted (by default) once a second at 4800 baud. John Becker wrote an excellent article encompassing NMEA in the January '04 edition, *GPS to PIC and PC Interfacing*. For this Camera Watch project we get all the information we need in the NMEA GPGGA message. The format of this message is:

```
$GPGGA,hhmmss.ddd,xxmm.dddd,
<NIS>,yyyymm.dddd,<EIW>,v,ss,d,
d,h,h,M,g,M,a,a,xxxx*hh<CR><LF>
```

The fields we are interested in are:

```
xxmm.dddd latitude
<NIS> character for North or South
yyyymm.dddd longitude
<EIW> character for East or West
v "Valid" flag; set to character "1"
when data is valid
```

As each character from the GPGGA message is received the PIC builds up a signed binary representation of the latitude and longitude positions. Once the complete message has been received, the PIC has one second to scan through all the stored data points and do all its calculations before it has to start all over again.

For each stored location, the PIC reads the location from the EEPROM and first does a very rough calculation to see if the position is reasonably nearby (about 10 miles). If it is not, it is discarded and the next location is read. For each location that is nearby, the exact position is calculated. Once all locations have been scanned and the closest position found, the bargraph l.e.d.s are updated to reflect the distance.

The author settled on the following values, reading the bargraph from left to right:

D1 (green)	any location within approximately 3km
D2 (green)	< 1km
D3 (green)	< 500m
D4 (green)	< 400m
D5 (amber)	< 300m
D6 (amber)	< 200m
D7 (red)	< 100m

An acoustic sounder gives a low level beep once l.e.d. D6 is illuminated.



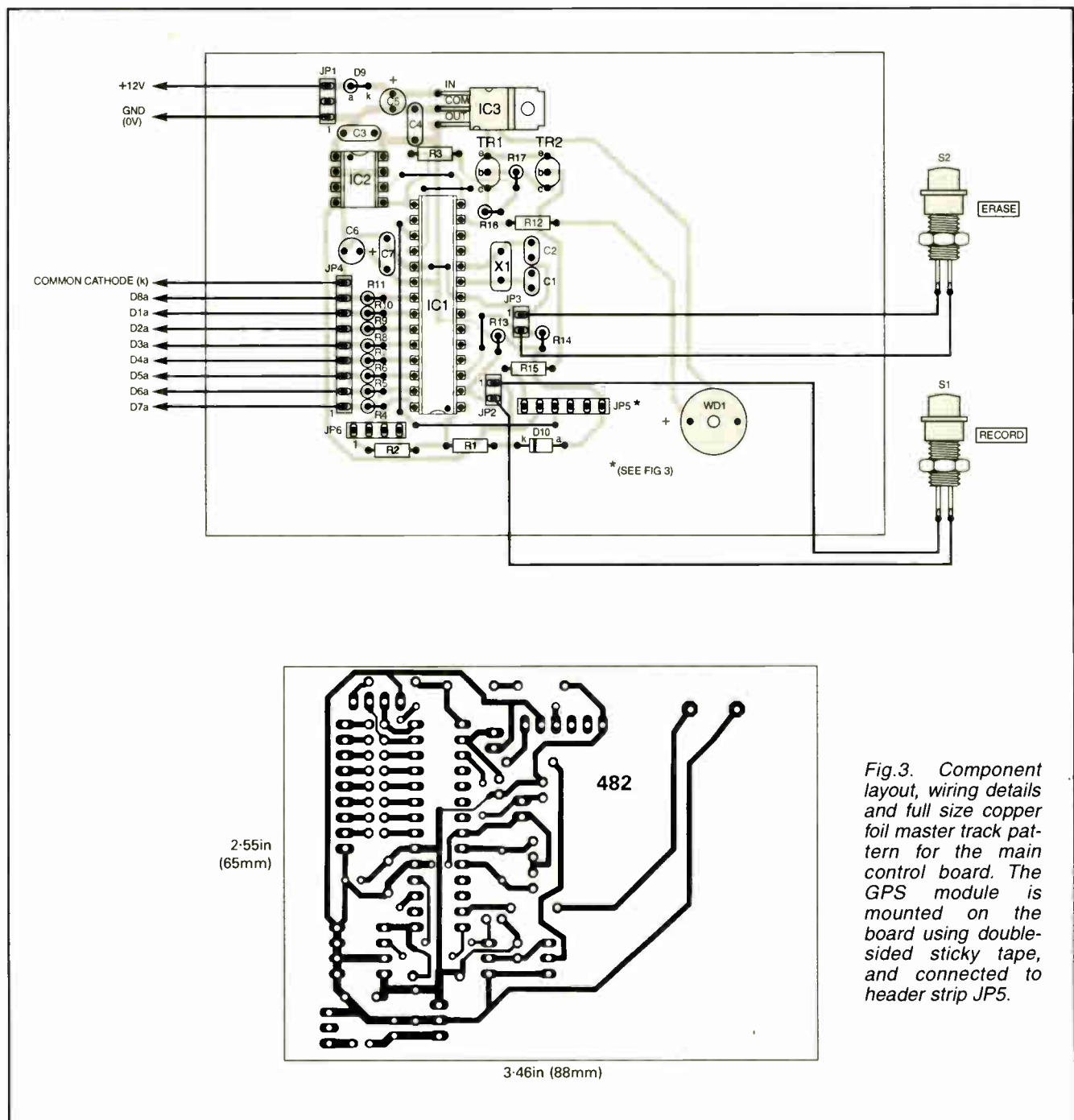

Fig. 3. Component layout, wiring details and full size copper foil master track pattern for the main control board. The GPS module is mounted on the board using double-sided sticky tape, and connected to header strip JP5.

COMPONENTS

Main Unit Resistors

R1	1k
R2	100Ω
R3, R18	3k3 (2 off)
R4 to R11	470Ω (8 off)
R12	270Ω
R13 to R17	4k7 (5 off)

All 0.25W 5% or better.

Capacitors

C1, C2	22p ceramic disc, 5mm pitch (2 off)
C3, C4, C7	100n, ceramic disc, 5mm pitch (3 off)
C5, C6	10μ radial elect, 16V

See
**SHOP
TALK
page**

Semiconductors

D1 to D4, D8	green l.e.d., 3mm (5 off)
D5, D6	amber l.e.d., 3mm (2 off)
D7	red l.e.d., 3mm
D9	1N4001 rectifier diode
D10	1N4148 signal diode
IC1	PIC16F873-20 microcontroller, pre-programmed (see text)
IC2	24LC64 8K x 8 serial EEPROM
IC3	7805 +5V 1A voltage regulator
TR1, TR2	BC548 npn transistor (2 off)

Miscellaneous

S1, S2	min. momentary push-to-make switch
X1	20MHz crystal
X2	Holux GM21 GPS module, 5V
WD1	piezo buzzer, active

Printed circuit board, available from the *EPE PCB Service*, code 482; plastic case 32mm x 114mm x 76mm (see text); 28-pin d.i.l. socket; 8-pin d.i.l. socket; 1mm pin header strip, cut to required lengths; p.c.b. supports (4 off); connecting wire; solder, etc.

Approx. Cost
Guidance Only

£75

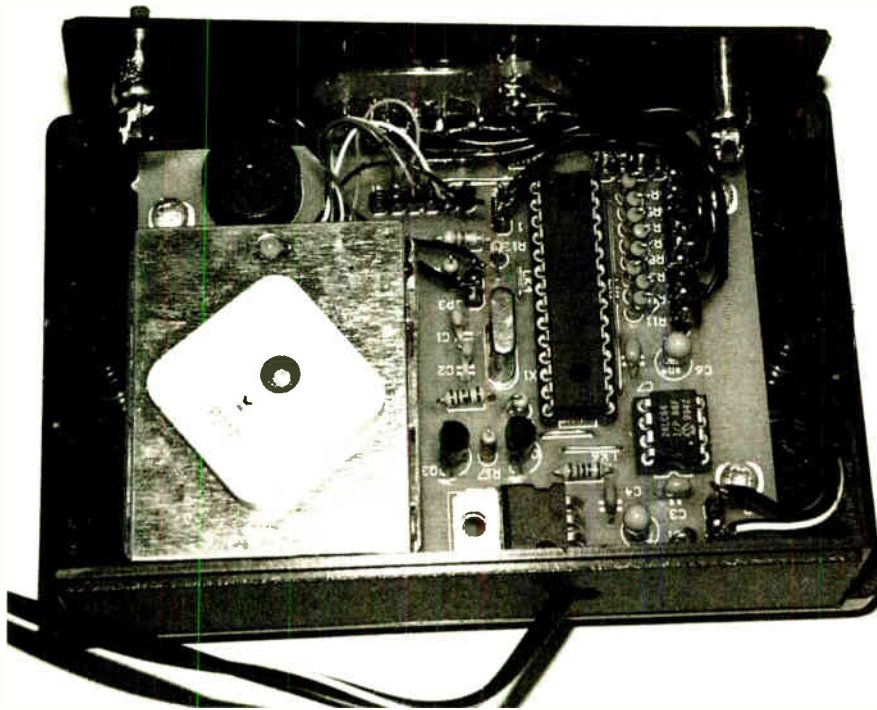

I.e.d. between pins 8 and 9 of JP4 (anode to pin 8.) Apply power again. If all is well, the I.e.d. should flash on and off at a rate of once a second. Remove the I.e.d.

Enclosure

In the prototype a plastic case measuring 114mm x 76mm x 32mm was used (see photographs). This has four sections, top, base, plus front and back panels. Drill holes in the front panel for the I.e.d.s and switches (see photographs).

Fit the I.e.d.s onto the panel, positioning them with the anodes (a – the long leg) towards the top of the panel. From the back of the panel glue the I.e.d.s in place, preferably using a hotmelt glue gun. Trim the legs back to about 1cm length, and solder all the cathodes (k) together.

As supplied, the GPS module is fitted with a serial cable that would normally plug into the COM port of a PC, and this needs to be removed. Cut the cable off about 5cm from the module, leaving enough wire to solder onto p.c.b. pin header JP5. Strip the individual wires back by about 3mm and tin them.

Attach the GPS module to the p.c.b. using double-sided foam sticky tape, then solder the module wires onto JP5 (see Fig.3).

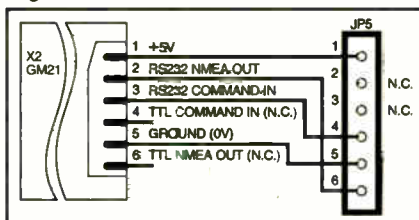

Fig.3. Pin connections for the GPS module

Mount the p.c.b. in the case, and fit the front panel. Then solder the I.e.d.s to the p.c.b. (see Fig 2) and wire up switches S1 and S2.

Power is supplied from the car's cigar lighter socket. You can purchase suitable plugs with integral fuses but if you are using one without a fuse the author

recommends fitting an in-line 1-25A slow blow fuse. Cigar lighter sockets are normally capable of supplying 10A continuously, which is sufficient to melt the p.c.b. tracks if you have a p.c.b. short-circuit somewhere!

To connect the power cable drill a hole in the rear panel close to the p.c.b.'s power connector, JP1, and thread the cable through. Use a locking grommet or cable tie to prevent the cable pulling out (knots in cables are frowned upon!).

The circuit is protected from reverse polarity by diode D9 but care should be made that the connections to JP1 do not short out. A blob of hotmelt glue over the power connection is recommended.

In Use

Place the CameraWatch on your dashboard where it can get as much view of the sky as possible, without affecting your driving vision. Plug it into the cigar lighter socket and away you go!

When the device is switched on the power-on I.e.d. will flash until the GPS receiver has a valid signal. This can take up

to one minute depending on the number of satellites in view and when the device was last powered up. Sometimes the GPS receiver will lose lock (typically because one or more satellites have been blocked by buildings or trees). When this happens the power I.e.d. (D8) will start to flash again until the signal is re-acquired.

Once I.e.d. D8 stops flashing you can start recording positions. Pressing the Record switch (S1) at any time will commit the current location to memory.

When you are within range of a selected site (see earlier) the piezo sounder will alert you to this fact. The sounder can be silenced by pressing the Erase switch (S2). Pressing S2 again when the alert is silent will delete the current location from memory.

A two-second switch debounce has been implemented to ensure that multiple location deletions or additions do not accidentally occur. A short beep is emitted when the switch press has been accepted.

Some vehicles provide continuous power to the cigar socket even when the engine is turned off. If this is the case in your car, disconnect the device when the engine is off to save draining the battery.

PC Interfacing

Built into the software is the facility to download a list of known locations into the unit's EEPROM prior to use. Some web sites, such as Pocket GPS World, provide this information free of charge. A link to their website is at the end of this article.

A simple interface circuit is temporarily needed between the unit and the PC for this download. The circuit diagram is shown in Fig.4.

It consists of an RS232 interface chip (IC4) whose purpose it is to tailor the signal levels from the PC's serial port to suit the PIC. A suggested stripboard assembly layout is shown in Fig.5.

Downloading Data

To obtain the Pocket GPS World data, first download the zipped file from their website and extract file `pocketgps_uk_gatso.csv`. This file lists over 3000 speed cameras, so you will need to delete lines from the file to bring it down to a more sensible number. The author used Excel to sort the file and deleted lines that were not near to home. Keep the list down to no more than 900, to allow space for

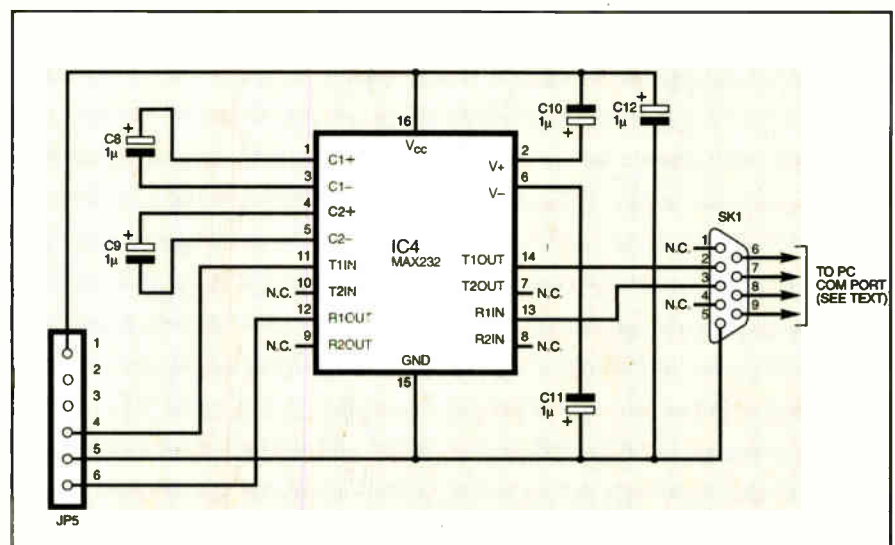
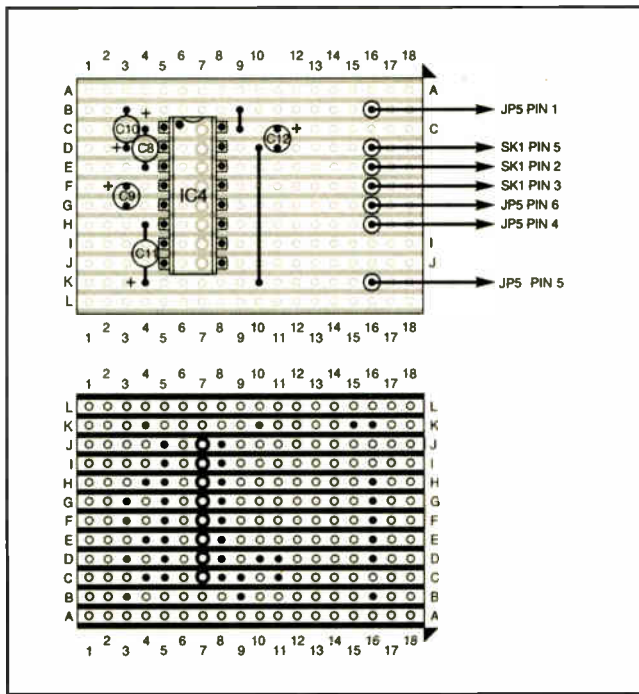

Fig.4. Circuit diagram for the optional PC interface.



COMPONENTS

RS232 Interface (optional)

Capacitors
C8 to C12 1µ radial elect, 16V (5 off)

Semiconductors
IC4 MAX232 RS232 interface

Miscellaneous
SK1 9-pin D-connector, female, to suit PC serial cable

Stripboard, size 12 strips × 18 holes; 16-pin d.i.l. socket; 1mm pin header strip, cut to required lengths; connecting wire; solder, etc.

See
SHOP
TALK
page

Approx. Cost
Guidance Only£6.50

Fig.5 (above left). Suggested stripboard layout for the optional PC interface circuit

adding extra points. The database is not 100% accurate so do not rely on it too much!

Once you have created your list, install the **cwloc.exe** program by copying the **cwloc.zip** file from the *EPE* website and extracting it to a folder on your PC. Run the program by clicking on the **cwloc.exe** file.

Type in the filename, including the full directory path, and click on "Load File". Click on the serial port you want to use.

Now plug the download cable into the PC's serial port, and the other end into the serial connector SK1 of the interface circuit. Connect the interface's JP5 header to the JP5 header on the main p.c.b. (disconnecting the GPS receiver first, of course).

Connect power to the main unit and wait for i.e.d. D8 to start flashing. Click on "Download", and wait for the transfer to complete. This can take several minutes. When the download has completed, disconnect power and the interface, and plug the GPS receiver back in.

Back to School

To fully understand how the software works, a refresher on mathematics would be required! However, we can skip over the complex stuff but leave in the interesting details so you can see how and why certain decisions have been made.

Latitude and longitude values define a point on the surface of the Earth, and the Earth is (more or less) round. These values are relative to the equator and the prime meridian; the equator is the line that runs round the Earth half way between the north and south poles, and the prime meridian is the line that runs from the north pole to the south pole through Greenwich, London.

Latitude is the angle relative to the equator (north is positive, south negative) and longitude is the angle from the prime meridian (east is positive, west is negative).

Let's say we have two points on the Earth (see Fig.6). Call them M (for my position) and C (for the camera position). Imagine a line drawn between the centre of the Earth (call it point O) to point M, and another line drawn between the centre of the Earth and point C. The distance we are interested in is the length of the arc

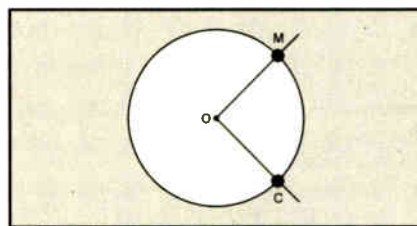

Fig.6. Distance arc between two points on the Earth's surface

between C and M. The distances O to C and O to M are the radius of the Earth.

The equation for calculating the distance CM is:

$$\text{distance} = (\text{radius} \times \text{angle} \times \pi \times 2) / 360$$

where π is taken as the constant 3.141, and "angle" is the angle between lines OC and OM, in degrees.

It may look simple, but there are two problems. The first one is, *what is the angle?* The equation for that is *not* simple!

The explanation of the maths is beyond the scope of this article but can be found on the Dr Math website (see reference at the end). So let's go to the final answer for the distance between two points on the Earth:

$$\text{distance} = \text{radius} \times \arccos(\sin(\text{latM}) \times \sin(\text{latC}) + \cos(\text{latM}) \times \cos(\text{latC}) \times \cos(\text{longM} - \text{longC}))$$

That's a lot of trigonometric maths to do on a poor PIC!

Even armed with the proper equation we are faced with problem number two: Although the equation is mathematically correct it is computationally useless!

The trigonometric functions operating on the differences of small angles yield very small numbers, and computers do not have enough precision to handle them. Even a Pentium PC gives inaccurate figures.

There are clever alternative equations, such as the Haversine algorithm, but these still require a large number of computations. So what do we do?

If you look outside your window, chances are you may notice something. The Earth is flat! The radius of the Earth is large enough that over short distances (say, less than 10 miles) a "flat Earth" approximation works

quite well. So how does that help?

If we assume that the latitude and longitude values correspond to *x* and *y* coordinates on a flat surface (see Fig.7) we get considerably simpler maths. The distance is now calculated as:

$$\text{distance} = \text{square-root}(((\text{LatM} - \text{LatC}) \times (\text{LatM} - \text{LatC})) + (\cos(\text{LatC}) \times (\text{longM} - \text{longC}) \times \cos(\text{LatC}) \times (\text{longM} - \text{longC})))$$

We can ignore the square-root term by taking this into account when we illuminate the bargraph i.e.d.s.

Although the above equation still looks complicated we can jiggle with the numbers to reduce the problem to three multiplications, two additions, two subtractions and a cosine lookup.

But we have to do this for each point of interest, so that is at up to 1000 times per second! Our multiplications have to be very quick, and this is where the way the numbers are stored becomes important.

The question now is what kind of multiplication routines to use. There are three main choices; integer, floating point or fixed point.

Although integer maths routines are the quickest, it is difficult to maintain the accuracy we require while using sensible sized variables. Floating point routines tend to be very slow. Fixed point routines are a fair compromise between variable size, accuracy and speed.

Fixed point numbers, as the name suggests,

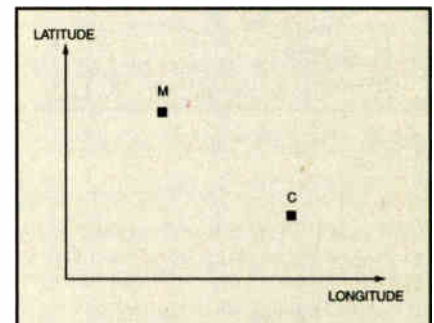

Fig.7. Points M and C plotted relative to a "flat" Earth

use a fixed number of bits to represent the integer and fractional parts of the number. The integer part is the "whole" number to the left of the decimal point; the fractional part is the bit on the right. The author has chosen to represent all numbers used in the distance calculation as 24-bit (3-byte) numbers; 8-bit for the whole (integer) part, and 16-bit for the fractional part.

The choice of variable size is important since it is a trade-off between processing time and accuracy. We store latitude and longitude values to an accuracy of 1/100 of a minute of arc; this gives us enough accuracy (a distance of about 20 miles), while allowing up to 1000 points to be stored and scanned each second.

Going Further

Several improvements could be made to the Camera Watch by readers who have suitable facilities and abilities, in some cases requiring a little hardware modification. Program-wise, there is a very small amount of code space left in the PIC but this can be enlarged by removing the RS232 debugging code. There is plenty of RAM available since only Bank 0 is used.

As the GPS module also outputs the current speed, it would be straight forward to add a feature where the device sounds a warning beep when a user-selected speed is exceeded; pushbutton switches could be added for selecting 30, 40, 50 and 70 m.p.h., for example. Additionally, if an alphanumeric I.c.d. module were added it



would be possible to display position and altitude information. These modifications and their implementation, though, are beyond the scope of this article and no further information is offered!

References

Floating Point Maths for PICs,
Malcolm Wiles, *EPE* Nov '04
Microchip AN617 - fixed point maths

routines. ww1.microchip.com/downloads/en/AppNotes/00617.pdf

Dr Math - several explanations of the maths involved. www.mathforum.com/library/drmath/view/51711.html

Holux - supplier of the GPS module. www.holux-uk.com/Embedded/index.htm

Pocket GPS World - database of speed camera locations. www.pocketgps.co.uk/uksafetycameras.php □



A COMPLETE RANGE OF INVERTERS 150W TO 2500W - 12V & 24V

A Complete range of regulated inverters to power 220V and 240V AC equipment via a car, lorry or boat battery. Due to their high performance (>90%) the inverters generate very little heat. The high stability of the output frequency (+/-1%) makes them equally suitable to power sensitive devices.



These inverters generate a modified sine wave, which are considerably superior to the square waves which are produced by most other inverters. Due to this superior feature they are capable of powering electrical equipment such as TV's, videos, desktop & notepad computers, microwave ovens, electrical lamps, pumps, battery chargers, etc.

Low Battery Alarm

The inverters give an audible warning signal when the battery voltage is lower than 10.5V (21V for the 24V version). The inverter automatically shuts off when the battery voltage drops below 10V (20V for the 24V version). Fuse protected input circuitry.

Order Code	Power	Voltage	Was	Price
651.581	150W Continuous	12V	£36.39	£29.72
651.578	150W Continuous	24V	£36.39	£29.72
651.582	300W Continuous	12V	£50.64	£41.93
651.580	300W Continuous	24V	£50.64	£41.93
651.583	600W Continuous	12V	£101.59	£83.76
651.581	600W Continuous	24V	£101.59	£83.76
651.587	1000W Continuous	12V	£177.18	£147.52
651.587	1000W Continuous	24V	£177.18	£147.52
651.602	1500W Continuous	12V	£314.52	£261.18
651.605	1500W Continuous	24V	£314.52	£261.18
651.589	2500W Continuous	12V	£490.54	£416.27
651.589	2500W Continuous	24V	£490.54	£416.27



All prices are inclusive of V.A.T. Carriage £8.00 Per Order

Many uses include:- . Fetes . Fairgrounds . Airshows . Picnics . Camping . Caravans . Boats . Carnivals . Field Research and . Amateur Radio field days * Powering Desktop & Notepad Computers.

DELIVERY CHARGES ARE £6.00 PER ORDER. OFFICIAL ORDERS FROM SCHOOLS, COLLEGES, GOVT. BODIES, PLC'S ETC. PRICES ARE INCLUSIVE OF V.A.T. SALES COUNTER. VISA AND ACCESS ACCEPTED BY POST, TELEPHONE OR FAX, OR EMAIL US AT SALES@BKELEC.COM ALTERNATIVELY SEND CHEQUE OR POSTAL ORDERS MADE PAYABLE TO BK ELECTRONICS.



B.K. ELECTRONICS



UNIT 1, COMET WAY, SOUTHEND-ON-SEA, ESSEX, SS2 6TR
TEL: +44(0)1702-527572 FAX: +44(0)1702-420243

For Full Specifications View our web site at:-

WWW.BKELEC.COM/INVERTERS.HTM

PATENTLY UNDESIRABLE?

A battle looms over whether or not software can be patented, as Barry Fox reports

IT is now crunch time for European patents, with a showdown between warring factions in Europe's hi-tech companies and the Open Source movement of the computer industry. The European Parliament wants to harmonize European patent law and remove ambiguity over what kind of computer invention can be patented, and what cannot.

The large IT, communications and consumer electronics companies— including Microsoft — are represented by the European Information and Communication Technology Association. "This Directive is extremely important for the future of innovation in Europe as it concerns two-thirds of all inventions in the European high-tech industry", says Mark MacGann, Director General of European Information, Communications and Consumer Electronics Industry (EICTA). "A complex legal issue has become emotional as a result of the sensationalised and inaccurate treatment by opponents to the legislation."

Open Source

"Open source" software, typified by Linux which grew out of Unix, is often referred to as "free". But this denotes freedom to play with the nuts and bolts source code, and improve it for the common good, not *free gratis*. Free software can still cost money to buy from whoever has packaged a saleable version.

The Open Source movement is diffuse, with no clear representation or costly PR machine like the EICTA. Web sites such as www.gnu.org, which is sponsored by the Free Software Foundation in Boston USA, are funded mainly by individual donations and voluntary work. The movement is united in its opposition to the idea of patenting software. This dates back to 1976 when Bill Gates and Microsoft wrote an open letter accusing them of stealing one of Microsoft's first programs.

"Rolling trains are hard to halt" says the Foundation for a Free Information Infrastructure (FFII), warning that "governments are blindly trusting their *patent experts* — those people who have screwed things at the European Patent Office" (EPO).

"The industry is united in its rejection of patenting of software", assures Mark MacGann, EICTA's Director General. "Those who depict the draft directive as some sort of *software patent law* are at best misinformed and at worst dishonest and

malicious. Patents for software have never existed and should never exist in Europe because software is already protected by copyright law."

Copyright protects only exact copying; patent protection is broader because it covers variations. Under current European law, which dates back to the European Patent Convention of 1973, computer programs, algorithms and business methods are not patentable. But computer-enabled devices and processes are.

The FFII, claims that the EPO has already granted more than 30,000 patents on rules and calculation disguised as "computer-implemented" inventions, and has posted a colourful "webshop" with examples of business schemes and computer process patents that the EPO has granted. Examples include video distribution through the web, allowing rebate codes to be entered, automated loan applications, use of TV as a metaphor and showing related results if a customer likes the current ones (<http://webshop.ffii.org>).

EU Commission Draft Drafts

In February 2002 the EU Commission drafted changes in the law but failed to draw a clear distinction between software-controlled inventions, and the software that does the controlling. This would effectively have made software patentable. In September 2003 the European Parliament amended the draft, with a wording that clearly said *no* to pure software patents.

The Open Source community generally liked the draft, but EICTA lambasted some of the clauses. Says EICTA spokesman Leo Baumann: "Article 9 was absurd; it was absolutely unclear and could have completely destroyed valuable patents". The offending Article 9 decreed that when the "use of a patented technique is needed for a significant purpose ... such use is not considered to be a patent infringement."

Hugh Dunlop, Partner of the London firm of Patent Attorneys, R.G.C. Jenkins & Co., and member of the Computer Technology Committee of the Chartered Institute of Patent Agents, brands the wording "daft: it would mean patents could only be enforced for trivial purposes. Parliament surely didn't intend such an absurdity?"

EICTA also warns that the Parliament draft could — by another accident of wording — have wiped out two-thirds of all high tech

patents. The draft said that a computer invention could only be patented if it "constitutes a new teaching on cause-effect relations in the use of controllable forces of nature." This, says Baumann, could invalidate all data processing patents, and all digital technology such as image and voice recognition.

The European Council of Ministers tried to revise the draft in May 2004. Now the wording is going back to Parliament for a second reading. If the Council and Parliament are both happy, the draft becomes a Directive and sweeps through Europe as a new law.

Opposing Sides

EICTA likes the Council's new draft; the FFII most definitely does not. "It permits unlimited patentability and patent enforceability", says the FFII, "the European Commission proposes to legalize the granting of patents on computer programs".

EICTA has countered with its own website (www.patents4innovation.org) and warns that "failure to adopt the text agreed by the Council of Ministers would jeopardize the work and livelihood of several hundred thousand researchers and inventors, and invalidate the bulk of Europe's high tech patent portfolio".

SYNCING AUDIO-VISUALLY

GOING digital may mean clearer TV pictures, but it can also make viewing an uncomfortable experience. A digital TV set, plasma or l.c.d. panel, or wireless networked screen, so heavily processes the video in a daisy chain of decoders and enhancers that the pictures are delayed behind the audio. The viewer then hears speech before the lips move, something which is never experienced in nature where sound always lags behind vision. Humans notice a delay of 30 milliseconds; modern TV delays can be 80ms or more.

German company Micronas of Freiburg has an easy answer. A \$5 chip set with onboard memory delays the audio by 40ms or 80ms. Stringing two chips together doubles the delay. Manufacturers can either bury the device inside a TV and preset the delay, or give users external control to match the different delays seen when signals are received over the air or come from a DVD.

Barry Fox

SPECIALITY TIME WATCHING

The TechNote Time Watch Company of Florida designs, produces, and markets specialty Ohm's law wristwatches and clocks geared towards tradesmen in the electrical and electronics fields. The company's initial product line consists of wall and desk clocks and analogue wrist watches which incorporate Ohm's law formulae for a.c. or d.c. power, and a resistor colour code chart.

Anne Dorsey, Sales and Marketing Manager for TechNote Time, states that, "We have knowledge-based products which can simplify many engineer's daily job demands. Our company's "Magic Wheel" technical watches can save tradesmen valuable time in the field and time saved is money". She goes on to say that, "These watches are also a very handy study tool for any student preparing for professional examinations".

TechNote Time Watch Company is a privately held start-up technical watch producer and technical watch distribution company. Its strategy is to serve the technical niche market of producing watches specifically for the electronics



"Obviously, that poor guy has never heard of TechNote Time's watches! Never fumble for a formula again!"

and electrical professions. Their product line will eventually be expanded to include desk and wall clocks, and will serve other trades professionals, as well.

For more information browse:
www.technotetime.com.

SHERWOOD'S 2005 CAT

Most readers will be aware of the good value electronic products that can be bought from our regular advertiser Sherwood Electronics. We have just received Sherwood's 2005 catalogue, a 100+ A5 booklet itemising their current range of full specification components and equipment, with new products and increased ranges of existing stock.

It is worth noting that Sherwood do not require a minimum order value, VAT is not chargeable and UK customers are only required to pay £1.50 postage and packing to all orders. Most orders are despatched by return of post. The catalogue costs £1 but there are two 50p vouchers in it.

For more information contact Sherwood Electronics, Dept EPE, 7 Williamson Street, Mansfield, Notts NG19 6TD.

WCN Flyer

WCN Supplies have sent us another flyer detailing items in a Clearance Sale. Whilst it is likely that the particular items listed may have already sold out, it's worth your while asking WCN to keep you informed about their latest offers of electronic equipment, components and allied products. The current flyer, for instance, lists a "fantastic digital multimeter" at only £5, a switch mode PSU at £20, and a vibrating motor at just £1.

For more information contact WCN Supplies, Dept EPE, The Old Grain Store, Rear of 62 Rumbridge Street, Totton, Southampton SO40 9DS. Tel/fax: 023 8066 0700.

Email: info@wcnsupplies.fsnet.co.uk
Web: www.wcnsupplies.net.

British Wireless for the Blind Fund

The British Wireless for the Blind Fund (BWBF) has announced the winners of its Transmission 2004 fund raising week. Prizes were awarded for groups and individuals who raised the most money for the charity or made the most contacts.

Poldhu Amateur Radio Club in Cornwall was awarded the trophy for the most money raised by a club category, netting an impressive £1,304. The prize for the greatest number of contacts went to the Cray Valley Radio Society in Kent. Amateurs spent 43 hours on air and made a staggering 3000 contacts in more than 100 different countries.

The BWBF aims at "keeping blind people in touch with the world". Through a network of over 300 voluntary agents, it issues specially-adapted audio equipment on free permanent loan to blind and partially-sighted people in need across the UK. For more information about the

Fund, contact British Wireless for The Blind Fund, Gabriel House, 34 New Road, Chatham, Kent ME4 4QR. Tel: 01634 832501. Fax: 01634 817485.

Web: www.blind.org.uk.

Bins for Snapping Birds?

Bird-watchers often look like Christmas trees, carrying binoculars, a still picture camera and camcorder round their neck, all on different straps that tangle and strangle. Leading US optics company Bushnell is launching a pair of binoculars that also works as a still camera and camcorder.

The Instant Replay bins cost £450, have 8x magnification for normal viewing and a 2.1 megapixel sensor for capturing still images into memory. The sensor can also be switched to record a 30-second continuous loop of movie images, so the recorder always stores the last 30 seconds of any action. Pressing the Shutter Button stops the erase function so the recorder does not overwrite whatever it has just shot. The recorder can then go on to store four more 30-second loops, making five in all.

So birdwatchers can keep their bins trained on a kingfisher with the recorder running continually until the bird dives for a fish, and then stop the erasure as soon as it does. The images can be displayed on a small built-in, pop-up l.c.d. or transferred to a PC by USB link for more permanent storage or printing.

At the launch event in London, Bushnell's demonstrators seemed rather at sea with the technology, confusing on-board internal memory with removable card memory and saying the device used SD cards when in fact it takes the much more bulky Compact Flash cards. Also, although the 2.1Mp camera captures still images of fair quality, the video quality is poor. Bushnell's literature claims VGA resolution, 640 x 480 pixels, but Bushnell's demonstrators checked the specification sheet and confirmed it was only 320 x 240, and only at 15fps. The pictures are coarse and jerky.

The Instant Replay bins will thus be more use to birdwatchers who want to prove to doubting colleagues that they really did see the rare bird they claimed to see, than for making a video scrapbook of birds seen.

Barry Fox

SPEEDY BINDING POSTS

Pomona Electronics, the leading manufacturer of cable assemblies, connectors and test accessories, has announced new spring-loaded binding posts, designed to speed test applications that require frequent connections and disconnections. Built to rugged military specifications, these posts decrease the amount of time when conducting tests. Wiring is connected by simply pushing down a cap, inserting the wire into the open jaws, and releasing.

For more information browse
www.pomonaelectronics.com.



EVERYDAY
PRACTICAL
ELECTRONICS

www.epemag.co.uk
 EPE Online: www.epemag.com

Subscribe and

SAVE
51p

an issue over UK
 newstand prices on a
 one year subscription.



Plus:

- Avoid the price rises for the duration of the subscription.
- Your issue posted to you in time to arrive before publication date (UK).
- No more searching newsagents shelves for your copy.

Annual subscription rates:

- 6 Months: UK £16.50, Overseas £19.50 (standard air service), £28.50 (express airmail)
- 1 Year: UK £31.00, Overseas £37.00 (standard air service), £55 (express airmail)
- 2 Years: UK £57.00, Overseas £69.00 (standard air service), £105 (express airmail)

To: Everyday Practical Electronics,
 Wimborne Publishing Ltd., 408 Wimborne Road East, Ferndown,
 Dorset BH22 9ND
 Tel: 01202 873872 Fax: 01202 874562
 E-mail: subs@epemag.wimborne.co.uk
 Order from our web site at:
 www.epemag.co.uk



TAKE ADVANTAGE NOW!
SUBSCRIPTION ORDER FORM



To subscribe from the USA or Canada
 see the last magazine page

I enclose payment of £
 (cheque/PO in £ sterling only),
 payable to Everyday Practical Electronics



My card number is:
 Please print clearly, and check that you have the number correct

Signature

Card Security Code (The last 3 digits on or just under
 the signature strip)

Card Ex. Date Maestro Issue No.

Subscriptions can only start with the next available issue.
 For back numbers see the *Back Issues* page.

01/05

Name

Address

Post code Tel.

If you do not wish to cut your issue, send a letter or copy of this form.

Easy, Safe, Fast...



FREE
424 page
Catalogue

2004 Catalogue - all 424 pages

Our Jaycar catalogue priced in UK Pounds is crammed with over 6000 exciting products. You can get one FREE by logging on to our website and filling out the catalogue request form at www.jaycarelectronics.co.uk/catalogue

Check our website! Easy, safe, fast ordering & lots of information

- Entire Jaycar 2004 catalogue on-line – over 6000 products.
- 128-bit secure on-line ordering – safe & secure.
- Search by category, keyword or catalogue number, & advanced search.
- Over 3500 product datasheets & application notes available on-line.
- And we're from Australia so you can trust us!



Moreinfo?

www.jaycarelectronics.co.uk

Part of our extensive build-it-yourself kit range

Get the Best Quality Video from your Home Theatre System

KC-5390 £34.95

VIDEO SIGNAL STABILISER

Did you know you are not getting the best picture from that expensive movie collection you paid good money for?? Movie companies deliberately tamper with the video signal to restrict copying, but this robs you of the true high quality picture your system is capable of and you deserve. Get the picture you paid for and strip out these annoying signals, including copyright protection, by connecting our Doctor Video Kit inline with your DVD player or VCR. Kit supports S-Video and composite video signals. Case, circuit board, electronic components and comprehensive assembly instructions are supplied. Some SMD component soldering required.

Caution: During signal conditioning, this unit removes copyright protection. Piracy is a crime, and Jaycar Electronics takes no responsibility for its potential for unlawful use.



Theremin Synthesiser Kit

KC-5295 £14.95

The Theremin is a weird musical instrument that was invented early last century but is still used today. The Beach Boys hit: "Good Vibrations" featured the Theremin. You can have one of these kits (Cat no. KC-5295) for £14.95. All kits have first class instructions written in clear English text with plenty of illustrations and component identification.



This product is now available built and fully tested - Cat. AM-4025 £34.95

9VAC Wall Adaptor required (Maplin #GU09K - £9.99)

We Stock...

Electronic Components

Electronic Project Kits

Test & Measurement Equipment

Power Products & Accessories

Audio & Video Equipment & Accessories

Computer & Telecoms Accessories

Security & Surveillance Equipment

Programmable Electronic Ignition Kit

KC-5202 £18.85

Vary your engine's operating parameters. This project interfaces with our Universal High Energy Ignition Kit to allow programming of certain ignition features such as ignition advance, advance angle, dwell angle, and more. Kit supplied with PCB, keypad, pre-programmed PIC microprocessor, and all electronic components. THOUSANDS SOLD!



Log on to

www.jaycarelectronics.co.uk/catalogue

for your FREE catalogue!

0800 032 7241

(Monday - Friday 09.00 to 17.30 GMT + 10 hours only)

For those that want to write:

100 Silverwater Rd Silverwater NSW 2128 Sydney Australia

Jaycar

Electronics

Light Detector

Anthony H. Smith B.Sc. (Hons)

An unusual design which uses an L.E.D. both as the Light Sensor and Indicator

IN last month's issue, in the final part of the *Light Emitting Diodes* series, we showed how the *photodiode* can be used as a precision light sensor. By generating a *photocurrent* proportional to light intensity, the photodiode produces an electrical analogue of the measured light source that remains linear over some six or seven decades of light intensity.

Furthermore, by combining the basic photodiode function with additional circuitry, semiconductor manufacturers have produced a variety of light-sensitive devices that generate either a direct voltage output or, for example, in the case of light-to-frequency converters, a square-wave signal whose frequency varies according to the strength of the detected light source.

However, in many light sensing applications, there is often a need to detect simply a *change* in light level, rather than a linear response to light intensity. Typical examples are products like digital alarm clocks that use a light sensor to dim the 7-segment l.e.d. display when the ambient light level is relatively low, or automobile light sensors which prompt the driver to switch on the headlamps when it is getting dark. This project

makes use of an l.e.d. as a simple light sensor that generates a *photovoltage* that varies with light intensity. By comparing the photovoltage with a variable reference voltage, this Light Detector provides a digital output signal that changes state when the monitored light level crosses a preset threshold.

The detector also provides visual indication by illuminating the sensor l.e.d. when the light exceeds the preset level. In this way, the l.e.d. provides a dual function, acting as both the sensor and the indicator. An optional, optically-isolated output is also available.

Long Life Applications

When the monitored light exceeds the preset threshold, the circuit *latches* into its "tripped" state, and remains that way even if the light intensity decreases and falls to a level below the threshold. In its quiescent "unlatched" state, the circuit requires very little supply current, allowing it to operate for many months, or possibly several years, from a single PP3 9V battery.

The detector should find applications in meteorological or environmental experiments, where there is a need to monitor ambient light conditions and to record the

precise moment at which the light exceeds a particular level. The circuit could also be used to provide a warning of a dangerous situation. For example, when located in a darkened storeroom, it could be used as a rudimentary fire detector that could generate an alarm signal on sensing the light produced by the flames. The detector is also ideally suited to security applications, where a monitored light level can be used to indicate the presence of a trespasser, or to warn of the unauthorised use of a room or object. For example, by locating the detector close to a room's ceiling or wall lights, it can be used to signal that an intruder has entered the room and turned on the lighting.

Alternatively, by positioning the unit inside a cupboard or drawer such that it will be triggered when ambient light falls on it, the detector can provide visual or electronic indication that someone has gained unauthorised access to the cupboard's contents. The fact that the detector remains in its latched state means that the event is recorded even if the cupboard or drawer is closed again.

Micropower Comparator and Reference

The circuit diagram of the Light Detector is shown in Fig.1, where D1 is the l.e.d. that functions as both the detector and light emitter. The circuit owes its micropower quiescent behaviour to IC1, a MAX931 device that combines a voltage comparator and voltage reference inside a single, 8-pin package.

The voltage reference section is a $\pm 2\%$ accurate, 1.182V bandgap reference connected between pin 6 (REF) and pin 2 (V^-), the negative supply terminal. In the light detector circuit, both V^- and GND (pin 1) are connected to 0V, such that IC1 functions in single supply mode. This means that the stable reference voltage appearing at pin 6 (measured with respect to 0V) is 1.182V (nominal) with a tolerance of $\pm 24\text{mV}$.

The comparator section functions just like a normal voltage comparator, but with the addition of *programmable hysteresis*. Depending on the voltage difference between the HYST terminal (pin 5) and the REF terminal, the hysteresis appearing

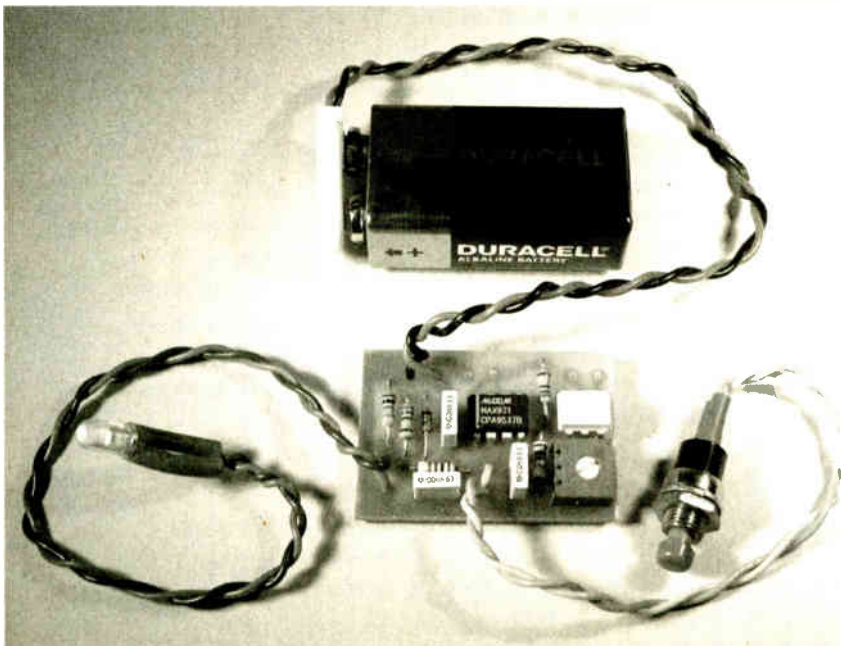
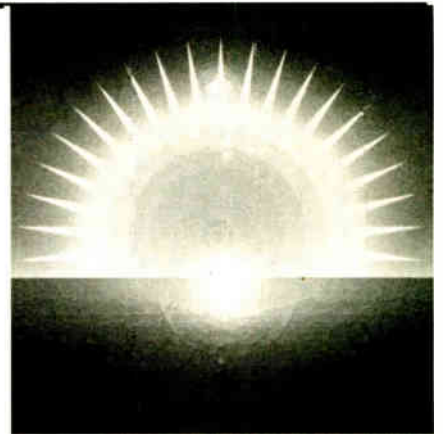

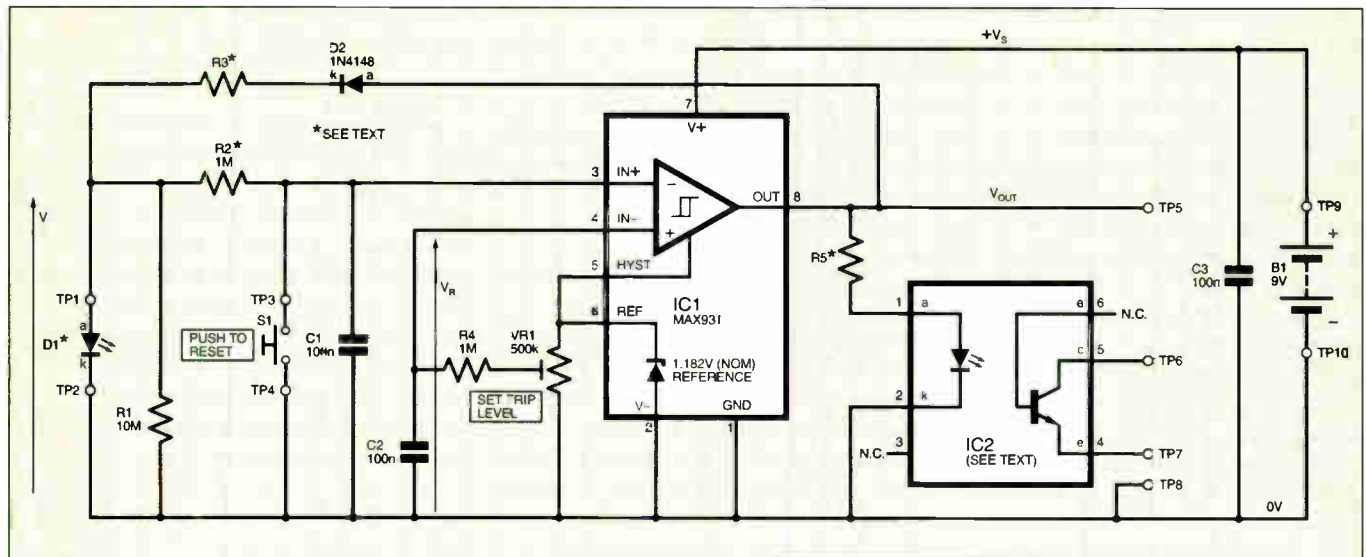

Fig. 1. Complete circuit diagram of the Light Detector.

between the comparator's input terminals can be varied from zero to around 100mV. However, as we shall see shortly, the light detector's latching behaviour means that comparator hysteresis is not required, and so to simplify the circuit the HYST pin is connected directly to the REF pin, resulting in zero hysteresis.

More information on hysteresis and micropower comparators can be found in *The Schmitt Trigger*, Part 7, May 2001.

Battery Powered

When operating from a single supply, the MAX931 has a supply voltage range of 2.5V to 11V, and a maximum supply current of just 3.2 μ A at room temperature. The relatively wide supply voltage range, together with the minuscule power requirements, make the device ideal for battery-powered applications.

Although the MAX931 could operate from just two series-connected alkaline cells with a nominal supply voltage of around 3.0V, the light detector makes use of a 9V supply. Not only does this provide plenty of "drive" to illuminate the l.e.d. and to power the optional optoisolator (IC2), it also allows the circuit to operate in its quiescent state for months or years without needing to replace the battery.

Furthermore, the requisite PP3 battery connector is relatively simple and inexpensive – an additional bonus.

Photovoltage

The photovoltage, V_F , generated by light falling on l.e.d. D1 is fed to the comparator's non-inverting input IN+ (pin 3) via a single-pole lowpass filter comprising R2 and C1. The photovoltage is compared with a variable reference voltage, V_R , at the comparator's inverting input, IN- (pin 4). The variable reference voltage (filtered by R4 and C2) is adjusted by preset VR1 connected to the 1.182V reference voltage output at IC1 pin 6.

In low light conditions, when photovoltage V_F is less than V_R , the comparator output voltage, V_{OUT} , is low (roughly at 0V) and diode D2 is reverse biased such that no current flows through R3.

However, when the light intensity falling on D1 increases to the point where V_F just exceeds V_R , the comparator output goes

high, thus forward biasing D2, allowing forward current to flow into D1 via current limiting resistor R3.

The function of D1 now changes from light detector to light emitter, and the l.e.d. illuminates to indicate that the monitored light has crossed the threshold set by VR1.

Latched

The circuit is now in its latched state, and the voltage, V_F , appearing across D1 is no longer a photovoltage generated by light energy, but is now simply the forward voltage of the forward biased l.e.d. Since the forward voltage of an l.e.d. is around 1.6V or more, V_F is now significantly larger than V_R (which can be no greater than 1.182V), and so the circuit latches into its "tripped" state.

Essentially, components R3 and D2 provide a *positive feedback* path from the comparator's output to its non-inverting input (via R2), thereby ensuring that the circuit makes a swift and clean transition into its latched state.

Diode D2 plays an important part. Without it, the "weak" photovoltage generated by D1 would see a very low impedance path through R3 and into the comparator's output. This would swamp the photovoltage, and would pull it down to a fraction of its normal "unloaded" value.

The presence of D2, however, ensures that the quiescent load on D1 is simply the combination of R1 shunted by the very high impedance of the comparators non-inverting input (which takes such little current that it can be assumed negligible). Therefore, given that the value of R1 is very high, D1 can be considered unloaded when the circuit is in its unlatched state.

When the circuit has tripped, it can be reset (unlatched) by closing S1, a momentary action, normally-open pushbutton. This shorts the comparator's non-inverting input to 0V, such that its output goes low, thereby depriving D1 of forward current. The circuit now reverts to its quiescent, unlatched state, where $V_{OUT} = 0V$. D2 is reverse biased, and V_F is the photovoltage generated by light falling on D1. Of course, if V_F is greater than V_R , the circuit will immediately latch again.

Filters

The two lowpass filters formed by C1/R2 and C2/R4 significantly attenuate any electrical noise appearing at the comparator's input terminals. This can be important if the detector is used in an electrically "noisy" environment, for example when monitoring the light from fluorescent tubes, or if located close to the brush gear of an electric motor.

However, the C1/R2 filter provides an additional function. If the detector is used to monitor a light source powered from an a.c. voltage, such as a mains-powered incandescent filament lamp, the photovoltage V_F generated by D1 will consist of a d.c. voltage plus a smaller a.c. component. Provided D1 is properly connected to the detector circuit, electrical noise will contribute only a relatively small part of this a.c. component. Instead, another mechanism is responsible for most of the alternating portion of V_F .

Most mains voltage supplies have a roughly sinusoidal waveshape with a frequency of 50Hz or 60Hz, depending on the country. In the UK, for example, the domestic mains frequency is nominally 50Hz, whereas in North America it is predominantly 60Hz. This means that the current flowing through a mains-powered filament lamp will vary in a sinusoidal manner, increasing and decreasing, and reaching a positive and negative peak, 50 or 60 times every second.

Hot Stuff

Now, an incandescent lamp is essentially a *thermal* light source, in that the light emitted by the lamp is caused by heating of the filament which glows white hot. Since the lamp has a relatively large thermal time constant, it cannot respond to each peak and trough of the mains sinusoidal waveform. In other words, because the filament heats up and cools down relatively slowly, it does not flicker on and off, but instead produces an "average" glow which is proportional to the *root mean square* (r.m.s.) value of the mains voltage.

Nevertheless, the filament does respond slightly to the alternating current, and the effect can be detected as a *modulation* of the light intensity. This phenomenon can be seen in the oscillograph shown in Fig.2,

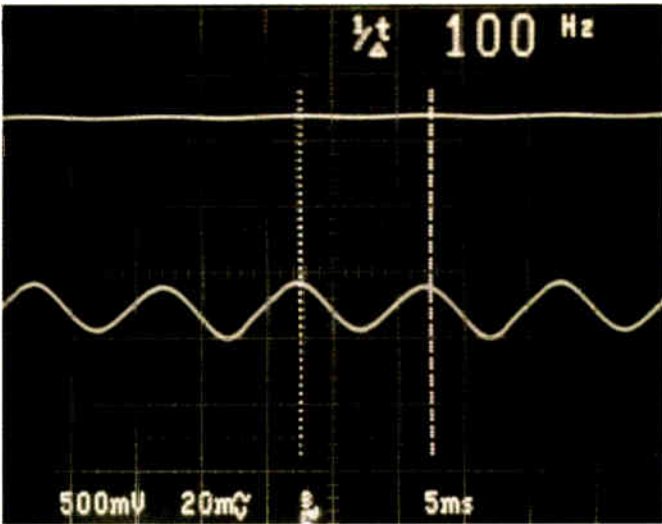

Fig.2. Oscillograph showing effects of light modulation on photovoltage (top trace: 500mV/div., d.c.-coupled; bottom trace: 20mV/div., a.c.-coupled; timebase: 5ms/div.

which displays the photovoltage generated by an l.e.d. located close to a 60W lamp powered by a 50Hz mains supply.

Note that each trace depicts the *same* photovoltage, that is, the two oscilloscope channels are connected to the same l.e.d. However, the top trace shows the photovoltage at a sensitivity of 500mV per division with the channel d.c. coupled, whereas the bottom trace has a sensitivity of 20mV per division with the channel a.c. coupled.

The top trace represents the average, or d.c., component of the photovoltage, which in this case is around 1.5V, and the modulation can just be seen as "ripple" on the d.c. level. The bottom trace, on the other hand, depicts the *modulated*, or a.c., component of the photovoltage, approximately 18mV in amplitude, which oscillates not at 50Hz, but at 100Hz. The a.c. component oscillates at twice the mains frequency because the mains sinusoidal waveform reaches a peak (one positive, one negative) twice every cycle, and each peak causes a slight increase in the lamp's light intensity.

Attenuation

Returning to Fig.1, we see that the C1/R2 filter has a time constant of: $100\text{nF} \times 1\text{M}\Omega = 100\text{ms}$, some ten times greater than the period of the 100Hz modulation. Therefore, the filter significantly attenuates the a.c. component of V_F , such that the a.c. waveform appearing at the comparator's non-inverting input is small enough to be negligible.

In this way, the C1/R2 filter ensures that the light detector responds only to the *average* value of the monitored light, and is not troubled by any mains-generated modulation.

When designing RC (resistor-capacitor) filters, large resistance values should be used with caution as they can produce relatively large d.c. voltage shifts that can introduce unacceptable errors. For example, a d.c. current of just $1\mu\text{A}$ flowing through a $1\text{M}\Omega$ filter resistor will produce a potential difference of 1V across the resistor. This is large enough to corrupt the noise immunity of a digital system and cause erroneous triggering of a logic gate.

In an analogue system, a voltage of 1V could actually be *larger* than the signal being measured, thus producing huge errors!

Therefore, large resistance values should only be used at the input to a device that has very high impedance and which requires very low bias current. The inputs to the MAX931 comparator have a maximum leakage current rating of just $\pm 5\text{nA}$. Consequently, the voltage drop produced across R2 or R4 by the input leakage current would be no greater than $\pm 5\text{mV}$, which is small enough to be negligible in the light detector circuit.

Pots of Resistance

The preset potentiometer, VR1, must have a large resistance value to ensure that it does not place undue load on the MAX931 reference voltage. A quick glance at the MAX931 specifications suggests that the REF pin can source around $25\mu\text{A}$ to an external load. If we use this value to calculate a suitable value for VR1, we find that:

$$\text{VR1} = V_{\text{REF}}/25\mu\text{A} = 1.182\text{V}/25\mu\text{A} = 47,280\Omega$$

It would appear, therefore, that a $50\text{k}\Omega$ pot would be suitable. However, the $25\mu\text{A}$ figure is a *typical* value and is only relevant at room temperature. If the light detector could be used over a wide range of temperatures, we must use the *minimum* current value that applies over the *full* temperature range. This value is just $6\mu\text{A}$, such that: $\text{VR1} = 1.182\text{V}/6\mu\text{A} = 197\text{k}\Omega$. Therefore, a $200\text{k}\Omega$ pot would be suitable, but a $500\text{k}\Omega$ type has been specified.

The larger value was chosen to ensure plenty of margin, and also has the advantage of minimising the light detector's overall quiescent current consumption.

Choice of L.E.D.

In Part 4 of the L.E.D.s series (last month), the use of an l.e.d. as a light detector was discussed in some detail. Reading through that section, you will see that not all l.e.d.s make good light detectors: some are extremely effective, others are useless. Therefore, you may have to experiment with different types to get the best performance.

A good starting point is to select an l.e.d. like the Agilent HLMP-D155. This is a 5mm red l.e.d. with a clear, untinted lens. When tested, samples of this part produced a good response, generating a photovoltage of around 1.5V when located close to a 60W bulb. Furthermore, the HLMP-D155 has the advantage of being a low current l.e.d., requiring a forward current of just 1mA to produce a minimum light intensity of 5mcd (millicandela). This is a useful feature for the light detector in that it minimises battery drain when the circuit has tripped and the l.e.d. is illuminated.

Trial and Error

If you have a selection of "unknown" l.e.d.s in your junk box and would like to select the best one for the light detector, a convenient approach is to measure the photovoltage with a high input impedance voltmeter. Most good quality *digital* multimeters have an input impedance in the range $1\text{M}\Omega$ to $10\text{M}\Omega$ in volts mode, making them well suited to measuring the relatively weak photovoltage.

Moving coil *analogue* voltmeters, on the other hand, tend to have fairly low input impedance, often just a few tens of kilohms. This type of meter should not be used as it would adversely load the l.e.d.'s output, making the photovoltage appear much lower than its "unloaded" value.

To measure the photovoltage, connect the sample l.e.d.'s anode (a) to the meter's positive lead, and the cathode (k) to the negative lead. Then, expose the l.e.d. to the kind of light levels that will be encountered in the intended application, and note the measured voltage. By repeating this process with other l.e.d. samples, the best l.e.d. (the one with the greatest photovoltage) can be selected.

Setting the Forward Current

When the circuit has tripped, the forward current, I_F , through l.e.d. D1 is given by the equation: D1 Forward Current,

$$I_F = (V_{\text{OUT(H)}} - V_{D2} - V_F)/R3 \text{ (A)}$$

where $V_{\text{OUT(H)}}$ is the comparator's high level output voltage, V_{D2} is the voltage drop across diode D2, and V_F is the l.e.d.'s forward voltage. Both V_{D2} and V_F can be estimated or measured fairly easily, but establishing a value for $V_{\text{OUT(H)}}$ is a little more difficult because it depends on supply voltage, $+V_S$, and also on the current sourced by the output.

As we shall show later, the MAX931's comparator output is very good at sourcing current to a load, and it is reasonable to assume that $V_{\text{OUT(H)}}$ will fall no more than 0.7V below $+V_S$ even when sourcing as much as 50mA. Therefore, we can assume that: $V_{\text{OUT(H)}} = (+V_S - 0.7\text{V})$. All that remains is to set a suitable value for the battery voltage, $+V_S$.

Worked Example

A worked example will illustrate the procedure. Let's assume that D1 is an HLMP-D155 and that we wish to drive 2mA through it. Rearranging the above equation, we see that:

$$R3 = (V_{\text{OUT(H)}} - V_{D2} - V_F)/I_F = (+V_S - 0.7\text{V} - V_{D2} - V_F)/I_F \text{ (\Omega)}$$

The HLMP-D155 has a forward voltage of around 1.7V when $I_F = 2\text{mA}$, and we can take 0.7V as the typical drop across D2. If we assume that the battery voltage can fall to, say, 7V after a period of continual use, the required value of R3 is:

$$R3 = (7\text{V} - 0.7\text{V} - 0.7\text{V} - 1.7\text{V})/2\text{mA} = 3.9\text{V}/2\text{mA} = 1,950\Omega$$

therefore, in this example, a preferred value of $2\text{k}\Omega$ would be ideal for R3.

If you select an "unknown" l.e.d. for D1, the appropriate value of R3 can be determined by experimenting with different values (start with a relatively high value, then work down until the required intensity is obtained), or by measuring V_F at the

required forward current and inserting the value into the above equation.

Whichever type of I.e.d. is selected, it is best to keep I_F below 10mA to reduce the loading on the comparator output and to minimise battery drain when the circuit is latched.

Interfacing

The comparator's output signal, V_{OUT} , is available between terminals TP5 and TP8. This is an "active high" digital signal, meaning that V_{OUT} is roughly at 0V in the quiescent state, and swings high (toward the positive supply voltage, $+V_S$) when the detector is latched. Feeding V_{OUT} to, say, a 4000-series logic gate operating on a 9V supply makes it easy to interface the light detector with an external digital system.

Note, however, that the high level at V_{OUT} varies with changes in battery voltage, and is also affected by loading. Even though it is possible for the light detector to function normally when the battery voltage has fallen as low as 4V, or less, the high level available at the comparator output will also be proportionally lower, and may be too low to be recognised as a valid high level by an external system.

The magnitude of a load connected to V_{OUT} also has an effect on the high and low output levels. For example, if the output is lightly loaded, V_{OUT} will swing "rail-to-rail". This means that the low level will be roughly at 0V, and the high level will be very close to the positive supply voltage, $+V_S$. Heavier loads, however, make quite a difference to the voltage levels.

The MAX931 is very good at sourcing current to a load. For example, when driving as much as 50mA into a load connected to 0V (TP8), the output high voltage will typically drop no more than 0.7V below the positive supply rail. This means that V_{OUT} could easily be used to drive one or more external I.e.d.s (with appropriately sized series ballast resistors).

Unfortunately, the MAX931 is not quite as good when sinking current through a load connected to a positive voltage (which could be the battery supply voltage, $-V_S$, or an external positive supply). For example, when sinking 10mA, the comparator's low level output voltage (ideally zero) could rise to as much as 1V, or more. Therefore, when using V_{OUT} to drive an external load, it is better to connect the load between TP5 and TP8 (0V), in order to benefit from the device's superior current sourcing capability.

Isolation

The optional optoisolator, IC2, provides an alternative way of interfacing the light detector to an external system. The optoisolator (sometimes called an optocoupler) provides an electrically isolated signal to indicate that the circuit has tripped. This can be useful if the detector is powered from a power supply other than a battery (such as a mains-powered bench supply) and is required to interface with an isolated system that does not share a common ground (0V) with the detector.

A detailed description of optoisolator behaviour is beyond the scope of this article. However, in simple terms, the device contains two elements, a light emitter and a light detector, housed inside the same

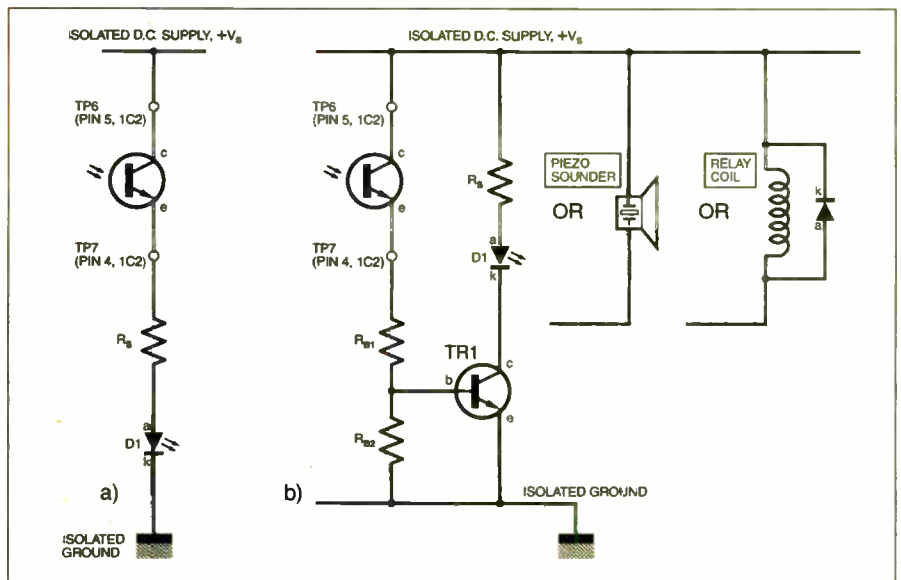

Fig.3. Interfacing the optoisolator photo transistor to external circuits.

package. The emitter, an I.e.d., is positioned next to the detector, usually a phototransistor, in such a way that light from the I.e.d. falls on the phototransistor causing it to conduct. This allows an electrical signal to be transferred from the input (the I.e.d.) to the output (the phototransistor) without any galvanic (i.e., electrically conducting) path between them.

Since the signal is transferred across the optoisolator using a light path, it is possible for a very large voltage (as much as several kilovolts) to exist between the emitter and detector. Therefore, the optoisolator can transmit signals between different systems that operate at vastly different common-mode potentials. Furthermore, the inherent electrical isolation makes the optoisolator ideal for safety critical applications, such as medical instruments, where it is essential to prevent potentially fatal voltages from reaching a patient in the event of a fault.

Current Transfer Ratio

The relationship between the optoisolator's output and input current is given by the current transfer ratio, or CTR, where: Current Transfer Ratio = $(I_C / I_F) \times 100\%$ where I_C is the output (collector) current flowing in the phototransistor, and I_F is the emitter I.e.d.'s forward current. Most manufacturers usually specify a minimum value of CTR, and occasionally a typical value. The particular value is often quoted for a given value of I_F . Thus, for example, a device with minimum CTR of 20% at $I_F = 10\text{mA}$ will generate a minimum output current of 2mA when the input (I.e.d.) current is 10mA.

Table 1 lists four readily available optoisolators that are suitable for IC2. Since they all share the same pinout as shown in Fig.1, any one of them can be

used in the light detector. Note that this list is just a small sample of suitable types, there are many other devices that could be used. However, if you choose an alternative type, make sure it has the correct pinout.

The 4N29 is slightly different to the other types in that it combines a phototransistor with a standard transistor in the output stage to form a "photo-Darlington" output. The extra current gain contributed by the Darlington stage is responsible for the relatively large minimum value of CTR (100%).

Forward Current

The required value of R_5 depends on the magnitude of the forward current needed to bias the optoisolator's I.e.d. This, in turn, depends on the particular value of CTR, and also on the current that must flow in the phototransistor. The precise value of collector current will depend on the way in which the phototransistor is used. A few example circuits are shown in Fig.3.

In Fig.3a, the phototransistor is connected to an isolated I.e.d. via current limiting resistor, R_5 . The I.e.d. could be located some distance from the light detector to provide remote indication that the circuit has tripped. The I.e.d.'s forward current is determined by the available emitter current provided by the phototransistor. Working through an example will make this clear.

The value of R_5 in Fig.1 can be determined in a similar way to R_3 . The required value is given by:

$$R_5 = (V_{OUT(H)} - V_F) / I_F = (+V_S - 0.7V - V_F) / I_F (\Omega)$$

where V_F and I_F are the optoisolator I.e.d.'s forward voltage and forward current, respectively. As with $D1$'s forward current, it is best to limit I_F to around 10mA. The

Table 1: Optoisolators Suitable for IC2

Part Number	Minimum CTR (%) @ $I_F=10\text{mA}$	Comments
4N25	20	Popular Type
4N26	20	Popular Type
4N27.300	10	Inexpensive
4N29	100	Darlington Output

value of V_f depends on the particular device used for IC2. All of the optoisolators in Table 1 have a maximum V_f of 1.5V. Therefore, with $I_f = 10\text{mA}$, $V_f = 1.5\text{V}$, and taking $+V_S = 7\text{V}$, we find that:

$$R_5 = (7\text{V} - 0.7\text{V} - 1.5\text{V})/10\text{mA} = 480\Omega$$

Thus, we could use the nearest preferred value of 470Ω for R_5 , although a higher preferred value, such as 510Ω or 560Ω , may be a better choice.

Phototransistor

Having set the nominal value of I_f to 10mA , we can now determine the minimum phototransistor current, $I_{C(\text{min})}$, from: $I_{C(\text{min})} = (\text{CTR}_{(\text{min})}/100) \times I_f$

where $\text{CTR}_{(\text{min})}$ is the minimum current transfer ratio. If, for example, we select a device like the 4N27.300 with $\text{CTR}_{(\text{min})} = 10\%$, we find that

$$I_{C(\text{min})} = (10/100) \times 10\text{mA} = 1\text{mA}$$

The implications for the circuit in Fig.3a are that a low current i.e.d. would be required to ensure adequate brightness if I_C is at its minimum level (1mA). It is quite possible, of course, that the optoisolator's actual CTR may be much higher than its minimum value, in which case I_C would also be correspondingly higher. It is wise, therefore, to include the series resistor, R_S , to limit the i.e.d.'s forward current to a reasonable value.

The required value of R_S can be determined simply by assuming that the phototransistor is saturated (fully "on") such that there is zero potential across it. Knowing the value of the isolated supply voltage, $+V_S$, and the forward voltage of the i.e.d., the value of R_S needed to limit the forward current to a safe level can be calculated in the usual manner (see *L.E.D.s Part one*)

Power Gain

For loads requiring more current than the phototransistor can provide, some kind of power gain stage is required to "boost" the optoisolator's output. A simple example is shown in Fig.3b, where npn transistor TR1 provides the current gain needed to drive "heavier" loads.

The type of transistor required depends on the load. For instance, a small-signal device such as a BC108C or BC550 may be sufficient to drive several tens of milliamps through a high brightness i.e.d. Alternatively, a medium power device, or even a power Darlington, may be needed for loads such as a piezoelectric sounder or a relay coil. Whatever type of device is used for TR1, base bias resistors R_{B1} and R_{B2} should be sized using conventional biasing theory to provide adequate base current for the transistor.

Maximum Ratings

Note that the phototransistor (like a standard transistor) has maximum voltage and power ratings that should not be exceeded. For the devices listed in Table 1, the maximum collector-emitter voltage, denoted $V_{CE(\text{max})}$, is 30V, and the phototransistor's maximum power rating, denoted $P_{D(\text{max})}$, is 150mW. These values should be adequate for most applications.

Provided they are not exceeded, it may be possible to simplify certain aspects of the interface circuit. For example, in Fig.3b, it may be appropriate to minimise

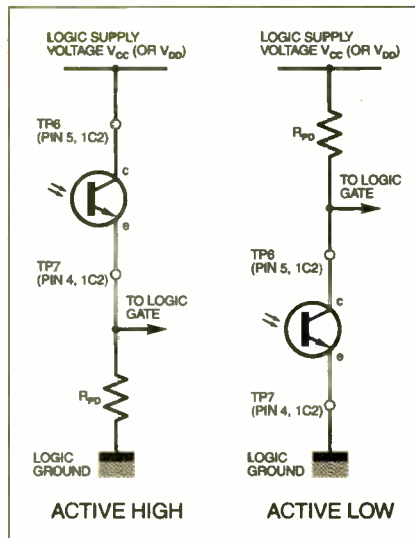

Fig.4. Interfacing the Light Detector to a digital system.

or even omit resistor R_{B1} , provided the phototransistor's voltage and power levels remain safely below the maximum rated values.

Logic Interface

The optoisolator makes it easy to interface the Light Detector to a digital system or logic gate. Fig.4 shows how this can be achieved for active high and active low signals. In each case, the "pull down" resistor (R_{PD}), or "pull up" resistor (R_{PU}), should be sized according to the type of logic family used.

For example, if CMOS logic devices from the 4000-series or 74C/74HC families are used, the resistor values can be quite high – around $100\text{k}\Omega$, or more. For bipolar logic devices, however, such as the 74LS family, the values must be much lower, usually in the kilohm range.

The value of R_5 should be selected to satisfy the requirements of the logic interface. If, for example, the optoisolator output is connected in series with a $100\text{k}\Omega$ pull down resistor to the input of a CMOS logic device operating at $V_{DD} = 5\text{V}$, the phototransistor must conduct at least $5\text{V}/100\text{k}\Omega = 50\mu\text{A}$ to ensure the correct high level for the logic signal.

If the optoisolator has a $\text{CTR}_{(\text{min})}$ of, say, 20%, this means that at least $250\mu\text{A}$ must flow through R_5 to ensure adequate drive for the optoisolator i.e.d. In practice, R_5 would probably be chosen to set the optoisolator input current to $300\mu\text{A}$, or more, in order to ensure adequate margin.

Construction

With the exception of the battery, push-switch S1 and, possibly, i.e.d. D1, all components are located on the small printed circuit board (p.c.b.) whose component layout and tracking details are shown in Fig.5. This board is available from the *EPE PCB Service*, code 481.

Diode D2 should be fitted first (take care with polarity), followed by the resistors, trimmer pot, capacitors, and finally IC1 and IC2 (if used). Remember that IC1 and IC2 are static-sensitive devices that can easily be damaged by electrostatic discharge and you should touch something grounded (earthed) before handling them to avoid this.

The layout will accommodate most types of single turn or multiturn trimmers,

COMPONENTS

Resistors

- R1 10M, 10%, 0.25W metal film
- R2, R4 1M, 10%, 0.25W metal film (2 off)
- R3, R5 (see text) 1%, 0.25W metal film (2 off)

Potentiometers

- VR1 500k min. preset

Capacitors

- C1 to C3 100n polyester or ceramic, 5mm pitch (3 off)

Semiconductors

- D1 i.e.d. (see text)
- D2 1N4148 signal diode
- IC1 MAX931CPA comparator and voltage reference
- IC2 optoisolator (see text)

Miscellaneous

- S1 single-pole push-to-make switch

Printed circuit board, available from the *EPE PCB Service*, code 481; metal or plastic case (to suit – optional, see text); 6-pin d.i.l. socket; 8-pin d.i.l. socket; twisted-pair wire; PP3 battery and clip; connecting wire; solder, etc.

Approx. Cost
Guidance Only
excluding case & battery

£12

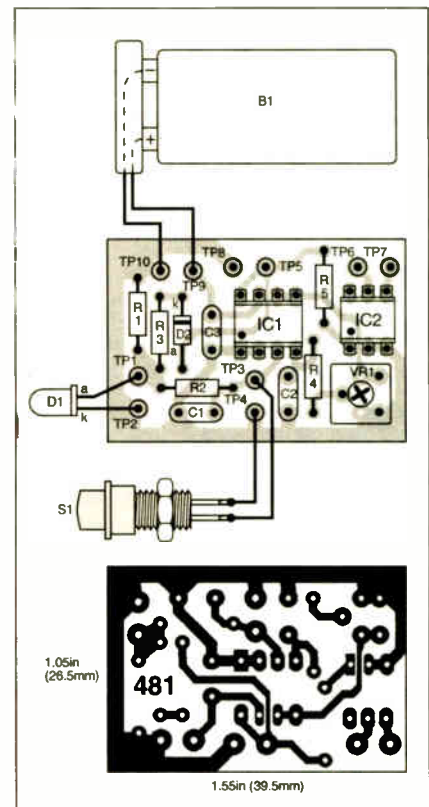
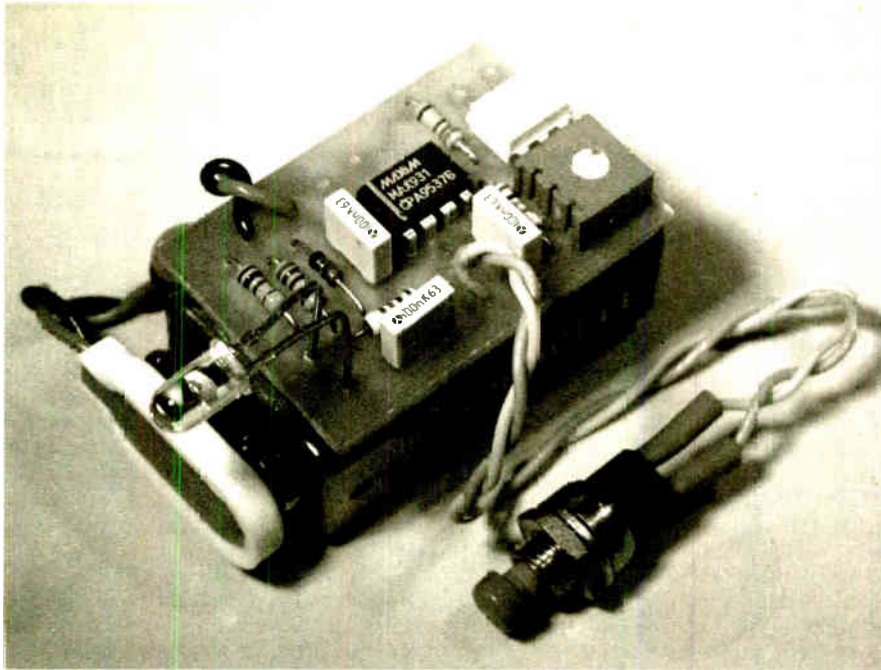

Fig.5. Component layout and master track pattern for the Light Detector.



provided the pins are on a 0.1in (2.54mm) matrix. The PP3 battery connector should be attached next by soldering the wires to terminals TP9 (positive) and TP10 (negative) taking care to ensure correct polarity. Switch S1 can then be soldered to terminals TP3 and TP4 using short lengths of twisted wires.

If the l.e.d. is to be located off-board using flying leads, twisted-pair wiring should again be used to minimise the possibility of noise pickup. Solder the l.e.d.'s anode (a) lead to terminal TP1, and the cathode (k) lead to TP2. Finally, solder wires to terminals TP5 to TP8, if required.

Remember to crop all leads and check for solder splashes before connecting the battery. It is also wise to make a last check that IC1 and IC2 have been inserted the right way around.

Testing and Calibration

Power up the circuit either by connecting the PP3 battery, or by means of a bench power supply set to 9V. To calibrate the unit to detect the required light level, first rotate the preset in such a way as to *maximise* the value of reference voltage V_R (the direction of rotation will depend on the type of trimmer used). If the l.e.d. is initially illuminated, press S1 and it should turn off.

Next, locate l.e.d. D1 in the particular light level to be detected. For example, if the unit is to be used to detect light from a ceiling lamp, position the l.e.d. a suitable distance from the lamp and switch it on. Slowly rotate VR1 so as to reduce (gradually) reference voltage V_R . Eventually, when V_R is just slightly less than the l.e.d. photovoltage, V_F , the circuit will trip and the l.e.d. will illuminate.

If the light source is now decreased or completely removed (for example, by switching off the ceiling lamp), the l.e.d. should remain illuminated to indicate that the circuit has tripped. Pressing S1 will then turn off the l.e.d. and reset the detector so that it is "primed" ready to detect an increase in light level.

An alternative way of setting the trip threshold is to disconnect the l.e.d. from

the p.c.b., place it in the light level to be detected, and then measure the photovoltage using a high input impedance voltmeter as described earlier. Note the particular value of photovoltage, V_F , generated, then connect the voltmeter between VR1's wiper and 0V to measure V_R , and adjust the trimmer until V_R is just less than the value of V_F . For example, if the measured photovoltage is, say, 0.76V, the trimmer should be adjusted to set $V_R = 0.75V$. Then, with the l.e.d. reconnected to the p.c.b., the detector should trip at the correct light level.

Troubleshooting

If the detector fails to operate properly, check the values of all resistors and make sure D2 has been inserted correctly. If the l.e.d. fails to illuminate, check that the value of R3 is not too large, and make sure there are no faults around R1 or C1 that could short circuit D1. Check, also, that the l.e.d. has been connected with correct polarity. If the l.e.d. stays on all the time, or if it illuminates in abnormally low light levels, there may be a problem with the reference voltage, V_R .

Check the value of VR1, and ensure there are no short circuits across C2, or between pin 4 of IC1 and 0V. If necessary, use a high impedance voltmeter to measure the REF voltage at pin 6 of IC1, and make sure it lies in the range 1.158V to 1.206V. If the circuit appears to be completely lifeless, check the connections to terminals TP9 and TP10, and make sure you are using a healthy battery.

Enclosure

The p.c.b. and battery can be housed inside a small plastic or metal case, if required. There are many types of ABS and diecast aluminium enclosures from which to choose. The p.c.b. can be secured in the case using double-sided adhesive tape; four small strips, one in each corner of the board, should be adequate.

For indoor applications, where the unit is not likely to be disturbed or tampered with, the p.c.b. can simply be attached to one side of the battery, again using

double-sided tape (see photo). In this example, the l.e.d. has been soldered directly into the p.c.b., and the leads have been carefully bent to angle the l.e.d. toward the light source.

If you opt for this configuration, take care that the p.c.b. tracks and solder joints do not come into contact with the battery's metallic case. This also applies, of course, if the board is mounted inside a metal case.

Increasing Battery Life

We have shown that the circuit can operate in its quiescent (unlatched) state for very long periods without excessively draining the battery. In fact, the quiescent current drain of the prototype unit was found to be just 5 μ A! Once tripped, however, the supply current needed to illuminate D1 and to drive IC2 (if used) is around a thousand times greater than the quiescent value, and will quickly drain the battery if the circuit is not reset.

For applications that use the comparator output signal at V_{OUT} to indicate the detector's state, and where illumination of D1 is not required, battery drain in the tripped state can be reduced enormously by omitting R5 and IC2, and by increasing the value of R3.

The circuit will operate perfectly well even if the value of R3 is as high as 1M Ω , or more. Although this reduces D1's forward current to a few microamps (far too low to illuminate the l.e.d.), the circuit still latches properly because the voltage at the comparator's non-inverting input is pulled higher than V_R when V_{OUT} goes high. This would allow the circuit to operate for many months in a remote location using just a three-wire interface, namely: V_{OUT} , a common 0V connected to TP8, and a reset signal connected to TP3.

Desensitise

In applications where the circuit is used to detect the difference between two relatively high light levels, it is possible that the minimum photovoltage generated by D1 could be *greater* than the maximum value of V_R . In this case, it would be impossible to reset the circuit and the detector would remain constantly in its tripped state.

This problem is unlikely, but if necessary it can be resolved by reducing the value of R1. This increases the loading on D1 and effectively "desensitises" the detector. Some trial and error may be required to find the best value of R1. More information on the effects of loading the l.e.d. when used as a light detector can be found in *L.E.D.s* Part 4.

Although this project is not intended as a "precision" light detector, it does provide reasonably accurate and consistent indication of a change in light levels. Furthermore, with a little ingenuity, it can be adapted to suit other applications. For example, by moving the detector relative to a fixed light source of constant intensity, the unit can be made to act as a crude proximity detector that indicates when the l.e.d. has reached a certain distance from the light source.

Whatever its final use may be, the project demonstrates the remarkable utility of the light emitting diode. □

Trust Misplaced

Are you in danger of unwittingly giving away highly personal information about yourself? Andy Emmerson exposes significant traps.

AS computer users go, you're pretty clued-up. You're fully aware that demon diallers can hijack your dial-up Internet connection and land you with a monster phone bill for premium rate calls for your surfing activity. You've read about the "phishing" scams that tempt innocent users into divulging their credit card PIN codes, benefiting crooks to the tune of \$400 million so far. You're also on your guard whenever asked by email to confirm any personal details.

Tragically not everyone is as savvy, as the statistics prove. The most commonly occurring element in the universe, as any scientist will tell you, is stupidity (the rarest, incidentally, is *unobtainium*). The second most common is greed, which is why so many people fall for the bogus lottery winner messages. Even though they never even entered the lottery they have allegedly won, they nevertheless are perfectly happy to confirm their home address and bank details to receive the fabulous prize they think they have earned.

Official Warning

And hey, these emails must be genuine because they contain the correct wording (it's always an "official" message!) and display the exact kind of logos and anti-fraud warnings that you'd expect from the authentic source. Frequently you are also directed to a website that looks exactly like the ones you're familiar with when you click on the blue link displaying an Internet address that looks 100 per cent correct (unless you're a spoilsport and right-click to display its actual properties).

The inevitable result is that any information you then enter is used to siphon money from your bank account or place credit card orders that you may not even notice if, like many people, you don't scrutinise your statements in depth.

Phishing scams are becoming ever more sophisticated, weaving their way through a complex trail of genuine and false web pages, fooling many victims along the way. There's one very easy means of testing the authenticity of an identity check, however. If a page asks for your password, enter something bogus. If the page accepts it, you're on a phishing line and should not allow yourself to be reeled in. If the intentionally wrong password is rejected, you're on a legitimate website and can safely re-enter the correct details.

Compromised Computers

You may wonder who directs these phishing operations and although few of the masterminds have been apprehended,

most are believed to be in eastern Europe. The mass-mailing of bogus emails is performed by an expanding number of "zombie" PCs known as "botnets". The computers themselves belong to innocent but ignorant people who have not installed up-to-date antivirus software. Worms such as MyDoom and Bagle, also Trojan programs such as Phatbot, open a "back door" to their computers, allowing them to distribute virus-infected emails, spam or even distributed denial of service (DDoS) attacks under another person's control and without the owner's knowledge.

According to the messaging security appliance firm CipherTrust, just under a third of the zombie computers are located in the USA. Some 16 per cent belong to South Koreans and the remainder are in Europe and the rest of the world. The crooks are clever enough to use compromised computers in Europe for messages relating to European banks and so on.

Charitable Thoughts

This Christmas-time and New Year your mind will be off the normal rat-race, inclined instead to thoughts of peace and goodwill to all men. It may be a welcome break for you and me but for the low-life of the Internet it will be business as usual. What's more, for them the New Year brings all manner of new opportunities to make money while creating misery for others. Extortion is one of their new ventures.

A short while back the BBC reported that one online betting website Blue Square had received threats from criminals to send out emails in its name containing images of child pornography unless the firm paid up 7,000 Euro (£4,863). This was reinforced with a virulent DDoS assault and is by no means the first time companies have been threatened.

Court in the Act

DDoS attacks can be used very effectively to disable e-commerce websites, especially if botnet PCs are used. One such attack took place last summer, when three men believed to have masterminded an extortion attempt of this kind were arrested in a joint operation involving Britain's National Hi-Tech Crime Unit and counterparts in the Russian Federation. A month later the first-ever case involving the use of sophisticated DDoS attacks directed against business rivals came to court.

Online news service The Register (www.theregister.co.uk) reported that the Massachusetts-based Orbit

Communication Corporation allegedly engaged computer hackers in several US states and the UK to launch computer attacks against its competitors. Orbit's chief, who faces a five-count federal indictment, is now on the run.

Password Scam

Another deception is the eBay page that asks you to reconfirm your password. Relieved they are not being asked their credit card details, many people willingly provide the simple information requested.

Bad move! The next thing you know is when you want to place a bid and find your eBay password is rejected; someone has thoughtfully changed it, meaning you can no longer manage your account. Next you receive dozens of emails from people congratulating you on the Buy It Now offers you have won and you find yourself owing some angry people a lot of money. Not very nice.

Loyalty Pays?

If you're convinced your accounts are secure, what about your personal data? If you have a Tesco (or similar) store loyalty card, have you ever considered how much information this gives away about you? The issuer knows your age, where you live, what sort of district this is, to what extent you travel around the country, how much you spend and thus what sort of income you have.

From petrol spending it knows whether you run a car and can also "data mine" its records to discover whether you have a dog, cat or children. It knows whether you are a smoker, drink alcohol or have a chocolate addiction, which type of music you buy, the kind of DVDs you enjoy, plus far more information that enables it to build up an inspired profile of the kind of person you are. Armed with this, it can send you targeted mailings that will always appeal to you and may well lure you into further spending!

Loyalty cards are in fact a dream ticket for retailers and "dream ticket" is the actual phrase used by David Simons, who co-ordinated the Advantage Card for Boots The Chemists. In his words, "Retailers gain not only loyalty to their outlets but also priceless data on consumption habits. The card gathers this data perfectly and there's a secondary benefit in that the card drives sales into the stores. Best of all, the sales generated by the loyalty mechanism pay for the data you collect."

Never forget, you provide all this information willingly in return for a discount of a penny in the pound!



BS2-IC



BS2-SX

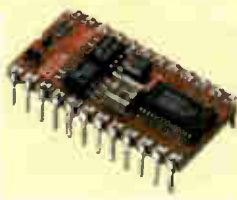

BS2E-IC



BS2P/24

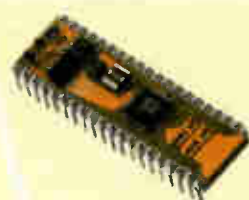

BS2P/40

Parallax BASIC Stamps - still the easy way to get your project up and running!



**Serial Alphanumeric and Graphic Displays,
Mini-Terminals and Bezel kits**

www.milinst.com



Animated Head



3-Axis Machine



Six-Legged Walkers



Robotic Arms



Bipeds

Robotic models for both the beginner and the advanced hobbyist



Servo Drivers



Motor Drivers



On-Screen Displays



DMX Protocol



U/Sound Ranging

Animatronics and Specialist Interface-Control Modules



Quadravox
MP3 & Speech Systems



SensoryInc
Voice Recognition



Parallax
Ubicom Tool Kits



Tech-Tools
PIC & Rom Emulators

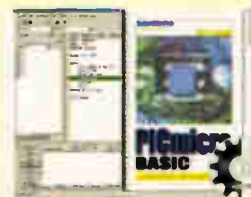

BASICMicro
PIC BASIC Compilers

Development Tools

Milford Instruments Limited Tel 01977 683665, Fax 01977 681465, sales@milinst.com

Circuit Surgery

Alan Winstanley and Ian Bell

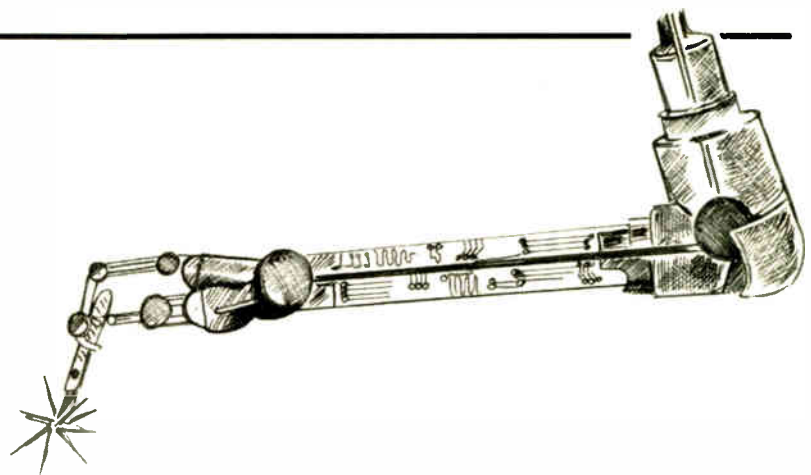

Our surgeons put the Universal Serial Bus (USB) under the microscope in a short series describing the ubiquitous PC serial connection in depth

LAST month we introduced the Universal Serial Bus (USB), which is the popular and versatile serial port connection found in most modern PCs. We also looked at related power supply issues. This month we continue our *Circuit Surgery* USB mini series with a look at the signals used in USB data transfer.

Before we start, however, recall from last month that the raw transfer rates for USB 1.1 are 1.5Mbits/sec (referred to as **Low Speed** operation) and 12Mbits/sec (referred to as **Full Speed** operation). USB 2.0 adds 480Mbits/sec (referred to as **High Speed** operation).

USB Data Transmission

Universal Serial Bus data is not transferred in a continuous stream, but is broken up into "packets". The packets start with a synchronisation pattern (to allow the start of a packet to be reliably identified) – see Fig.1. This is followed by a code, called the **Packet Identifier** or **PID**, which identifies the type of packet being sent. The PID may be followed by a peripheral device address and/or device data depending on the type of PID.

Most of the PIDs relate to the protocol or "handshaking" by which the host and peripherals communicate in a controlled and well-defined manner. There are two PIDs for the actual data which are alternated to facilitate the detection of lost data – so if the same data PID is received twice in a row then a data packet is known to have been lost.

Table 1: Some USB 1.1 Packet Identifiers

PID	Description
SETUP	Setup info for addressed USB device. Transmitted by Host
ACK	Acknowledgement of receipt of error free packet. Transmitted by Host or Device
NACK	Receiver is unable to accept packet. Transmitted by Host or Device
SOF	Start of frame. Transmitted by Host
DATA0	Even data packet. Transmitted by Host or Device
DATA1	Odd Data packet. Transmitted by Host or Device
IN	Host is accepting data from addressed USB device. Transmitted by Host
OUT	Host is sending next data packet to addressed USB device. Transmitted by Host

For reference, some of the packet identifiers used in USB 1.1 are shown in Table.1. The higher speed USB 2.0 adds further PIDs to those defined in USB 1.1.

USB uses serial data communication over two data signals called **D+** and **D-**, which form a twisted pair inside the USB cable. These are usually used in differential manner – that is, when one is high the other is low.

The signal voltages for Low Speed and Full Speed are 3-3V, but for high speed a much lower level of 400mV is used to keep the transmitted power low. Differential signals are used because they are far less susceptible to external interference than single-ended signals. Note that, as we saw last month, the USB

Table 2: Signal Condition

D+	D-	State
Low	Low	SE0 (single-ended zero)
Low	High	K
High	Low	J
High	High	SE1 (single-ended one)

power wire carries 5V whereas the signals are at 3-3V or 400mV.

The use of the two wires D+ and D- means that the signal wires can be in one of four states as shown in Table 2. The J state is used for idle conditions (no data being sent) and for data 1s the K state is used for data 0s. The SE0 state indicates the end of a packet and bus reset. The synchronisation pattern at the start of each packet is KJKJKKK. USB 2.0 extends the number of states by adding J and K High Speed "chirps".

NRZI Encoding

The 1s and 0s on the D+ and D- line are not a direct representation of the data 1s and 0s to be transmitted, but instead they use a coding called NRZI – Non Return to Zero Inverted (see Fig. 2). Using this coding system, an original data 1 causes the USB bus to remain in the same state, whereas an original data zero causes the

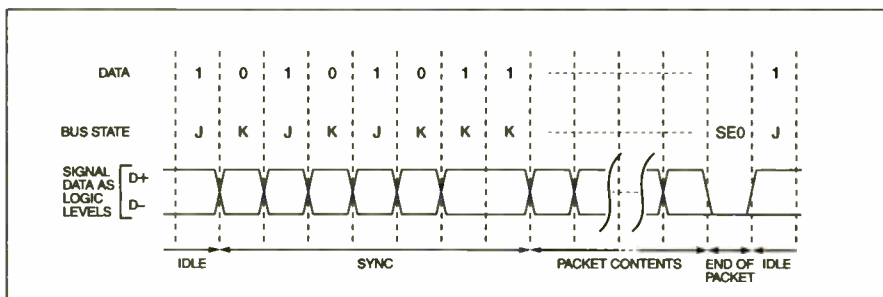

Fig.1. A USB data packet

bus to toggle (change 0 to 1, or 1 to 0 – or more correctly in USB terms J to K or K to J).

In order for the USB transceiver that is receiving the data to remain accurately synchronised with the timing of the data, it must see regular transitions in the data. If the original data is all 1s the basic NRZI code will not toggle.

To overcome this, the data is “zero bit stuffed” on every six consecutive 1s in the original data (see Fig. 3). This means that after six consecutive 1s a 0 is inserted into the data (it is not part of the real data). The stuffed bit is removed by the receiver and is not interpreted as data.

Speeding

Before a Host starts communication with a peripheral device, it has to find out what speed to use. Low Speed and Full Speed peripherals are identified by means of a pull-up resistor placed on either the D+ (Full Speed) or D- (Low Speed) – see Fig.4. This pull up resistor connects to +3.3V and has a value of 1.5kΩ. Both the D+ and D- lines in the Host are pulled low using 15kΩ resistors.

High Speed USB 2.0 connections are a bit more complicated. Initially they start in USB 1.1 Full Speed mode, but then the Host asserts an SE0 state (both D+ and D- low), which causes a reset of the device; after 3ms a High Speed USB 2.0 device will send a High Speed J chirp.

A USB 1.1 Host will ignore this, but a USB 2.0 Host will respond with alternating J and K High Speed chirps to which the device will respond by setting itself into High Speed mode. If this response is not obtained from the Host the device will operate in USB 1.1 Full Speed mode, thus maintaining compatibility with the earlier standard. In High Speed mode the 1.5kΩ pull-up resistor is disconnected so that it does not unbalance the differential data lines.

Transceiver Chips

Transceiver chips are available which can handle the signals we have been describing. These include the USB 2.0 compliant ISP1105 and ISP1106 devices from Philips – see Fig. 5. Received data is output on the RCV, VP and VM pins. Data can be transmitted in two modes (single-ended and differential) using the ISP1105 and in the differential mode using the ISP1106 via the FSE0) and VO or VMO pins.

The receive and transmit operations are summarised in Table 3 and Table 4. Further details of these devices can be obtained from the datasheet which is available as a PDF download from the Philips web site.

Table 3. ISP 1106 Transmit Operation

VMO	VPO	Transmitted Data
0	0	SE0
0	1	Differential 0
1	0	Differential 1
1	1	Illegal

Table 4. IPS1106 Receive Operation

Received on D+, D-	RCV	VP	VM
0	0	0	1
1	1	1	0
SE0	Previous RCV	1	1

Our discussion here has covered several of the key aspects of the electrical signals and low-level protocols involved in USB operation. However, this is far from the whole story even at this level; and after that there is the software and “higher level” protocols to worry about as well.

For the hobbyist, devices such as the Philips transceiver are

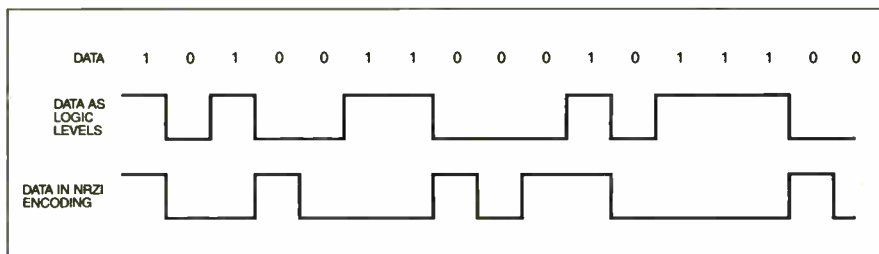

Fig.2. Non Return to Zero Inverted (NRZI) encoding of data – a logic 0 toggles the USB bus

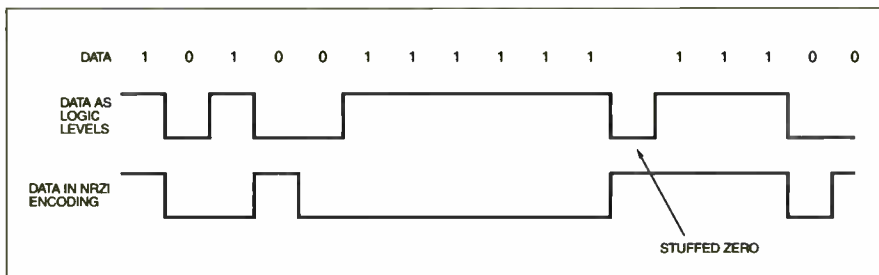

Fig.3. Zero bit stuffing – every sixth 1 is followed by a stuffed 0

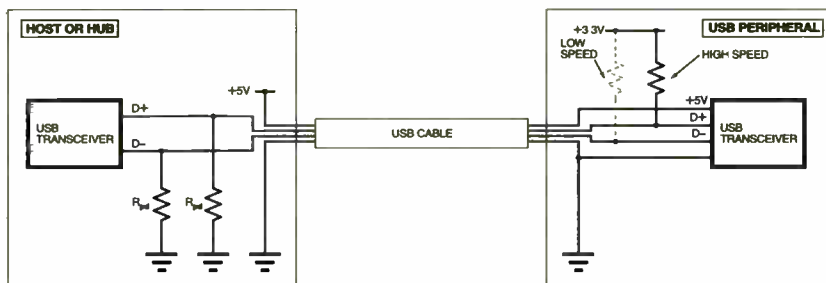

Fig.4. High and Low speed operation. High speed USB peripheral has a pull-up resistor on the D+ data line. The Low speed USB uses a pull-up resistor on the D- data line. These resistors are typically 1.5kΩ. Both the D+ and D- lines in the Host are pulled low using 15kΩ resistors (R_{pd})

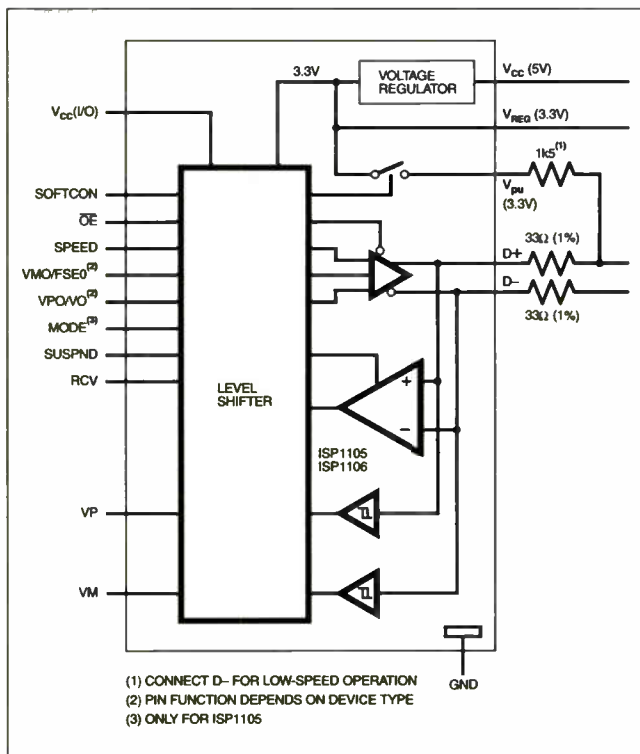

Fig.5. The internal structure and pin information for the Philips ISP1105 and ISP1106 USB transceiver chips (Courtesy Philips)



A USB hub showing four ports plus the B-type connector

possibly not very useful as they only provide the correct electrical signals and do not handle the protocol complexities. Fortunately more sophisticated devices are available which do make it feasible to use USB connections in home-brew electronics projects. *I.M.B*

Flashy L.E.D.s

Opto-electronics is one of the most fascinating and intriguing fields of modern microelectronics, and is sometimes the "trigger" that leads people to take up electronics as a hobby or career. There are many exciting trends developing in the application of l.e.d.s, starting with blue, then white and now multicolour l.e.d.s for automotive lighting, solid-state flashlights and decorative lighting as well, and these trends are set to continue with high power intelligent displays becoming available.

Our project *Versatile PIC Flasher Mk 2* (December 2004) is an interesting upgrade of an earlier design. It creates a dazzling display that can be modulated by external influences, including temperature, light, motion and

sound. The article also discusses some of the latest high brightness devices.

As with most *EPE* PIC micro-based projects, you do not need a computer or the ability to program these devices in order to enjoy building a sophisticated project that would previously have needed dozens of discrete logic devices to assemble it: most ready-programmed PIC micros are available from Magenta Electronics (buy online at www.magenta2000.co.uk). However, some may only be obtainable directly from the author – a glance at the *Shoptalk* page will usually give the purchasing details.

Regular readers of *EPE* will doubtless have been following the excellent series on the use of *Light-Emitting Diodes* written by Anthony H. Smith (Sept. 2004 on). This series starts with all the basic information that you need to know about using light-emitting diodes before describing more advanced applications, which includes surface mount devices that enable users to control l.e.d.s efficiently.

Evolution

In the 1980's integrated circuits evolved that enabled us to do clever things with new-fangled light-emitting diodes. For hobbyists, sad to say the ubiquitous National LM3909 low power l.e.d. flasher i.c., which used a single AA cell to flash a 2V l.e.d., has long been discontinued (and the writer treats his meagre stock of them like gold). The device was produced in an 8-pin d.i.l. package and found all sorts of uses.

These days, miniaturisation and industry-led demand means that specialist l.e.d. controller devices tend to be surface mount

types, but this should not deter hobbyists from trying their hand with them, using a fine tip iron. Note also that some l.e.d.s are classed as static-sensitive and require suitable handling precautions, to prevent the sensitive chips from being zapped by an electrostatic discharge (ESD).

Be sure to check out Anthony Smith's in-depth series and have ago with some of the designs, including the single-cell l.e.d. flasher circuit in the November 2004 issue: probably the next best thing to an LM3909! For experimenters, a number of voltage boost designs have appeared in *Ingenuity Unlimited* in the past: e.g. the *High-Efficiency L.E.D. Torch* (IU Oct. 2004) and the useful *Switched Mode L.E.D. Nightlight* (IU Dec. 2002). Back issues are available from www.epemag.co.uk.

Just when you think they have run out of ideas, the writer found in the electronics components section of eBay.co.uk an l.e.d. with a difference: it's a water-clear two-pin package that cycles through numerous colours and flashes as well! It contains a red, green and blue (RGB) chip to generate multicolour effects, and outputs a claimed 2,000mcd (millicandelas). The forward voltage is 3.3V at 30mA.

Unfortunately, the manufacturer's part number is unknown, as the product was repackaged and supplied by slatec.com, a modestly-sized supplier which provided a professional and conscientious service. Be sure to browse around eBay to see what's on offer today. *A.R.W.*

For rapid development of electronic systems...

E-BLOCKS™

E-blocks are small circuit boards each of which contains a block of electronics typically found in an electronic system. E-blocks can be programmed in C, Assembly and are tightly integrated with Flowcode - which instantly converts flow charts into PICmicro code.



Low cost USB PIC programmers (Starting at £27, model shown £66)



...plus a wide range of add-on boards and accessories...



.....plus incredibly easy to use software based on flow charts...

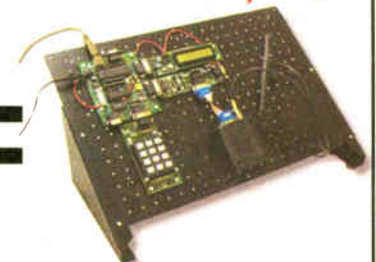

...equals extremely rapid system development: like this mobile text messaging system built from E-blocks.

...and solutions for learning and development...

Hands on training courses



training courses in PICmicro(R) programming, CPLD programming and ECAD

Resources for learning CPLD programming



Complete courses in electronics and programming



Equipment for datalogging, control and PC 'scopes



...and more at:



...see www.matrixmultimedia.co.uk

Matrix Multimedia Limited
sales@matrixmultimedia.co.uk
t. 0870 700 1831 f. 0870 700 1832



the atlas SCR

- Automatically analyse Thyristors and Triacs.
- Automatically identify all three leads.
- Automatic test currents from 100µA to 100mA!

SCR100
£99

atlas SCR
model SCR100

LCR40
£69.00

DCA55
£49.00

SCR100
£99.00

Passive components, semiconductors,
power devices, network cabling
Choose your perfect analyser

New Low Prices!

limited time only

the atlas LCR

- Automatically identify Inductors, Capacitors and Resistors.
- Inductors from 1µH to 10H.
- Capacitors from 1pF to 10,000µF.
- Resistors from 1Ω to 2MΩ
- 1% Basic accuracy.
- Automatic frequency selection.



LCR40
£69

"Star Pack"
LCR and DCA
in carry case
£118.00

Carry cases
£15.00

SMD Tweezer
Probes for LCR
£19.00

Spare Battery
£1.75

accessories & carry cases



Semiconductor Analysis

ESR Measurement



model ESR60
available December 2004

£49



model DCA55

Cat5 Cable Testing

£79



model UTP05

www.peakelec.co.uk

all prices include UK Delivery and VAT

Don't just test it...
...Analyse it!

READOUT

Email: john.becker@wimborne.co.uk

John Becker addresses some of the general points readers have raised. Have you anything interesting to say? Drop us a line!

All letters quoted here have previously been replied to directly.

WIN AN ATLAS LCR ANALYSER WORTH £79

An Atlas LCR Passive Component Analyser, kindly donated by Peak Electronic Design Ltd., will be awarded to the author of the *Letter Of The Month* each month.

The Atlas LCR automatically measures inductance from 1 μ H to 10H, capacitance from 1pF to 10,000 μ F and resistance from 1 Ω to 2M Ω with a basic accuracy of 1%.



★ LETTER OF THE MONTH ★

Challenging Ideas

Dear EPE,

I wonder if anybody who charts the progress of electronics as a hobby also feels that there is a dearth of new ideas? When the DIY make-a-computer-from-a-kit craze came about, there were things like home made eprommers, the BBC computer, the programmed Red Baron box that controlled your house electronics, all sorts of MIDI option boxes. All these things seem to have fallen by the wayside.

Now with the advent of digital camera memory cards there is the opportunity for a whole range of boxes, like a standalone MIDI read/write unit, an infinitely computer programmable system, and a washing machine receiver to obsolete time-wasting mechanical timers that stand idle for ages between options.

Since the early Sinclair computer was marketed with only 1K of memory, and sold like hot cakes, a box with up to 1GB of removable memory storage space should be well worth building. By now the explosion of memory systems should have got into home TV sets, but there are not many that can store even one sub-page of Teletext; no reason why a TV set could not download the lot from all of your favourite TV channels on switch-on and let you roam at speed, is there?

But then anybody with that sort of get up and go got up and went! Don't look to

me cos I am too old to work out what a PIC chip does! Being a lateral thinker, I always was a practical adapter of someone else's brilliant ideas.

George Chatley, via email

A "dearth of new ideas", George? Well - really - I'm flabbertigasted! I feel I know you well enough to tell you to "wash your keyboard out"! I thought you had taken EPE long enough to know that we publish many new and innovative ideas. Alright, so we also re-vamp old ideas in more recent technological clothing, but there are many younger readers who have never seen such ideas and deserve to know about them, even though we "oldies" have seen countless variants across the years. We need to cater for all age groups and levels of hobbyist experience!

Quite likely your comments will provoke disagreement from a lot of our contributors who believe that they do come up with "different" ideas, and who may well take umbrage at your contrary suggestion (me included)! But then again, perhaps there may be readers who share your views. So, let's hear it - readers, who supports George, who supports us? Will battle commence?!

(But, George, we do appreciate your interest in EPE and that you frequently email me on "this, that and the other", even though not all your thoughts get into Readout!)

next may generate some correspondence) if chosen well, the newer NiCad cells do not appear to have any memory effect over and above other battery types.

In support of that last comment, I not only found it so myself, but the now defunct *Electronics Australia* magazine (back issues of EA possibly available through Australian-published *Silicon Chip* magazine which bought the rights after EA's demise) carried a technical article some years ago where the author was adamant that his research showed that the *method of manufacture* of the NiCad cells was the main deciding factor as to whether the NiCad cell would exhibit classic memory effects or not. The author went so far as to name some NiCad brands of the day which were, and were not, in his experience, subject to memory effects. I think he also pointed out where the different factories were in the world, which made the different brands.

As an aside comment, in temperate New Zealand where I live, the huge backup batteries for the telephone exchanges are the well-known lead-acid type, and it is my job to ensure that they maintain full capacity capability. I have been told that in tropical Australia the batteries used are NiCad, apparently for their superior reliability and performance in Nature's warmer spots.

Godfrey should not write off the later-generation NiCads just yet. Maybe it is simply that, for the rechargeable battery applications which are important to both Godfrey and I, NiMH happens to work out as the better compromise some of the time for both of us personally! Horses for courses, or rather, batteries for applications, as Godfrey indicated so well.

Stan Hood, Licensed Electrical Service Technician (NZ), via email

Thanks for that interesting input Stan.

PIC16F87XA Programming

Dear EPE,

Andrew Jarvis's interesting article on the PIC16F87xA family (Nov '04 *Pic n' Mix*) may give the impression that these devices *must* be programmed eight words at a time. In fact, the PIC16F87xA programming spec (Microchip document DS39589B) describes an "alternative sequence" which can be done one word at a time. While not quite as fast as the method Andrew describes, for exactly the reasons discussed in his article, it's probably easier to modify existing programming software to use this alternative sequence.

I have managed to get the alternative word-at-a-time sequence working on an 877A. There are a couple of wrinkles necessary to get it to go, but since probably relatively few readers will want to do this for themselves I won't take up valuable *Readout* space

Wart and Virus Zappers

Dear EPE,

I built the *Virus Zapper* from the March 2002 *EPE* article when it first came out (still on stripboard) but I didn't have any luck with that treatment. However, I have had a red mark on the back of my hand for some time and about two months ago it flared up to a red weal. When I read about the *Wart Zapper* in the September 2004 issue, I dug out the *Virus Zapper* and followed Thomas Scarborough's treatment routine. After six treatments of about three to four minutes each twice a day using the *Zapper* without any modifications, a scab appeared and two months later only a very faint mark is visible in bright sunlight. It really impressed me.

What also prompted me to write is the article I saw recently in the *Sunday Tribune* newspaper in Durban. The terms used sound similar to those in Aubrey Scoon's *The End to All Disease of EPE* April 2001.

Robin Harrison, South Africa, via email.

Glad the Zapper impressed you Robin! But reading the scanned copy of the newspaper clipping you sent me, I feel it would be difficult to convince me that it is not referring to one of the alleged scams to which Aubrey referred.

Batteries Again

Dear EPE,

I write in reply to Godfrey Manning's letter in *Readout* in December '04, and his question about why nickel cadmium (NiCad) batteries are still made. Godfrey has put a good case for choosing NiMH in preference to NiCad, and I have bought many NiMH myself for projects for the very reasons he chooses them.

In defence of NiCad batteries however, they are, as I understand it, superior to NiMH in terms of maintaining their capacity over a wider temperature range, they can provide a superior sudden high current surge when one needs such, they suffer less than NiMH from self-discharge and (this

describing them. But if any reader has any difficulties and would like to contact me via John.Becker@wimbome.co.uk, I'd be happy to help.

Malc Wiles, via email

Thanks Malc, I have also confirmed the one-word technique by running your software with the TK3 board. I'll send you any reader queries.

Volts Checker

Dear EPE,

Having read the *Volts Checker* (Oct '04) project I think I should bring to the attention of readers some safety aspects.

Firstly, the standard 4mm plugs and sockets used for the test leads are not suitable for mains operation. A plug could come loose or be accidentally pulled out with the possibility of it being live. Shrouded plugs and sockets should be used instead, the same as you find on a multimeter.

Not enough emphasis is given to the use of plastic nuts and bolts to hold the p.c.b. The use of metal bolts is positively dangerous in this design and must not be used.

Regarding the p.c.b., a minimum track separation of 3mm is required for operation at mains voltage. The p.c.b. must be able to withstand a voltage of 1500V peak without flashover between adjacent tracks. The reason for such a high voltage is that voltage spikes of this magnitude can be superimposed onto the mains waveform by the switching on and off of electric motors and other inductive devices. The published p.c.b. does not conform to the requirements.

Peter Hemsley, via email

Tony Smith, author of the Volts Checker replies:

Thank you for your concerns about safety. With regard to the 4mm sockets, I certainly agree that shrouded types would be preferable, and, indeed, during the development of the project I tried to locate a source for shrouded sockets that were inexpensive, easily available in single multiples, and which were small enough to fit into the case without difficulty.

By the time the article went to press, I was having problems locating a suitable part and was therefore unable to recommend an appropriate type. I'm afraid that sometimes it isn't possible to "cover all the angles", and perhaps more should have been done to locate and recommend a suitable part. Nevertheless, even though shrouded sockets weren't specifically recommended, I would draw your attention to that section of the article on p.703 which states that "Only properly insulated sockets, plugs and test leads should be fitted....."

I would certainly endorse your suggestion that plastic nuts and bolts should be used, especially as this would add an extra tier of insulation, and in this respect I would draw your attention to the bold type caution on p.701 which states that "the case must be a plastic type with no metal parts passing through it".

With regard to the p.c.b. layout, I assume that your reference to "the requirements" relates to the provisions set out in the Low Voltage Directive (LVD) and associated standards such as EN60950, EN61010, etc. These

standards set out particular requirements regarding various aspects of product safety, and although it is certainly good practice for magazine projects to follow the guidelines embodied in the standards and to comply wherever possible with their requirements, we need to be clear that they are aimed primarily at commercially-produced goods, i.e., products sold in significant volume onto the European open market. Similarly, other directives such as the Electromagnetic Compatibility (EMC) directive make specific and demanding requirements regarding a product's immunity to electromagnetic phenomena such as EMI, RFI, ESD, mains-borne interference, etc., but again these requirements apply primarily to commercial goods placed on the open market.

With this in mind, I believe it would be extremely difficult, if not impossible, to ensure that an EPE constructional project is able to comply with all requirements. This is not to suggest, however, that a project need not be designed to be safe – far from it. The standards relating to mains-powered equipment make specific requirements regarding protection against phenomena such as supply voltage interruptions, dips and fluctuations, fast transients, surge and gross overvoltage such as produced by lightning strikes, to name but a few. Meeting all these requirements for a magazine project intended to be continually connected to the mains supply for prolonged periods (such as a power supply) would be difficult enough, but to accommodate them all on a project like the *Volts Checker* which is only intended to be connected to a voltage source momentarily seemed unreasonable and would probably have introduced such complexity that the project would have become untenable.

With a magazine project, I believe it is a matter of balance between ensuring the right levels of safety whilst at the same time recognising that it may not be feasible to satisfy all of the requirements that apply to commercially designed and produced items. Therefore, I tried to steer a middle path by dealing with those aspects that I considered essential to ensure safety, such as: the proper rating of all components; the provision of a low-value, quick-blow fuse to protect against the failure of one or more components; and the advice to users not to touch the l.e.d. when testing mains voltages. Therefore, although the p.c.b. tracking may not meet all aspects of the requirements, I do not believe this makes the project unsafe provided it is properly constructed and used by a competent individual.

Nevertheless, your comments are extremely valuable in that they emphasise the need to keep safety in mind at all times when constructing and using a project that could be connected to a high voltage, and I apologise if the text perhaps did not go far enough in stressing the safety.

Anthony H. Smith, via email

Thank you Tony. I would add that when any mains-based design is published we emphasise that it should only be built by those who are suitably qualified or supervised.

8-pin PIC projects

Dear EPE,

I am one of EPE's subscribers (electronic version) and I would say you are doing a

very good job for all of us hobbyists all over the world. I can't thank you enough for all the very useful information that you have provided, and which led my interest to eventually learn about PIC programming.

I now have a basic knowledge of the PIC16F84 after self-study with the aid of Mr Becker's famous *PICutor* CD and Matrix MultiMedia's programmer V1. It helped me a lot to materialize all the projects I had in mind. Just after a couple of weeks learning I started to do my own gadgets. I was able to convert the mechanical timer of our washing machine using a PIC16F84, I built many gadgets for myself and my friends (like a universal timer, digital timer for my car, an intruder deterrent, multi-switching control module for my house lighting, with radio remote control, and some more automation for house use!

I would like to learn more using 8-, 28- and 40-pin PICs, especially the analogue/comparator features. I want to request if you can publish a project using a PIC12F675 or PIC16F628 for a Refrigerator/Air Condition Protector with the following features: time-on delay when power outage occurs; over-voltage cutout; under-voltage cutout. Using 8-pin PICs would be more interesting. Can it be done using a transformerless power supply and without external comparator?

To Mr Becker (the PIC Guru! - thanks a lot). I read somewhere on the *Chat Zone* that *Toolkit TK3* will be updated in the future. If you can, consider allowing 8-pins PICs to be programmed, at least the 12Fs. Thank you and more power...

Ferdie Fajardo, via email

Thanks for your emails Ferdie, which I have combined above. Andrew Jarvis started looking at 12F devices and TK3 through PIC n' Mix Dec '04, and continues in this issue. We have nothing in the pipeline regarding your circuit suggestion, but by quoting you here a reader might be inspired to offer us one.

Thank you very much for your kind words! There have recently been a couple of updates to TK3 (the latest is obtainable via www.epemag.co.uk), and more will follow when I complete several enhancements that I'm working on.

L.E.D. Biasing

Dear EPE,

With reference to *Light Emitting Diodes* Part 4, Dec '04, and the circuits in Fig.7 and Fig.8 - having used similar circuits as a reference source I have found that it is possible for the transistors not to switch on and hence no current in either collector.

The cheapest solution is the fitting of a resistor between TR2 base and the positive power line. This will get round what can well prove to be unreliable functioning at switch-on! I suggest that 0.5mA I_b for TR2 via this resistor would be satisfactory to get the circuit started.

P.S. Thank you for the Gray Code information (*Wind Direction Indicator*, Dec '04), which I had forgotten!

P.G. Diestler, Retired Engineer, Middleton, Manchester

Thank you very much for that helpful advice.

Gate Alarm

by Thomas Scarborough



Baffle callers to your home with this low-cost, easy-build, delayed action versatile alarm

FROM time-to-time, the author has placed electronic designs in the public domain. Recently he sought to find out which of these, over the years, had been the most popular, based on the quantity of mail received. It came as something of a surprise to him that this was a simple Gate Alarm.

This emitted a pip-pip-pip tone when a person entered the front gate. It was intended not so much as an *alarm*, as to give the impression, "You have been noticed".

The design presented here is a de-luxe version of the original – yet it remains very simple. Its chief characteristic is that the tone it emits is set apart from the action of the gate. Thus the perception is that the alarm has not been triggered by the gate. In fact during testing, people tended to look around to see how they might have been detected – not suspecting that the alarm was connected to the gate.

The Gate Alarm circuit is divided into two main sections – an oscillator section and a timer section. We shall first consider the oscillator section, which generates the sound when the gate is opened. The full Gate Alarm circuit diagram is shown in Fig. 1, but the oscillator section can be used alone if required, as described below.

Oscillator

The oscillator stage consists of two Schmitt NAND gates, IC2c and IC2d. The fact that these are Schmitt gates indicates that they have decisive switching (that is, hysteresis). As they are NAND indicates that their logic is the inverse of AND. That is, two "high" inputs cause the output to go "low", while all other combinations of inputs cause the output to go "high".

Let's assume that IC2d output pin 11 is high, causing capacitor C5 to charge through resistor R8. When the charge is high enough, IC2d's output pin 12 changes state, now going high. This in turn causes IC2d pin 11 to go low. Capacitor C5 thus discharges through R8, causing input pin 12 to now go low, which in turn causes output pin 11 to go high. This sets up an oscillation tone in piezo sounder WD1. The pitch of the oscillator may be adjusted by means of R8 and C5. Since piezo sounders have a resonant frequency, volume will be loudest at the resonant frequency, typically 3kHz to 4kHz.

Oscillator IC2d is further *gated* by means of input pin 13. This means that it may be switched on and off by pin 13.

If IC2d input pin 13 is held low, then no matter what happens at input pin 12, the state of output pin 11 remains high, therefore the oscillator is disabled. Only if input pin 13 is taken high is the oscillator enabled, producing a continuous tone.

Resistor R7 ensures that input pin 13 is normally held low, and diode D4 ensures that if it should be taken high, this will not overload IC2a output pin 3 if it should happen to be low.

Notice how piezo sounder WD1 is wired across gate IC2c. Sometimes it is assumed that such an arrangement must be a mistake. In fact as the inputs of gate IC2c go high, so the output goes low, and vice versa, so that the voltage is continually reversed across the sounder. This is called a "push-pull" configuration, and offers far better volume than if WD1 were wired between the output and one of the supply rails.

Sounder WD1 may be replaced with an l.e.d. if desired, and this is taken from IC2c output pin 10, being wired to 0V through R9, a 1kΩ ballast resistor – shown dashed in Fig. 1. The ballast resistor replaces a link wire on the p.c.b. (see later).

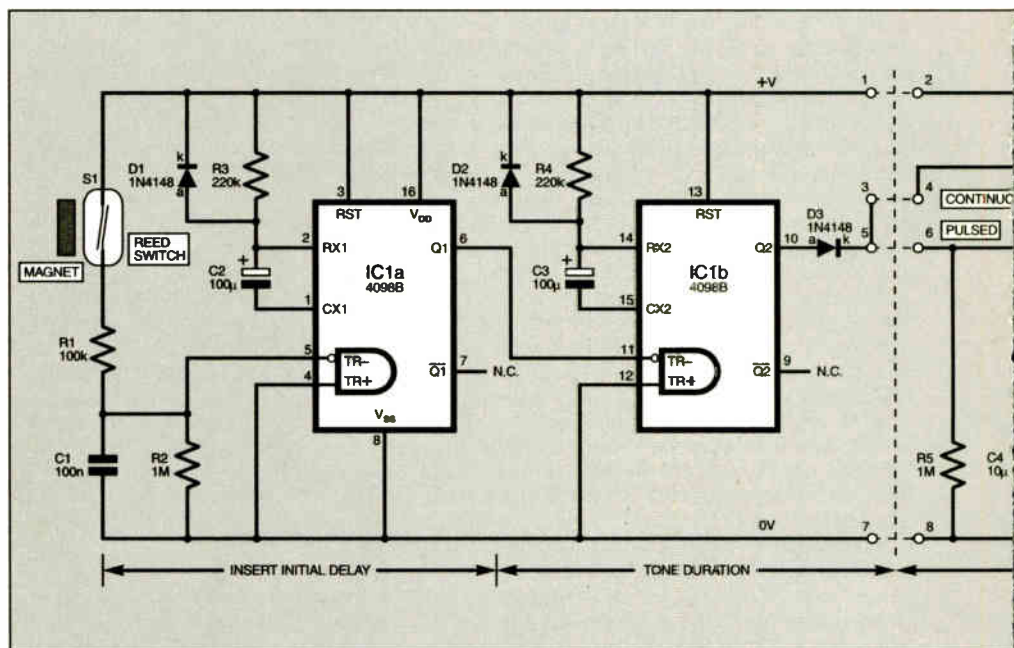

Fig. 1. Complete circuit diagram for the Gate Alarm. The circuit is divided into two



Pulsed Tone

Since it is identical in principle, oscillator IC2a/IC2b needs no further explanation, except to note that this oscillates at a far slower rate than IC2c/IC2d. Oscillator IC2a/IC2b thus switches oscillator IC2c/IC2d on and off by means of IC2d's input pin 13, creating a pulsed tone.

In a similar way to that already described, this oscillator may be enabled by taking IC2b input pin 5 high. Diode D3 (in the Tone Duration stage) serves the same purpose as D4. The switching frequency may be set by R6 and C4.

Depending on whether IC2d input pin 13 or IC2b input pin 5 is taken high, the circuit will either emit a continuous or a pulsed tone. This is accomplished by means of a normally closed switch which is wired between the input and the positive rail, activating the oscillator when it *closes*.

While normally-closed reed switches are not as common as normally open ones (a normally-closed switch closes when the gate opens), it is easy to make such a switch by strategically gluing a magnet to the gate adjacent to the switch. This serves as the simplest form of Gate Alarm, which is switched directly by the gate.

A particular advantage of this circuit is that it draws virtually zero current (just a few microamps), which means that it could be kept on standby with AA batteries for several years continuously. Alternatively, the oscillator circuit may be wired so as to be permanently enabled, with a switch interrupting the power supply.

Dual Retriggerable Monostable

To take the circuit to its full potential, an add-on, front-end, Delay Timer is included and serves to set the tone apart from the actions of the gate. The timer section thus introduces a delay *after* the gate opens, then causes the oscillator section to emit a tone. A continuous or pulsed tone may be selected, depending on how the timer and oscillator sections are inter-connected.

Depending how the timer section is built and wired up, it could, for example, cause the oscillator section to give a single pip

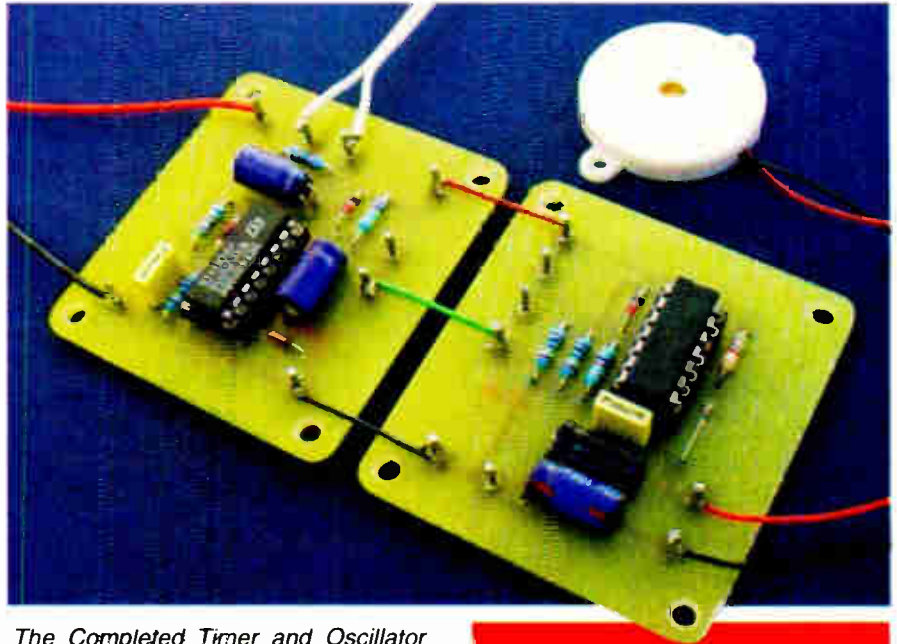

The Completed Timer and Oscillator boards interlinked to produce a pulsed output.

ten seconds after the gate opens, or a ten-second pulsed tone three seconds after the gate opens. With the component values shown in the circuit diagram, it will pause for approximately seven seconds after the gate opens, then emit a pulsed tone of about seven seconds. The duration of the pause is set by means of resistor R3 and capacitor C2, and the duration of the tone by means of R4 and C3.

The add-on delay circuit itself is quite simple. However, the CMOS device at its heart (IC1) is a complex device internally. This is a 4098 dual retriggerable monostable, which has a yet more sophisticated relative, the 4528, which is pin-for-pin compatible with the 4098 yet incorporates linear circuitry to achieve a more accurately specified period.

On the Trigger

A monostable timer, of which the 555 i.c. is the best known example, is normally non-retriggerable. This means that if, while

COMPONENTS

Resistors

R1	100k
R2, R5, R7	1M (3 off)
R3, R4	220k (2 off)
R6	47k
R8	5k6
R9	1k

All 0.25W 5% carbon film

Capacitors

C1, C5	100n polyester or ceramic (2 off)
C2, C3, C6	100µ radial elect. 16V(3off)
C4	10µ radial elect. 16V

Semiconductors

D1 to D4	1N4148 signal diode (4 off)
D5	3mm red l.e.d.
IC1	4098B CMOS dual retriggerable monostable
IC2	4093B CMOS quad NAND Schmitt

Miscellaneous

S1	normally open reed switch (with magnet)
WD1	piezo sounder (without integral oscillator)
B1	6V to 12V battery pack (AA cells), with holder and clips

Printed circuit boards available from the *EPE PCB Service*, codes 483(Osc.) and 484(Delay); 14-pin dual-in-line (d.i.l.) socket; 16-pin dual-in-line (d.i.l.) socket; twin-flex wire; link wire; solder pins; solder, etc.

Approx. Cost
Guidance Only

£15

exc. case and balls

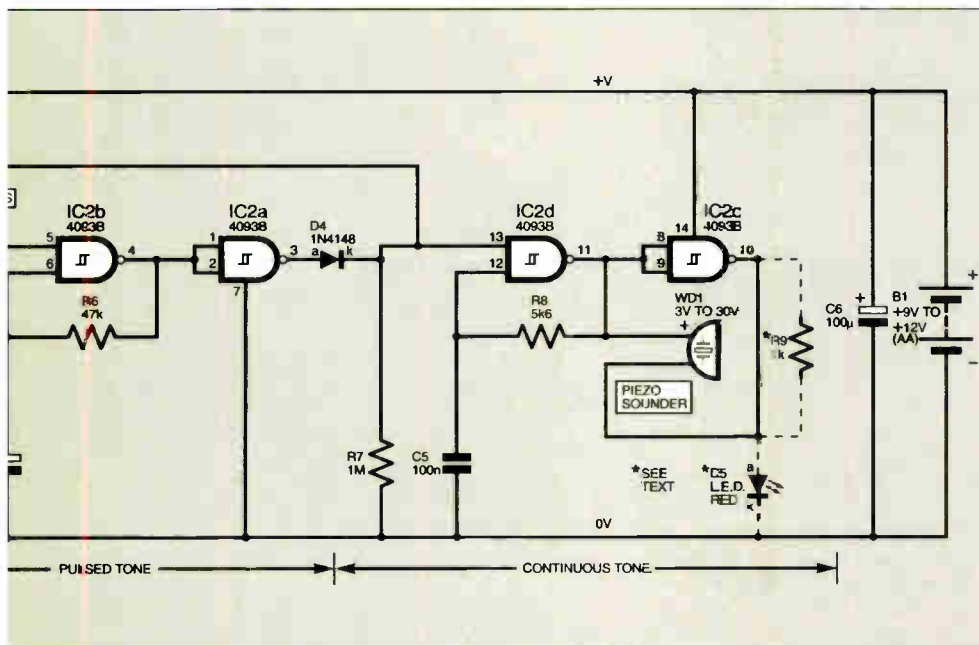

main sections; the Timer/Delay stages (IC1) and the Oscillator/Tone stages (IC2).

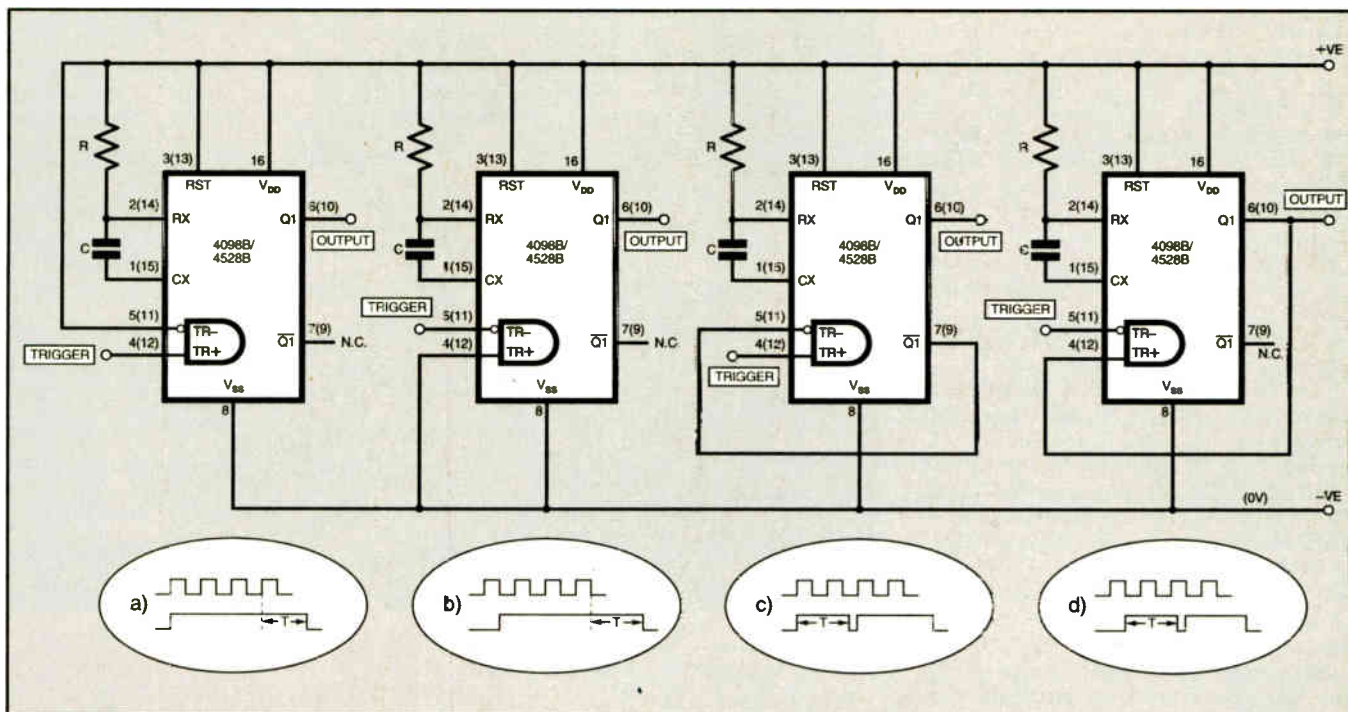

Fig.2. Modes of operation: a) leading edge triggered, retriggerable monostable; b) trailing edge triggered, retriggerable monostable; c) leading edge triggered, non-retriggerable monostable and d) trailing edge triggered, non-retriggerable monostable.

timing, it should receive a fresh trigger input, it will ignore the input. It will only respond to a fresh input once its timing period is over. In this circuit, IC1 is wired as a retriggerable monostable and is receptive to fresh trigger inputs, even while it is timing, so that it does not seem to stop-start-stop-start if, for instance, the gate is opened and closed by a number of people using it at the same time.

One of the advantages of using the 4098 i.c. for IC1 is that it can be triggered either by a leading or a trailing edge. A "leading edge" occurs when an input pin goes high, and a "trailing edge" occurs when an input pin goes "low". In this application, IC1 is so wired that the alarm is triggered only when reed switch S1 opens on opening the gate. That is, it triggers when IC1a input pin 5 goes "low".

The fact that a dual retriggerable monostable is used here has the additional advantage that the alarm does not continue to sound if the gate is accidentally left open, since it only triggers on a trailing edge. (If, however, the oscillator section alone is used, the alarm continues to sound until the gate is closed.)

Operating Modes

Monostable IC1 has four modes of operation, which are shown in Fig.2 for handy reference. In Fig.2a it is a leading edge triggered retriggerable monostable; in Fig.2b a trailing edge triggered retriggerable monostable; Fig.2c a leading edge triggered non-retriggerable monostable, and Fig.2d a trailing edge triggered non-retriggerable monostable.

Therefore, in case anyone should ask you what causes the Gate Alarm to trigger when they enter your property, you might wish to memorise the following: "It is quite simple, really. It is a dual trailing edge triggered retriggerable monostable" (as shown in Fig. 2b).

The output period of each retriggerable monostable (IC1a and IC1b in Fig.1.) is determined by capacitor C2 and resistor R3, and C3 and R4, respectively, and is equal to approximately RC seconds where non-electrolytic capacitors are used -

although this may vary considerably with the 4098 i.c. The manufacturers recommend that diodes D1 and D2 should be employed where electrolytic capacitors are used for C2 and C3.

Note that as IC1a output pin 6 goes low, so IC1b is triggered, thus enabling the oscillator at IC2b input pin 5, and generating either a continuous or pulsed tone in the oscillator section depending on which link is connected.

Reed Debounce

Resistors R1, R2 and capacitor C1 are used to debounce reed switch S1. Although in practice this was not found to be necessary, switch debouncing is added as a precaution in case a poorer quality switch should be employed.

Capacitor C1 thus "dampens" any jitter of the switch-on switching. If any trouble should be experienced in this department (particularly if the Gate Alarm should be triggered when the gate is closed), the value of C1 may be increased.

The timer/delay section is very economical with power, with the only significant

Current consumption when the oscillator is enabled is typically less than 5mA.

Note that no power supply reverse polarity protection is included in the circuit. If desired, a diode (e.g. 1N4001) may be inserted in the positive supply line for this purpose.

Construction

The Gate Alarm project is built up on two printed circuit boards (p.c.b.s), each measuring just 57mm (2.25in.) x 52mm (2in.), as shown in the layout and interwiring diagram of Fig.3. These boards are available from the EPE PCB Service, codes 483(Osc.) and 484(Delay).

The oscillator section may be built and tested first, then the timer section built and added on. As shown in Fig. 3, the Gate Alarm generates a delayed, pulsed tone when the gate is opened.

With each p.c.b., the general construction procedure should be as follows: Insert and solder in position the solder pins, the link wires (three in the oscillator section, and one in the timer section - note three links are under the i.c. sockets), the d.i.l. sockets and the resistors, followed by the capacitors and diodes (noting their polarities).

Next, solder the piezo sounder leads to its solder pins, see Fig.3. If an l.e.d. is

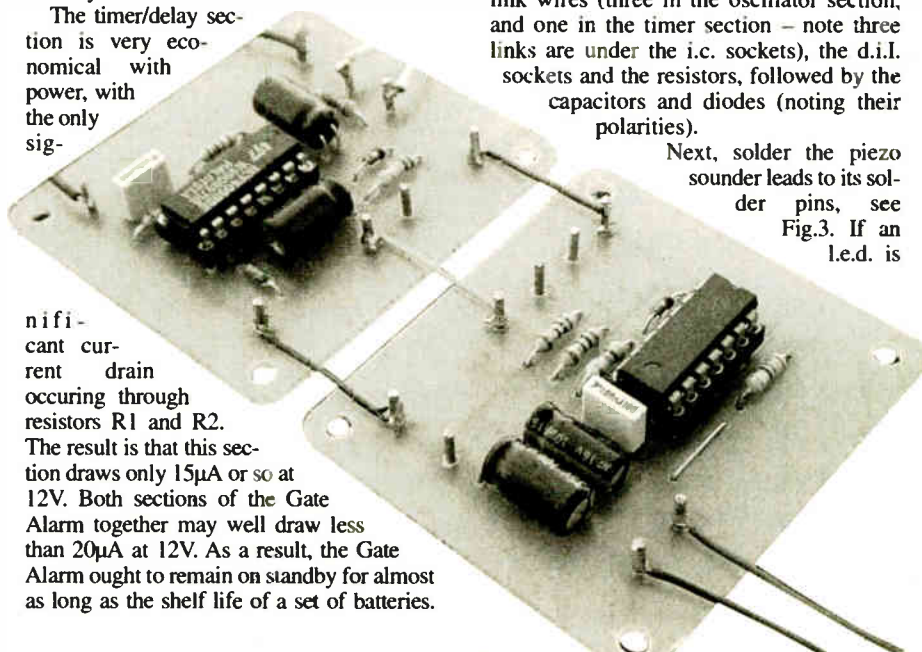

nificant current drain occurring through resistors R1 and R2. The result is that this section draws only 15µA or so at 12V. Both sections of the Gate Alarm together may well draw less than 20µA at 12V. As a result, the Gate Alarm ought to remain on standby for almost as long as the shelf life of a set of batteries.

to be used in place of the piezo sounder, replace the link wire at the right-hand side of IC2 with a 1kΩ resistor (R9), wiring the i.e.d.'s anode (a) lead to the uppermost WD1 solder pin and soldering its cathode (k) lead to the 0V solder pad below the lower WD1 pin. (The lower WD1 solder track is left unconnected).

Four options for the Gate Alarm follow:

- A *continuous tone* which is directly triggered by the gate (that is, using the Oscillator board alone).

Attach the battery clip to the power supply solder pins (Fig.3), taking careful note of polarity. Then solder reed switch S1 to solder pins 2 and 4. This circuit is triggered when switch S1 *closes*.

- A *pulsed tone* which is directly triggered by the gate (using the Oscillator p.c.b. alone).

Attach the battery clip to the supply pins, again taking careful note of polarity. This time solder switch S1 to solder pins 2 and 6. The circuit is again triggered when S1 *closes*.

- A *delayed, continuous tone* (using both the Timer and Oscillator boards).

Attach the battery clip to the main power supply solder pins on the Timer p.c.b. (Fig.3), taking careful note of polarity. Using plastic-covered wire links, connect the two p.c.b.s together at points 1 and 2, 3 and 4, and 7 and 8. In this set-up, the circuit is activated when switch S1 *opens*.

- A *delayed pulsed tone* (again using both p.c.b.s).

Attach the battery clip to the main supply solder pins, taking careful note of polarity. Using plastic-covered link wires, connect the two circuit boards together as shown in Fig.3. In this arrangement the alarm is also triggered when reed switch S1 *opens*.

Finally, insert IC1 and IC2 into their d.i.l. sockets, being careful to observe the correct orientation, as well as taking the usual anti-static precautions when handling CMOS devices (touch your body to earth immediately before handling).

If IC1 and IC2 are wired directly to their respective p.c.b.s, the entire Gate Alarm may be encapsulated in epoxy resin, thus making it virtually immune to weather conditions or abuse.

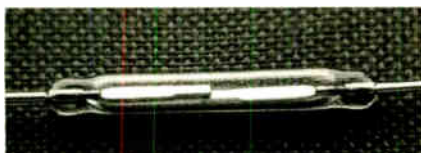

Typical glass-encapsulated reed switch, with normally open contacts

Gate Switch

It remains only to fix the necessary switch (S1) to the gate. This would most likely be a reed switch used in conjunction with a magnet, or a lever operated microswitch. If only the Oscillator section of the alarm is used, the switch on the gate should *close* when the gate *opens*. If both the Timer and Oscillator sections are used, the switch on the gate should *open* when the gate *opens*.

If a reed switch is used, this is embedded (concealed) in the gatepost, with the accompanying magnet being glued to the

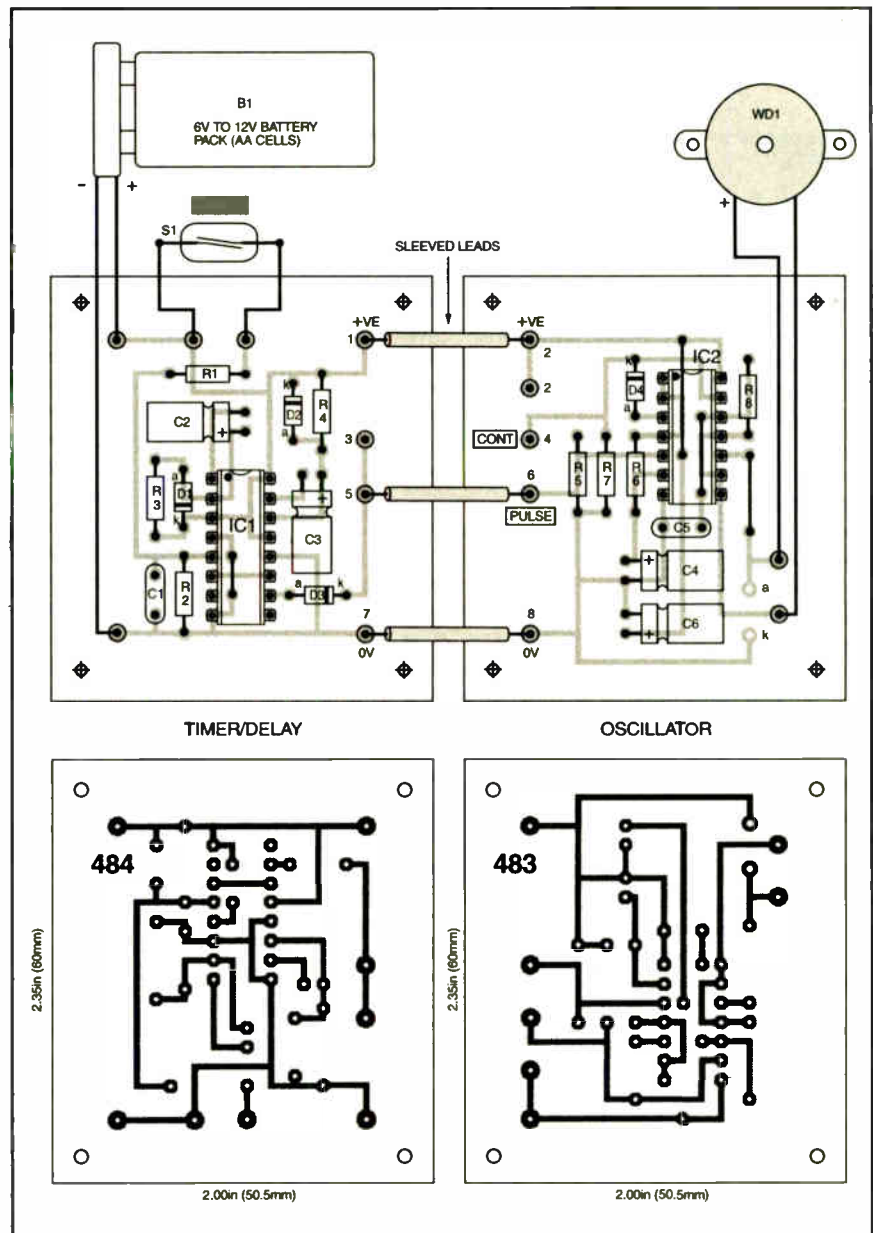

Fig.3. Printed circuit boards component layouts, interwiring and full size under-side copper foil masters for the Gate Alarm.

gate – so that when the gate closes, the magnet comes into line with the reed switch, within about 1 cm of the switch. Normally, such a magnet will *close* a reed switch when it comes near. In other words, this operation is best suited when the Timer and Oscillator sections of the Gate Alarm are used in combination, as described above.

However, a reed switch can be induced to operate in just the opposite way, if an additional magnet is glued near to the switch on the gatepost (the activating magnet is still glued to the gate as above). This option requires some careful experimentation with a continuity tester, to ensure that the switch will *open* when a magnet on the gate comes near.

Another possibility is a lever switch. A wide variety of lever-operated microswitches are available, and these usually have three terminals, with the centre terminal being a common terminal. When the lever of such a switch is depressed, two contacts close, and two open. Which close and which open when pressure is applied may be determined

with a continuity tester. Such a switch is screwed to the gate in such a way that the closing of the gate presses the lever and activates the switch.

Again, if only the Oscillator section of the Alarm is being used, this switch should *close* when the gate *opens*. If both the Timer and Oscillator boards are used, the switch should *open* when the gate *opens*.

In Conclusion

In some ways, the CMOS 4098 and 4528 i.c.s are far more versatile than the trusty 555/556 timer, yet they have been strangely neglected over the years. This article gives some basic information that would enable the hobbyist to experiment further with these devices.

To use the Gate Alarm, attach a battery or power supply, being careful to observe the correct polarity (reversed polarity could destroy the circuit).

All that remains is to amaze and baffle your friends as they ponder just how you might have detected them as they enter your property. □

PRACTICALLY SPEAKING

Robert Penfold looks at the Techniques of Actually Doing It!

THE subject of connectors is one that is covered from time-to-time in this series. It is noticeable that each time this topic is covered, the range of connectors on offer from the larger electronic component suppliers seems to have grown some more.

The "golden oldies" such as standard jack plugs and sockets are still going strong, while new applications are often accommodated by a range of new purpose-designed connectors. The sheer number of connectors, together with the numerous variations on most types, can make it difficult for beginners to find the right one.

Fortunately, most of the connectors listed in the larger component catalogues are not the type of thing that you are likely to need for a typical EPE project. You might have the occasional need for one of the more exotic plugs or sockets, but most projects use connectors from a relatively small "run of the mill" range. Even so, you still have to take due care to obtain the right type.

Jacks

The various types of audio connector are probably the most common type in EPE projects, although these are often utilised for purposes other than what could strictly be termed audio use. Jack plugs and sockets are one of the oldest types of connector, but they are probably used more today than ever before. Practically every pair of headphones, for example, is fitted with some form of jack plug. The original jack connector is the 1/4-inch (6.35mm) type, which is also known as the "standard" type.

Although large by modern standards, 6.35mm jacks are still used in modern

electronics, and they are used with electric guitars and associated gadgets such as amplifiers and effects units. They have the advantage of being very rugged.

The 3.5mm version was introduced for applications where small size was more important than toughness. There is an even smaller 2.5mm type, but this is less popular than the 3.5mm variety.

The size of jack connectors is the diameter of the plug's barrel. The difference in overall size between a standard jack and the miniature types is much more than this dimension would suggest (see Fig.1).

and type (stereo or mono), but there are one or two additional complications to consider.

Most jack sockets are available in "open" and "insulated" versions. The open type is of largely metal construction and the mounting bush connects internally to the earth tag.

The insulated type has a plastic case and mounting bush, giving no internal connection from the earth tag to the mounting bush. Also, the insulated type tends to be used where there are potential problems with earth loops, which in practice generally means guitar projects. Where an

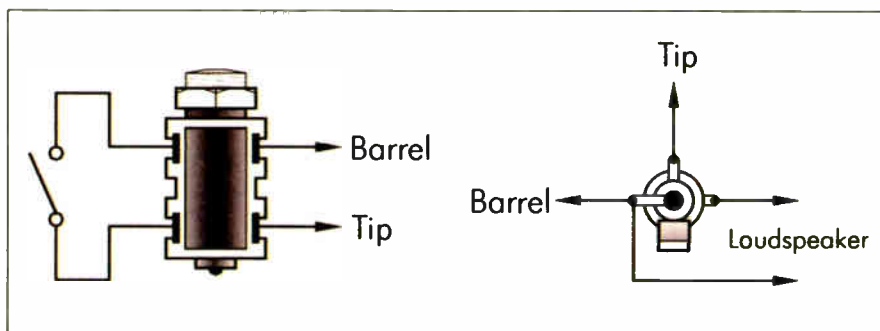

Fig.2. Connection details for an insulated jack socket (left) and an open construction miniature jack socket (right).

The range of jack connectors is doubled in size by having mono and stereo versions of each one. In the stereo version the barrel of the plug is in two sections, with the main section carrying the chassis or earth connection in the normal way. The smaller section (the "ring") is used for the right-hand connection and the tip carries the signal for the left-hand channel.

insulated jack socket is specified it is therefore best not to substitute an open construction type.

Tag This

The wiring to jack sockets can be problematic because there often seems to be too many tags. A mono jack socket only needs two tags, but open construction miniature jack sockets often have three. Insulated jack sockets often go one better and have four tags.

The additional tags are used to accommodate switch contacts that are only needed when the sockets are used for headphone outputs. The general idea is to have the internal loudspeaker automatically switched off when the headphones are plugged in. Of course, in many applications there is no internal loudspeaker, and the switch contacts and the extra tags are not needed.

The correct method of connecting an open construction miniature (2.5mm or 3.5mm) jack socket is shown in Fig.2 (right). Simply omit the two leads to the loudspeaker if the automatic switching is not required. The left-hand illustration identifies the tags of an insulated jack socket. In most cases the switch contacts are not needed, but they are simply connected into one of the speaker leads if automatic muting is required.

Open and Shut

Jack connectors are the obvious choice for many audio applications, but they are also useful as general purpose two or three way connectors. They are not suitable for use at high frequencies or with high currents. They are still suitable for many applications though, and jack connectors are used in numerous EPE projects.

When buying jack connectors it is clearly necessary to make sure that you obtain the correct size



Fig.1. The miniature jack plugs (middle and left) are much smaller than the standard type (right).

On Board

A further complication with jack sockets, and many other types of connector come to that, is that they are available in chassis mounting and printed circuit mounting (PCM) versions. The chassis mounting sockets have the usual mounting bushes and nuts so that they can be easily fitted to a chassis or panel.

The PCM type is fitted on the circuit board much like any other component, and in practice the sockets are always positioned at one edge of the board. A hole at the appropriate place in the case gives access to the socket.

Printed circuit board mounting sockets provide a neater solution, but it is essential to make sure that the sockets you use are physically compatible with

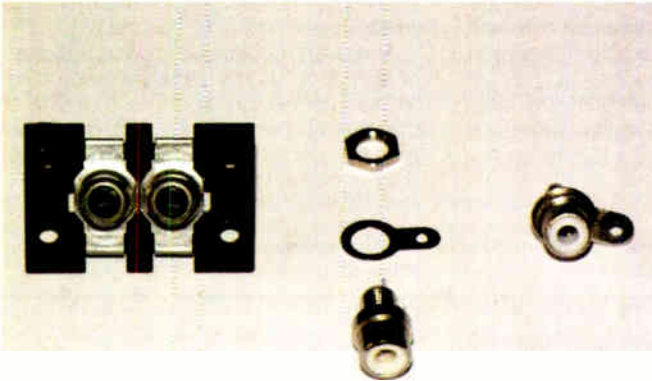

Fig.3. Phono sockets. Old style dual socket (left), disassembled single socket (middle), and assembled single socket (right).

the circuit board. There can be variations in the pin layout from one manufacturer to another. You also have to ensure that the sockets are securely fixed to the circuit board.

A fair amount of force is applied to the socket each time a plug is inserted into or removed from it. Problems with partially detached PCM sockets are not exactly unknown with commercial equipment, and will certainly arise with home constructed equipment if due care is not taken.

Large PCM connectors usually have provision for mounting bolts, but smaller sockets mostly rely on some extra pins. Make sure that the socket is flush against the circuit board before soldering it in place. Use plenty of solder for any large pins that are used primarily as a means of fixing the socket to the board.

It is worth bearing in mind that it is possible to use a chassis mounting socket where a board is designed to take a PCM type. This makes it easier to "do your own thing" with the mechanical side of construction, but the wiring from the socket to the board should be kept quite short. Also, make sure that the wiring carries the connections through to the socket correctly. It is easy to get a couple of crossed wires when doing this type of thing.

Phono Connection

A phono connector is a simple two-way type intended for audio applications, but this type of connector is also used with video equipment and for other high frequency applications. Strangely perhaps, this monophonic connector is the nearest thing to a standard connector for hi-fi systems. Stereo signals are accommodated by using pairs of phono connectors and twin (figure-of-8 style) connecting leads.

The old type of phono socket has one or more sockets on a panel made from an insulating material (see Fig.3 left). A mounting hole of about 9.5mm in diameter is required for each socket, and two or more smaller holes are required for the fixing bolts.

These days it is more usual for the sockets to be individual types that require a single mounting hole of about 6.35mm in diameter. The fixing nut fits over a large solder tag, and the latter provides the socket's chassis (earth) connection. A disassembled socket (middle) and an assembled type (right) is shown in Fig.3.

Normally a softly, softly approach is recommended with things like tightening mounting nuts for panel mounting components. However, modern phono sockets tend to work loose in use, and the mounting nuts therefore have to be tightened as much as you dare in order to mount them securely. Use a little common sense though, since using all the force you can muster is almost certain to shear the thread.

What a DIN

The range of DIN connectors has steadily grown over the years, and a bewildering array of them are now produced. The simplest type is a two-way connector intended for loudspeaker outputs of small audio power amplifiers. All the other DIN sockets are intended for low power audio use, and there are various types offering up to eight-way operation.

The original DIN connectors are about 12mm in diameter, but there are now miniature versions that are only about

half that size. These are used with computer mice and keyboards, digital cameras, and many other types of equipment.

You'll find that DIN connectors are used in projects less frequently than the jack and phono varieties, but they turn up in test equipment, audio gear, etc. The standard connector for the MIDI interface used with electronic musical instruments is the 180 degree version of the five-way DIN connector. This seems to be the only common use for DIN sockets in electronic projects.

When dealing with DIN connectors you have to be very careful to obtain the right type. For example, there are at least three different and incompatible 5-way DIN connectors, see Fig.4. Printed circuit mounting DIN sockets are available, but the chassis mounting type remains the most popular. These require a main mounting hole that is 12.5mm in diameter, and two smaller mounting holes for 6BA or M3 mounting bolts, see Fig.5.



Fig.4. The range of DIN connectors is vast. These are all 5-way DIN plugs. From left to right they are 240°, "Domino", and 180° plugs.



Fig.5. A chassis mounting DIN socket requires a main 12.5mm mounting hole and two smaller holes for the 6BA or M3 mounting bolts.

Making the connections to DIN plugs can be a bit awkward, especially when using types that have five or more ways. The task is much easier if the plug is held in a small vice or fixed to the worktop using Bostik Blu-Tack. When connecting leads to any plugs it is important to make sure that the ends of the wires and the tags of the plugs are well tinned with solder first.

When soldering the connections it is necessary to take due care to avoid short circuits between the tags, since there is very little gap between them.

This problem is common to practically all modern plugs. With DIN plugs and jack plugs always fit the plastic covers onto the lead before starting to connect it to the plug.

With DIN, jack, and most audio plugs there are a couple of metal grips that can be squeezed onto the cable using a pair of pliers, and this provides a simple but effective form of strain relief. When using a screened cable, having the screen exposed to the strain relief grips provides a connection between the screen and the chassis of the plug. However, it is advisable to ensure that a reliable connection is obtained by using some solder as well.

The Rest

Coaxial connectors, or "coax" connectors as they are more usually called, are intended for high frequency applications such as television aerials. The 75 ohm type is the most common, and they are sometimes used with test equipment as a low-cost alternative to BNC connectors. The latter is a high quality coaxial connector that has a bayonet fitting plus a locking ring. BNC

connectors are often used with test equipment such as oscilloscopes and digital frequency meters. Connecting leads to BNC plugs can be quite difficult, but this is not usually necessary. Ready-made BNC test leads as used with oscilloscopes, etc., are readily available.

Terminal Post

The connectors mentioned so far are only suitable for carrying low currents. Power supply units, audio power amplifiers, and a few other types of project require connectors that can comfortably handle several amps.

One approach is to abandon the normal plug and socket approach, and to use some form of spring terminal or a terminal post. In the case of the latter, the bare end of the lead is placed into a hole in a metal thread, and then the front part of the terminal is screwed down onto the lead to trap it firmly in place. The other type has a pair of sprung metal jaws that "bite" the bare wire. The springs are quite strong so that the wire is gripped tightly and a good connection is made.

The main alternative to a plug-free connection is a 4mm plug and socket. This is a very basic form of single-way connector, but it is adequate for many high power applications. Note that many terminal posts "back it both ways" and can also take 4mm plugs. There are smaller (one and two millimetre) versions of these plugs and sockets, but they have much lower current ratings and should not be used when a 4mm connector has been specified.

Many ready-made electronic gadgets are powered via mains adapters, and this method is used to some extent with projects for the home constructor. An advantage of using a mains adapter is that it provides a relatively safe method of powering a project from the mains supply. You only have to deal with the safe low-voltage output of the adapter and do not have to deal with any mains wiring at all.

The main problem with these adapters is that they use a variety of so-called "power" connectors on the output side of the supply. Try to avoid anything other than the standard versions of 3.1mm and 2.5mm power connectors.



PIC12F629/75 – Programming from a 16F Perspective

THERE are surprisingly few issues to consider when developing code for the 12F629/675 PICs (which we began to look at last month), especially if you are making the move from the 16F family. Despite the obvious size difference (only eight pins), they are still mid-range, flash-based, 14-bit instruction word devices that share the same instruction set and many of the same peripheral features.

Oscillator Options

Just like the 16F628, there are eight different modes to choose from when configuring the oscillator options, and they are set via the configuration bits FOSC2 through FOSC0. But working with a device that only has a maximum of six general-purpose I/O pins it is most likely that the internal oscillator will be required – and herein lies the first important difference.

The 12F629/75 PICs are amongst a number of devices that use a special function register called OSCCAL in Bank 1 to fine tune the frequency of the internal 4MHz oscillator, and thereby "trim" any process variation. OSCCAL must be loaded by the application programmer (that's us!), with a "factory" calibration value that is unique to each PIC, and which is stored at the last location

(word) of program memory – in this case 0x3FF.

This calibration word takes the form of an instruction: `retlw <n>`, where *n* is the unique value set by Microchip during production. It is then typical to initialise OSCCAL with code similar to that shown in Listing 1.

Storing the calibration instruction in this way is not without problems, because it could be erased! It is therefore the responsibility of the device programmer to avoid losing it by

Listing 1 OSCCAL Initialisation

```
...  
banksel OSCCAL  
call 0x3FF  
movwf OSCCAL  
...
```

reading and storing the value from the PIC before erasure or reprogramming, then replacing it after the programming operation is complete. If they don't do this the value will be lost, although it can be recovered by performing a calibration procedure.

If you experience unpredictable behaviour from your 12F629/75 PICs, it's always worthwhile checking to see if the calibration instruction has been corrupted. If it doesn't

exist, and you execute code similar to Listing 1 then you are effectively calling a subroutine with no return, and bad things will happen.

The Word is Out

It is interesting to note that subsequent devices like the 12F635 do not store the information in program memory as an instruction in this way. Instead they use a calibration word (at address 0x2008) that does not participate in erase operations unless a specific sequence is executed.

It's also worth remembering that you don't have to use OSCCAL, in fact none of this is relevant if your application isn't time critical, because you wouldn't bother setting the OSCCAL register anyway – and if it is time critical (and you can spare a couple of I/O pins) you might consider against using the internal oscillator anyway.

Calibration or Restoration

Microchip application note AN250, "Auto-calibration of the PIC12F6xx Internal RC Oscillator to +/- 1%" describes one technique for recalibrating the oscillator, but it requires a function generator and an oscilloscope. There are other ways too, Tutorial 7 supplied with Microchip's PicKit1 uses a 2.5kHz reference signal generated by the on-board

PIC16C745 and generates a 5kHz test signal (details can be found in the "PICKIT1 FLASH Starter Kit Users Guide" – 40051c.pdf).

To restore a previously noted calibration instruction, or even replace it with an experimental new one, John Becker's *Toolkit TK3* software now offers a new "Calibrate OSCCAL" dialog, shown in Fig. 1.

When invoked from the "Configure PIC" screen (12F devices must be selected for the option to appear, see later), the device ID is queried to determine the PIC type and that the calibration instruction is presented. To change it simply adjust the slider to the chosen value, and then "apply". Note that this is the only way to change the instruction word at 0x3FF, during "normal" programming. *TK3* attempts to remember the pre-existing value and then replace it afterwards.

GPIO and Magic Numbers

GPIO is the bi-directional port used for the 12F PICs (with corresponding data direction register TRISIO), replacing the more familiar PORTA or PORTB registers. You may be aware of some of the pitfalls associated with PORTA on 16F devices, like CMCON and the open drain output of RA4, which is why PORTB is often a more popular choice. There is no escape this time.

Each GPIO pin is multiplexed with some other peripheral function and is not necessarily available for general purpose I/O. In some cases, like with the comparator, the default state is peripheral enabled and you must specifically switch it off if you want to use the corresponding pins (GP0, GP1, GP2) as digital I/O.

The comparator operation is controlled by the comparator control register, CMCON. To turn it off completely, bits CM2:CM0 (bits 0, 1 and 2) should be set to 1. This explains why you might sometimes see "magic numbers" during initialisation, such as the one moved into CMCON in Listing 2, for no apparent reason.

For the 12F675 only, similar action must be taken to initialise the ANSEL register, which controls the functionality of the A/D module and specifically allows you to switch between analog and digital function (pins GP0, GP1, GP2 and GP4). Clearing ANSEL sets digital I/O.

It is important to maintain the correct bits in TRISIO (which controls the direction of the GP pins) – even when they are used as analog inputs.

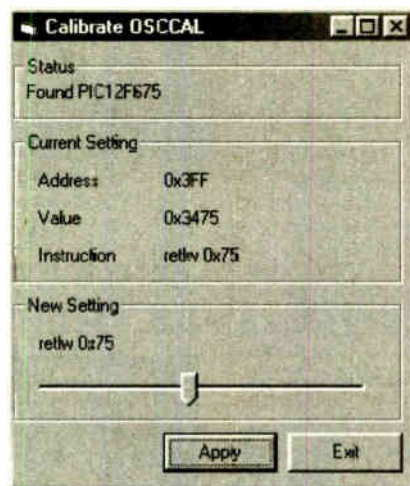

Fig.1. PIC12F629 OSCCAL Calibration in TK3

Some You Lose...

TK3 users will see that only the reading options are enabled on the configure PIC dialog for the 12F PICs, so it is not possible to toggle the bits in the configuration word, and send them to the device in the way that you can for 16F PICs.

This is because the author could not find a way to update configuration memory of the 12F PICs without first doing a bulk erase, despite the programming specification suggesting otherwise. Since bulk erase clears the entire memory, there seems little point in being able to "dynamically" update the configuration at the expense of wiping out the program memory.

(For the same reason, updating the calibration word described in the previous section, also has to perform a bulk erase – but confirmation is required before the program memory contents disappear!)

Listing 2 GPIO Initialisation

```
...
banksel CMCON
movlw 0x07
movwf CMCON
banksel ANSEL
clrf ANSEL
...
```

Config settings for the 12F's must therefore be specified in the assembly file using directives like:

```
_CONFIG h'31A4',
```

or the more symbolic

```
_CONFIG _INTRC_OSC_NOCLKOUT
& _WDT_OFF ...
```

Hopefully, this is enough information to at least get you started with 12F. More information on OSCCAL calibration (and Bandgap, which I haven't covered but which must also be preserved in the same way) can be found in the datasheets, and there are some great application notes too. For starters try "Tips 'n Tricks for 8-Pin Flash Microcontrollers" (40040b.pdf from the Microchip web site, www.microchip.com).

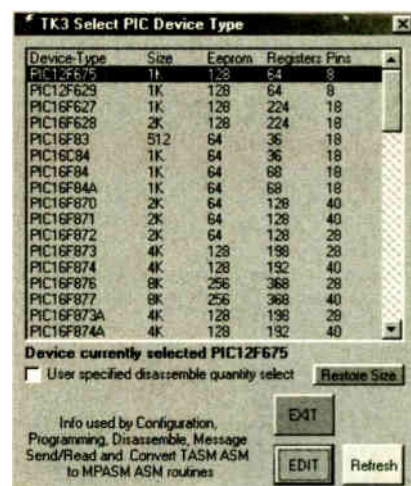

Fig.2. Amended PIC select screen

PIC Select Screen

TK3 users of version V2.24 must amend their Select PIC Type text file to use 12F629/75 devices, see Fig.2. Click the screen's Edit Button, to load the text file into Windows Notepad, then move the two lines for the 12Fs to the top, inserting them in numerical sequence. Then delete the words "not yet implemented" so that the columns are correctly aligned. Save the file and exit Notepad, then click the Refresh button now revealed. □

EVERYDAY PRACTICAL ELECTRONICS

THE No.1 MAGAZINE FOR ELECTRONICS TECHNOLOGY & COMPUTER PROJECTS

NEWSAGENTS ORDER FORM

Please reserve/deliver a copy of *Everyday Practical Electronics* for me each month

Signed

Name and Address

.....

..... Post Code

Everyday Practical Electronics is published on the second Thursday of each month and distributed S.O.R. by COMAG

Make sure of your copy of EPE each month – cut out or photostat this form, fill it in and hand it to your newsagent.

We can supply back issues of *EPE* by post, most issues from the past three years are available. An *EPE* index for the last five years is also available at www.epemag.wimborne.co.uk or see order form below. Alternatively, indexes are published in the December issue for that year. Where we are unable to provide a back issue a photocopy of any *one article* (or *one part* of a series) can be purchased for the same price. Issues from Nov. 98 are available on CD-ROM – see next page – and issues from the last six months are also available to download from www.epemag.com. Please make sure all components are still available before commencing any project from a back-dated issue.

DID YOU MISS THESE?

SEPT '03

PROJECTS • PIC-A-Colour • Vibration Alarm • Priority Referee • EPE PIC Met Office-2 • Radio Circuits-4 (Tuning Systems).
FEATURES • Using the PIC's "High" Operator • Practically Speaking • Ingenuity Unlimited • Circuit Surgery • Net Work – The Internet Page.

OCT '03

PROJECTS • RC Car Wars • Serial Interface for PICs and VB6 • Practical Radio Circuits-5 (Super Regen. Receiver) • Spooky Bug.
FEATURES • PIC Breakpoint • Ingenuity Unlimited • Interface • Techno-Talk • New Technology Update • Net Work – The Internet Page.

NOV '03

PROJECTS • PIC Random L.E.D. Flasher • Cardboard Clock • Practical Radio Circuits-6 (S.S.B. and Direct Conversion Receiver) • Anyone At Home?
FEATURES • Teach-In 2004 – Part 1 • Ingenuity Unlimited • Practically Speaking • Techno Talk • Circuit Surgery • New Technology Update • Net Work – The Internet Page.

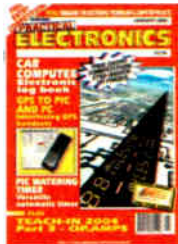

DEC '03

PROJECTS • PIC Nim Machine • Practical Radio Circuits-7 (Superhet Tuner) • PIC Virus Zapper Mk2 • Christmas Cheeks.
FEATURES • Teach-In 2004 – Part 2 • Electrotherapy • Circuit Surgery • Ingenuity Unlimited • Techno Talk • High-Speed Decimal To Binary For PICs • Interface • Network – The Internet.

JAN '04

PROJECTS • Car Computer • Practical Radio Circuits-8 (Dual-Conversion SW Receiver) • Bedside Nightlight • PIC Watering Timer.
FEATURES • GPS to PIC and PC Interface • Practically Speaking • Teach-In 2004 – Part 3 • Ingenuity Unlimited • Techno Talk • Circuit Surgery • New Technology Update • Net Work – The Internet Page.

FEB '04

PROJECTS • PIC LCF Meter • Sonic Ice Warning • Jazzy Necklace • PIC Tug-of-War.
FEATURES • Surface Mount Devices • Circuit Surgery • Teach-In 2004 – Part 4 • Interface • Ingenuity Unlimited • Techno Talk • Net Work – The Internet Page.

MAR '04

PROJECTS • Bat-Band Converter • Emergency Stand-by Light • MIDI Health Check • PIC Mixer for RC Planes.
FEATURES • Teach-In 2004 – Part 5 • New Scientist CD-Rom Review • Circuit Surgery • Techno Talk • Ingenuity Unlimited • Practically Speaking • Net Work – The Internet Page.

APRIL '04

PROJECTS • EPE Experimental Seismograph Logger 1 • Infra-Guard Monitor • Loft Light Alarm • PIC Moon Clock.
FEATURES • USB To PIC Interface • Ingenuity Unlimited • Teach-In 2004 Part 6 • Interface • Techno Talk • Circuit Surgery • New Technology Update • Net Work – The Internet Page • Pull-Out – Semiconductor Classification Data.



MAY '04

PROJECTS • Beat Balance Metal Detector • In-Car Laptop PSU • Low-Frequency Wien Oscillator • EPE Experimental Seismograph Logger-2.
FEATURES • Coping With Lead-Free Solder • Teach-In 2004 – Part 7 • Ingenuity Unlimited • Techno Talk • Circuit Surgery • Practically Speaking • Pic-N'-Mix • Net Work – The Internet Page.

JUNE '04

PROJECTS • PIC Quickstep • Crafty Cooling • MIDI Synchronome • Body Detector Mk2.
FEATURES • Clinical Electrotherapy • Ingenuity Unlimited • Teach-In 2004 – Part 8 • Interface • Circuit Surgery • Techno Talk • PIC-N'-Mix • Net Work – The Internet Page.

JULY '04

PROJECTS • Portable Mini Alarm • Bongo Box • Hard Drive Warbler • EPE PIC Magnetometry Logger-1.
FEATURES • Making Front Panel Overlays • Practically Speaking • Teach-In 2004 – Part 9 • Ingenuity Unlimited • Circuit Surgery • Techno Talk • PIC-N'-Mix • Net Work – The Internet Page.

AUG '04

PROJECTS • EPE Scorer • Keyring L.E.D. Torch • Simple F.M. Radio • EPE PIC Magnetometry Logger-2.
FEATURES • PIC To PS/2 Mouse and Keyboard Interfacing • Techno Talk • Circuit Surgery • Teach-In 2004 – Part 10 • Interface • Ingenuity Unlimited • PIC-N'-Mix • Net Work – The Internet Page.

SEPT '04

PROJECTS • EPE Wart Zapper • Radio Control Failsafe • Rainbow Lighting Control • Alphamouse Game.
FEATURES • Light Emitting Diodes – Part 1 • High Speed Binary-To-Decimal For PICs • Practically Speaking • Ingenuity Unlimited • Techno-Talk • Circuit Surgery • PIC-N'-Mix • Network – The Internet Page

OCT '04

PROJECTS • EPE Theremin • Smart Karts – Part 1 • Volts Checker • Moon and Tide Clock Calendar.
FEATURES • Light Emitting Diodes – 2 • Circuit Surgery • Interface • Ingenuity Unlimited • Techno Talk • PIC-N'-Mix • Network – The Internet Page • ROBOTS – Special Supplement



NOV '04

PROJECTS • Thunderstorm Monitor • M.W. Amplitude Modulator • Logic Probe • Smart Karts - 2.
FEATURES • Light Emitting Diodes-3 • Floating Point Maths for PICs • Ingenuity Unlimited • PE 40th Anniversary • Circuit Surgery • Techno Talk • PIC-N'-Mix • Net Work – The Internet Page.

DEC '04

PROJECTS • Super Vibration Switch • Versatile PIC Flasher • Wind Direction Indicator • Smart Karts - 3.
FEATURES • Light Emitting Diodes-4 • Ingenuity Unlimited • Circuit Surgery • Interface • PIC 'N' Mix • Techno Talk • Net Work – The Internet Page • INDEX Vol. 33.

BACK ISSUES ONLY £3.50 each inc. UK p&p.

Overseas prices £4 each surface mail, £5.50 each airmail.

We can also supply issues from earlier years: 1999 (except Feb., May, Aug., Sept., Dec.), 2000 (except Feb., Mar., July, Oct.), 2001 (except May, Aug. to Nov.), 2002 (except Feb., June, Aug. to Nov.), 2003 (except June) Where we do not have an issue a photocopy of any *one article* or *one part* of a series can be provided at the same price.

ORDER FORM – BACK ISSUES – PHOTOCOPIES– INDEXES

Send back issues dated

Send photocopies of (article title and issue date)

Send copies of last five years indexes (£3.50 for five inc. p&p – Overseas £4 surface, £5.50 airmail)

Name

Address

..... Tel:

I enclose cheque/P.O./bank draft to the value of £

Please charge my Visa/Mastercard/Amex/Diners Club/Switch £ Switch Issue No.

Card No.

Valid From Card Expiry Date Card Security Code

(The last 3 digits on or just under the signature strip)

SEND TO: Everyday Practical Electronics, Wimborne Publishing Ltd., 408 Wimborne Road East, Ferndown, Dorset BH22 9ND.

Tel: 01202 873872. Fax: 01202 874562.

E-mail: orders@epemag.wimborne.co.uk On-line Shop: www.epemag.wimborne.co.uk/shopdoor.htm

Payments must be in £ sterling – cheque or bank draft drawn on a UK bank. Normally supplied within seven days of receipt of order.

Send a copy of this form, or order by letter if you do not wish to cut your issue.

EW01/05

STORE YOUR BACK ISSUES ON MINI CD-ROMS



**VOL 11
NOW AVAILABLE**

**ONLY
£14.45 each**
including VAT
and p&p

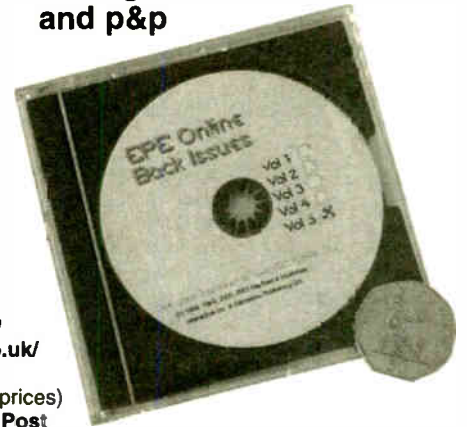

A great way to buy **EPE Back Issues** – our mini CD-ROMs contain back issues from our **EPE Online** website plus bonus articles, all the relevant PIC software and web links. Note: no free gifts are included. All this for just £14.45 each including postage and packing.

- VOL 1: BACK ISSUES** – January 1999 to June 1999
Plus some bonus material from Nov and Dec 1998
- VOL 2: BACK ISSUES** – July 1999 to December 1999
- VOL 3: BACK ISSUES** – January 2000 to June 2000
- VOL 4: BACK ISSUES** – July 2000 to December 2000
- VOL 5: BACK ISSUES** – January 2001 to June 2001
- VOL 6: BACK ISSUES** – July 2001 to December 2001
- VOL 7: BACK ISSUES** – January 2002 to June 2002
- VOL 8: BACK ISSUES** – July 2002 to December 2002
- VOL 9: BACK ISSUES** – January 2003 to June 2003
- VOL 10: BACK ISSUES** – July 2003 to December 2003
- VOL 11: BACK ISSUES** – January 2004 to June 2004

Order on-line from
www.epemag.wimborne.co.uk/shopdoor.htm
or www.epemag.com (USA \$ prices)
or by phone, Fax, E-mail or Post

NOTE: These mini CD-ROMs are suitable for use on any PC with a CD-ROM drive. They require Adobe Acrobat Reader (available free from the Internet – www.adobe.com/acrobat)

WHAT IS INCLUDED

All volumes include the **EPE Online** editorial content of every listed issue, plus all the available **PIC Project Codes** for the PIC projects published in those issues.

Note: Some supplements etc. can be downloaded free from the Library on the **EPE Online** website at www.epemag.com. No advertisements are included in Volumes 1 and 2; from Volume 5 onwards the available relevant software for **Interface** articles is also included.

EXTRA ARTICLES – ON ALL VOLUMES

BASIC SOLDERING GUIDE – Alan Winstanley's internationally acclaimed fully illustrated guide. **UNDERSTANDING PASSIVE COMPONENTS** – Introduction to the basic principles of passive components. **HOW TO USE INTELLIGENT L.C.D.s**, by Julyan Ilett – An utterly practical guide to interfacing and programming intelligent liquid crystal display modules. **PhyzyB COMPUTERS BONUS ARTICLE 1** – Signed and Unsigned Binary Numbers. By Clive "Max" Maxfield and Alvin Brown. **PhyzyB COMPUTERS BONUS ARTICLE 2** – Creating an Event Counter. By Clive "Max" Maxfield and Alvin Brown. **INTERGRAPH COMPUTER SYSTEMS 3D GRAPHICS** – A chapter from Intergraph's book that explains computer graphics technology. **FROM RUSSIA WITH LOVE**, by Barry Fox – Russian rockets launching American Satellites. **PC ENGINES**, by Ernest Flint – The evolution of Intel's microprocessors. **THE END TO ALL DISEASE**, by Aubrey Scoon – The original work of Rife. **COLLECTING AND RESTORING VINTAGE RADIOS**, by Paul Stenning. **THE LIFE & WORKS OF KONRAD ZUSE** – a brilliant pioneer in the evolution of computers. A bonus article on his life and work written by his eldest son, including many previously unpublished photographs.

Note: Some of the **EXTRA ARTICLES** require WinZip to unzip them.

BACK ISSUES MINI CD-ROM ORDER FORM

Please send me (quantity) BACK ISSUES CD-ROM VOL 1
Please send me (quantity) BACK ISSUES CD-ROM VOL 2
Please send me (quantity) BACK ISSUES CD-ROM VOL 3
Please send me (quantity) BACK ISSUES CD-ROM VOL 4
Please send me (quantity) BACK ISSUES CD-ROM VOL 5
Please send me (quantity) BACK ISSUES CD-ROM VOL 6
Please send me (quantity) BACK ISSUES CD-ROM VOL 7
Please send me (quantity) BACK ISSUES CD-ROM VOL 8
Please send me (quantity) BACK ISSUES CD-ROM VOL 9
Please send me (quantity) BACK ISSUES CD-ROM VOL 10
Please send me (quantity) BACK ISSUES CD-ROM VOL 11
Price £14.45 each – includes postage to anywhere in the world.

Name

Address

..... Post Code

I enclose cheque/P.O./bank draft to the value of £

Please charge my Visa/Mastercard/Amex/Diners Club/Maestro

£

Card No.

Card Security Code (The last 3 digits on or just under the signature strip)

Valid From Expiry Date

Maestro Issue No.

**SEND TO: Everyday Practical Electronics,
Wimborne Publishing Ltd.,
408 Wimborne Road East, Ferndown, Dorset BH22 9ND.
Tel: 01202 873872. Fax: 01202 874562.
E-mail: orders@epemag.wimborne.co.uk**

Payments must be by card or in £ Sterling – cheque or bank draft drawn on a UK bank.

Normally supplied within seven days of receipt of order.

PicoScope 3205 Review

by Robert Penfold



Robert puts Pico Tech's dual-trace PC Oscilloscope through its paces and finds that, together with its bundled software, it's easy to use and offers good value for money

THE idea of virtual test gear was still relatively new when we first reviewed a unit from the Picoscope range. For the benefit of those who are not familiar with this concept, the idea is to have a test instrument that is formed by a combination of an interface and software running on a computer. The interface has any necessary input and output sockets, and might have some controls. In most cases though, all or most of the controls are of the on-screen variety and are provided by the software.

Provided you already have a suitable computer, the virtual approach permits a sophisticated piece of test equipment to be obtained at a significantly lower cost than the real thing. The virtual approach is not just about saving money though. Having a test instrument based on a computer has its advantages, such as the ability to save results to disk, print out graphics produced by the program, and export results to a spreadsheet.

A virtual oscilloscope such as a Picoscope is basically just a high speed analogue to digital converter. There is a potential "bottle-neck" in the link between the interface and the computer, especially when using a very fast converter that can produce many millions of samples per second. Most real-world virtual oscilloscopes, including the unit reviewed here, therefore have some memory in the interface unit to provide buffering.

Seeing Double

The PicoScope 3205 reviewed here is a virtual dual-trace PC oscilloscope that is the middle unit in a range of three. The main difference between the three interfaces is their maximum effective sampling rates, which for the Picoscope 3204, 3205, and 3206 are respectively 2.5GS/s, 5GS/s, and 10GS/s.

Note that these rates are for repetitive sampling and involve some software trickery. The true sampling rates are used for single shot operation, and are much lower. In order to accurately display a waveform it is necessary to take a number of samples per input cycle. The quoted bandwidths are 50MHz, 100MHz, and 200MHz respectively.

There are no controls on the interface, but it does have three BNC sockets and an indicator light on the front panel. Two of the sockets are the main (Channel A and B) inputs, and the third is an external trigger input. The latter also acts as an output for the unit's built-in signal generator. The light switches on when the unit is active.

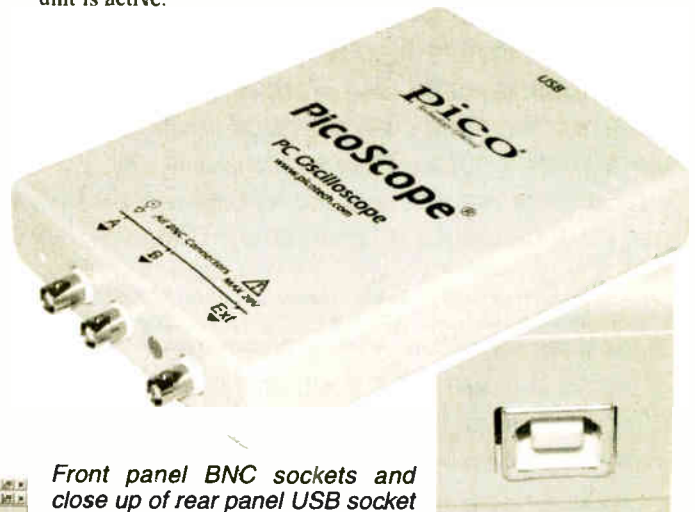

Front panel BNC sockets and close up of rear panel USB socket

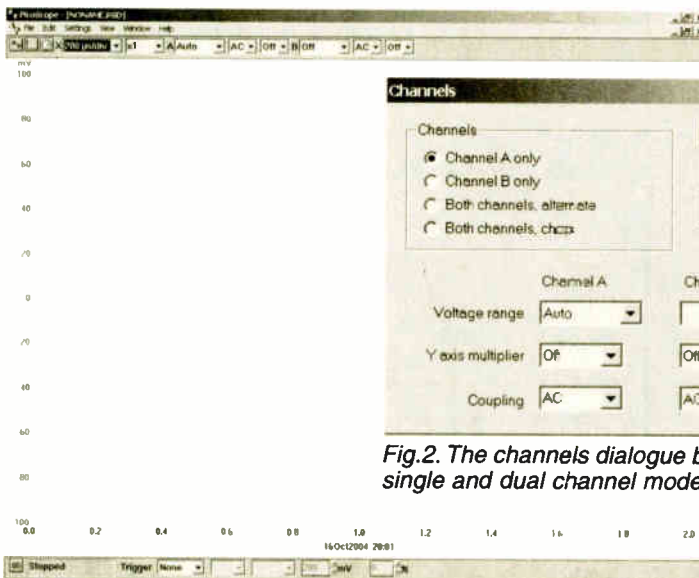

Fig.2. The channels dialogue box provides single and dual channel modes.

Fig.1. The PicoScope software uses conventional menus and toolbars rather than virtual controls.

On the rear panel there is a USB socket, and this is connected to a spare USB socket on the host computer using the supplied 2-metre cable. This is a standard USB cable of the type used with printers and scanners.

Power for the interface is obtained from the computer via the USB port. The port on the Picoscope is a high-speed USB 2.0 type, which should help to minimise any data "bottle-neck" problems. The unit is also compatible with USB 1.1 ports. Obviously, operation might not be quite as slick when using this type of USB port due to its much slower maximum transfer rate.

The interface is a neat and well made unit that measures about 185mm by 132mm by 33mm. Apart from the USB cable the only other accessory supplied is a BNC to BNC cable. Most users will also require two or three test leads of the type normally used with oscilloscopes, frequency meters, etc., but these should not add greatly to the cost.

A printed Installation Guide is included, and there is the usual online Help system that is installed with the programs. The

installation CD includes PDF manuals for the programs, and these are available in several languages.

Scope Software

The main piece of software provided with the interface is the Picoscope program, which provides the virtual dual-trace oscilloscope function. Some programs of this type have on-screen controls that look much like those of a conventional test instrument, but the Picoscope software uses conventional menus and toolbars (see Fig.1).

Virtual controls make a program more intuitive for users who have experience with the real thing, but a standard Windows-style interface is more compact and leaves masses of space to display waveforms. Also, the Picoscope user-interface is not exactly difficult to learn.

Below the title bar there is a conventional Windows menu system, and this includes a File menu that, amongst other things, permits the display area to be saved in various file formats such as JPEG. The display area can also be printed using any printer that is installed in Windows.

The Settings menu is used to access dialogue boxes that provide access to the main controls of the oscilloscope. For example, the Channels dialogue box (Fig.2) enables the user to select single

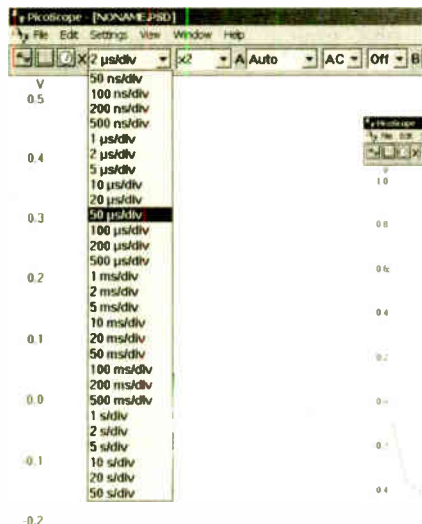

Fig.3. The tool bar has several drop-down menus. This one controls the sweep rate.

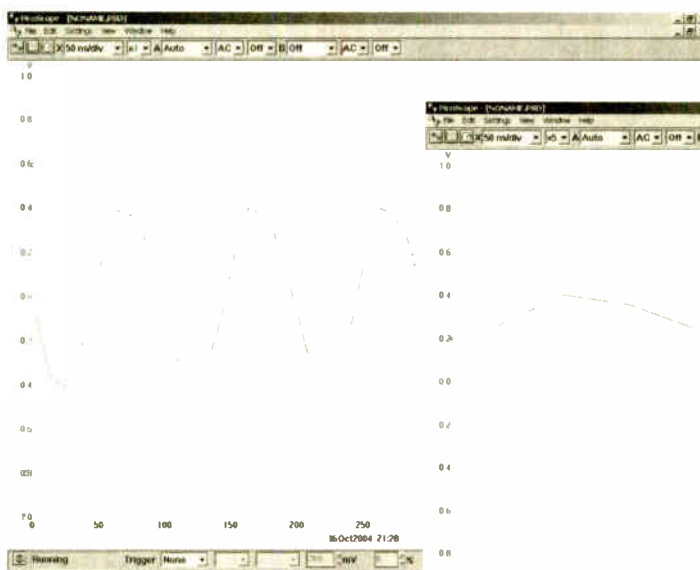

Fig.4. A 10MHz signal displayed using a sweep rate of 50ns per division.

channel operation using channel A or B, plus alternate or chopped dual trace operation. Other settings such as the sensitivity of each channel can also be set here.

Clean Sweep

Many of the controls can also be accessed via the toolbar below the main menu, which has a mixture of buttons and drop-down menus. The drop-down menu shown in Fig.3 is the time-base control, and it goes from 50ns to 50s per division. There is another toolbar along the bottom of the screen, and this controls the trigger function. There is an on/off button plus menus that provide the standard options such as triggering on the rising or falling edge, auto, repetitive, or single-shot operation, and the trigger level.

There is also an ETS (Equivalent Time Sampling) option for use with fast repetitive waveforms. This mode samples a number of cycles in an attempt to build up a more accurate model of the waveform, and effectively extend the bandwidth of the system. The fastest sweep rate is an impressive 2ns per division when using this mode.

A 10MHz signal display using a sweep rate of 50ns per division is shown in Fig.4. The sweep rate can be boosted to an effective rate of 10ns per division using the timebase's X5 feature. In Fig.5 an effective sweep rate of 10ns per division has been obtained with the aid of the ETS feature, and this seems to provide a more detailed view of the signal's waveform.

Extras

A couple of extras are available from the Picoscope software, and one of these is a spectrum analyser facility. This can have various maximum frequencies from 95Hz to 50MHz. The result of feeding the input with stray noise is shown in Fig.6, and as one would probably expect, this shows strong components at 50Hz and its harmonics. This analysis covers a range of 0 to 381Hz.

The other additional facility is a voltmeter that, like the spectrum analyser, appears in a new window. This can be used to read a.c. and d.c. voltages, frequency, and a.c. voltage with decibel scaling.

PicoLog

The software bundle includes a separate data logging program called *PicoLog*. This is inevitably less straightforward to use than the Picoscope software. Actually, *PicoLog* consists of two programs, which are the data recorder and the player. Since the recording program also has some playback facilities, it is possible to log and analyse data without resorting to the playback program. We will only consider the recording program here. The playback facilities of the two programs seem to be similar.

A certain amount of setting up is required before the recorder is ready to do anything useful, and the software includes a "guided tour" that helps to get you started. The first task is to select a filename for the new data to be saved under. Then the Settings menu plus some dialogue boxes are used to set parameters such as the rate at which data will be read, the maximum number of samples to be taken, the input voltage range, and the channel to be used.

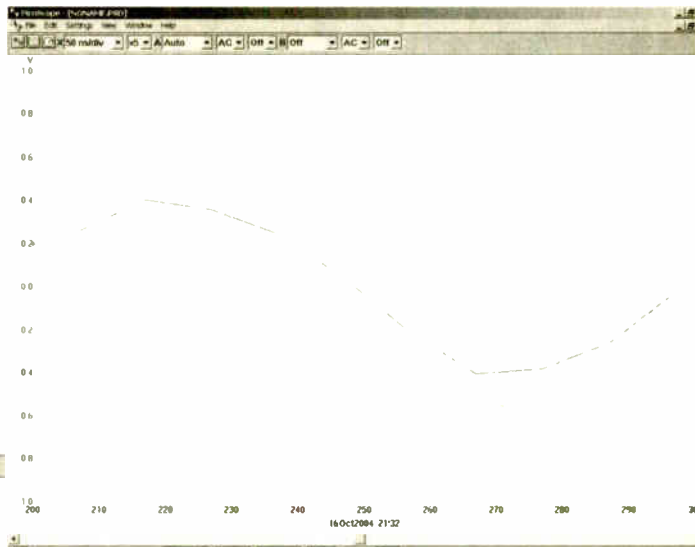

Fig.5. The 10MHz signal displayed using the ETS feature to obtain a sweep rate of 10ns per division.

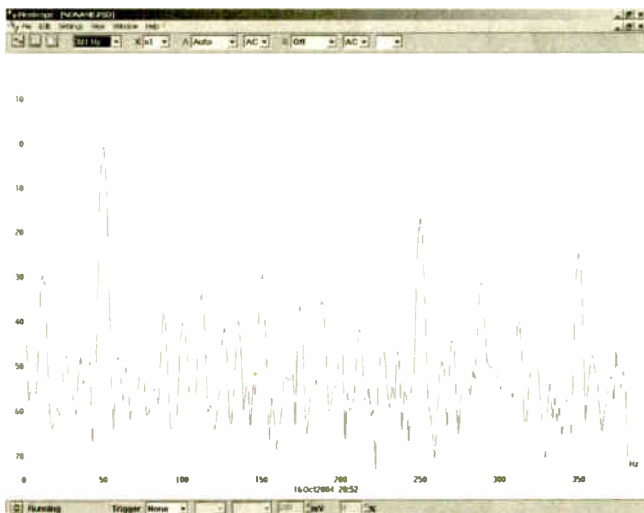

Fig.6. Spectrum analysis of stray noise showing the expected peak at 50Hz and its harmonics. The 381Hz setting was used.

With these preliminaries completed the data logging can commence, and there are tape recorder style control buttons just beneath the left end of the main menu. These provide re-record, record, pause/resume, and stop functions.

Three control buttons on the other side of the screen are used to view data. The first button launches a simple text editor that can be used for notes. The other two buttons enable the data to be viewed as a table of results or a graph. Various control buttons in the graph window enable part of the graph to be expanded for a detailed view, the graph to be printed or copied to the clipboard, etc.

Signal Generator

The built-in signal generator is controlled via the Picoscope program. It is switched on via the Settings menu, and activating it produces a small pop-up window (Fig.7). This offers a sine, square, or triangular waveform, and output frequencies from 1Hz to 1MHz or more. Inevitably, the quality of the output signal reduces somewhat at higher frequencies, but good quality signals are produced over the audio range and beyond.

The output level is about one volt peak-to-peak and is not adjustable, but obviously an external attenuator can be used to provide lower signal levels. The oscilloscope and signal generator functions can be used simultaneously. However, the trigger input is used as the output of the signal generator, so external triggering is not available when using the signal generator.

Conclusion

The minimum hardware requirements needed to run the software are not very demanding. It should all work properly if you have a PC that has 10 megabytes of spare hard disk space and runs under Windows 98 SE, ME, 2000, or XP. Obviously a vacant USB port is required as well, and the unit needs to be connected direct to the computer or via a powered hub. A passive hub is unlikely to provide the unit with sufficient power.

Although the software will run on virtually any PC, at times it seemed to place quite high loading on the 2.4GHz Pentium 4 PC used during the review. There is probably some advantage in using a fairly modern PC.

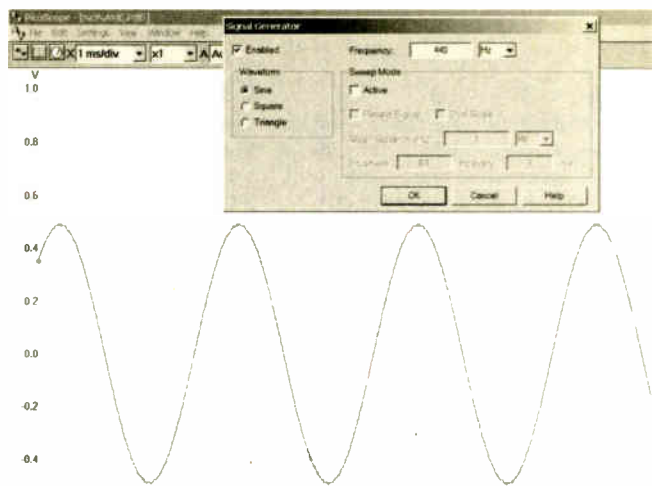

Fig.7. The built in signal generator provides a sine, square, or triangular waveform. This example is a 440Hz sinewave.

At respective prices of £399, £599, and £799 the 3204, 3205, and 3206 Picoscopes appear to be aimed more at professional users and educational establishments. Although the prices are quite high, so are the specifications. Together with the bundled software, all three units offer good value for money. The software offers some advanced features but it is still reasonably easy to use.

In a review such as this it is not possible to fully cover all the available features, and prospective buyers would be well advised to obtain the demonstration software so that they can check out the Picoscope system in detail.

For more information contact: **Pico Technology Ltd., Dept EPE, Mill House, Cambridge Street, St. Neots, Cambridgeshire, PE15 1QB, Tel. 01480 396395, Fax 01480 396296, Email: post@picotech.com.** More information, demonstration software, etc. is available from the Pico web site at www.picotech.com. □

SHOP TALK

with David Barrington

Light Detector

Apart from the MAX931CPA comparator and voltage reference chip, most of the components needed to construct the Light Detector project should be readily available from our component advertisers. The MAX931 used in the model came from Farnell (☎ 0870 1200200 or www.farnellinone.co.uk), code 632-193. Since it has the same pinout, the author suggests the LTCT440CN8 can be used as a "drop-in" replacement. It too came from the above source, code 790-904.

Although the author suggests using an opto-solator from the industry standard 4N2xx range, many other 6-pin opto-couplers, such as the CYN17 series, should work in this circuit. It should be one with a clear transparent lens/package. The small printed circuit board is available from the *EPE PCB Service*, code 481.

Speed Camera Watch

The heart of the Speed Camera Watch project is the Holux GM21 GPS module. This was purchased direct from Holux UK Ltd., Dept EPE, Navigation House, Lady Lea Industrial Estate, Lady Lea Road, Horsley Woodhouse, Ilkeston, Derby, DE7 6AZ. ☎ 0780 321 6929. Web: www.holux-uk.com/Embedded/index.htm. Quote code CM21EE for special price of £44.99, a saving of £5. We understand that they will be reviewing their prices in January 2005.

The MAX232 interface chip and the 20MHz crystal should be readily available. Some readers may experience difficulty in purchasing the 24LC64 serial EEPROM locally. If necessary you could use the 24LC256 version. If you wish to use the same case as the author this came from Farnell (☎ 0870 1200200 or www.farnellinone.com), code 605-670.

For those readers unable to program their own PICs a preprogrammed PIC16F873-20 20MHz microcontroller can be purchased from Magenta Electronics (☎ 01283 565435 or www.magenta2000.co.uk) for the inclusive price of £10 each (overseas add £1 p&p). The software is available on a 3.5in. PC-compatible disk (Disk 8) from the *EPE Editorial Office* for the sum of £3 (UK), to cover admin costs (for overseas charges see page 69).

It is also available for Free download via www.epemag.co.uk. The printed circuit board is available from the *EPE PCB Service*, code 482.

Gate Alarm

Practically all of our component advertisers should be able to offer a suitable normally – open contacts reed switch, together with an accompanying magnet, needed in the *Gate Alarm* project. The same comments also apply if you elect to use a lever-operated microswitch instead of the reed switch.

Readers should have no problems in finding and purchasing the 4093B CMOS quad NAND Schmitt i.c. and the 4098B dual retriggerable monostable i.c. They are certainly listed by Squires (☎ 01243 842424 or www.squirestools.com) and Cricklewood (☎ 0202 8452 0161 or www.cricklewoodelectronics.com). The more accurate 4528 retriggerable monostable, the pin-for-pin equivalent for the 4098, seems to be even more widely available.

The two printed circuit boards are obtainable from the *EPE PCB Service*, codes 483 (Osc) and 484 (Delay) – see page 69.

Smart Kart 4

Any possible hardware and component problems concerning the *Smart Kart SK-2* version of the buggy were reported on last month. This month's installment covers the software requirements needed to undertake the various movements detected by its additional "sensors".

The software is available on a 3.5in PC compatible disk (Disk 7) from the *EPE Editorial Office* for the sum of £3 (UK), to cover admin costs (for overseas charges see page 69). It is also available for Free download via www.epemag.co.uk.

Fully programmed PIC16F84s for SK-2 can be purchased from Magenta Electronics (☎ 01283 565435 or www.magenta2000.co.uk) for the inclusive price of £5.90 each (overseas add £1 for p&p).

Versatile PIC Flasher Mk2

Although not quite up to the claimed 5W rating for the Luxeon V white I.e.d. used in the last month's *PIC Flasher Mk2* project, we have just discovered that Jaycar Electronics have their "own brand" 1W I.e.d.s which they believe are just as bright, and at a much cheaper price. The white version is priced at just £3.60 each (this does not cover any handling or tax charges), code ZD-0416. Quite a saving on the £23 plus mentioned last month! Check out their website: jaycarelectronics.co.uk.

DrDAQ Data Logger

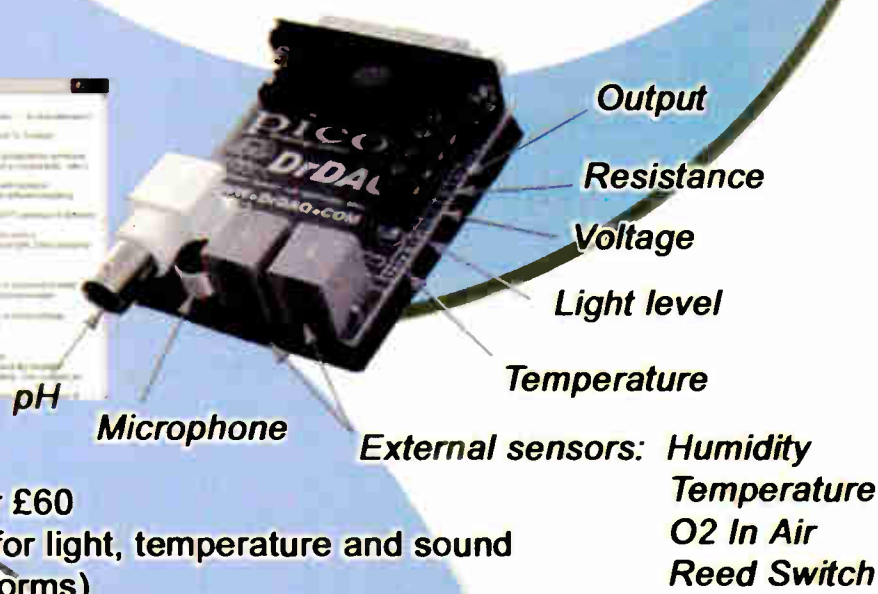
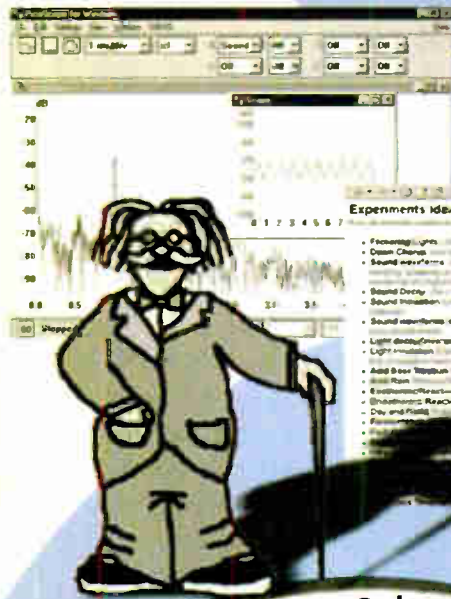

- Low cost- under £60
- Built in sensors for light, temperature and sound (level and waveforms)
- Use DrDAQ to capture fast signals
- Outputs for control experiments
- Supplied with both PicoScope (oscilloscope) and PicoLog (data logging) software

For more information on DrDAQ, please visit:

www.picotech.com/drdaq109

PC Oscilloscopes

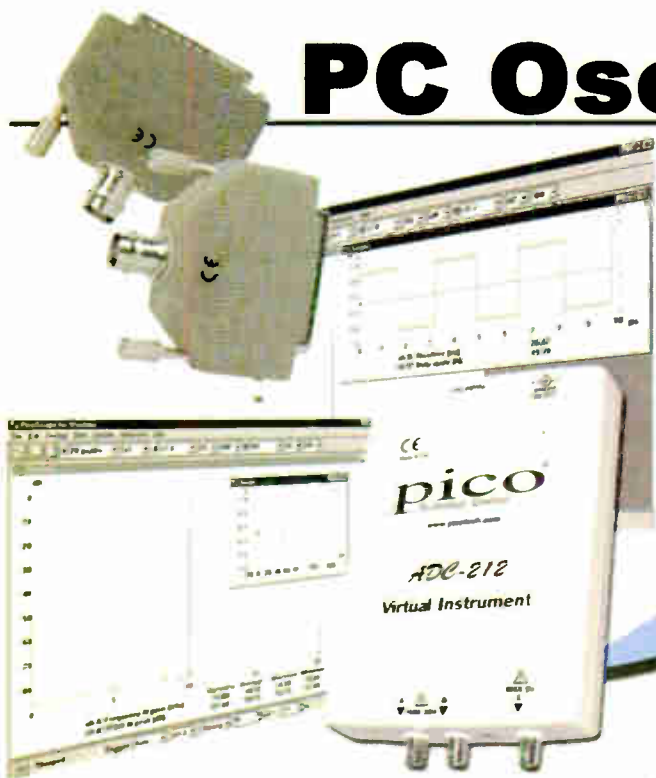

- Scope and spectrum analyser functions
- A fraction of the cost of benchtop scope
- Save multiple setups, for ease of use
- Save, print and e-mail your traces
- FREE technical support for life
- FREE software and upgrades
- Automated measurements

For more information on our scopes, please visit:

www.picotech.com/scope236

Tel: 01480 396395 Fax: 01480 396296 E-mail: sales@picotech.com

PICO
Technology Limited

SURFING THE INTERNET

NET WORK

ALAN WINSTANLEY

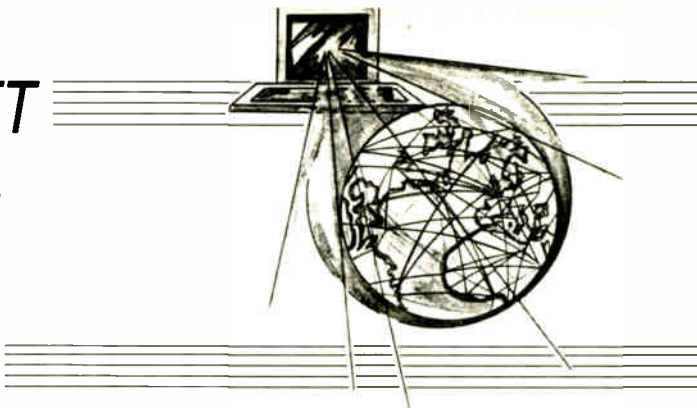

In previous *Net Work* articles, the subject of domain names has been covered in some depth, including buying and setting up domains, avoiding scams such as domain "slamming" and also the technique for transferring a domain name from one ISP to another. We also suggested a number of sources of domain names, including London-based easily.co.uk. It's simple to buy and set up domains yourself: try the Easily domain name banner advert on the *Net Work* page of the *EPE* web site, at www.epemag.co.uk.

We will continue this topic with some further considerations surrounding the buying or selling of domain names, starting with a real-life investigation of a domain acquisition and the steps taken to acquire a domain that was deliberately purchased by a mischievous buyer.

When it comes to *.co.uk* domains, Nominet goes to extraordinary lengths to remind registrants (the end-users) that they risk losing the domain if fees are not renewed. They will email and write directly with proforma invoices. If the fees are not met, a 30-day period of grace exists after which domains will be suspended – taking a web site and email service with it. After that, the domain may go on the open market. Firms such as www.detagged.co.uk and <http://yoursitehere/monitor.php> will help you track UK domains about to expire.

Irksome

Several years ago the writer was irked to discover that another party had cheekily registered the dot-com version of the *.co.uk* domain used by the writer's own firm. The domain name was of no conceivable use to anyone else but nonetheless, this surprise registration of the firm's dot-com domain had sneaked in under the radar and was worthy of some research. Eyes narrowed: how to get to the bottom of it?

The investigation started with a WHOIS lookup of the registrant's details. Dot-com information is accessible via a number of Registries, including register.com and easily.co.uk's web site as well. This highlighted details of the party (the registrant) that had registered "my" firm's name for itself.

The culprit was a limited company, so the next step was to run a free online search at Companies House (www.companieshouse.org.uk).

This revealed the names of the company directors and their location. More digging into company registration documents and it wasn't long before the picture emerged: they had purchased an off-the-shelf company name for a trivial sum (you know the sort: those meaningless duo-syllabic package names such as Throbtost Ltd.), and then changed the name to *Alan Winstanley's Own Firm's Name Ltd.* Then they bought the dot-com domain to match.

Hot on the Domain Trail

From the free data supplied online at Companies House, it was possible to deduce other details including the directors' addresses,

dates of birth and more besides and the fuller picture quickly fell into place of father and son setting up a number of holding companies. Provided that they did not work in the same market as the writer, there could be no confusion between their business and the writer's (otherwise the laws of passing off may apply), so nothing could be done except keep an eye on the domain and see if it would be re-registered when it expired, which indeed it was after two years.

Keeping a regular eye on Companies House over the years showed that the "culprit" company was not filing accounts and was about to be struck out. Fast forward to today's date and the domain name is now in the author's hands!

The purchase of an "about-to-expire" dot-com domain name can be a fast and furious affair. Previously it boiled down to a technology race lasting milliseconds, when buyers would place automated orders for expired domains. Very simply, the one with the fastest servers got in first and seized the domain name the moment it officially expired.

Snap To It

The system of capturing these domains is sometimes known as drop-catching and has now become a more orderly bidding process. Some 10,000 domains expire every day in the USA. Probably the most powerful online system for dot-com domain name capture is operated by SnapNames (see screen shot) which will monitor the change of status of domains and alert you accordingly, poised to grab it for you at the first opportunity. So for several years they kept an eye on the domain in question and notified the writer of any changes to status.

It is necessary to place a bid via SnapNames in the event that others may compete for the same name (unlikely in this case: \$100 should cover it). When the domain expired and was ready to go on the open market, it did indeed go to the sole bidder, and in a trice the domain name was transferred to the writer (more details at www.snapnames.com). SnapNames set up the domain with a new Registry.

As readers of *Net Work* will now know, it is necessary for the

author to meet the domain fees of the new Registry and also set up name server details to point it to a preferred ISP where web and email services can be provided. SnapNames also offers a *.co.uk* service but this has not been tried by the writer. Other domain grabbers include ExpireFish.com and Namewinner.com: they all operate different business models which may involve placing a bid.

Topicality

I hope you have found this in-depth briefing on domain names to be useful. If you have any comments or any particular topics that you would like to see discussed in *Net Work*, you can email alan@epemag.demon.co.uk.

SnapNames
Secure Your Domain

Log In Help

My Account | Support | About SnapNames | Partners

Get the domain name you want.
Frustrated because the domain name you really want is "unavailable"? Simply place a FREE domain name back-order below. We'll monitor it around the clock and attempt to secure it the instant it becomes available.

16,048 domain names will be deleted today – find yours!

- 1 Type in domain names you would like to back-order:
- 2 Choose extension(s):
 .com .net .org .de .info .co.uk
- 3 **SEARCH**

Network Solutions Preferred Partner for Expired Domain Names

Risk free! Try It today.



- 1 Back-ordering is risk free! Place all the orders you like at no cost. If you change your mind, you may change or even cancel your back-order at any time before we acquire the domain name.
- 2 If more than one person has back-ordered the same domain name, a brief auction will take place, with the domain name being awarded to the winning bidder.
- 3 You will be charged our low \$60 acquisition fee only if we are able to fulfill your order.

EADs

SnapNames is one of the most powerful and effective domain drop-and-catch acquirers.

PLEASE ENSURE YOU TELEPHONE TO CHECK AVAILABILITY OF EQUIPMENT BEFORE ORDERING OR CALLING.

MISCELLANEOUS CLEARANCE STOCK

OSCILLOSCOPES	POWER SUPPLY Model 12030 0-20V 0-30A - On Wheels £95	RACAL 9901 Universal Counter Timer DC-50 MHz £15
TEKTRONIX 465B Dual Trace 100 MHz Delay fitted into 19in rack frame £125	HARMER SIMMONS 5025/110 Input 240V 10A Output 50V 25A £100	RACAL 9900 Universal Counter Timer 30 MHz DC-30 MHz £15
HP 1740A Dual Trace 100 MHz delay (no lock) £40	CENTRONIC M100 Regavolt Input 240V 250 VA Output 240V 3000VA £50	WAVETEK 136 VCG/VCA Generator £20
HP 1740A Dual Trace 100 MHz Delay £60	DRAHEITZ 606 Line Distribution Analyser £35	HP 435A Power Meter - No lead no head £15
HP 1741 Dual Trace 100 MHz Analogue Storage £60	WAYNE KERR 9601 Radio Frequency Bridge £25	HP 8015A Pulse Generator £30
HP 1744A Dual Trace 100 MHz Analogue Storage £60	FEEDBACK TFA607 Transfer Function Analyser £25	HP 403B AC Voltmeter £15
PHILIPS PM3264 4 Ch. 100 MHz £125	WAVETEK 52 Data Multimeter £60	DI-LOG PR415 Phase Rotation Indicator £10
GOULD OS3000A Dual Trace 40 MHz £40	GOULD SG200 RF Signal Generator £20	MARYWOOD D2000 Digital Indicator £10
TRIO CS1040 Dual Trace 40 MHz £50	CHATILLON Force Meter £15	HP 3720A HPB Extender £10
GOLDSTAR OS9020P Dual Trace 20 MHz £50	ALFRED E105 Variable Attenuator 4-9Ghz £20	HATFIELD 2115 Attenuator 75ohm 100dB £10
HWATSU SS5702 Dual Trace 20 MHz £40	CAMMETRIC 6 Decade Resistance Box £15	HATFIELD 2118R Attenuator 75ohm 100B £10
KIKUSUI COS9020 Dual Trace 20 MHz £40	SULLIVAN CS710 Precision 5 Decade Capacitor Box £20	HATFIELD 2135 Attenuator 600ohm 100dB £20
POWER SUPPLIES	MARCONI 6033/3 Waveguide £20	TEKTRONIX 1103 Teleprobe Power Supply £10
FARNELL L30BT 0-30V 0-1A Twice £40	MARCONI 2169 Pulse Modulator £20	SYSTRON DOWNER E243A Freq Counter 20HZ-1250 MHz £35
FARNELL L30AT 0-50V 0-500MA Twice £30	MARCONI 2430A Frequency Meter 80MHz £30	LEVELL TG301 Digital Generator 1 MHz Sine/Sq/Tri £30
FARNELL L30-1 0-30V 0-1A Twice Scruffy £40	MARCONI 6950 RF Power Meter - No head £35	SOLARTRON 7045 Function Multimeter £30
FARNELL L30-2 0-30V 0-2A Scruffy £30	MARCONI 6960 RF Power Meter - No head - Digital £50	HP 4044A Leveling Amplifier £15
FARNELL L30-1 0-30V 0-1A Scruffy £20	HP X322A Variable Attenuator Waveguide £20	HP 3455A Digital Voltmeter £15
FARNELL L30B 0-30V 0-1A £25	HP 3316A Counter £50	FARNELL TMB True RMS RF Millivoltmeter £40
FARNELL L30AT 0-50V 0-500MA £20	HP 8750A Storage Normalizer £50	THURLEY 1503 Digital Multimeter £15
FARNELL C1 0-50V 0-1A - 2 Meters £30	HP 907A Co-axial Sliding Load £20	SULLIVAN 6666 Millimeter £15
Farnell TOPS1 5V 1A ±15V 200MA £35	PROGRAMMA TM2 Timer £20	K&L Tunable Bank Reject Filter £15
COUTANT LB500 2 0-30V 0-5A - 2 Meters £45	RACAL 9009 Modulation Meter £40	BAHR & STROUD EF4-01 Bank Pass Filter 1HZ-100KHZ £15
COUTANT LA200 2 0-3V 0-2A - 2 Meters £35	RACAL 9009A Modulation Meter £50	BAHR & STROUD EF4-02 LPHP Filter 1HZ-100KHZ £15
COUTANT LQT200 0-15V 0-2A - Twice £30	TEXCAN SASO 102dB in 1dB steps £15	FLUKE 8810A Digital Multimeter £30
COUTANT LQT100 0-30V 0-1A - Twice £40	BIRD Attenuator etc in box 30dB £15	FLUKE 8502A Digital Multimeter £25
COUTANT LQT5050 0-50V 0-100MA £30	BIRD B341-200 Coaxial Attenuator 20dB 40W 50ohm £25	ELECTRONIC VISUAL EV4040 TV Waveform Monitor £20
WEIR 761 0-30V 2A or 0-15V 4A £30	BIRD 61 Wattmeter 6 & 30W 50ohm 30-50MHz £40	TRACER NORTHERN TM1750 £30
WEIR 762 0-30V 2A or 0-15V 4A £30	TELEONIC TTF95-5-6EE Tunable Band Pass Filter £20	RS 555-279 UV Exposure Unit £10
WEIR 431D 0-30V 1A - 5V 4A £20	TELEONIC 190-3EE Tunable Band Reject Filter 125-250 £15	MICRODYNE CORP. Receiver £60
WEIR 400 0-30V 0.3A - 10V 1A £20	TELEONIC 95-3EE Tunable Band Reject Filter 60-125 £15	VARIAN V21-6941F1 Traveling Wave Tube Amplifier £30
WEIR 460 0-60V 0.3A - 20V 1A £20	HELPER INST CML 1 Snadder £30	MOORE READ SFC5001 AUXR Static Frequency Converter 120 Volts 400 HZ £50
HP 6266B 0-40V 0-5A 2 Meters £60	HELPER INST S103 Snadder 3 £30	DRAGER 2131 Multi Gas Detector £10
HP 6256B 0-10V 0-20A 2 Meters £95	SXP100 Parallel to Serial Converter £10	PHILIPS PM8237B Multipoint Data Recorder £20
HP 6111A 0-20V 0-1A £30	MICROMASTER LV £40	ENDEUCO 4417 Signal Conditioner X 2 £10
HP 6235A +6V 1A ±15V 200MA £25	DATAMAN S3 Programmer £30	PULSATEK 132 DC Current Calibrator £30
KINGSHILL 36V2C 0-36C 0-2A £30	RS 424-100 Logic Pulser £5	PH103B-D14 Display with 103B-N10 Network Analyser No Heads £50
MARCONI T2F158 0-30V 0-2A Twice £30	GLOBAL SQ1 Shortcircuit £20	MEGGER MJ4MK2 Wind Up 1000V Mohm £30
LAMBDA 422FM 0-40V 0-1A Twice 4 Meters £50	RS 180-7127 Conductivity Meter £35	METROMHM 250V Pat Tester £15
LAMBDA LK345A FM 0-60V 0-10A 2 Meters £75	EAGLE DC30 Probe 30Ku DC £5	SULLIVAN AC1012 4 Decade Resistance Box 0.05% £10
SYSTRON DOWNER SHR40-2 0-40V 0-2A - 2 Meters £60	AVO 100AMP Shunt for AVO 8 £5	BRANDENBURGH Q20 Static Freq Converter 110/240V input 50/60HZ Output 115V 400HZ 20VA £40
SORENSEN SRL6-4 0-60V 1-4A £60	SOUTHERN CALIFORNIA BTXRMS-S-10 2000 0 MHz £50	NARDA 706 Attenuator £10
GRENSON BPI14 - 5V 2.5A & - 15V 0.5A £25	MOTOROLA R2001D Communication System Analyser £250	ANALOGUE ASSOCIATES X800 Audio Amplifier 800watt (400w per Channel no DC Protection) £60
RS 813-991 2 x 5v 2.5A or 2 x 12V 1.5A or 2 x 5V 1A £40	WESTON 1149 Standard Cell 1.01859 ABS Volts at 20C £10	WIG PC32 PCM Channel Generator £30
RS 208-197 Line Voltage Conditioner - Output 240V 0.65A £40	MURHEAD A-6-B Resistance Box £45	SIVERS LAB 12400 - 18000 MHz £10
POWER CONVERSION PLC1000 Line Cond. 1000VA £50	RACAL 9917A UHF Frequency Meter 10Hz-560 MHz £40	SIVERS LAB 5212 2500 - 4000 MHz x C264 £10
HARLYN AUTOMATION IPP55200 System Power Supply £60	RACAL 9915M UHF Frequency Meter 10Hz-520 MHz £30	CROPCICO VS10 DC Standard 10V £30
POWERLINE LAB807 0-300V AC 0.75A £40		

EXTRA SPECIAL OFFERS

H.P. 8560A Spectrum Analyser, 50Hz-2.9GHz	£1250
H.P. 8569B Spectrum Analyser, 10MHz-2.2GHz	£1500
MARCONI 2382 Spectrum Analyser, 200Hz-400MHz	£1250
TEKTRONIX 2465A Oscilloscope, 4-ch., 350MHz	£750
TEKTRONIX 2246 Oscilloscope, 4-ch., 100MHz	£375
H.P. 8640A AM/FM Signal Gen, 500kHz-512MHz	£175

SPECIAL OFFERS

OSCILLOSCOPES	LECROY 9400A dual trace, 170MHz, 5GS	£500
Lecroy 9400 dual trace, 125MHz	£400	
TEKTRONIX 468 dual trace, 100MHz, digital storage	£300	
TEKTRONIX 475 dual trace, 200MHz, delay sweep	£250	
TEKTRONIX 465B dual trace, 100MHz, delay sweep	£250	
TEKTRONIX 465 dual trace, 100MHz, 0-lay sweep	£175	
PHILIPS PM3217 dual trace, 50MHz, delay sweep	£150	
THURLEY PL3200MD 0-30V 0-2A two- digital PSU	£160	
H.P. 66312A 0-20V 0-2A Communications PSU	£200	
H.P. 6626A Precision High Resolution PSU, 4 outputs, 0-7V 0-15A or 0-50V 0-0.5A twice, 0-1V 0-0.2A or 0-50V 0-2A twice	£500	
CIRRUS CRL254 Sound Level Meter with calibrator	£95	
80-120dB LED	£30	
WAYNE KERR B424 Component Bndp	£50	
RACAL 9300 True RMS Voltmeter, 5Hz-20MHz usable to 60MHz, 10V-316V	£50	
RACAL 9300B True RMS Voltmeter, 5Hz-20MHz usable to 60MHz, 10V-316V	£50	
AVO DA118 Digital Acometer with battery and leads	£20	
FARNELL LFMA Sine/Sq Oscillator, 10Hz-1MHz, low distortion TT, output amplitude meter	£75	
FARNELL J3B Sine/Sq Oscillator, 10Hz-100kHz, low dist.	£60	
HEMIE 1000 LCD Clamp Meter, 0-1000A, in carrying case	£35	
FLUKE 77 Multimeter 3 1/2 digit handheld with battery & leads	£45	
KENWOOD VT77B 2-Channel Multimeter	£50	
KENWOOD FL140 Wow and Flutter Meter	£75	
KENWOOD FL180A Wow and Flutter Meter	£50	
KENWOOD FL180 Wow and Flutter Meter, unused	£125	
MARCONI 6960B Power Meter with 6020 head, 10MHz-20GHz 40W	£75	
SOLARTRON 7150 DMM 6 1/2-digit True RMS IEEE	£75	
SOLARTRON 7150 Plus As 7150 ± temp measurement	£100	
IEEE Cables	£5	
H.P. 3312A Function Gen, 0-1Hz-13MHz, AM/FM Sweep/Sq/Tri/Burst etc	£200	
H.P. 3310A Function Gen, 0.005Hz-6kHz, Sine/Sq/Tri Ramp/Pulse	£60	
RACAL 9008 Automatic Modulation Meter, 1.5MHz-2GHz	£80	
ISOLATING Transformer, input 250V, output 500VA, unused	£30	
RACAL 1792 Receiver	£325	

STEWART OF READING

17A King Street, Mortimer, Near Reading RG7 3RS
 Telephone: (0118) 933 1111. Fax: (0118) 933 2375
 www.stewart-of-reading.co.uk
 Open 9am-5.00pm Monday to Friday (other times by arrangement)

Used Equipment – GUARANTEED. Manuals supplied
 This is a VERY SMALL SAMPLE OF STOCK. SAE or Telephone for lists.
 Please check availability before ordering.
 CARRIAGE all units £16. VAT to be added to Total of Goods and Carriage



DISTANCE LEARNING COURSES

- Electronic Circuits
- Digital Circuits
- Mathematics
- Electronic Testing & Fault Finding
- Programmable Logic Controllers
- Mechanics & Mechanisms

These courses lead to a **BTEC QUALIFICATION** and are suitable for beginners and those with more experience, needing to update their skills.

Register **NOW** and learn at your own pace with tutor support available to help you succeed.

For further details telephone
08456 345 445
 or visit our web site
www.oakcad.co.uk/nct.aspx



NCT is part of the OakCAD Training Group.

GSM Telemetry Solution
 - GSM technology with no range limitations -



The GSM alarm will send an SMS (text) message to the pre-programmed mobile numbers every time an input is triggered. Inputs can be anything from door openings or temperature changes etc....

You can also control connected devices by simply calling or send an SMS to the unit, i.e. open or close doors.

- Features:**
- Just insert a sim card and your ready.
 - Alerts you by SMS when an input has been triggered.
 - Up to 5 mobile numbers can be programmed to receive the alerts.
 - GSM Dual Band, will alert you where ever you are.
 - 2 Inputs & 2 Relay Outputs, all controlled via SMS.
 - Small & compact, easy to conceal.
 - Status information via LED's.

- Specifications:**
- GSM Dual Band 900/1800 Mhz
 - Supply Voltage: 6-15V
 - Dimensions: 100x53x25mm
 - Weight: 100g

Special Price: £199.00*
 *All prices exclude P&P and VAT.

Bitz Technology Ltd
 344 Kilburn Lane, London W9 3EF
 Tel: +44 (0) 208 968 0227 Fax: +44 (0) 208 968 0194
 E-Mail: info@spystoreuk.com

EPE IS PLEASED TO BE ABLE TO OFFER YOU THESE ELECTRONICS CD-ROMS

ELECTRONICS PROJECTS

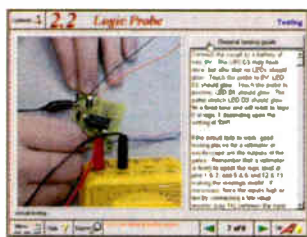

Logic Probe testing

Electronic Projects is split into two main sections: **Building Electronic Projects** contains comprehensive information about the components, tools and techniques used in developing projects from initial concept through to final circuit board production. Extensive use is made of video presentations showing soldering and construction techniques. The second section contains a set of ten projects for students to build, ranging from simple sensor circuits through to power amplifiers. A shareware version of Matrix's CADPACK schematic capture, circuit simulation and p.c.b. design software is included. The projects on the CD-ROM are: Logic Probe; Light, Heat and Moisture Sensor; NE555 Timer; Egg Timer; Dice Machine; Bike Alarm; Stereo Mixer; Power Amplifier; Sound Activated Switch; Reaction Tester. Full parts lists, schematics and p.c.b. layouts are included on the CD-ROM.

ELECTRONICS CAD PACK

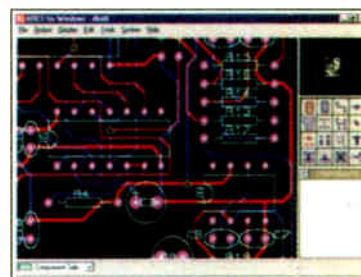

PCB Layout

Electronics CADPACK allows users to design complex circuit schematics, to view circuit animations using a unique SPICE-based simulation tool, and to design printed circuit boards. CADPACK is made up of three separate software modules. (These are restricted versions of the full Labcenter software.) **ISIS Lite** which provides full schematic drawing features including full control of drawing appearance, automatic wire routing, and over 6,000 parts. **PROSPICE Lite** (integrated into ISIS Lite) which uses unique animation to show the operation of any circuit with mouse-operated switches, pots, etc. The animation is compiled using a full mixed mode SPICE simulator **ARES Lite** PCB layout software allows professional quality PCBs to be designed and includes advanced features such as 16-layer boards, SMT components, and an autorouter operating on user generated Net Lists.

ELECTRONIC CIRCUITS & COMPONENTS V2.0

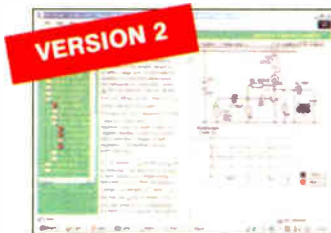

Circuit simulation screen

Provides an introduction to the principles and application of the most common types of electronic components and shows how they are used to form complete circuits. The virtual laboratories, worked examples and pre-designed circuits allow students to learn, experiment and check their understanding. Version 2 has been considerably expanded in almost every area following a review of major syllabuses (GCSE, GNVQ, A level and HNC). It also contains both European and American circuit symbols. Sections include: **Fundamentals**: units & multiples, electricity, electric circuits, alternating circuits. **Passive Components**: resistors, capacitors, inductors, transformers. **Semiconductors**: diodes, transistors, op.amps, logic gates. **Passive Circuits**. **Active Circuits**. **The Parts Gallery** will help students to recognise common electronic components and their corresponding symbols in circuit diagrams. Included in the Institutional Versions are multiple choice questions, exam style questions, fault finding virtual laboratories and investigations/worksheets.

ANALOGUE ELECTRONICS

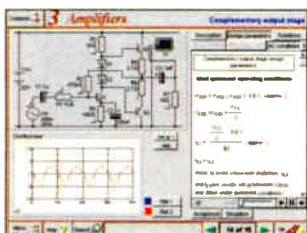

Complimentary output stage

Analogue Electronics is a complete learning resource for this most difficult branch of electronics. The CD-ROM includes a host of virtual laboratories, animations, diagrams, photographs and text as well as a SPICE electronic circuit simulator with over 50 pre-designed circuits. Sections on the CD-ROM include: **Fundamentals** – Analogue Signals (5 sections), Transistors (4 sections), Waveshaping Circuits (6 sections). **Op.Amps** – 17 sections covering everything from Symbols and Signal Connections to Differentiators. **Amplifiers** – Single Stage Amplifiers (8 sections), Multi-stage Amplifiers (3 sections). **Filters** – Passive Filters (10 sections), Phase Shifting Networks (4 sections), Active Filters (6 sections). **Oscillators** – 6 sections from Positive Feedback to Crystal Oscillators. **Systems** – 12 sections from Audio Pre-Amplifiers to 8-Bit ADC plus a gallery showing representative p.c.b. photos.

ROBOTICS & MECHATRONICS



Case study of the Milford Instruments Spider

Robotics and Mechatronics is designed to enable hobbyists/students with little previous experience of electronics to design and build electromechanical systems. The CD-ROM deals with all aspects of robotics from the control systems used, the transducers available, motors/actuators and the circuits to drive them. Case study material (including the NASA Mars Rover, the Milford Spider and the Furby) is used to show how practical robotic systems are designed. The result is a highly stimulating resource that will make learning, and building robotics and mechatronic systems easier. The Institutional versions have additional worksheets and multiple choice questions.

- Interactive Virtual Laboratories
- Little previous knowledge required
- Mathematics is kept to a minimum and all calculations are explained
- Clear circuit simulations

DIGITAL ELECTRONICS V2.0

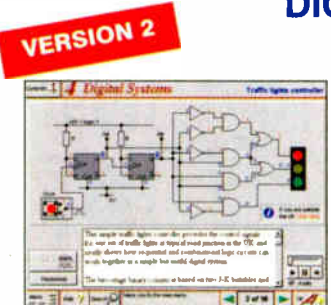

Virtual laboratory – Traffic Lights

Digital Electronics builds on the knowledge of logic gates covered in *Electronic Circuits & Components* (opposite), and takes users through the subject of digital electronics up to the operation and architecture of microprocessors. The virtual laboratories allow users to operate many circuits on screen. Covers binary and hexadecimal numbering systems, ASCII, basic logic gates, monostable action and circuits, and bistables – including JK and D-type flip-flops. Multiple gate circuits, equivalent logic functions and specialised logic functions. Introduces sequential logic including clocks and clock circuitry, counters, binary coded decimal and shift registers. A/D and D/A converters, traffic light controllers, memories and microprocessors – architecture, bus systems and their arithmetic logic units. Sections on Boolean Logic and Venn diagrams, displays and chip types have been expanded in Version 2 and new sections include shift registers, digital fault finding, programmable logic controllers, and microcontrollers and microprocessors. The Institutional versions now also include several types of assessment for supervisors, including worksheets, multiple choice tests, fault finding exercises and examination questions.

FILTERS

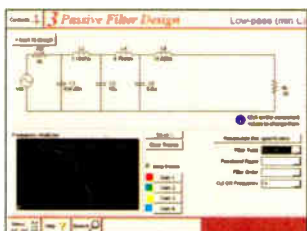

Filter synthesis

Filters is a complete course in designing active and passive filters that makes use of highly interactive virtual laboratories and simulations to explain how filters are designed. It is split into five chapters: **Revision** which provides underpinning knowledge required for those who need to design filters. **Filter Basics** which is a course in terminology and filter characterization, important classes of filter, filter order, filter impedance and impedance matching, and effects of different filter types. **Advanced Theory** which covers the use of filter tables, mathematics behind filter design, and an explanation of the design of active filters. **Passive Filter Design** which includes an expert system and filter synthesis tool for the design of low-pass, high-pass, band-pass, and band-stop Bessel, Butterworth and Chebyshev ladder filters. **Active Filter Design** which includes an expert system and filter synthesis tool for the design of low-pass, high-pass, band-pass, and band-stop Bessel, Butterworth and Chebyshev op.amp filters.

PRICES

Prices for each of the CD-ROMs above are:

(Order form on third page)

(UK and EU customers add VAT at 17.5% to "plus VAT" prices)

Hobbyist/Student£45 inc VAT
 Institutional (Schools/HE/FE/Industry).....£99 plus VAT
 Institutional 10 user (Network Licence)£199 plus VAT
 Site Licence.....£499 plus VAT

PICmicro TUTORIALS AND PROGRAMMING

HARDWARE

VERSION 2 PICmicro MCU DEVELOPMENT BOARD

Suitable for use with the three software packages listed below.

This flexible development board allows students to learn both how to program PICmicro microcontrollers as well as program a range of 8, 18, 28 and 40-pin devices. For experienced programmers all programming software is included in the PPP utility that comes with the development board. For those who want to learn, choose one or all of the packages below to use with the Development Board.

- Makes it easier to develop PICmicro projects
- Supports low cost Flash-programmable PICmicro devices
- Fully featured integrated displays – 13 individual I.e.d.s, quad 7-segment display and alphanumeric I.c.d. display
- Supports PICmicro microcontrollers with A/D converters
- Fully protected expansion bus for project work
- All inputs and outputs available on screw terminal connectors for easy connection

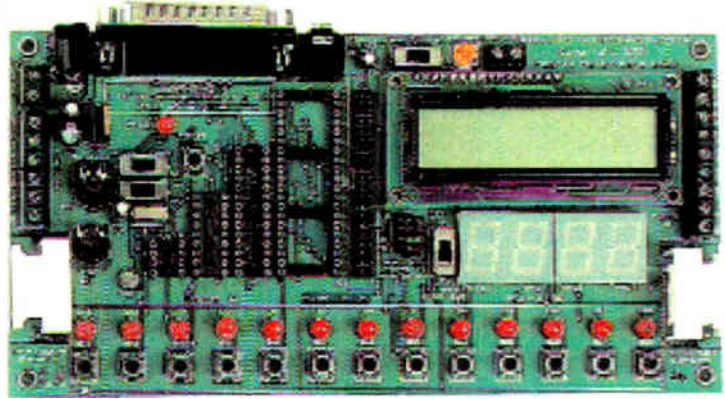

£145 including VAT and postage
12V 500mA plug-top PSU (UK plug) £7
25-way 'D' type connecting cable £5

SOFTWARE

Suitable for use with the Development Board shown above.

ASSEMBLY FOR PICmicro V2 (Formerly PICtutor)

Assembly for PICmicro microcontrollers V2.0 (previously known as PICtutor) by John Becker contains a complete course in programming the PIC16F84 PICmicro microcontroller from Arizona Microchip. It starts with fundamental concepts and extends up to complex programs including watchdog timers, interrupts and sleep modes. The CD makes use of the latest simulation techniques which provide a superb tool for learning: the Virtual PICmicro microcontroller. This is a simulation tool that allows users to write and execute MPASM assembler code for the PIC16F84 microcontroller on-screen. Using this you can actually see what happens inside the PICmicro MCU as each instruction is executed which enhances understanding.

- Comprehensive instruction through 39 tutorial sections
- Includes Vlab, a Virtual PICmicro microcontroller: a fully functioning simulator
- Tests, exercises and projects covering a wide range of PICmicro MCU applications
- Includes MPLAB assembler
- Visual representation of a PICmicro showing architecture and functions
- Expert system for code entry helps first time users
- Shows data flow and fetch execute cycle and has challenges (washing machine, lift, crossroads etc.)
- Imports MPASM files.

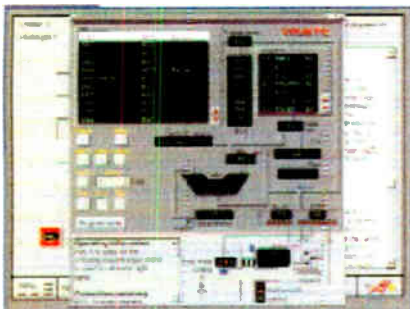

Virtual PICmicro

'C' FOR PICmicro VERSION 2

The C for PICmicro microcontrollers CD-ROM is designed for students and professionals who need to learn how to program embedded microcontrollers in C. The CD contains a course as well as all the software tools needed to create Hex code for a wide range of PICmicro devices – including a full C compiler for a wide range of PICmicro devices.

Although the course focuses on the use of the PICmicro microcontrollers, this CD-ROM will provide a good grounding in C programming for any microcontroller.

- Complete course in C as well as C programming for PICmicro microcontrollers
- Highly interactive course
- Virtual C PICmicro improves understanding
- Includes a C compiler for a wide range of PICmicro devices
- Includes full Integrated Development Environment
- Includes MPLAB software
- Compatible with most PICmicro programmers
- Includes a compiler for all the PICmicro devices.

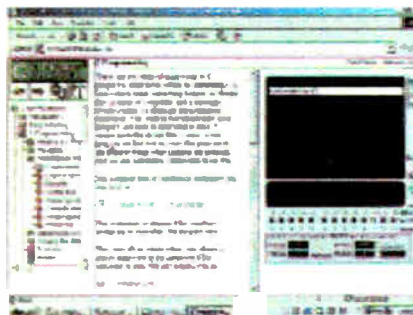

Minimum system requirements for these items: Pentium PC running Windows 98, NT, 2000, ME, XP; CD-ROM drive: 64MB RAM; 10MB hard disk space.

FLOWCODE FOR PICmicro V2

Flowcode is a very high level language programming system for PICmicro microcontrollers based on flowcharts. Flowcode allows you to design and simulate complex robotics and control systems in a matter of minutes.

Flowcode is a powerful language that uses macros to facilitate the control of complex devices like 7-segment displays, motor controllers and I.c.d. displays. The use of macros allows you to control these electronic devices without getting bogged down in understanding the programming involved.

Flowcode produces MPASM code which is compatible with virtually all PICmicro programmers. When used in conjunction with the Version 2 development board this provides a seamless solution that allows you to program chips in minutes.

- Requires no programming experience
- Allows complex PICmicro applications to be designed quickly
- Uses international standard flow chart symbols (ISO5807)
- Full on-screen simulation allows debugging and speeds up the development process
- Facilitates learning via a full suite of demonstration tutorials
- Produces ASM code for a range of 18, 28 and 40-pin devices
- Professional versions include virtual systems (burglar alarm, buggy and maze, plus RS232, IrDa etc.).

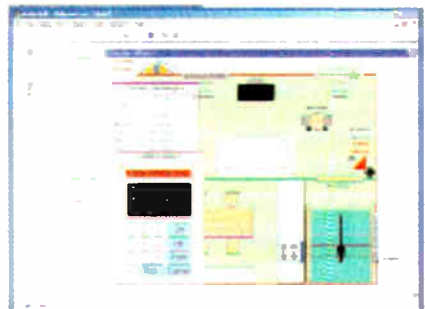

Burglar Alarm Simulation

PRICES

Prices for each of the CD-ROMs above are:

(Order form on next page)

(UK and EU customers add VAT at 17.5% to "plus VAT" prices)

Hobbyist/Student
Flowcode V2 Hobbyist/Student
Institutional (Schools/HEFE/Industry)
Flowcode Professional
Institutional/Professional 10 user (Network Licence)
Site Licence

£45 inc VAT
£57 inc VAT
£99 plus VAT
£99 plus VAT
£249 plus VAT
£599 plus VAT

TEACH-IN 2000 – LEARN ELECTRONICS WITH EPE

EPE's own *Teach-In* CD-ROM, contains the full 12-part *Teach-In* series by John Becker in PDF form plus the *Teach-In* interactive software (Win 95, 98, ME and above) covering all aspects of the series. We have also added Alan Winstanley's highly acclaimed *Basic Soldering Guide* which is fully illustrated and which also includes *Desoldering*. The *Teach-In* series covers: Colour Codes and Resistors, Capacitors, Potentiometers, Sensor Resistors, Ohm's Law, Diodes and L.E.D.s, Waveforms, Frequency and Time, Logic Gates, Binary and Hex Logic, Op.amps, Comparators, Mixers, Audio and Sensor Amplifiers, Transistors, Transformers and Rectifiers, Voltage Regulation, Integration, Differentiation, 7-segment Displays, L.C.D.s, Digital-to-Analogue. Each part has an associated practical section and the series includes a simple PC interface (Win 95, 98, ME ONLY) so you can use your PC as a basic oscilloscope with the various circuits.

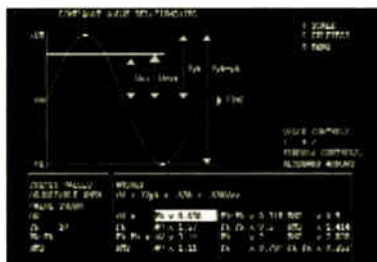

Sine wave relationship values

FREE BOOK WITH TEACH-IN 2000 CD-ROM

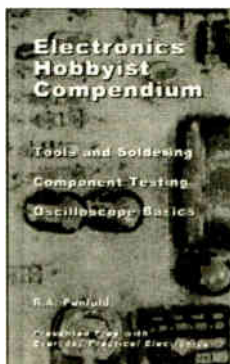

A hands-on approach to electronics with numerous breadboard circuits to try out.

£12.45 including VAT and postage. Requires Adobe Acrobat (available free from the Internet – www.adobe.com/acrobat).

FREE WITH EACH TEACH-IN CD-ROM – Electronics Hobbyist Compendium 80-page book by Robert Penfold. Covers Tools For The Job; Component Testing; Oscilloscope Basics.

DIGITAL WORKS 3.0

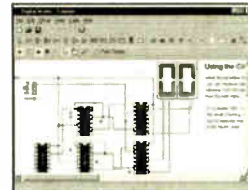

Counter project

Digital Works Version 3.0 is a graphical design tool that enables you to construct digital logic circuits and analyze their behaviour. It is so simple to use that it will take you less than 10 minutes to make your first digital design. It is so powerful that you will never outgrow its capability ● Software for simulating digital logic circuits ● Create your own macros – highly scalable ● Create your own circuits, components, and i.c.s ● Easy-to-use digital interface ● Animation brings circuits to life ● Vast library of logic macros and 74 series i.c.s with data sheets ● Powerful tool for designing and learning. **Hobbyist/Student £45 inc. VAT. Institutional £99 plus VAT. Institutional 10 user £199 plus VAT. Site Licence £499 plus VAT.**

ELECTRONICS IN CONTROL

Two colourful animated courses for students on one CD-ROM. These cover Key Stage 3 and GCSE syllabuses. **Key Stage 3:** A pictorial look at the Electronics section featuring animations and video clips. Provides an ideal introduction or revision guide, including multi-choice questions with feedback. **GCSE:** Aimed at the Electronics in many Design & Technology courses, it covers many sections of GCSE Electronics. Provides an ideal revision guide with Homework Questions on each chapter. Worked answers with an access code are provided on a special website.

Single User £29 inc. VAT. Multiple User £39 plus VAT
Student copies (available only with a multiple user copy) £6 plus VAT
 (UK and EU customers add VAT at 17.5% to "plus VAT" prices)

MODULAR CIRCUIT DESIGN

Contains a range of tried and tested analogue and digital circuit modules, together with the knowledge to use and interface them. Thus allowing anyone with a basic understanding of circuit symbols to design and build their own projects. Version 3 includes data and circuit modules for a range of popular PICs; includes PICAXE circuits, the system which enables a PIC to be programmed without a programmer, and without removing it from the circuit. Shows where to obtain free software downloads to enable BASIC programming. Essential information for anyone undertaking GCSE or "A" level electronics or technology and for hobbyists who want to get to grips with project design. Over seventy different Input, Processor and Output modules are illustrated and fully described, together with detailed information on construction, fault finding and components, including circuit symbols, pinouts, power supplies, decoupling etc.

Single User £19.95 inc. VAT. Multiple User £34 plus VAT
 (UK and EU customers add VAT at 17.5% to "plus VAT" prices)

VERSION 3

ELECTRONIC COMPONENTS PHOTOS

A high quality selection of over 200 JPG images of electronic components. This selection of high resolution photos can be used to enhance projects and presentations or to help with training and educational material. They are royalty free for use in commercial or personal printed projects, and can also be used royalty free in books, catalogues, magazine articles as well as worldwide web pages (subject to restrictions – see licence for full details). Also contains a **FREE** 30-day evaluation of Paint Shop Pro 6 – Paint Shop Pro image editing tips and on-line help included!

Price £19.95 inc. VAT

Minimum system requirements for these CD-ROMs: Pentium PC, CD-ROM drive, 32MB RAM, 10MB hard disk space. Windows 95/98/NT/2000/ME/XP, mouse, sound card, web browser.

Please send me: CD-ROM ORDER FORM

- Electronic Projects
- Electronic Circuits & Components V2.0
- Analogue Electronics
- Digital Electronics V2.0
- Filters
- Electronics CAD Pack
- Robotics & Mechatronics
- Assembly for PICmicro V2
- 'C' for PICmicro V2
- Flowcode V2 for PICmicro
- Digital Works 3.0

- Version required:
- Hobbyist/Student
 - Institutional
 - Institutional/Professional 10 user
 - Site licence



- PICmicro Development Board V2 (hardware)
- Development Board UK plugtop power supply
- Development Board 25-way connecting lead

- Teach-In 2000 + FREE BOOK
- Electronic Components Photos
- Electronics In Control – Single User
- Electronics In Control – Multiple User
- Modular Circuit Design – Single User
- Modular Circuit Design – Multiple User

Note: The software on each version is the same, only the licence for use varies.

Full name:

Address:

..... Post code: Tel. No:

Signature:

I enclose cheque/PO in £ sterling payable to WIMBORNE PUBLISHING LTD for £

Please charge my Visa/Mastercard/Amex/Diners Club/Switch: £

Valid From: Card expiry date:

Card No: Switch Issue No.

Card Security Code (The last 3 digits on or just under the signature strip)

ORDERING

ALL PRICES INCLUDE UK POSTAGE

Student/Single User/Standard Version price includes postage to most countries in the world
 EU residents outside the UK add £5 for airmail postage per order

Institutional, Multiple User and Deluxe Versions – overseas readers add £5 to the basic price of each order for airmail postage (do not add VAT unless you live in an EU (European Union) country, then add 17½% VAT or provide your official VAT registration number).

Send your order to:

**Direct Book Service
 Wimborne Publishing Ltd
 408 Wimborne Road East
 Ferndown, Dorset BH22 9ND**

To order by phone ring

01202 873872. Fax: 01202 874562

Goods are normally sent within seven days

E-mail: orders@wimborne.co.uk

Online shop:
www.epemag.wimborne.co.uk/shopdoor.htm

WIRELESS *for the* WARRIOR

Volume 4

CLANDESTINE RADIO

A technical history of Radio Communication Equipment in clandestine and special forces operations.

Volume 4 'Clandestine Radio' – not only 'spy' equipment but sets used by Special Forces, Partisans, Resistance, 'Stay Behind' organisations, Diplomatic Service, Australian Coast Watchers, RDF and intercept receivers, bugs and radar beacons. The information has been compiled through the collaboration of a vast number of collectors and enthusiasts around the world. Volume 4 includes information on more than 230 sets and ancillaries. It contains 692 pages in hardback format, and features over 850 photographs, 360 line drawings and 440 data tables.

Volume 1 'Wireless Sets No.1 to 88' – covers the early radios, prior to the outbreak of World War II, and wartime sets which were never released in large quantities or were abandoned after trials.

Volume 2 'Standard Sets for World War II' – provides information in detail of mass-produced Wireless Sets such as No.18, 19, 22 and 38. Additionally included are a number of post-war sets on which development had been started during World War II.

A technical history of Radio Communication Equipment in clandestine and special forces operations

WIRELESS *for the* WARRIOR

by Louis Meulstee and Rudolf F. Staritz
with Jan Bury, Erling Langemyr
Tor Marthinsen, Pete McCallum
and Antero Tanninen

VOLUME 4
CLANDESTINE RADIO



Volume 3 'Reception Sets' – the receivers described span the era 1932 to the 1960s, and coverage includes not only reception sets specifically designed or adapted for the British Army, but also sets adopted from other arms (RN and RAF), special receivers, direction finding receivers, army broadcast reception sets, Canadian and Australian army sets, commercial receivers adopted by the army, and army welfare reception sets.

PRICES INCLUDING POSTAGE

	UK	Europe airmail, Rest of World surface mail	Rest Of World airmail
Vol 1	£31.00	£32	£42
Vol 2	£43.50	£47*	£55.95*
Vol 3	£42.50	£47	£55.95
Vol 4	£45	£49*	£57.95*

*For delivery to Canada Vol.2 £58.50, Vol 4 £59.50

Cheques made payable to Direct Book Service.
Direct Book Service, Wimborne Publishing Ltd,
408 Wimborne Road East, Ferndown, Dorset BH22 9ND
Tel: 0202 873872 Fax: 0202 874562
www.radiobygones.co.uk

Please send me: **Wireless For The Warrior**

.....(quantity) Vol 1;(quantity) Vol 2;(quantity) Vol 3;(quantity) Vol 4

Name Address

Post Code I enclose cheque/postal order/bank draft to the value of £.....

Please charge my Visa/Mastercard/Amex/Diners Club/Maestro

£..... Card No:

Card security No: (last 3 digits on the signature strip)

Valid From Expiry Date Maestro Issue No

WIRELESS *for the* WARRIOR

Smart Karts

Owen Bishop

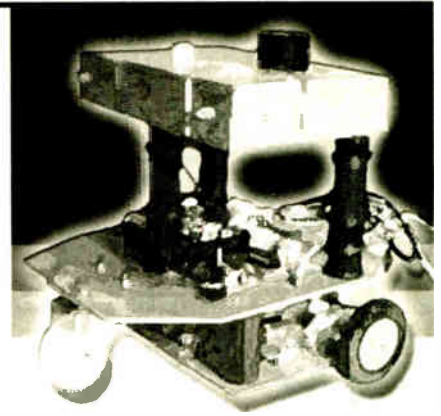

Part 4 – Software development for SK-2 mobile robot

LAST month we described the circuits for a second version of the Smart Kart, for which main details were published in Parts 1 and 2. We now discuss the software for this second version, SK-2.

Smart Kart SK-2 is equipped with three sets of sensors, which give it the ability to react to its environment in several different ways. Its programs are longer and slightly more complex than those of SK-1, but easily fit into the 1024 program commands that can be stored in the memory of the PIC16F84.

With more sensors, we have had to allocate more pins to input and, consequently, fewer to output. In Port A, pins RA0 to RA3 are outputs that control the motors, as before. Table 4.1 lists the allocations of the other pins.

Program Modes

Version SK-2 operates in four modes, the main features of which are listed in Table 4.2.

This selection of programs might well have been called Robot Zoo, for each one has some feature in common with the behaviour of a particular animal. Many robot designers exercise great skill and inventiveness in building robots with mechanisms that make them hop, jump, crawl or even swim in the same manner as animals. Here we use the same wheeled robot for all the “animals” but program their behaviour instead.

We now look at segments of the software to illustrate their make-up and show how they work. The variables used in the software are shown in Table 4.3.

Following the initialisation routine, the program reads the status of switches S3 and S4 in Part 3 Fig.3.9. This determines which Mode (behaviour) routine is to be used, as in Table 4.2. Its operation was described in Part 2 (Fig.2.6).

The PIC then jumps to the appropriate section of the program. All four sections are entirely separate, with their own sets of subroutines, except that they share the `pause2` delay subroutines.

Mode 1: Light Seeker

– The Moth

Mode 1 mimics the behaviour of a *moth* seeking the light. It is selected by switching

Table 4.1: Pin Allocations of SK-2

Pin	Input/Output	Connection	Action	
			When Low (0)	When High (1)
RA4	Output	Enable ultrasonic transmitter	Disabled	Enabled
RB0	Input	Left bumper	Not pressed	Pressed
RB1	Input	Right bumper	Not pressed	Pressed
RB2	Output	White l.e.d.s (headlamps)	Off	On
RB3	Output	Buzzer	Off	On
RB4	Input	Behaviour select switch (S8)	Switch Open	Switch Closed
RB5	Input	Behaviour select switch (S9)	Switch Open	Switch Closed
RB6	Input	Light sensor	Low light	High light
RB7	Input	Ultrasonic receiver	No echo	Echo

off S3 and S4, causing a branch to routine **Behave1**. This causes the robot to locate and move toward a source of light. In the trials, a 75W bench lamp was used as the principle light source. The robot was unaffected by diffused light sources in the room, except when it wandered near a large window reaching to floor level.

Moving toward the light is the robot's primary task but it may have problems when it comes across objects that are in its way. It detects these by using its bumpers. It then takes appropriate avoiding action: reversing, spinning to left or right, then looking for the light again.

This illustrates the important robot programming principle of *subsumption*. The robot normally pursues its primary task (seeking light) but gives this up and attends to a secondary task (avoiding obstacles) whenever necessary.

One way of programming subsumption

is by using interrupts triggered by a bumper touching against an obstacle. However, there are reasons why this approach is complicated for the Smart Kart and it was decided to rely on “polling” the bumper inputs at frequent intervals.

Polling

Polling is effected by a call to subroutine **bumpers**, which can be seen at two points on the flowchart in Fig.4.1. The calls are made when the robot is moving forward and is most likely to collide with objects.

The first action of the robot, after turning on its l.e.d.s and sounding its buzzer, is to enter the **search**: routine. If it sees a light ahead, it moves forward in stages, calling **bumpers**: as it goes.

If it cannot see light ahead, it spins left or right (using a routine explained later

Table 4.2: SK-2 Operating Modes

Mode Number	Settings S4	S3	Action of Robot	Sensors Used	Simulates
1	0	0	Light seeker	Light, bumpers	Moth
2	0	1	Wall follower	Bumpers, light	Earwig
3	1	0	Obstacle avoider	Ultrasonic, bumpers	Bat
4	1	1	Object visitor	Ultrasonic, bumpers	Bee

under Mode 3) until it has spun just over a complete revolution. As soon as it sees light, it stops spinning and, provided it has not acquired too many bumps, it returns to **search:** and continues forward on its new heading.

If it fails to detect light during its spin, it must be in a position from which the light cannot be seen. To look for the light it enters the **explore:** routine. It sounds the buzzer, turns on the l.e.d.s, spins, and sets off in a straight line to another part of the room.

On its way, it calls **bumpers:** frequently and repeatedly looks for light. If it sees light, or after it has travelled about 60cm without seeing light, it returns to **search:**.

If it can already see light, it moves towards it. If it cannot see light, it scans the neighbourhood from its new position.

When it reaches the light, it can go no further. It backs off and advances repeatedly, rather like a moth beating itself against an outdoor lamp or a lighted window. This is why this routine has been named *The Moth*. When the number of bumps reaches 20, the unfortunate moth is considered dead and the program ends.

Mode 2: Wall Follower — The Earwig

Mode 2 is called *The Earwig* and is selected by setting switch S3 on and S4 off.

Earwigs tend to linger in dark crevices. They tend to avoid light and to try to keep in contact with solid surfaces. In this way the robot behaves much like

an earwig, seeking the dark, and keeping on the move until its bumpers detect that it is pressed hard against a surface. Better still, if *both* bumpers are in contact, it judges that it is in a crevice, gives a few wriggles to increase the contact and then "stays put" indefinitely. Only a bright light can rouse it from its safe haven, and then it escapes to find another place to hide.

Robot Navigation

There is also a more serious side to this program. In the early stages, it illustrates a simple type of robot navigation – wall following. It moves forward until it bumps into a wall, either on the left or on the right. From then on, it follows the wall.

Supposing the first wall it strikes is on its left. It reverses a short distance, spins right to become approximately parallel with the wall, moves forward, spins left toward the wall, and finally moves forward until it hits the wall again. This looping action repeats indefinitely, so that it can navigate around a room, following the shape of the room,

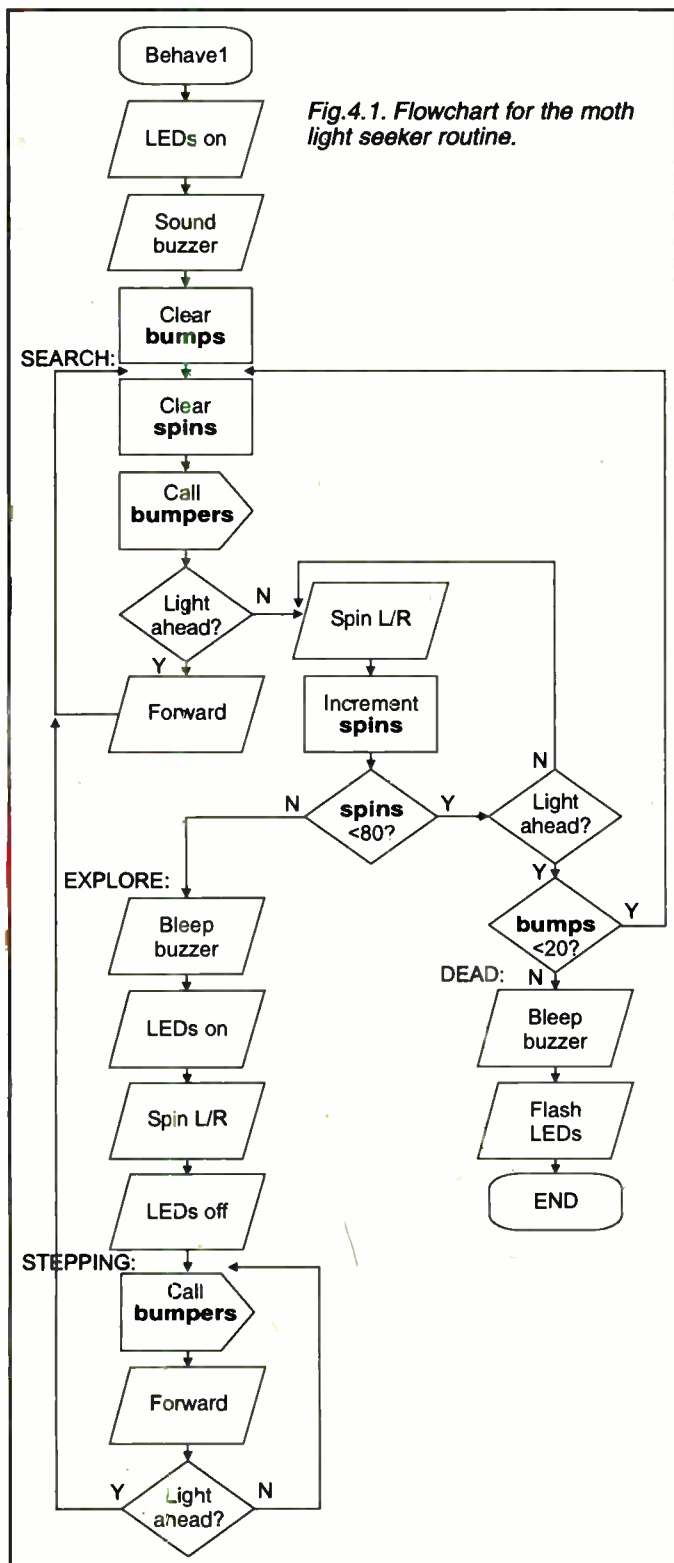
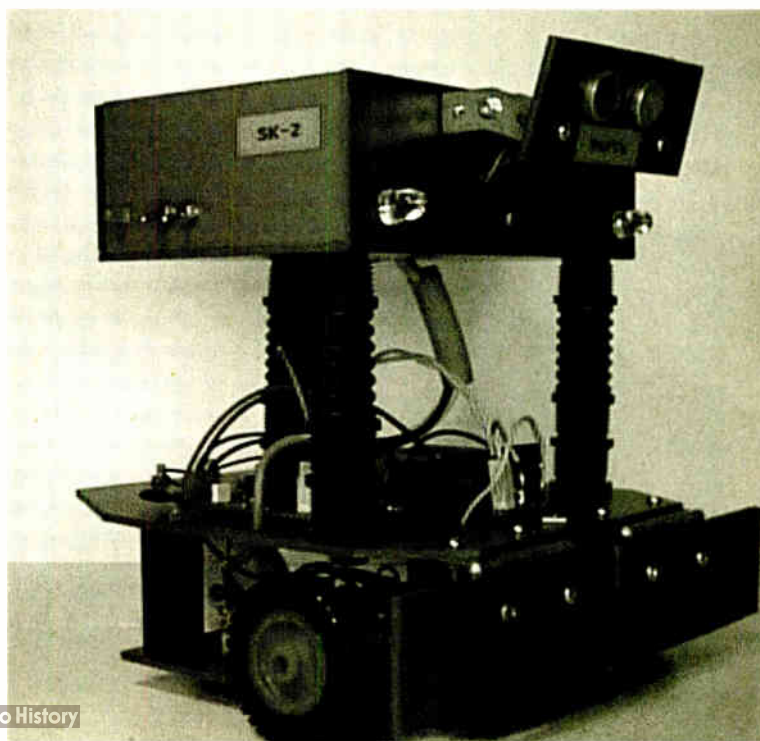

Fig.4.1. Flowchart for the moth light seeker routine.

Table 4.3: Variables

Name	Address	Mode and Functions
Delay0	0Ch	Loop counter (inner)*
Delay1	0Dh	Loop counter (middle)*
Delay2	0Eh	Loop counter (outer)*
Spins	0Fh	1: Counts spins in search;
Bumps	10h	1: Counts number of bumps; also used in 3.
Lefts	11h	2: Counts as robot loops along a wall on the left.
Rights	12h	2: Counts as robot loops along a wall on the right.
Wriggles	13h	2: Counts the wriggles as robot buries itself in a crevice.
Steps	14h	1: Counts steps as robot explores.
Turn	15h	Variable for alternating left and right spins.
Flights	16h	3: Counts 50mm segments of flight.

*used in the Pause2 timing subroutine, which is used in all modes



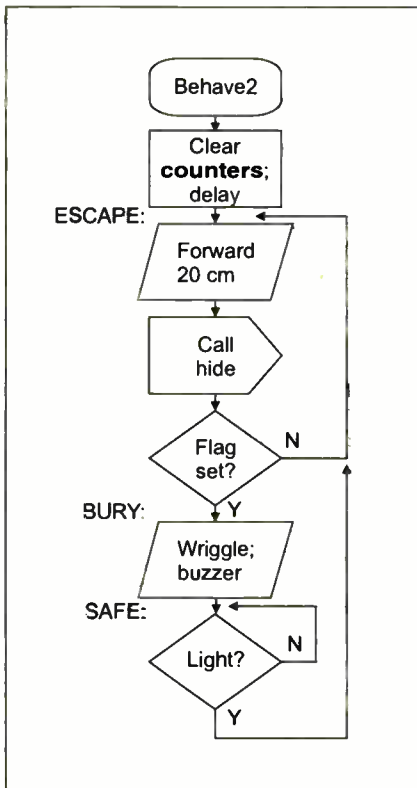

Fig.4.2. Main loop wall follower flowchart for the earwig.

doorways and major pieces of furniture.

If the first wall encountered is on the right, it loops around the room in the opposite direction. After demonstrating this ability for 15 loops, it becomes tired and stops, but it can be roused by shining a bright light at it. It stops also if it gets confused by bumping into a wall on the "wrong" side.

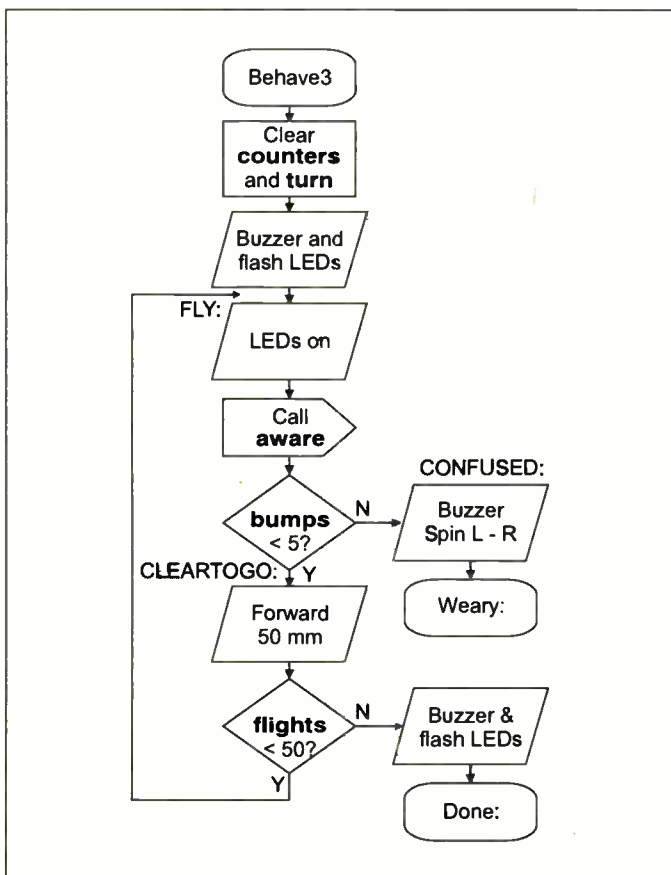

Fig.4.4. The bat obstacle avoider flowchart for the main loop

Loop Program

The main loop of the program is shown in Fig.4.2. The counters register how many times it has looped along the wall. It moves forward about 20cm then calls a subroutine, **Hide:**. In this subroutine (see Fig.4.3) it first looks for light. If it is heading toward light it does a sharp turn away from it. It then checks its bumpers. If the left bumper is pressed it calls a further subroutine named **keepleft:**, the action of which is to make it loop along the wall on its left side.

The flowchart refers to a **flag**. This is bit 0 of the working register, W. On returning from **keepleft:**, this bit is set (= 1) IF:

- when following a left wall, it bumps into a wall on the right (or the other way about), OR
- it has executed 15 wall-following loops

The program returns to the **hide:** subroutine and checks the **flag** bit. The program then returns to the original routine (Fig.4.2, fifth box down) with the **flag** bit set or not set. If it is not set, the robot continues on its way, trying to escape. If it is set, it enters the **bury:** routine which makes it **wriggle:** a little and then, at **safe:**, it stops. Now it waits until it sees light, when it starts the **escape:** action all over again.

The two **keepleft:** and **keeprgt:** subroutines do the same things but have left-right symmetry. They control the looping behaviour. In **keepleft:**, the robot reverses about 100mm, spins right for 45 degrees, moves forward 100mm, spins left 45 degrees, then moves forward in short (20mm) stages until it hits the wall.

This action is repeated up to 15 times, when the **flag** is set to 1 and there is a return to the escape subroutine, as explained above. There is also a flagged

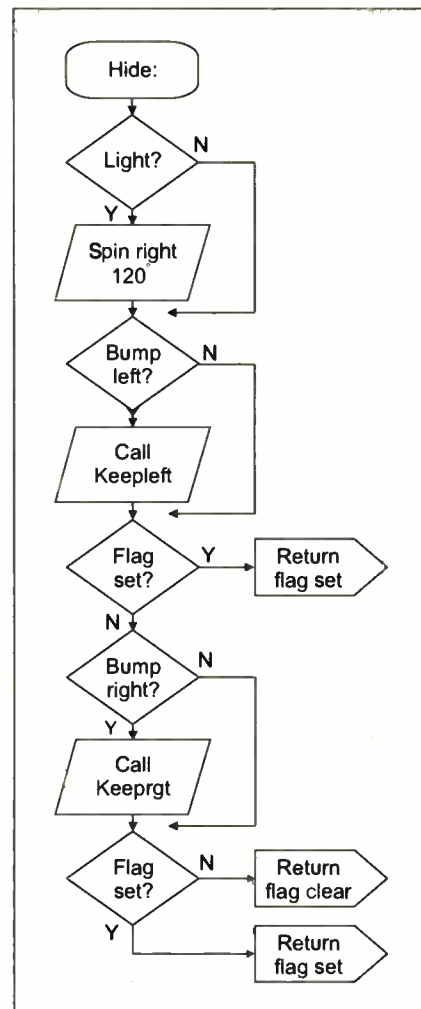

Fig.4.3. Flowchart for the **hide:** subroutine of the wall follower.

return if the right bumper is pressed.

On return to the calling routine, in this case **hide:**, the **flag** is tested for its status, 0 or 1, and the action indicated in Fig.4.3 is taken.

This wall-following technique is limited by the fact that the robot has no sensors on its sides. To locate the wall, it has to loop away and then run almost headlong into it!

You could, perhaps, design a wall-sensing device to mount on the sides of SK-2, possibly using PIC pins RB6 and RB7 as inputs

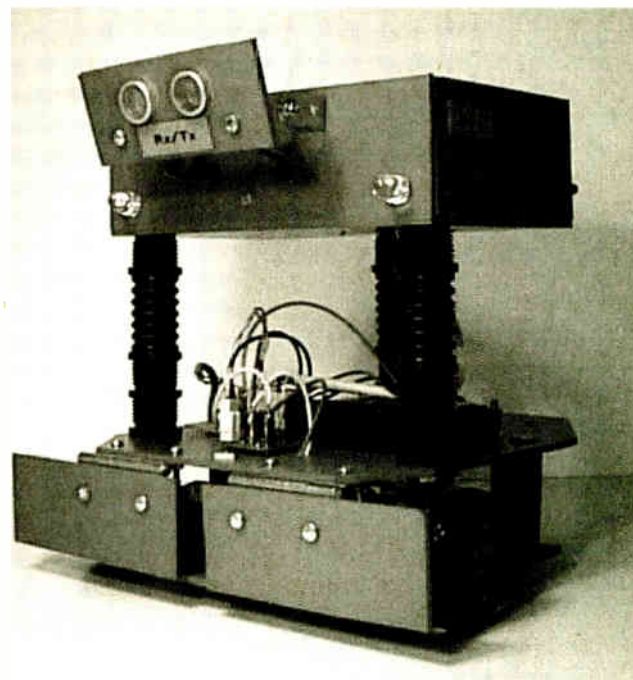

The ultrasonic transducers are mounted on an adjustable tilting panel.

for the left and right sensors. Then the robot needs to veer only slightly each time the sensor loses contact with the wall.

Obstacle Avoider – The Bat

In its role as *The Bat*, Mode 3 (S3 off, S4 on), the robot wanders around the room using its ultrasonic sensor to avoid obstacles. The floor is littered with obstacles, such as small paint cans, bricks, books and blocks of wood. Legs of tables and chairs, the walls, and the feet of spectators also count as obstacles.

To be totally successful it must travel a distance of up to 25m, consisting of 50 “flights” of 50mm each. Then it halts. However, in spite of the ultrasonics, it may occasionally collide with an obstacle. When this happens it backs off and changes direction. The bumps are counted and after five bumps the robot stops, confused and weary.

Bats usually fly in dusk or darkness, emitting short bursts of ultrasound. Their ears are sensitive to the echoes of the bursts returned by obstacles in their flight path and they take avoiding action. The bats estimate the distance of the objects by gauging the echo times, but this program uses only a simple echo/no-echo algorithm.

The flowchart (Fig.4.4) shows a simple loop beginning at **Fly**: and repeating 50 times. The loop begins by clearing variables. The counter for the five bumps is **bumps**. The variable **turn** gives an appearance of randomness to the robot's flights. When the robot finds that it is approaching an object it can turn either left or right to avoid it. The direction is decided within subroutine **missit**: by bit 0 of **turn**.

Later, **turn** is incremented and its least significant bit changes (*inverts*) from 0 to 1, or from 1 to 0. The robot turns alternately left or right each time the subroutine is called.

The ultrasonic sensor is enabled when RA4 is made high, from within routine **aware**:. After a short pause to allow the circuit to settle, its output is read via RB7, and RA4 is then taken low to turn off the sensor again.

The details of **aware**: are not shown in Fig.4.4, but it is elementary. It polls (reads the status of) the ultrasonic sensor, the left bumper and the right bumper in turn and then returns to the main program. If one of these polls detects an obstacle the routines **missit**:, **bumpedl**:, or **bumpedr**: are called to avoid or move SK-2 away from the obstacle and register any bumps that occur.

Erratic Behaviour

When you are running SK-2 in this mode, remember that the ultrasonic Transmitter emits only a narrow beam, about 20 degrees wide. The Receiver has a similar angle of acceptance. The obstacle is unlikely to be detected if it is more than 30 degrees on either side of the robot's axis.

For the same reason, a fairly small object less than about 10cm from the front of the robot may not be detected. You could try adjusting the downward angle of the transducers to see how this affects the responses of the robot.

If the behaviour of the robot appears to be erratic, it may be because of the sensitivity setting of the ultrasonic receiver. If preset VR3 is turned clockwise, the sensitivity is reduced. At the extreme, the output of the receiver is permanently low. Conversely,

turning VR3 anti-clockwise increases sensitivity and, at the extreme, the output is permanently high.

You may need to adjust the sensitivity to suit the situation. Large, nearby objects with flat, hard surfaces (for example, a brick or a block of wood) provide the strongest echoes. Small, distant objects with soft rounded or irregular surfaces (for instance, a tennis ball) have the weakest echoes.

On the Surface

The running surface has an effect on echoes. With a smooth floor (tiles, vinyl, wood) ultrasound that strikes the floor is reflected upwards and away from the robot. With a rough floor (carpet, cement) the ultrasound is scattered and some returns to the receiver. This creates “noise” in the system, making it more difficult to pick out genuine echoes reliably.

When setting VR3, use an object typical of those being used in the current mode, and placed at a typical distance in front of the robot, and on the type of surface on which it is to be run. Monitor the output voltage of the sensor when the program is running (switch off the power to the motors to prevent the robot from moving).

With the object absent (nothing in front of the robot for at least two metres) adjust VR3 clockwise until the output just falls to a few millivolts. It must not swing high until an object is placed in front. With the object absent, you may notice occasional “squeaks” on the output, probably due to “squeaks” from various sources that you cannot hear, but the sensor can. If so, reduce the sensitivity slightly until these no longer occur.

Object Visitor – The Bee

Mode 4's behaviour is typical of a *Bee* visiting flowers in the garden, roaming from one to another, gathering pollen. However, once the bee has found its way to the flower-patch it uses not ultrasound but its sense of smell and its vision to locate the flowers.

In Mode 4 (S3 and S4 both on), the robot scans the room looking for obstacles within range of the ultrasonic sensor. When it detects an object, it advances towards it until it strikes it. After a short pause, the robot backs away from the object, spins a little and then scans the room for other objects.

The mechanism of SK-2 works very differently but, as a programming challenge, you could try to make the simulation more realistic by using the robot's light sensor instead of its ultrasonic sensor.

The program (see Fig.4.5) has no end. The floor of the room is again littered with objects and the robot moves around the room, visiting one after another. It does this indefinitely until you pick it up and switch off the power. It is interesting to try to predict which objects it will visit and in what order. Here is the basis of a game of chance.

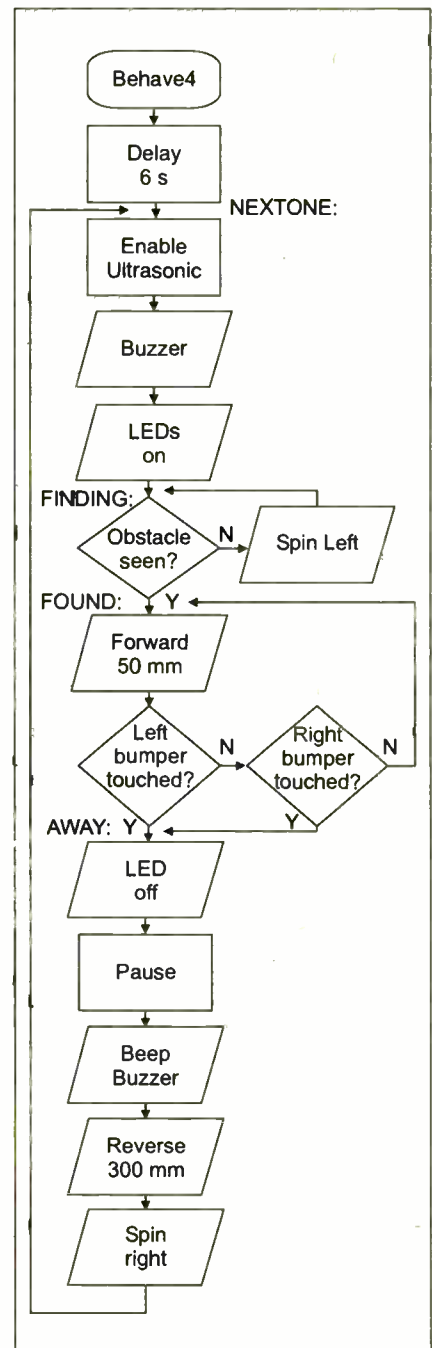
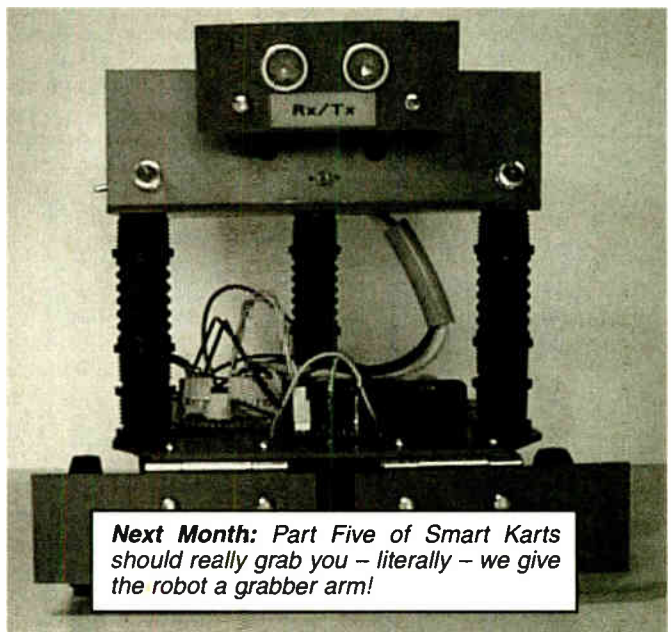

Fig.4.5. The bee object visitor flowchart



Next Month: Part Five of Smart Karts should really grab you – literally – we give the robot a grabber arm!

32-Bit Signed Integer Maths for PICs

by Peter Hemsley

An excellent suite of 32-bit signed integer maths routines to simplify your PIC programming ambitions

MATHS routines for computers, microprocessors and microcontrollers are nothing new. They have been around almost since the invention of the computer, but finding a comprehensive set of routines can be difficult. If you do not have the ability to write your own routines then you must rely on someone else's work. It may be poorly written or incomprehensible due to lack of documentation, which is often the author's experience.

The purpose of this article is to explain how various maths functions are performed and to present a complete 32-bit maths package which can handle huge numbers, and yet not take too much precious memory space. The routines presented here are:

- Add
- Subtract
- Multiply
- Divide
- Round (for divide)
- Square Root
- Binary to Decimal conversion
- Decimal to Binary conversion.

Multiple Precision

An 8-bit register or memory is able to store numbers in the range 0 to 255. If two 8-bit numbers are added together it is quite possible that the sum will exceed 255, so how do we cope with larger numbers? The answer is to use more bits.

Imagine a 16-bit register (or memory), this is able to hold numbers up to 65535. You can add numbers to this register many times so long as the total does not exceed 65535. Now split the 16-bit register down the middle into two 8-bit sections. This does not change the nature of the number it contains, but each section can now be stored in adjacent 8-bit (byte) memory locations. The two bytes are usually referred to as High byte and Low Byte.

Of course the PIC cannot add 16-bit numbers directly, you must program it to add each byte separately and deal with any overflow from one byte to the next. If you need numbers larger than 65535 this concept can be extended to 24 bits using three bytes for the number, or 32 bits using four bytes. The name given to this is Multiple Precision Numbers.

Two's Complement

General purpose maths routines should be able to cope with negative numbers as well as positive ones. Two's complement is one of several methods for representing both positive and negative numbers. It is a logical extension of unipolar (positive) numbers, which makes it the most widely used methods. Other methods such as signed magnitude and offset (also known as biased) are to be found in floating point format numbers and are beyond the scope of this article.

A disadvantage of two's complement is that it works only for addition and subtraction, for other functions the result sign must first be calculated and the numbers made positive before calculating the result.

First we shall look at how two's complement numbers are derived. If an 8-bit register contains a value of 0, when 1 is subtracted from it the result will be FF. Logically this is -1. If 2 is subtracted from 0 the result is FE which is -2, FD is -3 and so on. With an 8-bit register it is possible to represent a numeric range of -128 to +127. For a 16-bit register, -1 = FFFF, -2 = FFEE, -3 = FFFD etc with a range of -32768 to +32767.

This concept can be extended to any number of bits you wish although 32 bits is usually considered to be enough. This equates to a numerical range of -2,147,483,648 to +2,147,483,647. The term "two's complement" is derived from the method used to negate a number, i.e. change it's sign from positive to negative or vice versa. To do this first invert all the bits of the number, this is known as one's complement, and then add one to the number to obtain the two's complement.

Addition and Subtraction

Where a number is more than eight bits (one byte) long several consecutive bytes are used to store the number, this is called Multiple Precision. It is normally easy enough to add two multiple precision numbers, but the RISC instruction set of most PICs does not allow for carrying any overflow from addition into the next byte.

In the author's experience there often appears to be some confusion of how to do this. Listing 1 shows the correct method of adding two multiple precision numbers,

```

110001101
001110010
110001101
001110010
110001101
001110010
  
```

NUM1 and NUM2. The L, M and H at the end of the variable names refer to Low, Middle and High bytes respectively. The Carry will be correctly set on exit, indicating any overflow from the addition.

Subtraction is performed in a similar manner. Another way of subtracting a number is to first negate it (two's complement) then perform an addition. This eliminates the need for a separate subtraction routine. The arithmetic unit of microprocessors, including PICs, use two's complement to perform subtractions.

Listing 1

```

movf    NUM2L,W    ;Add low bytes
addwf   NUM1L,F
movf    NUM2M,W    ;Add mid bytes
skpnc   ;No carry_in, so
         just add
incfsz  NUM2M,W    ;Add carry_in to
         NUM2
addwf   NUM1M,F    ;Add and propa-
         gate carry_out
movf    NUM2H,W    ;Add high bytes
skpnc   ;No carry_in, so
         just add
incfsz  NUM2H,W    ;Add carry_in to
         NUM2
addwf   NUM1H,F    ;Add and propa-
         gate carry_out
  
```

Multiplication

You can perform binary multiplication in the same way that you do decimal multiplication by hand. Before going into detail we will look at a worked example of multiplying 13 by 10, in binary that is 1101 and 1010.

```

      1101 (multiplicand)
    × 1010 (multiplier)
    -----
      0000 (partial products)
      1101
      0000
      1101
    1000010 (product)
  
```

Starting with the least significant digit of the multiplier, multiply the multiplicand by each multiplier digit in turn and write the results (partial products) below. Ensure the rightmost digit of each partial product lines up with it's generating digit in the

multiplier. Keep going until you run out of digits in the multiplier. Now add all the partial products together and you have the final result. A quick check of the result confirms it is correct, $128 + 2 = 130$.

Now we shall look at how to write a multiply routine in assembler. Since the numbers are binary no multiplication is actually needed because multiplying by zero gives zero as a result, and multiplying by one produces the same number you started with. This just leaves the problem of whether to multiply by 0 or 1.

To do this each bit of the multiplicand is shifted into the Carry for testing. If the bit is a 1 then the multiplier (or more correctly, the multiplier times one) is added to the partial product, if the bit is a 0 then nothing is done since there is no point in adding zero to the partial product.

The final task is to ensure the bits are correctly aligned at each addition, this is simply achieved by shifting the partial product in line with the multiplicand.

Listing 2 shows a simplified 8-bit \times 8-bit multiply. The variables MPCAND and MPLIER are multiplied to give a 16-bit result in PRODH and PRODL. There are numerous variations of this routine. It is also possible to work from left to right, starting with the most significant digit and shifting left. The best method to choose depends on the processor for which it is written, the number of bits and the programmer's personal preference.

Listing 2

```

mult  clrf  PRODL,F  ;Clear result
      clrf  PRODH,F
      movlw 0x08    ;Bit counter
      movwf COUNT
      movf  MPCAND,W ;Multiplicand
                          in W reg
loop  rrf   MPLIER,F ;LSB into Carry
      skpnc ;Test Carry
      addwf PRODH,F ;Add multi-
                          plicand to result
      rrf   PRODH,F ;Align result
      rrf   PRODL,F
      decfsz COUNT,F ;Next bit
      goto loop

```

Division

You will probably not be surprised to learn that division is pretty much the reverse of multiplication. Binary division can also be performed in the same way that you do decimal long division by hand, and again because the numbers are binary no division is actually needed. Where multiplication uses successive shifts and addition, division is done by successive shifts and subtraction.

An example of long division in binary is shown below. Those who are familiar with decimal long division should have no problem with the format, although it has been expanded somewhat for clarity. It shows 15 divided by 3.

0011	0101	(quotient 5)
1	1111	(divisor 3, dividend 15)
1	1	(partial remainders)
11		
- 11	11	(subtract divisor)
0		
01		
011		
- 011	011	(subtract divisor)
0	0	(remainder)

The most significant digit of the dividend is put into the partial remainder and compared with the divisor. If the partial remainder is less than the divisor then the quotient digit is a 0. If the partial remainder is equal to or greater than the divisor, the quotient digit is a 1, the divisor is subtracted and the remainder written below. The next dividend digit is now appended to the new partial remainder and the comparison is repeated until all the dividend digits have been processed.

The partial remainder must always remain less than twice the divisor, for this reason division is not needed for binary numbers. Unless, of course, you insist that dividing by 1 is a valid argument.

In this example the division is exact i.e. the result is an exact integer. If, for example, 14 were divided by 3 the result would be 4 with a remainder of 2 on the bottom line. Integer division always rounds down to the nearest whole number unless extra code is written to provide rounding up the result if the remainder is 0.5 or more.

Converting the division procedure into an assembler routine is very easy. Listing 3 shows a simple 8-bit by 8-bit divide. Appending to the remainder is done by shifting the MSB of the dividend into the Carry and then into the LSB of the remainder. Because of their RISC instruction set most PICs do not have a compare instruction so subtract is used to compare the values of the remainder and divisor, the result of the subtraction being held in the W register. Setting the quotient bit is done by shifting in the Carry which was cleared or set by the subtraction.

Listing 3

```

divide clrf  QUOT    ;Clear quotient
clrf  REM    ;Clear remainder
movlw 0x08   ;Bit count
movwf COUNT
loop  rlf   DIVID,F ;Shift dividend bit
      rlf   REM,F   ;into remainder
      movf  DIVIS,W ;Trial subtraction
      subwf REM,W
      skpnc ;Subtraction was ok
      rlf   QUOT,F  ;Carry is result bit
      decfsz COUNT,F ;Next bit
      goto loop

```

Round

As previously mentioned the result of division is rounded down, or more correctly truncated, if the result is not an exact integer. We can obtain a more accurate result by rounding up or down to the nearest integer when there is a fractional part to the result. This routine adds one to the result if the remainder of the division is 0.1 binary or greater, which is equivalent to 0.5 decimal. This helps to minimise errors caused by multiple uses of division.

Square Root

You can square a number simply by multiplying it by itself, square rooting a number is a little more difficult. There are many ways to find the square root of a number, probably the best method for large numbers was described by the author in the August 2002 issue of *EPE*. It is very similar to division since the square root of a number is equal to the number divided by

its square root. The original 24-bit routine has now been expanded to 32-bit.

Getting It In And Out

Frequently you would like to see the results of all your calculations and would like it to be in decimal, similarly you want to input numbers in decimal. This makes Binary to Decimal and Decimal to Binary routines an essential part of any maths package. Many assembler programmers will at some time have attempted these conversions, usually in a crude fashion. (As were the author's attempts many years ago).

Methods such as subtracting the binary equivalent of powers of ten are perfectly valid and can be useful, but when it comes to very large numbers there are much better methods available. The Binary to Decimal and Decimal to Binary routines presented here complement each other, they both use the same method but each is the reverse of the other.

The method chosen for this package is simplicity itself and very flexible. The routine is compact and easily modified for various bit lengths. A simplified version is shown in Listing 4.

Listing 4

```

clrf  ONES
clrf  TENS
clrf  HUND
movlw 8 ;Bit count
movwf BCOUNT
loop  rlf  BINARY,F ;Shift msb into
      rlf  ONES,F   ;first digit
      movlw 10 ;Digit > 9 ?
      subwf ONES,W
      skpnc
      movwf ONES ;Digit = digit - 10
      rlf  TENS,F ;Shift carry in
      movlw 10 ;Digit > 9 ?
      subwf TENS,W
      skpnc
      movwf TENS ;Digit = digit - 10
      rlf  HUND,F ;Shift carry in
      decfsz BCOUNT,F ;Next bit
      goto loop

```

The most significant bit of BINARY is shifted into the least significant digit, ONES. If the digit has a value of 10 or more then 10 is subtracted from it and 1 is added to the next higher digit. The Carry is used to add 1 to the next digit as it will be set by the subtraction if the digit is greater than 9.

The rest of the digits are shifted and checked in a similar manner and the whole process repeated until all the bits of the binary number have been shifted out of BINARY and into the digits. The hundreds digit is not tested in this instance since it cannot overflow as the maximum decimal value for 8-bit binary is 255.

Decimal to Binary consists of the same procedure but doing it all in reverse. Shifting bits through the digits and into the Carry, adding 10 to the digits when necessary and shifting the Carry into the binary.

Using The 32-Bit Routines

Signed 32-bit numbers have a range of -2147483648 to +2147483647. However -2147483648 does not have a positive equivalent which would be needed in many cases and so the range is limited to

± 2147483647 , with -2147483648 being trapped as an error. Three 32-bit pseudo-registers are defined, REGA contains the first operand, REGB contains the second operand and REGC is used as temporary storage by the routines. The result is always returned in REGA.

Each pseudo-register consists of four consecutive bytes denoted by 0, 1, 2 and 3. Byte 0 is the least significant byte and Byte 3 is the most significant byte. High level languages have built-in run-time error checking but assembler has no such luxuries and the programmer must write his/her own. Comprehensive error checking is included in the routines and the Carry will be set on return from the routines if an error is found. The code required for error checking after calling a routine is shown below.

```
CALL      <function>
SKPNC
GOTO     <errorhandler>
```

Because the stack on most PICs cannot be manipulated errors would usually need to be passed back to the top-most level of the program. Most errors will be caused by an overflow, i.e. the result is greater than 32 bits. When an error is encountered the result returned in REGA will be meaningless. Checking the Carry after calling a routine is optional so long as you are sure no error will occur.

The header of each routine gives a brief description of its function and usage. The five basic arithmetic functions are given below for reference.

```
Add:      REGA = REGA + REGB
Subtract:  REGA = REGA - REGB
Multiply:  REGA = REGA * REGB
Divide:    REGA = REGA / REGB
Sq Root:   REGA = SQRT (REGA)
```

Note that multiplying two 32-bit numbers can produce a result of up to 64 bits. A limit on the number of bits has to be drawn somewhere and it is 32, so an error will be returned if the result exceeds the 32 bits of REGA.

The Round routine is intended to be called only after division, it will not round the result of Square Root. Only the simplest of rounding is used since it was considered unnecessary to use a more complex method. Check for division error (if needed) before calling this routine.

The Decimal to Binary routine was designed for flexibility and keypad input in mind. It accepts a variable length BCD string of digits. Your input routine should put the first (most significant) digit entered in the variable DIGIT1, the next digit into DIGIT2 and so on up to a maximum of 10 digits.

A count of the number of digits entered must be kept and loaded into the W register before the routine is called. The reason for this is that people are unlikely to include leading zeros when entering a number to make up the full 10 digits that would otherwise be required, it seems leading zero suppression is in human nature.

If your digits are in ASCII text format they should first be converted to BCD format by subtracting 48. It is also worthwhile checking that the digits are in the range of

0 to 9 to avoid the possibility of obtaining a meaningless result.

The routine also requires a sign bit to indicate whether the number is positive or negative. This is held in the variable DSIGN which should be set to 0 for a positive number or 1 for negative.

Binary to Decimal requires little in the way of explanation. DSIGN is again used to indicate a positive or negative number. You may use this to precede the number with a "+" or "-" in your output routine. No output formatting is included as this will be dependant upon the application.

Resources

The 32-bit maths source code files are available on 3.5-inch disk from the Editorial Office (a small handling charge applies – see the *EPE PCB Service* on page 69). They can also be downloaded free from the *EPE Downloads* page, accessible via the home page at www.epemag.co.uk. They are held in the PICs folder, under PIC Tricks.

The routines are contained in the file *Maths32.txt* and are intended to be opened with a text editor such as Notepad and then copied and pasted into your assembly program. You copy all the routines or just the ones you require. But do not forget to also copy the utility routines, most of which will be required. The variable declarations will also need to be copied and you will need to supply a start address for them.

The variables require 26 contiguous bytes of data memory but if you do not have this amount available they may be split. Only the variables DIGIT1 to DIGIT10 are required to be contiguous.

Radio Bygones

Restoring a KB BR20



Radio Bygones

HMS Collingwood Museum of Communications and Radar



Radio Bygones

Philo Verus Atwater Kent



Radio Bygones

Dorchester Beam Station



Radio Bygones

Restoring an Ekco A144



Radio Bygones

The leading UK magazine for vintage radio enthusiasts

ARTICLES on restoration and repair, history, circuit techniques, personalities, reminiscences and just plain nostalgia – you'll find them all. Plus features on museums and private collections and a full-colour photo-feature in every issue.

IT'S MOSTLY about valves, of course, but 'solid-state' – whether of the coherer and spark-gap variety or early transistors – also has a place.

FROM THE DAYS of Maxwell, Hertz, Lodge and Marconi to what was the state-of-the-art just a few short years ago . . .

THERE IS ALSO a selection of free readers' For Sale and Wanted advertisements in every issue.

Radio Bygones covers it all!

THE MAGAZINE is published six times a year, and is only available by postal subscription. It is not available at newsagents.

TO TAKE OUT a subscription, or to order a sample copy, please contact:

RADIO BYGONES, Wimborne Publishing Ltd.,
408 Wimborne Road East, Ferndown, Dorset BH22 9ND.
 Tel: 01202 873872. Fax 01202 874562.
 Web sites: www.radiobygones.co.uk

Now Also Available to

BUY ONLINE

www.radiobygones.com

Log on, pay by credit card and download the magazine to your PC

ONLY \$9.99 (US dollars)

FOR 6 ISSUES

A free issue is available

FREE Electronics Hobbyist Compendium book with Teach-In 2000 CD-ROM



EPE TEACH-IN 2000 CD-ROM

The whole of the 12-part *Teach-In 2000* series by John Becker (published in *EPE* Nov '99 to Oct 2000) is now available on CD-ROM. Plus the *Teach-In 2000* interactive software (Win 95, 98, ME and above) covering all aspects of the series and Alan Winstanley's *Basic Soldering Guide* (including illustrations and Desoldering).

Teach-In 2000 covers all the basic principles of electronics from Ohm's Law to Displays, including Op.Amps, Logic Gates etc. Each part has its own section on the interactive software where you can also change component values in the various on-screen demonstration circuits.

The series gives a hands-on approach to electronics with numerous breadboard circuits to try out, plus a simple computer interface (Win 95, 98, ME only) which allows a PC to be used as a basic oscilloscope.

ONLY **£12.45** including VAT and p&p

Order code Teach-In CD-ROM

Robotics

INTRODUCING ROBOTICS WITH LEGO MINDSTORMS Robert Penfold

Shows the reader how to build a variety of increasingly sophisticated computer controlled robots using the brilliant Lego Mindstorms Robotic Invention System (RIS). Initially covers fundamental building techniques and mechanics needed to construct strong and efficient robots using the various "click-together" components supplied in the basic RIS kit. Then explains in simple terms how the "brain" of the robot may be programmed on screen using a PC and "zapped" to the robot over an infra-red link. Also, shows how a more sophisticated Windows programming language such as Visual BASIC may be used to control the robots.

Details building and programming instructions provided, including numerous step-by-step photographs.

288 pages - large format Order code BP901 £14.99

MORE ADVANCED ROBOTICS WITH LEGO MINDSTORMS - Robert Penfold

Covers the Vision Command System

Shows the reader how to extend the capabilities of the brilliant Lego Mindstorms Robotic Invention System (RIS) by using Lego's own accessories and some simple home constructed units. You will be able to build robots that can provide you with 'waiter service' when you clap your hands, perform tricks, 'see' and avoid objects by using 'bats radar', or accurately follow a line marked on the floor. Learn to use additional types of sensors including rotation, light, temperature, sound and ultrasonic and also explore the possibilities provided by using an additional (third) motor. For the less experienced, RCX code programs accompany most of the featured robots. However, the more adventurous reader is also shown how to write programs using Microsoft's VisualBASIC running with the ActiveX control (Spirit OX) that is provided with the RIS kit.

Detailed building instructions are provided for the featured robots, including numerous step-by-step photographs. The designs include rover vehicles, a virtual pet, a robot arm, an 'intelligent' sweet dispenser and a colour conscious robot that will try to grab objects of a specific colour.

298 pages Order code BP902 £14.99

ANDROIDS, ROBOTS AND ANIMATRONS - Second Edition - John Iovine

Build your own working robot or android using both off-the-shelf and workshop constructed materials and devices. Computer control gives these robots and androids two types of artificial intelligence (an expert system and a neural network). A lifelike android hand can be built and programmed to function doing repetitive tasks. A fully animated robot or android can also be built and programmed to perform a wide variety of functions.

The contents include an Overview of State-of-the-Art Robots; Robotic Locomotion; Motors and Power Controllers; All Types of Sensors; Tilt; Bump; Roar; and Wall Detection; Light; Speech and Sound Recognition; Robotic Intelligence (Expert Type) Using a Single-Board Computer Programmed in BASIC; Robotic Intelligence (Neural Type) Using Simple Neural Networks (Insect Intelligence); Making a Lifelike Android Hand; A Computer-Controlled Robotic Insect Programmed in BASIC; Telepresence Robots With Actual Arcade and Virtual Reality Applications; A Computer-Controlled Robotic Arm; Animated Robots and Androids; Real-World Robotic Applications.

224 pages Order code MGH1 £16.99

DIRECT BOOK SERVICE

NOTE: ALL PRICES INCLUDE UK POSTAGE

The books listed have been selected by *Everyday Practical Electronics* editorial staff as being of special interest to everyone involved in electronics and computing. They are supplied by mail order to your door. Full ordering details are given on the last book page.

For a further selection of books see the next two issues of *EPE*.

Radio

BASIC RADIO PRINCIPLES AND TECHNOLOGY Ian Poole

Radio technology is becoming increasingly important in today's high technology society. There are the traditional uses of radio which include broadcasting and point to point radio as well as the new technologies of satellites and cellular phones. All of these developments mean there is a growing need for radio engineers at all levels.

Assuming a basic knowledge of electronics, this book provides an easy to understand grounding in the topic.

Chapters in the book: Radio Today, Yesterday, and Tomorrow; Radio Waves and Propagation; Capacitors, Inductors, and Filters; Modulation; Receivers; Transmitters; Antenna Systems; Broadcasting; Satellites; Personal Communications; Appendix - Basic Calculations.

263 pages Order code NE30 £18.99

PROJECTS FOR RADIO AMATEURS AND S.W.L.S. R. A. Penfold

This book describes a number of electronic circuits, most of which are quite simple, which can be used to enhance the performance of most short wave radio systems.

The circuits covered include: An aerial tuning unit; A simple active aerial; An add-on b.f.o. for portable sets;

A wavetramp to combat signals on spurious responses; An audio notch filter; A parametric equaliser; C.W. and S.S.B. audio filters; Simple noise limiters; A speech processor; A volume expander.

Other useful circuits include a crystal oscillator, and RTTY/C.W. tone decoder, and a RTTY serial to parallel converter. A full range of interesting and useful circuits for short wave enthusiasts.

92 pages Order code BP304 £4.45

AN INTRODUCTION TO AMATEUR RADIO I. D. Poole

Amateur radio is a unique and fascinating hobby which has attracted thousands of people since it began at the turn of the century. This book gives the newcomer a comprehensive and easy to understand guide through the subject so that the reader can gain the most from the hobby. It then remains an essential reference volume to be used time and again. Topics covered include the basic aspects of the hobby, such as operating procedures, jargon and setting up a station. Technical topics covered include propagation, receivers, transmitters and aerials etc.

150 pages Order code BP257 £5.49

Computers and Computing

THE INTERNET FOR THE OLDER GENERATION Jim Gatenby

Especially written for the over 50s. Uses only clear and easy-to-understand language. Larger type size for easy reading. Provides basic knowledge to give you confidence to join the local computer class.

This book explains how to use your PC on the Internet and covers amongst other things: Choosing and setting up your computer for the Internet. Getting connected to the Internet. Sending and receiving emails, photographs, etc., so that you can keep in touch with family and friends all over the world. Searching for and saving information on any subject. On-line shopping and home banking. Setting up your own simple web site.

223 pages Order code BP600 £8.99

HOW TO BUILD YOUR OWN PC - Third Edition Morris Rosenthal

More and more people are building their own PCs. They get more value for their money, they create exactly the machine they want, and the work is highly satisfying and actually fun. That is, if they have a unique beginner's guide like this one, which visually demonstrates how to construct a state-of-the-art computer from start to finish.

Through 150 crisp photographs and clear but minimal text, readers will confidently absorb the concepts of computer building. The extra-big format makes it easy to see what's going on in the pictures. For non-specialists, there's even a graphical glossary that clearly illustrates technical terms. The author goes "under the hood" and shows step-by-step how to create a socket 7 (Pentium and non-intel chipsets) and a Slot 1 (Pentium II) computer, covering: What first-time builders need to know; How to select and purchase parts; How to assemble the PC; How to install Windows 98. The few existing books on this subject, although badly outdated, are in steady demand. This one delivers the expertise and new technology that fledgling computer builders are eagerly looking for.

224 pages - large format Order code MGH2 £20.99

PIC YOUR PERSONAL INTRODUCTORY COURSE SECOND EDITION John Morton

Discover the potential of the PIC microcontroller through graded projects - this book could revolutionise your electronics construction work!

A uniquely concise and practical guide to getting up and running with the PIC Microcontroller. The PIC is one of the most popular of the microcontrollers that are transforming electronic project work and product design.

Assuming no prior knowledge of microcontrollers and introducing the PIC's capabilities through simple

projects, this book is ideal for use in schools and colleges. It is the ideal introduction for students, teachers, technicians and electronics enthusiasts. The step-by-step explanations make it ideal for self-study too: this is not a reference book - you start work with the PIC straight away.

The revised second edition covers the popular reprogrammable EEPROM PICs: P16C84/16F84 as well as the P54 and P71 families.

270 pages Order code NE36 £15.99

eBAY FOR BEGINNERS Cherry Nixon

NEW

There are two kinds of people, those who are trading on eBay and the rest who are missing out. Though eBay has been embraced by entrepreneurs all over the world, it remains the peoples' site and offers the largest market for the smallest fee.

eBay presents an opportunity for everyone, the trick is to master it. This book shows you how to start trading on eBay UK. It also offers advice on getting organised and tips to put you ahead.

The book has been developed from Cherry's popular hands-on course "Buying and Selling on eBay for Technological Simpletons". In addition to fully explaining eBay and how to trade on it there are sections on Paypal, producing pictures of your sale items, fees and accounts, safety and security including what to do when things go wrong and what protection is provided.

178 pages Order code BP551 £8.99

UNDERSTANDING PC SPECIFICATIONS R. A. Penfold (Revised Edition)

PCs range from simple systems of limited capabilities up to complex systems that can happily run applications that would have been considered beyond the abilities of a microcomputer not so long ago. It would be very easy to choose a PC system that is inadequate to run your applications efficiently, or one which goes beyond your needs and consequently represents poor value for money.

This book explains PC specifications in detail, and the subjects covered include the following: Differences between types of PC (XT, AT, 80386, etc); Maths co-processors; Input devices (keyboards, mice, and digitisers); Memory, including both expanded (EMS) and extended RAM; RAM disks and disk caches; Floppy disk drive formats and compatibility; Hard disk drives (including interleave factors and access times); Display adaptors, including all standard PC types (CGA, Hercules, Super VGA, etc); Contains everything you need to know if you can't tell your EMS from your EGA!

128 pages Order code BP282 £5.45

Theory and Reference

BEBOP TO THE BOOLEAN BOOGIE Second Edition Clive (Max) Maxfield

**BOOK PLUS
CD-ROM**

This book gives the "big picture" of digital electronics. This in-depth, highly readable, up-to-the-minute guide shows you how electronic devices work and how they're made. You'll discover how transistors operate, how printed circuit boards are fabricated, and what the innards of memory ICs look like. You'll also gain a working knowledge of Boolean Algebra and Karnaugh Maps, and understand what Reed-Muller logic is and how it's used. And there's much, MUCH more. The author's tongue-in-cheek humour makes it a delight to read, but this is a REAL technical book, extremely detailed and accurate. Comes with a free CD-ROM which contains an eBook version with full text search plus bonus chapter - An Illustrated History of Electronics and Computing.

Contents: Fundamental concepts; Analog versus digital; Conductors and insulators; Voltage, current, resistance, capacitance and inductance; Semiconductors; Primitive logic functions; Binary arithmetic; Boolean algebra; Karnaugh maps; State diagrams, tables and machines; Analog-to-digital and digital-to-analog; Integrated circuits (ICs); Memory ICs; Programmable ICs; Application-specific integrated circuits (ASICs); Circuit boards (PWBs and DWBs); Hybrids; Multichip modules (MCMs); Alternative and future technologies.

500 pages **Order code BEB1** £27.50

BEBOP BYTES BACK (and the Bebop Computer Simulator) CD-ROM Clive (Max) Maxfield and Alvin Brown

CD-ROM



This follow-on to *Bebop to the Boolean Boogie* is a multimedia extravaganza of information about how computers work. It picks up where "Bebop I" left off, guiding you through the fascinating world of computer design... and you'll have a few chuckles, if not belly laughs, along the way. In addition to over 200 megabytes of mega-cool multimedia, the CD-ROM contains a virtual microcomputer, simulating the motherboard and standard computer peripherals in an extremely realistic manner. In addition to a wealth of technical information, myriad nuggets of trivia, and hundreds of carefully drawn illustrations, the CD-ROM contains a set of lab experiments for the virtual microcomputer that let you recreate the experiences of early computer pioneers. If you're the slightest bit interested in the

inner workings of computers, then don't dare to miss this!
Over 800 pages in Adobe Acrobat format

CD-ROM **Order code BEB2 CD-ROM** £21.95

ELECTRONICS MADE SIMPLE Ian Sinclair

Assuming no prior knowledge, *Electronics Made Simple* presents an outline of modern electronics with an emphasis on understanding how systems work rather than on details of circuit diagrams and calculations. It is ideal for students on a range of courses in electronics, including GCSE, C&G and GNVQ, and for students of other subjects who will be using electronic instruments and methods.

Contents: waves and pulses, passive components, active components and ICs, linear circuits, block and circuit diagrams, how radio works, disc and tape recording, elements of TV and radar, digital signals, gating and logic circuits, counting and correcting, microprocessors, calculators and computers, miscellaneous systems.

199 pages **Order code NE23** £13.99

SCROGGIE'S FOUNDATIONS OF WIRELESS AND ELECTRONICS - ELEVENTH EDITION S. W. Amos and Roger Amos

Scroggie's Foundations is a classic text for anyone working with electronics, who needs to know the art and craft of the subject. It covers both the theory and practical aspects of a huge range of topics from valve and tube technology, and the application of cathode ray tubes to radar, to digital tape systems and optical recording techniques.

Since *Foundations of Wireless* was first published over 60 years ago, it has helped many thousands of readers to become familiar with the principles of radio and electronics. The original author Sowerby was succeeded by Scroggie in the 1940s, whose name became synonymous with this classic primer for practitioners and students alike. Stan Amos, one of the fathers of modern electronics and the author of many well-known books in the area, took over the revision of this book in the 1980s and it is he, with his son, who have produced this latest version.

400 pages **Temporarily out of print**

GETTING THE MOST FROM YOUR MULTIMETER

R. A. Penfold

This book is primarily aimed at beginners and those of limited experience of electronics. Chapter 1 covers the basics of analogue and digital multimeters, discussing the relative merits and the limitations of the two types. In Chapter 2 various methods of component checking are described, including tests for transistors, thyristors, resistors, capacitors and diodes. Circuit testing is covered in Chapter 3, with subjects such as voltage, current and continuity checks being discussed.

In the main little or no previous knowledge or experience is assumed. Using these simple component and circuit testing techniques the reader should be able to confidently tackle servicing of most electronic projects.

96 pages **Order code BP239** £5.49

THE AMATEUR SCIENTIST CD-ROM

CD-ROM

The complete collection of The Amateur Scientist articles from *Scientific American* magazine. Over 1,000 classic science projects from a renowned source of winning projects. All projects are rated for cost, difficulty and possible hazards.



Plus over 1,000 pages of helpful science techniques that never appeared in *Scientific American*. Exciting science projects in: Astronomy; Earth Science; Biology; Physics; Chemistry; Weather... and much more! The most complete resource ever assembled for hobbyists, and professionals looking for novel solutions to research problems.

Includes extensive Science Software Library with even more science tools. Suitable for Mac, Windows, Linux or UNIX. 32MB RAM minimum, Netscape 4.0 or higher or Internet Explorer 4.0 or higher.

Over 1,000 projects **Order code AS1 CD-ROM** £19.95

Music, Audio and Video

QUICK GUIDE TO ANALOGUE SYNTHESIS

Ian Waugh

Even though music production has moved into the digital domain, modern synthesisers invariably use analogue synthesis techniques. The reason is simple - analogue synthesis is flexible and versatile, and it's relatively easy for us to understand. The basics are the same for all analogue synths, and you'll quickly be able to adapt the principles to any instrument, to edit existing sounds and create exciting new ones. This book describes: How analogue synthesis works; The essential modules every synthesiser has; The three steps to synthesis; How to create phat bass sounds; How to generate filter sweeps; Advanced synth modules; How to create simple and complex synth patches; Where to find soft synths on the Web.

If you want to take your synthesiser - of the hardware or software variety - past the presets, and program your own sounds and effects, this practical and well-illustrated book tells you what you need to know.

60 pages **Order code PC118** £7.45

QUICK GUIDE TO MP3 AND DIGITAL MUSIC

Ian Waugh

MP3 files, the latest digital music format, have taken the music industry by storm. What are they? Where do you get them? How do you use them? Why have they thrown record companies into a panic? Will they make music easier to buy? And cheaper? Is this the future of music?

All these questions and more are answered in this concise and practical book which explains everything you need to know about MP3s in a simple and easy-to-understand manner. It explains:

How to play MP3s on your computer; How to use MP3s with handheld MP3 players; Where to find MP3s on the Web; How MP3s work; How to tune into Internet radio stations; How to create your own MP3s; How to record your own CDs from MP3 files; Other digital audio music formats.

Whether you want to stay bang up to date with the latest music or create your own MP3s and join the on-line digital music revolution, this book will show you how.

60 pages **Order code PC119** £7.45

ELECTRONIC MUSIC AND MIDI PROJECTS

R. A. Penfold

Whether you wish to save money, boldly go where no musician has gone before, rekindle the pioneering spirit, or simply have fun building some electronic music gadgets, the designs featured in this book should suit your needs. The projects are all easy to build, and some are so simple that even complete beginners at electronic project construction can tackle them with ease. Stripboard layouts are provided for every project, together with a wiring diagram. The

mechanical side of construction has largely been left to individual constructors to sort out, simply because the vast majority of project builders prefer to do their own thing in this respect.

None of the designs requires the use of any test equipment in order to get them set up properly. Where any setting up is required, the procedures are very straightforward, and they are described in detail.

Projects covered: Simple MIDI tester, Message grabber, Byte grabber, THRU box, MIDI auto switcher, Auto/manual switcher, Manual switcher, MIDI patchbay, MIDI controlled switcher, MIDI lead tester, Program change pedal, Improved program change pedal, Basic mixer, Stereo mixer, Electronic swell pedal, Metronome, Analogue echo unit.

124 pages **Order code PC116** £10.95 £5.45

THE INVENTOR OF STEREO - THE LIFE AND WORKS OF ALAN DOWER BLUMLEIN

Robert Charles Alexander

This book is the definitive study of the life and works of one of Britain's most important inventors who, due to a cruel set of circumstances, has all but been overlooked by history.

Alan Dower Blumlein led an extraordinary life in which his inventive output rate easily surpassed that of Edison, but whose early death during the darkest days of World War Two led to a shroud of secrecy which has covered his life and achievements ever since.

His 1931 Patent for a Binaural Recording System was so revolutionary that most of his contemporaries regarded it as more than 20 years ahead of its time. Even years after his death, the full magnitude of its detail had not been fully utilized. Among his 128 patents are the principal electronic circuits critical to the development of the world's first electronic television system. During his short working life, Blumlein produced patent after patent breaking entirely new ground in electronic and audio engineering.

During the Second World War, Alan Blumlein was deeply engaged in the very secret work of radar development and contributed enormously to the system eventually to become 'H2S' - blind-bombing radar. Tragically, during an experimental H2S flight in June 1942, the Halifax bomber in which Blumlein and several colleagues were flying, crashed and all aboard were killed. He was just days short of his thirty-ninth birthday.

420 pages **Order code NE32** £17.99

VIDEO PROJECTS FOR THE ELECTRONICS CONSTRUCTOR

R. A. Penfold

Written by highly respected author R. A. Penfold, this book contains a collection of electronic projects specially

designed for video enthusiasts. All the projects can be simply constructed, and most are suitable for the newcomer to project construction, as they are assembled on stripboard.

There are faders, wipers and effects units which will add sparkle and originality to your video recordings, an audio mixer and noise reducer to enhance your soundtracks and a basic computer control interface. Also, there's a useful selection on basic video production techniques to get you started.

Complete with explanations of how the circuit works, shopping lists of components, advice on construction, and guidance on setting up and using the projects, this invaluable book will save you a small fortune.

Circuits include: video enhancer, improved video enhancer, video fader, horizontal wiper, improved video wiper, negative video unit, fade to grey unit, black and white keyer, vertical wiper, audio mixer, stereo headphone amplifier, dynamic noise reducer, automatic fader, push-button fader, computer control interface, 12 volt mains power supply.

124 pages **Order code PC115** £10.95 £5.45

PC MUSIC - THE EASY GUIDE

Robin Vincent

How do I make music on my PC? Can I record music onto my PC? What's a sequencer? How can I get my PC to print a music score? What sort of a soundcard do I need? What hardware and software do I need? How do I connect a keyboard to my PC?

Just a few of the questions you've probably asked. Well, you'll find the answers to all these questions, and many more, in this book. It will show you what can be done, what it all means, and what you will need to start creating your own music on your PC. It's an easy read, it's fully illustrated and it will help you understand how a computer can be used as a creative music tool.

It covers soundcards, sequencers, hard disk digital audio recording and editing, plug-ins, printing scores with notation software, using your PC as a synthesiser, getting music onto and off the Internet, using Windows, sample PC music setups, FAQs, a glossary, advice on hardware and software, and a list of industry contacts.

116 pages **Order code PC117** £11.95

HIGH POWER AUDIO AMPLIFIER CONSTRUCTION

R. A. Penfold

Practical construction details of how to build a number of audio power amplifiers ranging from about 50 to 300/400 watts r.m.s. includes MOSFET and bipolar transistor designs.

96 pages **Temporarily out of print**

Circuits, Data and Design

PRACTICAL ELECTRONIC FILTERS

Owen Bishop

This book deals with the subject in a non-mathematical way. It reviews the main types of filter, explaining in simple terms how each type works and how it is used.

The book also presents a dozen filter-based projects with applications in and around the home or in the constructor's workshop. These include a number of audio projects such as a rhythm sequencer and a multi-voiced electronic organ.

Concluding the book is a practical step-by-step guide to designing simple filters for a wide range of purposes, with circuit diagrams and worked examples.

88 pages **Order code BP299** £5.49

DIGITAL ELECTRONICS – A PRACTICAL APPROACH

With FREE Software: Number One

FREE SOFTWARE

Systems – EASY-PC

Professional XM and Pulsar (Limited Functionality)

Richard Monk

Covers binary arithmetic, Boolean algebra and logic gates, combination logic, sequential logic including the design and construction of asynchronous and synchronous circuits and register circuits. Together with a considerable practical content plus the additional attraction of its close association with computer aided design including the FREE software.

There is a 'blow-by-blow' guide to the use of EASY-PC Professional XM (a schematic drawing and printed circuit board design computer package). The guide also conducts the reader through logic circuit simulation using Pulsar software. Chapters on p.c.b. physics and p.c.b. production techniques make the book unique, and with its host of project ideas make it an ideal companion for the integrative assignment and common skills components required by BTEC and the key skills demanded by GNVQ. The principal aim of the book is to provide a straightforward approach to the understanding of digital electronics.

Those who prefer the 'Teach-In' approach or would rather experiment with some simple circuits should find the book's final chapters on printed circuit board production and project ideas especially useful.

250 pages (large format) **Order code NE28** £21.99

A BEGINNER'S GUIDE TO TTL DIGITAL ICs

R. A. Penfold

This book first covers the basics of simple logic circuits in general, and then progresses to specific TTL logic integrated circuits. The devices covered include gates, oscillators, timers, flip/flops, dividers, and decoder circuits. Some practical circuits are used to illustrate the use of TTL devices in the 'real world'.

142 pages **Order code BP332** £5.45

DOMESTIC SECURITY SYSTEMS

A. L. Brown

This book shows you how, with common sense and basic do-it-yourself skills, you can protect your home. It also gives tips and ideas which will help you to maintain and improve your home security, even if you already have an alarm. Every circuit in this book is clearly described and illustrated, and contains components that are easy to source. Advice and guidance are based on the real experience of the author who is an alarm installer, and the designs themselves have been rigorously put to use on some of the most crime-ridden streets in the world.

The designs include all elements, including sensors, detectors, alarms, controls, lights, video and door entry systems. Chapters cover installation, testing, maintenance and upgrading.

192 pages **Order code NE25** £20.99

MICROCONTROLLER COOKBOOK

Mike James

The practical solutions to real problems shown in this cookbook provide the basis to make PIC and 8051 devices really work. Capabilities of the variants are examined, and ways to enhance these are shown. A survey of common interface devices, and a description of programming models, lead on to a section on development techniques. The cookbook offers an introduction that will allow any user, novice or experienced, to make the most of micro-controllers.

240 pages **Order code NE26** £23.99

For a further selection of books see the next two issues of EPE

Project Building & Testing

ELECTRONIC PROJECTS FOR EXPERIMENTERS

R. A. Penfold

Many electronic hobbyists who have been pursuing their hobby for a number of years seem to suffer from the dreaded "seen it all before" syndrome. This book is fairly and squarely aimed at sufferers of this complaint, plus any other electronics enthusiasts who yearn to try something a bit different. No doubt many of the projects featured here have practical applications, but they are all worth a try for their interest value alone.

The subjects covered include:- Magnetic field detector, Basic Hall effect compass, Hall effect audio isolator, Voice scrambler/descrambler, Bat detector, Bat style echo location, Noise cancelling, LED stroboscope, Infra-red "torch", Electronic breeze detector, Class D power amplifier, Strain gauge amplifier, Super hearing aid.

138 pages **Order code BP371** £5.45

FAULT-FINDING ELECTRONIC PROJECTS

R. A. Penfold

Starting with mechanical faults such as dry joints, short-circuits etc. coverage includes linear circuits, using a meter to make voltage checks, signal tracing techniques and fault finding on logic circuits. The final chapter covers ways of testing a wide range of electronic components, such as resistors, capacitors, operational amplifiers, diodes, transistors, SCRs and triacs, with the aid of only a limited amount of test equipment.

The construction and use of a Tristate Continuity Tester, a Signal Tracer, a Logic Probe and a CMOS Tester are also included.

136 pages **Temporarily out of print**

PRACTICAL FIBRE-OPTIC PROJECTS

R. A. Penfold

While fibre-optic cables may have potential advantages over ordinary electric cables, for the electronics enthusiast it is probably their novelty value that makes them worthy of exploration. Fibre-optic cables provide an innovative interesting alternative to electric cables, but in most cases they also represent a practical approach to the problem. This book provides a number of tried and tested circuits for projects that utilize fibre-optic cables.

The projects include:- Simple audio links, F.M. audio link, P.W.M. audio links, Simple d.c. links, P.W.M. d.c. link, P.W.M. motor speed control, RS232C data links, MIDI link, Loop alarms, R.P.M. meter.

All the components used in these designs are readily available, none of them require the constructor to take out a second mortgage.

132 pages **Order code BP374** £5.45

RADIO BYGONES

We also carry a selection of books aimed at readers of EPE's sister magazine on vintage radio *Radio Bygones*. These books include the *Comprehensive Radio Valve Guides* (five books with a Free copy of the Master Index) for just £15. Also Jonathan Hill's excellent *Radio Radio*, a comprehensive book with hundreds of photos depicting the development of the British wireless set up to the late 1960s.

The three volumes of our own *Wireless For the Warrior* by Louis Meulstee are also available. These are a technical history of radio communication equipment in the British Army from pre-war through to the 1960s.

For details see the shop on our UK web site at www.epemag.wimborne.co.uk or contact us for a list of *Radio Bygones* books.

BOOK ORDERING DETAILS

All prices include UK postage. For postage to Europe (air) and the rest of the world (surface) please add £2 per book. For the rest of the world airmail add £3 per book. CD-ROM prices include VAT and/or postage to anywhere in the world. Send a PO, cheque, international money order (£ sterling only) made payable to Direct Book Service or card details, Visa, Mastercard, Amex, Diners Club or Maestro to:

**DIRECT BOOK SERVICE, WIMBORNE PUBLISHING LTD.,
408 WIMBORNE ROAD EAST, FERNDOWN, DORSET BH22 9ND.**

Orders are normally sent out within seven days of receipt, but please allow 28 days for delivery – more for overseas orders. Please check price and availability (see latest issue of *Everyday Practical Electronics*) before ordering from old lists.

For a further selection of books and CD-ROMs see the next two issues of EPE.

Tel 01202 873872 Fax 01202 874562. Email: dbs@epemag.wimborne.co.uk
Order from our online shop at: www.epemag.wimborne.co.uk/shopdoor.htm

BOOK/CD-ROM ORDER FORM

Full name:

Address:

..... Post code: Telephone No:

Signature:

I enclose cheque/PO payable to DIRECT BOOK SERVICE for £

Please charge my card £ Card expiry date:

Card Number Maestro Issue No.

Card Security Code (The last 3 digits on or just below the signature strip)

Please send book/CD-ROM order codes:

Please continue on separate sheet of paper if necessary
If you do not wish to cut your magazine, send a letter or copy of this form

INGENUITY UNLIMITED



Our regular round-up of readers' own circuits. We pay between £10 and £50 for all material published, depending on length and technical merit. We're looking for novel applications and circuit designs, not simply mechanical, electrical or software ideas. Ideas *must be the reader's own work and must not have been published or submitted for publication elsewhere*. The circuits shown have NOT been proven by us. *Ingenuity Unlimited* is open to ALL abilities, but items for consideration in this column should be typed or word-processed, with a brief circuit description (between 100 and 500 words maximum) and full circuit diagram showing all component values. **Please draw all circuit schematics as clearly as possible.**

Send your circuit ideas to: *Ingenuity Unlimited*, Wimborne Publishing Ltd., 408 Wimborne Road East, Ferndown Dorset BH22 9ND. (We do not accept submissions for *IU* via E-mail.) Your ideas could earn you some cash and a prize!



WIN A PICO PC BASED OSCILLOSCOPE WORTH £586

- 100MS/s Dual Channel Storage Oscilloscope
- 50MHz Spectrum Analyser
- Multimeter • Frequency Meter
- Signal Generator

If you have a novel circuit idea which would be of use to other readers then a Pico Technology PC based oscilloscope could be yours. Every 12 months, Pico Technology will be awarding an ADC200-100 digital storage oscilloscope for the best *IU* submission. In addition, a DrDAQ Data Logger/Scope worth £69 will be presented to the runner up.

Tri-State Logic Probe - - Testing Every Which-Way

WHEN John Becker saw my submission for the *Repeatable Logic Probe* (*IU* July '04) he asked if it could lead to a development employing 74HC logic. Well, that isn't what happened! However, he started off a train of thought that brought about the development of the probe presented here.

The previous probe was designed as built-in test equipment where many logic levels were to be displayed, but each probe was always connected. Hence only low or high would be indicated; the third, high-impedance/disconnected state could not occur.

Circuit Details

The developed version shown in Fig.1 indicates on a bi-colour l.e.d., D1, the single logic level to which it is temporarily connected, and it also correctly responds to being disconnected by extinguishing the l.e.d. It must be powered from the circuit whose logic levels are to be measured.

As previously, a dual op.amp is required (IC1a/IC1b) but this time it is the only chip as the design dispenses with the complexity of window discriminators and accepts TTL levels (5V power rail) and CMOS levels (9V power rail maximum).

Think of the l.e.d. as at the centre pivot of a see-saw with the outputs of the two op.amps at the ends of the see-saw. If the two outputs are similar, the see-saw is about level, so there is insufficient voltage across the l.e.d. to turn it on. This is the disconnected case, where the only influence on the test probe input is from voltage divider R1/R2. This sets the probe at 40% of the power rail voltage, in between the ranges for low or high logic, whether CMOS or 5V TTL.

Both op.amps are configured as comparators with low gain. IC1a senses the test probe on its inverting input (pin 5) through resistor R3, the same signal being sensed by IC1b through R11, but on its non-inverting input (pin 7). The other point of comparison is a fixed 40% of the power rail as defined by potential divider R12/R13.

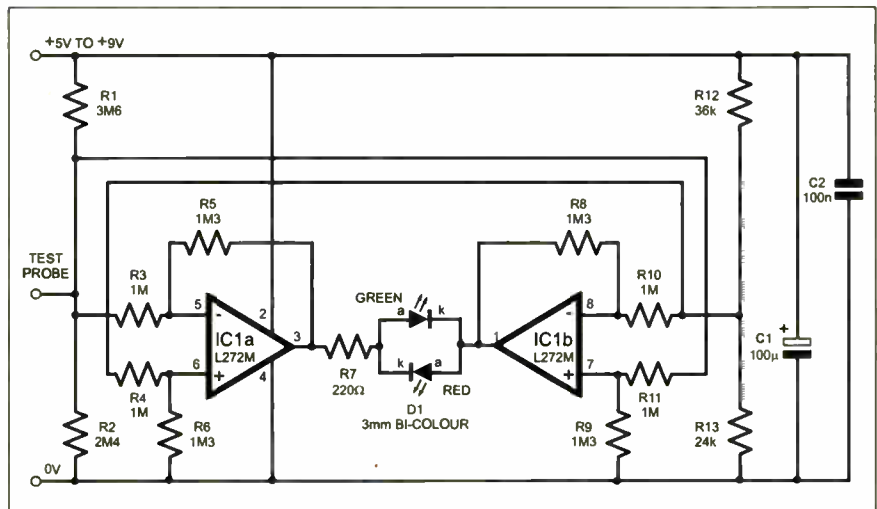

Fig.1. Tri-State Logic Probe circuit diagram

If a logic voltage is applied to the test probe then the high-impedance divider R1/R2 becomes ineffective and irrelevant. The logic level now pulls the output of IC1a close to one power rail, as it is so different to the fixed (R12/R13) comparison voltage. At the same time, IC1b also detects the difference between the test probe signal and the fixed comparison voltage. But, because these two levels are applied with the opposite polarity (test probe to non-inverting input), the output

swings near to the opposite rail compared to what is happening at IC1a.

As one end of the see-saw goes up, the other comes down and vice versa. This applies enough voltage across the l.e.d. to make the appropriate colour light-up, depending on which end is positive and which negative. Resistor R7 limits the current flow through the l.e.d.

Godfrey Manning G4GLM,
Edgware, Middx

INGENUITY UNLIMITED BE INTERACTIVE

IU is *your* forum where you can offer other readers the benefit of your Ingenuity. Share those ideas, earn some cash and possibly a prize!



64 L.E.D. Sequencer – On A Roll

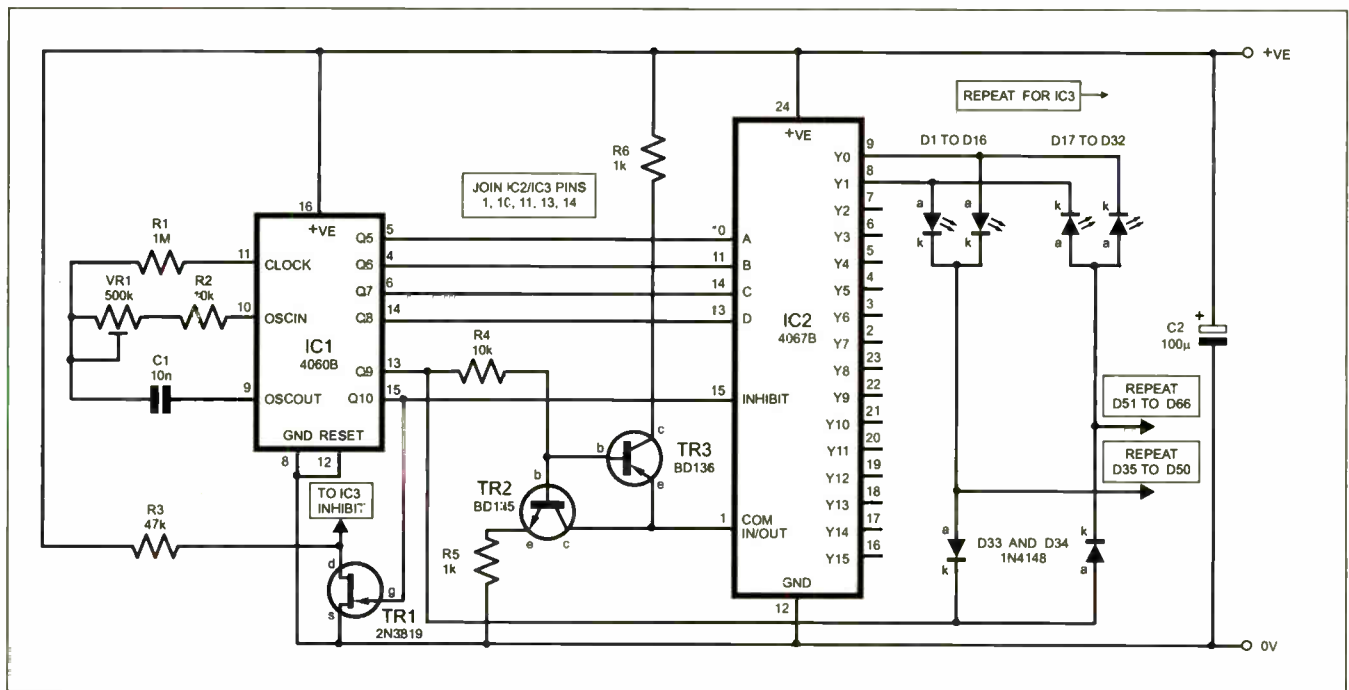

Fig.2. Circuit diagram for the 64 L.E.D. Sequencer

It is a fairly simple matter to illuminate either 10 or 16 l.e.d.s in sequence. However, circuits tend to become complicated once they venture beyond this. It is not uncommon to find circuits using one or even two or three components per l.e.d. in the sequence (unless a PIC microcontroller is used).

The circuit shown in Fig.2 uses just one component for every four l.e.d.s in the sequence. That is, it flashes 64 l.e.d.s in sequence with just 16 components – alternatively, it will flash 32 l.e.d.s in sequence with just 14 components. In this case, components R3, TR1 and IC3 are omitted, and IC2's Inhibit pin is taken to 0V.

At its core, the circuit comprises an oscillator/ripple counter (IC1), and a 1-pole 16-way bidirectional switch (IC2). In its simplest form, using four stages of IC1 (Q5 to Q8) to control IC2, this would provide a sequence of 16 l.e.d.s (D1 to D16). Since only one l.e.d. is illuminated at a time, and since all the anodes (a) are commoned, just a single ballast resistor is required (R6).

A further 16 l.e.d.s (D17 to D32) are then added to the sequence, with their polarity reversed. An H-bridge is used to reverse the voltage across all 32 l.e.d.s, and diodes D33 to D34 are employed to prevent reverse voltages across those l.e.d.s which are out of commission. One of the stages of IC1 (Q9) is pressed into service for the H-bridge, therefore only two transistors, or five components in all, are needed to increase the number of l.e.d.s sequenced to 32.

It is an even simpler matter to add a further 32 l.e.d.s to the sequence, making up a total of 64. The Inhibit pin of the 4067B allows the device to be switched in and out of service. Two 4067B i.c.s are therefore wired in parallel, each of them identically sequencing 32 l.e.d.s. However, their Inhibit pins are switched alternately by means of IC1 stage Q10 and the inverter formed by transistor TR1 and resistor R3.

To simplify the circuit, only four l.e.d.s out of the 64 have been shown, connected

to IC2 output Y0 and Y1, and IC3 has been omitted. The remaining 14 outputs of IC2 (Y2 to Y15) are wired up in similar fashion to the four l.e.d.s shown, and the additional 32 l.e.d.s (D35 to D66) are wired to IC3 in similar fashion to IC2, with 16 anodes (a) being taken to the D34 cathode (k), and 16 cathodes being taken to the D33 anode, as shown.

IC2 pins 1, 10, 11, 13 and 14 are taken to the corresponding pins of IC3, and IC3's Inhibit pin is taken to TR1's drain (d) as shown. Of course, IC3's +VE and GND (pins 24 and 12) must also be connected.

By using a relatively high supply voltage (12V), the circuit will sequence all types of colour l.e.d.s. The speed of the sequence may be controlled by preset potentiometer VR1, while the brightness of the l.e.d.s is determined by the values of resistors R5 and R6. These values should not be reduced to less than 470Ω.

Thomas Scarborough,
Cape Town, South Africa

L.E.D. Charging Indicator – On Charge

AFTER getting thoroughly fed up of leaving my scanner on charge overnight, only to find the next morning that the batteries had not charged due to a bad connection between the charger plug and scanner socket, I decided to fit some kind of "current flow" indicator.

The actual circuit used is shown in Fig.3a. The transistor used for the npn circuit was a BD124 device, though any power transistor will probably do. You can use either an npn or pnp transistor, both circuit versions are shown in Fig.3.

The circuit needs to be able to handle a range of current from around 50mA to 300mA so that the charger unit can power the scanner and charge the battery at the same time, or just charge the battery alone.

As the current through the circuit increases from zero, l.e.d. D1 starts to illuminate, and the voltage across resistor R1 starts to increase. When this voltage reaches 0.6V, transistor TR1 starts to conduct, shunting any additional current round the l.e.d. and R1. The value of resistor R1 determines the maximum current through l.e.d. D1, and, therefore, its brightness. Having chosen a current of about 10mA, a 56 ohm resistor was used.

The voltage across the circuit is 2.5V to 3V, so a slightly higher charger voltage may be required.

P.A. Tomlinson,
Hull, East Yorkshire

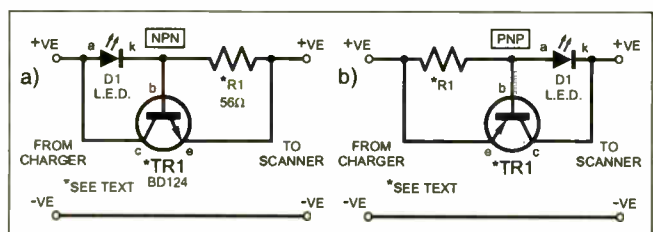
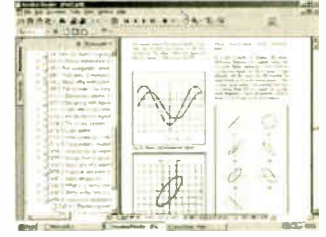
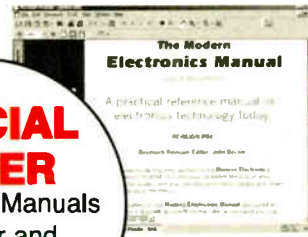
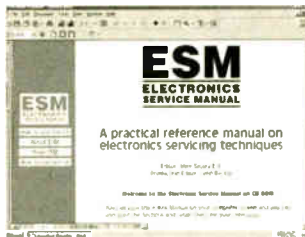

Fig.3. Circuit of the Charging Indicator

ELECTRONICS MANUALS ON CD-ROM £29.95 EACH

ELECTRONICS SERVICE MANUAL

THE MODERN ELECTRONICS MANUAL



SPECIAL OFFER
Order both Manuals together and **SAVE £10**

Everything you need to know to get started in repairing electronic equipment

- Around 900 pages • Fundamental principles • Troubleshooting techniques • Servicing techniques • Choosing and using test equipment • Reference data • Manufacturers' web links
- Easy-to-use Adobe Acrobat format • Clear and simple layout
- Vital safety precautions • Professionally written • Supplements

SAFETY: Safety Regulations, Electrical Safety and First Aid.
UNDERPINNING KNOWLEDGE: Electrical and Electronic Principles, Active and Passive Components, Circuit Diagrams, Circuit Measurements, Radio, Computers, Valves and Manufacturers' Data, etc.
PRACTICAL SKILLS: Learn how to identify Electronic Components, Avoid Static Hazards, Carry Out Soldering and Wiring, Remove and Replace Components.
TEST EQUIPMENT: How to Choose and Use Test Equipment, Assemble a Toolkit, Set Up a Workshop, and Get the Most from Your Multimeter and Oscilloscope, etc.
SERVICING TECHNIQUES: The Manual includes vital guidelines on how to Service Audio Amplifiers. The Supplements include similar guidelines for Radio Receivers, TV Receivers, Cassette Recorders, Video Recorders, Personal Computers, etc.
TECHNICAL NOTES: Commencing with the IBM PC, this section and the Supplements deal with a very wide range of specific types of equipment – radios, TVs, cassette recorders, amplifiers, video recorders etc.
REFERENCE DATA: Diodes, Small-Signal Transistors, Power Transistors, Thyristors, Triacs and Field Effect Transistors. Supplements include Operational Amplifiers, Logic Circuits, Optoelectronic Devices, etc.

The essential reference work for everyone studying electronics

- Over 800 pages • In-depth theory • Projects to build
 - Detailed assembly instructions • Full components checklists • Extensive data tables • Manufacturers' web links
 - Easy-to-use Adobe Acrobat format • Clear and simple layout • Comprehensive subject range • Professionally written • Supplements
- BASIC PRINCIPLES:** Electronic Components and their Characteristics; Circuits Using Passive Components; Power Supplies; The Amateur Electronics Workshop; The Uses of Semiconductors; Digital Electronics; Operational Amplifiers; Introduction to Physics, including practical experiments; Semiconductors and Digital Instruments.
CIRCUITS TO BUILD: The Base Manual describes 12 projects including a Theremin and a Simple TENS Unit.
ESSENTIAL DATA: Extensive tables on diodes, transistors, thyristors and triacs, digital and linear i.c.s.
EXTENSIVE GLOSSARY: Should you come across a technical word, phrase or abbreviation you're not familiar with, simply look up the glossary and you'll find a comprehensive definition in plain English.
 The Manual also covers **Safety** and provides web links to component and equipment **Manufacturers and Suppliers**.

Full contents list available online at: www.epemag.wimborne.co.uk

Supplements: Additional CD-ROMs each containing approximately 500 pages of additional information on specific areas of electronics are available for £19.95 each. Information on the availability and content of each Supplement CD-ROM will be sent to you.

Presentation: CD-ROM suitable for any modern PC. Requires Adobe Acrobat Reader which is included on the CD-ROM.

Wimborne Publishing Ltd., Dept Y12, 408 Wimborne Road East, Ferndown, Dorset BH22 9ND. Tel: 01202 873872. Fax: 01202 874562.

PLEASE send me



THE MODERN ELECTRONICS MANUAL CD-ROM

ELECTRONICS SERVICE MANUAL CD-ROM

I enclose payment of £29.95 (for one Manual) or £49.90 for both Manuals (saving £10 by ordering both together).

FULL NAME
(PLEASE PRINT)

ADDRESS

.....POSTCODE

SIGNATURE

I enclose cheque/PO in UK pounds payable to Wimborne Publishing Ltd.

Please charge my Visa/Mastercard/Amex/Diners Club/Switch/Maestro

Card No Switch/Maestro Issue No

Valid From Expiry Date

Card Security Code (The last 3 digits on or just under the signature strip)

ORDER FORM

Simply complete and return the order form with your payment to the following address:

Wimborne Publishing Ltd,
Dept. Y12,
408 Wimborne Road East, Ferndown,
Dorset BH22 9ND

Price includes postage to anywhere in the World

We will happily exchange any faulty CD-ROMs but since the content can be printed out we do not offer a refund on these items.

Your CD-ROM(s) will be posted to you by first class mail or airmail, normally within four working days of receipt of your order

PCB SERVICE

Printed circuit boards for most recent EPE constructional projects are available from the PCB Service, see list. These are fabricated in glass fibre, and are fully drilled and roller tinned. All prices include VAT and postage and packing. Add £1 per board for airmail outside of Europe. Remittances should be sent to **The PCB Service, Everyday Practical Electronics, Wimborne Publishing Ltd., 408 Wimborne Road East, Ferndown, Dorset BH22 9ND. Tel: 01202 873872; Fax 01202 874562; Email: orders@epemag.wimborne.co.uk. On-line Shop: www.epemag.wimborne.co.uk/shopdoor.htm.** Cheques should be crossed and made payable to **Everyday Practical Electronics (Payment in £ sterling only).**
NOTE: While 95% of our boards are held in stock and are dispatched within seven days of receipt of order, please allow a maximum of 28 days for delivery – overseas readers allow extra if ordered by surface mail.
Back numbers or photostats of articles are available if required – see the Back Issues page for details. We do not supply kits or components for our projects.
Please check price and availability in the latest issue.
A large number of older boards are listed on our website.
Boards can only be supplied on a payment with order basis.

PROJECT TITLE	Order Code	Cost
EPE Mini Metal Detector	JULY '03 396	£4.28
Radio Circuits – 2 Q-Multiplier	397	£4.28
MW Reflex Radio	398	£4.60
Wave Trap	399	£4.28
Speaker Amplifier	400	£4.44
Ohmmeter Adaptor MkII	401	£4.60
Ultimate Egg Timer (Top Tenner)	403	£4.91
★ EPE PIC Met Office	AUG '03 402	£10.46
Alarm System Fault Finder	404	£4.44
Radio Circuits–3 Regen. Radio	405	£5.07
Tuning Capacitor Board	406	£4.28
Master/Slave Intercom (Top Tenner)	407	£4.75
Two-Up (Top Tenner)	408	£4.91
Priority Referee (Top Tenner)	SEPT '03 410	£5.07
Vibration Alarm (Top Tenner)	411	£5.39
Radio Circuits–4 Varicap Tuner	412	£4.44
Coil Pack – General Coverage	413	£5.07
Coil Pack – Amateur Bands	414	£4.75
★ PIC-A-Colour – Software only	–	–
Spooky Bug (Top Tenner)	OCT '03 409	£5.07
Radio Circuits–5 Crystal Marker	415	£4.44
Super Regen. Receiver	419	£5.07
Buffer Amplifier	420	£4.44
★ ★ Serial Interface for PICs and VB6	416	£5.23
★ PIC Breakpoint – Software only	–	–
Anyone At Home – Logic Board	NOV '03 421	} Pair £6.35
– Relay Board	422	
Radio Circuits–6 Direct Conversion SW Receiver	423	£6.02
★ PIC Random L.E.D Flasher	424	£4.60
★ PIC Virus Zapper Mk2	DEC '03 425	£5.72
Radio Circuits–7 SW Superhet Tuner/Mixer	426	£5.70
Christmas Cheeks (double-sided)	427	£4.44
★ PIC Nim Machine – Software only	–	–
Bedside Nightlight (Top Tenner)	JAN '04	
Sound Trigger	417	£4.44
Timing/Lamp	418	£4.60
Radio Circuits–8 Dual Conversion SW Rec. – I.F. Amp	428	£5.71
– Signal-Strength Meter	429	£4.45
– B.F.O./Prod. Detector	430	£4.75
★ Car Computer (double-sided)	431	£7.61
★ PIC Watering Timer – Software only	–	–
★ GPS to PIC and PC Interface – Software only	–	–
Jazzy Necklace	FEB '04 432 pair	£5.40
Sonic Ice Warning	433	£5.39
★ LCF Meter	434	£5.00
★ PIC Tug-of-War	435	£5.00
Bat-Band Converter	MAR '04 436	£4.76
★ MIDI Health Check – Transmitter/Receiver	437 pair	£7.61
Emergency Stand-by Light	438	£5.55
★ PIC Mixer for RC Planes – Software only	–	–
★ Teach-In '04 Part 5 – Software only	–	–
Infra-Guard	APR '04 439	£5.07
★ Moon Clock	442	£5.71
★ Teach-In '04 Part 5 – Software only	–	–
★ EPE Seismograph Logger	APR '04	
Control Board	440	} pair £6.50
Sensor Amp. Board	441	
In-Car Lap-Top PSU	MAY '04 443	£4.60
Beat Balance Metal Detector	444	£4.60
Teach-In '04 Part 7 – Transmitter	445	£4.91
Receiver	446	£4.75
Moisture	447	£4.44
★ PIC Quickstep	JUNE '04 448	£5.71
Body Detector MkII	449	£4.91
★ Teach-In '04 Part 8 – Software only	–	–
★ MIDI Synchro – Software only	–	–
Hard Drive Warbler	JULY '04 450	£4.60
★ Bongo Box	451	£6.02
Portable Mini Alarm – Sensor	452	£5.23
– Counter	453	£5.07
★ Teach-In '04 Part 9		
PIC Combination Lock Alarm Monitor	454	£5.07
★ EPE Magnetometry Logger	455	£5.71

PROJECT TITLE	Order Code	Cost
Keyring L.E.D Torch	AUG '04 456	£4.12
★ Teach-In '04 Part 10 – PIC Curtain or Blind Winder	457	£5.39
Simple F.M. Radio – F.M. Tuner	458	£5.07
– Tone Control	459	£4.75
– Audio Power Amp (TDA2003)	347	£4.60
– Power Supply	460	£5.39
★ EPE Scorer – Control Board	461	£6.66
– Display Board	462	£7.93
– Slave Board	463	£5.55
★ PIC to Mouse/Keyboard – Software only	–	–
EPE Wart Zapper	SEPT '04 464	£4.60
★ Radio Control Failsafe	465	£4.76
★ AlphaMouse Game	466	£4.60
★ Rainbow Lighting Controller – Software only	–	–
★ Moon and Tide Clock Calendar	OCT '04 467	£5.55
Volts Checker	468	£4.20
★ Smart Karts – Software only	–	–
Logic Probe	NOV '04 469	£4.76
Thunderstorm Monitor	470	£5.39
MW Amplitude Modulator		
– V.F.O./Buffer	471	£4.76
– Modulator/PA	472	£5.07
– Power Supply	473	£4.76
Super Vibration Switch	DEC '04 474	£4.75
★ Wind Direction Indicator	475	£6.18
★ PIC Flasher Mk2		
– Control Board	476	£4.75
– Transmitter	477	£4.44
– Multipurpose Board	478	£4.75
– Simple Cyclor	479	£4.44
– Luxeon V Controller	480	£4.44
– Power Supply	473	£4.76
Light Detector	JAN '05 481	£4.44
★ Camera Watch	482	£6.03
Gate Alarm – Oscillator	483	£4.92
– Delay/Timer	484	£4.92

EPE SOFTWARE

Software programs for EPE projects marked with a single asterisk ★ are available on 3.5 inch PC-compatible disks or free from our Internet site. The following disks are available: **PIC Tutorial V2** (Apr-June '03); **EPE Disk 3** (2000); **EPE Disk 4** (2001 – excl. PIC Toolkit TK3); **EPE Disk 5** (2002); **EPE Disk 6** (2003 – excl. Earth Resistivity and Met Office); **EPE Disk 7** (2004); **EPE Disk 8** (Jan 2005 to current cover date); **EPE Earth Resistivity Logger** (Apr-May '03); **EPE PIC Met Office** (Aug-Sept '03); **EPE Seismograph** (Apr-May '04); **EPE Magnetometry Logger** (July-Aug '04); **EPE Teach-In 2000**; **EPE Spectrum**; **EPE Interface Disk 1** (October '00 issue to current cover date). **EPE Toolkit TK3** software is available on the **EPE PIC Resources** CD-ROM, £14.45. Its p.c.b. is order code 319, £8.24.
 ★ ★ The software for these projects is on its own CD-ROM. The 3.5 inch disks are £3.00 each (UK), the CD-ROMs are £6.95 (UK). Add 50p each for overseas surface mail, and £1 each for airmail. All are available from the **EPE PCB Service**. All files can be downloaded free from our Internet FTP site, accessible via our home page at: www.epemag.co.uk.

EPE PRINTED CIRCUIT BOARD SERVICE

Order Code	Project	Quantity	Price
Name			
Address			
Tel. No.			
I enclose payment of £..... (cheque/PO in £ sterling only) to:			
	Everyday Practical Electronics		
	MasterCard, Amex, Diners Club, Visa or Switch/Maestro	 	
Card No.			
Valid From		Expiry Date	
Card Security Code Switch/Maestro Issue No			
(The last 3 digits on or just under the signature strip)			
Signature			
NOTE: You can also order p.c.b.s by phone, Fax, Email or via our Internet site on a secure server:			
http://www.epemag.wimborne.co.uk/shopdoor.htm			

Everyday Practical Electronics reaches twice as many UK readers as any other UK monthly hobby electronics magazine, our sales figures prove it. We have been the leading monthly magazine in this market for the last nineteen years.

If you want your advertisements to be seen by the largest readership at the most economical price our classified and semi-display pages offer the best value. The prepaid rate for semi-display space is £10 (+VAT) per single column centimetre (minimum 2.5cm). The prepaid rate for classified adverts is 40p (+VAT) per word (minimum 12 words).

All cheques, postal orders, etc., to be made payable to Everyday Practical Electronics. **VAT must be added.** Advertisements, together with remittance, should be sent to Everyday Practical Electronics Advertisements, Mill Lodge, Mill Lane, Thorpe-le-Soken, Essex CO16 0ED. Phone/Fax (01255) 861161.

For rates and information on display and classified advertising please contact our Advertisement Manager, Peter Mew as above.

BOWOOD ELECTRONICS LTD
Suppliers of Electronic Components
 Place a secure order on our website or call our sales line
 All major credit cards accepted
 Web: www.bowood-electronics.co.uk
 Unit 1, McGregor's Way, Turnoaks Business Park,
 Chesterfield, S40 2WB. Sales: 01246 200222
 Send 60p stamp for catalogue

The Versatile, Programmable On Screen Display System
www.STV5730A.co.uk



PAL - NTSC compatible
 Go to www.stv5730a.co.uk for more details

- Fully programmable
- PIC 16F628 microcontroller
- Demo software code available
- OSD IC 28 by 11 screen
- I/O lines free to connect sensors or buttons
- Serial or PC keyboard interface versions

TEXT, GPS or DATA

X-10® Home Automation
 We put you in control™

Why tolerate when you can automate?
 An extensive range of 230V X-10 products and starter kits available. Uses proven Power Line Carrier technology, no wires required.

Products Catalogue available Online.
 Worldwide delivery.

Laser Business Systems Ltd.
 E-Mail: info@laser.com 
<http://www.laser.com>
 Tel: (020) 8441 9788
 Fax: (020) 8449 0430 

VVT TRANSFORMERS

Transformers and Chokes for all types of circuits including specialist valve units
 Custom design or standard range
 High and low voltage

Variable Voltage Technology Ltd
 Unit 3, Sheat Manor Farm, Chillerton,
 Newport, Isle of Wight, PO30 3HP
 Tel: 0870 243 0414 Fax: 01983 721572
 email: sales@vvt-cowes.freeserve.co.uk
www.vvttransformers.co.uk

TOTALROBOTS
ROBOTICS, CONTROL & ELECTRONICS TECHNOLOGY
 High quality robot kits and components
 UK distributor of the OOPic microcontroller

Secure on-line ordering
 Rapid delivery
 Highly competitive prices

Visit www.totalrobots.com
Tel: 0208 823 9220

Component Kits!

 CAP-001 93pcs Electrolytic Capacitor Kit (1-2200µF 16-63V) £4.99	 RES-001 1000pcs Metal Film Resistor Kit (10R-1M 0.25W 1%) £9.99
 CAP-002 1000pcs Polyester Capacitor Kit (1-470nF 63V) £4.99	 CAP-003 240pcs Ceramic Capacitor Kit (22pF-100nF 50V) £4.99

Mail order P&P: £2.50 (Free P&P orders over £20)
www.fastcomponents.co.uk
 Tel: 0870 750 4468 Fax: 0870 137 6005
 Winchester House, Winchester Rd,
 Walton-on-Thames, Surrey, KT12 2RH

TRANSFORMERS

- Custom Wound
- 1 Phase to 50kVA
- 3 Phase to 100kVA
- A.C. and D.C. Chokes
- H.T. up to 5kV
- Transformer Kits
- Coils up to 1m Dia.
- Transformer Rectifiers
- Toroidals
- Motor Generators

Visit www.jemelec.com for details or request our free leaflet
 Jemelec, Unit 16, Vanguard Trading Estate, Storrforth Lane,
 Chesterfield, S40 2TZ
Tel: 0870 787 1769

BTEC ELECTRONICS TECHNICIAN TRAINING

VCE ADVANCED ENGINEERING ELECTRONICS AND ICT
 HNC AND HND ELECTRONICS
 NVQ ENGINEERING AND IT
PLEASE APPLY TO COLLEGE FOR NEXT COURSE DATE
 FULL PROSPECTUS FROM

LONDON ELECTRONICS COLLEGE
 (Dept EPE) 20 PENYWERN ROAD
 EARLS COURT, LONDON SW5 9SU
 TEL: (020) 7373 8721

Miscellaneous

MICRO CHIP DEVICES for home and business. Projects and Products built on Microchip and 1-wire technologies are available to build or to buy. Visit our WEB Site at: www.microchipdevices.com

RADIO SPARES PARCEL! £15.00! Assorted Modules, Amplifiers, P.S.U's + Directions, Hundred's Components - K.I.A 1 Regent Road, Ilkley LS29

FREE! PROTOTYPE PRINTED CIRCUIT BOARDS! Free prototype p.c.b. with quantity orders. Call Patrick on 028 9073 8897 for details. Agar Circuits, Unit 5, East Belfast Enterprise Park, 308 Albertbridge Road, Belfast BT5 4GX.

PRINTED CIRCUIT BOARDS - QUICK SERVICE. Prototype and production artwork raised from magazines or draft designs at low cost. PCBs designed from schematics. Production assembly, wiring and software programming. For details contact Patrick at Agar Circuits, Unit 5, East Belfast Enterprise Park, 308 Albertbridge Road, Belfast, BT5 4GX. Phone 028 9073 8897, Fax 028 9073 1802, Email agar@argonet.co.uk.

VALVES AND ALLIED COMPONENTS IN STOCK. Phone for free list. Valves, books and magazines wanted. Geoff Davies (Radio), tel. 01788 574774.

KITS, TOOLS, COMPONENTS. S.a.e. catalogue: Sir-Kit Electronics, 52 Severn Road, Clacton, CO15 3RB. www.geocities.com/sirkituk.

Computer Software

FREE DOWNLOADABLE SOFTWARE: Electronics, Electrical and Computing V8.2. Computer Science V8.2 and GCSE Maths V8.2. Still selling at £120 each on CDROM is now available to download and fully install to your hard drive **COMPLETELY FREE OF CHARGE.** Latest update includes the new Web Links feature. Visit www.eptsoft.com for details.

YOU CAN ADVERTISE IN THIS SPACE FOR JUST

£40.00 + VAT
CONTACT PETER MEW ON
01255 861161

SQUIRES

MODEL & CRAFT TOOLS

A COMPREHENSIVE RANGE OF MINIATURE HAND AND POWER TOOLS AND AN EXTENSIVE RANGE OF

ELECTRONIC COMPONENTS

FEATURED IN A FULLY ILLUSTRATED

704 PAGE MAIL ORDER CATALOGUE

2005 ISSUE

**SAME DAY DESPATCH
FREE POST AND PACKAGING**

Catalogues: FREE OF CHARGE to addresses in the UK.
Overseas: CATALOGUE FREE, postage at cost charged to credit card

SHOP EXTENSION NOW OPEN

Squires, 100 London Road,
Bognor Regis, West Sussex, PO21 1DD

TEL: 01243 842424

FAX: 01243 842525



Europe's Largest Surplus Store

**20,000,000 Items on line NOW !
New items added daily**

Established for over 25 years, UK company Display Electronics prides itself on offering a massive range of electronic and associated electro-mechanical equipment and parts to the Hobbyist, Educational and Industrial user. Many current and obsolete hard to get parts are available from our vast stocks, which include:

- ◆ 6,000,000 Semiconductors
- ◆ 5,000 Power Supplies
- ◆ 25,000 Electric Motors
- ◆ 10,000 Connectors
- ◆ 100,000 Relays & Contactors
- ◆ 2000 Rack Cabinets & Accessories
- ◆ 4000 Items of Test Equipment
- ◆ 5000 Hard Disk Drives

**We Ship
Worldwide**

**Surplus
Wanted**

www.distel.co.uk

Display Electronics
29 / 35 Osborne Road
Thornton Heath
Surrey UK CR7 8PD

Telephone
[44] 020 8653 3333
Fax [44] 020 8653 8888

N. R. BARDWELL LTD (Est. 1948)

100	Signal Diodes 1N4148	£1.00	80	Ass'd capacitors 1nF to 1µF	£1.00
75	Rectifier Diodes 1N4001	£1.00	200	Ass'd disc ceramic capacitors	£1.00
50	Rectifier Diodes 1N4007	£1.00	50	Ass'd. SMD Presets (sm, sm rd, cermet)	£1.00
10	W01 Bridge Rectifiers	£1.00	50	Ass'd. RF chokes (inductor...)	£1.00
10	555 Timer ICs	£1.00	25	Ass'd. grommets	£1.00
4	741 Op Amps	£1.00	8	Ass'd. di switches	£1.00
50	Assorted Zener Diodes 400mW	£1.00	8	Ass'd. push-button switches, multi-bank, multi-pole	£1.00
12	Assorted 7-segment Displays	£1.00	30	Ass'd. di sockets up to 40-way	£1.00
35	Assorted I.e.d.s, var shape, colours & sizes	£1.00	10	TV coax plugs, plastic	£1.00
25	5mm I.e.d.s, red or green or yellow	£1.00	40	metre - very thin connecting wire, red	£1.00
25	3mm I.e.d.s, red or green or yellow	£1.00	20	1in glass reed switches	£1.00
75	5mm I.e.d.s, green 6.5mm legs	£1.00	100	Any one value 1/4W 5% of resistors range 1R to 10M	£0.45
50	Axial I.e.d.s, 2mcd red Diode Package	£1.00	10	7812 Voltage Regulators	£1.00
25	Ass'd High Brightness I.e.d.s, var cols	£1.00	300	Ass'd resistors, 1/4W/1/2W, mostly on tapes	£1.00
20	BC182L Transistors	£1.00			
25	BC212L Transistors	£1.00			
30	BC237 Transistors	£1.00			
20	BC327 Transistors	£1.00			
30	BC328 Transistors	£1.00			
30	BC547 Transistors	£1.00			
20	BC547B Transistor	£1.00			
30	BC548 Transistors	£1.00			
30	BC549 Transistors	£1.00			
25	BC557 Transistors	£1.00			
30	BC558 Transistors	£1.00			
25	BC559 Transistors	£1.00			
20	2N3904 Transistors	£1.00			
100	1nF 50V wkg Axial Capacitors	£1.00			
80	Ass'd capacitors electrolytic	£1.00			

288 Abbeydale Road, Sheffield S7 1FL

Phone (local rate): 0845 166 2329

Fax: 0114 255 5039

e-mail: sales@bardwells.co.uk

web: www.bardwells.co.uk

Prices include VAT Postage £1.85

44p stamp for lists or disk

POs, Cheques and Credit Cards accepted

SEE OUR WEB PAGES FOR MORE

COMPONENTS AND SPECIAL OFFERS

FRUSTRATED!

Looking for ICs TRANSISTORS?

A phone call to us could get a result. We offer an extensive range and with a world-wide database at our fingertips, we are able to source even more. We specialise in devices with the following prefix (to name but a few).



2N 2SA 2SB 2SC 2SD 2P 2SJ 2SK 3N 3SK 4N 6N 17 40 AD ADC AN AM AY BA
BC BD BDT BDV BDW BDX BF BFR BFS BFT BFX BFY BLY BLX BS BR
BRX BRY BS BSS BSV BSW BSX BT BTA BTB BRW BU BUK BUT BUY
BUW BUX BUY BUZ CA CD CX CXA DAC DG DM DS DTA DTC GL GM HA
HCF HD HEF ICL ICM IRF J KA KIA L LA LB LC LD LF LM M M5M MA
MAB MAX MB MC MDAJ MJE MJF MM MN MPS MPSA MP5H MP5U MRF
NJM NE OM OP PA PAL PIC PN RC S SAA SAB SAD SAJ SAS SDA SG SI SL
SN SO STA STK STR STRD STRM STRS SVI T TA TAA TAG TBA TC TCA
TDA TDB TEA TIC TIPL TEA TL TLC TMP TMS TPU U UA UAA UC UDN
ULN UM UPA UPC UPD VN X XR Z ZN ZTX + many others

**PLEASE VISIT OUR WEB SITE AT
www.cricklewoodelectronics.com**
We Stock a Massive Range of Components

Mail, phone, Fax Credit Card orders and callers welcome



Connect

Cricklewood Electronics Ltd

40-42 Cricklewood Broadway London NW2 3ET

Tel: 020 8452 0161 Fax: 020 8208 1441



Get your magazine "instantly" anywhere in the world - buy from the web.

TAKE A LOOK, A FREE ISSUE IS AVAILABLE

A one year subscription (12 issues)
costs just \$10.99 (US)
www.epemag.com

Watch Slides on TV.

Make videos of your slides. Digitise your slides (using a video capture card)
 "Liesgang diatv" automatic slide viewer with built in high quality colour TV camera. It has a composite video output to a phono plug (SCART & BNC adaptors are available). They are in very good condition with few signs of use. More details see www.diatv.co.uk.
 £91.91 + VAT = £108.00



Board cameras all with 512 x 582 pixels 8.5mm 1/3 inch sensor and composite video out. All need to be housed in your own enclosure and have fragile exposed surface mount parts. They all require a power supply of between 10V and 12V DC 150mA.
 47MR size 60 x 36 x 27mm with 6 infra red LEDs (gives the same illumination as a small torch but is not visible to the human eye) £37.00 + VAT = £43.48
 30MP size 32 x 32 x 14mm spy camera with a fixed focus pin hole lens for hiding behind a very small hole £35.00 + VAT = £41.13
 40MC size 39 x 38 x 27mm camera for 'C' mount lens these give a much sharper image than with the smaller lenses £32.00 + VAT = £37.60
 Economy C mount lenses all fixed focus & fixed iris
 VSL1220F 12mm F1.6 12 x 15 degrees viewing angle £15.97 + VAT £18.76
 VSL4022F 4mm F1-22 63 x 47 degrees viewing angle £17.65 + VAT £20.74
 VSL6022F 6mm F1-22 42 x 32 degrees viewing angle £19.05 + VAT £22.38
 VSL8020F 8mm F1-22 32 x 24 degrees viewing angle £19.90 + VAT £23.38

Better quality C Mount lenses

VSL1614F 16mm F1-6.30 x 24 degrees viewing angle £26.43 + VAT £31.06
 VWL813M 8mm F1.3 with iris 56 x 42 degrees viewing angle £77.45 + VAT = £91.00
 1206 surface mount resistors E12 values 10 ohm to 1M ohm
 100 of 1 value £1.00 + VAT 1000 of 1 value £5.00 + VAT

866 battery pack originally intended to be used with an orbitel mobile telephone it contains 10 1-6Ah sub C batteries (42 x 22 dia. the size usually used in cordless screw-drivers etc.) the pack is new and unused and can be broken open quite easily
 £7.46 + VAT = £8.77



Please add £1.66 + vat = £1.95 postage & packing per order

JPG Electronics

Shaws Row, Old Road, Chesterfield, S40 2RB.

Tel 01246 211202 Fax 01246 550959

Mastercard/Visa/Switch

Callers welcome 9.30 a.m. to 5.30 p.m. Monday to Saturday

SHERWOOD ELECTRONICS

FREE COMPONENTS

Buy 10 x £1 Special Packs and choose another one FREE

SP1	15 x 5mm Red LEDs	SP135	6 x Miniature slide switches
SP2	12 x 5mm Green LEDs	SP136	3 x BFY50 transistors
SP3	12 x 5mm Yellow LEDs	SP137	4 x W005 1-5A bridge rectifiers
SP5	25 x 5mm 1 part LED clips	SP138	20 x 2-2/63V radial elect. caps.
SP6	15 x 3mm Red LEDs	SP140	3 x W04 1-5A bridge rectifiers
SP7	12 x 3mm Green LEDs	SP142	2 x CMOS 4017
SP8	10 x 3mm Yellow LEDs	SP143	5 Pairs min. crocodile clips (Red & Black)
SP9	25 x 3mm 1 part LED clips	SP144	5 Pairs min. crocodile clips (assorted colours)
SP10	100 x 1N4148 diodes	SP146	10 x 2N3704 transistors
SP11	30 x 1N4001 diodes	SP147	5 x Stripboard 9 strips x 25 holes
SP12	30 x 1N4002 diodes	SP151	4 x 8mm Red LEDs
SP18	20 x BC182 transistors	SP152	4 x 8mm Green LEDs
SP20	20 x BC184 transistors	SP153	4 x 8mm Yellow LEDs
SP23	20 x BC549 transistors	SP154	15 x BC548 transistors
SP24	4 x CMOS 4001	SP156	3 x Stripboard, 14 strips x 27 holes
SP25	4 x 555 timers	SP160	10 x 2N3904 transistors
SP26	4 x 741 Op.Amps	SP161	10 x 2N3906 transistors
SP28	4 x CMOS 4011	SP164	2 x C106D thyristors
SP29	4 x CMOS 4013	SP165	2 x LF351 Op.Amps
SP33	4 x CMOS 4081	SP166	20 x 1N4003 diodes
SP34	20 x 1N914 diodes	SP167	5 x BC107 transistors
SP36	25 x 10/25V radial elect. caps.	SP168	5 x BC108 transistors
SP37	12 x 100/35V radial elect. caps.	SP171	8 Meters 18SWG solder
SP38	15 x 47/25V radial elect caps.	SP172	4 x Standard slide switches
SP39	10 x 470/16V radial elect. caps.	SP173	10 x 220/25V radial elect. caps
SP40	15 x BC237 transistors	SP174	20 x 22/25V radial elect. caps.
SP41	20 x Mixed transistors	SP175	20 x 1/63V radial elect. caps.
SP42	200 x Mixed 0.25W C.F. resistors	SP177	10 x 1A 20mm quick blow fuses
SP47	5 x Min. PB switches	SP178	10 x 2A 20mm quick blow fuses
SP49	4 x 5 metres stranded core wire	SP181	5 x Phono plugs - asstd colours
SP101	8 Meters 22SWG solder	SP182	20 x 4.7/63V radial elect. caps.
SP102	20 x 8-pin DIL sockets	SP183	20 x BC547 transistors
SP103	15 x 14-pin DIL sockets	SP187	15 x BC239 transistors
SP104	15 x 16-pin DIL sockets	SP189	4 x 5 metres solid core wire
SP105	4 x 74LS00	SP192	3 x CMOS 4066
SP109	15 x BC557 transistors	SP195	3 x 10mm Yellow LEDs
SP112	4 x CMOS 4093	SP197	6 x 20 pin DIL sockets
SP115	3 x 10mm Red LEDs	SP198	5 x 24 pin DIL sockets
SP116	3 x 10mm Green LEDs	SP199	5 x 2.5mm mono jack plugs
SP118	2 x CMOS 4047	SP200	5 x 2.5mm mono jack sockets
SP124	20 x Assorted ceramic disc caps		
SP126	6 x Battery clips - 3 ea. PP3 + PP9		
SP130	100 x Mixed 0.5W C.F. resistors		
SP131	2 x TL071 Op.Amps		
SP133	20 x 1N4004 diodes		
SP134	15 x 1N4007 diodes		

RESISTOR PACKS - C.Film

RP3	5 each value - total 365 0.25W	£3.30
RP7	10 each value - total 730 0.25W	£4.55
RP10	1000 popular values 0.25W	£6.45
RP4	5 each value-total 345 0.5W	£4.20
RP8	10 each value-total 690 0.5W	£6.85
RP11	1000 popular values 0.5W	£8.70

2005 Catalogue now available £1 inc. P&P or FREE with first order.

P&P £1.50 per order. NO VAT

Cheques and Postal Orders to:

Sherwood Electronics,
 7 Williamson St., Mansfield,
 Notts. NG19 6TD.

ADVERTISERS INDEX

N. R. BARDWELL	71
B.K. ELECTRONICS	Cover (iv)/17
BITZ TECH	51
BRUNNING SOFTWARE	7
BULL GROUP	Cover (ii)
CRICKLEWOOD ELECTRONICS	71
DISPLAY ELECTRONICS	71
ESR ELECTRONIC COMPONENTS	10
FOREST ELECTRONIC DEVELOPMENTS	2
JAYCAR ELECTRONICS	21
JPG ELECTRONICS	72
LABCENTER	Cover (iii)
MAGENTA ELECTRONICS	8/9
MATRIX MULTIMEDIA	32
MILFORD INSTRUMENTS	29
NATIONAL COLLEGE OF TECHNOLOGY	51
PEAK ELECTRONIC DESIGN	33
PICO TECHNOLOGY	49
QUASAR ELECTRONICS	4/5
SHERWOOD ELECTRONICS	72
SQUIRES	71
STEWART OF READING	51

ADVERTISEMENT MANAGER: PETER J. MEW

ADVERTISEMENT OFFICES:

EVERYDAY PRACTICAL ELECTRONICS, ADVERTISEMENTS,
 MILL LODGE, MILL LANE, THORPE-LE-SOKEN,
 ESSEX CO16 0ED. Phone/Fax: (01255) 861161

For Editorial address and phone numbers see page 11

EPE SUBSCRIPTIONS

Subscriptions for delivery direct to any address in the UK: 6 months £16.50, 12 months £31, two years £57; Overseas: 6 months £19.50 standard air service or £28.50 express airmail, 12 months £37 standard air service or £55 express airmail, 24 months £69 standard air service or £105 express airmail.

Cheques or bank drafts (in £ sterling only) payable to *Everyday Practical Electronics* and sent to *EPE* Subs. Dept., Wimborne Publishing Ltd., 408 Wimborne Road East, Ferndown, Dorset BH22 9ND. Tel: 01202 873872. Fax: 01202 874562. Email: subs@epemag.wimborne.co.uk. Also via the Web at <http://www.epemag.wimborne.co.uk>. Subscriptions start with the next available issue. We accept MasterCard, Amex, Diners Club, Switch or Visa. (For past issues see the Back Issues page.)

ONLINE SUBSCRIPTIONS

Online subscriptions, for downloading the magazine via the Internet, \$10.99US (approx. £7) for one year available from www.epemag.com.

USA/CANADA SUBSCRIPTIONS

To subscribe to *EPE* from the USA or Canada please telephone Express Mag toll free on 1877 363-1310 and have your credit card details ready. Or fax (514) 355 3332 or write to Express Mag, PO Box 2769, Plattsburgh, NY 12901-0239 or Express Mag, 8155 Larney Street, Anjou, Quebec, H1J 2L5.

Email address: expsmag@expressmag.com.

Web site: www.expressmag.com.

USA price \$60(US) per annum, Canada price \$97(Can) per annum - 12 issues per year.

Everyday Practical Electronics, periodicals pending, ISSN 0262 3617 is published twelve times a year by Wimborne Publishing Ltd., USA agent USACAN at 1320 Route 9, Champlain, NY 12919. Subscription price in US \$60(US) per annum. Periodicals postage paid at Champlain NY and at additional mailing offices. POSTMASTER: Send USA and Canada address changes to *Everyday Practical Electronics*, c/o Express Mag., PO Box 2769, Plattsburgh, NY, USA 12901-0239.

PROTEUS

The Complete Electronics Design System

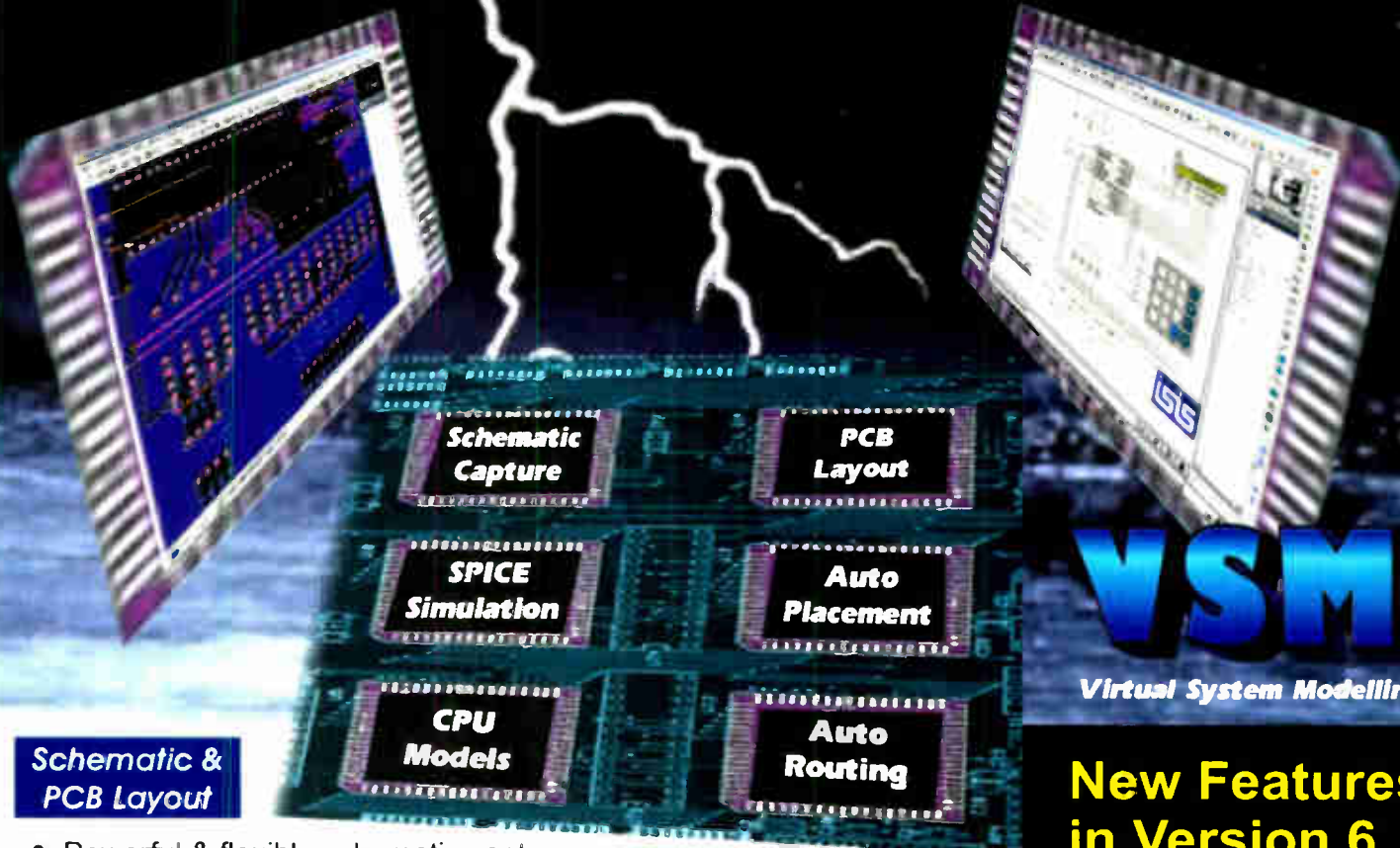

Schematic & PCB Layout

- Powerful & flexible schematic capture.
- Auto-component placement and rip-up/retry PCB routing.
- Polygonal gridless ground planes.
- Libraries of over 8000 schematic and 1000 PCB parts.
- Bill of materials, DRC reports and much more.

Mixed Mode SPICE Circuit Simulation

- Berkeley SPICE3F5 simulator with custom extensions for true mixed mode and interactive simulation.
- 6 virtual instruments and 14 graph based analysis types.
- 6000 models including TTL, CMOS and PLD digital parts.
- Fully compatible with manufacturers' SPICE models.

Proteus VSM - Co-simulation and debugging for popular Micro-controllers

- Supports PIC, AVR, 8051, HC11 and ARM micro-controllers
- Co-simulate target firmware with your hardware design.
- Includes interactive peripheral models for LED and LCD displays, switches, keypads, virtual terminal and much, much more.
- Provides source level debugging for popular compilers and assemblers from Crownhill, IAR, Keil, and others

VSM

Virtual System Modelling

New Features in Version 6

- Drag and drop toolbars.
- Visual PCB packaging tool.
- Improved route editing.
- Point and click DRC report.
- Multiple design rules (per net).
- Multiple undo/redo.

Call Now for Upgrade Pricing

Works with
PIC Basic Plus
from Crownhill
Associates

labcenter

Electronics
53-55 Main Street, Grassington. BD23 5AA

Tel: 01756 753440
Fax: 01756 752857

Contact us for
Free Demo CD

www.labcenter.co.uk
info@labcenter.co.uk



POWER AMPLIFIER MODULES-LOUDSPEAKERS-MIXERS 19 INCH STEREO AMPLIFIERS-ACTIVE CROSS/OVERS.

- * PRICES INCLUDE V.A.T.
- * PROMPT DELIVERY

OMP MOS-FET POWER AMPLIFIERS HIGH POWER, TWO CHANNEL 19 INCH RACK

10,000's
SOLD
TO PRO
USERS



THE RENOWNED MXF SERIES OF POWER AMPLIFIERS

FOUR MODELS:- MXF200 (100W + 100W) MXF400 (200W + 200W)
MXF600 (300W + 300W) MXF900 (450W + 450W)

ALL POWER RATINGS ARE R.M.S. INTO 4 OHMS, WITH BOTH CHANNELS DRIVEN
FEATURES:- * Independent power supplies with two toroidal transformers
* Twin L.E.D. Vu Meters * Level controls * Illuminated on/off switch * Jack / XLR inputs
* Speakon Outputs * Standard 775mv inputs * Open and Short circuit proof * Latest Mos-Fets for stress free delivery into virtually any load * High slew rate * Very low distortion * Aluminium cases * MXF600 & MXF900 fan cooled with D.C. Loudspeaker and thermal protection.

USED THE WORLD OVER IN CLUBS, PUBS, CINEMAS, DISCOS ETC

SIZES:-

MXF200 W19" D11" H3 1/2" (2U)
MXF400 W19" D12" H5 1/4" (3U)
MXF600 W19" D13" H5 1/4" (3U)
MXF900 W19" D14" H5 1/4" (3U)

PRICES:- MXF200 £175.00 MXF400 £233.85
MXF600 £329.00 MXF900 £449.15
SPECIALIST CARRIER DEL £12.50 Each



XLS200 Active Subwoofer System Price £279.00+ £8.00 Carriage

We have been designing and manufacturing 5 star award winning subs since 1992

Features

- * Uses a Peerless XLS10, one of the worlds best subwoofer drive units
- * True 200W RMS 400W Peak
- * Simultaneous high and low level connections
- * Solid construction 25mm baffle and back and 18mm MDF sides with real wood veneers
- * Four fantastic finishes
- * Compact size only 390D x 295H x 295W mm
- * Over engineered for sonic excellence weighs in at 20kg



At about a cubic foot the XLS200 can be easily hidden from view, but you will certainly know it is there. With the easy to setup controls it will take only minutes to get up and running showing its punch, agility and power. Due to its rigid sealed box enclosure and powerful 200W amplifier coupled to an extremely high quality 250mm drive unit the XLS200 sounds absolutely stunning from the off, with music that is underpinned by masses of low end extension. Movies will come to life too, as you hear the effects as well as feel them.

- ★ Free Accessories worth £40.00. 10M Speakon High Level Lead - 5M High Quality Gold Phono to Phono Lead and a set of spikes
- ★ Pay no extra for real wood veneers



Strength & Depth in the knowledge that we have supplied over 100,000 subs

For further details look on our website at :-
<http://www.bkelec.com/new>



100 WATT ACTIVE SUB BASS AMPLIFIER PANEL



AN ACTIVE SUB BASS AMPLIFIER WITH A TRUE 100W RMS OUTPUT SUPERB CONSTRUCTION WITH THE FACILITIES TO INTEGRATE SEEMLESSLY INTO MOST HI-FI OR HOME CINEMA SETUPS. USE THIS PANEL PLUS ONE OF OUR LOUDSPEAKERS TO MAKE YOUR OWN SUB WOOFER THAT WILL MATCH OR BEAT MOST COMMERCIALY AVAILABLE SUB WOOFERS.

FEATURES:- * 100W RMS INTO 8 OHMS * HIGH AND LOW LEVEL INPUTS * TOROIDAL TRANSFORMER * SHORT CIRCUIT PROTECTION * D.C. SPEAKER PROTECTION * FREQUENCY ROLL OFF, LOWER 10Hz, UPPER 60Hz TO 240Hz (FULLY ADJUSTABLE) * AC3 COMPATIBLE FILTER CAN BE BYPASSED FOR 5-1 FORMATS. * AIRTIGHT CONSTRUCTION * TENS OF THOUSANDS OF OUR PANELS ALREADY IN USE. * COMPLETE WITH LEADS

SPECIFICATIONS:- * POWER 100W RMS @ 8 OHMS * FREQ RESP. 10Hz 15KHz -3dB * DAMPING FACTOR >200 * DISTORTION 0.05% * S/N A WEIGHTED >100dB * SUPPLY 230V A.C. * WEIGHT 2.7Kg * SIZE H254 X W254 X D94mm

THERE ARE 2 VERSIONS OF THE ABOVE PANEL AVAILABLE :-BSB100/8 8 OHM VERSION BSB100/4 4 OHM VERSION BOTH PANELS ARE PRICED AT £117.44 + £5.00 P&P INCL. V.A.T. CHECK WEBSITE FOR PANELS UP TO 500W

ibl FLIGHTCASED LOUDSPEAKERS

A new range of quality loudspeakers, designed to take advantage of latest loudspeaker technology and enclosure designs. All models utilise high quality studio cast aluminium loudspeakers with factory fitted grilles, wide dispersion constant directivity horns, extruded aluminium corner protection and steel ball corners, complimented with heavy duty black covering. The enclosures are fitted as standard with top hats for optional loudspeaker stands. The FC15-300 incorporates a large 16 X 6 inch horn. All cabinets are fitted with the latest Speakon connectors for your convenience and safety. Five models to choose from.

WEDNESDAY 20-1-2004



PLEASE NOTE:- POWER RATINGS QUOTED ARE IN WATTS R.M.S. FOR EACH INDIVIDUAL CABINET ALL ENCLOSURES ARE 8 OHMS

15=15 Inch speaker
12=12 Inch speaker

ibl FC15-300 WATTS Freq Range 35Hz-20kHz, Sens 101dB, Size H695 W502 D415mm

Price:- £299.00 per pair

ibl FC12-300 WATTS Freq Range 45Hz-20kHz, Sens 96dB, Size H600 W405 D300mm

Price:- £249.00 per pair

ibl FC12-200 WATTS Freq Range 40Hz-20kHz, Sens 97dB, Size H600 W405 D300mm

Price:- £199.00 per pair

ibl FC12-100 WATTS Freq Range 45Hz-20kHz, Sens 100dB, Size H546 W380 D300mm

Price:- £179.00 per pair

ibl WM12-200 WATTS Freq Range 40Hz-20kHz, Sens 97dB, Size H418 W600 D385mm

SPECIALIST CARRIER DEL:- £12.50 per pair, wedge monitor £7.00 each
Optional Metal Stands PRICE £49.00 per pair Delivery:- £6.00

OMP MOS-FET POWER AMPLIFIER MODULES

SUPPLIED READY BUILT AND TESTED

These modules now enjoy a world-wide reputation for quality, reliability and performance at a realistic price. Four models are available to suit the needs of the professional and hobby market, ie. Industry, Leisure, Instrumental and Hi-Fi etc. When comparing prices, NOTE that all models include toroidal power supply, integral heatsink, glass fibre P.C.B. and drive circuits to power a compatible Vu meter. All models are open and short circuit proof

THOUSANDS OF MODULES PURCHASED BY PROFESSIONAL USERS

OMP/MF 100 Mos-Fet Output Power 110 watts R.M.S. into 4 ohms, frequency response 1Hz - 100kHz -3dB, Damping Factor >300, Slew Rate 45V/uS, T.H.D. typical 0.002%, Input Sensitivity 500mV, S.N.R. 110dB, Size 300 x 123 x 60mm.
Price:- £43.85 + £4.00 P&P

OMP/MF 200 Mos-Fet Output Power 200 watts R.M.S. into 4 ohms, frequency response 1Hz - 100kHz -3dB, Damping Factor >300, Slew Rate 50V/uS, T.H.D. typical 0.001%, Input Sensitivity 500mV, S.N.R. 110dB, Size 300 x 155 x 100mm.
Price:- £67.35 + £4.00 P&P

OMP/MF 300 Mos-Fet Output Power 300 watts R.M.S. into 4 ohms, frequency response 1Hz - 100kHz -3dB, Damping Factor >300, Slew Rate 60V/uS, T.H.D. typical 0.001%, Input Sensitivity 500mV, S.N.R. 110dB, Size 330 x 175 x 100mm.
Price:- £84.75 + £5.00 P&P

OMP/MF 450 Mos-Fet Output Power 450 watts R.M.S. into 4 ohms, frequency response 1Hz - 100kHz -3dB, Damping Factor >300, Slew Rate 75V/uS, T.H.D. typical 0.001%, Input Sensitivity 500mV, S.N.R. 110dB, Fan Cooled, D.C. Loudspeaker Protection, 2 Second Anti Thump Delay. Size 385 x 210 x 105mm.
Price:- £137.85 + £6.00 P&P

OMP/MF 1000 Mos-Fet Output Power 1000 watts R.M.S. into 2 ohms, frequency response 1Hz - 100kHz -3dB, Damping Factor >300, Slew Rate 75V/uS, T.H.D. typical 0.001%, Input Sensitivity 500mV, S.N.R. 110dB, Fan Cooled, D.C. Loudspeaker Protection, 2 Second Anti Thump Delay. Size 422 x 300 x 125mm.
Price:- £243.00 + £12.00 P&P

NOTE: MOS-FET MODULES ARE AVAILABLE IN TWO VERSIONS: STANDARD - INPUT SENS 500mV BANDWIDTH 100kHz OR PEC (PROFESSIONAL EQUIPMENT COMPATIBLE) - INPUT SENS 775mV, BANDWIDTH 50kHz ORDER STANDARD OR PEC

WHARFEDALE - CHALLENGER COMPETITION SERIES CAR SUB WOOFERS

A superb range of car sub woofer loudspeakers manufactured by Wharfedale. Five models to choose from. All 4 Ohm



Challenger ProBass professional series sub woofers with cast aluminium chassis, heavy duty magnets and fitted with a steel protective grille (Not Shown)
PB-10 10 Inch 100W RMS 300W Max Price £29.37
PB-15 15 Inch 300W RMS 800W Max Price £45.82

Titan Competition series with pressed steel chassis (No Grille)
TC10-150 10 Inch 150W RMS 400W Max Price £28.20
TC12-200 12 Inch 200W RMS 600W Max Price £36.42
TC15-300 15 Inch 300W RMS 800W Max Price £43.47

Shown TC15-300

For more bargains go to www.bkelec.com and click on the bargain corner button

Carriage £8.00 any quantity

A punchy 10 Inch, a shockingly powerful 12 Inch and an awesome 15 Inch that will make your ears inform your eyes what they are missing out on! CAR HI-FI magazine had this to say about the 10 Inch 150W sub. "This debutante needs a good shove by a punchy amplifier before it stirs, but when it does, the lion roars. There's no doubting the authority it carries, and there's a highly prominent musical element - precise and snappy!" Please note we have tried these loudspeaker for PA use with great success with our MXF range of amplifier and OMP MF mosfet modules.

B.K. ELECTRONICS

REF D9

UNIT 1 COMET WAY, SOUTHEND-ON-SEA, ESSEX. SS2 6TR.

TEL.: 01702-527572 FAX.: 01702-420243

Web:- <http://www.bkelec.com> E-Mail sales@bkelec.com



DELIVERY CHARGES:- PLEASE INCLUDE AS ABOVE, TO A MAXIMUM AMOUNT £30.00. OFFICIAL ORDERS FROM SCHOOL, COLLEGES, GOVT. PLCs ETC. PRICES INCLUSIVE OF V.A.T. SALES COUNTER. CREDIT CARD ORDERS ACCEPTED BY POST PHONE OR FAX.

