

**THE No.1 MAGAZINE FOR ELECTRONICS TECHNOLOGY & COMPUTER PROJECTS**

**EVERYDAY**

**OCTOBER 2003**

# **PRACTICAL ELECTRONICS**

**£3.10**

## **RC CAR WARS**

**Inexpensive "fighting"  
without destruction**



**UNIVERSAL SERIAL  
INTERFACE  
PIC & Windows  
compatible**

**SPOOKY BUG**  
**Halloween  
under a tenner  
project**



**PLUS**

**PIC BREAKPOINT**  
**Free debugging software explained**



<http://www.epemag.wimborne.co.uk>

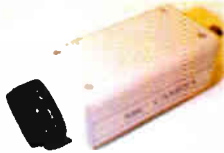

Colour CCTV camera, 8mm lens, 12V d.c. 200mA 582x628 Resolution 380 lines Automatic aperture lens Mirror function PAL Back Light Compensation MLR, 100x40x40mm. Ref EE2 £69

Built-in Audio .15lux CCD camera 12V d.c. 200mA 480 lines s/n ratio >48db 1V P-P output 110mm x 60mm x 50mm. Ref EE1 £99



Metal CCTV camera housings for internal or external use. Made from aluminium and plastic they are suitable for mounting body cameras in. Available in two sizes 1 - 100 x 70 x 170mm and 2 - 100 x 70 x 280mm. Ref EE6 £22 EE7 £26 multi-position brackets. Ref EE8 £8

Excellent quality multi-purpose TV/TFT screen, works as just a LCD colour monitor with any of our CCTV cameras or as a conventional TV. Ideal for use in boats and caravans 49.7MHz-91.75MHz - VHF channels 1-5, 168-25MHz-222.75MHz VHF channels 6-12, 471.25MHz-869.75MHz Cable channels 112-325MHz-166.75MHz Z1-Z7. Cable channels 224-25MHz-446.75MHz Z8-Z35 5" colour screen. Audio output 150mW. Connections, external aerial, earphone jack, audio/video input, 12V d.c. or mains. Accessories supplied Power supply. Remote control, Cigar lead power supply, Headphone Stand/Bracket. 5" model £139 Ref EE9, 6" model £149. Ref EE10



Self-cocking pistol plcr002 crossbow with metal body. Self-cocking for precise string alignment Aluminium alloy construction High tec fibre glass limbs Automatic safety catch Supplied with three bolts Track style for greater accuracy. Adjustable rear sight 50lb drawweight 150ft sec velocity Break action 17" string 30m range £21.65 Ref PLCR002

Fully cased IR light source suitable for CCTV applications. The unit measures 10 x 10 x 150mm, is mains operated and contains 54 infra-red LEDs. Designed to mount on a standard CCTV camera bracket. The unit also contains a daylight sensor that will only activate the infra-red lamp when the light level drops below a preset level. The infra-red lamp is suitable for indoor or exterior use, typical usage would be to provide additional IR illumination for CCTV cameras. £49. Ref EE11



Mains operated and designed to be used with any CCTV camera causing it to scan. The clips can be moved to adjust the scan angle, the motor reversing when it detects a clip. With the clips removed the scanner will rotate constantly at approx 2.3rpm. 75 x 75 x 80mm £23. Ref EE12

Colour CCTV Camera measures 60x45mm and has a built-in light level detector and 12 IR LEDs 0.2 lux 12 IR LEDs 12V d.c. Bracket Easy connect leads £69. Ref EE15



A high quality external colour CCTV camera with built-in infra-red LEDs measuring 60 x 60 x 60mm Easy connect leads colour Waterproof PAL 1/4in. CCD 542 x 588 pixels 420 lines 0.05 lux 3.6mm F2.78 deg lens 12V d.c. 400mA Built-in light level sensor. £99. Ref EE13

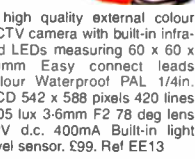

Colour pinhole CCTV camera module with audio. Compact, just 20x20x20mm, built-in audio and easy connect leads PAL CMOS sensor 6-9V d.c. Effective Pixels 628x552 Illumination 2 lux Definition >240 Signal/Noise ratio >40db Power consumption 200mW £35. Ref EE21



A small colour CCTV camera measuring just 35 x 28 x 30mm. Supplied complete with bracket, microphone and easy connect leads. Built-in audio. Colour 380 line resolution PAL 0.2 lux +18db sensitivity. Effective pixels 628 x 582 Power source 6-12V d.c. Power consumption 200mW £36. Ref EE16

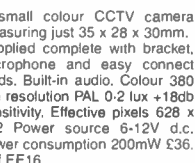

Complete wireless CCTV system with video. Kit comprises pinhole colour camera with simple battery connection and a receiver with video output. 380 lines colour 2.4GHz 3 lux 6-12V d.c. manual tuning Available in two versions, pinhole and standard. £79 (pinhole) Ref EE17, £79 (standard). Ref EE18



Small transmitter designed to transmit audio and video signals on 2.4GHz. Unit measures 45 x 35 x 10mm. Ideal for assembly into covert CCTV systems Easy connect leads Audio and video input 12V d.c. Complete with aerial Selectable channel switch £30. Ref EE19



2.4GHz wireless receiver Fully cased audio and video 2.4GHz wireless receiver 190x140x30mm, metal case, 4 channel, 12V d.c. Adjustable time delay, 4s, 8s, 12s, 16s. £45. Ref EE20

The smallest PMR446 radios currently available (54x87x37mm). These tiny handheld PMR radios not only look great, but they are user friendly & packed with features including VOX, Scan & Dual Watch. Priced at £59.99 PER PAIR they are excellent value for money. Our new favourite PMR radios! Standby: - 35 hours Includes: - 2 x Radios, 2 x Belt Clips & 2 x Carry Strap £59.95 Ref ALAN1 Or supplied with 2 sets of rechargeable batteries and two mains chargers £84.99. Ref Alan2



Beltronics BEL550 Euro radar and GATSO detector Claimed Detection Range: GATSO up to 400m. Radar & Laser guns up to 3 miles. Detects GATSO speed cameras at least 200 metres away, plenty of time to adjust your speed £319. Ref BEL550

The TENS mini Microprocessors offer six types of automatic programme for shoulder pain, back/neck pain, aching joints, Rheumatic pain, migraines headaches, sports injuries, perid pain. In fact all over body treatment. Will not interfere with existing medication. Not suitable for anyone with a heart pacemaker. Batteries supplied. £19.95 Ref TEN327 Spare pack of electrodes £5.99. Ref TEN327X



Dummy CCTV camera. These motorised cameras will work either on 2 AA batteries or with a standard DC adapter (not supplied) They have a built-in movement detector that will activate the camera if movement is detected causing the camera to 'pan' Good deterrent. Camera measures 20cm high, supplied with fixing screws. Camera also has a flashing red l.e.d. built in. £9.95. Ref CAMERAB

INFRA-RED FILM 6" square piece of flexible infra-red film that will only allow IR light through. Perfect for converting ordinary torches, lights, headlights etc to infra-red output only using standard light bulbs Easily cut to shape. 6" square £15. Ref IRF2 or a 12" sq for £29 IRF2A



**GASTON SEALED LEAD-ACID BATTERIES**



1-3AH 12V @ £5 REF GT1213  
3-4AH 12V @ £8 REF GT1234  
7AH 12V @ £8 REF FT127  
17AH 12V @ £18 REF GT1217

All new and boxed, bargain prices. Good quality sealed lead-acid batteries

SOLAR PANEL 10 watt silicon solar panel, at least 10 year life, 365 x 26mm, waterproof, ideal for fixing to caravans, boat, motorhomes etc. Nicely made unit with fixing holes for secure fittings. Complete with leads and connectors. Anodised frame. Supplied with two leads, one 3M lead is used for the o/p with two croc clips, the other lead is used to connect extra panels. Panels do NOT require a blocking diode, they can be left connected at all times without discharging the battery. £84.99. REF PAN  
8A solar regulator 12V. 96 watt, 150mm x 100mm x 25mm. £28. REF SOLREG2



High-power modules (80W+) using 125mm square multi-crystal silicon solar cells with bypass diode. Anti-reflection coating and BSF structure to improve cell conversion efficiency: 14%. Using white tempered glass, EVA resin, and a weatherproof film along with an aluminium frame for extended outdoor use. system Lead wire with waterproof connector. Four sizes. 80W 12V dc, 1200 x 530 x 35mm, £287. REF NE80. 123W 12V d.c., 1499 x 662 x 46mm, £439. REF NDL3. 125W 24V, 1190 x 792 x 46mm, £439. REF NEL5 and 165W 24V, 157 x 826 x 46mm, £593.

**BULL GROUP LTD**  
UNIT D, HENFIELD BUSINESS PARK,  
HENFIELD, SUSSEX BN5 9SL  
TERMS: CASH, PO, CHEQUE PRICES + VAT  
WITH ORDER PLUS £5.50 P&P (UK) PLUS VAT.  
24 HOUR SERVICE £7.50 (UK) PLUS VAT.  
OVERSEAS ORDERS AT COST PLUS £3.50  
Tel: 0870 7707520 Fax 01273 491813  
Sales@bullnet.co.uk  
www.bullnet.co.uk

THE TIDE CLOCK. These clocks indicate the state of the tide. Most areas in the world have two high tides and two low tides a day, so the tide clock has been specially designed to rotate twice each lunar day (every 12 hours and 25 minutes) giving you a quick and easy indication of high and low water. The Quartz tide clock will always stay calibrated to the moon. £21 REF TIDEC



LINEAR ACTUATORS 12-36V D.C. BUILT-IN ADJUSTABLE LIMIT SWITCHES POWER COATED 18in THROW UP TO 1,000lb THRUST (400lb RECOMMENDED LOAD). SUPPLIED WITH MOUNTING BRACKETS DESIGNED FOR OUTDOOR USE. These brackets originally made for moving very large satellite dishes are possibly more suitable for closing gates, mechanical machinery, robot wars etc. Our first sale was to a company building solar panels that track the sun! Two sizes available, 12in. and 18in throw. £29.95. REF ACT12, £34.95 REF ACT18



POWERSAFE DEEP CYCLE BATTERIES  
12V 51AH, NOW ONLY £29.95 EACH  
YUASA 6V 100AH NOW ONLY £19 EACH



BRAND NEW MILITARY ISSUE DOSE METERS (radiation detectors) Current NATO issue Standard emergency services unit. Used by most of the world's military personnel. New and boxed. £69 REF SIEM69

NIGHT VISION SYSTEM Superb hunting rifle sight to fit most rifles, grooved for a telescopic sight. Complete with infra-red illuminator. Magnification 2.7x. Complete with rubber eye shield and case. Opens up a whole new world! Russian made Can be used as a hand held or mounted on a rifle. £99 REF PN1



These Samarium magnets measure 57mm x 20mm and have a threaded hole (5/16th UNF) in the centre and magnetic strength of 2.2 gauss We have tested these on a steel beam running through the offices and found that they will take more than 170lb. (77kg) in weight before being pulled off. With keeper. £19.95. REF MAG77.

Peltier Effect heat pump. Sem conductor thermo-electric device which works on the Peltier effect. When supplied with a suitable electric current, can either cool or heat. Also when subject to an externally applied temperature gradient can produce an electric current. Ideal for cooling or controlling the temperature of sub assemblies. Each module is supplied with a comprehensive 18-page Peltier design manual featuring circuit designs, design information etc.. etc. The Peltier manual is also available separately. Maximum watts 56-2 40 x 40mm I max, 5-5A V max, 16-7 T max (c-dry N2). 72. £29.95 (inc. manual. REF PELT1. Just manual £4 REF PELT2.



New transmitter, receiver and camera kit. £69. Kit contains four channel switchable camera with built-in audio, six IR l.e.d.s and transmitter, four channel switchable receiver, 2 power supplies, cables, connectors and mounting bracket. £69. Wireless Transmitter. Black and white camera (75 x 50 x 55mm). Built-in 4 channel transmitter (switchable). Audio built-in 6 IR l.e.d.s. Bracket/stand. Power supply 30m range Wireless Receiver 4 channel (switchable) Audio/video leads and scart adapter. Power supply and manual. £69. REF COP24

This miniature Stirling Cycle Engine measures 7in. x 4 1/4in. and comes complete with built-in alcohol burner Red flywheels and chassis mounted on a green base, these all-metal beauties silently running at speeds in excess of 1,000 r.p.m. attract attention and create awe wherever displayed. This model comes completely assembled and ready to run. £97. REF SOL1

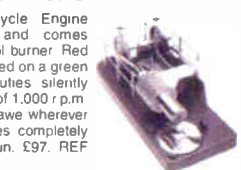

SHOP ONLINE  
WWW.BULLNET.CO.UK

ISSN 0262 3617  
 PROJECTS ... THEORY ... NEWS ...  
 COMMENTS ... POPULAR FEATURES ...

VOL. 32. No. 10 OCTOBER 2003

Cover illustration by jgr22

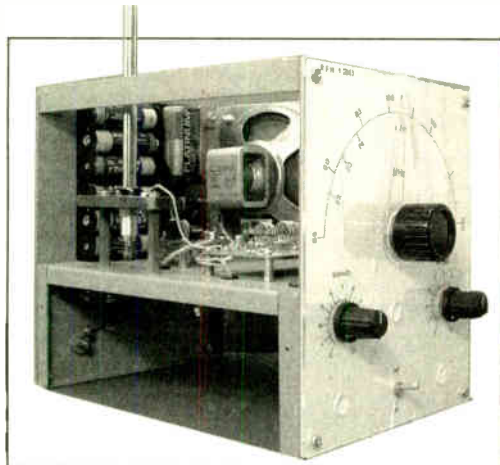
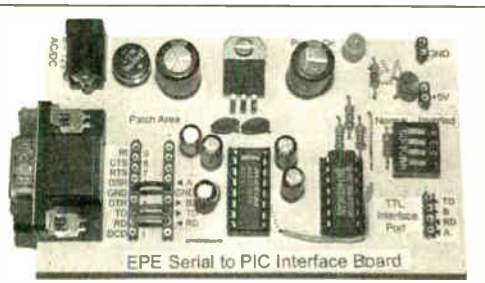

© Wimborne Publishing Ltd 2003. Copyright in all drawings, photographs and articles published in EVERYDAY PRACTICAL ELECTRONICS is fully protected, and reproduction or imitations in whole or in part are expressly forbidden.

EVERYDAY  
**PRACTICAL**  
**ELECTRONICS**

INCORPORATING ELECTRONICS TODAY INTERNATIONAL

[www.epemag.wimborne.co.uk](http://www.epemag.wimborne.co.uk)  
 EPE Online: [www.epemag.com](http://www.epemag.com)

## Projects and Circuits

- RC CAR WARS** by John Lanigan **668**  
 It's a bit like Robot Wars without the expense or destruction!
- SERIAL INTERFACE FOR PICS AND VB6** by Joe Farr **678**  
 Serial hardware plus stand-alone licence-free OCX software
- INGENUITY UNLIMITED - Sharing your ideas with others** **684**  
 Robo-Voice; Stereo Image Enhancer
- SPOOKY BUG** by Owen Bishop **690**  
 Hocus-pocus, get your Hallowe'en party off to a shriek! Another in our occasional Top Tenner series of simple low-cost circuits
- PRACTICAL RADIO CIRCUITS - Part 5. Super-regeneration** **700**  
 by Raymond Haigh  
 A highly sensitive receiving system, plus buffer amplifier, for the set builder and experimenter

## Series and Features

- TECHNO TALK** by Andy Emmerson **672**  
 How new is new - especially in the mobile phones arena?
- NEW TECHNOLOGY UPDATE** by Ian Poole **674**  
 Improved current monitoring devices
- INTERFACE** by Robert Penfold **698**  
 PC parallel port interfacing with VB and the new universal INPOUT32.DLL for Windows
- NET WORK - THE INTERNET PAGE** surfed by Alan Winstanley **711**  
 ADSL broadband alternatives
- CIRCUIT SURGERY** by Alan Winstanley and Ian Bell **713**  
 Concluding our introduction to SPICE simulation software
- PIC BREAKPOINT** by Richard Hinckley **716**  
 An excellent debugging tool offering realtime PC display of all PIC registers

## Regulars and Services

- EDITORIAL** **667**
- NEWS** - Barry Fox highlights technology's leading edge **675**  
 Plus everyday news from the world of electronics
- SHOPTALK** with David Barrington **683**  
 The *essential* guide to component buying for EPE projects
- READOUT** John Becker addresses general points arising **687**
- BACK ISSUES** Did you miss these? Many now on CD-ROM! **695**
- CD-ROMS FOR ELECTRONICS** **708**  
 A wide range of CD-ROMs for hobbyists, students and engineers
- DIRECT BOOK SERVICE** **720**  
 A wide range of technical books available by mail order, plus more CD-ROMs
- PRINTED CIRCUIT BOARD AND SOFTWARE SERVICE** **723**  
 PCBs for EPE projects. Plus EPE project software
- ELECTRONIC MANUALS** **724**  
 Essential reference works for hobbyists, students and service engineers
- ADVERTISERS INDEX** **728**

Our November 2003 issue will be published on Thursday, 9 October 2003. See page 659 for details

Readers Services • Editorial and Advertisement Departments **667**

Visit our website  
www.distel.co.uk

# THE ORIGINAL SURPLUS WONDERLAND!

## THIS MONTH'S SELECTION FROM OUR VAST EVER CHANGING STOCKS

Surplus always  
wanted for cash!

### GIANT 10" 7-SEGMENT DISPLAYS

A bulk purchase enables us to bring you to you these GIANT 7-segment digital displays at a now affordable price!! The 10" character size gives exceptional readability at long distances and enables a host of applications including, score boards, digital clocks, counters, event timers etc. As the units are a simple electro-mechanical device and operate from 12V DC, simple switching via switches, relays, PIC or PC may be used to control single or multiple digits. Units feature integral Zero Power memory which greatly simplifies design. For an excellent DIY practical article, see the May issue of 'Everyday Practical Electronics' magazine. Ideal School / College construction project. Supplied in good RIFE condition, complete with data sheet.



Less than 30% Only £29.95(B) or 4 / £99.00(D)  
of makers price Order RW44 Order PH26

### THE AMAZING TELEBOX



TV SOUND &  
VIDEO TUNER  
CABLE COMPATIBLE

**Converts your colour monitor into a QUALITY COLOUR TV!!**  
The TELEBOX is an attractive fully cased mains powered unit, containing all electronics ready to plug into a host of video monitors or AV equipment which are fitted with a composite video or SCART input. The composite video output will also plug directly into most video recorders, allowing reception of TV channels not normally receivable on most television receivers\* (TELEBOX MB). Push button controls on the front panel allow reception of 8 fully tuneable 'off air' UHF colour television channels. TELEBOX MB covers virtually all television frequencies VHF and UHF including the HYPERBAND as used by most cable TV operators. Ideal for desktop computer video systems & PIP (picture in picture) setups. For complete compatibility - even for monitors without sound - an integral 4 watt audio amplifier and low level Hi Fi audio output are provided as standard. Brand new - fully guaranteed.

TELEBOX ST for composite video input type monitors £36.95  
TELEBOX STL as ST but fitted with integral speaker £39.50  
TELEBOX MB Multiband VHF/UHF/Cable/Hyperband tuner £69.95  
For overseas PAL versions state 5.5 or 6 MHz sound specification.  
\*For cable / hyperband signal reception Telebox MB should be connected to a cable type service. Shipping on all Telebox's, code (B)

**NEW** State of the art PAL (UK spec) UHF TV tuner module with composite 1V pp video & NICAM hi fi stereo sound outputs. Micro electronics all on one small PCB only 73 x 160 x 52 mm enable full tuning control via a simple 3 wire link to an IBM pc type computer. Supplied complete with simple working program and documentation. Requires +12V & +5V DC to operate.  
**BRAND NEW - Order as MY00. Only £39.95 code (B)**  
See [www.distel.co.uk/data\\_my00.htm](http://www.distel.co.uk/data_my00.htm) for picture + full details

### HARD DISK DRIVES 1/2" - 14"

2 1/2" TOSHIBA MK1002MAV 1.1Gb laptop(12.5 mm H) New £59.95  
2 1/2" TOSHIBA MK4313MAT 4.3Gb laptop (8.2 mm H) New £105.00  
2 1/2" TOSHIBA MK6490MAV 6.1Gb laptop (12.7 mm H) New £138.00  
2 1/2" TOSHIBA MK1614GAV 18 Gb laptop (12.7 mm H) New £149.95  
2 1/2" / 3 1/2" conversion kit for PCs, complete with connectors £15.95  
3 1/2" COMPAQ 313706-B21 (IBM) 9 gb ULT/SCSI New £199.00  
3 1/2" FUJII FC-308-26 20mb MFH I/F RFE £59.95  
3 1/2" CONNER CP3024 20 mb IDE I/F (or equiv.) RFE £59.95  
3 1/2" CONNER CP3044 40 mb IDE I/F (or equiv.) RFE £69.00  
3 1/2" QUANTUM 40S Prodr1 46 42mb SCSI I/F, New RFE £49.00  
5 1/4" MINISCRIBE 3425 20mb MFH I/F (or equiv.) RFE £49.95  
5 1/4" SEAGATE ST-238R 30 mb RLL I/F RFE £69.95  
5 1/4" CDC 94205-51 40mb HH MFH I/F RFE tested £59.95  
5 1/4" HP 97548 850 Mb SCSI RFE tested £99.00  
5 1/4" HP C3010 2 Gbyte SCSI differential RFE tested £195.00  
8" NEC D2246 85 Mb SMD interface. New £99.00  
8" FUJITSU M2322K 160Mb SMD I/F RFE tested £195.00  
8" FUJITSU M2392K 2 Gb SMD I/F RFE tested £345.00  
Many other floppy & H drives, IDE, SCSI, ESDI etc from stock, see website for full stock list. Shipping on all drives is code

### TEST EQUIPMENT & SPECIAL INTEREST ITEMS

MITSUBISHI FA3445ETKL 14" Ind. spec SVGA monitors £245  
FURNELLE 0.60V DC @ 50 Amps, bench Power Supplies £995  
FARNELL AP3080 0-30V DC @ 200 Amps, bench Supply £1850  
KINGSHILL CZ403/1 0-50V @ DC 800 Amps - NEW £3950  
1kW to 400 kW - 400 Hz 3 phase power sources - ex stock £760  
IBM 8230 Type 1, Token ring base unit driver £2500  
Wayne Kerr RA200 Audio frequency response analyser INFODEC IUN, 24 port, RJ45 network patchpanels. #TH93 £49  
3COM 16670 12 Port Ethernet hub - RJ45 connectors #LD97 £69  
3COM 16671 24 Port Ethernet hub - RJ45 connectors £89  
3COM 16700 8 Port Ethernet hub - RJ45 connectors NEW £39  
IBM 53F5501 Token Ring IC5 20 port lobe modules £POA  
IBM MAU Token ring distribution panel 8228-23-5050N £45  
AIM 501 Low distortion Oscillator 9Hz to 330KHz, IEEE I/O £550  
ALLGON 8360.1 1805-1880 MHz hybrid power combiners £250  
Trend DSA 276 Data Analyser with 7(03)(2M) 64 i/o £14500  
Marconi 6310 Programmable 2 to 22 GHz sweep generator £14500  
Marconi 2022C 10KHz-1GHz RF signal generator £15500  
HP1650B Logic Analyser £3750  
HP3781 A Pattern generator & HP3782A Error Detector £1800  
HP6621 A Dual Programmable GPIB PSU 0-7 V 160 Watts £1800  
HP6264 Rack mount variable 0-20V @ 20A metered PSU £475  
HP54121A DC to 22 GHz four channel test set £7900  
HP8130A opt 020 300 MHz pulse generator, GPIB etc £POA  
HP A1, A0 8 pen HPGL high speed drum plotters - from HP DRAFTMASTER 1.8 pen high speed plotter £550  
EG-6 Brookdale 95035C Precision lock in amp £1800  
Keithley 590 CV capacitor / voltage analyser £3750  
Racial ICR40 dual 40 channel voice recorder system £4500  
Flakera 45KVA 3 ph On Line UPS - New batteries £1499  
Emerson AP130 2.5KVA industrial spec UPS £2200  
Mann Tally MT645 High speed line printer £945  
Intel SBC 486/133SE Multibus 486 system. 8Mb Ram

### IC's - TRANSISTORS - DIODES

OBSOLETE - SHORT SUPPLY - BULK  
10,000,000 items EX STOCK  
For MAJOR SAVINGS  
CALL or see web site www.distel.co.uk

### COMPUTER MONITOR SPECIALS

**Legacy products**  
**High spec genuine multisync.**  
CGA, EGA, VGA, SVGA  
Mitsubishi FA3415ETKL 14" SVGA Multisync colour monitor with fine 0.28 dot pitch tube and resolution of 1024 x 768. A variety of inputs allows connection to a host of computers including IBM PC's in CGA, EGA, VGA & SVGA modes, BBC, COMMODORE (including Amiga 1200), ARCHIMEDES and APPLE. Many features: Etched faceplate, text switching and LOW RADIATION MPR specification. Fully guaranteed, in EXCELLENT little used condition. Tilt & Swivel Base £4.75

VGA cable for IBM PC included. Only £129 (E) Order as CG73

External cables for other types of computers available - CALL

### Generic LOW COST SVGA Monitors

We choose the make, which includes Compaq, Mitsubishi, IBM, etc. Supplied ready to run with all cables, Standard RTB 90 day guarantee.

|            |            |            |
|------------|------------|------------|
| 14" £59.00 | 15" £69.00 | 17" £79.00 |
|------------|------------|------------|

Supplied in good used condition. Shipping code (D)

### VIDEO MONITORS

PHILIPS HCS35 (same style as CM8833) attractively styled 14" colour monitor with both RGB and standard composite 15.825 KHz video inputs via SCART socket and separate phono jacks. Integral audio power amp and speaker for all audio visual uses. Will connect direct to Amiga and Atari BBC computers. Ideal for all video monitoring / security applications with direct connection to most colour cameras. High quality with many features such as front concealed flap controls, VCR correction button etc. Good used condition - fully tested - guaranteed Dimensions: W14" x H12 3/4" x 15 1/2" D. Only £99.00 (E)

PHILIPS HCS31 Ultra compact 9" colour video monitor with standard composite 15.825 KHz video input via SCART socket. Ideal for all monitoring / security applications. High quality, ex-equipment fully tested & guaranteed (possible minor screen burns). In attractive square black plastic case measuring W10" x H10" x 13 1/2" D. 240 V AC mains powered. Only £79.00 (D)

### INDUSTRIAL COMPUTERS

Tiny shoebox sized industrial 40 Mhz 386 PC system measuring only (mm) 266 x X 88 h X 272 d. Ideal for dedicated control applications running DOS, Linux or even Windows / Steel case contains 85 to 265 V AC / 50 / 60 Hz 70 Watt PSU, a 3 slot ISA passive backplane and a Rocky 318 (PC104) standard, single board computer with 8 MByte NON VOLATILE solid state 'Disk On Chip' RAMDISK. System comprises: Rocky 318 (PC104) SBC ISA card with 40MHz ALI 386SX CPU, 72 pin SIMM slot with 16 MByte SIMM, AMI BIOS, battery backed up real time clock. 2 x 9 pin D 16550 serial ports. EPP/ECP printer port, mini DIN keyboard connector, floppy port, IDE port for hard drives up to 528 MByte capacity, watchdog timer and PC/104 bus socket. The 8 MByte solid state 'disk on a chip' has its own BIOS, and can be fdisked, formatted & booted. Supplied BRAND NEW fully tested and guaranteed. For full data see featured item on website. Order as Q001

Any of our applications inc: firewall, routers, robotics etc. Only £99.00 (D)

Save £££'s  
19" RACK CABINETS  
Europe's Largest Stocks of quality rack cabinets, enclosures and accessories. Over 1000 Racks from stock

This month's special  
33 / 42 / 47 U - High Quality  
All steel Rack Cabinets  
BIG £ SAVER

Made by Eurocraft Enclosures Ltd to the highest possible spec, rack features all steel construction with removable side, front and back doors. Front and back doors are hinged for easy access and all lockable with five secure 5 lever barrel locks. The front door is constructed of double walled steel with a 'designer style' smoked acrylic front panel to enable status indicators to be seen through the panel, yet remain unobtrusive. Internally the rack features fully slotted reinforced vertical fixing members to take the heaviest of 19" rack equipment. The two movable vertical fixing struts (extras available) are pre punched for standard 'cage nuts'. A main distribution panel internally mounted to the bottom rear, provides 8 x IEC 3 pin Euro sockets and 1 x 13 amp 3 pin switched utility socket. Overall ventilation is provided by fully louvered back door and double skinned top section with top and side louvers. The top panel may be removed for fitting of integral fans to the sub plate etc. Other features include: fitted castors and floor levelers, pre-punched utility panel at lower rear for cable / connector access etc. Supplied in excellent, slightly used condition with keys. Colour Royal blue. some grey available - CALL - Can be supplied in many other configurations.

| 33U<br>Order as BC44<br>External dimensions<br>mm=1625H x 635D x<br>603 W. (64" H x 25" D<br>x 23 3/4" W)<br>Only | 42U<br>Order as DT20<br>External dimensions<br>mm=2019H x 635D x<br>603 W. (79.5" H x 25"<br>x 23 3/4" W)<br>Only | 47U<br>Order as RV36<br>External dimensions<br>mm=2019H x 635D x<br>603 W. (89" H x 25" D<br>x 23 3/4" W)<br>Only |
|---|---|---|
| £245  | £345  | £410  |

Call for shipping quotation

### COLOUR CCD CAMERAS

Undoubtedly a miracle of modern technology & our special buying power! A quality product featuring a fully cased COLOUR CCD camera at a give away price! Unit features full auto light sensing for use in low light & high light applications. A 10 mm fixed focus wide angle lens gives excellent focus and resolution from close up to long range. The composite video output will connect to any composite monitor or TV (via SCART socket) and most video recorders. Unit runs from 12V DC so ideal for security & portable applications where mains power not available. Overall dimensions 66 mm wide x 117 deep x 43 high. Supplied BRAND NEW & fully guaranteed with user data, 100's of applications including Security, Home Video, Web TV, Web Cams etc. etc.  
Only £79.00 or 2 for £149.00 (E)

Order as LK33 ONLY £79.00 or 2 for £149.00 (E)

### SOFTWARE SPECIALS

NT4 WorkStation, complete with service pack 3 and licence - OEM packaged. ONLY £89.00 (B)  
ENCARTA 95 - CDROM, Not the latest - but at this price! £7.95  
DOS 5.0 on 3 1/2" disks with concise books c/w QBasic. £14.95  
Windows for Workgroups 3.11 + Dos 6.22 on 3.5" disks £55.00  
Windows 95 CDROM Only - No Licence - £19.95

Wordperfect 6 for DOS supplied on 3 1/2" disks with manual £24.95

### SOLID STATE LASERS

Visible red, 670nm laser diode assembly. Unit runs from 5 V DC at approx 50 mA. Originally made for continuous use in industrial barcode scanners, the laser is mounted in a removable solid aluminium block, which functions as a heatsink and rigid optical mount. Dims of block are 50 x 50 x 15 mm. Integral features include over temperature shutdown, current control, laser OK out put, and gated TTL ON / OFF. Many uses for experimental optics, comms & lightshows etc. Supplied complete with data sheet.  
Order as TD91 ONLY £24.95 (A)

### DC POWER SUPPLIES

Virtually every type of power supply you can imagine. Over 10,000 Power Supplies  
Ex Stock - Call or see our web site.

### RELAYS - 200,000 FROM STOCK

Save £££'s by choosing your next relay from our Massive Stocks covering types such as Military, Octal, Cradle, Hermetically Sealed, Continental, Contactors, Time Delay, Reed, Mercury Wetted, Solid State, Printed Circuit Mounting etc., CALL or see our web site [www.distel.co.uk](http://www.distel.co.uk) for more information. Many obsolete types from stock. Save £££'s



ALL MAIL TO  
Dept PE, 29 / 35 Osborne Rd  
Thornton Heath  
Surrey CR7 8PD  
Open Mon - Fri 9.00 - 5:30

18 Million Items On Line Now!  
Secure ordering, Pictures, Information  
www.distel.co.uk  
email = admin@distel.co.uk

ALL ENQUIRIES  
0208 653 3333  
FAX 0208 653 8888



All prices for UK Mainland. UK customers add 17.5% VAT to TOTAL order amount. Minimum order £10. Bona Fide account orders accepted from Government, Schools, Universities and Local Authorities - minimum account order £50. Cheques over £100 are subject to 7 working days clearance. Carriage charges (A)=£3.50, (B)=£5.50, (C)=£10, (D)=£15.00, (E)=£18.00, (F)=CALL. Allow approx 3 days for shipping - faster CALL. All goods supplied to our Standard Conditions of Sale which can be viewed at our website and unless stated guaranteed for 90 days. All guarantees on a return to base basis. All rights reserved to change prices / specifications without prior notice. Orders subject to stock. Discounts for volume. Top CASH prices paid for surplus goods. All trademarks, tradenames etc acknowledged. © Display Electronics 2002. E & O E.

World Radio History

# NEXT MONTH

**NEW SERIES**

## **TEACH-IN 2004**

*"How to apply electronics meaningfully" could be the sub-title given to our new 10-part educational series Teach-In 2004. Many of you already know what electronic components do in the general sense – it's what you then do with that knowledge is where the puzzlement can come.*

*This series aims to correct this situation – it explains in practical detail how the main categories of component actually function in electronic systems, giving life to circuit diagram concepts you may have studied in fascination but not fully understood.*

*The series is written by Max Horsey, Head of Electronics at Radley College, Oxford, who has great experience at inspiring his students in the art of practical electronics, enabling them to achieve success in national competitions, and in their subsequent careers.*

*In Part 1 next month, Max recaps on the nature of the main component families and illustrates experimentally some of their attributes. In the following parts he examines specific topics such as transistors, operational amplifiers and logic gates, and demonstrates how you can achieve some useful fully-functioning electronic designs.*

### **PIC RANDOM L.E.D. FLASHER**

*We present this design in plenty of time for Christmas when it can be put to good use as a party dress enhancement or Christmas tree decoration etc. Employing just a handful of components plus the l.e.d.s, this project is inexpensive and easy to build. In addition to random flashing, various flashing sequences are included in the software, which, as usual, will be available free from our website.*

### **CARDBOARD CLOCK**

*The Cardboard Clock uses a simple battery-powered circuit to control a pendulum and thus turn three gear wheels to show the time. There are just five moving parts, including the gear wheels, and you can watch them at work. The clock is unusual, inexpensive and will keep time to within 15 seconds per day. It is easy and fascinating to build using only normal home tools.*



**PLUS**

## **PRACTICAL RADIO CIRCUITS – PART 6**

# **NO ONE DOES IT BETTER**

EVERYDAY  
**PRACTICAL**  
**ELECTRONICS**

**DON'T MISS AN  
ISSUE – PLACE YOUR  
ORDER NOW!**  
Demand is bound to be high

NOVEMBER 2003 ISSUE ON SALE THURSDAY, OCTOBER 9



**Quasar Electronics Limited**  
 PO Box 6935, Bishops Stortford,  
 CM23 4WP  
 Tel: 0870 246 1826  
 Fax: 0870 460 1045  
 E-mail: sales@quasarelectronics.com

Add £2.00 P&P to all UK orders. 1st Class Recorded - £4.  
 Next day (insured £250) - £7. Europe - £5. Rest of World - £10.  
 We accept all major credit/debit cards. Make cheques/PO's  
 payable to Quasar Electronics Limited.  
 Prices include 17.5% VAT. MAIL ORDER ONLY.  
 Call now for our FREE CATALOGUE with details of over 300  
 high quality kits, projects, modules and publications.

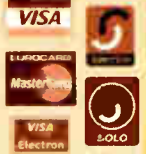

# QUASAR 0871 CREDIT CARD SALES 717 7168

electronics

Helping you make the right connections!

## PIC & ATMEL Programmings

We have a wide range of low cost PIC and ATMEL Programmings. Complete range and documentation available from our web site.

### Programmer Accessories:

**40-pin Wide ZIF socket (ZIF40W) £15.00**  
**18VDC Power supply (PSU201) £5.95**  
**Leads: Parallel (LEAD108) £4.95 / Serial (LEAD76) £4.95 / USB (LEADUAA) £4.95**

### NEW! USB 'All-Flash' PIC Programmer

USB PIC programmer for all 'Flash' devices. No external power supply making it truly portable. Supplied complete with 40-pin wide-slot ZIF socket, box and Windows Software.  
 Kit Order Code: 3128KT - £49.95  
 Assembled Order Code: AS3128 - £54.95



### Enhanced "PICALL" ISP PIC Programmer

Will program virtually ALL 8 to 40 pin PICs plus certain ATMEL AVR, SCENIX SX and EEPROM 24C devices. Also supports In System Programming (ISP) for PIC and ATMEL AVRs. Free software. Blank chip auto detect for super fast bulk programming. Requires a 40-pin wide ZIF socket (not included)  
 Kit Order Code: 3144KT - £54.95  
 Assembled Order Code: AS3144 - £59.95



### ATMEL 89xxxx Programmer

Uses serial port and any standard terminal comms program. 4 LED's display the status. ZIF sockets not included. Supply: 16VDC.  
 Kit Order Code: 3123KT - £29.95  
 Assembled Order Code: AS3123 - £34.95



### NEW! USB & Serial Port PIC Programmer

USB/Serial connection. Ideal for field use. Header cable for ICSP. Free Windows software. Call or see website for PICs supported. ZIF socket not incl. 18VDC.  
 Kit Order Code: 3149KT - £29.95  
 Assembled Order Code: AS3149 - £44.95



### Introduction to PIC Programming

Go from a complete PIC beginner to burning your first PIC and writing your own code in no time! Includes a 49 page step-by-step Tutorial Manual, Programming Hardware (with LED bench testing section), Win 3.11—XP Programming Software (will Program, Read, Verify & Erase), and a rewritable PIC16F84A that you can use with different code (4 detailed examples provided for you to learn from). Connects to PC parallel port.  
 Kit Order Code: 3081KT - £14.95  
 Assembled Order Code: AS3081 - £24.95



### ABC Mini Microcontroller Board

Currently learning about microcontrollers? Need to do more than flash a LED or sound a buzzer? The ABC Mini Starter Kit is based on ATMELs AVR 8535 RISC technology and will interest both the beginner and expert alike. Beginners will find that they can write and test a simple program, using the BASIC programming language, within an hour or two of connecting it up. Experts will like the power and flexibility of the ATMEL microcontroller, as well as the ease with which the board can be "designed-in" to a project. The ABC Mini STARTER PACK includes everything you need to get up and experimenting right away. On the hardware side, there's a pre-assembled ABC Mini Board with parallel and serial cables for connection to your PC. Windows software included on CD-ROM features an Assembler, BASIC compiler and in-system programmer.  
 Order Code ABCMINISP - £54.95  
 The ABC Mini boards only can also be purchased separately at £34.95 each.



ABC Mini Starter Pack

## Controllers & Loggers

Here are just a few of the controller and data acquisition and control units we have. See website for full details. Suitable PSU for all units: Order Code PSU203 £9.95

### Rolling Code 4-Channel UHF Remote

State-of-the-Art. High security. 4 channels. Momentary or latching relay output. Range up to 40m. Up to 15 Tx's can be learnt by one Rx (kit includes one Tx but more available separately). 4 indicator LED 's. Rx: PCB 77x85mm, 12VDC/6mA (standby). Two & Ten Channel versions also available.  
 Kit Order Code: 3180KT - £41.95  
 Assembled Order Code: AS3180 - £49.95



### Computer Temperature Data Logger

Serial port 4-channel temperature logger. °C or °F. Continuously logs up to 4 separate sensors located 200m+ from board. Wide range of free software applications for storing/using data. PCB just 38x38mm. Powered by PC. Includes one DS1820 sensor and four header cables.  
 Kit Order Code: 3145KT - £22.95  
 Assembled Order Code: AS3145 - £29.95  
 Additional DS1820 Sensors - £3.95 each



Most items are available in kit form (KT suffix) or pre-assembled and ready for use (AS prefix).

### NEW! DTMF Telephone Relay Switcher

Call your phone number using a DTMF phone from anywhere in the world and remotely turn on/off any of the 4 relays as desired. User settable Security Password, Anti-Tamper, Rings to Answer, Auto Hang-up and Lockout. Includes plastic case. 130 x 110 x 30mm. Power: 12VDC.  
 Kit Order Code: 3140KT - £39.95  
 Assembled Order Code: AS3140 - £59.95



### Serial Port Isolated I/O Module

Computer controlled 8 channel relay board. 5A mains rated relay outputs and 4 opto-isolated digital inputs (for monitoring switch states, etc). Useful in a variety of control and sensing applications. Programmed via serial port (use our new Windows interface, terminal emulator or batch files). Serial cable can be up to 35m long. Once programmed, unit can operate without PC. Includes plastic case 130x100x30mm. Power: 12VDC/500mA.  
 Kit Order Code: 3108KT - £54.95  
 Assembled Order Code: AS3108 - £64.95

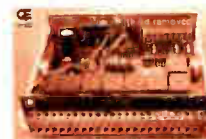

### Infrared RC 12-Channel Relay Board

Control 12 onboard relays with included infrared remote control unit. Toggle or momentary. 15m+ range. 112 x 122mm. Supply: 12VDC/0.5A  
 Kit Order Code: 3142KT - £41.95  
 Assembled Order Code: AS3142 - £59.95



### PC Data Acquisition & Control Unit

Monitor and log a mixture of analogue and digital inputs and control external devices via the analogue and digital outputs. Monitor pressure, temperature, light intensity, weight, switch state, movement, relays, etc. with the appropriate sensors (not supplied). Data can be processed, stored and the results used to control devices such as motors, sirens, relays, servo motors (up to 11) and two stepper motors.



#### Features

- 11 Analogue Inputs - 0-5V, 10 bit (5mV/step)
- 16 Digital Inputs - 20V max. Protection 1K in series, 5.1V Zener
- 1 Analogue Output - 0-2.5V or 0-10V. 8 bit (20mV/step)
- 8 digital Outputs - Open collector, 500mA, 33V max
- Custom box (140x110x35mm) with printed front & rear panels.
- Windows software utilities (3.1 to XP) and programming examples.
- Supply: 12V DC (Order Code PSU203).

Kit Order Code: 3093KT - £69.95  
 Assembled Order Code: AS3093 - £99.95

## Hot New Kits This Summer!

Here are a few of the most recent kits added to our range. See website or join our email Newsletter for all the latest news.

### NEW! EPE Ultrasonic Wind Speed Meter

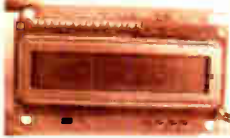

Solid-state design wind speed meter (anemometer) that uses ultrasonic techniques and has no moving parts and

does not need calibrating. It is intended for sports-type activities, such as track events, sailing, hang-gliding, kites and model aircraft flying, to name but a few. It can even be used to monitor conditions in your garden. The probe is pointed in the direction from which the wind is blowing and the speed is displayed on an LCD display.

#### Specifications

- Units of display: metres per second, feet per second, kilometres per hour and miles per hour
- Resolution: Nearest tenth of a metre
- Range: Zero to 50mph approx.

Based on the project published in *Everyday Practical Electronics*, Jan 2003. We have made a few minor design changes (see website for full details). Power: 9VDC (PP3 battery or Order Code [PSU203](#)). Main PCB: 50x83mm.

Kit Order Code: 3168KT - **£34.95**

### NEW! Audio DTMF Decoder and Display

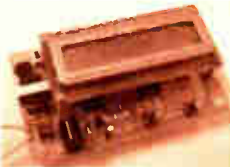

Detects DTMF tones via an on-board electret microphone or direct from the phone lines through an audio transformer. The

numbers are displayed on a 16 character, single line display as they are received. Up to 32 numbers can be displayed by scrolling the display left and right. There is also a serial output for sending the detected tones to a PC via the serial port. The unit will not detect numbers dialled using pulse dialling. Circuit is microcontroller based. Supply: 9-12V DC (Order Code [PSU203](#)). Main PCB: 55x95mm. Kit Order Code: 3153KT - **£17.95**  
Assembled Order Code: AS3153 - **£29.95**

### NEW! EPE PIC Controlled LED Flasher



This versatile PIC based LED or filament bulb flasher can be used to flash from

1 to 160 LEDs. The user arranges the LEDs in any pattern they wish. The kit comes with 8 super bright red LEDs and 8 green LEDs. Based on the *Versatile PIC Flasher* by Steve Challinor, *EPE Magazine* Dec 02. See website for full details. Board Supply: 9-12VDC. LED supply: 9-45VDC (depending on number of LED used). PCB: 43x54mm. Kit Order Code: 3169KT - **£10.95**

Most items are available in kit form (KT suffix) or assembled and ready for use (AS prefix).

## FM Bugs & Transmitters

Our extensive range goes from discreet surveillance bugs to powerful FM broadcast transmitters. Here are a few examples. All can be received on a standard FM radio and have adjustable transmitting frequency.

### MMTX' Micro-Miniature 9V FM Room Bug



Our best selling bug! Good performance. Just 25x15mm. Sold to detective agencies worldwide. Small enough to hide just about anywhere. Operates at the 'less busy' top

end of the commercial FM waveband and also up into the more private Air band. Range: 500m. Supply: PP3 battery. Kit Order Code: 3051KT - **£8.95**  
Assembled Order Code: AS3051 - **£14.95**

### HPTX' High Power FM Room Bug

Our most powerful room bug.



Very impressive

performance. Clear and stable output signal thanks to the extra circuitry employed.

Range: 1000m @ 9V. Supply: 6-12V DC (9V PP3 battery clip supplied). 70x15mm.

Kit Order Code: 3032KT - **£9.95**  
Assembled Order Code: AS3032 - **£17.95**

### MTTX' Miniature Telephone Transmitter



Attach anywhere along phone line.

Tune a radio into the signal and hear exactly what both parties are saying. Transmits only when phone is used. Clear, stable signal. Powered from phone line so completely maintenance free once installed. Requires no aerial wire - uses phone line as antenna. Suitable for any phone system worldwide. Range: 300m. 20x45mm.

Kit Order Code: 3016KT - **£7.95**  
Assembled Order Code: AS3016 - **£13.95**

### 4 Watt FM Transmitter



Small, powerful FM transmitter. Audio preamp stage and three RF stages deliver 4 watts of RF power. Can be used

with the electret microphone supplied or any line level audio source (e.g. CD or tape OUT, mixer, sound card, etc). Aerial can be an open dipole or Ground Plane. Ideal project for the novice wishing to get started in the fascinating world of FM broadcasting. 45x145mm. Kit Order Code: 1028KT - **£22.95**  
Assembled Order Code: AS1028 - **£34.95**

### 25 Watt FM Transmitter

Four transistor based stages with a Philips BLY89 (or equivalent) in the final stage. Delivers a mighty 25 Watts of RF power. Accepts any line level audio source (input sensitivity is adjustable). Antenna can be an open dipole, ground plane, 5/8, J, or YAGI configuration. Supply 12-14V DC, 5A. Supplied fully assembled and aligned - just connect the aerial, power and audio input. 70x220mm. Order Code: 1031M - **£124.95**



**QUASAR**  
electronics  
*Helping you make the right connections!*

**CREDIT  
CARD  
SALES**  
0871  
717  
7168

## Electronic Project Labs

Great introduction to the world of electronics. Ideal gift for budding electronics expert!

### 500-in-1 Electronic Project Lab

This is the top of the range and is a complete electronics course taking you from beginner to A level standard and beyond! It contains all the parts and instructions to assemble 500 projects.

You get three comprehensive course books (total 368 pages) - *Hardware Entry Course*, *Hardware Advanced Course* and a micro-computer based *Software Programming Course*. Each book has individual circuit explanations, schematic and assembly diagrams. Suitable for age 12 and above.

Order Code EPL500 - **£149.95**

**30, 130 - 200 and 300-in-1 project labs also available - see website for details.**



## Number 1 for Kits!

With over 300 projects in our range we are the UK's number 1 electronic kit specialist. Here are a few other kits from our range.

- 1046KT—25W Stereo Car Booster £26.95
- 3087KT—1W Stereo Amplifier £4.95
- 3105KT—18W BTL Mono Amplifier £9.95
- 3106KT—50W Mono Hi-fi Amplifier £19.95
- 3143KT—10W Stereo Amplifier £9.95
- 1011KT—Motorbike Alarm £11.95
- 1019KT—Car Alarm System £10.95
- 1048KT—Electronic Thermostat £9.95
- 1080KT—Liquid Level Sensor £5.95
- 3005KT—LED Dice with Box £7.95
- 3006KT—LED Roulette Wheel £8.95
- 3074KT—8-Ch PC Relay Board £29.95
- 3082KT—2-Ch UHF Relay £26.95
- 3126KT—Sound Activated Relay £7.95
- 3063KT—One Chip AM Radio £10.95
- 3102KT—4-Ch Servo Motor Driver £15.95
- 3160KT—PIC16F62x Experimenter £8.95
- 1096KT—3-30V, 5A Stabilised PSU £30.95
- 3029KT—Combination Lock £6.95
- 3049KT—Ultrasonic Detector £13.95
- 3130KT—Infrared Security Beam £12.95
- SG01MKT—Train Sounds £6.95
- SG10MKT—Animal Sounds £5.95
- 1131KT—Robot Voice Effect £8.95
- 3007KT—3V FM Room Bug £6.95
- 3028KT—Voice Activated FM Bug £12.95
- 3033KT—Telephone Recording Adpt £9.95
- 3112KT—PC Data Logger/sampler £18.95
- 3118KT—12-bit Data Acquisition Unit £52.95
- 3101KT—20MHz Function Generator £59.95

**No.1  
KITS**

[www.quasarelectronics.com](http://www.quasarelectronics.com)

Secure Online Ordering Facilities • Full Product Listing, Descriptions & Photos • Kit Documentation & Software Downloads

# EPE PIC RESOURCES CD-ROM



A companion to the EPE PIC Tutorial V2 series of Supplements (EPE April, May, June 2003)

**ONLY £14.45**  
INCLUDING VAT and P&P

Contains the following Tutorial-related software and texts:

- EPE PIC Tutorial V2 complete demonstration software, John Becker, April, May, June '03
- PIC Toolkit Mk3 (TK3 hardware construction details), John Becker, Oct '01
- PIC Toolkit TK3 for Windows (software details), John Becker, Nov '01

Plus these useful texts to help you get the most out of your PIC programming:

- How to Use Intelligent L.C.D.s, Julyan Ilett, Feb/Mar '97
- PIC16F87x Microcontrollers (Review), John Becker, April '99
- PIC16F87x Mini Tutorial, John Becker, Oct '99
- Using PICs and Keypads, John Becker, Jan '01
- How to Use Graphics L.C.D.s with PICs, John Becker, Feb '01
- PIC16F87x Extended Memory (how to use it), John Becker, June '01
- PIC to Printer Interfacing (dot-matrix), John Becker, July '01
- PIC Magick Musick (use of 40kHz transducers), John Becker, Jan '02
- Programming PIC Interrupts, Malcolm Wiles, Mar/Apr '02
- Using the PIC's PCLATH Command, John Waller, July '02
- EPE StyloPIC (precision tuning musical notes), John Becker, July '02
- Using Square Roots with PICs, Peter Hemsley, Aug '02
- Using TK3 with Windows XP and 2000, Mark Jones, Oct '02
- PIC Macros and Computed GOTOs, Malcolm Wiles, Jan '03
- Asynchronous Serial Communications (RS-232), John Waller, unpublished
- Using I<sup>2</sup>C Facilities in the PIC16F877, John Waller, unpublished
- Using Serial EEPROMs, Gary Moulton, unpublished
- Additional text for EPE PIC Tutorial V2, John Becker, unpublished

NOTE: The PDF files on this CD-ROM are suitable to use on any PC with a CD-ROM drive. They require Adobe Acrobat Reader – included on the CD-ROM

Order on-line from  
[www.epemag.wimborne.co.uk/shopdoor.htm](http://www.epemag.wimborne.co.uk/shopdoor.htm)  
or [www.epemag.com](http://www.epemag.com) (USA \$ prices)  
or by Phone, Fax, Email or Post.

## EPE PIC RESOURCES CD-ROM ORDER FORM

Please send me ..... (quantity) EPE PIC RESOURCES CD-ROM

Price £14.45 each – includes postage to anywhere in the world.

Name .....

Address .....

.....

.....

..... Post Code .....

I enclose cheque/P.O./bank draft to the value of £ .....

Please charge my Visa/Mastercard/Amex/Diners Club/Switch

£ .....

Card No. ....

Card Security Code ..... (The last 3 digits on or just under the signature strip)

Expiry Date ..... Switch Issue No. ....

SEND TO: **Everyday Practical Electronics,**  
**Wimborne Publishing Ltd.,**  
**408 Wimborne Road East, Ferndown, Dorset BH22 9ND.**  
Tel: 01202 873872. Fax: 01202 874562.  
**Email: [orders@epemag.wimborne.co.uk](mailto:orders@epemag.wimborne.co.uk)**

Payments must be by card or in £ Sterling – cheque or bank draft drawn on a UK bank.

Normally supplied within seven days of receipt of order.

Send a copy of this form, or order by letter if you do not wish to cut your issue.

**BECOME A PIC WIZARD WITH THE HELP OF EPE!**





## MAIL ORDER ONLY • CALLERS BY APPOINTMENT

### EPE PROJECT PICS

Programmed PICs for \*EPE Projects  
 12C508/9 - £3.90; 16F627/8 - £4.90  
 16C84/16F84/16C71 - £5.90  
 16F876/877 - £10.00  
 All inc. VAT and Postage  
 (\*Some projects are copyright)

### EPE MICROCONTROLLER P.I. TREASURE HUNTER

The latest MAGENTA DESIGN - highly stable & sensitive - with I.C. control of all timing functions and advanced pulse separation techniques.

- High stability drift cancelling
- Easy to build & use
- No ground effect, works in seawater



- Detects gold, silver, ferrous & non-ferrous metals

- Efficient quartz controlled microcontroller pulse generation.
- Full kit with headphones & all hardware

**KIT 847 .....£63.95**

### PIC PIPE DESCALER

- SIMPLE TO BUILD
- HIGH POWER OUTPUT
- AUDIO & VISUAL MONITORING
- SWEPT FREQUENCY

An affordable circuit which sweeps the incoming water supply with variable frequency electromagnetic signals. May reduce scale formation, dissolve existing scale and improve lathering ability by altering the way salts in the water behave. Kit includes case, P.C.B., coupling coil and all components. High coil current ensures maximum effect. L.E.D. monitor.



**KIT 868 ..... £22.95 POWER UNIT.....£3.99**

### MICRO PEST SCARER

Our latest design - The ultimate scarer for the garden. Uses special microchip to give random delay and pulse time. Easy to build reliable circuit. Keeps pets/pests away from newly sown areas, play areas, etc. uses power source from 9 to 24 volts.



- RANDOM PULSES
- HIGH POWER
- DUAL OPTION

Plug-in power supply £4.99

**KIT 867.....£19.99**

**KIT + SLAVE UNIT.....£32.50**

### WINDICATOR

A novel wind speed indicator with LED readout. Kit comes complete with sensor cups, and weatherproof sensing head. Mains power unit £5.99 extra.

**KIT 856.....£28.00**

## ★ TENS UNIT ★

### DUAL OUTPUT TENS UNIT

As featured in March '97 issue.

Magenta have prepared a FULL KIT for this excellent new project. All components, PCB, hardware and electrodes are included. Designed for simple assembly and testing and providing high level dual output drive.

**KIT 866. Full kit including four electrodes £32.90**

Set of 4 spare electrodes  
£6.50

### 1000V & 500V INSULATION TESTER



Superb new design. Regulated output, efficient circuit. Dual-scale meter, compact case. Reads up to 200 Megohms.

Kit includes wound coil, cut-out case, meter scale, PCB & ALL components.

**KIT 848.....£32.95**

## EPE TEACH-IN 2000

Full set of top quality NEW components for this educational series. All parts as specified by EPE. Kit includes breadboard, wire, croc clips, pins and all components for experiments, as listed in introduction to Part 1.

\*Batteries and tools not included.

**TEACH-IN 2000 -**

**KIT 879 £44.95**

**MULTIMETER £14.45**

### SPACEWRITER

An innovative and exciting project. Wave the wand through the air and your message appears. Programmable to hold any message up to 16 digits long. Comes pre-loaded with "MERRY XMAS". Kit includes PCB, all components & tube plus instructions for message loading.

**KIT 849.....£16.99**

### 12V EPROM ERASER

A safe low cost eraser for up to 4 EPROMS at a time in less than 20 minutes. Operates from a 12V supply (400mA). Used extensively for mobile work - updating equipment in the field etc. Also in educational situations where mains supplies are not allowed. Safety interlock prevents contact with UV.

**KIT 790.....£29.90**

### SUPER BAT DETECTOR

1 WATT O/P, BUILT IN SPEAKER, COMPACT CASE 20kHz-140kHz NEW DESIGN WITH 40kHz MIC.

A new circuit using a 'full-bridge' audio amplifier i.c., internal speaker, and headphone/tape socket. The latest sensitive transducer, and 'double balanced mixer' give a stable, high performance superheterodyne design.

**KIT 861.....£24.99**

ALSO AVAILABLE Built & Tested...£39.99



### 68000 DEVELOPMENT TRAINING KIT

- NEW PCB DESIGN
- 8MHz 68000 16-BIT BUS
- MANUAL AND SOFTWARE
- 2 SERIAL PORTS
- PIT AND I/O PORT OPTIONS
- 12C PORT OPTIONS

### KIT 621

**£99.95**

- ON BOARD 5V REGULATOR
- PSU £6.99
- SERIAL LEAD £3.99

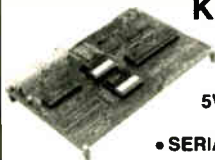

### Stepping Motors

MD100...Std 100 step...£9.99

MD200...200 step...£12.99

MD24...Large 200 step...£22.95



### MOSFET MKII VARIABLE BENCH POWER SUPPLY 0-25V 2.5A

Based on our Mk1 design and preserving all the features, but now with switching pre-regulator for much higher efficiency. Panel meters indicate Volts and Amps. Fully variable down to zero. Toroidal mains transformer. Kit includes punched and printed case and all parts. As featured in April 1994 EPE. An essential piece of equipment.



Kit No. 845 .....£64.95

### ULTRASONIC PEST SCARER

Keep pets/pests away from newly sown areas, fruit, vegetable and flower beds, children's play areas, patios etc. This project produces intense pulses of ultrasound which deter visiting animals.

- KIT INCLUDES ALL COMPONENTS, PCB & CASE
- EFFICIENT 100V TRANSDUCER OUTPUT
- COMPLETELY INAUDIBLE TO HUMANS



- UP TO 4 METRES RANGE
- LOW CURRENT DRAIN

**KIT 812.....£15.00**

### SIMPLE PIC PROGRAMMER

**KIT 857... £12.99**

Includes PIC16F84 chip, disk, lead, plug, p.c.b., all components and instructions

Extra 16F84 chips £3.84  
Power Supply £3.99

## MAGENTA BRAINIBOT I & II

- Full kit with ALL hardware and electronics
- As featured in *EPE* Feb '03 – KIT 910
- Seeks light, beeps, avoids obstacles
- Spins and reverses when 'cornered'
- Uses 8-pin PIC
- ALSO KIT 911 – As 910 PLUS programmable from PC serial port – leads and software CD provided

**NEW**

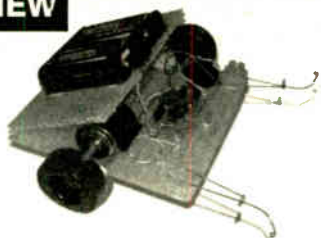

**KIT 910 £16.99    KIT 911 £24.99**

## PIC 16F84 MAINS POWER 4-CHANNEL CONTROLLER & LIGHT CHASER

- ZERO VOLT SWITCHING
- OPTO ISOLATED 5 Amp
- 12 KEYPAD CONTROL
- HARD-FIRED TRIACS
- WITH SOURCE CODE
- SPEED & DIMMING POT.
- EASILY PROGRAMMED

**Kit 855 £39.95**

## PIC 16F84 LCD DISPLAY DRIVER

INCLUDES 1-PIC16F84 WITH DEMO PROGRAM SOFTWARE DISK, PCB, INSTRUCTIONS AND 16-CHARACTER 2-LINE

**LCD DISPLAY**

**Kit 860 £19.99**

Power Supply £3.99

FULL PROGRAM SOURCE CODE SUPPLIED – DEVELOP YOUR OWN APPLICATION!

Another super PIC project from Magenta. Supplied with PCB, industry standard 2-LINE x 16-character display, data, all components, and software to include in your own programs. Ideal development base for meters, terminals, calculators, counters, timers – Just waiting for your application!

## 8-CHANNEL DATA LOGGER

As featured in Aug./Sept. '99 *EPE*. Full kit with Magenta redesigned PCB – LCD fits directly on board. Use as Data Logger or as a test bed for many other 16F877 projects. Kit includes programmed chip, 8 EEPROMs, PCB, case and all components.

**KIT 877 £49.95 inc. 8 x 256K EEPROMS**

## ICEBREAKER

□□□□□□□□□□

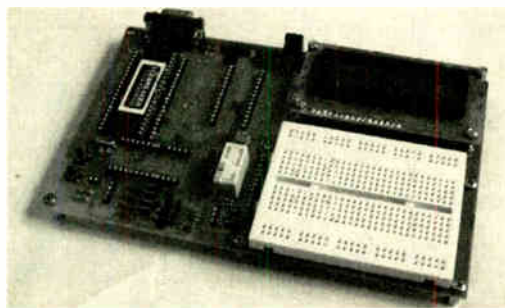

## PIC Real Time In-Circuit Emulator

- Icebreaker uses PIC16F877 in circuit debugger
- Links to Standard PC Serial Port (lead supplied)
- Windows™ (95+) Software included
- Works with MPASM and MPLAB Microchip software
- 16 x 2 L.C.D., Breadboard, Relay, I/O devices and patch leads supplied

As featured in March '00 *EPE*. Ideal for beginners AND advanced users. Programs can be written, assembled, downloaded into the microcontroller and run at full speed (up to 20MHz), or one step at a time. Full emulation means that all I/O ports respond exactly and immediately, reading and driving external hardware.

Features include: Reset; Halt on external pulse; Set Breakpoint; Examine and Change registers, EEPROM and program memory; Load program, Single Step with display of Status, W register, Program counter, and user selected 'Watch Window' registers.

**KIT 900 . . . £34.99**

POWER SUPPLY £3.99    STEPPING MOTOR 100 STEP £9.99

## EPE PIC TOOLKIT 3

**NEW**

- THE LATEST TOOLKIT BOARD – 8, 18, 28 AND 40-PIN CHIPS
- MAGENTA DESIGNED P.C.B. WITH COMPONENT LAYOUT AND EXTRAS
- L.C.D., BREADBOARD AND PIC CHIP INCLUDED
- ALL TOP QUALITY COMPONENTS AND SOFTWARE SUPPLIED

**KIT 880 . . . £34.99 with 16F84 . . . £39.99 with 16F877**

## PIC TOOLKIT V2

- SUPER UPGRADE FROM V1 • 18, 28 AND 40-PIN CHIPS
- READ, WRITE, ASSEMBLE & DISASSEMBLE PICS
- SIMPLE POWER SUPPLY OPTIONS 5V-20V
- ALL SWITCHING UNDER SOFTWARE CONTROL
- MAGENTA DESIGNED PCB HAS TERMINAL PINS AND OSCILLATOR CONNECTIONS FOR ALL CHIPS
- INCLUDES SOFTWARE AND PIC CHIP

**KIT 878 . . . £22.99 with 16F84 . . . £29.99 with 16F877**

## EPE PIC Tutorial

At last! A Real, Practical, Hands-On Series

- Learn Programming from scratch using PIC16F84
- Start by lighting I.e.d.s and do 30 tutorials to Sound Generation, Data Display, and a Security System.
- PIC TUTOR Board with Switches, I.e.d.s, and on board programmer

## PIC TUTOR BOARD KIT

Includes: PIC16F84 Chip, TOP Quality PCB printed with Component Layout and all components\* (\*not ZIF Socket or Displays). Included with the Magenta Kit is a disk with Test and Demonstration routines.

**KIT 870 .... £27.95, Built & Tested .... £42.95**

Optional: Power Supply – £3.99, ZIF Socket – £9.99

LCD Display ..... £7.99    LED Display ..... £6.99

Reprints Mar/Apr/May 98 – £3.00 set 3

## SUPER PIC PROGRAMMER

- READS, PROGRAMS, AND VERIFIES
- WINDOWS™ SOFTWARE
- PIC16C AND 16F – 6X, 7X, AND 8X
- USES ANY PC PARALLEL PORT
- USES STANDARD MICROCHIP • HEX FILES
- OPTIONAL DISASSEMBLER SOFTWARE (EXTRA)
- PCB, LEAD, ALL COMPONENTS, TURNED-PIN SOCKETS FOR 18, 28, AND 40 PIN ICs

• SEND FOR DETAILED INFORMATION – A SUPERB PRODUCT AT AN UNBEATABLE LOW PRICE.

**Kit 862    £29.99**

Power Supply £3.99

**DISASSEMBLER SOFTWARE    £11.75**

## PIC STEPPING MOTOR DRIVER

INCLUDES PCB, PIC16F84 WITH DEMO PROGRAM, SOFTWARE DISC, INSTRUCTIONS AND MOTOR.

**Kit 863 £18.99**

FULL SOURCE CODE SUPPLIED ALSO USE FOR DRIVING OTHER POWER DEVICES e.g. SOLENOIDS

Another Magenta PIC project. Drives any 4-phase unipolar motor – up to 24V and 1A. Kit includes all components and 48 step motor. Chip is pre-programmed with demo software, then write your own, and re-program the same chip! Circuit accepts inputs from switches etc and drives motor in response. Also runs standard demo sequence from memory.

# MAGENTA

All prices include VAT. Add £3.00 p&p. Next day £6.99

Tel: 01283 565435    Fax: 01283 546932    E-mail: sales@magenta2000.co.uk

102003



Station Road, Cullercoats, Tyne & Wear, NE30 4PQ

Prices Exclude Vat @17.5% UK Carriage £1.50 (less than 1kg) £3.50 greater than 1kg Cheques / Postal orders payable to ESR Electronic Components PLEASE ADD CARRIAGE & VAT TO ALL ORDERS

See Next / Last Months Ad. for ELECTRONIC COMPONENTS

DIL Sockets

Table listing various DIL sockets including Stamped Pin, Turned Pin, ZIF Sockets, Transistor Sockets, and IDC Cable Sockets with their respective prices.

Transition Headers

Table listing transition headers with prices.

D Type Connectors

Table listing D type connectors including Solder Basket, IDC Ribbon Mounting, and Right Angled PCB.

Table listing PCB Box Headers with prices.

Table listing PCB Latch Headers with prices.

Table listing DIL Headers with prices.

Table listing Audio Connectors with prices.

Table listing Phono Series connectors with prices.

Table listing XLR Series - metal connectors with prices.

RF Connectors

Table listing RF connectors including BNC Plug, TNC Plug, and UHF Plug with prices.

Push Switches

Table listing push switches including Miniature Round and Standard Square with prices.

Table listing Terminals with prices.

Table listing Power Connectors DC Low Voltage with prices.

Table listing IEC Mains GA 250Vac connectors with prices.

Table listing 8 Way Bulgin connectors with prices.

Table listing Toggle Switches with prices.

Table listing Sub-Miniature connectors with prices.

Table listing Miniature connectors with prices.

Table listing Standard connectors with prices.

Table listing Slide Switches with prices.

Table listing Miniature connectors with prices.

Table listing Rotary Switches with prices.

Boxes & Cases

Table listing boxes and cases with prices.

Table listing General Purpose Plastic with prices.

Table listing Diecast Aluminium with prices.

Table listing Wire & Cable Ribbon Cable with prices.

Table listing Enamelled Copper Wire with prices.

Table listing Tinned Copper Wire with prices.

Table listing Equipment Wire with prices.

Table listing Extra Flex Cable with prices.

Table listing Crystals with prices.

Table listing HC 49/U Case with prices.

Table listing Leads & Cables with prices.

Table listing Medium Leads with prices.

Table listing PC Link Leads with prices.

Table listing Patch Lead with prices.

Table listing Internal Leads with prices.

Table listing various electronic components with prices.

Also In stock Low Profile Crystals, 2 & 3 Pin Ceramic Resonators

Details on our web site

Opto Electronics LEDs

7 Segment Displays

Infra Red Devices

Equipment Wire

Computer Accessories Adaptors

Leads & Cables

Medium Leads

PC Link Leads

Patch Lead

Internal Leads

Networking

Technical Books & CD ROMs

Data Table & Equivalent charts from ECA Characteristics, pin outs, equivalents & selector tables for semiconductor. Demo version of the CD ROMs & full details of the complete range are available from our web site.

Semiconductors Equivalents & Reference

Covering: Transistors, Diodes, Thyristors, Triacs & ICs. These reference books series covers more than 115,000 types with more than 200,000 equivalent types. Each type is provided with information as to device family, short-form description and the salient electrical data, along with the dimensioned outline drawing and pin assignments. Split into two paper volumes or available on one CDROM.

vr1 volume 1 A-Z Device Codes £14.34 ISBN3881090339 1184 Pages, 14th Update 2002

vr1 volume 2 1N...60 000...u Device Codes £14.34 ISBN3881090355 720 Pages, 13th Update 2002

These books are zero vat rate, carriage for one OR both £3.50+vat

vr1-disk 2003 CD ROM, £30.55+vat ISBN3881090703 Windows 95/98/NT/2000/XP

The software version of the two vr1 books. In addition to pin assignments of all discrete semiconductor this CD-ROM version contains the pin assignments for all standard CMOS /4000/7400, TTL 7400 circuits, many operational amplifiers and some Audio and Video ICs. Extensive search facility. Manufacturers Details, a "Note-Function" to add your own data for each device. Carriage for CD only £1.50+vat

Full details of UK, European or Worldwide Order information on our web site.

Tel: 0191 2514363 Fax: 0191 2522296 Email: sales@esr.co.uk http://www.esr.co.uk

# EVERYDAY PRACTICAL ELECTRONICS

THE No.1 MAGAZINE FOR ELECTRONICS TECHNOLOGY & COMPUTER PROJECTS

**VOL. 32 No. 10 OCTOBER 2003**

**Editorial Offices:**  
EVERYDAY PRACTICAL ELECTRONICS EDITORIAL  
WIMBORNE PUBLISHING LTD., 408 WIMBORNE ROAD EAST,  
FERNDOWN, DORSET BH22 9ND  
Phone: (01202) 873872. Fax: (01202) 874562.

Email: enquiries@epemag.wimborne.co.uk  
Web Site: www.epemag.wimborne.co.uk  
EPE Online (downloadable version of EPE): www.epemag.com  
EPE Online Shop: www.epemag.wimborne.co.uk/shopdoor.htm  
See notes on Readers' Technical Enquiries below – we regret lengthy technical enquiries cannot be answered over the telephone.

**Advertisement Offices:**  
EVERYDAY PRACTICAL ELECTRONICS ADVERTISEMENTS  
MILL LODGE, MILL LANE,  
THORPE-LE-SOKEN, ESSEX CO16 0ED  
Phone/Fax: (01255) 861161 Email: epeads@aol.com

## TEACH-IN 2004

The *EPE Teach-In* series have established a world-wide reputation for excellence over the years. Every two years we publish a new series, each with a different slant. The last one – *Teach-In 2002* published in the November 2001 to August 2002 issues – was subtitled *Making Sense Of The Real World* and concentrated on sensors, explaining their operation and helping with the design of associated circuitry. The new series – *Teach-In 2004* – starts next month and goes back to basics for those with little knowledge of electronics, or for those with some experience who want to brush up on their background knowledge.

The series is being written by Max Horsey, who is Head of Electronics at Radley College, Oxford. Many readers will know Max from his previously published projects and from his students' regular appearances in the prizewinners list for the annual YEDA (Young Electronic Designer Awards) competition.

## EXPERIMENTALLY

The new series is designed to show, experimentally, how components function as part of circuits and systems. It will cover a wide range of basic electronics, both analogue and digital and will be enhanced with relevant projects to build, each demonstrating the application of the theory being covered. The aim is not to get bogged down in detailed theory, but to provide a good basic understanding of how things work, for instance we will not be going into the internal atomic level theory of semiconductor operation but readers will get a good basic understanding of how a transistor or diode functions in a circuit.

In this way Max can cover a large range of subjects and impart a sound basic understanding of circuit operation. Enough to lead readers on to designing their own projects and fault-finding them.

No doubt this will be another popular series – don't miss Part 1 next month.



## AVAILABILITY

Copies of *EPE* are available on subscription anywhere in the world (see opposite), from all UK newsagents (distributed by COMAG) and from the following electronic component retailers: Omni Electronics and Yebo Electronics (S Africa). *EPE* can also be purchased from retail magazine outlets around the world. An Internet on-line version can be purchased and downloaded for just \$10.99US (approx £7) per year available from [www.epemag.com](http://www.epemag.com)

## SUBSCRIPTIONS

Subscriptions for delivery direct to any address in the UK: 6 months £16.50, 12 months £31, two years £57; Overseas: 6 months £19.50 standard air service or £28.50 express airmail, 12 months £37 standard air service or £55 express airmail, 24 months £69 standard air service or £105 express airmail. To subscribe from the USA or Canada see the last magazine page. Online subscriptions, for downloading the magazine via the Internet, \$10.99US (approx £7) for one year available from [www.epemag.com](http://www.epemag.com).

Cheques or bank drafts (in £ sterling only) payable to *Everyday Practical Electronics* and sent to EPE Subs, Dept., Wimborne Publishing Ltd, 408 Wimborne Road East, Ferndown, Dorset BH22 9ND. Tel: 01202 873872. Fax: 01202 874562. Email: subs@epemag.wimborne.co.uk. Also via the Web at: <http://www.epemag.wimborne.co.uk>. Subscriptions start with the next available issue. We accept MasterCard, Amex, Diners Club, Switch or Visa. (For past issues see the *Back Issues* page.)

## BINDERS

Binders to hold one volume (12 issues) are available from the above address. These are finished in blue p.v.c., printed with the magazine logo in gold on the spine. Price £6.95 plus £3.50 p&p (for overseas readers the postage is £6.00 to everywhere except Australia and Papua New Guinea which cost £10.50). Normally sent within seven days but please allow 28 days for delivery – more for overseas.

Payment in £ sterling only please. Visa, Amex, Diners Club, Switch and MasterCard accepted. Send, fax or phone your card number, card expiry date and card security code (the last 3 digits on or just under the signature strip), with your name, address etc. Or order on our secure server via our UK web site. Overseas customers – your credit card will be charged by the card provider in your local currency at the existing exchange rate.

**Editor:** MIKE KENWARD

**Deputy Editor:** DAVID BARRINGTON

**Technical Editor:** JOHN BECKER

**Business Manager:** DAVID J. LEAVER

**Subscriptions:** MARILYN GOLDBERG

**Administration:** FAY KENWARD

**Editorial/Admin:** (01202) 873872

**Advertisement Manager:**

PETER J. MEW, (01255) 861161

**Advertisement Copy Controller:**

PETER SHERIDAN, (01202) 873872

**On-Line Editor:** ALAN WINSTANLEY

**EPE Online** (Internet version) **Editors:**

CLIVE (MAX) MAXFIELD and ALVIN BROWN

## READERS' TECHNICAL ENQUIRIES

E-mail: techdept@epemag.wimborne.co.uk

We are unable to offer any advice on the use, purchase, repair or modification of commercial equipment or the incorporation or modification of designs published in the magazine. We regret that we cannot provide data or answer queries on articles or projects that are more than five years old. Letters requiring a personal reply *must* be accompanied by a stamped self-addressed envelope or a self-addressed envelope and international reply coupons.

## PROJECTS AND CIRCUITS

All reasonable precautions are taken to ensure that the advice and data given to readers is reliable. We cannot, however, guarantee it and we cannot accept legal responsibility for it.

A number of projects and circuits published in *EPE* employ voltages that can be lethal. You should not build, test, modify or renovate any item of mains powered equipment unless you fully understand the safety aspects involved and you use an RCD adaptor.

## COMPONENT SUPPLIES

We do not supply electronic components or kits for building the projects featured, these can be supplied by advertisers (see *Shoptalk*). We advise readers to check that all parts are still available before commencing any project in a back-dated issue.

## ADVERTISEMENTS

Although the proprietors and staff of EVERYDAY PRACTICAL ELECTRONICS take reasonable precautions to protect the interests of readers by ensuring as far as practicable that advertisements are *bona fide*, the magazine and its Publishers cannot give any undertakings in respect of statements or claims made by advertisers, whether these advertisements are printed as part of the magazine, or in inserts.

The Publishers regret that under no circumstances will the magazine accept liability for non-receipt of goods ordered, or for late delivery, or for faults in manufacture.

## TRANSMITTERS/BUGS/TELEPHONE EQUIPMENT

We advise readers that certain items of radio transmitting and telephone equipment which may be advertised in our pages cannot be legally used in the UK. Readers should check the law before buying any transmitting or telephone equipment as a fine, confiscation of equipment and/or imprisonment can result from illegal use or ownership. The laws vary from country to country; readers should check local laws.



# Constructional Project

# RC CAR WARS



**JOHN LANIGAN**

*It's a bit like Robot Wars without the expense or final destruction!*

**U**NLESS you are a dedicated radio control enthusiast the fun soon goes out of driving a radio controlled (RC) model car around the patio. The circuit described here will put back some of the fun into what is otherwise a solitary amusement and turn it into a battle for life or death.

At least two RC cars are required operating on different frequencies. The object of the "new" game is to avoid being hit yourself whilst scoring three hits on your opponent's car. This is a little like the popular TV game of *Robot Wars*.

Unlike *Robot Wars*, simply pressing a reset button returns you to the next game with another three lives – no extensive repair work necessary. Warning! You may find yourself spending too much time playing and being unable to do the dishes, wash the car, mow the lawn, clean the windows . . . etc.

## UNDER THE BONNET

The simplest way to disable Radio Control model cars is to turn off the power to the Receiver Board. Interrupting the supply to the motor itself is complicated a little by the model's need for the motor to be reversible. This can, of course, be done but is not necessary for this project.

At the *budget* end of the range (you can do this with the really super and expensive models but the author has found that Dads want to kill you if you do), a single board handles all of the signal processing, motor control and steering functions. Interrupting the negative connection from this board to the battery box means a simple transistor switch can be used.

A digital counter i.c. will make sure a fixed number of "hits" produces the disable signal. Hit signals can be generated using cheap and simple push-to-make, non-latching switches and some de-bouncing circuitry. Mount the switches so their "collision buttons" are in exposed areas on the outside of the model car, and fit the disable circuit into the receiver (Rx) board's negative supply line and we have a means to inflict "virtual" damage – and have a bit more fun.

## CAR POWER

Radio Controlled cars from High Street stores come with 2, 4 or 6 size AA battery compartments. This gives 3V or 6V operation and the 6-cell versions use two of the cells to run the electronics exclusively.

The circuit to be described here will work with either of the 4 or 6 battery models. The 3V, 2-battery types have some interesting surface mount electronics on the underside of the double-sided Rx board. Briefly, this part of the board boosts the speed performance of the motor. The author used a TIP121 Darlington power transistor successfully with all the models used in the preparation of this article.

The maximum voltage for the circuit is determined by the 18V upper limit for the 4017 counter chip. Lowest recommended operating voltage is quoted at 3V but the prototype circuit operated well below this, leaving plenty of room for battery run down.

## HOW IT WORKS

This is the section read by die-hard enthusiasts or when things go wrong – the author always reads this section.

The full circuit diagram for the RC Car Wars is shown in Fig.1. This is, of course, for a single car and is repeated for each "contestant's" car. It breaks down into three sections: a switch and de-bounce circuit (IC1a to IC1c), followed by an i.c. counter (IC2) with optional i.e.d. state indicators, and a power "switch" (TR1).

The "hit" switches, S1 and S2, are connected in parallel and so a hit on either switch counts. Three NAND gates of IC1

are arranged as a flip-flop with capacitor C1 and resistor R1 providing a 100 $\mu$ s delay to mask contact bounce in the switches. Hit counting is performed by IC2, a 4017 CMOS decade counter, sometimes called a Johnson Counter. Transistor TR1 handles the power switching. Base current into TR1 is limited by resistor R5.

Light-emitting diodes, D1 to D3, are optional and indicate the current "life" state of the Robo-car. They make use of the first three outputs (Q0, Q1, Q2) on pins 3, 2 and 4 of IC2 as it counts up.

When three counts have been reached, IC2 pin 7 (Q3) goes high. This is inverted

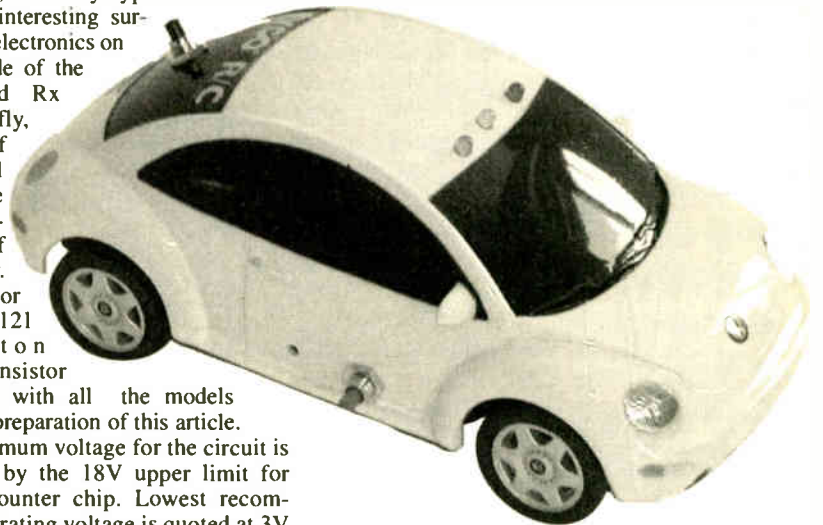

by IC1d so turning off Darlington transistor TR1. As the transistor no longer conducts it effectively disconnects the ground (or negative supply) lead from the Rx board that we have re-routed to the transistor's collector (c).

When the Reset pushbutton S3 is operated it momentarily pulls the reset pin (15) of IC2 high, which is the condition required to reset the counter to zero. Dead simple!

## OUT FOR THE COUNT

On each clock input at pin 14 of IC2, it puts a "high" on one of its output pins. Any existing count output is turned-off. So the "active" output ripples up from 1 to 10. It is convenient that each output remains high only for one clock cycle.

Only one load is driven by the outputs at any time thus reducing the battery drain – very important for RC models. A lot of batteries were recharged playing with the prototypes!

In this circuit we only need a count to 3 but, as stated earlier, the Johnson Counter will count to 10, therefore, counting must be stopped at three as a fourth hit would re-enable the car. Fortunately, a clock inhibit pin is provided, at IC2 pin 13, and any of

the outputs can be connected to it. So connecting IC2 pin 7 (the count 3 output) to pin 13 (the clock inhibit input) effectively latches pin 7 high, stopping the count at 3 as required.

As IC2 pin 7 is also connected to both input pins of IC1d, this makes IC1d gate act as an inverter, therefore, its output will be “low” when the count reaches three. The output of IC1d (pin 11) is taken to the base of transistor TR1 so a “low” will turn-off the transistor. The counter electronics are independently connected to the battery supply so operating the Reset pushbutton S3 restores power to the model’s receiver (Rx) board.

wiring one of the trial circuits did generate enough heat to make the transistor uncomfortable to hold. But it survived!

## CONSTRUCTION

The RC Car Wars “hit counter” circuit is built on a small piece of stripboard just 12 strips by 22 holes. You will probably need to cut a piece from a larger board. The top-side component layout, interwiring and details of breaks required in the copper tracks are shown in Fig.2.

Commence construction by first making the breaks (26) in the copper tracks. You can use a 5mm dia. drill, or a special hand-held tool which is available for this. Next,

## COMPONENTS

### PER CAR

#### Resistors

|          |             |
|----------|-------------|
| R1 to R3 | 10k (3 off) |
| R4       | 630Ω        |
| R5       | 1k          |

All 0.25W 5% carbon film

#### Capacitors

|    |                       |
|----|-----------------------|
| C1 | 100n plate ceramic    |
| C2 | 100n polyester        |
| C3 | 100μ axial elect. 35V |

#### Semiconductors

|     |                                  |
|-----|----------------------------------|
| D1  | 3mm l.e.d., green                |
| D2  | 3mm l.e.d., yellow               |
| D3  | 3mm l.e.d., red                  |
| TR1 | TIP121 npn Darlington transistor |
| IC1 | 4011 CMOS quad 2-input NAND gate |

See **SHOP TALK** page

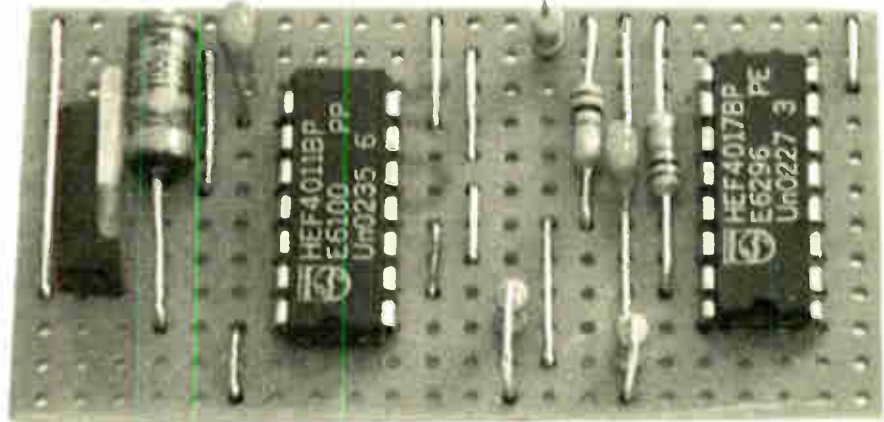

Partially completed prototype “hit/counter” board showing most of the link wires in position.

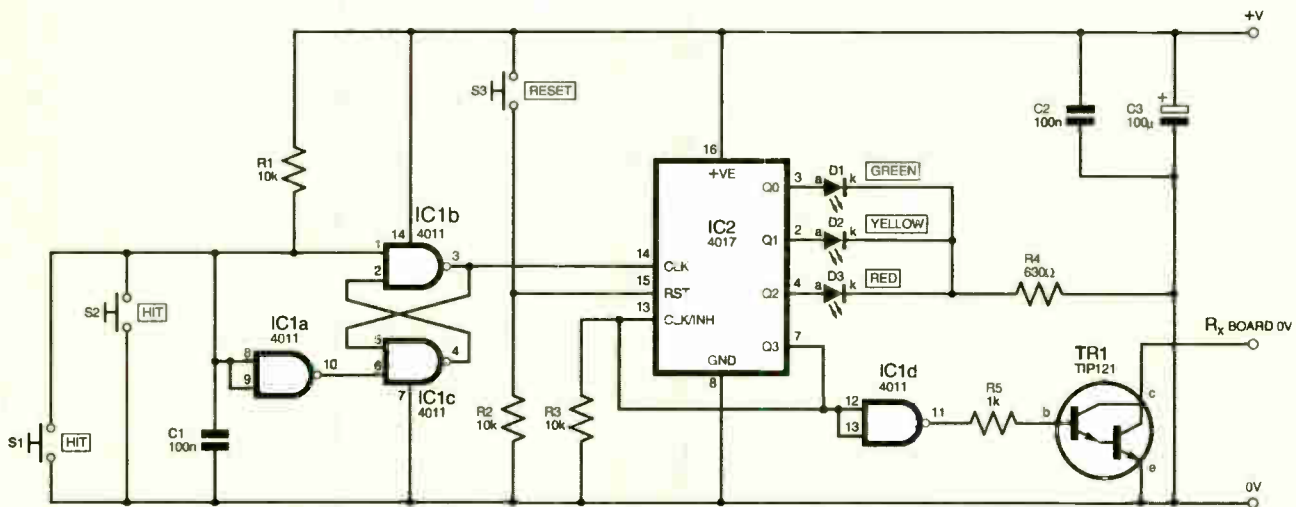

Fig.1. Complete circuit diagram for the RC Car Wars.

IC2 4017 CMOS decade counter/divider

#### Miscellaneous

|        |   |
|--------|---|
| S1, S2 | sub-min. pushswitch, push-to-make (red – 2 off) |
| S3     | sub-min. pushswitch, push-to-make (black)       |

Stripboard, size 12 strips x 22 holes; model RC car; 14-pin low-profile d.i.l. socket; 16-pin low-profile d.i.l. socket; multistrand connecting wire; piece of double-sided adhesive tape or pad; solder etc.

Approx. Cost Guidance Only

**£6** per car  
excl. RC car & batts

## POWER NEEDS

The power switching Darlington transistor TR1 is a fairly heavy current carrier as transistors go. It needs to be because it will be passing the full load current of the motor plus a little overhead for the Receiver board.

Starting and worse, rapidly switching the motor into reverse, can pull up to 2A from the batteries momentarily. In practice, the transistor was easily able to cope in the prototype although a slight mishap or two in

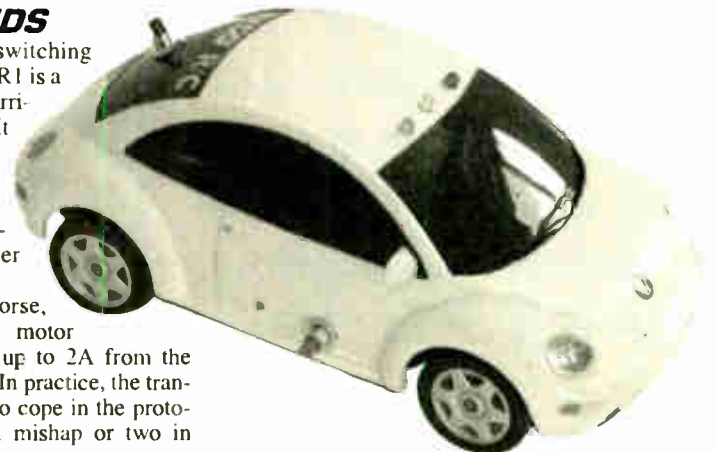

the inter-track links should be carefully inserted and soldered in position. Note the two diagonal dashed links can be inserted below the low-profile i.c. sockets or soldered on the copper track side when inserting the sockets.

Having double-checked the link wires, the rest of the components can be mounted on the board. Start with the i.c. sockets then the resistors, some of which are mounted upright (vertically).

The power transistor is mounted at one end of the board, with the metal tab towards the centre, see Fig.2. A small crocodile clip attached to each pin as it is inserted will act as a good heatsink while soldering the lead in position. Make sure the transistor pins are inserted correctly before soldering. The i.c.s should not be plugged into their sockets until all wiring has been completed and double-checked.

Board lead-off wires to the switches and l.e.d.s should be made long enough to allow comfortable assembly and disassembly of the model. Depending upon available space within the model car, it may be necessary to sleeve the legs of the l.e.d.s. The board interwiring is also included in Fig.2

### TEST RUN

To test the completed circuit board a load must be connected with its negative lead going to the collector of transistor TR1. A small motor or 6V lamp is suitable but if a motor is used make sure it has a ceramic "suppression" capacitor and diode (cathode on positive side) across the input terminals.

All of the RC model motors have this suppression capacitor and as well as reducing radio interference it absorbs some of the spikes generated by the motor commutation. That is it will offer a little protection to the power transistor during testing.

All of the prototypes performed perfectly well with their original, unmodified motors. The receiver (Rx) board will have been designed to cope with a dirty - digitally speaking, electro-mechanical component like the motor.

### INSTALLATION

It helps to think of the new board as simply a switch operating in the negative battery lead of the Rx board, see Fig.3. The final interwiring between the receiver (Rx)

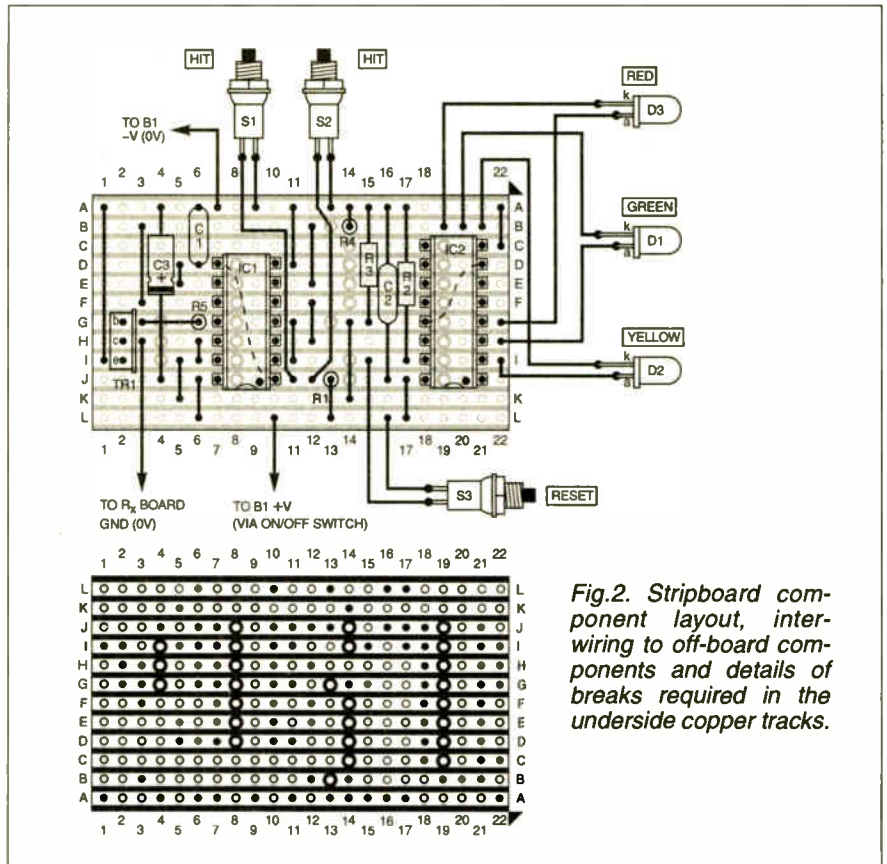

Fig.2. Stripboard component layout, interwiring to off-board components and details of breaks required in the underside copper tracks.

board, on/off switch, the battery box and new "collision" board is shown in Fig.4.

The battery box is usually accessed from underneath the model car by a cover. The batteries should be removed before any disassembly work is undertaken. Several screws will hold the body moulding to the model base and the aerial wire will be fixed to the Rx board with a screw that also secures the Rx board.

The aerial wire passes through the body moulding of some models and will/should have a plastic bobble on the end or more likely be tightly wound into a coil. **This is a safety feature and should not be removed.** Without such protection the sharp end of the wire could very easily cause injury - particularly to the eyes.

It is not necessary to completely remove the aerial as unscrewing it from the Rx board will allow removal of both the body moulding and the aerial together. Cheaper and new

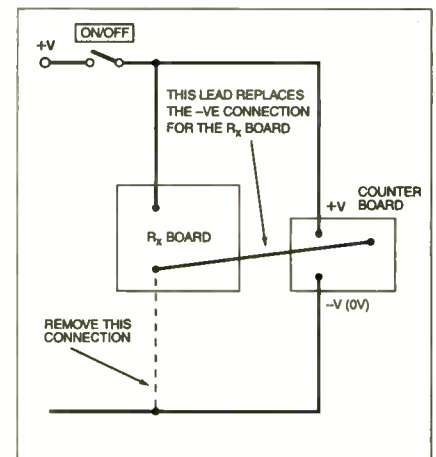
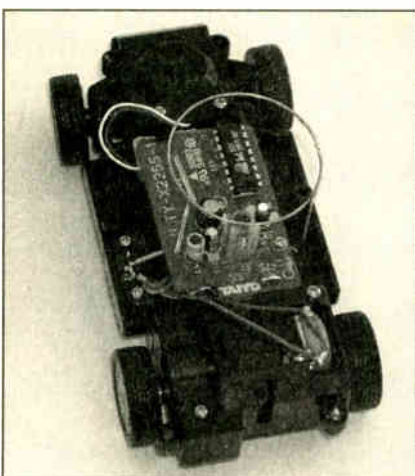
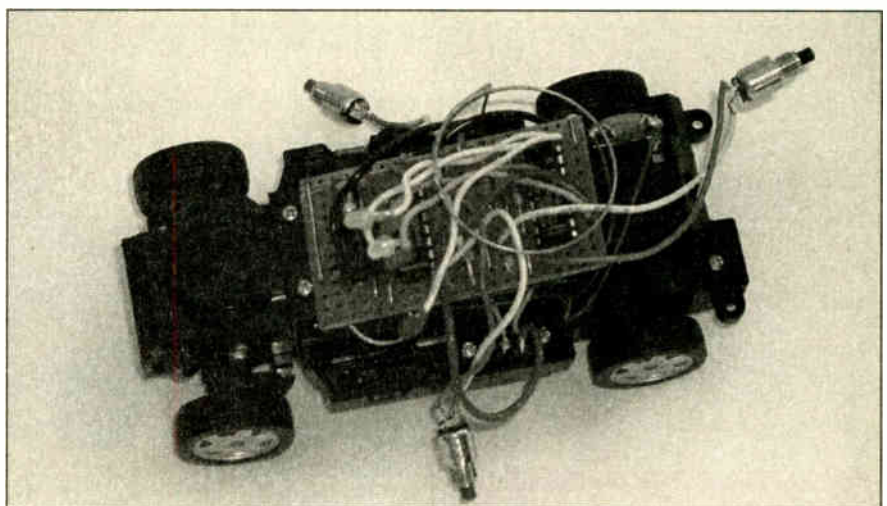

Fig.3. Re-routing the receiver (Rx) negative supply lead to the hit/counter board.



One of the prototype cars with its body-shell removed to reveal the receiver board and aerial.



The "collision/counter" board fixed above the receiver board using double-sided tape. The board should just squeeze below the aerial "loop".



models have an aerial that is enclosed within the body moulding. These may present a challenge when fitting the new board.

Tracing the leads from the board to the battery connections should be straightforward. Release the wires from the nooks and crannies the manufacturer tucks them into so that you can turn the receiver board over. De-solder the negative lead from the board end and re-solder it to the counter board – see Fig. 3.

The positive lead from the counter or “hit” board should now be connected to the switched contact of the model’s on/off switch. That is the one already connected to the Rx board, (see Fig. 4).

Solder the remaining lead from the counter board into the Rx board in the same position from which the original negative lead came – you made a note of it when you took it out didn’t you? Many of these mass produced boards are generic to a range of models and may have a number of unused component positions making it easy to forget which one you need to use.

### PARKING SPACE

With the body mouldings separated you will be able to see how much space you have in which to fit the new parts. If you are using the l.e.d.s then somewhere on the roof or bonnet of the car is suitable. A spot

of glue or l.e.d. clips will hold them in place, but a 3mm hole was found to give a reasonably snug fit – the prototypes did not need glue.

The Hit switches should be mounted on the side panels between the front and rear wheels – so that they are exposed enough to be “hit”. The Reset switch can be mounted anywhere convenient. For the original prototypes the switch solder tags had to be bent at right angles as there was too little space behind the body moulding. The models used for this article were a little more accommodating.

### THROTTLE TIME

Fixing the Hit counter board is best done with a strip of double-sided foam tape or self-adhesive pads on the copper side. This gives a good fix and insulates the board connections.

Test that everything works before re-assembly and then go and have some fun! □

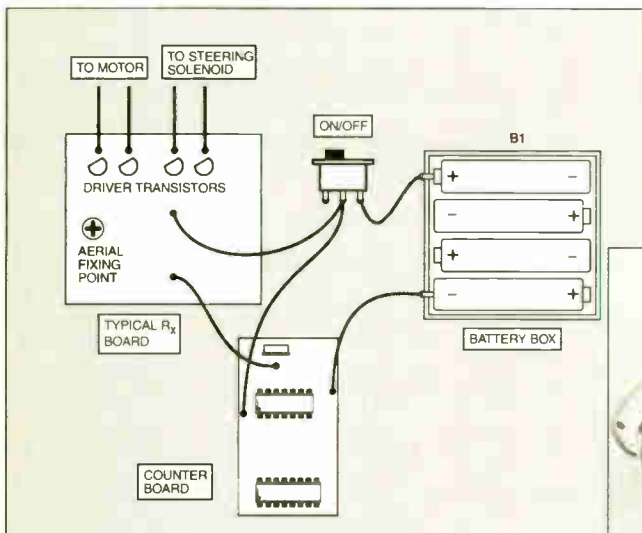

Fig.4 (left) Final interwiring between the counter board, receiver (Rx) board, battery box and receiver's on/off switch.



**FREE Catalogue Available On Request**

**WCN SUPPLIES**

WCN Supplies • Dept EPE • The Old Grain Store • Rear Of 62 Rumbridge Street • Totton • Southampton • SO40 9DS  
Telephone or Fax On Southampton 023 8066 0700 • Email: info@wcnsupplies.fsnet.co.uk

**Telephone, Fax Or Email For Your Free Catalogue**

## It's New . . . Or is It?

**How new is new? Some of the latest ideas in electronics are positively old hat, as Andy Emmerson reveals.**

**I**N the mobile phone arena there's a battle royal going on currently. Front-runner in the third generation stakes, 3, has discovered the best way of winning new recruits to its network is by dropping prices. The tactic is certainly proving successful, with most new customers motivated more by attractive tariff options than the system's live video transmission capabilities and other multimedia gizmos.

Across the Atlantic another new-breed operator has a different USP or unique sales proposition. The winning feature of its cellphones is an additional "walkie-talkie" mode that allows users to talk directly to another user on the network, just like using a walkie-talkie or business radio handset.

### **PUSH TO TALK**

It's called PTT mode (push-to-talk) and these phone-to-phone calls are included in the cost of users' monthly calling plan. Users love it and consider it a total novelty, even though from a boring technology viewpoint it's nothing more than a kind of abbreviated code dialling, in which the network memorises the person(s) to whom you want an instant hotline facility. Nevertheless, to users it seems like magic.

Each Nextel phone is assigned a unique 5-digit number which identifies it on the direct connect network. The phones are easily programmed with "talk groups" which are assigned groups of numbers – for example, within a single company or shared between a company and its primary suppliers, etc. – and you just select a name from the phone's display and press the push-to-talk button to connect.

If the other phone is turned on and within the coverage area, it issues a loud beep and one can immediately talk ("Hey, George, swing by the plant and pick up some items before you go to the customer's site."). If the target Nextel is not available, you can press an "alert" button and when the target phone is back on the network, it will immediately be alerted with a loud tone and display text that your phone is trying to reach it.

Of course, the Nextel also works as a typical digital cellphone and as an alphanumeric pager. It can be enabled for Internet email and the Web for an additional monthly fee.

### **SYSTEM ADVANTAGES**

One of the advantages of the direct connect system is that you know it's an internal call coming in and the subscriber placing the call does not have to wait for dial switching and for the usual cellular delay as the cell system tries to determine

if the called party is within range of a cell site. But, if the called party is not, the direct connect caller is not shunted into voicemail. Instead, the caller just leaves an alert that is sent when the called party is reachable once more. This beats leaving unnecessary voicemails that need attention when the called party is back in range.

If you're worried this will mean we shall all be saying "Over" and "Roger" like CB users, have no fear. It doesn't work like that... The Nextel beeps to let you know when it's ready for you to talk and makes an unhappy-sounding note when you step on the other party's transmission. So you know instantly when not to talk.

### **OVER AND OUT**

It's a clever novelty and certainly has its applications, even though in many situations a conventional full-duplex call (one in which you can both talk at the same time without waiting for "Over") is superior, both in quality and in ease. Direct-connect is a very poor system for conducting a normal conversation. It is a good system for quickly exchanging brief factual information and its format discourages the time-consuming social overhead of "small talk" and traditional telephone courtesies.

Adding this facility to an existing cellular network is not easy. In Britain, Orange demonstrated it to the press a while back but then dropped the idea, mainly because it required special handsets with an extra push-to-talk button. There were pricing problems too; if cut-price hotline calls became too popular, this would not be good for call revenue overall.

There is a network called Dolphin, which combines the benefits of cellular technology with instant press-to-talk connections that Dolphin calls Express Connect. Dolphin is targeted at business users, however, with tariffs that would not attract casual users.

### **ORIGINS IN CB**

None of this hotline radio stuff is new. In fact the same technique, right down to 5-digit numbers, talk groups and instant connections, was on offer in the late 1980s, when the late lamented UHF personal radio service provide the self-same facility.

PRS, if you recall, was an ingenious cross between citizens' band and cellular radio, providing private communication between two radio users using automatic selective calling. It didn't use an exchange or anything like that and you could link up only with people within

normal radio range, but conversations cost nothing once you had the equipment – and a £10 CB licence.

Operation was extremely simple. All you did was key in the five-digit call number of the person you want and then press the PTT switch briefly.

If the rig belonging to the person you want was switched on and was on standby, the set responded automatically and a spare channel found without any further action on your part. Your set then beeped and you could speak. If you wanted to make an "All Stations" or CQ call you punched in five zeros and anyone in radio range tuned to the calling channel would hear you.

Dead clever, highly effective and extremely popular – in Japan, where the system originated. In Switzerland it appealed to business and private users alike and was also launched briefly in Holland.

However, it attracted only a handful of users on the 934MHz band in Britain (which was later withdrawn) and although the concept was re-launched twice, once as short range radio (SRR) using analogue technology and then with the title private advanced radio system (PARS) using the same digital technology as GSM cellular radio.

Nothing serious came of either scheme, however. Sometimes a good idea fails simply because it's ahead of its time.

### **AND EARLIER STILL!**

Speaking of which, take a look at this quotation and have a guess when it was written...

*Maybe it will sound a far-fetched idea today, but the time is surely approaching when everyone will be able to carry about with him a small radio telephone. War-time development of apparatus to work on very short wavelengths has opened up many entrancing possibilities.*

*Hundred of thousands of "radio-telephone channels" can be used over short distances without interference; and the installation of a network of automatic telephone exchanges might well be utilized for handling the calls from a multitude of pedestrian or automobile telephone subscribers, to sort them out and pass them by line or by radio link to main exchanges. Certainly it is but a matter of time before the railway traveller is able to pick up the phone and dial his office or his home.*

It comes from a British book of 1946, *The Miracle of Wireless* by Miles Henslow. Cellular radio was introduced here in 1985 by the way.

# PROTEUS

**The Complete Electronics Design System**

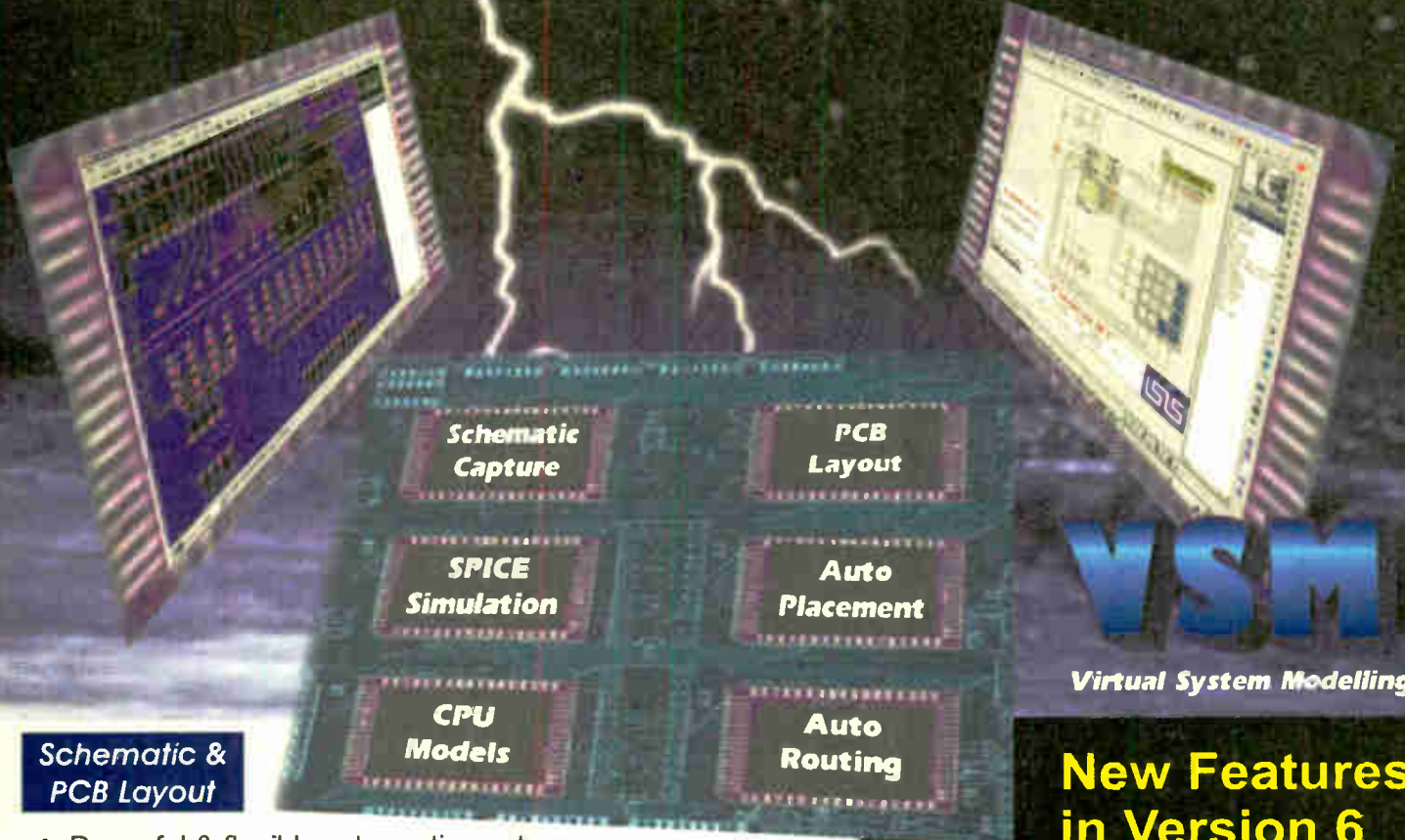

## Schematic & PCB Layout

- Powerful & flexible schematic capture.
- Auto-component placement and rip-up/retry PCB routing.
- Polygonal gridless ground planes.
- Libraries of over 8000 schematic and 1000 PCB parts.
- Bill of materials, DRC reports and much more.

## Mixed Mode SPICE Circuit Simulation

- Berkeley SPICE3F5 simulator with custom extensions for true mixed mode and interactive simulation.
- 6 virtual instruments and 14 graph based analysis types.
- 6000 models including TTL, CMOS and PLD digital parts.
- Fully compatible with manufacturers' SPICE models.

## Proteus VSM - Co-simulation and debugging for popular Micro-controllers

- Supports PIC, AVR, 8051, HC11 and ARM micro-controllers.
- Co-simulate target firmware with your hardware design.
- Includes interactive peripheral models for LED and LCD displays, switches, keypads, virtual terminal and much, much more.
- Provides source level debugging for popular compilers and assemblers from Crownhill, IAR, Keil, and others.

## New Features in Version 6

- Drag and drop toolbars.
- Visual PCB packaging tool.
- Improved route editing.
- Point and click DRC report.
- Multiple design rules (per net).
- Multiple undo/redo.

**Call Now for Upgrade Pricing**

Works with  
**PIC Basic Plus**  
from Crownhill  
Associates

labcenter

Electronics  
53-55 Main Street, Grassington. BD23 5AA

Tel: 01756 753440  
Fax: 01756 752857

Contact us for  
**Free Demo CD**

**www.labcenter.co.uk**  
**info@labcenter.co.uk**

# New Technology Update

*A new approach to an old technology promises improved current monitoring facilities, reports Ian Poole.*

**M**EASUREMENT of current can present problems under a number of circumstances. The traditional method to make a measurement is to place a meter in series with the circuit in which the current needs to be measured.

This is usually possible for many small current applications such as those found in electronics circuit design. However, it may not be feasible where the service cannot be interrupted or where it may not be feasible to break into the circuit.

In many cases these problems occur in instances where high currents are involved, possibly on power lines or other similar applications. Here it is not possible to break the circuit, yet it is still necessary to be able to measure the current flow.

To overcome this problem there are a number of solutions that can be adopted. One is to use a Hall effect device that measures the magnetic effect around the conductor and in this way the current can be determined. A variety of forms of coil may be used, although a less well known approach is to use a coil known as a Rogowski coil.

## Rogowski Coil

Rogowski coils are air-cored coils that have been used since 1912 as current sensors. The very early applications were limited because the output from the coils was very low.

Also, the measuring instruments of the day were not very sensitive and this meant that any measurements that were taken tended to be inaccurate. However, in more recent years, with the improvements in electronics technology, the low output has not been a problem and this has enabled their use to grow.

Many current sensors require that either an electric or magnetic circuit is made around the wire carrying the current to be measured. This introduces a number of mechanical and electrical problems as the circuits need to be made very efficiently. Also it introduces a number of mechanical problems and these can considerably increase the complexity and cost of any sensor.

The Rogowski coil, it is claimed, overcomes these problems. It consists of a coil as shown in Fig.1. Here it can be seen that there is a break in the circle, and this enables it to be placed over or around the conductor in which the current is to be measured. Whilst care has to be taken to ensure that there is sufficient compensation for the interruption in turns at the end of the coil, this can be achieved relatively easily. In operation

the coil acts basically as a current transformer.

In construction the coils are wound evenly spaced in a toroidal shape and the output is largely independent of the distortions in the shape of the toroid. This means that the coil can be made flexible so that it can quickly wrap around the conductor to be measured. A further advantage is that being air-spaced the coils do not suffer from the saturation effects experienced by coils with cores.

The coils are produced by a number of manufacturers and for a number of different applications. Current measuring capabilities range from full-scale ranges extending from around 30A up to 100kA.

The frequency range is also important. Being an inductive component this is naturally limited, but this is not of great importance to many users as the coils are generally used for power applications that are normally limited to around 50Hz or 60Hz. Nevertheless, bandwidths range between 1kHz right up to 1.5MHz.

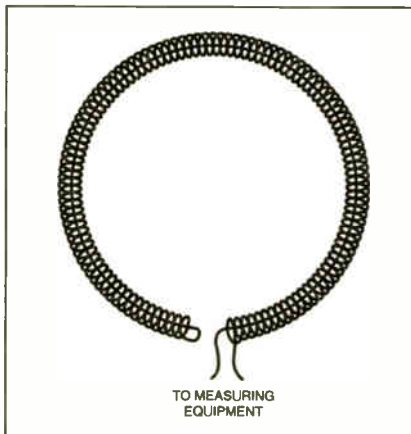

Fig.1. Traditional Rogowski coil.

One of the major problems with the Rogowski coil is its sensitivity. However, with the capabilities of modern electronics this can be overcome to a large degree. The coil itself can be designed to maximise the output by increasing the number of turns to increase the level of flux linkage. In some cases two or more layers of windings can be used.

## New Development

In a new development, a Swiss sensor maker named LEM has developed a novel coil design. One of the problems with the Rogowski coils is that they are susceptible to interference caused by external fields.

To overcome this problem, LEM have introduced a second slightly larger coil around the sensing coil. By careful design of the geometry it can be wound such that the two-coil arrangement will be virtually immune to external fields whilst still remaining able to accurately measure the current in the conductor under test.

A further development simplifies the construction. Wound components of any sort are notoriously expensive to manufacture because they are time consuming and often require techniques that do not lend themselves to modern day automatic manufacturing techniques.

## A Discrete Fix

As a result of this, LEM have used a series of discrete fixed coils on printed circuit boards. The arrangement is to have a main circular circuit board with a large slot cut in one side to accommodate the conductor under test. Then small boards with two coils side by side are mounted perpendicular to the main board. In this way the turns are effectively distributed in lumped elements around the circle.

The printed circuit boards for the small coils have eight layers and these are soldered to the main board making construction particularly easy. In addition to this the use of printed circuits makes the design far more repeatable as it is not dependent upon the tolerances of coil winding.

As a result, the new sensor is able to offer tolerances of better than 8%. This is a great improvement over coils made using traditional wound techniques. The bandwidth has also been tailored to suit the main requirements for these coils and extends from 10Hz to 1kHz and it can operate within the temperature range  $-20^{\circ}\text{C}$  to  $+60^{\circ}\text{C}$ .

The new sensors include a family of 12 devices covering the 10A to 400A range. They incorporate their own conversion electronics circuitry providing a 0V to 5V or 0V to 10V output and they require an external 24V power source

## Summary

This new development provides a very useful and fascinating insight into the possibilities of a technology that has been around for many years. Despite its age there are many applications, particularly in the area of high power current measurement.

Further information about radio and electronics technology can be found at [www.radio-electronics.com](http://www.radio-electronics.com).

## DETER THE ARTFUL DODGER!

The world of fine arts should act to prevent high tech piracy that is crippling the music and movie industries. Barry Fox reports.

**N**EW schemes unveiled recently by the National Gallery in London may earn extra revenue, but risk making life easier for art pirates who sell unauthorised copies of famous paintings.

The National Gallery, and project partner Hewlett Packard, said that they want to model the future of fine arts on the music industry. This comes as the music industry warns that poor security in the CD system means that one in three music CDs is now a pirate copy.

The National Gallery has been working with HP for eight years on a scheme to digitise all its 2300 paintings. The images have been captured with a digital camera that steps backwards and forwards over the painting to achieve a resolution of 100 megapixels, twenty times that of the best consumer camera. Each image, of around 0.5 gigabytes, is stored on the Gallery's main computer. A six-colour printer in the Gallery's shop prints out very high quality copies on demand from the public, in just five minutes.

Says Huw Robson, Manager of HP's Digital Media Systems Lab: "Quality is unsurpassed. Automatic calibration of the colour means that the difference between the print and the original is imperceptible. We plan to have accredited print shops in other cities and other countries".

Says Vyomesh Joshi, Executive VP HP Imaging and Printing Group, said: "The music industry has gone digital, end-to-end. Distribution can be on the Internet. We want to see the same process in the world of Fine Arts. This is the first baby step to becoming just like the music industry. A whole new revolution has happened".

Reassures Clare Gough of the National Gallery: "We own the paintings and the copyright in the digital scans."

### Superior Scans Help Forgers

The quality of home PC scanners, colour copiers and printers is now so good that the US and UK governments are changing the design of bank notes and identity cards to try and make them harder to copy. So is the National Gallery worried about people buying and scanning one of the Gallery's high quality prints, for posting on the Internet or selling prints in street markets and picture frame shops?

Says Gallery spokeswoman Jennifer Lea: "There is nothing we can do about it."

The video industry is already using watermarks to identify pirate copies. Huw

Robson confirms that the National Gallery system uses no watermark in the prints, either visible or invisible.

The International Federation of the Phonographic Industry, world trade body for the record companies, recently warned that lack of effective music copy control and the proliferation of PC burners lets music pirates sell a billion discs a year, worth \$4.6bn.

Said Jay Berman, Chairman and CEO of the IFPI: "If we had ever envisaged CD-R we would have pressed for greater protection in the CD system. We tried to talk to the computer industry about copy control. No way, they said. Nothing. We were desperate but there was no level of co-operation".

### Think Tactically

After the National Gallery launch Berman added: "The music industry was the first to learn just what a huge threat internet piracy poses, and just how critical it is to protect your product in digital format. The film industry is now learning the same thing, and it would not surprise me if this will eventually be a big issue for the fine art world too".

Michael Kuhn helped Polygram and Philips launch CD twenty years ago, and then went on to run the highly successful Polygram Filmed Entertainment company which made *Four Weddings and a Funeral*. "Looking back," he says, "top management at record companies should have spent 9am to noon every day thinking about piracy and the Internet and nothing else. Film studio brass should be doing that now. So too the Fine Art bosses."

## KEMPTON SHOW

THE autumn 2003 *Kempton Radio and Electronics Show* will be held at Kempton Park Racecourse on 26 October. The organisers tell us that they are aiming to have a large number of young people at the rally so, as usual, they will be issuing free tickets to anyone under 16. They are also offering free entry to anyone who takes the Morse proficiency certificate.

The site offers easy access and free parking and "there will be great catering, live music, lots of marketing and big crowds".

Browse [www.kemptonrally.co.uk](http://www.kemptonrally.co.uk) for more information.

## THUMP AND SNAP!

Barry Fox

CARCAMS are coming. Digital cameras and Webcams are now so cheap that cars will soon come with half a dozen factory-mounted to tell the owner who bumped and scratched the car while it was in the street or car park. Philips has filed a patent on the plan to catch culprits red-handed (WO 03/012746).

Pressure sensors are buried in the front and rear bumper fenders, and decorative trim down the sides. The sensors respond to any jolts by triggering one of four wide angle cameras hidden in the front windscreen, rear and side windows. The camera snaps a quick series of shots which are stored in memory as evidence. The cameras can use the new cellphone picture system to send an alarm call and image to the driver's mobile, for double quick return to the scene of the crime.

## Luxury Lighting

VOS PAD has been launched as a "blueprint for future living" and is the world's first apartment to be lit solely by I.e.d.s. It is the brainchild of Marcel Jean Vos and is the first in a series of interior environments that integrate the latest technologies.

The apartment is completely lit by RGB colour-changing I.e.d.s., supplied by British company ACDC Lighting, all of which are fully dimmable with complete chromatic control. The ambience is controlled by a Lutron custom-built computerised system that operates the lighting and other features. The level and colour of the I.e.d.s in different areas can be changed instantly. Vos Pad is also the first property in the world to feature a new high-end range of "screw-free" sockets and switches from leading UK manufacturer MK Electric.

To quote the information on the Vos Pad website, [www.thevospad.com](http://www.thevospad.com), "colours and moods may be changed by using intelligent lighting systems and design features, rather than by repainting or papering walls . . . working in this way saves resources, energy and money".

Vos Pad has many more novel technological features apart from I.e.d. lighting. For more information browse the above URL and [www.vossolutions.com](http://www.vossolutions.com).

## HULL STUDENTS' COMPETITION SUCCESS



Hull's Team Random: Phil Price, Andrew Sterland, David Waby and Will Johnson.

THE first-ever Microsoft Imagine Cup was held at *Microsoft TechEd 2003 Europe* in Barcelona, Spain, with the awards being made on 1 July. This year's theme was: "Imagine a world where technology connects people, information, systems, and devices." Teams selected from universities around the globe demonstrated their entries to a panel of judges from academia and the technology industry in this prestigious showcase event.

Of particular interest to *EPE* is that a team of four first year students from the Department of Computer Science, University of Hull, came joint-third out of fifteen teams in a competition that had over 20,000 entries from around the world. The teams' overseeing lecturer in this department is Rob Miles, who regular readers will recall was a co-author of our *Teach-In 2002* series.

The team, who call themselves Team Random, consists of Andrew Sterland, Will Johnson, Phil Price and David Waby. Having taught themselves to program in .NET, they initially won an internal competition within the Computer Science Department at Hull. They then took their project to Microsoft in Reading and came away as winners of the UK heat. Their prize included an all expenses paid trip to Barcelona and a chance to pitch for the worldwide prize.

Rob Miles says "It is a wonderful experience for such a young team. They built their product from scratch in less than three months and then presented it in a thoroughly professional way." The judges were impressed with the flair of the presentation and the way that the students had thought through all the aspects of their product.

Their product is Mercury – The Traveller's Assistant, which is designed to make travel as convenient as possible. Mercury provides capabilities such as currency and language conversion, restaurant recommendations and directions, news and reviews, and tailored partnering opportunities for third parties. It won the team a cheque for \$10,000 dollars.

First place in the competition went to a one-man team, Tu Nguyen, from Nebraska. He wowed the judges with a virtual presentation of his Point of Delivery System (iPODS), a multi-language wireless application that allows a waiter using a PDA to take orders in one language and transmit them immediately to a server for translation into the chef's native language.

Second place went to Team India. Bombay University students Tejas Shah, Abhijit Akhawe and Yash Doshi designed Sanjeevani to unleash the true potential of computers in the medical field. The solution integrates different mobile devices and helps to increase collaboration between health organizations, thereby empowering these organizations to provide mission-critical care and treatment.

Team Singapore tied with Hull's Team Random for third place. Kapil Vaidyanathan, Anumeha Bisaria, Harishankar Vijayarajan, and Kunal Talwar competed with Smart Cart, the world's first .NET-savvy shopping cart. Smart Cart allows shoppers to navigate through aisles to find a particular product, provides access to a customer's virtual shopping list, and displays product information and promotions.

You can find out more about the competition itself from [www.imaginecup.com/default.htm](http://www.imaginecup.com/default.htm), and take a peek at the Hull contender at [www.mercury-mobile.co.uk](http://www.mercury-mobile.co.uk).

Our congratulations to all this year's Imagine Cup winners!

# YOU WON'T GET YOUR FINGERS BURNT

It may surprise you but buying an Antex soldering iron costs less than you think in the long run. British made to exacting standards, they last significantly longer than imported brands. And with a wide range of thermally balanced soldering irons, you can pick up a "fixed temperature" or "in-handle" temperature model that will suit your needs perfectly.

None of which will burn a hole in your pocket.

If your hobby demands the best iron for the job but you don't want to get your fingers burnt by the cost, visit our website or your electronics retailer for the coolest models around.

Pick up an

**ANTEX**  
Not just any old iron.



[www.antex.co.uk](http://www.antex.co.uk)

2 Westbridge Industrial Estate Tavistock  
Devon PL19 8DE Tel 01822 613565

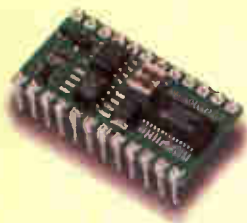

BS2-IC



BS2-SX



BS2E-IC

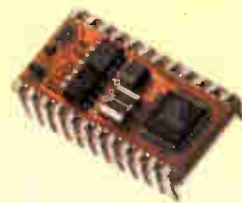

BS2P/24

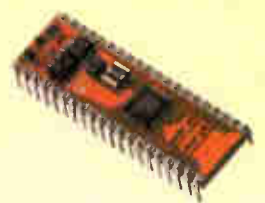

BS2P/40

**Parallax BASIC Stamps - still the easy way to get your project up and running!**

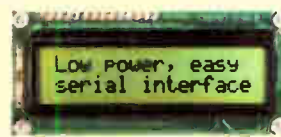

**Serial Alphanumeric and Graphic Displays,  
Mini-Terminals and Bezel kits**

# www.milinst.com



Animated Head



3-Axis Machine



Six-Legged Walkers



Robotic Arms



Bipeds

**Robotic models for both the beginner and the advanced hobbyist**



Servo Drivers

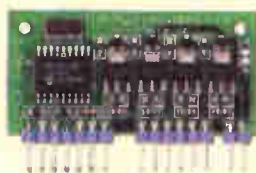

Motor Drivers



On-Screen Displays



DMX Protocol



U/Sound Ranging

**Animatronics and Specialist Interface-Control Modules**

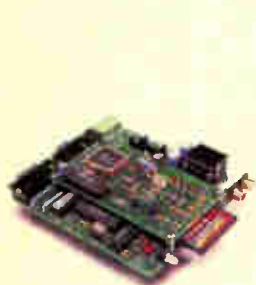

Quadravox  
MP3 & Speech Systems



SensoryInc  
Voice Recognition



Parallax  
Ubicom Tool Kits



Tech-Tools  
PIC & Rom Emulators



BASICMicro  
PIC BASIC Compilers

**Development Tools**

Milford Instruments Limited Tel 01977 683665, Fax 01977 681465, sales@milinst.com

# SERIAL INTERFACE FOR PICS AND VB6

**JOE FARR**

*Serial hardware plus stand-alone licence-free OCX software for VB6 on Windows 95, 98, ME, NT4, 2000 and XP.*

**M**ANY PIC project developers would like to be able to interface their designs with a PC's serial port, but encounter several difficulties.

The principal one for those readers using Visual Basic on their PC is that not all versions of VB allow access to the MSCOMM Active-X serial communications control function. Whilst there are "work-arounds" to this problem, they have varying degrees of success.

The other problem is that serial port voltages can vary considerably from PC to PC, and these voltages need to be converted to standard TTL voltage levels to enable connection to a PIC.

The project described here provides a two-fold solution to this problem.

Firstly, a small circuit board is described that allows safe interfacing between a PC and a PIC, or other digital design.

Secondly, and importantly, a freeware Active-X (OCX control) software component suitable for use with all versions of Visual Basic 6 is provided and its use described. This software allows the developer complete access to the serial port and its pins and is compatible with all current versions of Microsoft Windows, namely 95, 98, ME, NT4, 2000 and XP. It can be used with other designs without the interface board described here.

## HOW SERIAL COMMS WORK

For those readers who require detailed information on how serial communications work, there are many excellent books and texts available, and an Internet search turns up literally hundreds of pages of information. However, it is worth covering some of the basics here just to get you started.

Serial ports commonly come in two flavours, using 9-pin and 25-pin D-type connectors. Most PCs now ship with at least one 9-pin connector. Fig.1 and Tables 1 and 2 show the pin arrangement and functions. Note that the RI signal is not always available on all PCs, so using this signal should be avoided if possible.

To help make serial communications as reliable as possible, serial data is

transmitted as a series of negative and positive voltages representing binary ones and zeros respectively. Using a *positive* voltage to represent logic 0 and a *negative* voltage to represent logic 1 (the opposite to what one might expect)

instead of just +V and 0V helps remove the possibility of decoding errors introduced by resistance and pickup noise in long cable runs.

The signal voltages on a serial port vary from manufacturer to manufacturer, but voltages from -2.5V to +12V or higher could be present. These negative/positive voltages need to be translated into TTL voltage levels (0V to +5V) that are suitable for use by a PIC and in this interface it is done with the aid of a MAX232 serial interface i.c.

From a single 5V supply, the MAX232 is capable of converting incoming signals to TTL voltage levels and outgoing TTL signals to serial line voltages.

When used with PCs and PICs, RS232 communication is asynchronous. That means that an external clock signal is not provided or required. Instead, the devices at each end of the cable are responsible for generating their own internal clock signals

to control timing. Each frame transmitted is synchronised using a start bit, see Fig.2.

When there is no activity, the line is in the Mark state (logic 1). The start of a transmission is indicated by a Start bit being sent (logic 0). Each bit of the frame is then sent down the line sequentially, starting with the LSB (least significant bit) of the data word and then being followed by one or two Stop bits.

The waveform in Fig.2 shows that instead of the line returning to logic 1 after the Stop bit has been sent, it remains at logic 0. This indicates that another frame of data is

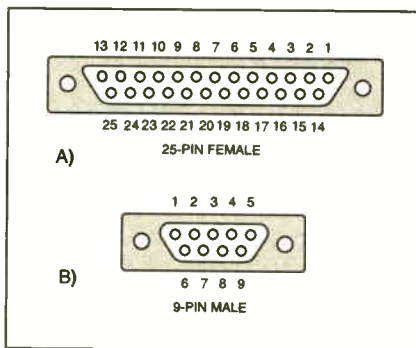

Fig.1. Pin numbering of 25-pin female and 9-pin male connectors.

Table 1. Pin usage for a 9-pin male connector on a PC

| Pin | Use | Direction | Description   |
|-----|-----|-----------|---|
| 1   | DCD | IN        | Data Carrier Detect (also called CD - Carrier Detect) |
| 2   | RX  | IN        | Receive data  |
| 3   | TX  | OUT       | Transmit data   |
| 4   | DTR | OUT       | Data Terminal Ready                                   |
| 5   | GND |           | Ground connection                                     |
| 6   | DSR | IN        | Data Set Ready  |
| 7   | RTS | OUT       | Request To Send                                       |
| 8   | CTS | IN        | Clear To Send   |
| 9   | RI  | IN        | Ring Indicator  |

Table 2. Pin usage for a 25-pin male connector on a PC (only common pins)

| Pin | Use  | Direction | Description   |
|-----|------|-----------|---|
| 1   | PGND |           | Protective signal ground                              |
| 2   | TX   | OUT       | Transmit data   |
| 3   | RX   | IN        | Receive data  |
| 4   | RTS  | OUT       | Ready To Send   |
| 5   | CTS  | IN        | Clear To Send   |
| 6   | DSR  | IN        | Data Set Ready  |
| 7   | SG   |           | Ground connection                                     |
| 8   | DCD  | IN        | Data Carrier Detect (also called CD - Carrier Detect) |
| 20  | DTR  | OUT       | Data Terminal Ready                                   |
| 22  | RI   | IN        | Ring Indicator  |



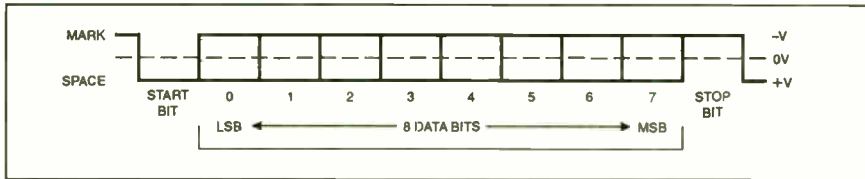

Fig.2. Expected waveform for an 8N1 frame of data (8 data bits, No parity, 1 stop bit).

expected and this is the next frame's Start bit. If the line status returns to logic 1 after a frame has been sent, this indicates that no more data is expected.

It is important that both ends operate at the same data rate, word length parity and use the same number of stop bits, otherwise data errors will arise.

### SERIAL MONITORING

Because serial data is transmitted as a series of positive and negative pulses instead of the positive and 0V (ground) pulses that are more common in digital electronic circuits, there is a simple way of monitoring activity on a serial port.

By connecting a bicolour l.e.d. (actually two separate l.e.d.s wired in parallel but one being the opposite polarity to the other) and a suitable current limiting resistor, say 470Ω, between a serial port pin and the GND pin, it is possible to see the current logic state of the pin being monitored.

This technique often forms the basis of an "RS232 Break-out box". This device is extremely useful when attempting to connect different serial devices together and the exact serial connection pin assignment is unknown, or there is a need to monitor the signal levels on each pin – useful when debugging software that uses the serial port for example. (Such a box is planned for a future issue. Ed.)

This type of unit is classed as unpowered, which means that the current required to light the bicolour l.e.d.s is actually taken from the serial port being monitored and

not supplied from an external source, such as a battery.

Because of this, the unit may actually interfere with the serial ports being monitored in some cases, especially with lap-top type PCs that do not have large amounts of voltage or current available on their serial ports. When using any type of serial monitor, cable lengths should be kept as short as possible

### SERIAL INTERFACE CIRCUIT

The complete circuit diagram for the Serial Interface is shown in Fig.3.

When power is supplied to the board, it first passes through bridge rectifier REC1. If the input is a.c., the rectifier converts it to d.c. If the input is already d.c. the rectifier ensures that the polarity is correct for regulator IC1, which regulates the voltage down to +5V. A power-on indication is provided by l.e.d. D1, buffered by resistor R1. Capacitors C1 to C6 provide smoothing.

The RS232 to TTL level conversion is performed by IC2, a MAX232 device, whose functional drawing is shown in Fig.4. Capacitors C7 to C10 are used by IC2's internal circuitry to raise the supplied voltage from 5V to the required ±10V needed for serial data transmission.

Note that on the p.c.b., capacitor C5 is positioned as close as possible to the MAX232 to provide additional smoothing to it during peak power demands, in accordance with the manufacturer's (Maxim) datasheet.

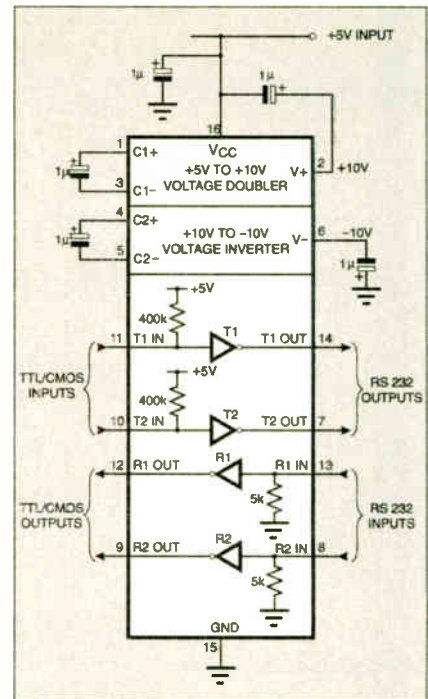

Fig.4. Functional diagram for the MAX232 device.

The TTL logic level signals to and from the MAX232 are fed via four quad 2-input XOR gates, IC3a to IC3d, that allow each of the four signals to be inverted by setting the appropriate setting of the quad dual-in-line (d.i.l.) switch S1. This feature will be of use with PICs which do not have serial interface support built in (e.g. PIC16F84).

Connector TB4 provides for input/output connections to be made to the gates, forming the "TTL Interface Port".

Connection to the PC is via a 9-pin female D-type connector, SK1.

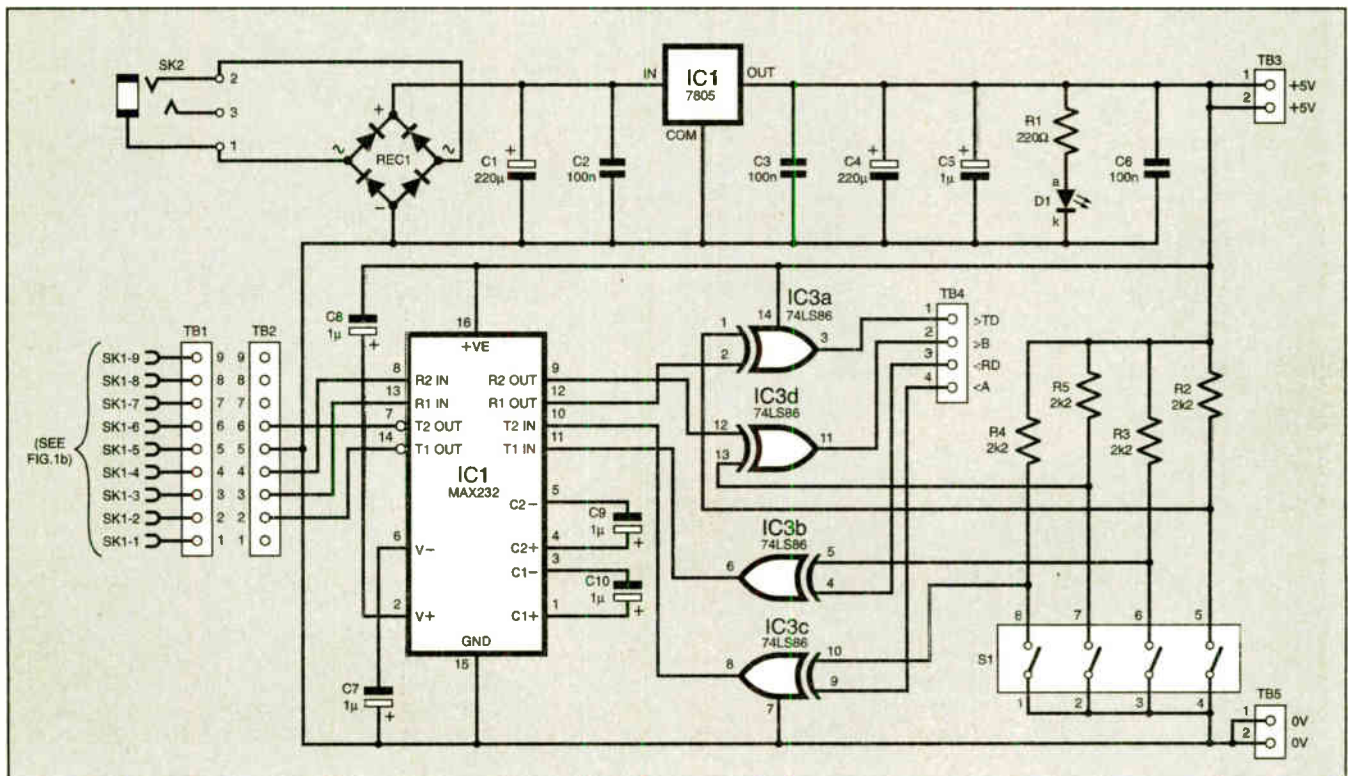

Fig.3. Complete circuit diagram for the Serial Interface for PICs and VB6.

# COMPONENTS

## Resistors

R1 220Ω  
R2 to R5 2k2 (4 off)

## Capacitors

C1, C4 220μ radial elect. 25V (2 off)  
C2, C3, C6, 100n ceramic disc (3 off)  
C5, C7 to, C10 1μ radial elect. 63V (5 off)

## Semiconductors

D1 green l.e.d., 5mm  
REC1 W01 50V 1A bridge rectifier  
IC1 7805 +5V 1A voltage regulator  
IC2 MAX232 RS232 interface  
IC3 74LS86 quad XOR gate

## Miscellaneous

S1 4-way DIP switch  
SK1 9-pin female right-angled Cannon D-type connector, p.c.b. mounting  
SK2 2.5mm d.c. power socket, p.c.b. mounting

Printed circuit board, available from the *EPE PCB Service*, code 416; heatsink, TO220 drilled (see text); turned-pin sockets as required; connecting wire; solder, etc.

Approx. Cost  
Guidance Only

**£17**

See  
**SHOP**  
**TALK**  
page

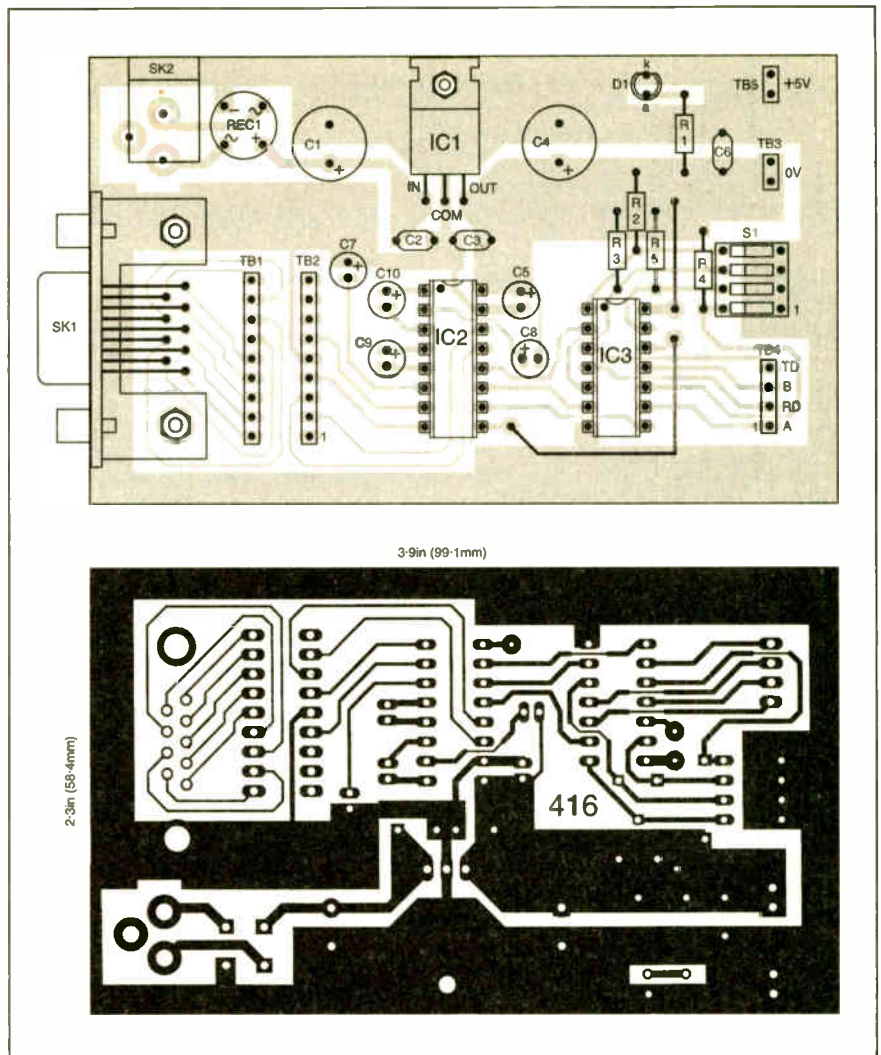

Fig.5. Component positioning and full size copper foil master track pattern for the Serial Interface for PICs and VB6.

## POWER SUPPLY

It is expected that when in service, the interface will be powered from a sealed plug-in mains power supply unit. Either an a.c. or d.c. supply can be used and the connections to the p.c.b. are not polarity sensitive. A unit capable of supplying at least 50mA at between 7V to 12V should be ideal.

The prototype draws approximately 40mA when in use, but the exact current drawn will depend on whether the regulated 5V supply is used to drive external circuitry. In the later case, or if the input voltage exceeds 12V, then it will be necessary to fit a TO220 heatsink to regulator IC1.

## CONSTRUCTION

The Interface is constructed on a single-sided p.c.b. whose component positioning and track layout details are shown in Fig.5. This board is available from the *EPE PCB Service*, code 416.

Assemble the board in order of ascending component size, and being careful to observe the correct polarity of the semiconductors and electrolytic capacitors. It is recommended that good quality d.i.l. sockets are used for IC2 and IC3, but do not fit IC2 or IC3 until the correct operation of the power supply has been verified.

The "patch connections" area on the board, notated TB1 and TB2, should be

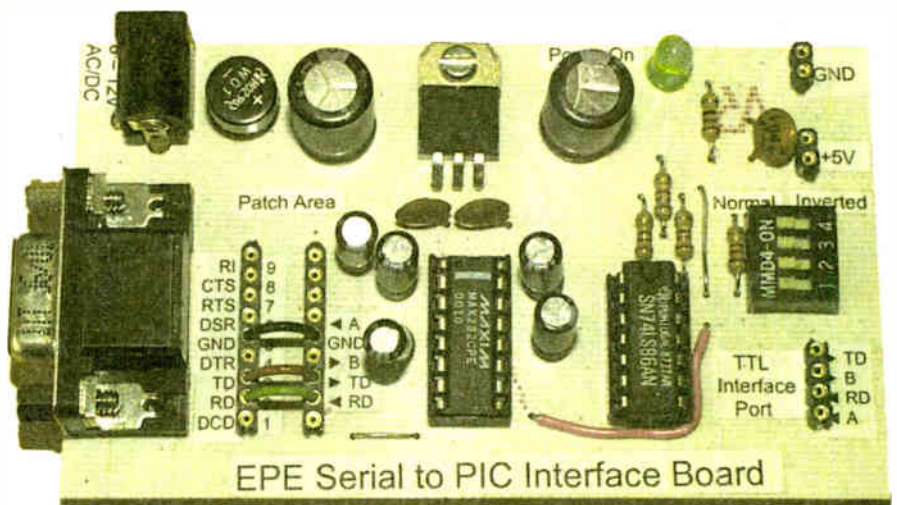

assembled using two strips of turned-pin sockets to allow single core wire or resistors to be used as jumpers (more on this later). The p.c.b. layout will accommodate a standard 18 pin d.i.l. turned-pin socket that can perform the same job if required. Turned-pin sockets should also be used for the external connection points marked TB3 to TB5.

Rigidity can be provided for regulator IC1 by bolting it to the p.c.b. The D-type connector should also be bolted to the board.

## FIRST TESTS

Once construction is completed, re-check that all components have been oriented correctly and look for any solder splashes or bridges that might have occurred during assembly. Using a multimeter set to ohms, check the resistance across capacitor C4 to ensure that there is no short circuit. A brief reading may be obtained whilst C1 to C5 charge.

If all is OK continue, otherwise do not attempt to apply power until the short has

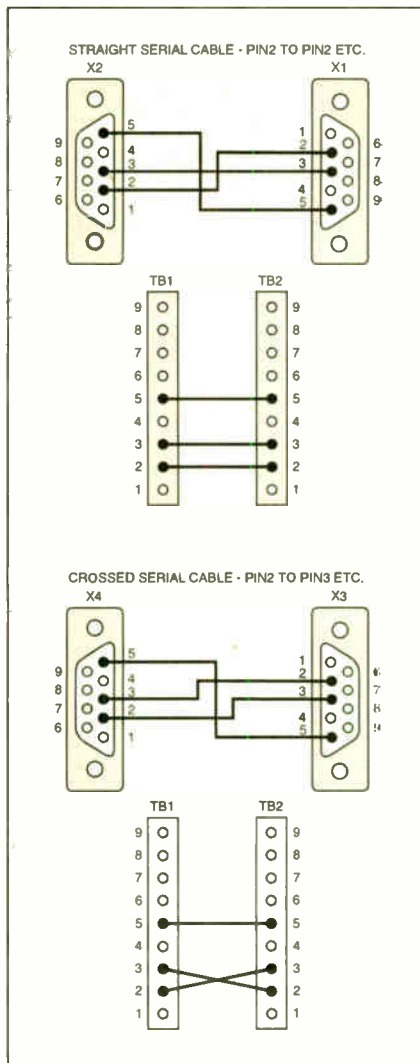

Fig.6. 9-pin serial cables and associated interface board patch area settings.

been removed as IC1, the bridge rectifier or the power supply unit may be damaged.

Making sure that the board is not resting on anything conductive, connect a suitable power supply unit. Switch on the power and i.e.d. D1 should illuminate. Switching the multimeter to d.c. volts, measure the voltage on pins 14 (+VE) and 7 (GND) of the socket for IC3. A reading of approximately 5V, within a few percent, should be present.

Switch off the power supply unit and disconnect it from the mains supply. If the 5V rail is not present or i.e.d. D1 did not illuminate, carefully check around IC1 for short circuits or dry joints and the polarity of the i.e.d.

Once everything seems to be in order, insert IC2 and IC3, ensuring their correct orientation and that none of their pins bend under the body whilst being inserted.

Next, jumper links must be inserted into the "Patch" area next to the serial port connector (TB1 and TB2). The links required depend on the type of cable being used to connect the board to your PC (see Fig.6). If you are plugging the board directly into the PC or using a straight through cable (pin 1 to pin 1, pin 2 to pin 2 etc.) then Patch pins 2, 3 and 5 should be linked ("patched") to their respective counterparts. If using a crossed serial cable, then pin 2 should be patched to pin 3, pin 3 to pin 2 and pin 5 to pin 5.

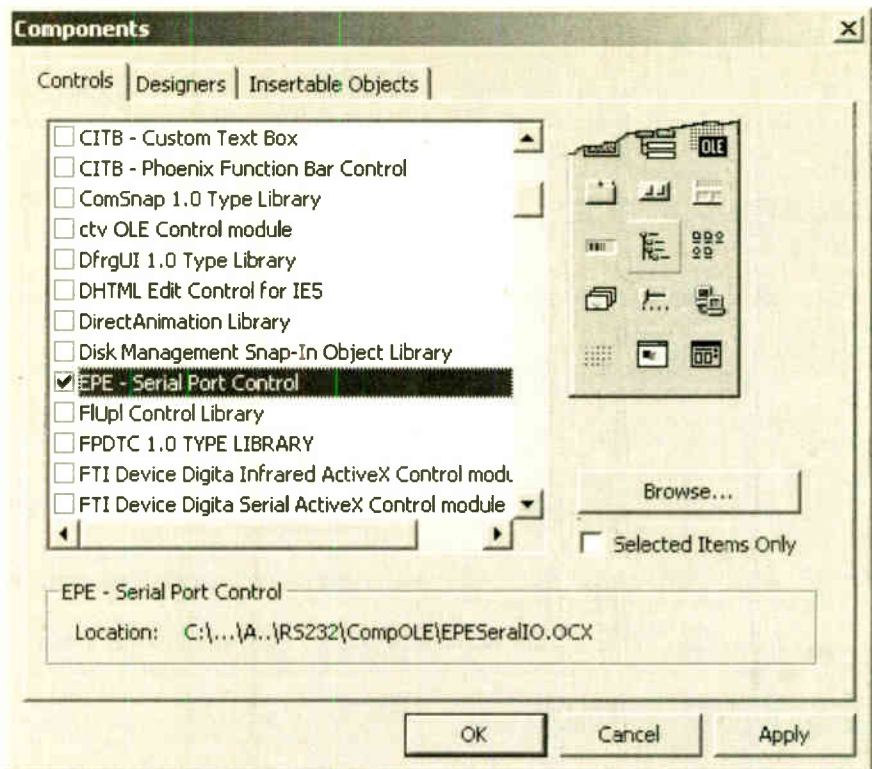

Fig.7. Visual Basic 6 Components window showing the EPE Serial Control selected.

## SWITCH SETTINGS

The four slide switches that form S1 allow for the signals presented at the "TTL Interface Port" pins (via TB4) to be logically inverted. This feature will be of use to those developers who use PICs that do not support serial communications natively, or for use in none-PIC applications.

The MAX232 contains four buffers, two transmit and two receive. One pair is accessed by the TD (transmit) and RD (receive) connections at TB4, the other pair is accessed via TB4's A and B connections. For most applications it is expected that the TD and RD signals will nearly always be used, leaving one transmit (A) and one receive buffer (B) available for use as required.

So, if for example you also required use of the DTR signal from the PC, and since this is an output signal from the PC, it could be patched to "B". Likewise, if it is required to send an additional signal to the PC from the PIC, "A" could be patched to DSR or any other input pin on the serial port.

You should never connect any PIC/TTL, etc., circuits to any of the pins in the Patch area (TB1 and TB2) or directly to a serial port unless you are sure your circuit can handle the +VE/-VE voltages that might be present. For normal operation, only connect to the TB4 pins.

## PATCH JUMPERS

As already explained, the TB1/TB2 Patch area allows control signals to be routed to and from the four buffers contained in the MAX232 chip. Under normal conditions, the MAX232 is a very hardy chip and should be able to cope with short circuits and incorrectly wired cables etc.

With the board in service, however, it was noted that with the PSU disconnected from it, i.e.d. D1 sometimes remained lit.

This was traced to an incorrect cable being used that was feeding TX power from the PC, to the TX pin on the board and thus to an output on the MAX232.

Whilst the MAX232 seemed more than able to cope with this error, it might be advisable to replace the Patch jumpers with 47Ω resistors, for example, to provide some additional protection when using unproven cables and configurations. The GND jumper should *always* be used and *not* replaced by a resistor.

## SOFTWARE INSTALLATION

Software for this project is available for free download from the EPE ftp site, accessible via the home page [www.epemag.wimborne.co.uk](http://www.epemag.wimborne.co.uk), in folder Serial OCX. It is also available on CD ROM from the Editorial office, for which a nominal handling charge applies. See the EPE PCB Service page for details.

The PC software has been written in Visual Basic 6 (VB6) and should run on any Microsoft 32-bit operating system including Windows 95, 98, ME, NT4, 2000 and XP, providing it has VB6 installed.

The installation set consists of three files, Setup.exe which is the installation program, Setup.lst which provides setup control parameters to Setup.exe, and the EPESerialIO.cab which contains the EPE Serial Active-X control, VB6 runtime files and a Help file.

Also, a folder containing Sample applications is supplied. All the sample programs were written for VB6 and Microchip's MPASM PIC assembler.

Unzip the downloaded or CD ROM file into a hard-drive directory called, for example, C:\EPESerial, and then run the Setup.exe either by entering C:\EPESerial\Setup.exe in the Windows Run dialogue window or by double clicking the Setup.exe in the file explorer.

Once the setup has begun, most users should be able to accept the default settings. During the installation process, you may be asked to restart your computer if you have not previously installed the VB6 runtime components or they are out of date. Reboot the computer and restart the setup process as required.

## CREATING A TEST PROGRAM

Whilst a VB tutorial is beyond the scope of this article, it is possible to create a very simple test program to prove correct operation of the hardware and software.

First start a new Standard EXE project in VB6.

Select **Project and Components** from the VB main menu and scroll down the list until **EPE Serial Port Control** is found. See Fig.7. Select it by placing a tick in the box on the left, then click OK. This adds the **EPE – Serial Port Control** to the standard VB toolbox window.

Place the control icon (EPE symbol) on a form and add a **Command** button and a **List Box**, see Fig.8.

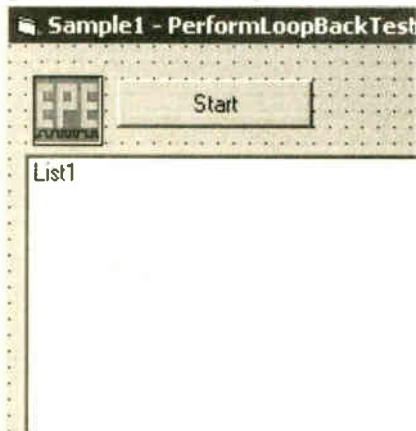

Fig.8. Section of VB Form showing the EPE Serial Control icon in the top left corner, plus a command button and a list box control.

Next, add the code in Listing 1 (be sure to include the decimal point that precedes the commands between **With EPESerial1** and **End With**. (The VB and PIC source codes for these demos are located within the Samples directories to save you typing it in.)

The comments in Listing 1 should make the code self-explanatory, however, a brief explanation of the **PerformLoopBackTest** function is in order:

This function sends a predefined sequence of characters out of the serial port selected on the TD pin, and checks that the same sequence is received back on the RD pin. This can be useful for checking cables and the interface board.

## TESTING THE INTERFACE

To test the Interface, first make sure that the four slide switches of S1 are in the ON position (non-inverting).

Next, connect the Interface board to your PC using a suitable cable. Set the jumper links in the TB1/TB2 Patch area according to the cable being used (see Fig.6). On the "TTL Interface Port" pins section (TB4), place a jumper wire

## LISTING 1 – program Sample 1

```
Private Sub Command1_Click()
List1.Clear
With EPESerial1
.ComPort = 1           ' Change this to your required COM port number (1 or 2)
.Speed = sio19200     ' Sets speed to 19200 baud
.WordLength = sio8Bits ' 8 bits per word
.StopBits = sio1Bit   ' 1 stop bit
.Parity = sioNoParity ' No Parity
.PortStatus = sioPortopen ' open the serial port
.PerformLoopBackTest 10 ' perform loopback test 10 times
.PortStatus = sioPortClosed ' Close the serial port when done
End With
End Sub

Private Sub EPESerial1_LoopBack(TestNumber As Integer, TestPass As Boolean,
BufferContents As String)

' This event fires each time a loop-back test has been performed.
' TestNumber counts from 1 to n
' TestPass indicates if the loop-back test completed correctly
' BufferContents contains any characters that were received from the serial port

List1.AddItem Format$(TestNumber) & ", " & Format$(TestPass, "Yes/No") & ", " &
BufferContents

End Sub
```

between RD and TD. Connect a suitable power supply unit to the board and switch on.

Run the program in Listing 1 and the screen shown in Fig.9 should be seen.

You will see that half way through the test, at line 7, it started to fail. This was because the jumper wire that had been placed between the RD and TD pins in the TTL Interface Port had been removed to prove that the signals were in fact travelling from the PC's serial port, through the cable and into the Interface, then through the jumper wire and back along the same path.

## EXAMPLE CIRCUIT

The schematic diagram in Fig.10 shows a test circuit using a PIC16F877-20 and its connections to the Interface board. The *Toolkit TK3* p.c.b. (Oct '01) makes an ideal host for this simple circuit, and its software (Nov '01) can be used to program the PIC.

The **Sample2** directory contains the necessary VB source code and PIC Source Code/Assembled code for a PIC16F877-20. (Note that *TK3* software since V1.5 now includes a Baud rate calculation facility to simplify setting PICs for serial communications in respect of different oscillator rates. Ed.)

With *TK3* connected to the Interface board and the PIC programmed with its **Sample2** code, run the VB **Sample2** application. Click the Start button and type some text into the TextBox (see Fig.11).

The upper window shows the EPESerial control's built-in data monitor. It will show exactly what data was sent to and from the PC's serial port. The red line at the top shows characters sent by the serial port. The three digits underneath are the decimal

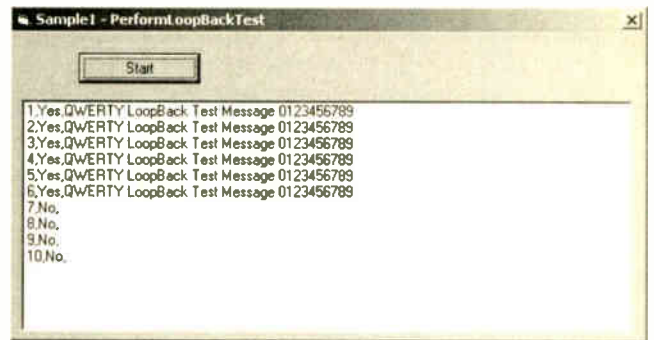

Fig.9. Test results from Loopback test program.

value of the ASCII character sent. The green line shows characters received and below that the decimal value of each character received.

The Control frame shows the status of the serial port's control signals. As can be seen, for each character entered the PIC responded with the binary representation of each character it received, followed by OK. The black vertical bars are characters that the VB ListBox cannot display. In this case, looking at the data-monitor window tells us that these characters are CR (Carriage Return – ASCII 13) and LF (Line Feed – ASCII 10) characters.

Note that some PCs, and the author's Sony lap-top included, send odd character sequences when the serial port is first opened. This can be seen in the first response sent from the PIC. Notice it has four black bar characters at the start of the line instead of two. This has been checked on various PCs and has occurred on several of them.

For this reason, it is best to get the PIC to send a message, "Ready" followed by CR+LF when it first starts up and then get the Visual Basic program to wait for this message – ignoring all leading characters that are not recognised.

## DOCUMENTATION

The documentation for the EPESerial control is too large to reproduce here, so

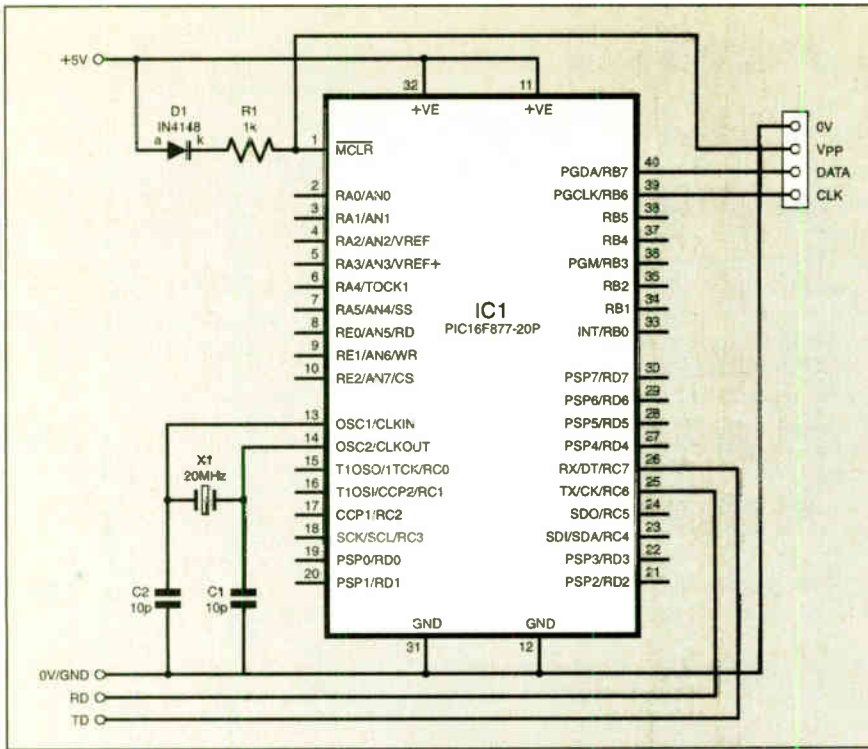

Fig 10. Example PIC16F877-20P test circuit.

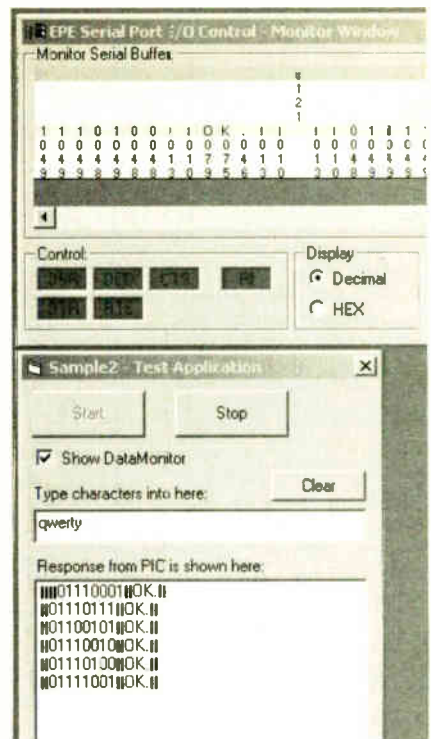

Fig.12. Section of the serial control data monitor window and the main form from the Sample 2 program.

it has been provided in a compiled HTML Help file (EPESerialIO.chm) which can be found in the installation folder and contains a wealth of information.

The Samples folder referred to earlier includes other small VB/PIC programs to demonstrate some of the features of the software.

## CONCLUSION

Serial port programming under Visual Basic can be a little tricky, however, with some care, the EPESerial control and the

sample programs to get you going, there is light at the end of the tunnel.

Happy interfacing.

## EDITORIAL NOTE

Joe's EPESerial control was used in the VB source code for the *EPE Earth Resistivity Logger* (Apr/May '03) and *EPE PIC Met Office* (Aug/Sept '03). Readers who wish to modify the VB source code for these designs can now do so once they have installed Joe's facility. There are other VB projects in the pipeline that also use Joe's highly-useful OCX.

## USEFUL WEB SITES

Maxim's web site is available at [www.maxim-ic.com](http://www.maxim-ic.com) for information on the MAX232 i.c.

Two good resource sites for RS232 information are:

[www.lammertbies.nl/comm/info/RS-232.html](http://www.lammertbies.nl/comm/info/RS-232.html), and [www.beyondlogic.org/serial/serial.htm#2](http://www.beyondlogic.org/serial/serial.htm#2)

Datasheets and related software downloads for PICs can be found at [www.microchip.com](http://www.microchip.com). □

# SHOP TALK

with David Barrington

## RC Car Wars

The circuit for the *RC Car Wars* project is aimed at the cheap "high street" stores type radio control cars and is not geared for the more sophisticated models.

All of the semiconductor devices, including the TIP121 power Darlington, should be readily available from most of our components advertisers. They should also stock low-profile i.c. sockets. You can, if you wish, like the author, solder the i.c.s directly on the circuit board and solder the diagonal link wires to their relevant pins on the board trackside.

With the space inside the car at a premium, the "collision" push-switches must be the sub-miniature, push-to-make, release-to-break, type. We see that **Rapide Electronics** (☎ 01206 851166 or [www.rapidelectronics.co.uk](http://www.rapidelectronics.co.uk)) list a micro-miniature pushswitch which they claim is just 12mm long, 7mm diameter (but only a red actuator), code 78-0090.

## Practical Radio Circuits-5

All the coils and r.f. choke called for in the *Super-Regenerative Receiver*, this month's main project in the *Practical Radio Circuits* series, are hand-wound. As previously, the enamelled copper wire came from **JAB Electronic Components** (☎ 0121 682 7045 or [www.jabdog.com](http://www.jabdog.com)). They only supply by mail order.

The author claims almost any polyvaricon (polythene dielectric) variable capacitor designed for a.m./f.m. portable radios will work in these circuits. They consist of an antenna and oscillator section, plus trimmers. They are currently stocked by **ESR Components** (☎ 0191 251 4363 or [www.esr.co.uk](http://www.esr.co.uk)), code 896-110 and **Sherwood Electronics** (see page 728), code CT9. The a.m./f.m. varicon

capacitor used in the prototype models was obtained from **Maplin** (☎ 0870 264 6000 or [www.maplin.co.uk](http://www.maplin.co.uk)), code AB11M. Only one f.m. gang (5pF to 25pF) is used here.

All the printed circuit boards are available from the *EPE PCB Service*: code 419 (Super-Regen.); 406 (T/Cap - optional); 420 (Buffer Amp.) and 415 (Crystal). Ample alternative transistors are given in the article, so no sourcing problems should arise but check pinouts before inserting on the p.c.b.

## Serial Interface for PICs and VB6

The only component that could possibly give local sourcing problems for the *Serial Interface for PICs and VB6* project is the Maxim MAX232 RS232 interface driver chip. The one in the model came from **RS Components**, code 655-290. You can order direct (credit card only) from **RS** on ☎ 01536 444079 or [rswww.com](http://rswww.com). A handling charge will be made.

Software for this project is available for free download from the *EPE* ftp site, easily accessed via the click-link on the home page when you enter the main web site at [www.epemag.wimborne.co.uk](http://www.epemag.wimborne.co.uk), in folder **Serial OCX**. It is also available on a CD-Rom from the Editorial Office, for which a nominal admin. charge is made, see *EPE PCB Service*, page 723.

The Serial Interface printed circuit board can be obtained from the *EPE PCB Service*, code 416 (see page 723).

## Spooky Bug (Top Tenner)

Only the Siemens SFH2030 photodiode used in *Spooky Bug*, this month's *Top Tenner* project, could prove troublesome to find. The one in the prototype "bug" was purchased from **Maplin** (☎ 0870 264 6000 or [www.maplin.co.uk](http://www.maplin.co.uk)), code CY90X.

If you encounter any difficulties in obtaining the BUZ71 n-channel power MOSFET, try **Cricklewood Electronics** (☎ 020 8452 0161). Rectangular l.e.d.s (for his/her eyes) do appear to be widely stocked.

The printed circuit board is available from the *EPE PCB Service*, code 409 (see page 723).

# INGENUITY UNLIMITED

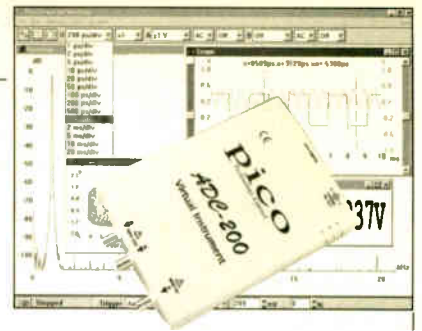

## WIN A PICO PC BASED OSCILLOSCOPE WORTH £586

- 100MS/s Dual Channel Storage Oscilloscope
- 50MHz Spectrum Analyser
- Multimeter • Frequency Meter
- Signal Generator

If you have a novel circuit idea which would be of use to other readers then a Pico Technology PC based oscilloscope could be yours. Every 12 months, Pico Technology will be awarding an ADC200-100 digital storage oscilloscope for the best IU submission. In addition, a DrDAQ Data Logger/Scope worth £69 will be presented to the runner up.



Our regular round-up of readers' own circuits. We pay between £10 and £50 for all material published, depending on length and technical merit. We're looking for novel applications and circuit designs, not simply mechanical, electrical or software ideas. Ideas *must be the reader's own work and must not have been submitted for publication elsewhere*. The circuits shown have NOT been proven by us. *Ingenuity Unlimited* is open to ALL abilities, but items for consideration in this column should be typed or word-processed, with a brief circuit description (between 100 and 500 words maximum) and full circuit diagram showing all relevant component values. **Please draw all circuit schematics as clearly as possible.** Send your circuit ideas to: *Ingenuity Unlimited*, Wimborne Publishing Ltd., 408 Wimborne Road East, Ferndown Dorset BH22 9ND. (We do not accept submissions for IU via E-mail.) Your ideas could earn you some cash and a prize!

## ROBO-VOICE

— EXTERMINATE!

One of the easiest sound effects to implement electronically is the "robotic voice", which chops up the voice to create the "robotic" effect, similar to the Dalek voice.

The circuit of Fig.1 possibly represents the simplest possible implementation of this, using a standard transmission gate oscillator to do so, employing any CMOS 4016 i.c. This particular i.c. is very sensitive to static, and requires antistatic precautions (discharge your body to earth before handling).

The timing components of the oscillator are preset VR1, resistor R2, and capacitor C1. The oscillator works by continually reversing the polarity across C1 through bilateral switches IC1b and IC1c. Note, therefore, that C1 must be a non-polarised type. As the polarity reverses, so bilateral switches IC1b and IC1c alternately open and close, thus sustaining the oscillation. The charge on C1 is further used to switch IC1a at control pin 13, which modulates the voice presented at input pin 1.

The frequency of the oscillator may be roughly calculated as follows:

$$f = 1 / (2.2 \times (VR1 + R2) \times C1)$$

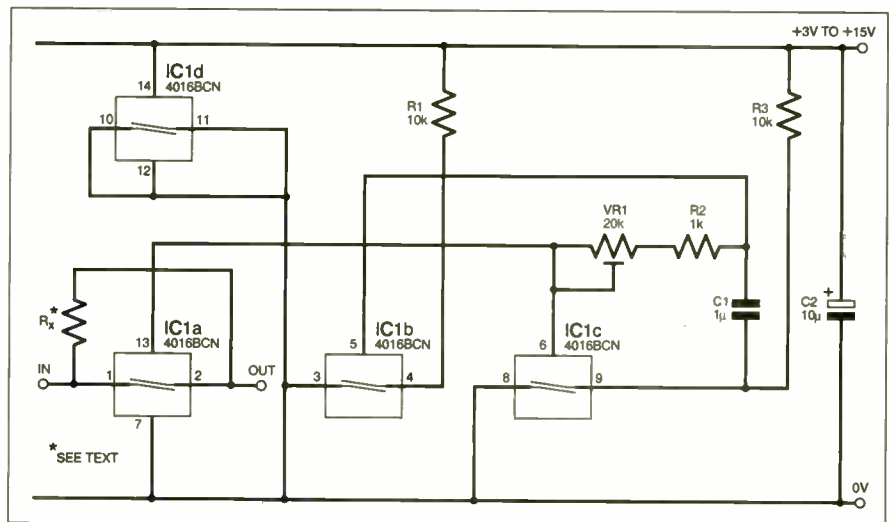

Fig.1. Circuit diagram for producing the Robo-Voice.

Preset VR1 serves to change the frequency of the "chopping", and its mid-position should be about ideal. A particular advantage of the circuit of Fig.1 is that it will admit almost any input, from a few millivolts up to the full supply line voltage, provided the output current does not exceed 25mA.

Since the "robotic" effect might be too exaggerated, resistor Rx (between about 220Ω and 5kΩ) may be inserted across IC1 pins 1 and 2 to reduce the effect. Strangely, the circuit has a more marked effect on the female voice.

Thomas Scarborough, South Africa

## STEREO IMAGE ENHANCER

— WIDER SPLITS

The circuit diagram shown in Fig.2 improves the separation of an audio signal by enhancing the "leftness" or "rightness" of the stereo image.

If the signal is of the same amplitude in both channels, i.e. it is mono, the signal voltage across potentiometer VR1 is zero, so the signal remains unchanged. If, however, the signal is stronger in one channel than the other, there will be a signal voltage developed across VR1. This produces a current through VR1, which also flows through op.amp feedback resistors R1 and R2.

This current is produced by both op.amps, IC1a and IC1b, and their output voltage therefore changes in order to compensate for the voltages developed across the feedback resistors. These output voltage changes result in the "loud" channel getting louder, and the "quiet" channel getting quieter.

The amount of increase in separation produced by the circuit is a function of the ratio R1/VR1, although this can be taken too far. If this happens, an antiphase signal is generated in the "quiet" channel and the "over-separated" image sounds louder than it should.

In order to reduce the risk of this happening, a resistor of equal value to R1 is placed in series with VR1. A value for VR1 of 10 × R1 seems about right, because with VR1 at maximum there is virtually no increase in stereo separation.

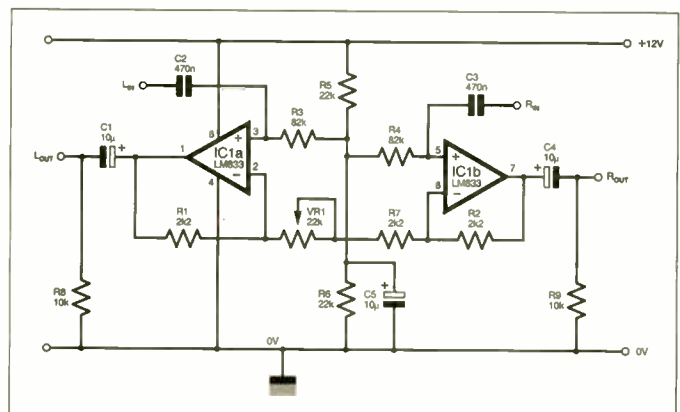

Fig.2. Circuit diagram for a Stereo Images Enhancer.

The overall circuit has a voltage gain of one. It can be fed directly from a CD player, the output feeding the CD input of a stereo amplifier. An LM833 dual op.amp was used in the prototype, though any dual op.amp should do.

P.A. Tomlinson, Hull

# Autotrax<sup>TM</sup>

Electronic Design Automation

autodesk<sup>®</sup>  
authorised developer

Schematic Capture  
SPICE Simulation  
PCB Layout  
Auto-Layout/Router  
3D PCB Visualization  
Database Support

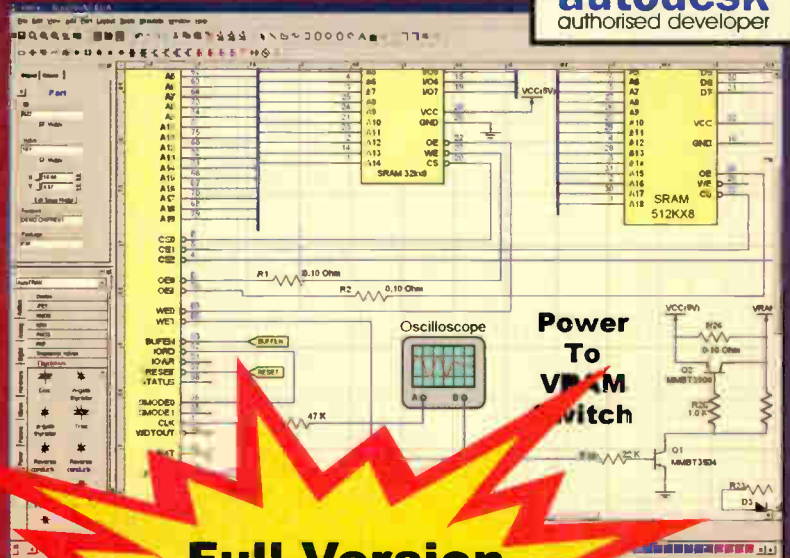

**Full Version  
Only £57(\$95)  
No Limits!**

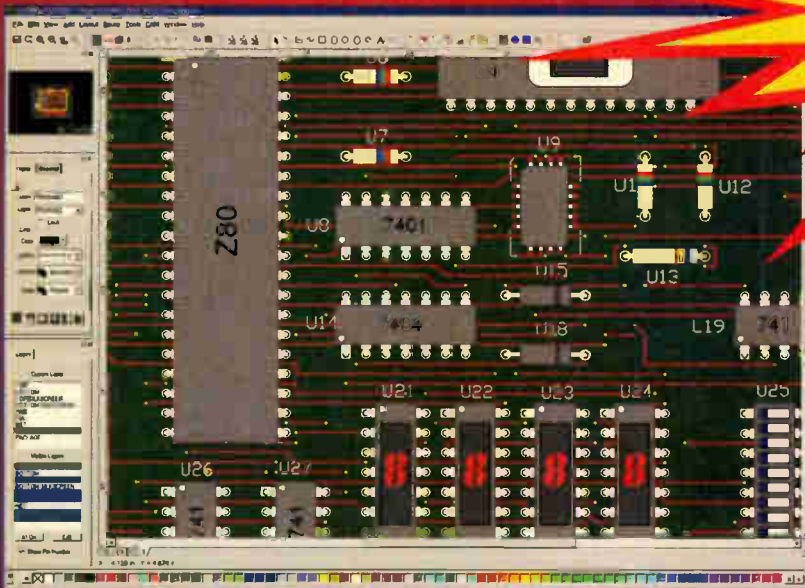

- Drag and drop parts onto your schematic.
- Connect them together.
- Add virtual instruments such as scopes and function generators.
- Use the PCB design wizard to create your PCB.
- Autolayout and autoroute the board.
- View the board in 3D.
- Output to Gerber and AutoCAD/Solidworks.

To find out more go to [www.autotraxEDA.com](http://www.autotraxEDA.com)

*First, I want to congratulate you on an excellent EDA concept. Great graphics, nice storage concept, nice integration. And you have got the tool use JUST RIGHT. It might seem minor, but sensible ways of doing things like building parts, adding pins to parts, using wires, etc make a massive difference to the basic useability of an EDA tool. I've been using EDA tools for 20 years now ... and the system you have here is as good as anything I've ever used ... Phillip Dimond*

**2.0**  
It just gets better

**Why wait? Download AutoTRAX EDA NOW!**

**[www.autotraxEDA.com](http://www.autotraxEDA.com)**

# Learn About Microcontrollers

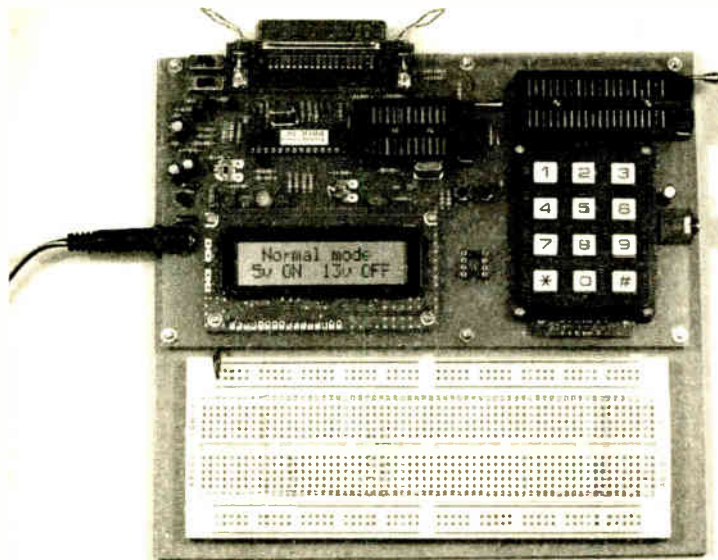

## PIC Training & Development System

The best place to start learning about microcontrollers is the PIC16F84. This is easy to understand and very popular with construction projects. Then continue on using the more sophisticated PIC16F877 family.

The heart of our system is a real book which lies open on your desk while you use your computer to type in the programme and control the hardware. Start with four very simple programmes. Run the simulator to see how they work. Test them with real hardware. Follow on with a little theory....

Our complete PIC training and development system consists of our universal mid range PIC programmer, a 306 page book covering the PIC16F84, a 262 page book introducing the PIC16F877 family, and a suite of programmes to run on a PC. The module is an advanced design using a 28 pin PIC16F872 to handle the timing, programming and voltage switching requirements. The module has two ZIF sockets and an 8 pin socket which between them allow most mid range 8, 18, 28 and 40 pin PICs to be programmed. The plugboard is wired with a 5 volt supply. The software is an integrated system comprising a text editor, assembler disassembler, simulator and programming software. The programming is performed at normal 5 volts and then verified with plus and minus 10% applied to ensure that the device is programmed with a good margin and not poised on the edge of failure. DC version (shown) for UK, battery version for overseas. UK orders include a plugtop power supply.

- Universal mid range PIC programmer module
  - + Book *Experimenting with PIC Microcontrollers*
  - + Book *Experimenting with the PIC16F877* (2nd edition)
  - + Universal mid range PIC software suite
  - + PIC16F84 and PIC16F872 test PICs. . . . . £139.00
- (Postage & insurance UK £9, Europe £14, Rest of world £24)

## Experimenting with PIC Microcontrollers

This book introduces the PIC16F84 and PIC16C711, and is the easy way to get started for anyone who is new to PIC programming. We begin with four simple experiments, the first of which is explained over ten and half a pages assuming no starting knowledge except the ability to operate a PC. Then having gained some practical experience we study the basic principles of PIC programming, learn about the 8 bit timer, how to drive the liquid crystal display, create a real time clock, experiment with the watchdog timer, sleep mode, beeps and music, including a rendition of Beethoven's *Für Elise*. Finally there are two projects to work through, using the PIC16F84 to create a sinewave generator and investigating the power taken by domestic appliances. In the space of 24 experiments, two projects and 56 exercises the book works through from absolute beginner to experienced engineer level.

## Hardware & Ordering Information

Our PIC software is supplied as a self installing programme which will operate on any modern PC whichever operating system is used. For full information click onto 'Using PIC Software' on our web site.

Telephone with Visa, Mastercard or Switch, or send cheque/PO for immediate despatch. All prices include VAT if applicable.

Web site:- [www.brunningssoftware.co.uk](http://www.brunningssoftware.co.uk)

Mail order address:

**Brunning Software** 138 The Street, Little Clacton, Clacton-on-sea, Essex, CO16 9LS. Tel 01255 862308

## NEW 32 bit PC Assembler

*Experimenting with PC Computers* with its kit is the easiest way ever to learn assembly language programming. If you have enough intelligence to understand the English language and you can operate a PC computer then you have all the necessary background knowledge. Flashing LEDs, digital to analogue converters, simple oscilloscope, charging curves, temperature graphs and audio digitising.

Kit now supplied with our 32 bit assembler with 84 page supplement detailing the new features and including 7 experiments PC to PIC communication. Flashing LEDs, writing to LCD and two way data using 3 wires from PC's parallel port to PIC16F84.

- Book + made up kit 1a + software..... £73.50
  - Book + unmade kit 1u + software..... £66.50
- (PP UK £4, Europe £10, Rest of world £14)

## C & C++ for the PC

*Experimenting with C & C++ Programmes* teaches us to programme by using C to drive the simple hardware circuits built using the materials supplied in the kit. The circuits build up to a storage oscilloscope using relatively simple C techniques to construct a programme that is by no means simple. When approached in this way C is only marginally more difficult than BASIC and infinitely more powerful. C programmers are always in demand. Ideal for absolute beginners and experienced programmers.

- Book + made up kit 2a + software ..... £57.50
  - Book + unmade kit 2u + software ..... £51.50
  - Book + top up kit 2t + software ..... £37.98
- (PP UK £4, Europe £10, Rest of world £14)

## The Kits

The assembler and C & C++ kits contain the prototyping board, lead assemblies, components and programming software to do all the experiments. The 'made up' kits are supplied ready to start. The 'top up' kit is for readers who have already purchased kit 1a or 1u.

## Assembler and C & C++

Click on 'Special Offers' on our website for details of how to save by buying a combined kit for assembler and C & C++.

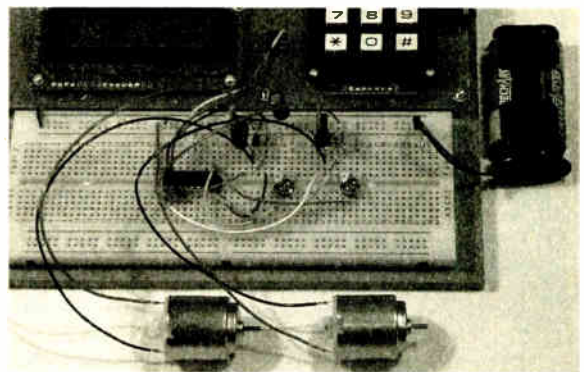

## Experimenting with the PIC16F877

The second PIC book starts with the simplest of experiments to give us a basic understanding of the PIC16F877 family. Then we look at the 16 bit timer, efficient storage and display of text messages, simple frequency counter, use a keypad for numbers, letters and security codes, and examine the 10 bit A/D converter.

The 2nd edition has two new chapters. The PIC16F627 is introduced as a low cost PIC16F84. We use the PIC16F627 as a step up switching regulator, and to control the speed of a DC motor with maximum torque still available. Then we study how to use a PIC to switch mains power using an optoisolated triac driving a high current triac.



# READOUT

Email: [john.becker@wimborne.co.uk](mailto:john.becker@wimborne.co.uk)

**John Becker addresses some of the general points readers have raised. Have you anything interesting to say? Drop us a line!**

All letters quoted here have previously been replied to directly.

## WIN AN ATLAS LCR ANALYSER WORTH £79

An Atlas LCR Passive Component Analyser, kindly donated by Peak Electronic Design Ltd., will be awarded to the author of the *Letter Of The Month* each month.

The Atlas LCR automatically measures inductance from 1 $\mu$ H to 10H, capacitance from 1pF to 10,000 $\mu$ F and resistance from 1 $\Omega$  to 2M $\Omega$  with a basic accuracy of 1%.



## ★ LETTER OF THE MONTH ★

### PCB TRACK COPYING

Dear EPE,

I've been playing with my p.c.b. etching kit and I think I've come up with a near-foolproof method for transferring a p.c.b. master from an issue of *EPE* onto a copper-plated p.c.b. blank using Press-n-Peel (PnP), though the method could probably be adapted for other "toner transfer" p.c.b. etching systems.

First of all, scan the p.c.b. image into IrfanView (from [www.irfanview.com](http://www.irfanview.com)), making sure it's as straight as possible. Scan it in "256 Greyscales" mode at either 300dpi or 600dpi. When IrfanView has finished loading the scanned image, zoom out until all of the p.c.b. pattern is visible. Open the Image menu, then select Enhance Colours. Move the Contrast slider all the way to the right and click OK.

This should have left you with a near-flawless black and white image. Save it to disk and edit it in Paintshop Pro, Paint or whatever graphics editing program you usually use. The objective in this case is to get a p.c.b. image in black and white with no filled in pads or short-circuited tracks. Save the image and load it into IrfanView again.

Next, select Print from the File menu. Select your printer and set its resolution to match the resolution of the scanned image (300 or 600 dpi). Click OK. In the next window, select "Original size (from image DPI)". Make sure your printer is loaded with blank paper, then click the Print button. When the image has printed, cut a piece of PnP toner-transfer material to match the image, but oversize it by half an inch (13mm) on each side.

Remove a label from a sheet of laser printer labels (or tear a bit off). Use the label to stick down the PnP. Make sure the label is affixed to the leading edge – the side the printer starts loading from. Reload the paper. If your printer uses an oiled cleaning pad or roller to keep the fuser pads clean, remove it temporarily. Print the image again using the same settings as before.

When the transfer has printed, cut it off of the paper sheet with a sharp pair of scissors (or a craft knife). Cut a piece of p.c.b. laminate to size, leaving a 5mm or so border. Set a normal

clothes iron to "No steam", "Cotton/Linen". Put on a pair of rubber gloves and clean the p.c.b. with a green scouring pad and some washing-up liquid. When properly cleaned, the board will be a bright copper colour with no signs of dirt or grime on it. Water should form a solid "sheet" on the board instead of beading up.

Make sure the surface of the PnP is clean (no dust) and place it on the p.c.b. blank. Heat one corner of the PnP for around five seconds to melt the toner and stick the PnP down. Place a sheet of paper on top of the PnP and start ironing down the transfer. This should take around 30 seconds – make sure you don't stay in one place for too long and don't apply too much pressure. Ideally the weight of the iron should be doing most of the work.

After the 30 seconds are up, remove the iron and the sheet of paper and put the board and PnP under cold running water for a few seconds to "set" the toner. Dry the board and use a craft knife to lift the corner of the PnP sheet. Keep pulling the PnP back carefully. If some of the PnP hasn't fused to the board, put the sheet of paper back on top and iron that area for an additional 30 seconds.

Cool the board and remove the PnP again. Generally, if the PnP didn't fuse the second time, either the iron isn't hot enough or there's some dirt on the PnP or the board. Touch up with a sharp tool (such as a craft knife) and an etch-resist pen.

Etch the board as normal (around 20 minutes in ferric chloride at around 25°C), then clean off the PnP and toner with a scouring pad and washing up liquid. If you want, you can use acetone (it's a bit quicker) but that's up to you.

**Philip Pemberton,  
via email**

*Thank you Philip, that sounds extremely useful. I'll put your advice into our PIC Tricks folder on our ftp site (even though it's not strictly speaking "PICing").*

*Doing a Google search showed about 1200 entries for PnP, of which the first two are: [www.techniks.com](http://www.techniks.com) and [www.cibs.co.uk](http://www.cibs.co.uk).*

### SERIAL L.C.D. CONTROL

Dear EPE,

Since starting to program PICs back in 1998, I've developed a habit of writing my code in reusable modules, the first of which is for a standard alphanumeric (HD44780) l.c.d. display controller module. It currently supports 4-bit mode and 2-wire serial mode.

Serial mode involves connecting a 74LS164 or 74HC164 parallel output shift register, a 1N4148 diode and a 10k resistor. It uses two I/O lines (shift reg data, shift reg clock and l.c.d. E-line). Basically, a data nibble is loaded into the shift register (bits 5 to 2), bit 6 is the RS bit and bit 7 is used to gate the l.c.d.'s E-line (enable/clock). After a data byte has been loaded (with reg pin 13 high), the diode and resistor act like an AND gate.

If reg pin 13 is low, l.c.d. pin E is pulled low through the diode. If reg pins 1, 2 and 13 are high, E is high and the l.c.d. clocks in the data nibble.

The connections required are:

|         | 74xx164  | L.C.D.                |
|---------|----------|-----------------------|
| PIC RB7 | 1 and 2  | E, via 10k resistor   |
| PIC RB6 | 8        | -                     |
| -       | 5        | D4                    |
| -       | 6        | D5                    |
| -       | 10       | D6                    |
| -       | 11       | D7                    |
| -       | 12       | RS                    |
| -       | 13       | E, via 1N4148 diode * |
| Vcc     | 9 and 14 | Vcc                   |
| Vss     | 7        | Vss                   |

\*Connect the 1N4148's cathode to 74xx164 pin 13, and its anode to l.c.d. pin E (which also has the 10k resistor connected to it).

I could have used a CMOS or TTL AND gate, but that would have unnecessarily increased the chip count and a diode/resistor AND gate works just as well.

Run MPASM to compile one of the test files, program into a PIC16F874 (or PIC16F877), connect up an l.c.d. and power up. I've tested the code on a PIC16F84 and a PIC16F628 as well. But the standard disclaimer applies – it works for me, your mileage may vary.

I have to say that a 16 x 1 l.c.d. connected over a two-wire interface is one of the most useful PIC code debugging tools I've got.

**Philip Pemberton,  
via email**

*That seems nice and simple Philip, and very useful, thank you. The test files you refer to have been put into the PIC Tricks folder on our ftp site.*

### SPURIOUS PIC RESETS

Dear EPE,

Your *PIC Met Office* project was worth waiting for. My own weather station, PIC16F877 based, runs from a mains PSU 24/7, but it's always suffered from the occasional spurious reset due to mains borne noise, usually when nearby equipment, often my PC printer, is switched on or off.

I've tried loads of capacitance and ferrites on the power rails near the PIC, but they never completely cured the problem. I mostly fixed it in software by writing startup code to detect these

### BIOPIC UPGRADE

Dear EPE,

I'd like to suggest three possible enhancement ideas for your *Biopic Heartbeat Monitor* of Jun '02: a plug-in memory card (usual photo memory card), so as to be able to capture the heart activity on the move and to analyse it on a PC later; an l.c.d. display (with good resolution) for two pulses maximum; an ST deviation measurement/calculation with displayed result.

**Cristian, via email**

*Thanks for the suggestions Cristian. The first two I could probably implement should I ever do another Biopic, but I don't know what ST stands for, and <http://labs1.google.com/glossary> doesn't either in this context – enlighten me!*

### RESOURCEFUL

Dear EPE,

I would like to express appreciation for your *PIC Tutorial V2*, *TK3* software and *PIC Resources* CD-ROM. They form, without doubt, the finest combination of articles and software I have seen on this topic for those starting out on PIC programming. I would also commend Magenta Electronics for the excellent quality and value for money of their version of the *TK3* board.

I hope other readers thinking of starting PIC programming will be encouraged to have a go through this route. All we need now is a cheap source of ZIF sockets!

**Brian George, Orpington, via email**

*Thanks for your kind comments Brian! Yes, ZIFs do seem wickedly priced.*

spurious resets – they fortunately usually leave the PIC's data and EEPROM memory (where the accumulated weather data are stored) intact, so if consistency checks on this memory are OK at startup I ignore the reset.

Recently, however, browsing the Microchip disk in the knowledge base, I found an FAQ that seemed to apply to my case. This was: "My program works fine, but sometimes resets mysteriously. How can I prevent this?" The reply says:

"In the current architecture, a master clear reset is completely asynchronous (sic) and has very little pulse width requirement. It is usually a good idea to put a capacitor on this pin to decouple this noise away. A 0.01µF capacitor may be enough, but if there is noise of a high frequency nature, like RFI or ESD, it may be necessary to add a 0.001µF capacitor as well."

I put a 100nF polyester directly between MCLR and 0V, and since doing this several weeks ago I've had no further instances of the spurious reset. It's a negative test, of course, but I'm getting cautiously optimistic that it might have fixed the problem completely. It has certainly substantially reduced the incidence. So if anyone else suffers mysterious resets, particularly in mains powered PIC projects, they might care to see if this simple fix works for them too.

Malcolm Wiles,  
via email

*Glad you like my Met, Malc. Writing the software for it was a marathon, but I enjoyed doing it and am pleased with the results.*

*Regarding spurious resets, I've never knowingly suffered from them, but your comments could prove useful to other PIC addicts, thank you.*

## PICtutor V1 PSF FILES

Reader Ashley Preston-Rowen emailed us to ask "Please could you send me the user documentation for the PICtutor Version 1 by John Becker because we are having problems downloading the Virtual PIC programmer to the PIC on the project board. How do we convert a PSF file to an ASM?"

*The PSF files Ashley refers to were only used with the original PICtutor V1. They are not used by the current version, now called Assembly for PICmicro V2, which only uses ASM files in the MPASM format. With PICtutor V1, there was no facility provided for translating PSF to ASM.*

*However, when I wrote the software for Toolkit TK3 (Oct/Nov '01) I also wrote a facility that would do this translation. I told Ashley about it and that the TK3 software can be downloaded free from our ftp site (accessible via our home page at [www.epemag.wimborne.co.uk](http://www.epemag.wimborne.co.uk)). He replied later:*

Thank you very much John for letting me know about your TK3. It was very useful and saved a lot of work. I would like to thank you on behalf of the whole two years of ND students who would not have passed without it. The problem was that the only lecturer who knew what to do was taken ill and I was the only other person (and I'm only an ND1 student!) who knew how to use PICtutor and the assembler, but I couldn't convert to an ASM file. With your facility I was able to download everyone's program to the PIC from PICtutor so that their work could be marked. So thank you very much again,

Ashley Preston-Rowen,  
via email

*That's great to know, Ashley, well done. It's a facility that I felt would be useful for TK3, but you are the only person who has told me they've actually used it.*

## MORE ON PICS AND XP

Dear EPE,

A few years ago I purchased a cheap programming unit for use on a PC parallel port, consisting of a circuit board with a 40-pin ZIF socket, some buffers/transistors and I.e.d.s

capable of programming many of the PIC family. It came with a Visual Basic software routine which worked well with Windows 98. However, upgrading to a laptop supporting Windows XP, the programmer would not work.

I eventually stumbled across <http://www.ic-prog.com/> which is a gem of a site for this very problem. If one can trace out the inner workings and PC interface signals of their programming unit, as I did, this site provides a free downloadable software package with sufficient details to configure the software to run many types of programmer.

This appears to include serial interfaced units, and details of several programmer types which are directly supported and are given in the form of schematics and links to appropriate sites. It is not too difficult to compare these with the programmer you own, and get a matching order of signals for PC interfacing. At worst one could electrically re-jig a programmer to appear like one of the examples.

One particularly nice feature of this software is a Hardware Check which allows the individual signals sent to the programmer to be exercised in real-time. This enables DVM measurement of the various signals arriving at the programmer to check that they are in the correct order and state of inversion. What is more, there is XP support, so save yourself a few quid and check it out.

If any readers want basic help with this, I am willing to reply to emails, provided they are discernable from spam.

Paul Bryce, via email,  
[paul@brycep.freemove.co.uk](mailto:paul@brycep.freemove.co.uk)

*Thanks Paul, that could prove useful to readers who are upgrading. As far as TK3 is concerned, of course, we seem to have got a really simple solution through reader Ian Stedman's discovery of the new "universal" version of *Inpout32.dll*, which is in the TK3 and Interface folders on our ftp site and just replaces the previous version.*

*Robert Penfold is covering it in his Interface this month, and in a future issue.*

## AVR PROGRAMMING

Dear EPE,

I read the letter from Davis (aka Techy Fellow) in the August '03 *Readout*, and I agree!

Us Intel MCS-51 fellows are left in the dark when it comes to microcontrollers. As one of the oldest microcontrollers around, it is a shame what little support there is for developers and hobbyists alike, apart from expensive development tools available from third party vendors. I also wish that we could have similar support for these versatile workhorses (I only use the MCS-51 code for programming, particularly the Atmel 89Cx range of microcontrollers).

Development tools like the ones available for PICs (TK3, etc.) would certainly come in handy. I have drooled over the prospect of being able to use graphics I.c.d.s on the 8051 controllers, with very little information available on the Net. The same goes for the AVR range. I was shocked at how few people actually know how to write programs for these. I've recently had to change the software code for one project and battled to find someone who could assist me, to no avail! So please EPE, help us!

I sometimes have to convert some of the interesting projects for PICs into code for the Atmel 89C2051 controller, like the *Virus Zapper* in the March '02 issue. I went a little further and added an I.c.d. display to the project to indicate the treatment periods and count down the 20 minute intervals.

Herman Beukes,  
South Africa, via email

*Well Herman, that's two of you with an interest in AVRs! Sadly, though, commercial interests require that far more than two readers will be interested in something before we can commit time and space to it. Let's see if a lot more readers feel as you do.*

## WELL RECEIVED!

Dear EPE,

I was really pleased to see the *Regenerative Radio* article in the August '03 issue. I will remember building a circuit exactly like the one shown in Fig.3.1 from an article in *Practical Wireless* (circa 1968). If I remember correctly the author was F. G. Rayer. All the hardware was bought from Home Radio, sadly no longer in business.

At the end of the 60s – having just graduated and being short of money – I was teaching myself to build circuits so that I could make my own hifi amplifier (I did – several times!). My ambition was to have something comparable to the Quad 33/303 system which was way beyond my pocket. *Practical Electronics* in the early 70s actually produced a design which, while not being an exact copy, drew heavily on the Quad system's design even down to having triple Darlington output stages. Why I never built this one I do not know.

I also purchased other (cheaper) kits but was never fully satisfied each time. Do today's constructors know the exquisite agony of switching on an amplifier for the first time and seeing (and hearing!) the output transistors fry? (Yes I did – my first effort is best forgotten!). Another time I inadvertently put 45V across a BC169: there was a sharp crack and all that was left of the poor transistor were three wires standing proud of the p.c.b.

Another cause of an amplifier not working first time was not easy to find but I kicked myself when I did! I had wired the DIN plugs to pins 1, 2 and 3 and the sockets to pins 3, 4 and 5! Come on, own up, we've all done it or something similar.

I hadn't seen EPE for some time because not all branches of W H Smith's stock it, and those that do tend to put it in a different place every month so it is sometimes difficult to find. I have now treated myself to the back numbers with the radio circuits and the audio circuits for last year; it's nice to see some circuits that I can identify with.

I stopped making my own amplifiers many years ago when the price of off-the-shelf items became so low that it was hardly worth the bother making one. And when PIC circuits came on the scene I really could not understand them so my interest in building circuits waned. Now that you have rekindled my interest, perhaps I will reconsider my dream of making something like the Quad 33/303.

Thanks for an interesting read.

Alan Jones, London,  
via email

*Glad you're pleased with our series Alan. Raymond's really good! So too was Rayer, a person whose designs I learned from in those far gone days. Best wishes for Quadding-up!*

## CLONING RAYMOND

Reader John North recently posted a thread on our Chat Zone entitled "Is Raymond Haigh a synonym for Sony?", continuing within the text:

I ask because I am astounded by the quality of construction manifest in photos of the gear he designs for EPE. I think it is the best I've ever seen in any electronics magazine in the thirty-odd years I've been reading them. Does he make it himself? If so EPE should despatch a staffer to interview him about his skills and facilities and ascertain whether his clones are available in pill form!

*To which I replied that we are very proud that Raymond shares his excellent skills with us all. I don't know his origins but judging by the quality and style of the illustrations he sends us he's probably been trained as an engineer of "the old school".*

*If pills were available that would imbue us with his skills I for one would want them – on the NHS of course!*

# Electronics, Mechanics and Computing Principles V8.1

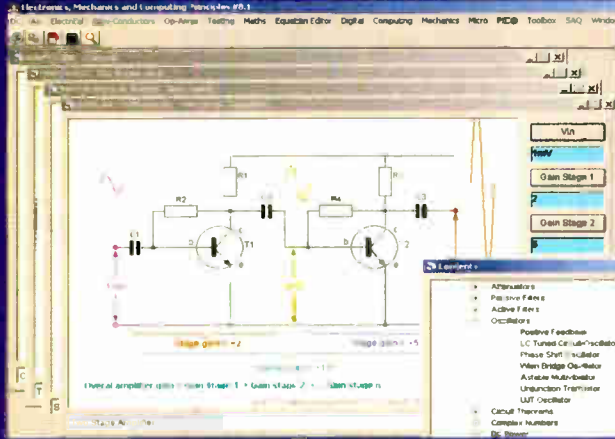

"First of all may I say what great software. Electronics, Mechanics & Computing Principles V8.1 really will keep me absorbed for months and it is so well presented. Well done."

Now only  
£14.95

Geoff Woolley. Head of Design Technology at Nottingham High School.

If you're looking for an easy and enjoyable way to learn electronics or just want to keep up-to-date, then this is the package for you! Also a valuable interactive reference tool for hobbyists and engineers, containing more than a thousand electronics, electrical, mechanics, maths, computing and PIC microcontroller topics. This highly acclaimed electronics software can also be found in hundreds of schools, colleges and universities to support GCSE, A-Level, City and Guilds, BTEC Nationals and many other courses up to degree level by students all over the world, yet still remains extremely easy to use.

There are more than a thousand electronics, electrical, mechanics, physics, maths, computing and PIC micro controller topics. See web site for full listing. EPV8.1 contains most of the content from the other two packages.

Still trying to get the hang of PIC micro controllers? This software contains an enormous amount of help to get you started, explaining how the PIC microcontroller works, where all the instructions can be interactively explored. Listed on the Microchip web site as a training tool for use in conjunction with their LATEST FREE downloadable MPLAB IDE programmer and simulator. Simply run the two packages together and you have all you need to begin programming.

## Mathematics and Computing Principles V8.1

Includes A-Level Computing, Computer Science and Information Technology.



Now only  
£9.95

Now combining mathematics along with a vast amount of interactive, computing and ICT material, much more than available from any other single source.

Includes the unique Equation and Graph Editors, plus full colour printing, white board technology and a host of other features.

## GCSE Mathematics Principles V8.1

Struggling with GCSE Maths or just need those better grades, then try this to make it easier!

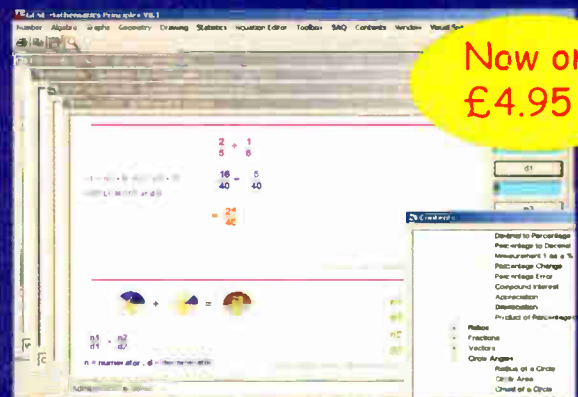

Now only  
£4.95

Studying with this dynamic software, you'll learn through doing and exploring mathematics! It's much more exciting than poughing through a static textbook!

[www.eptsoft.com](http://www.eptsoft.com) to download.

SAVE more than £105 on the previous V8 price.  
FREE downloadable updates.  
FREE trial evaluation.  
NETWORK LICENCE see web site for details.



Certified software for Curriculum Online and eLearning credits.

New Internet technology enables us to bring you our latest software at a fraction of the previous price.

Simple one-click to download and fully install to your hard drive with a backup copy, by visiting our web site.

eptsoft limited. Glebe House, School Lane, East Keal, Spilsby  
Lincolnshire UK PE23 4AU  
info@eptsoft.com : Tel: 01790 754037 : Fax: 0870 0509660

# SPOOKY BUG

**OWEN BISHOP**



*This short collection of projects, some useful, some instructive and some amusing, can be made for around the ten pounds mark. The estimated cost does not include an enclosure.*

## Hocus-Pocus – Get your Hallowe'en party off to a shriek!

**T**HIS is one of those novelty projects that leave the constructor with full scope to use their imagination and skill. The essential idea is that the circuit is made to look like a fearsome (or perhaps foolish) bug. In the light, the bug just stands there looking fearsome (or foolish). As soon as the light level falls below the preset level, the eyes of the bug start to glow and it emits a weird wailing sound. This continues until the light is switched on again.

This is only one of several possible applications for this circuit, some bug-related, some not.

### HOW IT WORKS

Referring to the full circuit diagram for the Spooky Bug shown in Fig.1, light level is detected by the photodiode D1. This is reverse-biased so that a small leakage current flows through it and on through resistor R1. The current through R1 produces a positive voltage at the inverting input (-) of op.amp IC1. The voltage at the non-inverting input (+) is set by adjusting preset VR1.

In the light, leakage current through D1 is relatively large and so is the voltage across R1. The voltage at the inverting input is higher than that at the non-inverting input and the output of the op.amp (pin 6) swings low, turning off transistor TR1. In the dark, the voltage at the inverting input swings low, the output rises and TR1 is turned on.

When TR1 is on, it has a drain-source resistance of about 0.12Ω. Current immediately begins to flow through the remainder of the circuit. In other words, TR1 behaves as an on/off switch in the 0V line of that part of the circuit.

When TR1 is on, it has a drain-source resistance of about 0.12Ω. Current immediately begins to flow through the remainder of the circuit. In other words, TR1 behaves as an on/off switch in the 0V line of that part of the circuit.

### BUG-EYED

Light emitting diodes (l.e.d.s) D2 and D3 begin to glow. These are the eyes of the bug. If you prefer, you can use flashing l.e.d.s, in which case connect a wire link in

place of resistor R2 (flashing l.e.d.s have their own built-in current limiter).

While TR1 is on, the astable circuit based on IC2 oscillates. Its frequency is determined by the capacitor C1 and the current flowing into it.

Each cycle takes about 1.7 seconds. Of this, the output of IC2 is high for about 0.2s and low for about 1.5s. Normally the high period of a 555 timer is longer than the low period, but diodes D4 and D5 in the timing chain cause the reverse effect.

The values of C2 and R6 are chosen so that, with the timing fixed by R3 and R4, a sawtooth waveform passes to IC3. It rises sharply, then falls slowly, reaching its minimum before rising sharply again.

### SOUNDS SPOOKY

Device IC3 is connected as a voltage controlled oscillator

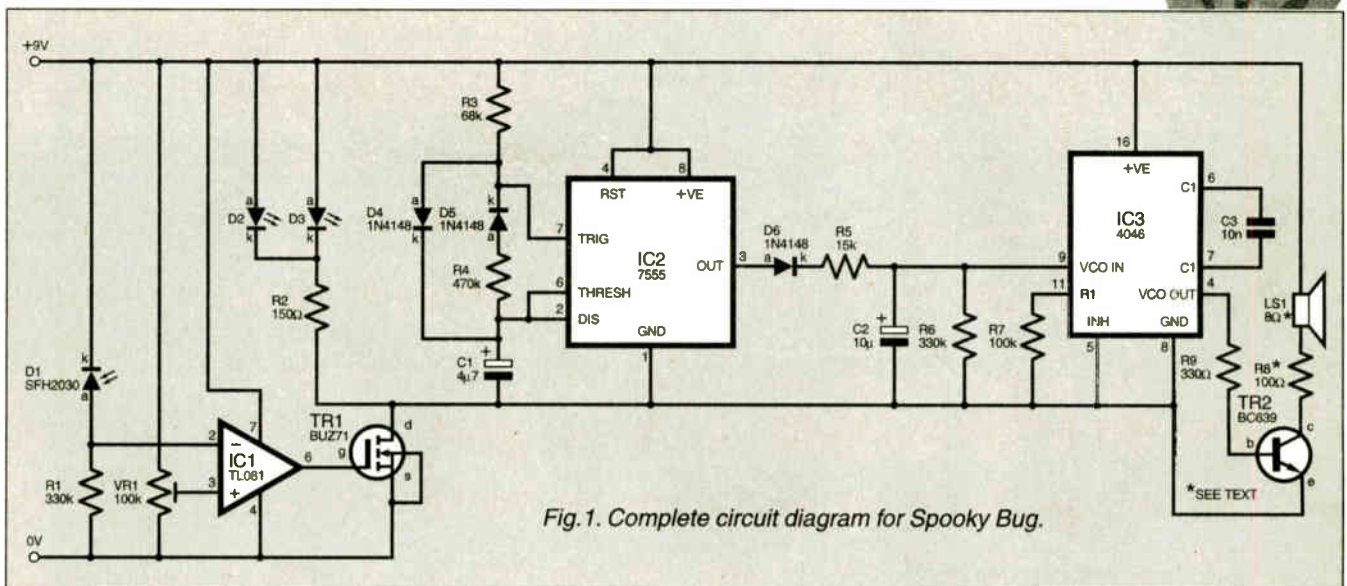

Fig. 1. Complete circuit diagram for Spooky Bug.

(v.c.o.). Its output at pin 4 drives TR2, which switches current through the loudspeaker LS1. The basic frequency of the sound is fixed by the values of R7 and C3.

As the input voltage at pin 9 varies with a sawtooth waveform, the pitch of the sound rises sharply and falls slowly, repeating every two seconds. The effect is a spooky, wailing sound.

This circuit can be tailored to produce a range of sounds. You can alter:

- The repetition rate (R3 and R4)
- The length of the high output pulse (R3)
- The length of the low output pulse (R4)
- The rate of rise of pitch (C2 and R5)
- The rate of fall of pitch (C2 and R6)
- The basic frequency of the sound (R7 and C3)

There is plenty of scope for the ambitious experimenter!

## CONSTRUCTION

Apart from the battery, miniature loudspeaker and an on/off switch (not shown), all other Spooky Bug components are mounted on a printed circuit board (p.c.b.). This board is available from the *EPE PCB Service*, code 409.

The component layout, full-size copper foil master and four lead-off wires to off-board components are shown in Fig.2. The on/off switch goes in the battery positive lead. Rectangular l.e.d.s were used for the eyes in the prototype, slanting these slightly to give a demonic expression.

The circuit diagram shows an 8Ω speaker with a 100Ω resistor (R8) in series with it. You can try reducing the resistor value to obtain a louder sound, though this may cause feedback troubles and prevent the circuit from working properly.

In tests, it was found that the arrangement shown gave a sound that is plenty loud enough.

# COMPONENTS

Approx. Cost  
Guidance Only

£10

excl. case, batt. & speaker

### Resistors

|        |                 |
|--------|-----------------|
| R1, R6 | 330k (2 off)    |
| R2     | 150Ω            |
| R3     | 68k             |
| R4     | 470k            |
| R5     | 15k             |
| R7     | 100k            |
| R8     | 100Ω (see text) |
| R9     | 330Ω            |

All 0.25W, 5% carbon film or better.

### Potentiometer

|     |                         |
|-----|-------------------------|
| VR1 | 100k min. horiz. preset |
|-----|-------------------------|

### Capacitors

|    |  |
|----|--|
| C1 | 4μ7 tantalum bead or radial elect. 16V |
| C2 | 10μ tantalum bead or radial elect. 16V |
| C3 | 10n ceramic disc                       |

### Semiconductors

|            |   |
|------------|---|
| D1         | SFH2030 photodiode, or similar                    |
| D2, D3     | red l.e.d. rectangular (see text) (2 off)         |
| D4, D5, D6 | 1N4148 signal diode (3 off)                       |
| IC1        | TL081 f.e.t. op.amp, or similar                   |
| IC2        | 7555 CMOS low power timer                         |
| IC3        | 4046 phase-lock loop                              |
| TR1        | BUZ71 <i>n</i> -channel power MOSFET, or similar  |
| TR2        | BC639 <i>n</i> p <i>n</i> medium power transistor |

### Miscellaneous

|     |                             |
|-----|-----------------------------|
| LS1 | min. loudspeaker (see text) |
|-----|-----------------------------|

Printed circuit board, available from the *EPE PCB Service*, code 409; 1mm solder terminal pins (4 off); 8-pin d.i.l. socket (2 off); 16-pin d.i.l. socket; PP3 battery and clip; materials for making model (see text); connecting wire; solder etc.



See  
SHOP  
TALK  
page

If you have a spare 64Ω speaker, perhaps cannibalised from a defunct radio set, you could use this instead. A suitable value for R8 would be 33Ω.

The position of the battery and speaker depend on how you have constructed the

model. Instead of mounting the battery in or on the model, use a small box to hold the battery and to act as a plinth on which to stand the model. To adjust VR1, place the bug in a moderately dark place and turn VR1 until the bug just becomes inactive.

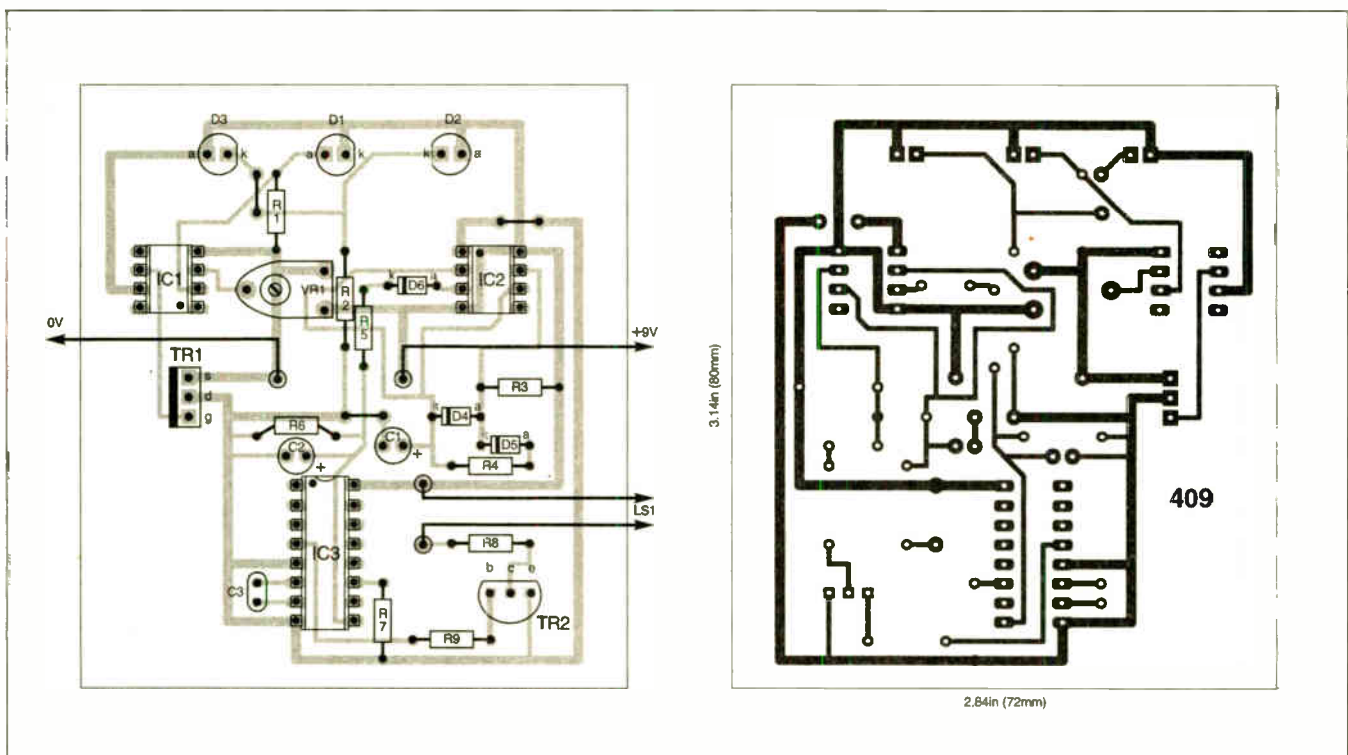
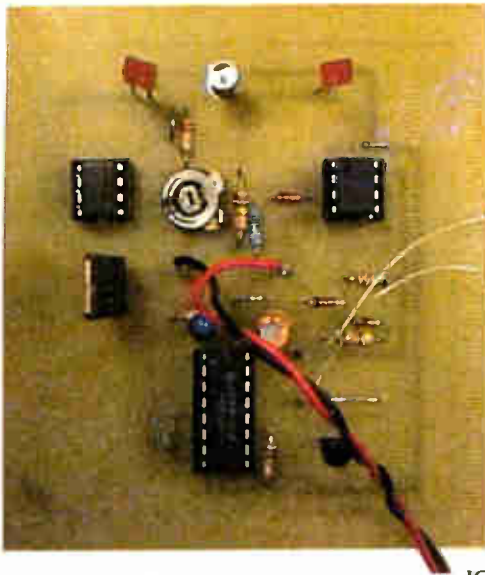

Fig.2. Spooky Bug printed circuit board component layout, wiring and full-size copper foil master. Note an on/off switch should be inserted in the battery positive lead.



Completed Spooky board.

Any further decrease in light intensity turns it on.

### TESTING

Following thorough checking, the completed circuit is easily tested in stages. Insert IC1 in its socket (right way round!) and apply power. The l.e.d.s should come on when light sensor D1 is shaded. The light level at which they switch on is adjustable by altering preset VR1. If this section of the circuit fails to work, check the polarity of diodes D1, D2 and D3, noting that D2 has its anode on the right.

Next insert IC2 (other way round to IC1) and apply power, then shade D1 to switch on TR1 and so apply power to IC2. Check the rise and fall of the output from IC2 pin 3. Finally, insert IC3. A wailing sound from the speaker should be heard when you shade D1.



The real fun begins when you dress up the circuit to look like a bug!

# Radio Bygones

The leading magazine for vintage radio enthusiasts

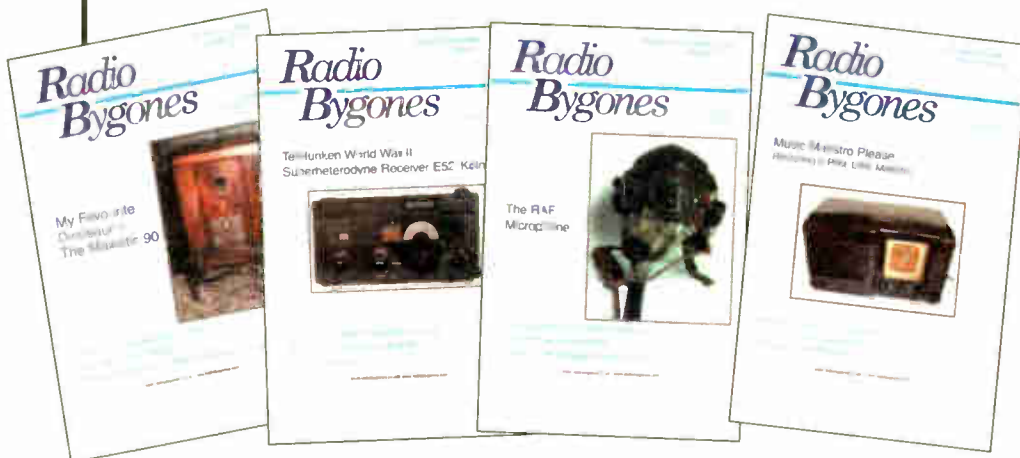

Now Also Available To **BUY ONLINE**

[www.radiobygones.com](http://www.radiobygones.com)  
Log on, pay by credit card and download the magazine to your PC

**ONLY \$9.99 (US dollars)**  
FOR 6 ISSUES  
A free issue is available

WHETHER your interest is in restoring domestic radio and TV or in amateur radio, in military, aeronautical or marine communications, in radar and radio navigation, in instruments, in broadcasting, in audio and recording, or in professional radio systems fixed or mobile, RADIO BYGONES is the magazine for you.

ARTICLES on restoration and repair, history, circuit techniques, personalities, reminiscences and just plain nostalgia – you'll find them all. Plus features on museums and private collections and a full-colour photo-feature in every issue.

IT'S MOSTLY about valves, of course, but 'solid-state' – whether of the coherer and spark-gap variety or early transistors – also has a place.

FROM THE DAYS of Maxwell, Hertz, Lodge and Marconi to what was the state-of-the-art just a few short years ago . . . There is also a selection of free readers' For Sale and Wanted advertisements in every issue.

**Radio Bygones covers it all!**

THE MAGAZINE is published six times a year, and is available by postal subscription. It is **not available at newsagents.**

TO TAKE OUT a subscription, or to request a sample copy, please contact:

RADIO BYGONES, Wimborne Publishing Ltd, 408 Wimborne Road East, Ferndown, Dorset BH22 9ND.

Tel: 01202 873872. Fax 01202 874562. Web sites: [www.radiobygones.co.uk](http://www.radiobygones.co.uk)

[www.radiobygones.com](http://www.radiobygones.com)

# New Product

Atlas LCR Passive Component Analyser (Model LCR40)

**"No other LCR is as easy as this!"**

Just clip on the test leads and press test. The Atlas LCR will automatically identify the type of component, apply the appropriate test level and frequency, display the component's value and more!

Probes are detachable too, so you can use the optional SMT tweezers for your tiny unmarked passives - **fantastic**.

Inductance range: 1 $\mu$ H to 10H  
 Capacitance range: 1pF to 10,000 $\mu$ F  
 Resistance range: 1 $\Omega$  to 2M $\Omega$   
 Basic accuracy: 1%  
 Test signals: 1V, 3mA max



# £79

fully inclusive UK price



Lots of accessories available soon!

- Automatic component identification (Inductor, Capacitor or Resistor).
- Component value measurement.
- Automatic test frequency selection (DC, 1kHz, 15kHz or 200kHz).
- Inductor DC resistance measurement.
- Non-volatile probe compensation memory.
- Detachable probes allowing use of optional test prods, SMT tweezers, etc...
- Hands free mode with value hold.

# atlas

semiconductor analyser

Check and identify your semi's

# £60

fully inclusive UK price

- Automatic component identification
- Pinout identification
- Transistor gain measurement
- MOSFET gate threshold measurement
- PN junction characteristics measurement
- Shorted Junction identification
- Transistor leakage measurement
- Just connect the part anyway round and press the button!
- Auto power on/off

NPN bipolar Darlington  
 Diode protection between C-E

Resistor shunt between B-E

Current gain Hfe=126

Enhancement mode N-Ch MOSFET

Gate Threshold Vgs=3.4V

ESD SENSITIVE BLUE Col Emit

0.77V

0.77V

0.77V

0.77V

0.77V

0.77V

0.77V

0.77V

### Supports:

- Bipolar transistors,
- Darlington transistors,
- Diode protected transistors,
- Resistor shunted transistors,
- Enhancement mode MOSFETs,
- Depletion mode MOSFETs
- Junction FETs,
- Low power triacs and thyristors,
- Diodes and diode networks,
- LEDs (+ bicolours)

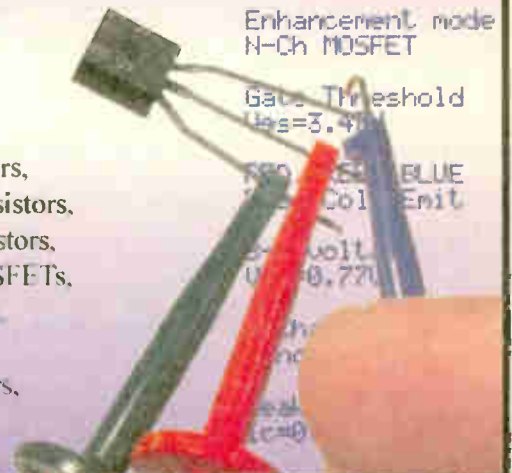

**NOW MEASURES TRANSISTOR LEAKAGE!**

enclosure colours may vary

Visit [www.peakelec.co.uk](http://www.peakelec.co.uk) to download the data sheets, user guides and copies of independent reviews. You can pay using a cheque, postal order, credit or debit card and even pay securely online. Please contact us for your volume requirements.

Also available from: (prices vary)



**PEAK**  
 electronic design ltd

Atlas House, Kiln Lane  
 Harpur Ind. Est., Buxton  
 Derbyshire, SK17 9JL, UK

[www.peakelec.co.uk](http://www.peakelec.co.uk)  
[sales@peakelec.co.uk](mailto:sales@peakelec.co.uk)

Tel. 01298 70012 Fax. 01298 70046



# SPECIAL EPE READER OFFER L.E.T. PIC BASIC PRO COMPILER

## HIGH PERFORMANCE LOW COST COMPILER FOR PIC MICROCONTROLLERS

L.E.T. PIC BASIC has been updated by Crownhill Associates and we are therefore able to offer readers the original version at the fantastic price of just **£22.50** including VAT and UK postage. It was previously advertised at **£58.69 plus postage**.

**Windows 95/98/ME/2000 compatible**

L.E.T. PIC BASIC produces tight concise code from your program written in the easy to learn yet powerful BASIC language. No machine code to learn in order to use the popular PIC microcontrollers. The compiler will produce code for both the 12-bit and 14-bit micros, therefore it can be used to produce code for many of the popular PIC devices including the 12C508 and 12C509 and the 16F84 and 16F877 and other popular Flash devices.

### **The pack includes:**

- L.E.T. PIC BASIC Pro Compiler on CD-ROM
- L.E.T. PIC BASIC User Guide on CD-ROM
- Data Sheets and support documents on CD-ROM
- StampPlot Lite Trial
- Printed User Guide
- *L.E.T. PIC BASIC Unleashed* book by Les Johnson covering the following subjects:

Interfacing to L.C.D. and L.E.D. Displays; Interfacing to Keypads; Infra-red Remote Control; Using the 433MHz Transmitter/Receiver modules; Interfacing to Serial Devices; Temperature Measurement; Downloading the Computer's Time; Using the On-board A to D Converter; Advanced Programming Techniques; RS232 Serial Communications Demystified; Implementing Interrupts in BASIC; Temperature Data Logging Project.

**Offer available while stocks last**



**PRICES – UK £22.50** including VAT and p&p  
Other EU Countries **£28.50** including VAT  
and p&p  
Rest of the World **£26.50** including postage  
Please allow 7 working days for delivery – more for  
overseas orders

### SPECIAL EPE OFFER L.E.T. PIC BASIC PRO COMPILER

Please send me ..... (quantity) sets of L.E.T. PIC BASIC  
PRO Compiler

Name .....

Address .....

..... Post Code .....

I enclose cheque/P.O./bank draft to the value of £ .....  
Payable to Everyday Practical Electronics

Please charge my Visa/Mastercard/Amex/Diners Club/Switch

£ .....

Card No. ....

Card Security Code ..... (The last 3 digits on or just under  
the signature strip)

Expiry Date ..... Switch Issue No. ....

SEND TO: **Everyday Practical Electronics,  
Wimborne Publishing Ltd.,**

**408 Wimborne Road East, Ferndown, Dorset BH22 9ND.**

Tel: 01202 873872. Fax: 01202 874562.

**E-mail: orders@epemag.wimborne.co.uk**

Payments must be by card or in £ Sterling – cheque or bank  
draft drawn on a UK bank.

Normally supplied within seven working days of receipt of order.

Send a copy of this form, or order by letter if you do not wish to cut your issue.



We can supply back issues of *EPE* by post, most issues from the past three years are available. An *EPE* index for the last five years is also available at [www.epemag.wimborne.co.uk](http://www.epemag.wimborne.co.uk) or see order form below. Alternatively, indexes are published in the December issue for that year. Where we are unable to provide a back issue a photocopy of any *one article* (or *one part* of a series) can be purchased for the same price. Issues from Nov. 98 are available on CD-ROM – see next page – and issues from the last six months are also available to download from [www.epemag.com](http://www.epemag.com).

## DID YOU MISS THESE?

### JUNE '02

**PROJECTS** • Biopic Heartbeat Monitor • Frequency Standard Generator • Simple Audio Circuits – 2 • World Lamp.  
**FEATURES** • Teach-In 2002 – Part 8 • Interface • New Technology Update • Circuit Surgery • Ingenuity Unlimited • Net Work – The Internet Page.

### JULY '02

**PROJECTS** • EPE StyloPIC • Infra-Red Autoswitch • Simple Audio Circuits – 3 • Rotary Combination Lock.  
**FEATURES** • Teach-In 2002 – Part 9 • Practically Speaking • Using The PIC's PCLATH Command • Ingenuity Unlimited • Circuit Surgery • New Technology Update • Net Work – The Internet Page.

### AUG '02 Photocopies only

**PROJECTS** • PIC World Clock • Pickpocket Alarm • Big-Ears Buggy • Simple Audio Circuits – 4.  
**FEATURES** • Teach-In 2002 – Part 10 • Using Square Roots with PICs • Ingenuity Unlimited • Evolutionary Electronics • Interface • Circuit Surgery • Net Work – The Internet Page.

### SEPT '02 Photocopies only

**PROJECTS** • Freebird Glider Control • Portable Telephone Tester • EPE Morse Code Reader • Vinyl to CD Pre-amplifier.  
**FEATURES** • Circuit Surgery • New Technology Update • Practically Speaking • Net Work • Flowcode for PICmicro • Logic Gate Inverter Oscillators • Net Work – The Internet Page.

### OCT '02 Photocopies only



**PROJECTS** • EPE Bounty Treasure Hunter • IC Tester • Headset Communicator • PIC-Pocket Battleships.  
**FEATURES** • Circuit Surgery • New Technology Update • Logic Gate Inverter Oscillators – 2 • Interface • Network – The Internet Page • Using TK3 With Windows XP and 2000.

### NOV '02 Photocopies only

**PROJECTS** • EPE Hybrid Computer – 1 • Tuning Fork and Metronome • Transient Tracker • PICAXE Projects-1 (Egg Timer – Dice Machine – Quiz Game Monitor).  
**FEATURES** • Practically Speaking • Ingenuity Unlimited • Circuit Surgery • New Technology Update • Net Work – The Internet Page.

### DEC '02

**PROJECTS** • Versatile PIC Flasher • EPE Hybrid Computer – 2 • Door Defender • PICAXE Projects – 2 (Temperature Sensor – Voltage Sensor – VU Indicator).  
**FEATURES** • Electronic Paper • Alternative Uses for Transistors • Interface • Circuit Surgery • New Technology Update • Ingenuity Unlimited • Net Work – The Internet Page • 2002 Annual Index.

### JAN '03

**PROJECTS** • EPE Minder • FM Frequency Surfer • Wind Speed Meter • PICAXE Projects-3 (Chaser Lights).  
**FEATURES** • Who Really Invented The Transistor • TechnoTalk • Circuit Surgery • Practically Speaking • New Technology Update • Computer GOTOs • Ingenuity Unlimited • Net Work – The Internet Page.



### FEB '03

**PROJECTS** • Wind Tunnel • Brainbot Buggy • Back To Basics-1 (Hearing Aid, Audio Power Amplifier) • Tesla High Voltage Transformer.  
**FEATURES** • In The Bag • Techno Talk • Circuit Surgery • New Technology Update • Interface • Ingenuity Unlimited • Net Work – The Internet Page.

### MAR '03

**PROJECTS** • Wind-Up Torch Mk II • 200kHz Function Generator • Driver Alert • Back-To-Basics-2 (Metal Detector, Simple Timer).  
**FEATURES** • Ingenuity Unlimited • Practically Speaking • Techno Talk • New Technology Update • Circuit Surgery • Peak LCR Component Analyser Review • Net Work – The Internet Page.

### APR '03

**PROJECTS** • Atmospherics Monitor • Intelligent Garden Lights Controller • Back-To-Basics-3 (Touch Light, Plant Watering Reminder) • Earth Resistivity Logger-Part 1.  
**FEATURES** • Ingenuity Unlimited • Techno Talk • New Technology Update • Circuit Surgery • Interface • Network – The Internet Page • SPECIAL SUPPLEMENT – EPE PIC Tutorial V2-Part 1.

### MAY '03

**PROJECTS** • Super Motion Sensor • Earth Resistivity Logger – Part 2 • Door Chime • Back-To-Basics-4 (Live Wire Detector, Medium Wave Radio).  
**FEATURES** • Ingenuity Unlimited • Techno Talk • Practically Speaking • Circuit Surgery • Net Work – The Internet Page • SPECIAL SUPPLEMENT – EPE PIC Tutorial V2 – Part 2.

### JUNE '03

**PROJECTS** • Fido Pedometer • PICronos L.E.D. Wall Clock-Part 1 • Back-To-Basics-5 (Mini Theremin, Twilight Switch) • Radio Circuits-1 (Crystal Set, MK484 TRF Receiver, Headphone Amplifier).  
**FEATURES** • Ingenuity Unlimited • Techno Talk • Interface • Circuit Surgery • New Technology Update • Net Work – The Internet Page • SPECIAL SUPPLEMENT – EPE PIC Tutorial V2 – Part 3.

### JULY '03

**PROJECTS** • EPE Mini Metal Detector • Low Range Ohmmeter Adaptor Mk2 • Radio Circuits-2 (Q-Multiplier, MW Reflex Radio, Speaker Amplifier) • Ultimate Egg Timer • PICronos L.E.D. Wall Clock – Part 2.  
**FEATURES** • Ingenuity Unlimited • Circuit Surgery • Techno Talk • Practically Speaking • Flowlog Lite Review • Net Work – The Internet Page.



### AUG '03

**PROJECTS** • EPE PIC Met Office-1 • Alarm System Fault Finder • Master/Slave Intercom • Electronic Two-Up • Radio Circuits-3 (Regenerative Receivers).  
**FEATURES** • Digital Command Control for Model Trains • Ingenuity Unlimited • Circuit Surgery • Interface • Techno Talk • New Technology Update • Net Work – The Internet Page.

### SEPT '03

**PROJECTS** • PIC-A-Colour • Vibration Alarm • Priority Referee • EPE PIC Met Office-2 • Radio Circuits-4 (Tuning Systems).  
**FEATURES** • Using the PIC's "High" Operator • Practically Speaking • Ingenuity Unlimited • Techno Talk • Circuit Surgery • Net Work – The Internet Page.

## BACK ISSUES ONLY £3.50 each inc. UK p&p.

Overseas prices £4 each surface mail, £5.50 each airmail.

We can also supply issues from earlier years: 1998 (except Jan. to May, July, Sept., Nov., Dec.), 1999 (except Feb., May, Aug., Dec.), 2000 (except Feb.), 2001 (except May, Sept., Oct.), 2002 (except Aug. to Nov.) Where we do not have an issue a photocopy of any *one article* or *one part* of a series can be provided at the same price.

### ORDER FORM – BACK ISSUES – PHOTOCOPIES – INDEXES

- Send back issues dated .....
- Send photocopies of (article title and issue date) .....
- Send copies of last five years indexes (£3.50 for five inc. p&p – Overseas £4 surface, £5.50 airmail)

Name .....

Address .....

.....Tel: .....

I enclose cheque/P.O./bank draft to the value of £ .....

Please charge my Visa/Mastercard/Amex/Diners Club/Switch £ ..... Switch Issue No. ....

Card No. ....

Card Expiry Date ..... Card Security Code ..... (The last 3 digits on or just under the signature strip)

SEND TO: Everyday Practical Electronics, Wimborne Publishing Ltd., 408 Wimborne Road East, Ferndown, Dorset BH22 9ND.

Tel: 01202 873872. Fax: 01202 874562.

E-mail: [orders@epemag.wimborne.co.uk](mailto:orders@epemag.wimborne.co.uk) On-line Shop: [www.epemag.wimborne.co.uk/shopdoor.htm](http://www.epemag.wimborne.co.uk/shopdoor.htm)

Payments must be in £ sterling – cheque or bank draft drawn on a UK bank. Normally supplied within seven days of receipt of order.

Send a copy of this form, or order by letter if you do not wish to cut your issue.

M1003

# STORE YOUR BACK ISSUES ON MINI CD-ROMS



**VOL 8  
NOW AVAILABLE**

**ONLY  
£14.45** each  
including VAT  
and p&p

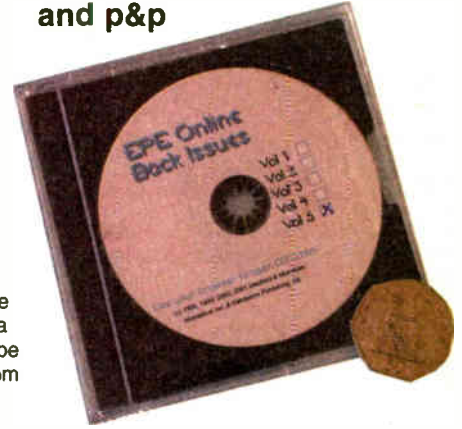

A great way to buy *EPE* Back Issues – our mini CD-ROMs contain back issues from our *EPE Online* website plus bonus articles, all the relevant PIC software and web links. Note: no free gifts are included. All this for just £14.45 each including postage and packing.

## VOL 1 CONTENTS

BACK ISSUES – November 1998 to June 1999

## VOL 2 CONTENTS

BACK ISSUES – July 1999 to December 1999

## VOL 3 CONTENTS

BACK ISSUES – January 2000 to June 2000

## VOL 4 CONTENTS

BACK ISSUES – July 2000 to Dec. 2000

## VOL 5 CONTENTS

BACK ISSUES – January 2001 to June 2001

## VOL 6 CONTENTS

BACK ISSUES – July 2001 to December 2001

## VOL 7 CONTENTS

BACK ISSUES – Jan 2002 to June 2002

## VOL 8 CONTENTS

BACK ISSUES – July 2002 to December 2002

## WHAT IS INCLUDED

All volumes include the full editorial content of every listed issue, plus all the available PIC Project Codes for the PIC projects published in those issues.

Note that no advertisements are included in Volumes 1 and 2; from Volume 5 onwards the available relevant software for *Interface* articles is also included.

## EXTRA ARTICLES – ON ALL VOLUMES

**BASIC SOLDERING GUIDE** – Alan Winstanley's internationally acclaimed fully illustrated guide. **UNDERSTANDING PASSIVE COMPONENTS** – Introduction to the basic principles of passive components. **HOW TO USE INTELLIGENT L.C.D.s**, by Julyan Ilett – An utterly practical guide to interfacing and programming intelligent liquid crystal display modules. **PhyzyB COMPUTERS BONUS ARTICLE 1** – Signed and Unsigned Binary Numbers. By Clive "Max" Maxfield and Alvin Brown. **PhyzyB COMPUTERS BONUS ARTICLE 2** – Creating an Event Counter. By Clive "Max" Maxfield and Alvin Brown. **INTERGRAPH COMPUTER SYSTEMS 3D GRAPHICS** – A chapter from Intergraph's book that explains computer graphics technology. **FROM RUSSIA WITH LOVE**, by Barry Fox – Russian rockets launching American Satellites. **PC ENGINES**, by Ernest Flint – The evolution of Intel's microprocessors. **THE END TO ALL DISEASE**, by Aubrey Scoon – The original work of Rife. **COLLECTING AND RESTORING VINTAGE RADIOS**, by Paul Stenning. **THE LIFE & WORKS OF KONRAD ZUSE** – a brilliant pioneer in the evolution of computers. A bonus article on his life and work written by his eldest son, including many previously unpublished photographs.

Note: Some of the EXTRA ARTICLES require WinZip to unzip them.

NOTE: These mini CD-ROMs are suitable for use on any PC with a CD-ROM drive. They require Adobe Acrobat Reader (available free from the Internet –

[www.adobe.com/acrobat](http://www.adobe.com/acrobat))

## Order on-line from

[www.epemag.wimborne.co.uk/shopdoor.htm](http://www.epemag.wimborne.co.uk/shopdoor.htm)

or [www.epemag.com](http://www.epemag.com) (USA \$ prices)

or by phone, Fax, E-mail or Post

## BACK ISSUES MINI CD-ROM ORDER FORM

Please send me ..... (quantity) BACK ISSUES CD-ROM VOL 1  
 Please send me ..... (quantity) BACK ISSUES CD-ROM VOL 2  
 Please send me ..... (quantity) BACK ISSUES CD-ROM VOL 3  
 Please send me ..... (quantity) BACK ISSUES CD-ROM VOL 4  
 Please send me ..... (quantity) BACK ISSUES CD-ROM VOL 5  
 Please send me ..... (quantity) BACK ISSUES CD-ROM VOL 6  
 Please send me ..... (quantity) BACK ISSUES CD-ROM VOL 7  
 Please send me ..... (quantity) BACK ISSUES CD-ROM VOL 8  
**Price £14.45 each** – includes postage to anywhere in the world.

Name .....

Address .....

.....

..... Post Code .....

I enclose cheque/P.O./bank draft to the value of £ .....

Please charge my Visa/Mastercard/Amex/Diners Club/Switch

£ .....

Card No. ....

Card Security Code ..... (The last 3 digits on or just under the signature strip)

Expiry Date ..... Switch Issue No. ....

**SEND TO: Everyday Practical Electronics,  
Wimborne Publishing Ltd.,**

**408 Wimborne Road East, Ferndown, Dorset BH22 9ND.**

Tel: 01202 873872. Fax: 01202 874562.

E-mail: [orders@epemag.wimborne.co.uk](mailto:orders@epemag.wimborne.co.uk)

Payments must be by card or in £ Sterling – cheque or bank draft drawn on a UK bank.

Normally supplied within seven days of receipt of order.

Send a copy of this form, or order by letter if you do not wish to cut your issue.

# FLOWLOG

datalogging • control • electrical measurement

## A NEW, LOW COST OSCILLOSCOPE, DATALOGGER AND CONTROL UNIT

**£99**  
+VAT

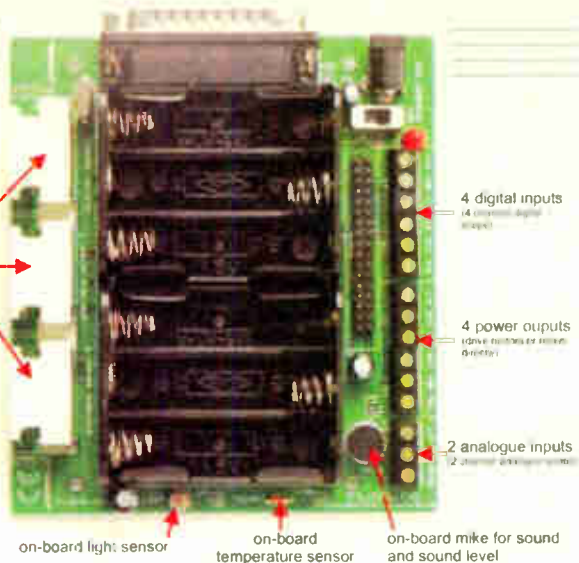

external sockets for a range of over 30 sensors including pH, current, ECG, temperature, magnetic field, humidity etc.

4 digital inputs (4 channels digital scope)

4 power outputs (4 channels analogue scope)

2 analogue inputs (2 channels analogue scope)

on-board light sensor

on-board temperature sensor

on-board mike for sound and sound level

FREE SOFTWARE APPLICATIONS INCLUDE:

2 channel analogue scope



4 channel digital scope

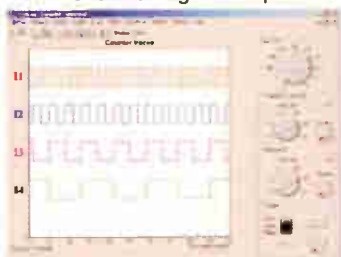

advanced datalogging software

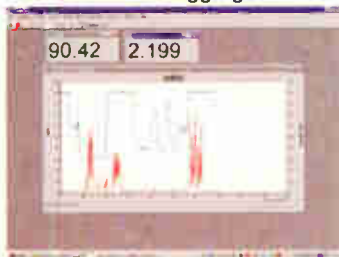

flexible control software



Flowlog is a new computer interface that provides datalogging, control and electrical measurement functions for use in science and electronics. Flowlog provides unrivalled value for money and performance. Please log onto our web site for full specification and description.

[www.matrixmultimedia.co.uk](http://www.matrixmultimedia.co.uk)  
[sales@matrixmultimedia.co.uk](mailto:sales@matrixmultimedia.co.uk)  
 t. 0870 700 1831 f. 0870 700 1832



## A COMPLETE RANGE OF INVERTERS 150W TO 2500W - 12V & 24V

A Complete range of regulated inverters to power 220V and 240V AC equipment via a car, lorry or boat battery. Due to their high performance (>90%) the inverters generate very little heat. The high stability of the output frequency (+/-1%) makes them equally suitable to power sensitive devices.



These inverters generate a modified sine wave, which are considerably superior to the square waves which are produced by most other inverters. Due to this superior feature they are capable of powering electrical equipment such as TV's, videos, desktop & notepad computers, microwave ovens, electrical lamps, pumps, battery chargers, etc.

### Low Battery Alarm

The inverters give an audible warning signal when the battery voltage is lower than 10.5V (21V for the 24V version). The inverter automatically shuts off when the battery voltage drops below 10V (20V for the 24V version). Fuse protected input circuitry.

| Order Code | Power            | Voltage | Was                | Price   |
|------------|------------------|---------|--------------------|---------|
| 651.581    | 150W Continuous  | 12V     | <del>£36.39</del>  | £29.72  |
| 651.578    | 150W Continuous  | 24V     | <del>£36.39</del>  | £29.72  |
| 651.582    | 300W Continuous  | 12V     | <del>£50.64</del>  | £41.93  |
| 651.585    | 300W Continuous  | 24V     | <del>£50.64</del>  | £41.93  |
| 651.583    | 600W Continuous  | 12V     | <del>£101.59</del> | £83.76  |
| 651.593    | 600W Continuous  | 24V     | <del>£101.59</del> | £83.76  |
| 651.587    | 1000W Continuous | 12V     | <del>£177.18</del> | £147.52 |
| 651.597    | 1000W Continuous | 24V     | <del>£177.18</del> | £147.52 |
| 651.602    | 1500W Continuous | 12V     | <del>£314.52</del> | £261.18 |
| 651.605    | 1500W Continuous | 24V     | <del>£314.52</del> | £261.18 |
| 651.589    | 2500W Continuous | 12V     | <del>£490.54</del> | £416.27 |
| 651.599    | 2500W Continuous | 24V     | <del>£490.54</del> | £416.27 |



ILLUSTRATION SHOWN IS 651.583 400W VERSION

All prices are inclusive of V.A.T. Carriage £8.00 Per Order

Many uses include:- \* Fetes \* Fairgrounds \* Airshows \* Picnics \* Camping \* Caravans \* Boats \* Carnivals \* Field Research and \* Amateur Radio field days \* Powering Desktop & Notepad Computers.



**B.K. ELECTRONICS**



UNIT 1, COMET WAY, SOUTHEND-ON-SEA, ESSEX. SS2 6TR  
 TEL.: +44(0)1702-527572 FAX.: +44(0)1702-420243

DELIVERY CHARGES ARE £6.00 PER ORDER. OFFICIAL ORDERS FROM SCHOOLS, COLLEGES, GOVT. BODIES, PLC'S, ETC. PRICES ARE INCLUSIVE OF V.A.T. SALES COUNTER. VISA AND ACCESS ACCEPTED BY POST, PHONE OR FAX, OR EMAIL US AT SALES@BKELEC.COM ALTERNATIVELY SEND CHEQUE OR POSTAL ORDERS MADE PAYABLE TO BK ELECTRONICS.

For Full Specifications View our web site at:-

[WWW.BKELEC.COM/INVERTERS.HTM](http://WWW.BKELEC.COM/INVERTERS.HTM)

# INTERFACE

Robert Penfold

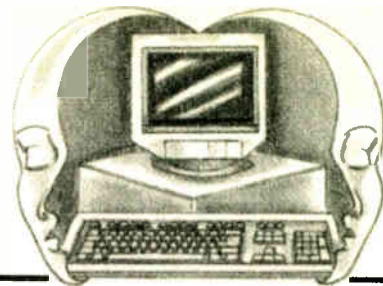

## INTERFACING VISUAL BASIC WITH THE NEW INPOUT32.DLL

INTERFACING via the PC parallel and serial ports port using `Inpout32.dll` has been covered in previous *Interface* articles, and in conjunction with Visual BASIC it represents what is probably the easiest means of using a PC with your own circuits. As regular readers will be aware, it does have a major flaw in that this add-on does not work with Windows NT4, 2000 or XP.

With Windows ME to be phased out in due course and many PC users having already changed to Windows XP, this is an increasing important failing. Fortunately, there is now an easy solution to the problem.

### Chat Line

I am grateful to John Becker (*Tech. Ed*) for pointing out an item in the *EPE Chat Zone* that gives the source of a new version of `Inpout32.dll` that will work with any version of Windows from 95 through to XP. In the original item Ian Stedman explained that it could be used to make the *EPE PIC Toolkit TK3* run under Windows NT/2000/XP, but the new version seems to have the same effect with any program designed for use with the original `Inpout32.dll`.

This means that these earlier programs should now work with Windows NT/2000/XP provided the new version of `Inpout32.dll` is used. It also means that users of these operating systems can now directly access the serial and parallel ports under Visual BASIC with a minimum of fuss.

### Recap

The original `Inpout32.dll` was written by Jan Axelson to accompany her books on interfacing PCs, but she kindly made it available as freeware. It works fine with Windows 95, 98, and ME, but not with Windows NT, etc., which do not permit programs to directly access ports. The new version is also freeware, and it is available from the Logix4U website: <http://www.logix4u.net/inpout32.htm>

This version accesses the ports via the operating system's approved channels, and it will therefore work with any 32-bit version of Windows. Although it operates in a rather different fashion, it is used in exactly the same way as the original.

The purpose of both versions is to add the `Inp` and `Out` commands to Visual BASIC. These commands are present in QBASIC and some other BASIC languages, but have never been a feature of Visual BASIC. They enable bytes of data to be written to or read from a specified port.

Using `Inpout32.dll` seems to have given some readers a few problems, so it is perhaps a good idea to go over the basics once again. It is very easy to use, but Visual BASIC does need a certain amount of help in order to find and utilise any `.dll` file.

It is simplicity itself to use if you are just running an *EPE* program that requires this file. Provided `Inpout32.dll` is in the same directory as the executable program file (the `*.exe` file), the program should work properly. The alternative is to place it in the `C:\windows\system` folder, where there will probably be a few thousand other `.dll` files.

The advantage of this method is that you can use the same copy of the file with several programs. Regardless of the location of the program, Windows will look in the system folder for `Inpout32.dll` and use the copy it finds in that location.

### A Bit More To Do

There is a bit more to do if you wish to write your own programs that utilise `Inpout32.dll`. This file must be available to Visual BASIC, and the easiest way of achieving this is to place it in the `C:\windows\system` folder. Next you have to give Visual BASIC the information it needs in order to use the added commands provided by the `.dll` file. There is a file with a `.BAS` extension that is provided with both versions of `Inpout32.dll`, and this must be loaded into Visual BASIC.

Start Visual BASIC in the normal way and opt to produce a standard EXE program file. Once the program has loaded, choose `Add File` from the `Project` menu. This is correct for Visual BASIC 6, but the `Add File` command might be under a different menu with other versions.

The usual file browser will appear, and this is used to locate and load the `BAS` file, which will be called something like `INPOUT32.BAS` or `INPOUTV4.BAS`. The `Inp` and `Out` commands are then ready for use, and they operate in the same way as the QBASIC equivalents. Note that the `BAS` file must be loaded each time that you start work on a program that uses the `Inp` and `Out` instructions.

### Proof of the Pudding

It is a good idea to try a simple test program to ensure that everything is working properly. For those new to `Inpout32.dll` a test program or two can also serve to demonstrate how the two new commands are used.

Enlarge the form slightly and equip it with a label, a timer, and a horizontal scrollbar. Select the timer component and using the `Properties` window set its interval at 50 milliseconds.

Next, select the scrollbar and use the `Properties` window to set its maximum value at 255. The minimum value must be 0, but it should have this setting by default. Make the label quite large and set a large font size (about 48 or 72 points).

The idea of the program is to output to a printer port the values produced via the scrollbar. In order to do this it is necessary to know the base address of the printer port.

These days most PCs only have one printer port, and it is usually at a base address of `&H378`. However, a few PCs use `&H3BC` as the base address. If there is a second printer port it is usually at `&H238`, but it will be at `&H378` if the first port has `&H3BC` as its base address.

The certain way of determining the base address of a port is to go into the `Windows Control Panel`, double-click the `System` icon, and then launch `Device Manager`. Expand the `Ports (COM and LPT)` section, select the appropriate port, and then operate the `Properties` button. In Windows XP either double-click the entry for the appropriate port or select it and then choose `Properties` from the `Action` menu.

In the `Properties` window operate the `Resources` tab, and the address range of the port will then be shown in the main

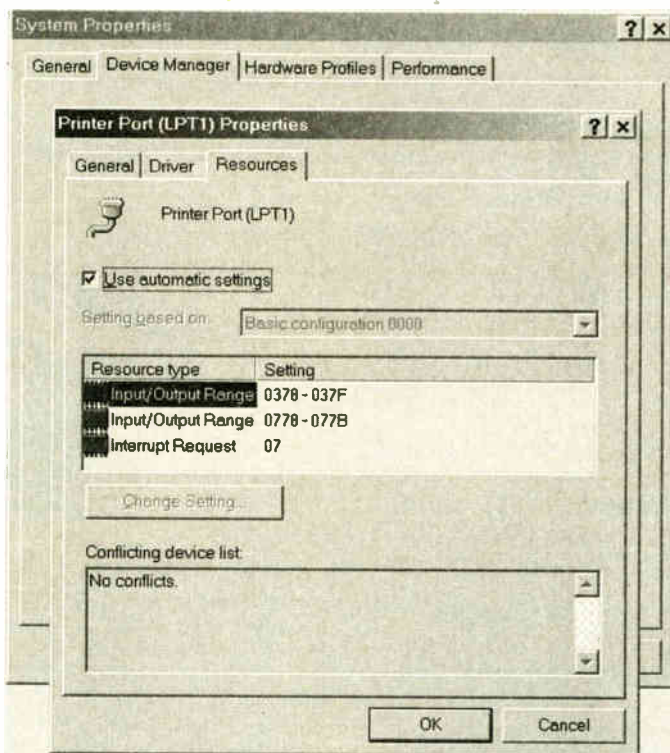

Fig. 1. Device Manager can be used to locate port addresses.

panel of the window (see Fig.1). It is the first figure in the entry at the top that provides the base address, and note that the values are in hexadecimal.

### It's a Scroll

In order to get the program to work it is merely necessary to double-click on the timer component to bring up the Code window, and then add these two lines of code into the timer's subroutine:

```
Out &H378, HScroll1.Value
Label1.Caption = HScroll1.Value
```

The first line outputs the current value of the scrollbar to the port at address &H378, which is the base address for printer port 1 on my PC. This address is used to write data to the port, so setting a value using the scrollbar should result in the corresponding bit pattern appearing on the data outputs. Of course, if the printer port has a different base address in your PC, this address must be used in the Out instruction.

The second line of code simply writes the scrollbar's value to the label. This enables the scrollbar to be adjusted to produce the required value. The program in operation is shown in Fig.2.

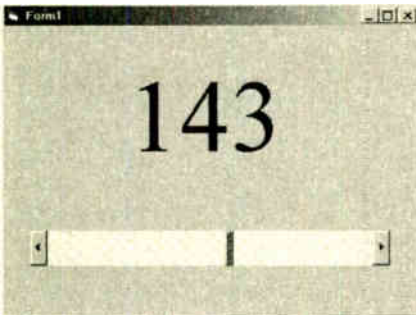

Fig.2. The output program in operation. It worked perfectly when tried with Windows XP.

When using the original version of **Inpout32.dll** it was not unusual for programs to give the outward appearance of normality. However, there could be error messages or other problems, but more usually the program ran and looked plausible, but did not actually read or write any data. Using the new **Inpout32.dll** the program ran properly under Windows XP with the correct bit patterns appearing on the printer port's eight data lines.

### Inputting

Inputting data from a port is equally straightforward. The same basic setup can be used for a program to read a port, but the scrollbar is not required. Double-click on the form and add this line of code into its subroutine:

```
Out &H37A, 32
```

This will write a value of 32 to a control register of the printer port, which sets its data lines to operate as inputs. The input mode requires a bidirectional printer port, but any PC built within the last seven years or so should have a suitable port.

Return to the form and double-click on the timer component. It is assumed here that the printer port's base address is &H378. The control register is at &H27A if the base address is &H278, or at &H3BE if the base address is &H3BC.

Next add this line of code to the timer's subroutine:

```
Label1.Caption = Inp(&H378)
```

The Inp instruction reads the data lines and the returned value is used as the caption for the label. Like QBASIC, Visual BASIC does not require any string conversions in order to get the returned value to display properly. The returned value will be automatically converted to the corresponding character string and displayed properly on the label.

The port reading program in operation under Windows XP is shown in Fig.3. Floating data lines are normally taken high by internal pull-up resistors, so a value of 255 will probably be returned if no input signals are applied to the port. In Fig.3 the D4 data line has been connected to ground and the display is reading the correct value of 239.

### Easy VB

The original **Inpout32.dll** was a really excellent add-on for PC interfacing, and with its Windows XP compatibility the new version is even better. There are numerous add-ons to permit Visual BASIC to communicate with the outside world, but most of them are difficult to use, or expensive, or unreliable, or all three! Using **Inpout32.dll** with a project tends to bring in enquiries from readers having difficulties, but Visual BASIC add-ons do not come any simpler than this one.

Remember that any program requiring this file can only work if the file is available to the system. If you download

an *EPE* program that uses **Inpout32.dll**, make sure that you also download this .dll file. Also make sure that it is available to the system.

Place it in the same folder as the program file or move it into the Windows System folder. If you wish to produce your own Visual BASIC programs using the Inp and Out commands, copy **Inpout32.dll** to the Windows System folder.

Do not forget to load the **Inpout32.BAS** file into Visual BASIC before you start using the Inp and Out commands. This seems to be a common error, but Visual BASIC will definitely not recognise the Inp and Out instructions until the file with the BAS extension has been loaded, even if **Inpout32.dll** is in the System folder.

The BAS file must be loaded each time a program that uses **Inpout32.dll** is started. There is no need to load it when you return to one of these programs, as it should be automatically loaded along with the rest of the project. Do not move or remove the BAS file, or Visual BASIC will not be able to find it and an error message will be produced. Remember to distribute **Inpout32.dll** with the programs that you produce. The programs will not function without it.



Fig.3. Operating under Windows XP, the port reading program also worked perfectly.

Using **Inpout32.dll** should be a doddle provided you stick to these simple guidelines. Although it has been used here to access a printer port, it can also be used for directly accessing the built-in serial ports. In fact any port can be accessed, but as few PCs have an ISA expansion port these days, the built-in serial and parallel ports are probably the only ones that can be usefully accessed.

Accessing the serial port using the new **Inpout32.dll** will be discussed in a future *Interface* article.



## EPE BINDERS



KEEP YOUR MAGAZINES SAFE – RING US NOW!

This ring binder uses a special system to allow the issues to be easily removed and re-inserted without any damage. A nylon strip slips over each issue and this passes over the four rings in the binder, thus holding the magazine in place.

The binders are finished in hard-wearing royal blue p.v.c. with the magazine logo in gold on the spine. They will keep your issues neat and tidy but allow you to remove them for use easily.

The price is £6.95 plus £3.50 post and packing. If you order more than one binder add £1 postage for each binder after the initial £3.50 postage charge (overseas readers the postage is £6.00 each to everywhere except Australia and Papua New Guinea which costs £10.50 each).

Send your payment in £'s sterling cheque or PO (Overseas readers send £ sterling bank draft, or cheque drawn on a UK bank or pay by card), to **Everyday Practical Electronics, Wimborne Publishing Ltd, 408 Wimborne Road East, Ferndown, Dorset BH22 9ND. Tel: 01202 873872.**

**Fax: 01202 874562.**  
**E-mail: editorial@epemag.wimborne.co.uk. Web site: http://www.epemag.wimborne.co.uk**  
**Order on-line from www.epemag.wimborne.co.uk/shopdoor.htm**



We also accept card payments. Mastercard, Visa, Amex, Diners Club or Switch (minimum card order £5). Send your card number and card expiry date plus



# PRACTICAL RADIO CIRCUITS

## RAYMOND HAIGH



### Part 5: Super-regeneration: A highly sensitive receiving system

*Circuits for the set builder and experimenter*

**T**HIS month we consider the technique known as super-regeneration. No other radio circuit, it is claimed, produces more gain from a single valve or transistor.

Readers who have access to a Frequency Counter may wish to use it as a digital readout dial for the Regenerative Receivers covered in Parts Three and Four, and the Direct Conversion receiver to be described later in the series. Details of a simple buffer amplifier for linking receiver to counter are given this month.

Before we tune-in to the subject of super-regeneration, readers may care to build the simple low-cost Crystal Marker calibration aid shown opposite. This is aimed particularly at last month's amateur bands receiver.

#### **SUPER-REGENERATION**

Regeneration, whereby positive feedback from an amplifier is used to cancel out losses in a tuned circuit and increase its  $Q$  factor, was covered at length in Part Three. For the greatest increase in sensitivity and selectivity, the feedback has to be sufficient to almost completely overcome the losses. A little more and the circuit oscillates and becomes unsuitable for processing signals (other than single-sideband transmissions).

In practice it is impossible to set and hold a  $Q$ -multiplier on the very threshold of oscillation when a signal is being received, and the ultimate sensitivity which regeneration can offer is never fully realised.

The super-regenerative receiver overcomes this by imposing an oscillating voltage on the  $Q$ -multiplier to repeatedly sweep it across the critical threshold. This "quench oscillation", as it is called, can be provided by a separate stage or the multiplier itself can be made to perform a dual function.

Quenching must be at a supersonic frequency or it will be heard as a tone in the headphones or loudspeaker. In practice, the signal frequency is usually more than

1000 times the quench frequency, and this confines the circuit to the radio spectrum above 20MHz.

#### **SENSITIVITY**

Oscillations in the super-regenerator build up from a signal voltage developed across the tuned circuit. In the absence of an external signal, the random movement of electrons, or "noise", triggers the action.

During the build-up, the amplitude of the oscillations can exceed that of the signal by as much as a million times. These phenomena give rise to the enormous sensitivity of the circuit and the loud hiss emitted by the speaker under no-signal conditions.

It is important that  $Q$ -multiplier oscillations die away during quench cycles or they will build up again from fading oscillations instead of the signal. Some means of controlling quench amplitude must, therefore, be provided.

#### **QUENCHING**

Signal frequency oscillations can be "quenched" before they reach their maximum amplitude. The peak amplitude of the oscillations is then proportional to signal voltage and the receiver is said to operate in the *linear* mode.

If the quenching action is such that the oscillations reach, or even momentarily rest at, their maximum value, the circuit is said to be in *logarithmic* mode. Signals across the tuned circuit then speed up the rate at which the oscillations rise to, and decay from, their maximum value.

Operation in logarithmic mode causes  $Q$ -multiplier current drain to

follow the signal modulation. Because of this, the circuit combines detection with signal amplification, delivering an audio output that has a logarithmic relationship to the applied signal.

This condition introduces noticeable distortion on a.m. (amplitude modulation), but the drawback is not so pronounced with f.m. (frequency modulation). Logarithmic operation imposes a limiting action on noise spikes and strong signals, and the inherent a.g.c. (automatic gain control) is very apparent.

In the case of separately quenched receivers, they can be made to operate in either mode. Self-quenching receivers, which are, in effect, squegging oscillators, operate logarithmically.

Whatever the mode, the enormous increase in selectivity afforded by regeneration or  $Q$  multiplication is lost when the circuit is re-configured as a super-regenerator. Moreover, the quenched oscillator radiates hash at signal frequencies and, unless precautions are taken, interferes with other receivers.

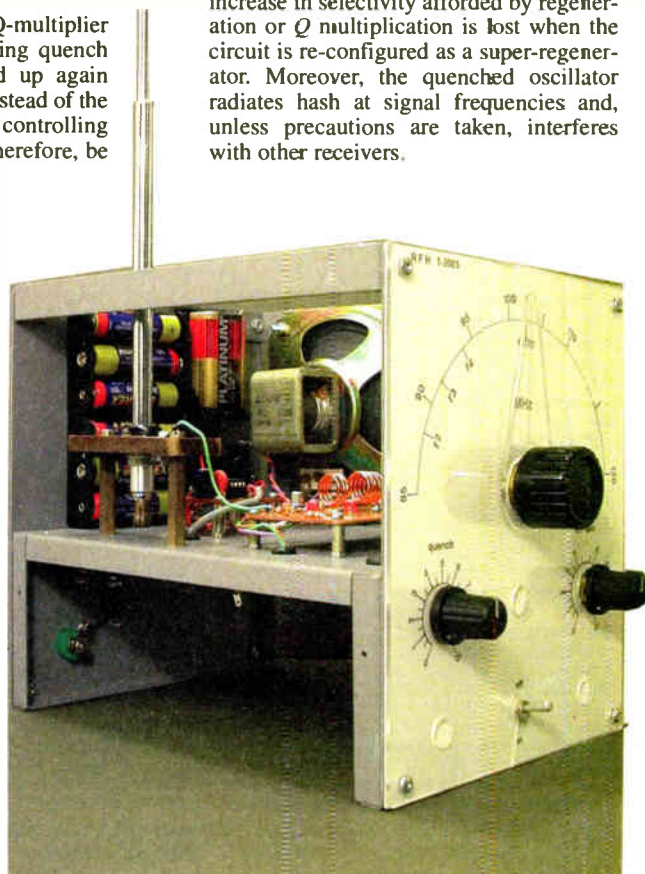

# COMPONENTS

## CRYSTAL MARKER

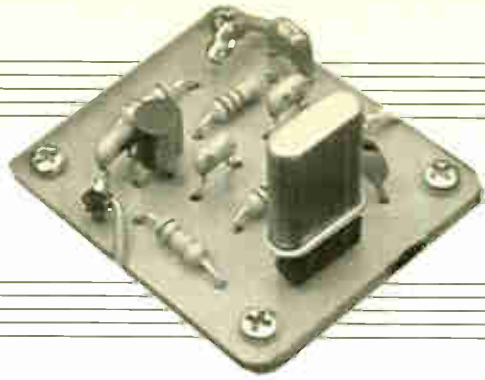

### Calibration aid

The amateur bands receiver described last month presents particular calibration problems. Signals can be weak and difficult to resolve; sometimes the bands are dead.

Constructors who do not have access to a calibrated receiver with a b.f.o. need some means of locating them. This can take the form of a simple and inexpensive crystal marker and, as the bands have a harmonic relationship, one crystal will pinpoint them all.

A circuit diagram for a simple amateur bands Crystal Marker is given in Fig.5.1, where transistor TR1 and crystal X1 are configured in Clapp's version of a Colpitt's oscillator. The crystal acts as a tuned circuit with high inductance, very low capacitance, extremely high *Q*, and exceptional stability.

Feedback from TR1 emitter is applied to the capacitance tap provided by C2 and C3. Crystal loading capacitor C1 is usually a 5pF to 60pF variable used to set the crystal frequency to its stated value against a known standard. The simpler circuit given here is accurate enough for our purposes.

Base bias is fixed by resistors R1 and R2, and TR1 emitter bias is developed across R4. Collector load resistor R3 must not be greater than R4 or oscillation will be inhibited. The signal output is taken from TR1 collector, via capacitor C4. Capacitor C5 avoids the possibility of erratic operation with ageing batteries.

The marker crystal used in this circuit is a 3.579545MHz component used in the colour sub-carrier circuitry of American

TV receivers. It is widely available at low cost. Its fundamental lies within the 80 metre band, the second harmonic within the 40 metre band (just outside the UK allocation), and the third harmonic within the 20 metre band.

### IN USE

If the marker unit is placed very close to the receiver, the coil cores can be adjusted until the relevant harmonic beats with the oscillating *Q*-multiplier to produce an audible tone. Band allocations, marker frequencies and harmonic numbers were listed last month in Table 4.1.

This particular circuit will oscillate with 1MHz to 15MHz crystals, and units cut to convenient round-figure frequencies can be used to calibrate the general coverage receiver's shortwave ranges. A 1MHz crystal will inject signals at reasonably close intervals. It is easy to lose track of the higher harmonics, and an 8MHz or 10MHz crystal is needed to provide unambiguous markers at higher frequencies.

### ASSEMBLY

The Crystal Marker unit is assembled on the printed circuit board illustrated in Fig.5.2, together with the p.c.b. foil master and wiring. This board is also available from the *EPE PCB Service*, code 415 (Marker). If it is to be used for general calibration purposes, a socket should be fitted so that the crystal can be changed easily.

### CRYSTAL MARKER

#### Resistors

|    |      |
|----|------|
| R1 | 100k |
| R2 | 120k |
| R3 | 680Ω |
| R4 | 1k2  |

All 0.25W 5% carbon film

See

**SHOP**  
**TALK**  
page

#### Capacitors

|        |   |
|--------|---|
| C1     | 27p polystyrene or ceramic "low k"          |
| C2, C3 | 220p polystyrene or ceramic "low k" (2 off) |
| C4     | 10p disc ceramic                            |
| C5     | 100n disc ceramic                           |

#### Semiconductors

|     |  |
|-----|--|
| TR1 | BC549C npn silicon transistor                        |
| X1  | 3.579545MHz crystal (American TV colour sub-carrier) |

#### Miscellaneous

|    |                        |
|----|------------------------|
| S1 | s.p.s.t. toggle switch |
|----|------------------------|

Printed circuit board available from the *EPE PCB Service*, code 415 (Crystal); plastic case, size 111mm x 57mm x 22mm approx.; 4mm terminal/socket (2 off); 2-pin crystal holder, cut from i.c. socket (3-pins, see text); 9V battery and holder; connecting wire; solder pins; solder etc.

Approx. Cost  
Guidance Only

**£9**

excl. case & batt.

The lead spacing on common HC-49/U and the lower profile U4 crystals is 4.88mm. This spans three pins on an i.c. holder, from which a socket can be cut.

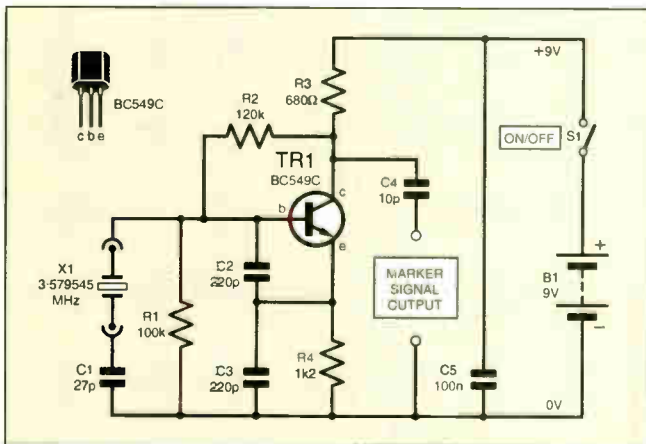
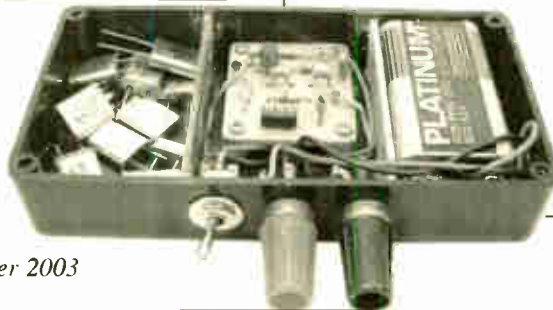
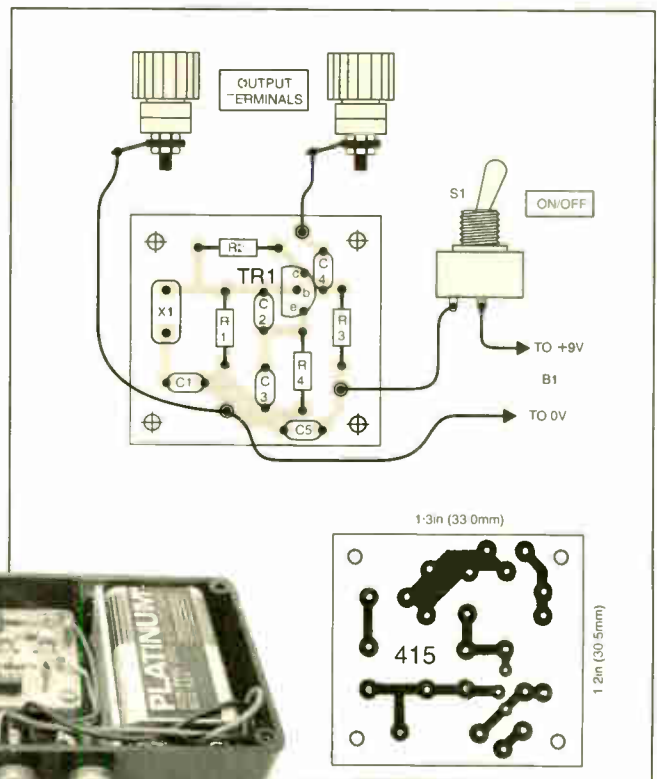

Fig.5.1. Circuit diagram for an amateur bands Crystal Marker.

Fig.5.2 (right). Crystal Marker printed circuit board component layout, interwiring and full-size copper foil master. Also shown is the completed prototype; note the spare crystal compartment.



# SUPER-REGENERATIVE RECEIVER

*A low-cost super sensitive three-band (85MHz to 150MHz) regenerative receiver*

## PRACTICAL CIRCUIT

A practical, semiconductor interpretation of a Super-Regenerative V.H.F. Receiver is shown in the circuit diagram of Fig.5.3. Originality is not claimed; the design is typical of many produced during the late sixties and seventies.

Grounded base signal amplifier TR1 isolates the regenerative detector TR2 from the aerial circuit. The audio preamplifier stage TR3 boosts the demodulated signal so that a decent loudspeaker output can be delivered by the simple audio power amplifier described in Part Two.

Emitter resistor R1 and bias resistors R2 and R3 fix the operating conditions of transistor TR1. Incoming signals from the aerial are applied to TR1 emitter via capacitor C1, and coupling coil L1 acts as the collector load. The stage is decoupled from the supply by R4 and C3, and C2 grounds TR1 base (b) at radio frequencies.

Input impedance is of the order of 50 ohms: a reasonable match to coaxial aerial cables. Quite short whip aerials are a quarter wavelength long at v.h.f., and they, too, can be adjusted to present a decent match.

The output from the r.f. stage is lightly coupled by L1 to the tuned circuit formed by coil L2 and tuning capacitor VC1. Increasing coupling to maximize signal transfer is likely to result in the erratic operation of the detector.

## REGEN. OSCILLATOR

Super-regenerative detector, TR2, is configured as a Colpitts oscillator. Colpitt's capacitor tapping is a little obscure with this v.h.f. version of his circuit. The internal gate-source capacitance of TR2 forms one element and trimmer capacitor VC2 the other. The trimmer presets the feedback that makes the transistor oscillate at the signal frequency.

The source (s) of TR2 is held at r.f. potential by r.f. choke L3 and C5 is a d.c. blocking capacitor. Quenching action is adjusted by potentiometer VR1, the range of control being confined to the critical region by resistor R6. Supply line decoupling is provided by R5 and C4, and this capacitor also eliminates potentiometer noise.

The tuning capacitor VC1 is one of the 5pF to 25pF f.m. gangs of a polyvaricon.

Stray capacitances with this simple receiver are comparatively low, and the swing is consequently too great for the required tuning range (88MHz to 108MHz). Moreover, if the tuning capacitance is too high, the super-regenerator will behave erratically or not function at all. Accordingly, fixed capacitor C6 reduces the maximum capacitance to suit the tuning range, and alternative values for different bands are given in Fig.5.5. Winding and construction details of the coils, including r.f. choke L3, are also depicted in Fig.5.5.

## AUDIO OUTPUT

An audio signal is developed across TR2 source resistor R7; and C7, R8 and C10 remove residual radio and quench frequencies. The signal is then applied to the base (b) of audio preamplifier TR3 by d.c. blocking capacitor C9.

The preamplifier stage is biased by R9 and emitter resistor R12. Resistor R11 forms TR3's collector (c) load which is shunted by capacitor C8 in order to attenuate the higher audio frequencies. Decoupling is effected by R10 and C14. Blocking capacitor C15 couples the output to Volume control potentiometer VR2.

Audio and radio frequency bypass capacitors, C12 and C13, ensure the

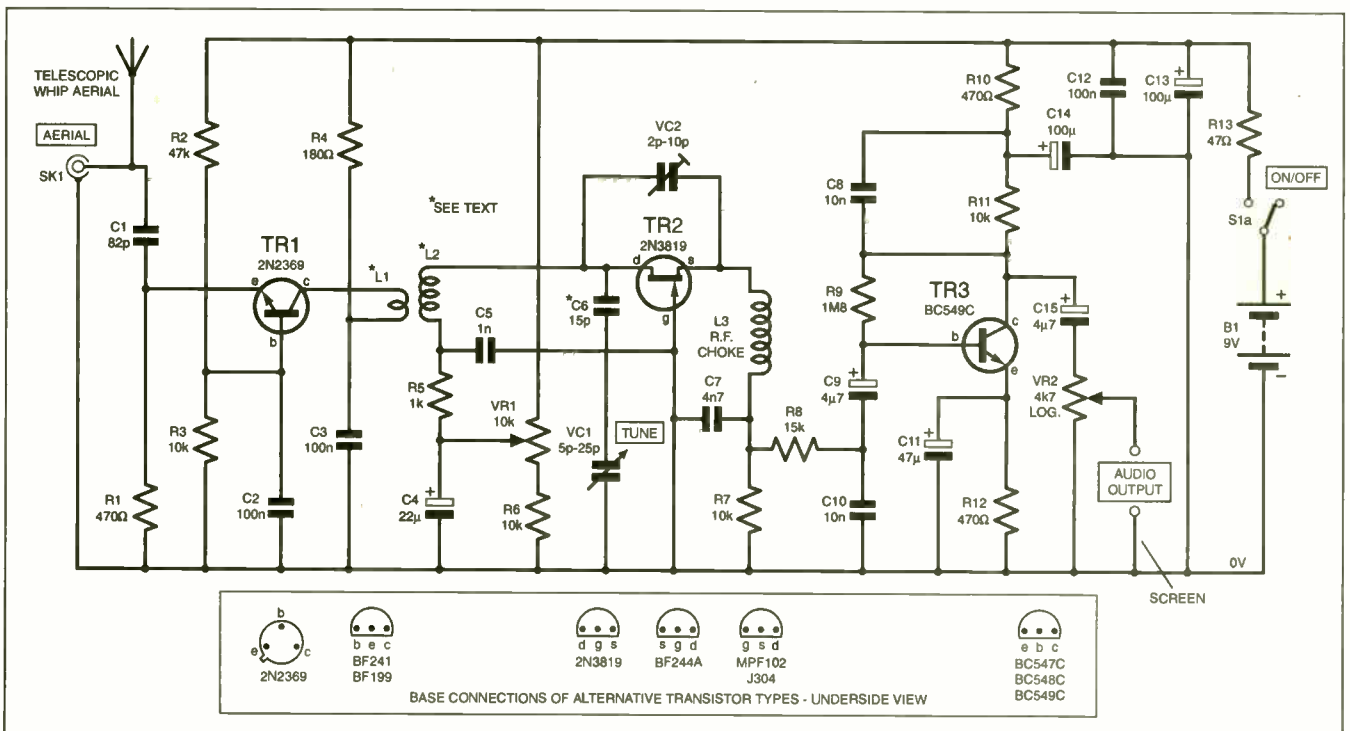

Fig.5.3. Full circuit diagram for a Super-Regenerative V.H.F. Receiver. Successful alternative semiconductors are shown inset. The other half of switch S1(b) controls the power supply to the simple Power Amp module from Part 2.



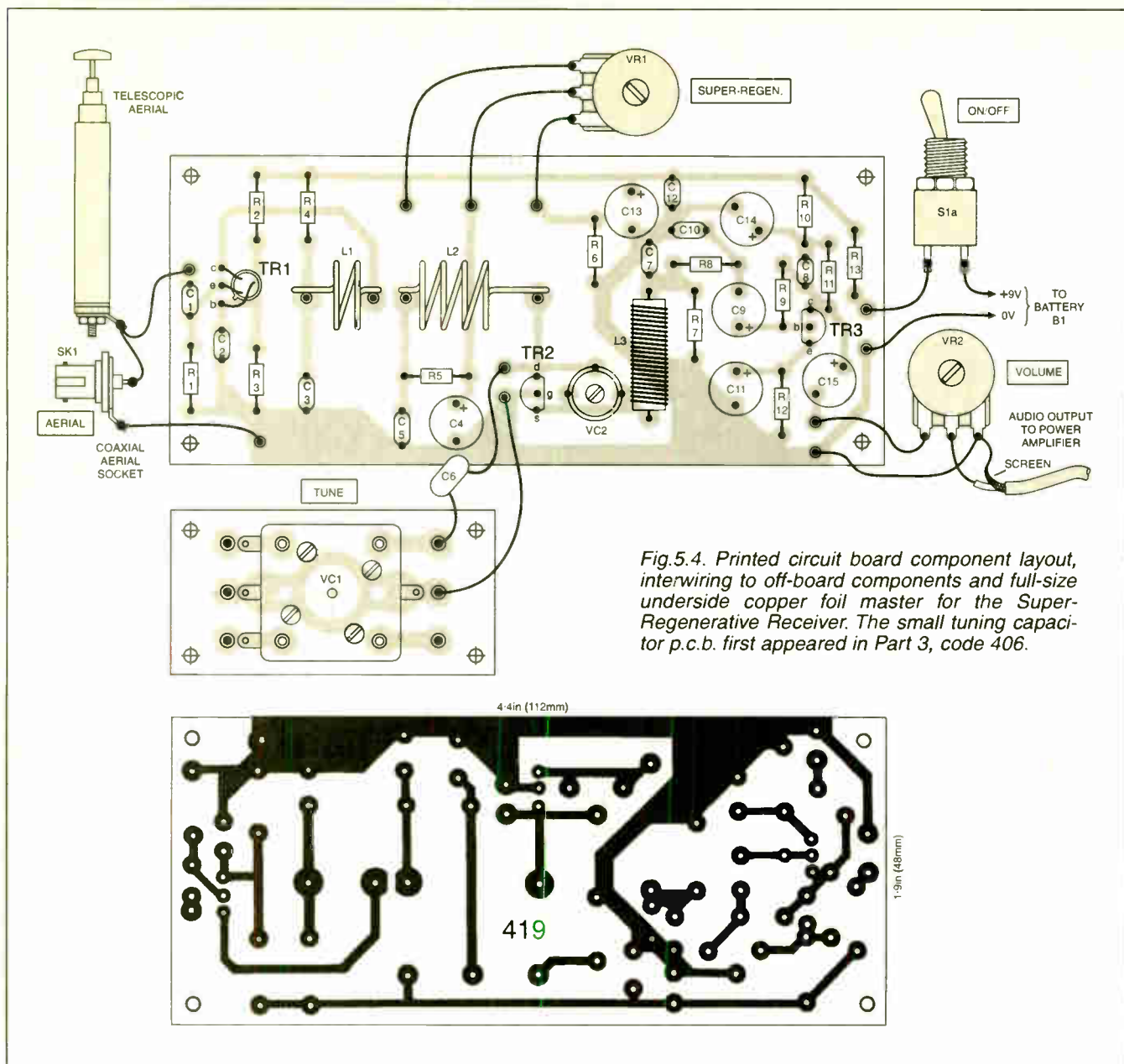

Fig.5.4. Printed circuit board component layout, interwiring to off-board components and full-size underside copper foil master for the Super-Regenerative Receiver. The small tuning capacitor p.c.b. first appeared in Part 3, code 406.

stability of the circuit, and resistor R13 isolates the battery and its supply leads at radio frequencies (signal pick-up by off-board wiring can make simple v.h.f. receivers behave erratically). The other half of the On/Off switch S1 (S1b) controls the supply to the audio power amplifier module, see Part Two.

As with the Regenerative Radio (Part 3), separate battery supplies for the receiver and audio power amplifier are strongly recommended. Even low power audio amplifiers can cause significant voltage swings on the supply rail and this will disturb the operation of receivers of this kind, even when decoupling is generous.

### SEMICONDUCTORS

Transistor types are not critical, and base connections for a number of alternative devices are included in Fig.5.3. The r.f. stage transistor, TR1, should have a high  $f_T$ , preferably not less than 500MHz.

Of all the devices tested in the TR2 position, only the 2N3819 would oscillate up to 150MHz, and available samples of J310 did *not* work well in this circuit. The suggested alternative transistors will,



Completed Super-Regen. circuit board.

however, function on the v.h.f. f.m. band. Any small-signal *npn* transistor should work in the TR3 position, but a low-noise device with an  $h_{fe}$  of 500 or more is to be preferred.

### CONSTRUCTION

All of the components, with the exception of tuning capacitor VC1, swing limiting capacitor C6 and potentiometers VR1 and VR2, are mounted on a single-sided printed circuit board. The topside component layout, full-size copper foil master

and the off-board wiring details are illustrated in Fig.5.4. This board is available from the *EPE PCB Service*, code 419, together with the small variable tuning capacitor p.c.b., code 406.

Begin construction by inserting solder pins at the lead-out and coil mounting points, then solder the resistors and capacitors in position. Mount the semiconductors last. The leads of TR1 and TR2 should be kept quite short: just leave sufficient to attach a miniature crocodile clip to act as a heat shunt during soldering.

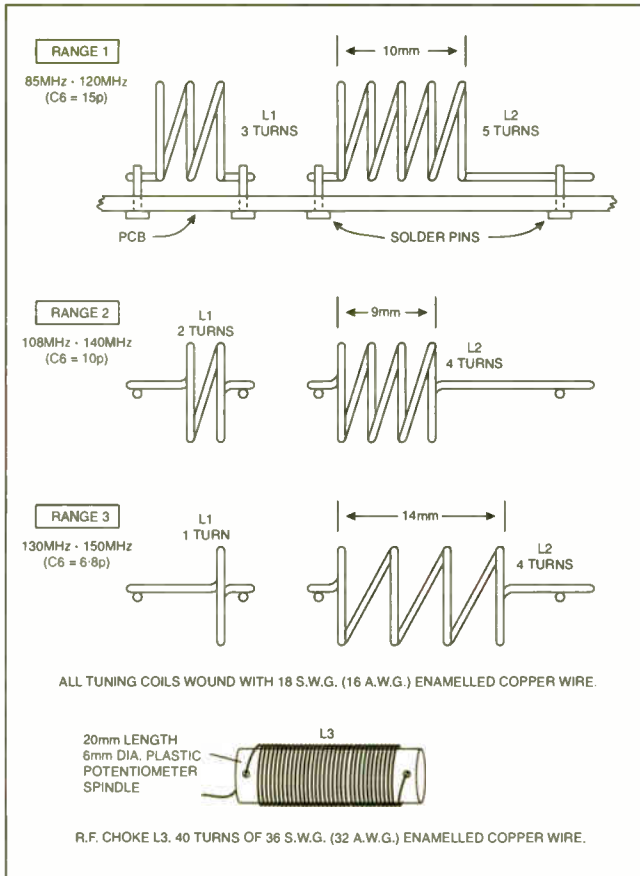

Fig. 5.5. Individual coils and r.f. choke details for the three tuning ranges. Tuning coils L1 and L2 both have a 10mm internal diameter. Wind around the shank of a 10mm drill

## COILS

The simple coils are hand-wound and full details are given in Fig. 5.5. Coupling and tuning coils, L1 and L2, are formed by winding them around the shank of a 10mm drill bit. Wind the turns on tightly, and bend the ends as shown in the diagram, before withdrawing the drill from the coil.

Radio frequency choke L3 is wound on a short length of 6mm diameter plastic potentiometer spindle (you could use a piece of wood dowelling). Holes, drilled close to the ends, secure the turns of wire.

Scrape the enamel from the wire until bright metal is exposed, then thoroughly "solder tin" the ends of the windings. Failure to make a perfect connection will prevent the receiver functioning at these frequencies.

Coupling and tuning coils are mounted on solder pins. The short, horizontal extension to the tuned winding permits the coil to be squeezed or extended to adjust its inductance and frequency coverage.

Quite small changes in coil dimensions, wiring and components have a significant effect on coverage at these frequencies. If, however, the receiver is constructed as described, the coils depicted in Fig. 5.5, should be within gentle "squeezing and pulling" range of the specified bands.

The Range 1 coils, which span the v.h.f. f.m. band, should be soldered in place first. Broadcast signals on these frequencies are strong and reliable, and this is of great assistance during the setting-up process. The Range 2 coils cover the v.h.f. Aircraft Band, and Range 3 the Two Metre Amateur band.

## TESTING

Check the printed circuit board for poor soldered joints and bridged tracks. Check the semiconductors and electrolytic capacitors are correctly orientated. If all is in order, the board can be tested on the workbench before being mounted on a chassis or in an enclosure.

Connect variable capacitor VC1 to the receiver p.c.b. using the leads of capacitor C6 as the "hot" connection, and wire up controls VR1 and VR2, see Fig. 5.4. Use screened audio/coaxial leads to connect the receiver to the audio power amplifier described in Part Two. Set the vanes of trimmer capacitor VC2 to quarter-mesh and connect the batteries, via S1. Current consumption should be in the region of 3mA.

Advance Quench control VR1 until a loud hiss is heard in the speaker, indicating that TR2 is oscillating and quenching or squegging. If the set seems dead, or if the hiss dies away at the maximum or minimum setting of the tuning capacitor, adjust trimmer VC2. The setting of VC2 is fairly critical and varies from transistor to transistor. It should, however, lie between 10 percent and 50 percent of full mesh.

Now connect a short length of flex (about 600mm or 24in.) to act as an aerial, and rotate tuning capacitor VC1 very slowly. Broadcast transmissions should be heard. When they have been identified, coil L2 can be compressed or expanded until the entire band is covered.

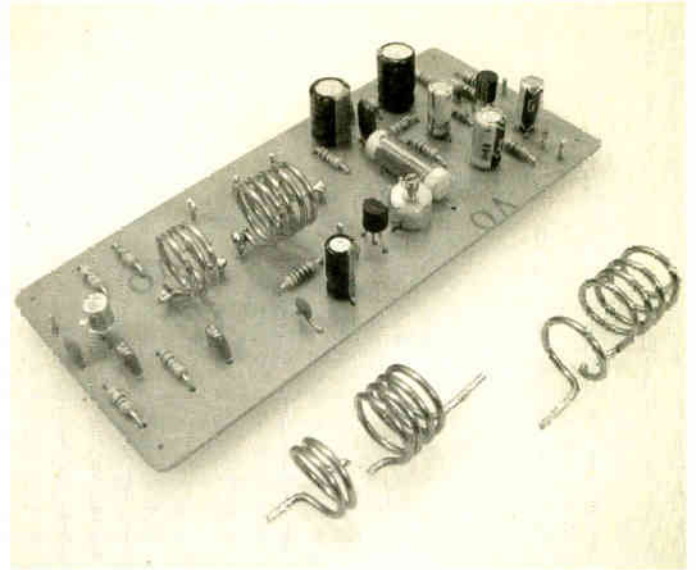

Completed receiver board with alternative bands coils.

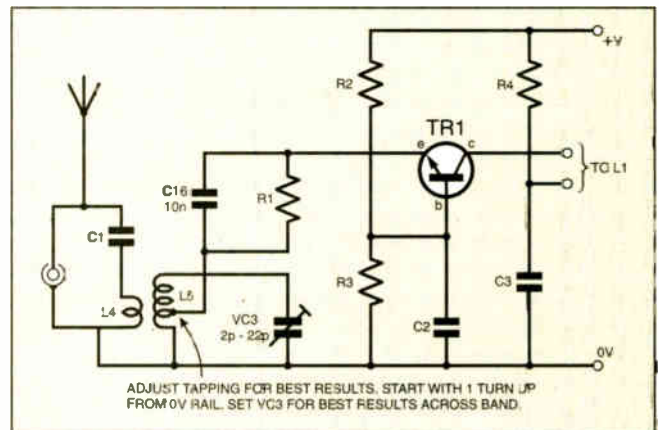

Fig. 5.6. Circuit diagram for a simple front-end modification for tuning the input to the receiver. Note that L4 and L5 are identical to L1 and L2.

Despite the fairly broad selectivity of the super-regenerative detector, tuning at these frequencies is quite critical. Demodulation of the f.m. signal is achieved by tuning the receiver onto the carrier's side skirts. There are thus two, closely spaced, points on the dial where each station can be heard comparatively free from distortion.

After tuning the receiver, refine the adjustment of Quench control VR1: best results will usually be obtained with it set as low as possible.

## ASSEMBLY

The printed circuit board and tuning capacitor must be rigidly mounted and located so that the wiring between the two is as short as possible. Indeed, the back of the capacitor should almost touch the receiver p.c.b. Tuning will be considerably eased if tuning capacitor VC1 is fitted with some form of slow-motion drive.

The accompanying photographs show the board and VC1 mounted on the metal chassis and front panel used to evaluate other receivers in the series. The arrangement works well and the printed circuit board is reasonably accessible for coil changing.

If an aluminium box is used as an enclosure, make sure it is big enough for the coupling and tuning coils to be spaced at least 25mm (1 in.) from its metal sides.

## SUPER-REGEN. RECEIVER

### Resistors

|                 |              |
|-----------------|--------------|
| R1, R10, R12    | 470Ω (3 off) |
| R2              | 47k          |
| R3, R6, R7, R11 | 10k (4 off)  |
| R4              | 180Ω         |
| R5              | 1k           |
| R8              | 15k          |
| R9              | 1MΩ          |
| R13             | 47Ω          |

All 0.25W 5% carbon film

### Potentiometers

|     |                         |
|-----|-------------------------|
| VR1 | 10k rotary carbon, lin. |
| VR2 | 4k7 rotary carbon, log. |

### Capacitors

|              |  |
|--------------|--|
| C1           | 82p disc ceramic   |
| C2, C3, C12  | 100n disc ceramic (3 off)                                    |
| C4           | 22μ radial elect. 16V  |
| C5           | 1n disc ceramic  |
| C6 (Range 1) | 15p ceramic "low k"  |
| (Range 2)    | 10p ceramic "low k"  |
| (Range 3)    | 6p8 ceramic "low k"  |
| C7           | 4n7 polyester  |
| C8, C10      | 10n disc ceramic (2 off)                                     |
| C9, C15      | 4μ7 radial elect. 16V (2 off)                                |
| C11          | 47μ radial elect. 16V  |
| C13, C14     | 100μ radial elect. 16V (2 off)                               |
| C16          | 10n disc ceramic (optional – see text)                       |
| VC1          | 5p to 25p polythene dielectric variable capacitor (see text) |

See  
**SHOP**  
**TALK**  
page

|     |  |
|-----|--|
| VC2 | 2p to 10p min. film dielectric trimmer capacitor             |
| VC3 | 2p to 25p min. film dielectric trimmer (optional – see text) |

### Semiconductors

|     |  |
|-----|--|
| TR1 | 2N2369 <i>n</i> pn small signal, high frequency transistor |
| TR2 | 2N3819 <i>n</i> -channel field effect transistor           |
| TR3 | BC549C <i>n</i> pn low power general purpose transistor    |

### Miscellaneous

|                  |   |
|------------------|---|
| L1, L2, (L4, L5) | hand-wound with 18s.w.g. (16a.w.g.) enamelled copper wire – see text and Fig.5.5) |
| L3               | r.f. choke, hand-wound with 36s.w.g. (32a.w.g.) – see Fig.5.5                     |
| S1               | d.p.s.t. toggle switch  |
| SK1              | coaxial aerial socket   |

Printed circuit board available from the *EPE PCB Service*, code 419 (Super-Regen.) and optional 406 (T/Cap); 50g (2oz) reel 18s.w.g. (16a.w.g.) enamelled copper wire for coils; 50g (2oz) 36s.w.g. (32a.w.g.) enamelled copper wire for r.f. choke; 20mm approx. length, 6mm dia., plastic rod for r.f. choke former; one large and two small control knobs; telescopic whip aerial (optional); tagstrip (see text); batteryholder, with clips; slow-motion drive, spindle extender and/or coupler (optional – see text); multistrand connecting wire; solder pins; solder etc.

## ALTERNATIVE TUNING

The electronic tuning (Varicap Tuner) system, described last month, can be used with this receiver; at least on the v.h.f. f.m. band. The fine-tuning version, incorporating a BB105 varicap diode, should be built, and the connections between the boards must be as short as possible.

The varicap diode bias supply can be taken from the battery used to power the receiver. When this arrangement is adopted, it is *imperative* that the audio power amplifier be connected to a separate battery.

Readers who wish to carry out serious experiments with super-regenerative receivers should fit an air-spaced variable

capacitor with ceramic insulation. A Jackson C804 with a 3pF to 10pF swing would be suitable, and series capacitor C6 would only be required on Range 3. The slightly higher *Q* of the air-spaced component should help to maximize the operating frequency of the circuit.

## R.F. STAGE TUNING

The grounded-base r.f. stage (TR1) isolates the super-regenerative detector from the aerial, helps to reduce the radiation of oscillator "hash", and makes the performance of the receiver more predictable. However, the simple arrangement adopted here provides little or no signal gain, and readers may wish to try an additional tuned circuit at the input in an attempt to improve performance.

The circuit diagram for a simple front-end modification is given in Fig.5.6. Aerial coupling coil L4 and the additional tuned winding L5 are duplicates of L1 and L2. A 2pF to 22pF trimmer capacitor, VC3, tunes L5 to the centre of the band.

Emitter resistor R1 is connected to the 0V rail via a tapping on L5. One turn above the 0V rail is a good starting point, but the position which gives the best signal-to-noise ratio should be found by trial and error. The emitter resistor R1 must be bypassed by additional capacitor C16.

Increasing TR1's collector current may improve performance. To do this, connect resistors ranging in value from 100 kilohms to 22 kilohms in parallel with R2 (the lower the value the greater the current).

The additional coils and trimmer capacitor can be mounted on a short solder tagstrip, and L4 and L5 must be orientated at right angles to L1 and L2. If the

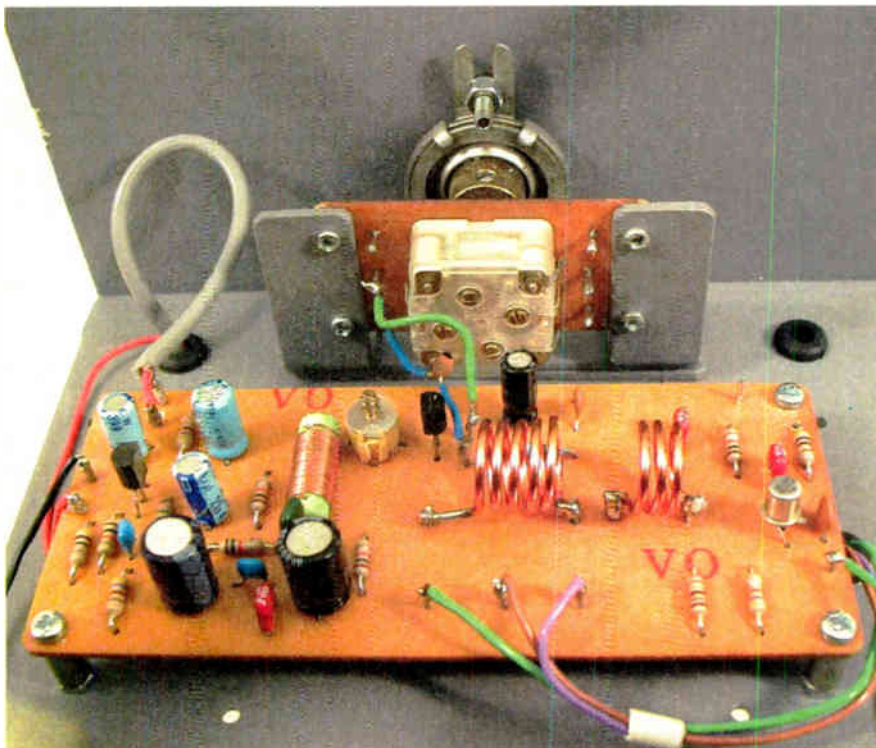

Super-Regen. Receiver board mounted on the metal chassis, via stand-off pillars, and wired to the tuning capacitor.

## HISTORY

The discovery of super-regeneration is attributed to that great American radio pioneer, Howard H. Armstrong. In presenting his paper on the technique to the American Institute of Radio Engineers in 1922, he paid tribute to the earlier work of Turner and Bolitho. L. B. Turner had used critical biasing to hold a valve on the threshold of oscillation and make a signal-activated relay more sensitive. Bolitho patented a refinement of Turner's design in which the mechanical relay was replaced by a valve.

RCA purchased Armstrong's patents and various experimenters made attempts to apply the technique to medium wave reception which, by that time, had growing commercial importance in the USA. Designs usually incorporated a small frame aerial to overcome shortcomings in selectivity, and crude audio filtering to reduce the whistle from quenching oscillations.

For reasons already outlined in the main text, the circuit is unsuited to amplitude modulated broadcast reception, particularly on medium waves. Not surprisingly, therefore, the concept was not taken up by domestic receiver manufacturers, and ownership of the patent rights failed to produce much income for RCA (Radio Corporation of America).

During the twenties and thirties the circuit was used extensively by the police and emergency services. The Second World War saw the technique adopted for I.F.F (identification-friend-or-foe) responders. These devices received a radar pulse and responded, with a minimum of delay, by transmitting an identifying signal.

German air interception radar systems also relied upon the circuit. Perhaps the best known of these war-time applications was the American "walky-talky", in which the super-regenerative detector doubled as the transmitter valve.

The post-war years saw the establishment of high-quality frequency modulation broadcasting systems in Europe and America. In 1947, B. D. Loughlin developed a design for a double-triode (12AT7) super-regenerative f.m. tuner, one valve being used as a frequency changer, the other as the detector. Known as the "Fremodyne", the circuit was licensed by the American Hazeltine Electronics Corporation. Whilst the Fremodyne suffered all of the defects super-regenerators are prone to, it did have the advantages of simplicity and low cost.

At the present time, super-regeneration is still used for simple toy and model control receivers, car central locking and garage door opening systems.

modification causes instability, fix a metal screen between the tagstrip and the printed circuit board.

## PERFORMANCE

This simple Super Regen. circuit effectively demonstrates the extremely high sensitivity of Armstrong's super-regenerative system. Frequency stability is remarkably good, hand-capacitance effects are not too pronounced and the super-regeneration

control is smooth and effective. Automatic gain control action (a.g.c.) is very evident, and the loud hissing which characterizes circuits of this kind is completely suppressed by a strong signal.

On the v.h.f. f.m. band, careful adjustment of the tuning and super-regeneration controls enables an acceptable compromise to be struck between audio output and distortion. However, as constructors of the Hazeltine Fremodyne (including the

author) found, performance falls short of a conventional superheterodyne receiver with a ratio detector or Foster-Seeley discriminator as the signal demodulator.

Domestic f.m. superhets have seven or more tuned circuits and perhaps five transistors amplifying at radio frequencies. A basic super-regenerator has only one tuned circuit and one valve or transistor providing gain at radio frequencies. Armstrong's genius continues to inspire.

## BUFFER AMPLIFIER

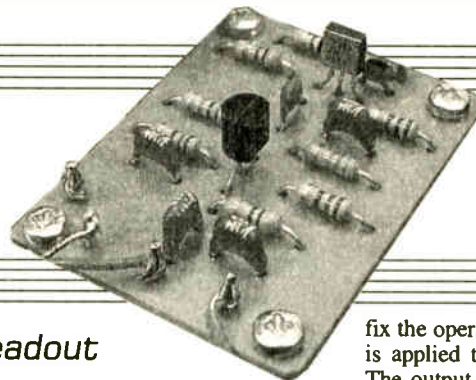

### Adding tuned frequency digital readout

Some readers who have built one of the versions of the regenerative radios described in Parts Three and Four will have access to a Digital Frequency Counter, and they may wish to use it to give a digital readout of receiver tuning.

Damping of the receiver's tuned circuit must be kept to an absolute minimum, and the signal levels across it are usually too low to reliably trigger most frequency counters. Direct connection is, therefore, out of the question, and a buffer amplifier must be placed between the two units.

### BUFFER CIRCUIT

The circuit diagram for a suitable Buffer Amplifier is given in Fig.5.7.

Field-effect transistor TR1 is arranged as a common drain or source follower stage. Its high input impedance, together with the low value of coupling capacitor C1 minimises disturbance and damping to the receiver's tuned circuit. The d.c. potential on TR1 gate is held at 0V by resistor R1 and TR1's output is developed across source load resistor R3. Supply rail decoupling is provided by R2 and C2.

The circuit output stage consists of an r.f. transistor, TR2, configured as a common-emitter amplifier. Bias resistors R4 and R5

fix the operating conditions, and the signal is applied to TR2 base via capacitor C3. The output signal is taken from TR2 collector to the Frequency Counter, via capacitor C6. The collector load resistor is R7, and R6 and C5 decouple the output stage.

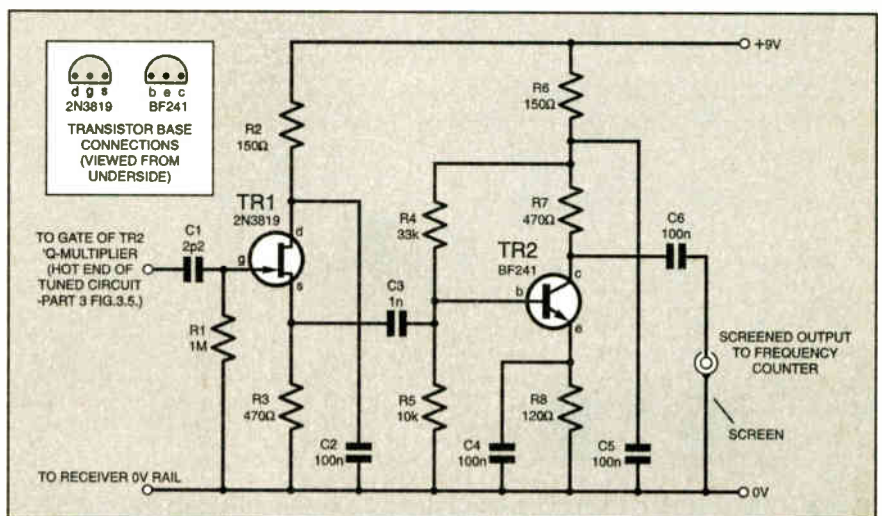

Fig.5.7. Circuit diagram for a Buffer Amplifier for a Digital Frequency Counter. A frequency counter, connected to the tuned circuit via this buffer, will give a digital display of the receiver tuning. This arrangement is NOT suitable for the Super-Regen. Receiver – see text.

# COMPONENTS

## BUFFER AMP.

### Resistors

|        |              |
|--------|--------------|
| R1     | 1M           |
| R2, R6 | 150Ω (2 off) |
| R3, R7 | 470Ω (2 off) |
| R4     | 33k          |
| R5     | 10k          |
| R8     | 120Ω         |

See  
**SHOP  
TALK**  
page

All 0.25W 5% carbon film

### Capacitors

|        |                  |
|--------|------------------|
| C1     | 2p2 disc ceramic |
| C2, C4 | to C6            |
| C3     |                  |

### Semiconductors

|     |   |
|-----|---|
| TR1 | 2N3819 <i>n</i> -channel field effect transistor          |
| TR2 | BF241 <i>n</i> pn small signal, high frequency transistor |

### Miscellaneous

Printed circuit board available from the *EPE PCB Service*, code 420; input connector, to suit frequency counter; single-core screened audio cable; multi-strand connecting wire; solder pins; solder etc.

Approx. Cost  
Guidance Only

£8

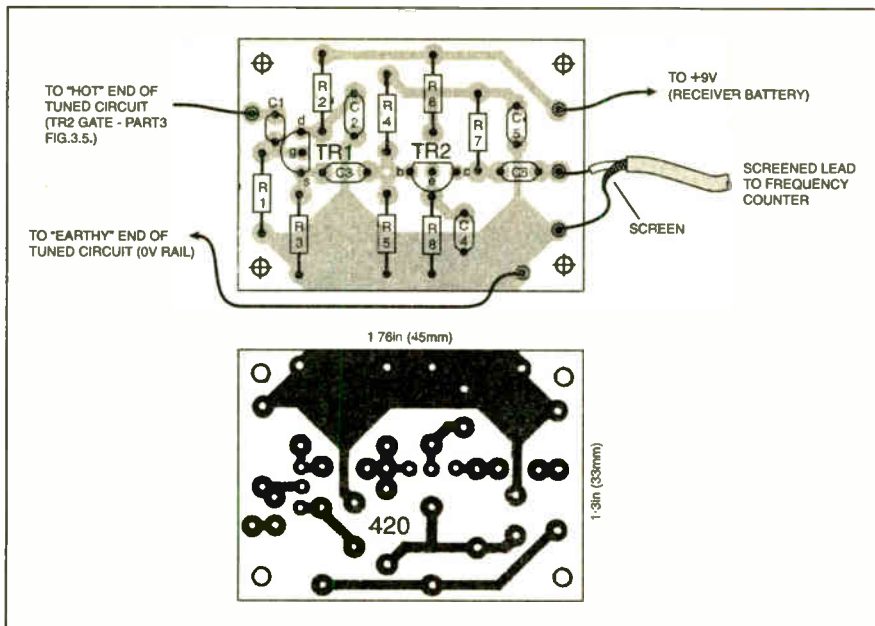

Fig. 5.8. Buffer Amplifier printed circuit board component layout, wiring details and full-size copper foil master.

Most *n*-channel field-effect transistors will prove suitable for TR1. The BF199, BF494 and 2N222A were in-circuit tested in the TR2 position and they all worked well. Base connections vary and should be checked.

## CONSTRUCTION

All of the Buffer Amp. components are mounted on a small printed circuit board and the component layout, copper foil master and wiring details are shown in Fig. 5.8. This board is available from the *EPE PCB Service*, code 420.

Solder pins at the lead-out points simplify the off-board wiring, and they should be inserted into the p.c.b. first. Follow these with the resistors, then the capacitors and, finally, the transistors. As before, keep the transistor leads just long enough to permit the use of a miniature crocodile clip as a heat shunt during soldering.

## TESTING

Check the printed circuit board for poor soldered joints and bridged tracks, and check the positioning of the transistors. Connect the unit to a 9V supply. Current consumption should be in the region of 7mA.

Make a very short connection, certainly no more than 75mm (3in.), between the buffer amplifier's input and the "hot" end of the receiver's tuned circuit. Connect the amplifier's 0V rail to the ground or 0V tap on the tuning capacitor. Power for the amplifier can be taken from the receiver battery.

Connect the output from the buffer amplifier to the Frequency Counter via a short (no more than 600mm or 24in.) length of screened cable.

## OPERATION

Set the counter's input controls, tune in a station and advance the regeneration control, turning down the receiver's input attenuator, as necessary. When tuning is correct and the regeneration setting has been optimized, the counter should display the "tuned" frequency.

The counter will normally only give a frequency reading when a station is tuned in. To check tuning on a quiet part of the dial, advance the regeneration control until the Q-multiplier is oscillating. The counter will then display the operating frequency.

When receiving single-sideband signals the regeneration control has to be advanced until the Q-multiplier is oscillating in order to replace the carrier suppressed at the transmitter. The counter will, therefore, give a continuous frequency readout as the receiver is tuned across the amateur bands.

## OTHER RECEIVERS

The Buffer Amplifier and Frequency Counter combination cannot be used with the Super-Regen. Receiver. Here the oscillating stage is "squegging" and the

counter cannot distinguish between signal and quenching frequencies. Moreover, buffer amplifier loading, although extremely light, makes detector operation erratic.

The arrangement is also unsuitable for superhet receivers (*to be offered in a later issue*) in which the oscillator runs at a higher frequency than the reception frequency. Additional circuitry is required to accommodate the difference.

Direct conversion receivers incorporate an oscillator that operates at signal frequency. The Buffer Amplifier and counter set-up will, therefore, form an accurate digital tuning display. Widely used by amateur radio enthusiasts for the reception of single-sideband transmissions, this receiving system will be covered next month.

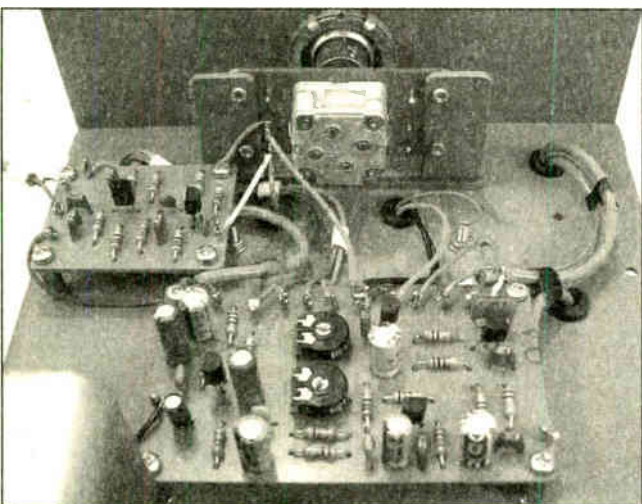

The Buffer Amplifier wired to the Regenerative Radio (Part 3) and the tuning capacitor p.c.b.s.

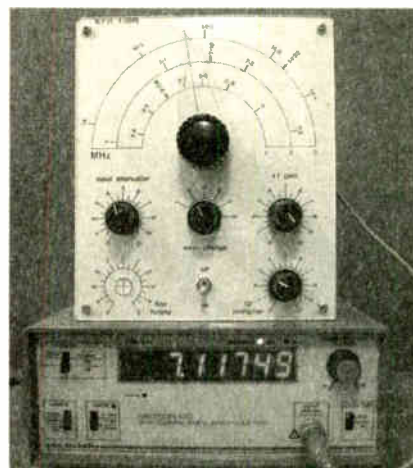

A frequency counter wired, via the Buffer Amplifier, to the Regenerative Radio and showing an amateur band frequency readout.

# EPE IS PLEASED TO BE ABLE TO OFFER YOU THESE ELECTRONICS CD-ROMS

## ELECTRONICS PROJECTS



Logic Probe testing

*Electronic Projects* is split into two main sections: **Building Electronic Projects** contains comprehensive information about the components, tools and techniques used in developing projects from initial concept through to final circuit board production. Extensive use is made of video presentations showing soldering and construction techniques. The second section contains a set of ten projects for students to build, ranging from simple sensor circuits through to power amplifiers. A shareware version of Matrix's CADPACK schematic capture, circuit simulation and p.c.b. design software is included.

The projects on the CD-ROM are: Logic Probe; Light, Heat and Moisture Sensor; NE555 Timer; Egg Timer; Dice Machine; Bike Alarm; Stereo Mixer; Power Amplifier; Sound Activated Switch; Reaction Tester. Full parts lists, schematics and p.c.b. layouts are included on the CD-ROM.

## ELECTRONICS CAD PACK

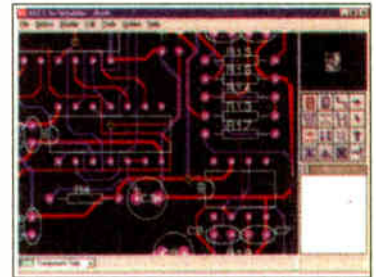

PCB Layout

Electronics CADPACK allows users to design complex circuit schematics, to view circuit animations using a unique SPICE-based simulation tool, and to design printed circuit boards. CADPACK is made up of three separate software modules. (These are restricted versions of the full Labcenter software.) **ISIS Lite** which provides full schematic drawing features including full control of drawing appearance, automatic wire routing, and over 6,000 parts. **PROSPICE Lite** (integrated into ISIS Lite) which uses unique animation to show the operation of any circuit with mouse-operated switches, pots, etc. The animation is compiled using a full mixed mode SPICE simulator **ARES Lite** PCB layout software allows professional quality PCBs to be designed and includes advanced features such as 16-layer boards, SMT components, and an autorouter operating on user generated Net Lists.

## ELECTRONIC CIRCUITS & COMPONENTS V2.0

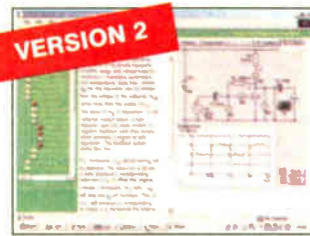

Circuit simulation screen

Provides an introduction to the principles and application of the most common types of electronic components and shows how they are used to form complete circuits. The virtual laboratories, worked examples and pre-designed circuits allow students to learn, experiment and check their understanding. Version 2 has been considerably expanded in almost every area following a review of major syllabuses (GCSE, GNVQ, A level and HNC). It also contains both European and American circuit symbols. Sections include: **Fundamentals:** units & multiples, electricity, electric circuits, alternating circuits. **Passive Components:** resistors, capacitors, inductors, transformers. **Semiconductors:** diodes, transistors, op.amps, logic gates. **Passive Circuits. Active Circuits. The Parts Gallery** will help students to recognise common electronic components and their corresponding symbols in circuit diagrams. Included in the Institutional Versions are multiple choice questions, exam style questions, fault finding virtual laboratories and investigations/worksheets.

## ANALOGUE ELECTRONICS

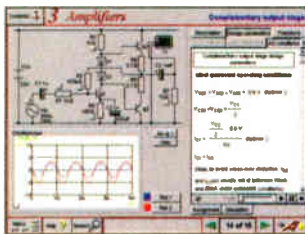

Complimentary output stage

*Analogue Electronics* is a complete learning resource for this most difficult branch of electronics. The CD-ROM includes a host of virtual laboratories, animations, diagrams, photographs and text as well as a SPICE electronic circuit simulator with over 50 pre-designed circuits.

Sections on the CD-ROM include: **Fundamentals** – Analogue Signals (5 sections), Transistors (4 sections), Waveshaping Circuits (6 sections). **Op.Amps** – 17 sections covering everything from Symbols and Signal Connections to Differentiators. **Amplifiers** – Single Stage Amplifiers (8 sections), Multi-stage Amplifiers (3 sections). **Filters** – Passive Filters (10 sections), Phase Shifting Networks (4 sections), Active Filters (6 sections). **Oscillators** – 6 sections from Positive Feedback to Crystal Oscillators. **Systems** – 12 sections from Audio Pre-Amplifiers to 8-Bit ADC plus a gallery showing representative p.c.b. photos.

## ROBOTICS & MECHATRONICS



Case study of the Milford Instruments Spider

Robotics and Mechatronics is designed to enable hobbyists/students with little previous experience of electronics to design and build electromechanical systems. The CD-ROM deals with all aspects of robotics from the control systems used, the transducers available, motors/actuators and the circuits to drive them. Case study material (including the NASA Mars Rover, the Milford Spider and the Furby) is used to show how practical robotic systems are designed. The result is a highly stimulating resource that will make learning, and building robotics and mechatronic systems easier. The Institutional versions have additional worksheets and multiple choice questions.

- Interactive Virtual Laboratories
- Little previous knowledge required
- Mathematics is kept to a minimum and all calculations are explained
- Clear circuit simulations

## DIGITAL ELECTRONICS V2.0

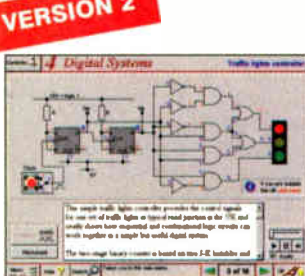

Virtual laboratory – Traffic Lights

*Digital Electronics* builds on the knowledge of logic gates covered in *Electronic Circuits & Components* (opposite), and takes users through the subject of digital electronics up to the operation and architecture of microprocessors. The virtual laboratories allow users to operate many circuits on screen.

Covers binary and hexadecimal numbering systems, ASCII, basic logic gates, monostable action and circuits, and bistables – including JK and D-type flip-flops. Multiple gate circuits, equivalent logic functions and specialised logic functions. Introduces sequential logic including clocks and clock circuitry, counters, binary coded decimal and shift registers. A/D and D/A converters, traffic light controllers, memories and microprocessors – architecture, bus systems and their arithmetic logic units. Sections on Boolean Logic and Venn diagrams, displays and chip types have been expanded in Version 2 and new sections include shift registers, digital fault finding, programmable logic controllers, and microcontrollers and microprocessors. The Institutional versions now also include several types of assessment for supervisors, including worksheets, multiple choice tests, fault finding exercises and examination questions.

## FILTERS

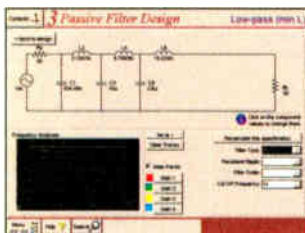

Filter synthesis

*Filters* is a complete course in designing active and passive filters that makes use of highly interactive virtual laboratories and simulations to explain how filters are designed. It is split into five chapters: **Revision** which provides underpinning knowledge required for those who need to design filters. **Filter Basics** which is a course in terminology and filter characterization, important classes of filter, filter order, filter impedance and impedance matching, and effects of different filter types. **Advanced Theory** which covers the use of filter tables, mathematics behind filter design, and an explanation of the design of active filters. **Passive Filter Design** which includes an expert system and filter synthesis tool for the design of low-pass, high-pass, band-pass, and band-stop Bessel, Butterworth and Chebyshev ladder filters. **Active Filter Design** which includes an expert system and filter synthesis tool for the design of low-pass, high-pass, band-pass, and band-stop Bessel, Butterworth and Chebyshev op.amp filters.

## PRICES

Prices for each of the CD-ROMs above are:

(Order form on third page)

(UK and EU customers add VAT at 17.5% to "plus VAT" prices)

|   |               |
|---|---------------|
| Hobbyist/Student .....                        | £45 inc VAT   |
| Institutional (Schools/HE/FE/Industry).....   | £99 plus VAT  |
| Institutional 10 user (Network Licence) ..... | £199 plus VAT |
| Site Licence.....                             | £499 plus VAT |

# PICmicro TUTORIALS AND PROGRAMMING

## HARDWARE

### VERSION 2 PICmicro MCU DEVELOPMENT BOARD

*Suitable for use with the three software packages listed below.*

This flexible development board allows students to learn both how to program PICmicro microcontrollers as well as program a range of 8, 18, 28 and 40-pin devices. For experienced programmers all programming software is included in the PPP utility that comes with the development board. For those who want to learn, choose one or all of the packages below to use with the Development Board.

- Makes it easier to develop PICmicro projects
- Supports low cost Flash-programmable PICmicro devices
- Fully featured integrated displays – 13 individual l.e.d.s, quad 7-segment display and alphanumeric l.c.d. display
- Supports PICmicro microcontrollers with A/D converters
- Fully protected expansion bus for project work
- All inputs and outputs available on screw terminal connectors for easy connection

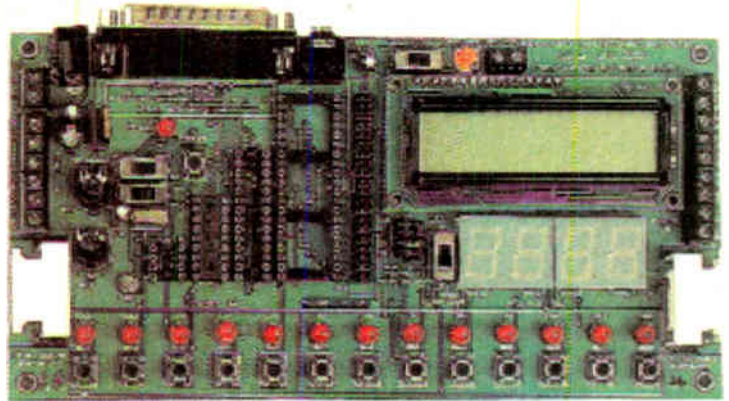

**£145 including VAT and postage**  
**12V 500mA plug-top PSU (UK plug) £7**  
**25-way 'D' type connecting cable £5**

## SOFTWARE

*Suitable for use with the Development Board shown above.*

### ASSEMBLY FOR PICmicro V2 (Formerly PICtutor)

Assembly for PICmicro microcontrollers V2.0 (previously known as PICtutor) by John Becker contains a complete course in programming the PIC16F84 PICmicro microcontroller from Arizona Microchip. It starts with fundamental concepts and extends up to complex programs including watchdog timers, interrupts and sleep modes. The CD makes use of the latest simulation techniques which provide a superb tool for learning: the Virtual PICmicro microcontroller. This is a simulation tool that allows users to write and execute MPASM assembler code for the PIC16F84 microcontroller on-screen. Using this you can actually see what happens inside the PICmicro MCU as each instruction is executed which enhances understanding.

- Comprehensive instruction through 39 tutorial sections
- Includes Vlab, a Virtual PICmicro microcontroller: a fully functioning simulator
- Tests, exercises and projects covering a wide range of PICmicro MCU applications
- Includes MPLAB assembler
- Visual representation of a PICmicro showing architecture and functions
- Expert system for code entry helps first time users
- Shows data flow and fetch execute cycle and has challenges (washing machine, lift, crossroads etc.)
- Imports MPASM files.

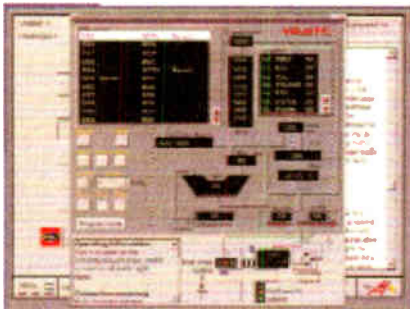

Virtual PICmicro

### 'C' FOR PICmicro VERSION 2

The C for PICmicro microcontrollers CD-ROM is designed for students and professionals who need to learn how to program embedded microcontrollers in C. The CD contains a course as well as all the software tools needed to create Hex code for a wide range of PICmicro devices – including a full C compiler for a wide range of PICmicro devices.

Although the course focuses on the use of the PICmicro microcontrollers, this CD-ROM will provide a good grounding in C programming for any microcontroller.

- Complete course in C as well as C programming for PICmicro microcontrollers
- Highly interactive course
- Virtual C PICmicro improves understanding
- Includes a C compiler for a wide range of PICmicro devices
- Includes full Integrated Development Environment
- Includes MPLAB software
- Compatible with most PICmicro programmers
- Includes a compiler for all the PICmicro devices.

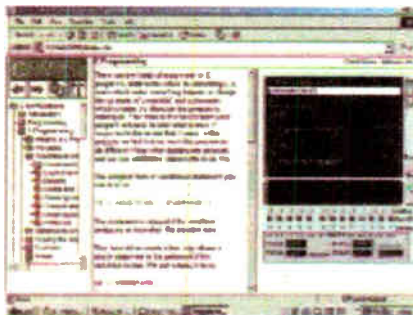

Minimum system requirements for these items: Pentium PC running Windows 98, NT, 2000, ME, XP; CD-ROM drive: 64MB RAM; 10MB hard disk space.

### FLOWCODE FOR PICmicro

Flowcode is a very high level language programming system for PICmicro microcontrollers based on flowcharts. Flowcode allows you to design and simulate complex robotics and control systems in a matter of minutes.

Flowcode is a powerful language that uses macros to facilitate the control of complex devices like 7-segment displays, motor controllers and l.c.d. displays. The use of macros allows you to control these electronic devices without getting bogged down in understanding the programming involved.

Flowcode produces MPASM code which is compatible with virtually all PICmicro programmers. When used in conjunction with the Version 2 development board this provides a seamless solution that allows you to program chips in minutes.

- Requires no programming experience
- Allows complex PICmicro applications to be designed quickly
- Uses international standard flow chart symbols (ISO5807)
- Full on-screen simulation allows debugging and speeds up the development process
- Facilitates learning via a full suite of demonstration tutorials
- Produces ASM code for a range of 8, 18, 28 and 40-pin devices
- Institutional versions include virtual systems (burglar alarms, car parks etc.).



Burglar Alarm Simulation

## PRICES

Prices for each of the CD-ROMs above are:

*(Order form on next page)*

*(UK and EU customers add VAT at 17.5% to "plus VAT" prices)*

Hobbyist/Student  
 Institutional (Schools/HE/FE/Industry)  
 Flowcode Institutional  
 Institutional 10 user (Network Licence)  
 Site Licence

£45 inc VAT  
 £99 plus VAT  
 £70 plus VAT  
 £249 plus VAT  
 £599 plus VAT

# TEACH-IN 2000 – LEARN ELECTRONICS WITH EPE

EPE's own *Teach-In* CD-ROM, contains the full 12-part *Teach-In* series by John Becker in PDF form plus the *Teach-In* interactive software covering all aspects of the series. We have also added Alan Winstanley's highly acclaimed *Basic Soldering Guide* which is fully illustrated and which also includes *Desoldering*. The *Teach-In* series covers: Colour Codes and Resistors, Capacitors, Potentiometers, Sensor Resistors, Ohm's Law, Diodes and L.E.D.s, Waveforms, Frequency and Time, Logic Gates, Binary and Hex Logic, Op.amps, Comparators, Mixers, Audio and Sensor Amplifiers, Transistors, Transformers and Rectifiers, Voltage Regulation, Integration, Differentiation, 7-segment Displays, L.C.D.s, Digital-to-Analogue.

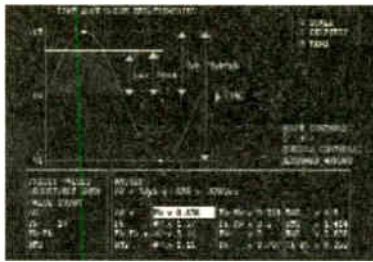

Sine wave relationship values

Each part has an associated practical section and the series includes a simple PC interface so you can use your PC as a basic oscilloscope with the various circuits.

**A hands-on approach to electronics with numerous breadboard circuits to try out.**

**£12.45 including VAT and postage.** Requires Adobe Acrobat (available free from the Internet – [www.adobe.com/acrobat](http://www.adobe.com/acrobat)).

**FREE WITH EACH TEACH-IN CD-ROM** – *Electronics Hobbyist Compendium* 80-page book by Robert Penfold. Covers Tools For The Job; Component Testing; Oscilloscope Basics.

**FREE BOOK WITH TEACH-IN 2000 CD-ROM**

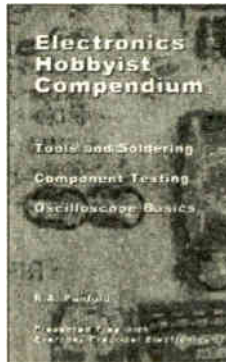

# DIGITAL WORKS 3.0

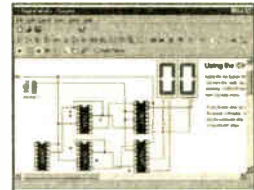

Counter project

*Digital Works Version 3.0* is a graphical design tool that enables you to construct digital logic circuits and analyze their behaviour. It is so simple to use that it will take you less than 10 minutes to make your first digital design. It is so powerful that you will never outgrow its capability ● Software for simulating digital logic circuits ● Create your own macros – highly scalable ● Create your own circuits, components, and i.c.s ● Easy-to-use digital interface ● Animation brings circuits to life ● Vast library of logic macros and 74 series i.c.s with data sheets ● Powerful tool for designing and learning.  
**Hobbyist/Student £45 inc. VAT.**  
**Institutional £99 plus VAT.**  
**Institutional 10 user £199 plus VAT.**  
**Site Licence £499 plus VAT.**

## ELECTRONICS IN CONTROL

Two colourful animated courses for students on one CD-ROM. These cover Key Stage 3 and GCSE syllabuses. **Key Stage 3:** A pictorial look at the Electronics section featuring animations and video clips. Provides an ideal introduction or revision guide, including multi-choice questions with feedback. **GCSE:** Aimed at the Electronics in many Design & Technology courses, it covers many sections of GCSE Electronics. Provides an ideal revision guide with Homework Questions on each chapter. Worked answers with an access code are provided on a special website.

**Single User £29 inc. VAT. Multiple User £39 plus VAT**  
**Student copies (available only with a multiple user copy) £6 plus VAT**  
*(UK and EU customers add VAT at 17.5% to "plus VAT" prices)*

## MODULAR CIRCUIT DESIGN

Contains a range of tried and tested analogue and digital circuit modules, together with the knowledge to use and interface them. Thus allowing anyone with a basic understanding of circuit symbols to design and build their own projects. **Version 3** includes data and circuit modules for a range of popular PICs; includes PICAXE circuits, the system which enables a PIC to be programmed without a programmer, and without removing it from the circuit. Shows where to obtain free software downloads to enable BASIC programming. Essential information for anyone undertaking GCSE or "A" level electronics or technology and for hobbyists who want to get to grips with project design. Over seventy different Input, Processor and Output modules are illustrated and fully described, together with detailed information on construction, fault finding and components, including circuit symbols, pinouts, power supplies, decoupling etc.

**Single User £19.95 inc. VAT. Multiple User £34 plus VAT**  
*(UK and EU customers add VAT at 17.5% to "plus VAT" prices)*

**VERSION 3**

## ELECTRONIC COMPONENTS PHOTOS

A high quality selection of over 200 JPG images of electronic components. This selection of high resolution photos can be used to enhance projects and presentations or to help with training and educational material. They are royalty free for use in commercial or personal printed projects, and can also be used royalty free in books, catalogues, magazine articles as well as worldwide web pages (subject to restrictions – see licence for full details).

Also contains a **FREE** 30-day evaluation of Paint Shop Pro 6 – Paint Shop Pro image editing tips and on-line help included!

**Price £19.95 inc. VAT**



Minimum system requirements for these CD-ROMs: Pentium PC, CD-ROM drive, 32MB RAM, 10MB hard disk space. Windows 95/98/NT/2000/ME/XP, mouse, sound card, web browser.

**CD-ROM ORDER FORM**

Please send me:

|  |   |
|--|---|
| <input type="checkbox"/> Electronic Projects                       | Version required:<br><input type="checkbox"/> Hobbyist/Student<br><input type="checkbox"/> Institutional<br><input type="checkbox"/> Institutional 10 user<br><input type="checkbox"/> Site licence |
| <input type="checkbox"/> Electronic Circuits & Components V2.0     |   |
| <input type="checkbox"/> Analogue Electronics                      |   |
| <input type="checkbox"/> Digital Electronics V2.0                  |   |
| <input type="checkbox"/> Filters                                   |   |
| <input type="checkbox"/> Electronics CAD Pack                      |   |
| <input type="checkbox"/> Robotics & Mechatronics                   |   |
| <input type="checkbox"/> Assembler for PICmicro                    |   |
| <input type="checkbox"/> 'C' for PICmicro                          |   |
| <input type="checkbox"/> Flowcode for PICmicro                     |   |
| <input type="checkbox"/> Digital Works 3.0                         |   |
| <input type="checkbox"/> PICmicro Development Board (hardware)     |   |
| <input type="checkbox"/> Development Board UK plugtop power supply |   |
| <input type="checkbox"/> Development Board 25-way connecting lead  |   |
| <input type="checkbox"/> Teach-In 2000 + FREE BOOK                 |   |

Electronic Components Photos  
 Electronics In Control – Single User  
 Electronics In Control – Multiple User  
 Modular Circuit Design – Single User  
 Modular Circuit Design – Multiple User

Note: The software on each version is the same, only the licence for use varies.

Full name: .....

Address: .....

.....Post code: .....Tel. No: .....

Signature: .....

I enclose cheque/PO in £ sterling payable to WIMBORNE PUBLISHING LTD for £ .....

Please charge my Visa/Mastercard/Amex/Diners Club/Switch: £ .....Card expiry date: .....

Card No: .....Switch Issue No. ....

Card Security Code ..... (The last 3 digits on or just under the signature strip)

## ORDERING

**ALL PRICES INCLUDE UK POSTAGE**

Student/Single User/Standard Version price includes postage to most countries in the world  
 EU residents outside the UK add £5 for airmail postage per order

**Institutional, Multiple User and Deluxe Versions** – overseas readers add £5 to the basic price of each order for airmail postage (do not add VAT unless you live in an EU (European Union) country, then add 17½% VAT or provide your official VAT registration number).

**Send your order to:**  
**Direct Book Service**  
**Wimborne Publishing Ltd**  
**408 Wimborne Road East**  
**Ferndown, Dorset BH22 9ND**

To order by phone ring  
**01202 873872. Fax: 01202 874562**

Goods are normally sent within seven days  
**E-mail: [orders@wimborne.co.uk](mailto:orders@wimborne.co.uk)**

Online shop:  
[www.epemag.wimborne.co.uk/shopdoor.htm](http://www.epemag.wimborne.co.uk/shopdoor.htm)



# SURFING THE INTERNET

# NET WORK

## ALAN WINSTANLEY

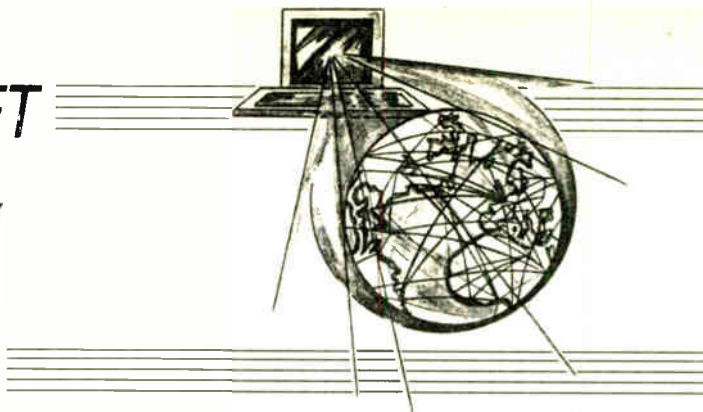

**M**ANY urban regions now enjoy ADSL broadband through their phone lines, much to the chagrin of the rest of us in non-urban or rural areas – the ones who could probably benefit the most from having broadband Internet access. Some readers who emailed me are doubly frustrated, living in large “progressive” towns where broadband ADSL isn’t available to them either.

British Telecom dangles a tantalising carrot in the form of “trigger levels” for each telephone exchange. A spokeswoman for BT Wholesale told me that the targets reflect the actual costs of upgrading an exchange, in the sense that they are set at 50% of the amount of customers they need to return the investment on that exchange within a reasonable time. They are not set as percentage of the amount of connections on that exchange.

If narrowband dial-up exasperates you and ADSL is never likely to arrive, then it’s time to start thinking about other emerging technologies. As usual, I take a general-interest view without dwelling on systems that relate more to industrial or commercial applications.

### Look, No Wires!

A number of wireless solutions are starting to roll out which on the surface appear to be just localised services. Invisible Net-works (<http://www.invisible.uk.net>) is one such supplier, but they have recently slashed the numbers on the workforce. Another company is WRBB (Wireless Rural Broadband) at <http://wrbb.net> – a small but dynamic Lincolnshire-based company that is planning some highly attractive services to rural users all around the country, deliberately avoiding urban or ADSL/cable enabled regions. WRBB promises to bring us “Sunshine” and is dedicated to providing rural users with broadband solutions using wireless technologies.

As always, the problem is that trying to nail down new technology is like trying to pour cement on shifting sands: many users will remember what dial-up was like, moving from 9.6kbps then 14.4, 28.8, 33.6 and finally V.92 56k. Then came serial, ISA, PCI and USB modems, not to mention US Robotics’ own standard X2. Modems and racks were being thrown away almost annually.

Wireless technology is no different with a number of standards having evolved, with the attendant risk that they can be superseded almost overnight. There is the on-going problem of customers buying the wrong or obsolete equipment.

In considering the IEEE 802.11 standard, WRBB chose to delay and wait until the newest 802.11g standard was finally ratified in 2003. This operates on a rate of 54Mbps maximum, which is not the “surfing speed” as such: we’re told to expect up to five or ten times faster broadband services than BT 512k ADSL. Just twice as fast (1Mbps) would be good . . .

### Neighbourhood Watch

WRBB also highlights other benefits of working wirelessly – for example, a network could be provided locally so that you could play games or network with friends across the road, and this would be free. Only when users reach out onto the Internet would costs be incurred.

The proposed costings are extremely attractive and are built on a PAYG (pay-as-you-go) structure, so customers just buy a chunk of gigabytes of Internet traffic and do what they like with it. The cheapest service will be £10.00 per month, for 1Gb of traffic + 0.014 per extra MB. An attractive range of rates for home and business is quoted on their web site.

WRBB’s CEO “TJ” or “Titch” is extremely enthusiastic and highly skilful, clearly appearing to have considered all the technical and commercial implications of building a wireless network from scratch. A live demonstration of IEEE 802.11g highlighted its remarkable transmission rate over a LAN – which anyone can actually demonstrate with suitable bits of 54Mbps wireless kit – but, of course, the actual rollout of this Internet service is still tantalisingly distant.

### On Trial

Trials are under way in deliberately “difficult” places – and indeed the terrain is likely to be one of the biggest hurdles to overcome: 802.11g needs “line-of-sight” between aerials. Trees, hills or even ferrous strata in the earth may badly affect the service.

Computer simulations of the geography help to determine the best sites for aerials, and in some places you take on 802.11g “at your own risk” helped by online computer maps. Critically, the target range will be 10km line-of-sight of a point of presence, using a suitable antenna.

WRBB has started a registration process (which didn’t cope with the initial volumes), gathering figures just

as BT did, but ‘TJ’ is adamant that unlike BT broadband, meeting a trigger level is not a prerequisite before the service could be installed. Although they will target business users initially, residential clients will be catered for as well. Refreshingly, “TJ” accuses BT of adversely conditioning users’ expectations into accepting “trigger levels” as the *de facto* criterion for activating a broadband service. Ultimately, WRBB will just build it anyway, and you can sign up if you want.

The “Sunshine” that WRBB promises to deliver has however suffered from a false dawn, because there aren’t yet enough 802.11g certified broadband routers available to them for re-distribution. So the rollout date has already been postponed, the company being clearly very nervous about selling non-certified equipment.

Keeping one’s powder dry until a fully compatible wireless network is ready for launch is admirably brave. However, one risk is that further methods of deploying wireless networks will come along, leading to a myriad of confused customers with wrong or obsolete equipment.

The older protocol 802.11b runs at 11Mbps maximum, although 802.11g is retro-compatible with it. More new wireless standards are in the pipeline that could overcome “line-of-sight” problems altogether, but that’s some time ahead yet.

We need the likes of WRBB with its young and enthusiastic team, and its refreshingly customer-focused approach deserves to be highly successful. Fingers crossed . . . You can email comments to [alan@epemag.demon.co.uk](mailto:alan@epemag.demon.co.uk).



**Sunshine from WRBB**

**G'Day Sunshine!**

Sunshine will be launched in the Autumn of 2003. Please [view the announcement](#) for the latest news. The service will be aimed, primarily, at business users in the initial phase but residential subscribers will be welcome and catered for.

Residential and SME tariffs will deliver internet access at line speeds of up to 54Mbps whilst the Virtual Leased Line service can deliver in multiples of 54Mbps, potentially providing connection speeds orders of magnitude faster than ADSL.

Within 3 months of launch, Sunshine will be available to businesses and communities within 10km of the following Points of Presence (subject to terrain):

Bingham, Bottesford, Bourne, Eron, Scalford, South Witham, Stamford, and Uppingham.

More Points of Presence (PoPs) are being planned in Cambridgeshire, Essex, Leicestershire, Lincolnshire, Norfolk, North Lincolnshire, Nottinghamshire, Rutland, Suffolk, and are expected to be live between Autumn 2003 and Spring 2004.

See our Coverage maps for more information. Sunshine is building a national service that will be available by the end of 2005.

**ADSL Exchanges**

If you live in an area that has reached its trigger level for ADSL, and would like to use ADSL prior to Sunshine going live in your community, you can sign up for WRBB and receive an ADSL service that can be switched to Sunshine with no penalties, and provides for a trade-in of your ADSL equipment for WiFi equipment.

**WRBB aims to stimulate the rural economy by providing the opportunity for local agents to become involved in sales and support of the service. The Partner Referral Scheme will pay 5% of revenues (ex VAT) for each directly introduced subscription customer for the first 6 months of their contract. An additional rate of 2.5% will be paid to Community Advocates that bring Sunshine to a community. (A local agent is not a pre-requisite for coverage).**

The Sunshine service offers a wide range of tariffs to suit the needs of residential, SOHO and business customers. The tariffs start at £10 per month with a 1 month contract term for the My Wideband domestic service. There are no connection fees for the domestic and SME services.



# CIRCUIT SURGERY

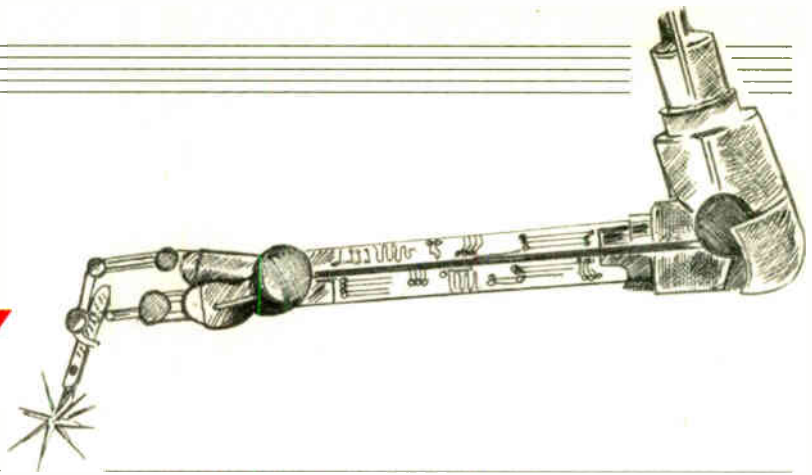

**ALAN WINSTANLEY  
and IAN BELL**

*Concluding our introduction to SPICE simulation software, creating a netlist and running the various simulator functions.*

LAST month we highlighted the student version of PSpice circuit simulator software that is available as a free download from Cadence Design Systems Inc. ([www.cadencepcb.com/products/downloads/Pspicestudent](http://www.cadencepcb.com/products/downloads/Pspicestudent)). The software weighs in at a mighty 28MB and the documentation adds a further 13MB, and a free utility such as Leechget ([www.leechget.de](http://www.leechget.de)) may help dialup users with this mammoth download.

This month we continue with instructions for running a PSpice Simulation using the Demo Version, to show some of the software's powerful simulation functions that are available.

## Start the Capture Program

Run the Capture program (Start->Programs->PSpice Student->Capture Student). When the program opens use the iconbar or select File->New->Project... from the menu. Type your project name into the Name box. Select 'Analog or Mixed A/D' from the list of project types.

Browse to create a target location to file the project: it is best to use a new directory. Then select 'Create a blank project' and click OK.

Expand the OrCAD window to full screen. You will see three sub-windows, resize them as desired, see Fig.1. As usual, when entering data into an application, you should save your work regularly (File->Save or CTRL + S).

## Example Circuit

The example circuit we are going to simulate is the one shown in Fig.1 last month (page 622), and also repeated here in Fig.6 with "voltage labels", which was captured from the PSpice schematic editor. The circuit is a single stage transistor amplifier with bias stabilisation feedback provided by resistor R4. This is bypassed at a.c. by capacitor C3 to give plenty of gain. The circuit is a well-known standard configuration. The 2N2222 is used simply because it is one of the transistor models available in the demo version.

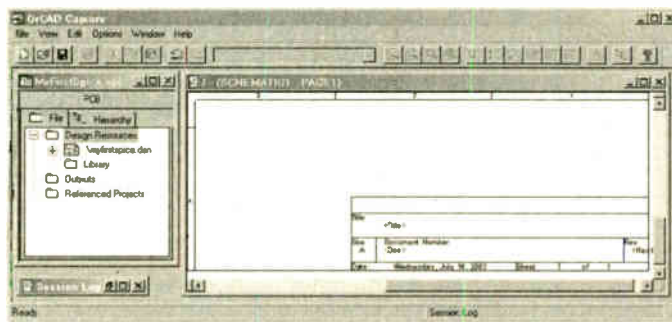

Fig.1. The initial windows that open with a new project.

Note that the schematic includes a voltage source to create the input signal, and a load resistor for the output. This is usual when simulating – you must include the input signals and load conditions in order to have a meaningful simulation, although these items would not normally be shown on a schematic used for construction purposes. During simulation work, be prepared to edit the schematic to change the input signals for different types of analysis.

## Adding Components

Select Place->Part... from the menu then click the Add Library... button in the Place Part window which opens. Select analog.olb, eval.olb and source.olb (hold down the Ctrl key and click on them in turn). Then click on the OPEN button. The libraries will appear in the Libraries: list in the Place Part window.

Select Place->Part... from the menu again. Click on EVAL in Libraries: list, then scroll down the Part List: and click on Q2N2222. Click OK and move the cursor over schematic window.

Click on the schematic to place the transistor symbol on the schematic and then hit the ESC key. If you click the schematic again before pressing ESC you will finish up with two or more transistors. To delete one, click on it near the centre to select it and hit the Delete key. You can also use the Edit->Undo menu item to undo unwanted schematic drawing operations.

Now add the five resistors in a similar way. Place->Part... then click on ANALOG in library list, scroll down part and click on R (for resistor). Click OK and move cursor over the schematic window. Hit the R key to rotate the resistor to the required orientation. Click to place the four resistors symbols by clicking on the schematic and then hit the ESC key.

Try to place the resistors exactly where they should go to form a neat schematic, if you end up with one in the wrong place you can click on it and the drag it with the mouse to the desired location. Don't worry about what resistor values are shown at the moment, we will set these later. Leave space between the components for the wires we will be adding later.

Add the capacitors like the resistors (they are called C and are in the ANALOG library). Add input and output capacitors

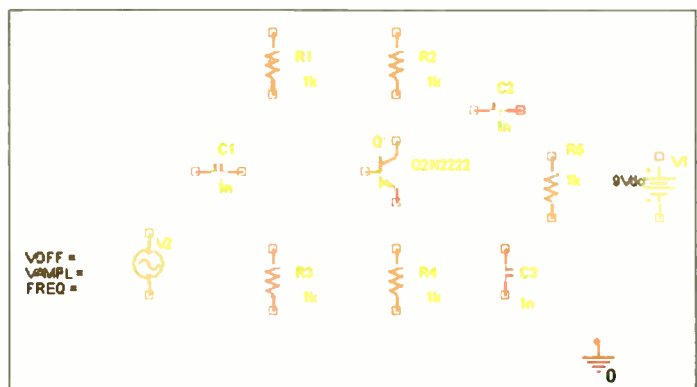

Fig.2. All components added and labelled. Note the Ground '0' element, bottom right.

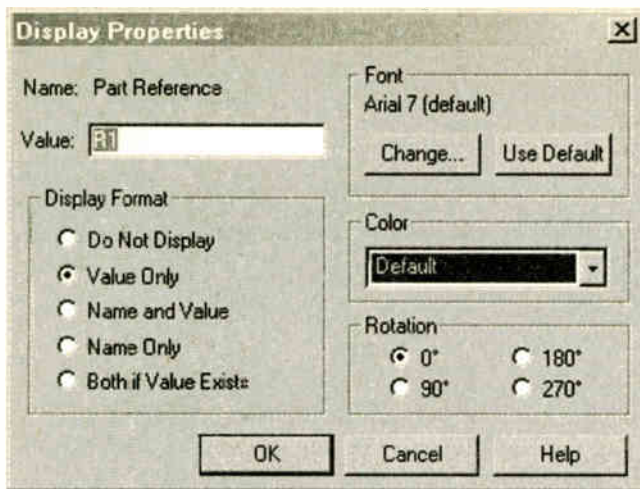

Fig.3. Naming a part by giving it a value.

(C1 and C2), then hit the R key to rotate the symbol for adding the feedback bypass capacitor (C3). Also place the VDC element for supply voltage and the VSIN element for the input signal from the SOURCE library.

We also have to add the correct ground to get the "node zero" which must be present in all SPICE circuits. Not doing this is a common cause of mysterious problems for novice SPICE users!

To place the ground connections, first click on the Ground button in the tool palette on the right hand side of the main OrCAD Capture window (you can also use this tool palette for other actions such as placing components). It is marked with a Ground symbol and "GND". When clicked, a window will appear similar to the Place Part window. Click on Add Library... and add source.olb from the PSpice library as you did before. Select the source library and the 0 element from the Parts List. Place the ground symbol on the schematic. Make sure there is a Zero next to your ground symbol on the schematic, see Fig.2.

### Add the wires

Having placed the parts and ground, you are now ready to add the wires to the schematic. Select Place->Wire from the menu. A crosshair cursor will appear over the schematic. Click on the start point of a wire – the ends of the wire stubs on the components, which will have little grey boxes around them.

If you move the cursor over a valid point for wiring to – another wire or component pin – then a red blob appears. Clicking at this point will make the connection. If you

you put the wire there, then a warning symbol appears instead.

The wires automatically form one right-angle bend as you move the cursor around. If you need a more complicated wire path (i.e. one with more bends), simply click at the point where you need a corner. Each time you click you add a new segment to the wire. Hit the ESC key to stop drawing the wire. You can start and finish a wire in "mid-air" if you wish, this point will then get a little grey box indicating it is an open connection.

If you make mistakes with the wiring you can use Edit->Undo from the menu or click the undo button. You can also click on a wire segment to select it (it changes colour) and hit the Delete key to remove it. Make sure you hit ESC to edit wiring before doing some other operation.

### All Change

To change the component names from the defaults created when you placed them double-click directly on the name (not on the component symbol). A window will open titled Display Properties in which you will see the text "Name: Part Reference". Change the text in the Value box to the name you require for your component, see Fig.3.

To change component values double-click directly on the value text (again not on the circuit symbol). This will also open a Display Properties window, this time with "Name: Value". Change the Value text to what you require.

Note the voltage source for the input signal has three values to set. Double click these in turn to set the three values, VOFF

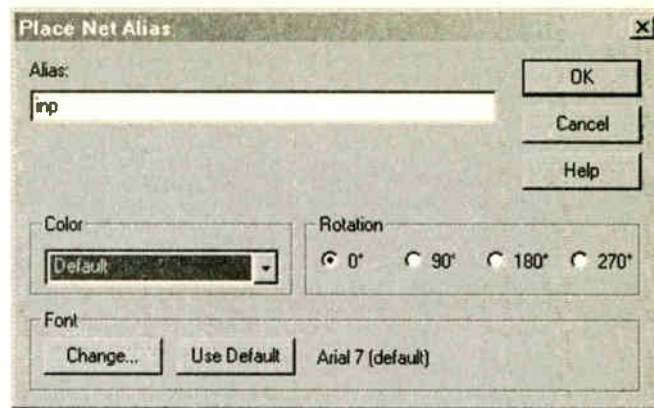

Fig.4. Naming a wire by giving it an Alias.

as 0, VAMPL as 10m, and FREQ as 1k. You can edit the document information at the bottom right hand corner of the schematic in a similar way to the component values.

### Name the Wires

To label wires: Select Place->Net Alias... from the menu. This will open the Place Net Alias window. Type the wire name you want into the Alias: box and click on OK, see Fig.4.

A small box will move over the schematic with the cursor, place this right next to the wire you want to name. Hit ESC to cancel the command. Repeat for each wire name and save your schematic. Eventually your schematic should look like Fig.6, without voltage labels.

### Netlisting

It is useful to netlist the schematic as this will tell you if there are any errors in the drawing. Select PSpice->Create Netlist. If there are errors a message dialogue will appear, if not nothing much will happen. To see the netlist go to the project hierarchy window, expand the outputs section if necessary (click on +) and then double click on the schematic1.net item. Our netlist is given below, yours may be a little different, but it should contain the same items.

```
* source      CIRCUIT1
R_R4         0 EMITTER 1k
Q_Q1        COLLECTOR BASE
            EMITTER Q2N2222
R_R3         COLLECTOR VCC 4.7k
R_R2         0 BASE 10k
R_R1         BASE VCC 47k
C_C1        INP BASE 1u
C_C2        COLLECTOR OUTP 1u
```

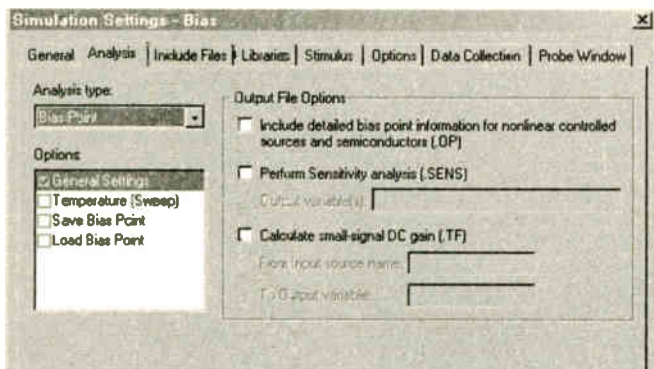

Fig.5. Checking the circuit bias conditions using Bias Point analysis type.

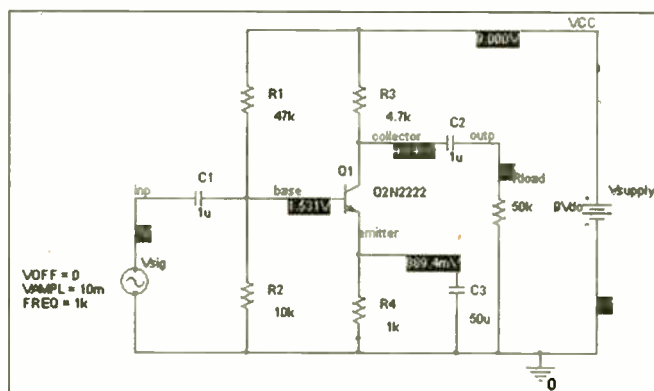

Fig.6. PSpice displays the bias voltages in the circuit.

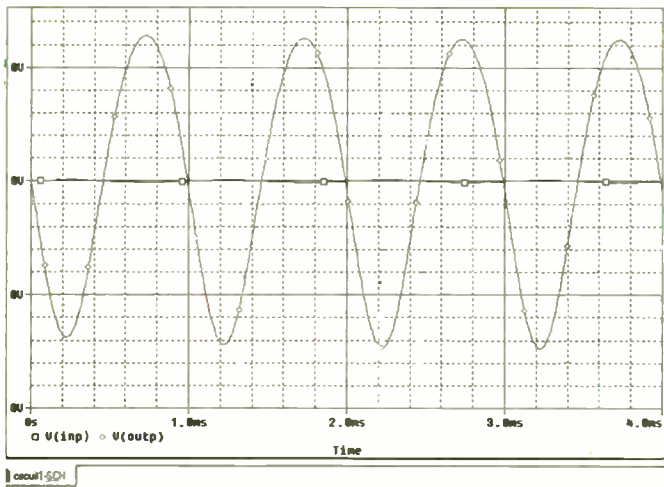

Fig.8. The simulated output sinewave, approx. 1.3V peak

C\_C3 0 EMITTER 50u  
 R\_Fload 0 OUTP 50k  
 V\_Vsupply VCC 0 9Vdc  
 V\_Vsig INP 0  
 +SIN 0 10m 1k 0 0 0

### Simulation

We can run the simulator using the following method, starting by checking the circuit's bias conditions. Select PSpice->New Simulation Profile. Type Bias into the Name: box and leave Inherit From: as None. Click Create. A window titled Simulation Settings - Bias will open. Change Analysis Type: to Bias Point and click OK, see Fig.5.

Now select PSpice->Run to start the simulation. A simulation output window will appear and report progress of the simulation. If you get any error messages check that your schematic was drawn correctly and that it matches Fig.1 last month.

No waveforms will be displayed at this point as we are only looking at the bias conditions. The bias voltages will be displayed on the schematic, see Fig.6. If you built the circuit you should be able to measure d.c. voltages similar to this with zero input applied.

Now we can simulate the circuit to see how it responds to the 10mV input sine wave. Select PSpice->New Simulation Profile. Type Transient into the Name: box and leave Inherit From: as None. Click Create. In the Simulation Settings window set the following (see Fig.7).

Analysis Type: Time Domain (Transient)  
 Run to Time: 10ms  
 Maximum Step Size: 10us

Note that the maximum time step controls the time accuracy of the simulation. If this is too low the simulation will take too

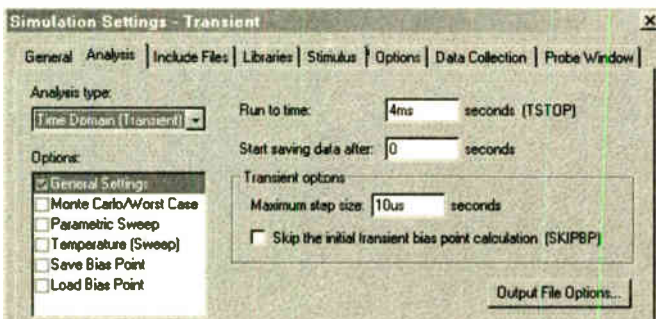

Fig.7. Enter the parameters required for running a transient analysis.

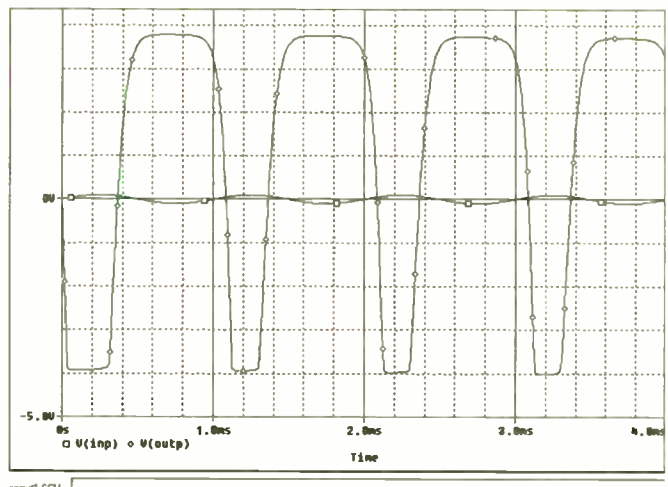

Fig.9. Simulating distortion of the sinewave, due to amplifier

long, but if it is too high the results will not be accurate.

Select PSpice->Run to start the simulation. Again the output window will appear and after a while you will get a blank waveform display. Select Trace->Add Trace... In the Add Traces window scroll down the list of signals and click once on V(inp) and once on V(outp). These names will appear in the Trace Expression: box at the base of the window. Click on OK to display the waveform. You should see that the output is a clean sinewave of much larger amplitude than the input (around 1.3V peak), see Fig.8.

Close the simulation window and go to the schematic. Double click on the VAMPL text next to the Vsig input signal voltage source. This will open the Display Properties window. Change the Value to 100mV. We now have a 100mV input signal, rather than 10mV.

Run the simulation again and display the input and output waveform as before. You will now see that the output is distorted due to saturation of the amplifier, see Fig.9. Close the simulation window.

Now we can look at the frequency response. Go to the schematic, click on the Vsig source symbol and hit the Delete key to remove it. Add a VAC element from the SOURCE library in place of Vsig. This has two values to set, change ACMAG to 10mVac and leave DC as 0V d.c.

Select PSpice->New Simulation Profile. Type the label Frequency into the Name: box and leave Inherit From: as None. Click Create. In the Simulation Settings window set the following (see Fig.10).

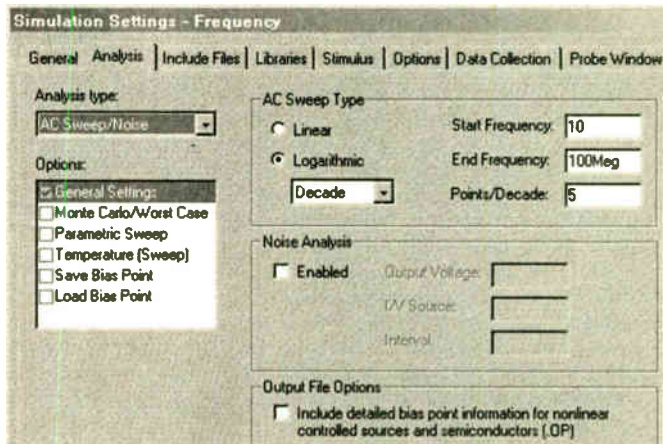

Fig.10. Simulating the amplifier's Frequency Response in the AC Sweep dialogue box.

Analysis Type: AC Sweep/Noise  
 Logarithmic  
 Decade  
 Start Frequency: 10  
 End Frequency: 100Meg  
 Points/Decade: 5

Leave the noise analysis enabled box unchecked. Click OK and select PSpice->Run to start the simulation.

When the blank results display appears in the simulation window select Trace->Add Trace... as before. This time, however, do not click on any signals, simply type the following into the Trace Expression: box (make sure you get it exactly right)

DB(V(outp)/V(inp))

This calculates the gain V(outp)/V(inp) and converts it to decibel format. Click on OK to display the frequency response of the circuit. Note this result is fairly idealised. We have not included stray capacitances in the simulation, which would reduce the high frequency gain.

This concludes our simulation example which we hope is sufficient to give you the confidence to try creating your own projects in PSpice. For more examples, read Chapter 2 of the pspug.pdf file (user guide) supplied in documentation download.

Next month, we will answer a reader's query on op.amps, by simulating it in PSpice. I.M.B.

# PIC BREAKPOINT

## RICHARD HINCKLEY

*A PIC debugging tool that allows your PC to display all register contents at selected stages of a program's operation.*

**A**FTER a particularly frustrating afternoon trying to debug a PIC-controlled transmitter circuit, which had no l.c.d. or l.e.d.s attached to help, the author decided that a breakpoint debugging aid would be a useful addition to the *EPE Toolkit TK3* assembly and programming aid (Oct/Nov '01). So a Visual Basic program was written to upload the whole of the PIC data memory to a PC at various points in the program.

In summary, PIC Breakpoint (PB1) runs as part of *TK3* on any PC that will run *TK3* and has a bi-directional parallel port for verification. Either the *EPE* or the Magenta version of the *TK3* board may be used, but both require the addition of an extra link and a 10kΩ resistor, as described in a moment.

To use PB1 the program to be debugged is simply edited to include temporary breakpoint commands at positions of interest. When the program reaches a breakpoint the whole of the data memory, including the special registers, is uploaded to the PC for display and analysis. PB1 is written for 800 × 600 displays. It will work on larger ones and on 640 × 480 displays – in the latter case the screen layout is slightly different from that shown in the photos.

### PREPARING TK3 P.C.B.

Two straightforward modifications are required to the *TK3* board. The layout of the *EPE* board together with the modifications is shown in Fig.1. The Magenta board is slightly different, but the equivalent needs should be obvious.

**Modification 1.** An insulated wire link is required between the RB6 external input/output terminal pin at the righthand side of the board (which derives from pin 5 of IC3, the 4053 i.c.) and pin 31 (INIT) of the Centronics connector. The link should be made on the underside of the board. (Note that the RB6 I/O pin is *not* the RB6 pin used for in-circuit programming.)

**Modification 2.** A 10kΩ resistor needs to be soldered on the component side of the board as shown. (Circuit-wise this resistor is connected between 0V and the RB7 pin used for in-circuit programming.)

### SOFTWARE

Install *TK3* V5.0 (or later). Version 5.0 was released onto the *EPE* ftp site (access via the *EPE* home page at [www.epemag.wimborne.co.uk](http://www.epemag.wimborne.co.uk)) in early August 2003 (via path **PUB/PICs/Toolkit3**). Ensure that verification is enabled.

If you are installing *TK3* for the first time you also need the published text. This is available as back issues from the Editorial Office, and on the *PIC Resources CD ROM*. See elsewhere in this issue for ordering details. The CD ROM also holds the software for *TK3*, but it as an earlier version than V5.0 and will not work with PIC Breakpoint.

You also need the suite of files for PIC Breakpoint. These are obtainable from the Editorial office on 3.5in disk, for which a nominal handling charge applies (see the *EPE PCB Service* page for ordering details). They are also available *free* from the *EPE* ftp site (via path **PUB/PICs/Breakpoint**).

Unzip the file **PB1.zip** into any folder of your choice. The files contained are:

**README.TXT.** This gives a brief summary of PB1, and may contain other information that was too late for the publication date of this article.

**PBM.INC.** This is an INCLUDE file which contains PIC PB1 code that will be inserted into the program to be debugged.

**TUT26TEST.ASM.** This is a version of the *PIC Tutorial V1* demo program *TUT26.ASM* modified to demonstrate the features of PB1.

Four .HEX starting with **PB\_CAL\_**, whose purpose is described next.

### CALIBRATING PB1

A calibration program must be run to match the frequency of a PIC's oscillator to the speed of the PB1 program being run on the PC.

First insert any of the PIC devices that are supported by *TK3* into the appropriate socket on its board. Load *TK3*, select the

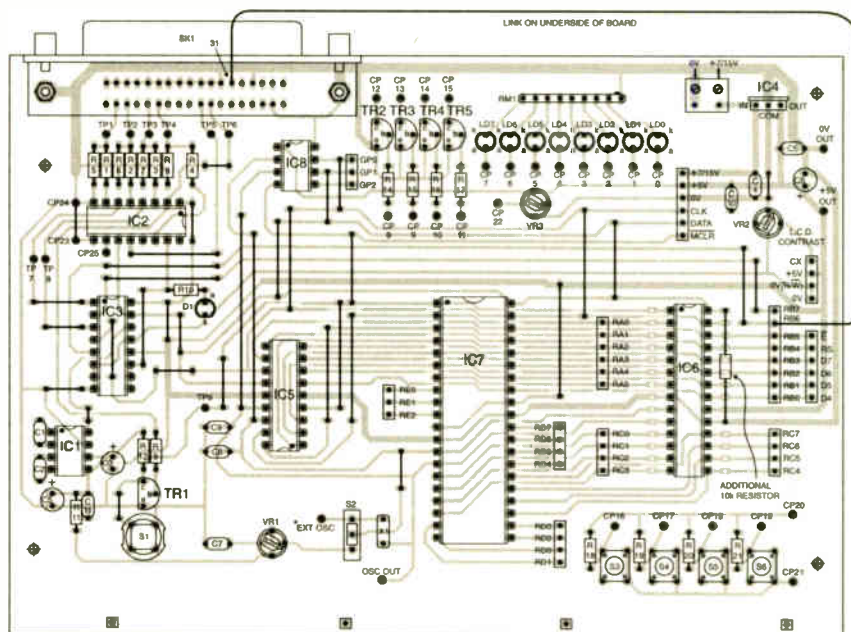

Fig.1. Amendment to *TK3* p.c.b. (see text).

PIC type and configure the PIC (POR on, WDT off, oscillator type as appropriate).

On the *TK3* screen use the DIR button in the Programming main screen area to select the folder containing PB1. Four .HEX files will be shown:

```
PB_CAL_16F62x.HEX
PB_CAL_16F83.HEX
PB_CAL_16F84x.HEX
PB_CAL_16F87x.HEX
```

Select the hex file applicable for the PIC type that is being used (e.g. **PB\_CAL\_16F84x.HEX** for a PIC16F84) and SEND it to the PIC. Assuming Verification is OK, the *TK3* Send Program Code to PIC screen will be seen to have an extra button on it, **TEST HEX** (see Fig.2). Click it.

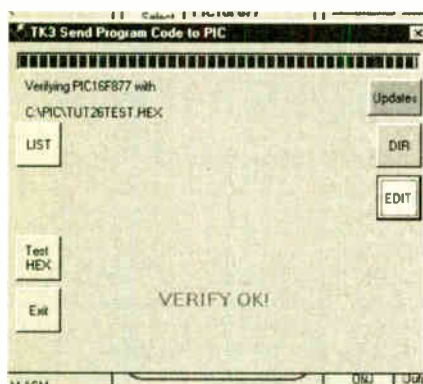

Fig.2. Programming sub-screen showing new **TEXT HEX** button.

The PB1 screen will appear (Fig.3) with a message explaining that calibration is to take place. If a mistake has been made and the wrong calibration program for the PIC device has been sent, an error message will be given. In this case click the **Return to TK3** button and send the right one.

Clicking OK to the message will cause calibration to start and a progress bar to appear. What happens next depends on the

frequency of the PIC oscillator. At frequencies above about 1.5MHz only one iteration of the progress bar will be seen, very briefly, for less than a second (though the period may vary according to the speed of the PC), followed by a message advising that calibration is complete.

For frequencies between about 60kHz and 1.5MHz the progress bar will iterate, getting gradually slower, until PB1 decides that the calibration is satisfactory. Follow any messages output during the process. Note that PB1 will not work with PIC oscillator frequencies of 60kHz and below, and will give up quickly if tried.

The final message announces that calibration is complete, and also advises that PB1 should be re-calibrated if the PIC oscillator frequency is changed. This is important as otherwise incorrect results might be obtained. It is NOT necessary to recalibrate if the PIC is changed to a different type, but the frequency remains the same. If it is necessary to recalibrate, just click the **SETUP** button.

If the calibration process iterates to the point where it gives up using a PIC oscillator frequency that should be acceptable, then it is possible that the PIC has a byte of duff memory (dead register location). The author found one such PIC in his collection.

Ignore the other buttons visible on the screen, and the temptation to click one. Although no harm will occur, it is better to use the **TUT26TEST** program to understand what PB1 can do. Instead, click the OK message and then click the **Return to TK3** button.

## PIC BREAKPOINT DEMONSTRATION

The original **TUT26** program uses the **TMR0** counter to measure one-second intervals, at which point a second count is incremented and output to an l.e.d. display via **PORTB**. **TUT26TEST** has been modified to show how PB1 is used.

Referring to the full **TUT26TEST**.ASM file listing supplied with the software, the extra PB1 lines used in the

program are indicated by the comment **\*\*\*\*\*PB1**. Ignore the statements within the "<>" chevron brackets for the moment.

For timing accuracy the PIC oscillator frequency should be 3.2768MHz, but if a different frequency is being used it does not matter for the purposes of this demonstration. The l.e.d. display is *not* required.

Returning to *TK3*'s main screen, from within the Assembly section use **DIR** to select **TUT26TEST.ASM** from whatever folder it was unzipped to, and then click the **Edit ASM** button to load it into the editor. It might be helpful to print off the file (and the assembly listing file later).

The first line following the introductory comments lines is an assembler directive:

```
LIST p = PIC16F877, r = dec
```

This tells the *TK3* assembler that the program is to be assembled for a PIC16F877, and that the radix to be used is decimal. (For a more detailed explanation of the radix directive see John Becker's *EPE PIC Tutorial V2 Part 3*, June 2003).

This directive is essential for PB1 to work correctly. It must be edited to specify the appropriate PIC device if a PIC other than a PIC16F877 is being used. For instance if you are using a PIC16F84, the line should be edited to read:

```
LIST p = PIC16F84, r = dec
```

Having edited the line, resave the file. Note that this directive over-rides that previously specified via the **Select PIC Type** option.

The **LIST** directive is followed by:

```
INCLUDE PBM.INC
```

This causes the PB1 macro code to be loaded when the program is assembled.

Further down the listing the next additional PB1 lines are:

```
clrf PORTB
clrf TRISB
bsf TRISB,6
bsf TRISB,7
```

These instructions clear the pins used by PB1 (**RB6** and **RB7** of **PORTB**) to zero and set them to inputs (there are other ways to do this, but the **bsf** instructions have been shown for clarity). It might seem a little strange to set both pins to inputs. This is done to prevent premature triggering of the **PC** PB1 program by an error in the PIC program. The PB1 code will set **RB7** to output before being used.

Following label **OUTPUT**, these extra lines appear:

```
setc
bkpt
clrc
```

The **setc** and **clrc** instructions have been inserted only to demonstrate one of PB1's features.

The **bkpt** instruction is a macro call, which will cause part of the PB1 code to be inserted into the program when assembled. (Macros were discussed in Malcolm Wiles' *PIC Macros and Computed GOTOS*, Jan '03). A further **bkpt** macro call has been made three instructions from the end of the program.

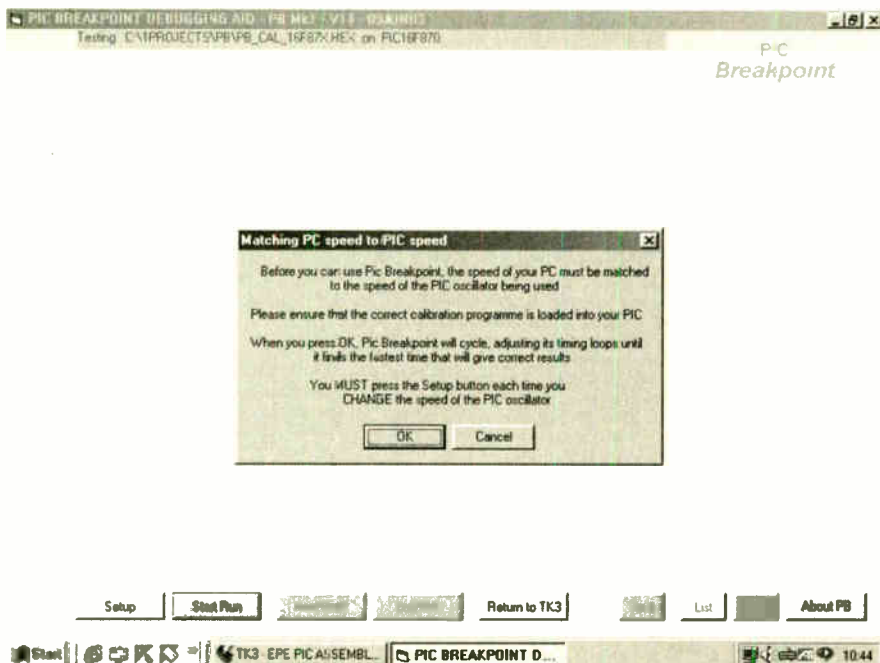

Fig.3. PIC Breakpoint's calibration sub-screen superimposed on its main screen.

The final additional line is just:

pb

This is another macro call that causes the bulk of the PB1 code to be inserted into the program when it is assembled.

## ASSEMBLING AND TESTING

Assemble the TUT26TEST.ASM program. If you examine the assembly listing via the LIST button you will see where the PB1 statements and instructions have been inserted during assembly, corresponding to where the text in "<" chevron brackets occurs in the ASM file.

Now, finally, it is time to try out PB1. Click the new TEST HEX button on the Programming sub-screen, or in the Programming section on the main screen.

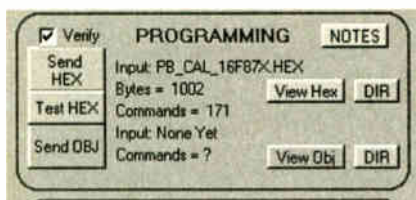

Fig.4. TK3's Programming zone on the main screen, showing new TEST HEX button

The PB1 screen will appear. Note that the top line of the screen shows the full path of the program being tested and the PIC type.

Now click Start Run. A message WAITING FOR PIC BREAKPOINT will appear briefly, followed by a progress bar. When this has finished (usually in less than one second) Bank 0 (128 bytes) of user memory data plus other information now appears on the screen (see Fig.5).

The top line of the screen is now replaced by an expansion of the STATUS byte. The next line shows the number of the breakpoint and the program address, in hex, at which it occurred. Reference to the listing will show that the address points to the first instance of the bkpt statement. As this was immediately preceded by a setc (Set Carry) instruction, the STATUS expansion shows C as 1.

On the left hand side of the screen the special registers relating to the particular PIC device being used are displayed, except for INDF. As this register always reads as whatever FSR is pointing at, it has been replaced in the display by the contents of the W register. Apart from RB6 and RB7 of PORTB, the contents of all the registers are shown as they were at the point of the bkpt statement.

Each line in the boxes (yellow on screen) shows the contents of a byte of data memory in the format:

Hex Address, Decimal Contents, Hex Contents, Binary Contents shown as two nibbles.

The contents of some lines may be shown blank – this is because this address is not available for this particular PIC type. Zero contents are shown in black, and non-zero contents are shown in red at this stage.

From the assembly listing (access via the LIST button) address 20h (hex) is known to hold CLKCNT, and shows the

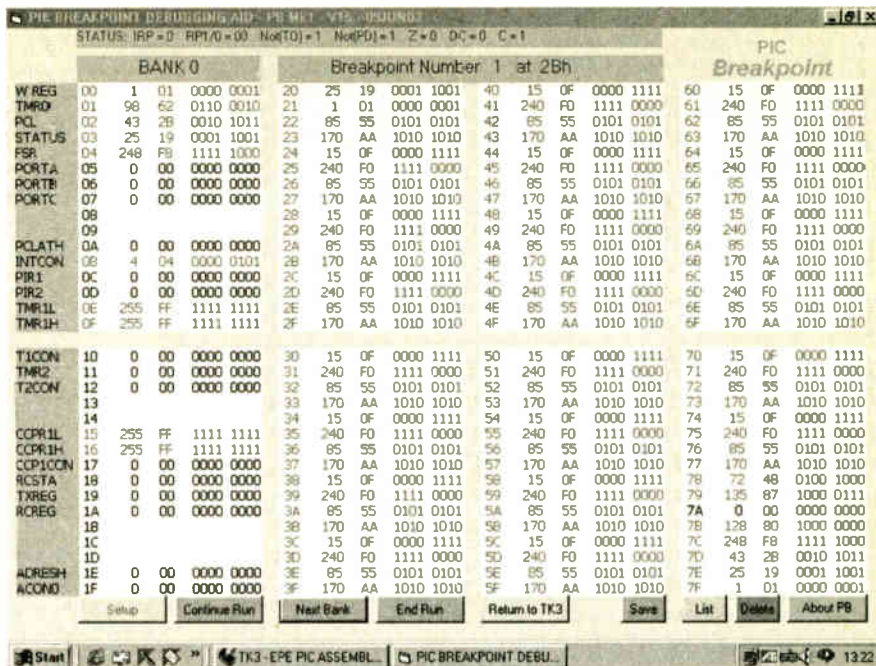

Fig.5. Example of PIC Breakpoint's display of Bank 0 registers as they occurred at one breakpoint interruption.

value of 25. This checks with the first few program instructions where CLKCNT is decremented according to the TOIF flag in INTCON, when it falls through the loop and is reset to 25.

CLKSEC at address 21h has been incremented to 1, and just before the bkpt statement it is loaded into the W register. Most of the rest of the data memory addresses are binary patterns left over from the calibration process.

Clicking the Next Bank button will show Bank 1 of data memory. Depending on whether the PIC type has two or four banks, further clicks of the Next Bank button will display either Bank 0 again, or go on to show Banks 2 and 3.

The last eight or nine bytes of data memory are reserved for PB1 use, depending on whether the PIC has more than 2K words of program memory. For PIC16F62x and PIC16F87x devices the last 16 bytes of data memory are the same in all banks – see Table 1 for a summary of resources used by PB1.

The caption on Start Run button has now changed to Continue Run. If this is

clicked the data memory as it stands at the second breakpoint is uploaded. The expanded STATUS line now shows C as 0, matching the clr c in the program.

The breakpoint number now reflects the second bkpt statement in the program. Most of the display has turned to blue numbers, which indicates that they have not changed since the previous breakpoint – this is to help show what is going on.

Examination of the assembly listing shows that a table call has been made to convert CLKSEC into an output for the l.e.d. display, which is returned in register W and output via PORTB. Examination of the PB1 display indeed shows that W contains the expected value, binary 11111001, but PORTB contains 00111001. This is because PB1 uses RB6 and RB7, and overwrites any data there.

Further clicking of the Continue Run allows TUT26TEST to cycle, and the increasing count in CLKSEC and the conversion in the W register can be viewed on the PC screen.

Finally, clicking the Save button will append the current screen of uploaded

Table 1. Resources used by PIC Breakpoint

| Pic Type  | Program Memory | Data Memory | Instructions per bkpt | Instructions in pb | PB1 Reserved Addresses |
|-----------|----------------|-------------|-----------------------|--------------------|------------------------|
| PIC16F627 | 1K             | 224         | 10                    | 69                 | 78 – 7F*               |
| PIC16F628 | 2K             | 224         | 10                    | 69                 | 78 – 7F*               |
| PIC16F83  | 512            | 36          | 10                    | 69                 | 28 – 2F                |
| PIC16C84  | 1K             | 36          | 10                    | 69                 | 48 – 4F                |
| PIC16F84  | 1K             | 68          | 10                    | 69                 | 48 – 4F                |
| PIC16F84A | 1K             | 68          | 10                    | 69                 | 48 – 4F                |
| PIC16F870 | 2K             | 128         | 10                    | 69                 | 78 – 7F*               |
| PIC16F871 | 2K             | 128         | 10                    | 69                 | 78 – 7F*               |
| PIC16F872 | 2K             | 128         | 10                    | 69                 | 78 – 7F*               |
| PIC16F873 | 4K             | 192         | 16                    | 72                 | 77 – 7F*               |
| PIC16F874 | 4K             | 192         | 16                    | 72                 | 77 – 7F*               |
| PIC16F876 | 8K             | 368         | 16                    | 72                 | 77 – 7F*               |
| PIC16F877 | 8K             | 368         | 16                    | 72                 | 77 – 7F*               |

\*On these PICs equivalent addresses in Banks 1, 2 and 3 are also reserved



data to a file and clicking List will send the file to the editor specified in *TK3*, where it can be saved to a named file and/or printed off for later analysis. The editor should use a fixed font such as Courier New or FixedSys for correct spacing. Any number of screens can be saved. The Delete button deletes the file of saved screens.

If a re-run of the program is required, click **End Run** followed by **Start Run**. Otherwise click **Return** to *TK3*.

## USING PIC BREAKPOINT

Using PIC Breakpoint with your own programs requires exactly the same technique as shown for *TUT26TEST* – you simply place the breakpoints at the places in your program where you wish to know the register details.

Note that the *PBM.INC* file *must* be copied into the folder that holds the *.ASM* source of the program you want to test.

Ensure that *TK3*'s verification is enabled. Run the calibration program if the PIC oscillator frequency has been changed. Insert the *LIST* and *INCLUDE* directives. Remember to specify the correct PIC type in the *LIST* directive.

Clear RB6 and RB7 of *PORTB* to zero and define them as inputs. Insert *bkpt*

statements into the code at as many points as required (subject to program memory space). Insert the *pb* statement anywhere a subroutine can be inserted, but it is usually convenient to place it at the end of the program. Note that *pb* can be placed in any program memory segment.

There are a few other items to be taken into account:

- Pins RB6 and RB7 should not have circuitry attached to them
- The program should avoid writing to RB6 and RB7
- Do not let your program use the eight or nine bytes reserved for PB1 use
- PB1 disables all interrupts during its processing by clearing the GIE bit in *INTCON*. If GIE was set prior to the *bkpt* statement being encountered, it will be set again on return
- Although PB1 clears the RBIF flag in *INTCON* to prevent false interrupts arising from PB1 use, using the port change interrupt feature may prove difficult – the author has not tried it
- *bkpt* statements can be placed in interrupt routines. However, the relevant interrupt flag should be reset *after* the *bkpt* call rather than before it, otherwise the program under test may interrupt continuously

● Because PICs can respond to interrupts, PB1 does not actually halt the PIC program after it has uploaded data – instead the program is allowed to continue and can process interrupts in the usual way. The program will stop when the next breakpoint is reached, where it will wait until the **Continue Run** button is pressed

● PB1 will display a message if the **Start** or **Continue Run** button is clicked and no breakpoint is reached within five seconds. PB1 cannot determine whether the program is operating correctly and no breakpoint should have been reached yet, or has hung up because of a program bug. If you suspect the latter, insert a few more breakpoints earlier in the program to see what is going on. Happy Debugging!

## ACKNOWLEDGEMENTS

The author thanks some "guinea pigs" – John Becker, Andrew Jarvis, John Waller and Malcolm Wiles – for making many invaluable suggestions during "field testing" of PIC Breakpoint. Special thanks to John for implementing some elements of MPASM macros, and for enabling the integration of PIC Breakpoint into *TK3*.

IT'S ABOUT TIME TO TAKE A NEW LOOK AT ELECTRONICS  
SO ORDER YOUR COPY NOW

★ **TEACH-IN 2004** ★

PLUS

**CARDBOARD CLOCK  
PIC RANDOM FLASHER  
RADIO CIRCUITS-6**



### Annual subscription rates:

- 6 Months: UK £16.50, Overseas £19.50 (standard air service),  
£28.50 (express airmail)  
1 Year: UK £31.00, Overseas £37.00 (standard air service)  
£55.00 (express airmail)  
2 Years: UK £57.00, Overseas £69.00 (standard air service)  
£105.00 (express airmail)

To: Everyday Practical Electronics,  
Wimborne Publishing Ltd., 408 Wimborne Road East,  
Ferndown, Dorset BH22 9ND  
Tel: 01202 873872 Fax: 01202 874562  
E-mail: [subs@epemag.wimborne.co.uk](mailto:subs@epemag.wimborne.co.uk)  
Order from our online shop at:  
[www.epemag.wimborne.co.uk/shopdoor.htm](http://www.epemag.wimborne.co.uk/shopdoor.htm)

### SUBSCRIPTION ORDER FORM

To subscribe from the USA or Canada  
see the last magazine page

I enclose payment of £ .....  
(cheque/PO in £ sterling only),  
payable to Everyday Practical Electronics



My card number is: .....  
Please print clearly, and check that you have the number correct

Signature .....

Name .....

Card Security Code ..... (The last 3 digits on or just under  
the signature strip)

Address .....

Card Ex. Date ..... Switch Issue No. ....

Post code ..... Tel. ....

Subscriptions can only start with the next available issue.  
For back numbers see the *Back Issues* page.

If you do not wish to cut your issue, send a letter or copy of this form.

FREE *Electronics Hobbyist Compendium* book with Teach-In 2000 CD-ROM



## EPE TEACH-IN 2000 CD-ROM

The whole of the 12-part *Teach-In 2000* series by John Becker (published in *EPE* Nov '99 to Oct 2000) is now available on CD-ROM. Plus the *Teach-In 2000* interactive software covering all aspects of the series and Alan Winstanley's *Basic Soldering Guide* (including illustrations and Desoldering).

*Teach-In 2000* covers all the basic principles of electronics from Ohm's Law to Displays, including Op.Amps, Logic Gates etc. Each part has its own section on the interactive software where you can also change component values in the various on-screen demonstration circuits.

The series gives a hands-on approach to electronics with numerous breadboard circuits to try out, plus a simple computer interface which allows a PC to be used as a basic oscilloscope.

ONLY **£12.45** including VAT and p&p

Order code Teach-In CD-ROM

## Robotics

### INTRODUCING ROBOTICS WITH LEGO MINDSTORMS

Robert Penfold

Shows the reader how to build a variety of increasingly sophisticated computer controlled robots using the brilliant Lego Mindstorms Robotic Invention System (RIS). Initially covers fundamental building techniques and mechanics needed to construct strong and efficient robots using the various 'click-together' components supplied in the basic RIS kit. Then explains in simple terms how the 'brain' of the robot may be programmed on screen using a PC and 'zapped' to the robot over an infra-red link. Also, shows how a more sophisticated Windows programming language such as Visual BASIC may be used to control the robots.

Details building and programming instructions provided, including numerous step-by-step photographs.

288 pages - large format Order code BP901 £14.99

### MORE ADVANCED ROBOTICS WITH LEGO MINDSTORMS - Robert Penfold

Covers the Vision Command System

Shows the reader how to extend the capabilities of the brilliant Lego Mindstorms Robotic Invention System (RIS) by using Lego's own accessories and some simple home constructed units. You will be able to build robots that can provide you with 'waiter service' when you clap your hands, perform tricks, 'see' and avoid objects by using 'bats radar', or accurately follow a line marked on the floor. Learn to use additional types of sensors including rotation, light, temperature, sound and ultrasonic and also explore the possibilities provided by using an additional (third) motor. For the less experienced, RCX code programs accompany most of the featured robots. However, the more adventurous reader is also shown how to write programs using Microsoft's VisualBASIC running with the ActiveX control (Spirit.OCX) that is provided with the RIS kit.

Detailed building instructions are provided for the featured robots, including numerous step-by-step photographs. The designs include rover vehicles, a virtual pet, a robot arm, an 'intelligent' sweet dispenser and a colour conscious robot that will try to grab objects of a specific colour.

298 pages Order code BP902 £14.99

### ANDROIDS, ROBOTS AND ANIMATRONS - Second Edition - John Iovine

Build your own working robot or android using both off-the-shelf and workshop constructed materials and devices. Computer control gives these robots and androids two types of artificial intelligence (an expert system and a neural network). A lifelike android hand can be built and programmed to function doing repetitive tasks. A fully animated robot or android can also be built and programmed to perform a wide variety of functions.

The contents include an Overview of State-of-the-Art Robots; Robotic Locomotion; Motors and Power Controllers; All Types of Sensors; Tilt; Bump; Road and Wall Detection; Light; Speech and Sound Recognition; Robotic Intelligence (Expert Type) Using a Single-Board Computer Programmed in BASIC; Robotic Intelligence (Neural Type) Using Simple Neural Networks (Insect Intelligence); Making a Lifelike Android Hand; A Computer-Controlled Robotic Insect Programmed in BASIC; Telepresence Robots With Actual Arcade and Virtual Reality Applications; A Computer-Controlled Robotic Arm; Animated Robots and Androids; Real-World Robotic Applications.

224 pages Order code MGH1 £16.99

# DIRECT BOOK SERVICE

NOTE: ALL PRICES INCLUDE UK POSTAGE

The books listed have been selected by *Everyday Practical Electronics* editorial staff as being of special interest to everyone involved in electronics and computing. They are supplied by mail order to your door. Full ordering details are given on the last book page.

For a further selection of books see the next two issues of *EPE*.

## Radio

### BASIC RADIO PRINCIPLES AND TECHNOLOGY

Ian Poole

Radio technology is becoming increasingly important in today's high technology society. There are the traditional uses of radio which include broadcasting and point to point radio as well as the new technologies of satellites and cellular phones. All of these developments mean there is a growing need for radio engineers at all levels.

Assuming a basic knowledge of electronics, this book provides an easy to understand grounding in the topic.

Chapters in the book: Radio Today, Yesterday, and Tomorrow; Radio Waves and Propagation; Capacitors, Inductors, and Filters; Modulation; Receivers; Transmitters; Antenna Systems; Broadcasting; Satellites; Personal Communications; Appendix - Basic Calculations.

263 pages Order code NE30 £17.99

### PROJECTS FOR RADIO AMATEURS AND S.W.L.S.

R. A. Penfold

This book describes a number of electronic circuits, most of which are quite simple, which can be used to enhance the performance of most short wave radio systems.

The circuits covered include: An aerial tuning unit; A simple active aerial; An add-on b.f.o. for portable sets; A wavetrap to combat signals on spurious responses; An audio notch filter; A parametric equaliser; C.W. and S.S.B. audio filters; Simple noise limiters; A speech processor; A volume expander.

Other useful circuits include a crystal oscillator, and RTTY/C.W. tone decoder, and a RTTY serial to parallel converter. A full range of interesting and useful circuits for short wave enthusiasts.

92 pages Order code BP304 £4.45

## Computers and Computing

### THE INTERNET FOR THE OLDER GENERATION

Jim Gatenby

Especially written for the over 50s. Uses only clear and easy-to-understand language. Larger type size for easy reading. Provides basic knowledge to give you confidence to join the local computer class.

This book explains how to use your PC on the Internet and covers amongst other things: Choosing and setting up your computer for the Internet. Getting connected to the Internet. Sending and receiving emails, photographs, etc., so that you can keep in touch with family and friends all over the world. Searching for and saving information on any subject. On-line shopping and home banking. Setting up your own simple web site.

228 pages Order code BP600 £8.99

### HOW TO BUILD YOUR OWN PC -

Third Edition

Morris Rosenthal

More and more people are building the own PCs. They get more value for their money, they create exactly the machine they want, and the work is highly satisfying and actually fun. That is, if they have a unique beginner's guide like this one, which visually demonstrates how to construct a state-of-the-art computer from start to finish.

Through 150 crisp photographs and clear but minimal text, readers will confidently absorb the concepts of computer building. The extra-big format makes it easy to see what's going on in the pictures. For non-specialists, there's even a graphical glossary that clearly illustrates technical terms. The author goes "under the hood" and shows step-by-step how to create a socket 7 (Pentium and non-intel chipsets) and a Slot 1 (Pentium II) computer, covering: What first-time builders need to know; How to select and purchase parts; How to assemble the PC; How to install Windows 98. The few existing books on this subject, although badly outdated, are in steady demand. This one delivers the expertise and new technology that fledgling computer builders are eagerly looking for.

224 pages - large format Order code MGH2 £20.99

### AN INTRODUCTION TO AMATEUR RADIO

I. D. Poole

Amateur radio is a unique and fascinating hobby which has attracted thousands of people since it began at the turn of the century. This book gives the newcomer a comprehensive and easy to understand guide through the subject so that the reader can gain the most from the hobby. It then remains an essential reference volume to be used time and again. Topics covered include the basic aspects of the hobby, such as operating procedures, jargon and setting up a station. Technical topics covered include propagation, receivers, transmitters and aerials etc.

150 pages Order code BP257 £5.49

### VALVE RADIO AND AUDIO REPAIR HANDBOOK (Second Edition) Chas Miller

This book is not only an essential read for every professional working with antique radio and gramophone equipment, but also dealers, collectors and valve technology enthusiasts the world over. The emphasis is firmly on the practicalities of repairing and restoring, so technical content is kept to a minimum, and always explained in a way that can be followed by readers with no background in electronics. Those who have a good grounding in electronics, but wish to learn more about the practical aspects, will benefit from the emphasis given to hands-on repair work, covering mechanical as well as electrical aspects of servicing. Repair techniques are also illustrated throughout.

A large reference section provides a range of information compiled from many contemporary sources, and includes specialist dealers for valves, components and complete receivers.

270 pages Order code NE34 £20.99

### PIC YOUR PERSONAL INTRODUCTORY COURSE

SECOND EDITION John Morton

Discover the potential of the PIC microcontroller through graded projects - this book could revolutionise your electronics construction work!

A uniquely concise and practical guide to getting up and running with the PIC Microcontroller. The PIC is one of the most popular of the microcontrollers that are transforming electronic project work and product design.

Assuming no prior knowledge of microcontrollers and introducing the PIC's capabilities through simple projects, this book is ideal for use in schools and colleges. It is the ideal introduction for students, teachers, technicians and electronics enthusiasts. The step-by-step explanations make it ideal for self-study too: this is not a reference book - you start work with the PIC straight away.

The revised second edition covers the popular re-programmable EEPROM PICs: P16C84/16F84 as well as the P54 and P71 families.

270 pages Order code NE36 £13.99

### UNDERSTANDING PC SPECIFICATIONS

R. A. Penfold (Revised Edition)

PCs range from simple systems of limited capabilities up to complex systems that can happily run applications that would have been considered beyond the abilities of a microcomputer not so long ago. It would be very easy to choose a PC system that is inadequate to run your applications efficiently, or one which goes beyond your needs and consequently represents poor value for money.

This book explains PC specifications in detail, and the subjects covered include the following: Differences between types of PC (XT, AT, 80386, etc); Maths co-processors; Input devices (keyboards, mice, and digitisers); Memory, including both expanded (EMS) and extended RAM; RAM disks and disk caches; Floppy disk drive formats and compatibility; Hard disk drives (including interleave factors and access times); Display adaptors, including all standard PC types (CGA, Hercules, Super VGA, etc); Contains everything you need to know if you can't tell your EMS from your EGA!

128 pages Order code BP282 £5.45

# Theory and Reference

## Bebop To The Boolean Boogie

By Clive (call me Max) Maxfield  
Specially imported by EPE - Excellent value

An Unconventional Guide to Electronics Fundamentals, Components and Processes

This book gives the "big picture" of digital electronics. This in-depth, highly readable, up-to-the-minute guide shows you how electronic devices work and how they're made. You'll discover how transistors operate, how printed circuit boards are fabricated, and what the innards of memory ICs look like. You'll also gain a working knowledge of Boolean Algebra and Karnaugh Maps, and understand what Reed-Muller logic is and how it's used. And there's much, MUCH more (including a recipe for a truly great seafood gumbo!). Hundreds of carefully drawn illustrations clearly show the important points of each topic. The author's tongue-in-cheek British humor makes it a delight to read, but this is a REAL technical book, extremely detailed and accurate. A great reference for your own shelf, and also an ideal gift for a friend or family member who wants to understand what it is you do all day...

470 pgs - large format **Order code BEB1** £26.95

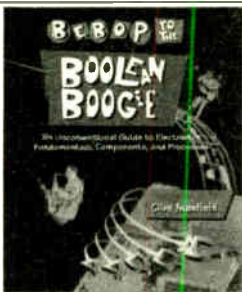

and you'll have a few chuckles, if not belly laughs, along the way. In addition to over 200 megabytes of mega-cool multimedia, the CD-ROM contains a virtual microcomputer, simulating the motherboard and standard computer peripherals in an extremely realistic manner. In addition to a wealth of technical information, myriad nuggets of trivia, and hundreds of carefully drawn illustrations, the CD-ROM contains a set of lab experiments for the virtual microcomputer that let you recreate the experiences of early computer pioneers. If you're the slightest bit interested in the inner workings of computers, then don't dare to miss this!

Over 800 pages in Adobe Acrobat format  
**£21.95 including VAT and p&p**

**Order code BEB2 CD-ROM**

## ELECTRONICS MADE SIMPLE

Ian Sinclair

Assuming no prior knowledge, *Electronics Made Simple* presents an outline of modern electronics with an emphasis on understanding how systems work rather than on details of circuit diagrams and calculations. It is ideal for students on a range of courses in electronics, including GCSE, C&G and GNVQ, and for students of other subjects who will be using electronic instruments and methods.

Contents: waves and pulses, passive components, active components and ICs, linear circuits, block and circuit diagrams, how radio works, disc and tape recording, elements of TV and radar, digital signals, gating and logic circuits, counting and correcting, microprocessors, calculators and computers, miscellaneous systems.

199 pages **Order code NE23** £13.99

## SCROGGIE'S FOUNDATIONS OF WIRELESS AND ELECTRONICS - ELEVENTH EDITION

S. W. Amos and Roger Amos

Scroggie's Foundations is a classic text for anyone working with electronics, who needs to know the art and craft of the subject. It covers both the theory and practical aspects of a huge range of topics from valve and tube technology, and the application of cathode ray tubes to radar, to digital tape systems and optical recording techniques.

Since *Foundations of Wireless* was first published over 60

years ago, it has helped many thousands of readers to become familiar with the principles of radio and electronics. The original author Sowerby was succeeded by Scroggie in the 1940s, whose name became synonymous with this classic primer for practitioners and students alike. Stan Amos, one of the fathers of modern electronics and the author of many well-known books in the area, took over the revision of this book in the 1980s and it is he, with his son, who have produced this latest version.

400 pages **Order code NE27** £21.99

## GETTING THE MOST FROM YOUR MULTIMETER

R. A. Penfold

This book is primarily aimed at beginners and those of limited experience of electronics. Chapter 1 covers the basics of analogue and digital multimeters, discussing the relative merits and the limitations of the two types. In Chapter 2 various methods of component checking are described, including tests for transistors, thyristors, resistors, capacitors and diodes. Circuit testing is covered in Chapter 3, with subjects such as voltage, current and continuity checks being discussed.

In the main little or no previous knowledge or experience is assumed. Using these simple component and circuit testing techniques the reader should be able to confidently tackle servicing of most electronic projects.

96 pages **Temporarily out of print**

## DIGITAL GATES AND FLIP-FLOPS

Ian R. Sinclair

This book, intended for enthusiasts, students and technicians, seeks to establish a firm foundation in digital electronics by treating the topics of gates and flip-flops thoroughly and from the beginning.

Topics such as Boolean algebra and Karnaugh mapping are explained, demonstrated and used extensively, and more attention is paid to the subject of synchronous counters than to the simple but less important ripple counters.

No background other than a basic knowledge of electronics is assumed, and the more theoretical topics are explained from the beginning, as also are many working practices. The book concludes with an explanation of microprocessor techniques as applied to digital logic.

200 pages **Order code PC106** £9.95

## BEBOP BYTES BACK (and the Bebop Computer Simulator) CD-ROM

Clive (Max) Maxfield and Alvin Brown

This follow-on to *Bebop to the Boolean Boogie* is a multimedia extravaganza of information about how computers work. It picks up where "Bebop I" left off, guiding you through the fascinating world of computer design...



# Music, Audio and Video

## QUICK GUIDE TO ANALOGUE SYNTHESIS

Ian Waugh

Even though music production has moved into the digital domain, modern synthesisers invariably use analogue synthesis techniques. The reason is simple - analogue synthesis is flexible and versatile, and it's relatively easy for us to understand. The basics are the same for all analogue synths, and you'll quickly be able to adapt the principles to any instrument. To edit existing sounds and create exciting new ones. This book describes: How analogue synthesis works; The essential modules every synthesiser has; The three steps to synthesis; How to create that bass sounds; How to generate filter sweeps. Advanced synth modules; How to create simple and complex synth patches; Where to find soft synths on the Web.

If you want to take your synthesiser - of the hardware or software variety - past the presets, and program your own sounds and effects, this practical and well-illustrated book tells you what you need to know.

60 pages **Order code PC118** £7.45

## QUICK GUIDE TO MP3 AND DIGITAL MUSIC

Ian Waugh

MP3 files, the latest digital music format, have taken the music industry by storm. What are they? Where do you get them? How do you use them? Why have they thrown record companies into a panic? Will they make music easier to buy? And cheaper? Is this the future of music?

All these questions and more are answered in this concise and practical book which explains everything you need to know about MP3s in a simple and easy-to-understand manner. It explains:

How to play MP3s on your computer; How to use MP3s with handheld MP3 players; Where to find MP3s on the Web; How MP3s work; How to tune into Internet radio stations; How to create your own MP3s; How to record your own CDs from MP3 files; Other digital audio music formats.

Whether you want to stay bang up to date with the latest music or create your own MP3s and join the on-line digital music revolution, this book will show you how.

60 pages **Order code PC119** £7.45

## ELECTRONIC MUSIC AND MIDI PROJECTS

R. A. Penfold

Whether you wish to save money, boldly go where no musician has gone before, rekindle the pioneering spirit, or simply have fun building some electronic music gadgets, the designs featured in this book should suit your needs. The projects are all easy to build, and some are so simple that even complete beginners at electronic project construction can tackle them with ease. Stripboard layouts are provided for every project, together with a wiring diagram. The mechanical side of construction has largely been left to individual constructors to sort out, simply because the vast majority of project builders prefer to do their own thing in this respect.

None of the designs requires the use of any test equipment in order to get them set up properly. Where any setting up is required, the procedures are very straightforward, and they are described in detail.

Projects covered: Simple MIDI tester, Message grabber, Byte grabber, THRU box, MIDI auto switcher, Auto/manual switcher, Manual switcher, MIDI patchbay, MIDI controlled switcher, MIDI lead tester, Program change pedal, Improved program change pedal, Basic mixer, Stereo mixer, Electronic swell pedal, Metronome, Analogue echo unit.

124 pages **Order code PC116** ~~£10.95~~ £4.95

## THE INVENTOR OF STEREO - THE LIFE AND WORKS OF ALAN DOWER BLUMLEIN

Robert Charles Alexander

This book is the definitive study of the life and works of one of Britain's most important inventors who, due to a cruel set of circumstances, has all but been overlooked by history.

Alan Dower Blumlein led an extraordinary life in which his inventive output rate easily surpassed that of Edison, but whose early death during the darkest days of World War Two led to a shroud of secrecy which has covered his life and achievements ever since.

His 1931 Patent for a Binaural Recording System was so revolutionary that most of his contemporaries regarded it as more than 20 years ahead of its time. Even years after his death, the full magnitude of its detail had not been fully utilized. Among his 128 patents are the principal electronic circuits critical to the development of the world's first electronic television system. During his short working life, Blumlein produced patent after patent breaking entirely new ground in electronic and audio engineering.

During the Second World War, Alan Blumlein was deeply engaged in the very secret work of radar development and contributed enormously to the system eventually to become 'H2S' - blind-bombing radar. Tragically, during an experimental H2S flight in June 1942, the Halifax bomber in which Blumlein and several colleagues were flying, crashed and all aboard were killed. He was just days short of his thirty-ninth birthday.

420 pages **Order code NE32** £16.99

## VIDEO PROJECTS FOR THE ELECTRONICS CONSTRUCTOR

R. A. Penfold

Written by highly respected author R. A. Penfold, this book contains a collection of electronic projects specially designed for video enthusiasts. All the projects can be simply constructed, and most are suitable for the newcomer to project construction, as they are assembled on stripboard.

There are faders, wipers and effects units which will add sparkle and originality to your video recordings, an audio mixer and noise reducer to enhance your soundtracks and a basic computer control interface. Also, there's a useful selection on basic video production techniques to get you started.

Complete with explanations of how the circuit works, shopping lists of components, advice on construction, and guidance on setting up and using the projects, this invaluable book will save you a small fortune.

Circuits include: video enhancer, improved video enhancer, video fader, horizontal wiper, improved video wiper, negative video unit, fade to grey unit, black and white keyer, vertical wiper, audio mixer, stereo headphone amplifier, dynamic noise reducer, automatic fader, push-button fader, computer control interface, 12 volt mains power supply.

124 pages **Order code PC115** ~~£10.95~~ £4.95

## PC MUSIC - THE EASY GUIDE

Robin Vincent

How do I make music on my PC? Can I record music onto my PC? What's a sequencer? How can I get my PC to print a music score? What sort of a soundcard do I need? What hardware and software do I need? How do I connect a keyboard to my PC?

Just a few of the questions you've probably asked. Well, you'll find the answers to all these questions, and many more, in this book. It will show you what can be done, what it all means, and what you will need to start creating your own music on your PC. It's an easy read, it's fully illustrated and it will help you understand how a computer can be used as a creative music tool.

It covers soundcards, sequencers, hard disk digital audio recording and editing, plug-ins, printing scores with notation software, using your PC as a synthesiser, getting music onto and off the Internet, using Windows, sample PC music setups, FAQs, a glossary, advice on hardware and software,

116 pages **Order code PC117** £11.95

and a list of industry contacts.

## HIGH POWER AUDIO AMPLIFIER CONSTRUCTION

R. A. Penfold

Practical construction details of how to build a number of audio power amplifiers ranging from about 50 to 300/400 watts r.m.s. includes MOSFET and bipolar transistor designs.

96 pages **Order code BP277** £4.49

**ALL PRICES INCLUDE UK POST AND PACKING**  
**CD-ROM prices include VAT and/or postage to anywhere in the world**

# Circuits, Data and Design

## PRACTICAL ELECTRONIC FILTERS

Owen Bishop

This book deals with the subject in a non-mathematical way. It reviews the main types of filter, explaining in simple terms how each type works and how it is used.

The book also presents a dozen filter-based projects with applications in and around the home or in the constructor's workshop. These include a number of audio projects such as a rhythm sequencer and a multi-voiced electronic organ.

Concluding the book is a practical step-by-step guide to designing simple filters for a wide range of purposes, with circuit diagrams and worked examples.

88 pages

Order code BP299

£5.49

## DIGITAL ELECTRONICS – A PRACTICAL APPROACH

With FREE Software: Number One Systems – EASY-PC

FREE SOFTWARE

Professional XM and Pulsar (Limited Functionality) Richard Monk

Covers binary arithmetic, Boolean algebra and logic gates, combination logic, sequential logic including the design and construction of asynchronous and synchronous circuits and register circuits. Together with a considerable practical content plus the additional attraction of its close association with computer aided design including the FREE software.

There is a 'blow-by-blow' guide to the use of EASY-PC Professional XM (a schematic drawing and printed circuit board design computer package). The guide also conducts the reader through logic circuit simulation using Pulsar software. Chapters on p.c.b. physics and p.c.b. production techniques make the book unique, and with its host of project ideas make it an ideal companion for the integrative assignment and common skills components required by BTEC and the key skills demanded by GNVQ. The principal aim of the book is to provide a straightforward approach to the understanding of digital electronics.

Those who prefer the 'Teach-In' approach or would rather experiment with some simple circuits should find the book's final chapters on printed circuit board production and project ideas especially useful.

250 pages (large format)

Order code NE28

£19.99

## A BEGINNER'S GUIDE TO TTL DIGITAL ICs

R. A. Penfold

This book first covers the basics of simple logic circuits in general, and then progresses to specific TTL logic integrated circuits. The devices covered include gates, oscillators, timers, flip/flops, dividers, and decoder circuits. Some practical circuits are used to illustrate the use of TTL devices in the "real world".

142 pages

Order code BP332

£5.45

## DOMESTIC SECURITY SYSTEMS

A. L. Brown

This book shows you how, with common sense and basic do-it-yourself skills, you can protect your home. It also gives tips and ideas which will help you to maintain and improve your home security, even if you already have an alarm. Every circuit in this book is clearly described and illustrated, and contains components that are easy to source. Advice and guidance are based on the real experience of the author who is an alarm installer, and the designs themselves have been rigorously put to use on some of the most crime-ridden streets in the world.

The designs include all elements, including sensors, detectors, alarms, controls, lights, video and door entry systems. Chapters cover installation, testing, maintenance and upgrading.

192 pages

Temporarily out of print

## MICROCONTROLLER COOKBOOK

Mike James

The practical solutions to real problems shown in this cookbook provide the basis to make PIC and 8051 devices really work. Capabilities of the variants are examined, and ways to enhance these are shown. A survey of common interface devices, and a description of programming models, lead on to a section on development techniques. The cookbook offers an introduction that will allow any user, novice or experienced, to make the most of micro-controllers.

240 pages

Order code NE26

£21.99

For a further selection of books see the next two issues of EPE

# Project Building & Testing

## ELECTRONIC PROJECTS FOR EXPERIMENTERS

R. A. Penfold

Many electronic hobbyists who have been pursuing their hobby for a number of years seem to suffer from the dreaded "seen it all before" syndrome. This book is fairly and squarely aimed at sufferers of this complaint, plus any other electronics enthusiasts who yearn to try something a bit different. No doubt many of the projects featured here have practical applications, but they are all worth a try for their interest value alone.

The subjects covered include:- Magnetic field detector, Basic Hall effect compass, Hall effect audio isolator, Voice scrambler/descrambler, Bat detector, Bat style echo location, Noise cancelling, LED stroboscope, Infra-red "torch", Electronic breeze detector, Class D power amplifier, Strain gauge amplifier, Super hearing aid.

138 pages

Order code BP371

£5.45

## FAULT-FINDING ELECTRONIC PROJECTS

R. A. Penfold

Starting with mechanical faults such as dry joints, short-circuits etc, coverage includes linear circuits, using a meter to make voltage checks, signal tracing techniques and fault finding on logic circuits. The final chapter covers ways of testing a wide range of electronic components, such as resistors, capacitors, operational amplifiers, diodes, transistors, SCRs and triacs, with the aid of only a limited amount of test equipment.

The construction and use of a Tristate Continuity Tester, a Signal Tracer, a Logic Probe and a CMOS Tester are also included.

136 pages

Order code BP391

£5.49

## PRACTICAL FIBRE-OPTIC PROJECTS

R. A. Penfold

While fibre-optic cables may have potential advantages over ordinary electric cables, for the electronics enthusiast it is probably their novelty value that makes them worthy of exploration. Fibre-optic cables provide an innovative interesting alternative to electric cables, but in most cases they also represent a practical approach to the problem. This book provides a number of tried and tested circuits for projects that utilize fibre-optic cables.

The projects include:- Simple audio links, F.M. audio link, P.W.M. audio links, Simple d.c. links, P.W.M. d.c. link, P.W.M. motor speed control, RS232C data links, MIDI link, Loop alarms, R.P.M. meter.

All the components used in these designs are readily available, none of them require the constructor to take out a second mortgage.

132 pages

Order code BP374

£5.45

## RADIO BYGONES

We also carry a selection of books aimed at readers of EPE's sister magazine on vintage radio *Radio Bygones*. These books include the *Comprehensive Radio Valve Guides* (five books with a Free copy of the Master Index) for just £15. Also Jonathan Hill's excellent *Radio Radio*, a comprehensive book with hundreds of photos depicting the development of the British wireless set up to the late 1960s.

The three volumes of our own *Wireless For the Warrior* by Louis Meulstee are also available. These are a technical history of radio communication equipment in the British Army from pre-war through to the 1960s.

For details see the shop on our UK web site at [www.epemag.wimborne.co.uk](http://www.epemag.wimborne.co.uk) or contact us for a list of *Radio Bygones* books.

## BOOK ORDERING DETAILS

All prices include UK postage. For postage to Europe (air) and the rest of the world (surface) please add £2 per book. For the rest of the world airmail add £3 per book. CD-ROM prices include VAT and/or postage to anywhere in the world. Send a PO, cheque, international money order (£ sterling only) made payable to Direct Book Service or card details, Visa, Mastercard, Amex, Diners Club or Switch to:

DIRECT BOOK SERVICE, WIMBORNE PUBLISHING LTD.,  
408 WIMBORNE ROAD EAST, FERNDOWN, DORSET BH22 9ND.

Books are normally sent within seven days of receipt of order, but please allow 28 days for delivery – more for overseas orders. Please check price and availability (see latest issue of Everyday Practical Electronics) before ordering from old lists.

For a further selection of books see the next two issues of EPE.

Tel 01202 873872 Fax 01202 874562. Email: [dbs@epemag.wimborne.co.uk](mailto:dbs@epemag.wimborne.co.uk)  
Order from our online shop at: [www.epemag.wimborne.co.uk/shopdoor.htm](http://www.epemag.wimborne.co.uk/shopdoor.htm)

## BOOK ORDER FORM

Full name: .....

Address: .....

.....

.....

..... Post code: ..... Telephone No: .....

Signature: .....

I enclose cheque/PO payable to DIRECT BOOK SERVICE for £ .....

Please charge my card £ ..... Card expiry date.....

Card Number ..... Switch Issue No.....

Card Security Code ..... (The last 3 digits on or just below the signature strip)

Please send book order codes: .....

.....

Please continue on separate sheet of paper if necessary  
If you do not wish to cut your magazine, send a letter or copy of this form

# PCB SERVICE

Printed circuit boards for most recent *EPE* constructional projects are available from the PCB Service, see list. These are fabricated in glass fibre, and are fully drilled and roller tinned. All prices include VAT and postage and packing. Add £1 per board for airmail outside of Europe. Remittances should be sent to The PCB Service, *Everyday Practical Electronics*, Wimborne Publishing Ltd., 408 Wimborne Road East, Ferndown, Dorset BH22 9ND. Tel: 01202 873872; Fax 01202 874562; Email: [orders@epemag.wimborne.co.uk](mailto:orders@epemag.wimborne.co.uk). On-Line Shop: [www.epemag.wimborne.co.uk/shopdoor.htm](http://www.epemag.wimborne.co.uk/shopdoor.htm). Cheques should be crossed and made payable to *Everyday Practical Electronics* (Payment in £ sterling only). NOTE: While 95% of our boards are held in stock and are dispatched within seven days of receipt of order, please allow a maximum of 28 days for delivery – overseas readers allow extra if ordered by surface mail.

Back numbers or photostats of articles are available if required – see the *Back Issues* page for details. We do not supply kits or components for our projects.

**Please check price and availability in the latest issue.**

**A number of older boards are listed on our website.**

Boards can only be supplied on a payment with order basis.

| PROJECT TITLE  | Order Code          | Cost        |
|--|---------------------|-------------|
| Camcorder Power Supply   | <b>OCT '01</b> 318  | £5.94       |
| PIC Toolkit Mk3  | 319                 | £8.24       |
| Perpetual Projects Uniboard-4. Gate Sentinel. Solar-powered Bird Scarer and Solar-Powered Register | 305                 | £3.00       |
| Teach-In 2002 Power Supply   | <b>NOV '01</b> 320  | £4.28       |
| Lights Needed Alert  | 321                 | £5.39       |
| Pitch Switch   | 322                 | £5.87       |
| ★ ★ PIC Toolkit TK3 – Software only  | –                   | –           |
| 4-Channel Twinkling Lights   | <b>DEC '01</b> 325  | £6.82       |
| Ghost Buster – Mic   | 326                 | } Set £5.78 |
| – Main   | 327                 |             |
| ★ PIC Polywhatsit – Digital  | 328                 |             |
| – Analogue   | 329                 | } Set £7.61 |
| Forever Flasher  | <b>JAN '02</b> 330  |             |
| Time Delay Touch Switch  | 331                 | £4.60       |
| ★ PIC Magick Musick  | 332                 | £5.87       |
| Versatile Bench Power Supply   | 333                 | £5.71       |
| ★ PIC Spectrum Analyser  | <b>FEB '02</b> 334  | £7.13       |
| Versatile Current Monitor  | 335                 | £4.75       |
| Guitar Practice Amp  | 336                 | £5.39       |
| ★ PIC Virus Zapper   | <b>MAR '02</b> 337  | £4.75       |
| RH Meter   | 338                 | £4.28       |
| ★ PIC Mini-Enigma – Software only  | –                   | –           |
| ★ Programming PIC Interrupts – Software only   | –                   | –           |
| ★ PIC Controlled Intruder Alarm  | <b>APR '02</b> 339  | £6.50       |
| ★ PIC Big Digit Display  | <b>MAY '02</b> 341  | £6.02       |
| Washing Ready Indicator  | 342                 | £4.75       |
| Audio Circuits-1 – LM386N-1  | 343                 | £4.28       |
| – TDA7052  | 344                 | £4.12       |
| – TBA820M  | 345                 | £4.44       |
| – LM380N   | 346                 | £4.44       |
| – TDA2003  | 347                 | £4.60       |
| – Twin TDA2003   | 348                 | £4.75       |
| World Lamp   | <b>JUNE '02</b> 340 | £5.71       |
| Simple Audio Circuits-2 – Low, Med and High Input Impedance Preamplifiers (Single Trans.)          | 349                 | £4.60       |
| Low-Noise Preamplifier (Dual Trans.)   | 350                 | £4.75       |
| Tone Control   | 351                 | £4.60       |
| Bandpass Filter  | 352                 | £4.75       |
| Frequency Standard Generator – Receiver  | 353                 | £4.12       |
| – Digital  | 354                 | £6.82       |
| ★ Biopic Heartbeat Monitor   | 355                 | £5.71       |
| Simple Audio Circuits – 3  | <b>JULY '02</b>     |             |
| – Dual Output Power Supply   | 356                 | £4.60       |
| – Crossover/Audio Filter   | 357                 | £4.44       |
| Infra-Red Autoswitch   | 358                 | £4.91       |
| ★ EPE StyloPIC   | 359                 | £6.50       |
| Rotary Combination Lock – Main Board   | 360                 | £5.39       |
| – Interface Board  | 361                 | £4.91       |
| ★ Using the PIC's PCLATH Command – Software only   | –                   | –           |
| Big-Ears Buggy   | <b>AUG '02</b> 362  | £5.71       |
| ★ PIC World Clock  | 363                 | £5.39       |
| Simple Audio Circuits-4 – Low Freq. Oscillator   | 364                 | £4.44       |
| – Resonance Detector   | 365                 | £4.28       |
| Vinyl-To-CD Preamplifier   | <b>SEPT '02</b> 366 | £5.71       |
| ★ Freebird Glider Control  | 367                 | £4.91       |
| ★ Morse Code Reader  | 368                 | £5.23       |
| Headset Communicator   | <b>OCT '02</b> 369  | £4.75       |
| EPE Bounty Treasure Hunter   | 370                 | £4.77       |
| ★ ★ Digital I.C. Tester  | 371                 | £7.14       |
| ★ PIC-Pocket Battleships – Software only   | –                   | –           |
| Transient Tracker  | <b>NOV '02</b> 372  | £4.75       |
| ★ PICAXE Projects-1: Egg Timer; Dice Machine; Quiz Game Monitor (Multiboard)                       | 373                 | £3.00       |
| ★ Tuning Fork & Metronome  | 374                 | £5.39       |
| ★ ★ EPE Hybrid Computer – Main Board   | } double-sided      | £18.87      |
| – Atom Board   |                     |             |
| ★ PICAXE Projects-2: Temperature Sensor; Voltage Sensor; VU Indicator (Multiboard)                 | <b>DEC '02</b> 373  | £3.00       |
| ★ Versatile PIC Flasher  | 377                 | £5.07       |
| ★ PICAXE Projects-3: Chaser Lights   | <b>JAN '03</b> 373  | £3.00       |
| 6-Channel Mains Interface  | 381                 | £5.08       |
| EPE Minder – Transmitter   | 378                 | £4.75       |
| – Receiver   | 379                 | £5.39       |
| ★ Wind Speed Monitor   | 380                 | £5.08       |

| PROJECT TITLE                          | Order Code          | Cost   |
|--|---------------------|--------|
| Tesla Transformer                      | <b>FEB '03</b> 382  | £5.07  |
| ★ Brainbot Buggy                       | 383                 | £3.00  |
| ★ Wind Tunnel                          | 384                 | £6.02  |
| 200kHz Function Generator              | <b>MAR '03</b> 385  | £6.34  |
| Wind-Up Torch Mk II                    | 386                 | £4.75  |
| ★ Driver Alert                         | 387                 | £6.35  |
| ★ Earth Resistivity Logger             | <b>APR '03</b> 388  | £6.02  |
| ★ Intelligent Garden Lights Controller | 389                 | £3.96  |
| ★ PIC Tutorial V2 – Software only      | –                   | –      |
| Door Chime                             | <b>MAY '03</b> 390  | £5.07  |
| Super Motion Sensor                    | 391                 | £5.55  |
| Radio Circuits-1 MK484 TRF Receiver    | <b>JUNE '03</b> 392 | £4.44  |
| Headphone Amp.                         | 393                 | £4.28  |
| ★ Fido Pedometer                       | 394                 | £4.91  |
| ★ PICronos L.E.D. Wall Clock           | 395                 | £14.65 |
| EPE Mini Metal Detector                | <b>JULY '03</b> 396 | £4.28  |
| Radio Circuits – 2 Q-Multiplier        | 397                 | £4.28  |
| MW Reflex Radio                        | 398                 | £4.60  |
| Wave Trap                              | 399                 | £4.28  |
| Speaker Amplifier                      | 400                 | £4.44  |
| Ohmmeter Adaptor MkII                  | 401                 | £4.60  |
| Ultimate Egg Timer (Top Tenner)        | 403                 | £4.91  |
| ★ EPE PIC Met Office                   | <b>AUG '03</b> 402  | £10.46 |
| Alarm System Fault Finder              | 404                 | £4.44  |
| Radio Circuits-3 Regen. Radio          | 405                 | £5.07  |
| Tuning Capacitor Board                 | 406                 | £4.28  |
| Master/Slave Intercom (Top Tenner)     | 407                 | £4.75  |
| Two-Up (Top Tenner)                    | 408                 | £4.91  |
| Priority Referee (Top Tenner)          | <b>SEPT '03</b> 410 | £5.07  |
| Vibration Alarm (Top Tenner)           | 411                 | £5.39  |
| Radio Circuits-4 Varicap Tuner         | 412                 | £4.44  |
| Coil Pack – General Coverage           | 413                 | £5.07  |
| Coil Pack – Amateur Bands              | 414                 | £4.75  |
| ★ PIC-A-Colour – Software only         | –                   | –      |
| Spooky Bug (Top Tenner)                | <b>OCT '03</b> 409  | £5.07  |
| Radio Circuits-5 Crystal Marker        | 415                 | £4.44  |
| Super Regen. Receiver                  | 419                 | £5.07  |
| Buffer Amplifier                       | 420                 | £4.44  |
| ★ ★ Serial Interface for PICs and VB6  | 416                 | £5.23  |
| ★ ★ PIC Breakpoint – Software only     | –                   | –      |

## EPE SOFTWARE

Software programs for *EPE* projects marked with a single asterisk ★ are available on 3.5 inch PC-compatible disks or free from our Internet site. The following disks are available: PIC Tutorial V2 (Apr-June '03); *EPE* Disk 1 (Apr '95-Dec '98); *EPE* Disk 2 (1999); *EPE* Disk 3 (2000); *EPE* Disk 4 (2001); *EPE* Disk 5 (2002); *EPE* Disk 6 (Jan 2003 issue to current cover date – excl. Earth Resistivity); *EPE* Earth Resistivity Logger (Apr-May '03); *EPE* PIC Met Office (Aug-Sept '03); *EPE* Teach-In 2000; *EPE* Spectrum; *EPE* Interface Disk 1 (October '00 issue to current cover date). ★ ★ The software for these projects is on its own CD-ROM. The 3.5 inch disks are £3.00 each (UK), the CD-ROMs are £6.95 (UK). Add 50p each for overseas surface mail, and £1 each for airmail. All are available from the *EPE PCB Service*. All files can be downloaded free from our Internet FTP site, accessible via our home page at: [www.epemag.wimborne.co.uk](http://www.epemag.wimborne.co.uk).

## EPE PRINTED CIRCUIT BOARD SERVICE

Order Code Project Quantity Price

.....

Name .....

Address .....

.....

Tel. No. ....

I enclose payment of £..... (cheque/PO in £ sterling only) to:



**Everyday Practical Electronics**



**MasterCard, Amex, Diners Club, Visa or Switch**



Card No. ....

Card Exp. Date ..... Switch Issue No .....

Card Security Code .....

(The last 3 digits on or just under the signature strip)

Signature .....

NOTE: You can also order p.c.b.s by phone, Fax, Email or via our Internet site on a secure server:

<http://www.epemag.wimborne.co.uk/shopdoor.htm>

**WHETHER ELECTRONICS IS YOUR HOBBY  
OR YOUR LIVELIHOOD . . .  
YOU NEED THE MODERN ELECTRONICS MANUAL  
and the ELECTRONICS SERVICE MANUAL**

## **THE MODERN ELECTRONICS MANUAL (CD-ROM VERSION ONLY)**



**NEW  
CD-ROM VERSION  
OF THE  
MODERN ELECTRONICS  
MANUAL  
AVAILABLE NOW  
ONLY  
£29.95**

**The essential reference  
work for everyone  
studying electronics**

- Over 800 pages
- In-depth theory
- Projects to build
- Detailed assembly instructions
- Full components checklists
- Extensive data tables
- Manufacturers' web links
- Easy-to-use Adobe Acrobat format
- Clear and simple layout
- Comprehensive subject range
- Professionally written
- Regular Supplements

## **EVERYTHING YOU NEED TO GET STARTED AND GO FURTHER IN ELECTRONICS!**

The revised CD-ROM edition of the Modern Electronics Base Manual (MEM) contains practical, easy-to-follow information on the following subjects:

**BASIC PRINCIPLES:** Electronic Components and their Characteristics (16 sections from Resistors and Potentiometers to Crystals, Crystal Modules and Resonators); Circuits Using Passive Components (10 sections); Power Supplies; The Amateur Electronics Workshop; The Uses of Semiconductors; Digital Electronics (6 sections); Operational Amplifiers; Introduction to Physics, including practical experiments; Semiconductors (5 sections) and Digital Instruments (3 sections).

**CIRCUITS TO BUILD:** There's nothing to beat the satisfaction of creating your own projects. From basic principles, like soldering and making printed circuit boards, to the tools needed for circuit-building, the Modern Electronics Manual and its Supplements describe clearly, with appropriate diagrams, how to assemble a radio, loudspeaker circuits, amplifiers, car projects,

a computer interface, measuring instruments, workshop equipment, security systems, medical and musical circuits, etc. The Base Manual describes 12 projects including a Theremin and a Simple TENS Unit.

**ESSENTIAL DATA:** Extensive tables on diodes, transistors, thyristors and triacs, digital and linear i.c.s.

**EXTENSIVE GLOSSARY:** Should you come across a technical word, phrase or abbreviation you're not familiar with, simply look up the glossary included in the Manual and you'll find a comprehensive definition in plain English.

The Manual also covers **Safety** and provides web links to component and equipment **Manufacturers and Suppliers**. The most comprehensive reference work ever produced at a price you can afford, the CD-ROM edition of **THE MODERN ELECTRONICS MANUAL** provides you with all the **essential** information you need.

## **THE MODERN ELECTRONICS MANUAL (MEM - CD-ROM version only)**

**Revised CD-ROM Edition of Basic Work:** Contains over 800 pages of information in Adobe Acrobat format. Edited by John Becker.

**Regular Supplements:** Additional CD-ROMs each containing approximately 500 pages of additional information on specific areas of electronics are available for £19.95 each. Information on the availability and content of each Supplement CD-ROM will be sent to you.

**Presentation:** CD-ROM suitable for any modern PC. Requires Adobe Acrobat Reader which is included on the MEM CD-ROM.

**Price of the Basic Work: £29.95 POST FREE.**

## **ORDER BOTH MANUALS TOGETHER AND SAVE £20**

**A mass of well-organised and clearly explained information is brought to you by expert editorial teams whose combined experience ensures the widest coverage**

**Regular Supplements to these unique publications, keep you abreast of the latest technology and techniques if required**

# ELECTRONICS SERVICE MANUAL

(PRINTED VERSION ONLY)

## EVERYTHING YOU NEED TO KNOW TO GET STARTED IN REPAIRING AND SERVICING ELECTRONIC EQUIPMENT

**SAFETY:** Be knowledgeable about Safety Regulations, Electrical Safety and First Aid.

**UNDERPINNING KNOWLEDGE:** Specific sections enable you to Understand Electrical and Electronic Principles, Active and Passive Components, Circuit Diagrams, Circuit Measurements, Radio, Computers, Valves and Manufacturers' Data, etc.

**PRACTICAL SKILLS:** Learn how to identify Electronic Components, Avoid Static Hazards, Carry Out Soldering and Wiring, Remove and Replace Components.

**TEST EQUIPMENT:** How to Choose and Use Test Equipment, Assemble a Toolkit, Set Up a Workshop, and Get the Most from Your Multimeter and Oscilloscope, etc.

**SERVICING TECHNIQUES:** The regular Supplements include vital guidelines on how to Service Audio Amplifiers, Radio Receivers, TV Receivers, Cassette Recorders, Video Recorders, Personal Computers, etc.

**TECHNICAL NOTES:** Commencing with the IBM PC, this section and the regular Supplements deal with a very wide range of specific types of equipment – radios, TVs, cassette recorders, amplifiers, video recorders etc..

**REFERENCE DATA:** Detailing vital parameters for Diodes, Small-Signal Transistors, Power Transistors, Thyristors, Triacs and Field Effect Transistors. Supplements include Operational Amplifiers, Logic Circuits, Optoelectronic Devices, etc.

## The essential work for servicing and repairing electronic equipment

- Around 900 pages
- Fundamental principles
- Troubleshooting techniques
- Servicing techniques
- Choosing and using test equipment
- Reference data
- Easy-to-use format
- Clear and simple layout
- Vital safety precautions
- Professionally written
- Regular Supplements
- Sturdy gold blocked ring-binder

## ELECTRONICS SERVICE MANUAL (ESM – Printed version only)

**Basic Work:** Contains around 900 pages of information. Edited by Mike Tooley BA  
**Regular Supplements:** Unlike a book or encyclopedia, this Manual is a living work – continuously extended with new material. If requested, Supplements are sent to you on approval approximately every three months. Each Supplement contains around 160 pages – all for only £23.50+£2.50 p&p. You can, of course, return any Supplement (within ten days) which you feel is superfluous to your needs. You can also purchase a range of past Supplements to extend your Base Manual on subjects of particular interest to you.

**Presentation:** Durable looseleaf system in large A4 format

**Price of the Basic Work: £29.95**  
 (to include a recent Supplement FREE).



### Guarantee

Our 30 day money back guarantee gives you complete peace of mind. If you are not entirely happy with the *Electronics Service Manual*, for whatever reason, simply return it to us in good condition within 30 days and we will make a full refund of your payment – no small print and no questions asked. All we ask is that you pay the return postage. (Overseas buyers also have to pay our overseas postage charge). Sorry, but we can only make exchanges on the *Modern Electronics Manual* (CD-ROM version) if the CD-ROM is faulty. we cannot offer a money back guarantee on this product as the content can be printed out.

Wimborne Publishing Ltd., Dept Y10, 408 Wimborne Road East, Ferndown, Dorset BH22 9ND. Tel: 01202 873872. Fax: 01202 874562.  
 Online shop: [www.epemag.wimborne.co.uk/shopdoor.htm](http://www.epemag.wimborne.co.uk/shopdoor.htm)

**PLEASE** send me



- THE MODERN ELECTRONICS MANUAL (CD-ROM version only)
- ELECTRONICS SERVICE MANUAL plus a FREE SUPPLEMENT (Printed version only)
- I enclose payment of £29.95 (for one Manual) or £39.90 for both Manuals (saving £20 by ordering both together) plus postage if applicable.
- I also require the appropriate ESM Supplements four times a year. These are billed separately and can be discontinued at any time. (Please delete if not required.)

FULL NAME .....  
 (PLEASE PRINT)

ADDRESS .....  
 .....  
 .....  
 POSTCODE .....

SIGNATURE .....

- I enclose cheque/PO in UK pounds payable to Wimborne Publishing Ltd.
- Please charge my Visa/Mastercard/Amex/Diners Club/Switch Switch Issue No .....
- Card No .....

Card Exp. Date ..... Card Security Code .....

(The last 3 digits on or just under the signature strip)

### ORDER FORM

Simply complete and return the order form with your payment to the following address:  
**Wimborne Publishing Ltd, Dept. Y10, 408 Wimborne Road East, Ferndown, Dorset BH22 9ND**  
 We offer a 30 day MONEY BACK GUARANTEE on ESM – see the panel above for details.

### POSTAGE CHARGES FOR ESM

MEM CD-ROM POST FREE TO ALL COUNTRIES  
 (Note we use the VAT portion of the MEM CD-ROM payment to pay for overseas postage)

| Postal Region                            | Price PER ESM PRINTED MANUAL |          |
|--|------------------------------|----------|
|  | Surface                      | Air      |
| Mainland UK                              | FREE                         | –        |
| Scottish Highlands,<br>UK Islands & Eire | £7 each                      | –        |
| Europe (EU)                              | –                            | £23 each |
| Europe (Non-EU)                          | £23 each                     | £30 each |
| USA & Canada                             | £28 each                     | £39 each |
| Far East & Australasia                   | £35 each                     | £43 each |
| Rest of World                            | £28 each                     | £52 each |

Please allow four working days for UK delivery.

NOTE: Surface mail can take over 10 weeks to some parts of the world. Each ESM weighs about 4kg when packed.

Everyday Practical Electronics reaches twice as many UK readers as any other UK monthly hobby electronics magazine, our sales figures prove it. We have been the leading monthly magazine in this market for the last eighteen years.

If you want your advertisements to be seen by the largest readership at the most economical price our classified and semi-display pages offer the best value. The prepaid rate for semi-display space is £8 (+VAT) per single column centimetre (minimum 2.5cm). The prepaid rate for classified adverts is 30p (+VAT) per word (minimum 12 words).

All cheques, postal orders, etc., to be made payable to Everyday Practical Electronics. VAT must be added. Advertisements, together with remittance, should be sent to Everyday Practical Electronics Advertisements, Mill Lodge, Mill Lane, Thorpe-le-Soken, Essex CO16 0ED. Phone/Fax (01255) 861161.

For rates and information on display and classified advertising please contact our Advertisement Manager, Peter Mew as above.

## VVT TRANSFORMERS

Transformers and Chokes for all types of circuits including specialist valve units  
Custom design or standard range  
High and low voltage

### Variable Voltage Technology Ltd

Unit 3, Sheat Manor Farm, Chillerton,  
Newport, Isle of Wight, PO30 3HP  
Tel: 0870 243 0414 Fax: 01983 721572  
email: sales@vvt-cowes.freemove.co.uk

[www.vvttransformers.co.uk](http://www.vvttransformers.co.uk)

## BTEC ELECTRONICS TECHNICIAN TRAINING

VCE ADVANCED ENGINEERING  
ELECTRONICS AND ICT  
HNC AND HND ELECTRONICS  
NVQ ENGINEERING AND IT  
**PLEASE APPLY TO COLLEGE FOR  
NEXT COURSE DATE  
FULL PROSPECTUS FROM**

**LONDON ELECTRONICS COLLEGE  
(Dept EPE) 20 PENYWERN ROAD  
EARLS COURT, LONDON SW5 9SU  
TEL: (020) 7373 8721**

## BOWOOD ELECTRONICS LTD

Suppliers of Electronic Components

Place a secure order on our website or call our sales line  
All major credit cards accepted

Web: [www.bowood-electronics.co.uk](http://www.bowood-electronics.co.uk)  
7 Bakewell Road, Baslow, Derbyshire DE45 1RF.  
Sales: 01246 583777

Send 42p stamp for catalogue

## D.C. MOTORS



P.M.1 Motor, 24V, 8,000 r.p.m.,  
gun metal outer casing, with  
permanent magnet inner, will  
run for great duration, durable  
and long lasting.



08 28V, 5,000 r.p.m. with much  
the same quality as the above  
(Vactrics).



08 12V, 3A, 5,000 r.p.m., these  
are from the Rank Organisation  
(A1 pulling control motor). Same  
quality as above.

**£125 each**

**J. W. Fisher, The White House,  
90 Western Avenue, Newport NP20 3QZ  
Tel: 01633 211058**

## X-10® Home Automation We put you in control™

### Why tolerate when you can automate?

An extensive range of 230V X-10 products  
and starter kits available. Uses proven Power  
Line Carrier technology, no wires required.

Products Catalogue available Online.

Worldwide delivery.

### Laser Business Systems Ltd.

E-Mail: [info@laser.com](mailto:info@laser.com)

<http://www.laser.com>

Tel: (020) 8441 9788

Fax: (020) 8449 0430



## LED Torch

Batteries  
last up to  
30 hours.  
Ultrabright.  
**£7.99**  
3 for £20



## Silver Camera

with mount.  
2 Lux.  
Colour  
with  
Sound  
**£24.99**



UK recorded delivery £1.50

Send orders to

## FERNBOND ELECTRONICS

Thomas House, RM232,  
47 Botanic Ave., Belfast BT4 3JN  
Tel: 02890 926182 Ext. 1011

Wholesale enquiries welcome

Visa and Switch orders taken online

[www.fernbond.com/mailorder](http://www.fernbond.com/mailorder)  
[mailorder@fernbond.com](mailto:mailorder@fernbond.com)



## TRANSFORMERS

- Custom Wound
- 1 Phase to 50kVA
- 3 Phase to 100kVA
- A.C. and D.C. Chokes
- H.T. up to 5kV
- Transformer Kits
- Coils up to 1m Dia.
- Transformer Rectifiers
- Toroidals
- Motor Generators

Visit [www.jemelec.com](http://www.jemelec.com) for details  
or request our free leaflet

Jemelec, Unit 7, Shirebrook Business Park, Mansfield, NG20 8RN

**Tel: 0870 787 1769**

## SWAYSCIENCE

LOW TEMPERATURE DESOLDERING  
(60°C-80°C)

Remove electronic components without heat  
damage to semiconductors or p.c.b.s.

★ New Product ★ Cost Effective

★ Free Details

★ Safer than most solder itself

★ Trade and Retail Enquiries Welcome

**TEL: 0778 770 3785**

## TOTALROBOTS

### ROBOTICS, CONTROL & ELECTRONICS TECHNOLOGY

High quality robot kits and components  
UK distributor of the OOPic microcontroller

Secure on-line ordering

Rapid delivery

Highly competitive prices

Visit [www.totalrobots.com](http://www.totalrobots.com)

**Tel: 0208 823 9220**

## PC Oscilloscope & Signal Generator



3-in-1 Digital Oscilloscope + Signal Generator + Spectrum  
Analyser. Samples at 20 or 30 Msps. Programmable signal  
generator with built in sine, triangular, saw and square waves  
in normal & sweep modes Plugs into printer port

Prices from £139 - CL SYSTEM

Visit [www.clsystem.co.uk](http://www.clsystem.co.uk) or call 07986 860815

## Miscellaneous

**FREE PROTOTYPE PRINTED CIRCUIT  
BOARDS!** Free prototype p.c.b. with quantity  
orders. Call Patrick on 028 9073 8897 for  
details. Agar Circuits, Unit 5, East Belfast  
Enterprise Park, 308 Albertbridge Road, Belfast  
BT5 4GX.

**PRINTED CIRCUIT BOARDS - QUICK  
SERVICE.** Prototype and production artwork  
raised from magazines or draft designs at low  
cost. PCBs designed from schematics.  
Production assembly, wiring and software pro-  
gramming. For details contact Patrick at Agar  
Circuits, Unit 5, East Belfast Enterprise Park,  
308 Albertbridge Road, Belfast, BT5 4GX.  
Phone 028 9073 8897, Fax 028 9073 1802,  
Email [agar@argonet.co.uk](mailto:agar@argonet.co.uk).

**G.C.S.E. ELECTRONICS KITS, TOOLS,**  
pocket money prices. S.A.E. for free catalogue.  
**SIR-KIT Electronics,** 52 Severn Road, Clacton,  
CO15 3RB. [www.geocities.com/sirkituk](http://www.geocities.com/sirkituk).  
**VALVES AND ALLIED COMPONENTS IN  
STOCK.** Phone for free list. Valves, books and  
magazines wanted. Geoff Davies (Radio), tel.  
01788 574774.

**CONSTRUCTION PROJECT GUIDES,** Kits and  
Component Kits for *Everyday Practical  
Electronics* Projects - new improved web site!  
Visit [www.metastable.electronics.btinternet.co.uk](http://www.metastable.electronics.btinternet.co.uk).

**SUPER BRIGHT 5MM L.E.D.s,** 7000 to 8000  
mcd. Pure white Grade A, same l.e.d.s as used in  
the most modern flashlights. Available £1.50  
each or £14 for 10, 50p p&p. N. Williams, 537  
London Road South, Lowestoft, Suffolk, NR33  
0PD. Email: [ivanelixias@aol.com](mailto:ivanelixias@aol.com).

**SOMETHING DIFFERENT.** Forbidden  
knowledge, plans and experiments. More infor-  
mation: [info@dacdirect.co.uk](mailto:info@dacdirect.co.uk). Unit 2, 105  
London Street, Reading, RG1 4QA.



## IMPROVE YOUR SKILLS WITH A HOME STUDY COURSE

Make a real success of yourself by gaining the vital skills and qualifications you need with an ICS home study course. You learn in your own time, at your own pace and from the comfort of your home. And with over 13 million successful students, you'll be joining the most experienced home study school in the world. You can do it with ICS! So why not improve your prospects today by calling us now or returning the coupon below.

- Electrical Contracting & Installation
- Electrical Engineering
- C&G Basic Electronic Engineering
- C&G Basic Mechanical Engineering
- TV & Video Servicing
- Radio & Hi-Fi Servicing
- Refrigeration, Heating & Air Conditioning
- Motorcycle Maintenance

**FREEPHONE 0800 056 6137** Extra 10p Mon - Fri 8.30 am - 8 pm

Or write to: ICS, FREEPOST 882, Glasgow, G3 8BR. Tel: Eire call 1800 620 490

Please send me my Free Information on your Technical Courses.

Mr/Ms/Ms/Miss (BLOCK CAPITALS PLEASE) \_\_\_\_\_ Date of Birth: / / \_\_\_\_\_  
 Address \_\_\_\_\_  
 Postcode \_\_\_\_\_  
 Tel No \_\_\_\_\_ Dept ZEEVT103 www.icslearn.co.uk

**ICS THE WORLD'S NO.1** From time to time, we permit other carefully screened organisations to contact you about products and services. If you prefer not to hear from such organisations please tick box

## Autonomous Programmable Robot Kits Accessories - Sensors - Controller Boards

**competition-robotics.com**

Secure on-line ordering. Fast, friendly service.

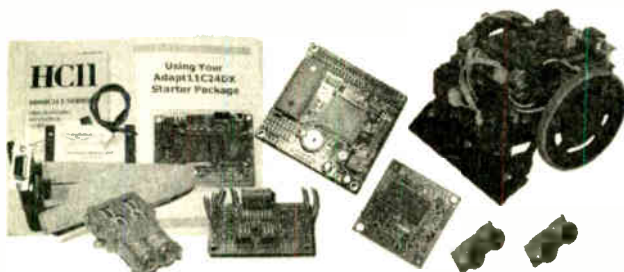

Web: [www.competition-robotics.com](http://www.competition-robotics.com) Tel: 01793 638119 Fax: 01793 705772 e-Mail: [sales@competition-robotics.com](mailto:sales@competition-robotics.com)

## N. R. BARDWELL LTD (Est. 1948)

|     |  |       |     |   |       |
|-----|--|-------|-----|---|-------|
| 100 | Signal Diodes 1N4148                           | £1.00 | 80  | Ass'd. capacitors 1nF to 1µF                        | £1.00 |
| 75  | Rectifier Diodes 1N4001                        | £1.00 | 200 | Ass'd. disc ceramic capacitors                      | £1.00 |
| 50  | Rectifier Diodes 1N4007                        | £1.00 | 50  | Ass'd. Skel Presets (sm, stand, cermet)             | £1.00 |
| 10  | W01 Bridge Rectifiers                          | £1.00 | 50  | Ass'd. RF chokes (Inductors)                        | £1.00 |
| 10  | 555 Timer I.C.s                                | £1.00 | 50  | Ass'd. grommets                                     | £1.00 |
| 4   | 741 Op Amps                                    | £1.00 | 10  | Ass'd. crystals - plug in                           | £1.00 |
| 50  | Assorted Zener Diodes 400mW                    | £1.00 | 8   | Ass'd. di switches                                  | £1.00 |
| 12  | Assorted 7-segment Displays                    | £1.00 | 8   | Ass'd. push-button switches, multi-bank, multi-pole | £1.00 |
| 35  | Assorted I.e.d.s, var. shapes, colours & sizes | £1.00 | 30  | Ass'd. di sockets up to 40 way                      | £1.00 |
| 25  | 5mm I.e.d.s, red or green or yellow            | £1.00 | 10  | TV coax plugs, plastic                              | £1.00 |
| 25  | 3mm I.e.d.s, red or green or yellow            | £1.00 | 40  | metres very thin connecting wire, red               | £1.00 |
| 75  | 5mm I.e.d.s, green, 6-5mm legs                 | £1.00 | 20  | 1in. glass reed switches                            | £1.00 |
| 50  | Axial I.e.d.s, 2mcd red Diode Package          | £1.00 | 100 | Any one value 1/4W 5% cf resistors range 1R to 10M  | £0.45 |
| 25  | Ass'd. High Brightness I.e.d.s, var code       | £1.00 | 10  | 7812 Voltage Regulators                             | £1.00 |
| 20  | BC182L Transistors                             | £1.00 | 300 | Ass'd. resistors, W/W/W, mostly on tapes            | £1.00 |
| 25  | BC212L Transistors                             | £1.00 |     |   |       |
| 25  | BC237 Transistors                              | £1.00 |     |   |       |
| 20  | BC327 Transistors                              | £1.00 |     |   |       |
| 30  | BC328 Transistors                              | £1.00 |     |   |       |
| 30  | BC347 Transistors                              | £1.00 |     |   |       |
| 20  | BC547B Transistor                              | £1.00 |     |   |       |
| 30  | BC548 Transistors                              | £1.00 |     |   |       |
| 30  | BC549 Transistors                              | £1.00 |     |   |       |
| 25  | BC557 Transistors                              | £1.00 |     |   |       |
| 30  | BC558 Transistors                              | £1.00 |     |   |       |
| 30  | BC559 Transistors                              | £1.00 |     |   |       |
| 20  | 2N3904 Transistors                             | £1.00 |     |   |       |
| 100 | 1nf 50V wkg Axial Capacitors                   | £1.00 |     |   |       |
| 100 | 4nT 50V wkg Axial Capacitors                   | £1.00 |     |   |       |
| 80  | Ass'd capacitors electrolytic                  | £1.00 |     |   |       |

288 Abbeydale Road, Sheffield S7 1FL  
 Phone (local rate): 0845 166 2329  
 Fax: 0114 255 5039  
 e-mail: [sales@bardwells.co.uk](mailto:sales@bardwells.co.uk)  
 web: [www.bardwells.co.uk](http://www.bardwells.co.uk)  
 Prices include VAT, Postage £1.85  
 44p stamp for lists or disk  
 POs, Cheques and Credit Cards accepted  
 SEE OUR WEB PAGES FOR MORE  
 COMPONENTS AND SPECIAL OFFERS



Get your magazine "instantly" anywhere in the world - buy from the web.

TAKE A LOOK, A FREE ISSUE IS AVAILABLE

A one year subscription (12 issues) costs just \$10.99 (US)  
[www.epemag.com](http://www.epemag.com)



National College of Technology

## DISTANCE LEARNING COURSES

The following courses are available:

- Electronic Circuits
- Digital Circuits
- Fibre-Optics
- Mathematics
- Electronic Testing & Fault Finding
- Programmable Logic Controllers
- Mechanics & Mechanisms

These courses lead to a BTEC QUALIFICATION and are suitable for beginners and those with more experience, needing to update their skills.

Tutor support is available to help you succeed.

Register for any of these courses NOW and learn at your own pace.

[www.oakcad.co.uk/nct.aspx](http://www.oakcad.co.uk/nct.aspx)

or telephone: 08456 345 445



OakCAD Training is now running the National College of Technology and will endeavour to provide the same high level of service and support.

## Low cost USB I/O For Datalogging & Control

**THE LABJACK U12 - ONLY £95**



- ◆ 8-Analogue in, 2-Analogue out, 20 digital I/O counter, watchdog
- ◆ USB plug-and-play - no PSU needed
- ◆ FREE 'scope and logger software
- ◆ Write data to disk, web page or email

◆ Temperature and Humidity Sensors connect directly

- ◆ Visual Basic, C++, Delphi, LabVIEW, Testpoint drivers
- ◆ Control pumps, lights, valves with Relay and opto-input expansion boards

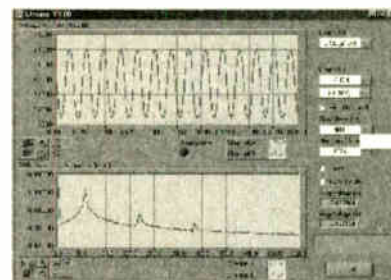

All prices exclude VAT and delivery. Order on-line: major credit/debit cards accepted.



**AUDON Electronics**

[www.audon.co.uk](http://www.audon.co.uk) +44 (0)115 925 8412 <> Fax (0)115 925 9757

## Watch Slides on TV.

Make videos of your slides. Digitise your slides (using a video capture card)  
"Liesgang diatv" automatic slide viewer with built in high quality colour TV camera. It has a composite video output to a phono plug (SCART & BNC adaptors are available). They are in very good condition with few signs of use. More details see [www.diatv.co.uk](http://www.diatv.co.uk).  
£91.91 + VAT = £108.00



Board cameras all with 512 x 582 pixels 8-5mm 1/3 inch sensor and composite video out. All need to be housed in your own enclosure and have fragile exposed surface mount parts. They all require a power supply of between 10V and 12V DC 150mA.  
47MIR size 60 x 36 x 27mm with 6 infra red LEDs (gives the same illumination as a small torch but is not visible to the human eye) £37.00 + VAT = £43.48  
30MP size 32 x 32 x 14mm spy camera with a fixed focus pin hole lens for hiding behind a very small hole £35.00 + VAT = £41.13  
40MC size 39 x 38 x 27mm camera for 'C' mount lens these give a much sharper image than with the smaller lenses £32.00 + VAT = £37.60  
Economy C mount lenses all fixed focus & fixed iris  
VSL1220F 12mm F1.6 12 x 15 degrees viewing angle £15.97 + VAT £18.76  
VSL4022F 4mm F1.22 63 x 47 degrees viewing angle £17.65 + VAT £20.74  
VSL6022F 6mm F1.22 42 x 32 degrees viewing angle £19.05 + VAT £22.38  
VSL8020F 8mm F1.22 32 x 24 degrees viewing angle £19.90 + VAT £23.38

## Better quality C Mount lenses

VSL1614F 16mm F1.6 30 x 24 degrees viewing angle £26.43 + VAT £31.06  
VWL813M 8mm F1.3 with iris 56 x 42 degrees viewing angle £77.45 + VAT = £91.00  
1206 surface mount resistors E12 values 10 ohm to 1M ohm  
100 of 1 value £1.00 + VAT 1000 of 1 value £5.00 + VAT

866 battery pack originally intended to be used with an orbitel mobile telephone it contains 10 1.6Ah sub C batteries (42 x 22 dia. the size usually used in cordless screwdrivers etc.) the pack is new and unused and can be broken open quite easily  
£7.46 + VAT = £8.77



Please add £1.66 + vat = £1.95 postage & packing per order

## JPG Electronics

Shaws Row, Old Road, Chesterfield, S40 2RB.  
Tel 01246 211202 Fax 01246 550959

Mastercard/Visa/Switch

Callers welcome 9.30 a.m. to 5.30 p.m. Monday to Saturday

# ADVERTISERS INDEX

|                                |                |
|--------------------------------|----------------|
| ANTEX                          | 676            |
| AUTOTRAX                       | 685            |
| AUDON ELECTRONICS              | 727            |
| N. R. BARDWELL                 | 727            |
| B.K. ELECTRONICS               | Cover (iv)/697 |
| BRUNNING SOFTWARE              | 686            |
| BULL GROUP                     | Cover (ii)     |
| CRICKLEWOOD ELECTRONICS        | 663            |
| CROWNHILL ASSOCIATES           | Cover (iii)    |
| DISPLAY ELECTRONICS            | 658            |
| ENERGISE TECHNOLOGY            | 727            |
| EPT SOFTWARE                   | 689            |
| ESR ELECTRONIC COMPONENTS      | 666            |
| ICS                            | 727            |
| JPG ELECTRONICS                | 728            |
| LABCENTER                      | 673            |
| MAGENTA ELECTRONICS            | 664/665        |
| MATRIX MULTIMEDIA              | 697            |
| MILFORD INSTRUMENTS            | 677            |
| NATIONAL COLLEGE OF TECHNOLOGY | 727            |
| PEAK ELECTRONIC DESIGN         | 693            |
| PICO TECHNOLOGY                | 712            |
| QUASAR ELECTRONICS             | 660/661        |
| SHERWOOD ELECTRONICS           | 728            |
| SQUIRES                        | 663            |
| STEWART OF READING             | 663            |
| WCN SUPPLIES                   | 671            |

ADVERTISEMENT MANAGER: PETER J. MEW

ADVERTISEMENT OFFICES:

EVERYDAY PRACTICAL ELECTRONICS, ADVERTISEMENTS,  
MILL LODGE, MILL LANE, THORPE-LE-SOKEN,  
ESSEX CO16 0ED.

Phone/Fax: (01255) 861161

For Editorial address and phone numbers see page 667

# SHERWOOD ELECTRONICS

## FREE COMPONENTS

Buy 10 x £1 Special Packs and choose another one FREE

|       |                                     |       |  |
|-------|-------------------------------------|-------|--|
| SP1   | 15 x 5mm Red LEDs                   | SP134 | 15 x 1N4007 diodes                         |
| SP2   | 12 x 5mm Green LEDs                 | SP135 | 6 x Miniature slide switches               |
| SP3   | 12 x 5mm Yellow LEDs                | SP136 | 3 x BFY50 transistors                      |
| SP6   | 15 x 3mm Red LEDs                   | SP137 | 4 x W005 1.5A bridge rectifiers            |
| SP7   | 12 x 3mm Green LEDs                 | SP138 | 20 x 2.2/63V radial elect. caps.           |
| SP8   | 10 x 3mm Yellow LEDs                | SP140 | 3 x W04 1.5A bridge rectifiers             |
| SP10  | 100 x 1N4148 diodes                 | SP142 | 2 x CMOS 4017                              |
| SP11  | 30 x 1N4001 diodes                  | SP143 | 5 Pairs min. crocodile clips (Red & Black) |
| SP12  | 30 x 1N4002 diodes                  | SP145 | 6 x ZTX300 transistors                     |
| SP18  | 20 x BC182 transistors              | SP146 | 10 x 2N3704 transistors                    |
| SP20  | 20 x BC184 transistors              | SP147 | 5 x Stripboard 9 strips x 25 holes         |
| SP21  | 20 x BC212 transistors              | SP151 | 4 x 8mm Red LEDs                           |
| SP23  | 20 x BC549 transistors              | SP152 | 4 x 8mm Green LEDs                         |
| SP24  | 4 x CMOS 4001                       | SP153 | 4 x 8mm Yellow LEDs                        |
| SP25  | 4 x 555 timers                      | SP154 | 15 x BC548 transistors                     |
| SP26  | 4 x 741 Op.Amps                     | SP156 | 3 x Stripboard, 14 strips x 27 holes       |
| SP28  | 4 x CMOS 4011                       | SP160 | 10 x 2N3904 transistors                    |
| SP29  | 3 x CMOS 4013                       | SP161 | 10 x 2N3906 transistors                    |
| SP34  | 20 x 1N914 diodes                   | SP165 | 2 x LF351 Op.Amps                          |
| SP36  | 25 x 10/25V radial elect. caps.     | SP166 | 20 x 1N4003 diodes                         |
| SP37  | 12 x 100/35V radial elect. caps.    | SP167 | 5 x BC107 transistors                      |
| SP39  | 10 x 470/16V radial elect. caps.    | SP168 | 5 x BC108 transistors                      |
| SP40  | 15 x BC237 transistors              | SP172 | 4 x Standard slide switches                |
| SP41  | 20 x Mixed transistors              | SP174 | 20 x 22/25V radial elect. caps.            |
| SP42  | 200 x Mixed 0.25W C.F. resistors    | SP175 | 20 x 1/63V radial elect. caps.             |
| SP47  | 5 x Min. PB switches                | SP177 | 10 x 1A 20mm quick blow fuses              |
| SP49  | 4 x 5 metres stranded core wire     | SP182 | 20 x 4-7/63V radial elect. caps.           |
| SP102 | 20 x 8-pin DIL sockets              | SP183 | 20 x BC547 transistors                     |
| SP103 | 15 x 14-pin DIL sockets             | SP187 | 15 x BC239 transistors                     |
| SP104 | 15 x 16-pin DIL sockets             | SP189 | 4 x 5 metres solid core wire               |
| SP105 | 4 x 74LS00                          | SP192 | 3 x CMOS 4066                              |
| SP109 | 15 x BC557 transistors              | SP195 | 3 x 10mm Yellow LEDs                       |
| SP112 | 4 x CMOS 4093                       | SP197 | 6 x 20 pin DIL sockets                     |
| SP115 | 3 x 10mm Red LEDs                   | SP198 | 5 x 24 pin DIL sockets                     |
| SP116 | 3 x 10mm Green LEDs                 | SP199 | 5 x 2.5mm mono jack plugs                  |
| SP124 | 20 x Assorted ceramic disc caps     | SP200 | 5 x 2.5mm mono jack sockets                |
| SP126 | 6 x Battery clips - 3 ea. PP3 + PP9 |       |  |
| SP130 | 100 x Mixed 0.5W C.F. resistors     |       |  |
| SP131 | 2 x TL071 Op.Amps                   |       |  |
| SP133 | 20 x 1N4004 diodes                  |       |  |

## RESISTOR PACKS - C.Film

|      |                                 |       |
|------|---------------------------------|-------|
| RP3  | 5 each value - total 365 0.25W  | £3.10 |
| RP7  | 10 each value - total 730 0.25W | £4.35 |
| RP10 | 1000 popular values 0.25W       | £6.25 |
| RP4  | 5 each value-total 345 0.5W     | £4.00 |
| RP8  | 10 each value-total 690 0.5W    | £6.65 |
| RP11 | 1000 popular values 0.5W        | £8.50 |

2003 Catalogue now available £1 inc. P&P or FREE with first order.

P&P £1.50 per order. NO VAT

Orders to:

**Sherwood Electronics,**  
7 Williamson St., Mansfield,  
Notts. NG19 6TD.

## EPE SUBSCRIPTIONS

Subscriptions for delivery direct to any address in the UK: 6 months £16.50, 12 months £31, two years £57; Overseas: 6 months £19.50 standard air service or £28.50 express airmail, 12 months £37 standard air service or £55 express airmail, 24 months £69 standard air service or £105 express airmail.

Cheques or bank drafts (in £ sterling only) payable to *Everyday Practical Electronics* and sent to *EPE Subs. Dept.*, Wimborne Publishing Ltd., 408 Wimborne Road East, Ferndown, Dorset BH22 9ND. Tel: 01202 873872. Fax: 01202 874562. Email: [subs@epemag.wimborne.co.uk](mailto:subs@epemag.wimborne.co.uk). Also via the Web at <http://www.epemag.wimborne.co.uk>. Subscriptions start with the next available issue. We accept MasterCard, Amex, Diners Club, Switch or Visa. (For past issues see the Back Issues page.)

## ONLINE SUBSCRIPTIONS

Online subscriptions, for downloading the magazine via the Internet, \$10.99US (approx. £7) for one year available from [www.epemag.com](http://www.epemag.com).

## USA/CANADA SUBSCRIPTIONS

To subscribe to *EPE* from the USA or Canada please telephone Express Mag toll free on 1877 363-1310 and have your credit card details ready. Or fax (514) 355 3332 or write to Express Mag, PO Box 2769, Plattsburgh, NY 12901-0239 or Express Mag, 8155 Larny Street, Anjou, Quebec, H1J 2L5.

Email address: [expsmag@expressmag.com](mailto:expsmag@expressmag.com).

Web site: [www.expressmag.com](http://www.expressmag.com).

USA price \$59.40(US) per annum, Canada price \$83.88(Can) per annum - 12 issues per year.

*Everyday Practical Electronics*, periodicals pending, ISSN 0262 3617 is published twelve times a year by Wimborne Publishing Ltd., USA agent USACAN at 1320 Route 9, Champlain, NY 12919. Subscription price in US \$59.40 per annum. Periodicals postage paid at Champlain NY and at additional mailing offices. POSTMASTER: Send USA and Canada address changes to *Everyday Practical Electronics*, c/o Express Mag., PO Box 2769, Plattsburgh, NY, USA 12901-0239.

# PIC BASIC

Crownhill Associates

smart electronic solutions

The most cost effective solution to PIC programming and development - Ever!!

## Proton <sup>New Improved</sup> LET PIC BASIC

- ReWritten from the ground up
- Best Value For Money
- Most powerful entry level compiler
- 100% MPASM™ compatibility
- Windows™ 98, ME, 2000, NT & XP compliant
- Real-Time Syntax checking
- Integrated PIC Programmer driver
- Program with one keystroke
- View BASIC and the resulting Assembly
- Supplied with book "LET PIC BASIC Unleashed" by Les Johnson

Free Evaluation copy from:  
[www.picbasic.org](http://www.picbasic.org)

LET PIC BASIC £65.00

## Proton <sup>ACCESS THE WORLD OF</sup> SMART SMART CARDS

PIC BASIC Smart Card Development system

Another First from Crownhill, access the world of SMART CARDS using PIC BASIC. This versatile development system provides a platform for the development of applications using SMART memory cards and SECURE memory cards. Detailed documentation describes all aspects of development using the sample cards supplied, source code and circuit diagrams are included.

- Includes card Reader/Writer hardware and circuit
- Integrated Boot Loader - No programmer required
- Sample cards, Documentation
- Fully commented LICENSE FREE Source code

Proton Smart from £79.95

10 smart cards in stock over 20 types and 40,000 smart cards in stock over 20 types

## Proton <sup>LCD</sup> Low Power, easy serial interface

2 x16 serial LCD display, supplied as a kit or ready assembled. PCB, PICmicro, LCD display, Circuit, LICENSE FREE commented source code

Proton LCD £16.95

## Proton <sup>PIC BASIC PLUS</sup> v2

- Windows™ Integrated Development Environment
- Integrated serial bootloader software "program without a programmer!"
- Support for 12/14/18bit series devices
- Handles 32bit signed and unsigned variables (numbers up to ± 2147483647)
- Specific commands for on-chip peripherals
- Comprehensive command set
  - Tighter code generation than MBASIC
  - More functionality than MELABS PICBASIC Pro
  - More flexible than all BASIC Stamps
- Integrates directly into Proteus VSM - allows you to build a virtual circuit and see your BASIC code run in real-time - see [www.labcenter.co.uk](http://www.labcenter.co.uk)
- Easy macro Integration (includes Floating pointmath example)
- Aimed at graduates, and professionals, all code produced is LICENCE FREE

Free Evaluation copy from:  
[www.picbasic.org](http://www.picbasic.org)

Crownhill PIC BASICv2 £125.00

## Proton <sup>NET</sup> PIC BASIC / InterNet Development System

The worlds First PIC BASIC InterNet development system allowing PIC BASIC projects to communicate across the WORLD via the InterNet. Development board includes RS232, Ethernet Interface and dedicated controller, LCD, Prototype area, Power supply and full documentation.

Proton Net £169.95

Visit [www.picbasic.org](http://www.picbasic.org) for comprehensive details of these and other PIC BASIC products, including:

### Proton <sup>VSM</sup>

Full range of DEVELOPMENT boards, incl Graphics LCD's and Audio

### Proton <sup>DEV</sup>

[www.labcenter.co.uk](http://www.labcenter.co.uk)  
Proteus VSM Fully supported by PICBASIC Plus

### Proton <sup>DEV-IR</sup>

Infra RED TX and Rx development system, with experiments and source code

All prices subject to Postage Packing and VAT  
All major credit cards accepted, telephone, web or mail order.

www.picbasic.org

Old Station Yard, Station Road, Wilburton, Cambs, Cb6 3PZ, UK Tel: +44 (0) 1353 749990 Fax: +44 (0) 1353 749991



**POWER AMPLIFIER MODULES-LOUDSPEAKERS-MIXERS  
19 INCH STEREO AMPLIFIERS-ACTIVE CROSS/OVERS.**

- \* PRICES INCLUDE V.A.T.
- \* PROMPT DELIVERY

**OMP MOS-FET POWER AMPLIFIERS  
HIGH POWER, TWO CHANNEL 19 INCH RACK**

10,000's  
SOLD  
TO PRO  
USERS



**THE RENOWNED MXF SERIES OF POWER AMPLIFIERS**

FOUR MODELS:- MXF200 (100W + 100W) MXF400 (200W + 200W)  
MXF600 (300W + 300W) MXF900 (450W + 450W)

**ALL POWER RATINGS ARE R.M.S. INTO 4 OHMS, WITH BOTH CHANNELS DRIVEN**  
FEATURES:- \* Independent power supplies with two toroidal transformers  
\* Twin L.E.D. Vu Meters \* Level controls \* Illuminated on/off switch \* Jack / XLR inputs  
\* Speakon Outputs \* Standard 775mv inputs \* Open and Short circuit proof \* Latest Mos-Fets  
for stress free delivery into virtually any load \* High slew rate \* Very low distortion \* Aluminium  
cases \* MXF600 & MXF900 fan cooled with D.C. Loudspeaker and thermal protection.

USED THE WORLD OVER IN CLUBS, PUBS, CINEMAS, DISCOS ETC

**SIZES:-**

|        |      |      |         |      |
|--------|------|------|---------|------|
| MXF200 | W19" | D11" | H3 1/2" | (2U) |
| MXF400 | W19" | D12" | H5 1/4" | (3U) |
| MXF600 | W19" | D13" | H5 1/2" | (3U) |
| MXF900 | W19" | D14" | H5 1/2" | (3U) |

**PRICES:-** MXF200 £175.00 MXF400 £233.85  
MXF600 £329.00 MXF900 £449.15  
SPECIALIST CARRIER DEL £12.50 Each



**FLIGHTCASED  
LOUDSPEAKERS**

A new range of quality loudspeakers, designed to take advantage of latest loudspeaker technology and enclosure designs. All models utilise high quality studio cast aluminium loudspeakers with factory fitted grilles, wide dispersion constant directivity horns, extruded aluminium corner protection and steel ball corners, complemented with heavy duty black covering. The enclosures are fitted as standard with top hats for optional loudspeaker stands. The FC15-300 incorporates a large 16 X 6 inch horn. All cabinets are fitted with the latest Speakon connectors for your convenience and safety. Five models to choose from.

WEDGEMONITOR



**PLEASE NOTE:- POWER RATINGS QUOTED ARE IN WATTS R.M.S. FOR EACH INDIVIDUAL CABINET ALL ENCLOSURES ARE 8 OHMS**

15-15 Inch speaker  
12-12 Inch speaker

- ibl FC15-300 WATTS Freq Range 35Hz-20kHz Sens 101dB, Size H695 W502 D415mm Price:- £299.00 per pair
  - ibl FC12-300 WATTS Freq Range 45Hz-20kHz, Sens 96dB, Size H600 W405 D300mm Price:- £249.00 per pair
  - ibl FC12-200 WATTS Freq Range 40Hz-20kHz, Sens 97dB, Size H600 W405 D300mm Price:- £199.00 per pair
  - ibl FC12-100 WATTS Freq Range 45Hz-20kHz, Sens 100dB, Size H546 W380 D300mm Price:- £179.00 per pair
  - ibl WM12-200 WATTS Freq Range 40Hz-20kHz, Sens 97dB, Size H418 W600 D385mm Price:- £125.00 Each
- SPECIALIST CARRIER DEL £12.50 per pair, wedge monitor £7.00 each  
Optional Metal Stands PRICE £40.00 per pair Delivery:- £6.00

**CATALOGUE 2001-2002**

**Robots** **Electronic Kits**

Test Tools

**The Sky's The Limit Catalogue**

Communication

**B.K. Electronics**

Unit 1, Comet Way, Southend-on-Sea, Essex, SS2 6TR  
Tel:- 01702-527572 Fax:- 01702-420243  
E-Mail:- sales@bkelec.com  
Web Site:- www.bkelec.com

FREE over 3000 items

The catalogue is free with any item ordered from this advert and to personal callers or £4.00 to cover P&P if ordered separately. This is fully refundable with your first order.

**OMP X03-S STEREO 3 WAY ACTIVE CROSSOVER SWITCHABLE 2-WAY**



**FEATURES:-**

Advanced 3-Way Stereo Active Cross-Over (Switchable two way), housed in a 19" x 1U case. Each channel has three level controls: Bass, Mid & Top. The removable front face allows access to the programmable DIL switches to adjust the cross-over frequency; There are two versions available:- X03-S Bass-Mid 125/250/500Hz, Mid-Top 1.8/3/5kHz, all at 24 dB per octave. X03 Bass-Mid 250/500/1kHz, Mid-Top 1.8/3/5kHz, all at 24 dB per Octave. Please make sure you ask for the correct model when ordering. The 2/3 way selector switches are also accessed by removing the front face. Each stereo channel can be configured separately. Bass Invert Switches are incorporated on each channel. Nominal 775mv Input/output. Fully compatible with the OMP Rack Amplifier and Modules.

BOTH MODELS PRICED AT :- £117.44 + £5.00 P&P

**OMP MOS-FET POWER AMPLIFIER MODULES**

SUPPLIED HEAVY BUILT AND TESTED

These modules now enjoy a world-wide reputation for quality, reliability and performance at a realistic price. Four models are available to suit the needs of the professional and hobby market. Industry, Leisure, Instrumental and Hi-Fi etc. When comparing prices, NOTE that all models include toroidal power supply, integral heatsink, glass fibre P.C.B. and drive circuits to power a compatible Vu meter. All models are open and short circuit proof.

**THOUSANDS OF MODULES PURCHASED BY PROFESSIONAL USERS**

- OMP/MF 100 Mos-Fet Output Power 110 watts R.M.S. into 4 ohms, frequency response 1Hz - 100kHz -3dB, Damping Factor >300, Slew Rate 45V/uS, T.H.D. typical 0.002%, Input Sensitivity 500mV, S.N.R. 110dB, Size 300 x 123 x 60mm. Price:- £42.95 + £4.00 P&P
  - OMP/MF 200 Mos-Fet Output Power 200 watts R.M.S. into 4 ohms, frequency response 1Hz - 100kHz -3dB, Damping Factor >300, Slew Rate 50V/uS, T.H.D. typical 0.001%, Input Sensitivity 500mV, S.N.R. 110dB, Size 300 x 155 x 100mm. Price:- £66.35 + £4.00 P&P
  - OMP/MF 300 Mos-Fet Output Power 300 watts R.M.S. into 4 ohms, frequency response 1Hz - 100kHz -3dB, Damping Factor >300, Slew Rate 60V/uS, T.H.D. typical 0.001%, Input Sensitivity 500mV, S.N.R. 110dB, Size 300 x 175 x 100mm. Price:- £83.75 + £5.00 P&P
  - OMP/MF 450 Mos-Fet Output Power 450 watts R.M.S. into 4 ohms, frequency response 1Hz - 100kHz -3dB, Damping Factor >300, Slew Rate 75V/uS, T.H.D. typical 0.001%, Input Sensitivity 500mV, S.N.R. 110dB, Fan Cooled, D.C. Loudspeaker Protection, 2 Second Anti Thump Delay. Size 385 x 210 x 105mm. Price:- £135.85 + £6.00 P&P
  - OMP/MF 1000 Mos-Fet Output Power 1000 watts R.M.S. into 2 ohms, frequency response 1Hz - 100kHz -3dB, Damping Factor >300, Slew Rate 75V/uS, T.H.D. typical 0.001%, Input Sensitivity 500mV, S.N.R. 110dB, Fan Cooled, D.C. Loudspeaker Protection, 2 Second Anti Thump Delay Size 422 x 300 x 125mm. Price:- £261.00 + £12.00 P&P
- NOTE: MOS-FET MODULES ARE AVAILABLE IN TWO VERSIONS: STANDARD - INPUT SENS 500mV BANDWIDTH 100kHz OR PEC (PROFESSIONAL EQUIPMENT COMPATIBLE) - INPUT SENS 775mV BANDWIDTH 50kHz ORDER STANDARD OR PEC

**100 WATT ACTIVE SUB BASS AMPLIFIER PANEL**



AN ACTIVE SUB BASS AMPLIFIER WITH A TRUE 100W RMS OUTPUT SUPERB CONSTRUCTION WITH THE FACILITIES TO INTEGRATE SEAMLESSLY INTO MOST HI-FI OR HOME CINEMA SETUPS. USE THIS PANEL PLUS ONE OF OUR LOUDSPEAKERS TO MAKE YOUR OWN SUB WOOFER THAT WILL MATCH OR BEAT MOST COMMERCIALY AVAILABLE SUB WOOFERS.

FEATURES:- \* 100W RMS INTO 8 OHMS \* HIGH AND LOW LEVEL INPUTS \* TOROIDAL TRANSFORMER \* SHORT CIRCUIT PROTECTION \* D.C. SPEAKER PROTECTION \* FREQUENCY ROLL OFF, LOWER 10Hz, UPPER 60Hz TO 240Hz (FULLY ADJUSTABLE) \* AC3 COMPATIBLE FILTER CAN BE BYPASSED FOR 5-1 FORMATS. \* AIRTIGHT CONSTRUCTION \* TENS OF THOUSANDS OF OUR PANELS ALREADY IN USE. \* COMPLETE WITH LEADS

SPECIFICATIONS:- \* POWER 100W RMS @ 8 OHMS \* FREQ RESP. 10Hz 15KHz -3dB \* DAMPING FACTOR >200 \* DISTORTION 0.05% \* S/N A WEIGHTED >100dB \* SUPPLY 230V A.C. \* WEIGHT 2.7Kg \* SIZE H254 X W254 X D94mm

THERE ARE 2 VERSIONS OF THE ABOVE PANEL AVAILABLE :-BSB100/8 8 OHM VERSION BSB100/4 4 OHM VERSION BOTH PANELS ARE PRICED AT £117.44 + £5.00 P&P INCL. V.A.T. CHECK WEBSITE FOR PANELS UP TO 500W

**B.K. ELECTRONICS** REF D5  
UNIT 1 COMET WAY, SOUTHEND ON SEA, ESSEX. SS2 6TR.  
TEL.: 01702-527572 FAX.: 01702-420243  
Web:- <http://www.bkelec.com> E-Mail [sales@bkelec.com](mailto:sales@bkelec.com)

DELIVERY CHARGES:- PLEASE INCLUDE AS ABOVE, TO A MAXIMUM AMOUNT £30.00. OFFICIAL ORDERS FROM SCHOOL, COLLEGES, GOVT. PLCs ETC. PRICES INCLUSIVE OF V.A.T. SALES COUNTER, CREDIT CARD ORDERS ACCEPTED BY POST PHONE OR FAX.